

Institute of Radio Engineers

(INCORPORATED)

Organized 1912



YEAR BOOK 1932

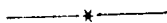

*Published by the Institute of Radio Engineers
33 West 39th Street
New York, N. Y.*

YEAR BOOK

of the

Institute of Radio Engineers

1932

*Copyright, 1932,
by the
Institute of Radio Engineers*

CONTENTS

	Page
Officers and Board of Directors, 1932	4
Past Officers of the Institute	5
Institute Committees for 1932	6
Institute Representatives in Other Technical Bodies	8
General Information	9
History of the Institute	9
Aims of the Institute	9
Publications	10
Awards for Meritorious Achievement	10
Grades of and Qualifications for Membership	12
Institute Badges	12
Indication of Membership Grade	14
Certificates of Membership	14
Meetings	14
Institute Sections	14
American Standards Association	16
Report of the Secretary for 1931	18
Comparative Financial Balance Sheet	30
Constitution of the Institute	31
Amendments to the Constitution	38
Constitution for Sections	48
Annual Meetings of Sections	51
Index to the Constitution	52
Index to Section Constitution	53
American Standards Association Radio Standards Report	54
Catalog of Membership, Alphabetically Listed	75
Catalog of Membership, Geographically Listed	237

— * —

Price \$1.50 per copy

Supplement to the PROCEEDING for March, 1932

OFFICERS AND BOARD OF DIRECTORS, 1932
(Terms expire January 1, 1933, except as otherwise noted)

President
W. G. CADY

Vice President
E. V. APPLETON

Treasurer *Secretary* *Editor*
MELVILLE EASTHAM HAROLD P. WESTMAN ALFRED N. GOLDSMITH

Directors

ARTHUR BATCHELLER C. M. JANSKY, JR.
J. V. L. HOGAN R. H. MARRIOTT
H. W. HOUCK WILLIAM WILSON

Serving until January 1, 1934

L. M. HULL A. F. VAN DYCK

Serving until January 1, 1935

O. H. CALDWELL E. L. NELSON

Junior Past Presidents

LEE DE FOREST
R. H. MANSON

BOARD OF EDITORS, 1932

ALFRED N. GOLDSMITH, *Chairman*
STUART BALLANTINE G. W. PICKARD
R. R. BATCHER L. E. WHITTEMORE
W. WILSON

Assistant Editor
H. S. RHODES

Advertising Manager
M. P. ROY

Past Officers of the Institute

Name	Pres.	Vice Pres.	Sec'y	Assist. Sec'y	Treas.	Editor	Assoc. Editor	Director
E. F. W. Alexanderson	1921	1920						1917-18
E. H. Armstrong								1916-19; 1921
L. W. Austin	1914							1915-17
Arthur Batcheller								1928-31
Edward M. Bennett								1923-25
Ralph Bown	1927	1926						1916; 21
W. H. G. Bullard						1929		1928
W. G. Cady								
E. L. Chaffee		1922						
G. H. Clark							1914	
John M. Clayton			1928-29	1927-28				
E. H. Colpitts		1927						1921-23
Frank Conrad		1921						
Fulton Cutting	1922							
George S. Davis								1915; 17-19
Lee de Forest	1930							1931
J. H. Dellinger	1925	1924						1928-31
B. Dudley				1930-31				
Melville Eastham					1927-31			1922-27
C. P. Edwards		1931						
Lloyd Espenschied								1913; 1915-26; 31
L. F. Fuller								1928
Alfred N. Goldsmith	1928		1918-27				1913-28 1930-31	
A. H. Grebe								1924-26; 28
J. H. Hammond, Jr.					1914			
Louis A. Hazeltine								1923-27
R. A. Heising								1927-30
Guy Hill								1914-16; 18-20
J. V. L. Hogan	1921	1916-19						1913-15; 21-31
H. W. Houck								1931
Warren Hubley						1915-16 1918-27		
Lewis M. Hull								1920-31
C. M. Jansky, Jr.	1916							1920-31
A. E. Kennelly								
L. R. Krumm					1917			1921
Irving Langmuir	1923							
R. H. Langley				1914				
A. G. Lee		1930						
George H. Lewis								1918-19; 26
Donald McNicol	1926	1925						1910-24
R. H. Manson	1931							1927-30
R. H. Marriott	1912	1913						1914-16; 20-22
								1926-31
Alexander Meissner		1929						
George R. Metcalfe							1920-27	
J. H. Morecroft	1924	1923						1922
H. W. Nichols								1924-25
G. W. Pickard	1913							
G. W. Pierce	1918-19	1915						
C. J. Porter						1928		
M. I. Pupin	1917							1918-19
A. E. Reoch								1925-27
D. Sarnoff				1915-17				1918-20
E. J. Simon				1913-14				1915
G. O. Squier								1918-22
John Stone Stone	1915	1911						1910-19
A. Hoyt Taylor	1920							1930-31
Thomas T. Trapnell						1914		
A. F. Van Dyck								1930-31
R. A. Weagant								1914-17
H. P. Westman			1930-31	1929				
L. E. Whittemore			1928					1920-27; 1929

COMMITTEES OF THE INSTITUTE OF RADIO ENGINEERS, 1932

Admissions Committee

ARTHUR BATCHELLER
C. P. EDWARDS
H. C. GAWLER
H. W. HOUCK

A. F. VAN DYCK, *Chairman*
C. M. JANSKY, JR.
A. G. LEE
A. V. LOUGHREN
E. R. SHUTE
J. S. SMITH

Awards Committee

A. N. GOLDSMITH
J. V. L. HOGAN

WILLIAM WILSON, *Chairman*
J. W. HORTON
R. H. MANSON

Bibliography Committee

M. C. BATSEL
J. H. DELLINGER
C. B. JOLLIFFEE
A. E. KENNELLY
R. H. LANGLEY
DONALD McNICOL
G. W. PICKARD

MELVILLE EASTHAM, *Chairman*
H. M. TURNER
A. F. VAN DYCK
H. A. WHEELER
L. P. WHEELER
W. C. WHITE
L. E. WHITTEMORE
WILLIAM WILSON

Board of Editors

STUART BALLANTINE
R. R. BACHER
H. H. BEVERAGE

A. N. GOLDSMITH, *Editor*
F. W. GROVER
G. W. PICKARD
L. E. WHITTEMORE
WILLIAM WILSON

Broadcasting Committee

ARTHUR BATCHELLER (EMERY H. I. LEE, alternate)
E. K. COHAN (A. B. CHAMBERLAIN, alternate)
B. R. CUMMINGS
HARRY DART
RAYMOND GUY

E. L. NELSON, *Chairman*
J. V. L. HOGAN
C. W. HORN
L. M. HULL
C. M. JANSKY, JR. (S. L. BAILEY, alternate)
C. B. JOLLIFFE
R. H. MARRIOTT

Constitution and Laws Committee

AUSTIN BAILEY
ARTHUR BATCHELLER
O. H. CALDWELL
H. E. HALLBORG

J. V. L. HOGAN, *Chairman*
R. A. HEISING
H. W. HOUCK
C. M. JANSKY, JR.
H. A. ZEAMANS

Membership Committee

W. W. BROWN
J. M. CLAYTON
DAVID GRIMES
F. A. KOLSTER
S. R. MONTCALM
A. F. MURRAY

H. C. GAWLER, *Chairman*
M. E. PACKMAN
C. R. ROWE
J. E. SMITH
J. C. STROEBEL, JR.
A. M. TROGNER

Chairmen of Membership Committees of Sections, ex officio

C. N. ANDERSON
AUSTIN BAILEY
M. C. BATSEL
H. H. BEVERAGE

New York Program Committee

E. R. SHUTE, *Chairman*
H. C. GAWLER
C. W. HORN
R. H. RANGER
J. L. REYNOLDS

Nominations Committee

ARTHUR BATCHELLER
MELVILLE EASTHAM

R. H. MANSON, *Chairman*
C. P. EDWARDS
E. L. NELSON
A. F. VAN DYCK

Papers Committee

WILLIAM WILSON, *Chairman*
Theory, Circuit, and General
PAUL O. FARNHAM
Generating Apparatus and Theory
B. R. CUMMINGS
L. P. WHEELER
Receiving Apparatus and Theory
F. B. LLEWELLYN
H. A. WHEELER
Transmission Through Space
G. W. KENRICK
R. K. POTTER
Measurements and Standards
J. K. CLAPP
E. L. HALL
H. M. TURNER
Miscellaneous Technical Papers
S. S. KIRBY
R. R. RAMSEY
Vacuum Tubes and Thermionics
B. E. SHACKELFORD
W. C. WHITE
Aerial Systems
G. C. SOUTHWORTH
R. M. WILMOTTE

Acoustics and Audio Systems
IRVING WOLFF
Aircraft Radio
F. M. RYAN
Stations and Operating, Broadcasting
E. K. COHAN
R. M. MORRIS
Television
D. E. REPLOGLE
Picture Transmission
R. H. RANGER
Miscellaneous Communication Systems
H. A. AFFEL
Piezo-Electricity
K. S. VAN DYKE
Radio Communication Systems
T. A. M. CRAVEN
Radio Manufacturing
G. G. THOMAS
Nonradio and Radio Law
R. H. MARRIOTT

Publicity Committee

O. H. CALDWELL
O. E. DUNLAP
FRED EHLERT
W. G. H. FINCH

C. E. BUTTERFIELD, *Chairman*
A. H. HALLORAN
LLOYD JACQUET
J. F. L. MAHER
DONALD McNICOL
K. B. WARNER

Sections Committee

AUSTIN BAILEY
W. R. G. BAKER
ARTHUR BATCHELLER
H. B. COXHEAD
D. H. GAGE

C. W. HORN, *Chairman*
H. C. GAWLER
V. M. GRAHAM
R. H. LANGLEY
B. E. SHACKELFORD
R. M. WILMOTTE

Chairman of each Section, ex officio

Standards Committee

STUART BALLANTINE
E. L. BOWLES
W. W. BROWN
E. D. COOK
J. H. DELLINGER
W. E. DOWNEY
A. B. DUMONT
C. P. EDWARDS
MALCOM FERRIS
A. N. GOLDSMITH
V. M. GRAHAM
J. V. L. HOGAN
F. H. KROGER

J. W. HORTON, *Chairman*
C. M. JANSKY, JR.
H. M. LEWIS
D. G. LITTLE
E. L. NELSON
HARADEN PRATT
D. E. REPLOGLE
B. E. SHACKELFORD
H. M. TURNER
K. S. WEAVER
H. A. WHEELER
L. E. WHITTEMORE
WILLIAM WILSON
R. M. WILMOTTE

Tellers Committee

A. N. GOLDSMITH, *Chairman*

C. N. ANDERSON
O. H. CALDWELL

R. H. MANSON
A. F. VAN DYCK

H. P. WESTMAN, *Secretary*

INSTITUTE REPRESENTATIVES IN OTHER
TECHNICAL BODIES

A.I.E.E.—Subcommittee on Radio of the Committee on Applications to Marine Work.....T. E. NIVISON and J. L. PRESTON
Committee for Observance of Decennial of Commercial Broadcasting....
.....C. W. HORN
Council for the American Association for the Advancement of Science.....
.....J. C. JENSEN
Engineering Index.....J. H. DELLINGER
Liaison Committee on Aeronautic Radio Research.....F. M. RYAN
.....C. C. SHANGRAW (alternate)
National Advisory Council on Radio in Education.....L. ESPENSCHIED,
...ALFRED N. GOLDSMITH, C. W. HORN, L. M. HULL, and R. H. MARRIOTT
Radio Advisory Committee, Bureau of Standards, Department of Commerce
.....L. M. HULL
Radio Broadcasting Committee, American Engineering Council.....
.....MELVILLE EASTHAM
U. R. S. I.—(International Scientific Radio Union) Executive Committee....
.....R. H. MARRIOTT
U. S. National Committee—Advisers on Electrical Measuring Instruments
(I.E.C.).....MELVILLE EASTHAM and HAROLD OLESEN
U. S. National Committee—Advisers on Symbols (I.E.C.).....
.....L. E. WHITTEMORE and J. W. HORTON

AMERICAN STANDARDS ASSOCIATION

Sectional Committee on Radio...J. V. L. HOGAN, L. M. HULL, L. E. WHITTEMORE
Sectional Committee on Electrical Installations on Shipboard...J. V. L. HOGAN
Sectional Committee on Preferred Numbers.....A. F. VAN DYCK
Sectional Committee on Scientific Symbols and Abbreviations...A. E. KENNELLY
Sectional Committee on Specifications for Dry Cells and Batteries.....
.....H. M. TURNER
Subcommittee on Electrical Abbreviations—Including Radio.....
.....A. E. KENNELLY, L. E. WHITTEMORE (alternate)
Sectional Committee on Standards for Drawings and Drafting Room Practices
.....L. E. WHITTEMORE
Sectional Committee on Definitions of Technical Terms...HARADEN PRATT
Standards Council.....ALFRED N. GOLDSMITH, B. DUDLEY (alternate)

GENERAL INFORMATION

Institute History

Prior to the formation of the Institute of Radio Engineers, two other organized groups of radio enthusiasts held meetings in New York and Boston. These were the Wireless Institute and the Society of Wireless Telegraph Engineers.

On May 13, 1912, these two organizations were merged, taking the new name of the Institute of Radio Engineers. Headquarters were established in New York.

The Society of Wireless Telegraph Engineers had a membership of eleven on January 1, 1907, and forty-three on January 1, 1912. The Wireless Institute had fourteen members on January 1, 1909, and twenty-seven members on January 1, 1912. The Institute of Radio Engineers, at the time of its foundation, had less than fifty paid-up members.

Prominent in the early work of the Society of Wireless Telegraph Engineers were John Stone Stone, Lee de Forest, and Fritz Lowenstein. Those identified with the initial work of the Wireless Institute included: John S. Murphy, R. A. Somerville, Joseph D. Fountain, R. B. Respress, R. A. Cleve, John Gregg, E. Barnwell, Philip Farnsworth, Sidney L. Williams, R. H. Marriott, G. W. Pickard, Harry Shoemaker, and Eugene Thurston. The consolidation of these two societies and the initial work of organizing the Institute of Radio Engineers were done by A. N. Goldsmith, J. V. L. Hogan, and R. H. Marriott.

Aims of the Institute

The Institute of Radio Engineers functions solely to advance the art and science of radio communication. It numbers among its members nearly all of the men who have been prominent in the development of radio in the United States, as well as many noted radio engineers and scientists in other countries.

The membership of the Institute consists of those persons who are qualified for any of its several grades of membership, either through their interest in radio communication, or by practice of some phase of radio engineering as a profession. The eligibility of an applicant to membership in any grade is finally determined by the Board of Directors of the Institute, in most cases on the recommendation of the Committee on Admissions.

Through the presentation and publication of original papers, by affording its members the opportunity of meeting to discuss radio prob-

lems, by awards of honors and prizes, and in other ways, the Institute fosters and encourages the development of this important means of communication, and particularly aids in the exchange of radio information of a technical and engineering nature.

Publications

The papers presented at the meetings of the Sections and of the Institute in New York, together with the discussions and other papers submitted by Institute members, are printed in the PROCEEDINGS of the Institute of Radio Engineers, published monthly. The PROCEEDINGS thus constitutes a continually growing store of information on all phases of radio engineering. Since the first issue in 1913, 917 papers discussions, and book reviews have been printed. The PROCEEDINGS is sent free to all Institute members of all grades. The subscription price to nonmembers is \$10.00 per year.

Standardization reports giving definitions of terms and standard graphical symbols used in radio communication were issued in 1913, 1915, 1922, 1926, and 1929. The standardization report for 1928 was published in the 1929 YEAR BOOK, and that for 1931 in the 1931 YEAR BOOK. These standardization reports have become an important reference authority on terminology and symbols in radio practice.

This YEAR BOOK is the ninth the Institute has published; the first appearing in 1914, the second in 1916, the third in 1926, and subsequent issues each year.

Institute Awards for Meritorious Achievement in Radio

The Institute each year makes two awards to radio investigators in recognition of noteworthy inventions or other developments in radio technique.

One award, the Institute Medal of Honor, is a gold medal suitably engraved. The Medal of Honor is awarded to that person who has made public the greatest advance in the science or art of radio communication, regardless of the time of performance or publication of the work on which the award is based.

The advance may be an unpatented or patented invention which has been completely and adequately described in a scientific or engineering publication of recognized standing, and must be in actual operation. Preference will be given to widely used and widely useful inventions.

The advance may also be a scientific analysis or explanation of hitherto unexplained phenomena of distinct importance to the radio art, though the application thereof need not be immediate. Preference will

be given analyses directly applicable in the art. Publication, in this case also, must be in full and approved form.

The advance may further be a new system of traffic regulation or control; a new system of administration of radio companies or of service of steamship, railroad, or other companies; a legislative program beneficial to the radio art, or any portion of the operating or regulating features of the art. It must be described publicly in clear and approved form and must, in general, be actually adopted in practice.

This medal has been awarded to the following:

E. H. Armstrong.....	1918	M. I. Pupin.....	1924
E. F. W. Alexanderson....	1919	G. W. Pickard.....	1926
G. Marconi.....	1920	L. W. Austin.....	1927
R. A. Fessenden.....	1921	Jonathan Zenneck.....	1928
Lee de Forest.....	1922	G. W. Pierce.....	1929
John Stone Stone.....	1923	P. O. Pedersen.....	1930
		G. A. Ferrié.....	1931

The other award is known as the Morris Liebmann Memorial Prize. This award was made possible through the generosity of Emil J. Simon, a Fellow of the Institute. It is given to perpetuate the memory of the late Colonel Morris N. Liebmann. The award consists of the sum of five hundred dollars which is the annual income derived from the principal of the gift of ten thousand dollars.

The award is made by a special committee, appointed annually by the Board of Directors, to that member of the Institute who, in the opinion of this committee, shall have made the most important contribution to the radio art during the preceding calendar year.

The Morris Liebmann Memorial Prize has been awarded to the following:

L. F. Fuller.....	1919	Frank Conrad.....	1925
R. A. Weagant.....	1920	Ralph Bown.....	1926
R. A. Heising.....	1921	A. H. Taylor.....	1927
C. S. Franklin.....	1922	W. G. Cady.....	1928
H. H. Beverage.....	1923	E. V. Appleton.....	1929
J. R. Carson.....	1924	A. W. Hull.....	1930
		Stuart Ballantine.....	1931

All members of the Institute are eligible as candidates for these highly valued prizes. Each year's developments are carefully reviewed and examined by the Awards Committee, and by the Board of Directors, the awards being made by vote of the Board in the case of the

Institute Medal of Honor, and by vote of the committee appointed by the Board in the case of the Liebmann Memorial Prize.

Grades of and Qualifications for Membership

The several grades of membership in the Institute of Radio Engineers as well as the qualifications required for each, dues, fees, etc., are tabulated on page 13. Full details will be found in the Constitution under Articles II, III, and IV. All the benefits of membership are available at once to all new members of any grade, except that Juniors and Students are not eligible to vote. Membership means, also, that one is enrolled with others having a similar interest in radio, and that one is on record as being among those who are interested and active in the development of this new and useful branch of the electrical engineering industry.

The grades of Fellow and Member require a much higher degree of technical training and experience than the grade of Associate. In order to maintain a high standard of membership, the Board of Directors in each case very carefully scrutinizes the application for Fellow and Member grades.

Before applying for membership in any grade the applicant should carefully read the Constitution of the Institute to ascertain for which of the several grades he is eligible. An extract from the Constitution dealing with admissions, eligibility, fees, etc., is printed on the back of the application form obtainable from Institute Headquarters.

When filling in the application form, the applicant should submit the names of those persons who have knowledge of his professional experience, rather than those who have a high professional standing, but cannot vouch for him. The personal signatures of references are not required.

Institute Badges



All Institute badges are in the form of the emblem shown herewith, and are of 14-karat gold, finished in gold and enamel. The Fellow's badge is of blue lettering on a gold background while those of other grades of membership are reversed and show gold lettering on a colored enameled background. The background of the Member's badge is blue; the Associate's, maroon; the Junior's, white; and the Student's, green. Three forms of badges are available; a screw-back lapel button, a lapel pin, and a watch charm. The lapel button which is approximately half the size of the illustration may be obtained at \$2.75 each. The lapel pin is of approximately the same size as the illustration and is priced at \$3.00. The watch charm, finished on both sides, is provided with a ring to

MEMBERSHIP REQUIREMENTS, FEES, ETC.

Grade	Minimum Age	Years in Active Radio Engineering	References Required	Entrance Fee	Transfer Fee to Next Grade	Annual Dues
Fellow	32	10	Five Fellows	\$10	—	\$15
Member	25	4	Five Fellows or Members	\$5	\$5	\$10
Associate	21	A Person Who is Interested in or Connected with the Radio Arts	†Three Fellows, Members, or Associates	\$3	\$2	\$6
Junior	16*	A Person Interested in the study of Radio	†Three Fellows, Members, or Associates	\$1	\$2	\$4
Student	None	None	One Faculty Member	None	\$1 to Junior Grade \$3 to Associate Grade	\$3

* The maximum age of a Junior member is 20 years. Upon attaining the age of 21, the Junior member is transferred to the grade of Associate.

† In the case of the Junior or Associate applicant who is unable to supply the names of three members of the required grade, it is sufficient, usually, if the names of three business associates or friends are given. These should preferably be persons engaged in engineering or scientific work.

permit its suspension from a watch fob or chain and is also of the same size as illustrated. It is supplied at \$5.00. All badges may be obtained in any membership grade and should be ordered through the office of the Secretary.

Indication of Membership Grade

Institute members are authorized to use the following abbreviations or symbols indicating their grade of membership:

Fellow—Fel. I.R.E.

Member—Mem. I.R.E.

Associate—Assoc. I.R.E.

Junior—Jr. I.R.E.

Student—Std. I.R.E.

All other methods of indicating grade of membership are contrary to the expressed opinion of the governing body of the Institute. The use of the Institute emblem upon personal and business stationary, cards, et cetera, is likewise not approved by the Board of Directors and members are requested to call this to the attention of the Secretary as directed in the By-Laws to the Constitution.

Certificates of Membership

Upon application to the Secretary's office membership cards are sent to all members each year, and diplomas are supplied to Members and Fellows. The membership cards are signed by the Secretary and the diplomas are signed by the President and the Secretary.

Meetings

New York meetings of the Institute of Radio Engineers are held on the first Wednesday of each month (except during July and August) at the Engineering Societies Building, 33 West 39th Street, New York City. On these occasions engineering papers are presented, describing recent developments in radio, and are the subject of general discussion on the part of those in attendance.

Institute Sections

The following Sections of the Institute, which in most cases meet once a month, have been organized in localities where there is a sufficient number of Institute members:

ATLANTA—H. F. Dobbs, chairman; Philip C. Bangs, secretary, 23 Kensington Road, Avondale Estates, Georgia.

BOSTON—George W. Pierce, chairman; Melville Eastham, 30 State St., Cambridge, Mass.

BUFFALO-NIAGARA—L. Grant Hector, chairman; E. C. Waud, secretary, 235 Huntington Ave., Buffalo, N.Y.

CHICAGO—J. Barton Hoag, chairman; Donald H. Miller, McGraw-Hill Publishing Company, 520 N. Michigan Ave., Chicago, Ill.

CINCINNATI—D. D. Israel, chairman; H. G. Boyle, secretary, Crosley Radio Corporation, Cincinnati, Ohio.

CLEVELAND—E. L. Gove, chairman; Deane S. Kintner, secretary, 3622 Lindholm Rd., Cleveland, Ohio.

CONNECTICUT VALLEY—L. F. Curtis, chairman; George Grammer, secretary, 334 South Quaker Lane, West Hartford, Conn.

DETROIT—H. L. Byerlay, chairman; Samuel Firestone, secretary, Room 615, 2000 Second Avenue, Detroit, Mich.

LOS ANGELES—E. H. Schreiber, chairman; H. W. Andersen, secretary, 2332 Lake View Ave., Los Angeles, Calif.

NEW ORLEANS—Pendleton E. Lehde, chairman; Anton A. Schiele, secretary, 1812 Masonic Temple, New Orleans, La.

PHILADELPHIA—G. W. Carpenter, chairman; G. C. Blackwood, secretary, 243 E. Upsall St., Mt. Airy, Philadelphia, Pa.

PITTSBURGH—J. G. Allen, chairman; J. G. McKinley, secretary, West Penn Electric Company, 14 Wood St., Pittsburgh, Pa.

ROCHESTER—H. A. Brown, chairman; M. A. Wood, secretary, 175 Winbourne Ave., Rochester, N.Y.

SAN FRANCISCO—Ralph M. Heintz, chairman; Frederick E. Terman, secretary, Stanford University, Calif.

SEATTLE—Leslie C. Austin, chairman; Herbert H. Bouson, secretary, Staff Headquarters, 13th Naval District, Joseph Vance Building, Seattle, Wash.

TORONTO—F. K. Dalton, chairman; W. F. Choat, secretary, 355 King St., W., Toronto, Ont., Canada.

WASHINGTON—J. H. Dellinger, chairman; Hugh Mitchell, secretary, Signal Corps, Office Chief Signal Officer, Munitions Building, Washington, D.C.

In forming a Section of the Institute, the following is the approved procedure:

Procedure to be Followed in Forming a Section

- a. Carefully read all portions of the Constitution and By-Laws concerning Sections together with the Constitution for Sections which appear elsewhere in this YEAR BOOK.

b. Make a tentative canvass of the members residing within the territorial limits of the proposed Section. If at least fifty (preferably seventy-five members, of whom five or more are Members or Fellows, favor and will support a Section, if established, obtain from Institute Headquarters a petition form. In making this tentative canvass effort should be made to obtain applications from desirable and eligible nonmembers. Wherever there are less than twenty-five members of the Institute, but it is felt that applications can be obtained from the necessary number of eligible nonmembers, this tentative canvass may be made, and the membership applications forwarded to the Institute office. In making this tentative canvass consideration should be given to the probable permanent chairman and other officers of the Section, if formed. Much of the success of a Section depends on the caliber of the chairman and the interest taken by him in the affairs of the Section. Institute Headquarters, therefore, would like information as to the probable candidates at the time the request is made for the petition forms.

c. On receipt of the petition forms and lists of members residing within the territorial limits, an organization meeting should be called for the purpose of obtaining signatures to the petition, and to form a temporary organization.

d. The petition form, properly signed by the required number of members and accompanied by the minutes of the temporary organization meeting, should then be forwarded to the Institute Headquarters for presentation to the Board of Directors.

e. Upon receipt of the approval of the Board of Directors of the Institute, a meeting should be called for the purpose of forming the permanent organization. At this meeting the officers of the Section should be elected and the several standing committees organized.

f. Thereafter not less than five meetings shall be held annually.

g. A full report of each meeting must be made to the Headquarters of the Institute on the form supplied by the Institute.

American Standards Association

The American Standards Association serves as a national clearing house for engineering and industrial standardization, and acts as the official channel of cooperation in international standardization. It conducts its work through the activity of Sectional Committees, the responsibility for each of the several hundred standardization projects being in the hands of one or more cooperating agencies known as "sponsors."

The Institute of Radio Engineers and the American Institute of Electrical Engineers are joint sponsors for the Sectional Committee on Radio. The Institute of Radio Engineers is also cooperating in the formulation of standards on five other subjects, its representatives on all of these Sectional Committees being given on page 8.

The Sectional Committee on Radio is composed of representatives from sixteen cooperating organizations. The Executive Committee of the Sectional Committee on Radio consists of the following officers and chairmen of Technical Committees:

ALFRED N. GOLDSMITH, *Chairman*
C. H. SHARP, *Vice Chairman*
B. DUDLEY, *Secretary*

Chairmen of Technical Committees:

Radio Receivers and Parts.....	VIRGIL M. GRAHAM
Radio Transmitters and Parts.....	HARADEN PRATT
Vacuum Tubes.....	J. C. WARNER
Electro-Acoustic Devices.....	IRVING WOLFF

REPORT OF THE SECRETARY INSTITUTE OF RADIO ENGINEERS

1931

THE following report is submitted to the membership in order that they may become better acquainted with the more important details of the Institute's activities during 1931. The material which is contained therein has been obtained from a number of sources, and is the result of the efforts of over two hundred and fifty members who have been good enough to give of their time and efforts in behalf of the Institute, and who have comprised the many committees through which Institute operations are advanced.

General

There were 6734 members of the Institute on December 31, 1931, as compared to 6535 at the close of 1930. This increase in membership during the year of approximately two hundred is somewhat smaller than has been the gain in membership during the past few years, but in view of business conditions both within and without the radio industry is considered gratifying.

Our seventeen Sections have shown considerable activity and ability in maintaining uninterruptedly their normal operation. In addition to the Sixth Annual Convention, which was held under the auspices of the Chicago Section in June, the Rochester Section sponsored a fall meeting in November which was well attended.

Almost seventy-five meetings were held by the various standing and special committees, and in addition a considerable amount of committee work has been accomplished outside of such meetings. The Papers Committee and Board of Editors in particular did practically all of their work by correspondence so the number of meetings held gives no indication of their activities. Volume 19 of the PROCEEDINGS contained a few more pages than any of its predecessors, and the 1931 Year Book was more than 50 per cent larger than any which had been issued previously by the Institute.

Our new Constitution, which is the result of the efforts of the Constitution and Laws Committee and the Board of Directors, establishes for the first time a Student grade of membership which should be particularly appealing to those college students whose interest lies in the communications field.

An examination of the comparative balance sheet which appears at the end of this report discloses a small net gain from operation for the

year which, in view of the continued and unreduced service which has been rendered the membership, indicates that reasonable care is being exercised in handling Institute funds.

Board of Directors

The governing body of the Institute is known as the Board of Directors, and all general policies are established by it. During 1931 ten meetings were held, nine of which were regular meetings and the tenth, a special meeting called to consider the final draft of the new Constitu-

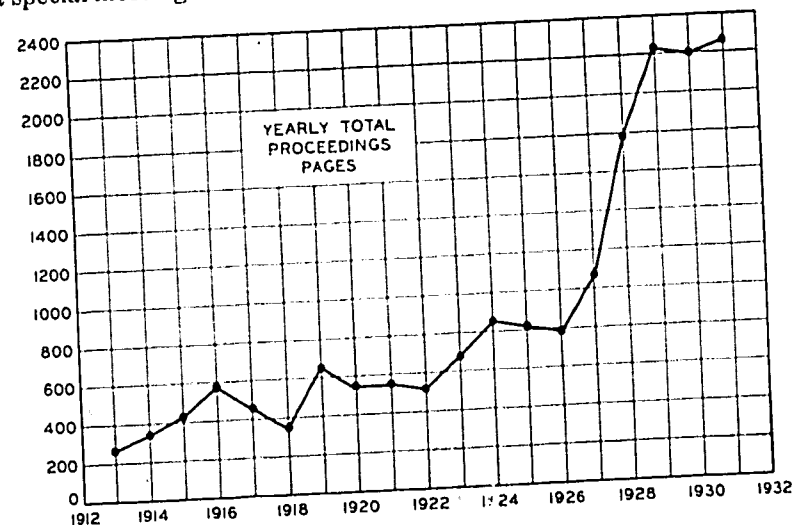

FIG. 1

tion which was approved by the membership in a subsequent ballot. There was no meeting in June as would normally be the case because the annual convention was held then.

Annual Convention

Under the able chairmanship of Byron B. Minnum, the Chicago Section sponsored the Sixth Annual Convention, the headquarters of which were at the Hotel Sherman in Chicago, Illinois, on June 4, 5, and 6. The attendance at the convention totaled approximately four hundred, the large majority of whom were from outside the Chicago Section area. On the technical program there were eighteen papers on diverse subjects in addition to a special paper presented by Arthur H. Compton of the University of Chicago. An official luncheon was given on the opening day of the Convention and the annual banquet was held on the evening of the second day. An exhibition of component parts, measurement devices, and manufacturing aids served to ac-

quaint those in attendance with the latest developments in these fields. The group which served on the Convention Committee and through whose efforts its success was achieved deserve the thanks of all those in attendance, as well as those who could not attend, for their efforts have assisted the Institute greatly in becoming more valuable in the engineering field of radio.

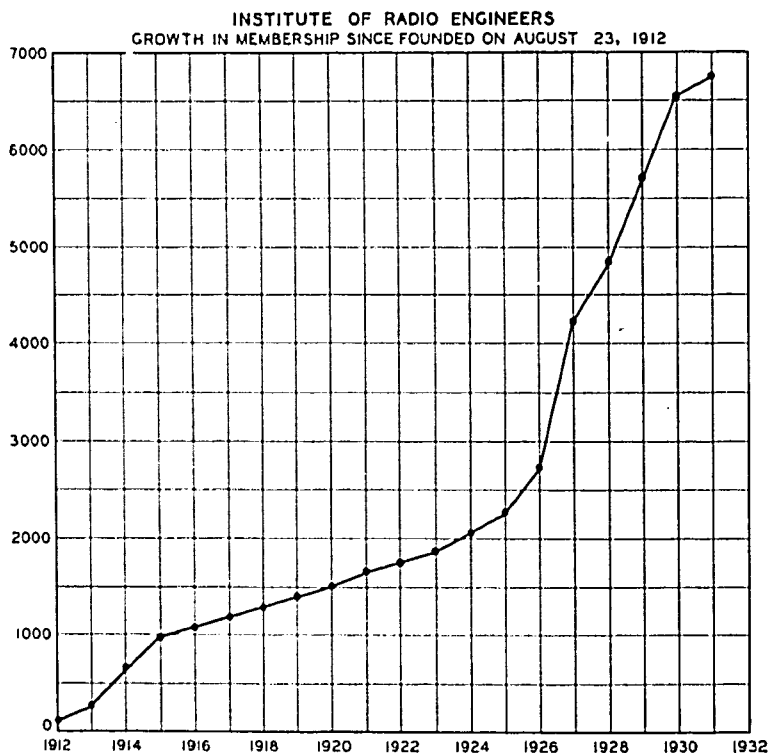

FIG. 2

Rochester Fall Meeting

The Rochester Fall Meeting, which is rapidly becoming an annual affair, was held on November 9th and 10th, and was attended by three hundred and thirty. A dozen papers were presented in the informal fashion which has made these meetings of such interest in the past. In addition to the informal banquet which was held on the evening of the last day, group luncheons were arranged for both days and a group dinner for the first day of the meeting. It was, accordingly, unnecessary to leave the group activities of the Convention from the time of the first meeting in the morning to the close of the day's events. An exhibition of components, measuring instruments, and manufacturing aids was a part of this meeting. The arrangements were the work of a com-

mittee under the chairmanship of Virgil M. Graham, and sincere thanks are due to all who served for their efforts in our behalf.

New York Meetings

New York meetings of the Institute were held on the first Wednesday of each month during the year except in June, July, and August.

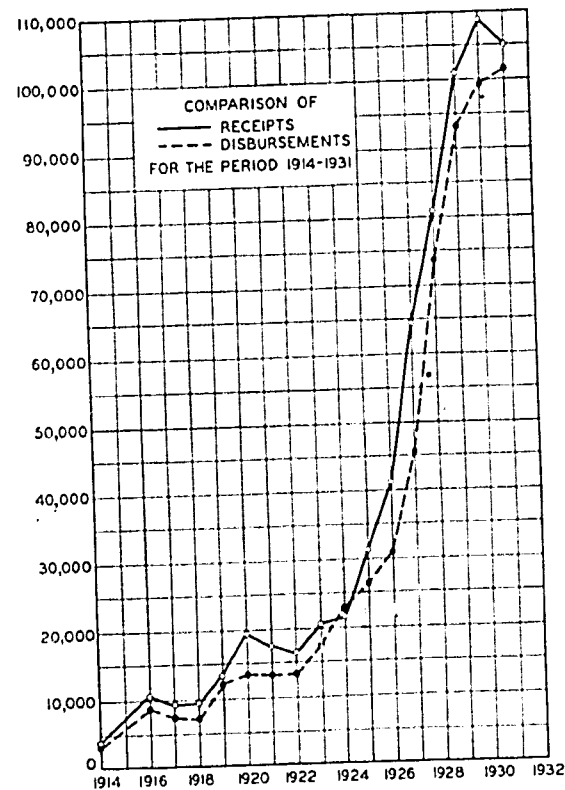

FIG. 3

The June meeting was in conflict with the date of the Convention in Chicago and the meeting was omitted. No meetings are held in July or August because a large number of members are not available in the city during these summer months. Through the courtesy of the New York Section of the Society of Motion Picture Engineers, those members of the Institute residing in the New York area were invited to attend a meeting at which was given a demonstration and paper on recent developments in vertical cut records.

Committees

A number of standing committees whose duties are outlined in the Constitution or have been determined by past operation are appointed

each year. These committees, in addition to handling such problems as arise during the normal course of events, are many times instructed by the Board of Directors to consider and report upon matters which arise and which are of an abnormal nature. These committees submit their opinions to the Board and aid it in its determination of satisfactory policies by which the Institute may be guided. The debt which each individual member of the Institute owes to these committee workers is a substantial one and it is unfortunate that the appreciation of the membership cannot be made evident to them in some suitable fashion.

ADMISSIONS

It is the duty of the Admissions Committee to examine critically each application which is submitted to the Institute for either the Member or Fellow grades of membership. Upon receipt of an application for either of these grades, suitable blanks are forwarded to the sponsors whose names are submitted by the applicant and when these are filled in and returned, all of the material is placed in the hands of the Admissions Committee for its consideration and determination as to the fitness of the applicant for the grade of membership desired. The responsibility of this committee in determining upon whether the qualifications of an applicant can be construed as being within the requirements of the Constitution is apparent, as it is through their efforts that the standards of the higher grades of membership are maintained. Under the chairmanship of C. M. Jansky, Jr., the committee held nine meetings and critically scrutinized one hundred applications for the two highest grades of membership. The distribution of these and the decisions reached are tabulated below. The committee does not normally examine applications for the Junior or Associate grades of membership.

	<i>Acted upon</i>	<i>Approved</i>
Admission to Fellow grade.....	2	0
Transfer to Fellow grade.....	9	7
Admission to Member grade.....	49	24
Transfer to Member grade.....	40	26

The committee also reviewed the new application blanks and made a number of suggestions for their improvement.

AWARDS

It is the duty of the Awards Committee to recommend to the Board of Directors suitable candidates as recipients for the two awards issued annually by the Institute. These are the Institute Medal of Honor and the Morris Liebmann Memorial Prize. For 1931 the Medal of Honor

was awarded to General G. A. Ferrié of Paris for his pioneer work in the up-building of radio communication in France and in the world, his long continued leadership in the communication field, and his outstanding contributions to the organization of international cooperation in radio. Because of his outstanding theoretical and experimental investigations of numerous radio and acoustic devices, the Morris Liebmann Memorial Prize was awarded to Stuart Ballantine of Boonton, N. J.

Mr. Ballantine received the Morris Liebmann Memorial Prize, which is a check for \$500, at the annual banquet held in Chicago. It was unfortunate that General Ferrié was unable to be in attendance at this banquet but his duties as chairman of the International Consulting Committee on Radio meeting held in Copenhagen at about the same time prevented this. Arrangements were made whereby a dinner was given in honor of General Ferrié by a number of members of the Institute who attended the meeting in Copenhagen and the presentation made there.

BOARD OF EDITORS

The Board of Editors have as their chief responsibility the determination of the fitness for publication in the PROCEEDINGS of all manuscripts submitted. Under the chairmanship of Alfred N. Goldsmith the committee examined one hundred and thirty-nine papers of which one hundred and twenty-six were approved for publication. It was not found necessary to hold any meetings of the Board of Editors during the year as the personnel was identical with that of the previous year.

BROADCAST COMMITTEE

The Broadcast Committee under the chairmanship of L. M. Hull held seven meetings and continued with its consideration of a number of questions which were submitted to it by the Federal Radio Commission. Reports were made to the Board of Directors on Federal Radio Commission General Orders Numbered 91 and 97 on "The Power Rating of Broadcast Transmitters" and "Modulation Capabilities of Broadcast Transmitters," respectively. These reports were approved and forwarded to the Commission.

The committee was instructed by the Board of Directors to consider problems other than those submitted to it by the Federal Radio Commission and a study of broadcasting as a systems proposition was suggested.

Dr. Hull found that it would be impossible for him to carry on his duties as chairman of this committee and in November asked to be relieved of this work. In accepting his resignation the Board of Direc-

tors extended to him its thanks and appreciation for the efforts he has made during the past several years in guiding the committee in its successful consideration of the many important and involved problems which have been presented to it. E. L. Nelson of the Bell Telephone Laboratories was appointed to succeed Dr. Hull.

CONSTITUTION AND LAWS

This committee under the chairmanship of R. H. Marriott held two meetings, one of which was devoted to a consideration of a proposed uniform registration law for professional engineers and land surveyors being sponsored by the American Society of Civil Engineers and upon which the Institute was asked to comment. The other meeting was devoted to the preparation of a report for the Board of Directors on such bills concerning radio as were pending in Congress.

MEMBERSHIP

Although the net gain in membership for 1931 amounted to only 3 per cent this is not felt to be a poor showing when general conditions are taken into consideration.

In view of the changes made in the Constitution upon its recent revision, a new membership blank had to be prepared and the committee gave this matter careful thought. It was also necessary to draft a new blank for the Student grade of membership.

DISTRIBUTION OF INSTITUTE MEMBERSHIP AS OF DECEMBER 31, 1931

Continental United States.....	5403
Alaska.....	5
Argentina.....	8
Austria.....	1
Australia.....	43
Bahama Islands.....	1
Belgium.....	4
Bermuda.....	1
Bolivia.....	1
Brazil.....	11
British Guiana.....	1
British North Borneo.....	1
British West Indies.....	2
Canada.....	284
Canal Zone.....	7
Channel Islands.....	2
Chile.....	4
China.....	40
Colombia.....	4
Costa Rica.....	2

Cuba.....	3
Czechoslovakia.....	4
Denmark.....	13
Dutch East Indies.....	1
East Africa.....	1
Egypt.....	2
England.....	436
Federated Malay States.....	9
France.....	31
Friendly Islands.....	1
Germany.....	16
Great Britain.....	3
Greece.....	2
Guam.....	1
Hawaiian Islands.....	32
Holland.....	13
Hungary.....	2
India.....	16
Ireland.....	11
Italy.....	12
Japan.....	140
Kenya Colony.....	1
Latvia.....	1
Mariannas Islands.....	9
Mexico.....	1
New Foundland.....	34
New Zealand.....	2
Nicaragua.....	2
Palestine.....	3
Panama.....	7
Peru.....	7
Philippine Islands.....	6
Poland.....	3
Porto Rico.....	2
Portugal.....	1
Samoa.....	19
Scotland.....	1
Siam.....	22
South Africa.....	1
South India.....	10
Spain.....	1
Spanish Morroco.....	2
Straits Settlements.....	8
Sweden.....	3
Switzerland.....	2
Tasmania.....	1
Trinidad.....	7
U.S.S.R. (Russia).....	2
Wales.....	1
West Indies.....	1
Total.....	6734

NEW YORK PROGRAM

Three meetings of the New York Program Committee were held under the chairmanship of Austin Bailey to determine upon programs for nine New York meetings of the Institute.

NOMINATIONS

The Nominations Committee held one meeting to prepare a list of candidates for officers for the forthcoming year. This meeting was held under the chairmanship of J. H. Dellinger, and the recommendations of the committee were submitted to the Board of Directors for its approval.

PAPERS

The Papers Committee, under the chairmanship of William Wilson found it necessary to hold but one meeting during the year. However, almost one hundred and fifty papers were forwarded to members of the committee throughout the year for their opinions as to the suitability of the manuscripts for publication in the PROCEEDINGS and for check on the technical accuracy and completeness of the material submitted. The following tabulation of the results of the efforts of the committee will give some idea of its accomplishments.

Papers reviewed for publication.....	139
Papers published*.....	126
Papers rejected.....	13
Papers returned for revision.....	19
Book reviews prepared and published.....	16
Discussions published.....	7

* Of these 13 required translation into English.

SECTIONS

The Sections Committee held four meetings, one of which was the annual meeting held during the Sixth Annual Convention in Chicago and another a special meeting held in Rochester during the Rochester Fall Meeting. It was thus possible for a considerable number of representatives of Sections to be present at the two special meetings and this helped considerably in maintaining a closer contact between the Sections and the committee.

A standard financial report form was prepared to simplify the work of Section treasurers and permit reports to be comparable over long periods of time. Although the new rebate system which allots to each Section \$10.00 for each meeting held during the year and 50 cents for each paid member residing in the Section territory was only put

into operation on the first of the year, it appears to have assisted a number of the smaller Sections in their financial affairs. The following table lists some pertinent information regarding the seventeen Sections of the Institute.

	Membership December 31, 1931	Meetings Held			Average Attendance	Per cent of Av- erage Attend- ance to Total Membership
		1929	1930	1931		
Atlanta.....	27	6	4	8	30	111
Boston.....	266	2	5	5	114	43
Buffalo-Niagara.....	55	10	7	3	27	50
Chicago.....	392	6	4	5	104	27
Cincinnati.....	105	4	8	10	52	50
Cleveland ¹	118	10	8	9	92	78
Connecticut Valley.....	140	4	1	9	47	34
Detroit ²	132	10	10	10	136	103
Los Angeles ³	269	8	10	10	93	35
New Orleans.....	36	4	2	—	—	—
Philadelphia.....	437	7	9	8	136	31
Pittsburgh ⁴	99	8	9	7	105	106
Rochester ⁵	66	8	6	9	198	300
San Francisco.....	187	9	11	11	51	27
Seattle.....	65	9	7	10	66	101
Toronto.....	173	8	7	10	87	50
Washington.....	217	9	9	9	65	30

¹ Joint meeting with A.I.E.E. March 25th—attendance 300.

² Joint meeting with A.I.E.E. March 17th—attendance 750.

³ Joint meetings with A.I.E.E. April 14, May 19, attendance 250 and 155, respectively.

⁴ Joint meeting with A.I.E.E. and E.S. of W.P.—attendance 500.

⁵ Rochester Fall Meeting, November 9 and 10—attendance 330.

STANDARDS

The last standards report was issued early in 1931 and it is anticipated that the next report will be available in 1933. The main Standards Committee is composed of about twenty-five members under the chairmanship of J. W. Horton. Six technical committees have been appointed. The names of these committees together with the chairmen are listed below:

Technical Committee on Electro-Acoustic Devices
E. D. Cook, *Chairman*

Technical Committee on Electro-Visual Devices
J. V. L. Hogan, *Chairman*

Technical Committee on Fundamental Units and Measurements
H. M. Turner, *Chairman*

Technical Committee on Radio Receivers
H. A. Wheeler, *Chairman*

Technical Committee on Radio Transmitters and Antennas
William Wilson, *Chairman*

Technical Committee on Vacuum Tubes
B. E. Shackelford, *Chairman*

These committees and a number of subcommittees which were appointed to consider specific problems held sixteen meetings during the year.

SECTIONAL COMMITTEE ON RADIO

The Sectional Committee on Radio is operated under the procedure outlined by the American Standards Association, and is sponsored jointly by the American Institute of Electrical Engineers and the Institute of Radio Engineers. The chairman of the committee is Alfred N. Goldsmith and there is operating under the committee a number of technical committees as follows:

Technical Committee on Electro-Acoustic Devices
Irving Wolf, *Chairman*

Technical Committee on Radio Receivers
Virgil M. Graham, *Chairman*

Technical Committee on Transmitters and Parts
Haraden Pratt, *Chairman*

Technical Committee on Vacuum Tubes
J. C. Warner, *Chairman*

These committees and their subcommittees held seven meetings during the year and have submitted for approval as American Standard, a report which appears elsewhere in this YEAR BOOK.

Deaths

With deep regret we inscribe below the names of those whose membership has been terminated by death.

Anderson, S. E.
Bentz, Carl F.
Bernhard, Frederick S.

Boerstler, Loren L.
Bohling, C. F.
Burdett, Sam

Campbell, Harold G.
Cunningham, H. C.
Dean, Samuel W.
Eastman, Fred T.
Ehle, Francis R.
Hall, Edward G.
Hayes, Clifford D.
Kimmell, William J.

Kratz, C. F.
McCullah, Arthur B.
McQueen, Harry D.
Morgan, N. R.
Mott, Lawrence
Nyholm, Christian
Whiting, Donald F.

Acknowledgment

In closing this report to the membership, I take this opportunity of acknowledging the loyal support and coöperation which has been my good fortune to receive from the Institute headquarters staff, without which the contents of this report would have been seriously abbreviated.

The Institute of Radio Engineers, Inc.
COMPARATIVE BALANCE SHEET
December 31, 1931 and 1930

ASSETS	Dec. 31, 1931	Dec. 31, 1930	INCREASE DECREASE
CASH			
General Fund—Corn Exchange Bank.....	\$8,287.37	14,831.61	6,544.24
Special Fund—Corn Exchange Bank.....	1,706.11	348.41	1,357.70
Petty Cash Fund.....	175.00	175.00	
TOTAL CASH.....	10,168.48	15,355.02	5,186.54
ACCOUNTS RECEIVABLE—CURRENT			
Junior.....	58.00	122.00	64.00
Associate.....	1,732.77	1,470.67	253.10
Members.....	15.00	20.00	5.00
Entrance Fees.....	1,076.50	978.00	98.50
Transfer Fees.....		10.00	10.00
Advertising.....	961.55	2,510.81	1,546.26
Reprints.....	107.82	301.87	194.05
ACCOUNTS RECEIVABLE—COLLECTIONS DEFERRED			
Junior.....	40.00		40.00
Associate.....	1,473.00		1,473.00
Member.....	255.00		255.00
Fellow.....	60.00		60.00
Due from Chicago Section.....	1,828.00		60.00
	579.47		579.47
TOTAL ACCOUNTS RECEIVABLE.....	6,362.11	5,422.35	939.76
INVENTORY			
PROCEEDINGS on Hand.....	4,984.87	4,444.92	539.95
Bound Volumes on Hand.....	118.00	111.55	6.45
Binders on Hand.....	245.14	157.08	88.06
Emblems on Hand.....	347.20	252.30	94.90
TOTAL INVENTORY.....	5,695.21	4,965.85	729.36
INVESTMENTS—AT COST.....			
(Market Value Dec. 31, 1931, \$38,092.50)	57,607.62	47,493.00	10,114.62
FURNITURE AND FIXTURES.....			
Less—Reserve for Depreciation.....	8,398.61		
	3,753.38		
ACCRUED INTEREST ON INVESTMENTS.....	1,092.43	892.43	200.00
PREPAID EXPENSES			
1932 Convention Expense.....	238.50		238.50
Unexpired Insurance Premiums.....	61.24	74.32	10.08
Stationery Inventory.....	400.00	729.37	328.37
Section Expense.....	250.00		250.00
TOTAL ASSETS.....	\$80,523.82	80,037.26	6,486.56
LIABILITIES			
ACCOUNTS PAYABLE			
SUSPENSE			
DUES, ETC., PAID IN ADVANCE.....	\$3,013.97	491.64	2,522.33
Junior.....	100.70	115.70	9.00
Associate.....	11.50	40.00	28.50
Member.....	826.48	902.68	76.20
Fellow.....	169.64	67.23	102.41
Entrance Fees.....	7.50	68.71	51.21
Subscriptions to PROCEEDINGS.....	92.50	142.50	50.00
Advertising.....	3,514.65	3,365.20	149.36
	64.00		64.00
TOTAL LIABILITIES.....	7,806.94	5,183.75	2,623.19
MORRIS LIEBMAN MEMORIAL FUND			
Principal.....	10,000.00	10,000.00	
Unexpended Income.....	77.87	77.87	
TOTAL MORRIS LIEBMAN FUND.....	10,077.87	10,077.87	
SURPLUS			
Balance, January 1.....	64,775.64	55,562.67	9,212.97
Operating Profit for Year.....	3,863.37	9,212.97	5,349.60
SURPLUS DECEMBER 31.....	68,639.01	64,775.64	3,863.37
TOTAL LIABILITIES AND SURPLUS.....	\$88,523.82	80,037.26	6,486.56

Patterson and Ridgeway, Certified Public Accountants
74 Trinity Place, New York, N. Y.

The Institute of Radio Engineers
(Incorporated May 13, 1912)

CONSTITUTION

ADOPTED AT THE FIRST MEETING OF THE INSTITUTE OF RADIO
ENGINEERS MAY 13, 1912. AMENDED NOVEMBER 2, 1914
DECEMBER 5, 1915, AND OCTOBER 7, 1931.

ARTICLE I

NAME AND OBJECT

SEC. 1—The name of this organization shall be The Institute of Radio Engineers, Incorporated.

SEC. 2—Its objects shall be the advancement of the theory and practice of radio and allied branches of engineering and of the related arts and sciences, their application to human needs, and the maintenance of a high professional standing among its members. Among the means to this end shall be the holding of meetings for the reading and discussion of professional papers and the publication of papers, discussions, communications, and such other matters as may be appropriate for the fulfillment of its objects.

ARTICLE II

MEMBERSHIP

SEC. 1—The membership of the Institute shall consist of:

- Fellows, who shall be entitled to all rights and privileges of the Institute.
- Members, who shall be entitled to all rights and privileges of the Institute except the right to hold the offices of President and Vice President.
- Associates, who shall be entitled to all rights and privileges of the Institute except the right to hold any elective office specified in Article V.
- Juniors, who shall be entitled to attend all meetings and to receive copies of all Institute publications.
- Students, who shall be entitled to attend all meetings and to receive copies of all Institute publications.

SEC. 2—A Fellow shall not be less than thirty-two years of age and shall be either:

- A radio engineer by profession. As such he shall have attained distinction in his profession and shall be eminently qualified to take responsible charge of important radio work and shall have been in the active practice of his profession for at least ten years, and shall have had responsible charge of important radio work for at least three years.

When the applicant holds in a principal national society of an allied branch of engineering or science membership in a grade for which the qualifications indicate a standing equal to that required for the grade of Fellow herein, such membership shall be considered equivalent to three years of the required ten years of active practice of the radio profession.

b. A professor of physical science or of electrical engineering. As such he shall have attained special distinction as an expounder of the principles of radio science and of radio engineering and shall have had at least ten years experience as a teacher of physical or electrical subjects and shall have had responsible charge, for three years, of a radio course in a school of science or engineering of recognized standing. Any experience, as defined in paragraph "a", that the applicant may have had as a radio engineer shall be considered the equivalent of the same number of years of experience as a "teacher of radio subjects."

c. A person who has done notable original work of service to radio engineering of a character to give him a recognized standing at least equivalent to that required for Fellow under paragraph "a" or "b."

d. A person regularly engaged in radio work for at least ten years, who, by invention or by special proficiency in contributions to the radio science or the radio arts or radio literature, has attained a standing at least equivalent to that required for Fellow under paragraph "a" or "b."

SEC. 3—A Member shall not be less than twenty-five years of age and shall be either:

a. A radio engineer by profession. As such, under general direction he shall have designed and taken responsibility for important radio engineering work or science and shall have been in the active practice of his profession for at least four years.

When the applicant holds in a principal national society of an allied branch of engineering, membership of a grade for which the qualifications indicate a standing equal to that required for the grade of Member herein, such membership shall be considered equivalent to two years of the requisite four years of active practice of the radio profession.

b. A teacher of physical science or of electrical engineering. As such he shall have had at least four years experience as a teacher of radio subjects in a school of recognized standing. Any years of experience the applicant may have had as a radio engineer shall be considered the equivalent of the same number of years' experience as a "teacher of radio science or of radio engineering."

c. A person regularly employed in radio or closely allied work for at least four years, who by invention or proficiency in radio science, the radio arts, or radio literature, or as an executive of any radio enterprise of large scope, has attained a standing equivalent to that required for Member under paragraph "a" or "b." In case of such an executive the applicant must be qualified to take responsible charge of the broader features of radio engineering involved in the work under his direction.

d. A person at least twenty-eight years of age who is an engineer by profession in work closely allied to radio. As such, under general direction, he shall have taken responsibility in important engineering work in his field, or science, and shall have been in active practice of his profession for at least seven years.

SEC. 4—An Associate shall be not less than twenty-one years of age and shall be a person who is interested in or connected with the study or application of radio science or the radio arts.

SEC. 5—A Junior shall have attained the sixteenth anniversary of his day of birth but shall not have passed the twenty-first anniversary thereof, and shall be a person who is interested in the study or application of radio science or the radio arts.

SEC. 6—A student shall be a person registered as a full-time student in a university or technical school of recognized standing who is pursuing a regular course of study in the science of engineering. The designation of full-time student is intended to include those who devote either their entire time or the major part of their time to studies. The expression "school of recognized standing" is interpreted as applying to schools of college grade providing an engineering curriculum of not less than three years and granting degrees.

SEC. 7—In all cases, graduation from the radio course or electrical course of a school of science or of engineering of recognized standing shall be considered the equivalent of one year's radio experience.

SEC. 8—The provisions of this Constitution, unless so stated, shall not be retroactive.

SEC. 9—The terms "member" and "membership" when printed without an initial capital where used in the constitution and By-Laws includes Fellows, Members, Associated, Juniors, and Students.

ARTICLE III

ADMISSIONS AND EXPULSIONS

SEC. 1—Applications may be made for admission or transfer to any grade of membership as required by the By-Laws.

The Board of Directors may refuse to elect or transfer any applicant whose character, reputation, or professional conduct has been such as would make him, in the opinion of the Board of Directors, an undesirable member.

SEC. 2—An affirmative vote, oral or written, of at least two-thirds of the Board members voting at any regular meeting of the Board shall elect or transfer an applicant for any grade.

SEC. 3—A rejected applicant may renew his application for membership or transfer at any time after the expiration of one year from the date of the ballot rejecting his previous application.

SEC. 4—All elected candidates shall be duly notified. If acceptance of election by payment of admission fee and dues is not received within six months from the notification, such election shall be considered void, unless for special reasons the time shall be extended by the Board of Directors. Membership of any person shall date from the date of his election. If such date is subsequent to July 1st, only one-half of the annual dues are payable for that year. The applicant shall receive the publications of the Institute, if available, for the period for which dues are paid but if such publications are not available he shall receive a proportionate refund.

SEC. 5—Any member may be expelled from the Institute by a unanimous vote of the Board of Directors.

SEC. 6—A member may resign his membership by a written communication to the Secretary, who shall present the same to the Board of Directors; when, if all his dues have been paid, his resignation shall be accepted.

ARTICLE IV

ENTRANCE FEES AND DUES

SEC. 1—The entrance fees, transfer fees, and annual dues shall be as follows:

Entrance Fees

Fellow.....	\$10.00
Member.....	5.00
Associate.....	3.00
Junior.....	1.00
Student.....	

The transfer fee from one grade of membership to another shall be the difference between the corresponding entrance fees.

Annual Dues

Fellows.....	\$15.00
Members.....	10.00
Associates.....	6.00
Juniors.....	4.00
Students.....	3.00

SEC. 2—The annual dues shall be payable in advance on the first day of January. It shall be the duty of the Secretary to notify each member of the amount due.

SEC. 3—The Board of Directors may temporarily excuse any member from payment of annual dues and may waive in whole or in part dues in arrears.

SEC. 4—Every person admitted to the Institute shall be considered as belonging thereto and liable for the payment of all membership dues until his connection therewith shall have terminated.

ARTICLE V

OFFICERS

SEC. 1—The governing body of the Institute shall be broadly representative of the membership. It shall be known as the Board of Directors and shall consist of the President, Vice President, Secretary, Treasurer, nine elected Directors, five appointed Directors, and the past Presidents of the Institute for the preceding two years.

SEC. 2—The terms of all officers, except the nine elected Directors and the past Presidents, shall be one year each. The President and the Vice President shall not be eligible for immediate renomination to the same office.

SEC. 3—Three Directors shall be elected by the membership annually and shall serve for three years each. At the first election under this Constitution, additional Directors shall be elected, one for one year and one for two years.

SEC. 4—The five appointed Directors shall be chosen by the Board of Directors to serve for terms of one year each.

SEC. 5—The Board of Directors is authorized to appoint a successor to any officer to fill an unexpired term caused by death or resignation.

SEC. 6—No officer shall receive, directly or indirectly, any salary, compensation, or emolument from the Institute, either as such officer, or in any other capacity, unless authorized by a vote of a majority of the entire Board of Directors, except as authorized by the By-Laws.

ARTICLE VI

MANAGEMENT

SEC. 1—The President shall have general supervision of the affairs of the Institute. He shall preside at meetings of the Institute and of the Board of Directors at which he may be present and shall be an ex officio member of all committees.

The Vice President shall assume the duties of the President in event of the absence or incapacity of the President.

In the event that the President or Vice President cannot personally act as Chairman of the Board of Directors, the Board shall elect a Chairman from the Board membership who is so situated relative to the executive office that he can perform any or all of the duties of the President and he is hereby authorized to perform such duties.

SEC. 2—The Board of Directors shall manage the affairs of the Institute in conformity to the laws under which the Institute is organized and the provisions of the Constitution and By-Laws. It shall direct the investment and care of the funds of the Institute, make appropriations for specific purposes, act upon applications for membership as herein provided, take measures to advance the interests of the Institute, appoint all its employees, and generally direct its business. The Board of Directors shall make an annual report to the membership of the Institute, transmitting digests of reports of the Treasurer and of the other officers and of committees. Six members of the Board of Directors shall constitute a quorum.

SEC. 3—The Board of Directors may make, amend, or revoke such By-Laws as are necessary from time to time. To make, amend, or revoke the By-Laws, the proposed changes and reasons therefor shall be prepared in written form and mailed to all members of the Board of Directors thirty days or more before the stipulated meeting at which the vote of the Directors on the proposed changes shall be counted. A two-thirds majority of all Directors' votes either in writing or in person, received at the stipulated meeting, shall be required to adopt any new By-Laws, amendments, or revocations.

SEC. 4—The Treasurer shall see that all monies are deposited in the name of the Institute. He shall invest all funds not needed for current disbursements, as shall be ordered by the Board of Directors. He shall see that all bills are paid when approved as provided by the Board of Directors. He shall make an annual report and such other reports as may be prescribed by the Board of Directors. A digest of the annual report shall be published for the information of the membership of the Institute.

The Board of Directors shall secure a surety bond on the Treasurer.

SEC. 5—The Secretary shall attend all meetings of the Board of Directors and principal meetings of the Institute, prepare the business thereof, and duly record the proceedings thereof. He shall see that all monies due the Institute are carefully collected, and without loss transferred to the custody of the Treasurer. He shall carefully scrutinize all expenditures and use his best endeavor to secure

economy in the administration of the Institute. Subject to the instructions of the Board, he shall approve before payment all bills or vouchers on which money is to be paid, and shall countersign the checks drawn by the Treasurer, President, or Vice President, or Chairman of the Board, against the funds of the Institute when such drafts are known to him to be proper and duly authorized. He shall have charge of the books of account of the Institute, and shall furnish, when required by the Board of Directors, a statement of receipts and expenses under their several headings, and also a statement of monthly balances. He shall present annually, to the Board of Directors, a balance sheet of his books as of December 31st and shall furnish from time to time such other statements as may be required of him. He shall conduct the correspondence of the Institute and keep full records of the same. He shall perform all other duties which may from time to time be assigned to him by the Board of Directors.

The Board shall secure a surety bond on the Secretary. An annual audit of the affairs of the Institute shall be made by certified public accountants and submitted to the Board.

SEC. 6—All standing committees shall be chosen in accordance with the By-Laws by the incoming President before January first, the appointments to take effect at the annual meeting of the Institute. Additional standing committees and other committees may be appointed by the President with the consent of the Board of Directors at other times as may be required to carry out the objects of the Institute.

SEC. 7—The fiscal year of the Institute shall end with the 31st day of December.

ARTICLE VII

NOMINATION AND ELECTION OF PRESIDENT, VICE PRESIDENT, AND THREE DIRECTORS AND APPOINTMENT OF SECRETARY, TREASURER, AND FIVE DIRECTORS

SEC. 1—On or before July 1st of each year the Board of Directors shall call for nominations by petition and shall at the same time submit to qualified voters a list of the Board's nominations containing at least two names for each elective office, together with a copy of this article.

Nomination by petition shall be made by letter to the Board of Directors setting forth the name of the proposed candidate and the office for which it is desired he be nominated. For acceptance a letter of petition must reach the executive office before August 15th of any year, and shall be signed by at least thirty-five Fellows, Members, or Associates.

Each proposed nominee shall be consulted and if he so requests his name shall be withdrawn. The names of proposed nominees who are not eligible under the Constitution, as to grade of membership or otherwise, shall be withdrawn by the Board.

On or before September 15th, the Board of Directors shall submit to the Fellows, Members, and Associates in good standing as of September 1st, a list, of nominees for the offices of President, Vice President, and three Directors. This list shall comprise at least two names for each office, the names being arranged in alphabetical order and shall be without indication as to whether the nominees were proposed by the Board or by petition. The ballot shall carry a statement to the effect that the order of the names is alphabetical for convenience only and indicates no preference.

Fellows, Members, and Associates shall vote for the officers whose names appear on the list of nominees, by written ballots in plain sealed envelopes, enclosed within mailing envelopes marked "Ballot" and bearing the member's written signature. No ballots within unsigned outer envelopes shall be counted. No votes by proxy shall be counted. Only ballots arriving at the executive office prior to October 25th shall be counted. Ballots shall be checked, opened, and counted under the supervision of a Committee of Tellers, between October 25th and the first Wednesday of November. The result of the count shall be reported to the Board of Directors at its first meeting in November and the nominees for President and Vice President and the three nominees for Directors receiving the greatest number of votes shall be declared elected. In the event of a tie vote the Board shall choose by lot between the nominees involved.

SEC. 2—The Treasurer, Secretary, and five appointive Directors shall be appointed by the Board of Directors at its annual meeting for a term of one year or until their successors be appointed.

ARTICLE VIII

MEETINGS

SEC. 1—There shall be an annual meeting of the Board of Directors as soon as practicable after January 1st and before February 1st, at which newly elected officers shall begin their terms of service, and the Board shall make necessary appointments. There shall be a meeting of the Board of Directors in November on or after the first Wednesday to receive the report of the Tellers Committee.

SEC. 2—There shall be an annual meeting of the Institute as soon as practicable after the annual meeting of the Board of Directors at which newly appointed Directors, officers, and committees shall begin their terms of service and at which general reports of the Secretary and Treasurer shall be made, and at which the retiring and incoming Presidents shall be requested to present addresses in person or by proxy.

SEC. 3—Additional business meetings and meetings for the reading and discussions of papers shall be held as prescribed in the By-Laws.

SEC. 4—The Institute may adopt, from time to time, rules for the order of business at its meetings.

SEC. 5—In addition to the annual and November meetings of the Board of Directors, meetings of the Board shall be held at such times as are necessary to carry out the provision of this Constitution and may be held at such other times as any three members of the Board may determine, but only on notice to all members of the Board.

ARTICLE IX

INSTITUTE SECTIONS

SEC. 1—Whenever, in the judgment of the Board of Directors, a sufficient number of Fellows, Members, and Associates shall petition, in writing, these members may form, subject to the Constitution and all By-Laws and regulations which may be hereafter prescribed by the Board of Directors, a Section of the Institute of Radio Engineers for the purpose of more effectually carrying out the aims of the Institute.

SEC. 2—Any member may become a member of such Section, but no such member shall be entitled to vote, or hold office, in more than one Section at a given time.

SEC. 3—The Board of Directors may at any time terminate the existence of any section when in its judgment the interests of the Institute make such action desirable.

ARTICLE X AMENDMENTS

SEC. 1—Amendments to this Constitution may be proposed by means of a petition signed by not less than thirty-five (35) Fellows, Members, or Associates, or by means of a resolution adopted by the Board of Directors. Such proposed amendment or amendments shall be submitted to legal counsel by the Board of Directors, and if, in the opinion of such counsel, they are in accordance with the laws under which the Institute is organized, a copy shall be mailed, with a letter ballot, to each member.

SEC. 2—Constitutional amendment ballots shall be mailed to the membership sixty days before the date set for counting the ballots, and the ballots shall carry a statement of the time limit for delivery to the executive office. The Secretary shall hand these ballots to a Committee of Tellers, which shall count such votes and make a sealed report in duplicate to the Board of Directors at the next meeting of the Board, one copy of which shall forthwith be filed with the Secretary, while the other copy shall remain in possession of the chairman of the committee, who shall hand this report to the presiding officer. In the absence of this report by the chairman of the committee the Secretary shall produce the duplicate copy and hand the same to the presiding officer of the meeting. The presiding officer shall then cause the report to be read. If the total vote be not less than twenty per cent (20%) of the total membership of the Institute, and if seventy-five per cent (75%) or more of all the Fellows, Members, and Associates voting shall declare themselves in favor of the proposed amendment or amendments, the same shall become a part of the Constitution.

SEC. 3—Amendments shall take effect thirty (30) days after their adoption, but officers and officers-elect of the Institute at the time any amendment becomes effective shall continue in office until the end of the terms for which they were elected.

SEC. 4—The Secretary shall print copies of the amendments as soon as practicable after adoption, and distribute the same to the membership.

SEC. 5—A complete history of amendments shall be kept in the files of the Institute.

BY-LAWS OF THE INSTITUTE OF RADIO ENGINEERS

Article VI, Sec. 3, of the Constitution provides for By-Laws as follows:

"The Board of Directors may make, amend, or revoke such By-Laws as are necessary from time to time. To make, amend, or revoke the By-Laws, the proposed changes and reasons therefore shall be prepared in written form and mailed to all members of the Board of Directors thirty days or more before the stipulated meeting at which the vote of the Directors on the proposed changes shall be counted. A two-thirds majority of all Directors' votes either in writing or in person, received at the stipulated meeting shall be required to adopt any new By-Laws, amendments, or revocations."

BY-LAWS

MEMBERSHIP

SEC. 1—Institute members are authorized to use the following abbreviations or symbols indicating their grade of membership:

Fellow—Fel. I.R.E.
Member—Mem. I.R.E.
Associate—Assoc. I.R.E.
Junior—Jr. I.R.E.
Student—Std. I.R.E.

SEC. 2—The term member (when printed without a capital), where used herein, includes Fellows, Members, Associates, Juniors, and Students.

SEC. 3—It shall be the duty of all members to call the attention of the Secretary to any improper use of Institute badges or symbols, or to claims made by nonmembers that they belong to the Institute. The Secretary shall thereupon investigate the facts and lay the matter before the Board of Directors.

SEC. 4—All applications for admission to the Institute in the Fellow or Member grades or for transfer to these grades shall be made in a form approved by the Board of Directors, and shall embody a full record of the general technical education of the applicant and of his professional career. Applicants for various grades of membership shall refer to the following number and grade of sponsors:

For the grade of Fellow, to five Fellows.

For the grade of Member, to five Fellows or Members.

For the grade of Associate, to three Fellows, Members, or Associates.

For the grade of Junior, to three Fellows, Members, or Associates.

For the grade of Student, to a member of the faculty of the school which he attends.

Each application for admission or for transfer from one grade to another shall embody a concise statement, with dates, of the candidate's training and experience, and shall be in such form and such detail as may be prescribed by the By-Laws. It shall be signed by the applicant, and shall contain a promise to conform to the requirements of that grade of membership to which he may be elected.

Each of the members referred to by the applicant shall be requested by the Secretary to address a confidential letter of prescribed form to the Board of Directors stating the extent of the writer's personal knowledge of the training and experience of the applicant and the writer's opinion of the character of the applicant. If at least a majority of the members named as reference do not furnish the requisite endorsement, the Secretary shall call upon the applicant for additional names, and not until written communications have been received from at least three members, in the case of Fellow and Member grades, shall the application be considered by the Board of Directors.

The requirements of the foregoing paragraphs may be waived in whole or in part where the applicant is well known, either personally or by reputation, to the Board of Directors, or where the application is for Junior, Student, or Associate grade.

An applicant for the Member or Fellow grade who is so situated as not to be known personally to more than three of the required number of members of

suitable grade may give the names, occupations, and addresses of responsible nonmembers to complete the required number of references.

SEC. 5—No application for admission or transfer shall be acted upon by the Admissions Committee until the number of replies prescribed above is received, except where requirements have been waived as provided in the foregoing Section

SEC. 6—An applicant for admission to the Institute, who, in the judgment of the Admissions Committee, is not eligible for the grade applied for, but is eligible for admission to a lower grade, may be so notified, and be given the opportunity of changing his application accordingly.

SEC. 7—The names of applicants for admission to, or transfer in, the Institute after approval by the Admissions Committee or other authority shall be posted in the PROCEEDINGS with a request that any member objecting to the election or transfer of any candidate shall make written communication to the Secretary, who shall refer such communication to the Board of Directors at the time of submission of the name of such candidate.

SEC. 8—Transfer of an Associate or Member to a higher grade may be proposed by any member acting as sponsor, in which case the sponsor shall fill out the application blank and provide letters of reference for submission to the Admissions Committee. If the application is favorably acted upon, the sponsor shall secure the candidate's signature to a duplicate application blank after which the application shall be posted and submitted to the Board of Directors with other applications as specified in Section 7.

SEC. 9—The Membership Committee shall, each year, select from the membership list the names of all members whom they think are entitled to a higher rank in membership, and shall act as sponsors as prescribed in Section 8 of these By-Laws.

SEC. 10—Objection to the admission or transfer of any candidate to any grade must be accompanied by reasons for such objection. All such statements shall be treated as confidential.

SEC. 11—The privileges attaching to membership in the Institute, shall not be accorded to applicants for admission until they have been duly elected, and have paid their entrance fees and current dues.

SEC. 12—A prompt notification of his election, accompanied by a statement of his initiation fee (if unpaid) and dues, shall be mailed to each candidate by the Secretary. A second notice of his indebtedness shall be sent by mail one month later to every candidate remaining in arrears in the continental United States and Canada and two months later to all other candidates. The Secretary may, at his discretion, cancel the election of any applicant who has not paid his initiation fee and remains in arrears three months after the mailing of the second notice.

SEC. 13—Any member who has resigned in good standing may be reelected without payment of entrance fee.

If such applicant so desires he may be reinstated, retaining his original date of membership or transfer, by payment of all dues which have accrued during the interim, and he will then be entitled to such Institute publications issued during this period as may be available and a rebate for such publications as are not available.

SEC. 14—Any member who has been dropped as delinquent may upon payment of the dues for which he was in arrears be reinstated or he may at his op-

tion be reelected to that grade of membership previously held upon payment of the entrance fee and current dues for that grade.

SEC. 15—The Institute rights and privileges of each member shall be personal to himself, and shall not be transferable or transmissible by his own act or by operation of law.

SEC. 16—A member whose membership shall terminate for any cause shall have no right or interest in any property of the Institute or any claim or privilege in or against the Institute or pertaining thereto.

SEC. 17—Any member whose dues are more than two months in arrears shall be notified by the Secretary. Should his dues not be paid when they become three months in arrears, he shall lose the right to vote or to receive the publications of the Institute. Should his dues become six months in arrears, he shall be again notified in form prescribed by the Board of Directors, and if such dues become ten months in arrears, he shall forfeit his connection with the Institute. The Board of Directors may, however, for cause deemed by it sufficient, extend the time for payment and for the application of these penalties.

SEC. 18—The mailing of bills or statements to the most recent address received from a member shall be considered a valid notice of indebtedness.

SEC. 19—Allied vocation, work, art, and science shall be construed largely upon the interest in the PROCEEDINGS of this Institute and upon the present and future applications of radio developments. Any work, art, or science which in its present state is obviously dependent on past, present, or probable future radio developments, any work, art, or science from which there is an obvious demand for the PROCEEDINGS of the Institute, and any work, art, or science that obviously contributes to the development of radio engineering shall be considered as an allied branch of engineering or of the related arts or sciences.

In each individual case the decision as to whether or not a candidate's occupation is sufficiently closely related to the purposes of the Institute shall be made by the Board of Directors in cooperation with the Admissions Committee.

ELECTION OF OFFICERS

SEC. 20—In January the Board of Directors shall select three of its members to serve as a Nominations Committee who shall select a chairman from their number and two or more additional committee members, if they deem it desirable.

As soon as practicable the Nominations Committee shall meet to select nominees and shall present its selections to the Board of Directors before April 15th. They shall suggest three or more names for each office and shall avoid naming persons who would presumably not accept the nominations, in so far as may be practicable.

SEC. 21—The Secretary, appointed as prescribed in Article VII, Sect. 2 of the Constitution shall be paid a salary, the amount of which shall be determined by the Board of Directors.

BOARD OF DIRECTORS

SEC. 22—Meetings of the Board of Directors shall be held the first Wednesday of each month in the office of the Institute in New York City except that in July and August meetings may be omitted.

Minutes of all meetings of the Board of Directors shall be sent to each member of the Board of Directors.

INSTITUTE MEETINGS

SEC. 23—Meetings shall be held by the Institute on the first Wednesday of each month except July and August and at such other times and places as the Board of Directors may elect.

SEC. 24—There shall be one or more general conventions of the Institute each year. Regional conventions may also be held. The location and dates of all conventions shall be determined by the Board of Directors.

SEC. 25—The President shall appoint a Convention Committee for each convention. The duties of this committee shall consist in making all necessary local arrangements for the convention, in cooperation with the Secretary and the Papers Committee. The chairman of the Convention Committee shall appoint such subcommittees as he deems necessary, as, for example, Committees on Publicity, Finance, Technical Sessions, Inspection Trips, Entertainment Features, Hotel Arrangements, etc.

SECTIONS

SEC. 26—A petition for the formation of a Section shall be signed by not less than twenty-five (25) Fellows, Members, and Associates residing within the territorial limits hereinafter prescribed. The Board of Directors may decline to authorize the formation of a Section when in its judgment such an organization would not be compatible with the interests of the Institute.

SEC. 27—All Sections will conform to a Constitution for Sections provided by the Institute. The Constitution for Sections will be found following these By-Laws.

SEC. 28—In the initial Section organization only petitioners shall have the right to vote.

SEC. 29—A Section of the Institute may cooperate with other local organizations in the holding of joint meetings, and may invite members of such organizations and the public to its meetings.

SEC. 30—The territory of a Section shall include the locality naturally tributary thereto, but shall not include territory so remote or inaccessible that members cannot readily attend meetings. For the purpose of determining the maximum amount to which the Section is entitled under these By-Laws, points more than sixty miles from the regular meeting place of the Section shall not be considered a part of that Section, except that, when special conditions warrant such action, additional territory within a reasonable distance may be authorized by the Board of Directors, upon approval of the Sections Committee. If adjacent Sections are so situated that the sixty-mile limit embraces common territory, the question as to which Section may claim such members as reside within this common territory shall, if possible, be decided by agreement between the Sections concerned, otherwise by the Sections Committee.

SEC. 31—The Board of Directors may at any time terminate the existence of any Section when in its judgment the interests of the Institute make such action desirable.

SEC. 32—Papers and discussions presented before a Section shall be the property of the Institute, and may be published only on authorization by the Board of Editors.

SEC. 33—Each Section shall conduct its affairs in such a manner as to demand for its maintenance a minimum of financial support by the Institute consistent with the activities carried on by that Section.

The appropriation of Institute funds during any fiscal year for aid in Section maintenance shall be the sum determined as follows: Fifty cents for each Fellow, Member, and Associate residing within the territory of the Section at the beginning of the fiscal year, namely, January 1st, plus ten (\$10.00) dollars for each meeting up to and including the tenth meeting held during the year.

Sections shall have no authority to contract debts, pledge the credit, or in any way bind the Institute.

SEC. 34—Section Secretaries shall forward to the Secretary of the Institute a report of each meeting held by the Section for the presentation or discussion of papers, and on January 1st of each year a statement of the past year's accounts.

SECTION DELEGATES

SEC. 35—The Section delegates attending a convention shall be members of the Institute. The duties of these delegates shall be as follows:

a. To attend such meetings of the Sections Committee as may be held during the convention.

b. To exchange views and experiences in connection with Section activities and management and to make recommendations of an advisory nature upon such matters to the Board of Directors.

c. To exchange and discuss ideas regarding subjects for inclusion in technical programs of future Section meetings.

d. To advise the chairman of the Sections Committee at least sixty days in advance of the convention of questions of interest to the Institute Sections which, in their opinion, should be discussed by the delegates at the meetings of the Sections Committee during the convention. The chairman of the Sections Committee shall appoint a subcommittee of three, who with the chairman, ex-officio, shall prepare in advance of the convention a program of such questions for discussion.

e. Past chairmen or chairmen-elect of Sections, if in attendance at the convention, shall have the privilege of attending all meetings of the Sections Committee but each Section shall be entitled to one vote only, which shall be cast by the chairman of the Section or other official delegate of the Section.

STUDENTS

SEC. 36—Each application for enrollment as a Student shall be endorsed by a member of the faculty of the school which he attends.

SEC. 37—The period of Student enrollment shall not exceed three years, nor shall it extend more than one and one-half years beyond the date of award of the baccalaureate degree or leaving the university or technical school. The period of enrollment shall date from the first of January nearest the date of filing application.

SEC. 38—The annual fee paid by each Student shall be applied as a subscription to the PROCEEDINGS for the year covered by such payment.

SEC. 39—A Student changing his mailing address without notifying the Secretary shall be entitled to duplicate copies of the Proceedings when available upon payment of fifty cents each.

COMMITTEES AND THEIR DUTIES

SEC. 40—The standing committees to be appointed by the President shall include the following:

Admissions Committee
Awards Committee
Board of Editors
Constitution and Laws Committee
Membership Committee
New York Program Committee
Nominations Committee
Papers Committee
Publicity Committee
Section Committee
Standards Committee
Tellers Committee

The President shall appoint the members and designate the chairman of each committee, who shall select a Vice Chairman and a Secretary. Copies of minutes of all meetings and actions of committees shall be forwarded promptly by the committee secretary to the Secretary of the Institute for his file.

Standing committees shall serve from annual meeting to annual meeting.

The President or the Board of Directors may appoint additional members to any committee at any time.

SEC. 41—The Admissions Committee shall consist of five or more Fellows and Members of the Institute. The duties of this Committee are indicated in Article III of the Constitution and under "Membership" in the foregoing By-Laws.

SEC. 42—The Awards Committee shall consist of the Chairman of the Papers Committee, acting as Chairman, together with the Chairmen of the Constitution and Laws Committee, the Papers Committee of the previous year, and the Chairmen of such other committees as the Board of Directors may designate. This Committee shall recommend recipients for the awards established by the Institute in accordance with the details of procedure adopted by the Board of Directors.

SEC. 43—The Board of Editors shall consist of four or more appointed members and the Secretary ex-officio. The Chairman shall be selected from the Board of Directors.

This Committee shall have supervision of the PROCEEDINGS, and other publications of the Institute, including matters pertaining to the format of these publications, decisions regarding the publication of papers, discussions, and all other matter available for publication, and the formulation and carrying out of plans for bringing into practice the policies regarding Institute publications that may be determined from time to time by the Board of Directors.

SEC. 44—The Constitution and Laws Committee shall consist of five or more members of the Institute, one of whom is a lawyer. It shall consider and investigate all matters relating to the Constitution and By-Laws of the Institute, the duties and jurisdiction of its officers and committees, its legal status and responsibilities, and like legal and cognate questions referred to it by the Board of Directors for action thereon. The committee may consult legal and technical counsel with reference to any question before it.

SEC. 45—The Membership Committee shall consist of five or more members, and the chairmen of the Membership Committees of the Sections of the Institute, ex-officio.

This Committee shall bring the advantages of membership to the attention of desirable candidates for admission to the Institute. The Committee may enlist the cooperation of the Sections in its work or take such other measures as it may consider advisable to interest prospective members of the standing and qualifications specified for the various grades of membership.

SEC. 46—The New York Meetings Program Committee shall consist of five or more members and shall prepare the programs for New York meetings of the Institute.

SEC. 47—The Nominations Committee shall consist of five or more members who shall recommend to the Board of Directors on or before the May meeting of the Board of Directors, a list of nominees for the offices of President, Vice President, and three Directors.

SEC. 48—The Papers Committee of five or more members shall be appointed for their ability to obtain, examine, and select papers.

This Committee shall cooperate with the Convention Committees. The Committee shall receive and consider all papers and in addition shall arrange directly for papers relating to subjects within the scope of Institute activity.

SEC. 49—The Publicity Committee shall consist of five or more members and shall give such publicity through the public press of Institute activities as will contribute to the growth and usefulness of the Institute.

SEC. 50—The Sections Committee shall consist of five or more appointed members and the chairman of each Section, ex-officio, or his representative.

This Committee shall have the general supervisor and management of the Sections of the Institute. The Committee shall confer with the Section officers and it shall consider, investigate, and make reports and recommendations to the Board of Directors for action upon all matters regarding or involving the interests and welfare of Sections.

SEC. 51—The Standards Committee shall consist of ten or more members with such additional members as may be necessitated by the plan of organization adopted by the Standards Committee.

This Committee shall consider and investigate all matters relating to units and standards appertaining to or applicable in radio engineering and in the allied engineering arts and sciences. The committee shall make reports and recommendations to the Board of Directors for action thereon.

SEC. 52—The Tellers Committee shall consist of the Secretary and at least one Associate, one Member, and one Fellow.

SEC. 53—The functions of temporary committees shall be defined by the Board of Directors. At the beginning of each administrative year the Secretary shall transmit to all the members of each temporary committee whose duties may be continued, copies of the original resolutions constituting such temporary committee.

SEC. 54—Committees shall be listed in alphabetical order in Institute publications.

REPRESENTATIVES UPON JOINT COMMITTEES AND OTHER BODIES

SEC. 55—The Board of Directors may appoint representatives of the Institute upon joint committees, boards, and other local, national, and international bodies, for the purpose of bringing about closer cooperation between the Institute and other organizations. The terms of these representatives shall terminate on December 31st except where the terms are otherwise specified in the regulations of the body to which they are appointed.

SEC. 56—The Board of Directors may authorize payment of the expenses of any officer or member when that member is sent by the Board of Directors to represent the Institute. The Board of Directors, in carrying out the objects of the Institute, may authorize any officer(s) or member(s) to represent the Institute on any subject when the degree and time of representation is specified.

PAPERS AND DISCUSSIONS

SEC. 57—Preprints or reprints of any paper published by the Institute not exceeding 50 copies will be furnished, without covers, free of charge for the personal use of the author if requested within 30 days before the month of publication. Special covers will be charged for.

For reprints or preprints in excess of 50 copies, or when ordered later than specified above, a charge will be made.

SEC. 58—The President may invite any nonmember to discuss any paper presented at a meeting of the Institute, and the chairman of any Section may invite any nonmember to discuss any paper presented at the Section of which he is chairman.

SEC. 59—No paper or written contribution to a discussion shall be given to the press for publication in advance of its presentation except by authority of the Board of Directors. Abstracts may be given to the press by the Publicity Committee.

SEC. 60—No person shall receive monetary compensation from the reprinting of any paper or discussion presented before the Institute or before any Section without previous authorization from the Secretary, excepting such reprints as are supplied by the Institute. All copyrights belong to the Institute.

PUBLICATIONS

SEC. 61—The regular publications of the Institute shall include the PROCEEDINGS, to be published monthly.

SEC. 62—The PROCEEDINGS may have two principal divisions:

- a. For current matter and Institute news.
- b. For technical papers, discussions, and other matter of engineering character.

SEC. 63—The Secretary is authorized to receive annual subscriptions to the monthly PROCEEDINGS at the rate of \$10.00 per annum with an extra postage charge sufficient to cover the mailing cost to all countries to which the bulk rate of postage does not apply. A discount of fifty per cent from the subscription price of \$10.00 will be allowed to colleges, public libraries, and libraries of learned organizations or institutions of standing upon direct subscription to Institute headquarters. Members, publishers and subscription agencies may be allowed a discount of twenty-five per cent.

SEC. 64—A reinstated or new member shall be entitled to receive single copies of the PROCEEDINGS issued during the period covered by his payment of dues when copies are available, and shall be entitled to a rebate of twenty-five cents per copy when such PROCEEDINGS are not available.

SEC. 65—An alphabetical and geographical list of members shall be published annually. The grade of each member shall be indicated in either list, or both, by a difference in type or otherwise, at the Secretary's discretion. This list, usually in the form of a YEAR BOOK, shall be sent to all members without charge. The list of members shall be corrected to January 1st and mailed as soon thereafter as practicable.

PUBLICITY

SEC. 66—Officers and committees, who consider that publicity regarding any Institute activities under their jurisdiction should be given in the daily or technical press, are urged to prepare such announcements as they may deem desirable, which should then be forwarded, with recommendations, to the Secretary. The Secretary will promptly refer them to the Publicity Committee. If the Secretary or the Publicity Committee is in doubt as to the propriety of publication the question may be referred to the Board of Directors. If the subject is a matter of news, the news value may be retained by discussing the matter over the telephone with as many committee members as are available.

CONSTITUTION FOR SECTIONS

(NAME OF PLACE OR GEOGRAPHICAL DISTRICT SECTION OF)

THE INSTITUTE OF RADIO ENGINEERS

CONSTITUTION

ARTICLE I

NAME AND OBJECT

SEC. 1—This organization shall be known as the.....
Section of the Institute of Radio Engineers.

SEC. 2—The Section shall strive for the advancement of the theory and practice of radio engineering and of the allied arts and sciences, and the maintenance of a high professional standing among its members, all in consonance with the Constitution and By-Laws of the Institute and with special attention to such aims within the territory of the Section as are hereinafter defined.

SEC. 3—The Section shall aid in promoting close cooperation and good fellowship among its members and to this end shall hold meetings for the transaction of the regular business of the Section and for the presentation of papers and their discussion.

ARTICLE II

MEMBERSHIP

SEC. 1—All members of the Institute residing within the territory of the Section are automatically members of this Section. There shall be no other grades of membership.

SEC. 2—All Fellows, Members, and Associates of the Institute residing within the territory of the Section shall be entitled to attend meetings, vote, and hold office.

SEC. 3—Junior and Student members of the Institute shall be entitled to attend meetings but shall not have the right to vote or hold office.

ARTICLE III

TERRITORY

SEC. 1—The territory of the Section shall comprise (counties and State or States).

ARTICLE IV

DUES

SEC. 1—There shall be no Section dues.

CONSTITUTION

SEC. 2—The ordinary expenses of the Section shall be defrayed by the funds supplied by the Institute.

SEC. 3—Emergency or extraordinary expenses may be provided for by voluntary contributions from the membership of the Section. A unanimous vote of the Executive Committee is required before such a request may be made.

ARTICLE V

OFFICERS

SEC. 1—The officers of the Section shall be a Chairman, a Vice Chairman and a Secretary-Treasurer.

SEC. 2—Terms of all officers shall be for one year beginning at the close of the annual meeting at which election is held and continuing until their successors are duly elected and take office.

ARTICLE VI

MANAGEMENT

SEC. 1—There shall be an Executive Committee consisting of the officers, the Junior Past Chairman, the Chairman of the Meetings and Papers Committee, the Chairman of the Membership Committee, the Chairman of the Publicity Committee, and, if desired by the Executive Committee, one additional member to be appointed by the Chairman.

SEC. 2—The Chairman, responsible to the Executive Committee, shall have general supervision of the affairs of the Section. He shall preside at meetings of the Section and the Executive Committee and have such other powers and perform such other duties as may be provided for in the By-Laws, or as may be delegated to him by vote of the Section. In his absence his duties shall be performed by the Vice Chairman.

SEC. 3—The Secretary-Treasurer shall receive and deposit all monies in the name of the Section in such depository as shall be determined by the Executive Committee. He shall make only such disbursements as shall be ordered by the Executive Committee.

SEC. 4—The Secretary-Treasurer shall send out notices, prepare the agenda for, and record the minutes of all meetings of the Section and of the Executive Committee. He shall make such reports of his activities as may be required by the Executive Committee of the Institute.

SEC. 5—The Chairman, as soon as expedient after the annual meeting, shall appoint the following standing committees:

Meetings and Papers Committee
Membership Committee
Publicity Committee

Members appointed shall serve until their successors are appointed or the committee dissolved.

Other Committees may be authorized by vote of the Section at any regular meeting, and shall be appointed by the Chairman of the Section.

ARTICLE VII

NOMINATION AND ELECTION OF OFFICERS

SEC. 1—All officers shall be elected at the annual meeting of the Section upon nomination by a nominating committee of three members not then officers of the Section, duly appointed by the Chairman of the Section two months before the annual meeting. These nominations shall be announced in the notice of the annual meeting. Nominations may also be made from the floor.

SEC. 2—Vacancies in office occurring during the year shall be filled by the Executive Committee for the remainder of the unexpired term unless otherwise provided for.

SEC. 3—If for any reason the best interests of the Section seem to require a change in the governing body during the year, the matter shall be duly and carefully considered by the Executive Committee. Upon not less than two-thirds vote of the Executive Committee, or upon receipt by the Executive Committee of a petition signed by fifteen (15) members of the Section, recommendation shall be made to the Section for action at a special meeting to be duly called by the Executive Committee for the sole purpose of considering and voting upon such a change.

A two-thirds vote of the members present shall be necessary to declare an office vacant. Upon a two-thirds vote of the members present the vacant office may be filled for the unexpired term upon nomination from the floor.

ARTICLE VIII

MEETINGS

SEC. 1—The Section shall not hold less than five regular meetings during the year, one of which shall be an annual meeting.

SEC. 2—These meetings shall be held at some specific time in the year as prescribed in the Section By-Laws.

SEC. 3—The fiscal year of the Section shall correspond with the fiscal year of the Institute. (Calendar year.)

SEC. 4—Fifteen members shall constitute a quorum at all meetings of the Section called for the transaction of regular business and requiring a vote to be taken.

SEC. 5—A plurality vote of the members present is necessary for the election of officers.

SEC. 6—Meetings of the Executive Committee shall be held at such times as shall be found necessary. Executive Committee meetings may be called by the Chairman of the Section at his own discretion or shall be at the request of three members of the committee.

SEC. 7—Four members shall constitute a quorum at all meetings of the Executive Committee except as otherwise provided herein.

SEC. 8—A majority vote of the Executive Committee shall be necessary, in the conduct of its business except as otherwise provided in this Constitution or in the Section By-Laws.

SEC. 9—The Secretary-Treasurer shall send out notices of all regular Section meetings to all Institute members in the territory of the Section at least one week prior to the date of meeting. These notices shall contain a full statement of the time, place, and business of the meeting.

ARTICLE IX

AMENDMENTS

SEC. 1—This Constitution may be amended by a two-thirds vote of all members present at any annual meeting of the Committee on Sections provided that notices of the proposed meeting and the proposed change has been sent to all members of the Committee on Sections at least one month in advance of the meeting. Such action shall be subject to the approval of the Board of Directors of the Institute.

SEC. 2—In the event of absence of any member of the Committee on Sections, he may vote by proxy on amendments to this constitution.

SEC. 3—Suitable By-Laws to this constitution may be adopted by a two-thirds vote of the Section provided they are consonant with the Constitution and By-Laws of the Institute and this Constitution. A copy of these By-Laws shall be filed in the Institute office.

ANNUAL MEETINGS

The annual meeting at which officers for the succeeding year are elected is usually a regular monthly meeting. The particular month chosen by each of the Sections is tabulated below.

Sections	Month
Atlanta	January
Boston	December
Buffalo-Niagara	June
Chicago	December
Cincinnati	December
Cleveland	December
Connecticut Valley	Last regular meeting of calendar year
Detroit	December
Los Angeles	December
New Orleans	June
Philadelphia	June
Pittsburgh	May
Rochester	Last spring meeting
San Francisco	June
Seattle	December
Toronto	May
Washington	December

INDEX TO CONSTITUTION AND BY-LAWS

Roman numerals refer to Articles; arabic numerals, to Sections; and numbers in parentheses, to By-Laws.

Abbreviations.....	(1)
Improper Use of.....	(3)
Admission.....	III, 1, 2
Committee.....	(5) (40) (41)
Objection to.....	(10)
Allied arts.....	(10)
Amendments, By-Laws.....	VII, 3
Constitution.....	X, 1
Ballot.....	X, 2
Effective Date.....	X, 3
File.....	X, 5
Publication.....	X, 4
Applications.....	III, 1
Change of grade.....	(0)
Published.....	(7)
Renewal.....	III, 3
Associate, Abbreviation.....	(1)
Dues.....	IV, 1
Entrance Fee.....	IV, 1
Privileges.....	II, 1
When Obtained.....	(11)
Requirements.....	II, 4
Sponsors.....	(4)
Transfer Fee.....	IV, 1
Awards Committee.....	(40) (42)
Badges, Improper Use of.....	(3)
Board of Directors.....	V, 1
Chairman.....	VI, 1
Duties.....	VI, 2
Meetings.....	VIII, 5, (22)
Annual.....	VIII, 1
Minutes of.....	(22)
Quorum.....	VI, 2
Board of Editors.....	(40) (43)
By-Laws.....	VI, 3
Committees, Appointment of.....	VI, 6, (40)
Listing in Publications.....	(54)
Secretaries.....	(40)
Standing.....	(40)
Temporary.....	(53)
Terms of Members.....	(40)
Vice Chairmen.....	(40)
Constitution, Nonretroactive.....	II, 8
and Laws Committee.....	(40) (44)
Conventions.....	(24)
Committees.....	(25)
Directors.....	V, 1
Appointed.....	V, 4
Elected.....	V, 3
Vacancies.....	V, 5
Dues.....	IV, 1
Arrears.....	(17)
Notice of.....	(18)
Waived.....	IV, 3
When Payable.....	IV, 2
Election of Officers.....	VII
Expenses of Representatives.....	(56)
Expulsions.....	III, 5
Entrance Fee.....	IV, 1
Election, Notification of.....	(12)
Fiscal Year.....	VI, 7
Fellow, Abbreviation.....	(1)
Dues.....	IV, 1
Entrance Fee.....	IV, 1
Privileges.....	II, 1
When Obtained.....	(11)
Requirements.....	II, 2
Sponsors.....	(4)
Transfer Fee.....	IV, 1
Junior, Abbreviation.....	(1)
Dues.....	IV, 1
Entrance Fee.....	IV, 1
Privileges.....	II, 1
When Obtained.....	(11)
Requirements.....	II, 5
Sponsors.....	(4)
Transfer Fee.....	IV, 1
Management.....	VI
Meetings.....	VIII, (23)
Annual.....	VIII, 2, 3
Member, Abbreviation.....	(1)
Dues.....	IV, 1
Entrance Fee.....	IV, 1
Privileges.....	II, 1
When Obtained.....	(11)
Requirements.....	II, 3
Sponsors.....	(4)
Terminology.....	(2)
Transfer Fee.....	IV, 1
Membership, Grades.....	II, 1
List.....	(65)
Alphabetical.....	(65)
Geographical.....	(65)
Claims.....	(16)
Committee.....	(9) (40) (45)
Limitations.....	(15)
School Credit.....	II, 7
Use of Term.....	II, 9
Name.....	I, 1
New members, Notification to.....	III, 4
New York Program Committee.....	(40) (46)
Nomination.....	VII
Committee.....	(20) (40) (47)
Object.....	I, 2
Officers.....	V, 1
Appointment.....	VII, 2
Election.....	VII, 1
Nomination.....	(20)
Salary.....	V, 6
Terms.....	V, 2
Papers, Committee.....	(40) (48)
Discussion.....	(58)

Preprints.....	(57)
Presented.....	(32)
Publication Elsewhere.....	(32)
Publicity for.....	(50)
Reprints.....	(60)
President.....	V, 1
Duties.....	VI, 1
PROCEEDINGS.....	(61)
Back Copies for Students.....	(39)
Discounts.....	(63)
Material.....	(62)
Subscriptions.....	(63)
Publications.....	(61)
Publicity.....	(66)
Advance.....	(59)
Committee.....	(40) (49)
Reinstatement, Delinquent.....	(14)
Publications Obtainable.....	(64)
Resigned.....	(13)
Representatives on Other Bodies.....	(55)
Reprints.....	(60)
Resignations.....	III, 6
Secretary.....	V, 1
Duties.....	VI, 5
Salary.....	(21)
Sections.....	IX
Appropriation.....	(33)
Committee.....	(40) (50)
Constitution.....	(27)
Cooperation.....	(29)
Debts.....	(33)
Delegates.....	(35)
Finances.....	(33)
Formation.....	IX, 1
Membership.....	IX, 2
Organization.....	(23)
Papers.....	(32)
Petition.....	(26)
Secretaries.....	(34)
Termination.....	IX, 3 (31)
Territory.....	(30)
Sponsors.....	(4)
Waived.....	(4)
Standards Committee.....	(40) (51)
Student, Abbreviation.....	(1)
Back Copies of PROCEEDINGS.....	(39)
Dues.....	IV, 1 (38)
Entrance Fee.....	IV, 1
Mailing Address.....	(39)
Period of Enrollment.....	(37)
Privileges.....	II, 1
When Obtained.....	(11)
Requirements.....	II, 6
Sponsors.....	(4) (30)
Symbols, Improper Use of.....	(3)
Transfer, Fee.....	IV, 1
Objection to.....	(10)
Recommended.....	(8)
Tellers Committee.....	(40) (52)
Treasurer.....	V, 1
Duties.....	VI, 4
Vice President.....	V, 1
Duties.....	VI, 1
YEAR BOOK.....	(65)

INDEX TO SECTION CONSTITUTION AND BY-LAWS

Roman numerals refer to Articles; arabic numerals, to Sections; and numbers in parentheses, to By-Laws.

Amendments.....	IX, 1
Vote on.....	IX, 2
Annual Meeting.....	VII, 1
Associates, Privileges of.....	II, 2
By-Laws.....	IX, 3
Filed.....	IX, 3
Vote on.....	IX, 3
Chairman.....	V, 1, VI, 2
Committees.....	VI, 5
Temporary.....	VI, 5
Terms of.....	VI, 5
Dues.....	IV, 1
Election, Officers.....	VII, 1
Executive Committee.....	VI, 1
Meetings.....	VIII, 6
Quorum.....	VIII, 7
Vote.....	VIII, 8
Expenses, Extraordinary.....	IV, 3
Ordinary.....	IV, 2
Fellows, Privileges.....	II, 2
Fiscal Year.....	VIII, 3
Junior Past Chairman.....	VI, 1
Juniors, Privileges.....	II, 3
Management.....	VI
Meetings.....	I, 3, VIII, 1
Executive Committee.....	VIII, 6
Notices of.....	VI, 4, VIII, 9
Special.....	VII, 8
Time of.....	VIII, 2
Quorum for.....	VIII, 4
Membership.....	II, 1
Privileges.....	II, 2
Name.....	I, 1
Nomination, Officers.....	VII, 1
Object.....	I, 2
Officers.....	V, 1
Change of.....	VII, 3
Election.....	VII, 1, VIII, 6
Nomination.....	VII, 1
Terms of.....	V, 2
Vacated.....	VII, 2
Secretary-Treasurer.....	V, 1, VI, 3, VIII, 9
Students, Privileges.....	II, 3
Territory.....	III, 1
Treasurer.....	V, 1, VI, 3, VIII, 9
Vice Chairman.....	V, 1

SECTIONAL COMMITTEE ON RADIO AMERICAN STANDARDS ASSOCIATION

THE conception of the American Standards Association was made in 1919 by a group of technical societies, who took the initiative to establish an authoritative channel through which nationally acceptable standards might be promulgated. The organization formed was first known as the American Engineering Standards Committee, and its purpose was to serve as a clearing house through which trade associations, technical societies, or governmental departments might develop national standards. In 1929 the Committee was reorganized to include a broader industrial scope and its name was changed to the American Standards Association.

The ASA is now essentially a federation of forty-five national technical societies, trade associations, and Federal Government departments. Under its procedure, standards on practically any subject may be initiated by any responsible, authoritative group. The organization of the ASA is such as to provide adequate means for the appointment, by the various groups concerned, of broadly representative committees whose function it is to study and formulate standards. Since these committees, known as Sectional Committees, are made up of individuals officially appointed by the organizations concerned with the subject under consideration, there is assurance, when the preponderance of committee opinion is favorable, that the standard recommended by the Sectional Committee has the extensive approval necessary to make it an American Standard.

In December, 1922, the A.E.S.C. received a request from the National Bureau of Standards asking that a Sectional Committee on Radio be formed for the purpose of establishing standards in the field of radio communication. A conference for the discussion of the project was held in January 1923, and upon the recommendation of the representatives attending this conference, joint sponsorship for the Sectional Committee on Radio was assigned to the Institute of Radio Engineers and the American Institute of Electrical Engineers.

In July, 1929, a standard covering dimensions and arrangements of terminals on four-prong vacuum tube bases was submitted to the American Standards Association and approved as an American Tentative Standard.

In October, 1929, a meeting was held to reorganize the work of the Committee and to apportion the work among four technical committees. Dr. Alfred N. Goldsmith was elected chairman, and Dr. C. H.

Sharp, vice chairman of the Committee. The details confronting the Sectional Committee were assigned to the Technical Committee on Transmitters and Parts, under the chairmanship of Haraden Pratt; the Technical Committee on Radio Receivers and Parts, under the chairmanship of V. M. Graham; the Technical Committee on Vacuum Tubes, under the chairmanship of J. C. Warner; and the Technical Committee on Electro-Acoustic Devices, under the chairmanship of Irving Wolff. The division of the work before the Sectional Committee, into four groups corresponding to the four technical committees provided a satisfactory set-up for the establishing of standards on radio matters. During 1930 and the early part of 1931 these four technical committees worked in close cooperation with the similar technical committees of the I.R.E. Committee on Standardization, and during June, 1931, a 44-page pamphlet on "Proposed American Standards on Radio" was forwarded to the members of the Sectional Committee on Radio for ballot vote. The material contained in the "Proposed American Standards on Radio" was based principally on the standards set up by the Institute of Radio Engineers and Radio Manufacturers Association, and contained "Standard Definitions of Terms Used in Radio", "Standard Tests of Broadcast Radio Receivers", "Standard Vacuum Tube Base and Socket Dimensions", and "Manufacturing Standards Applying to Broadcast Receivers".

On November 18, 1931, a meeting of the Sectional Committee was held and the "Standard Vacuum Tube Base and Socket Dimensions" and "Manufacturing Standards Applying to Broadcast Receivers" appearing in the following sixteen pages were unanimously approved by the Committee. Since then this material has been approved by both sponsor bodies and now awaits final approval by the American Standards Association before its adoption as an American Standard.

STANDARD VACUUM TUBE BASE AND SOCKET DIMENSIONS

SMALL FOUR-PIN BASE

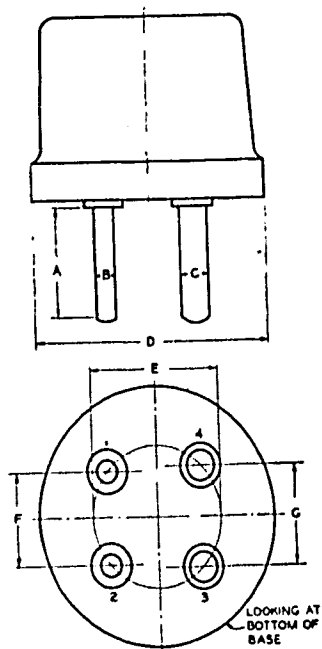

	Nominal	Min.	Center	Max.
A. Length of Pins	1/2 in.	0.122 in.	0.125 in.	0.128 in.
B. Diameter of Small Pins		0.153 "	0.156 "	0.159 "
C. Diameter of Large Pins	1 1/16 "			
D. Diameter of Base			0.640 "	
E. Diameter of Pin Circle			0.437 "	
F. Spacing Between Small Pins			0.468 "	
G. Spacing Between Large Pins				
Pins are rigid, not split.				

STANDARD VACUUM TUBE DIMENSIONS

LARGE FOUR-PIN BASE WITH BAYONET PIN

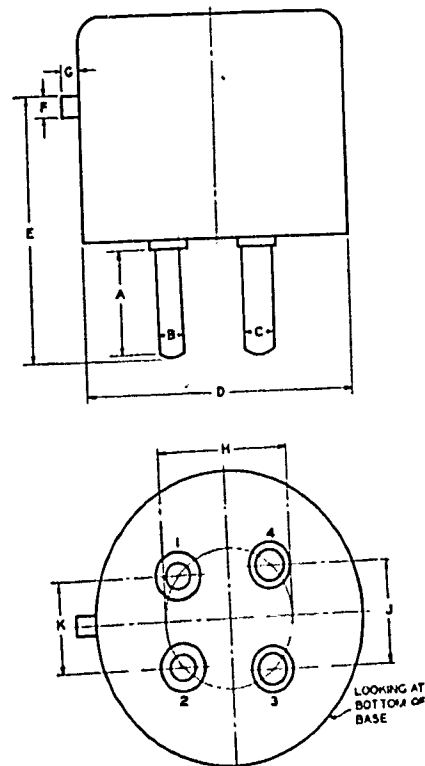

	Nominal	Min.	Center	Max.
A. Length of Pins	1/2 in.	0.122 in.	0.125 in.	0.128 in.
B. Diameter of Small Pins		0.153 "	0.156 "	0.159 "
C. Diameter of Large Pins				1.377 "
D. Diameter of Base				
E. Distance from Top of Bayonet Pin to Bottom of Contact Pin	1 1/16 "			0.080 "
F. Diameter of Bayonet Pin				0.078 "
G. Length of Bayonet Pin			0.640 "	
H. Diameter of Pin Circle			0.468 "	
J. Spacing Between Large Pins			0.437 "	
K. Spacing Between Small Pins				
Pins are rigid, not split.				

LARGE FOUR-PIN BASE, WITHOUT BAYONET PIN

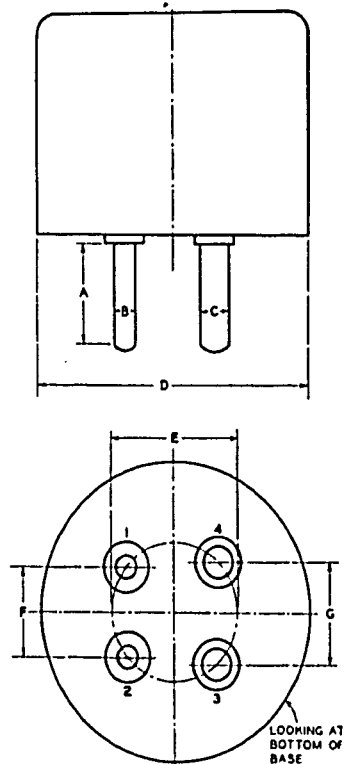

- A. Length of Pins
 B. Diameter of Small Pins
 C. Diameter of Large Pins
 D. Diameter of Base
 E. Diameter of Pin Circle
 F. Spacing Between Small Pins
 G. Spacing Between Large Pins
 Pins are rigid, not split.

	Nominal $\frac{1}{2}$ in.	Min.	Center	Max.
A.		0.122 in.	0.125 in.	0.128 in.
B.		0.153 "	0.156 "	0.159 "
C.			0.640 "	1.377 "
D.			0.437 "	
E.			0.468 "	
F.				
G.				

LARGE FIVE-PIN BASE

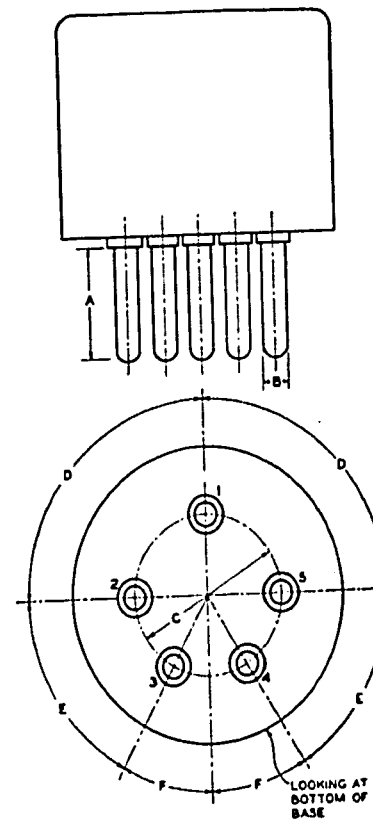

- | | Nominal
$\frac{1}{2}$ in. | Min. | Center | Max. |
|----|------------------------------|-----------|-----------|-----------|
| A. | | 0.122 in. | 0.125 in. | 0.128 in. |
| B. | | | 0.750 " | |
| C. | | | 90 deg. | |
| D. | | | 60 " | |
| E. | | | 30 " | |
| F. | | | | |
- Pins are rigid, not split.

TERMINAL CAP

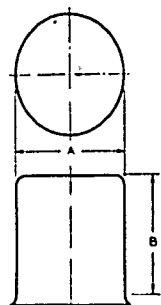

TERMINAL CAP FOR RECEIVING TUBES

	Nominal	Min.	Center	Max.
A. Diameter of Cap		0.346 in.	0.358 in.	0.370 in.
B. Length of Cap	1/8 in.			

TERMINAL CAP FOR TRANSMITTING TUBES

	Nominal	Min.	Center	Max.
A. Diameter of Cap		0.550 in.	0.563 in.	0.576 in.
B. Length of Cap	1/2 in.			

FOUR-PIN TRANSMITTING TUBE BASE

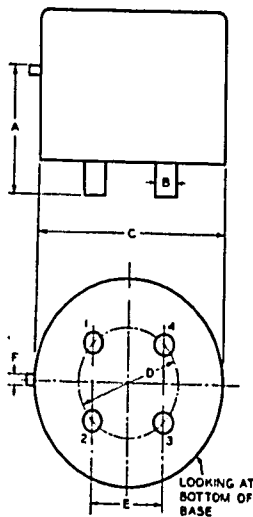

	Nominal	Min.	Center	Max.
A. Distance from Top of Bayonet Pin to Bottom of Contact Pins		1.146 in.	1.165 in.	1.184 in.
B. Diameter of Pins	1/16 in.			
C. Diameter of Base				1.867 "
D. Diameter of Pin Circle			0.972 "	
E. Spacing Between Pins			0.687 "	
F. Diameter of Bayonet Pin		0.078 "	0.080 "	0.082 "

Pins are rigid, not split.

LARGE TRANSMITTING TUBE BASE

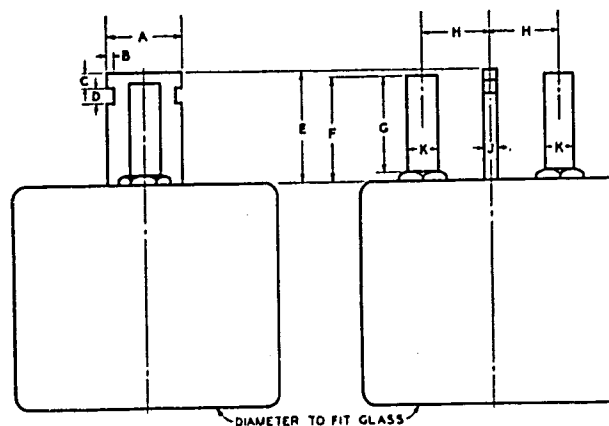

	Nominal
A. Width of Flat Pin	3/4 in
B. Depth of Slot	1/16 "
C. Distance from End of Slot to End of Flat Pin	1/8 "
D. Width of Slot	1/8 "
E. Distance from End of Flat Pin to Shell	1 1/32 "
F. Distance from End of Round Pin to Shell	2 1/32 "
G. Length of Round Pins	7/8 "
H. Spacing Between Pins	1 1/16 "
J. Thickness of Flat Pin	1/8 "
K. Diameter of Round Pins	5/16 "

Round pins are rigid, not split.

TERMINAL CAP OF LARGE TRANSMITTING TUBE

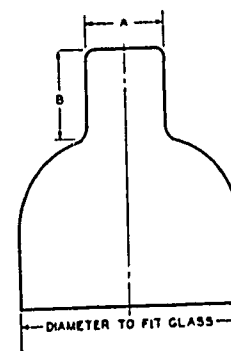

	Nominal
A. Diameter of Contact	11/64 in.
B. Length of Contact	13/16 "

FOUR-PIN SOCKET FOR RECEIVING TUBES

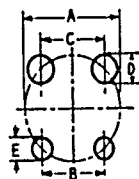

	<i>Min.</i>	<i>Center</i>	<i>Max.</i>
A. Diameter of Pin Circle		0.640 in.	
B. Spacing Between Small Pins	0.435 in.	0.437 "	0.440 in.
C. Spacing Between Large Pins	0.465 "	0.468 "	0.471 "
D. Diameter of Large Pins	0.173 "	0.176 "	0.179 "
E. Diameter of Small Pins	0.142 "	0.145 "	0.148 "

FIVE-PIN SOCKET FOR RECEIVING TUBES

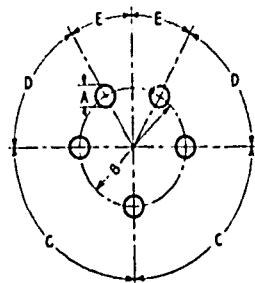

	<i>Min.</i>	<i>Center</i>	<i>Max.</i>
A. Diameter of Pins	0.142 in.	0.145 in.	0.148 in.
B. Diameter of Pin Circle		0.750 "	
C. Angular Separation of Pins 1-2 and 1-5		90 deg.	
D. Angular Separation of Pins 2-3 and 4-5		60 deg.	
E. Angular Separation Between Center Line and Pins 3 and 4		30 deg.	

STANDARD CONNECTIONS FOR
VACUUM TUBE BASES

In directly-heated receiving triodes, it shall be standard to connect the grid to pin 1, the plate to pin 2, and the filament terminals to pins 3 and 4 of the standard four-pin base.

In indirectly-heated receiving triodes, it shall be standard to connect the grid to pin 1, the plate to pin 2, the heater terminals to pins 3 and 4, and the cathode to pin 5 of the standard five-pin base.

In the directly-heated full-wave hot-cathode rectifying tube, it shall be standard to connect the anodes separately to pins 1 (grid) and 2 (plate) and the filament terminals to pins 3 and 4 of the standard four-pin base.

In a directly-heated half-wave hot-cathode rectifying tube, it shall be standard to connect the anode to pin 2 (plate), and the filament terminals to pins 3 and 4 of the standard four-pin base.

In the directly-heated receiving screen-grid tube, it shall be standard to connect the screen grid to pin 1 (grid), the plate to pin 2 (plate), and the filament terminals to pins 3 and 4 of the standard four-pin base. The control grid is to be connected to the cap at the top of the envelope.

In the indirectly-heated receiving screen-grid vacuum tube, it shall be standard to connect the screen grid to pin 1 (grid), the plate to pin 2 (plate), the heater terminals to pins 3 and 4 (heater), and the cathode to pin 5. The control grid is connected to the cap at the top of the envelope.

MANUFACTURING STANDARDS APPLYING TO BROADCAST RECEIVERS

1. **Battery Operated Radio Receiver.** A radio receiver designed to operate from primary and/or storage batteries shall be known as a battery operated radio receiver.
2. **Socket-Powered Radio Receivers.** A radio receiver of the battery operated type, when connected to a power unit operating from the electric light line, supplying both filament and plate potentials to the tubes of the receiver, shall be known as a socket-powered radio receiver.
3. **Electric Radio Receiver.** A radio receiver operating from the electric light line, with a built-in power unit, shall be known as an electric radio receiver.
4. **A-C Electric Radio Receiver.** An electric radio receiver employing tubes which obtain their operating power from an alternating-current electric light line shall be known as an a-c electric radio receiver.
5. **D-C Electric Radio Receiver.** An electric radio receiver employing tubes which obtain their operating power from a direct-current electric light line shall be known as a d-c electric radio receiver.
6. **Selector (Station Selector.)** The manual adjustment means by which the user of a broadcast receiver is enabled to bring one or more of its circuits into resonance with any desired signal within the range of the receiver. There are three general methods of manual station selection. In these the mechanical means used in any of the three methods may consist of direct connected drives, with or without auxiliary close adjustment means, or may consist of close adjustment means only.
Note—The use of the word "control" as applying specifically to manual tuning adjustments is not approved.
7. **Multiple Selector.** That method of manual tuning adjustment in which mechanical means are provided for setting independently each of two or more tuned circuits or groups of tuned circuits to resonance at any frequency within the range of the device.
8. **Master Selector.** That method of manual tuning adjustment in which one mechanical means is used to bring all the tuned circuits simultaneously into approximate resonance with any desired fre-

quency within the range of the device, and additional auxiliary means are provided to bring one or more of the tuned circuits into exact resonance.

9. **Single Selector.** That method of manual tuning adjustment in which one and only one mechanical means is provided to the user for bringing all tuned circuits into practical resonance at any desired frequency within the range of the receiver, there being no additional separate means for resonance adjustment and no other controls which appreciably affect the calibration of the single selector.
10. **Direct Selectors.** Direct selectors are those in which the motion ratio between the knob, dial, or other actuating means and the device is unity.
11. **Close Selectors.** Close selectors are those in which the motion ratio between the knob, dial, or other actuating means and the driven device is greater than unity.
Note—The auxiliary tuning adjustments in master selector arrangements will ordinarily be "close" in their effect and may be so referred to regardless of the actual mechanical motion ratio which they employ.
12. **Volume Control.** The manual adjusting means by which the user of a broadcast receiver is enabled to adjust the sound volume delivered by the sound reproducing device on any signal input, within limits depending on the strength of the signal and the sensitivity of the receiver and the sound reproducing device.
13. **Range Control.** The manual adjusting means by which the user of a broadcast receiver may produce changes in the circuit to obtain two or more degrees of sensitivity. This may also be called "local-distance switch."
14. **On-Off Switch.** The manual means for connecting and disconnecting a source or sources of power which are supplied to the receiver.
15. **On-Off Switches.** When the lever of an "on-off" switch in a radio receiver operates with an up-and-down motion it shall be standard to have the "up" position for "on."
When the lever of an "on-off" switch in a radio receiver operates in a horizontal plane it shall be standard to have the "on" position to the right facing the switch.
When an "on-off" switch of the push-pull type is used in a radio receiver it shall be standard to have the "out" position for "on."
When an "on-off" switch of a radio receiver operates with a rotary motion with a limited angular movement of the knob, it shall be

standard to reach the "on" position with clockwise rotation of the knob and to reach the "off" position with counterclockwise rotation.

When an "on-off" switch of a radio receiver operates with a rotary motion in one direction reaching "on" and "off" positions alternately, it shall be standard to have the knob rotate in a clockwise direction.

16. **Broadcast Receivers—Frequency Range.** The frequency range of standard broadcast receivers shall be the broadcast frequency band from 550 kilocycles (545.1 meters) to 1500 kilocycles (199.9 meters).

17. **Design and Rating of Socket Power Devices and Electric Radio Receivers.** It shall be standard to rate and design socket-power devices and electric radio receivers for operation on voltages from 105 to 125 volts.

When means for adapting a socket power device or electric radio receiver to the line voltage is provided, it shall be standard to design the low range from 105 to 115 volts and the high range from 115 to 125 volts. Normal rating for the low range will be 110 volts and for the high range 120 volts.

18. **Nomenclature—Antenna Parts.** The standard nomenclature to apply to broadcast radio receiving antenna parts shall be as follows:

(a) Antenna wire.

(b) Lead-in wire.

That wire extending from an outdoor antenna to a window lead-in strip, or through a wall insulation directly to the radio set.

(c) Ground wire.

1. Receiver ground wire.
2. Protective ground wire.

The ground wire shall be separately designated as to whether the wire shall run from the receiving set ground binding post to a grounded fixture within the building or whether it run from the receiving set to the outdoor ground, as the conductor may be different.

(d) Insulation.

1. Antenna insulator.
2. Lead-in insulator.
3. Wall insulator.

(e) Ground clamp.

(f) Lead-in connector.

This is the device which is used to fasten or connect the lead-in wire to the antenna wire.

(g) Protective device.

This refers to the lightning arrester, regardless of type.

(h) Supporter of antenna.

This refers to any mast or other rigging to which the antenna wire is attached.

19. **Antenna Installation Instructions.** It shall be standard for manufacturers of receiving sets requiring an outside antenna and for manufactures of outside antenna material sold in unit packages to include in the instruction book or instruction card accompanying the radio receiving set or antenna unit package, reasonably complete instructions for erecting the antenna containing two statements, one cautioning the user that the installation should be made in accordance with these instructions and in accordance with the National Electrical Code and the National Electrical Safety Code, and the other as follows: When erecting the antenna be careful not to allow any wire or rope to come in contact with any electric power or light wires. Such contact is DANGEROUS.

20. **Soldering Tests—Cord Terminals.** The standard test for quality of soldering of cord tips or terminals to radio cords shall be a straight pull of 5 pounds applied to the cord tip or terminal.

21. **Cord Tip—Cylindrical Type.** The standard cylindrical type cord tip for use on the ends of cords connecting to headsets and loud speakers, where concealed binding post connections are employed in the headset or loud speaker, shall have the following dimensions:

Dimension	Minimum in inches	Tolerance in inches	Maximum in inches
A	0.3125 ($\frac{5}{16}$)	0.0625 ($\frac{1}{16}$)	0.375 ($\frac{3}{8}$)
B	0.151	0.010	0.161
C			0.20 (No. 31 D. G.)
D			$\frac{1}{16}$

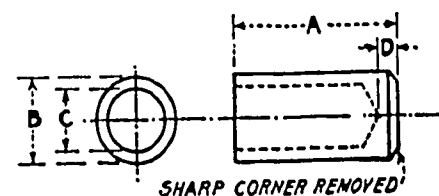

22. **Cord Tip—Pin Type.** The standard cord tip for use on the plug or receiving set end of headset and loud speaker cord conductors shall be of the pin type with important dimensions as listed in the following table:

Dimension	Minimum in inches	Tolerance in inches	Maximum in inches
A	0.9580	0.0620	1.0200
B	0.4900	0.0200	0.5100
C	0.4680	0.0420	0.5100
D	0.1510	0.0100	0.1610
E	0.0800	0.0020	0.0820
F			0.120 (No. 31 D. G.)
G			$\frac{7}{16}$

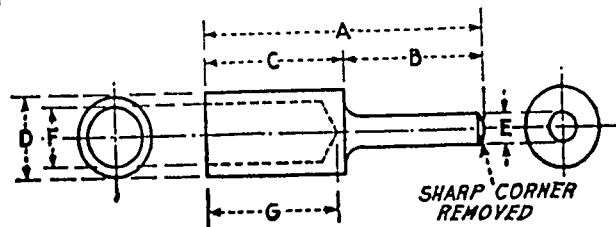

23. **Binding Posts—Drilling Dimensions.** Standard dimensions for the cord tip openings and the fastening screw locations of binding posts to accommodate the standard pin and cylindrical types of cord tip are as follows:

FOR PIN TYPE CORD TIPS:

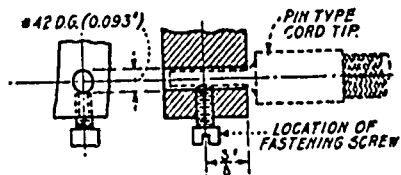

FOR CYLINDRICAL TYPE CORD TIPS:

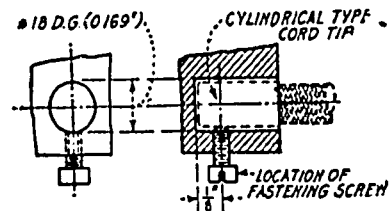

24. **Cable Terminal—Spade Type.** The standard cable terminals for the outer end of battery connecting conductors on radio receiving sets shall have the following dimensions:

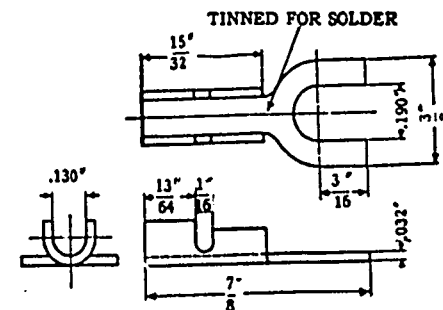

(This terminal is designed for use with binding posts having No. 8-32 or No. 6-32 screws and can be used with spring-type battery connecting clips.)

25. **Radio Plugs—Dimensions.** The important dimensions of standard radio plugs for use in connection with the standard radio spring jacks are as follows:

Dimension	Minimum in inches	Tolerance in inches	Maximum in inches
A	1.179	0.020	1.199
B			0.959
C			0.863
D	0.248	0.002	0.250
E	0.243	0.002	0.245
F	$\frac{3}{16}$		

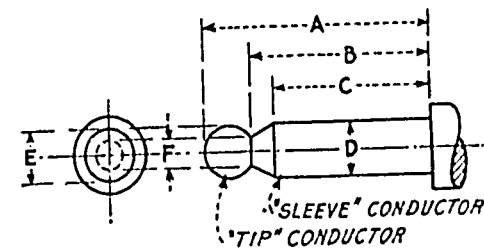

26. **Radio Jacks—Dimensions.** The important dimensions of standard radio spring jacks for use in connection with the standard radio plugs are as follows:

Dimension	Minimum in inches	Tolerance in inches	Maximum in inches
A	1.000	0.040	1.040
B	0.770	0.020	0.790

C	0.2515	0.0015	0.2530
D	0.020	0.010	0.030
E	0.030	0.010	0.040
F			0.450
G	$\frac{1}{8}$		$\frac{1}{4}$

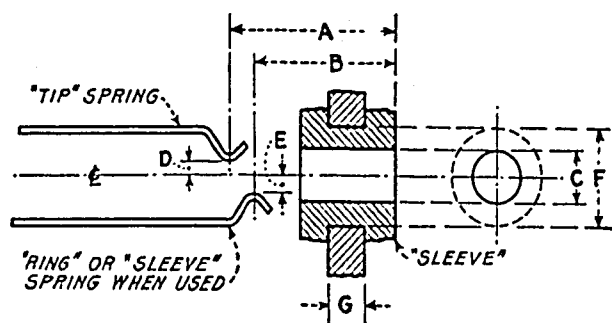

27. Pilot Lamp, Radio Receiver—Base. The standard base for an incandescent lamp to be used for receiver panel illumination shall be the standard miniature screw base, as shown in standard 28 below, with additional important dimensions as follows:

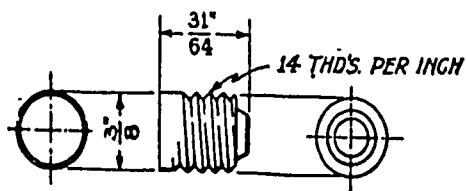

28. Edison-Type Screw Shells, Miniature Size—Standard Form and Dimensions

Diameter Dimensions.

	Lamp Holder Shell	Lamp Base Shell
"Go" gauge, top of thread	0.3775 in.	0.3750 in.
"Not Go" gauge, top of thread	0.3835 in.	0.3700 in.
"Go" gauge, bottom of thread	0.3375 in.	0.3350 in.
"Not Go" gauge, bottom of thread	0.3435 in.	0.3300 in.
Threads per inch	14	14
Depth of thread	0.020 in.	0.020 in.

Form of Thread

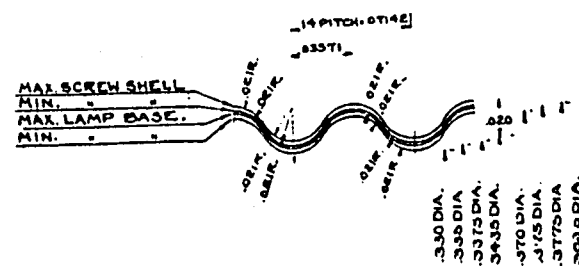

STANDARD FOR MINIATURE SCREW SHELL AND LAMP BASE.

29. Pilot or Panel Lamp—Radio Receiver. The standard radio receiver pilot lamp shall have the following dimensions:

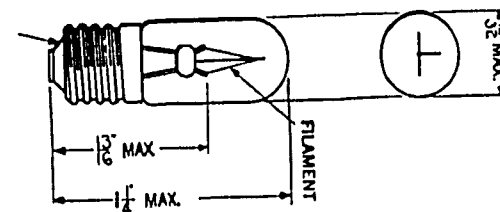

30. Magnetic Pick-up Jack—Connection. When a jack is used for connecting a magnetic pick-up into the input of the audio amplifier of a radio receiving set, it shall be standard to have the sleeve of the jack grounded or connected to the low side of the circuit.

CATALOG *of* MEMBERSHIP

ARRANGED ALPHABETICALLY

and

GEOGRAPHICALLY

CATALOG OF MEMBERSHIP
(This list is corrected only to December 31, 1931)

LIST OF MEMBERS OF ALL GRADES

Arranged Alphabetically

(See note on page 74)

A

- ABBITT, WILLIAM H. (A'28), Professor of Physics, Texas Technological College, Lubbock, Tex.
- ABBOTT, DONALD (A'30), Radio Engineer, Radio Pictures, Inc., 41 Park Row, New York, N.Y. For mail: 34-41-79th St., Jackson Heights, L.I., N.Y.
- ABBOTT, HARALD W. (A'30), Director of Laboratories, Speer Carbon Company, St. Marys, Pa. For mail: 150 N. St. Michael St., St. Marys, Pa.
- ABEL, ADAM E., JR. (A'31), Graduate Student, Electrical Engineering Department, University of Illinois, Urbana, Ill. For mail: 208 N. Harvey St., Urbana, Ill.
- ABELSON, LESTER S. (A'31), President, Steinite Manufacturing Company, 8440 S. Chicago Ave., Chicago, Ill.
- ABERCROMBIE, JULIUS B. (A'27), Manager, Abercrombie Radio Service, 1618 Frederick Ave., St. Joseph, Mo. For mail: 1810 Crescent Dr., St. Joseph, Mo.
- ABEY, ROBERT E. (A'27), Proprietor, Radio Shop, 905 W. Magnolia Ave., Fort Worth, Tex. For mail: 1601 Enderly Pl., Fort Worth, Tex.
- ABRAHAM, F. X. J. (A'27), Experimental Station G-5SW, The British Broadcasting Corporation, Chelmsford, Essex, England.
- ABRAHAMS, SAMUEL L. (A'21), Electrical Engineer, General Electric Company, River Works, Lynn, Mass.
- ABSHERE, LILBURN O. (A'28), General Delivery, Boise City, Okla.
- ACETO, LOUIE (A'31), Radio Engineer, RCA Victor Company, Inc., Camden, N.J. For mail: 212 Euclid Ave., Haddonfield, N.J.
- ACHATZ, RAYMOND V. (A'20), Secretary and General Manager, Southern Indiana Telephone Company, Aurora, Ind.
- ACHESON, MARCUS A. (A'29), Design Engineer, General Electric Company, Bldg. 37, Schenectady, N.Y. For mail: 1132 Baker Ave., Schenectady, N.Y.
- ACKERMAN, E. K. (A'27), Engineer, Amplivox Engineering, 7113 Euclid Ave., Cleveland, Ohio.
- ACKERMAN, MILTON J. (A'25), Development Engineer, Test Engineering Division, RCA Victor Company, Inc., Camden, N.J. For mail: 308 Penn St., Camden, N.J.
- ACKERMAN, RUDOLPH W. (M'28), Engineer, Arcturus Radio Tube Company, 720 Frelinghuysen Ave., Newark, N.J. For mail: 46 N. Arlington Ave., East Orange, N.J.
- ACKMAN, H. E. (A'31), Vacuum Tube Engineer, Hygrade Sylvania Corporation, Emporium, Pa. For mail: 414 W. 4th St., Emporium, Pa.
- ACTON, EDWARD H. (A'26), Superintendent, Aluminum Company of Canada, Ltd., Box 100, Shawinigan Falls, P.O., Canada.
- ACUNA, SEGUNDO P. (A'30), Technical Editor, *Revista Grafica*, Peru 135, Buenos Aires, Argentina. For mail: Navarro, 4159, V. Devote, Buenos Aires, Argentina.
- ADACHI, WILLIAM Y. (A'26), Chief, Brooklyn Edison Company, 380 Pearl St., Brooklyn, N.Y. For mail: 1569 Ocean Ave., Brooklyn, N.Y.
- ADAIR, SAMUEL E. (A'19-M'19), Treasurer and Director, Engineering Department, Jenkins and Adair, Inc., 3333 Belmont Ave., Chicago, Ill.
- ADAMS, CHARLES H. (A'30), Statistician, Shell Company of Australia, Ltd., Grenfell St., Adelaide, South Australia. For mail: 33 Hewitt Ave., Rose Park, Adelaide, South Australia.
- ADAMS, FRANK S. (A'26), Radio Engineer, 110 Ivor Rd., Sparkhill, Birmingham, England.
- ADAMS, GEORGE G. (A'27), Engineer, Pan American Airways, Inc., Miami, Fla. For mail: P.O. Box 1105, Miami, Fla.
- ADAMS, IRA J. (A'20-M'28), Patent Lawyer, 41 Park Row, New York, N.Y.
- ADAMS, JOHN C. (A'30), Radio Service and Repair Laboratory, 196 Main St., Gloucester, Mass. For mail: 64 Grove St., Gloucester, Mass.
- ADAMS, MARVYN S. (A'31), Technical Supervisor, Radio Station KFUD, Culver City, Calif. For mail: 8951 B Hubbard St., Culver City, Calif.
- ADAMS, QUINTON (M'28), National Broadcasting Company, Inc., 711-5th Ave., New York, N.Y.
- ADAMS, RICHARD A. (A'31), Manufacturers' Representative, R. A. Adams Company, 5071 Oregon Ave., Detroit, Mich.
- ADAMS, WALTER L. (A'31), Designer and Builder, Condenser Microphones and Sound Equipment, 609 W. 104th St., Los Angeles, Calif.
- ADAMS, WILLIAM E. (A'27), Service Engineer, Elliott Engineering Company, 215 Washington St., Binghamton, N.Y.
- ADCOCK, S. E. (A'28), General Manager, Stuart Broadcasting Corporation, 1828-32 W. Cumberland Ave., Knoxville, Tenn. For mail: P.O. Box 1563, Knoxville, Tenn.
- ADELBERGER, PAUL J. (A'29), Manager, Radio Department, Lynam Electric Company, 114 Wayne Ave., Wayne, Pa. For mail: 18 Louella Ct., Wayne, Pa.
- ADEENDORFF, GERALD V. (M'28), Consulting Engineer, Hilliards Chambers, Church Sq., Cape Town, South Africa.
- ADLER, BENJAMIN (A'29), Broadcast Transmitter Sales Engineer, RCA Victor Company, Inc., 914 Santa Fe Bldg., Dallas, Tex.
- ADLER, LEONARD E. (A'29), Technical Employee, American Telephone and Telegraph Company, 820 Poydras St., New Orleans, La. For mail: 1833 Robert St., New Orleans, La.

NOTE

The following list of membership is divided into two sections; the first contains an alphabetical list of members of the Institute of all grades and the second comprises a geographical list of members. In the alphabetical portion, the letter and date immediately following the member's name indicate the grade of membership and date of election. Where more than one letter and date group follow the member's name, the subsequent notations refer to the grade and date of transfer to a higher grade. (F) denotes the grade of Fellow; (M) Member; (A) Associate; (J) Junior.

Where only one address is shown in the alphabetical list it is the mailing address.

The geographical list contains the state and town in which the member is located and his present grade of membership in the Institute.

- APPEL, HERMAN A. ('14), Engineer, Department of Development and Research, American Telephone and Telegraph Company, 195 Broadway, New York, N.Y. For mail: 827 Morningside Rd., Ridgewood, N.J.
- AGATE, CARLTON S. (A'19-M'29), Assistant to Technical Director, The Electric and Musical Industries, Ltd., Blythe Rd., Hayes, Middlesex, England. For mail: 33 Dornton Rd., South Croydon, England.
- AGUSTY, JOAQUIN (A'26), Station WAQ, Radio Corporation of Porto Rico, San Juan, Porto Rico. For mail: P.O. Box 868, San Juan, Porto Rico.
- AIKEN, CHARLES B. P. (A'25), Radio Engineer, Bell Telephone Laboratories, Inc., 463 West St., New York, N.Y.
- AINSWORTH, A. L. (A'22), Vice President, DeForest Radio Corporation, 245 Carlaw Ave., Toronto, Ont., Canada.
- AINSWORTH, HAROLD (A'31), Engineering Department, DeForest Crosley, 243 Pape Ave., Toronto, Ont., Canada.
- AIRSTON, ALEXANDER J. (A'31), Engineer, RCA Victor Company, Inc., Camden, N.J. For mail: 2002 N. Broad St., Philadelphia, Pa.
- AITKENHEAD, JOHN, JR. (A'26), Chief Engineer, Station WADC, Akron, Ohio. For mail: 222 Twin Oaks Rd., Apartment 28, Akron, Ohio.
- AKAMATSU, KAWORU (A'30), Engineer, Japanese Broadcasting Corporation, c/o Nihon-Hoso-Kaikai, Shisci-Kaikau, No. 2, 1-chome, Kojimachi, Tokyo, Japan.
- AKERS, DALLAS C. (A'26), Salesman, Henderson Electric Company, Ampere, N.J. For mail: 181 Greenwood Ave., East Orange, N.J.
- AKERS, WILLIAM F. (A'30), P.A. Sound Engineer, Radio Station WHK, Radio Air Service Corporation, Higbee Bldg., Cleveland, Ohio. For mail: 1242 E. 167th St., Cleveland, Ohio.
- AKIN, ROBERT M., JR. (A'26), Director, Westchester Radio Laboratories, 62 Water St., Ossining, N.Y. For mail: Ossining, N.Y.
- AKRE, ROLAND O. S. (A'31), Second Lieutenant, Air Corps, U. S. Army, Langley Field, Hampton, Va.
- AKUTSU, SHIJI (A'27), Haranomachi, Fukushima, Japan.
- AKUZAWA, SIRO (A'31), Radio Engineer, Hirosima Broadcasting Station, Hirosima, Japan. For mail: c/o T. Ikeda, Nagatukamura, Asagun, Hirosima, Japan.
- ALBEE, NORMAN E. (A'16), Manager, Electrical Appliances, Department 620, Sears, Roebuck and Company, Chicago, Ill. For mail: 423 S. Taylor Ave., Oak Park, Ill.
- ALBERSHARDT, MILTON (A'30), Proprietor, A.C. Radio Electric Shop, 652 E. 52nd St., Indianapolis, Ind.
- ALBERT, ARTHUR L. (A'31), Assistant Professor, Electrical Engineering, Oregon State College, Corvallis, Ore.
- ALBERT, WILLIAM H. (A'26), Laboratory Assistant, Radio Frequency Laboratories, Inc., Boonton, N.J. For mail: 151 Mandeville Ave., Boonton, N.J.
- ALBERT, WILLIAM V. (A'15), Electrician Mate, U. S. Navy, 1 C. No. 1.173.321 Chief, Reading, Pa. For mail: General Delivery, Reading, Pa.
- ALBIN, FREDERICK G. (A'26), Assistant Transmission Engineer, United Artists Studio Corporation, 1041 N. Formosa, Hollywood, Calif. For mail: 1030 S. Arapahoe St., Los Angeles, Calif.
- ALBISTON, WILLIAM A. (A'25), Engineer, Daily Express, Ltd., Manchester, England. For mail: BM-BRD4, London, W.C. 1, England.
- ALBRECHT, HAROLD D. (A'31), Student University of Arkansas, Fayetteville, Ark. For mail: A.L.T. House, Fayetteville, Ark.
- ALBRIGHT, ARTHUR W. (A'30), Radio Operator, Radio Station WREH and WAL, Paterson Plank Rd., Carlstadt, N.J. For mail: 204 President St., Passaic, N.J.
- ALBRIGHT, GORDON E. (A'30), Service Instructor, Stromberg-Carlson Telephone Manufacturing Company, 100 Carlson Rd., Rochester, N.Y. For mail: 62 Minnesota St., Rochester, N.Y.
- ALBRIGHT, ROBERT B. (A'31), 212 Euclid Ave., Haddonfield, N.J.
- ALDRICH, GORDON H. (A'30), Area Manager, Kolster Brandes, Ltd., Canon's Marsh, Bristol, England. For mail: 1 Balmoral Mansions, St. Andrews, Bristol, Gloucester, England.
- ALEXANDER, LOUIS (A'26), Sales Engineer, Aerovox Wireless Corporation, 70 Washington St., Brooklyn, N.Y.
- ALEXANDER, WAYNE (A'29), Experimental Worker, Hedman Manufacturing Company, 1158 Center St., Chicago, Ill. For mail: 4253-5th Ave., Chicago, Ill.
- ALEXANDERSON, E. F. W. (A'13-M'13-F'15), Consulting Engineer, General Electric Company, 1 River Rd., Schenectady, N.Y.
- ALKER, CHARLES (A'28), Woodworking and Radio Experimenting, California Art Wood Company, 607 E. Newmark Ave., Monterey Park, Calif.
- ALKER, T. F. (M'30), Engineer, Research Laboratories of Electrical Communication, R. Hungarian Post Office, I Gyali ut 22, Budapest, Hungary. For mail: I. Csend ucca 22, Budapest, Hungary.
- ALLAIN, JOSEPH A. (J'29), Plant Engineer, Tube Plant, Grigsby-Grunow Company, 2020 N. Austin Blvd., Chicago, Ill. For mail: 4720 Dover St., Chicago, Ill.
- ALLAN, ERNEST J. (A'24), Radio Engineer, E. J. Allan and Company, Nethergate, Dundee, Scotland. For mail: 8 Westfield Pl., Dundee, Scotland.
- ALLAN, J. T. (A'26), Sales Department, General Electric Company, Ltd., Magnet House, Kingsway, London, W.C. 1, England.
- ALLAWAY, G. N. P. (A'28-M'30), Radio Engineer, Philips South African Electric Corporation, P.O. Box 1219, Durban, South Africa.
- ALLCUTT, E. BURTON (A'30), Physician, 1 W. 34th St., New York, N.Y. For mail: Rm. 212, Hotel Woodstock, 127 W. 43rd St., New York, N.Y.
- ALLEN, ALBERT (A'27), Research Engineer, Atlantic Precision Company, 80 Federal St., Boston, Mass. For mail: 16 Wildwood St., Winchester, Mass.
- ALLEN, FORREST G. (A'30), Second Lieutenant, U. S. Army Air Corps, Chanute Field, Rantoul, Ill.
- ALLEN, GIBBERT D. (A'31), Centralized Radio Service Engineer, RCA Victor Company, Inc., Camden, N.J. For mail: 611 W. 113th St., New York, N.Y.

- ALLEN, HUGH E. (A'23-M'31), Radio Engineer, RCA Victor Company, Inc., Camden, N.J. For mail: 235 Crestmont Ter., Collingswood, N.J.
- ALLEN, JAMES G. (A'28-M'31), Radio Engineer, Duquesne Light Company, 800 Duquesne Bldg., Pittsburgh, Pa. For mail: 123 Harrison Ave., Avalon, Pa.
- ALLEN, JAY M. (A'31), Radio Products Superintendent, Stewart-Warner Corporation, 1826 Diversey Pkwy., Chicago, Ill.
- ALLEN, JOHN E. (A'23), Chief of Tests, Pennsylvania Water and Power Company, 1611 Lexington Bldg., Baltimore, Md.
- ALLEN, JOHN H. (J'31), Radio Engineer, Extension Service, Radio Station KSAC, Manhattan, Kan. For mail: 731 Humboldt St., Manhattan, Kan.
- ALLEN, JOHN P. (A'30), Engineer, RCA Victor Company, Inc., Camden, N.J. For mail: 51 E. Collingswood Ave., Oaklyn, N.J.
- ALLEN, JUSTUS (A'27), Assistant Engineer, Station WENR, Downers Grove, Ill. For mail: 946 Summit St., Downers Grove, Ill.
- ALLEN, OTIS T. (A'28), Radio Electrician, Radio Station WZG, Fort Bragg, N.C.
- ALLEN, PRESTON D. (A'27), Director, Broadcasting Station KLX, Tribune Publishing Company, Hotel Oakland, Oakland, Calif. For mail: Hotel Oakland, Oakland, Calif.
- ALLEN, RAYMOND HARTWELL (A'31), Radio Service Engineer, Harris Brothers and Company, Inc., 337 Bleecker St., Utica, N.Y. For mail: 1526 Elm St., Utica, N.Y.
- ALLEN, ROY (A'28), Service Manager, Southern Distributing Corporation, 310 W. 2nd St., Oklahoma City, Okla. For mail: 2020 N. Indiana St., Oklahoma City, Okla.
- ALLEY, KENNETH G. (J'27-A'28), Meterman, Central Illinois Public Service Company, Marion, Ill. For mail: 804 E. Main, Marion, Ill.
- ALLINSON, CYRIL P. (A'26), Radio Journalist and Engineer, Radio Press, Ltd., Bush House, London, W.C. 2, England. For mail: 38 Barrow Hill Rd., St. John's Wood, N.W. 3, England.
- ALLNER, FREDERICK A. (A'22), General Superintendent, Pennsylvania Water and Power Company, Lexington Bldg., Baltimore, Md.
- ALLSTON, WILLIAM F. (A'29), Superintendent of Construction, Tropical Radio Telegraph Company, 1 Federal St., Boston, Mass. For mail: P.O. Box 488, Hialeah, Fla.
- ALLYN, R. S. (A'27), Patent Lawyer and Consulting Engineer, 41 Park Row, New York, N.Y.
- ALMAS, STAN L. (A'28), President, K.L.A. Radio Laboratories, 363 E. Larned St., Detroit, Mich. For mail: 9173 Meyers Rd., Detroit, Mich.
- ALMBERG, CLARENCE H. (J'30), Radio Specialist, U. S. Army, Headquarters Detachment, 1st Battalion, 13th Field Artillery, Schofield Barracks, Hawaii.
- ALMQUIST, MILTON L. (A'22), Engineer, American Telephone and Telegraph Company, 195 Broadway, New York, N.Y.
- ALONSO, JULIO (A'24), Engineer, Marques del Puerto 7, Bilbao, Spain.
- ALPERN, DWIGHT K. (J'21-A'24), Electro-Chemical Laboratory, Columbia University, Broadway at 119th St., New York, N.Y.
- ALSTON, VERNON C. (A'27), Chief Engineer, Radio Station WSPD, Commodore Perry Hotel, Toledo, Ohio. For mail: 11712 Cooley Ave., Cleveland, Ohio.
- ALTHOFF, FREDERICK E. (A'29), 3435 Hartford Ave., St. Louis, Mo.
- ALVARADO, MICHAEL A. (A'31), 1851-7th Ave., New York, N.Y.
- ALVERSON, GEORGE S. (A'29), General Manager, G. S. Alverson Company, 420 Lexington Ave., New York, N.Y.
- ALVERSON, JAMES G. (A'26), Chief Engineer, Addison Investment Company, Los Angeles, Calif. For mail: 1129 S. Harvard Blvd., Los Angeles, Calif.
- AMARI, S. (A'30), Electrical Engineer, c/o Japan Wireless Telegraph Company, Jiji Bldg., Marunouchi, Japan.
- AMBROZICH, JOHN L. (J'26-A'28), Electric Inspector and Superintendent of Fire Alarms, Village of Chisholm, Minn. For mail: 417 1/2 W. Spruce St., Chisholm, Minn.
- AMEY, S. H. (A'30), Research Department, Marconi Wireless Telegraph Company, Ltd., Marconi House, London, England. For mail: 60 Tudor Ave., Chelmsford, Essex, England.
- AMIS, FREDERICK H. (M'28), Electrical Engineer, International Standards Electric Corporation, Connaught House, Aldwych, London, W.C. 2, England.
- AMOS, WILLIAM G. (J'31), Standardizer, Radio Valve Company of Canada, 189 Dufferin St., Toronto, Ont., Canada. For mail: 20 Virtue St., Toronto 3, Ont., Canada.
- AMY, ERNEST V. (A'20-M'27), President, Amy, Aceves and King, Inc., 11 W. 42nd St., New York, N.Y.
- ANAZAWA, CHUHEI (A'25), Radio Engineering Section, Department of Communications, Tokyo, Japan. For mail: 302 Tsunohazu, Yodobasimachi, Tokyo, Japan.
- ANDERSEN, DONALD (J'31), Graduate Student, Physics Department, Iowa State College, Ames, Iowa. For mail: 910 Lincoln Way, Ames, Iowa.
- ANDERSEN, H. W. (A'28), 2332 Lake View Ave., Los Angeles, Calif.
- ANDERSON, A. D. (A'31), Chief Radio Instructor, Druleigh College, Anzac Ave., Auckland, New Zealand. For mail: 1 Seddon Ter., Otahuhu, Auckland, New Zealand.
- ANDERSON, ADOLPH (A'30), 904 Division St., Grand Island, Neb.
- ANDERSON, C. ALBIN (A'31), Sound Research Engineer and Assistant to Dr. P. E. Sabine, Riverbank Laboratories, Geneva, Ill.
- ANDERSON, CLIFFORD N. (A'19), Radio Telephone Engineer, American Telephone and Telegraph Company, 195 Broadway, New York, N.Y.
- ANDERSON, EDWARD R. (A'26), Technician, Bob Brown Radio Shop, 4353 S. Figueroa, Los Angeles, Calif. For mail: 6225 S. Wilcox Ave., Bell, Calif.
- ANDERSON, EDWIN C. (A'20), Instructor, R.C.A. Institutes, Inc., 75 Varick St., New York, N.Y. For mail: 220 W. 24th St., New York, N.Y.
- ANDERSON, GEORGE (A'31), Salesman, The Beaver Radio Company, 60-62 Whitechapel, Liverpool, England. For mail: 83 Broad Green Rd., Liverpool, Lancashire, England.
- ANDERSON, GILBERT J. C. (J'27-A'28), Proprietor, Anderson Radio Laboratory, 101

- Madison St., Port Clinton, Ohio. For mail: 418 Washington St., Port Clinton, Ohio.
- ANDERSON, HENRY A. (A'30)**, Proprietor, Electrical Store, 214 Southwestern Ave., Los Angeles, Calif.
- ANDERSON, HERBERT L. (J'31)**, 1825 La-combe Ave., New York, N.Y.
- ANDERSON, HOMER G. (A'30)**, Engineering Department, Raytheon Manufacturing Company, Watertown, Mass. For mail: 25 Barbara Rd., Woburn, Mass.
- ANDERSON, J. E. (A'26)**, Technical Editor, *Radio World*, 145 W. 45th St., New York, N.Y. For mail: 300 Gramatan Ave., Mount Vernon, N.Y.
- ANDERSON, J. E. (A'29)**, Radio Engineer, Audio Division, General Motors Radio Corporation, Miami Chapel Rd., Dayton, Ohio. For mail: 859 Kumlcr Ave., Dayton, Ohio.
- ANDERSON, J. SUMNER (A'30)**, c/o Boeing Air Transport, Inc., Des Moines, Iowa.
- ANDERSON, JOHN P. (A'28)**, Chief Load Dispatcher, Hydro Electric Power Commission, Belleville, Ont., Canada. For mail: P.O. Box 46, Belleville, Ont., Canada.
- ANDERSON, L. N. (A'30)**, Assistant Manager, All America Cables, Inc., Casilla 2336, Lima, Peru.
- ANDERSON, PAUL E. (J'29-A'31)**, Broadcast Operator, Radio Station WTAG, 18 Franklin St., Worcester, Mass.
- ANDERSON, PIERSON A. (A'26-M'27)**, Assistant to Manager, Engineering Products Division, RCA Victor Company, Inc., Camden, N.J.
- ANDERSON, RAYMOND T. (A'26)**, Chief Engineer, The V. D. Anderson Company, 1935 W. 96th St., Cleveland, Ohio. For mail: 223 Westbridge Dr., Berea, Ohio.
- ANDERSON, ROLAND A. (A'31)**, Proprietor, Anderson and Webster Electric Company, Wahoo, Neb. For mail: Wahoo, Neb.
- ANDERSON, ROY S. (J'31)**, Engineering Department, Stromberg-Carlson Telephone Manufacturing Company, 100 Carlson Rd., Rochester, N.Y. For mail: 341 Farmington Rd., Rochester, N.Y.
- ANDERSON, THURE C. (A'27)**, Proprietor, T. C. Anderson, Radio Service, 145 Main St., Ridgway, Pa. For mail: 416 N. Broad St., Ridgway, Pa.
- ANDERSON, WILLIAM A. (A'30)**, Pictou, Colo.
- ANDRAE, ROBERT T. (A'23)**, Statistic Engineer, Power Corporation of Canada, 330 Coristine Bldg., Montreal, P.Q., Canada. For mail: 1483 Atwater Ave., Apartment 5, Montreal, P.Q., Canada.
- ANDRES, LLOYD J. (A'27)**, Chief Engineer and General Superintendent, Automatic Musical Instrument Company, 1500 Union Ave., S.E., Grand Rapids, Mich.
- ANDRES, PAUL G. (A'27)**, Chief Engineer, Temple Radio, Ltd., 283 King St., E., Toronto, Ont., Canada. For mail: 220 Glen Manor Dr., W., Toronto, Ont., Canada.
- ANDRESEN, SIGURD (A'30)**, Operations Engineer, Northern Electric Company, Ltd., 637 Craig St., W., Montreal, P.Q., Canada. For mail: 5209 Globert St., Montreal, P.Q., Canada.
- ANDREW, VICTOR J. (A'25-M'30)**, Graduate Student, Ryerson Physical Laboratories, University of Chicago, Chicago, Ill. For mail: 4949 Indiana Ave., Chicago, Ill.
- ANDREWARTHA, H. C. (A'29)**, Department Manager, C. E. Needham and Brothers, Ltd., Change Alley, Sheffield, York, England. For mail: "Tresco," 33 Wayland Rd., Sharrow, Sheffield, York, England.
- ANDREWS, EDWARD F. (A'26)**, President and Engineer, Andrews-Hammond Corporation, 2409 Surrey Ct., Chicago, Ill.
- ANDREWS, HOWARD L. (A'29)**, Instructor, Brown University, Providence, R.I. For mail: 154 Walnut St., East Providence, R.I.
- ANDREWS, JOSEPH F. (A'18-M'26)**, American Telephone and Telegraph Company, 15 Dey St., New York, N.Y.
- ANDREWS, PAUL D. (A'23-M'29)**, Radio Engineer, Radio Engineering Department, General Electric Company, 1 River Rd., Schenectady, N.Y. For mail: 9 N. Ferry St., Schenectady, N.Y.
- ANDREWS, W. A. (M'20)**, Lecturer, University of Bristol, Superintendent, Merchant Venturers' Technical College, Bristol, England.
- ANDRIATCH, NICHOLAS D. (A'30)**, Service Engineer, Majestic Wholesalers, 390 Elm St., Buffalo, N.Y. For mail: 265 Bird Ave., Buffalo, N.Y.
- ANDRUS, ROY E. (A'29)**, Manager, Radio Department, Carlisle-Allen Company, Ashtabula, Ohio. For mail: R.D. No. 2, Ashtabula, Ohio.
- ANGELL, DOUGLAS H. (A'30)**, Radio Telephone Operator, *R.M.S. Olympic*, White Star Line, 1 Broadway, New York, N.Y. For mail: 27 Lansdown, Stroud, Gloucester, England.
- ANGLE, G. B. (A'29)**, Tropical Telegraph Company, P.O. Box 488, Hialeah, Fla.
- ANGUS, G. W. (A'31)**, Communications Superintendent, Pan American Grace Airways, Inc., Lima, Peru.
- ANKERSEN, G. W. (J'27-A'28)**, 927 Montana St., Chicago, Ill.
- ANNUCCI, LOUIS M. (A'27)**, Dry-Ice Corporation of America, 631 W. 34th St., New York, N.Y. For mail: 97 Echo Ave., New Rochelle, N.Y.
- ANOLICK, J. (A'31)**, District Sound Engineer, Kinemas, Ltd., Princes Kinema, Bulawayo, Rhodesia, South Africa.
- ANSELM, S. C. (A'15)**, Engineer-in-Chief, "Radio-Suisse" S. A., Munchenbuchsee, Cton Berne, Switzerland.
- ANSLEY, ARTHUR C. (A'30)**, Director, Ansley Radio Laboratory, 147 W. 23rd St., New York, N.Y.
- ANSON, C. T. (A'29)**, Radio Engineer, General Electric Company, Schenectady, N.Y. For mail: 2334 Turner Ave., Schenectady, N.Y.
- ANTHONY, A. W., JR. (A'29)**, President-Treasurer, Pease-Anthony Equipment Company, 30 Charles River Rd., Cambridge, Mass. For mail: 31 Horne Rd., Belmont, Mass.
- ANTONICH, PETER L. (A'31)**, Proprietor, Radio Service, 620 E. Park Ave., Anaconda, Mont.
- APKER, CHARLES L. (A'26)**, Engineer, 4932 N. Mervine St., Philadelphia, Pa.
- APPEL, HENRY W. (A'29)**, Assistant Radio Engineer, RCA Victor Company, Inc., Bldg. 15, Floor 5, Camden, N.J. For mail: 145 E. 82nd St., New York, N.Y.
- APPEL, JOSEPH H., JR. (A'26)**, President, Appel and Henderson Electrical Communica-

- tions Equipment, Inc., 485 Madison Ave., New York, N.Y. For mail: 13 Circle Rd., Scarsdale, N.Y.
- APPICH, WILLIAM H. (A'29)**, Assistant General Manager of Credits, Beatrice Creamery Company, 1526 S. State St., Chicago, Ill. For mail: 1526 Schrieber Ave., Chicago, Ill.
- APPLEBY, BERTIE (A'28)**, Master Mechanic, Cronch-Bolas, Inc., 21 Campbell St., Pawtucket, R.I. For mail: 56 Benedict St., Pawtucket, R.I.
- APPLEGATE, HOMER E. (A'30)**, Westinghouse Electric and Manufacturing Company, Chicopee Falls, Mass. For mail: 18 Vassar St., Springfield, Mass.
- APPLETON, EDWARD V. (A'26-F'31)**, Professor, Wheatstone Laboratory, King's College, London, England. For mail: St. John's Darke's Lane, Potters Bar, Middlesex, England.
- APPLETON, HARRY (A'27)**, The Rola Company, 1321 S. Maple Ave., Los Angeles, Calif. For mail: 1215 S. Norton, Los Angeles, Calif.
- APPLETON, SAMUEL (A'20)**, U.S.S. *Nekomis*, c/o Postmaster, New York, N.Y. For mail: 35 Hull St., Beverly, Mass.
- APPLETON, WILLIAM A. (M'20)**, Radio and Electric Engineer, Gloucester House, 19 Charing Cross Rd., London, England. For mail: 189 Wembley Hill Rd., Wembley, England.
- APULI, JOHN ARNE (A'31)**, Student Engineer, General Motors Radio Corporation, 340 W. 1st St., Dayton, Ohio.
- ARAKAWA, DAITARO (A'19)**, Radio Engineer, Komukioku, Teishin-sho, Tokyo, Japan. For mail: No. 7, I-chome, Nishihara-Machi, Koishikawa, Tokyo, Japan.
- ARCAND, WILFRED E. (J'30)**, Technical Operator, American Telephone and Telegraph Company, Rm. 2426-A, 24 Walker St., New York, N.Y. For mail: 75 Robertson Ave., White Plains, N.Y.
- ARCHER, THOMAS A. (A'31)**, Electrician, The Pacific Cable Board, Barbados, West Indies. For mail: "Verona," Bank Hall Rd., Barbados, West Indies.
- ARISAKA, IWAO (A'31)**, First Lieutenant, Tohoku University, Sendai, Japan. For mail: 28 Nakasugiyamadori, Sendai, Japan.
- ARMAGOST, HAROLD C. (A'30)**, Chief Engineer, Radio Station KGMB, Honolulu Broadcasting Company, 119 Merchant St., Honolulu, Hawaii. For mail: 1752 Fern St., Honolulu, Hawaii.
- ARMER, AUSTIN A. (A'28)**, Engineer, Frank Rieber, Inc., 170-2nd St., San Francisco, Calif. For mail: 1053 Peralta Ave., Berkeley, Calif.
- ARMOR, JAMES C. (A'15)**, Electrical Engineer, Allis-Chalmers Manufacturing Company, N.S., Pittsburgh, Pa. For mail: 652 Highland Pl., Bellevue, Pa.
- ARMOUR, CHRISTIAN D. (A'31)**, 15 Florida St., Mount Florida, Glasgow, S.2, Scotland.
- ARMSTRONG, EDWIN H. (A'14-F'27)**, Marcellus Hartley Research Laboratory, Columbia University, New York, N.Y. For mail: The Beresford, 211 Central Park West, New York, N.Y.
- ARMSTRONG, HAROLD W. (J'27-A'30)**, Transmission Man, American Telephone and Telegraph Company, 315 W. Washington St., Chicago, Ill. For mail: 7337 Coles Ave., Chicago, Ill.
- ARMSTRONG, H. M. (A'26)**, Engineer, Research Department, Kellogg Switchboard and Supply Company, 1066 W. Adams St., Chicago, Ill. For mail: 185-4th St., Hinsdale, Ill.
- ARMSTRONG, L. J. HEATON (A'28)**, Les Laboratories Standard, 46 Ave. de Breteuil, Paris 7^e, France.
- ARMSTRONG, RALPH W. (A'29)**, Radio Engineer, Westinghouse Electric and Manufacturing Company, East Pittsburgh, Pa. For mail: 6 Woodside Rd., Wilkinsburg, Pa.
- ARNOLD, JOHN W. (A'29)**, Engineering Department, Western Union Telegraph Company, 60 Hudson St., New York, N.Y.
- ARNOLD, PRESCOTT N. (A'29)**, Instructor in Physics, Cruft Laboratory, Harvard University, Cambridge, Mass.
- ARNOLD, ROBERT M. (A'31)**, Chief Engineer, Radio Division, Grigsby-Grunow Company, 5801 Dickens Ave., Chicago, Ill.
- ARNOLD, THOMAS E. (A'27)**, Instructor, Communications Department, Air Corps Technical School, Chanute Field, Rantoul, Ill. For mail: P.O. Box 215, Rantoul, Ill.
- ARPS, MERVIN W. (A'14-M'19)**, Lieutenant Commander, U. S. Navy, U. S. Naval Research Laboratory, Bellevue, Anacostia, D.C. For mail: 1618-28th St., S.E., Washington, D.C.
- ARTHUR, RALPH L. (A'28)**, Machine Shop Foreman, Howard Radio Company, South Haven, Mich. For mail: 910 St. Joseph St., South Haven, Mich.
- ARTZT, MAURICE (A'26)**, Engineer, RCA Victor Company, Inc., Camden, N.J.
- ASCH, MARCUS (A'29)**, Chief Recording Engineer, Metropolitan Studios, 1000 Broadway, New York, N.Y. For mail: 5519-32nd Ave., Woodside, L.I., N.Y.
- ASCH, MOE (A'27)**, Chief Radio Engineer, Radio Laboratories, 869 Driggs Ave., Brooklyn, N.Y. For mail: 248 Hewes St., Brooklyn, N.Y.
- ASHBAUGH, EDWIN C. (A'27)**, Mount Gilead, Ohio.
- ASHBROOK, ROY B. (A'26)**, Communication Engineer, Southern California Edison Company, 3rd and Broadway, Los Angeles, Calif. For mail: 601 N. Mission Dr., San Gabriel, Calif.
- ASHBY, A. L. (A'31)**, Vice President and General Attorney, National Broadcasting Company, Inc., Rm. 1545, 711-5th Ave., New York, N.Y.
- ASHENDEN, G. K., JR. (A'29)**, Radio Operator, Radiomarine Corporation of America, 470 Atlantic Ave., Boston, Mass. For mail: 120 George St., Roxbury, Mass.
- ASHMORE, J. W. (A'20)**, Engineer, Operating Division, R.C.A. Communications, Inc., Riverhead, L.I., N.Y. For mail: Riverhead, L.I., N.Y.
- ASHTHANA, RAJENDRA PRASADA (A'30)**, Resident Engineer, Power House, Ujjain, India.
- ASHTON, JOHN E. (J'28-A'31)**, Switchman, New Jersey Telephone Company, Baldwin St., East Orange, N.J. For mail: 163 Waldo Pl., Englewood, N.J.
- ASHWIN, CECIL W. H. (A'26)**, Radio Operator and Engineer, Marconi Communications Company, Ltd., Marconi House, Lon-

- don, England. For mail: 26 Thorncliff Rd., Barrow-in-Furness, Eng'land.
- ASSERSON, RAYMOND (M'27)**, Radio Frequency Laboratories, Inc., Boonton, N.J. For mail: 49 Pollard Rd., Mountain Lakes, N.J.
- ATHERTON, MALCOLM J. V. (A'26)**, P.O. Box 87, Fullerton, Calif.
- ATKIN, ROBERT (A'29)**, Studio Engineer, National Broadcasting Company, Inc., 711-5th Ave., New York, N.Y.
- ATKINS, CARL EDWARD (J'29)**, Radio Technician, Sparks-Withington Company, Jackson, Mich. For mail: 302 E. Biddle St., Jackson, Mich.
- ATKINSON, CYRIL T. (A'23)**, Manager, Test Department, Messrs. Gent and Company, Ltd., Faraday Works, Leicester, England. For mail: La Casa Rosa, Greenland Ave., Humberstone, Leicester, England.
- ATTMORE, WILLIAM B. (A'28)**, Sales Engineer, Victor Talking Machine Company, Camden, N.J. For mail: Clementon, N.J.
- ATWOOD, RALPH F. (A'31)**, Engineer, Raytheon, Inc., 232 Main St., Cambridge, Mass. For mail: 1949 Commonwealth Ave., Brighton, Mass.
- AUCKERMAN, U. H. (A'29)**, Signal Apprentice, Chesapeake and Ohio Railway, c/o C. A. Taylor, Superintendent of Signals, Richmond, Va.
- AUGHENBAUGH, WILLIAM K. (A'27)**, Control Room Operator, Radio Station WLW, Crosley Radio Corporation, Cincinnati, Ohio. For mail: 3608 Madison Rd., Cincinnati, Ohio.
- AUGUSTINE, ROY W. (A'23-M'26)**, Utah Radio Products Company, 820 Orleans St., Chicago, Ill. For mail: 249 Thomas St., Oak Park, Ill.
- AUGUSTUS, LEE M. (A'29)**, Engineering Student, Michigan Bell Telephone Company, Detroit, Mich. For mail: 416 Florence St., Ypsilanti, Mich.
- AULL, WILSON, JR. (A'17-M'27)**, Radio Engineer, Rm. 707, 41 Park Row, New York, N.Y.
- AULT, HAROLD B. (A'31)**, Proprietor, Radio Shop, 74 Morley St., Bradford, York, England.
- AURYNGER, JOHN J. (A'30)**, Typist, Army Air Corps, Munitions Bldg., Washington, D.C. For mail: P.O. Box 4253, Takoma Park, D.C.
- AUSTIN, A. O. (F'30)**, Factory Manager and Chief Engineer, Ohio Insulator Company, 9th and Park Sts., Barberton, Ohio.
- AUSTIN, EDWARD (A'23-M'30)**, Test and Inspection Engineer, Crosley Radio Corporation, Colerain Ave. and Sassafras St., Cincinnati, Ohio.
- AUSTIN, JOHN W. (A'31)**, Engineer, RCA Victor Company, Inc., Camden, N.J. For mail: 309 Melrose Ave., Palmyra, N.J.
- AUSTIN, KIRBY B. (A'25)**, Assistant Engineer, Radio Sales Department, General Electric Company, Bridgeport, Conn. For mail: 543 N. Somerfield Ave., Bridgeport, Conn.
- AUSTIN, LESLIE C. (A'28)**, Manager, Radio Department, Woolley and Company, Inc., 1113-3rd Ave., Seattle, Wash. For mail: 540 N. 82nd St., Seattle, Wash.
- AUSTIN, LOUIS W. (A'13-M'13-F'15)**, Laboratory, Special Transmission Research, U. S. Bureau of Standards, Washington, D.C.
- AUSTIN, OTTO C. (A'27)**, Distribution Engineer, Madison Gas and Electric Company, 200 W. Mifflin St., Madison, Wis. For mail: 2631 Kendall Ave., Madison, Wis.
- AVERY, ROBERT D. (J'29)**, Assistant Broadcast Engineer, Radio Station WDBJ, P.O. Box 398, Roanoke, Va. For mail: 206 Virginia Ave., Virginia Heights, Roanoke, Va.
- AVES, FRED J. (J'30)**, 303 Ocean Front, Venice, Calif.
- AX, LELAND S. (A'30)**, Electrical Engineering Student, Tri-State College, Angola, Ind. For mail: 1540 Byron St., S.W., Massillon, Ohio.
- AXTEN, BERNARD J. (A'26)**, Engineer-in-Charge, Radio Laboratory, Standard Telephones and Cables, Ltd., Columbia House, Aldwych, London, W.C. 2, England. For mail: 49 Ealing Rd., Wembley, Middlesex, England.
- AYER, OLIVER G. (A'27)**, Box 640, Ardsley, N.Y.
- AYER, RAYMOND B. (A'26)**, Vacuum Tube Development, General Electric Company, 1 River Rd., Schenectady, N.Y. For mail, 211 Hugh St., Schenectady, N.Y.
- AYRES, FREDERICK (A'30)**, Engineer, "His Master's Voice" Gramophone Company, London, England. For mail: 17 Dorset Rd., Ealing, London, England.
- AYMAR, ERWIN (A'26)**, c/o Le Claire Hotel, Moline, Ill.

B

- BAART, JOHN C. (A'24)**, Radio Inspector, Radio Material Office, Navy Yard, Norfolk, Va. For mail: 844 N. Park Ave., Portsmouth, Va.
- BABCOCK, STUART M. (A'30)**, Member of Technical Staff, Bell Telephone Laboratories, Inc., 395 Hudson St., New York, N.Y.
- BACCHINI, CESARE (A'29)**, General Director of Allochio, Bacchini and Company, Corso Sempione 95, Milan, Italy.
- BACH, ROY O. (A'19)**, Engineer, Pacific Telephone and Telegraph Company, Dexter Horton Bldg., Seattle, Wash.
- BACHMAN, EDWIN J. (A'28)**, Manager, Radio Service Department, Bee, Inc., 622 Linden St., Allentown, Pa. For mail: 1064 Catasauqua Rd., Fullerton, Pa.
- BACHOFER, C. LEONARD (J'26-A'27)**, Radio Experimenter, Stromberg-Carlson Telephone Manufacturing Company, 100 Carlson Rd., Rochester, N.Y. For mail: 939 Woodbine Ave., Rochester, N.Y.
- BACKUS, CYRUS D. (A'19-M'26)**, Examiner, U. S. Patent Office, Washington, D.C.
- BACON, DANA H. (A'31)**, Radio Engineer, 61 Sherman St., Malden, Mass. For mail: 1257 Salem St., Malden, Mass.
- BADEN, MARTIN W. (A'30)**, Research Engineer, The Trees Oil Company, Winfield, Kan. For mail: Box 520, Winfield, Kan.
- BADGEROW, BERT E. (J'26-A'31)**, Radio Operator, Radio Station KGPI, Omaha Police Department, 901 Florence Heights Blvd., Omaha, Neb.
- BAGGS, A. D. (A'30)**, District Telegraph Engineer, Post and Telegraph Department, P.O. Box 238, Wellington, New Zealand.
- BAGNALL, VERNON B. (A'30)**, Communications Engineer, Long Lines Engineering Department, American Telephone and Telegraph Company, 15 Dey St., New York, N.Y. For mail: 17 Webster Pl., East Orange, N.J.
- BAGSHAW, GEORGE W. (A'27)**, Engineer and Manager, Messrs. J. G. Graves, Ltd., Wireless Manufacturing, Sheffield, England. For mail: 148 Sandygate Rd., Sheffield, England.
- BAIER, ARTHUR H. (A'27)**, President, H. J. Baier and Son, Inc., 3241 War-Center Rd., Warrensville, Ohio. For mail: 13110 Cedar Rd., Cleveland Heights, Ohio.
- BAILEY, AMBROSE L. (J'28-A'30)**, Radio Service Manager, T. Eaton Company, Ltd., Hamilton, Ont., Canada. For mail: 15 Huxley Ave., North Hamilton, Ont., Canada.
- BAILEY, ARNOLD B. (A'27)**, Radio Engineer, Bell Telephone Laboratories, Inc., 463 West St., New York, N.Y.
- BAILEY, AUSTIN (A'22-M'25)**, Telephone Engineer, American Telephone and Telegraph Company, Rm. 2012, 195 Broadway, New York, N.Y.
- BAILEY, E. G. (A'31)**, Development Engineer, Amalgamated Wireless Association, Sydney, Australia. For mail: 11 Ocean St., Kogarah, New South Wales, Australia.
- BAILEY, NEIL, (A'30)**, Foreman, Radio Division, Cardon-Phonocraft Corporation, Jackson, Mich. For mail: 1507 E. North St., Jackson, Mich.
- BAILEY, STUART L. (A'28)**, Consulting Radio Engineer, Jansky and Bailey, 922 National Press Bldg., Washington, D.C.
- BAILEY, WALTER H. (M'27)**, Radio Superintendent, Thomas and John Brocklebank, Ltd., Cunard Bldgs., Liverpool, England.
- BAILEY, WILLIAM B. (A'31)**, Radio Officer, U.S.S. Pennsylvania, c/o Postmaster, San Pedro, Calif.
- BAILEY, WILLIAM M. (M'23)**, Chief Engineer, Dubilier Condenser Corporation, 4377 Bronx Blvd., New York, N.Y. For mail: 41 Walton Ave., White Plains, N.Y.
- BAILY, F. A. A. (A'30)**, Radio Engineer, Canadian Marconi Company, 173 William St., Montreal, P.Q., Canada. For mail: 4332 Kensington Ave., N.D.G., Montreal, P.Q., Canada.
- BAIN, GEORGE W. (A'31)**, Chief Engineer, Ken-Rad Corporation, Owensboro, Ky. For mail: 411 W. 13th St., Owensboro, Ky.
- BAIN, J. C. (A'30)**, Technical Staff, Bell Telephone Laboratories, Inc., Rm. K65, 463 West St., New York, N.Y.
- BAIN, J. R. (A'29)**, Operating Supervisor, Research Products Engineering Department, Northern Electric Company, Ltd., 150 Robson St., Vancouver, B.C., Canada.
- BAINBRIDGE-BELL, L. H. (A'26)**, Radio Research Station, Slough, Bucks, England. For mail: Bowood, London Rd., Datchet, Windsor, England.
- BAIR, RALPH S. (A'21)**, Radio Engineer, Bell Telephone Laboratories, Inc., 463 West St., New York, N.Y.
- BAIRD, FREDERICK (A'23)**, Secretary, Wardle Engineering Company, Ltd., Elsinore Rd., Old Trafford, Manchester, England. For mail: "Lewaigue," 13 Hornby Rd., Stretford, Manchester, England.
- BAIRD, HOLLIS S. (A'28)**, Chief Engineer, Shortwave and Television Laboratory, 70 Brookline Ave., Boston, Mass.
- BAIRD, ROBERT E. (A'30)**, Inspection Engineer, Operadio Manufacturing Company, St. Charles, Ill. For mail: 303 W. Main St., St. Charles, Ill.
- BAKER, CARL I. (M'31)**, Vacuum Tube Engineer, Bell Telephone Laboratories, Inc., 395 Hudson St., New York, N.Y. For mail: Pearl River, N.Y.
- BAKER, EARL W. (A'30)**, Marine Inspector, Radiomarine Corporation of America, 502 National Bldg., Seattle, Wash.
- BAKER, JUDD O. (A'28)**, Engineer-in-Charge, Theater Equipment Department, RCA Photophone, Inc., 411-5th Ave., New York, N.Y. For mail: 20 Villard Ave., Hastings-on-Hudson, N.Y.
- BAKER, THOMAS S. (A'29)**, Engineer, Press Wireless, Inc., Chicago, Ill. For mail: P.O. Box 292, Hicksville, L.I., N.Y.
- BAKER, W. R. G. (A'19-F'26)**, Vice President, RCA Victor Company, Inc., Camden, N.J.
- BALCH, J. A. (M'17)**, President, Mutual Telephone Company, P.O. Box 2200, Honolulu, Hawaii.
- BALDWIN, ARTHUR V. (A'27)**, Radio Engineer, Johnsonburg Radio Company, Johnsonburg, Pa. For mail: 516 High St., Johnsonburg, Pa.
- BALDWIN, CHARLES O. (A'31)**, Engineer, Philco Products, Ltd., Dufferin St., Toronto, Ont., Canada. For mail: 21 Pinewood Ave., Toronto, Ont., Canada.
- BALDWIN, CHESTER PAUL (A'30)**, Radio Service Manager, Aeolian Company, 780 E. 138th St., St. Albans, L.I., N.Y. For mail: 121-04-195th St., St. Albans, L.I., N.Y.
- BALDWIN, FRANK H. (A'31)**, 9 Joy St., Boston, Mass.
- BALDWIN, GEORGE (A'27)**, Radio Service Engineer, Service Department, Canadian Westinghouse Company, Ltd., Hamilton, Ont., Canada.
- BALDWIN, JOHN M. (A'26)**, Chief Engineer, Radio Station KDYL, Ezra Thompson Bldg., Salt Lake City, Utah.
- BALDWIN, PRESTON DE GRAUW (J'27-A'29)**, Installation and Service Engineer, RCA Photophone, Inc., 7500 Euclid Ave., Cleveland, Ohio.
- BALDWIN, ROBERT S. (A'31)**, Radio Technician, Radio Station KFRC, 1000 Van Ness Ave., San Francisco, Calif.
- BALL, GEORGE F. (A'26)**, 37 Stanley Rd., East Cliff, Folkestone, Kent, England.
- BALL, I. DALE (A'19)**, Junior Radio Inspector, Radio Division, U. S. Department of Commerce, Frequency Monitoring Station, P.O. Box 788, Grand Island, Neb.
- BALLANTINE, STUART, (A'16-F'28)**, Radio Frequency Laboratories, Inc., Boonton, N.J.
- BALLARD, RANDALL C. (A'29)**, Television Engineer, RCA Victor Company, Inc., Camden, N.J. For mail: 606 W. Maple Ave., Merchantville, N.J.
- BALLARD, WILLIAM C. (A'16-M'27)**, Instructor, Engineering Department, Cornell University, Ithaca, N.Y.
- BALLENTINE, EDWIN C. (A'25-M'29)**, Radio Engineer, RCA Victor Company, Inc., Camden, N.J. For mail: 506 Irving Ter., Moorestown, N.J.
- BALLING, ALFRED W. (A'26)**, Chief Transmitter Operator, Radio Station WHAM, Victor, N.Y. For mail: 1625 Clinton Ave., Rochester, N.Y.

- BALSBAUGH, CLAIR L.** (A'28), Serviceman, The Radio Shop, Main St., Palmyra, Pa. For mail: 113 E. Cherry St., Palmyra, Pa.
- BALSLEY, JAMES R.** (A'26), President, Halley and Phillips, Inc., 845 Seward St., Hollywood, Calif. For mail: 522 N. Roxbury Dr., Beverly Hills, Calif.
- BANFI, ALESSANDRO** (A'29), Chief Engineer, Italian Broadcasting Company, Corso Francia 80, Turin, Italy.
- BANGS, PHILIP C.** (A'18), Partner, Acoustic Equipment Company, 1906 William-Oliver Bldg., Atlanta, Ga. For mail: 23 Kensington Rd., Avondale Estates, Ga.
- BANK, MAURICE** (A'29), Engineer, 1247 S. Kedvale Ave., Chicago, Ill.
- BANKS, CHARLES R.** (A'31), 55 Monroe Pl., Bloomfield, N.J.
- BANKS, J. VERNON** (A'29), Manager, Alhambra Radio Company, 1309 E. 15th St., Tulsa, Okla.
- BANNISTER, M. W.** (J'26-A'28), Technical Supervisor, Radio Station KFXV, 117 N. Beaver St., Flagstaff, Ariz. For mail: Box 512, Flagstaff, Ariz.
- BARBEE, VIRGIL A.** (A'30), Quality Supervisor, Test Engineering Division, RCA Victor Company, Inc., Camden, N.J. For mail: 103 Cooper Ave., Collingswood, N.J.
- BARBER, ALFRED W.** (A'31), Radio Engineer, Radio Inventions, Inc., 3104 Northern Blvd., Long Island City, L.I., N.Y. For mail: 146-24 Queens Ave., Flushing, L.I., N.Y.
- BARBER, ORVILLE B.** (J'31), Kinistino, Sask., Canada.
- BARBER, WALTER G.** (A'26), Sales Manager, Baldwin International Radio of Canada, Ltd., 620 King St., W., Toronto, Ont., Canada.
- BARBOUR, JOHN HENRY** (A'30), 2250 Beaconsfield Ave., Montreal, P.Q., Canada.
- BARBUDESCO, CONSTANTIN D.** (M'27), Radio Engineer, Air Corps Radio Laboratories, Wright Field, Dayton, Ohio. For mail: 343 Greenmount Blvd., Dayton, Ohio.
- BARCLAY, HUGH N.** (A'26), Radio Service Department, Kent Piano Company, Ltd., 339 Hastings St., W., Vancouver, B.C., Canada. For mail: 227-6th St., W., North Vancouver, B.C., Canada.
- BARDIN, WILLIAM F.** (A'25-M'30), Radio Engineer, Broadcasting Station 4QG, Brisbane, Australia.
- BAREISS, MAX** (M'31), Engineer, Raytheon Manufacturing Company, 55 Chapel St., Newton, Mass. For mail: 59 Bailey Rd., Watertown, Mass.
- BARGAMIAN, JOHN** (A'29), Proprietor, Bargamian Radio Engineers, 627 Park Ave., Cranston, R.I. For mail: 161 Woodbine St., Cranston, R.I.
- BARIS, ISIDORE** (A'31), P.O. Box 10, Bedford Cape, South Africa.
- BARKER, HOWARD J.** (J'30), 1315 Stillwood Dr., Atlanta, Ga.
- BARKER, L. T.** (A'29), Telegraph Operator, C. B. and Q. Railroad Company, Waldron, Mo. For mail: Waldron, Mo.
- BARKER, PERCY L.** (A'28), Assistant Engineer, Radio Section, P.O. Research Station, Dollis Hill Lane, London, W.C. 2, England.
- BARKHAUSEN, H.** (A'26-F'30), Professor, Technische Hochschule Institut, Helmholtzstrasse 9, Dresden, Germany.
- BARKLEY, HOWARD F.** (A'25), P.O. Box 148, Great Barrington, Mass.
- BARKLEY, WILLIAM J.** (M'29), Assistant to President, DeForest Radio Company, 139 Franklin St., Jersey City, N.J. For mail: 21 Clinton Ave., Maplewood, N.J.
- BARLOW, ROY G.** (A'28), Engineer, General Petroleum Corporation, Higgins Bldg., Los Angeles, Calif. For mail: R.F.D. No. 1, Box 637 C, Rivera, Calif.
- BARLOW, WILLIAM H.** (A'28), Supervisor, Mail Sales Division, Albert Pick-Barth, Inc., 1200 W. 35th St., Chicago, Ill. For mail: 1019 N. Dearborn, Chicago, Ill.
- BARNARD, ROY M.** (A'31), Radio Engineer, c/o Standard Telephones and Cables, The Hyde, Hendon, London, N.W. 9, England. For mail: 259 The Broadway, West Hendon, London, N.W. 9, England.
- BARNARD, T. A.** (J'30), Radio Station KDB, Hotel Faulding, Santa Barbara, Calif. For mail: 529 King St., Monrovia, Calif.
- BARNES, H. M.** (A'31), Engineer, Pye Radio, Ltd., Cambridge, England. For mail: 83 Hawthorne Way, Chesterton, Cambridge, England.
- BARNES, HARRY C.** (J'31), c/o Phil Roper, Jr., Hobart, Ind.
- BARNES, JAMES C.** (J'28-A'28), Bell Telephone Laboratories, Inc., 463 West St., New York, N.Y.
- BARNES, JOHN L.** (A'27), Graduate Student in Mathematics, Princeton University, Princeton, N.J. For mail: 113 Warwick Rd., Hadfield, N.J.
- BARNES, T. DANA** (A'27), Meter Engineer, Westinghouse Electric and Manufacturing Company, Newark Works, Newark, N.J. For mail: 206 Roseville Ave., Newark, N.J.
- BARNETT, ERIC E.** (A'24), Director, Chenik and Barnett (Wireless), Ltd., Steytlers Bldgs., 42 Loveday St., Johannesburg, Transvaal, South Africa. For mail: P.O. Box 745, Johannesburg, Transvaal, South Africa.
- BARNETT, LOUIS W.** (J'28-A'30), Radio Engineer, Studio Division, Radio Station WKBF, Indianapolis Broadcasting, Inc., 540 1/2 N. Meridian St., Indianapolis, Ind. For mail: 1319 N. New Jersey St., Indianapolis, Ind.
- BARNETT, M. A. F.** (A'26), Physicist, Dominion Laboratory, Wellington, New Zealand.
- BARNETTE, ALLEN F.** (A'31), Service Technician, Barnette and Sons Radio Service, 2052 1/2 E. 76th St., Los Angeles, Calif.
- BARNWELL, WALTER J.** (A'30), Service Engineer, Sparks-Withington Company, Jackson, Mich. For mail: 208 Moores River Dr., Lansing, Mich.
- BARONE, SALVATORE A.** (J'16-A'19), Radio Engineer, Wired Radio, Inc., Ampere, N.J. For mail: 1242 Bonnie View, Lakewood, Ohio.
- BARONOWSKY, JAMES E.** (J'31), 921 Sparta St., Chester, Ill.
- BARRAGAN, MILO B.** (A'31), Officer, U. S. Army, Varsity Apartments, West Lafayette, Ind.
- BARREGARYE, LAURENCE H.** (J'29), Proprietor, Barregarye Radio Service Company, 707 S. Lafayette St., Beardstown, Ill. For mail: 605 S. Lafayette St., Beardstown, Ill.
- BARRETT, HERMAN R.** (A'28), Old Post Rd., North Attleboro, Mass.

- BARRIS, H. ALLEN** (A'31), Proprietor, Radio and Electrical Service, 837 W. Central Ave., Toledo, Ohio.
- BARRON, ALFRED** (A'31), Radio Service Manager, Havens Electric Company, 31 Hudson Ave., Albany, N.Y. For mail: 940 Broadway, Watervliet, N.Y.
- BARRON, ARTHUR J.** (A'30), Superintendent, Betts Radio and Electric Company, 229 N. Broadway, Shawnee, Okla. For mail: 309 S. Penn Ave., Shawnee, Okla.
- BARRON, J. H., JR.** (M'29), Radio Engineer, Federal Radio Commission, Washington, D.C.
- BARROW, FREDERICK A.** (A'23), Designing Engineer, Canadian Marconi Company, 66 Wicksteed Ave., Mount Royal, P.Q., Canada. For mail: 4463 Wilson Ave., Montreal, N.W. 9, Canada.
- BARROW, W. L.** (A'28), Doctor, Massachusetts Institute of Technology, Cambridge, Mass.
- BARRY, BERT** (A'30), Service Manager, Greenbaum Radio Shop, 62 Broadway, Paterson, N.J. For mail: R.F.D. No. 1, East 11th St., Fair Lawn, N.J.
- BARRY, FRANCIS J.** (J'28-A'30), Laboratory, Raytheon Manufacturing Company, Chapel St., Newton, Mass. For mail: 18 Longfellow St., Dorchester, Mass.
- BARRY, JAMES A.** (J'23-A'28), Proprietor, Gray and Barry, 923 S. 24th St., Fort Smith, Ark.
- BARTAL, OTTO** (A'28), Service Manager, Neapolitan Talking Machine Company, 311 Court St., Brooklyn, N.Y. For mail: 1271 E. 88th St., Brooklyn, N.Y.
- BARTH, BRUNO B.** (A'31), Radio Service, Aeolian Hall, 689-5th Ave., New York, N.Y. For mail: 179-73 Selover Rd., St. Albans, L.I., N.Y.
- BARTHOLD, GODFREY L.** (A'30), Managing Director, Radesco Pty., Ltd., 92 Union St., Malvern, Victoria, Australia. For mail: 72 Union St., Malvern, Victoria, Australia.
- BARTHOLOMEW, ROBERT G.** (A'29), Radio Technician, 526 W. Broad St., Quakertown, Pa.
- BARTLETT, A. C.** (A'29), Research Laboratories, General Electric Company, Ltd., Wembley, England. For mail: 31 Malden Rd., Watford, Herts, England.
- BARTLETT, KENNETH R.** (A'30), Chief Radioman, U. S. Navy, U.S.S. *Louisville*, c/o Postmaster, New York, N.Y.
- BARTLETT, MILLARD C.** (A'26), Service, Trilling and Montague, 7th and Arch Sts., Philadelphia, Pa. For mail: 6911 Cedar Park Ave., Philadelphia, Pa.
- BARTLETT, WALLACE A.** (A'22), Executive, Brandes, Ltd., Cray Works, Sidcup, Kent, England.
- BARTON, FRED C.** (A'31), Division Engineer, RCA Victor Company, Inc., Camden, N.J.
- BARTON, LOY E.** (M'29), Engineer, RCA Victor Company, Inc., Camden, N.J. For mail: 228 Burrwood Ave., Collingswood, N.J.
- BARZEE, GEORGE W.** (A'31), Sound Equipment Engineer, Western Electric Company of Brazil, Praca Ramos de Azevedo 16, Sao Paulo, Brazil.
- BASKETT, FREDERICK J.** (A'30), Engineer, Standard Radio Relay Services, Ltd., Bush House, Aldwych, London, England. For mail: "Osmington," Parkfield Gardens, Harrow, Middlesex, England.
- BASSFORD, SYDNEY W., JR.** (A'31), Engineer, Monumental Radio, Inc., 811 W. Lanvale St., Baltimore, Md. For mail: 3300 Rosekemp Ave., Baltimore, Md.
- BASSLER, CARL J.** (A'31), Radioman, U. S. Navy, U.S.S. *Saratoga*, San Pedro, Calif.
- BATCHELDER, LAURENCE** (A'29), Electrical Engineer, Submarine Signal Corporation, 160 State St., Boston, Mass. For mail: 22 Channee St., Cambridge, Mass.
- BATCHELLER, ARTHUR** (A'14-M'20), U. S. Supervisor of Radio, Sub-treasury Bldg., Nassau and Wall Sts., New York, N.Y.
- BATCHELOR, HAROLD** (A'30), Radio Engineer, RCA Victor Company, Inc., Camden, N.J. For mail: 323 Westmont Ave., Westmont, N.J.
- BATCHER, RALPH R.** (A'18-M'22), Vice President, Decatur Manufacturing Company, 45 Harmon St., Brooklyn, N.Y. For mail: 11335-198th St., Hollis, L.I., N.Y.
- BATE, JAMES R. T.** (A'31), Service Engineer, Cosmos Lamp Works, Brimsdown, Enfield, Middlesex, England. For mail: 8 St. Georges Rd., Forty Hill, Enfield, Middlesex, England.
- BATES, CLIFFORD W.** (A'29), 403 N. Narberth Ave., Narberth, Pa.
- BATES, CYRIL R.** (A'26), Messrs. L. McMichael, Ltd., Descham Rd., Slough, Bucks, England. For mail: 49 Woodbridge Rd., Knowle, Bristol, England.
- BATES, LEE A.** (A'28), President, The Lee A. Bates Radio Company, 274 Main St., Worcester, Mass.
- BATHE, CHARLES E.** (A'29), Superintendent of Standards and Radio, Oklahoma Gas and Electric Company, 321 N. Harvey St., Oklahoma City, Okla.
- BATSEL, MAX C.** (A'21-F'27), Chief Engineer, RCA Photophone, Inc., 411-5th Ave., New York, N.Y.
- BATTEY, E. L.** (A'31), Assistant Communications Manager, American Radio Relay League, 38 La Salle Rd., West Hartford, Conn. For mail: 221 South St., Elmwood, Conn.
- BAUDINO, JOSEPH E.** (A'28), Plant Manager, Radio Station WBZ, Hotel Bradford, Boston, Mass.
- BAUER, A. T.** (A'30), Engineer, Queensland Radio Service, c/o 406, Elizabeth St., Brisbane, Queensland, Australia. For mail: Rose St., Annerley, South Brisbane, Queensland, Australia.
- BAUER, BRUNTON** (A'29), Bell Telephone Laboratories, Inc., 180 Varick St., New York, N.Y.
- BAUER, FRITZ** (A'28), Engineer, Radio Station KGBX, St. Joseph, Mo. For mail: 304 S. 17th St., St. Joseph, Mo.
- BAUER, PAUL S.** (J'20-A'26), Student, Morgan Hall, Harvard Business School, Soldiers Field, Boston, Mass.
- BAUER, WARREN** (A'31), Radio Operator, Trans-continental and Western Air, Inc., Harrisburg Municipal Airport, Harrisburg, Pa.
- BAUKAT, HENRY W.** (A'27-M'29), Advertising Manager, H. W. B. Drew Company, 30 W. Bay St., Jacksonville, Fla. For mail: Ortega, Fla.

- BAUM, SYDNEY H. (A'24), Chief Engineer, Empire Electrical Products Company, 102 Wooster St., New York, N.Y. For mail: 384 Essex St., Brooklyn, N.Y.
- BAUMGARTEN, FRANK A. (A'26), Vice President, Wireless Electric Company, 206 Stanwix St., Pittsburgh, Pa. For mail: Kings Arms Apartments, S. Negley and Walnut Sts., Pittsburgh, Pa.
- BAUNACH, EDWARD L. (J'26-A'29), 7823-10th Ave., Brooklyn, N.Y.
- BAXTER, CHARLES E. (A'27), Telegraph and Telephone Engineer, New York Central Lines, Michigan Central Station, Detroit, Mich.
- BAXTER, E. W. (A'31), Electrical and Radio Mechanic, c/o E. A. McLean, 157 Pirie St., Adelaide, South Australia. For mail: 148 Watson Ave., Toorak, Adelaide, South Australia.
- BAXTER, HENRY W. (A'31), Research, British Electrical Research Association, 36 and 38 Kingsway, London, W.C. 2, England. For mail: 12 Henwood Rd., Rotherhithe, London, S.E. 16, England.
- BAYNE, R. R. (A'28), Radio Repairs and Service, Canadian Westinghouse Company, 355 King St. W., Toronto, Ont., Canada. For mail: 374 Jane St., Toronto, Ont., Canada.
- BEACH, CHESTER L. (A'20), Broadcast Apparatus Sales Engineer, RCA Victor Company, Inc., Camden, N.J. For mail: 300 Main St., Apartment 1, Riverton, N.J.
- BEACH, ERNEST W. (A'30), Staff Operator, Radio Station WABC, Ozone Park, L.I., N.Y. For mail: 8642-106th St., Richmond Hill, L.I., N.Y.
- BEACHLEY, VANCE E. (A'27), Radio and Interference Service Technician, Vance E. Beachley Company, 1926 Park St., Harrisburg, Pa.
- BEAKES, WILLIAM E. (A'14-M'14), Vice President and General Manager, Tropical Radio Telegraph Company, 1 Federal St., Boston, Mass.
- BEAL, RALPH R. (A'15), Electrical Engineer, Federal Telegraph Company, Palo Alto, Calif. For mail: 755 Hamilton Ave., Palo Alto, Calif.
- BEANE, E. A. (M'27), Consulting Engineer, E. A. Beane, Engineers, 325 W. Huron St., Chicago, Ill.
- BEANS, FLOYD L. (A'29), Radio Sales and Service, 801 Cattell St., Easton, Pa.
- BEAR, WILLIAM P. (A'23), Power Sales Engineer, Pacific Gas and Electric Company, San Francisco, Calif.
- BEARD, J. GREGSON (A'29-M'30), Radio Engineer, Westinghouse Electric and Manufacturing Company, Chicopee Falls, Mass. For mail: 895 Worthington St., Springfield, Mass.
- BEARUP, T. W. (M'27), Manager for Victoria, Australian Broadcasting Company, Ltd., Stations 3LO and 3AR, Melbourne Pl., 120a Russell St., Melbourne, C.I., Australia.
- BEASLEY, IRA E. (A'19), Assistant Physics Department, Cleveland Clinic, Euclid Ave. and 93rd St., Cleveland, Ohio. For mail: 870 E. 130th St., East Cleveland, Ohio.
- BEASLEY, WILLIAM A. (A'31), Proprietor, Beasley Radio Service, 1451 Byron Ave., Topeka, Kan.
- BEATTY, DWIGHT L. (A'30), Senior Administrative Officer, U. S. Forest Service, Washington, D.C. For mail: Box 72, Bend, Ore.
- BEATTY, RUE THOMPSON (A'29), Radio Service, Bender Radio Store, Field St., Kane, Pa. For mail: 805 Welsh St., Kane, Pa.
- BEATTY, W. E. (A'29), General Patent Attorney, Warner Brothers Pictures, Burbank, Calif.
- BEAUMONT, WILLIAM FREDERICK (A'29), Service Manager, Jamestown Philco Sales Company, 309 W. 3rd St., Jamestown, N.Y. For mail: 72 Campbell Ave., Jamestown, N.Y.
- BECHLER, W. C., JR. (A'28), Senior Radio Inspector, U. S. Navy Yard, Philadelphia, Pa.
- BECK, ALFRED C. (A'30), Member of Technical Staff, Bell Telephone Laboratories, Inc., 463 West St., New York, N.Y. For mail: P.O. Box 107, Red Bank, N.J.
- BECKER, CARL WILLIAM (A'30), Assistant Radio Engineer, 70 Brookline Ave., Boston, Mass. For mail: 80 Brighton Ave., Allston, Mass.
- BECKER, STEWART (A'31), Radio Engineer, General Electric Company, Schenectady, N.Y. For mail: 196 Division St., Schenectady, N.Y.
- BECKLEY, JOHN G. (A'30), Radio Service, Beckley-Ralston Company, 52 W. 22nd St., Chicago, Ill. For mail: 541 S. Kensington Ave., LaGrange, Ill.
- BECKLEY, S. A. (A'30), Lieutenant, 1st F.A., Fort Sill, Okla.
- BEDFORD, A. V. (A'31), Photophone Engineer, RCA Victor Company, Inc., Camden, N.J. For mail: 118 E. Palmer Ave., Collingswood, N.J.
- BEDFORD, GEORGE W. (A'28), Lighthouse Service, U. S. Department of Commerce, U. S. Lighthouse Depot, 3rd District Staten Island, N.Y. For mail: 61 Burnside Ave., West New Brighton, S.I., N.Y.
- BEEHLER, ELMER G. (A'31), Radio Engineer and Operator, P.O. Box 307, Yuma, Colo.
- BEEM, RAYMOND M. (A'25), Proprietor, "The Radio Shop," 403 W. 3rd St., Little Rock, Ark. For mail: 5117 Q St., Little Rock, Ark.
- BEER, H. G. (A'31), Assistant Engineer, Radio Section, G.P.O., Engineer-in-Chief's Office, Alder House, London, England.
- BEER, RICHARD M. (A'31), Graduate Student, Ohio State University, Columbus, Ohio. For mail: 236-15th Ave., Columbus, Ohio.
- BEERS, G. LISLE (A'27-M'29), Section Engineer, RCA Victor Company, Inc., Camden, N.J. For mail: 119 Summerfield Ave., Collingswood, N.J.
- BEGG, W. E. (A'30), Manager, B and B Radio Laboratories, Inc., 509 Terry Ave. N., Seattle, Wash. For mail: 902 N. 107th St., Station F, Seattle, Wash.
- BEHN, LUDWIG F. (A'15), Directeur des Services Techniques, Etablissements Constable Celeston, 47 Boulevard de Levallois, Neuilly-sur-Seine, France. For mail: 14 Rue Lacreteille, Paris (XVme), France.
- BEHNER, HERBERT C. (A'16-M'25), Lieutenant, U. S. Navy, U.S.S. Langley, c/o Postmaster, New York, N.Y.
- BEHR, F. J. (A'13-M'13-F'20), Chairman, Porto Rican Hurricane Relief Commission, San Juan, Porto Rico.

- BEIDLEMAN, HOWARD B. (A'28), Service Manager, Stewart-Warner Sales Company, 134 Sussex Ave., Newark, N.J. For mail: 15 Waldo Ave., Bloomfield, N.J.
- BEINDORF, LUCIEN J. (A'28), Director, Scientific Development Laboratories, 1253-1259 Diversey Pkwy., Chicago, Ill.
- BEISEL, KEITH (A'30), Engineering Research Staff, Metro-Goldwyn-Mayer Studios, Culver City, Calif. For mail: 417 Cypress St., Santa Ana, Calif.
- BEIZER, HAROLD (A'30), 419 Quincy Ave., Scranton, Pa.
- BELL, FLOYD W. (A'30), Junior Engineer, General Motors Radio Corporation, Dayton, Ohio. For mail: 725 Grand Ave., Dayton, Ohio.
- BELL, GEORGE D. (A'31), Proprietor, Radio Service, 5752 N. Lawrence St., Philadelphia, Pa.
- BELL, JOHN C. (A'26), Secretary and Treasurer, Birmingham Broadcasting Company, Bankhead Hotel, Birmingham, Ala.
- BELL, RICHARD (A'30), Radio Engineer, Philadelphia Storage Battery Company, Ontario and C Sts., Philadelphia, Pa. For mail: 14 W. Franklin Ave., Collingswood, N.J.
- BELLEM, LEWIS S., JR. (A'30), 143 Eastwood Ave., Providence, R.I.
- BELLEVILLE, LOGAN (J'29-A'30), Radio Service Company, 141-2nd Ave. E., Twin Falls, Idaho. For mail: 263-5th Ave. E., Twin Falls, Idaho.
- BELTZ, WILLIS H. (A'28), Assistant Manager, Installation and Service Department, RCA Photophone, Inc., 438 W. 37th St., New York, N.Y.
- BEMIS, EDWIN W. (A'22), Engineering Department, American Telephone and Telegraph Company, 195 Broadway, New York, N.Y.
- BEMIS, ISABEL S. (A'31), Engineering Assistant, American Telephone and Telegraph Company, Rm. 2010, 195 Broadway, New York, N.Y.
- BENDER, JOHN A. (A'31), Chief Radio Operator, S.S. President Coolidge, Dollar Steamship Lines Inc., Ltd., 311 California St., San Francisco, Calif. For mail: 793 Arguello Blvd., San Francisco, Calif.
- BENDER, LOUIS B. (M'23), Army Industrial College, Munitions Building, Washington, D.C. For mail: 7100 Chestnut St., N.W., Washington, D.C.
- BENGE, J. R. (A'29), Supervisor, Material Test and Approval Section, RCA Victor Company, Inc., Camden, N.J. For mail: 843 E. Price St., Philadelphia, Pa.
- BENHAM, HAROLD J. (A'31), Sound Engineer, RCA Photophone, Inc., Boston, Mass. For mail: 41 Milton St., Arlington, Mass.
- BENIN, ZOLMON (A'29), Engineer, Ergon Electric Corporation, 20 Bergen St., Brooklyn, N.Y. For mail: 105 Van Wagenen Ave., Jersey City, N.J.
- BENIOFF, HUGO (J'20-A'20), Physicist, Carnegie Institution of Washington, Seismological Laboratory, Pasadena, Calif. For mail: Route No. 1, Box 55, La Canada, Calif.
- BENJAMIN, ABRAHAM S. (A'22), Sales Engineer, Teletype Corporation, 1400 Wrightwood Ave., Chicago, Ill. For mail: 5710 N. Spaulding Ave., Chicago, Ill.
- BENKELMAN, GLEN F. (A'28), Treasurer and Electrical Engineer, Continental Carbon Company, Inc., 13904 Lorain Ave., Cleveland, Ohio.
- BENNER, HAROLD S. (A'27), Radiomarine Corporation of America, 35 S. 3rd St., Philadelphia, Pa. For mail: Schwenkville, Pa.
- BENNETT, DONALD P. (A'30), Editor, Wilding Picture Products, Inc., 1358 Mullett St., Detroit, Mich.
- BENNETT, EDWARD (M'17-F'18), Engineering Bldg., University of Wisconsin, Madison, Wis.
- BENNETT, F. T. (A'28), Proprietor, Wireless Telegraph Company, Rue du Pre, Guernsey, Channel Islands.
- BENNETT, GORDON S. (A'30), Carrier Chief, Canadian Pacific Railway Company, Telegraphs, Winnipeg, Manit., Canada. For mail: 354 Baltimore Rd., Winnipeg, Manit., Canada.
- BENNETT, HUGH (A'31), Radio Serviceman, The Wentworth Radio-Auto Supply Company, Hamilton, Ont., Canada. For mail: 174 Main St., W., Hamilton, Ont., Canada.
- BENNETT, MAURICE C. (A'30), Laboratory Assistant and Draftsman, Howard Radio Company, South Haven, Mich. For mail: 312 Michigan Ave., South Haven, Mich.
- BENNETT, MORRIS H. (A'26), Electrical Engineer, Scovill Manufacturing Company, Waterbury, Conn. For mail: R.F.D. No. 2, Waterbury, Conn.
- BENNINGTON, T. W. (A'31), Chief Technical Operator, International Marine Radio Company, Ltd., Connaught House, Aldwych, London, England. For mail: Church Farm House, Happisburgh, Norfolk, England.
- BENSON, FRANCIS S. (A'28), Assistant Engineer, Department of Engineering, Pacific Gas and Electric Company, 245 Market St., San Francisco, Calif.
- BENT, ARTHUR E. (A'31), Lawyer, Old Rd., Weston, Mass.
- BENZOF, C. G. (A'30), Radio Electrician, U. S. Department of Commerce, Airways Radio Station, Cleveland, Ohio.
- BERCHE, P. (A'29), Chief Editor, *L'Antenne*, 53 Rue Reaumur, Paris 2, France. For mail: 7 Place Pereiere, Paris 17, France.
- BEREJKOFF, ANATOL PETROVICH (A'23), Member of Engineering Staff, Radio Engineering Department, General Electric Company, 1 River Rd., Schenectady, N.Y. For mail: 1238 Union St., Schenectady, N.Y.
- BERG, ARTHUR A. E. (A'28), Service Manager, The Mathes Company, 412 Polk St., Amarillo, Tex.
- BERG, ERNEST J. (A'17), Consulting Engineer, General Electric Company, 1 River Rd., Schenectady, N.Y. For mail: 28 Lowell Rd., Schenectady, N.Y.
- BERGE, SIGFRED F. (A'31), Junior Radio Inspector, U. S. Department of Commerce, 1012 Exchange Bldg., Seattle, Wash.
- BERGERON, ROSARIO (A'29), Radio Specialist, 104-1st St., E., Cornwall, Ont., Canada.
- BERGLUND, E. B. (A'31), Engineer, RCA Victor Company, Inc., Bldg. 5, 3rd Floor, Camden, N.J. For mail: 639 Lakeview Dr., Collingswood, N.J.
- BERGMAN, G. WILEY (J'25-A'25), Radio Interference Engineer, Public Service Company of Northern Illinois, Rm. 1335, 72 W. Adams St., Chicago, Ill.
- BERGMANN, HOWARD J. (J'29), Radio Operator, Radio Station WBen, Buffalo, N.Y. For mail: 741 LaSalle Ave., Buffalo, N.Y.

- BERGTOLD, A. L. (A'30)**, Representative, Technical Department, Thomas Patrick, Inc., Hotel Chase, St. Louis, Mo., For mail: 1318 Clara Ave., St. Louis, Mo.
- BERHALTER, JOSEPH J. (A'30)**, 328 W. 76th St., New York, N.Y.
- BERHLEY, FRED (A'29)**, Engineer, Ambassador Radio Company, 79 Cortland St., New York, N.Y. For mail: 3411 Astoria Ave., Astoria, L.I., N.Y.
- BERKHEIMER, R. H. (A'21)**, Proprietor, Hardware and Furniture, Gig Harbor, Wash.
- BERKNER, LLOYD V. (A'26)**, Radio Section, U. S. Bureau of Standards, Washington, D.C. For mail: 3901 Connecticut Ave., Washington, D.C.
- BERKOWITZ, LOUIS (J'29)**, Radio Serviceman, Louis Berkowitz Radio Company, 849 Blue Hill Ave., Dorchester, Mass.
- BERMAN, HENRY O. (A'30)**, President and General Manager, Radio Engineering and Service Corporation, 836 N. Howard St., Baltimore, Md.
- BERNARD, HERMAN (A'25)**, General Manager, *Radio World*, 145 W. 45th St., New York, N.Y. For mail: 300 Gramatan Ave., Mount Vernon, N.Y.
- BERNER, AARON (A'29)**, Radio Technician, Davega, Inc., 526 W. 25th St., New York, N.Y. For mail: 392 Sackman St., Brooklyn, N.Y.
- BERNHARDT, EDWARD E. (A'30)**, Service Manager, 150-05-88th Ave., Jamaica, L.I., N.Y.
- BERNSTEIN, JULIUS (A'30)**, Public Address Operator, Broadcasting Station WNYC, Municipal Bldg., New York, N.Y. For mail: c/o The University of North Carolina, Chapel Hill, N.C.
- BERRIEN, PAUL H. (A'30)**, Technical Instructor, R.C.A. Institutes, Inc., 1211 Chestnut St., Philadelphia, Pa. For mail: 4202 Hartel St., Holmesburg, Philadelphia, Pa.
- BERRY, FINLEY L. (A'31)**, Senior Radioman, Radio Laboratory, U. S. Coast Guard, Pier 18, Clifton, S.I., N.Y. For mail: 9430-113th St., Richmond Hill, L.I., N.Y.
- BERRY, HENRY P. (A'24)**, Preliminary Plans Engineer, Chesapeake and Potomac Telephone Company, Charleston, W.Va. For mail: 1107 Highland Rd., Charleston, W.Va.
- BERRY, JAMES L. (A'27)**, 114 Nansen Ave., Brooklyn, N.Y.
- BERRY, JAMES S. (A'29)**, Radio Service, Saitillo, Tenn.
- BERRY, ROBERT C. (A'27)**, Sound Engineer, Warner Brothers, 1277 E. 14th St., Brooklyn, N.Y. For mail: 1148 E. 19th St., Brooklyn, N.Y.
- BERRYMAN, FORREST G. (A'27)**, Radio Serviceman, Royston, Ga.
- BERTOLET, BENVILLE S. (A'29)**, Merchandise and Service Manager, Metropolitan Edison Company, 2nd and Ferry Sts., Easton, Pa. For mail: 312 Hanover St., Bethlehem, Pa.
- BERTONIS, PETER W. (A'31)**, c/o Carl Russo, 1230 New Hampshire Ave., Washington, D.C.
- BERTZOW, JOHANNES A. (A'29)**, Captain in Danish Army, Kastelsvej No. 3, Copenhagen, Denmark.
- BEST, ALBERT O. (A'31)**, Electrical Testman, Bureau of Power and Light, 207 S. Broadway, Los Angeles, Calif. For mail: 925 Yale St., Santa Monica, Calif.
- BEST, VICTOR C. (A'30)**, Radio Serviceman, Joseph Horne Company, Pittsburgh, Pa. For mail: 726-6th St., Oakmont, Pa.
- BETHENOD, J. F. J. (A'17)**, Consulting Engineer, 16 Rue de Varize, Paris 16e, France.
- BETTERLEY, JACK A. (A'21)**, Proprietor, Bear Valley Electric Company, Pine Knot P.O. Calif.
- BETTS, PHILANDER H. (A'23)**, Radio Engineer, Bell Telephone Laboratories, Inc., 463 West St., New York, N.Y.
- BEUSMAN, ROBERT M. (A'29)**, Production Engineer, Belmont Radio Corporation, 520 N. Michigan Ave., Chicago, Ill. For mail: 5429 Eddy St., Chicago, Ill.
- BEVER, ANTHONY J. M. (A'24)**, Director, Drum Engineering Company, Ltd., Bradford, England. For mail: Lodge Hill Bungalow, Ilkley, York, England.
- BEVERAGE, HAROLD H. (A'15-M'26-F'28)**, Chief Communications Engineer, R.C.A. Communications, Inc., 66 Broad St., New York, N.Y.
- BEVERIDGE, JOHN A. (M'29)**, Engineer-in-Charge, British Broadcasting Corporation, 87 George St., Edinburgh, Scotland. For mail: "Dunelm," 8 Cluny Dr., Edinburgh, Scotland.
- BEVIS, JAMES (A'31)**, Plumber and Painter, J. M. Sullings and Son, Stanford-le-Hope, Essex, England. For mail: "Singlewell," The Rookery Estate, near Stanford-le-Hope, Essex, England.
- BEVITT, WILLIAM D. (A'28)**, Chief Inspector, A. H. Grebe and Company, Inc., 70 Van Wyck Blvd., Jamaica, L.I., N.Y. For mail: 8925 Parsons Blvd., Jamaica, L.I., N.Y.
- BEWICK, W. (A'31)**, Assistant Engineer, Radio Section, Engineer-in-Chief's Office, G.P.O., London, E.C. 1, England.
- BEYER, HAIM (A'30)**, Chief Engineer, Cornell Electric Manufacturing Company, Rawson and Anable Sts., Long Island City, L.I., N.Y. For mail: 16 W. 77th St., New York, N.Y.
- BEYER, RAYMOND G. (A'30)**, Assistant Engineer, National Electric Light Association, 420 Lexington Ave., New York, N.Y.
- BIAR, L. E. (J'28-A'30)**, Radio Instructor, Meridian School of Radio, Elks Bldg., Meridian, Miss. For mail: 401 Chambers St., Giddings, Tex.
- BICKEL, HOWARD I. (A'27)**, Engineer, Ohio Bell Telephone Company, 215 W. 2nd St., Dayton, Ohio. For mail: 258 Delaware Ave., Dayton, Ohio.
- BICKELMAN, JOHN E. (A'30)**, Service Department, Cumberland-Young, Inc., 822-824 Main St., Buffalo, N.Y. For mail: 152 Goodrich St., Buffalo, N.Y.
- BIDLACK, CECIL S. (A'27)**, Technical Supervisor, Radio Station WEOA, Ohio State University, Columbus, Ohio. For mail: 1448 N. 6th St., Columbus, Ohio.
- BIELE, CHARLES E. (A'27)**, Sales Engineer, Charles F. Biele and Sons Company, 33-39 Bethune St., New York, N.Y. For mail: 54 Woodland Rd., Maplewood, N.J.
- BIEVER, FRED H. (A'26)**, Manager, Backus Novelty Company, Smethport, Pa. For mail: 707 W. Water St., Smethport, Pa.
- BILES, FRANK V. (A'27)**, Telegrapher, Lehigh Valley Railroad, Geneva, N.Y. For mail: 178 William St., Geneva, N.Y.

- BILLIAMS, FRANK J. (A'31)**, Electro-Acoustical Engineer, Authorized Silver-Marshall Service Station, 107 Plane St., Stanhope, N.J. For mail: P.O. Box 123, Stanhope, N.J.
- BILLINGS, HORACE P. (A'31)**, Chemical Engineer, RCA Victor Company, Inc., Front and Linden Sts., Camden, N.J. For mail: 6359 Grant Ave., Merchantville, N.J.
- BILLINGSLEY, JOSEPH B. (J'31)**, Radio Technician, Rad-Elec-Service, 103 W. McHarg, Stamford, Tex. For mail: 406 E. Campbell St., Stamford, Tex.
- BILLUPS, ROBERT W. (A'28)**, Sales Engineer, Kolster Radio, Inc., Newark, N.J. For mail: Franklin Park, Roslyn, Va.
- BILTZ, FRANCIS J. (A'31)**, Graduate Student in Electrical Engineering, University of Minnesota, Rochester, Minn. For mail: 1225-1st St., S.W., Rochester, Minn.
- BINGHAM, JOHN M. (A'22)**, Box 1079, Christchurch, New Zealand.
- BINNS, JOHN R. (A'26)**, Treasurer, Hazeltine Corporation, and Radio Editor, *Collier's*, Rm. 2043, 42 Broadway, New York, N.Y.
- BINYON, BASIL (A'14-M'14)**, Managing Director, Radio Communications Company, Ltd., 34 Norfolk St., London, W.C. 2, England. For mail: Hawthornden, Hayes, Kent, England.
- BIRD, C. H. R. (A'30)**, Engineer, Canadian Marconi Company, Yamachiche, P.Q., Canada.
- BIRD, J. RAYMOND (A'30)**, Engineer, Bell Telephone Laboratories, Inc., 463 West St., New York, N.Y. For mail: 8 Barrow St., New York, N.Y.
- BIRD, R. J. (M'29)**, Engineer-in-Charge, British Broadcasting Corporation, Westerglen Falkirk, Scotland.
- BIRD, SYDNEY S. (A'30)**, Managing Director, Sydney S. Bird and Sons, Ltd., "Cyclodon" Works, Sarnesfield Rd., Enfield Town, London, England.
- BIRKHAHN, ROBERT C. (A'22)**, Lawyer, 420 Lexington Ave., New York, N.Y. For mail: Woodmere, L.I., N.Y.
- BISBEE, ROBERT H. (A'30)**, Service Engineer, RCA Photophone, Inc., 411-5th Ave., New York, N.Y. For mail: 2109 Biddle St., Wilmington, Del.
- BISHOP, CHESTER K. (A'30)**, Mount Liberty, Ohio.
- BISHOP, NATHANIEL (A'26)**, 301 Park Pl., Bridgeport, Conn.
- BISHOP, WILLIAM T. (A'31)**, Radio Engineer, DeForest Radio Company, Passaic, N.J. For mail: 45 River Dr., Passaic, N.J.
- BITTER, A. ROMEYN (A'26)**, Instructor, Radio and Electrical Engineering, Woodward High School, Toledo, Ohio. For mail: 2207 Fulton St., Toledo, Ohio.
- BIVER, CARL J. (A'29)**, Engineer, Ken-Rad Corporation, Owensboro, Ky. For mail: 1634 Parrish Ave., Owensboro, Ky.
- BLACK, DONALD M. (A'30)**, Engineer, Bell Telephone Laboratories, Inc., 463 West St., New York, N.Y.
- BLACK, JOEL CANTRELL (J'30)**, Student, Loomis Radio College, Washington, D.C. For mail: 2440-16th St., N.W., Washington, D.C.
- BLACK, K. CHARLTON (M'29)**, Engineer, Bell Telephone Laboratories, Inc., 180 Varick St., New York, N.Y.
- BLACK, OLIVER M. (A'27)**, R.C.A. Institutes, Inc., 899 Boylston St., Boston, Mass.
- BLACK, ROBERT (A'28)**, Transmission Department, Southern California Telephone Company, 740 S. Olive St., Los Angeles, Calif. For mail: 15734 Sherman Way, Van Nuys, Calif.
- BLACKBURN, JOHN F. (A'29)**, Research Fellow in Physics, California Institute of Technology, Pasadena, Calif. For mail: 1719 N. Gardner St., Hollywood, Calif.
- BLACKBURN, WESLEY (J'30)**, Sonora Corporation of Canada, 345 Adelaide St., W., Toronto, Ont., Canada.
- BLACKMAR, ABEL E., JR. (A'24)**, Attorney-at-Law, Sheffield and Betts, 27 Cedar St., New York, N.Y.
- BLACKWELL, OTTO B. (M'20-F'28)**, Transmission Development Engineer, American Telephone and Telegraph Company, 195 Broadway, New York, N.Y.
- BLACKWELL, WILLIAM J. (A'31)**, Service Manager, c/o F. Higgins, Palmerston St., Westport, New Zealand. For mail: 171 Willis St., Wellington, New Zealand.
- BLACKWOOD, GEORGE C. (A'30)**, 243 E. Upsal St., Mount Airy, Philadelphia, Pa.
- BLAICH, J. RAY (A'27)**, Operator, Radio Station WSYR, Hotel Syracuse, Syracuse, N.Y. For mail: 412 S. Alford St., Syracuse, N.Y.
- BLAIR, RUSSELL M. (A'23-M'30)**, Engineer, Crosley Radio Corporation, 3401 Colemain Ave., Cincinnati, Ohio. For mail: 3930 Ivanhoe Ave., Norwood, Ohio.
- BLAIR, WILEY, JR. (A'27)**, 1215 Wood Ave., Colorado Springs, Colo.
- BLAIS, ALPHY L. (A'26)**, Radio and Chemical Engineer, Theford Mines City, County Meganbe P.Q., Canada.
- BLAKE, ROBERT I. (A'31)**, Equipment and Building Engineer, Pacific Telephone and Telegraph Company, 140 New Montgomery St., San Francisco, Calif.
- BLAKELY, ROBERT JOHN (A'28)**, Assembly Supervisor, Canadian Brandes, 207 Queens Quay, Toronto, Ont., Canada. For mail: 61 Mutual St., Toronto, Ont., Canada.
- BLAN, MICHAEL (A'29)**, President, Blau, The Radio Man, Inc., 89 Cortlandt St., New York, N.Y.
- BLANC, VICTOR (A'31)**, Electrical Engineer, Western Electric Company, Inc., Kearny, N.J. For mail: P.O. Box 174, Times Plaza Station, Brooklyn, N.Y.
- BLANFORD, EDWIN C. (J'28-A'30)**, Radio Service, Malcolm Music House, 115 W. Kearsley St., Flint, Mich. For mail: 2208 Cadillac St., Flint, Mich.
- BLANK, S. A. (A'31)**, District Manager, Radiomarine Corporation of America, 227 Fries Ave., Wilmington, Calif. For mail: 111 East N St., Wilmington, Calif.
- BLATTERMAN, HEADLEE L. (A'31)**, Chief Engineer, Radio Station KFI, Earle C. Anthony, 1000 S. Hope, Los Angeles, Calif. For mail: 121 State St., Los Angeles, Calif.
- BLAUFOX, JOSEPH D. (A'30)**, Managing Director, U.S. Moss Broadway Theatre, Broadway and 53rd St., New York, N.Y. For mail: 87-76-148th St., Jamaica, L.I., N.Y.
- BLENHEIM, WILLIAM J. (A'26-M'28)**, American Traffic Manager, Western Union Cable System, 60 Hudson St., New York, N.Y.

- BLESSING, G. W. (A'28), Chief Engineer, Utah Radio Products Company, 559 College St., Toronto, Ont., Canada.
- BLETT, E. BARTON (A'30), Service Manager, State Distributors, Inc., 10th and Fort Sts., Detroit, Mich. For mail: 2124 Springdale, Detroit, Mich.
- BLINZLER, RICHARD F. (A'31), Radio Operator, Buffalo Broadcasting Corporation, Buffalo, N.Y. For mail: 111 Virgil Ave., Buffalo, N.Y.
- BLITCH, JAMES D. (A'26), Radio Service, Southern Division, Georgia Power Company, Statesboro, Ga. For mail: Statesboro, Ga.
- BLOCK, WESLEY S., JR. (A'31), Salesman, 15 E. 26th St., New York, N.Y.
- BLODGETT, EDWARD D. (A'29), Direction Finder Engineer, RCA Victor Company, Inc., Camden, N.J. For mail: Haddonfield Manor, Haddonfield, N.J.
- BLOM, ROY (A'29), Radio Service, Master Electric Company, 3451 Beach Ave., Chicago, Ill.
- BLOOM, WALTER (A'30), Engineering Staff, RCA Victor Company, Inc., Camden, N.J. For mail: 1624 E. Eyre St., Philadelphia, Pa.
- BLOOMENTHAL, SIDNEY (A'27), Research Physicist, RCA Victor Company, Inc., Camden, N.J.
- BLUMENTHAL, RAYMOND W. (A'28), Radio Clerk, 1244 Randolph St., Detroit, Mich. For mail: 6221 Crane St., Detroit, Mich.
- BLUZAT, CLAUDE R. (A'27), Vice President, Standard Transformer Company, 852 Blackhawk St., Chicago, Ill. For mail: 232 N. Elmwood Ave., Oak Park, Ill.
- BOCK, ASHLEY P. (A'27-M'30), Radio Engineer, Westinghouse Electric and Manufacturing Company, Chicopee Falls, Mass. For mail: 39 Pratt St., Springfield, Mass.
- BOEHME, H. O. (M'15), President, H. O. Boehme, Inc., 117-119 E. 24th St., New York, N.Y.
- BOERNER, THOMAS J. (A'26), R.C.A. Communications, Inc., Rocky Point, L.I., N.Y.
- BOERUM, HENRY S. (A'30), Proprietor, Auto Marine Electric Company, 305 Front St., Greenport, L.I., N.Y.
- BOES, W. W. (A'27), Representative, 9 S. Clinton St., Chicago, Ill. For mail: 735 Junior Ter., Chicago, Ill.
- BOESCHE, F. W. (A'29), Radio Engineer, Bell Telephone Laboratories, Inc., 463 West St., New York, N.Y.
- BOGARDUS, HENRY L. (A'20-M'23), 1447a-7th Ave., San Francisco, Calif.
- BOGENBERGER, JOHN W., JR. (A'27), President, Bogenberger Radio Corporation, 2611 N. 3rd St., Milwaukee, Wis.
- BOGER, CLAIR E. (A'26), Research Engineer, The Hoover Company, North Canton, Ohio. For mail: 607 McKinley St., North Canton, Ohio.
- BOHLKE, W. HOLLANDER (A'28), Student Engineer, 28 Cochran St., Chicopee Falls, Mass. For mail: 220 Amboy Ave., Metuchen, N.J.
- BOHMAN, VICTOR A. (A'29), Receiver Design Engineer, De Forest Radio Company, Passaic, N.J. For mail: 41-50 Landing St., Little Neck, L.I., N.Y.
- BOHN, WILLIAM C. (A'18), Engineer, American Telephone and Telegraph Com-
- pany, 195 Broadway, New York, N.Y. For mail: 139 Sagamore Rd., Maplewood, N.J.
- BOHNER, CHANCE E. (A'30), Radio Engineer, Wired Radio, Inc., Ampere, N.J. For mail: 106 N. Walnut St., East Orange, N.J.
- BOISE, EVERETT B. (A'25), Engineer, Radio Corporation of America, New York, N.Y. For mail: 961 Prospect Ave., Plainfield, N.J.
- BOJI, LOUIS D. (A'27), Radio Superintendent, U. S. Radio and Television, 33rd and Lincoln Blvd., Marion, Ind.
- BOKOVOY, SAM A. (A'30), Radio Engineer, RCA Victor Company, Inc., Camden, N.J. For mail: 220 Cooper St., Camden, N.J.
- BOLAN, ROBERT S. (A'27), Chief Lamp Engineer, Hygrade Lamp Company, 60 Boston St., Salem, Mass.
- BOLAND, JOHN N. (J'31), Student, Danville Military Institute, Danville, Va.
- BONANNO, JOSEPH L. (A'27), Manager, C. B. Engineering Company, 610 S. 21st St., Irvington, N.J. For mail: 7011-110th St., Forest Hills, L.I., N.Y.
- BOND, ELMER FREDERICK (A'29), R.C.A. Communications, Inc., Riverhead, L.I., N.Y.
- BOND, M. E. (A'29), Audio Engineer, United American Bosch Corporation, Springfield, Mass.
- BOND, ORVILLE J. (A'30), Proprietor, Radio Sales and Service, 3303 Sturtevant Ave., Detroit, Mich.
- BONDY, HUGO ALOIS, JR. (A'29), Radio Operator, Radiomarine Corporation of America, 326 Broadway, New York, N.Y. For mail: 123 Phelps Rd., Ridgewood, N.Y.
- BONETT, DAVID J. (A'27), Assistant Patent Attorney, Radio Corporation of America, 570 Lexington Ave., New York, N.Y.
- BONN, NORMAN E. (A'28), Research Engineer, Rubican Company, 24 N. 6th St., Philadelphia, Pa. For mail: 6963 Cedar Park, Philadelphia, Pa.
- BOOKER, EUGENE R. (M'31), Instructor, California School of Mechanical Arts, San Francisco, Calif. For mail: Box 531, Route No. 1, San Jose, Calif.
- BOOLER, ERNEST (A'30), 62 Toftwood Rd., Crookes, Sheffield, England.
- BOONE, VIRGIL (A'29), Sales and Serviceman, The Radio Shop, 511 Main St., Little Rock, Ark. For mail: 224 Vernon St., Little Rock, Ark.
- BOOTH, CHARLES F. (A'30), Chief Inspector, Radio Section, G.P.O., Dollis Hill, London, England. For mail: 8 Durham Rd., Harrow, Middlesex, England.
- BOOTH, HOWARD A. (A'29), Chief Radio Electrician, U. S. Navy, U.S.S. Pennsylvania, c/o Postmaster, San Pedro, Calif.
- BOOTH, HOWARD M. (A'27-M'30), President and Chief Engineer, Booth Radio Laboratories, Inc., 23 Summers St., Tilton, N.H.
- BOOTH, JAMES D. (A'27), Radio Engineer, Westinghouse Electric and Manufacturing Company, Chicopee Falls, Mass. For mail: 609 Longmeadow St., Longmeadow, Mass.
- BOREK, JOHN J. (A'30), 3843 N. 11th St., Milwaukee, Wis.
- BORGES, FRANCISCO B. (A'31), Chief Technical Assistant, Companhia Portuguesa Radio Marconi, Lisbon, Portugal. For mail: Rua das Amoreiras, 50 r/c, E., Lisbon, Portugal.

- BORGES, V. A. (A'30), Engineer-in-Charge, S. A. Philips do Brazil, Caixa Postal 954, Rio de Janeiro, Brazil.
- BORGESON, CARL A. (A'27), Long Lines Department, American Telephone and Telegraph Company, 15 Dey St., New York, N.Y. For mail: 376 Prospect St., East Orange, N.J.
- BORING, HAROLD M. (A'31), 812 E. 28th St., Los Angeles, Calif.
- BORISLAVSKY, MICHAEL A. (A'25), 240 E. 104th St., New York, N.Y.
- BORN, W. THEODORE (A'27), Physicist, Geophysical Research Corporation, 15 Ward St., Bloomfield, N.J.
- BORTHWICK, JAMES H. (A'26), Secretary-Treasurer, Borthwick Undertaking Company, Ltd., Honolulu, Hawaii. For mail: 1565 Nuuanu St., Honolulu, Hawaii.
- BORTON, F. W. (A'30), Miami Broadcasting Company, 42 N.W. 4th St., Miami, Fla.
- BOSCO, JOSEPH F. (J'29), Radio Technician and Instructor, Audio-Vision Appliance Company, Camden, N.J. For mail: 224 E. Sharpnack St., Philadelphia, Pa.
- BOSSARD, GIBBERT L. (M'30), P.O. Box 761, Dayton, Ohio.
- BOSSART, PAUL N. (A'29), Physicist, Research Department, Union Switch and Signal Company, Swissvale, Pa.
- BOSTAD, JOHN (A'27), Engineering Department, Wired Radio, Inc., Ampere, N.J. For mail: 244 Roseville Ave., Apartment 304, Newark, N.J.
- BOSTWICK, L. G. (A'30), Member of Technical Staff, Research Department, Bell Telephone Laboratories, Inc., 463 West St., New York, N.Y.
- BOSTWICK, WILLIAM E. (A'30), Physics Department, Cornell University, Ithaca, N.Y. For mail: 206 Willard Way, Ithaca, N.Y.
- BOSWELL, JAMES R. (A'30), Student Engineer, RCA Victor Company, Inc., Camden, N.J. For mail: 27 Lincoln Ave., Collingswood, N.J.
- BOU, JOHN M. (A'31), Radio Service, Ludwig Baumann and Company, 45 Pearson St., Long Island City, L.I., N.Y. For mail: 148-5th St., Midland Beach, S.I., N.Y.
- BOUCHARD, I. H. (A'30), Manager, Radio Service Company, 207 Pythian Bldg., South Bend, Ind.
- BOUCHERON, PIERRE H. (A'20-M'26), Eastern Radio Sales Manager, RCA Victor Company, Inc., Camden, N.J.
- BOUCK, ZEH (A'24-M'26), Consultant and Technical Writer, 36-20-168th St., Flushing, L.I., N.Y.
- BOUMAN, H. J. J. (A'30), Sound Engineer, Manager, Theatre Equipment Department, N.V. Transformer Works, Amsterdam, (C), Holland. For mail: Tilanusstraat 66, Amsterdam, (O), Holland.
- BOUNDY, GLEN G. (A'28), Radio Engineer, West Virginia Broadcasting Corporation, Wheeling, W.Va. For mail: 1420 National Rd., Wheeling, W.Va.
- BOURGEAIS, ALLEN B. (A'29), Camp Superintendent, Cia. Mexicana de Petroleo "El Aguila" S. A. Apartado 86, Puerto Mexico, Vera Cruz, Mexico. For mail: Apartado 86, Puerto Mexico, Vera Cruz, Mexico.
- BOURNE, ROLAND B. (M'29), Research Engineer, Maxim Silencer Company, Box 2102, Hartford, Conn. For mail: 167 Palm St., Hartford, Conn.
- BOUSON, HERBERT H. (M'26), Staff Headquarters, 13th Naval District, Joseph Vance Bldg., Seattle, Wash.
- BOUSQUET, ARTHUR G. (A'29), General Radio Company, 30 State St., Cambridge, Mass.
- BOWDITCH, FRED T. (A'24), Radio Engineer, Research Laboratory, Edgewater Plant, National Carbon Company, 1280 W. 73rd St., Cleveland, Ohio.
- BOWEN, HAROLD C. (J'16-A'18), Treasurer, Joseph L. Bowen, 100 Pleasant St., Fall River, Mass. For mail: P.O. Box 403, Fall River, Mass.
- BOWEN, LEONARD R. (A'29), Radio Serviceman, Edgar Music Company, 700 S. Main St., Tulsa, Okla. For mail: 2808 E. 7th St., Tulsa, Okla.
- BOWER, JAMES (A'29), Junior Engineer, Brooklyn Edison Company, 55 Johnson St., Brooklyn, N.Y. For mail: 253 Cumberland St., Brooklyn, N.Y.
- BOWER, WARD E. (A'29), Assistant Radio Engineer, U. S. Naval Research Laboratory, Bellevue, Anacostia, D.C. For mail: 1705 Bay St., S.E., Washington, D.C.
- BOWERS, E. J. (A'29), Chief Engineer, Radio Station CFRB, Aurora, Ont., Canada. For mail: 37 Lowther Ave., Toronto, Ont., Canada.
- BOWERS, FRANK L. (A'31), Technician and Experimenter, 933 W. Somerset St., Philadelphia, Pa.
- BOWKER, WINTHROP H. (A'26), Electrical Engineer, New England Telephone and Telegraph Company, 50 Oliver St., Boston, Mass. For mail: 2184 Massachusetts Ave., Lexington, Mass.
- BOWLES, EDWARD L. (A'22-M'28), Instructor in Electrical Engineering, Massachusetts Institute of Technology, Cambridge, Mass.
- BOWLES, THEODORE C. (A'26), Manager, Radio Department, Western Auto Supply Company, 1100 S. Grand Ave., Los Angeles, Calif. For mail: 910 N. Geneva, Glendale, Calif.
- BOWMAN, CHARLES W. (A'29), Repairman, H. K. Radio Engineering Company, 959 Turner St., Allentown, Pa. For mail: 246 S. Madison St., Allentown, Pa.
- BOWMAN, LEON F. (A'31), Control Operator, Radio Station WGAR, Statler Hotel, Cleveland, Ohio.
- BOWMASTER, J. M. (A'29), 27 High St., Springfield, Mass.
- BOWN, RALPH (M'22-F'25), Telephone Engineer, American Telephone and Telegraph Company, 195 Broadway, New York, N.Y.
- BOWYER, ROBERT A., JR. (A'30), Service Manager, Dakota Radio Apparatus Company, 322-324 Douglas Ave., Yankton, S.D. For mail: 711 W. 4th St., Yankton, S.D.
- BOYD, BRUCE (A'30), Tester, Westinghouse Electric and Manufacturing Company, Chicopee Falls, Mass. For mail: 21 Olmstead St., Springfield, Mass.
- BOYD, JOHN W. G. (A'31), Chief Engineer, Radio Station CKNC, Canadian National Carbon Company, Ltd., 805 Davenport Rd., Toronto, Ont., Canada. For mail: 59 Gormley Ave., Toronto, Ont., Canada.
- BOYD, W. FORBES (A'28), The London Electric Wire Company, and Smiths, Ltd., Church Rd., London, E. 10, England.

BOYDEN, DAVIS S. (A'28), Department Superintendent, The Edison Illuminating Company of Boston, 39 Boylston St., Boston, Mass. For mail: 1496 Commonwealth Ave., Boston, Mass.

BOYER, WILLIAM P. (A'28), Engineer, Stevenson Radio Syndicate, Barr Bldg., 910-17th St., Washington, D.C.

BOYLAN, E. BRANDT (A'28), President, Radio Service Laboratories Company, 2205 Monree St., Wilmington, Del.

BOYLE, FRANK A. (A'29), Proprietor, Frank A. Boyle Company, Manchester Rd., Poughkeepsie, N.Y. For mail: P.O. Box 234, Poughkeepsie, N.Y.

BOYLE, H. G. (A'30), Radio Engineer, Engineering Department, Crosley Radio Corporation, Cincinnati, Ohio. For mail: 664 Greenwood Ave., Cincinnati, Ohio.

BOYNTON, FREDERICK L. (A'27), 307 N. Main St., Sycamore, Ill.

BOYSON, CARL V. (A'30), Designer, International Communications Laboratory, 200 Mount Pleasant Ave., Newark, N.J. For mail: 92 Monroe Pl., Bloomfield, N.J.

BRAATEN, ARTHUR M. (A'27), Engineer, Design Division, R.C.A. Communications, Inc., Riverhead, L.I., N.Y. For mail: P.O. Box 979, Riverhead, L.I., N.Y.

BRACH, LEON S. (A'22-M'29), 325 Harrison St., East Orange, N.J.

BRACKETT, HAROLD H. (A'22), Engineer, Toll Plant Extension and Transmission, New Jersey Bell Telephone Company, 540 Broad St., Newark, N.J. For mail: 515 Summit Ave., Oradell, N.J.

BRACKETT, QUINCY A. (M'20), Technical Assistant to Manager, Radio Commercial Department, Westinghouse Electric and Manufacturing Company, Chicopee Falls, Mass. For mail: 116 S. Park Ave., Longmeadow, Mass.

BRACKETT, RICHARD T. (A'27), Instructor, University of Nebraska, E.E. 106, Lincoln, Neb.

BRADBURY, BURKE (A'26-M'30), Radio Engineer, RCA Victor Company, Inc., Camden, N.J. For mail: 104 Stratford Ave., Westmont, N.J.

BRADBURY, G. V. (A'24), Contractor, 415 Ridge Bldg., Kansas City, Mo.

BRADEN, PAUL F. (J'30), Student, Ohio State University, Dayton, Ohio. For mail: 305 Park St., Dayton, Ohio.

BRADEN, RENE A. (A'23), Engineer, RCA Victor Company, Inc., Camden, N.J. For mail: 310 Plymouth Pl., Merchantville, N.J.

BRADFIELD, GEOFFREY (A'31), Design Engineer, E. K. Cole, Ltd., "Ekco" Works, Southend, England. For mail: 161 Hainault Ave., Westcliff-on-Sea, England.

BRADFORD, HENRY K. (A'29), Instructor in Radio, National Radio Institute, 1536 U St., N.W., Washington, D.C.

BRADLEY, ERNEST A. (A'29), Post and Telegraph Department, Wanganui, New Zealand.

BRADLEY, FREDERICK W. (A'31), Engineering Department, Michigan Bell Telephone Company, 1365 Cass Ave., Detroit, Mich., and Radio Instructor, Evening Division, Cass Technical High School, Detroit, Mich. For mail: 19132 Greeley, Detroit, Mich.

BRADLEY, JOHN C. (A'30), Chief Engineer, Champion Radio Manufacturing Cor-

poration, 1865 W. Gage Ave., Los Angeles, Calif. For mail: 1515 W. 84th St., Los Angeles, Calif.

BRADLEY, JOHN T. (A'26-M'31), Proprietor, Special Radio Service Company, 1062 Howard St., San Francisco, Calif. For mail: 2120 Lyon St., San Francisco, Calif.

BRADSHAW, DAVID Y. (A'31), Sound Engineer, Fox-Hearst Corporation, 460 W. 54th St., New York, N.Y.

BRADSHAW, EDWIN (A'31), Acting Chief Engineer, Wells-Gardner and Company, 816 N. Kedzie Ave., Chicago, Ill.

BRADSHAW, LYNWOOD (A'25), Chief Technician, Pacific Broadcasting Corporation, 988 Market St., San Francisco, Calif. For mail: P.O. Box 2498, San Francisco, Calif.

BRADSHAW, ROBERT C. (A'27), The Radio Stores, 564 E. Colorado St., Pasadena, Calif. For mail: P.O. Box 302, Pasadena, Calif.

BRADY, JOHN B. (A'20-M'29), Counsellor-at-Law, Ouray Bldg., Washington, D.C. For mail: 315 Cumberland Ave., Chevy Chase, Md.

BRADY, LESLIE R. (A'29), Radio Inspector, U. S. Government, U. S. Subtreasury Bldg., Pine and Nassau Sts., New York, N.Y. For mail: 20 E. 14th St., New York, N.Y.

BRAFFET, DONALD H. (J'29-A'29), Radio Serviceman, Paw Paw, Ill.

BRAFFORD, CHARLES P. (A'26), 3320 Galena St., Milwaukee, Wis.

BRAGGIO, J. C. (A'30), Cia Radio Int. do Brasil, 50 Rua Alfandega, Rio de Janeiro, Brazil.

BRAIL, STEPHEN L. (A'30), Engineer, Radio Laboratory, 1576 Norris St., Camden, N.J.

BRAINSON, WILLIAM (A'30), Manager, Radio Service Department, Rabsons, 1373-6th Ave., New York, N.Y. For mail: 596 Edgecombe Ave., New York, N.Y.

BRAKE, BASIL H. (A'30), Radio Engineer, Ohio Power Company, Portsmouth, Ohio. For mail: P.O. Box 18, Portsmouth, Ohio.

BRAKE, PAUL (J'29), Member of Technical Staff, Bell Telephone Laboratories, Inc., 463 West St., New York, N.Y.

BRAMSVLEV, GUNNAR (A'31), Radio Department, Danish Posts and Telegraphs, Centralpostbygningen, Copenhagen, Denmark. For mail: Classensgade 19 A, Copenhagen, Denmark.

BRANCH, L. W. (M'29), Manager, Hawaii Telephone System, P.O. Box 425, Hilo, Hawaii.

BRANCH, WILLIAM E. (M'25), Chief Engineer, Radio Engineering Laboratory, 3721 Crestline Rd., Fort Worth, Tex.

BRANDT, KRISTIAN (A'26), Engineer, 19 Berkeley Pl., Brooklyn, N.Y.

BRANDT, WILLIAM A. (A'24), Operating Engineer, Automatic Electric, Inc., 1033 W. Van Buren St., Chicago, Ill. For mail: 4107 Rosemont Ave., Drexel Hill, Pa.

BRAUM, C. M. (A'30), Radio Station KGPB, Police Department, City Hall, Minneapolis, Minn. For mail: 3832 Elliot Ave., Minneapolis, Minn.

BRAUN, W. C. (A'24), President, W. C. Braun Company, 563 W. Randolph St., Chicago, Ill. For mail: P.O. Box 589, Chicago, Ill.

BREATY, LAWRENCE S. (A'29), Engineer, Southern Pacific Railroad Roundhouse, West Oakland, Calif. For mail: 1208 E. 18th St., Oakland, Calif.

BREEDLOVE, BERNARD H. (J'30-A'31), Radio Operator, Radiomarine Corporation of America, *SS Steel Age*, 50 Trinity Pl., New York, N.Y. For mail: 407 Napier Ave., Macon, Ga.

BREIMER, S. H. (A'28), Laboratory Engineer, Ned. Seintoestellen Fabriek, Hilversum, Holland. For mail: Newweg 298, Hilversum, Holland.

BREMER, HARRY A. (A'25), Proprietor, Hudson City Radio Shop, 89-91 Franklin St., Jersey City, N.J.

BRENCHLEY, C. C. (A'30), Radio Engineer, 36 Nether Hall Rd., Doncaster, York, England.

BRENNAN, J. W. (A'31), Field Engineer, General Electric Company, Bridgeport, Conn. For mail: 1311 Maywood Ave., Independence, Mo.

BRENNAN, JOHN B., JR. (A'26), Managing Editor, *Radio News*, 381-4th Ave., New York, N.Y. For mail: 9050-206th St., Bellaire, L.I., N.Y.

BRENT, HERBERT C. (M'23), Telegraph Engineer, Post and Telegraph Department, Palmerton North, New Zealand.

BREUER, JOHN (A'31), Radio Engineer, RCA Victor Company, Inc., Camden, N.J. For mail: 1950 E. Clarence St., Philadelphia, Pa.

BREWER, NOBLE E. (A'28), Radio Consultant, 418 W. 5th St., Abilene, Kan.

BREWIN, ROBERT R. (A'27), Radio Engineer, Georgia Power Company, 211 Decatur St., Atlanta, Ga. For mail: 341 Clifford Ave., N.E., Atlanta, Ga.

BREWINGTON, CARL W. (A'23), Lieutenant Commander, U. S. Navy, 12th Naval District Headquarters, 100 Harrison St., San Francisco, Calif.

BREWSTER, GRANT (A'31), Service and Installation Engineer, RCA Victor Company, Inc., Camden, N.J. For mail: 1631 N. 59th St., Philadelphia, Pa.

BREWSTER, O. H. (A'29), Chief Engineer, CeCo Manufacturing Company, 1200 Eddy St., Providence, R.I. For mail: 101 Grand Ave., Cranston, R.I.

BRICK, FRANK R., JR. (A'25-M'26), American Radio News Corporation, 235 E. 45th St., New York, N.Y. For mail: 856 Colonial Rd., Elizabeth, N.J.

BRICKHILL, G. A. (A'28), Chief Engineer, African Broadcasting Company, Ltd., P.O. Box 2551, Cape Town, South Africa.

BRICKSON, HERBERT O. (A'25), Radio Engineer, Radio Station WLBI, Stevens Point, Wis. For mail: 208 Center Ave., Stevens Point, Wis.

BRIDGES, W. C. (A'27), General Manager, Head of the Lakes Broadcasting Company, Superior, Wis.

BRIDGMAN, FRANCIS K. (A'25), Commercial Radio Representative, Illinois Bell Telephone Company, 212 W. Washington St., Chicago, Ill. For mail: 5807 Dorchester Ave., Chicago, Ill.

BRIGGS, JOSEPH A. (A'30), Engineer, RCA Victor Company, Inc., Camden, N.J. For mail: 52 Wesley Ave., Erlton, N.J.

BRIGGS, LAWRENCE W. (A'31), Student, Dodge Radio Institute, 405 E. Monroe St., Valparaiso, Ind.

BRIGGS, LOYD A. (M'29), Manager, RCA Central Frequency Bureau, Radio Corporation of America, 66 Broad St., New York, N.Y. For mail: 31 Spruce St., Cranford, N.J.

BRIGGS, THOMAS H., IV (A'30), Vacuum Tube Engineer, Raytheon Manufacturing Company, Newton, Mass.

BRIGHAM, CECIL E. (A'28-M'30), Chief Engineer, Brandes Products Corporation, 360 Thomas St., Newark, N.J. For mail: 203 Washington Ave., Belleville, N.J.

BRIGHAM, CYRIL A. (A'23), Engineer, Bell Telephone Laboratories, Inc., 463 West St., New York, N.Y. For mail: 382 Park Ave., East Orange, N.J.

BRIMBERG, ISAAC (A'26), Radio Engineer, City of New York, Rm. 2514, Municipal Bldg., New York, N.Y. For mail: 1062 Park Pl., Brooklyn, N.Y.

BRINGHURST, ELDEN S. (A'31), Student, Dodge Radio Institute, Valparaiso, Ind.

BRISTOW, FREDERICK R. (A'27), Vice President, R.C.A. Institutes, Inc., 75 Varick St., New York, N.Y. For mail: 55 Hanson Pl., Brooklyn, N.Y.

BRITO, ALBERTO R. (M'19), Captain, Jefe del Departamento de Comunicaciones Navales, Correo 15, Santiago, Chile.

BRITAIN, LOUIS B. (A'30), Factory Superintendent, Ufonic Radio Corporation, Ltd., 968 N. Formosa St., Inglewood, Calif. For mail: 608 Hillside St., Inglewood, Calif.

BRITTON, FRANK L. (A'27-M'28), Radio Editor, *Popular Mechanics*, 200 E. Ontario St., Chicago, Ill.

BROCKMAN, FRANCIS C. (A'15), Radio Engineer, General Electric Company, Schenectady, N.Y. For mail: 81 Robinson St., Schenectady, N.Y.

BROCKWAY, DON C. (A'30), Instructor, Electricity and Radio, James A. Foshay Junior High School, 3751 S. Harvard Blvd., Los Angeles, Calif. For mail: 4909 Sunset Blvd., Hollywood, Calif.

BRODIE, ALFRED H. (A'31), Radio Technician, Radio Station KLN, Tribune Tower, Oakland, Calif.

BROKAW, CHARLES A. (A'23), Radio Engineer, RCA Victor Company, Inc., Camden, N.J. For mail: 320 Grove St., Haddonfield, N.J.

BROKAW, HAL R. (A'26), Palace Drug Company, 405 Alvarado St., Monterey, Calif.

BROLLY, A. H. (A'27), Chief Engineer, Television Laboratories, Ltd., 202 Green St., San Francisco, Calif. For mail: 817 Lincoln Ave., Palo Alto, Calif.

BROMLEY, JOHN E., JR. (A'27), 818 E. Rittenhouse St., Philadelphia, Pa.

BRONSON, G. E. (A'27), Division Engineer, City of Chicago, 207 City Hall, Chicago, Ill.

BROOK, ALF (A'29), Draftsman, Radio Engineering Department, Westinghouse Electric and Manufacturing Company, East Pittsburgh, Pa. For mail: Maple St., Irwin, Pa.

BROOKE, E. F. (A'31), Radio Engineer, Bell Telephone Laboratories, Inc., 463 West St., New York, N.Y. For mail: 463 Springdale Ave., East Orange, N.J.

BROOKE, ROBERT O. (J'29), Chief Engineer, Radio Station WRHM, Andrews Hotel, Minneapolis, Minn. For mail: 3848 Harriet Ave., S., Minneapolis, Minn.

BROOKER, VIVIAN M. (A'27), Findlay and Wills Broadcasters, Ltd., Findlay Bldgs., Brisbane St., Launceston, Tasmania.

- BROOKS, J. R. (A'30)**, Radio Engineer, Parson's Atwater Kent Radio Service, Spey St., Invercargill, New Zealand.
- BROOKS, N. M. (A'31)**, Electrical Engineer, RCA Victor Company, Inc., Camden, N.J. For mail: 606 W. Maple Ave., Apartment E-1, Merchantville, N.J.
- BROPHY, FRANCIS JOSEPH, JR. (A'29)**, Radio Operator, William F. Gable Company, Radio Station WFBG, Altoona, Pa. For mail: Carrolltown, Pa.
- BROSE, FRED O. (A'29)**, Priras Research Laboratory, 323 Garfield Ave., American Falls, Idaho.
- BROTHERS, JAMES T. (A'29)**, Radio Receiver Engineer, Patent Department, License Division, Radio Corporation of America, 75 Varick St., New York, N.Y.
- BROUGHTON, W. G. (A'30)**, Aircraft Radio Engineer, Radio Engineering Department, General Electric Company, Schenectady, N.Y.
- BROWER, WILLIAM M. (M'28)**, 220 Rinconada Ave., Palo Alto, Calif.
- BROWN, ALVIN H. (A'29)**, Branch Store Clerk, Toronto Radio Company, 2114 Danforth Ave., Toronto 13, Ont., Canada. For mail: 588 Bathurst St., Toronto 4, Ont., Canada.
- BROWN, ARCHIBALD S. (A'14)**, Executive Engineer, Federal Telegraph Company, Palo Alto, Calif. For mail: 1528 Byron St., Palo Alto, Calif.
- BROWN, BAYNE (A'30)**, Electrician, Wired Radio, Inc., 4th Ave. and 13th St., Newark, N.J. For mail: Box 56 Ampere, East Orange, N.J.
- BROWN, CHARLES J. (A'25)**, New York Representative, Samson Electric Company, 369 Lexington Ave., New York, N.Y.
- BROWN, D. S. (A'15)**, Rm. 2055, 50 Church St., New York, N.Y.
- BROWN, ELMER L. (A'26)**, Box 33A, Route No. 1, Folsom City, Calif.
- BROWN, GEORGE H. (A'30)**, Electrical Laboratory, University of Wisconsin, Madison, Wis.
- BROWN, GEORGE W. (A'28)**, Radio Service Manager, Central Radio Company, 37 County St., Attleboro, Mass. For mail: 38 Bay State Rd., Atlantic, Mass.
- BROWN, GORDON P. (A'26)**, Manager, The Brown Radio Service and Laboratory, 192 S. Goodman St., Rochester, N.Y.
- BROWN, H. WILBUR (A'25)**, 422 Walnut St., Philadelphia, Pa.
- BROWN, HENRY J. (A'26)**, Service Engineer, Electrical Research Products, Inc., 250 W. 57th St., New York, N.Y. For mail: 301 S. St. Cloud St., Allentown, Pa.
- BROWN, HOWARD A. (A'26)**, Laboratory Engineer, Rochester Gas and Electric Corporation, 87 East Ave., Rochester, N.Y. For mail: 46 Shelter St., Rochester, N.Y.
- BROWN, HOWELL C. (A'26)**, 120 N. El Molino Ave., Pasadena, Calif.
- BROWN, HUGH A. (A'16-M'29)**, Assistant Professor of Electrical Engineering, 212 Electrical Engineering Laboratory, University of Illinois, Urbana, Ill.
- BROWN, J. KENNETH (A'26)**, Radio Engineer, Morrow and Brown, 924 S. Flower St., Los Angeles, Calif.
- BROWN, JAMES F. (A'26)**, Member of Firm, Brown Distributing Company, 18th St. at Potrero Ave., San Francisco, Calif. For mail: 1755 Palm Ave., San Mateo, Calif.
- BROWN, JAMES H. (A'31)**, Technician, Radio Station KFOX, 220 E. Anaheim St., Long Beach, Calif. For mail: Box 65, Long Beach, Calif.
- BROWN, JESSE E. (A'24-M'28)**, Assistant U. S. Supervisor of Radio, Radio Division, U. S. Department of Commerce, 2909 David Stott Bldg., Detroit, Mich.
- BROWN, KENNETH L. (A'24)**, Radio Operator, Detroit Edison Company, Port Huron, Mich. For mail: P.O. Box 418, Port Huron, Mich.
- BROWN, L. D. (A'31)**, Radioman, Box 10, U.S.S. Saratoga, San Pedro, Calif.
- BROWN, N. D. (A'31)**, Installer, Northern Electric Company, 3131 Western Ave., Seattle, Wash. For mail: 1729-12th Ave., Seattle, Wash.
- BROWN, RALPH M. (A'25)**, Chief Engineer, Brown Radio Manufacturing Company, 777 Wyoming Ave., Kingston, Pa. For mail: 81 S. Vaughn St., Kingston, Pa.
- BROWN, REYNOLDS D., JR. (A'30)**, Research Department, Philadelphia Storage Battery Company, Ontario and C. Sts., Philadelphia, Pa. For mail: 548 Ellet St., Mount Airy, Philadelphia, Pa.
- BROWN, STANLEY W. (A'27-M'30)**, Consulting Radio Engineer, 306 Dartmouth Ave., Buffalo, N.Y. For mail: 356 Highgate Ave., Buffalo, N.Y.
- BROWN, W. CRAIG (A'31)**, Charge Communications, Pan American Airways, Inc., Miami, Fla. For mail: Aberdeen, Md.
- BROWN, WALTER J. (M'25)**, Research Department, The Gramophone Company, Ltd., Hayes, Middlesex, England. For mail: Danesmoor, Harefield Rd., Uxbridge, Middlesex, England.
- BROWN, WILFRED E. (A'29)**, Assistant Engineer, Indiana Bell Telephone Company, Indianapolis, Ind. For mail: Westfield, Ind.
- BROWN, WILLIAM A. R. (A'25)**, Development Engineer, National Broadcasting Company, Inc., 711-5th Ave., New York, N.Y.
- BROWN, WILLIAM G. (A'28)**, Radio Editor, *Cheltenham Chronicle*, Cheltenham, England. For mail: 52 Winstonian Rd., Cheltenham, England.
- BROWN, WILLIAM W. (M'18)**, Assistant Engineer-in-Charge, Radio Engineering Department, General Electric Company, Schenectady, N.Y. For mail: 119 Fairview Ave., Schenectady, N.Y.
- BROWNE, MERTON S. (A'28)**, Certified Radiotrician, 443-3rd St., Toledo, Ohio.
- BROWNE, THEODORE C. (M'27)**, Consulting Engineer, Gillson, Mann and Cox, 53 W. Jackson Blvd., Chicago, Ill. For mail: 170 N. Lincoln St., Hinsdale, Ill.
- BROWNE, WALRAM S. (A'14)**, Manufacturers Paper Company, 122 E. 42nd St., New York, N.Y. For mail: P.O. Box 244, Amityville, L.I., N.Y.
- BROWNING, ELLIOT ANDREW (J'30)**, Radio Broadcast Control Operator, Radio Station WORC, 60 Franklin St., Worcester, Mass. For mail: Box 110, Oxford, Mass.
- BROWNING, GLENN H. (A'24-M'28)**, President, Browning-Drake Corporation, 110 Brookline St., Cambridge, Mass. For mail: Appalachian Rd., Winchester, Mass.
- BROWNING, ROY H. (A'26)**, President, Browning Radio Engineering Company, 5564 Bartmer Ave., St. Louis, Mo.

- BROWNING, S. D. (A'31)**, Engineer, Federal Telegraph Company, 200 Mount Pleasant Ave., Newark, N.J.
- BRUCE, BIRGER (A'30)**, Inspector, Westinghouse Electric and Manufacturing Company, Chicopee Falls, Mass. For mail: 48 Summit St., Springfield, Mass.
- BRUCE, EDMOND (A'26-M'29)**, Research Engineer, Bell Telephone Laboratories, Inc., Box 31, Cliffwood, N.J. For mail: 27 Buena Pl., Red Bank, N.J.
- BRUCE, JAMES R. (A'31)**, Assistant Engineer, c/o Staff Department, Imperial and International Communications, Ltd., Electra House, Moorgate, London, E.C. 2, England.
- BRUCE, RAGNAR (A'30)**, Draftsman, 48 Summit St., Springfield, Mass.
- BRUCK, HERMAN (A'31)**, Radio Serviceman, Ludwig Baumann and Company, 45 Pearson St., Long Island City, L.I., N.Y. For mail: 1050 Lowell St., New York, N.Y.
- BRUGGEMAN, JOHN T. (J'28-A'30)**, Engineering Assistant, Chief Engineer's Office, New Jersey Bell Telephone Company, 540 Broad St., Newark, N.J. For mail: 1297 Lexington Ave., New York, N.Y.
- BRUMP, H. L. (A'30)**, Section Engineer, General Motors Radio Corporation, Miami Chapel Rd. and Wisconsin Blvd., Dayton, Ohio. For mail: 43 W. Norman Ave., Dayton, Ohio.
- BRUNET, MEADE (M'26)**, Sales Manager, RCA Radiotron Company, Inc., 215 S. 5th St., Harrison, N.J.
- BRUSCHI, LEWIS JOHN (A'29)**, Radio Merchant, 26 Market St., Bangor, Pa. For mail: 28 Market St., Bangor, Pa.
- BRYAN, WILLIAM J. (A'29)**, Radio Operator, Radio Station KFDM, Magnolia Petroleum Company, Beaumont, Tex.
- BRYAN, WILLIAM J. (A'30)**, Manager, Technical Service Department, California Victor Distributing Company, 948 Santee St., Los Angeles, Calif. For mail: P. O. Box 1922, Los Angeles, Calif.
- BRYANT, WILLIAM (A'30)**, Radiotrician, 427 Russell St., Covington, Ky.
- BUCHANAN, ARTHUR B. (A'26)**, Electrical Engineer, Detroit Edison Company, 2000-2nd Ave., Detroit, Mich.
- BUCHANAN, D. W. (A'31)**, Secretary, Buchanan's Flour Mills, Ltd., West St., Ashburton, New Zealand. For mail: 74 Wills St., W., Ashburton, New Zealand.
- BUCHANAN, ORRIN R. (A'31)**, Chief Operator, Radio Station WHIA, Sterling Hall, University of Wisconsin, Madison, Wis. For mail: 428 1/2 W. Gilman St., Madison, Wis.
- BUCHER, E. E. (M'13-F'29)**, Executive Vice President, RCA Photophone, Inc., 411-5th Ave., New York, N.Y.
- BUCKINGHAM, WILLIAM D. (A'29)**, Engineering Assistant, Western Union Telegraph Company, Watermill, L.I., N.Y. For mail: 47 Layton Ave., Southampton, N.Y.
- BUCKLER, JOHN J. (A'29)**, Manager, Radio Service, Gimbel Brothers, 120 W. 32nd St., New York, N.Y. For mail: 502 W. 152nd St., New York, N.Y.
- BUCKLEY, FRANCIS P. (A'30)**, Manager, Boulevard Radio and Electric Company, Randolph Ave. and Hewlett St., Waterbury, Conn. For mail: 50 Hewlett St., Waterbury, Conn.
- BUDD, LEONARD W. (A'31)**, Radio Engineer, Charles Begg and Company, Ltd., Princes St., Dunedin, New Zealand.
- BUDENBOM, HORACE T. (A'30)**, Engineer, Radio Development Department, Bell Telephone Laboratories, Inc., 463 West St., New York, N.Y.
- BUECHE, HARRY S. (A'26)**, Assistant Professor, Kansas State College, Manhattan, Kan. For mail: 1119 Kearney St., Manhattan, Kan.
- BUERGER, CHARLES B. (A'28)**, General Manager, Gulf Refining Company, P.O. Box 1214, Pittsburgh, Pa.
- BUFFINGER, W. G. (A'28)**, President, Radio Institute of California, 1117 Venice Blvd., Los Angeles, Calif. For mail: 1444 S. Norton Ave., Los Angeles, Calif.
- BULGIN, ARTHUR F. (A'23-M'26)**, Radio Engineer, A. F. Bulgin and Company, 9-11 Curistor St., Chancery Lane, London, E.C. 4, England.
- BULL, EDWARD M. (A'31)**, Proprietor, Radio Sales and Service, Slaterville Springs, N.Y.
- BULLARD, WILLIAM R. (A'22)**, Distribution Engineer, Electric Bond and Share Company, 2 Rector St., New York, N.Y.
- BULLIS, ORMOND F. (A'31)**, Control Engineer, Radio Station WHAM, Sagamore Hotel, Rochester, N.Y. For mail: 33 Erion Crescent, Rochester, N.Y.
- BULLOCK, GILBERT D. (A'15)**, Electrician, Pedro Miquel Locks, Box 56, Pedro Miquel, Canal Zone.
- BULLOCK, JOHN W. (J'30)**, Operator and Radio Salesman, Campbell and Colcord, 2212 Rhode Island Ave., Washington, D.C. For mail: Route No. 4, Box 29, Louisa, Va.
- BULLOCK, WALTER H. (A'19)**, Secretary, A. C. Neon Corporation, 122 Greenwich St., New York, N.Y. For mail: 93 Remsen St., Brooklyn, N.Y.
- BULZONI, ALBERT L. (J'31)**, Radio Operator, R.C.A. Institutes, Inc., 75 Varick St., New York, N.Y. For mail: 86-11-103rd Ave., Ozone Park, L.I., N.Y.
- BUMBAUGH, HAROLD L. (A'17)**, Vitaphone Engineer, Warner Brothers Studios, Hollywood, Calif. For mail: 215 S. New Hampshire Ave., Los Angeles, Calif.
- BUNDAY, DALE L. (A'30)**, Radio Engineer, RCA Victor Company, Inc., Camden, N.J. For mail: 1115 White Horse Pike, Oaklyn, N.J.
- BUNN, E. (A'30)**, 234 E. 5th Ave., Vancouver, B.C., Canada.
- BURBANK, JEROME (A'30)**, Engineer, Buffalo, Niagara and Eastern Power Corporation, 300 Electric Bldg., Buffalo, N.Y.
- BURGER, CLARENCE WALTER (A'29)**, Superintendent of Factory, National Electric Supply Company, 1330 New York Ave., N.W., Washington, D.C.
- BURGER, EMIL S. (A'30)**, Engineering Student, Central Y.M.C.A. Evening College, Chicago, Ill. For mail: 2543 S. Avers Ave., Chicago, Ill.
- BURGESS, A. G. (A'30)**, Lines Section, P.O. Engineering Research Section, 6-8 Marshalsea Rd., S.E. 1, London, England. For mail: "Castelnau," 189 Gunnersbury Lane, Acton, London, W. 3, England.
- BURGESS, WARREN B. (A'20-M'31)**, Radio Engineer, U. S. Naval Research Laboratory, Bellevue, Anacostia, D.C. For mail: 2900-26th St., N.E., Washington, D.C.
- BURGHARD, G. E. (A'18-M'26)**, Merchant, Continental Radio Corporation, 160 Varick St., New York, N.Y.

- BURGOYNE, ROGER M. (A'27), Physician, 407 Main St., Winchester, Mass.
- BURKE, CHARLES T. (A'25-M'27), Engineer, General Radio Company, 30 State St., Cambridge, Mass.
- BURKE, DAVID J., JR. (A'29), Assistant Radio Inspector, U. S. Navy, Radio Test Shop, Navy Yard, Washington, D.C. For mail: 2207 Franklin St., N.E., Washington, D.C.
- BURKE, HAROLD E. (A'31), Supervisor, Manual Arts Sales Corporation, Ltd., 4315 S. Vermont Ave., Los Angeles, Calif. For mail: 5963 S. Halldale Ave., Los Angeles, Calif.
- BURKE, JAMES M., JR. (J'31), Radio Operator, Rome Broadcasting Corporation, 10-3rd Ave., Rome, Ga. For mail: 310 College St., Cedartown, Ga.
- BURKE, JAMES WILLIAM (A'29), Clerk, Navy Department, Headquarters U. S. Marine Corps, Rm. 3210, Navy Bldg., 18th St. and Constitution Ave., Washington, D.C. For mail: 2712 Wisconsin Ave., N.W., Washington, D.C.
- BURKWEST, LEONARD G. (A'28), General Manager, N-I. Radio Laboratories, 1224 Belmont Ave., Chicago, Ill.
- BURLEIGH, JOHN A. (A'27), Telephone Engineer, Pacific Telephone and Telegraph Company, 903 Telephone Bldg., Seattle, Wash. For mail: 2049 E. Newton St., Seattle, Wash.
- BURLEIN, LESTER F. (A'29), Radio Technician, Service Department, F. A. Jenkins Music House, Main St., Honesdale, Pa. For mail: 818 Court St., Honesdale, Pa.
- BURNAP, ROBERT S. (A'30), Commercial Engineer, RCA Radiotron Company, Inc., Harrison, N.J.
- BURNET, WILLIAM L. (A'27), Radio Electrician, U. S. Naval Radio Station, Chollas Heights, San Diego, Calif. For mail: 4814 Idaho St., San Diego, Calif.
- BURNHAM, WALTER W. (M'21-F'23), Manager, Radio Section, Edison and Swan Company, Ltd., 123 Queen Victoria St., London, England. For mail: The Plateau, Sundridge, Kent, England.
- BURNISON, JAMES W. (A'31), General Superintendent, RCA Victor Company, Inc., Camden, N.J. For mail: Plaza Club Hotel, Camden, N.J.
- BURNS, ELMER E. (A'28), Physics Teacher, Austin High School, Chicago, Ill. For mail: 3515 Home Ave., Berwyn, Ill.
- BURNS, G. AUSTIN (A'20), Sound Department, Metro-Goldwyn-Mayer Studios, Culver City, Calif.
- BURNS, GEORGE D. (A'28), Assistant Secretary, Daniel M. Hicks, Inc., 200-5th Ave., New York, N.Y. For mail: 8906 Colonial Rd., Brooklyn, N.Y.
- BURNS, ROBERT P. (A'28), Projection Supervisor, Publix-Balaban and Katz, 408 N. Ashland Ave., Chicago, Ill. For mail: 3034 Leland Ave., Chicago, Ill.
- BURNSIDE, DON G. (A'13), Engineer, RCA Radiotron Company, Inc., Harrison, N.J. For mail: 232 W. Gargas Lane, Philadelphia, Pa.
- BURRICHTER, DONALD E. (J'30), Radio Operator, Radio Station KFNF, Henry Field Company, Shenandoah, Iowa. For mail: Monticello, Iowa.
- BURRILL, CHARLES M. (A'24-M'30), Research Engineer, Rogers-Majestic Corpora-
- tion, Ltd., Fleet St., Toronto, Ont., Canada. For mail: 39 Strath Ave., Old Mill P.O., Toronto, Ont., Canada.
- BURROWES, FRANCIS E. (A'20), Engineer, Marconi's Wireless Telegraph Co., Ltd., Marconi House, Strand, London, W.C. 2, England.
- BURROWS, CHARLES B. (A'24), Radio Research Engineer, Bell Telephone Laboratories, Inc., 463 West St., New York, N.Y. For mail: P.O. Box 68, West Long Branch, N.J.
- BURROWS, FRED A. (A'30), Draftsman, Thordarson Electric Manufacturing Company, Chicago, Ill. For mail: 735 Prairie Ave., Wilmette, Ill.
- BURTON, EVERETT T. (A'30), Research Engineer, Bell Telephone Laboratories, Inc., 463 West St., New York, N.Y.
- BUSH, CHARLES R. (A'30), Geophysical Department, Sun Oil Company, Box 790, Beaumont, Tex.
- BUSH, GEORGE P. (M'25), Captain, U. S. Army, Signal Corps. For mail: R.R. No. 10, Box 64, Bethesda, Md.
- BUSH, WALTER S. (A'29), 3330 Abner Pl., St. Louis, Mo.
- BUSHONG, VICTOR L. (A'30), Radio Engineer, Radio Station WCSO, Wittenberg College, Springfield, Ohio. For mail: R.F.D. No. 3, Springfield, Ohio.
- BUSSARD, E. J. H. (A'24-M'30), Radio Engineer, Crosley Radio Corporation, 3491 Colerain Ave., Cincinnati, Ohio. For mail: 2701 Stratford Ave., Cincinnati, Ohio.
- BUTLER, H. R. (A'23), Radio Engineer, Wired Radio, Inc., 4th Ave. and 13th St., Newark, N.J. For mail: 278 Rutledge Ave., East Orange, N.J.
- BUTLER, ROY (A'27), District Manager, Mackay Radio and Telegraph Company, Inc., 10700 Helena Ave., Cleveland, Ohio.
- BUTLER, WILSON M. (J'28-A'29), 201 N. Front St., Milton, Pa.
- BUTMAN, CARL H. (A'28-M'29), Radio Consultant, 832 National Press Bldg., Washington, D.C.
- BUTOW, ALVIN J. (A'31), Radio Serviceman, Butow Electric Shop, Inc., 2006 Central St., Evanston, Ill. For mail: 2630 Prairie Ave., Evanston, Ill.
- BUTT, HARVEY R. (A'30), Superintendent, New England Division, Radiomarine Corporation of America, 470 Atlantic Ave., Boston, Mass.
- BUTTERFIELD, CHARLES E. (A'26-M'29), Radio Editor, The Associated Press, 383 Madison Ave., New York, N.Y.
- BUTTERFIELD, ROY O., JR. (A'26), Manager, S.L.S. Stores, Inc., 20 Main St., Park Ridge, Ill.
- BUTTNER, HAROLD H. (M'27), Assistant Vice President, International Telephone and Telegraph Company, 67 Broad St., New York, N.Y.
- BUTTOLO, ROMEO L. (A'31), Wireless Telegraph Operator, S.S. Roma, S.I.R.M. Via Condotti, II Rome, Italy. For mail: 1/26A Via A.G. Barrili, Genoa, Italy.
- BUZALASKI, THOMAS J. (A'31), Engineer, National Broadcasting Company, Inc., 711-5th Ave., New York, N.Y. For mail: 6805 Baycliff Ter., Brooklyn, N.Y.
- BUZZARD, A. J. (J'23-A'26), Manager of Radio Departments, Spear and Company, 915 Penn Ave., Pittsburgh, Pa.

- BYERLAY, H. LE ROY (A'28), Michigan Bell Telephone Company, Rm. 820, 1365 Cass Ave., Detroit, Mich. For mail: 25 Glendale Ave., Highland Park, Mich.
- BYERS, HARRISON O. (A'25), Radio Interference Engineer, Kansas Gas and Electric Company, 3rd and Kelly Sts., Wichita, Kan. For mail: 333 Laura Ave., Wichita, Kan.
- BYERS, JAMES CLIFTON (A'30), Special Agent, Electrical Sheets, Wheeling Steel Corporation, Portsmouth, Ohio.
- BYLANDER, J. CLIFFORD (A'30), Recording Engineer, Electrical Research Products, Inc., 250 W. 57th St., New York, N.Y. For mail: 9426-34th Rd., Jackson Heights, L.I., N.Y.
- BYLER, HENRY W. (A'31), Division Engineer, Test Engineering Division, RCA Victor Company, Inc., Camden, N.J. For mail: 125 E. Bettewood Ave., Oaklyn, N.J.
- BYRAM, F. CAMERON (A'29), Engineer, Dongan Electric Manufacturing Company, 2991-3001 Franklin St., Detroit, Mich. For mail: 11061 Strathmoor Ave., Detroit, Mich.
- BYRD, NEVIN C. (A'31), Engineer, General Motors Radio Corporation, 1420 Wisconsin Blvd., Dayton, Ohio. For mail: 2212 Wayne Ave., Dayton, Ohio.
- BYRNE, PAUL F. (A'30), Student, University of Stanford, Stanford University, Calif. For mail: Box 2351, Stanford University, Calif.
- BYRNES, IRVING F. (A'23), Radio Engineer, Radiomarine Corporation of America, 66 Broad St., New York, N.Y.
- C
- CABOT, GEORGE E. (A'16-M'30), Cabot, Cabot and Forbes, Boston, Mass. For mail: 169 Marlborough St., Boston, Mass.
- CABOT, SEWELL (M'14), Electrical Engineer, Electrical Conversion Company, Boston, Mass. For mail: 100 Tappan St., Brookline, Mass.
- CADMAN, CLAUDE G. (M'28), Engineer-in-Chief, Posts and Telegraphs, G. P. O. Kuala Lumpur, Federated Malay States.
- CADY, WALTER G. (A'14-F'27), Professor of Physics, Scott Laboratory, Wesleyan University, Middletown, Conn.
- CAHILL, WILLIAM J. (A'29), Research Engineer, Research Department, International Communications Laboratory, 67 Broad St., New York, N.Y.
- CAICEDO, A. D. (A'30), Estacion Inalambrica, Estacion Inalambrica, Cucuta-Norte de Santander, Colombia.
- CALDWELL, LOUIS G. (M'29), Member of Law Firm, Kirkland, Fleming, Green and Martin, National Press Bldg., Washington, D.C.
- CALDWELL, O. H. (M'28), Editor, *Radio Retailing and Electronics*, McGraw-Hill Publishing Company, 330 W. 42nd St., New York, N.Y.
- CALKINS, WILLIAM G. (A'27), Radio Engineer, 8520 Carnegie Ave., Cleveland, Ohio.
- CALLAHAN, EDWARD P. (A'31), Radio Mechanic, R.C.A. Communications, Inc., Riverhead, L.I., N.Y. For mail: Box 1041, Riverhead, L.I., N.Y.
- CALLAHAN, JOHN L. (A'21-M'31), Research Engineer, R.C.A. Communications, Inc., 66 Broad St., New York, N.Y. For mail: 2011 Newkirk Ave., Brooklyn, N.Y.
- CALENDER, EDWIN R. (A'27), Engineer, New York, Ontario, and Western Railroad, Middletown, N.Y. For mail: 374 1/2 North St., Middletown, N.Y.
- CALLER, JAMES M. (A'30), Engineering Department, RCA Victor Company, Inc., Camden, N.J. For mail: 1106 Sycamore St., Haddon Heights, N.J.
- CALLIGHERIS, JOHN S. (A'22), Electrical and Radio Engineer, The J. S. Calligheris Engineering Company, 1050 Coney Island Ave., Brooklyn, N.Y.
- CALVER, FRANK N. (M'29), Engineer-in-Charge, British Broadcasting Corporation, Borough Hill, Daventry, England.
- CAM, FRANK A. (A'31), Chief Engineer, and Director, Sound Ltd., New Hall, Bag, goed, South Wales. For mail: "Sunnycroft," Bryn Rd., Pontllanfraith, Monmouth, England.
- CAMERON, HENRY L., JR. (A'28), Service Manager, Radio Department, Globe Department Store, 33 N. Genesee St., Waukegan, Ill.
- CAMERON, J. A. (A'30), Vacuum Tube Engineer, Munder Electrical Company, 97 Orleans St., Springfield, Mass.
- CAMP, V. F. (A'13), Brightwaters, L.I., N.Y.
- CAMPBELL, AUGUSTUS G. (A'31), Research Engineer, Arcturus Radio Tube Company, 720 Freylinghuysen Ave., Newark, N.J. For mail: 325-29th St., West New York, N.J.
- CAMPBELL, CARLETON W. (J'30-A'31), Radio Technician, Radio Station KNN, Paramount Studio, 5555 Marathon St., Hollywood, Calif. For mail: 5315 1/2 La Cuesta Ct., Hollywood, Calif.
- CAMPBELL, CHARLES H. (A'23), Radio Engineer, National Broadcasting Company, Inc., 711-5th Ave., New York, N.Y.
- CAMPBELL, DONALD W. (A'30), Salesman, c/o Wetmore Savage A.E. Company, 588 Commonwealth Ave., Boston, Mass.
- CAMPBELL, GEORGE R. (A'29), R.F.D. No. 6, Ann Arbor, Mich.
- CAMPBELL, HOWARD E. (A'14-M'14), Director of Recording Pathé Cinema, 6 Rue Francourt, Paris, France.
- CAMPBELL, JOHN A. (A'27), Editor, *Gage Electrical Encyclopedia*, Gage Publishing Company, 461-8th Ave., New York, N.Y.
- CAMPBELL, JOHN S. (A'31), Teller, American National Bank, Church St., Nashville, Tenn. For mail: 1704 Grand Ave., S.W., Nashville, Tenn.
- CAMPBELL, MARK E. (A'31), Member of Technical Staff, Bell Telephone Laboratories, Inc., 463 West St., New York, N.Y. For mail: 2384-26th St., Astoria, L.I., N.Y.
- CAMPBELL, O. V. (A'30), Technician, Bateman Radio Sales and Service Company, 466 E. Exchange St., Akron, Ohio. For mail: 1818 Shaw Ave., Akron, Ohio.
- CAMPBELL, ROBERT H. (A'25), President, Campbell Engineering Company, 622 Monadnock Bldg., Chicago, Ill. For mail: 7108 Luella Ave., Chicago, Ill.
- CAMPBELL, WALTER H. (M'31), Assistant Radio Engineer, Department of Radio Engineering, U. S. Army, Signal Service at Large, Department Signal Office, Quarry Heights, Canal Zone. For mail: Box 1035, Balboa, Canal Zone.

CAMPBELL, WILLIAM N. (A'28), Radio Sales and Service, X-L Radio Service, 1136 N. Vermont St., Los Angeles, Calif. For mail: 1233 N. New Hampshire St., Los Angeles, Calif.

CAMPBELL, WINIFERD H. (A'27), Production Engineer, Magnavox Company, Fort Wayne, Ind. For mail: 1217 Summit St., Fort Wayne, Ind.

CANADAY, DONALD RAY (A'16), Chief Engineer, Canaday Recording Equipment Company, 712 Leader Bldg., Cleveland, Ohio. For mail: 19570 S. Sagamore Rd., Fairview Village, Cleveland, Ohio.

CANAVACIOL, FRANK E. (A'25-M'29), Assistant Professor, Department of Electrical Engineering, Polytechnic Institute of Brooklyn, 99 Livingston St., Brooklyn, N.Y. For mail: 71-19 Juno St., Forest Hills, L.I., N.Y.

CANFIELD, N. A. (A'25), Assistant Engineer-in-Charge, R.C.A. Communications, Inc., Point Reyes Station, Calif. For mail: Inverness, Calif.

CANFIELD, WILSON R. (A'29), Inspector, Electrical Research Products, Inc., 250 W. 57th St., New York, N.Y. For mail: 508 Norwood St., East Orange, N.J.

CANN, JOHN O. G. (M'16-F'21), Electrical Sound Equipment Company, 1415 St. Mark St., Montreal, P.Q., Canada. For mail: 93 Columbia Ave., Westmount, P.Q., Canada.

CANNER, WILLIAM (J'27-A'29), Service Manager, Commonwealth Radio Service, 1150 Commonwealth Ave., Boston, Mass. For mail: 343 S. Huntington Ave., Jamaica Plain, Mass.

CANON, HARTMAN B. (J'26-A'30), Engineer, Wills-Gardner Company, 816 N. Kedzie Ave., Chicago, Ill. For mail: 8953 S. Ada St., Chicago, Ill.

CANTOR, ARTHUR B. (A'30), Engineer, Marvin Radio Tube Corporation, 76 Coit St., Irvington, N.J. For mail: 29 Burling Lane, New Rochelle, N.Y.

CAPEN, WILLIAM H. (M'31), Transmission Engineer, International Telephone and Telegraph Company, Inc., 67 Broad St., New York, N.Y.

CAPOALE, PETER (A'28), Radio Acoustic Engineer, RCA Victor Company, Inc., Camden, N.J. For mail: 1603 Ellsworth St., Philadelphia, Pa.

CAPRON, E. S. (A'29), Consulting Service, 43 Park St., Oxford, Mich.

CAPUTO, NICHOLS J. (A'27), Transmission Engineer, New York Telephone Company, 360 Bridge St., Brooklyn, N.Y. For mail: 184-03-90th Ave., Hollis, L.I., N.Y.

CARAZO, LOUIS A. (A'29), Director General de Radios Nacionales, Gobierno de Costa Rica, San Jose, Costa Rica. For mail: P.O. Box 300, San Jose, Costa Rica.

CARDUNER, WILLIAM (A'28), Manager, Service Department, Klein's Radio, 30 Park Pl., New York, N.Y. For mail: 312 Beach 46th St., Edgemere, L.I., N.Y.

CARDWELL, ALLEN D. (A'14), President, The Allen D. Cardwell Manufacturing Corporation, 81 Prospect St., Brooklyn, N.Y. For mail: 443 Lakeview Ave., Rockville Centre, L.I., N.Y.

CARINI, LOUIS (J'28), Junior Radio Engineer, Carini Radio Laboratory, Wethersfield, Conn. For mail: 246 Wolcott Hill Rd., Wethersfield, Conn.

CARLETON, THOMAS F. (J'27-A'31), Ship Operator, Tropical Radio Telegraph Company, P.O. Box 1167, Baton Rouge, La.

CARLSON, C. O. (J'29), Radio Operator, Radio Service Company, 1023 E-G Winnett St., Savannah, Ga.

CARLSON, CARL F. (A'30), Radioman, Box 17, U.S.S. California, San Pedro, Calif.

CARLSON, EINAR C. (A'28), Junior Engineer, Radio Corporation of America, 75 Varick St., New York, N.Y. For mail: 22 Glenbrook Rd., Stamford, Conn.

CARLSON, WENDELL L. (A'19), RCA Victor Company, Inc., Camden, N.J.

CARLTON, RAYMOND A. (J'25-A'26), Sales Engineer, Amplivox Engineering, 7113 Euclid Ave., Cleveland, Ohio. For mail: 17817 Delavan Rd., Cleveland, Ohio.

CARLTON, ROGER C. (A'29), Engineer, Bell Telephone Laboratories, Inc., 463 West St., New York, N.Y.

CARMENT, JAMES M. (A'27), Chief Engineer, Radio Station WCIII, Chicago, Ill. For mail: P.O. Box 227, Deerfield, Ill.

CARNEY, LOUIS PAUL (A'30), Chief Inspector, Ditto, Inc., Harrison and Oakley Blvd., Chicago, Ill. For mail: 2418 Moffatt St., Chicago, Ill.

CARNEY, PHILIP G. (A'27), Roycraft Corporation, 1625 Hennipen Ave., Minneapolis, Minn. For mail: 2207 Portland Ave., Minneapolis, Minn.

CARNIE, BEN (A'28), First Wireless Operator, British Wireless Marine Service, 22 Chapel St., Liverpool, England. For mail: Lothian Gardens, Glasgow, N.W., Scotland.

CAROTHERS, WILLIAM D. McL. (A'26), Electrical Engineering Department, Union Switch and Signal Company, Swissvale, Pa. For mail: 7438 Irvine St., Swissvale, Pa.

CARPENTER, ARCHIE V. (A'28), Rewey, Wis.

CARPENTER, CHARLES I. (A'31), Assistant Operator, Airways Radio Station, U. S. Department of Commerce, Fort Worth, Tex.

CARPENTER, GLENN W. (A'18), Division Engineer, Broadcast Receivers Department, RCA Victor Company, Inc., Camden, N.J. For mail: Haddonfield Manor, Haddonfield, N.J.

CARPENTER, HUGH (A'29), Operator, Radio Station KVOO, Southwestern Sales Corporation, Tulsa, Okla. For mail: 2628 E. 6th St., Tulsa, Okla.

CARPENTER, RALPH H. (A'29), Chief Engineer, Radio Station WBCM, Tuscola Rd., Bay City, Mich. For mail: 1602-4th St., Bay City, Mich.

CARPENTER, RUPERT E. H. (M'23), Chief Engineer, R.M. Radio, Ltd., 19 Carrick St., London, W.C. 2, England. For mail: 35 Croham Valley Rd., Croydon, Surrey, England.

CARR, EDWARD MAYES (A'29), Tabulator, American Rolling Mill Company, 11th St. and Greenup Ave., Ashland, Ky.

CARR, J. O. (A'22), Manager, Sales Engineering Department, Morkrum Company, 1410 Wrightwood Ave., Chicago, Ill. For mail: 901 S. Crescent Ave., Park Ridge, Ill.

CARRANZA, JOSE J. (M'22), Manager, Compania Radiografica Internacional de Costa Rica, P.O. Box 54, San Jose, Costa Rica.

CARRICK, WILLIAM E. (A'30), Sound Picture Engineer, Research Products Engineering Department, Northern Electric Company, Ltd., 637 Craig St., W., Montreal, P.Q., Canada. For mail: 3617 Decarie Blvd., Notre Dame de Grace, Montreal, P.Q., Canada.

CARROLL, MICHAEL J. (A'29), RCA Radiotron Company, Inc., Department 92, 415 S. 5th St., Harrison, N.J.

CARSON, ANDREW H. (A'25), Engineer, Post and Telegraph Department, Kuala Lumpur, Federated Malay States.

CARSON, JOHN M. (A'26), Joint-Manager, Radio Maritime, Ltd., Broadway Chambers, Hammersmith, London, W.6, England. For mail: Elan Valley Hotel, Rhayader Radnor, Wales.

CARSON, JOHN R. (M'16), Telephone Research Engineer, American Telephone and Telegraph Company, 195 Broadway, New York, N.Y.

CARSON, WALTER E. (A'29), 57 Hyde Park Ave., Jamaica Plain Station, Boston, Mass.

CARSON, WILLIAM G. (A'30), Engineer, c/o Johnsonburg Radio Company, Johnsonburg, Pa.

CARTER, A. J. (M'26), President, Carter Television Company, 2657 Farwell Ave., Chicago, Ill.

CARTER, E. FINLEY (A'23), Radio Engineer, United Research Corporation, 41-39 Van Pelt St., Long Island City, L.I., N.Y.

CARTER, F. C. (A'27), Radio Engineer, Radio Section, P.O. Research Station, Dollis Hill, London, N.W. 2, England.

CARTER, FRANK L. (A'26), Service Manager, Ludwig Baumann and Company, 500-8th Ave., New York, N.Y. For mail: 9 W. Cook St., Bay Park, East Rockaway, L.I., N.Y.

CARTER, GEORGE W. (M'30), Professor of Physics, College of the City of Detroit, Cass and Warren Aves., Detroit, Mich.

CARTER, O. M. (A'30), Manufacturing Engineer, Western Electric Company, Inc., Hawthorne Station, Chicago, Ill. For mail: 1010 Madison St., Lockport, Ill.

CARTER, PHILIP S. (A'29), Engineer Design Section, Radio Corporation of America, Rocky Point, L.I., N.Y. For mail: 238 E. Broadway, Port Jefferson, L.I., N.Y.

CARTER, REGINALD F. (A'31), Supervisor of Inoperative Material, General Motors Company, Regina, Sask., Canada. For mail: 1404-15th Ave., Regina, Sask., Canada.

CARTER, WILLIAM H., JR. (A'29), Oakdale Ave., Houston, Tex.

CARTWRIGHT, RANDLE V. (A'31), Department of Physics, University of Colorado, Boulder, Colo.

CASCIATO, DOMINICK (A'30), Electrical Engineer, Electrical Research Products, Inc., 3931 S. Winchester Ave., Chicago, Ill. For mail: 5489 University Ave., Chicago, Ill.

CASE, MYRON D. (A'29), Receiving Engineer, R.C.A. Communications, Inc., Inverness, Calif. For mail: P.O. Box 173, Inverness, Calif.

CASE, NELSON P. (A'26-M'31), Engineer, Hazeltine Corporation Laboratory, 210th St. and 26th Ave., Bayside, L.I., N.Y.

CASEY, K. K. V. (A'26), Director of Sales, 5058 du Pont Bldg., Wilmington, Del.

CASPERD, CHRISTOPHER C. (A'21), Marconi House, Strand, London, W.C. 2, England.

CASS, LEWIS S. (A'29), Sound Technician, Paramount Sound News, 544 W. 43rd St., New York, N.Y. For mail: 2040-7th Ave., New York, N.Y.

CASSADY, P. H. (A'25), Assistant Superintendent, Walter T. Bradley Company, Hershey, Pa. For mail: 100 Poplar Ave., Hummelstown, Pa.

CASSELL, JOSEPH L. (A'29), Radio Engineer, Wired Radio, Inc., Ampere, N.J.

CASSENS, FRED BENJAMIN (A'29), Service Manager, Lindeman-Hoffer Company, 2914 Washington Ave., St. Louis, Mo. For mail: c/o Mrs. L. Jorgensen, 701a Garfield Ave., Chicago, Ill.

CASTLE, DONALD HEWITT (A'29), Bell Telephone Laboratories, Inc., 463 West St., New York, N.Y. For mail: 1197 E. 34th St., Brooklyn, N.Y.

CASTOR, AMASEA H. (A'26), Manager, Power Tube Sales, RCA Victor Company, Inc., Bldg. 2, Camden, N.J.

CATON, WILLIAM A. (A'27), Radio Inspector, Canadian Government, Department of Marines and Fisheries, Ottawa, Ont., Canada. For mail: P.O. Box 595, Toronto, Ont., Canada.

CATT, JAMES E. (A'20-M'23), Radio Engineer, Royal Aircraft Establishment, Hampshire, England. For mail: Pretoria, Osborne Rd., South Farnborough, Hampshire, England.

CATTELL, GILBERT W. (A'25), R.F.D. No. 1, Box 104, Saratoga, Calif.

CATTERALL, JOHN (J'28-A'30), Service Manager, C. E. Beckman Company, 11-35 Commercial St., New Bedford, Mass. For mail: 155 David St., New Bedford, Mass.

CAUGHEY, WILLIAM K. (A'30), Radio Engineer, Bell Telephone Laboratories, Whippany, N.J. For mail: 24 Jersey St., Bloomfield, N.J.

CAULTON, CYRUS O. (A'30), Sound Speaker Development Engineer, RCA Victor Company, Inc., Camden, N.J. For mail: 5006 Willows Ave., West Philadelphia, Pa.

CAUM, HAROLD (A'31), Wireless Operator, SS Malleonak, Radiomarine Corporation, 75 Varick St., New York, N.Y.

CENTER, EDGAR R. (A'26), Center's Radio Service, 1331 E. Lincoln St., Estherville, Iowa. For mail: 609 E. Pleasant St., Estherville, Iowa.

CERSTVIK, STEPHEN (A'29), Patent Attorney, Bendix Aviation Corporation, 754 Lexington Ave., Brooklyn, N.Y. For mail: 28 Willoughby St., Newark, N.J.

CERVENY, J. P. (A'31), Radio Engineer, RCA Victor Company, Inc., Camden, N.J. For mail: 639 Lakeview Dr., Collingswood, N.J.

CESAR, AMARAL (A'28), Amaral Cesar and Cia. Ltd., Avenida Sao Joao 24, Caixa Postal 2150, Sao Paulo, Brazil.

CHADDER, E. G. (A'29), Engineer-in-Charge, British Broadcasting Corporation, 15 Belmont St., Aberdeen, Scotland. For mail: 71 Braemar Pl., Aberdeen, Scotland.

CHADWICK, RAY E. (J'29-A'31), Independent Serviceman, 4509 N. Damen Ave., Chicago, Ill.

CHAFFEE, E. LEON (M'17-F'21), Professor of Physics, Harvard University, Cruft Laboratory, Cambridge, Mass.

CHAFFEE, JOSEPH G. (A'26), Engineer, Bell Telephone Laboratories, Inc., 463 West St., New York, N.Y.

CHAGNON, M. L. (A'31), Radio Dealer and Repairman, 36 Lafayette St., Salem, Mass. For mail: 46 Leach St., Salem, Mass.

CHALLENGER, ANSEL (J'25-A'26), Radio Engineer, Bell Telephone Laboratories, Inc., 806 Graybar-Varick Bldg., 180 Varick St., New York, N.Y.

CHALLENGER, GEORGE A. (A'30), Control Man, Radio Station WGBS, Hotel Lincoln, New York. For mail: 873 St. Nicholas Ave., New York, N.Y.

CHAMBERLAIN, ADOLPH B. (A'27-M'30), Chief Broadcast Engineer, Columbia Broadcasting System, Inc., 485 Madison Ave., New York, N.Y.

CHAMBERLAIN, NEWTON M. (A'23), Professor of Physics, South Philadelphia High School for Boys, 32nd and Chestnut Sts., Philadelphia, Pa. For mail: 126 N. Lynn Blvd., Upper Darby, Pa.

CHAMBERLAIN, PAUL (A'31), Foreman, Winding Department, Crosley Radio Corporation, Arlington St., Cincinnati, Ohio. For mail: 2953 Coleraine Ave., Cincinnati, Ohio.

CHAMBERLAIN, ROBERT R. (A'16), Associate Radio Engineer, Munitions Bldg., Signal Corps, Washington, D.C. For mail: 1814 G St., N.W., Washington, D.C.

CHAMBERS, CARL C. (A'30), Radio Engineer, RCA Victor Company, Inc., Camden, N.J. For mail: 305 S. 40th St., Philadelphia, Pa.

CHAMBERS, JOSEPH A. (A'28-M'30), Technical Supervisor of Broadcasting, Crosley Radio Corporation, 1326 Arlington St., Cincinnati, Ohio.

CHAMPNESS, THOMAS J. (A'31), Serviceman, Ludwig Baumann and Company, 45 Pearson St., Long Island City, L.I., N.Y. For mail: 28-49-36th St., Astoria, L.I., N.Y.

CHAN, GEORGE S. (A'31), Senior in Electrical Engineering, Lewis Institute of Technology, Chicago, Ill. For mail: 2017 W. Monroe St., Chicago, Ill.

CHANDLER, CHARLES K. (A'15), Royal Air Force, South Farnborough, Hants, England. For mail: The Roses Gordon Rd., Camberley, Surrey, England.

CHANG, TING CHIN (M'18), Professor of Communications and Dean, Nanyang University, College of Electrical Engineering, Siccawei, Shanghai, China. For mail: 18 Shaio Yu Ly, Siccawei, Shanghai, China.

CHAPMAN, ALAN B. (A'29), Service Engineer, RCA Photophone, Inc., New York, N.Y. For mail: 708 W. Grand, Oklahoma City, Okla.

CHAPMAN, DAVID E. (J'29), Student, University of Illinois, Urbana, Ill. For mail: 1201 W. Springfield St., Urbana, Ill.

CHAPMAN, EDWARD T. (A'30), Radio Dealer and Electrician, Studland, Swanage, Dorset, England. For mail: "Dawn Cottage," Studland, near Swanage, Dorset, England.

CHAPMAN, J. P. J. (A'30), Radio Engineer, The Huon, Branksome Hill Rd., Bourne-mouth, England.

CHAPMAN, ROBERT T. (A'31), Photo-engraver, Chapman and Rapp, Cincinnati, Ohio. For mail: Hunt Rd. and Conklin Ave., Blue Ash, Ohio.

CHAPMAN, THOMAS J. (A'25), Marconi International Marine Communications Company, Ltd., Calcutta, India. For mail: 5 Temple Chambers, Calcutta, India.

CHAPPLE, JAMES M. (A'29), Assistant Radio Inspector, Rm. 523, Brownstein Louis Bldg., Los Angeles, Calif. For mail: 751 S. Figueroa, Los Angeles, Calif.

CHARBONNEAU, ALLAN P. (J'27-A'29), Engineer, Cutler-Hammer, Inc., Milwaukee, Wis. For mail: 913 E. Kilbourn Ave., Milwaukee, Wis.

CHARBONNEAU, L. H. (A'28), Radio Repairs, Design, Building, etc., P.O. Box 145, Orange, Calif.

CHARLAT, ARNOLD (J'29), Radio Serviceman, Motive Radio Service, 130 W. 42nd St., New York, N.Y. For mail: 1272 E. 10th St., Brooklyn, N.Y.

CHARLES, ERNEST E. (A'31), Shift Officer, H.M. Imperial Radio Station, Hillmorton, Rugby, England. For mail: 194 Narborough Rd., Leicester, England.

CHARRIER, GEORGE M. (A'30), Langdon, N.D.

CHARTON, PAUL W. (A'29), Research Engineer, Arcturus Radio Company, 220 Elizabeth Ave., Newark, N.J. For mail: 73 Orange Rd., Montclair, N.J.

CHASE, LESLIE H. (J'25-A'27), Radio Engineer, Chicago Talking Machine Company, 111 N. Canal St., Chicago, Ill. For mail: 431 N. Lombard Ave., Oak Park, Ill.

CHATEAU, ARTHUR (A'29), Proprietor, Chateau Radio Sales and Service Company, 311 Louisiana Avenue Pkwy., New Orleans, La.

CHAUVIN, STANLEY (A'30), DeForest Phonofilm of Canada, 366 Mayor St., Montreal, P.Q., Canada. For mail: 1184 Cote des Neiges Rd., Montreal, P.Q., Canada.

CHEFTEL, ALEXIS M. (M'28), Consulting Engineer, 22 Rue du Civry, Paris 16^e, France.

CHEN, C. C. (A'28), Electrical Engineering Department, Kiangnan Dock and Engineering Works, Shanghai, China.

CHEN, C. MAYO (A'27), Radio Engineer, Philips China Company, 41 Szechuen Rd., Shanghai, China. For mail: 18 An Check Li, Scott Rd., Shanghai, China.

CHEN, SHUJEN (A'26), Peking Radio Station, Temple of Heaven, Peking, China.

CHEN, YING-CHIEN (A'28), Manager, Leconte Company 10, Recreation Rd., Tientsin, China.

CHENIK, AARON (A'24), Director, P.O. Box 745, Johannesburg, Transvaal, South Africa.

CHERNE, LEO J. (A'29), Proprietor, Cherne Radio Shop, 1204 N. Kedzie Ave., Chicago, Ill. For mail: 1539 N. Irving Ave., Chicago, Ill.

CHERNOW, MORRIS (A'27), Chief Engineer, Polyphase Engineering Company, 24 W. 15th St., New York, N.Y. For mail: 11 Essex St., New York, N.Y.

CHERNYSHOFF, ALEXANDER (A'30), Professor of Polytechnical Institute, Leningrad 21, U.S.S.R.

CHERRY, RICHARD O. (A'29), Research Physicist, Natural Philosophy Laboratory, University of Melbourne, Melbourne, Australia.

CHESBRO, ALBERT L. (A'31), J. M. Leonard and Son, Inc., Main St., Osterville, Mass. For mail: Winanno Ave., Osterville, Mass.

CHESLEY, ARTHUR D. (A'29), City Mail Carrier, Post Office, Falls City, Neb. For mail: 1801 Morton St., Falls City, Neb.

CHESNEY, ALONZO P. (A'31), Radio Technician, City of Los Angeles, Rm. 225, City Hall, Los Angeles, Calif. For mail: 6952 Vesper Ave., Van Nuys, Calif.

CHESSLER, MAXWELL A. (A'28), Proprietor, M. T. Bowdoin Radio Service and Manufacturing Laboratory, 3 Eric St., Dorchester, Mass. For mail: 32 Wilder St., Dorchester, Mass.

CHESTERTON, ARTHUR J. (M'28), Resident Inspector, Marconi International Marine Communications Company, Ltd., Marconi House, Strand, London, W.C. 2, England. For mail: Silvestre, Charteris Rd., Woodford Green, Essex, England.

CHIANG, P. C. (A'31), Radio Assistant, Tsinghua University, Peiping, China.

CHIEN, F. C. (A'28), c/o R. Schwob, Siemens China Company, P.O. Box 27, Hongkong, China.

CHINI, CARL J. (A'30), Radio Operator and Technician, Transcontinental and Western Air, Inc., Grand Central Air Terminal, Glendale, Calif. For mail: 102 N. Burbank Blvd., Burbank, Calif.

CHINITZ, EDWARD (A'30), Engineer, European Phonograph Company, 158 Avenue A, New York, N.Y. For mail: 1740 President St., Brooklyn, N.Y.

CHINN, HOWARD A. (A'27), Research Assistant, Massachusetts Institute of Technology, Round Hill, South Dartmouth, Mass. For mail: P.O. Box 156, South Dartmouth, Mass.

CHIPMAN, STUART EVANS (A'31), Graduate Work, University of Michigan, Ann Arbor, Mich. For mail: 1001 E. Huron St., Ann Arbor, Mich.

CHITTICK, K. A. (A'26), Radio Engineer, RCA Victor Company, Inc., Camden, N.J. For mail: Station Avenue Apartments, Haddon Heights, N.J.

CHIU, TSUNYI (J'29), Student Engineer, China Electric Company, 212, Kiangse Rd., Shanghai, China.

CHOAT, WILLIAM F. (A'25), Radio Salesman, Canadian Westinghouse Company, Ltd., 355 King St., W., Toronto 2, Ont., Canada.

CHOATE, HERBERT R. (A'31), Superintendent, Brunswick Radio of Canada, Hanna Ave., Toronto, Ont., Canada. For mail: 1792 Bloor St., W., Toronto, Ont., Canada.

CHOPSKY, PETER A. (J'28-A'30), Process Inspector, General Electric Company, Bridgeport, Conn. For mail: 91 Columbia St., Bridgeport, Conn.

CHORPENING, GEORGE B. (A'26), President, Clarksburg Automobile Company, Clarksburg, W.Va. For mail: P.O. Box 537, Clarksburg, W.Va.

CHRISTENSEN, JENS P. (A'16), Sostedamsgade 1, Copenhagen, Denmark.

CHRISTIDES, STRATIS C. (A'30), Marine Engineer, U.S.S. Marblehead, Boston, Mass.

CHRISTMAN, CHARLES (A'31), Radio Service, Hammarlund Manufacturing Company, 424 W. 33rd St., New York, N.Y. For mail: 462 E. 28th St., Brooklyn, N.Y.

CHRISTOPHERSON, FREDERICK (A'30), Proprietor, Radio Service, 2219 Central St., Evanston, Ill.

CHRISTY, EDMUND H. (A'31), Real Estate Department, Canal Bank, 1204 Canal Bank Bldg., New Orleans, La. For mail: 5347 Coliseum St., New Orleans, La.

CHROMY, B. J. (J'25-A'26), Patent Attorney, National Press Bldg., Washington, D.C. For mail: 909-20th St., N.W., Washington, D.C.

CHU, CHIH TEIH (A'29), Professor of Physics, Sun Yat-sen University, Canton, China.

CHU, K. T. (A'21), Engineer-in-Chief, Chinese Government Radio Administration, 565 Mingkon Rd., Shanghai, China. For mail: 3 Shor Gili, Next to South Western Hospital, Outside Shan Wen Men, Shanghai, China.

CHU, QUONG Y. (J'28), 629 W. 170th St., New York, N.Y.

CHU, YUN (J'28), Technical Expert, Ministry of Communications, Nanking, China. For mail: c/o Professor Z. L. Zsoon, Nanyang University, Siccawei, Shanghai, China.

CHUBB, LEWIS W. (M'21), Director, Research Laboratories, Westinghouse Electric and Manufacturing Company, East Pittsburgh, Pa.

CHUBB, WILLIAM M. (A'15), Signal Office, Army Base, Boston, Mass.

CHUN, HERBERT H. (A'26), Engineer, Arcurus Radio Tube Company, Newark, N.J. For mail: 76 Bank St., Newark, N.J.

CHUNG, CHI FAH (A'30), Radio Engineer, Transcontinental Radio Station, Cheju, Shanghai, China.

CHURCH, ARTHUR B. (A'25), Managing Director, Midland Broadcasting Company, Kansas City, Mo. For mail: 1410 W. Walnut St., Independence, Mo.

CHURCH, JOHN FRANKLIN (M'30), Engineering Department, Jensen Radio Manufacturing Company, 6601 S. Laramie Ave., Chicago, Ill.

CHUTE, DUDLEY H. (A'29), Standardizing Laboratory, General Radio Company, 30 State St., Cambridge, Mass. For mail: 16 Cliff Ave., Lexington, Mass.

CIOFFARI, BERNARD (A'30), Engineer, RCA Victor Company, Inc., Camden, N.J. For mail: 88 Washington Ave., New Rochelle, N.Y.

CLAPP, JAMES K. (A'24-M'28), Engineer, General Radio Company, 30 State St., Cambridge, Mass. For mail: 21 Lasell St., Auburndale, Mass.

CLARK, BAYARD H. (A'26), Salesman, The Magnavox Company, 155 E. Ohio St., Chicago, Ill. For mail: 1285-2nd St., De Kalb, Ill.

CLARK, C. R. (M'30), Commander, U. S. Navy, U.S.S. Richmond, c/o Postmaster, New York, N.Y.

CLARK, CHARLES F. (A'28), 2215 Spruce St., Philadelphia, Pa.

CLARK, CLARENCE M. (A'27), District Sales Manager, Silver-Marshall, Inc., 6401 W. 65th St., Chicago, Ill. For mail: 1114 Gladys Ave., Pittsburgh, Pa.

CLARK, EDWIN L. (A'31), Engineer, RCA Victor Company, Inc., Camden, N.J. For mail: 17 Oriental Ave., Westmont, N.J.

CLARK, GEORGE W. (A'25), Station Manager, Mackay Radio and Telegraph Company, 713 Bishop St., Honolulu, Hawaii.

CLARK, KENNETH G. (A'30), Assistant Supervisor of Radio, U. S. Department of Commerce, 328 Custom House, San Francisco, Calif.

CLARK, LEE B. (A'31), Section Hand, New York Central Railroad, Parker, Ind. For mail: Parker, Ind.

CLARK, LLOYD W. (A'30), Test Engineer, RCA Victor Company, Inc., Camden, N.J. For mail: 108 S. Monastery Ave., Baltimore, Md.

CLARK, LOUIS E. (A'27), Glenwood Laboratories, 142 Market St., Glen Rock, N.J.

- For mail: 98 Highwood Ave., Glen Rock, N.J.
- CLARK, RALPH L.** (A'29), Junior Radio Inspector, Radio Division, U. S. Department of Commerce, 2909 David Stott Bldg., Detroit, Mich.
- CLARK, R. U.** (A'29), Sales Engineer, Sprague Specialties Company, North Adams, Mass. For mail: Box 834, Williamstown, Mass.
- CLARK, ROBERT G.** (A'31), Engineer, Mul-lard Radio Valve Corporation, 45 Nightingale Lane, Balham, London, England. For mail: 55 Colne Rd., Winchmore Hill, London, England.
- CLARK, ROBERT K.** (J'30-A'30), Radio Operator, Radio Station WJR, Goodwill Station, Inc., 2800 Fisher Bldg., Detroit, Mich. For mail: Box 229, Pontiac, Mich.
- CLARK, ROBERT W.** (A'29), Studio Engineer, National Broadcasting Company, Inc., 111 Sutter St., San Francisco, Calif. For mail: 2143 N. Point St., San Francisco, Calif.
- CLARK, THOMAS E.** (M'13), President, Tel-claco, Inc., 1507 Cass Ave., Detroit, Mich.
- CLARK, THOMAS F.** (A'29), Chief Radioman, U. S. Navy, U.S.S. Noa 343, San Diego, Calif.
- CLARKE, ALLEN S.** (A'25), Engineer, Clarke Laboratories, 531 Main St., Danville, Va.
- CLARKE, DOUGLAS F.** (A'29), Beam Wireless Station, Imperial and International Communications, Ltd., Tetney, Grimsby, Lincolnshire, England.
- CLARKE, GEORGE E.** (A'25), G.P.O., Radio Station Baldock, Royston, Herts, England. For mail: 4, Lankester Rd., Royston, Herts, England.
- CLARKE, J. L.** (A'30), Transmission Engineer, Bell Telephone Company of Canada, Beaver Hall Mill, Montreal, P.Q., Canada. For mail: 124-44th St., Lachine, P.Q., Canada.
- CLARKE, MAURICE H.** (A'26), Chief Engineer, Radio Station WHEC, 40 Franklin St., Rochester, N.Y. For mail: Ridge Rd., Greece, N.Y.
- CLARKE, R. E.** (A'29), 713 South Blvd., Evanston, Ill.
- CLARKE, RALPH S.** (A'21), Henrici Laundry Machinery Company, Mattapan, Mass. For mail: 27 Milton Ave., Dorchester, Mass.
- CLARKE, VARRO J.** (A'29), Radio Engineer, General Electric Company, 1 River Rd., Schenectady, N.Y. For mail: 52 Washington Rd., Scotia, N.Y.
- CLARKSON, CHARLES N.** (A'22), c/o Pacific Gas and Electric Company, Stockton, Calif.
- CLARKSON, T. R.** (A'30), Engineering Cadet, Post and Telegraph Department, c/o District Telegraph Engineer, Auckland, New Zealand.
- CLARRY, HAROLD E.** (A'27), Radio Engineer, Westinghouse Electric and Manufacturing Company, Bloomfield, N.J. For mail: 41 Glenwood Pl., East Orange, N.J.
- CLARY, HOWARD L.** (A'30), Assistant to Service Engineer, Ludwig Hommel and Company, 929 Penn Ave., Pittsburgh, Pa.
- CLAUSING, LEROY M. E.** (A'19), Radio Engineer, 5509 1/2 Lincoln Ave., Chicago, Ill.
- CLAUSS, FRED W.** (A'27), Manager, Radio Department, The Motors Accessories Com-
- pany, 1041 Hamilton St., Allentown, Pa. For mail: 1016 N. 19th St., Allentown, Pa.
- CLAVIER, A. G.** (M'30), 33 Madison St., Glen Ridge, N.J.
- CLAYCOMB, HUGH** (A'26), 212 Marshall St., Shreveport, La.
- CLAYTON, JOHN M.** (A'23-M'26), Manager of Operations, Heintz and Kaufman, Ltd., 311 California St., San Francisco, Calif. For mail: 251 Madrono St., Palo Alto, Calif.
- CLAYTON, WILLIAM P.** (A'31), Manager, Radio Division, Taylor, Pearson and Carson, Ltd., 210-11th Ave., W., Calgary, Alta., Canada.
- CLEAR, K. Y.** (A'29), Radio Engineer, 24 Florence Rd., Sandenstead, Surrey, England.
- CLEATOR, P. E.** (A'31), Secretary, The Scientific Research Syndicate, 34 Oarside Dr., Wallasey, Cheshire, England.
- CLEMANS, HERSHEL L.** (A'30), Eastern Air Transport, Candler Field, Atlanta, Ga.
- CLEMENT, JACK D.** (A'28), Sound Development Engineer, Columbia Pictures Corporation, 1432 Gower St., Hollywood, Calif. For mail: 416 W. Lexington Dr., Glendale, Calif.
- CLEMENT, LEWIS M.** (A'14-M'17-F'26), Radio Engineer, Federal Telegraph Company, 200 Mount Pleasant Ave., Newark, N.J.
- CLEMMONS, WALLACE A.** (A'27), Gulf Radio School, 844 Howard Ave., New Orleans, La.
- CLIFTON, B. S. Y.** (M'15), Engineer-in-Charge, R.C.A. Communications, Inc., Rocky Point, L.I., N.Y.
- CLIPP, ROGER W.** (A'31), Commercial Engineering, National Broadcasting Company, Inc., 711-5th Ave., New York, N.Y. For mail: Evedell Ave., Hillsdale, N.J.
- CLIPSHAM, K. M.** (A'30), Engineer-in-Charge, Enamelled Wire and Coil Departments, Canada Wire and Cable Company, Ltd., Leaside, Ont., Canada. For mail: 97 Caithness Ave., Toronto 6, Ont., Canada.
- CLOSSON, LUKE E.** (A'29), Research Engineer, Rudolph Wurlitzer Manufacturing Company, North Tonawanda, N.Y. For mail: Colonial Apartments, North Tonawanda, N.Y.
- CLOUGH, KENDALL** (A'27), Chief Engineer, Silver-Marshall, Inc., 6401 W. 65th St., Chicago, Ill. For mail: 4209 N. Ashland Blvd., Chicago, Ill.
- CLUFF, HAROLD D.** (A'25), Captain, Royal Canadian Corps of Signals, Camp Borden, Ont., Canada.
- CLUTE, FRANK H.** (A'31), Radio Technician, Post Radio Station WYA, Mitchell Field, L.I., N.Y.
- CURRIE, W. OTHO** (A'31), Serviceman, Bol-Abey Radios, 905 W. Magnolia, Fort Worth, Tex. For mail: 3711 Meadowbrook Dr., Fort Worth, Tex.
- COATES, B. FRANKLIN** (A'29), Instructor, Wallace Radio Institute, 103 W. 13th St., Oklahoma City, Okla. For mail: Box 36, Tuttle, Okla.
- COATES, FRANK M.** (A'28), Manager, Radio Department, Westinghouse Electric Supply Company, Inc., 1005 Dace St., Sioux City, Iowa. For mail: 3605-5th Ave., Sioux City, Iowa.
- COBB, F. ARTHUR** (A'26-M'28), Manager, Public Address Department, Messrs. Philips Lamps, Ltd., 145 Charing Cross Rd., London, W.C.1, England. For mail: 28 Manor Gardens, Purley, Surrey, England.

- COBB, HOWARD L.** (A'30), Electrochemical Engineer, Boonton Research Corporation, Boonton, N.J. For mail: Fairview Ave., Boonton, N.J.
- COBB, STANLEY W.** (A'31), Radio Technician and Proprietor, Stanley W. Cobb Radio Service Laboratory, 22 Angell Ave., South Portland, Maine.
- COBLENTZ, ORHAN R.** (A'30), Radio Promotion Manager, Colonial Radio Corporation, 254 Rano St., Buffalo, N.Y. For mail: 410 S. Catalina St., Los Angeles, Calif.
- COCHRANE, IAN D.** (A'31), Radio Engineer, Cochrane and Alexander, 81 Mount Joy St., Timmins, Ont., Canada.
- COCHRANE, MELVIN R.** (A'31), Aircraft and Ground Transmitter Work, Candler Field, Eastern Air Transport, Inc., Atlanta, Ga.
- COCKADAY, LAURENCE M.** (A'27), Editor, Radio Science Publications, Inc., 381-4th Ave., New York, N.Y.
- CODAY, WILLIAM A. JR.** (A'31), Radio Operator, Station KGHF, 113 Broadway, Pueblo, Colo.
- CODEL, MARTIN** (A'30), Newspaper Correspondent, Radio News Bureau, 956 National Press Bldg., Washington, D.C.
- CODINGTON, JEROME H.** (J'27-A'30), P.O. Box 127, Albany, Tex.
- COE, ALFRED** (A'26), Director, Coe Radio Institute, 78-80 Cortlandt St., New York, N.Y. For mail: 917 Newkirk Ave., Brooklyn, N.Y.
- COE, ERNEST W.** (A'26), Columbia Pictures, Inc., 1438 N. Gower St., Hollywood, Calif. For mail: 942 N. Ardmore, Los Angeles, Calif.
- COE, JAMES C.** (A'25), Assistant Radio Engineer, Signal Corps Aircraft Radio Laboratory, Wright Field, Dayton, Ohio.
- COE, ROBERT S.** (A'30), Broadcast Operator, Radio Station WTIC, Travelers Broadcasting Service, Hartford, Conn. For mail: 42 Brownell Ave., Hartford, Conn.
- COGGESHALL, IVAN S.** (A'26-M'29), General Traffic Supervisor, Western Union Telegraph Company, 60 Hudson St., New York, N.Y.
- COGSWELL, W. P.** (A'31), Lieutenant, U. S. Navy, Naval Air Station, Anacostia, D.C.
- COHAN, EDWIN K.** (M'31), Technical Director, Columbia Broadcasting System, Inc., 485 Madison Ave., New York, N.Y.
- COHEN, FRED** (A'31), General Manager, Radio Service Laboratories, 130 E. Duval St., Philadelphia, Pa. For mail: 5006 Rorer St., Philadelphia, Pa.
- COHEN, HYMAN A.** (A'29), Junior Radio Inspector, Radio Division, U. S. Department of Commerce, Fort McHenry, Baltimore, Md. For mail: 1626 Warwick Ave., Baltimore, Md.
- COHEN, ISAAC J.** (A'26), Assistant Engineer, P.O. Research Station, Dollis Hill Lane, London, England. For mail: 13 St. Ann's Hill, Wandsworth, London, England.
- COHEN, LOUIS** (M'14-F'15), North Cathedral Mansions, Washington, D.C.
- COHEN, MONTE** (A'30), F. W. Sickles Company, 191 Chestnut St., Springfield, Mass. For mail: 87 Malden St., Worcester, Mass.
- COHEN, SAMUEL** (A'16-M'22), Vice President, General Instrument Corporation, 225 Varick St., New York, N.Y. For mail: 401-76th St., Brooklyn, N.Y.
- COHEN, SAMUEL H.** (A'28), Chief of Designs, H. Clarke and Company, Atlas Works, Manchester, England. For mail: 6 Springfield Rd., Blackpool, Lancashire, England.
- COHEN, THEODORE** (J'27-A'30), Chief Engineer, Lake Research Laboratories, 1272 N. Wood St., Chicago, Ill. For mail: 1856 S. Central Park Ave., Chicago, Ill.
- COHN, HUGO** (M'30), Treasurer, Radio Receptor Company, Inc., 106-7th Ave., New York, N.Y.
- COHN, RALPH I.** (A'29), Assistant Radio Engineer, Signal Corps Laboratory, Fort Monmouth, Oceanport, N.J.
- COIL, NEIL B.** (A'30), Radio Operator, Radio Station WRIIM, Andrews Hotel, Minneapolis, Minn. For mail: 995 Winslow Ave., St. Paul, Minn.
- COKE, CHARLES B.** (A'30), Representative, Engineering Service, Equitable Life Assurance Society, 570-7th Ave., New York, N.Y. For mail: 1323 E. 64th St., Brooklyn, N.Y.
- COLBY, CHARLES C. JR.** (A'28), Radio Tube Engineer, Raytheon Manufacturing Company, Newton, Mass.
- COLBY, EDWARD B.** (A'27), Radio Operator, Radiomarine Corporation of America, 470 Atlantic Ave., Boston, Mass. For mail: 132 Dodge St., Beverly, Mass.
- COLE, ARTHUR B.** (M'15), President, Cole Radio Manufacturing Company, Bloomfield, N.J. For mail: 86 Westville Ave., Caldwell, N.J.
- COLE, BURTON R.** (A'29), Radio Engineer, Bell Telephone Laboratories, Inc., 463 West St., New York, N.Y.
- COLE, CHARLES H.** (A'31), Toll Service Supervisor, Pacific Telephone and Telegraph Company, 140 New Montgomery St., San Francisco, Calif.
- COLE, JRED S.** (A'26), Heating and Ventilating Engineer, M. Friedman Company, 844 Sulter Ave., Brooklyn, N.Y. For mail: 221-8th Ave., Brooklyn, N.Y.
- COLE, G. C.** (A'29), Captain, Rm. 3315, Divisions Operations Training, U. S. Marine Corps, Washington, D.C. For mail: Headquarters, U. S. Marine Corps, Washington, D.C.
- COLE, NEIL D.** (A'29), Radio Engineer, Westinghouse Electric and Manufacturing Company, Chicopee Falls, Mass. For mail: 47 Florence St., Springfield, Mass.
- COLE, ROY H.** (A'27), Chief Engineer, Radio Station WACO, Waco, Tex.
- COLE, WILLIAM K.** (A'31), Studio Engineer, National Broadcasting Company, Inc., Merchandise Mart, Chicago, Ill. For mail: 7655 Coles Ave., Chicago, Ill.
- COLEMAN, JOHN B.** (A'25-M'29), Radio Engineer, RCA Victor Company, Inc., Camden, N.J. For mail: 102 Avondale Ave., Had-donfield, N.J.
- COLEMAN, ROBERT M.** (A'27), Serviceman, The Coleman Radio Laboratory, 30 S. Chestnut Ave., Niles, Ohio.
- COLES, FRANCIS A.** (A'30), Member of Technical Staff, Bell Telephone Laboratories, Inc., 463 West St., New York, N.Y.
- COLLETT, PAUL** (A'31), Proprietor, Radio Service, Penn St., New Bethlehem, Pa.
- COLLIER, GEORGE X. M.** (A'31), Operating Engineer, N.W. Broadcasting, Inc., Minneapolis, Minn. For mail: 2314 N. Ferry St., Anoka, Minn.

- COLLINS, ARTHUR A.** (J'26), 514 Fairview Dr., Cedar Rapids, Iowa.
- COLLINS, EDWARD M.** (A'30), Assistant Laboratory Instructor, Radio Institute of California, 921 W. 6th St., Los Angeles, Calif. For mail: 2822 Halldale Ave., Los Angeles, Calif.
- COLLINS, FRANK J.** (A'31), Drafting Section Leader, RCA Victor Company, Inc., Camden, N.J. For mail: 760 Mount Vernon Ave., Haddonfield, N.J.
- COLLINS, FREDERICK V.** (J'22-A'26), Radio and Sound Engineering Consultant, 150 Puritan Ave., Highland Park, Mich.
- COLLINS, JOHN** (J'27-A'28), Electrical Engineering Student, College of Engineering, Newark, N.J. For mail: 34 Harding Ave., North Arlington, N.J.
- COLLINS, JOHN FRANCIS** (A'30), Installation Engineer, 220 S. Johnson St., New Orleans, La.
- COLLINS, LAURENCE H.** (A'29), Vice President and Service Manager, Penn-Cliff Service Company, 2678 Pennsylvania Ave., Baltimore, Md.
- COLLINS, LEWIS R.** (A'28), Service Engineer, RCA Photophone, Inc., 438 W. 37th St., New York, N.Y. For mail: 313 Deering Ave., Portland, Maine.
- COLPITTS, A. B.** (A'31), 2150 Bedford Ave., Brooklyn, N.Y.
- COLPITTS, EDWIN H.** (A'14-F'26), Assistant Vice President, American Telephone and Telegraph Company, 195 Broadway, New York, N.Y.
- COLVIN, R. S.** (A'27), Radio Receiving Engineer, Radio Corporation of America, Riverhead, L.I., N.Y. For mail: Jamesport, N.Y.
- COLVIN, RAYMOND A.** (A'31), Designer and Builder, Radio Test Equipment, General Motors Radio Corporation, Dayton, Ohio. For mail: 37 Lawn St., Dayton, Ohio.
- COLVIN, RUEL** (A'27), Radio Engineer, Radio Research Company, Inc., 1204 Irving St., N.E., Washington, D.C. For mail: 143 Quincey Pl., N.E., Washington, D.C.
- COLWELL, ROBERT C.** (A'21-M'29), Professor of Physics, West Virginia University, Morgantown, W.Va. For mail: 332 Demain Ave., Morgantown, W.Va.
- COMACH, STANLEY I.** (A'29), Service Engineer, Research Products Engineering Department, Northern Electric Company, Ltd., 637 Craig St. W., Montreal, P.Q., Canada.
- COMPTON, ROBIN D.** (J'27-A'29), Radio Engineer, Radio Station KSAC, Kansas State College Campus, Manhattan, Kan. For mail: 730 Moro Ave., Manhattan, Kan.
- CONE, DONALD I.** (A'31), Transmission and Protection Engineer, Pacific Telephone and Telegraph Company, 140 New Montgomery St., San Francisco, Calif.
- CONE, F. E.** (A'30), Radio Engineer, RCA Victor Company, Inc., Camden, N.J. For mail: 4700 Lafayette Ave., Merchantville, N.J.
- CONKLIN, JAMES W.** (A'31), Design and Development Engineer, R.C.A. Communications, Inc., Rocky Point, L.I., N.Y.
- CONLEY, S. D.** (A'30), Engineering Department, RCA Victor Company, Inc., Camden, N.J. For mail: Century Hotel, 111 W. 46th St., New York, N.Y.
- CONNELL, W. H.** (A'30), Engineer, The Gramophone Company, Ltd., Hayes, Middlesex, England. For mail: 4 Dorset Way, Hillingdon, Middlesex, England.
- CONNETTE, T. W.** (A'29), Vice President and General Manager, Lockport Light, Heat and Power Company, 115 Main St., Lockport, N.Y.
- CONNOLLY, NORMAN C.** (A'31), Superintendent, Tropical Radio Telegraph Company, 1001-4th St., San Francisco, Calif.
- CONRAD, FRANK** (M'17-F'27), Electrical Engineer, Westinghouse Electric and Manufacturing Company, East Pittsburgh, Pa.
- CONRON, WILLIAM H.** (A'31), Radio Engineer, RCA Victor Company, Inc., Camden, N.J. For mail: 301 Bank Ave., Riverton, N.J.
- CONROY, JOSEPH M.** (A'23), Works Engineer, Canadian Marconi Company, 211 St. Sacramento St., Montreal, P.Q., Canada.
- CONTENT, EDWARD J.** (A'30), Radio Engineer, Radio Station WOR, 1440 Broadway, New York, N.Y. For mail: 8642-57th Rd., Elmhurst, L.I., N.Y.
- CONVISER, HARRY** (A'31), Printer Attendant, Associated Press, *Herald Tribune*, 230 W. 41st St., New York, N.Y. For mail: 32 W. 111th St., New York, N.Y.
- COOK, ALFRED B.** (A'31), Savings Bank Department, G.P.O., Blythe Rd., Kensington, London, W. 14, England. For mail: 1 Odessa Rd., Hardsden, London, N.W. 10, England.
- COOK, ARTHUR L.** (A'26), Head, Electrical Engineering Department, Pratt Institute, 215 Ryerson St., Brooklyn, N.Y.
- COOK, BERNARD L.** (A'28), Professional Radio Service, 26 Sunset Ave., Medford, Mass.
- COOK, EDWARD H.** (A'27), Engineer, Boydell Corporation, 2732 Broadway, Fort Wayne, Ind. For mail: 1010 W. Wayne St., Fort Wayne, Ind.
- COOK, ELLIS C.** (A'27), Engineer, X-Ray Work, Hettiger Brothers Manufacturing Company, P.O. Box 1126, Kansas City, Mo. For mail: 5009 Wyandotte St., Kansas City, Mo.
- COOK, ELLSWORTH D.** (A'21), 145-53 Willets Point Blvd., Flushing, L.I., N.Y.
- COOK, FRANK W.** (A'30), Radio Technician, Montgomery Ward and Company, Kansas City, Mo. For mail: 107 N. Gladstone, Kansas City, Mo.
- COOK, J. M.** (A'27), Southern Bell Telephone and Telegraph Company, Atlanta, Ga. For mail: 164-4th St., N.E., Atlanta, Ga.
- COOK, JOHN W.** (A'17), Professor, Mathematics and Physics, Junior College, El Centro, Calif.
- COOK, JOHN W.** (A'26), Equipment Engineer, Telegraph Department, American Telephone and Telegraph Company, Santa Fe Railway, Topeka, Kan. For mail: 1500 Van Buren St., Topeka, Kan.
- COOK, ROBERT O.** (A'26), Sound Engineer, Disney Film Recording Company, 5360 Melrose Ave., Hollywood, Calif. For mail: 3465 Rowena Ave., Los Angeles, Calif.
- COOK, RONALD P.** (A'30), Engineer, Booth Engineering, Inc., 2526 1/2 San Fernando Rd., Pasadena, Calif. For mail: 1307 N. Wilson Ave., Pasadena, Calif.
- COOK, WILBERT H.** (A'27), Chief Engineer, The Radio Service Company, 433 Cambridge St., Allston, Mass. For mail: 34 Mansfield St., Allston, Mass.

- COOKE, GERALD W.** (A'26), Radio Engineer, Consolidated Gas, Electric Light and Power Company, 660 Lexington Bldg., Baltimore, Md.
- COOKE, LAWRENCE S.** (A'30), Assistant Manager, Federal Electric Company, 3008 University Ave., S.E., Minneapolis, Minn. For mail: 2615 Park Ave., Minneapolis, Minn.
- COOLEY, ELIHU H.** (A'28), Chief Engineer, Shalleross Manufacturing Company, 700 Parker Ave., Collingsdale, Pa. For mail: 71 Beech Ave., Alden, Pa.
- COOMBS, CLYDE F.** (A'27), Broadcast Transmitter Sales Engineer, RCA Victor Company, Inc., 235 Montgomery St., San Francisco, Calif.
- COONLEY, F. A. W.** (A'30), Radio Operator, Radio Station KMA, Shenandoah, Iowa. For mail: P.O. Box 203, Shenandoah, Iowa.
- COOPER, ALFRED S.** (J'31), Draftsman, De Forest Radio Corporation, 245 Carlaw Ave., Toronto, Ont., Canada. For mail: 699 Sammon Ave., Toronto, Ont., Canada.
- COOPER, ASHTON B.** (A'26), General Manager, Ferranti Electric, Ltd., Mount Dennis, Toronto 9, Ont., Canada.
- COOPER, C. B.** (A'14), Manufacturers Sales Representative, Rm. 1019, 175-5th Ave., New York, N.Y.
- COOPER, DONALD H.** (A'30), 105 Hamilton St., Aurora Hills, Alexandria, Va.
- COOPER, G. R.** (A'30), Chief Engineer, High St., Mundesley, Norfolk, England. For mail: "Cliffside," Mundesley, Norfolk, England.
- COOPER, GEORGE R.** (A'29), Sound Engineer, Columbia Picture Corporation, 1438 Gower St., Hollywood, Calif. For mail: 3305 Wood Ter., Hollywood, Calif.
- COOPER, GUSTAVUS A.** (A'29), Service Manager, The Lowery Radio Company, 4506-41st St., Long Island City, L.I., N.Y. For mail: 7424-87th Ave., Woodhaven, L.I., N.Y.
- COOPER, HAROLD G.** (A'28), Engineer and Instructor, California Aerial Transport, 633-3rd St., Hermosa Beach, Calif.
- COOPER, J. A.** (A'22), Engineer-in-Charge, Midland Regional Studios, British Broadcasting Corporation, 282 Broad St., Birmingham, England. For mail: 97 Bournbrook Rd., Selly Park, Birmingham, England.
- COOPER, J. R.** (A'30), Assistant Station Engineer, Rogers-Majestic Corporation, Radio Station CFRB, Toronto, Ont., Canada. For mail: 157 Hope St., Toronto, Ont., Canada.
- COOPER, JOHN C., JR.** (A'17), Attorney-at-Law, Cooper, Knight, Adair, Cooper, and Osborne, Atlantic National Bank Bldg., Jacksonville, Fla.
- COOPER, LOWELL** (M'30), Lieutenant Commander, U. S. Navy, District Communication Officer, U. S. Naval Radio Station, 13th Naval District, Navy Yard, Bremerton, Wash.
- COOPER, ORVILLE T.** (A'27), U. S. Naval Research Laboratory, Bellevue, Anacostia, D.C.
- COOPER, SAMUEL J.** (A'25), Engineer, Canadian Marconi Company, 11 St. Sacramento St., Montreal, P.Q., Canada.
- COOPER, W. H. B.** (J'28), Telephone Engineering Department, G.P.O., 2 the Parade, Marlborough, Wilts, England.
- COOPER, WILLIAM H.** (A'30), 1144 E. Lawnview Blvd., Dayton, Ohio.
- COPELAND, HERMAN A.** (A'28), Graduate Student, Ohio State University, Columbus, Ohio. For mail: R.F.D. No. 6, Wapakoneta, Ohio.
- COPELAND, WILLIAM H.** (A'31), Radio Laboratory Engineer, Canadian Westinghouse Company, 1910 Metropolitan Bldg., Toronto, Ont., Canada. For mail: 224 Grosvenor Ave., S., Hamilton, Ont., Canada.
- COPP, ROY S.** (A'25), Proprietor, Copp Radio Laboratories, 352 W. Monument Ave., Dayton, Ohio. For mail: 61 Stratford Ave., Dayton, Ohio.
- COPPINGS, WILLIAM H.** (A'31), Draughtsman, Electrical Designer, High Frequency Engineering Company, Ltd., Ducon Works, Victoria Rd., North Acton, London, W. 3, England. For mail: 65 Leigh Rd., East Ham, E. 6, London, England.
- CORBETT, CLIFFORD W.** (J'31), Radio Engineer, Columbia Broadcasting System, Inc., 485 Madison Ave., New York, N.Y. For mail: 25-28-122nd St., College Point, L.I., N.Y.
- CORBETT, EDWARD L.** (A'30), Lawyer, 217 Broadway, New York, N.Y.
- CORBETT, WALTER E.** (A'26), Proprietor, Corbett Concrete Pipe Company, P.O. Box 214, Milford, Mass.
- CORCORAN, EDWARD M.** (A'27), Proprietor, E. M. Corcoran Radio Company, 436 N. Main St., Artesia, Calif. For mail: 438 N. Main St., Artesia, Calif.
- CORCORAN, GEORGE L.** (J'27-A'30), Technician, Corcoran Radio Company, 1508 Main St., Artesia, Calif. For mail: 1510 Main St., Artesia, Calif.
- CORDELL, PETER C.** (A'29), Laboratory Assistant, Radio Frequency Laboratories, Inc., Princeton, N.J. For mail: 302 Dawson Ave., Princeton, N.J.
- CORDERMAN, WILLIAM P.** (A'27), Second Lieutenant, Signal Corps, U. S. Army, c/o Adjutant General of the Army, Washington, D.C. For mail: 4401 Leland St., Washington, D.C.
- CORDES, EDWIN L.** (A'26), Instructor, Marquette University, 1217 Wisconsin Ave., Milwaukee, Wis. For mail: 3317 N. Oakland Ave., Milwaukee, Wis.
- CORDOVA, F. B.** (A'27), Radio Technician, Philco Storage Battery Company, C and Ontario Sts., Philadelphia, Pa. For mail: 2625 W. Fletcher St., Philadelphia, Pa.
- CORDREY, E. E.** (A'27-M'29), Manager, Department of Physical Science, State Teachers College, Conway, Ark.
- CORE, CHRISTOPHER W.** (A'31), Radio Inspector, Atlas Stores, Inc., 38 Park Pl., New York, N.Y. For mail: Box 343, City Hall Annex, New York, N.Y.
- COREY, JAMES H.** (A'27), Signal Maintainer, New York Central Railroad, c/o G. A. Guyer, Signal Supervisor, Union Station, Albany, N.Y. For mail: 78 Oxford Rd., Albany, N.Y.
- CORMACK, ALAN N.** (A'31), Technical Director, c/o KFRC, 1000 Van Ness Ave., San Francisco, Calif. For mail: 1466-40th Ave., San Francisco, Calif.
- CORNEY, WILLIAM D.** (A'31), Serviceman, International Marine Radio Company, Ltd., 8 Fruit Market Chambers, Southampton Docks, England. For mail: 7 Glenloyn Ter., Bellevue Ter., Southampton, England.
- CORNFIELD, M.** (A'29), Radio Engineer, Indian Broadcasting Company, Ltd., Radio

- House, Apollo Bunder, Bombay, India. For mail: Y.M.C.A., Woodhouse Rd., Fort Bombay, India.
- CORONITI, SAMUEL C.** (A'31), 401 North St., Keiser, Pa.
- CORRIGAN, C. J.** (A'30), Marine Operator, Radio Station WAX, Tropical Radio Telegraph Company, P.O. Box 488, Hialeah, Fla.
- CORRIGAN, JAMES T.** (A'26), Recording Engineer, Pathé Sound News, 35 W. 45th St., New York, N.Y. For mail: 1819 G St., N.W., Washington, D.C.
- CORWIN, CHARLES I.** (A'26), Advertising Department, National Carbon Company, Inc., 30 E. 42nd St., New York, N.Y.
- CORWIN, WILLIS P.** (A'27), 117 E. McCarty St., Jefferson City, Mo.
- CORWITH, HOWARD P.** (M'26), Special Development Engineer, Western Union Telegraph Company, Water Mill, L.I., N.Y.
- COTA, PEDRO N.** (A'23), Jefe del Dep. de Radio-Comunicacion, Direccion Gral de Telegs. Nacionales, Mexico, D.F.
- COTE, OMER E.** (A'23), Coil Engineer, Valley Appliances, Inc., Rochester, N.Y. For mail: 276 Washington Ave., Kenmore, N.Y.
- COTTER, EDWIN MEREDITH** (A'29), Manager, Cotter P.A. Laboratories, Dayton, Ohio. For mail: 1606 Salem Ave., Dayton, Ohio.
- COTTER, WILLIAM F.** (A'27), Radio Engineer, United American Bosch Corporation, Springfield, Mass.
- COTTON, RICHARD J.** (A'28), Junior Radio Inspector, Radio Division, U. S. Department of Commerce, Secondary Frequency Monitoring Station, 1005 Tualatin Ave., Portland, Ore. For mail: 704 E. 58th St., N., Portland, Ore.
- COTTRELL, CASPER L.** (A'29), Assistant Professor of Physics, Kenyon College, Gambier, Ohio.
- COTTRELL, MC KENZIE** (A'28), Radio Engineer, General Electric Company, Schenectady, N.Y. For mail: 1426 Sumner Ave., Schenectady, N.Y.
- COULTER, HOWARD N.** (M'29), Lieutenant, U. S. Navy, U. S. Naval Air Station, Lakehurst, N.J.
- COULTON, ARTHUR** (A'31), Radio Engineer, 171 Manchester Rd., Haslingden, Rossendale, England.
- COURCHENE, HOMER B.** (A'27), Transmission Engineer, Radio Station WLS, Crete, Ill. For mail: 5424 Aberdeen St., Chicago, Ill.
- COURSEY, PHILIP R.** (A'17), Dubilier Condenser Company, Ltd., Ducon Works, London, W.3, England. For mail: 67 Queens Rd., Richmond, Surrey, England.
- COURTENAY, JUSTIN A.** (A'31), Transmission Maintenance Supervisor, Southern Telephone and Telegraph Company, 820 Poydras St., New Orleans, La. For mail: 6025 Coliseum St., New Orleans, La.
- COURTENAY-PRICE, GEORGE** (A'25), Captain, The Barracks, Gt. Brook St., Birmingham, England. For mail: 2 St. Annes Villas, Hewlett Rd., Cheltenham, England.
- COURTER, H. L.** (A'29), Engineer, Western Electric Company, Inc., Hawthorne, Ill. For mail: 4030 S. Vernon Ave., Brookfield, Ill.
- COURTIS, REGINALD P.** (A'26), 620 Parkview, Detroit, Mich.
- COUSINS, VAN METER** (A'25), Electrical Engineer, Bell Telephone Laboratories, Inc., 463 West St., New York, N.Y.
- COWAN, EDWARD J.** (A'28), Assistant Patent Attorney, Patent Department, Radio Corporation of America, 570 Lexington Ave., New York, N.Y. For mail: Edgewood Ave. and Chatfield St., Springdale, Conn.
- COWAN, FRANK A.** (M'30), Transmission Engineer, American Telephone and Telegraph Company, Inc., Rm. 1208, 15 Dey St., New York, N.Y.
- COWLES, E. E.** (A'31), Field Engineer, RCA Victor Company, Inc., Camden, N.J. For mail: 210 Park Towers Apartments, Kemble Ave., Philadelphia, Pa.
- COWLES, JOHN W., JR.** (J'28-A'30), Superintendent, Radio Service Department, Richman-Crosby Company, 229 S. Front St., Memphis, Tenn. For mail: 920 N. Barksdale St., Memphis, Tenn.
- COWLES, LAURENCE G.** (A'31), Member of Technical Staff, Bell Telephone Laboratories, Inc., 463 West St., New York, N.Y. For mail: Bell Telephone Laboratories, Inc., 180 Varick St., New York, N.Y.
- COX, ALFRED** (A'31), Assistant Foreman, Westinghouse Lamp Company, Bloomfield, N.J. For mail: 46 Hinrich's Pl., Bloomfield, N.J.
- COX, C. F.** (A'27), Recording Technician, Paramount News, 1, Rue Meyerbeer, Paris IX*, France. For mail: Strathmore Station Rd., Bramley, Guildford, England.
- COX, GEORGE C.** (A'19), Lieutenant Colonel, 500 Roosevelt Ave., Cartaret, N.J.
- COX, HECTOR S.** (J'29), Ponsford, Minn.
- COX, T. ALFRED** (J'31), 1030 Church St., Hannibal, Mo.
- COX, WALLACE** (A'31), Installation Engineer, RCA Photophone, Inc., 536 Statler Bldg., Boston, Mass. For mail: 616 W. 8th St., Rushville, Ind.
- COXHEAD, HARRY B.** (A'21-M'26), Telegraph Engineer, Department of Development and Research, American Telephone and Telegraph Company, 195 Broadway, New York, N.Y. For mail: 1046 Sleepy Hollow Lane, Plainfield, N.J.
- COZZENS, BRADLEY** (A'27), Research Engineer, Bureau of Power and Light of Los Angeles, 207 S. Broadway, Los Angeles, Calif. For mail: P.O. Box 529, San Jose, Calif.
- CRABTREE, ALFRED E.** (A'26), Radio Serviceman, Titcher-Goettinger Company, Elm and St. Paul, Dallas, Tex. For mail: 2812 S. Britton, Dallas, Tex.
- CRAFT, JAMES A.** (A'31), Radio Technician, 3 Carlton St., Binghamton, N.Y.
- CRAIG, ALBERT G.** (A'27), Brasleton, Whitcomb and Davies, 52 Vanderbilt Ave., New York, N.Y. For mail: 579 Van Cortlandt Park Ave., Yonkers, N.Y.
- CRAIG, JACK** (J'27), 611 E. Gibson Ave., Connellsville, Pa.
- CRAIG, PALMER H.** (A'25), Vice President and Technical Director, Invox Corporation, Westwood Bank Bldg., Harrison and Boudinot Aves., Cincinnati, Ohio.
- CRAIG, ROBERT B.** (A'30), 1066 Franklin St., Pierre, S.D.
- CRAMPTON, WILLIAM J.** (M'21), Electrical Engineer, 73 Queen Victoria St., London, E.C., England

- CRANE, EDWIN S.** (A'28), Partner, Radio Sales, Nassau Radio Service, 330 Fulton Ave., Hempstead, L.I., N.Y. For mail: 67 Front St., Hempstead, L.I., N.Y.
- CRANEY, E. B.** (A'31), Manager, Radio Station KGIK, Butte, Mont.
- CRAVEN, T. A. M.** (F'29), Consulting Radio Engineer, 922 National Press Bldg., Washington, D.C.
- CRAWFORD, ARTHUR B.** (A'29), Member of Technical Staff, Bell Telephone Laboratories, Inc., P.O. Box 97, Red Bank, N.J.
- CRAWFORD, CECIL G.** (A'26), Engineer, Standard Telephones and Cables, Ltd., The Hyde, Hendon, London, N.W. 9, England. For mail: 4 Holmwood Ter., Mill Hill, N.W. 7, England.
- CRAWFORD, DAVID M.** (A'21), Major, Office Chief Signal Officer, Munitions Bldg., Washington, D.C.
- CRAWFORD, J. B.** (A'27), Technical Manager, Public Address Service, 218 S. 20th St., Omaha, Neb.
- CRAWFORD, J. WILLIAM** (A'31), Laboratory Assistant, Wired Radio, Inc., Ampere, N.J. For mail: 111 N. Walnut St., East Orange, N.J.
- CRAWFORD, JOHN D.** (A'29), Engineer, General Radio Company, 30 State St., Cambridge, Mass.
- CREAGER, FREDERICK L.** (A'31), Process Development Engineer, RCA Victor Company, Inc., Camden, N.J. For mail: 602 W. Maple Ave., Camden, N.J.
- CREAMER, W. J., JR.** (A'29), Associate Professor of Electrical Communications, University of Maine, Orono, Maine. For mail: 32 Forest Ave., Orono, Maine.
- CREASER, ISAJAH** (A'26), Engineer, Inspection and Test Department, Westinghouse Electric and Manufacturing Company, East Springfield, Mass. For mail: 76 Cortland St., Springfield, Mass.
- CREIGHTON, ROBERT R.** (A'31), Student Engineer, Engineering Department, RCA Victor Company, Inc., Camden, N.J. For mail: 227 Virginia Ave., Audubon, N.J.
- CRESPO, JOSE** (M'25), Jimenez de Quesada, Madrid, Spain.
- CRESWICK, E. A.** (A'31), Engineer, Radio Valve Company of Canada, 189 Dufferin St., Toronto, Ont., Canada. For mail: 46 Spencer Ave., Toronto, Ont., Canada.
- CRIPPEN, EUGENE G.** (A'23), Radio Engineer, General Electric Company, 1 River Rd., Schenectady, N.Y. For mail: 1706 State St., Schenectady, N.Y.
- CRISANTE, ALDO** (A'29), 102 Sulzbacher Ave., Mingo Junction, Ohio.
- CRISER, ROBERT J.** (A'31), Machinist Helper, Chesapeake and Ohio Railway, Hinton, W.Va. For mail: 110 Main St., Hinton, W.Va.
- CRITCHLEY, WALTER H.** (A'30), Wireless Operator, Marconi International Marine Communication Company, Ltd., London, England. For mail: 17 Hulme Rd., Sale, near Manchester, England.
- CRITE, MITCHEL** (A'28), Tester, Quality Department, RCA Victor Company, Inc., 211 North St., Camden, N.J. For mail: 526 W. 49th St., New York, N.Y.
- CROCKETT, DAVID R.** (A'30), Chief Crane Operator, Studebaker Corporation of America, South Bend, Ind. For mail: P.O. Box 868, South Bend, Ind.
- CROFTS, CECIL T.** (A'29), Radio Dealer, The Radio Shop, 467 King St., E., Hamilton, Ont., Canada. For mail: 200 London St., S., Hamilton, Ont., Canada.
- CROM, GEORGE C., JR.** (A'22-M'24), Colonial Radio Corporation, 254 Rano St., Buffalo, N.Y.
- CRONK, HAROLD W.** (A'30), General Foreman, Canadian National Carbon Company, Ltd., 805 Davenport Rd., Toronto, Ont., Canada. For mail: 549 Indian Rd., Toronto, Ont., Canada.
- CROSAS, ERNESTO G.** (A'31), Assistant Operator, Radio Station KWWG, Brownsville, Tex. For mail: P.O. Box 318, Brownsville, Tex.
- CROSBY, GEORGE L.** (M'23), Vice President, Roller-Smith Company, 2136 Woolworth Bldg., New York, N.Y.
- CROSBY, GORDON J.** (A'30), Lieutenant, U.S.S. Rochester, c/o Postmaster, New York, N.Y.
- CROSBY, HOWARD M.** (A'31), Radio Engineer, General Electric Company, Schenectady, N.Y. For mail: 134 Plymouth Ave., Schenectady, N.Y.
- CROSBY, MURRAY G.** (A'25), Radio Engineer, R.C.A. Communications, Inc., Riverhead, L.I., N.Y. For mail: 41-3rd St., Riverhead, L.I., N.Y.
- CROSLEY, POWELL, JR.** (A'22-M'25), President, Crosley Radio Corporation, 3401 Colerain Ave., Cincinnati, Ohio.
- CROSS, A.** (J'30), Engineer-in-Charge, Northern Wireless Relay Coy, Ltd., 22 Grove St., Newcastle, England.
- CROSSETT, EDWARD C.** (A'27), President, Crossett Western Company, 821 Railway Exchange Bldg., Chicago, Ill.
- CROSSLAND, HENRY A.** (A'28), Assistant Engineer, Radio Sales Department, General Electric Company, Bridgeport, Conn. For mail: 971 Fairfield Ave., Bridgeport, Conn.
- CROSSLEY, ALFRED** (A'19-M'26), Chief Engineer, Howard Radio Company, South Haven, Mich.
- CROTEAU, CARLTON W.** (A'28), Radio Service Technician, Brooksville Ave., Mount Carmel, Conn.
- CROTHERS, H. M.** (A'20), Dean, Division of Engineering, South Dakota State College, Brookings, S.D.
- CROUTER, LESLIE E.** (A'25), Automatic Switchman, Mountain States Telephone and Telegraph Company, Butte, Mont. For mail: 652 S. Jackson St., Butte, Mont.
- CROWE, MERWIN E.** (A'31), Service Engineer, Lehr Radio Company, Spring Grove Ave., Cincinnati, Ohio. For mail: 2805 Madison Rd., Cincinnati, Ohio.
- CROZIER, WILLIAM D.** (A'27), Oakdale, Iowa.
- CRUIKSHANK, JOHN M.** (A'31), Doctor and Acting Director, Medical Services, British Government Hospital, Nassau, Bahama Islands.
- CRUIKSHANK, OMAR T.** (A'27), 1107 Island Ave., N.S., Pittsburgh, Pa.
- CRUPPER, HOMER L.** (A'31), Radio Operator, U. S. Department of Commerce, Airways Division, P.O. Box 4286, Portland, Ore. For mail: 1114 Williams Ave., Portland, Ore.
- CUBERT, JOSEPH R.** (A'29), Engineer, Story and Clark Radio Corporation, 173 N.

- Michigan Ave., Chicago, Ill. For mail: 6741 Lafayette St., Chicago, Ill.
- CUERVO, LUIS S.** (A'25), Managing Director, Sociedad Iberica de Construcciones Electricas, Madrid, Spain. For mail: Apartado 990, Barquille I, Madrid, Spain.
- CULLEY, LESTER D.** (A'27), Maintenance Engineer, R.C.A. Communications, Inc., Point Reyes, Calif. For mail: P.O. Box 164, Inverness, Calif.
- CULLEY, PAWSON** (A'31), Todd Engineering Corporation, 594 Bedford Ave., Brooklyn, N.Y.
- CULLUM, A. EARL, JR.** (J'28-A'31), Radio Department, American Airways, Love Field, Dallas, Tex. For mail: 3615 Princeton Ave., Dallas, Tex.
- CULVER, CHARLES A.** (M'20), Professor of Physics, Carleton College, Northfield Minn.
- CULVER, CLARENCE C.** (A'14-M'14), Colonel, U. S. Army Air Corps, War Department, Washington, D.C. For mail: 3030 Macomb St., N.W., Washington, D.C.
- CUMERFORD, ARTHUR S.** (A'26), Radio Service, 13 Glenwood Ave., Eden Park, R.I.
- CUMMING, GEORGE** (A'27), Wood Patternmaker, Illinois Malleable Iron Company, 1801 Diversey Blvd., Chicago, Ill. For mail: 2017 Grace St., Chicago, Ill.
- CUMMING, KENNETH N.** (A'16-M'28), Assistant Plant Engineer, R.C.A. Communications, Inc., 66 Broad St., New York, N.Y. For mail: 1416 Park Ave., Plainfield, N.J.
- CUMMING, L. GORDON** (A'27), Sales Engineer, Atlantic Precision Company, 80 Federal St., Boston, Mass. For mail: 295 Beacon St., Boston, Mass.
- CUMMING, NOEL D.** (A'26-M'31), Chief Engineer, African Broadcasting Company, Durban Station, 204 West St., Durban, Natal, South Africa.
- CUMMINGS, ALAN P.** (A'30), Radio Engineering Department, General Electric Company, Schenectady, N.Y. For mail: 223 James St., Scotia, N.Y.
- CUMMINGS, B. RAY** (A'18-M'20), Engineering Department, Transmitter Division, RCA Victor Company, Inc., Camden, N.J. For mail: Chancellor Hall, 13th and Chestnut Sts., Philadelphia, Pa.
- CUMMINGS, JOHN J.** (A'30), Consultant, 434 N. 7th St., Camden, N.J.
- CUMMINGS, WILBUR H.** (J'25-A'28), Radio Instructor, Dodge Radio Institute, Valparaiso, Ind. For mail: 306 E. Indiana Ave., Valparaiso, Ind.
- CUNLIFFE, PAUL R.** (A'28), 48 Hill St., Bloomfield, N.J.
- CUNNINGHAM, DAVID H.** (A'28), Radio Engineer, RCA Victor Company, Inc., Camden, N.J. For mail: 237 Wayne Ave., Haddonfield, N.J.
- CUNNINGHAM, FREDERICK W.** (A'26-M'28), Radio Installation Engineer, Bell Telephone Laboratories, Inc., 463 West St., New York, N.Y. For mail: 45 Park Rd., Maplewood, N.J.
- CUNNINGHAM, LODGE** (A'27), Sound Director, Caddo Company, United Artists Studio, 1041 N. Formosa Ave., Hollywood, Calif. For mail: 5942 Willoughby Ave., Hollywood, Calif.
- CUNNINGHAM, THOMAS D.** (A'27), Radio Engineer, Photophone and Applications Division, RCA Victor Company, Inc., Camden, N.J. For mail: 649 Bettelwood Ave., Collingswood, N.J.
- CURLL, VAN C.** (A'30), Sales Engineer, Engineering Products Division, RCA Victor Company, Inc., 100 W. Monroe, Chicago, Ill. For mail: 8230 Euclid Ave., Cleveland, Ohio.
- CURRAN, GEORGE W.** (A'25), Technical Department, Radio Station KFI-KECA, 1000 S. Hope St., Los Angeles, Calif. For mail: 1110 E. 68th St., Inglewood, Calif.
- CURRIE, BURTON ALEX** (A'31), Radio Technician, Western Auto Supply Company, 1100 S. Grand Ave., Los Angeles, Calif. For mail: 4583 Ellenwood Dr., Los Angeles, Calif.
- CURRIER, STUART E.** (A'31), Engineer, RCA Victor Company, Inc., Camden, N.J. For mail: 123 Madison Ave., Erlton, N.J.
- CURRY, WALTER A.** (A'25), Teacher, Columbia University, New York, N.Y.
- CURTIS, AUSTEN M.** (A'12-M'13), Member of Technical Staff, Bell Telephone Laboratories, Inc., 463 West St., New York, N.Y. For mail: 132 N. 19th St., East Orange, N.J.
- CURTIS, FRANCIS C.** (A'24), Captain, Royal Signals, Staff College, Camberley, Surrey, England.
- CURTIS, JAMES O.** (A'27), Service Manager, First Points Radio Company, 499 W. Exchange St., Akron, Ohio. For mail: 646 Fultz St., Akron, Ohio.
- CURTIS, LESLIE F.** (A'18-M'29), Chief Engineer, United American Bosch Corporation, Springfield, Mass. For mail: 162 Springfield St., Springfield, Mass.
- CURTIS, R. C.** (A'30), Engineer, Wired Radio, Inc., Ampere, N.J. For mail: 106 N. Walnut Ave., East Orange, N.J.
- CURTIS, WESTLEY F.** (A'29), Junior Physicist, U. S. Naval Research Laboratory, Bellevue, Anacostia, D.C. For mail: 300 Raleigh St., S.E., Washington, D.C.
- CURTISS, ARTHUR N.** (A'30), Radio Engineer, RCA Victor Company, Inc., Camden, N.J. For mail: 405 Haddon Ave., Collingswood, N.J.
- CUSHING, T. FRANK** (A'31), Proprietor, Radio Retail Sales and Service, 345 Worthington St., Springfield, Mass. For mail: 78 College St., Springfield, Mass.
- CUSHION, L.** (A'30), Marconi International Marine Communications Company, Ltd., c/o Marconi House, Strand, London, England. For mail: "Tredaly," 40 W. Way, Wickham Rd., Shirley, Surrey, England.
- CUSTER, CHARLES J.** (A'30), Member of Technical Staff, Bell Telephone Laboratories, Inc., Rm. 812, 180 Varick St., New York, N.Y.
- CUTLER, KENNETH W.** (A'31), Student, Radio Institute of California, Los Angeles, Calif. For mail: 1225 W. 39th Pl., Los Angeles, Calif.
- CUTTING, FULTON** (M'15-F'21), Colonial Radio Corporation, 254 Rano St., Buffalo, N.Y.

D

- DACK, ALLAN J. S.** (A'25), Wireless Operator, Radio Communication Company, Ltd., Strand, London, England. For mail: 17 Salisbury Rd., Harrow, Middlesex, England.
- DACK, JOHN H. A.** (A'26), Radio Inspector, Standard Telephone and Cable Company, Ltd., New Southgate, London, N.11, England.

- For mail: 17 Salisbury Rd., Harrow, Middlesex, England.
- DA COSTA, ROBERT C.** (A'31), Superintendent, H. H. Eby Manufacturing Company, Inc., 22nd St. and Lehigh Ave., Philadelphia, Pa. For mail: 8419 Anderson St., Philadelphia, Pa.
- DADY, ARTHUR O.** (A'16), President and Chief Engineer, The Delta Company, Inc., North Chicago, Ill.
- DAILEY, ARTHUR C.** (A'30), Manager and President, Broadcasting Station KVL, Inc., Benjamin Franklin Hotel, Seattle, Wash.
- DAILY, HAROLD C.** (A'31), Radio Operator, Tropical Radio Telegraph Company, 1001-4th St., San Francisco, Calif.
- DALE, GEORGE V.** (A'30), Engineer, Bell Telephone Laboratories, Inc., 463 West St., New York, N.Y.
- DALEY, RAYMOND E. J.** (A'31), Engineer, RCA Victor Company, Inc., Camden, N.J. For mail: 422 Woodlawn Ave., Collingswood, N.J.
- DALLIN, EDWIN B.** (M'29), Engineer, Submarine Signal Company, 160 State St., Boston, Mass. For mail: 84 Oakland Ave., Arlington Heights, Mass.
- DALLY, ROY** (A'30), Sound Engineer, Webster Electric Company, Racine, Wis. For mail: Sheridan Manor, 736 S. Main St., Racine, Wis.
- DALTON, F. K.** (M'27), Testing Engineer, Electrical Laboratory, Hydro Electric Power Commission of Ontario, 8 Strachan Ave., Toronto, Ont., Canada.
- DALTON, ROBERT E.** (A'29), Field Engineer, National Broadcasting Company, Inc., Rm. 2017, Merchandise Mart, 222 N. Bank Dr., Chicago, Ill.
- DALTON, STUART P.** (A'28), Radio Interference Engineer, Radio Trades Association, 234 Chamber of Commerce Bldg., Los Angeles, Calif. For mail: 2906 E. Walnut St., Huntington Park, Calif.
- DALY, EDMUND** (A'29), Radio Department, Daly's Garage, Seaforth, Ont., Canada. For mail: P.O. Box 515, Seaforth, Ont., Canada.
- DAMM, FRED** (J'30-A'31), Carleton, Neb.
- DAMM, GEORGE J., JR.** (A'26), Radio Service Department, Jebens Company, 107 Western Ave., Blue Island, Ill. For mail: 2100 Desplaines St., Blue Island, Ill.
- DANA, ALAN S.** (A'21), Research Engineer, Kerite Insulated Wire and Cable Company, Seymour, Conn.
- DANA, DAVID W.** (A'28), Physicist, General Electric Vapor Lamp Company, 410-8th St., Hoboken, N.J. For mail: 14 Edgewater Rd., Cliffside, N.J.
- DANE, FRANCIS W.** (M'26), Engineering Department, Wireless Specialty Apparatus Company, Boston, Mass. For mail: P.O. Box 28, Hamilton, Mass.
- DANFORTH, RICHARD S.** (A'27), 16 California St., San Francisco, Calif.
- DANIELS, HAROLD H.** (A'31), Purchasing Agent, Remler Company, Ltd., 2101 Bryant St., San Francisco, Calif. For mail: 1717 Versailles, Alameda, Calif.
- DANIELS, PAUL H.** (J'25-A'27), Salesman, A.B.C. Candy Company, Beaumont, Tex. For mail: 1397 Corley Ave., Beaumont, Tex.
- DANIELSON, ERNEST G.** (A'16), Gray and Danielson Manufacturing Company, 2101 Bryant St., San Francisco, Calif.
- DANNALS, EARL W.** (A'16-M'26), Research Engineer, Wired Radio, Inc., 13th and 4th Aves., Ampere, N.J. For mail: 41 Ampere Pkwy., East Orange, N.J.
- DANNINGER, LOUIS** (A'31), Technical Productions Section, Gilbert Advertising, Ltd., 14-18 Holborn, London, E.C. 1, England. For mail: 103 Tolworth Rise, Tolworth, Surrey, England.
- DANZ, HERMAN** (A'29), Treasurer, Ad. Auriema, Inc., 116 Broad St., New York, N.Y.
- DANZIGER, HAROLD I.** (J'21-A'26-M'29), 40 E. 10th St., New York, N.Y.
- DARLINGTON, EDGAR T.** (A'26), Chief Operator, Radio Station WFI, Strawbridge and Clothier, Philadelphia, Pa. For mail: 2848 Idaho Rd., Camden, N.J.
- DARLINGTON, EUGENE S.** (A'26), Vacuum Tube Engineering Department, General Electric Company, Schenectady, N.Y.
- DARROW, JOHN A., JR.** (A'31), Engineer, Electrical Research Products, Inc., 250 W. 57th St., New York, N.Y. For mail: 43-61 S. 30th St., Flushing, L.I., N.Y.
- DARROW, LEO H.** (A'17), Engineer, Building and Equipment Department, New Jersey Bell Telephone Company, 1060 Broad St., Newark, N.J. For mail: 54 Cedar St., Maplewood, N.J.
- DART, HARRY F.** (A'20-M'26), Radio Engineer, Westinghouse Lamp Company, Bloomfield, N.J. For mail: 33 Burnett St., Glen Ridge, N.J.
- DASPIT, L. RANDALL** (A'29), Lieutenant (jg), U. S. Navy, U.S.S. Childs, c/o Postmaster, New York, N.Y.
- DAUBER, ARTHUR O. F.** (A'29), Specifications and Drawings, Engineering Department, Arceturus Radio Tube Company, 226 Sherman Ave., Newark, N.J. For mail: 180 Runyon St., Newark, N.J.
- DAUGHERTY, C. F.** (A'31), Radio Station WSB, c/o The Atlanta Journal, Biltmore Hotel, Atlanta, Ga.
- DAVENPORT, RALPH W.** (A'31), Proprietor, Davenport Electric Company, 339 Main St., East Orange, N.J.
- DAVID, BRUCE W.** (A'22-M'27), Radio Engineer, Cleveland Electric Illuminating Company, 75 Public Sq., Cleveland, Ohio.
- DAVID, WILLIAM R.** (A'26), Radio Engineering Department, General Electric Company, 1 River Rd., Schenectady, N.Y.
- DAVIES, I. TEGWYN** (A'31), Wireless Operator, S.S. Automedon, c/o Messrs. Alfred Holt and Company, India Bldgs., Liverpool, England. For mail: Llwynonn, Carmel, Llanelly, Wales.
- DAVIS, CHESTER** (A'29), Engineering Assistant, Michigan Bell Telephone Company, 1365 Cass Ave., Detroit, Mich. For mail: 71 Alger St., Detroit, Mich.
- DAVIS, CHESTER E.** (A'31), c/o RCA Victor Company, Inc., Camden, N.J.
- DAVIS, CHESTER L.** (A'24-M'28), Manager, Washington Office, Patent Department, Radio Corporation of America, 1227-1233 National Press Bldg., Washington, D.C.
- DAVIS, DARYL D.** (A'14), Assistant Professor of Electrical Engineering, Department of Mechanics, University of California, Berkeley, Calif.
- DAVIS, EDMONSTON J.** (A'31), R.F.D. No. 3, Morocco, Ind.
- DAVIS, GEORGE C.** (A'30), Assistant Radio Inspector, Radio Division, U. S. Depart-

- ment of Commerce, Rm. 1206, Gimble Bldg., Philadelphia, Pa. For mail: 624 Chain St., Norristown, Pa.
- DAVIS, GLEN A. (A'29), Chief Radio Operator, Radio Station WFBE, Hotel Parkview, Cincinnati, Ohio. For mail: Mendota, Miss.
- DAVIS, GLENWOOD (A'26), Electrician, Idaho Power Company, Pocatello, Idaho. For mail: 735 S. 5th St., Pocatello, Idaho.
- DAVIS, HAROLD (A'31), Manager, The Davis Radio Company, Box 114, Route No. 2, Pasadena, Calif. For mail: 2419 S. Highland Ave., Los Angeles, Calif.
- DAVIS, IRVING C. (A'26), 5050 Grayton Rd., Detroit, Mich.
- DAVIS, JOSEPH A. (A'23), Radio Engineer, 565 Mount Pleasant Rd., Toronto, Ont., Canada.
- DAVIS, R. K. (A'26), Lieutenant, JAG Office, Navy Department, Washington, D.C.
- DAVIS, R. L. (A'25), Radio Engineering Department, Westinghouse Electric and Manufacturing Company, Chicopee Falls, Mass.
- DAVIS, ROBERT J. (A'27), Engineer, Wired Radio, Inc., Newark, N.J. For mail: Kirksville, Mo.
- DAVIS, SELDEN I. (A'28), Assistant Supervisor, Sound Engineering Department, Warner Brothers Theatres, 207 Clark Bldg., Pittsburgh, Pa. For mail: 425 Montview Pl., Wilkensburg, Pa.
- DAVIS, THOMAS M. (M'28), Radio Engineer, U. S. Naval Research Laboratory, Bellevue, Anacostia, D.C. For mail: 4302 Brandywine St., N.W., Washington, D.C.
- DAVY, FRANCIS G. (A'30), Manager, H. Panagakis, 19 Manchester St., Liverpool, England. For mail: 1 Oakdale Rd., Waterloo, Liverpool, England.
- DAWE, FRANK W. (A'31), Radio Test Engineer, The Gramophone Company, Hayes, Middlesex, England. For mail: 61 Hoodcote Gardens, Winchmore Hill, London, England.
- DAWES, HOWARD H. (A'31), Service Manager, General Radio Company, 30 State St., Cambridge, Mass.
- DAWSON, FRANCIS A. (A'31), Engineer, Kingston Products Corporation, Kokomo, Ind. For mail: 908 W. Taylor St., Kokomo, Ind.
- DAWSON, WILFRED M. (A'27), Technical Engineer, Philips Lamps, Ltd., Box 1673, Wellington, New Zealand.
- DAY, JOHN F. (A'29), Service Manager, Clines, Inc., 920-14th St., N.W., Washington, D.C. For mail: 3706-24th St., N.E., Washington, D.C.
- DAY, LAURENCE E. (A'30), Wireless Operator, Mutual Telegraph Company, Wahiawa, Hawaii. For mail: P.O. Box 142, Wahiawa, Hawaii.
- DAY, RALPH P. (A'30), Radio Technician, Howard H. Amidon Company, 10 Norwich St., Worcester, Mass. For mail: West Millbury, Mass.
- DAYMUE, JOHN F. (A'29), Proprietor, Radio and Electrical Supplies, 4350 Pearl Rd., Cleveland, Ohio.
- DEAKIN, GERALD (A'16), First Assistant Chief Engineer, International Telephone and Telegraph Company, 67 Broad St., New York, N.Y.
- DEAL, HARMON B. (A'22-M'29), Engineer, Atwater Kent Manufacturing Company, 4700
- Wissahickon Ave., Philadelphia, Pa. For mail: 570 W. Clapier St., Philadelphia, Pa.
- DEAN, C. E. (A'29), Engineer, Hazeltine Service Corporation Laboratory, 26th Ave. and 210th St., Bayside, L.I., N.Y.
- DEAN, LEON W. (A'29), Sound Engineer, Southwest Division, Paramount-Publix Corporation, 2024 Jackson St., Dallas, Tex. For mail: 53 Union St., Mansfield, Mass.
- DEANER, HAYDN M. (A'29), 704 E. Market St., Danville, Pa.
- DEARDORFF, RALPH W. (A'14), Transmission and Protection Engineer, Pacific Telephone and Telegraph Company, Portland, Ore.
- DE BARDELEBEN, JOHN F. (A'27), Radio Operator, Houston Broadcasting Company, 816 Texas Ave., Houston, Tex.
- DE BARRO, FRANCIS (A'31), Assistant Engineer, Marconi's Wireless Telegraph Company of Egypt, Sh. Sherif, Cairo, Egypt.
- DE BELLESCIZE, HENRI J. J. M. (M'26), 47 Boulevard de La Seine, Neuilly (Seine), France.
- DE BOZAS, GUY DU BOURG (A'19), De lasko d'Enterprises Electro-Techignes, Paris, France. For mail: 35 Rue du General Foy, Paris, France.
- DE BURGH, DESMOND H. (A'24-M'26), Squadron Leader, Headquarters, Royal Air Force, Simla, India.
- DECINO, ALFRED (A'29), Radio Research Engineer, Bell Telephone Laboratories, Inc., Box 122, Deal, N.J.
- DE COLA, RINALDO (A'29), Research Work, Tung-Sol Radio Tubes, Inc., Newark, N.J. For mail: 26-28 Broad St., Newark, N.J.
- DE COUTOULY, GUSTAVE C. (A'20), Radio Engineer, Bell Telephone Laboratories, Inc., 463 West St., New York, N.Y. For mail: Burnet Ter., Madison, N.J.
- DEDMAN, ERNEST A. (A'31), Radio Engineer, 63a Kingston Rd., New Malden, Surrey, England.
- DEELEY, PAUL M. (A'26-M'29), Vice President, Buckingham Radio Corporation, 440 W. Superior St., Chicago, Ill. For mail: 5746 Drexel Blvd., Chicago, Ill.
- DE FOREST, LEE (M'14-F'18), General Talking Picture Corporation, 8190 Hollywood Blvd., Hollywood, Calif. For mail: 7160 Santa Monica Blvd., Hollywood, Calif.
- DE FOREST, M. J. (A'26), 2204 Estes Ave., Chicago, Ill.
- DE GRAAFF, ANTONIUS (A'23), Bibliotheek-Centrale Department, N.V. Philips' Gloeilampenfabrieken, Eindhoven, Holland.
- DE GRAVE, CLAUDE (A'27), Supervisor, Canadian Brandes Company, Ltd., Queens Quay, Toronto, Ont., Canada. For mail: 1 The Cedars, 100 Bain Ave., Toronto 6, Ont., Canada.
- DE HAVEN, THOMAS V. (A'25), Radio Engineer, Television Department, RCA Victor Company, Inc., Camden, N.J. For mail: 12 Park Pl., Audubon, N.J.
- DEILER, THEODORE G. (A'27-M'27), U. S. Supervisor of Radio, Rm. 326, Custom House, New Orleans, La.
- DE JARNETTE, W. Y. (A'31), President and General Manager, Public Address Installation Company, 1316 N. 11th St., Waco, Tex.
- DE LA MATER, FRANK A. (J'31), Assistant Operator, Radio Station KSAC, 1201 Vattier St., Manhattan, Kan.

- DE LAND, ROBERT E. (A'27), Instructor, The School of Engineering, 163 E. Wells St., Milwaukee, Wis. For mail: 2226 N. 29th St., Milwaukee, Wis.
- DELBERT, SIMON, JR. (A'17), Media, Pa.
- DELBORD, Y. L. (A'30), 5 Rue Hermel, Paris, France.
- DELLA CORTE, JOSEPH P. (A'27), Radio Engineer, Amphix Instrument Company, 231 E. 21st St., New York, N.Y. For mail: 4110 Bronxwood Ave., New York, N.Y.
- DELLENBAUGH, F. S., JR. (M'21), Massachusetts Institute of Technology, Cambridge, Mass. For mail: 91 Spooner Rd., Chestnut Hill, Mass.
- DELLINGER, J. H. (F'23), Chief Physicist, U. S. Bureau of Standards, Washington, D.C. For mail: 6607 Delfield St., Chevy Chase, Md.
- DE LONG, OSCAR A., JR. (A'20), American Telephone and Telegraph Company, 195 Broadway, New York, N.Y. For mail: P.O. Box 190, Montclair, N.J.
- DELORAIN, EDMOND M. (M'25), Radio Engineer, International Standard Electric Corporation, 46 Avenue de Breteuil, Paris, France.
- DELP, PAUL L. (A'29), Radio Service Manager, Mantz Radio and Electric Company, 119 W. Broad St., Tamaqua, Pa. For mail: South Tamaqua, Pa.
- DEL POZO, LUIS (A'31), Professor, Institute of Electrical and Mechanical Technology, Asoc. Arg. de Electro-Mecanicos, Maipu 4F4, Buenos Aires, Argentina. For mail: Necochea 1396, San Fernando, Buenos Aires, Argentina.
- DE MANN, WILLIAM (J'26-A'31), Chief Technician, Real Radio Service Corporation, 550 State St., Brooklyn, N.Y. For mail: 1504 Prospect Pl., Brooklyn, N.Y.
- DEMAREST, CHARLES S. (A'22-M'26), Electrical Engineer, American Telephone and Telegraph Company, 195 Broadway, New York, N.Y.
- DE MARS, PAUL A. (M'30), Technical Director, Shepard Broadcasting Company, 1 Winter Pl., Boston, Mass.
- DE MELO, WILLIAM (A'25), Local Manager, Western Electric Company of Mexico, Edificio Cidosa No. 54, Despacho 410, Mexico, D.F.
- DE MIRANDA, RODRIGUES J. (A'30), N. V. Nijkerk's Radio Warmoesstraat 94, Amsterdam, -C, Holland. For mail: Oosterpark 58, Amsterdam, -O, Holland.
- DEMMER, A. H. (A'28), Engineer, Telephone Division, RCA Victor Company, Inc., Camden, N.J. For mail: 1655 Park Blvd., Camden, N.J.
- DEMPSEY, WILLIAM E. (A'29), Proprietor, Middletown Radio Service, 174 W. Main St., Middletown, N.Y.
- DEMPSTER, BURGESS (A'31), Chief Engineer, Magnavox Company, Ltd., Fort Wayne, Ind.
- DEMUTH, G. W. (I'29), Technician, 320 S. Minnesota Ave., Wichita, Kan.
- DE MYER, HAROLD (A'30), Operator, Cable Picture Transmission, Daily News, 225 E. 42nd St., New York, N.Y. For mail: 9031 Fort Hamilton Pkwy., Brooklyn, N.Y.
- DE NARDO, FEDERIGO (J'29-A'31), 1683 Van Vranken Ave., Schenectady, N.Y.
- DENNIS, FRANK L. (A'23), P.O. Box 777, Nairobi, Kenya Colony, East Africa.
- DENSHAM, ROBERT S. (A'26), Maintenance Engineer, New York Telephone Company, 360 Bridge St., Brooklyn, N.Y. For mail: 44 Willow St., Floral Park, L.I., N.Y.
- DENSTAEDT, EDWIN C. (A'30), Supervisor of Radio, Radio Division, Detroit Police Department, Detroit, Mich. For mail: 2041 McDougall Ave., Detroit, Mich.
- DENTON, FRANK O. (A'29), Clerk, New York, Chicago and St. Louis Railroad, Rankin, Ill. For mail: Box 195, Rankin, Ill.
- DE PASQUALE, RAY H. (A'31), Technical Correspondent, Silver-Marshall, Inc., 41 Water St., New York, N.Y. For mail: 3834 Bailey Ave., New York, N.Y.
- DE PEREZ, JOSE (A'30), Motion Picture Sound Operator, Cine Mundial, Mexico, D.F. For mail: Santa Maria la Redonda 30, Interior 2, Mexico, D.F.
- DER BEDROSSYAN, MARK (A'28), President, Superior Radio and Electric Company, 1130 State St., Springfield, Mass.
- DE REMER, C. W. (J'27-M'28), Salesman, RCA Victor Company, Inc., Camden, N.J. For mail: 108 E. Idaho, Boise, Idaho.
- DERING, FRED J. (A'26), Proprietor, Spencer and Dering Radio Service, 5722 Santa Monica Blvd., Hollywood, Calif.
- DE ROND, BERNARD (A'30), Radio Service Engineer, Montgomery Ward and Company, Huntington, W.Va. For mail: 1315 Monroe Ave., Huntington, W.Va.
- DE ROSA, LOUIS A. (J'30), Student, Brooklyn Polytechnic Institute, 99 Livingston St., Brooklyn, N.Y. For mail: 423 Jersey St., Staten Island, N.Y.
- DERRY, F. R. (A'30), Chief Radioman, U. S. Navy, U.S.S. *Nexada*, San Pedro, Calif.
- DESAULNIERS, RUSSELL R. (A'31), Radio Engineer, Canadian Marconi Company, Montreal, P.Q., Canada. For mail: 2230 Old Orchard Ave., Montreal, P.Q., Canada.
- DESCH, JOSEPH R. (A'30), Inspection Engineer, General Motors Radio Corporation, Dayton, Ohio. For mail: 146 Kirkham St., Dayton, Ohio.
- DESNOES, ARNOLD B. (A'25), Telephone Engineer, New York Telephone Company, 1775 Grand Concourse, New York, N.Y.
- DE SOTO, CLINTON B. (A'30), Assistant to Secretary, American Radio Relay League, 38 La Salle Rd., West Hartford, Conn. For mail: 462 S. Quaker Lane, West Hartford, Conn.
- DE SOUSA, GEORGE S. (M'16), Treasurer, Radio Corporation of America, RCA Bldg., 570 Lexington Ave., New York, N.Y.
- DE TARNAVA, C., JR. (A'30), Tarnava y Cia., P.O. Box 147, Monterrey, N.L., Mexico.
- DETRICK, HAROLD M. (J'29), Silver-Marshall Products, Inc., Chicago, Ill. For mail: 4193 Grove Ave., Western Springs, Ill.
- DETSKY, CHARLES F. (A'21), Technical Director, Standard Electric Company, Ltd., Ujpest, 4, near Budapest, Hungary.
- DETTMAN, ROBERT A. (J'31), Radio Operator, Radio Station KFJM, University of North Dakota, Grand Forks, N.D. For mail: 406 Oak St., Grand Forks, N.D.
- DETWELLER, JAY E. (J'28-A'31), Draftsman and Serviceman, 2021 N. 6th St., Harrisburg, Pa.
- DE URGOITI, RICARDO M. (A'25), Director General, De Union Radio, Pi y Margall, 10, Madrid, Spain.

DEUTSCHMAN, BORAH H. (J'29-A'29), Proprietor, Lightning Service Shop, 19 S. 6th St., Easton, Pa.

DEVINE, WILLIAM F. (A'26), Service Engineer, Electrical Research Products, Inc., 530 Wisconsin Ave., Milwaukee, Wis. For mail: 518 Fisher Ave., Rockford, Ill.

DE WALT, K. C. (A'29), Vacuum Tube Engineering Department, General Electric Company, Schenectady, N.Y. For mail: 949 Maple Ave., Schenectady, N.Y.

DEWAR, JOHN A. (A'31), Radio Technician, A. G. Dobbie and Company, 39 King St., W., Brockville, Ont., Canada. For mail: 58 King St., W., Brockville, Ont., Canada.

DE WARDT, ROBERT G. (M'22), Engineer-in-Chief's Office, Alder House, Aldersgate, London, E.C. 1, England.

DE WESE, HERBERT WILLIAM (A'29), Student Engineer, Physics Department, Ohio State University, Columbus, Ohio. For mail: 144 W. Lane Ave., Columbus, Ohio.

DEWEY, FRED L. (A'25-M'30), Manager, Metropolitan District, Mackay Radio and Telegraph Company, 22 Battery St., San Francisco, Calif.

DEWHIRST, THORNTON P. (A'25), Research Consultant, Power Cinephone Equipment Corporation, 723-7th Ave., New York, N.Y. For mail: 138-6th St., Stewart Manor, Garden City, L.I., N.Y.

DE WITT, HAROLD (A'29), Sales and Service Manager, O. A. Hesla Company, Box 658, Prescott, Ariz.

DEWITT, JOHN H. (A'31), Member, Technical Staff, Bell Telephone Laboratories, Inc., 180 Varick St., New York, N.Y.

DIAMOND, HARRY (A'26-M'30), Senior Radio Engineer, U. S. Bureau of Standards, Washington, D.C. For mail: 3221 Connecticut Ave., N.W., Washington, D.C.

DIAMOND, HARVEY (A'16), Avenida Concepcion 105, Providencia, Santiago, Chile.

DIAMOND, HYMAN (A'29), Engineer, Radio Engineering Department, Westinghouse Electric and Manufacturing Company, East Pittsburgh, Pa. For mail: 733 Cheslett St., Pittsburgh, Pa.

DIAZ, ERNESTO (A'29), Engineer-in-Charge, Central Radio Service Company, 1813 Lexington Ave., New York, N.Y.

DIBBLEE, JOHN (A'28), Assistant Operating Engineer, Hydro Electric Power Commission of Ontario, 190 University Ave., Toronto 2, Ont., Canada.

DICK, N. J. (A'30), Advertising Manager, *Radio Trade Builder*, 347 Adelaide St., W., Toronto, Ont., Canada. For mail: 4 Pretoria Ave., Toronto, Ont., Canada.

DICKEY, EDWARD T. (J'15-A'17-M'23), Engineer, RCA Victor Company, Inc., Bldg. 5, Camden, N.J.

DICKEY, J. W. (A'27), Proprietor, J. W. Dickey, Radio Engineering and Repairing, 1924 Avenue M., Galveston, Tex.

DICKINSON, THEODORE M. (A'29), Vacuum Tube Development Engineer, Research Laboratory, General Electric Company, Schenectady, N.Y. For mail: 1247 Garner Ave., Schenectady, N.Y.

DICKSON, H. L. (A'29), 127 S. Detroit Ave., Los Angeles, Calif.

DIECKMAN, WILLIAM (J'29), Student, University of Colorado, Boulder, Colo. For mail: 1100 Pennsylvania, Boulder, Colo.

DIEFFENBACHER, C. C. (A'30), Department Manager, Faller Brothers, 709 Penn Ave., Wilkensburg, Pa. For mail: 706 Wallace Ave., Carnahan Bldg., Apartment 5, Wilkensburg, Pa.

DIEHL, CHARLES B. (A'28), Railroad Telegrapher, Missouri Pacific Railway Company, 15th and Grace Sts., Omaha, Neb. For mail: 5605 Cedar St., Omaha, Neb.

DIEHL, WILLIAM F. (A'19-M'29), Assistant Chief Engineer, RCA Victor Company, Inc., Camden, N.J. For mail: 19 Evergreen Lane, Haddonfield, N.J.

DIETRICH, FREDERICK (A'14), 1136-5th Ave., New York, N.Y.

DIETSCH, CARL G. (J'18-A'23), Assistant Radio Engineer, National Broadcasting Company, Inc., Rm. 1224, 711-5th Ave., New York, N.Y.

DIETZE, EGINHARD (A'19), Engineering Department, American Telephone and Telegraph Company, 195 Broadway, New York, N.Y.

DIGGETT, HAROLD (A'31), Proprietor, Southern Silver-Marshall Service Station, 147 Drysdale St., Jacksonville, Fla.

DIGGLE, A. J. (A'27), British Wireless Marine Service, East Ham, London, England. For mail: Sketchley Cottages, Hinceley, Leicester, England.

DIGHE, K. S. (A'29), D.R.E., Radio Electric Company, Kathiawad Diwanji's Wada, Bava-jipura, Baroda, India.

DILL, GEORGE C. (A'16), Electrical Engineer, Westinghouse Electric and Manufacturing Company, East Pittsburgh, Pa. For mail: 1015 Farragut St., East Liberty Station, Pittsburgh, Pa.

DILLABY, EDWIN F. (A'29), Vacuum Tube Engineer, Raytheon Manufacturing Company, Newton, Mass. For mail: 46 Francesca Ave., West Somerville, Mass.

DILLINGHAM, H. C. (A'30), Professor, A. and M. College of Texas, Box 256 F.E., College Station, Tex.

DILLOW, ARTHUR P. (A'27), Radioman, Second Class, U.S.S. *Pequot*, U. S. Coast Guard, Curtis Bay, Md.

DINGA, EMIL (A'24), Engineer, United Research Corporation, Long Island City, L.I., N.Y. For mail: 4514-43rd St., Long Island City, L.I., N.Y.

DINGER, HAROLD E. (A'27), Chief Radio Instructor, McKim Electric Schools, Inc., 120 Ash St., Akron, Ohio. For mail: 905 Berwyn Ave., Akron, Ohio.

DINGLEY, EDWARD N., JR. (A'28), Engineer, RCA Radiotron Company, Inc., Harrison, N.J. For mail: 180 Ashland Ave., Apartment 37B, Bloomfield, N.J.

DINSDALE, ALFRED (A'26-M'31), Producer, Columbia Broadcasting System, Inc., 485 Madison Ave., New York, N.Y. For mail: 68 Central Ave., St. George, S.I., N.Y.

DISBROW, JOHN D. (A'25), Operation Supervisor, National Broadcasting Company, Inc., 1367 E. 6th St., Cleveland, Ohio.

DISTAD, MERRIL (J'31-A'31), Graduate Student, University of Minnesota, Minneapolis, Minn. For mail: Royal Beach, Bemidji, Minn.

DITCHAM, WILLIAM T. (M'14), Research Engineer, Marconi's Wireless Telegraph Company, Ltd., Marconi Works, Chelmsford, England. For mail: Tudor House, Broomfield Rd., Chelmsford, England.

DIVER, FREDERICK G. (J'24-A'26), Chief Test Engineer, L. McMichael, Ltd., Wexham Rd., Slough, Bucks, England. For mail: Stewart Glen, Wexham, Bucks, England.

DIWELL, HARRY (A'30), Proprietor, Radio Store, 265 King St., E., Toronto, Ont., Canada.

DIXON, C. C. (A'27), Sales Representative, Griffith-Victor Distributing Corporation, Cincinnati, Ohio. For mail: 3746 Wieman Ave., Cincinnati, Ohio.

DOAN, GEORGE F. (A'30), Yard Conductor, Canadian Pacific Railway, Kenora, Ont., Canada. For mail: P.O. Box 135, Kenora, Ont., Canada.

DOBBS, F. W. (A'26), Chief Engineer, World Address Systems, Ltd., Fenton, Mich. For mail: 217-1st St., Fenton, Mich.

DOBBS, HARRY F. (A'22), President, Harry F. Dobbs, Inc., 245 Spring St., N.W., Atlanta, Ga.

DOCKREE, GEORGE E. (A'31), Maintenance Engineer, British Broadcasting Corporation, Bournemouth, England. For mail: "Chiquita," Emsbury Gardens, Bournemouth, England.

DODDS, LEONARD F. (A'31), Laboratory, Radio Service Company, 2727 Walnut St., Kansas City, Mo. For mail: 4235 Holmes St., Kansas City, Mo.

DODGE, ALBERT O. (A'28), Radio Engineer, General Electric Company, Schenectady, N.Y. For mail: 2801 Gunderland Ave., Schenectady, N.Y.

DODGE, FRANK R. (A'30), Commander, U.S.S. *Eagle 58*, c/o Postmaster, New York, N.Y.

DODGE, JOSEPH B. (A'20), Manager, Club Huts and Camps, Appalachian Mountains Club, 5 Joy St., Boston, Mass. For mail: Pinkham Notch Hut, Gorham, N.H.

DODGE, RICHARD M. (A'30), California Institute of Technology, Pasadena, Calif.

DOELLNER, LE ROY J. (A'28), New City, Rockland County, N.Y.

DOHERTY, WILLIAM H. (A'29), Radio Engineer, Bell Telephone Laboratories, Inc., Whippany, N.J.

DOIG, JOHN H. (A'27), Instructor, San Diego City Board of Education, 12th and Russ Sts., San Diego, Calif. For mail: 3548 Cherokee St., San Diego, Calif.

DOLAN, WILLIAM R. (A'30), Engineer, RCA Victor Company, Inc., 4th Floor, Bldg. 7, Camden, N.J. For mail: 766 Beacon Lane, Merion, Pa.

DOLBEAR, BENJAMIN L. (A'14-M'15), Chief Engineer, Airplane and Marine Direction Finder Corporation, Lindenhurst, L.I., N.Y. For mail: 206 School St., Belmont, Mass.

DOLESH, FRANK J. (J'21-A'22), Engineer, Western Electric Company, Inc., Chicago, Ill. For mail: 38 Milford Ave., Newark, N.J.

DOLID, ABRAHAM (J'20-A'23), Western Electric Company, Inc., 161-6th Ave., New York, N.Y. For mail: 5101 J-39th Ave., Long Island City, L.I., N.Y.

DOLOVITZ, RONALD (A'30), Manager and Chief Engineer, Olympia Radio, Ltd., Bradshawgate, Bolton, England.

DOLPH, STANLEY E. (A'15), President and General Manager, Seranton Pump Company, 1445 Meylert Ave., Seranton, Pa. For mail: 732 N. Webster Ave., Seranton, Pa.

DOMÉ, ROBERT B. (A'27), Engineer-in-Charge, South Schenectady Development, Gen-eral Electric Company, Schenectady, N.Y. For mail: 2410 Campbell Ave., Schenectady, N.Y.

DOMIZI, DANTE (A'27), Radio Engineer, Kusdan Radio Corporation, 1743 Strathmore Ave., E., Cleveland, Ohio. For mail: 3097 West Blvd., Cleveland, Ohio.

DONALDSON, ROBERT O. (A'25), Assistant Airway Traffic Supervisor, Airways Division, U. S. Department of Commerce, Municipal Airport, Cleveland, Ohio. For mail: 18000 Larchwood Ave., Cleveland, Ohio.

DONBAR, C. FLOYD (A'27), Chief Engineer, Radio Station KQV, Double-Day Hill Electric Company, 2108 Investment Bldg., Pittsburgh, Pa. For mail: 233 S. Starr Ave., Bellevue, Pa.

DONOHUE, EDWARD F. (A'30), Radiotri-cian, 45 Barnet Ave., Trenton, N.J.

DONOVAN, DANIEL R. (A'26), Vice President, Radio Products Corporation, 543 S. 11th St., Newark, N.J.

DONOVAN, JAMES R. (A'30), Chief Engineer, Radio Station WTOG, P.O. Box 83, Savannah, Ga.

DOOLITTLE, FRANKLIN M. (A'13-M'30), President, The Doolittle Radio Corporation, 11 Asylum St., Hartford, Conn. For mail: 167 Willard St., New Haven, Conn.

DORASWAMY, M. N. (A'29), 454 Viswes-warapwam, Bangalore, India.

DORAZIL, A. F. (A'28), Service Manager, Radio and Refrigeration Department, The Cleveland Ignition Company, 1301 Superior Ave., N.E., Cleveland, Ohio. For mail: 2200 Tampa Ave., Cleveland, Ohio.

DOREMUS, CORNELIUS W. (A'29), Assistant Radio Inspector, Radio Test Shop, Navy Yard, Washington, D.C. For mail: 618 Morris St., N.E., Washington, D.C.

DORN, FERRY P. (A'27), Inventor, 9007 Detroit Ave., Cleveland, Ohio.

DORSEY, HERBERT G. (M'19), Principal Electrical Engineer, U. S. Coast and Geodetic Survey, Washington, D.C.

DORTE, PHILIP N. (A'27), Forestie House, Oatlands Park, Weybridge, Surrey, England.

DOTY, W. E. (A'25), Treasurer, Battle Creek Equipment Company, Battle Creek, Mich. For mail: 928 W. Michigan Ave., Battle Creek, Mich.

DOUGLAS, EARL C. (A'23), 5508 Montrose Ave., Altoona, Pa.

DOUGLAS, JAMES M. (A'27), Proprietor, Peerless Radio Shop, 4433 N. Robey St., Chicago, Ill.

DOUGLASS, EDGAR J. (J'31), Draftsman, Duquesne Light Company, 1241 Reedsdale St., Pittsburgh, Pa. For mail: 5420 Kincaid St., Pittsburgh, Pa.

DOUGLASS, ROBERT H. (A'30), Service Manager, Joseph Horne Company, Penn and Stanwick Sts., Pittsburgh, Pa. For mail: 5420 Kincaid St., Pittsburgh, Pa.

DOUGLASS, WILLIAM A. (A'30), Research Chemist, Jackson Laboratory, Dupont Company, P.O. Box 525, Wilmington, Del. For mail: 28 Ziegler Tract, Penns Grove, N.J.

DOUTHIT, M. L. (A'27), Engineer, RCA Victor Company, Inc., Camden, N.J. For mail: 4647 Roosevelt Ave., Camden, N.J.

DOW, J. B. (M'26), Lieutenant, U. S. Navy, Radio Division, Bureau of Engineering, Navy Department, Washington, D.C.

DOW, JOHN (A'31), 232 Sisgar St., Toronto, Ont., Canada.

- DOW, M. THORNTON** (A'19), Engineer, Department of Development and Research, American Telephone and Telegraph Company, Rm. 426, 195 Broadway, New York, N.Y.
- DOW, ORVILLE E.** (A'31), Design Engineer, R.C.A. Communications, Inc., Rocky Point, L.I., N.Y. For mail: 211 Thompson St., Port Jefferson, L.I., N.Y.
- DOWIE, JAMES A.** (A'20-M'26), Chief Instructor, National Radio Institute, 16th and U Sts., Washington, D.C. For mail: Washington Ave., North Braddock, Alexandria, Va.
- DOWNNEY, C. E.** (A'30), Chief Engineer, Radio Station KFJF, Security Bldg., Oklahoma City, Okla.
- DOWNNEY, W. E.** (M'28), Assistant Chief, Radio Division, U. S. Department of Commerce, Washington, D.C.
- DOWNING, GEORGE E. C.** (A'28), General Manager, Hustler Simpson and Webb, Ltd., 55-57 Tanner St., London, S.E. 1, England. For mail: 44 Highbury Hill, London, N. 8, England.
- DOWNING, RICHARD E.** (A'29), Department of Development and Research, American Telephone and Telegraph Company, 195 Broadway, New York, N.Y.
- DOWNS, WALTER P.** (A'31), The Travancore Apartments, 1620 Cedar Ave., Montreal, P.Q., Canada.
- DOWSETT, HARRY M.** (M'16), Marconi's Wireless Telegraph Company, Ltd., Marconi House, Strand, London, W.C. 2, England. For mail: 47 Drayton Gardens, Winchmore Hill, London, N. 21, England.
- DOYEL, LEE CONAN** (A'28), Radio Service Engineer, Community Radio Service, Crawfordsville, Ind. For mail: General Delivery, Linnburg, Ind.
- DOYLE, E. D.** (A'27), Patent Engineer, Leeds and Northrup Company, 4901 Sienton Ave., Philadelphia, Pa.
- DOYLE, E. J.** (A'29), Engineer, Transformer Corporation of America, 2309 S. Keeler Ave., Chicago, Ill. For mail: 206 Ayres Ave., Hinsdale, Ill.
- DRAIGH, CANTON V.** (A'28), Transmitting Engineer, R.C.A. Communications, Inc., Rocky Point, L.I., N.Y.
- DRAKE, CHESTER E.** (A'31), Chief Engineer, Delta Broadcasting Company, Vicksburg, Miss. For mail: Route No. 1, Jackson, Miss.
- DRAKE, FREDERICK H.** (A'25-M'28), Radio Frequency Laboratories, Boonton, N.J. For mail: 334 Morris Ave., Boonton, N.J.
- DRAKE, GEORGE P.** (J'27-A'29), Marine Radio Operator, Blue Funnel Line, Alfred Holt and Company, Wireless Department, India Bldgs., Water St., Liverpool, England. For mail: "Newlyn," 22 Stainburn Ave., Chapel Allerton, Leeds, York, England.
- DRAKE, ROBERT L.** (A'31), Student, Electrical Engineering, University of Cincinnati, Cincinnati, Ohio. For mail: 469 Warner St., Cincinnati, Ohio.
- DREHER, CARL** (A'17-M'23-F'28), Director of Sound Department, RKO Studios, 780 Gower St., Los Angeles, Calif.
- DREISBACH, ROBERT H.** (A'28), Engineer, United Research Corporation, Long Island City, L.I., N.Y. For mail: 47-37 S. 159th St., Flushing, L.I., N.Y.
- DRESDNER, HAROLD D.** (A'31), Instructor, Public School 66, Watkins St. and Sutter Ave., Brooklyn, N.Y. For mail: 449 Chestnut St., Brooklyn, N.Y.
- DRESSER, CARL C.** (A'27), Assistant Chief Engineer, Dongan Electric Manufacturing Company, 2987 Franklin Ave., Detroit, Mich. For mail: 324 Glidden Ave., Riverside, Ont., Canada.
- DRESSER, O. C.** (A'30), Assistant Radio Engineer, U. S. Naval Research Laboratory, Bellevue, Anacostia, D.C. For mail: Arlington, Va.
- DREW, CHARLES E.** (A'23-M'27), Chief Radio Instructor, Home Study Division, R.C.A. Institutes, Inc., 75 Varick St., New York, N.Y. For mail: 115 Hutchinson Blvd., Scarsdale, N.Y.
- DREWS, ERNEST** (J'26-A'29), 45 Ravine Ave., Jersey City, N.J.
- DREYER, HARRY W.** (M'29), Consulting Engineer, P.O. Box 451, Bristol, Conn.
- DRINKWATER, ERIC W.** (J'31), Salesman, Radio Department, Army and Navy Stores, 105 Victoria St., S.W. 1, London, England. For mail: 185 Trafalgar Rd., East Greenwich, London, S.E. 10, England.
- DROBIG, LEO** (A'26), Automobile Engineer, Transport Motor Company, Sprague and Madison Aves., Spokane, Wash. For mail: 1408 W. Alice Ave., Spokane, Wash.
- DRUMHEISER, ANDREW W.** (A'31), Chief Control Operator, Radio Station WHIP, 418 Telegraph Bldg., Harrisburg, Pa. For mail: 1616 N. 5th St., Harrisburg, Pa.
- DRURY, PAUL O.** (A'27), Foreman, Quality Division, Engineering Department, RCA Victor Company, Inc., Camden, N.J. For mail: 3900 Cathedral Ave., Washington, D.C.
- DRYLAND, ALAN G.** (M'29), Assistant Engineer-in-Charge, British Broadcasting Corporation, Savoy Hill, London, England. For mail: Windycot-Sugden Rd., Long Ditton, Surrey, England.
- DUBILIER, WILLIAM** (A'14-M'18-F'29), Executive and Consulting Engineer, 10 E. 40th St., New York, N.Y.
- DU BUCLET, SIDONIO L.** (A'27), General Manager, Radio Division, Radio Television and Finance Corporation, 540 N. Michigan Ave., Chicago, Ill. For mail: 3722 Concord Pl., Chicago, Ill.
- DUCATI, ADRIANO C.** (A'28), Technical Director, Societa Scientifica Radio, 51 Secondo, Guidotti, Bologna, Italy. For mail: 51 Viale Guidotti, Bologna, Italy.
- DUDLEY, BEVERLY** (J'24-A'27), Assistant Secretary, Institute of Radio Engineers, 33 W. 39th St., New York, N.Y. For mail: 4739 N. Central Park Ave., Chicago, Ill.
- DUDLEY, CHARLES B., JR.** (A'29), Radio Service Engineer, Sparks-Withington Company, Jackson, Mich. For mail: 1413 John St., Baltimore, Md.
- DUGAN, PAUL F.** (A'31), Lieutenant, Radio Officer, U. S. Navy, U.S.S. California, San Pedro, Calif.
- DUGGAN, JOHN** (A'31), Shop Service, Atlas Stores, Inc., 526 W. 25th St., New York, N.Y. For mail: 97 W. Orchard St., City Island, New York, N.Y.
- DU MARCE, HERMAN** (A'29), Morse Cable and Radio Operator, Washington Alaska Military Cable and Telegraph System, Headquarters, 3113 Arcade Bldg., Seattle, Wash.

- DUMMETT, H. W.** (A'28), Experimental Radio Engineer, 632 Kings Highway, Brooklyn, N.Y. For mail: 2520 Quentin Rd., Brooklyn, N.Y.
- DU MONT, ALLEN B.** (M'30-F'31), Consulting Engineer, 9 Bradford Way, Upper Montclair, N.J.
- DUNBAR, JAMES** (A'24), Manager, Regal Radio, 45 Long St., Capetown, South Africa. For mail: 29 Springbook Rd., Green Point, Capetown, South Africa.
- DUNCAN, DON C.** (A'29), Transmission Engineer, Illinois Bell Telephone Company, 300 W. Adams St., Chicago, Ill. For mail: 1418 Touhy Ave., Chicago, Ill.
- DUNCAN, JAMES E.** (A'26), 8520-104th St., Edmonton, S. Alta., Canada.
- DUNCAN, R. D., JR.** (A'13-M'25), Chief Engineer, Wired Radio, Inc., 60 Broadway, New York, N.Y. For mail: 250 Harrison St., East Orange, N.J.
- DUNCAN, RUDOLPH L.** (A'22-M'26), President, Radio Training Schools, Inc., 326 Broadway, New York, N.Y.
- DUNHAM, JOHN S.** (A'26), President, QRV Radio Service, Inc., 155 W. 72nd St., New York, N.Y.
- DUNLAP, ORRIN E., JR.** (M'25), Radio Editor, *New York Times*, 229 W. 43rd St., New York, N.Y.
- DUNN, EARL C.** (A'30), Technician, Carter Sales Company, Corpus Christi, Tex. For mail: Route No. 2, Box 304, Corpus Christi, Tex.
- DUNN, GANO** (F'15), President, The J. G. White Engineering Corporation, 43 Exchange Pl., New York, N.Y.
- DUNN, JAMES C.** (A'28), Draftsman, George W. Smith Woodworking Company, 1651 S. 51st St., Philadelphia, Pa. For mail: 5307 N. 13th St., Philadelphia, Pa.
- DUNN, LAWRENCE J.** (A'24-M'26), Dentist, 80 Hanson Pl., Brooklyn, N.Y.
- DUNNIGAN, FRANK A.** (A'29), Proprietor and Manager, United Radio Service, 813 W. 2nd Ave., Spokane, Wash. For mail: 103 E. 29th Ave., Spokane, Wash.
- DUNNING, JOHN R.** (A'28), Instructor, Department of Physics, Columbia University, New York, N.Y.
- DUNPHY, THOMAS O.** (A'27), Operator, Sea Going Staff, British Wireless Marine Service, Marconi House, Strand, London, England. For mail: 21 Shortcourse, Waterford City, Irish Free State.
- DUNSTAN, A. S.** (A'30), Radio Service Engineer, The Gramophone Company, Hayes, Middlesex, England. For mail: The Governor's House, Royal Victoria Infirmary, Newcastle-on-Tyne, England.
- DUPREE, E. M.** (A'22-M'28), President, Star Electric and Engineering Company, 613 Fannin St., Houston, Tex. For mail: 1702 Main Street, Houston, Tex.
- DUPUIS, ERNEST F.** (J'29), Assistant Shipping Clerk, Allen A. Smith Company, 1216 W. Bancroft St., Toledo, Ohio. For mail: 1357 Elmwood Ave., Toledo, Ohio.
- DURAN, ALBERT E.** (A'29), Chief Engineer, Station WAPL, Protective Life Bldg., Birmingham, Ala. For mail: 901 S. 38th St., Birmingham, Ala.
- DURHAM, J. B.** (A'30), Chief of Inspection Section, Western Electric Company, Inc., Hawthorne Station, Chicago, Ill. For mail: 3104 S. Euclid Ave., Berwyn, Ill.
- DURKEE, K. M.** (A'29), Radio Test Department, General Electric Company, 1 River Rd., Schenectady, N.Y. For mail: 1176 Wendell Ave., Schenectady, N.Y.
- DURKEE, LINCOLN** (A'31), Engineer, American Telephone and Telegraph Company, Rm. 2012, 195 Broadway, New York, N.Y.
- DU TREIL, L. J. N.** (A'14-M'26), Radio Inspector, U. S. Department of Commerce, New Orleans, La. For mail: 480 Audubon St., New Orleans, La.
- DUTERA, W. S.** (J'25-A'29), Plant Operation and Engineering Department, National Broadcasting Company, Inc., 711-5th Ave., New York, N.Y. For mail: 4015-48th St., Long Island City, L.I., N.Y.
- DUTTON, CHARLES E.** (A'27), District Plant Manager, American Telephone and Telegraph Company, Rm. 222, 15 W. New York St., Indianapolis, Ind.
- DUTTON, GEORGE I.** (A'28), 3523 Fremont St., Wesleysville, Pa.
- DUTTON, GLENN H.** (A'31), President, Dutton Radio Institute, DePaul University Bldg., 64 E. Lake St., Chicago, Ill.
- DUTTON, LAURENCE E.** (A'30), Radio Engineer, Radio Station WIOD, Isle of Dreams Broadcasting Company, Collins Island, Miami Beach, Fla. For mail: P. O. Box 102, Miami Beach, Fla.
- DUTTON, WATSON P.** (A'31), 210 E. Pine St., Audubon, N.J.
- DU VALL, CHARLES** (A'30), Radio Operator, Mackay Radio and Telegraph Company, San Francisco, Calif. For mail: 806 Marco Pl., Venice, Calif.
- DU VALL, FRANK B.** (A'31), Research Engineer, Jenkins Television Corporation, Passaic, N.J. For mail: 15 Alden Pl., Maplewood, N.J.
- DWYER, ROBERT J.** (A'28), Student, University of Cincinnati, Cincinnati, Ohio. For mail: 2210 Madison Ave., Norwood, Ohio.
- DWYER, VINCENT J.** (A'29), Colonial Radio Corporation, 634 Lexington Ave., Rochester, N.Y. For mail: 74 Orchard St., Rochester, N.Y.
- DYER, JOHN NEWTON** (J'30), 30 Columbus Ave., Haverhill, Mass.
- DYMOND, CLIFTON** (A'30), 1414 Pratt Blvd., Chicago, Ill.
- DYNES, CLARENCE W.** (J'31), Technician, Sonora Corporation, 345 Adelaide St., Toronto, Ont., Canada. For mail: 312 Strathmore Blvd., Toronto 6, Ont., Canada.
- DYSON, H. R.** (A'26), Radio Transmitter Engineer, RCA Victor Company, Inc., Camden, N.J. For mail: 111 E. Park Ave., Oaklyn, Audubon, N.J.

E

- EARLE, ROY D.** (J'30), 614 N. Bright Ave., Whittier, Calif.
- EARLE, RALPH P.** (A'25), Teacher, Overbrook High School, Philadelphia, Pa. For mail: Aldan, Delaware County, Pa.
- EARNHART, GLEN W.** (A'26-M'30), U. S. Assistant Radio Inspector, Radio Division, U. S. Department of Commerce, 538 Custom House, Denver, Colo.
- EARNSHAW, DAVID P.** (A'28), Radio Engineer, Philadelphia Storage Battery Company, Ontario and C Sts., Philadelphia, Pa.

- For mail: 252 Rochele Ave., Philadelphia, Pa.
- EAST, LAWRENCE A. W.** (A'25), Radio Engineer, Canadian Pacific Railway Telegraphs, 204 Hospital St., Montreal, P.Q., Canada.
- EASTHAM, MELVILLE** (A'13-M'13-F'25), President, General Radio Company, 30 State St., Cambridge, Mass.
- EASTMAN, AUSTIN V.** (A'23), Assistant Professor of Electrical Engineering, University of Washington, Seattle, Wash.
- EASTON, J. H.** (A'29), CRM, U. S. Navy, U.S.S. Dobbin, c/o Postmaster, New York, N.Y.
- EATON, GEORGE W., JR.** (A'27), 316 Wiota St., West Philadelphia, Pa.
- EATON, W. G.** (M'30), Associate Radio Engineer, Radio Laboratory, Wright Field, Dayton, Ohio.
- EBERHARD, LAWRENCE E.** (A'25), Staff Manager, New York Credit Men's Adjustment Bureau, 470-4th Ave., New York, N.Y. For mail: 78 Smull Ave., Caldwell, N.J.
- EBERHARDT, GEORGE M.** (A'26), Member of Technical Staff, Bell Telephone Laboratories, Inc., P.O. Box 122, Deal, N.J.
- EBERLE, WILBERT H.** (A'26), Secretary, Hickok Electrical Instrument Company, 10514 Dupont Ave., Cleveland, Ohio. For mail: 1410 E. 110th St., Cleveland, Ohio.
- EBY, HUGH H.** (A'26), President, H. H. Eby Manufacturing Company, 22nd St. and Lehigh Ave., Philadelphia, Pa.
- EBY, JOHN B.** (A'27), Electrical Engineer, American Telephone and Telegraph Company, 534 Bourse Bldg., Philadelphia, Pa. For mail: 1218 Overington St., Philadelphia, Pa.
- ECKELS, AUGUST E.** (A'31), Engineer, Radio Station WCBM, Keith's Theater Bldg., Lexington and Park Ave., Baltimore Md. For mail: 2810 Ailsa Ave., Baltimore, Md.
- ECKERSLEY, P. P.** (F'25), c/o Dubilier Condenser Company, Victoria Rd., North Acton, W. 3, England.
- ECKERT, BRYON H.** (A'28), Radio Sales and Service, Bee Automobile Company, 618-20-22 Linden St., Allentown, Pa. For mail: 333 N. 10th St., Allentown, Pa.
- ECKERT, CLARENCE C.** (A'30), Engineer, General Motors Radio Corporation, Dayton, Ohio. For mail: 531 Kenwood Ave., Dayton, Ohio.
- ECKERT, EDWARD J.** (A'26), Radio Salesman, H. C. Roberts Electric Supply Company, 1101-05 Race St., Philadelphia, Pa. For mail: 4606 A St., Philadelphia, Pa.
- ECKSTROM, HERBERT E.** (A'31), Radio Service Manager, Radio Department, Rumbaugh's Radio Shop, 2822 Wetmore, Everett, Wash. For mail: 2015 State St., Everett, Wash.
- EDE, FRANK C.** (A'28), Director, Leede Electrical Laboratory, 395 Bubbling Well Rd., Shanghai, China. For mail: P.O. Box 1284, Shanghai, China.
- EDELMAN, PHILLIP E.** (A'14), 10559 S. Wood St., Chicago, Ill.
- EDES, NOEL H.** (A'22), Captain, c/o Royal Canadian Signals, Camp Borden, Ont., Canada.
- EDGAR, J. CLIFTON** (A'27), New York Telephone Company, 140 West St., New York, N.Y. For mail: 1331 E. 2nd St., Long Beach, Calif.
- EDGCOMB, A. J.** (A'27), Proprietor, The Wireless Shop, 150 Glendale Blvd., Los Angeles, Calif.
- EDGERLY, ALBERT HENRY** (A'29), Radio Serviceman, Edgerly's Radio Service Company, Kensington, Conn.
- EDGEWORTH, KENNETH E.** (A'27), Lieutenant Colonel, Cherbury, Booterstown, County Dublin, Ireland.
- EDISON, THEODORE M.** (A'28), Research Director, Edison Laboratories, Orange, N.J. For mail: 106 N. Walnut St., East Orange, N.J.
- EDWARDS, CHARLES** (A'29), Research, Frequency Transmission Lines, Charles Edwards Company, 2128 Point St., Chicago, Ill.
- EDWARDS, CHARLES P.** (M'13-F'15), Director of Radio, Canadian Marine Department, Ottawa, Ont., Canada.
- EDWARDS, GEORGE W.** (J'27-A'30), 117 Franklin Ave., River Forest, Ill.
- EDWARDS, HENRY W.** (A'25), Aircraft Radio Technician, Northwest Airways, Inc., St. Paul, Minn. For mail: 3930 Pillsbury Ave., Minneapolis, Minn.
- EDWARDS, JOSEPH B.** (A'14), Electrical Engineer, Western Electrical Instrument Corporation, 4 Weston Ave., Newark, N.J. For mail: 2213 Berwyn St., Union, N.J.
- EDWARDS, LYMAN M.** (A'28), National President, Alpha Sigma Delta, Radio Fraternity, University of Oklahoma, 702 Lahoma St., Norman, Okla. For mail: 515 S. Lincoln St., Enid, Okla.
- EDWARDS, R. M.** (J'28-A'30), Wireless Engineers' Assistant, British Broadcasting Corporation, 1 Lochee Rd., Dundee, Scotland. For mail: c/o Mrs. Baxter, 22 Nelson St., Dundee, Scotland.
- EDWARDS, ROBERT B.** (A'31), Member, Technical Staff, Bell Telephone Laboratories, Inc., Rm. K-48, 463 West St., New York, N.Y.
- EDWARDS, SAMUEL W.** (M'28), Supervisor, Development and Production Department, U. S. Department of Commerce, Frequency Monitoring Station, P.O. Box 788, Grand Island, Neb.
- EELLS, M. MERWIN** (A'22), Communications Engineer, National Air Transport, Inc., 5936 S. Cicero Ave., Chicago, Ill. For mail: 6028 Dorchester Ave., Chicago, Ill.
- EGERT, SAMUEL S.** (A'30), Secretary-Treasurer, Wireless Egert Engineering, Inc., 179 Varick St., New York, N.Y.
- EGGERS, EARL L.** (A'30), Radio Engineer, Grant City Park Corporation, Grant City, Mo. For mail: Box 83-D, Grant City, Mo.
- EHLERS, PAUL** (A'23), Vice President, Gwen Manufacturing Company, 102 S. Brady St., Davenport, Iowa. For mail: 619 Gaines St., Davenport, Iowa.
- EHLERT, FRED C.** (A'26), Technical Radio Editor, *The Sun*, 280 Broadway, New York, N.Y. For mail: 186-12 Jordan Ave., St. Albans, L.I., N.Y.
- EHRET, CORNELIUS D.** (F'16), Patent Attorney, 2121 Land Title Bldg., Philadelphia, Pa. For mail: 6911 Clearview St., Mount Airy, Philadelphia, Pa.
- EHRET, KENNETH M.** (A'30), Accountant, Oklahoma City, Okla. For mail: 2904 N. Robinson St., Oklahoma City, Okla.
- EHRlich, KARL** (A'30), Constructor, Rathausplatz 9, Vienna, Austria. For mail: Wahringerstrasse, 123, Vienna, 18, Austria

- EILER, DONALD L.** (A'31), Service Manager, Bieh's, Inc., 500 S. Center St., Pottsville, Pa. For mail: 336 Dock St., Schuylkill Haven, Pa.
- EILER, E. E.** (M'24), Captain, U. S. Marine Corps, Washington, D.C. For mail: 854 Hartzell St., Pacific Palisades, Calif.
- EILERS, JOHN** (J'27), 115 N. Adams St., Glendale, Calif.
- EISELEIN, J. E.** (A'30), Superintendent, Underground Construction, Terrell Electric Company, 715 Cherry St., Chattanooga, Tenn. For mail: 3317 Windsor Ct., Chattanooga, Tenn.
- EISENHAUSER, HARRY D.** (A'29), Manager and Radio Engineer, Scientific Radio Service, 124 Jackson Ave., University Park, Hyattsville, Md.
- EKLUND, GUS** (A'28), G. A. Eklund Radio Service, 9712-135th Ave., Ozone Park, L.I., N.Y.
- EKSTRAND, EDWARD B.** (J'27-A'30), Consulting Engineer, 47 Hancock St., West Somerville, Mass.
- EKSTROM, EMMETT J.** (A'31), Exhauster, Power Tube Department, De Forest Radio Company, Passaic, N.J. For mail: 151 1/2 Howe Ave., Passaic, N.J.
- ELAM, DAVID L.** (A'25), President and Chief Engineer, Unique Radio Corporation, 1411 Grace St., Chicago, Ill. For mail: 714 Grace St., Chicago, Ill.
- ELDRIDGE, EARLE E.** (A'31), Radio Engineer, Press Wireless, Inc., Hicksville, L.I., N.Y. For mail: Donald Apartments, Westbury, L.I., N.Y.
- ELDRIDGE, FRANK E.** (M'25), Manager, Radio Products, Westinghouse Electric and Manufacturing Company, Chicopee Falls, Mass.
- ELDRIDGE, FREDERICK B.** (A'30), 2103 Plum St., Schenectady, N.Y.
- ELDRIDGE, H. W.** (A'31), Assistant Engineer, New York Telephone Company, Rm. 1485, 140 West St., New York, N.Y.
- ELLER, KEITH B.** (A'29), Engineer, Western Union Telegraph Company, 60 Hudson St., New York, N.Y.
- ELLER, WALTER H.** (M'25), Professor of Physics, State Teachers College, Macomb, Ill. For mail: 308 Sherman Ave., Macomb, Ill.
- ELLER, WILLARD H.** (A'19), Instructor in Physics, University of Hawaii, Honolulu, Hawaii.
- ELLERT, CHARLES A.** (A'26), U. S. Radio Inspector, Radio Division, U. S. Department of Commerce, Fort McHenry, Baltimore, Md.
- ELLINGER, ALBERT E.** (A'31), Proprietor, Ellinger's Service, 92 Washington Highway, Snyder, N.Y.
- ELLINGHAM, IRVING** (A'28), Research Engineer, Empire News Company, 224 E. 34th St., New York, N.Y. For mail: 1647 E. 45th St., Brooklyn, N.Y.
- ELLINTHORPE, J. W.** (A'30), Inspector, Fire and Police Telegraphs, 174 Rupert St., Winnipeg, Manit., Canada. For mail: 520 Jubilee Ave., Winnipeg, Manit., Canada.
- ELLINWOOD, CARL W.** (A'30), Engineering Department, RCA Victor Company, Inc., Camden, N.J. For mail: 1933 Hillcrest Ave., Merchantville, N.J.
- ELLINWOOD, KENNETH M.** (J'29-A'30), Student, Drexel Institute, Philadelphia, Pa. For mail: Thouron Ave. and Gorgas Lane, Mount Airy, Philadelphia, Pa.
- ELLIOT, PHILIP T.** (A'30), Investigating Engineer, Western Electric Company, Inc., Chicago, Ill. For mail: 6 S. Mason Ave., Chicago, Ill.
- ELLIOTT, FRANK E.** (A'28), Wireless Engineer, Station 6WF, The Westralian Farmers, Ltd., Perth, West Australia. For mail: 36 Fairfield St., Mount Hawthorn, Perth, West Australia.
- ELLIOTT, FRANK W.** (A'27), Manager, Radio Station WOC, Davenport, Iowa.
- ELLIOTT, H. F.** (M'25), Consulting Engineer, 1320 Webster St., Palo Alto, Calif.
- ELLIOTT, ISAAC** (A'28), Radio Engineer, The Elliott Radio Manufacturing Company, Ltd., 87 Senhouse St., Maryport, Cumberland, England.
- ELLIOTT, RALPH W.** (A'27), Office Technician, Prairie Pipe Line Company, Box 460, Rm. M, Independence, Kan.
- ELLIOTT, WILLIAM H.** (A'29), Sawyer, Pickering Lumber Company, Tuolumne, Calif. For mail: Box 134, Tuolumne, Calif.
- ELLIS, GEORGE D.** (A'25), Sound Recorder, RKO Studios, Inc., 780 Gower St., Hollywood, Calif. For mail: 2050 Watson St., Glendale, Calif.
- ELLIS, ROBERT MARCUS** (A'29), Service Manager, Silver-Marshall, Inc., 6401 W. 65th St., Chicago, Ill. For mail: 6148 S. Meade, Chicago, Ill.
- ELLIS, W. C.** (A'30), Radio Operator, Baker Studios, Radio Station WFAA, Dallas, Tex.
- ELLIS, WILLIAM G.** (A'19-M'25), District Sales Manager, Ohio Electric Manufacturing Company, 15 Atlantic Bldg., Philadelphia, Pa.
- ELLSWORTH, WILLIAM C.** (A'26), Radio Engineer, Westinghouse Electric and Manufacturing Company, Chicopee Falls, Mass. For mail: 70 Pine St., Chicopee Falls, Mass.
- ELMQUIST, TORSTEN** (A'29), AFG Radio Department, Stockholm, Sweden. For mail: Baltzar u. Platensquatan, Stockholm, Sweden.
- ELSER, F. JOHNSON** (A'28), Student, Stanford University, Palo Alto, Calif. For mail: c/o Fred W. Mitchell, Carlsbad, Calif.
- ELWELL, CYRIL F.** (M'14-F'18), Technical Adviser, British Talking Pictures, Ltd., 197 Queens Gate, London, S.W. 7, England.
- EMANUEL, JOHN H.** (A'17), 181 Linden Ave., Englewood, N.J.
- EMBRECHTS, A. C.** (A'30), Radio Engineer, Sales Division, Bell Telephone Manufacturing Company, 18 Rue Boudewyns, Antwerp, Belgium.
- EMERSON, CHARLES W., JR.** (A'24), Assistant Engineer, New York Telephone Company, 140 West St., New York, N.Y. For mail: 148 Hamilton Ave., Grant City, S.I., N.Y.
- EMERSON, KENNETH H.** (A'29), Engineering Department, U. S. Radio and Television Corporation, Marion, Ind.
- EMERSON, R. WALDO** (A'28), Radio Engineer, 3 St. Ann's Ter., St. John's Wood, London, N.W. 8, England.
- EMERY, E. J.** (M'29), Service Manager, Marconiphone Company, Ltd., 210-212 Tottenham Ct. Rd., London, W. 1, England.

EMERY, RALPH C. (A'14), Treasurer, Emery Insurance Agency, Boston, Mass. For mail: 126 State St., Boston, Mass.

EMES, KARL C. (A'27), Testing and Inspecting Department, DeForest Radio Corporation, 245 Carlaw Ave., Toronto, Ont., Canada. For mail: 104 Kenilworth Ave., Toronto, Ont., Canada.

ENDERLE, JACKSON J. (A'29), 19 Pine St., Woodsville, N.H.

ENDERS, CHARLES F. (A'26), Radio Engineer, University Radio Company, 80 W. Kingsbridge Rd., New York, N.Y. For mail: 37 Hildreth Pl., Yonkers, N.Y.

ENDO, K. (A'30), Electrical Engineer, Japan Wireless Telegraph Company, Jiji Bldg., Marunouchi, Japan.

ENGEL, FRANCIS H. (A'25-M'28), Radio Engineer, Hygrade Lamp Company, Salem, Mass. For mail: 21 Thorndike St., Beverly, Mass.

ENGEL, G. C. (A'28), 589 Upper Blvd., Ridgewood, N.J.

ENGEN, RALPH E. (A'27), Manager, Radio Service, Glendale Music Company, Glendale, Calif. For mail: 1712 Woodland Lane, Glendale, Calif.

ENGHOLM, BERNARD A. (A'22-M'27), Vice President, The Rola Company, 2570 E. Superior Ave., Cleveland, Ohio.

ENGLUND, CARL R. (A'17-F'28), Member of Technical Staff, Bell Telephone Laboratories, Inc., P.O. Box 97, Red Bank, N.J. For mail: 54 Court St., Freehold, N.J.

ENGST, NORBERT K. (A'13), Engineer, Inspection Development Department, Western Electric Company, Inc., Hawthorne Works, Chicago, Ill. For mail: 741 Woodlawn Ave., La Grange, Ill.

ENGSTROM, ELMER W. (A'25), Engineer, RCA Victor Company, Inc., Camden, N.J.

ENGWICHT, HARRY (J'22-A'26), Graduate Student, Stanford University, Stanford, Calif. For mail: 405 N. 3rd St., San Jose, Calif.

ENNIS, FRED E. (A'26), Serviceman, 37 Maltbie Ave., Suffern, N.Y.

ENNIS, JOEL B., JR. (A'30), Radio Operator, S.S. Edward Pierce, Tad Jones and Company, New Haven, Conn. For mail: R.F.D. No. 1, Johnstown, N.Y.

ENON, ERNEST R. (A'30), P.O. Box 895, Bombay, India.

EOYANG, THOMAS T. (A'30), Student Engineer, International Telephone and Telegraph Corporation, 67 Broad St., New York, N.Y. For mail: International House, 500 Riverside Dr., New York, N.Y.

EPPSTEIN, RALPH M. (A'29), 4849 N. Lawndale Ave., Chicago, Ill.

ERDMAN, H. (A'29), Manager, Wireless Manufacturers, Hogarth Works, Chiswick, London, England. For mail: 42 Fairhazel Gardens, Hampstead, London, N.W. 6, England.

ERHARD, JOHN A. (A'27), Service Station Manager, QRV Radio Service, Inc., 140 Halsey St., Newark, N.J. For mail: 251 Palisades Ave., Union City, N.J.

ERNST, MURRAY C. (A'29), Transmitting Station, American Telephone and Telegraph Company, Lawrenceville, N.J.

ERSTAD, JOHANNES (A'30), Engineer, Tung-Sol Radio Tubes, Inc., Newark, N.J. For mail: 161 W. 10th St., New York, N.Y.

ERWIN, RAYMOND W. (A'22), Superintendent, Canadian National Carbon Company Ltd., 805 Davenport Rd., Toronto 4, Ont., Canada.

ERWOOD, JOHN (A'30), Engineer, Webster Company, 850 Blackhawk St., Chicago, Ill. For mail: 1849 Lunt Ave., Chicago, Ill.

ESCOLANO, MANUEL (M'19), General Manager, Compani Telmar, Jimenez de Quesada 2, Madrid, Spain.

ESCRICH, JAMES P. (A'14), Avenida Isabel la Catolica, No. 41, Aguascalientes-Agtes, Mexico.

ESKUCHEN, FRANK G. (A'30), Radio Engineer, RCA Victor Company, Inc., Camden, N.J. For mail: 3424 N. Dillman St., Philadelphia, Pa.

ESMAKER, JOHN B. (A'27), Instructor in Physics, St. Ignatius High School, Chicago, Ill. For mail: 1076 Roosevelt Rd., Chicago, Ill.

ESPENSCHIED, LLOYD (M'13-F'24), Electrical Engineer, American Telephone and Telegraph Company, 195 Broadway, New York, N.Y.

ESSARY, WILLIAM M. (A'29), Radiotrician, Box 541, Corinth, Miss.

ESTEN, PERRY W. (A'29), Radio Operator, Radio Station WABC, Wayne, N.J. For mail: 64 Grafton St., Rochester, N.Y.

ESTEP, CARL R. (J'31), Student, Los Angeles Polytechnic High School, Los Angeles, Calif. For mail: 5114 Hillcrest Dr., Los Angeles, Calif.

ESTES, FRED B. (A'31), Radio Operator, Los Angeles Steam Ship Company S.S. Helen Whittier, Los Angeles, Calif. For mail: 4751-12th Ave., N.E., Seattle, Wash.

ESTEY, F. CLIFFORD (A'21), Sales Engineer, Illinois Zinc Company, 332 S. Michigan Ave., Chicago, Ill.

ETHEREDGE, GEORGE W., JR. (A'30), Chief Radio Operator, Radio Station WSPA, Montgomery Bldg., Spartanburg, S.C. For mail: P.O. Box 91, Spartanburg, S.C.

ETKIN, HARRY (A'25), Quality Control Department, RCA Victor Company, Inc., Camden, N.J. For mail: 520 McClellan St., Philadelphia, Pa.

EUBANK, ROBERT N. (A'30), Chief Operator, Radio Station WRVA, 22nd and Main Sts., Richmond, Va. For mail: 2817 Montrose Ave., Richmond, Va.

EVANS, ALFRED (A'29), Radio Engineer, 22-24 Station Rd., Wigan, Lancashire, England. For mail: 4 Springfield St., Wigan, Lancashire, England.

EVANS, CARL B. (J'30), Student, University of New Hampshire, Durham, N.H. For mail: 80 N. State St., Concord, N.H.

EVANS, EDWARD H. (A'30), Engineer, Marconi Wireless Telegraph Company, Ltd., Marconi Works, Chelmsford, Essex, England. For mail: 47 Vicarage Rd., Chelmsford, Essex, England.

EVANS, GEORGE L. (A'28), Service Manager, The Robert Simpson Company, Ltd., Toronto, Ont., Canada. For mail: 581 Huron St., Toronto 5, Ont., Canada.

EVANS, HARRY R. (A'27), Proprietor, Evans Radio Service, Albion, Ind. For mail: 315 N. York St., Albion, Ind.

EVANS, JAMES C. (A'25), Director, Trade and Technical Education, West Virginia State College, Institute, W.Va.

EVANS, NICHOLAS O. (A'30), Radio Service Manager, Frank H. Clay Company, 322 N. Rose St., Kalamazoo, Mich. For mail: 1132 Mason St., Kalamazoo, Mich.

EVANS, PORTER H. (M'23-F'31), Chief Engineer, Eastern Studios of Vitaphone Corporation, 1277 E. 14th St., Brooklyn, N.Y.

EVANS, RICHARD C. (A'31), Engineer, International Radio Corporation, Ann Arbor, Mich. For mail: 3458 Wager Ave., Detroit, Mich.

EVANS, WALTER C. (M'28), Radio Operations Department, Westinghouse Electric and Manufacturing Company, East Pittsburgh, Pa.

EVANS, YOUNG W. P. (A'23-M'25), Engineer and Manager, Radio Communication Company, 66 Oxford Rd., Manchester, England. For mail: 2 Parkside Rd., Princess Rd., Manchester, England.

EVE, HARRY (A'30), Northern Electric Company, Ltd., 637 Craig St., Montreal, P.Q., Canada.

EVELETH, LAURENCE NELSON (A'29), Electrical Engineering Draftsman, New York Department of Agriculture, Albany, N.Y. For mail: 89 Robinson St., Schenectady, N.Y.

EVEREST, AUGUSTINE R. (A'15), Consulting Engineer, British Thomson-Houston Company, Ltd., Rugby, England.

EVERETT, LIONEL E. B. (M'27), Director, Bognor Regis Redifusion Service, Ltd., Longford Rd., Bognor Regis, Sussex, England. For mail: Old Point Cottage, Middleton, Bognor Regis, Sussex, England.

EVERETT, LYNN C. (A'14-M'18), Estimating Engineer, Radio Corporation of America, 66 Broad St., New York, N.Y.

EVERITT, WILLIAM L. (A'25-M'29), Associate Professor, Department of Electrical Engineering, Ohio State University, Columbus, Ohio.

EVERT, W. E. (A'27), Receiver Service Manager, Main St., Lodi, Wis. For mail: 221 Parr St., Lodi, Wis.

EWALD, FRED J., JR. (A'28), Engineer, Edison General Electric Appliance Company, 5600 Taylor St., Chicago, Ill. For mail: 1029 Desplaines Ave., Forest Park, Ill.

F

FACEY, JOHN W. (A'13), Synod House, 110th St. and Amsterdam Ave., New York, N.Y.

FAGER, BRADFORD M. (A'31), Radio Interference Investigator, Pennsylvania Power and Light Company, Harrisburg, Pa. For mail: 321 Reno St., New Cumberland, Pa.

FAHNESTOCK, HARRIS, JR. (A'27), Student, Harvard University, Cambridge, Mass. For mail: 162 Coolidge Hill, Cambridge, Mass.

FAIN, EDGAR A. (A'27), Seismologist, Geophysical Service, Inc., Dallas, Tex. For mail: P.O. Box 584, Dallas, Tex.

FAIRCHILD, F. EARLE (A'21), Electrical Engineer, Department of Development and Research, American Telephone and Telegraph Company, 195 Broadway, New York, N.Y. For mail: 30 Mountain Ave., Summit, N.J.

FALCONI, LOUIS (A'31), Proprietor, Falconi Electric Service, Box 21, Roswell, N.M.

FALING, CECIL L. (A'30), Railroad Conductor, New York, Ontario, and Western Railway, 114 Madison Ave., Childs, Pa.

FALKNER, FRANK B. (A'20-M'28), Consulting Engineer, Doolittle and Falkner, Inc., 1306-08 W. 74th St., Chicago, Ill. For mail: 8028 Vernon Ave., Chicago, Ill.

FALLAIN, FRANK D. (A'26), Engineer and Proprietor, Radio Station WFDF, Union Industrial Bldg., Flint, Mich.

FARMER, ERIC W. (A'30), Electrical Engineer, Canadian Marconi Company, Trenton Canora Rds., Town of Mount Royal, P.Q., Canada. For mail: 35 Beverly Ave., Town of Mount Royal, P.Q., Canada.

FARNHAM, RALPH E. (A'27), Electrical Engineer, General Electric Company, Nela Park, Cleveland, Ohio. For mail: 1064 Greyton Rd., Cleveland Heights, Ohio.

FARNSWORTH, DANIEL W. (A'29), Member of Technical Staff, Bell Telephone Laboratories, Inc., 463 West St., New York, N.Y. For mail: Clove Rd., R.F.D., Little Falls, N.J.

FARNSWORTH, PHILO T. (A'28), Director of Research, Television Laboratories, Inc., 202 Green St., San Francisco, Calif.

FARNUM, WILLIS H. (A'29), Radio Operator and Dispatcher, Western Air Express, Municipal Field, Salt Lake City, Utah. For mail: P.O. Box 894, Salt Lake City, Utah.

FARRAN, DEAN (A'17), Pilot, Century Pacific Lines, Ltd., Grand Central Air Terminal, Glendale, Calif. For mail: 2123 Holmby Ave., Los Angeles, Calif.

FARRAND, C. L. (A'14-M'23-F'31), President, United Research Corporation, 41-39 Van Pelt St., Long Island City, L.I., N.Y. For mail: c/o Warner Brothers Pictures, Inc., 321 W. 44th St., New York, N.Y.

FARRELL, JOHN J. (A'30), Radio Engineer, General Electric Company, 1 River Rd., Schenectady, N.Y. For mail: 1102 Baker Ave., Schenectady, N.Y.

FARRINGTON, JOHN F. (A'19-M'29-F'31), Consulting Engineer, 4360-170th St., Flushing, L.I., N.Y.

FASS, SYDNEY J. (A'26), Partner, Zemanisky and Fass, c/o Radio Department, The White House, San Francisco, Calif.

FASSBENDER, HEINRICH (F'30), Professor, Berlin Radio Institute, Berlin, Germany. For mail: Deutsche Versuchsanstalt für Luftfahrt E.V., Berlin, Germany.

FAST, JOHN E. (A'27), President, John E. Fast and Company, Chicago, Ill. For mail: 3123 N. Crawford Ave., Chicago, Ill.

FAUHL, WILLIAM B. (A'31), Plumber's Apprentice, Graham's Plumbing Shop, Bessemer, Mich. For mail: P.O. Box 802, Bessemer, Mich.

FAULKNER, DOUGLAS (A'29), Physicist, General Motors Research Laboratory, 2nd St. at Milwaukee Ave., Detroit, Mich. For mail: 806 Lathrop Ave., Detroit, Mich.

FAULKNER, HARRY (M'24), Executive Engineer, Radio Section, Engineer-in-Chief's Office, G.P.O., Alder House, Aldergate St., London, E.C. 1, England.

FAUSETT, FLOYD (A'30), Chief Engineer, Supreme Instruments Corporation, Greenwood, Miss. For mail: 808 W. Henry St., Greenwood, Miss.

FAY, CLIFFORD E. (A'26), Engineer, Bell Telephone Laboratories, Inc., 463 West St., New York, N.Y.

FAY, LEWIS C. (A'29), Student, Battle Creek College, Battle Creek, Mich. For mail: 245 Capital Ave., S.W., Battle Creek, Mich.

FAYERS, ALFRED A. (A'31), Engineer, Gramophone Company Ltd., Hayes, Middlesex, England. For mail: 34 Hogarth Gardens, Heston, Middlesex, England.

FEARING, JUSTIN L. (A'19), Patent Lawyer, 3018 DuPont Building, Wilmington, Del.

FEDOTOFF, NICHOLAS V. (A'26), Engineer, Hazeltine Corporation, 521 River St., Hoboken, N.J. For mail: 39 Robertson Rd., Lynbrook, L.I., N.Y.

FEICKERT, CARL A. (A'27), Secretary-Treasurer, American Body Company, 5115 E. Grand Ave., Dallas, Tex. For mail: 3020 Bryan St., Dallas, Tex.

FEIKERT, GRANT S. (A'30), Chief Operator, Radio Station KOAC, Oregon State College, Corvallis, Ore. For mail: 320 N. 21st St., Corvallis, Ore.

FEINDEL, ABBOTT (A'29), Engineer, Arcurus Radio Tube Company, 260 Sherman Ave., Newark, N.J. For mail: 37 Lehigh Ave., Newark, N.J.

FELCH, H. F. (A'26), Technician and Announcer, Radio Station KXN, Hollywood, Calif. For mail: 622 N. Holliston Ave., Pasadena, Calif.

FELD, JOHN (A'26), P.O. Box 292, Altoona, Pa.

FELDMAN, CARL B. (A'26), Member, Bell Telephone Laboratories, Inc., P.O. Box 97, Red Bank, N.J.

FELDMAN, NICHOLAS (A'31), Elifabetes iela 69 Dz. 2, Riga, Latvia.

FELDMAN, SARLEY M. (A'30), Radio Service, Feldman Radio Service Company, 121 Draper St., Dorchester, Mass.

FELDSTEIN, M. A. (A'29), Field Engineer, Merchandise Department, General Electric Company, 211 W. 40th St., New York, N.Y. For mail: 41 W. 86th St., New York, N.Y.

FELICIANO, FIDENCIO A. (A'31), 2400 Antipolo, Station Cruz, Manila, Philippine Islands.

FELIX, CLARENCE G. (A'29), Measurements Engineer, Crosley Radio Corporation, Cincinnati, Ohio. For mail: 3120 Montana Ave., Cincinnati, Ohio.

FELIX, EDGAR (J'17-A'19-M'25), Broadcast Consultant, 202 Beechwood Rd., Ridgewood, N.J.

FELL, HERBERT (A'31), Managing Director, Fel-Ectric Radio, 56 Garden St., Sheffield, York, England. For mail: 125 S. View Rd., Sharrow, Sheffield, York, England.

FELSTEAD, CHARLES F. (A'24), Sound Engineer, Universal Pictures Corporation, Universal City, Calif. For mail: 2010-6th Ave., Los Angeles, Calif.

FELTHOUSEN, A. (A'27), Sound Engineer, Brunswick Radio Corporation, 1277 E. 14th St., Brooklyn, N.Y. For mail: 1375 E. 18th St., Brooklyn, N.Y.

FENNER, PAUL R. (A'17), Radio Inspector, Radio Division, U. S. Department of Commerce, 328 Custom House, San Francisco, Calif. For mail: 1338 Masonic Ave., San Francisco, Calif.

FENNESSY, JOHN R. (A'30), Technical Manager, Radio Department, Messrs. C. Pratt and Sons, Ltd., 33 North Parade, Bradford, England. For mail: 90 Leeds Old Rd., Bradford, England.

FENTON, A. NORWOOD (A'24), Transmission Engineer, Sound Department, Metro-Goldwyn-Mayer Studios, Culver City, Calif.

For mail: 2808 Wigtown Rd., Los Angeles, Calif.

FENTON, KENNETH G. (J'30), Student, Dodge Radio Institute, Valparaiso, Ind. For mail: c/o P.M. Railway, Ludington, Mich.

FENWICK, JAMES R. (A'31), Research Products Service Engineer, Northern Electric Company, Ltd., 1231 Shearer St., Montreal, P.Q., Canada. For mail: 4808 Grosvenor Ave., Montreal, P.Q., Canada.

FERDINAND, HARRY P. (A'22), Proprietor, H. P. Radio Shop, 215 Miriam Ave., Rockford, Ill.

FERGUSON, GEORGE WELLS (A'29), Radio Engineer, RCA Photophone, Inc., New York, N.Y. For mail: 265 Converse St., Longmeadow, Mass.

FERGUSON, JOHN D. (M'26), Staff Engineer, Power and Wireless Section, Department of Posts and Telegraphs, Leinster House, The Castle, Dublin, Irish Free State.

FERGUSON, THEODORE P. (A'30), Clerk and Engineer Accountant, Southern Railway Company, Southern Railway Executive Office Bldg., McPherson St., Washington, D.C. For mail: 1723 Euclid St., N.W., Washington, D.C.

FERNANDEZ, DAN T. (A'26), Sears, Roebuck and Company, Homan and Arthington Sts., Chicago, Ill. For mail: 6231 N. Fairfield Ave., Chicago, Ill.

FERNANDEZ, JOSE DE PEDRO (A'31), Plaza Mayor 5, Alcalá de Henares, Spain.

FERNANDEZ, MANUEL A. (A'27), President, Manuel Angel Fernandez and Company, Benito Juarez, 39 Vera Cruz, Mexico. For mail: Apartado Postal 18 Bis., Mexico, D.F.

FERRELL, ENOCH B. (A'25-M'29), Member of Technical Staff, Bell Telephone Laboratories, Inc., Deal, N.J.

FERRIE, G. A. (F'17), 51 bis Blvd. Latour-Maubourg, Paris, France.

FERRIS, HARRY J. (A'30), Service Manager, Van Ashe Radio Company, 210 N. 10th St., St. Louis, Mo. For mail: 720 S. 4th St., St. Louis, Mo.

FERRIS, MALCOLM (A'14-M'29), Consulting Radio Engineer, Fairview Ave., Boston, N.J.

FERRIS, WARREN ROBERT (A'29-M'31), Vacuum Tube Engineer, Development Laboratory, RCA Radiotron Company, Inc., 415 S. 5th St., Harrison, N.J.

FERRONI, JOSEPH A. (A'30), Landau Brothers, Victor Talking Machine Products Company, 60 S. Main St., Wilkes-Barre, Pa. For mail: 1201 Wyoming Ave., Exeter Boro, Pa.

FERROTTA, JOSEPH L. (A'26), Transmission Man, American Telephone and Telegraph Company, 24 Walker St., New York, N.Y. For mail: 314-79th St., Apartment 3C, Brooklyn, N.Y.

FETSCH, JOSEPH T., JR. (A'25), Assistant Radio Engineer, U. S. Naval Research Laboratory, Bellevue, Anacostia, D.C. For mail: 1702 Hanover St., Baltimore, Md.

FETTERHOFF, MILTON J. (A'31), 3523 Roseview Ave., Los Angeles, Calif.

FETTERMAN, D. M. (F'27-A'30), 3222 Michigan Ave., Chicago, Ill.

FETZER, JOHN E. (A'24-M'28), President and General Manager, Radio Station WKZO, Inc., Burdick Hotel, Kalamazoo, Mich.

FICHEL, F. CARL (A'31), Chief Equipmentman, New York Telephone Company, 65 Franklin St., Buffalo, N.Y. For mail: 244 Victoria Blvd., Kenmore, N.Y.

FICHTER, LUDWIG (A'31), Draftsman, Engineering Department, DeForest Radio Corporation, 245 Carlaw Ave., Toronto, Ont., Canada. For mail: 322 Logan Ave., Toronto, Ont., Canada.

FICK, CLIFFORD G. (A'25), General Electric Company, Schenectady, N.Y. For mail: 12 Riverside Ave., Scotia, N.Y.

FICKAS, MERWIN J. (A'30), Engineer, R.C.A. Communications, Inc., Kahuku Oahu, Hawaii.

FICKETT, LOUIS W. (A'31), Proprietor, Music Store, 397 Main St., Rockland, Maine.

FIECHTNER, THEODORE G. (A'28), Air Corps, U.S. Army, Box 1881, Luke Field, Hawaii.

FIEDLER, LEROY (A'30), Chief Operator, Radio Station WKBW, R.F.D. No. 1, Tonawanda, N.Y. For mail: 98 West Ave., Lockport, N.Y.

FIEDLER, OSCAR W. (A'30), Installation Department, Western Electric Company, Inc., 63 E. Delavan Ave., Buffalo, N.Y.

FIEGHEH, MAURICE G. (A'28), Service Manager, Music Company of Canada, Ltd., 310 Spadina Ave., Toronto, Ont., Canada. For mail: 37 Grenadier Rd., Toronto, Ont., Canada.

FIELD, GEORGE S. (A'30), Junior Research Physicist, Division of Physics, National Research Council of Canada, Ottawa, Ont., Canada. For mail: 45B Bertrand St., Ottawa, Ont., Canada.

FIELD, PERCY A. (A'30), Student, University of Alberta, Edmonton, Alta., Canada. For mail: 10434-69th Ave., Edmonton, Alta., Canada.

FIELD, ROBERT F. (A'18-M'30), Engineer, General Radio Company, 30 State St., Cambridge, Mass. For mail: 104 Church St., Watertown, Mass.

FIELD, ROBERT W. (A'31), Proprietor, Radio Sets and Supplies, 808 Frederica St., Owensboro, Ky.

FIELD, W. THAYER (A'15), Hardwick, Field and Leeb, Inc., 231 Murray St., Newark, N.J. For mail: 262 Charlton Ave., South Orange, N.J.

FIELDT, CHARLES F. (M'29), Lieutenant Commander, Radio Material Officer, Navy Yard, New York, N.Y.

FIGGINS, FRANK M. (A'31), Maintenance Engineer, Radio Station KFAC-KFVD, Los Angeles, Calif. For mail: 8951 B Hubbard St., Culver City, Calif.

FILDERSON, JOSEPH (A'31), RCA Victor Company, Inc., Camden, N.J. For mail: 3849 N. 18th St., Philadelphia, Pa.

FILGATE, JOHN T. (A'29), Radio Engineer, General Motors Radio Corporation, Dayton, Ohio.

FILL, JOHN V. (J'27), 135-14th Ave., N., St. Petersburg, Fla.

FILLMORE, FRANCIS A. (J'26-A'30), Radio Operator, Greater St. Louis Broadcasting Company, Hotel Chase, St. Louis, Mo. For mail: 4222 Nebraska Ave., St. Louis, Mo.

FILMER, WALTER L., JR. (A'30), Radio Development Engineer, Bell Telephone Laboratories, Inc., Rm. 812, 180 Varick St., New York, N.Y.

FILTNESS, ARTHUR W. (A'24), The Canadian Marconi Company, 207 Hastings St. W., Vancouver, B.C., Canada. For mail: 1986 W. 11th Ave., Vancouver, B.C., Canada.

FINCH, JAMES L. (A'19-M'28), R.C.A. Communications, Inc., Kahuku, Oahu, Hawaii.

FINCH, JOSEPH E. (A'30), Engineer, Radio Station KGHF, 113 Broadway, Pueblo, Colo.

FINCH, WILLIAM G. H. (J'16-A'18-M'25), Secretary and Chief Engineer, American Radio News Corporation, 235 E. 45th St., New York, N.Y. For mail: 315 Riverside Dr., New York, N.Y.

FINDLEY, THOMAS J. (A'31), Radio Operator, S.S. Missoula, San Pedro, Calif. For mail: 1547 W. 46th St., Los Angeles, Calif.

FINGADO, FRANCIS H. (A'28), Principal, Rock Cliff Junior High School, Seibert, Colo. For mail: Seibert, Colo.

FINK, JACK (A'30), Radio Serviceman, 316-12th St., S.E., Cedar Rapids, Iowa.

FINLAY, ROBERT C. S. (A'25), Assistant Vice President, Haines, Spencer and Chancellor, 342 Madison Ave., New York, N.Y.

FINTER, CLYDE V. (A'20), Captain, Air Corps, Brooks Field, San Antonio, Tex.

FIRESTONE, SAMUEL (A'28), Planning Division, Detroit Edison Company, Rm. 715, 2000-2nd Ave., Detroit, Mich.

FIRTH, ROY (A'31), Technical Manager, Harrison's Reproduction Equipment, 103 City Rd., Bradford, York, England. For mail: 13, St. Margaret's Pl., Bradford, York, England.

FISCHER, ANDREW, JR. (A'26), The Continental Fibre Company, Chicago, Ill. For mail: 3007 Blaine Pl., Chicago, Ill.

FISCHER, FRED F. (A'30), General Manager, Radio Service Company, 562 Main St., Poughkeepsie, N.Y.

FISCHER, FRED W. (A'31), Radio Operator, Radio Station WOWO, Fort Wayne, Ind. For mail: 1114 Crescent Ave., Fort Wayne, Ind.

FISCHER, HERBERT B. (A'25), Engineer, Bell Telephone Laboratories, Inc., 463 West St., New York, N.Y.

FISCHER, LEONARD O. (A'27), 3444 Knox Pl., New York, N.Y.

FISH, ARTHUR S. (M'29), U. S. Radio Inspector, U. S. Department of Commerce, Radio Service, Subtreasury Bldg., New York, N.Y.

FISH, CLARENCE A. (A'31), Assistant Engineer, Radio Station WOS, Jefferson City, Mo.

FISH, EDWARD H. (A'19), 54 Sherwood Rd., Ridgewood, N.J.

FISH, GEORGE R. (A'31), Graduate Student, Yale University, New Haven, Conn. For mail: 82 Wall St., New Haven, Conn.

FISHBERG, SIDNEY (A'28), Radio Engineer, Polymet Manufacturing Corporation, 839 E. 134th St., New York, N.Y. For mail: 102 E. 32nd St., Brooklyn, N.Y.

FISHER, CARROLL S. (A'27), Airport Radio Operator, Communications Department, Pan American Airways, Cristobal, Canal Zone.

FISHER, CHARLES H. (A'28), Testing Department, Atwater Kent Manufacturing Company, 4760 Wissahickon Ave., Philadelphia,

- Pa. For mail: 447 Chestnut St., Pottstown, Pa.
- FISHER, E. H.** (A'29), Research Assistant, Stanford University, Calif. For mail: 221 River St., Santa Cruz, Calif.
- FISHER, FRANK E.** (A'28), Research and Development Division, Precision Scientific Company, Chicago, Ill. For mail: 1750 N. Springfield Ave., Chicago, Ill.
- FISHER, H. R.** (A'30), Radio and Television Laboratory, 542 Benton St., Council Bluffs, Iowa.
- FISHER, JOSEPH J.** (A'26), Senior Radio Operator, Airways Division, U. S. Department of Commerce, Airway Radio Station, Cheyenne, Wyo.
- FISHER, NORMAN** (A'26), Test Engineer, RCA Victor Company, Inc., Front and Cooper Sts., Camden, N.J. For mail: 51 Beilitt Ave., Audubon, N.J.
- FISHER, ROY S.** (A'27), Electrical Engineer, J. S. Timmons, Inc., 79 E. Wister St., Philadelphia, Pa. For mail: 1123 E. Rittenhouse St., Philadelphia, Pa.
- FISHER, THEODORE** (A'27), Marine Wireless Operator, Standard Shipping Company, Rm. 574, 26 Broadway, New York, N.Y. For mail: S.S. *Beaconstar*, Rm. 574, 26 Broadway, New York, N.Y.
- FISK, ERNEST T.** (M'15-F'26), Amalgamated Wireless, Ltd., 47 York St., Wireless House, Sydney, New South Wales, Australia.
- FISK, LAWRENCE S.** (A'28), Radio Operator, Radio Stations WBBM-WJBT, 306 S. Wabash Ave., Chicago, Ill. For mail: 416 Keeney St., Evanston, Ill.
- FITCH, J. ALTON** (A'31), Proprietor, Radio Service Laboratory, 105 Francis St., Rome, N.Y.
- FITCH, WILLIAM A.** (J'26-A'29), Radio Engineer, General Electric Company, Schenectady, N.Y. For mail: 1431 Baker Ave., Schenectady, N.Y.
- FITHIAN, WILLIAM S.** (J'15-A'18), Technical Advisory, Victor Export Division, RCA Victor Company, Inc., Camden, N.J. For mail: 212 Merion Ave., Haddonfield, N.J.
- FITTS, LINCOLN W.** (A'30), Manager, Smith-Fitts Electric Company, 1286 Beacon St., Brookline, Mass. For mail: 376 Clinton Rd., Brookline, Mass.
- FITTS, RUPERT A.** (A'28), Engineer, Broadcasting Station 3HA, Hamilton, Victoria, Australia. For mail: 16 Horner St., Hamilton, Victoria, Australia.
- FITZPATRICK, GEORGE WILLIAM** (A'29), Draftsman, Westinghouse Electric and Manufacturing Company, E. Marginal Way and Spokane Ave., Seattle, Wash. For mail: 113 E. 55th St., Seattle, Wash.
- FITZSIMONS, FRANK** (A'31), Designer, RCA Victor Company, Inc., Camden, N.J. For mail: 326 Lincoln Ave., Mount Ephraim, N.J.
- FLAGG, LEONARD B.** (A'25), District Engineer, British Talking Pictures, Ltd., 88 Imperial Bldgs., Oxford Rd., Manchester, England. For mail: The Mansion, Arden Park, Bredbury, near Stockport, England.
- FLAHERTY, MARK** (A'31), Engineer, RCA Victor Company, Inc., Camden, N.J. For mail: 414-9th Ave., Haddon Heights, N.J.
- FLANNIGAN, COKE** (M'26), Apparatus Design Engineer, Electrical Research Products, Inc., 250 W. 57th St., New York, N.Y. For mail: 10 W. Morris Ave., Mountain Lakes, N.J.
- FLATHMAN, EDWARD** (J'27), Wire Chief's Assistant, New York Telephone Company, St. James, L.I., N.Y.
- FLAUM, JOE** (J'30), Manager, Sheepshead Radio Company, 2315 Avenue 2, New York, N.Y.
- FLEBBE, WALTER E.** (A'31), Route No. 1, Box 499 A. North Platte, Neb.
- FLEISCHER, A. P.** (A'30), Proprietor, Radio Retailing and Repairing, 246 Broadway, Monticello, N.Y.
- FLEMING, JOSEPH W.** (A'31), Partner and Manager, J. W. Fleming and Company, 80 Mount Vernon St., Ridgefield Park, N.J.
- FLEMING, MYRON NEIL** (A'30), Control Operator, Radio Station WRHM, Minnesota Broadcasting Corporation, c/o Andrews Hotel, Minneapolis, Minn. For mail: 5253-2nd Ave., S., Minneapolis, Minn.
- FLEMING, SAMUEL** (A'28), Assistant Maintenance Engineer, British Broadcasting Corporation, 1, Lochee Rd., Dundee, Scotland. For mail: 291 Arbroath Rd., Dundee, Forfarshire, Scotland.
- FLESSEL, FRANK B., JR.** (J'29), Radiotician, 15 Wall St., Huntington, L.I., N.Y.
- FLETCHER, EARLE S.** (A'26-M'27), Radio Electrician, U. S. Coast Guard, Rm. 417, Custom House, San Francisco, Calif.
- FLETCHER, LOUIS D., JR.** (A'30), Patent Lawyer, Darby and Darby, 405 Lexington Ave., New York, N.Y. For mail: 60 Broad St., Mount Vernon, N.Y.
- FLETT, WILLIAM J.** (A'27), Radio Service and Repair, 117 N. Kingston Ave., Atlantic City, N.J.
- FLICK, A. A., JR.** (A'28), Engineer, Chicago-Jefferson Fuse and Electric Company, 501 S. Green St., Chicago, Ill.
- FLICKINGER, J. H.** (A'30), Consulting Engineer, Flix Meter and Test Equipment Laboratory, 1105 W. 10th St., Los Angeles, Calif.
- FLINTHAM, HERBERT** (A'25), Electrical and Radio Engineer, 50 Burton Ave., Doncaster, England.
- FLOREZ, HERMANN A.** (A'30), Chief Engineer, Radio Station WFOX, 1375 E. 18th St., Brooklyn, N.Y.
- FLOYD, WILLIAM F.** (J'29-A'31), Student and Technical Editor of Journal, Montague House, Russell Sq., London, W.C. 1, England, For mail: 20 West Way, Neasden, Middlesex, England.
- FLUHARTY, WILLIAM G.** (A'30), Telegraph Engineer, 195 Broadway, New York, N.Y. For mail: 161 Lawson Ave., Rockville Centre, L.I., N.Y.
- FLYTHE, THOMAS Y.** (J'29), Shop Inspector, RCA Photophone, Inc., 4014-1st Ave., Brooklyn, N.Y. For mail: 1064 Woodycrest Ave., New York, N.Y.
- FOGEL, MORTIMER H.** (J'26-A'30), Sales Manager, Sun Radio Company, 64 Vesey St., New York, N.Y. For mail: 298 Avenue P, Brooklyn, N.Y.
- FOIN, OWEN F., JR.** (J'27), 827 Divisadero St., Fresno, Calif.
- FOLEY, J. W. B.** (A'15), Instructor, Radio Communications, Toledo High Schools, Toledo, Ohio. For mail: 1124 Forsythe St., Toledo, Ohio.
- FOLEY, JACK** (J'27), Transmission Man, American Telephone and Telegraph Com-

- pany, 308 S. Linn St., Iowa City, Iowa. For mail: 1615-29½ St., Rock Island, Ill.
- FOLEY, JOSEPH H.** (A'31), Lieutenant (jg), U.S.S. *West Virginia*, c/o Postmaster, San Pedro, Calif.
- FOLEY, W. R.** (J'29-A'30), U. S. Radio Inspector, U. S. Department of Commerce, Custom House, Norfolk, Va.
- FONGER, C. IRWIN** (A'30), Technician, Brunswick-Balke-Collender Company, Muskegon, Mich. For mail: 985 Pine St., Muskegon, Mich.
- FOORD, HENRY D. G.** (M'19), Oak Cottage, Lymington, South Devon, England.
- FOOTE, GEOFFREY E.** (A'31), Radio Engineer, Colin B. Kennedy of Canada, Ltd., 20 Trinity St., Toronto, Ont., Canada. For mail: 357 Kingston Rd., Toronto, Ont., Canada.
- FORBES, ALLAN C.** (A'15-M'23), Account Executive, Vanderhoof and Company, 167 E. Ontario St., Chicago, Ill. For mail: 5140 Bernard St., Chicago, Ill.
- FORBES, EUGENE D.** (M'12-F'14), Consulting Engineer, Eugene D. Forbes Company, 102 Beacon St., Framingham, Mass.
- FORBES, F. D.** (A'31), Radio Engineer, 22 Station Approach, Purley, Surrey, England.
- FORBES, HENRY C.** (A'20-M'29), R.R. No. 12, 1100 Broadview Blvd., Dayton, Ohio.
- FORD, J. S.** (A'28), Electrical Engineer, Canadian National Telegraphs, 436 Wellington St., W., Toronto, Ont., Canada. For mail: 34 Coolmine Rd., Toronto 3, Ont., Canada.
- FORD, JOHN R.** (J'28-A'30), 421 Woodbine Ave., Narberth, Pa.
- FORD, WALTER B.** (A'24), Instructor, Radio and Electricity Department, Eagle Rock High School, 1750 Yosemite Dr., Los Angeles, Calif. For mail: 1410 Cedaredge Ave., Eagle Rock, Calif.
- FORD, WARREN A.** (A'19), Radio Engineer, General Electric Company, Schenectady, N.Y. For mail: 1491 Parkwood Blvd., Schenectady, N.Y.
- FORREST, GERARD E.** (A'31), Radio Service, Ludwig Baumann and Company, 45 Pearson St., Long Island City, L.I., N.Y. For mail: 43-26-41st St., Sunnyside, L.I., N.Y.
- FORSBERG, OTTO J.** (A'20), Electrical Engineer, Vacua Electrical Specialty Company, 1111 Webster Ave., Chicago, Ill.
- FORSTALL, EDWARD L.** (A'26), Assistant Engineer, Bell Telephone Company of Pennsylvania, 1835 Arch St., Philadelphia, Pa. For mail: Rosemont, Pa.
- FORSTER, KENNETH L.** (A'31), Lieutenant, U. S. Navy, Radio Officer, Cruiser Division, U.S.S. *Chicago*, c/o Postmaster, New York, N.Y.
- FORTINGTON, WILLIAM H.** (A'25-M'27), President, International Broadcasting Equipment Company, 3112 W. 51st St., Chicago, Ill.
- FORTNER, OBED D.** (J'29-A'30), Radio Service Engineer, Moore's Radio Shop, 314 N. Hickory St., Champaign, Ill.
- FOSSETT, FRED E.** (A'26), Research Laboratory, Atwater Kent Manufacturing Company, Philadelphia, Pa. For mail: 3419 N. 17th St., Philadelphia, Pa.
- FOSTER, DUDLEY E.** (A'26), Assistant Chief Engineer, U. S. Radio and Television Corporation, Marion, Ind.
- FOSTER, LEONARD** (A'30), Service Manager, Maritime Division, DeForest Crosley Radio Corporation, 92 Union St., St. John, N.B., Canada.
- FOSTER, NICK H.** (A'28), Radio Specialist, General Electric Supply Corporation, 1212-1st Ave., S., Seattle, Wash.
- FOUNTAIN, J. CLARENCE** (A'30), 2122 Griswold St., Port Huron, Mich.
- FOUTS, AVERY L.** (A'29), Radio Service Manager, J. W. Jenkins Music Company, 21st and Wyandotte Sts., Kansas City, Mo. For mail: 4707 Grand Ave., Kansas City, Mo.
- FOWLER, D. W.** (A'27), Radio Engineer, U. S. Engineers' Depot, Fort of Arsenal, St. Louis, Mo. For mail: 4940 Botanical Ave., St. Louis, Mo.
- FOWLER, LESTER T.** (A'30), Radio Engineer, RCA Victor Company, Inc., Camden, N.J. For mail: Cedar Court Apartments, 1115 White Horse Pike, Oaklyn, N.J.
- FOWLER, WALTER D.** (A'16), McGill University, Montreal, P.Q., Canada. For mail: 105 Dinnick Crescent, Toronto 12, Ont., Canada.
- FOX, BENJAMIN** (A'31), Patent Examiner, U.S. Patent Office, Washington, D.C. For mail: 327 Allison St., N.W., Washington, D.C.
- FOX, BERT M.** (J'28), Directing Engineer, Aero Radio Corporation, 5927 Franklin Ave., Hollywood, Calif. For mail: 1907 Carmen Ave., Hollywood, Calif.
- FOX, FLORIAN J.** (A'27), Radio Engineer, Rogers-Majestic Company, Ltd., 622 Fleet St., Toronto, Ont., Canada.
- FOX, JOHN D.** (A'30), Press Telegraphist, *Daily Express*, Great Ancoats St., Manchester, Lancashire, England. For mail: 25 Kingswood Dr., Kings Park, Glasgow, S. 2, Scotland.
- FOX, JOHN E.** (A'28), Chief Inspector, Audiola Radio, 430 S. Green St., Chicago, Ill. For mail: 3037 N. Long Ave., Chicago, Ill.
- FOX, PAUL X.** (A'31), Radio Department Manager, Tungsram Electric Lamp Works, Ltd., Britannica House, 74 Wellington St., Leeds, York, England.
- FOX, ROBERT A.** (A'26), 1011 King Ave., Lorain, Ohio.
- FRAME, FLOYD H.** (A'26), Professor of Electrical Engineering, Missouri School of Mines and Metallurgy, Rolla, Mo. For mail: 703-12th St., Rolla, Mo.
- FRANCIS, OLIVER T.** (A'30), Captain, U. S. Marine Corps, Fourth Marines, Shanghai, China. For mail: c/o Postmaster, Seattle, Wash.
- FRANCIS, THOMAS C.** (A'27), Accountant, Hanley Oil Company, 2 Main St., Bradford, Pa. For mail: 65 State St., Bradford, Pa.
- FRANCIS, THOMAS L.** (A'31), Clerk, Post Office, Kansas City, Kan. For mail: P.O. Box 358, Kansas City, Kan.
- FRANCK, ERNEST W.** (A'30), Engineer, Research Department, Columbia Phonograph Company, 1819 Broadway, New York, N.Y. For mail: 299 Pacific St., Paterson, N.J.
- FRANK, CHARLES W.** (A'28), Engineer, Champion Radio Works, Danvers, Mass. For mail: 152 Jackson St., Lawrence, Mass.
- FRANK, JAMES, JR.** (A'29), Commercial Engineer, RCA Photophone Company, Inc., 411-5th Ave., New York, N.Y.

FRANKEL, MORTIMER (M'29), President and General Manager, Audiola Radio Company, 430 S. Green St., Chicago, Ill.

FRANKIS, ERNEST E. (A'31), Engineer-in-Charge, Imperial and International Communications, Ltd., Beam Wireless Station, Skegness, Lincolnshire, England.

FRANKLIN, LYMAN T. (A'30), Special Representative, Pacific Telephone and Telegraph Company, 140 New Montgomery St., San Francisco, Calif.

FRANKLIN, T. BEDFORD (A'30), Headmaster, Stancliff Hall, near Matlock, Derby, England.

FRANSSON, FRANS J. (A'20), c/o Svenska A-B, Gasaccumulator, Stockholm-Lidingo, Sweden.

FRANZWA, FREDERICK J. (A'29), 58 Redder Ave., Dayton, Ohio.

FRASER, D. M. (A'30), President and General Manager, D. M. Fraser, Ltd., 149 Adelaide St., E., Toronto 2, Ont., Canada. For mail: 82 Hillsdale Ave. W., Toronto, Ont., Canada.

FRAZIER, HOWARD S. (A'27-M'31), Chief Engineer, William Penn Broadcasting Company, 217 S. Broad St., Philadelphia, Pa. For mail: 255 Lamport Rd., Upper Darby, Pa.

FREDENDALL, BEVERLY (A'29), Field Engineer, National Broadcasting Company, Inc., 711-5th Ave., New York, N.Y.

FREDERICK, ALBERT P. (A'30), Radio Operator, Pennsylvania Broadcasting Company, 104 S. 4th St., Harrisburg, Pa. For mail: 333 Price Ave., Souderton, Pa.

FREDERICK, ANDREW (A'31), Radio Operator, Radiomarine Corporation of America, S.S. J. E. O'Neil, c/o Atlantic Refining Company, Philadelphia, Pa. For mail: 342 S. 2nd St., Philadelphia, Pa.

FREDERICK, CALVIN M. (A'28), Central Y.M.C.A., 1421 Arch St., Philadelphia, Pa.

FREDERICK, HALSEY A. (M'29), Transmission Instruments Engineer, Bell Telephone Laboratories, Inc., 463 West St., New York, N.Y.

FREDERICKS, JOHN E. (A'15), Chief Radio Electrician, U. S. Navy, U. S. Naval Radio Station, Arlington, Va.

FREED, JOSEPH D. R. (J'15-A'18-M'23-F'28), Chairman of the Board, Freed Television and Radio Corporation, 22-17-41st Ave., Long Island City, L.I., N.Y. For mail: Great Neck Estates, 35 Gateway Dr., Great Neck, L.I., N.Y.

FREEDMAN, H. J. (A'26), Construction Engineer, Progressive Electric Construction Company, Inc., Philadelphia, Pa. For mail: 413 S. 2nd St., Philadelphia, Pa.

FREEDMAN, JOHN L. (A'31), Student, Massachusetts Institute of Technology, Cambridge, Mass. For mail: 19 Vesta Rd., Dorchester, Mass.

FREEDMAN, SAM (J'29-A'30), Radio Service Manager, Max Freedman Radio and Electric Shop, 117 William St., Buffalo, N.Y.

FREEMAN, ERNEST H. (M'27), Professor of Electrical Machinery, Armour Institute of Technology, 33rd and Federal Sts., Chicago, Ill.

FREEMAN, JOHN T. (A'31), Box 132, Edmonton, Alta., Canada.

FREEMAN, STEPHEN, JR. (J'24-A'24), B. Walter and Company, Wabash, Ind. For mail: 265 Falls Ave., Wabash, Ind.

FREERICKS, BERNARD, JR. (A'23), 895 Dicks St., West Hollywood, Calif.

FREIERMUTH, VINCENT J. (A'26), Engineer, Pacific Telephone and Telegraph Company, 140 New Montgomery St., San Francisco, Calif.

FREIMANN, FRANK (A'24), Technical Editor, Radio Age, Inc., 500 S. Dearborn St., Chicago, Ill. For mail: 3920 Nottingham Ave., Chicago, Ill.

FREIRE, ALVARO (A'30), Technical Supervisor, Cia. Telefonica Rio-Grandense, Avenida Rio Branco 149, Rio de Janeiro, Brazil.

FRENCH, BENEDICT V. K. (M'30), Assistant Radio Engineer, United American Bosch Corporation, Springfield, Mass.

FRENCH, HENRY G. (A'26), Design Engineer, General Electric Company, Radio Department, Bldg. 77, Schenectady, N.Y. For mail: 1105 Adams Rd., Schenectady, N.Y.

FRENCH, JAMES B. (A'31), Assistant Engineer, Columbia Broadcasting System, Inc., 485 Madison Ave., New York, N.Y. For mail: 281 Westminster Rd., Brooklyn, N.Y.

FRENZ, HARRY J. (A'29), Manager, Amplifier Test and Inspection Department, Victor Talking Machine Company, Camden, N.J. For mail: 5735 W. Walnut Ave., Merchantville, N.J.

FREY, R. C. (A'31), Technical Man, Pacific Telephone and Telegraph Company, Rm. 100, 333 Grant Ave., San Francisco, Calif. For mail: 260 Portola Ave., Palo Alto, Calif.

FREY, ROBERT H. (A'27), Radio Supervisor, A. H. Bull and Company, Inc., 115 Broad St., New York, N.Y. For mail: Monroe Ave., P.O. Box 167, Wyckoff, N.J.

FRIDAY, WILBUR L. (A'27), Proprietor, Friday Radio Laboratories, 9530 S. Robey St., Chicago, Ill.

FRIDGEN, EDWARD N. (A'29), Radio Engineer, Phoenix Ave., Bellefonte, Pa.

FRIEDENTHAL, ANDREW (A'28), Studio Engineer, Radio Station WJR, 2800 Fisher Bldg., Detroit, Mich.

FRIEDLER, DEWEY, P. (A'27), Robertson Cataract Electrical Company, 186 Clinton Ave., North Rochester, N.Y. For mail: 762 Bay St., Rochester, N.Y.

FRIEDMAN, HARRY (A'29), Radio Engineer, General Motors Radio Corporation, Dayton, Ohio. For mail: 16 Bremen St., Dayton, Ohio.

FRIEND, HALTON H. (A'26), Research Engineer, RCA Photophone, Inc., 153 E. 24th St., New York, N.Y.

FRIGAR, JOHN, III (A'27), Superintendent of Building, 1900 Rittenhouse Sq., Philadelphia, Pa. For mail: 2115 Stenton Ave., Philadelphia, Pa.

FRIIS, H. T. (A'18-M'26-F'29), Research Engineer, Bell Telephone Laboratories, Inc., Cliffwood, N.J. For mail: Rumson, N.J.

FRIMERMAN, FRANK (A'27), F. Z. Radio, 740 Prospect Ave., New York, N.Y.

FRINK, FREDERICK WILLIAM (A'29), Radio Engineer, General Electric Company, Schenectady, N.Y. For mail: 2 Eagle St., Schenectady, N.Y.

FRITSCHER, EUGENE H. (A'26), Engineer, Radio Department, General Electric Company, Schenectady, N.Y.

FRITZ, HARRY R. (A'28), General Transmission and Production Engineer, Southwest-

ern Bell Telephone Company, 1921 Telephone Bldg., St. Louis, Mo.

FRITZEL, JOSEPH (A'29), Serviceman and Technician, Atlas Radio Corporation, 660 W. Adams St., Chicago, Ill. For mail: 441 W. North Ave., Chicago, Ill.

FROST, E. (A'31), Radio Engineering Department, General Electric Company, Schenectady, N.Y. For mail: 210 Bradley St., Schenectady, N.Y.

FRY, LLOYD L. (A'29), Radio and Accessories, 312 Franklin Ave., Wapello, Iowa.

FUELLING, PAUL W. (A'30), Radio Engineer-in-Charge, Radio Station WRNY, Aviation Radio Station, Inc., Coytesville, N.J. For mail: 538-3rd St., Carlstadt, N.J.

FUGAZZI, FRANK J. (A'30), 4201-9th St., N.W., Washington, D.C.

FUJIKURA, KEIHIRO (A'28), The Nihon Musen Denshin Kaisha, Jiji Bldg., 2-chome, Marunouchi, Tokyo, Japan.

FUJIMOTO, TADASHI (M'25), Research Fellow, Department of Electrical Engineering, Tohoku Imperial University, Tokyo, Japan. For mail: 429 Taishido Setagaya, Tokyo, Japan.

FUKUSHIMA, T. (A'29), Radio Engineer, Tokyo Central Broadcasting Station, Atagoyama, Tokyo, Japan.

FULGHUM, CHARLES K. (A'26), 315 Palmer St., Delta, Colo.

FULLER, J. CONRAD (M'20), 9 Clifton Rd., South Norwood, London, S.E. 25, England.

FULLER, LEONARD F. (A'14-M'14-F'25), Executive, Vice President, Federal Telegraph Company, Palo Alto, Calif. For mail: 1535 Cowper St., Palo Alto, Calif.

FULLER, LYMAN D. (A'30), Student, Electrical Engineering Department, University of Michigan, Ann Arbor, Mich. For mail: 216 Packard St., Ann Arbor, Mich.

FULLMER, DON A. (A'29), Student, Brigham Young University, Provo, Utah. For mail: Spanish Forks, Utah.

FULTON, R. (A'30), Vacuum Tube Department, General Electric Company, 1 River Rd., Schenectady, N.Y.

FULTZ, MILES E. (A'17), Electrical Engineer, Bell Telephone Laboratories, Inc., 463 West St., New York, N.Y. For mail: 96 Irma Ave., Port Washington, L.I., N.Y.

FUNG, HUO-SIU (J'29), Student, c/o Professor K. C. Chang, Nanyang University, Shanghai, China.

FUNG, JOHN HAMILTON (A'30), Representative, P.O. Box 73, Georgetown, Demerara, British Guiana.

FURIA, JOHN J. (A'18), Instructor in Physics, Manhattan College, 242nd St. and Broadway, New York, N.Y. For mail: 1222 Tinton Ave., New York, N.Y.

FURLOW, JOHN T. (A'31), Mount Enterprise, Tex.

FURTH, ERNEST L. (A'30), Materials and Process Engineering Department, Westinghouse Electric and Manufacturing Company, East Pittsburgh, Pa. For mail: 442 Ross Ave., Wilkensburg, Pa.

FUSSELL, LEWIS (A'26), Professor of Electrical Engineering, Swarthmore College, Swarthmore, Pa.

FUXA, ALBERT E. (J'25-A'26), Manager, Radio Department, Strobeck Electric Com-

pany, Hopkins, Minn. For mail: 221-11th Ave., N., Hopkins, Minn.

FYLER, GEORGE W. (A'30), Radio Engineer, General Electric Company, Schenectady, N.Y.

G

GABLE, M. (A'30), Sales Engineer, Denham Sales and Service, 904 E. Pike St., Seattle, Wash.

GABLE, ROBERT B. (A'30), President, The William F. Gable Company, Altoona, Pa.

GABY, FREDERICK A. (A'19), Chief Engineer, Hydro Electric Power Commission, 190 University Ave., Toronto, Ont., Canada.

GADY, JOHN W. (A'31), Printer, Bermuda Book Stores, Reid and Burnaby Sts., Hamilton, Bermuda. For mail: P.O. Box 404, Hamilton, Bermuda.

GAGE, DAVID H. (A'19-M'26), Foreign Wire Relations Engineer, Postal Telegraph and Cable Company, 67 Broad St., New York, N.Y. For mail: 56 Vreeland Ave., Rutherford, N.J.

GAGE, HENRY PHELPS (A'24), Corning Glass Works, Corning, N.Y.

GAGER, F. MALCOLM (J'24-A'26), Instructor, Electrical Engineering Communications Division, Massachusetts Institute of Technology, Cambridge, Mass.

GAGNEBIN, WILLIAM B. (A'31), Short-wave and Television Laboratory, Colhasset, Mass.

GAINER, WILLIAM P. (J'27-A'28), Operator, Radio Station WISN, Milwaukee, Wis. For mail: 1408 Marshall St., N., Milwaukee, Wis.

GAISER, MARTIN (J'30), Radio Servicing, Tipton, Ind. For mail: R.F.D. No. 1, Tipton, Ind.

GALBRAITH, R. A. H. (A'20), Captain, c/o The Commandant, Military College of Science, Red Barracks, Woolwich, England.

GALGAY, WILLIAM F. (A'31), Sound Picture Engineer, Northern Electric Company, Ltd., c/o Nickel Theatre, St. John's, Newfoundland. For mail: 256 New Gower St., St. John's, Newfoundland.

GALLAGHER, DANIEL F. (A'31), Maintenance and Test Equipment, 7729 S. Morgan, Chicago, Ill. For mail: 4843 S. Union Ave., Chicago, Ill.

GALLO, LOUIS J. (A'27-M'27), Gallo Radio Laboratories, 2222 Lapeyrouse St., New Orleans, La.

GALLOWAY, C. HADFIELD (A'30), Publicity Department, Mullard Wireless Service Company, Ltd., Mullard House, Charing Cross Rd., London, W.C. 2, England. For mail: 9 Clydesdale Mansions, Clydesdale Rd., London, W. 11, England.

GAMBRELL, HORACE W. (A'25-M'30), Edison Swan Electric Company, 123-5 Queen Victoria St., London, E.C.4, England.

GANNETT, DANFORTH K. (M'31), Engineer, Department of Development and Research, American Telephone and Telegraph Company, 195 Broadway, New York, N.Y.

GANO, ALFRED S. (A'31), Bell Telephone Laboratories, Inc., 463 West St., New York, N.Y. For mail: 45 Gates Ave., Montclair, N.J.

GARANT, EDWARD C. (A'30), Branch Manager, Capital Electric Company, 7 Auburn Ave., Atlanta, Ga. For mail: 2819 Linden Ave., Knoxville, Tenn.

- GARARD, EARL A. (A'26), Instructor in Radio Engineering, Department of Electrical Engineering, University of North Dakota, Grand Forks, N.D. For mail: P.O. Box 162, University Station, Grand Forks, N.D.
- GARCEAU, ERNEST L. (A'31), Electrical Engineer, Harvard Medical School, Boston, Mass. For mail: 20 Sherman St., Cambridge, Mass.
- GARDBERG, JOSEPH (J'26-A'27), Radio Service Department, Mather Brothers Furniture Company, 229 Peachtree St., Atlanta, Ga. For mail: 712 Cherry St., Atlanta, Ga.
- GARDNER, WILLIAM J. (A'30), Manager, H. Panagakis Radio Specialists, 91 Dale St., Liverpool, England. For mail: 34 Woodgreen Rd., Stoneycroft, Liverpool, England.
- GARDNER, KENNETH J. (A'31), Assistant to Chief Engineer, Radio Station WHAM, Sagamore Hotel, Rochester, N.Y. For mail: 287 Genesee Park Blvd., Rochester, N.Y.
- GARDNER, LEROY H. (A'31), Field Engineer, Columbia Broadcasting System, Inc., 485 Madison Ave., New York, N.Y. For mail: 570 E. 26th St., Brooklyn, N.Y.
- GARDNER, WILLIAM L., JR. (A'26), Service Manager, R. M. Peffer, 334 Chestnut St., Harrisburg, Pa. For mail: 2226 Boas St., Harrisburg, Pa.
- GARNER, MELVIN E. (J'31), Junior Clerk, United Engineering Trustees, Inc., 29 W. 39th St., New York, N.Y. For mail: 230 W. 107th St., New York, N.Y.
- GAROFALO, FRANK (A'31), Ludwig Baumann and Company, 45 Pearson St., Long Island City, L.I., N.Y. For mail: 1175 Wheeler Ave., New York, N.Y.
- GARRETT, CHARLES R. (A'28), Engineer, Radio Engineering Department, RCA Victor Company, Inc., Camden, N.J.
- GARRISON, PAUL J. (A'25), Radio Operator, 114 Seneca Rd., Clemson College, S.C.
- GARSTANG, WILLIAM W. (A'31), Field Engineer, P. R. Mallory and Company, Inc., 3029 E. Washington St., Indianapolis, Ind. For mail: 3504 Evergreen Ave., Indianapolis, Ind.
- GARVEY, EDMOND (A'29), Manager, Radio Inspection and Testing, United American Bosch Corporation, Springfield, Mass. For mail: 18 Rittenhouse Ter., Springfield, Mass.
- GARY, L. A. (A'26), Pacific Telephone and Telegraph Company, Rm. 1021, 140 New Montgomery St., San Francisco, Calif.
- GASPAROVITCH, STEPHEN (A'26), Radio Electrician, U. S. Lighthouse Service, Detroit, Mich. For mail: 3747 Humboldt Ave., Detroit, Mich.
- GATI, BELA (A'28), Consulting Electrical Engineer, 326 Audubon Ave., New York, N.Y.
- GAUSDEN, P. (A'30), Radio Operator, Marconi, International Marine Communications Company, Marconi House, 3-5 High St., S., East Hampton, London, England. For mail: The Vineyard, Much Hadham, Herts, England.
- GAVORET, GEORGE (A'31) General Manager, Etablissements Gamma, 21 Rue Dautecourt, Paris, France.
- GAWLER, HENRY C. (M'23), Sales Manager, Federal Telegraph Company, 200 Mount Pleasant Ave., Newark, N.J. For mail: 102 N. 22nd St., East Orange, N.J.
- GAY, PAUL F. (A'29), Service Engineer, Chicago Talking Machine Company, 111 N. Canal St., Chicago, Ill. For mail: 3624 Paris Ave., Chicago, Ill.
- GAY, PAUL STEAD (A'31), Chief Engineer, Sterling Manufacturing Company, Cleveland, Ohio. For mail: 12907 Clifton Blvd., Cleveland, Ohio.
- GAYDOS, GEORGE J. (A'31), Laboratory Technician, E. T. Cunningham, Inc., 370-7th Ave., New York, N.Y. For mail: 381 Troutman St., Brooklyn, N.Y.
- GEBHARD, LOUIS A. (A'20), Radio Engineer, U. S. Naval Research Laboratory, Bellevue, Anacostia, D.C.
- GEBHARDT, PAUL B. (A'27), Chief Engineer, Colin B. Kennedy Corporation, South Bend, Indiana. For mail: 1301 Leeper Ave., South Bend, Ind.
- GEBHART, BERNARD R. (A'30), R. R. No. 5, Chilton, Wis.
- GEE, HARRY T. P. (A'25), Patent Agents, Gee and Company, Staple House, 51-52 Chancery Lane, London, W.C. 2, England.
- GEE, WALTER C. (A'26-M'31), Assistant Engineer, Posts and Telegraph Department, Kuala Lumpur, Federated Malay States. For mail: 1682, Petaling Hill, Kuala Lumpur, Federated Malay States.
- GEIGER, DOUGLAS G. (A'31), Transmission Engineer, W. A. Bell Telephone Company of Canada, Rm. 902, Canada Permanent Bldg., Toronto, Ont., Canada.
- GEISE, JULIUS C., JR. (A'28), Engineer-in-Charge, Radio Station WKJC, Kirk Johnson Bldg., 16-18 W. King St., Lancaster, Pa. For mail: 221 N. Lime St., Lancaster, Pa.
- GEIST, HENRY J. (A'31), Test Engineer, RCA Victor Company, Inc., Camden, N.J. For mail: 6144 Wayne Ave., Philadelphia, Pa.
- GELARDI, MATTHEW (A'29), Service Manager, Richard Radio Service Company, 77 Roxbury St., Roxbury, Mass. For mail: 36 George St., Revere, Mass.
- GELBERT, GEORGE M. (A'26), Physician, 282 Somerset St., N.W., Ottawa, Ont., Canada.
- GELLERUP, D. W. (A'30), Station Engineer, WTMJ, Milwaukee Journal, Milwaukee, Wis. For mail: 2840 N. Cramer St., Milwaukee, Wis.
- GELOSO, JOHN (A'27), Chief Engineer, Pilot Radio and Tube Corporation, Everett Mills, Lawrence, Mass. For mail: 23 Swan Ave., Lawrence, Mass.
- GENGENBACH, ALBERT W. (J'27-A'28), Radio Operator, Radio Station WCAU, 1321 Arch St., Philadelphia, Pa. For mail: 1681 Brill St., Philadelphia, Pa.
- GEOGHEGAN, EAMONN D. A. (A'29), Engineer, Engineering Department, RCA Victor Company, Inc., Camden, N.J. For mail: 41 W. 72nd St., New York, N.Y.
- GEORGE, EDWARD M. (A'29), Radio Engineer, Radio Station WJDX, Lamar Life Bldg., Jackson, Miss. For mail: P.O. Box 117, Fondren, Miss.
- GEORGE, EVERETT E. (A'22), Superintendent of Electrical Operation, Tennessee Electric Power Company, Chattanooga, Tenn.
- GEORGE, PHILIP H. F. (A'23), Wireless Station, Penang, Straits Settlements.
- GEORGE, RALPH W. (A'31), Radio Engineer, c/o R.C.A. Communications, Inc., Riverhead, L.I., N.Y.
- GERBER, NATHAN (A'26), Gerber Radio and Battery Service, 149-A Humboldt Ave., Roxbury, Boston, Mass.

- GERBER, PAUL D. (A'31), Student Engineer, RCA Victor Company, Inc., Camden, N.J. For mail: 204 Evergreen Ave., Woodlynne, Camden, N.J.
- GEREL, ALEXANDER (A'27), Engineering Division, Westinghouse Electric and Manufacturing Company, Brooklyn, N.Y. For mail: 7214-7th Ave., Brooklyn, N.Y.
- GERLACH, GERALD G. (A'31), Radio Engineer, Wired Radio, Inc., 13th St. and 4th Ave., Ampere, N.J. For mail: 2236-28th St., Astoria, L.I., N.Y.
- GERNS, WILLIAM H. (M'29), Designer, Wired Radio, Inc., Ampere, N.J. For mail: 49 S. Clinton St., East Orange, N.J.
- GERSTEIN, M. GEORGE (J'30) Student, Public Address and Photophone Engineer, R.C.A. Institutes, Inc., 75 Varick Street, New York, N.Y. For mail: 849 Stebbins Ave., New York, N.Y.
- GERSTLE, JOHN (A'28), Research Director, Chemical and Electrical Research Laboratories, 432 Ludlow Arcade Bldg., Dayton, Ohio.
- GERTSCH, ELMER P. (A'31), c/o J. A. Renhard, RCA Victor Company, Inc., Camden, N.J. For mail: 265 W. Kings Highway, Haddonfield, N.J.
- GEYH, CHARLES P. (A'31), Contact Engineer, RCA Victor Company, Inc., Camden, N.J. For mail: 324 E. Pine St., Audubon, N.J.
- GHOSH, B. N. (J'29), 24 Luxa, Benares City, India.
- GIANNINI, GABRIEL M. (A'30), Electro-Acoustic Research Engineer, Curtis Institute of Music, Rittenhouse Sq., Philadelphia, Pa.
- GIARD, E. A. (A'27), Manager, Vacuum Tube Research Department, Cutler-Hammer, Inc., Milwaukee, Wis.
- GIBBON, QUINCY D. (A'31), Proprietor, Gibbon Radio Shop, Cleveland, Miss.
- GIBBONS, JOSEPH W. (A'28), Proprietor, Pioneer Radio Laboratory, Holden Bldg., Sussex St., Port Jervis, N.Y.
- GIBBS, EARL (A'30), 3011 Grand Ave., S., Minneapolis, Minn.
- GIBBS, R. J. (A'29), Instructor and Senior Radio Engineer Operator, New Zealand Air Force, Wigram Aerodrome, Christchurch, New Zealand. For mail: 180 Rolleston St., Christchurch, New Zealand.
- GIBSON, NESBIT (A'30), American Telephone and Telegraph Company, 24 Waiker St., New York, N.Y. For mail: 58 E. 126th St., New York, N.Y.
- GIBSON, ROBERT (A'31), General Foreman, Erie Railroad, Little Ferry, N.J. For mail: 91 Franklin Ave., Rochelle Park, N.J.
- GIBSON, ROBERT D. (A'18), Bell Telephone Laboratories, Inc., 463 West St., New York, N.Y. For mail: 144 Elm St., Rahway, N.J.
- GIESE, RAYMOND C. (A'22-M'31), Division Plant Engineer, American Telephone and Telegraph Company, 1421 Champa St., Denver, Colo.
- GIET, G. ROBERT (A'25-M'29), Associate Professor, Post-Graduate School, U. S. Naval Academy, Annapolis, Md.
- GIFFORD, DELBERT K. (A'26), Airways Communication Station, U. S. Department of Commerce, Fresno, Calif.
- GIHRING, HERMAN E. (A'29), Radio Engineer, RCA Victor Company, Inc., Camden, N.J. For mail: 1102 Park Ave., Collingswood, N.J.
- GILBERT, GEORGE (A'27), 514 Sturdee St., Esquimalt, Victoria, B.C., Canada.
- GILBERT, JOHN C. (A'31), Radio and Sound Specialist, John C. Gilbert Company, 15 N.W. 12th Ave., Miami, Fla.
- GILBERT, JOHN J. (A'16), Engineer, Bell Telephone Laboratories, Inc., 463 West St., New York, N.Y.
- GILBERT, LESTER H. (A'31), Radio Engineer, Howitt-Wood Radio Company, 92 Seneca St., Binghamton, N.Y.
- GILBERT, WALTER E. (A'30), Engineer, H. H. Eby Manufacturing Company, 22nd and Lehigh Aves., Philadelphia, Pa. For mail: 125 Apsley St., Philadelphia, Pa.
- GILBERTSON, BERNARD (A'30), Engineer, Frank Rieber, Inc., 170-2nd St., San Francisco, Calif. For mail: 429-43rd St., Oakland, Calif.
- GILCHER, V. J. (A'29), Plant Engineer, National Broadcasting Company, Inc., 711-5th Ave., New York, N.Y. For mail: 435 Palsade Ave., Bogota, N.J.
- GILDEMEYER, F. H. (A'31), Engineer and Division Inspector, Electrical Research Products, Inc., 2111 Woodward Ave., Detroit, Mich. For mail: c/o Electrical Research Products, Inc., 916 Francis Palms Bldg., Detroit, Mich.
- GILFILEN, LOUIS J. (A'31), Radio Technician, Gilfilen Radio Promotion Systems, 115 Baer St., Huntington, W.Va.
- GILL, ARCHIBALD J. (M'20), Executive Engineer, Engineering Department, G.P.O., London, E.C.1, England.
- GILL, WILLIAM (A'26), Vice President, Zaney Cill Corporation, 1727 W. 22nd St., Chicago, Ill.
- GILLEN, JOHN JAMES (A'31), Assistant Division Engineer of Inspection and Test, RCA Victor Company, Inc., Camden, N.J. For mail: 2329 St. Albans St., Philadelphia, Pa.
- GILLET, GLENN D. (A'22-M'27), Engineer, Bell Telephone Laboratories, Inc., 463 West St., New York, N.Y. For mail: 279 Audubon Rd., Englewood, N.J.
- GILLETTE, E. C., JR. (A'31), Lieutenant, Instructor, Department of Chemistry and Electricity, U. S. Military Academy, West Point, N.Y.
- GILLETTE, K. G. (A'29), RCA Victor Company, Inc., Camden, N.J. For mail: Grahamsville, N.Y.
- GILLIATT, LELAND W. (A'26), Munder Electrical Company, 97 Orleans St., Springfield, Mass.
- GILLILAND, THEODORE R. (A'28), Assistant Physicist, Radio Laboratory, U. S. Bureau of Standards, Washington D.C.
- GILLINGHAM, A. (A'30), Royal Canadian Signals, Camp Borden, Ont., Canada. For mail: General Delivery, Barrie, Ont., Canada.
- GILLMEISTER, FREDERICK W. (A'31), Student, University of California, Berkeley, Calif. For mail: 405 Meridian Rd., San Jose, Calif.
- GILLULE, WILLIAM J. (A'28), Field Engineer, Mackay Radio and Telegraph Company, 33 S. William St., New York, N.Y. For mail: 762 Hopkinson Ave., Brooklyn, N.Y.

- GILMAN, GEORGE W. (A'29), American Telephone and Telegraph Company, Radio Station, Lawrenceville, N.J.
- GILMOUR, PETER (A'29), Electrical Engineer, Main Rd., Muizenberg Cape, South Africa.
- GIMMY, NORMAN H. (A'26), Radio Sales, General Electric Company, Bridgeport, Conn.
- GIOGA, PETER C. (A'26), Recorder, Columbia Pictures Corporation, Hollywood, Calif. For mail: 3205 Berkeley Ave., Los Angeles, Calif.
- GIOVANINI, FRANK (A'28), Member of Technical Staff, Bell Telephone Laboratories, Inc., Rm. J-40, 463 West St., New York, N.Y.
- GIRARD, E. J. (A'28), Superintendent, Marine Department, Mackay Radio and Telegraph Company, 33 S. William St., New York, N.Y.
- GIRO, DANIEL J. (A'29), Head of Order Department, The New England News Company, 93-101 Arch St., Boston, Mass. For mail: 140 Harrishof St., Roxbury, Mass.
- GJELHAUG, JOHN A. (A'17), County Surveyor and Civil Engineer, Baudette, Minn.
- GLADKOV, CYRIL A. (A'29), Chief of the Physico-Technical Division, Scientific Research Institute of Motion Picture Industries, Jitnaia 29, Moscow, U.S.S.R. For mail: Miasnitskaia 46 Kv. 5, Moscow, U.S.S.R.
- GLASER, EDWARD M. (A'27), Electrical Research Engineer, Radio Station W2BRB, 209 E. 16th St., Brooklyn, N.Y.
- GLASER, MARCUS (A'28), In Charge of Engineering, United Scientific Laboratories, 510-6th Ave., New York, N.Y. For mail: 2300 E. 13th St., Brooklyn, N.Y.
- GLASGOW, ROY S. (M'26), Associate Professor of Electrical Engineering, Washington University, St. Louis, Mo. For mail: 7373 Kingsbury Blvd., University City, Mo.
- GLASS, ROBERT Z. (A'27), Proprietor, Public Address Service Company, 2024 1/2 Commerce St., Dallas, Tex. For mail: 5502 East Side, Dallas, Tex.
- GLASSCOCK, GLEN R. (A'28), Industrial Lubrication Engineer, Standard Oil Company, 21 N. 12th St., Brooklyn, N.Y. For mail: 139-47-87th Ave., Jamaica, L.I., N.Y.
- GLASSMAN, GEORGE (A'29), Engineer and Manager, Consultation Department, Radio Training Association of America, 4513 Ravenswood Ave., Chicago, Ill. For mail: 5720 S. Hoyne Ave., Chicago, Ill.
- GLATZEL, EARLE D. (A'26), Radio Engineer, Detroit Edison Company, 2000-2nd Ave., Detroit, Mich. For mail: 139 Grove Ave., Highland Park, Mich.
- GLAUBER, JOHN J. (A'27), Laboratory Assistant, Arcturus Radio Company, 255 Sherman Ave., Newark, N.J. For mail: 151 N. 12th St., Newark, N.J.
- GLEASON, ALBERT E. (A'29), Public Address Systems, 14 Ferraro St., Worcester, Mass.
- GLEASON, HAROLD H. (A'25), Production Test Engineer, RCA Victor Company of Massachusetts, 76 Atherton St., Jamaica Plain, Mass. For mail: 47 Berwick St., Belmont: 1304 E. 62nd St., Seattle, Wash.
- GLEASON, ROBERT J. (A'31), Radio Electrician, Washington, Alaska Military Cable and Telegraph System, Signal Corps, U. S. Army, Arcade Bldg., Seattle, Wash. For E. 62nd St., Seattle, Wash.
- GLEASON, STERLING (A'29), Writer, 650 California Ave., Venice, Calif.
- GLENDENNING, D. B. (J'26-A'28), Radio Technician, Auto Courtesy Shop, 2302 Salem Ave., Dayton, Ohio.
- GLESSNER, JACK M. (A'30), Radio Engineer, Engineering Department, Crosley Radio Corporation, Cincinnati, Ohio.
- GLOSSOP, ARTHUR A. (A'26), Consulting Radio Engineer, 33 Park Head Crescent, Ecclesall, Sheffield, England.
- GLOVER, HARRY (A'31), Wireless Engineer, E. and H. Glover, 2 Skinnergate, Darlington Co., Durham, England.
- GROVER, RALPH P. (A'28), In Charge of Sound Equipment, Development and Production, Silver-Marshall, Inc., 6401-6451 W. 65th St., Chicago, Ill. For mail: 7632 S. Shore Dr., Chicago, Ill.
- LUCK, E. J. (A'26), General Manager, Radio Station WBT, Charlotte, N.C.
- GODDARD, DEWITT R. (A'31), R.C.A. Communications, Inc., Riverhead, L.I., N.Y. For mail: 303 Main St., Riverhead, L.I., N.Y.
- GODDARD, FREDERICK M. (A'26), Proprietor, Bay Ridge Radio Service, 509-76th St., Brooklyn, N.Y. For mail: 668-77th St., Brooklyn, N.Y.
- GODDARD, JOHN B. (J'29), Consulting Engineer, Fayette Investment Company, Inc., Fayette County National Bank Bldg., Fayetteville, W. Va.
- GODFREY, F.E. (A'30), Radio Engineer, 4 High St., Hampstead, London, N.W. 3, England.
- GODFREY, JAMES S. (A'30), Operator, Radio Station WTAG, Worcester Telegram and Gazette, 18 Franklin St., Worcester, Mass.
- GODLEY, PAUL F. (A'14), Secretary-Treasurer, Chalmers-Godley Corporation, 879 Broad St., Newark, N.J. For mail: 10 Marion Rd., Upper Montclair, N.J.
- GODSHO, ALBERT P. (A'21), Engineer of Transmission and Protection, Bell Telephone Company of Pennsylvania, 1835 Arch St., Philadelphia, Pa.
- GOEBEL, EUGENE S. (A'26), Secretary and Treasurer, Western Michigan Music Company, 59 Market St., Grand Rapids, Mich.
- GOERING, RAYMOND A. (A'30), Radio Service Manager, Corner Book Store, 28 S. Main St., Canandaigua, N.Y. For mail: 11 1/2 Sly St., Canandaigua, N.Y.
- GOHEEN, RICHARD C. (A'30), Chief Inspector, Crosley Radio Corporation, 3401 Colerain Ave., Cincinnati, Ohio.
- GOLD, HERMAN (A'21), 282 Broadway, Paterson, N.J.
- GOLDENBERG, HENRY E. (J'23-A'26), Announcer and Operator, Radio Station WHB, Sweeney School, Kansas City, Mo. For mail: 6009 Central St., Kansas City, Mo.
- GOLDER, FRANK E. (A'29), Chief Engineer, Radio Station KTAT, Fort Worth, Tex.
- GOLDFINCH, H. R. (A'30), Star Radio and Electrical Supplies, Dawson St., Strathalbyn, South Australia.
- GOLDHAMER, SAUL A. (A'31), Toronto District Service Supervisor, Research Products Engineering Department, Northern Electric Company, Ltd., 131 Simcoe St., Toronto, Ont., Canada. For mail: 1 Starr Ave., Toronto, Ont., Canada.

- GOLDIN, HYMAN C. (A'27), Eastern Division Operating Supervisor, Northern Electric Company, Ltd., 637 Craig St., W., Montreal, P.Q., Canada. For mail: 4890 Queen Mary Rd., Montreal, P.Q., Canada.
- GOLDING, ROBERT M. (A'28), Installation Department, Western Electric Company, Inc., 111 W. Washington St., Chicago, Ill. For mail: 1702 Geneva Pl., Milwaukee, Wis.
- GOLDMAN, SHERMAN (A'29), Manager, Postal Telegraph and Cable Company, 1537 Graliot Ave., Detroit, Mich. For mail: 5432 Livernois Ave., Detroit, Mich.
- GOLDMAN, STANLEY (A'27), Radio Service Manager, Lexington Radio Stores, 2039 W. Madison St., Chicago, Ill. For mail: 3505 W. Adams St., Chicago, Ill.
- GOLDNER, JACK H. (A'31), Radio Service, Ludwig Baumann and Company, 45 Pearson St., Long Island City, L.I., N.Y. For mail: 41-16-51st St., Woodside, L.I., N.Y.
- GOLDSMITH, ALFRED N. (M'12-F'15), Vice President and General Engineer, Radio Corporation of America, RCA Bldg., 570 Lexington Ave., New York, N.Y.
- GOLDSMITH, LLOYD T. (A'27), Engineer, Transmission Department, Warner Brothers Pictures, Inc., Burbank, Calif. For mail: 4617 Clarissa Ave., Hollywood, Calif.
- GOLDSTEIN, HENRY R. (A'29), Radio Sales and Service, 632 S. Peters St., New Orleans, La.
- GOLDSTEIN, MAXWELL K. (A'30), 1701 E. Lanville St., Baltimore, Md.
- GOLDSTINE, HALLAN E. (A'29), Radio Transmitter Design Engineer, Radio Corporation of America, Radio Central, Rocky Point, L.I., N.Y.
- GOLTEN, J. N. (A'27), Field Engineer, Stewart-Warner Corporation, 1826 Diversey Pkwy., Chicago, Ill. For mail: 5242 Hyde Park Blvd., Chicago, Ill.
- GONZALES, JORGE L. (A'28), P.O. Box 1368, Havana, Cuba.
- GOOD, HORACE D. (A'28), Technician, Reading Broadcasting Company, Pomeroy Bldg., Reading, Pa. For mail: 419 Gordon St., Reading, Pa.
- GOODALL, WILLIAM M. (A'29), Member of Technical Staff, Bell Telephone Laboratories, Inc., P.O. Box 122, Deal, N.J.
- GOODBERLET, EDWARD (A'31), Chief Engineer, Radio Station KWK, Greater St. Louis Broadcasting Corporation, Hotel Chase, St. Louis, Mo. For mail: 6604 Tyler Ave., St. Louis, Mo.
- GOODBOY, GEORGE O. (A'31), Audit Clerk, Union Railroad Company, 1419 Carnegie Bldg., Pittsburgh, Pa. For mail: 3341 Latonia Ave., Dormont, Pittsburgh, Pa.
- GOODE, KENNETH H. (A'27), Professor of Chemistry, Colgate University, Hamilton, N.Y. For mail: 30 Milford St., Hamilton, N.Y.
- GOODENOW, GRUDE J. (A'31), Proprietor, Radio Service, 608 Main St., Riverton, N.J.
- GOODFELLOW, DAVID H. (A'31), Watch Engineer, R.C.A. Communications, Inc., Rocky Point, L.I., N.Y. For mail: P. O. Box 171, Rocky Point, L.I., N.Y.
- GOODRICH, ROBERT R., II (J'27-A'28), Student Engineer, RCA Victor Company, Inc., Camden, N.J. For mail: 427 Penn St., Camden, N.J.
- GOODSPEED, LYNMORE S. (A'27), Chief Technician, Brunswick Radio of Canada, Ltd., Toronto, Ont., Canada.
- GOODWIN, EDWIN A. (A'30), Assistant Radio Engineer, Fort Monmouth, Oceanport, N.J. For mail: P.O. Box 64, Long Branch, N.J.
- GOODWIN, W. NELSON, JR. (A'15-M'29), Chief Electrical Engineer, Weston Electrical Instrument Corporation, Newark, N.J. For mail: 30 Scheerer Ave., Newark, N.J.
- GOORD, H.V. (A'29), First Operator, Wireless Telegraph Section, Messrs. Siemens Brothers and Company, Ltd., Woolwich, London, England. For mail: 15 Southey Rd., Wimbledon, London, S.W. 19, England.
- GORDINHO, T.J. (A'31), Wireless Operator, Posts and Telegraphs, Lumbo-Mozambique, Portuguese East Africa. For Mail: Post Office, Lourenco Marques, Portuguese East Africa.
- GORDON, GEORGE (A'25), Harrington Park, N.J.
- GORDON, HARRY E. (A'26), Equipment Engineer, Rochester Telephone Corporation, 25 North St., Rochester, N.Y. For mail: 307 Laburium Crescent, Rochester, N.Y.
- GORDON, MALCOLM J. (A'31), Radio Serviceman, Ludwig Baumann and Company, 45 Pearson St., Long Island City, L.I., N.Y. For mail: 121-06-109th Ave., Richmond Hill, L.I., N.Y.
- GORDON, MALCOLM K., JR. (A'29), Transmission Research Department, Bell Telephone Laboratories, Inc., 463 West St., New York, N.Y. For mail: 219 Broad St., Newark, N.J.
- GORECKI, JOSEPH M. (J'31), Student, East Technica High School, Cleveland, Ohio. For mail: 3682 E. 61st St., Cleveland, Ohio.
- GORHAM, ROBERT C. (A'26), Assistant Professor of Electrical Engineering, University of Pittsburgh, Parkman and O'Hara Sts., Pittsburgh, Pa.
- GORMAN, ROBERT (A'30), Manager, The Commercial Engineering Company, Colne Rd., Brierfield, Lancashire, England. For mail: 88 Colne Rd., Brierfield, Burnley, Lancashire, England.
- GORTON, ROLLAND ELMER (A'24), 217 Walnut St., Montclair, N.J.
- GOSHAW, IRL R. (A'30), Patent Attorney, c/o Wired Radio, Inc., Ampere, N.J.
- GOTHE, ALBRECHT (A'30), Engineer, Telefunken, Hallesches Ufer 12, Berlin, S.W. 11, Germany.
- GOTTIER, THOMAS L. (A'30), Radio Engineer, Sparks-Withington Company, 115 S. Horton, Jackson, Mich. For mail: 1105 W. Michigan Ave., Jackson, Mich.
- GOUGH, JOHN H. (A'30), Radio Engineer, Westinghouse Electric and Manufacturing Company, Chicopee Falls, Mass. For mail: 18 Arlington St., Chicopee Falls, Mass.
- GOULD, GEORGE B. (A'26), 124 Park St., San Francisco, Calif.
- GOULD, HOWARD S. (A'25), University of Michigan, Detroit, Mich. For mail: 214 Tuxedo Ave., Highland Park, Mich.
- GOULD, WILLIAM B., III (A'26), 84 Stoughton Ave., Hyde Park, Mass.
- GOUNARIDES, A. D. (A'29), c/o Gounarides and Vassiliades, 31 Syngrou, Salonica, Greece.

GOVE, EDWARD L. (A'28), Technical Supervisor, Radio Air Service Corporation, Terminal Tower Bldg., Cleveland, Ohio.

GOWAN, HUBERT S. (A'25), Model Builder, Victor Talking Machine Company, Lenoir St., Montreal, P.Q., Canada. For mail: 819 Godin Ave., Verdun, P.Q., Canada.

GOWEN, ROBERT F. (M'20), Consulting Engineer and Director, The Robert F. Gowen Laboratories, Ossining-on-Hudson, N.Y. For mail: Overton Rd., Ossining, N.Y.

GOWER, S. GIFFORD (A'28), Mabry Radio Service Shop, Hazel St., Beaumont, Tex. For mail: 1007 Ewing St., Beaumont, Tex.

GOYDER, C. W. (A'30), International Standard Electric Corporation, 46 Avenue de Breteuil, Paris, France.

GRABO, IRVING C. (A'31), Radio Engineer, Radio Station WOR, 1440 Broadway, New York, N.Y. For mail: 129 Midland Ave., Glen Ridge, N.J.

GRACE, A. (A'27), Chief Engineer, 3KZ Broadcasting Company, 40 Victoria St., Melbourne, Australia. For mail: 10 Service St., Essendon, Victoria, Australia.

GRACIE, JOHN A. (A'28), Radio Engineer, Engineer-in-Chief's Office, G.P.O., Research Laboratories, Dollis Hill, London, N.W. 2, England.

GRAEF, HENRY H. (A'31), Proprietor, Graef Radio Service, 3110 N. Damen Ave., Chicago, Ill.

GRAF, ALOIS W. (A'26), Patent Attorney, General Electric Company, Schenectady, N.Y. For mail: 9 N. Church St., Apartment 306, Schenectady, N.Y.

GRAF, HERMAN, JR. (A'19), Radio Engineer, Bureau of Engineering, Navy Department, Washington, D.C. For mail: 3035 Pressman St., Baltimore, Md.

GRAF, WILLIAM (A'31), Serviceman, Ludwig Baumann and Company, 45 Pearson St., Long Island City, L.I., N.Y. For mail: 169-01-144th Ave., Springfield Gardens, L.I., N.Y.

GRAFT, J. EMMET (A'26), Chief Engineer, Radio Station WHAS, The Louisville Courier-Journal Company, Louisville, Ky. For mail: 2214 Wrockledge Ave., Louisville, Ky.

GRAHAM, BURWELL (A'28), Inspector, Chassis Test, Spartan of Canada, Ltd., Elm St., London, Ont., Canada. For mail: 70 Byron Ave., London, Ont., Canada.

GRAHAM, C. (A'30), Wireless Operator, British Wireless Marine Service, London, England. For mail: 67 Carleton Rd., Tufnell Park, London, N. 7, England.

GRAHAM, FRANK H. (A'23), Theatre System Engineering and Synchronized Pictures, Electrical Research Products, Inc., 250 W. 57th St., New York, N.Y.

GRAHAM, GEORGE W. (A'26), Major, U. S. Army, Savanna Ordnance Depot, Savanna, Ill.

GRAHAM, HERBERT T. (A'28), Graduate Instructor of Physics, Michigan State College, East Lansing, Mich. For mail: 302 N. Francis St., Lansing, Mich.

GRAHAM, VIRGIL M. (A'24-M'27), Radio Engineer, Stromberg-Carlson Telephone Manufacturing Company, 100 Carlson Rd., Rochester, N.Y.

GRAHAM, WILLIAM A. (A'16-M'17), Assistant to Executive Vice President, RCA

Photophone, Inc., 411-5th Ave., New York, N.Y.

GRAINGER, MAURICE J. (A'29), Recording Engineer, 112-37-175th Pl., St. Albans, L.I., N.Y.

GRAMMER, GEORGE (A'30), Assistant Technical Editor, QST, American Radio Relay League, West Hartford, Conn. For mail: 334 S. Quaker Lane, West Hartford, Conn.

GRAMMES, CLARENCE W. (A'30), Proprietor, Grammes Radio Service, 1425 Gordon St., Allentown, Pa.

GRANGE, GIFFORD (A'27), Senior Radio Operator, Broadcasting Station WJAX, Jacksonville, Fla. For mail: Route No. 1, P.O. Box 103, South Jacksonville, Fla.

GRANGER, HAROLD (A'31), Radio Section, U. S. Naval Research Laboratory, Bellevue, Anacostia, D.C.

GRANT, ERIC A. (J'27-A'29), Radio Technician, DeForest Crosley Radio Corporation, Carlaw Ave., Toronto, Ont., Canada. For mail: 38 Radford Ave., Toronto, Ont., Canada.

GRANT, INGOL M. (A'30), Field Engineer, Roger's Radio Tubes, Ltd., 100 Sterling Rd., Toronto, Ont., Canada. For mail: 985 Queen St., S.E., Toronto, Ont., Canada.

GRANT, LAWRENCE E. (J'28-A'29), Radio Operator, Radio Station WDRC, Bloomfield, Conn. For mail: 51 Bartlett Ave., Belmont, Mass.

GRANT, MARK S. (A'30), Radio Instructor, New York University, University Heights, New York, N.Y. For mail: 404-10th Ave., Paterson, N.J.

GRANT, R. L. C. (J'27-A'29), Laboratory, G.P.O., Wellington, New Zealand.

GRAVES, WILLIAM S. (A'21), Cutting and Washington, New York, N.Y. For mail: Sunapee, N.H.

GRAVESON, GEORGE L. (A'28), Studio Service Superintendent, Electrical Research Products, Inc., 250 W. 57th St., New York, N.Y.

GRAVLIN, LEE F. (A'26), 805 Park Ave., Bridgeport, Conn.

GRAY, ALFRED R. (A'27), Production Engineer, RCA Victor Company of Massachusetts, 76 Atherton St., Jamaica Plain, Boston, Mass. For mail: Box 82, Northwood Ridge, N.H.

GRAY, DE WAYNE R. (J'29), Electrical Engineer, Continental Can Company, Camden, N.J. For mail: Andes, Delaware County, N.Y.

GRAY, FLOYD E. (A'25), Radio Engineer, Eastern Air Transport, Inc., Candler Field, Atlanta, Ga.

GRAY, HAROLD E. (A'25-M'29), Communications Engineer, Universal Division, American Airways, Inc., Robertson, Mo.

GRAY, J. BIRNIE (A'31), Mechanic, Pratt and Whitney Aircraft, East Hartford, Conn. For mail: 48 Livingston Rd., East Hartford, Conn.

GRAY, JOHN M. (A'31), Proprietor, Radio Service Shop, Box 449, Anniston, Ala.

GRAY, KLINE (A'30), Sales Engineer, Westburg Engineering Company, 53 W. Jackson Blvd., Chicago, Ill. For mail: Rm. 703, Monadnock Bldg., Chicago, Ill.

GRAY, RICHARD E. (A'26), Radio Engineer, International Standard Electric Corporation, 46 Avenue de Breteuil, Paris, France.

GRAY, WILLIAM (A'30), Chief Engineer, Clausing's, Ltd., 119 W. Anaheim, Wilmington, Calif. For mail: 1895 Walnut Ave., Long Beach, Calif.

GREATHEAD, ARTHUR W. (A'29), Proprietor, Radio Service, 109 S. Franklin Ave., Morton, Pa.

GREAVES, V. FORD (F'28), Assistant Chief Engineer, Federal Radio Commission, Washington, D.C. For mail: 524 Woodley Park Towers, Washington, D.C.

GREBE, ALFRED H. (A'17-F'27), 70 Van Wyck Blvd., Richmond Hill, L.I., N.Y.

GREELEY, PHILIP H. (A'28), Technical Radio Editor, Washington Herald, Advertising Department, Washington, D.C. For mail: 2632 Garfield St., Washington, D.C.

GREEN, ALBERT A. (A'31), East 105, 22 Avenue S, St. Petersburg, Fla.

GREEN, ALFRED L. (A'28), Commonwealth Research Officer, Commonwealth Council for Scientific and Industrial Research, The University, Sydney, New South Wales, Australia.

GREEN, ASHBEL (A'19), New York Stock Exchange, 11 Wall St., New York, N.Y.

GREEN, CHARLES M., JR. (A'27), President and General Manager, Radio Sales and Service Company, 30 E. Pine St., Orlando, Fla.

GREEN, DARRELL B. (A'29), Assistant Professor, Physics and Electrical Engineering, Ohio University, Athens, Ohio. For mail: 291 E. State St., Athens, Ohio.

GREEN, ERNEST (A'17), Penrose, Long Stomps Ave., Chelmsford, Essex, England.

GREEN, ESTILL I. (A'27), Communication Engineering, Department of Development and Research, American Telephone and Telegraph Company, 195 Broadway, New York, N.Y.

GREEN, GARNETT L. (A'31), Production Superintendent, Spartan of Canada, Ltd., Elm St., London, Ont., Canada. For mail: 1237 Florence St., London, Ont., Canada.

GREEN, IRVING L. (A'30), Engineer, Federal Telegraph Company, Palo Alto, Calif. For mail: 213 Fulton St., Palo Alto, Calif.

GREEN, JOHN J. (A'31), Gulf States Utilities Company, 2535 Grand Ave., Beaumont, Tex.

GREEN, PRESTON W. (A'31), Chief Radioman, U. S. Navy, U. S. Submarine Base, Pearl Harbor, Hawaii. For mail: 741-8th Ave., Honolulu, Hawaii.

GREEN, RALPH W. (A'30), Electrician, Wired Radio, Inc., 4th Ave. and 13th St., Newark, N.J. For mail: 18 Girard Ave., East Orange, N.J.

GREEN, WALTER M. (A'29), Proprietor, Central Radio Service, 10335 Hamilton Ave., Detroit, Mich.

GREEN, WILLIAM (A'31), Chief Engineer, Columbia Specialty Company, 925 Westchester Ave., New York, N.Y. For mail: 755 West End Ave., New York, N.Y.

GREEN, WILLIAM G. (A'25), Geophysicist, Seismograph Service Corporation, 346 Kennedy Bldg., Tulsa, Okla.

GREENBLATT, LOUIS (A'28), Service Engineer, Waterbury Radio Service, 167 S. Main St., Waterbury, Conn. For mail: 289 Cooke St., Waterbury, Conn.

GREENE, GEORGE J. (J'27-A'28), Radio Serviceman, Ditmars Radio and Electric Supply Company, 911-2nd Ave., Astoria, L.I., N.Y.

GREENE, HARRY A. (J'16-A'20), Radio Engineer, Remler Company, Ltd., San Francisco, Calif. For mail: 44 Escondido Ave., San Francisco, Calif.

GREENE, HARRY A. (A'26), Ditmars Radio and Electrical Supply Company, 911-2nd Ave., Long Island City, L.I., N.Y.

GREENE, LLOYD C. (A'22), Radio Editor, Boston Globe, 244 Washington St., Boston, Mass. For mail: 43 Hillside Ave., Wollaston, Mass.

GREENE, PAUL A. (M'26), Manager of Broadcasting, Columbia Broadcasting System, Inc., 485 Madison Ave., New York, N.Y. For mail: 47 E. 61st St., New York, N.Y.

GREENE, WARREN L. (A'30), 706 S. State St., Grangeville, Idaho.

GREENFIELD, DANIEL C. (J'30), 2nd Class Communication Wireless Operator, Douds, Iowa.

GREENMAN, ROGER B. (A'26), Radio Operator, Radio Station WPDR, 140 Bronson Ave., Rochester, N.Y. For mail: 62 Shelter St., Rochester, N.Y.

GREENSTEIN, PHILIP (A'28), Instructor in Electrical Engineering, New York University, University Heights, New York, N.Y.

GREENWALD, ARTHUR A. (A'28), Service Manager and Instructor, H. C. Roberts Electric Supply Company, 11th and Race Sts., Philadelphia, Pa. For mail: 141 N. Madison Ave., Highland Park, Pa.

GREGER, J. G. (A'29), 1810 S. Chapel St., Alhambra, Calif.

GREGORY, CHARLOTTE C. (A'18), The John Crerar Library, Chicago, Ill. For mail: P.O. Box N, Winnetka, Ill.

GREGORY, S. D. (A'29), Radio Engineer, Radio Operations Department, Westinghouse Electric and Manufacturing Company, East Pittsburgh, Pa. For mail: 7915 St. Lawrence Ave., Swissvale, Pa.

GREIBACH, EMIL H. (A'31), Chief Engineer, Sonotone Corporation, 19 W. 44th St., New York, N.Y. For mail: 863 Carroll St., Brooklyn, N.Y.

GREIFF, VICTOR (M'18), Research Engineer, Radio Receptor Company, 106-7th Ave., New York, N.Y. For mail: 202 W. 79th St., New York, N.Y.

GREIG, JAMES (A'30), Research Laboratory, General Electric Company, Ltd., Wembley, England.

GREIG, JOHN (A'25), Engineer, 802 Graybar Bldg., New York, N.Y.

GREIS, W. KARL (A'27), Radio Engineer, Westinghouse Electric and Manufacturing Company, Chicopee Falls, Mass. For mail: 102 Middlesex St., Springfield, Mass.

GRENIER, HENRY N. (A'28), Radio Service Laboratory, Hiawatha Ave., Lake View, Waltham, Mass.

GREVES, GEORGE L. (A'20), Engineer, Pacific Telephone and Telegraph Company, 140 New Montgomery St., San Francisco, Calif. For mail: 2635 Woolsey St., Berkeley, Calif.

GREY, CHARLES C. (A'31), Field Engineer, National Broadcasting Company, Inc., 711-5th Ave., New York, N.Y. For mail: 2 Sherwood Ter., Yonkers, N.Y.

GRIFFITH, M. H. (A'25), Radio Electrician, U. S. Coast Guard, Washington, D.C. For mail: U. S. Coast Guard, Custom House, Mobile, Ala.

- GRIFFITH, M. H. (A'31)**, 3250 Santa Ana St., Southgate, Calif.
GRIFFITH, PAUL E. (J'29-A'29), Electrical Technician in Psychology, State University of Iowa, 45-B Quadrangle, Iowa City, Iowa.
GRIFFITH, ROY T. (A'24), Transmission Engineer, Bell Telephone Company of Pennsylvania, 416-7th Ave., Pittsburgh, Pa.
GRIFFITHS, CLARENCE M. (A'21), Receiver Design Engineer, R.C.A. Communications, Inc., 66 Broad St., New York, N.Y.
GRIFFITHS, HERBERT V. (A'28), Research Department, Marconi's Wireless Telegraph Company, Ltd., Chelmsford, Essex, England.
GRIFFITHS, W. H. F. (M'27), Chief Engineer, W. H. Sullivan, Ltd., Leo St., London, S.E. 15, England. For mail: 220 Court Rd., Eltham, S.E. 9, London, England.
GRIGG, JAMES W. (A'31), Proprietor, Grigg Radio Laboratory, 80 E. Roanoke Ave., Phoenix, Ariz. For mail: 914 N. 3rd St., Phoenix, Ariz.
GRIGGS, ELMER V. (A'16), Western Electric Company, Inc., New York, N.Y. For mail: 16 Ridgeview Ave., White Plains, N.Y.
GRIM, CLAIR R. (A'24), Chief Engineer, Grim and Company, Camp Hill, Pa. For mail: 2228 Boas St., Harrisburg, Pa.
GRIMES, DAVID (A'20-M'28), Engineer, Patent Department, License Division, Radio Corporation of America, 75 Varick St., New York, N.Y. For mail: 1639 Richmond Rd., Dongan Hills, S.I., N.Y.
GRIMES, H. B. (A'31), Senior Engineer, Northern Electric Company, Ltd., 65 Rorie St., Winnipeg, Manit., Canada.
GRIMES, WILLIAM F. (A'16), Electrical Engineer, Westinghouse Electric and Manufacturing Company, 420 S. San Pedro St., Los Angeles, Calif. For mail: 416 La Frace Ave., Alhambra, Calif.
GRIMWOOD, FRED O. (A'30), Engineer, Radio Station WFIW, 8th and Main Sts., Hopkinsville, Ky. For mail: P.O. Box 353, Hopkinsville, Ky.
GRITZNER, FRED A. (A'24), Inspector, Radiomarine Corporation of America, 75 Varick St., New York, N.Y.
GRIVA, JOHN (A'28), Electrician, Hotel Statler, Detroit, Mich. For mail: 13943 Mayfield, Detroit, Mich.
GROGAN, LESLIE EDWARD (A'30), c/o RCA Photophone, Inc., 671-2nd Ave. N., Minneapolis, Minn.
GRONOW, WILLIAM R. (A'31), Radio Engineer and Experimenter, 346 St. Kilda Rd., Melbourne, Victoria, Australia.
GROSCLOSE, SAMUEL K. (A'31), c/o Bureau of Navigation, Navy Department, Washington, D.C.
GROSS, BENJAMIN F. (A'27), Assistant Manager and Radiotrician, Stecker's Book Store, 20 N. Oak St., Mount Carmel, Pa. For mail: 451 West Ave., Mount Carmel, Pa.
GROSS, GERALD C. (A'27-M'30), Radio Engineer, Federal Radio Commission, Washington, D.C. For mail: 201 E. Thornapple St., Chevy Chase, Md.
GROSS, RALPH (A'30), Engineer, 248 Palisade Ave., Jersey City, N.J.
GROSSELPINGER, WALTER H. (A'31), Radio Department, Embry-Riddle Division, American Airways, Inc., Lunken Airport, Cincinnati, Ohio.

GROSKOWSKI, J. (M'31), Professor, Higher Polytechnical School, Koszykowa 75, Warsaw, Poland. For mail: Grazyiny 7, Warsaw, Poland.

GROTE, ERNEST A. (A'30), Teacher, 1936 Sharon Ave., Detroit, Mich.

GROVE, GEORGE A. (A'26), Service Manager, Morey Company, Inc., Detroit, Mich. For mail: 2832 E. Grand Blvd., Detroit, Mich.

GROVE, HOWARD G. (A'30), Chief Instructor, Radio Institute of California, 1117 Venice Blvd., Los Angeles, Calif. For mail: 1647 S. Shenandoah St., Los Angeles, Calif.

GROVE, WILLIAM C. (A'27), Chief Operator, Radio Station KOW, 1429 Champa St., Denver, Colo. For mail: 1337 S. University St., Denver, Colo.

GROVER, FREDERICK W. (M'17), Union College, Engineering Department, Union College, Schenectady, N.Y.

GROVER, HARRY G. (M'30), Patent Attorney, Radio Corporation of America, 570 Lexington Ave., New York, N.Y.

GROVER, HORACE J. (A'31), Rockefeller Hall, Cornell University, Ithaca, N.Y.

GROVES, ERNEST F. (A'31), Expert Radiotrician, 10 Rutland St., Hudson, Mass.

GROVES, WAYLAND M. (A'27), Geophysicist, Humble Oil and Refining Company, Houston, Tex. For mail: 1204 Carrier St., Denton, Tex.

GRUENEWALD, HAROLD C. (A'29), Radio Serviceman, Southern California Music Company, 720 Broadway, San Diego, Calif. For mail: 3717 Wightman, San Diego, Calif.

GRUETZKE, CHARLES P. E., JR. (A'27), Service Manager, Bludworth, Inc., 254 W. 31st St., New York, N.Y. For mail: 1831 E. 34th St., Brooklyn, N.Y.

GRUMMAN, F. W. (J'30), Toro Point Radio Compass Station, Fort Sherman, Canal Zone.

GRUNDMANN, GUSTAVE L. (A'29), Engineer, RCA Victor Company, Inc., Camden, N.J. For mail: 112 E. Coulter Ave., Collingswood, N.J.

GRUNINGER, JOHN E. (J'27), Research Engineer, National Electric Company, 9916 Newton Ave., Cleveland, Ohio. For mail: 412 Conewango Ave., Warren, Pa.

GRUNWALD, WERNER J. (A'31), Radio Serviceman, Ludwig Baumann and Company, 45 Pearson St., Long Island City, L.I., N.Y. For mail: 2661 Decatur Ave., New York, N.Y.

GRUPE, EMILIO (A'27), Engineer, Radio Corporation of The Philippines, Manila, Philippine Islands. For mail: P.O. Box 2518, Manila, Philippine Islands.

GRUSKIN, GEORGE (A'30), Managing Editor, Radio Industries, 520 N. Michigan Ave., Chicago, Ill.

GRUZIN, HERMAN A. (J'30), Radio Operator, Radio Stations WORC-WEPS, 60 Franklin St., Worcester, Mass. For mail: 6 Fox St., Worcester, Mass.

GUARNIERI, GAETANO MONTI (A'31), Radio Engineer, Fabbrica Italiana Magneti Marelli, Sesto S. Giovanni, Milan, Italy. For mail: Viale Abruzzi 27, Milan, Italy.

GUBER, FRED H. (A'25), Mechanical Design Department, Radio Corporation of America, 70 Van Cortlandt Park South and Saxon Ave., New York, N.Y. For mail: 428-5th Ave., Roselle, N.J.

GUBIN, SAMUEL (A'30), Student, Yale University, New Haven, Conn. For mail: 56 Vernon St., New Haven, Conn.

GUGGENHEIM, S. (A'30), President, Telion A-G, Bahnhofplatz 3, Zurich, Switzerland.

GUILD, BALDWIN (J'16-A'17-M'26), Patent Attorney, Pennie, Davis, Marvin and Edmonds, 165 Broadway, New York, N.Y.

GUINAN, JOHN J. (A'31), Technical Representative and Field Engineer, RCA Victor Company, Inc., 260 Safford St., Wollaston, Mass. For mail: 2303 W. Thompson St., Philadelphia, Pa.

GUINER, GEORGE (A'28), Power Broadcasting Operator, Defiance Paper Company, 3rd and Walnut Sts., Niagara Falls, N.Y. For mail: P.O. Box 167, M.P.O., Niagara Falls, N.Y.

GULLANS, JOHN H. (A'30), Radio Operator, Radio Station WJZ, Bound Brook, N.J.

GUNBY, O. B. (A'29), Engineer, RCA Victor Company, Inc., Camden, N.J. For mail: 732 Atlantic Ave., Collingswood, N.J.

GUNN, DONALD (A'31), Radio Engineer, Johnson Talking Machine Company, Ltd., Wood St., Liverpool, England. For mail: 6 Plemond Rd., Stoneycroft, Liverpool, England.

GUNNLAUGSON, JACOB (J'30), Washington Island, Wis.

GUNSTON, A. D. (A'31), Chief Engineer, Radio Station KOL, Northern Life Tower, Seattle, Wash. For mail: 7017-19th N.W., Seattle, Wash.

GUNTHER, CLARENCE A. (A'27), Engineering Department, Special Apparatus Division, RCA Victor Company, Inc., Camden, N.J.

GUNTHER, FRANK A. (A'25-M'30), Vice President and Treasurer, Radio Engineering Laboratories, 100 Wilbur Ave., Long Island City, L.I., N.Y. For mail: 6140 Saunders St., Rego Park, L.I., N.Y.

GUNTHER, W. J. (A'29), Chief Engineer, Radio Station WJKS, Johnson Kennedy Radio Corporation, Elks Temple, Gary, Ind. For mail: Gateway Apartments 203, Gary, Ind.

GURD, RONALD H. (A'28), Manager, Radio Department, William Gurd and Company, 185 Dundas St., London, Ont., Canada.

GURNEY, ALBERT A. (A'31), Proprietor, Radio Shop, 2 Station Parade, Greenford, Middlesex, England.

GUSTAFSON, GILBERT E. (A'27), Chief Engineer, Radio Station WJAZ, Mount Prospect, Ill.

GUSTAFSON, MELVIN F. (A'31), Instructor, Chicago Radio Institute, 65 E. Lake St., Chicago, Ill. For mail: 5435 W. Kamerling Ave., Chicago, Ill.

GUSTIN, RICHARD W. (A'31), Chief Projectionist, Bijou Theatre, 164 Exchange St., Bangor, Maine. For mail: 127 Hammond St., Bangor, Maine.

GUTHEIL, CHARLES M. (A'31), Engineer, P. R. Malloy and Company, Inc., 3029 E. Washington St., Indianapolis, Ind. For mail: 5143 E. Washington St., Indianapolis, Ind.

GUTHRIE, FREDERICK P. (A'16-M'28), District Manager, Radio Corporation of America, 1112 Connecticut Ave., N.W., Washington, D.C.

GUTOFF, BORIS (A'28), Custom Built Sets and Service, 889 E. 180th St., New York, N.Y.

GUY, RAYMOND F. (A'25-M'31), Radio Engineer, National Broadcasting Company, Inc., 711-5th Ave., New York, N.Y.

GUZIK, NICHOLAS J. (A'30), 800 N. 8th St., Philadelphia, Pa.

H

HAAG, MERLIN W. (A'26), 303 S. Prairie St., Whitewater, Wis.

HAAS, JOHN G. (A'27), Radio Engineer, Bludworth, Inc., 79-5th Ave., New York, N.Y. For mail: 318 Dawson Ave., Boonton, N.J.

HAAS, MILTON J. (J'30), 1375 E. 18th St., Brooklyn, N.Y.

HAAS, PAUL (J'26-A'30), Mechanical Designer, United Research Corporation, 41-39-38th St., Long Island City, L.I., N.Y. For mail: 48-32-45th St., Woodside, L.I., N.Y.

HACKBUSCH, RALPH A. (A'26-M'30), Radio Engineer, Stromberg-Carlson Telephone Manufacturing Company, 211 Geary Ave., Toronto, Ont., Canada.

HACKETT, PAUL J. (A'28), Chief Engineer, Universal High Power Telephone Company, 6401 Carleton Ave., Seattle, Wash. For mail: 3209-15th Ave., Seattle, Wash.

HADDEN, HAROLD L. (J'26-A'28), Burwell's Beach, Milford, Conn.

HADDEN, WESTON (J'15-A'18), Toll Engineer, Long Lines Department, New York Telephone Company, 360 Bridge St., Brooklyn, N.Y. For mail: 1716 Albemarle Rd., Brooklyn, N.Y.

HADLEY, RAYMOND F. (A'30), Student, Rensselaer Polytechnic Institute, Troy, N.Y. For mail: 16 Fonda Ave., Troy, N.Y.

HAFNER, GILBERT (A'27), Department of Development and Research, American Telephone and Telegraph Company, 195 Broadway, New York, N.Y. For mail: 69 Summit Rd., Port Washington, L.I., N.Y.

HAGAN, EDWARD J. (J'27-A'30), 2223 N. Colorado St., Philadelphia, Pa.

HAGEMAN, OLIVER C. (A'28), Radio Technician, J. W. Jenkins Music Company, 113 S. 5th St., Leavenworth, Kan.

HAGEN, B. W. R. (A'26), Radio Operator, Radiomarine Station KSE, Radiomarine Corporation of America, P.O. Box 183, WALTERIA, Calif. For mail: 1223 W. 67th St., Los Angeles, Calif.

HAGIO, N. (A'31), Research Laboratory, Tokyo Electric Company, Kawasaki, Japan.

HAGMANN, NIKLAUS (A'27), Operator, National Broadcasting Company, Inc., Station WJZ, Bound Brook, N.J.

HAIG, JAMES H. (A'30), Manager, Oxo Radio Manufacturing Company, 1023-3rd Ave., Seattle, Wash.

HAIGH, M. C. (A'27), Radio Engineer, Stewart-Warner Radio Division, 1443 Locust St., Des Moines, Iowa. For mail: 3213 Oxford St., Des Moines, Iowa.

HAIGIS, C. D. (A'17), RCA Victor Company, Inc., Camden, N.J.

HAINES, DONALD G. (A'30), Development Engineer, RCA Radiotron Company, Inc., 415 S. 5th St., Harrison, N.J. For mail: 46 Ella St., Bloomfield, N.J.

HAINES, HOWARD J. (A'28), 90-34-54th Ave., Elmhurst, L.I., N.Y.

HAINES, JOSEPH, JR. (A'28), 2823 N. 5th St., Philadelphia, Pa.

HAIRE, A. F. (A'28), Service Engineer, RCA Photophone, Inc., 529 W. Congress St., Detroit, Mich.

- HAJIM, JACK** (A'28), Engineer-in-Charge, Radio Station WFOX, Brooklyn Fox Theatre, Brooklyn, N.Y. For mail: 2172-72nd St., Brooklyn, N.Y.
- HAJNY, GEORGE F.** (A'29), 1718 C St., W., Cedar Rapids, Iowa.
- HAKAM, SAMUEL** (J'27-A'28), Student, Worcester Polytechnic Institute, Worcester, Mass.
- HALDANE-DUNCAN, B.** (A'30), Radio Telephone Constructor, 5th Avenue Branch, Guaranty Trust Company, New York, N.Y. For mail: Rm. 1009, 122-5th Ave., New York, N.Y.
- HALINTON, HARRY** (A'31), Television Research Department, Radio Station WISN, 123 W. Michigan St., Milwaukee, Wis.
- HALL, ALBERT** (M'27), Chief Radio Operator, Ferranti, Ltd., Eagle Iron Works, Tame St., Stalybridge, England. For mail: 14 Ellesmere Rd., Heaton Chapel, Stockport, England.
- HALL, BASIL** (J'30), Member of Technical Staff, International Marine Radio Company, Ltd., Columbia House, London, England. For mail: 25 Coombe Gardens, New Malden, Surrey, England.
- HALL, CLIFFORD A.** (A'27), Secretary and Treasurer, Mechanical Equipment Company, 206 Centre St., New York, N.Y. For mail: North Ave., Fanwood, N.J.
- HALL, E. L.** (A'28), Electrical Engineer, Bureau of Standards, Washington, D.C.
- HALL, FRED F.** (J'27-A'30), 702 Grant St., Crown Point, Ind.
- HALL, HENRY D.** (A'28), Concord, Mass.
- HALL, NORMAN** (A'17), North Eastern Instrument Company, Gateshead, England. For mail: Westgarth, Lyndhurst, Low Fell, Gateshead-on-Tyne, England.
- HALL, NORMAN C.** (A'24), Engineer, Arc-turus Radio Tube Company, Newark, N.J. For mail: 64 Llewellyn Ave., Bloomfield, N.J.
- HALL, ROLAND C.** (A'30), Radio Engineer, British Thompson-Houston Company, Rugby, England. For mail: 89 Parchinore Rd., Thornton Heath, Surrey, England.
- HALL, THOMAS, JR.** (A'29), Proprietor, Hall's Company, 222 Chestnut St., Harrisburg, Pa.
- HALL, VICTOR E.** (A'26), Manager, Appliance Sales, Syracuse Supply Company, Syracuse, N.Y. For mail: 100 Medora St., Syracuse, N.Y.
- HALL, WHITMAN N.** (A'30), Transmitter Operations, Radio Station WGY, General Electric Company, 1 River Rd., Schenectady, N.Y. For mail: 11 Hampton Ave., Schenectady, N.Y.
- HALLAM, JOHN T.** (A'26), Engineer, Radio Station WOAI, Southern Equipment Company, P.O. Box 1478, San Antonio, Tex. For mail: P.O. Box 182-B, Route No. 3, San Antonio, Tex.
- HALLBORG, H. E.** (A'12-M'14-F'27), Engineer, R.C.A. Communications, Inc., 66 Broad St., New York, N.Y. For mail: 26 Macopin Ave., Upper Montclair, N.J.
- HALLEIN, JOHN, JR.** (A'31), Radio Operator, Station WBZ, East Springfield, Mass. For mail: 922 Memorial Ave., West Springfield, Mass.
- HALLENSTEIN, NATHAN A.** (A'31), Junior Radio Inspector, Radio Division, U. S. Department of Commerce, U. S. Subtreasury Bldg., New York, N.Y. For mail: 20 E. 14th St., New York, N.Y.
- HALLER, GEORGE L.** (A'28), Chief Engineer, E. A. Myers and Sons, 306 Beverly Rd., Mount Lebanon, Pittsburgh, Pa.
- HALLEY, SAMUEL R.** (A'23), Vice President and General Manager, Rapid Air Lines, Inc., Rapid City, S.D. For mail: Box 1119, Rapid City, S.D.
- HALLIDAY, LEW R.** (A'31), 388 River St., Manistee, Mich.
- HALLIGAN, CLAIR W.** (A'26), Engineer, American Telephone and Telegraph Company, 195 Broadway, New York, N.Y. For mail: 94 Grove St., New York, N.Y.
- HALLIGAN, WILLIAM J.** (A'26), President, Halligan and Company, 307 N. Michigan Blvd., Chicago, Ill.
- HALLMAN, L. B., JR.** (J'27-A'29), Chief Engineer, Montgomery Broadcasting Company, Jefferson Davis Hotel, Montgomery, Ala. For mail: 118 Virginia Ave., Montgomery, Ala.
- HALLORAN, A. H.** (M'26), Television Consultant, 2716 Belrose Ave., Berkeley, Calif.
- HALSTEAD, CANUTE** (A'31), Radio Operator, *SS Melville Dollar*, American Mail Line, Seattle, Wash. For mail: 4206 Woodland Park Ave., Seattle, Wash.
- HALSTEAD, WILLIAM S.** (J'23-A'25), Radio Consultant and Writer, 31 Greenridge Ave., White Plains, N.Y.
- HAM, FRANK M.** (A'16), Teacher of Physics, Bridgeport High School, Bridgeport, Conn. For mail: 34 Prescott St., Bridgeport, Conn.
- HAMADA, SHIGENORI** (A'29), Bachelor of Engineering, Tokyo Electric Company, Kawasaki, Japan. For mail: 944 Hirahari, Magomemachi, near Tokyo, Japan.
- HAMBLING, ARTHUR W.** (A'23), Hambling, Clapp and Company, London, England. For mail: 80 Brondesbury Rd., London, N.W. 6, England.
- HAMILTON, D.** (A'30), Radio Engineer, Standard Telephones and Cables, Ltd., Columbia House, Aldwych, London, England. For mail: 35 Petworth Rd., North Finchley, London, N. 12, England.
- HAMILTON, HENRY E. S.** (A'31), Chief Engineer, Trans Canada Broadcasting Company, King Edward Hotel, Toronto, Ont., Canada. For mail: 597 Bathurst St., Toronto, Ont., Canada.
- HAMILTON, HUGH, JR.** (A'30), Radio Engineer, Hygrade Lamp Company, 60 Boston St., Salem, Mass. For mail: 126 Highland Ave., Salem, Mass.
- HAMILTON, SAM** (A'30), 1231-16th Ave., Tuscaloosa, Ala.
- HAMLIN, FRANK E.** (A'30), Radio Electrician, U. S. Navy, *U.S.S. Beaver*, c/o Postmaster, Seattle, Wash.
- HAMMAN, G. B.** (A'27), 2308 McKinley Ave., Lakewood, Ohio.
- HAMMER, ROBERT H.** (A'29), Professional Engineer, 220 Lincoln Pl., Brooklyn, N.Y.
- HAMMOND, JOHN HAYS, JR.** (A'12-M'14), Hammond Radio Research Laboratories, Gloucester, Mass.
- HAMMOND, W. MURRAY** (A'29), Box 617, Edmonds, Wash.
- HAMMONTREE, ALVIN W.** (A'30), Student, Dodge Institute of Railway and Radio

- Wireless, Valparaiso, Ind. For mail: R.F.D. No. 2, Killbuck, Ohio.
- HAMPTON, ERNEST C.** (A'31), Proprietor, Radio Service, 25 Park Ave., Freehold, N.J.
- HANCE, KENNETH M.** (A'19), Assistant Manager, National Battery Broadcasting Company, Hotel St. Paul, St. Paul, Minn. For mail: 2062 Marshall Ave., St. Paul, Minn.
- HAND, CARL A.** (A'17), 415 N. 1st St., Rockford, Ill.
- HANDY, FRANCIS E.** (A'26), Communications Manager, American Radio Relay League, 38 La Salle Rd., West Hartford, Conn. For mail: 228 Colebrook St., Hartford, Conn.
- HANKINS, MARVIN J.** (A'27), Technician, Radio Station KGEF, 1201 S. Flower St., Los Angeles, Calif. For mail: 1817 W. 45th St., Los Angeles, Calif.
- HANKS, ALFRED J.** (A'25), Engineer, Research Department, Western Union Telegraph Company, 60 Hudson St., New York, N.Y. For mail: 2801 Hudson Blvd., Jersey City, N.J.
- HANLEY, JOHN F.** (J'19-A'24), Technical Assistant, Electrical Testing Laboratories, 80th St. and East End Ave., New York, N.Y.
- HANNA, CLINTON R.** (M'28), Manager, Development Division, Research Laboratory, Westinghouse Electric and Manufacturing Company, East Pittsburgh, Pa.
- HANNAFORD, HAROLD W.** (A'31), Radio Technician, Olson and Wilson, 517-1st St., Mount Vernon, Wash. For mail: 1539 S. 3rd St., Mount Vernon, Wash.
- HANNAH, GEORGE M.** (A'24), Toll Service Engineer, Chesapeake and Potomac Telephone Company, Baltimore, Md. For mail: 5231 Linden Heights Ave., Baltimore, Md.
- HANNAH, W. J.** (A'29), Technical Manager, Rothermel Radio Corporation, Inc., 24 Maddox St., London, W. 1, England.
- HANNON, JOHN P.** (A'27), Anchorage, Alaska.
- HANNUM, J. C.** (A'28), Accountant and Attorney, The Hunt and Dorman Manufacturing Company, 1600 E. 24th St., Cleveland, Ohio. For mail: 19400 Shoreland Ave., Rocky River, Cleveland, Ohio.
- HANOVER, EDWARD A.** (A'27), Purchasing Agent, Stromberg-Carlson Telephone Manufacturing Company, 1060 University Ave., Rochester, N.Y.
- HANSCOM, W. W.** (A'12-M'14), Consulting Engineer, 848 Clayton St., San Francisco, Calif.
- HANSELL, CLARENCE W.** (A'26-M'29), Transmitter Development Engineer, R.C.A. Communications, Inc., Rocky Point, L.I., N.Y. For mail: 115 Tuthill St., Port Jefferson, L.I., N.Y.
- HANSEN, EDMUND H.** (A'25-M'26), Operating Head and Chief Engineer, Sound Department, Fox Film Company, Los Angeles, Calif. For mail: 1837 N. Garfield Pl., Hollywood, Calif.
- HANSEN, ELMER** (A'30), Engineer, Messrs. Agricola Carabayllo, Cartavio Sugar Company, Hacienda Cartavio, Trujillo, Peru.
- HANSEN, HARVEY BENNETT** (A'29), Computer, Valuation Department, A.T. and S.F. Railway, 1231 Railway Exchange Bldg., Chicago, Ill. For mail: 5317 Argyle St., Chicago, Ill.
- HANSEN, JOHN C.** (A'29), Radio Engineer, RCA Victor Company, Inc., Bldg. 5, 2nd Floor, Camden, N.J.
- HANSEN, LELAND S.** (A'17), Laboratory Engineer, Howard Radio Company, South Haven, Mich. For mail: 62 South Haven St., South Haven, Mich.
- HANSEN, ROLF K.** (A'30), Engineer, RCA Radiotron Company, Inc., Development Laboratory, 415 S. 5th St., Harrison, N.J.
- HANSEN, RUSSELL C.** (A'31), Traffic Engineer's Assistant, Wisconsin Telephone Company, 722 N. Broadway, Milwaukee, Wis. For mail: 2026 W. Scott St., Milwaukee, Wis.
- HANSEN, WILLIAM H.** (J'28), 1703 N. Mozart St., Chicago, Ill.
- HANSON, EARL C.** (A'26), Special Electrical and Radio Research, 1249 W. Clifton Blvd., Lakewood, Ohio.
- HANSON, ERNEST R.** (A'28), Chief Chemist, Halowax Corporation, 230 Grove St., Bloomfield, N.J.
- HANSON, MALCOLM P.** (A'21-M'29), Radio Engineer, U. S. Navy, U. S. Naval Air Station, Anacostia, D.C. For mail: 109 Lincoln St., Bethesda, Md.
- HANSON, OSCAR B.** (A'18-M'27), Manager, Technical Operations and Engineering, National Broadcasting Company, Inc., 711-5th Ave., New York, N.Y. For mail: Imperial Park, Westport, Conn.
- HANSON, RALPH L.** (J'26-A'28), Radio Manager, R. L. Hanson Company, 110 W. Front St., Stockton, Ill.
- HANTZSCH, RALPH E.** (M'30), Chief Engineer, Best Manufacturing Company, 1200 Grove St., Irvington, N.J. For mail: 10 Alvin Ter., Springfield, N.J.
- HARDESTY, GEORGE K. C.** (J'30), 609-7th St. S.W., Washington, D.C.
- HARDIN, L. L., JR.** (A'29), Engineer, Tube Division, RCA Victor Company, Inc., Bldg. 7, Camden, N.J.
- HARDING, HENRY B.** (A'30), Receiver Development Engineer, Engineering Department, RCA Victor Company, Inc., Camden, N.J. For mail: 404 W. Cedar Ave., Oaklyn, N.J.
- HARDING, LAURENCE M.** (A'29), U. S. Lighthouse Service, c/o Superintendent of Lighthouses, 3760 E. Jefferson Ave., Detroit, Mich. For mail: 446 S. Eastlawn, Detroit, Mich.
- HARDNER, FRANCIS J.** (A'26), Radio Sales and Service Manager, Electrical Devices Company, Allentown, Pa. For mail: R.F.D. No. 6, Box 54, Allentown, Pa.
- HARDWICK, AMBROSE H.** (A'26-M'31), President, Hardwick, Hindle, Inc., 215 Emmet St., Newark, N.J.
- HARDY, CARROLL N.** (A'29), Partner and Radio Technician, The Urquhart-Hardy Radio Laboratories, 4 Arion St., Dorchester, Mass. For mail: 65 Monadnock St., Dorchester, Mass.
- HARDY, GEORGE E.** (A'28), Radio Serviceman, 616 S. 20th St., Harrisburg, Pa.
- HARGRAVE, W. A.** (A'27), Photophone Division, Bldg. 5, RCA Victor Company, Inc., Camden, N.J.
- HARINGTON, CONRAD F.** (A'30), Consulting Engineering Work, 212 E. 20th St., Little Rock, Ark.

HARKINS, PHILIP B. (A'31), Radio Engineer, Radio Station WOR, Bamberger Broadcasting Service, 1440 Broadway, New York, N.Y. For mail: 207 Wellington Rd., Short Hills, N.J.

HARLAN, EDWIN W. (A'26), P.O. Box 248, Denville, N.J.

HARLEY, JOHN B. (A'27), Recording Engineer, Bell Telephone Laboratories, Inc., Rm. K-30, 463 West St., New York, N.Y.

HARLOW, FRANK E. (A'31), Radio Department, New Zealand Express Company, Ltd., Fort St., Auckland, New Zealand. For mail: 39 Clarence St., Devonport, Auckland, New Zealand.

HARLOW, FRED G. (A'26), Testing Division, Westinghouse Electric and Manufacturing Company, Chicopee Falls, Mass. For mail: 121 East St., Chicopee Falls, Mass.

HARMER, LESLIE B. (A'27), Shanghai Mutual Telephone Company, Shanghai, China.

HARMON, R. N. (A'30), Radio Engineer, Development and Research Department, Westinghouse Electric and Manufacturing Company, East Pittsburgh, Pa. For mail: 2642 Taketon Rd., Wilkensburg, Pa.

HARMON, W. S. (A'26), Radio Engineer, General Motors Radio Corporation, Wisconsin Blvd., Dayton, Ohio. For mail: 836 Euclid Ave., Dayton, Ohio.

HARNESS, LEROY R. (A'30), Engineer, Supply Engineering Department, Westinghouse Electric and Manufacturing Company, East Pittsburgh, Pa. For mail: 330 Franklin Ave., Wilkensburg, Pa.

HARNESS, SAM A. (A'27), Radio Engineer, Bell Telephone Laboratories, Inc., 463 West St., New York, N.Y.

HARNETT, DANIEL E. (A'25), Hazeltine Service Corporation, 333 W. 52nd St., New York, N.Y.

HARNISH, RAY M. (A'28), Engineer, Kirk, Johnson and Company, 16-18 W. King St., Lancaster, Pa. For mail: Brownstown, Pa.

HAROLD, GEORGE (A'29), Service Manager, W. G. Walz Company, El Paso, Tex.

HARPER, A. E. (A'19-M'26), Engineer, American Telephone and Telegraph Company, Rm. 2012, 195 Broadway, New York, N.Y.

HARPER, EDGAR (M'20), c/o Mrs. Harper, Upper Flat, 55 Pearlhill Ave., Parkstone, Dorset, England.

HARPER, EVERETT L. (J'31), Student, Dodge Radio Institute, Valparaiso, Ind. For mail: 414 W. Columbia St., Oakland City, Ind.

HARRELL, FRED E. (A'30), Electrical Engineer, Reliance Electric and Engineering Company, 1088 Ivanhoe Rd., Cleveland, Ohio. For mail: 7708 South Shore Dr., Chicago, Ill.

HARRIES, JOHN H. O. (A'28), Wireless Consultant, Shirley, Old Rd., Frinton-on-Sea, Essex, England.

HARRINGTON, CARLTON E. (J'29), Technical Operator, Maritime Division, American Telegraph and Telephone Company, 24 Walker St., New York, N.Y. For mail: 165 Elm St., Bridgeport, Conn.

HARRIS, ARTHUR L. (M'22), Major, China Command Signal Company, Hong Kong, China.

HARRIS, C. C. (A'26-M'27), Radio Engineer, Tropical Radio Telegraph Company, 1 Federal St., Boston, Mass.

HARRIS, CHARLES S. (A'30), P.O. Box 53, Ampere, N.J.

HARRIS, CLIFFORD C. (A'30), Technical Supervisor, Radio Station WCAO, The Monumental Radio Company, 811 W. Lanville St., Baltimore, Md.

HARRIS, HENRY (A'31), Assistant Radio Engineer, Signal Corps Laboratory, Fort Monmouth, Oceanport, N.J. For mail: 194-7th Ave., Long Branch, N.J.

HARRIS, HIRAM D. (A'30), Instructor, Reusselaer Polytechnic Institute, Troy, N.Y.

HARRIS, LELAND D. (A'31), 1978 S. 12th St., E., Salt Lake City, Utah.

HARRIS, PERCY W. (M'24), Editor, *The Wireless Constructor*, Amalgamated Press, Ltd., Tallis House, Tallis St., London, E.C., England. For mail: 29 S. Ridgway Pl., Wimbledon, London, S.W. 19, England.

HARRIS, R. TURNER (J'31), Radio Serviceman and Set Builder, Clifton Station, Va.

HARRIS, RAYMOND (A'28), Radio Engineer, Berwick St., St. John Rectory, Shaftesbury, Dorset, England.

HARRIS, RICHARD P. (A'30), Service Manager, China's, Inc., 920-14th St., N.W., Washington, D.C. For mail: 1823 Wyoming Ave., N.W., Washington, D.C.

HARRIS, WILLIAM A. (A'30), Development Laboratory, RCA Radiotron Company, Inc., 215 S. 5th St., Harrison, N.J.

HARRISON, CHARLES I. (A'29), Radio Engineer, Bell Telephone Laboratories, Inc., 463 West St., New York, N.Y.

HARRISON, CHARLES W., JR. (J'30), Student of Radio Engineering, P.O. Box 102, Farmville, Va.

HARRISON, JAMISON R. (A'26), Assistant Professor of Physics, Department of Physics, Tufts College, Tufts College 57, Mass.

HARRISON, L. E. (A'30), Radio Interference Inspector, Dallas Power and Light Company, 515 Park Ave., Dallas, Tex. For mail: 903 Hollywood Ave., Dallas, Tex.

HARRISON, LOUIS A. (A'27), Chief Operator, Western Union Telegraph Company, 220 S. Washington St., Ellis, Kan. For mail: 503 W. Adams St., Ellis, Kan.

HARRISON, PERRY (A'26), Radiomarine Corporation of America, 75 Varick St., New York, N.Y.

HARRISON, WALTER L. (A'27), 72 Webb St., Wellington, New Zealand.

HARRISON, WALTER M. (J'31), 255 Pearl St., Rochester, N.Y.

HARRISON, WILLIAM B., JR. (A'31), Instructor, Virginia Mechanical Institute, Richmond, Va. For mail: 3410 Carolina Ave., Richmond, Va.

HARROWER, J. C. (A'30), Reserve Student Officer, U. S. Navy, Naval Air Station, Pensacola, Fla.

HART, ARTHUR H. (A'26), Laboratory Engineer, Gray and Danielson Manufacturing Company, 2101 Bryant St., San Francisco, Calif. For mail: 134 Hrowth St., San Francisco, Calif.

HART, FRANK A. (A'12), Engineering Department, Mackay Radio and Telegraph Company, Inc., 67 Broad St., New York, N.Y. For mail: P.O. Box 189, Sayville, N.Y.

HART, JAMES J. (A'29), Public Address Engineer, Radio Station WOR, Newark, N.J. For mail: 617 Grove St., Irvington, N.J.

HART, M. E. (A'14), Secretary and Manager, Enterprise Electrical Company, New Orleans, La. For mail: 826 Baronne St., New Orleans, La.

HART, ROY H. (M'20), Engineer, Recording Installation Department, Electrical Research Products, Inc., 7046 Hollywood Blvd., Hollywood, Calif.

HART, WILLIAM J. (A'28), Fuel and Furnace Efficiency Man, Standard Oil Company, El Segundo, Calif. For mail: P.O. Box 531, El Segundo, Calif.

HARTLEY, JOHN H. (J'31-A'31), Electrician, National Broadcasting Company, Inc., 711-5th Ave., New York, N.Y. For mail: 441 Eastern Pkwy., Brooklyn, N.Y.

HARTLEY, RALPH V. L. (M'18-F'28), Associate Transmission Research Director, Bell Telephone Laboratories, Inc., 463 West St., New York, N.Y.

HARTLOFF, GORDON S. (A'27), Radio Operator, Erie Company, Hamburg, N.Y. For mail: Route No. 2, Erie Co., Hamburg, N.Y.

HARTMAN, CHARLES D. (A'29), Bell Telephone Laboratories, Inc., 463 West St., New York, N.Y.

HARTWICK, FRANCIS C. (A'31), Manager, Service Department, Remler Company, Inc., 2101 Bryant St., San Francisco, Calif. For mail: 1346 Pine St., San Francisco, Calif.

HARTZ, J. ERNEST (A'31), 1902 Vine St., Berkeley, Calif.

HARVEY, FRANCIS M. (A'29), Proprietor and Manager, Radio Engineering and Service Laboratory, 11 S. Tejon St., Colorado Springs, Colo.

HARVEY, H. C. (A'30), Chief Engineer, Radio Station KFAB, Nebraska Buick Auto Company, Lincoln, Neb. For mail: 925 S. 32nd St., Lincoln, Neb.

HARVEY, HERBERT J. (A'25), Engineer and Manager, Modern Wireless Company, 43, Piccadilly, Hanley, Staffs, England.

HARVEY, LESTER M. (M'30), U.S.S. Louisville, c/o Postmaster, New York, N.Y.

HARVEY, LIONEL (M'29), Engineer-in-Charge, Lorch Regional Offices, British Broadcasting Corporation, Manchester, England. For mail: 38, Kingsway, Alkington, Middleton, Lancashire, England.

HASELWOOD, W. E. (A'30), Engineer, Chicago Telephone Supply Company, Elkhart, Ind. For mail: 124 S. Vine St., Elkhart, Ind.

HASHIDA, K. (A'31), Radio Engineer, Osaka Broadcasting Station JOBK, Seuri-Hososhko, Suita, Osaka-fu, Japan.

HASHIMOTO, CHUJI (A'28), Lieutenant, Naval Communication College, Taura Kanagawa-Ken, Japan. For mail: 1356 Hase-Inasegawa, Kamakura, Kanagawa-Ken, Japan.

HASHIMOTO, S. (A'20), 145 Aoyama Minamimachi 6-chome, Akasaka, Tokyo, Japan.

HASKINS, RUPERT L. (A'30), Research Engineer, Tobe Deutschmann Corporation, Canton, Mass. For mail: 77 Audubon Rd., Boston, Mass.

HASSEL, KARL E. (A'19-M'23), Radio Engineer, Zenith Radio Corporation, 3620 Iron St., Chicago, Ill.

HASSLER, W. DAN (A'27), Engineer, Radio Station WBRC, Birmingham Broadcasting Company, Inc., Bankhead Hotel, Birmingham, Ala. For mail: 61 Highland Ave., Pratt City, Ala.

HASTINGS, GERALD M. (A'29), 30-21-87th St., Jackson Heights, L.I., N.Y.

HASTINGS, HARRIS F. (A'28), Assistant Radio Engineer, U. S. Naval Research Laboratory, Bellevue, Anacostia, D.C. For mail: 905 B St., N.E., Washington, D.C.

HASTINGS, R. STUART (A'27), Fort Simpson, Northwest Territory, Canada.

HATCH, RAY D. (A'30), Marthens, Schroter and Company, Inc., 54 Dey St., New York, N.Y. For mail: 1003 Berwick St., Easton, Pa.

HATFIELD, LESTER N. (A'30), Chief Operator and Maintenance Engineer, Radio Station KWSC, Pullman, Wash. For mail: 812 Linden St., Pullman, Wash.

HATHAWAY, KENNETH A. (A'31), Executive Secretary, Institute of Radio Service Men, 720 S. Dearborn St., Chicago, Ill.

HATTER, ANGEREAN A. (A'30), 1347 H St., N.E., Washington, D.C.

HATTON, ARTHUR THOMAS (J'29-A'29), Radio Engineer, Educator Broadcast Equipment Company, 605 Broad St., Newark, N.J. For mail: 131 Summit Ave., Hillside, N.J.

HAUCK, VERNON D. (A'26), Radio Engineer, Wires Radio, Inc., Newark, N.J. For mail: 125 Main St., Orange, N.J.

HAUFFE, OTTO (A'28), Radio Engineering Laboratories, 100 Wilbur Ave., Long Island City, L.I., N.Y. For mail: 404 E. 59th St., Apartment 6, New York, N.Y.

HAUG, JOSEPH (A'29), Repairing of Testing Equipment, F.A.D. Andrea Radio Corporation, Long Island City, L.I., N.Y. For mail: 41-30-59th St., Winfield, L.I., N.Y.

HAUSER, ALBERT (A'28), Condenser Engineer, Transformer Corporation of America, 2301 S. Feeler Ave., Chicago, Ill. For mail: 7417 Phillips Ave., Chicago, Ill.

HAUSMANN, ERICH (M'22), Professor of Physics and Electrical Communication, Polytechnic Institute of Brooklyn, 85 Livingston St., Brooklyn, N.Y.

HAUSMANN, ERNEST O. (J'27-A'29), Electrical Testing and Research, The Coloron Company, Division of Diamond State Fibre, Bridgeport, Conn. For mail: 500 Buttonwood St., Norristown, Pa.

HAUTA, THEODORE (J'26-A'28), U.S.S. Beaver, Manila, Philippine Islands, c/o Postmaster, Seattle, Wash. For mail: 120-6th St., S., Virginia, Minn.

HAVENS, WILBUR M. (A'31), President, Havens and Martin, Inc., 914 W. Broad St., Richmond, Va. For mail: 1720 Westwood Ave., Richmond, Va.

HAWES, R. NESBITT (M'23), Wireless Experimental Division, Telegraph Storeyard Alipore, Calcutta, India.

HAWK, WILLIAM K. (A'26), Engineer, Broadcasting Department, Westinghouse Electric and Manufacturing Company, East Pittsburgh, Pa. For mail: P.O. Box 510, Greensburg, Pa.

HAWKESWOOD, A. E. (A'30), Assistant District Engineer, RCA Photophone, Ltd., 59 Charles St., Cardiff, South Wales.

HAWKINS, JOHN B. (A'28), Production Manager, Radio Coil and Wire Company, 847 W. Harrison St., Chicago, Ill. For mail: 6620-31st St., Berwyn, Ill.

HAWKINS, JOHN H. (A'27), Engineer, Marconi Beam Wireless Station, Dorchester, Eng-

land. For mail: 235 Elmhurst Mansions, Clapham, London, S.W. 4, England.

HAWKINS, LESLIE S. (A'15-M'26), Pacific Coast Manager, Canadian Marconi Company, 500 Beatty St., Vancouver, B.C., Canada.

HAWLEY, DOUGLASS (A'26), Proprietor, Radiola Sales and Service Company, Minneapolis, Minn. For mail: 2717 Fremont Ave., Minneapolis, Minn.

HAWTHORNE, W. G. (A'30), Major, Commanding Signal Battalion, Marine Barracks, Quantico, Va.

HAYASI, TATUO (A'30), Student, Tohoku Imperial University of Japan, Sendai, Japan. For mail: c/o Count Sakuma, 55 Kitanibanchō, Sendai, Japan.

HAYDEN, GILBERT (A'29), Lieutenant, Fort Monmouth, Oceanport, N.J.

HAYDEN, J. W. (J'28-A'30), Equipment Attendant, Pacific Telegraph and Telephone Company, 1411 J St., Sacramento, Calif. For mail: 3528-1st Ave., Sacramento, Calif.

HAYES, EARL DAVID (J'30), Assistant Engineer, RCA Victor Company, Inc., Bldg. 2, 8th Floor, Camden, N.J. For mail: 806 Somerset St., Gloucester, N.J.

HAYES, GEORGE W. (A'13), Av. R.S. Pena 636, Buenos Aires, Argentina.

HAYES, H. D. (M'29), U. S. Supervisor of Radio, Radio Division, U. S. Department of Commerce, 2022 Engineering Bldg., Chicago, Ill.

HAYES, HAMMOND V. (A'21), Consulting Engineer, 73 Long Wharf, Boston, Mass.

HAYES, JAMES D. (A'31), Watch Supervisor, Mackay Radio and Telegraph Company, Southampton, L.I., N.Y.

HAYES, RALPH S. (J'15-A'18), Assistant Engineer, Transmission School, Bell Telephone Company of Pennsylvania, 1312 Arch St., Philadelphia, Pa. For mail: 31 Oberlin Ave., Swarthmore, Pa.

HAYES, THOMAS P. (A'30), Proprietor, Superior Radio Service, 3416 Oak Lawn Ave., Dallas, Tex. For mail: 3506 Lindenwood Ave., Dallas, Tex.

HAYES, WILBUR A. (A'30), Laboratory Engineer, Rudolph Wurlitzer Company, Martinsville, N.Y. For mail: 289 Schenck St., North Tonawanda, N.Y.

HAYMAN, E. DAVID (A'31), Senior Electrician, Radio Branch, Department of Marine, Ottawa, Ont., Canada. For mail: 7 Fairbairn Ave., Ottawa, Ont., Canada.

HAYMAN, WILLIAM G. (A'24), Lecturer in Electrical Engineering, Technical College, Perth, Western Australia.

HAYNES, NAT (A'31), Research Engineer, Technical Consultant, Engineering Department, Coast to Coast Radio Corporation, 142 Liberty St., New York, N.Y. For mail: 421 Chester St., Brooklyn, N.Y.

HAYS, HOWARD D. (A'27), Manager, Hays Radio and Electric Shop, Plano, Colin Co., Tex. For mail: P.O. Box 154, Plano, Tex.

HAYSLETT, L. E. (A'27), Radio Engineer, Rudolf Wurlitzer Manufacturing Company, North Tonawanda, N.Y. For mail: Stirling Arms Apartment, 132 Stirling Ave., Buffalo, N.Y.

HAYWARD, JOHN B. (A'31), Vacuum Tube Engineer, Sylvania Products Company, Emporium, Pa. For mail: P.O. Box 721, Emporium, Pa.

HAYWARD, W. R. (A'31), Assistant Manager, H. C. Rawson, Ltd., 100 London Rd., Sheffield, England. For mail: 72 S. View Rd., Sheffield, York, England.

HAYWARD, WALTER (A'30), Marine Radio Operator, Mackay Radio and Telegraph Company, Southampton, L.I., N.Y.

HAZARD, WILLIS G. (A'29), Instructor, Harvard University, Cambridge, Mass. For mail: 35 Greenough Ave., Jamaica Plain, Mass.

HAZELTINE, LOUIS A. (A'16-M'18-F'21), 5, Sq. du Trocadero, Paris, France.

HEALEY, OLIVER (A'23), Western Representative, Imperial and International Communications, 2 Small St., Bristol, England. For mail: Nara, Lake Rd., Henleaze, Bristol, England.

HEAP, SHELDON S. (A'27), Traffic Engineer, New England Telephone and Telegraph Company, 245 State St., Boston, Mass. For mail: 49 Hovey St., Atlantic, Mass.

HEARTZ, LESLIE C. (A'27), Night Toll Wire Chief, New England Telephone and Telegraph Company, 11 Franklin St., Bangor, Maine. For mail: 120 Royal Rd., Bangor, Maine.

HEATHER, HAROLD (J'29-A'30), Proprietor, Heather Radio Repair Company, 2214 S. La Brea Ave., Los Angeles, Calif.

HEATON, VINCENT E. (A'27), Assistant Physicist, Radio Section, U. S. Bureau of Standards, Washington, D.C.

HEBAL, WILLIAM H. (A'26), Engineer-in-Charge, Radio Station WTMJ, Route No. 6, Box 130A, Waukesha, Wis.

HEBERLEIN, ARTHUR A. (J'20-A'21), Engineer, Department of Development and Research, American Telephone and Telegraph Company, 195 Broadway, New York, N.Y.

HEBERT, ARTHUR A. (A'12-M'26), Treasurer, American Radio Relay League, 38 La Salle Rd., West Hartford, Conn. For mail: 22 S. Highland St., West Hartford, Conn.

HECHT, ROYAL H. (A'25), 2115 Cedarhurst Dr., Los Angeles, Calif.

HECKMAN, J. W. (A'29), Radio Engineer, Pennsylvania Power and Light Company, 401 Wisconsin St., Harrisburg, Pa.

HECTOR, L. GRANT (A'26), Professor of Physics, Department of Physics, University of Buffalo, Buffalo, N.Y.

HEDGES, ELLSWORTH J. (A'28), Service Manager, Vim Electric Company, 7 E. Fordham Rd., New York, N.Y. For mail: 3111 Heath Ave., New York, N.Y.

HEDRICK, PHIL F., JR. (I'30-A'31), Chief Operator, Radio Station WSJS, Winston-Salem, N.C. For mail: 406 W. 1st St., Winston-Salem, N.C.

HEEDER, M. E. (A'30), 4052-23rd St., San Francisco, Calif.

HEEGAARD, FREDERICK D. (A'25), The Royal Danish States, Telephone Department of Radio Engineering, Copenhagen, Denmark. For mail: C. F. Ridsvej 99C, Copenhagen F, Denmark.

HEFFERNAN, S. K. (A'29), Chief Operator, Radio Station WCKY, L. B. Wilson, Inc., 6th and Madison Aves., Covington, Ky.

HEIGHTMAN, D. W. (J'30), Radio Engineer, Broadcast Relay Service, Ltd., 93 Hayes Rd., Clacton-on-Sea, Essex, England. For mail: "Belowda," Park Way, Clacton-on-Sea, Essex, England.

HEILIG, CARL G. (A'31), Radio Engineer, Canadian Westinghouse Company, Hamilton, Ont., Canada. For mail: 108 Victoria Ave., N., Hamilton, Ont., Canada.

HEIMBERGER, ALBERT E. (A'29), Chief Inspector, Colin B. Kennedy Corporation, 211 E. Ewing St., South Bend, Ind. For mail: 1508 Hermosa Ct., South Bend, Ind.

HEINA, WILLIAM M. (A'30), Sales Engineer, Crosley Radio Corporation, Cincinnati, Ohio.

HEINDEL, HAROLD J. (A'28), Radio Engineer, F. A. D. Andrea, Inc., Orchard and Queen Sts., Long Island City, L.I., N.Y. For mail: 1240 Woodcrest Ave., New York, N.Y.

HEINEMAN, JOHN T. (A'30), Radio Technician, Kemper Radio Corporation, 5527 Hollywood Blvd., Hollywood, Calif. For mail: 2144 Beachwood Dr., Hollywood, Calif.

HEINRICH, MORTIMER (J'30), 1001 Oxford St., Berkeley, Calif.

HEINS, HENRY F. (A'27), President, Heins and Bolet Radio and Electric Supply Corporation, 68 Cortland St., New York, N.Y. For mail: 132-10-106th St., Richmond Hill, L.I., N.Y.

HEINTZ, RALPH M. (A'21-M'27-F'30), President and General Manager, Heintz and Kaufman, Ltd., 219 Natoma St., San Francisco, Calif.

HEISER, ALBERT E. (A'29), Chief Engineer, Lynchburg Broadcasting Corporation, Radio Station WLVA, Lynchburg, Va.

HEISER, EDWIN S. (A'28), Assistant Radio Inspector, Radio Division, U. S. Department of Commerce, Rm. 413, Federal Bldg., St. Paul, Minn.

HEISING, RAYMOND A. (A'20-F'23), Engineer, Bell Telephone Laboratories, Inc., 463 West St., New York, N.Y.

HEITMAN, CHARLES E., JR. (A'31), Electrical Engineer, Edward G. Budd Manufacturing Company, Philadelphia, Pa. For mail: 41 W. Logan St., Philadelphia, Pa.

HELD, HERMAN E. (A'30), Sales, Jewell Electrical Instrument Company, 542 Call Bldg., San Francisco, Calif. For mail: 668-44th Ave., San Francisco, Calif.

HELFFENSTEIN, EDWIN (A'28), Director of Service School, Atwater Kent Manufacturing Company, 4700 Wissahickon Ave., Philadelphia, Pa. For mail: 132 S. 57th St., Philadelphia, Pa.

HELLSTROM, G. (A'26), Laboratory Assistant, Copenhagen Telephone Company, Copenhagen K., Denmark. For mail: c/o Radio 1917, Cort Adelerstgade, 8a 3, Copenhagen K., Denmark.

HELMAN, ROLF A. (A'30), 2639 N. Fairfield Ave., Chicago, Ill.

HELMUTH, CHARLES F. (A'31), Radio Service Manager, Radio Service and Equipment, 504 Adriatic Ave., Atlantic City, N.J. For mail: 420 N. Massachusetts Ave., Atlantic City, N.J.

HELT, SCOTT (A'29), Vice President and Chief Engineer, Radio Station WODX, Mobile Broadcasting Corporation, Mobile, Ala. For mail: P.O. Box 1462, Mobile, Ala.

HEMBERGER, E. F., JR. (A'27), Electrical Research Products, Inc., 250 W. 57th St., New York, N.Y.

HEMEDINGER, WILLARD (A'28), Instructor, Radio Telephony, Seneca Vocational School, 666 E. Delavan Ave., Buffalo, N.Y. For mail: 257 Commonwealth Ave., Buffalo, N.Y.

HEMRICH, WALTER A. (A'29), Radio, 520-2nd Ave., Seattle, Wash. For mail: 503 Melrose Ave., N., Seattle, Wash.

HENDERSON, FRANCIS A. (A'27), Electrical Engineer, Standard Telephones and Cables, Ltd., Aerodrome Rd., The Hyde, Hendon, London, England. For mail: 2 Whitefriars Dr., Wealdstone, Middlesex, England.

HENDERSON, J. P. (M'23), Assistant Astronomer, Dominion Observatory, Ottawa, Ont., Canada.

HENDERSON, JOHN T. (A'28), Student, Radio Research Station, Slough, Bucks, England. For mail: Royal Empire Society, Northumberland Ave., London, W.C. 2, England.

HENDERSON, KEN L. (A'25), United American Bosch Corporation, Springfield, Mass. For mail: 11 Whittier St., Springfield, Mass.

HENDERSON, ROY A. (A'27), Radio Engineer, De Forest Radio Company, Passaic, N.J. For mail: 85 Paulson Ave., Passaic, N.J.

HENDERSON, WALTER B. (A'28), The Little House, Little Heath, Chobham, Surrey, England.

HENDRICKS, LESTER A. (A'23), Associate Radio Engineer, Signal Corps Radio Laboratory, Wright Field, Dayton, Ohio.

HENDRICKS, PAUL S. (A'26), Research Assistant, Massachusetts Institute of Technology, Round Hill, South Dartmouth, Mass. For mail: P.O. Box 156, South Dartmouth, Mass.

HENDRY, J. S. (A'30), C.T.O. Bloemfontein, Box 640, Bloemfontein, O.F.S., South Africa.

HENERY, K. S. (A'29), Receiving Engineer, Radio Corporation of America, Rocky Point, L.I., N.Y.

HENLINE, HENRY H. (A'24-M'29), Assistant National Secretary, American Institute of Electrical Engineers, 33 W. 39th St., New York, N.Y.

HENNEY, J. K. (A'18-M'26), Editor, McGraw-Hill Publishing Company, 330 W. 42nd St., New York, N.Y. For mail: 111-5th St., Garden City, L.I., N.Y.

HENNING, CLARENCE I. B. (A'26), Assistant Director, Military Sales Division, du Pont Company, 5058 du Pont Bldg., Wilmington, Del.

HENRY, CHARLES C. (A'27), Radio Engineer, Lear Development Company, 847 W. Harrison St., Chicago, Ill. For mail: 801-33rd St., South Bend, Ind.

HENRY, FRANKLIN M. (A'23), Radio Engineer, 1547 Jackson St., San Francisco, Calif.

HENRY, GORDON I. (J'27), Radio Operator, Radio Stations KOIL-WONU, Mona Motor Oil Company, Council Bluffs, Iowa. For mail: 5334 N. 27th St., Omaha, Neb.

HENRY, NEIL E. (A'31), Bookkeeper, Armour and Company, 27-11th St., Lynchburg, Va. For mail: 1017 Knight St., Lynchburg, Va.

HENRY, T. J. (A'29), Tube Development Engineer, RCA Radiotron Company, Inc., 215 S. 5th St., Harrison, N.J. For mail: 42 Dodd St., Bloomfield, N.J.

HENSEL, W. G. (A'30), Member of Radio Engineering Department, Bell Telephone Laboratories, Inc., Whippany, N.J.

- HENTZ, ELMER G. (A'30), Sales Engineer, Southern Ohio Radio Corporation, 139 W. 4th St., Cincinnati, Ohio. For mail: 545 Purcell Ave., Cincinnati, Ohio.
- HENYAN, GEORGE W. (A'20), Commercial Engineer, Radio Department, General Electric Company, Schenectady, N.Y.
- HEPBURN, DUGALD (A'23-M'25), Radio Engineer, De Forest Radio Corporation, Ltd., 245 Carlaw Ave., Toronto, Ont., Canada. For mail: 52 Waverly Rd., Toronto, Ont., Canada.
- HERBER, JOHN C. (A'23), Member of Technical Staff, Bell Telephone Laboratories, Inc., 463 West St., New York, N.Y. For mail: c/o Bell Telephone Laboratories, Inc., 180 Varick St., New York, N.Y.
- HERBERT, HAROLD R. (A'24-M'27), Resident Buyer, Radio Department, Hahn Department Stores, Inc., 1440 Broadway, New York, N.Y. For mail: 146 E. 54th St., New York, N.Y.
- HERBERT, P. (A'30), Radio Engineer, A. Herbert and Sons, 22 St. Mary's Butts, Reading, England. For mail: "The Firs," 50 Armour Rd., Tilehurst, Reading, England.
- HERBRUCK, WILLIAM M. (A'25), Chief Electrical Inspector, American Electric Switch Corporation, Minerva, Ohio. For mail: 918-15th St., N.W., Canton, Ohio.
- HERBST, JOHN A. (A'26), 660 Palisade Ave., Grantwood, N.J.
- HERCHER, FREDERICK J. (A'27), 250 South St., Elmhurst, Ill.
- HERD, JAMES F. (A'19-M'22), Radio Research Station, Slough, England.
- HERDMAN, RAYMOND C. (A'29), Chief Service Engineer, Sonora Manufacturing Corporation, 67 W. 44th St., New York, N.Y. For mail: General Radio Service, 115 Hutchinson Blvd., Scarsdale, N.Y.
- HERDMAN, WILLIAM P. (A'30), Herdman Radio Service, Mamaroneck, N.Y. For mail: 4 Rose Ave., Mamaroneck, N.Y.
- HERMES, LAWRENCE W. (A'30), Radio and Electrical Engineering, Messrs. Siemens, 22 Betterton St., Drury Lane, London, W.C. 2, England. For mail: 1 Dickering Rd., Coombe Lane, Kingston Hill, Surrey, England.
- HERNDON, LONDON C. (A'27-M'28), U. S. Supervisor of Radio, U. S. Department of Commerce, Fort McHenry, Baltimore, Md.
- HEROLD, EDWARD W. (A'30), RCA Radiotron Company, Inc., 415 S. 5th St., Department 92, Harrison, N.J. For mail: 55 Kenmore Ave., Newark, N.J.
- HEROLD, JOSEPH L. (A'29), Radio Operator, Radio Station WOW, Woodmen of World Life Insurance Association, Omaha, Neb.
- HERON, LOUIS M. (M'27), Head, Electrical Department, McKinley Technical High School, Washington, D.C. For mail: 1314 Belmont St., N.W., Washington, D.C.
- HEROUX, GEORGE A. (A'31), Manager, Radio Department, McCarthy Dry Goods Company, 191 Main St., Woonsocket, R.I. For mail: 371 Nursery Ave., Woonsocket, R.I.
- HERR, BRUCE R. (A'31), Radio Engineer, Philco Radio Company, Philadelphia, Pa. For mail: 205 Church Rd., Elkins Park, Pa.
- HERRMAN, ALBERT, JR. (J'29), Engineer, Waukegan Sound Laboratories, Waukegan, Ill. For mail: 653 Mill Ct., Waukegan, Ill.
- HERRMAN, FRANK (A'30), Chief Engineer and Treasurer, KFNR Broadcasting Association, and Assistant Engineer, Oklahoma City Water Department, Oklahoma City, Okla. For mail: 1618 Linden St., Oklahoma City, Okla.
- HERROLD, GEORGE V. (A'30), Radio Production Engineer, U.S. Radio and Television Corporation, Marion, Ind. For mail: 1722 S. Boots St., Marion, Ind.
- HERSHEY, ARTHUR W. (A'28), Bell Telephone Laboratories, Inc., 180 Varick St., New York, N.Y.
- HERSHMAN, J. B. (A'28), Instructor, Indiana University, Bloomington, Ind.
- HERSON, JACOB S. (A'29), Junior Radio Engineer, Signal Corps Radio Laboratory, Oceanport, N.J. For mail: 165 Garfield Ave., Long Branch, N.J.
- HERTEL, ROGER H. (J'28), Radio Engineer, Radio Station KMMJ, Harry Johnson Company, Clay Center, Neb.
- HERTWECK, C. (A'29), Radio-Journalist, Bockingen, Heilbronn, Germany.
- HERVEY, JOHN P. (A'27), Cruft Laboratory, Harvard University, Cambridge, Mass.
- HESELTON, CHARLES C. (A'23-M'29), Salesman, Arcturus Radio Tube Company, 720 Frelinghuysen Ave., Newark, N.J.
- HESS, HOWARD H. (A'31), Radio Serviceman, Ellis Music Company, 5 N. Main St., Fort Scott, Kan. For mail: 407 S. Holbrook St., Fort Scott, Kan.
- HESSE, CECIL M. (A'31), RCA Photophone Engineer, Madam Theaters, Ltd., 5 Dharamtala St., Calcutta, India.
- HESSE, HENRY R. (A'29), Radio Laboratory Engineer, Rudolph Wurlitzer Manufacturing Company, North Tonawanda, N.Y. For mail: 1308 Pierce Ave., North Tonawanda, N.Y.
- HETLAND, JULIUS M. (A'31), Chief Engineer, c/o WDAY, Inc., Fargo, N.D.
- HETRICH, JOHN H. (A'30), Proprietor and Service Engineer, Precision Electrical Laboratory, 115 W. Penn St., Philadelphia, Pa. For mail: 7445 Beverly Rd., West Oak Lane, Philadelphia, Pa.
- HEUSCHKE, PAUL J. (A'27), Manager, Radio Division, Commercial Engineering Bureau, New York Edison Company, 4 Irving Pl., New York, N.Y.
- HEWETSON, GEOFFREY B. (J'29), Radio Operator, Messrs. A. Holt and Company, Water St., Liverpool, England. For mail: 10 Northolm Villas, Hesse, York, England.
- HEWINSON, EARL G. (A'31), Radio Operator, Radio Station WBZ, East Springfield, Mass. For mail: 33 Cortland St., Springfield, Mass.
- HEWITT, C. TEFFT (A'17), Librarian, Hackley Public Library, Muskegon, Mich.
- HEWSON, J. H. (A'30), Service Engineer, Northern Electric Company, Ltd., 61 Queen St., Ottawa, Ont., Canada. For mail: 478 Sunnyside Ave., Ottawa, Ont., Canada.
- HEYMAN, NICHOLAS (A'30), Consulting Industrial Engineer, 37 Marion Rd., Verona, N.J.
- HEYMANN, JOSEPH (J'25-A'27), Service Manager, Wholesale Radio Equipment Com-

- pany, 902 Broadway, New York, N.Y. For mail: 1781 E. 51st St., Brooklyn, N.Y.
- HICKLEY, THOMAS J. (A'30), Laboratory Assistant, Bell Telephone Laboratories, Inc., Deal, N.J. For mail: P.O. Box 95, Allenhurst, N.J.
- HICKMAN, C. NICHOLS (A'29), Research Physicist, American Piano Company, 29 W. 57th St., New York, N.Y. For mail: 125-22nd St., Jackson Heights, L.I., N.Y.
- HICKMAN, ROGER W. (A'29), Instructor in Physics, Cruft Laboratory, Harvard University, Cambridge, Mass. For mail: Conant Hall 11, Cambridge, Mass.
- HICKS, HERBERT J. (A'31), Radio Instructor, Hadley Vocational School, 3432 School St., St. Louis, Mo. For mail: 5571 Chamberlain Ave., St. Louis, Mo.
- HIGGINS, H. H. (A'30), Salesman, Northern Electric Company, Ltd., 637 Craig St., W., Montreal, P.Q., Canada.
- HIGGINS, HAROLD R. (A'31), Radio Engineer, WIP-WFAN Broadcasting Company, 8th and Market Sts., Philadelphia, Pa. For mail: 3714 N. Carlisle St., Philadelphia, Pa.
- HIGGINS, PERCY V. (A'31), Engineer, Workshops and Designs, Post and Telegraph Department, Kuala Lumpur, Federated Malay States.
- HIGGY, ROBERT C. (A'26), Director, Broadcasting Station WEAO, Ohio State University, Columbus, Ohio. For mail: 296 Piedmont Rd., Columbus, Ohio.
- HIGLEYMAN, RICHARD (M'26), Lieutenant, U. S. Navy, U.S.S. *Houston*, c/o Postmaster, Seattle, Wash.
- HIGHT, STUART C. (A'31), Research Engineer, Bell Telephone Laboratories, Inc., 180 Varick St., New York, N.Y.
- HIGONNET, RENE A. (A'31), Telephone Engineer, Le Material Telephonique, 26 Rue de Sevres, Boulogne s/Seine, France. For mail: 52 Avenue Bernard Palissy, Saint Cloud S.E.O., France.
- HIJIKATA, S. (A'29), Telephone Engineer, Nippon Electric Company, 2 Mita Shikokumachi Shiba, Tokyo, Japan.
- HILD, GEORGE E. (A'25), Service Engineer, RCA Photophone, Inc., 1076 Broadway, Albany, N.Y. For mail: 621 Walnut Ave., Syracuse, N.Y.
- HILGEDICK, W. C. (A'29), Supervisor, c/o Western Union Telegraph Company, New Orleans, La.
- HILL, ARTHUR P. (M'23), Acoustic Consulting Superintendent, Electrical Research Products, Inc., 7046 Hollywood Blvd., Hollywood, Calif. For mail: 1301 N. Mansfield Ave., Hollywood, Calif.
- HILL, ERNEST N. (A'28), Public Address Engineer, Mullard Wireless Service Company, Ltd., Mullard House, Charing Cross Rd., London, W.C. 2, England. For mail: 4 Matlock Rd., Caversham, Reading, England.
- HILL, FREDERICK A. (A'26), Editor, *Radio Call Book Magazine*, 508 S. Dearborn St., Chicago, Ill. For mail: P.O. Box 212, Hinsdale, Ill.
- HILL, GUY (M'13-F'15), Captain, Army and Navy Club, Manila, Philippine Islands.
- HILL, H. F. (A'27), Chief Operator, United Fruit Company, Santa Marta, Colombia.
- HILL, JAMES H. (A'28), c/o J. A. Givens, 350 N. St. Louis Ave., Chicago, Ill.
- HILL, ORVILLE (A'28), Chief Inspection Engineer, Stewart-Warner Alomite Corpora-
- tion, Ltd., Belleville, Ont., Canada. For mail: 327 Bleecker Ave., Belleville, Ont., Canada.
- HILL, OTIS (A'30), Manager, Hill Radio Company, 401 Wailuku St., Hilo, Hawaii. For mail: P.O. Box 952, Hilo, Hawaii.
- HILLEBRAND, W. A. (M'28), Electrical Engineer, Ohio Insulator Company, Barberton, Ohio.
- HILLEGAS-BAIRD, L. S. (A'22), Assistant Editor, *Radio Industries*, 520 N. Michigan Ave., Chicago, Ill. For mail: 2541 Blaine Pl., Chicago, Ill.
- HILLER, HARRY E. (A'22), Public Address Engineer, Roxy Theatre, 50th St. and 7th Ave., New York, N.Y. For mail: 364 Elmwood Ave., East Orange, N.J.
- HILLER, NICHOLAI H., JR. (A'27), Assistant to Chief Engineer, The Texas Company, 135 E. 42nd St., New York, N.Y.
- HILLIARD, JOHN K. (A'25-M'29), Transmission Engineer, United Artists Studio Corporation, 1041 Formosa Ave., Hollywood, Calif.
- HILLIARD, WINFIELD E. (J'29), Radiotrician, Radio Hospital, 2014 Wilsland St., Allentown, Pa. For mail: 438 Allen St., Allentown, Pa.
- HILLS, CHARLES E., JR. (A'26), Commercial Manager, General Radio Company, 30 State St., Cambridge, Mass. For mail: 5 Green Lawn Ave., Wellesley Farms, Mass.
- HILLS, EUGENE K. (J'27), R.F.D. No. 1, East Pepperell, Mass.
- HILLS, JOSEPH MELVILLE (A'31), Engineer, RCA Victor Company, Inc., Camden, N.J. For mail: 314 W. Delphine St., Philadelphia, Pa.
- HIMOE, CLIFFORD E. (J'25-A'27), Radio Engineer, De Forest Radio Company, Passaic, N.J.
- HINDERLICH, ALBERT (A'28), Quartz Oscillators, Ltd., 1 Lechmere Rd., London, N.W. 2, England. For mail: 2 Bridge Rd., London, N.W. 10, England.
- HINELINE, HARRIS D. (M'26), Patent Department, United Research Corporation, 39-41 Van Pelt St., Long Island City, L.I., N.Y. For mail: 825 W. 187th St., New York, N.Y.
- HINEMON, JOHN H., JR. (A'20), Major, Assistant Military Attache, American Embassy, Berlin, Germany. For mail: c/o Assistant C of S G-2, War Department, Washington, D.C.
- HINES, ALBERT D. (A'26), Service Manager, Western Division, United American Bosch Corporation, Springfield, Mass. For mail: 606 S. Highland Ave., Arlington Heights, Ill.
- HINES, JOSEPH (A'27), 248 E. 28th St., Brooklyn, N.Y.
- HINKS, GEOFFREY D. (J'22-A'24), Wireless Engineer, British General Radio, Inc., 36 Middle St., Yeovil, England.
- HINNERS, FRANK A. (M'15-F'26), 233 Raymond Ave., Rockville Center, L.I., N.Y.
- HINSON, MARCUS W. (A'28), Executive Vice President, Institute of Radio Service Men, 720 S. Dearborn, Chicago, Ill. For mail: 894 Linden Ave., Winnetka, Ill.
- HINTON, NORMAN P. (M'23), Engineer-in-Charge, Radio and Sound Reproducing Engineer, British Thomson-Houston Company, Ltd., Alma St., Coventry, England.

HINTZ, ROBERT T. (A'30), Engineering Assistant, Hazeltine Service Corporation, 333 W. 52nd St., New York, N.Y. For mail: 1151-75th St., Brooklyn, N.Y.

HIPP, RICHARD, JR. (A'31), Radio Serviceman and Electrical Contractor, Pomaria, S.C.

HIRLINGER, JOHN F. (A'30), Development Laboratory, RCA Radiotron Company, Inc., 415 S. 5th St., Harrison, N.J.

HIROSE, M. (A'29), c/o Radio Station JOSK, Kokura Hosokiyoku, Kokurasi, Japan.

HIRSCH, HARRY (A'29), Sales Engineer, Westinghouse Electric Supply Company, 152 Mulberry St., Newark, N.J. For mail: 500 Southern Blvd., New York, N.Y.

HIRSCH, OSCAR C. (A'26), Radio Station KFVS, Cape Girardeau, Mo. For mail: P.O. Box 275, Cape Girardeau, Mo.

HIRSIMAKI, EELI N. (J'31), P.O. Box 14, Jester Station, Conneaut, Ohio.

HISAMOTO, MASYAUKI (J'28-A'29), Student, Massachusetts Institute of Technology, Cambridge, Mass.

HITCHCOCK, JOSEPH F. (A'26), President, Automatic Utilities Corporation, 370 East Ave., Rochester, N.Y. For mail: 127 West Ave., Rochester, N.Y.

HITCHCOCK, R. C. (A'28-M'30), Research Engineer, Research Department, Westinghouse Electric and Manufacturing Company, East Pittsburgh, Pa.

HITZENHAMMER, ANTHONY deV. (A'29), Service Manager, S.L.S. Stores, Inc., 7044 N. Clark St., Chicago, Ill.

HIXSON, JOHN POPE (A'29), Naval Air Station, Coco Solo, Canal Zone.

HJERMSTAD, HANS U. (J'29-A'30), Radio Laboratory Instructor, School of Engineering, 163 E. Wells St., Milwaukee, Wis.

HOAG, J. BARTON (M'28), Physics Instructor, Reeson Laboratory, University of Chicago, Chicago, Ill.

HOAR, HAROLD G. (A'31), Chief, Engineering Supply Department, RCA Photophone, Ltd., Film House, Wardour St., London, W. 1, England. For mail: 141 Clitherow Ave., Harwell, London, W. 7, England.

HOARD, NORMAN F. (A'28), Engineer, RCA Victor Company, Inc., Camden, N.J. For mail: 27 Wendell Pl., Milton, Mass.

HOCH, ARTHUR L. (A'31), Radio Receiver Testing, RCA Victor Company, Inc., 311 Front St., Camden, N.J.

HODGDON, HERBERT J. (A'28), Jeweler, Edward J. Hodson and Company, Bristol Bldg., New Bedford, Mass. For mail: 31 Jenny Lind St., New Bedford, Mass.

HODGE, ALBERT WILLIAM (A'29), Appliance Repair Specialist, General Electric Supply Corporation, 1411 Walnut St., Kansas City, Mo. For mail: 2112 Aberdeen Ct., Kansas City, Mo.

HODGE, V. W. (A'29), Proprietor, Radio Repair Service, 227 Main St., Claremont, N.H.

HODGSON, ALAN D. (A'31), Radio Engineer, Marconi Wireless Telegraph Company, Croydon Aerodrome, Surrey, England. For mail: 24 Spencer Rd., Bedford, England.

HODGSON, EDWARD (A'28), Engineer-in-Charge, Marconi Beam Station, Yamachiche, P.Q., Canada.

HODKINSON, HENRY (A'28), Radio Engineer, 20 St. Huberts St., Great Harwood, Lancashire, England.

HODSOLL, MARTIN (A'26), Service Manager, Rogers-Majestic Corporation, 622 Fleet St., Toronto, Ont., Canada. For mail: 91 Watson Ave., Toronto 9, Ont., Canada.

HOEHLIN, FRED W. (A'30), Field Engineer and Draftsman, New York and Queens Gas Company, Flushing, L.I., N.Y. For mail: 121-17-12th Ave., College Point, L.I., N.Y.

HOFBERG, ALF H. (A'29), Supervisor, Calibration Section, Engineering Department, RCA Victor Company, Inc., Camden, N.J. For mail: 5642 N. 7th St., Philadelphia, Pa.

HOFERT, FRED A. (A'20), Foreman, Victor Electric Corporation, 236 S. Damen St., Chicago, Ill. For mail: 136 Malden Ave., La Grange, Ill.

HOFF, HENRY B. (J'30), Student, Case School of Applied Science, Cleveland, Ohio. For mail: 15104 Detroit Ave., Lakewood, Ohio.

HOFFMAN, E. F. (A'30), Technical Representative, RCA Victor Company, Inc., Camden, N.J. For mail: 106 Brook St., Wollaston, Mass.

HOFFMAN, HENRY J. (A'26), 26 Windsor Rd., Alwood, N.J.

HOFFMAN, RALPH (A'30), Radiotrician, Eden Park Radio Station, c/o Safety Section, City Hall, Cincinnati, Ohio. For mail: P.O. Box 20, Station 1, Cincinnati, Ohio.

HOFFMAN, ROSS B. (A'31), Engineer, C.I.R.A., 143 Defensa, Buenos Aires, Argentina.

HOFFMAN, SAMUEL O. (A'23), Industrial Scientific Research, 355 Hayes St., San Francisco, Calif.

HOFFMAN, W. HOLLIS (A'18), Radio Engineer, De Forest Radio Company, Passaic, N.J. For mail: 19 Clark Ave., Bloomfield, N.J.

HOFFMAN, WALTER HENRY (A'29), Proprietor, Walter H. Hoffman Company, R.F.D. No. 4, Monroeville, Ind.

HOFFMAN, WALTER R. (A'23), Chief Engineer, Detroit News, Radio Station WWJ, Detroit, Mich. For mail: 13565 Cherrylawn Ave., Detroit, Mich.

HOGAN, JOHN V. L. (M'12-F'15), Consulting Engineer, 41 Park Row, New York, N.Y.

HOGBEN, BERNARD T. (A'31), Proprietor, Radio Engineering and Service, 242 High Rd., London, N. 15, England.

HOGG, WILLIAM S. JR. (A'14-M'29), Bureau of Engineering, Navy Department, Washington, D.C. For mail: 3511 Jennifer St., N.W., Washington, D.C.

HOK, GUNNAR (A'31), 1663 Cambridge St., Cambridge, Mass.

HOKE, VERGNE L. (A'28), Radio Electrician, U. S. Signal Corps, Ketchikan, Alaska. For mail: c/o Alaska Military Cable Office, Ketchikan, Alaska.

HOLBEACH, WILLIAM M. (A'29), Works Manager, Kolster-Brandes, Ltd., Skelcup, Kent, England. For mail: Hamm Strathie, Hamm Court, Weybridge, Surrey, England.

HOLBORN, FREDERICK A. (M'23), Research Engineer, International Communications Laboratories, 67 Broad St., New York, N.Y. For mail: 15 Eastwood Pl., Cedar Grove, N.J.

HOLCOMB, E. RUSSELL (A'29), Service Engineer, Electrical Research Products, Inc., 1114 Continental National Bank Bldg., Salt

Lake City, Utah. For mail: P.O. Box 1956, Boise, Idaho.

HOLCOMBE, HENRY W. (A'24-M'26), 321 W. 94th St., New York, N.Y.

HOLDEN, C. F. (M'29), Lieutenant Commander, U. S. Navy, U.S.S. Arizona, c/o Postmaster, New York, N.Y.

HOLDEN, DALE S. (A'31), Radio and Sound Technician, Harris Recording Laboratories, 747 Seward Ave., Hollywood, Calif. For mail: 953 N. Crescent Heights Blvd., Hollywood, Calif.

HOLDEN, ELLIS GRAY (A'29), Chief Radioman, U. S. Coast Guard Headquarters, Washington, D.C. For mail: 632 C St., N.E., Washington, D.C.

HOLDEN, HAROLD C. (A'31), Engineer, RCA Victor Company, Inc., Camden, N.J.

HOLDEN, HARRY H. (A'27), Radio Sales and Service, Siasconset, Mass.

HOLETZ, ALEXANDER C. (A'29), Radio Engineer, Bell Telephone Laboratories, Inc., 463 West St., New York, N.Y. For mail: 1104 Wood Ave., Linden, N.J.

HOLEY, WALTER J. (A'31), Assistant U. S. Radio Inspector, Radio Division, U. S. Department of Commerce, Atlanta, Ga. For mail: 528 P.O. Bldg., Atlanta, Ga.

HOLLAND, JESSE W. (A'28), Radio Engineer, Kaess Aircraft Engineering Corporation, Lindenhurst, L.I., N.Y. For mail: 450 N. Broadway, Amityville, L.I., N.Y.

HOLLAND, LEWIS N. (A'27), 270 West Engineering Department, University of Michigan, Ann Arbor, Mich.

HOLLAND, WALTER E. (M'25), Chief Engineer, Philadelphia Storage Battery Company, Ontario and C Sts., Philadelphia, Pa.

HOLLANDS, LOUIS C. (A'30), Design Engineer, Howard Radio Company, South Haven, Mich. For mail: 528 Green St., South Haven, Mich.

HOLLIDAY, F. S. (A'29), Student, Georgia School of Technology, Atlanta, Ga. For mail: 79-12th St., N.E., Atlanta, Ga.

HOLLINSWORTH, V. E. (A'29), Engineer, De Forest Crosley Radio Corporation, Ltd., 345 Carlaw Ave., Toronto, Ont., Canada. For mail: 116 Woodycrest Ave., Toronto, Ont., Canada.

HOLLIS, HAMMOND H. (A'28), Assistant to Production Engineer, General Radio Company, 30 State St., Cambridge, Mass. For mail: 9 Brewster Pl., North Weymouth, Mass.

HOLLISTER, JAMES B. (A'31), Engineer, Twin City Radio Laboratory, First National Bank Bldg., Urbana, Ill. For mail: 602 W. Columbia Ave., Champaign, Ill.

HOLLISTER, KENNETH R. (A'31), Engineer, RCA Victor Company, Inc., Camden, N.J. For mail: 1642 N. 59th St., Philadelphia, Pa.

HOLLYWOOD, JOHN M. (J'30), 33 Peters Pl., Red Bank, N.J.

HOLM, EDWARD A. (A'31), Maintenance Engineer, National Broadcasting Company, Inc., Merchandise Mart, Chicago, Ill. For mail: 2711 N. Sayre Ave., Chicago, Ill.

HOLM, HENRY R. (J'27-A'30), Mechanic, Peerless Vulcanizing Company, Preston, Ont., Canada. For mail: 609 Laurel St., Preston, Ont., Canada.

HOLMAN, HENRY (J'27-A'28), Radio Service, Taylor Electric Company, 730 N. Jack-

son St., Milwaukee, Wis. For mail: 926 N. Cass St., Milwaukee, Wis.

HOLMES, ARNOLD (A'30), 55 Pleasant St., Concord, N.H.

HOLMES, CYRIL T. (A'29), Chief Instructor, Wireless Telegraphy, Municipal Technical College, Park St., Hull, England. For mail: 263 North Rd., Hull, York, England.

HOLMES, GEORGE R. (A'16), Assistant Advertising Manager, SKF Industries, Inc., 40 E. 34th St., New York, N.Y. For mail: 135 Garrison Ave., Jersey City, N.J.

HOLMES, RALPH S. (A'25), Radio Engineer, RCA Victor Company, Inc., Camden, N.J. For mail: 164 Merion Ave., Haddonfield, N.J.

HOLMES, ROBERT (A'30), Radio Research and Development Engineer, Lissen and Company, Ltd., Worples Rd., Isleworth, Middlesex, England. For mail: Worples Estate, 26 Crane Ave., Isleworth, Middlesex, England.

HOLMQUIST, CARL T. (A'27), Assistant Vacuum Tube Engineer, Kellogg Switchboard and Supply Company, 1066 W. Adams St., Chicago, Ill. For mail: 529 N. LeClaire Ave., Chicago, Ill.

HOLST, POUL F. G. (A'30), Radio Engineer, RCA Victor Company, Inc., Camden, N.J. For mail: 1115 White Horse Pike, Oaklyn, N.J.

HOLST, WENDELL L. (A'20-M'26), Radio Engineer, Grigsby-Grunow-Hinds Company, 4540 Armitage Ave., Chicago, Ill. For mail: 6142 Forest Glen Ave., Chicago, Ill.

HOLT, HILLIS W. (A'26), Radio Engineer, Westinghouse Electric and Manufacturing Company, Chicopee Falls, Mass. For mail: 62 Yale St., Springfield, Mass.

HOLT, LAURENCE J. (A'31), Student, University of Maryland, Baltimore, Md. For mail: 6701-6th St., N.W., Washington, D.C.

HOLT, PLINY E. (A'28), 1520 N. Eldorado St., Stockton, Calif.

HOLTSIZER, RALPH M. (J'18-A'24), Editorial Writer, Curtis-Martin Newspapers, Inc., Independence Sq., Philadelphia, Pa. For mail: 5428 Walnut St., Philadelphia, Pa.

HOLTZ, FREDERICK C. (A'18), Vice President and Chief Engineer, Sangamo Electric Company, Springfield, Ill.

HOLTZINGER, THEODORE E. (A'29), Assistant Commercial Engineer, The New York Edison Company, 4 Irving Pl., New York, N.Y. For mail: 481 Grand Ave., Long Island City, L.I., N.Y.

HOLZMAN, LOUIS (A'28), Proprietor, 37, Newman St., London, W. 1, England.

HOMER, EDWARD C. (A'28), Assistant Special Development Engineer, Western Union Telegraph Company, 195 Broadway, New York, N.Y. For mail: Box 488, Southampton, L.I., N.Y.

HOMSY, JOHN H. (A'30), U. S. Radio Inspector, U. S. Department of Commerce, 3619 Meyer St., San Pedro, Calif.

HONAMAN, R. KARL (A'23), Assistant Production Development Engineer, American Telephone and Telegraph Company, 195 Broadway, New York, N.Y.

HONNELL, PIERRE M. (J'27-A'29), Engineer, Bell Telephone Laboratories, Inc., 463 West St., New York, N.Y. For mail: 603 Asbury Ave., Asbury Park, N.J.

HOOD, NORMAN R. (A'27), Engineer, Police Radio Alarm System, City of Akron, Akron,

- Ohio. For mail: 141 Kirkwood Extension, Akron, Ohio.
- HOOD, SAM** (J'29), Student, Commerce, Ga.
- HOOKE, LIONEL A.** (M'31), Deputy General Manager, Amalgamated Wireless (A/sia), Ltd., Sydney, Australia.
- HOOKE, DONALD E.** (A'31), Radio Engineer, Ray-O-Vision Corporation, 940 Orange Dr., Los Angeles, Calif. For mail: 1240 S. 4th Ave., Los Angeles, Calif.
- HOOPER, ALBERT** (A'31), 81 E. Bay St., Charleston, S.C.
- HOOPER, EDGAR M.** (A'27), Operator-in-Charge, Radio Station 3 DB, Rowen St., Ashburton, Melbourne, Victoria, Australia. For mail: Harrison Ave., Burwood, E. 13, Melbourne, Victoria, Australia.
- HOOPER, S. C.** (F'28), Director, Naval Communications, Navy Department, Washington, D.C.
- HOOPES, THOMAS T.** (J'15-A'19), R.F.D., Rowley, Mass.
- HOOVEN, MORRIS D.** (A'26), Engineer, Public Service Electric and Gas Company, 80 Park Pl., Newark, N.J.
- HOOVER, HERBERT, JR.** (A'29), California Institute of Technology, Pasadena, Calif.
- HOOVER, RICHARD T.** (A'29), Hg. Det. 6th C.A., 1819 W. Pershing Rd., Chicago, Ill.
- HOPFENBERG, JOSEPH A.** (A'30), Manager, Radio Department, Max Glucksman, 729-7th Ave., New York, N.Y.
- HOPKINS, A. R.** (A'27), Radio Engineer, RCA Victor Company, Inc., Camden, N.J. For mail: 4742 Browning Rd., Merchantville, N.J.
- HOPKINS, JOHN S.** (J'25-A'30), Student, California Institute of Technology, Pasadena, Calif. For mail: 295 S. Wilson Ave., Pasadena, Calif.
- HOPKINS, NELSON S.** (A'27), President, Phenix Aircraft Products Company, Williamsville, N.Y. For mail: 5565 Main St., Williamsville, N.Y.
- HOPKINS, STEPHEN** (A'22), 11250 S. New Hampshire Ave., Los Angeles, Calif.
- HOPPER, C. L.** (A'29), Radio Operator, Ann Arbor R.R. Company, S.S. Ann Arbor 7, Frankfort, Mich. For mail: Box 543, Frankfort, Mich.
- HOPPER, FRANCIS L.** (A'26), Acoustic Consulting Engineer, Electrical Research Products, Inc., 7046 Hollywood Blvd., Los Angeles, Calif. For mail: 599 S. Hudson Ave., Pasadena, Calif.
- HORIGUCHI, JIRO** (A'25), Musengakari Department of Communications, Tokyo, Japan. For mail: Musengakari, Komuka, Teihinsho, Tokyo, Japan.
- HORLE, LAWRENCE C. F.** (A'14-M'23-F'25), Consulting Engineer, Hudson Terminal Bldg., New York, N.Y. For mail: 17 Longfellow Ave., Newark, N.J.
- HORN, C. O.** (A'30), Radio Section, P.O. Engineering Department, Alder House, Aldersgate St., London, England.
- HORN, CHARLES W.** (A'14-M'28-F'30), General Engineer, National Broadcasting Company, Inc., 711-5th Ave., New York, N.Y.
- HORN, TYREE R.** (A'31), Lieutenant, U. S. Army, Fort Monmouth, Oceanport, N.J.
- HORNBERGER, JOSEPH E.** (A'31), Manager, Radio and Refrigeration Department, Bright and Company, Reading, Pa. For mail: 242 S. 5th St., Reading, Pa.
- HORNE, TOM** (A'31), Inspector, c/o British Wireless Marine Service, 9 India St., Glasgow, Scotland. For mail: 13 Park Rd., Douglas, Isle of Man.
- HORNE, WILLIAM P.** (A'26), S. and W. Electric Company, Oak Bluffs, Mass. For mail: 52 Kennebec Ave., Oak Bluffs, Mass.
- HORNUNG, JULIUS L.** (A'18), Technical Supervisor, Y.M.C.A. Radio Institute, 126 W. 64th St., New York, N.Y. For mail: 2902 Grand Concourse, New York, N.Y.
- HORSCROFT, RICHARD G.** (A'31), Radio Service Engineer, R. H. Macy and Company, Inc., Herald Square, New York, N.Y. For mail: 89-91 Fairview Ave., New York, N.Y.
- HORTON, J. WARREN** (A'20-F'29), Chief Engineer, General Radio Company, 30 State St., Cambridge, Mass.
- HOSELTON, FRANK B.** (A'26), Salesman, Iowa Power and Light Company, Knoxville, Iowa. For mail: 1004-37th St., Des Moines, Iowa.
- HOSKINS, LABAN A.** (A'26), Beacon Radio Shop, Radios, Repairs and Accessories, 6907 Harrisburg Blvd., Houston, Tex. For mail: 8002 Eastern St., Houston, Tex.
- HOST, RAYMOND H.** (A'27), Service Manager, 629 Augusta St., Racine, Wis.
- HOSTETLER, AMOS C.** (A'26), Radio Electrician, 424 Federal Bldg., Milwaukee, Wis.
- HOTINE, LESLIE** (A'24-M'25), Radio Engineer, British Broadcasting Corporation, 21 Blythswood Sq., Glasgow, Scotland.
- HOTOPP, ALFRED H., JR.** (A'22-M'29), Division Engineer, Wired Radio, Inc., Amper, N.J. For mail: 45 Hillside Ave., Caldwell, N.J.
- HOTTEL, C. W.** (A'29), Partner, Hottel Brothers, 520 W. Broad St., Bethlehem, Pa.
- HOUCK, HARRY W.** (A'19-M'28), International Communication Laboratories, Inc., 200 Mount Pleasant Ave., Newark, N.J. For mail: 220 Bryant St., Rahway, N.J.
- HOUDYSHELL, LOWELL B.** (J'28-A'28), Engineer, Long Lines Department, Pacific Telephone and Telegraph Company, 433 S. Oliver St., Los Angeles, Calif. For mail: 1043 S. Kingsley Dr., Los Angeles, Calif.
- HOUGH, CLINTON WALLACE** (A'22), Director, North American Company, 60 Broadway, New York, N.Y.
- HOUGH, WILLIAM E.** (A'29), Manager, Radio Service Department, Interstate Sales Company, 743 N. 4th St., Milwaukee, Wis. For mail: 1918 N. 27th St., Milwaukee, Wis.
- HOUGHTON, HENRY G., JR.** (A'29), Research Assistant, Massachusetts Institute of Technology, Round Hill, South Dartmouth, Mass. For mail: P.O. Box 156, South Dartmouth, Mass.
- HOULDSON, CLYDE J.** (A'30), Technical Information Service, American Radio Relay League, 38 La Salle Rd., West Hartford, Conn.
- HOUSTON, G. PORTER, III** (A'28), 841 McCabe Ave., Baltimore, Md.
- HOUSTON, PHILIP M.** (A'30), Superintendent, Southern Radio Corporation, La Paz, Bolivia. For mail: Casilla de Correo 669, La Paz, Bolivia.

- HOVGAARD, OLE M.** (A'24-M'26), Radio Engineer, Bell Telephone Laboratories, Inc., 463 West St., New York, N.Y.
- HOWARD, AUSTIN A.** (A'16-M'29), President, Austin A. Howard Corporation, 1725 Diversey Pkwy., Chicago, Ill. For mail: 1530 Wilmette Ave., Wilmette, Ill.
- HOWARD, C. G.** (A'29), Mechanic and Electrician, Indo-European Telegraph Company, Ltd., 18 Old Broad St., London, E.C. 2, England. For mail: Chalisse, Langley Ave., Worcester Park, Surrey, England.
- HOWARD, C. M.** (A'27-M'28), Proprietor, Radio Research and Service Laboratories, 1018 N. Hamlin Ave., Chicago, Ill.
- HOWARD, C. ALEXANDER** (A'29), Service Engineer, Marconiphone Company, Tottenham Court Rd., London, W. 1, England. For mail: 7 Digby Rd., Finsbury Park, London, N. 4, England.
- HOWARD, DAVID G.** (A'30), Instructor, Department of Electrical Engineering, U. S. Naval Academy, Annapolis, Md. For mail: 69-5th St., Annapolis, Md.
- HOWARD, EDWARD J.** (A'28), Member of Technical Staff, Bell Telephone Laboratories, Inc., 463 West St., New York, N.Y. For mail: 2953 Grand Concourse, New York, N.Y.
- HOWARD, J. L.** (A'31), Assistant Engineer, Engineer-in-Chief's Office, G.P.O., Alder House, Aldersgate St., London, E.C. 1, England.
- HOWARD, L. W.** (A'28), Chief Engineer, National Electric Products Corporation, 1547 Venice Blvd., Los Angeles, Calif. For mail: 2918 S. Catalina Ave., Los Angeles, Calif.
- HOWE, A. E.** (A'28), Engineer, Canadian Marconi Company, Ltd., Marconi Beam Station, Drummondville, P.Q., Canada.
- HOWE, FRANKLIN JOACHIM** (A'29), Clerk, 200 S. Los Angeles St., Los Angeles, Calif. For mail: 5308-3rd Ave., Los Angeles, Calif.
- HOWE, WILLARD C.** (A'29), Publisher and Writer, Bar Bldg., Garden City, L.I., N.Y. For mail: 5 Suffolk Lane, Garden City, L.I., N.Y.
- HOWELL, CLIFFORD ALEXANDER** (A'27), Long Lines Department, American Telephone and Telegraph Company, 40 Rector St., New York, N.Y. For mail: 227 E. 239th St., New York, N.Y.
- HOWELL, JAMES P.** (A'30), Electrical Engineer, Bell Telephone Laboratories, Inc., 463 West St., New York, N.Y. For mail: 601 W. 115th St., Apartment 53, New York, N.Y.
- HOWELL, ROGER A.** (A'29), Radio Retailer, 200 E. 4th St., Long Beach, Calif.
- HOWELL, WALTER J.** (A'14-M'23), Radio Service, U. S. Inspector, Subtreasury Bldg., New York, N.Y.
- HOWES, DOUGLAS E.** (A'27), Associate Professor of Electrical Engineering, Norwich University, Northfield, Vt.
- HOWES, EDGAR T.** (A'26), Partner, Reeves and Howes, 1041 E. Green St., Pasadena, Calif. For mail: 1164 S. Los Robles Ave., Pasadena, Calif.
- HOWEY, WILLIAM J.** (A'30), Radio Serviceman, 4126 Concord Ave., Detroit, Mich.
- HOWITT, NATHAN** (A'31), Research Physicist, U. S. Naval Research Laboratory, Bellevue, Anacostia, D.C.
- HOWLETT, CHARLES A., JR.** (J'30), Radio Serviceman, Jones, McNally and Murphy, 209 Columbia St., Utica, N.Y. For mail: 1622 Sunset Ave., Utica, N.Y.
- HOWSE, H. A. G.** (A'25-M'28), Service Engineer, International Telephone and Telegraph Laboratories, Inc., Hendon, London, England. For mail: 3 Hilltop Way, Stanmore, Middlesex, England.
- HOXIE, CHARLES A.** (A'15), General Engineering Laboratory, General Electric Company, 1 River Rd., Schenectady, N.Y.
- HOYT, EDWARD C.** (J'30), Radio Serviceman, 13 Beauport Ave., Gloucester, Mass.
- HROMADA, JOSEPH C.** (J'27-A'27), Airways Division, Bureau of Lighthouses, Washington, D.C.
- HSU, C. L.** (J'28), China Radio Corporation, 8 Rue du Marechal Foch, Tientsin, China.
- HSU, PHILIP H.** (A'27), Sales Manager, Electrical Service Corporation, 20 Nanking Rd., Shanghai, China.
- HUBBARD, BEVERLY R.** (J'21-A'24), Director of Laboratory, Submarine Signal Company, State St., Boston, Mass. For mail: 125 Conant Rd., Melrose, Mass.
- HUBBARD, BURNETTE L.** (A'31), Engineer, RCA Victor Company, Inc., Camden, N.J. For mail: Haddon Heights Apartments, Haddon Heights, N.J.
- HUBBARD, CHARLES W.** (A'31), R.F.D. No. 2, Box 107 D, Rahway, N.J.
- HUBBARD, FRANK A.** (A'24), Radio Engineer, Research Department, Bell Telephone Laboratories, Inc., Rm. J40, 463 West St., New York, N.Y.
- HUBBARD, JAMES L.** (A'25), P.O. Box 244, Norwich, Conn.
- HUBBARD, WYMAN B.** (A'31), Radio Serviceman, Fitzgerald Music Company, 729 S. Hill St., Los Angeles, Calif.
- HUBER, LOUIS R.** (A'30), 4263-9th Ave., N.E., Seattle, Wash.
- HUCHBERGER, ALFRED P.** (A'31), Engineer, Sylvania Products Company, Emporium, Pa. For mail: 338 W. 4th St., Emporium, Pa.
- HUCKE, HERBERT M.** (A'31), Engineer, Communications Division, Pacific Air Transport Company, Oakland, Calif. For mail: Oakland Airport Inn, Oakland, Calif.
- HUDACK, JOHN MARTIN** (A'29), Engineer, Bell Telephone Laboratories, Inc., 463 West St., New York, N.Y.
- HUDDY, FRANKLIN S.** (A'30), Assistant to Chief Engineer, CeCo Manufacturing Company, 1200 Eddy St., Providence, R.I. For mail: 204 Bower St., Providence, R.I.
- HUDSON, JULIUS** (A'30), Superintendent, Duratron Radio Tube Corporation, 409-38th St., Union City, N.J.
- HUDTWALKER, WILLIAM THEODORE** (A'29), Assistant Engineer, RCA Victor Company, Inc., Camden, N.J. For mail: 814 Colford Ave., Collingswood, N.J.
- HUEBL, R. M.** (A'30), Lieutenant, U. S. Navy, Division Radio Officer, U.S.S. *Holland*, c/o Postmaster, San Francisco, Calif.
- HUFFMAN, CHARLES E.** (A'29), Engineer, American Television Laboratories, Ltd., 7160 Santa Monica Blvd., Hollywood, Calif. For mail: 916 N. Laurel Ave., Hollywood, Calif.
- HUFFMAN, KENNETH C.** (A'30), Planning Engineer, Department 6480-2, Western Elec-

- tric Company, Inc., Chicago, Ill. For mail: 1343 Pine St., Chicago, Ill.
- HUGHES, EMMETT N. (A'31), Manager, Radio Manufacturers' Supply Company, 1000 S. Broadway, Los Angeles, Calif.
- HUGHES, EVERETT J. (A'26), Engineer, Electrad, Inc., 175 Varick St. New York, N.Y. For mail: 615 Church St., Boonton, N.J.
- HUGHES, LESLIE E. C. (A'31), Transmission Engineer, Creed and Company, Croydon, England. For mail: 63 Curzon St., London, W. 1, England.
- HUGHES, LIONEL J. (A'23), The Telegraph Office, Mombasa, Kenya Colony, East Africa. For mail: BM-Hughes, London, W.C. 1, England.
- HUGHES, MICHAEL S. (A'31), Engineer, Engineering Department, RCA Victor Company, Inc., Camden, N.J.
- HUGHES, WILLIAM P. JR. (A'26), Radio Engineer, Radio Engineering Laboratories, 100 Wilbur Ave., Long Island City, L.I., N.Y. For mail: 5013-8th Ave., Brooklyn, N.Y.
- HULAN, A. G. (A'29), Director, Specifications Section, Engineering Department, RCA Photophone, Inc., 153 E. 24th St., New York, N.Y. For mail: Kerens, Tex.
- HULL, BLAKE D. (A'22), Engineer, Southwestern Bell Telephone Company, Dallas, Tex.
- HULL, CHARLES E. (A'30), President, State Radio Service, 21 Commercial Ave., New Brunswick, N.J. For mail: 426 Cedar Ave. Highland Park, New Brunswick, N.J.
- HULL, L. M. (J'17-A'19-M'27-F'28), Vice President, Radio Frequency Laboratories, Boonton, N.J.
- HULME, ARNOLD B. (A'30), Electrical Engineer, 8-9 Sadler Gate, Derby, England.
- HUME, J. MALCOLM (A'31), Transformer Engineer, Carter Radio Company, 407 S. Aberdeen St., Chicago, Ill. For mail: 4309 N. Whipple St., Chicago, Ill.
- HUMMEL, JEAN EMILE (A'31), Agent-Technique, Ets. Constable Celestion, 47 Blvd. de Levallois, Neuilly-sur-Seine, France. For mail: 44 Rue des Montes Clairs, Colombes, Seine, France.
- HUMMELING, WILLIAM G. A. M. (A'31), Radio and Sound Service Engineer, Signal Engineering Service, Rembrandtlaan 24, Hilversum, Holland.
- HUMPHREY, HARTLEY C. (A'29), Recording Operations Manager, Electrical Research Products, Inc., 250 W. 57th St., New York, N.Y. For mail: 45 Beverly Rd., Summit, N.J.
- HUMPHREY, STANLEY M. (A'28), Engineer, Hygrade Lamp Company, Salem, Mass. For mail: 12 Humphrey Ter., Swampscott, Mass.
- HUMPHREYS, IRL W. (A'29), Radio Serviceman, Connor Radio Company, 37 N. Euclid Ave., St. Louis, Mo. For mail: 5402 Page Blvd., St. Louis, Mo.
- HUND, AUGUST (M'16-F'27), Consulting Engineer, Wired Radio, Inc., Ampere, N.J.
- HUNGERFORD, N. C. (A'30), 1818 Evans Ave., Cheyenne, Wyo.
- HUNKINS, HAROLD R. (A'29), Research Engineer, International Communications Laboratories, Inc., 67 Broad St., New York, N.Y.
- HUNT, BERTRAM D. (A'31), Service Engineer, Stromberg-Carlson Company, 211 Geary Ave., Toronto, Ont., Canada. For mail: 34 Bartlett Ave., Toronto, Ont., Canada.
- HUNT, FREDERICK V. (A'28), Assistant Department of Physics, Cruft Laboratory, Harvard University, Cambridge, Mass. For mail: 20 Conant Hall, Cambridge, Mass.
- HUNT, J. W. (A'30), Radio Instructor, Houston Vocational Schools, Houston Public School, Houston, Tex. For mail: 7109 Illex St., Houston, Tex.
- HUNT, LOUIS W. (A'27), Professor of Chemical Engineering, Fenn College, Cleveland, Ohio. For mail: 2200 Prospect Ave., Cleveland, Ohio.
- HUNTER, THEODORE A. (A'29), Instructor in Physics, Rose Polytechnic Institute, Terre Haute, Ind. For mail: 2261 Crawford St., Terre Haute, Ind.
- HUNTINGTON, MAURICE B. (A'26), Assistant Laboratory Engineer, Rochester Gas and Electric Corporation, Rochester, N.Y. For mail: 86 Rockingham St., Rochester, N.Y.
- HUNTLEY, KENNETH L. (A'29), Specifications Engineer, Bell Telephone Laboratories, Inc., 463 West St., New York, N.Y.
- HUNTSINGER, F. J. (A'27), Assistant Radio Editor, *Buffalo Evening News*, Buffalo, N.Y. For mail: 118 W. Humboldt Pkwy., Buffalo, N.Y.
- HURD, VOLNEY D. (A'25), Radio Editor, *Christian Science Monitor*, Boston, Mass.
- HURFF, JOSEPH L. (A'28), Radio Engineer, Westinghouse Electric and Manufacturing Company, Chocoma Falls, Mass. For mail: 26 Prentice St., East Springfield, Mass.
- HURLBUT, HAROLD C. (A'30), 2633-11th Ave., N., Seattle, Wash.
- HURLEY, HENRY C. (A'31), Engineer, RCA Victor Company, Inc., Camden, N.J. For mail: 6710 Grant Ave., Merchantville, N.J.
- HURRELL, LESLIE W. (A'31), Radio Service Engineer, Calder Mackay Company, Ltd., Worcester St., Christchurch, New Zealand. For mail: 163 Edgeware Rd., Christchurch, New Zealand.
- HUSSEY, LUTHER W. (A'31), Engineer, Bell Telephone Laboratories, Inc., 180 Varick St., New York, N.Y. For mail: 55 Monroe Pl., Bloomfield, N.J.
- HUTCHESON, JOHN A. (A'28-M'30), Radio Engineer, Westinghouse Electric and Manufacturing Company, Chocoma Falls, Mass. For mail: 47 Florence St., Springfield, Mass.
- HUTCHINGS, ALLAN T. (A'31), "Bryn Avon," Callawadda, Victoria, Australia.
- HUTCHISON, MILLER (M'29), Engineer and Instructor, 90 West St., New York, N.Y.
- HUTCHISON, SAM T. (A'29), Manager, Order and Service Department, Harger and Blish Company, 112-11th St., Des Moines, Iowa. For mail: 1538-31st St., Des Moines, Iowa.
- HUTCHKO, FRANCIS J. (A'30), Repairman, RCA Victor Company, Inc., Camden, N.J. For mail: 317 Linden St., Camden, N.J.
- HUTTENLOCH, ROBERT M. (J'29-A'31), Commercial Radio Engineer, 653 N. 10th St., Philadelphia, Pa.
- HWANG, JU-TSU (J'29), Student, c/o Professor K. C. Chang, Nanyang University, Shanghai, China.

- HYMAN, KENNETH R. (J'30), 402 E. Locust St., San Antonio, Tex.
- HYMEL, L. F. (A'31), Proprietor, Radio Repair and Supply Shop, 202 1/2 Bourbon St., New Orleans, La.
- I
- IAMS, HARLEY (A'31), Engineer, Television Research Division, RCA Victor Company, Inc., Camden, N.J. For mail: 22 Merrick Villa, Collingswood, N.J.
- IDE, JOHN M. (J'28-A'30), Instructor in Physics, Cruft Laboratory, Harvard University, Cambridge, Mass. For mail: 41 Winthrop St., Cambridge, Mass.
- IINUMA, H. (A'28), Radio Engineer, Research Laboratory, Department of Communications, Denki-Shikensho 4-Bu., Osakimachi, Tokyo-fu, Japan.
- IMAOKA, YOSHIO (A'27), Research Staff, Tokyo Electric Company, P.O. Box 5, Kawasaki, Japan. For mail: No. 45, Minami-Machi, 5-chome, Aoyama, Tokyo, Japan.
- IMLACH, GEOGE (A'25), Radio Operator, Tropical Radio Telegraph Company, 1 Federal St., Boston, Mass. For mail: 94 Evans St., North Weymouth, Mass.
- IMLE, JOHN F. (A'30), Geophysicist, Standard Oil Company of Venezuela, Caripito, Venezuela.
- IMLER, GLENN M. (A'28), Radio Operator, Radio Station WLBW, Oil City, Pa.
- INADA, SANNOSUKE (M'22), 176 Kogaicho Azabu, Tokyo, Japan.
- INADA, SHIGERU (A'30), Shimizu Broadcasting Station JOGG, near Kumamoto City, Japan.
- INANAMI, SUEO (A'27), Radio Station, Komukyoku, Department of Communications, Tokyo, Japan.
- INGERSOLL, WILLIAM P. (A'25), 251 E. Chestnut St., Canton, Ill.
- INGHAM, JAMES, JR. (A'31), Test Maintenance, RCA Victor Company, Inc., Camden, N.J. For mail: 3048 D St., Philadelphia, Pa.
- INNS, STEPHEN H. (A'29), Radio Consultant Engineer, P.O. Box 84, La Habra, Calif.
- INSKIP, LEONARD S. (A'25), Department of Development and Research, American Telephone and Telegraph Company, 195 Broadway, New York, N.Y. For mail: 3301 Avenue J, Brooklyn, N.Y.
- INSTRALL, REGINALD C. (A'28), Captain, British Regular Army, No. 2 Wireless Company, R. Signals, Saraland, Palestine.
- INSULANDER, CLARENCE H. M. (A'30), Box 132, Prince Rupert, B.C., Canada.
- IREY, EARL R. (A'30), Technician, Radio Station KXO, 679 Main St., El Centro, Calif. For mail: 864 Olive St., El Centro, Calif.
- IRLAM, WILLIAM (A'30), Proprietor, Radio Sales and Service Company, 215 Station St., Wilmerding, Pa. For mail: 215 Card Ave., Wilmerding, Pa.
- IRVINE, BASIL (A'26), Radio Electrician, Dominion Government Radio Service, Vancouver, B.C., Canada. For mail: Port Coquitlam, B.C., Canada.
- IRVING, DONALD H. (A'27), Service Engineer, Philips Lamps, Ltd., 16 Temple St., Bristol, England. For mail: 15 Alexandra Park, Redland, Bristol, England.
- IRVING, EMMANUEL (J'27-A'31), Student, School of Engineering, Milwaukee, Wis. For mail: 1237 N. Cass St., Milwaukee, Wis.
- IRVING, IRA M. (A'26), President, Northeastern Radio Company, 302 Adams Ave., Scranton, Pa. For mail: 1707 Green Ridge St., Scranton, Pa.
- IRWIN, L. D. (A'30), Engineer and Superintendent, Sparton of Canada, London, Ont., Canada.
- ISBERG, REUBEN (J'31), Chief Operator, Radio Station KFKA, Midwestern Radio Corporation, 1002-9th St., Greeley, Colo. For mail: 514-6th St., Greeley, Colo.
- ISELE, HAROLD ADOLPH (A'26), Transmission Tests Engineer, New York Telephone Company, 102 Stevens Ave., Mount Vernon, N.Y. For mail: 22 W. 89th St., New York, N.Y.
- ISENBERG, RUDOLPH (A'31), Radio Operator, Radio Station WOWO, Fort Wayne, Ind. For mail: 1507 Melrose St., Chicago, Ill.
- ISHIKAWA, SHOICHI (A'25), Radio Section of Denki-Shikensho, Osakimachi, Suburbs of Tokyo, Japan.
- ISLER, SAMUEL (M'30), Radio Engineer, Wired Radio, Inc., Ampere, N.J. For mail: 73 Williamson Ave., Bloomfield, N.J.
- ISO, E. (A'30), Radio Section, Denki-Shikensho, Osaki, near Tokyo, Japan.
- ISRAEL, BERTRAM FRANCIS (A'30), Factory Manager, "Darelle Products," 363a Oxford St., Paddington, Sydney, Australia. For mail: 59 Imperial Ave., S. Bondi, Sydney, New South Wales, Australia.
- ISRAEL, DORMAN D. (A'23-M'30), Chief Engineer, Radio Division, Grigsby-Grunow Company, 5801 Dickens Ave., Chicago, Ill. For mail: 5502 Hyde Park Blvd., Chicago, Ill.
- ITOW, YUTAKA (A'26), Radio Engineer, Japan Broadcasting Association, 1. Uchiyama-shitachis, Kojimachiku, Tokyo, Japan. For mail: 36 Fujimicho, Azabuku, Tokyo, Japan.
- IVERSEN, I. VEE (A'26), Motor Car Operator, Northern Pacific Railway, Seattle, Wash. For mail: 6554-18th Ave., N.E., Seattle, Wash.
- IWAKATA, HIDEO (A'31), Assistant Professor, Electrical Engineering Department, Waseda University, Tokyo, Japan.
- IYOKI, O. (A'30), Radio Engineer, Japan Wireless Telegraph Company, Marunouchi, Tokyo, Japan. For mail: 18-2-chome, Marunouchi, Tokyo, Japan.
- IZENSTARK, MAURICE J. (A'24), Manager, Chicago Salvage Stock Store, 509 S. State St., Chicago, Ill. For mail: 2839 Palmier St., Chicago, Ill.
- IZZO, ANTHONY (A'28), Proprietor, Paramount Radio and Music Company, 624 Washington St., Hoboken, N.J.
- J
- JACK, ROBERT (A'31), Professor of Physics, University of Otago, Dunedin, New Zealand.
- JACKER, EDWARD W. (A'28), Radio Engineer, Radio Station WMBL, Addison, Ill. For mail: 36 S. Euclid Ave., Villa Park, Ill.
- JACKLIN, NORMAN L. (A'30), Transmitter Test Department, General Electric Company, 1 River Rd., Schenectady, N.Y. For mail: 457 Cedar St., Schenectady, N.Y.

- JACKSON, ALBERT H. (A'30), Radio Supervisor, Broadcasting Station WTIC, Travelers Insurance Company, Hartford, Conn. For mail: 8 Plymouth Rd., West Hartford, Conn.
- JACKSON, ALFRED C. (A'27), Radio Engineer, Broadcasting Station 4QG, Brisbane, Australia. For mail: Ashbey and Gilbert Sts., Fairchild, Brisbane, Queensland, Australia.
- JACKSON, C. H. (A'30), Radio Electrician, U. S. 11th Lighthouse District, Detroit, Mich. For mail: 446 S. Eastlawn, Detroit, Mich.
- JACKSON, CHESTER M. (A'31), Traffic Supervisor, R.C.A. Communications, Inc., 28 Geary St., San Francisco, Calif. For mail: 3216 Fernside Blvd., Alameda, Calif.
- JACKSON, FRANK P. (A'25), Chief Engineer, Radio Station KWWG, Brownsville, Tex.
- JACKSON, HENRY W. (M'23), Research Laboratory, General Electric Company, Schenectady, N.Y.
- JACKSON, LESLIE (A'28), Radio Service Engineer, Canadian Westinghouse Company, 355 King St., W., Toronto, Ont., Canada.
- JACKSON, N. H. (A'30), Radio Operator, Radio Department, American Airways, Inc., Love Field, Dallas, Tex.
- JACKSON, PAUL F. (A'30), Chief Engineer, Radio Products Company, 5th and Norwood Sts., Dayton, Ohio.
- JACKSON, SYLVAN E. (J'26-A'28), 725-2nd St., Portsmouth, Ohio.
- JACKSON, WILLIAM E. (A'29), Radio Engineer, Airways Division, U. S. Department of Commerce, Washington, D.C. For mail: 2301 Cathedral Ave., N.W., Washington, D.C.
- JACKSON, WILLIE (A'28-M'31), Lecturer in Electrical Communications, College of Technology, Sackville St., Manchester, England.
- JACOB, FREDERICK N. (A'31), c/o Meissner Manufacturing Company, 522 S. Clinton St., Chicago, Ill.
- JACOBS, ALWYN J. (A'25), District Engineer, Kinemas, Ltd., P.O. Box 3104, Cape Town, South Africa.
- JACOBS, FRANK (A'31), Instructor, R.C.A. Institutes, Inc., 75 Varick St., New York, N.Y. For mail: 8406-109th St., Richmond Hill, L.I., N.Y.
- JACOBS, LOUIS (A'28), Research Engineer, Splindorf Electric Company, 392 High St., Newark, N.J. For mail: 195 W. 10th St., New York, N.Y.
- JACOBSEN, BENT B. (A'31), International Telephone and Telegraph Laboratories, The Hyde, Hendon, London, England.
- JACOBSON, LARRY (J'31), Massachusetts Institute of Technology Dormitories, Cambridge, Mass.
- JACOBUS, RICHARD A. (A'31), RCA Radiotron Company, Inc., Harrison, N.J. For mail: 104 Alexander Ave., Montclair, N.J.
- JAEDERHOLM, HENRIK W. (A'31), Designing Draftsman, Canadian Marconi Company, Mount Royal Factory, Montreal, P.Q., Canada.
- JAEGER, HAROLD (A'31), Service Manager, Waltham Radio, Inc., 233 Spring St., New York, N.Y. For mail: 115 Avenue S., Brooklyn, N.Y.
- JAHRL, EDWIN (A'31), Custom Set Builder and Service, "Edco Radio," 2130-59th St., Brooklyn, N.Y.
- JAKOSKY, JOHN JAY (M'31), Director of Research, International Geophysics, Inc., and Electroblacks, Inc., 3520 Shaefer St., Culver City, Calif. For mail: 1518 S. Canfield Ave., Los Angeles, Calif.
- JAMES, V. NORVAL (J'30), Student Engineer, Box 9493, University of Minnesota, Minneapolis, Minn.
- JAMES, WALLACE MC NEAL (A'29), Engineer, Tube Division, RCA Victor Company, Inc., Front and Cooper Sts., Camden, N.J. For mail: 216 Morgan Ave., Collingswood, N.J.
- JAMES, WILLIAM P. (A'27), Editor and Manager, Editorials and News, Ltd., 32 Shoe Lane, London, E.C. 4, England. For mail: 4 Hilltop Way, Stanmore, Middlesex, England.
- JAMESON, MALCOLM F. (A'31), Research Engineer, Bell Telephone Laboratories, Inc., 463 West St., New York, N.Y.
- JAMISON, ALEXANDER (A'29), Chief Engineer, Ulster Rediffusion Service, Ltd., 21 Main St., Bangor, County Down, Ireland. For mail: 60 Clifton Rd., Bangor, County Down, Ireland.
- JAMROSS, RUDOLPH (A'26), 4231 Boyd Ave., New York, N.Y.
- JANACEK, KARL R. (A'31), 327-6th St., Portland, Ore.
- JANES, CLINTON W. (J'26-A'28), Chief Engineer, Radio Station WRHM, Wesley Temple Bldg., Minneapolis, Minn. For mail: 2161 Wellesley Ave., St. Paul, Minn.
- JANES, ROBERT B. (A'30), Graduate Student in Physics, Kenyon College, Gambier, Ohio.
- JANITSCHKE, E. O. (A'21), Design Draftsman, Industrial Department, U. S. Navy, Navy Yard, Pearl Harbor, Hawaii.
- JANKE, ALFRED H. (A'14-M'14), Electrical Engineer and Patent Attorney, 2 Rector St., New York, N.Y.
- JANSKY, C. M., JR. (A'18-M'25-F'28), Consulting Radio Engineer, Jansky and Bailey, 922 National Press Bldg., Washington, D.C.
- JANSKY, KARL G. (A'28), Radio Engineer, Bell Telephone Laboratories, Inc., 463 West St., New York, N.Y. For mail: P.O. Box 107, Red Bank, N.J.
- JANSSEN, JOHN F. (A'31), Proprietor, J. F. Janssen and Company, 1008 Erler Ave., Peoria, Ill.
- JARABIN, FRANK G. (A'25), Kolster Radio Corporation, 200 Mount Pleasant Ave., Newark, N.J. For mail: 202 W. 69th St., New York, N.Y.
- JARRATT, G. H. (A'30), Chief Technical Operator, c/o International Marine Radio Company, Connaught House, Aldwych, London, W.C. 2, England.
- JARVIS, KENNETH W. (A'24-M'27), Assistant to Chief Engineer, U. S. Radio and Television Corporation, S. Adams St., Marion, Ind. For mail: 631 W. 2nd St., Marion, Ind.
- JATLOW, J. L. (A'26), Research Engineer, Conner Crouse Corporation, 343 Lexington Ave., New York, N.Y. For mail: 756 Linden Ave., Elizabeth, N.J.
- JEAN, ROBERT P. (A'30), Engineer, Roger and Gallett, 210-11th Ave., New York, N.Y.

- JEFFREY, JACK H. (A'27), Wireless Engineer, Metro-Vick Supplies, Ltd., 14 Long Millgate, Manchester, England. For mail: 10 Sandgate Squires Gate, Blackpool, Lancashire, England.
- JELLEN, MATT J. (A'25), Radio Engineer, Stewart-Warner Speedometer Corporation, 1826 Diversey Blvd., Chicago, Ill. For mail: 4830 Barry Ave., Chicago, Ill.
- JELLCORSE, HAROLD L. (A'30), Chief Engineer, Radio Station WOPI, Inc., W. State and 22nd Sts., Bristol, Tenn. For mail: 119 Blountville Pike, Bristol, Tenn.
- JEN, C. K. (A'29), Cruft High Tension Laboratory, Harvard University, Cambridge, Mass.
- JENKINS, C. FRANCIS (A'28), 1519 Connecticut Ave., N.W., Washington, D.C.
- JENKINS, DAVID R. (A'26), Professor of Electrical Engineering, University of North Dakota, Grand Forks, N.D.
- JENKINS, HAROLD F. (A'31), Radio Technician, 660 Cedar St., Elmira, N.Y.
- JENKINS, J. ELLIOTT (M'30), Jenkins and Adair, Inc., 3333 Belmont Ave., Chicago, Ill.
- JENKINS, MYRON Z. (A'27), 595 E. 105th St., Cleveland, Ohio.
- JENKS, LESLIE E. (A'30), Radio Interference Inspector, c/o 1 Fire Department, La Crosse, Wis. For mail: 1028 Vine St., La Crosse, Wis.
- JENSEN, A. G. (A'23-M'26), Research Engineer, Bell Telephone Laboratories, Inc., Rm. 1323, Graybar Varick Bldg., 180 Varick St., New York, N.Y.
- JENSEN, GEORGE L. (A'29), U. S. Radio Inspector, Radio Division, U. S. Department of Commerce, Constant Frequency Monitoring Station, Grand Island, Neb.
- JENSEN, JOHN C. (M'19), Professor of Physics, Nebraska Wesleyan University, Lincoln, Neb. For mail: 4926 Leighton Ave., Lincoln, Neb.
- JENSEN, PETER L. (A'31), President and Chief Engineer, Jensen Radio Manufacturing Company, 6601 S. Laramie Ave., Chicago, Ill.
- JENSEN, RICHARD C. (A'31), Radio Engineer, General Electric Company, Schenectady, N.Y. For mail: 342 Mohawk Ave., Scotia, N.Y.
- JENSEN, ROBERT R. (J'31), College Student, Nebraska Wesleyan University, Lincoln, Neb.
- JENSEN, SVEN (A'26), 120 Melville Ave., Palo Alto, Calif.
- JEPHCOTT, ERNEST L. (A'29), Chief Engineer's Department, G.P.O., Salisbury, South Africa. For mail: Automatic Exchange, Box 391, G.P.O., Salisbury, Southern Rhodesia, South Africa.
- JEPSON, WARREN F. (A'20), Inspector of Radio Material, U. S. Coast Guard Headquarters, Washington, D.C. For mail: 54 Highview Ave., Melrose, Mass.
- JETT, EWELL K. (A'29), Lieutenant, U. S. Navy, Federal Radio Commission, Washington, D.C. For mail: 508 Rittenhouse St., N.W., Washington, D.C.
- JEWETT, F. B. (F'20), Vice President, American Telephone and Telegraph Company, 195 Broadway, New York, N.Y.
- JIMBO, S. (A'30), Chief Engineer, Electro-technical Laboratory, Ministry of Communications, Osakimachi, near Tokyo, Japan.
- JINMAN, ARTHUR M. (A'30), Engineer-in-Charge, British Broadcasting Corporation, 39 Park Pl., Cardiff, South Wales. For mail: "Ciscar," Hilary Gardens, Cyn Coed Rd., Llanishen, Cardiff, South Wales.
- JOHNS, FRANCIS J. (A'22), Design Engineer, Westinghouse Electric and Manufacturing Company, East Pittsburgh, Pa. For mail: Westinghouse Club, Wilkinsburg, Pa.
- JOHNSON, ALBERT E. (A'26), Control Engineer, National Broadcasting Company, Inc., Station WRC, 3308-14th St., Washington, D.C. For mail: Apartment 516, 4550 Connecticut Ave., Washington, D.C.
- JOHNSON, ARTHUR GRIMSHAW (A'30), Radio Engineer, The Bibby Line, 26 Chapel St., Liverpool, England. For mail: 13 Ben Nevis Rd., Prenton, Birkenhead, Cheshire, England.
- JOHNSON, ARTHUR R. (A'28), Station Engineer, Radio Station WENR, National Broadcasting Company, Inc., Downers Grove, Ill. For mail: 4821 Bryan Pl., Downers Grove, Ill.
- JOHNSON, C. M. (M'29), Lieutenant, U. S. Navy, Communication Officer, Naval Air Station, Lakehurst, N.J.
- JOHNSON, CARL A. (A'27), Chief Operator, Radio Station KGA, Northwest Broadcasting System, Sun Life Assurance Bldg., Spokane, Wash. For mail: 216 S. Cedar St., Spokane, Wash.
- JOHNSON, CARL C. (A'29), Radio Service Engineer, 1909-19th St., S., St. Petersburg, Fla.
- JOHNSON, CHARLES A. (A'27), Box 171, Lexington, Mass.
- JOHNSON, B. O. (A'29), Service Engineer, RCA Victor Company, Inc., Camden, N.J. For mail: 5666 Ridge Ave., Chicago, Ill.
- JOHNSON, EDGAR F. (A'27), Co-Partner, E. F. Johnson Company, Waseca, Minn. For mail: Waseca, Minn.
- JOHNSON, EDWARD C. (A'30), Principal, Johnson's Wireless School, 8-10 Brandon St., Wellington, New Zealand. For mail: P.O. Box 936, Wellington, New Zealand.
- JOHNSON, ESMOND E. (A'30), Radio Engineer, RCA Victor Company, Inc., Rm. 603, Bldg. 5, Camden, N.J.
- JOHNSON, H. FRANK (A'30), Chief Projectionist, Glen W. Dickinson Theatres, Inc., Kansas City, Mo. For mail: 518 W. Maumee St., Angola, Ind.
- JOHNSON, HARRY A. (A'31), Radio Technician, Reliable Radio Shop, 363 Clarkson St., Denver, Colo.
- JOHNSON, J. KELLY (A'25), Engineer, Hazeltine Service Corporation, 333 W. 52nd St., New York, N.Y.
- JOHNSON, JAMES A. (A'27), Architect, 781 Ellicott Sq., Buffalo, N.Y.
- JOHNSON, KENNETH S. (A'24-M'26), Research Department, Bell Telephone Laboratories, Inc., 463 West St., New York, N.Y.
- JOHNSON, LESLIE E. (A'31), Engineer, Hyde Park Radio Laboratories, 6117 Darchester Ave., Chicago, Ill.
- JOHNSON, MONTGOMERY H., JR. (J'28-A'29), Jefferson Physical Laboratory, Harvard University, Cambridge, Mass.

- JOHNSON, OSCAR E. (A'31), Clerk, Panida News Stand, 422 Antone St., Sandpoint, Idaho.
- JOHNSON, PAUL F. (A'23-M'26), 3100 Maiden Lane, Altadena, Calif.
- JOHNSON, R. STANLEY (A'29), 10 S. Oxford St., Brooklyn, N.Y.
- JOHNSON, REVERDY (A'26), Patent Engineer, Otis Elevator Company, 260-11th Ave., New York, N.Y. For mail: 444 E. 52nd St., New York, N.Y.
- JOHNSON, ROY L. (A'30), Radio Service Engineer, Saluda Radio Company, Saluda, N.C. For mail: P.O. Box 152, Saluda, N.C.
- JOHNSON, T. JR., (A'14-M'18), 189 McClellan St., Schenectady, N.Y.
- JOHNSON, V. (A'26), Proprietor, Johnson Radio Service, 908 Gaffey St., San Pedro, Calif. For mail: 868-6th St., San Pedro, Calif.
- JOHNSON, VIVION A. (A'29), 130 Percy St., Indianola, Miss.
- JOHNSON, WILLIAM D. (A'31), Assistant Radio Inspector, Radio Division, U. S. Department of Commerce, P.O. Box 2833, Dallas, Tex.
- JOHNSTON, DOUGLAS A. (A'26), Vice President, City Coal and Wood Company, 141 Elm St., New Britain, Conn.
- JOHNSTON, F. E. (M'30), Chief Engineer, Crosley Radio Corporation, Cincinnati, Ohio. For mail: 1515 Larry Ave., College Hill, Cincinnati, Ohio.
- JOHNSTON, GEORGE DAVID (A'30), 1479 Belmont Ave., Cleveland, Ohio.
- JOHNSTON, IVAN F. (A'29), Engineer, Western Electric Company, Inc., Chicago, Ill. For mail: 339 N. Parkside Ave., Chicago, Ill.
- JOHNSTON, JOHN P. (M'28), Engineer's Club, 32 W. 40th St., New York, N.Y.
- JOHNSTON, THOMAS F. (A'31), U. S. Radio Inspector, U. S. Subtreasury Bldg., Pine and Nassau Sts., New York, N.Y. For mail: 10 Sheridan Sq., New York, N.Y.
- JOHNSTONE, R. S. (A'22), Draftsman, American Bridge Company, 51st St., Pittsburgh, Pa. For mail: 201 E. Littlewood St., Etna, Pa.
- JOICE, W. S. (A'29), Sound Manager, Palace Theatre, High St., Sunderland, England. For mail: 3 Grange Crescent, Southwick, Sunderland, England.
- JOLLIFFE, CHARLES B. (M'25-F'30), Chief Engineer, Federal Radio Commission, National Press Bldg., Washington, D.C.
- JONES, ARTHUR B. (A'23), 1-A Glenlyon Rd., Eltham, S.E. 9, London, England.
- JONES, AUGUST F. (A'31), Engineer, International Telephone and Telegraph Corporation, 67 Broad St., New York, N.Y.
- JONES, BURLE R. (A'29), Proprietor, Jones Radio Service, 1235 S. Detroit Ave., Tulsa, Okla.
- JONES, CARL C. (A'30), Service Manager, Rike-Kulmer Company, Dayton, Ohio. For mail: Clayton, Ohio.
- JONES, DRAMIN D. (A'28), Chief Engineer, Radio Station WAAT, Hotel Plaza, Jersey City, N.J. For mail: 20 Evergreen Ave., Nutley, N.J.
- JONES, EDWARD T. (A'19-M'25), Manager, Wholesale Radio Department, Electrical Supply Company, 201 Magazine St., New Orleans, La. For mail: 857 Roosevelt Pl., New Orleans, La.
- JONES, ERNEST (A'31), 540 Hempshaw Lane, Stockport, England.
- JONES, FRANK C. (A'30), Consulting Engineer, 6 Mosswood Rd., Berkeley, Calif.
- JONES, FRANK E. B. (A'25), Captain, "Greystones," 4 Oaks Rd., Sutton Coldfield, Birmingham, England.
- JONES, FRANK H. (A'27), Chief Engineer, Tuinucu Sugar Company, Tuinucu, Cuba. For mail: Tuinucu, Cuba.
- JONES, FRANK M. (A'29), Broadcast Engineer, Radio Station KGKL, Inc., 8-10 W. Concho Ave., San Angelo, Tex. For mail: 16 S. Milton St., San Angelo, Tex.
- JONES, GEORGE I. (A'28), Radio Engineer, Radio Station WDAF, Kansas City, Mo. For mail: 3539 Gillham Rd., Kansas City, Mo.
- JONES, H. GARFIELD (A'28), Secretary and Manager, Hutton and Jones, Inc., 9 Whiting St., Plainville, Conn.
- JONES, H. ROSSITER (A'28), Engineer, Electrical Research Products, Inc., 250 W. 57th St., New York, N.Y. For mail: 1912 Hillcrest Ave., Merchantville, N.J.
- JONES, L. F., III (J'26-A'26), Transmitter Division, Engineering Department, RCA Victor Company, Inc., Camden, N.J.
- JONES, LESTER L. (A'12-F'25), President, Technidyne Corporation, 644 Broadway, New York, N.Y.
- JONES, MARGARET C. (A'31), Engineering Department, RCA Radiotron Company, Inc., Harrison, N.J.
- JONES, NEWELL R. (A'22), 247 Merion Ave., Haddonfield, N.J.
- JONES, RICHARD BURTON (A'30), Engineer, Radio Station WPDZ, Fort Wayne-Alen County Police Department, 319 E. Main St., Fort Wayne, Ind. For mail: 826 Washington Blvd., W., Fort Wayne, Ind.
- JONES, ROYS C. (A'30), Radio Operator, Plant Engineer, c/o Tropical Radio Telegraph Company, P.O. Box 1098, Panama City, Panama.
- JONES, VARNAKALE L. (A'26), Physics Department, University of Oklahoma, Norman, Okla. For mail: Chelsea, Okla.
- JONES, WALTER R. (A'26), Sales Engineer, Sylvania Products Company, Emporium, Pa.
- JORDAN, CHESTER H. (A'30), Radio Operator, Radiomarine Corporation of America, 75 Varick St., New York, N.Y. For mail: 729 Girod St., New Orleans, La.
- JORDAN, JACOB (A'28), Associate Professor of Physics, Oregon State College, Corvallis, Ore. For mail: 554 Jefferson St., Corvallis, Ore.
- JORDAN, JAMES R. (A'31), Radio Engineer, Ediswan Company, Ltd., 1A Newman St., London, W. 1, England. For mail: Doone Cottage, Warlingham, Surrey, England.
- JORDAN, RALPH E. (A'28), Proprietor and Manager, Jordan Radio Laboratory, 1019 E. 5th St., Erie, Pa.
- JORGENSEN, LAURITS (A'29), Radio Engineer, Philips Radio A/S, Studiestræde 24, Copenhagen K., Denmark. For mail: Kirsteinsgade 4, Copenhagen, Denmark.
- JORGENSEN, A. A. (A'30), Chief Radio Man, Naval Radio, Bremerton, Wash.
- JORGENSEN, HAROLD (A'27), Final Inspector, Howard Radio Company, South

- Haven, Mich. For mail: Janis Hotel, South Haven, Mich.
- JOSEPH, J. (M'26), Managing Director, Radio Instruments, Ltd., Purley Way, Croyden, Surrey, England.
- JOSEPH, J. BERNARD (A'30), 55 Providence St., Worcester, Mass.
- JOWDY, MITCHELL (A'29), Radio Dealer, Washington, N.C.
- JOY, HENRY B. (A'22), President, Joy Realty Company, 2766 Penobscot Bldg., Detroit, Mich.
- JOYCE, GILBERT B. (J'30), Radio Announcer, Sears, Roebuck and Company, Kansas City, Mo. For mail: 3821 Michigan Ave., Kansas City, Mo.
- JUDSON, ELBERT B. (A'26), Radio Engineer, Radio Transmission Research Laboratory, U. S. Bureau of Standards, Washington, D.C.
- JULIEN, IRA F. (A'15-M'26), Transmitting Station Manager, Mackay Radio and Telegraph Company, 22 Battery St., San Francisco, Calif. For mail: 740 Homer Ave., Palo Alto, Calif.
- JUNKEN, L. H. (A'25), Assistant Quality Manager, RCA Victor Company, Inc., Camden, N.J. For mail: 4 Tavistock Blvd., Haddonfield, N.J.
- K
- KAAR, IRA J. (J'22-M'29), Engineer, Radio Engineering Department, Transmitter Section, General Electric Company, Schenectady, N.Y.
- KACOURINE, SERGE N. (A'26), Chief Radio Laboratory, Scientific Research Institute of Transport, Gorohovskaia St., 8, Moscow, U.S.S.R. For mail: Stankevitch St., N. 11, Moscow, U.S.S.R.
- KA DELL, HAROLD WILLIAM (A'29), Sales Engineer, Radio Tube Division, National Carbon Company, Inc., 30 E. 42nd St., New York, N.Y. For mail: 300 Sheridan Blvd., Mount Vernon, N.Y.
- KADOW, A. C. (A'30), Radiotrician, Daniels and Clark, 221 E. Chicago St., Elgin, Ill. For mail: 636 Park St., Elgin, Ill.
- KAHNI, FRANK J. (A'20), 3266 West Blvd., Cleveland, Ohio.
- KAETEL, HERBERT C. (J'27-A'30), Manager, H. Charles Kaetel Radio Service, 2711 N. 27th St., Milwaukee, Wis.
- KAFKA, H. T. (A'27), Doctor, Ladowitz, Czechoslovakia.
- KAHANT, CHARLES G. (A'13), District Sales Agent, Roller-Smith Company, 233 Broadway, New York, N.Y.
- KAHN, ALBERT R. (J'25-A'28), Partner, The Radio Engineers, 119 W. Colfax Ave., South Bend, Ind.
- KAHN, ALFRED (A'31), Radio Technician, R.C.A. Communications, Inc., 66 Broad St., New York, N.Y. For mail: 132-48-114th St., South Richmond Hill, L.I., N.Y.
- KAHN, FREDERICK J. (A'22-M'26), Proprietor, Plaza Radio-Electric Shoppe, 21 Halsted St., East Orange, N.J. For mail: 157 Halsted St., East Orange, N.J.
- KAHN, LAMOS (A'27), Manager and Buyer, Radio Department, Herris-Kahn Company, 8401 Buffalo Ave., South Chicago, Ill. For mail: 7850 South Shore Dr., South Chicago, Ill.
- KAHN, LOUIS (A'31), Instructor, Engineering Building, Rutgers University, New Brunswick, N.J.
- KAHN, MORTON B. (A'29), Engineer, RCA Photophone, Inc., 411-5th Ave., New York, New York, N.Y. For mail: 617 W. 141st St., New York, N.Y.
- KAHN, P. O. (A'30), Cie. des Lampes, 29 Rue de Lisbonne, Paris, France.
- KAILUS, PETER C. (A'31), Motion Picture Projectionist, Grant Theatre, 1404 S. 49th Ct., Cicero, Ill. For mail: 1637 S. 51st St., Cicero, Ill.
- KAISER, FRED J. (A'27), 96 Ontario St., Albany, N.Y.
- KALB, ROBERT M. (A'30), Engineer, Bell Telephone Laboratories, Inc., 463 West St., New York, N.Y.
- KALBFLEISCH, ALBERT C., JR. (A'30), Assistant Instructor, National Radio Institute, Washington, D.C.
- KALE, SAMUEL S. (A'27), Radio Sales and Service, Raser and Kale, 330 Concord Ave., Trenton, N.J.
- KALIN, ALBERT (A'19), Electrical Engineer, Woodward Governor Company, Rockford, Ill.
- KAMIN, VERNON A. (A'27), Manager, Radio Department, Sears, Roebuck and Company, Chicago, Ill. For mail: 2039 S. 8th Ave., Maywood, Ill.
- KAMIO, K. (A'31), Research Staff, Research Laboratory, Tokyo Electric Company, Kawasaki, Japan.
- KAMMERMAN, JOHN O. (A'23), Professor of Electrical Engineering, South Dakota State School of Mines, Rapid City, S.D. For mail: 921 Columbus St., Rapid City, S.D.
- KAMPF, E. P. (A'31), Engineer, National Broadcasting Company, Inc., 711-5th Ave., New York, N.Y. For mail: 8310 Filmore Ave., Jackson Heights, L.I., N.Y.
- KANAYAMA, TOYOSAKU (A'29), Nihon-Hoso-Kyokai, Fukuoka-Hosokyoku, Fukuoka City, Japan.
- KANEKO, GEORGE T. (A'31), Clerk, Gay and Robinson Company, Makauli, Kauai, Hawaii. For mail: P.O. Box 41, Waima Kauai, Hawaii.
- KANKO, GO (A'28), Japan Wireless Telegraph Company, Oyamamachi Tochigiken, Japan.
- KANNENBERG, WALTER F. (A'25), Telephone Engineer, Bell Telephone Laboratories, Inc., 463 West St., New York, N.Y. For mail: 745 Ten Eyck Ave., Lyndhurst, N.J.
- KANNENSTINE, FABIAN M. (A'16), Director, Research Laboratory, Geophysical Research Corporation, 65 Broadway, New York, N.Y. For mail: 15 Ward St., Bloomfield, N.J.
- KANNO, GENGO (A'29), Chief Engineer, Nonochi, Sending Station JOJK, Kanazawa Broadcasting Station, Kanazawa City, Ishikawa-ken, Japan.
- KANTEBET, S. R. (A'25-M'31), Professor, Communication Engineering Laboratories, Indian Institute of Science, Bangalore, India.
- KAPLAN, ARTHUR A. (A'31), 851 W. 177th St., New York, N.Y.
- KAPLAN, JACOB (A'29), Patent Attorney, 900 F St., N.W., Washington, D.C.
- KAPPUS, PAUL B. (A'31), 662 Schiller Ave., Akron, Ohio.

- KARA, ALEXANDER R. (A'30)**, Chief Service Engineer, Boston Store, Chicago, Ill. For mail: 5132 S. Wells St., Chicago, Ill.
- KARCHER, DONALD (J'27-A'30)**, Radio Tester, Philadelphia Storage Battery Company, C and Ontario Sts., Philadelphia, Pa. For mail: 4433 Fleming St., Philadelphia, Pa.
- KARCHER, EDMUND M. (A'31)**, Service Engineer, RCA Victor Company, Inc., Camden, N.J.
- KARKER, ANTHONY S., JR. (A'31)**, Draftsman, Bell Telephone Company of Pennsylvania, 1312 Arch St., Philadelphia, Pa. For mail: 3834 N. 13th St., Philadelphia, Pa.
- KARKER, EARL C. (A'25)**, Head, Electrical Department, Rochester Mechanics Institute, Rochester, N.Y.
- KARL, OTTO G. (A'31)**, Radio Technician, Radio Manufacturers Supply Company, 1000 S. Broadway, Los Angeles, Calif. For mail: 1412 W. 10th Pl., Los Angeles, Calif.
- KARPLUS, EDUARD (A'31)**, Engineer, General Radio Company, 30 State St., Cambridge, Mass.
- KARPUK, ALEXANDER S. (A'31)**, 1630 Sedgwick St., Chicago, Ill.
- KASERMAN, FRANK S. (A'31)**, Junior Radio Engineer, Lighthouse Service, U. S. Department of Commerce, 3760 Jefferson, E., Detroit, Mich.
- KATO, KENZO (A'31)**, Research Work, Vacuum Tube Department, Tokyo Electric Company, Kawasaki, Japan.
- KATO, Y. (A'27)**, Radio Engineer, Japan Wireless Telegraph Company, Ltd., Marunouchi, Tokyo, Japan. For mail: 41 Ninami-Igumachi, Yotsuyaku, Tokyo, Japan.
- KATZ, DAVID (A'31)**, Radio Service, Ludwig Baumann and Company, 45 Pearson St., Long Island City, L.I., N.Y. For mail: 935 E. 104th St., Brooklyn, N.Y.
- KATZEN, MORRIS (A'31)**, Radio Salesman, Blau, The Radio Man, 89 Cordlandt St., New York, N.Y. For mail: 199 Adelaide St., Belleville, N.J.
- KATZIN, MARTIN (J'27-A'29)**, Radio Engineer, Design Division, R.C.A. Communications, Inc., Riverhead, L.I., N.Y. For mail: 1913-67th St., Brooklyn, N.Y.
- KAUFMAN, ARTHUR W. (J'27-A'30)**, Radio Repairman, Pacific Telephone and Telegraph Company, 333 Grant Ave., San Francisco, Calif. For mail: Olympia, Calif.
- KAUFMAN, JACK (A'30)**, Vice President, Heitz and Kaufman, Ltd., 311 California St., San Francisco, Calif.
- KAUFMAN, JOSEPH (M'30)**, Supervisor of Education, National Radio Institute, 16th and U Sts., Washington, D.C.
- KAUL, WILLIAM (A'29)**, 2829A S. 15th St., Milwaukee, Wis.
- KAULBACK, HAROLD D. (A'26)**, Airways Division, U. S. Department of Commerce, Municipal Airport, East Boston, Mass. For mail: P.O. Box 6, Stow, Mass.
- KAWAHARA, TAKEWO (A'25)**, Musengakari Communications Department, Tokyo, Japan.
- KAYNER, HARRY J. (A'30)**, Radio Engineer, United Air Cleaner Corporation, 9705 Cottage Grove Ave., Chicago, Ill. For mail: 7425 Cottage Grove Ave., Chicago, Ill.
- KAYSER, HERBERT (J'15-A'17)**, De Jur-Amsco Corporation, 95 Morton St., New York, N.Y. For mail: 290 Empire Blvd., Brooklyn, N.Y.
- KEAR, FRANK G. (A'24-M'31)**, Electrical Engineering Department, Massachusetts Institute of Technology, Cambridge, Mass.
- KEARNEY, HENRY B., JR. (A'31)**, Proprietor, Radio Service, 1205 Logan Ave., Tyrone, Pa.
- KEARNEY, L. E. (A'28)**, U. S. Radio Inspector, Radio Division, U. S. Department of Commerce, Philadelphia, Pa. For mail: 4238 Neilson St., Philadelphia, Pa.
- KEARNS, HENRY E. (A'30)**, Interference Engineer, Public Service Gas and Electric Company, Van Houten and Prospect Sts., Paterson, N.J.
- KECK, KENNETH K. (A'29)**, Proprietor, H. K. Radio Engineering Company, 959 Turner St., Allentown, Pa.
- KEEGAN, WILLIAM (A'30)**, Chief Technical Operator, Radio Telephone Department, S.S. Olympic, White Star Line, New York, N.Y. For mail: 8 Hawarden Ave., Birkenhead, England.
- KEELING, CHARLES H. (A'31)**, Salesman, The London Electric Wire Company and Smiths, Ltd., Church Rd., Leyton, E. 10, England. For mail: "Ulladulla," Victoria Rd., Buckhurst Hill, Essex, England.
- KEENE, K. W. (A'30)**, P.O. Box 248, Hartsdale, N.Y.
- KELLY, DELBAR P. (A'28)**, Commercial Marine Operator, Portland Trawling Company, Groton, Conn. For mail: 46 Palisade Ave., Windsor, Conn.
- KEIM, J. D. (A'25)**, Proprietor, Old Colony Appliance Company, 31 Bedford St., Boston, Mass. For mail: 287 Warren St., Needham, Mass.
- KEIM, JACOB A. (A'30)**, Testing Department, Belmont Radio Corporation, 1257 W. Fullerton Ave., Chicago, Ill. For mail: 2223 Clybourn Ave., Chicago, Ill.
- KEIM, LLEWELLYN B. (J'28-A'29)**, 270 Park Ave., New York, N.Y.
- KEIR, JOHN (M'21)**, Managing Director, Rua de Rosario B9, Rio de Janeiro, Brazil. For mail: Companhia Nacional de Comunicações Sem Fio, Caixa 126, Rio de Janeiro, Brazil.
- KELLER, EDWARD B. (A'31)**, Second Lieutenant, Signal Corps, 11th Signal Company, Schofield Barracks, Hawaii.
- KELLER, PAUL A. (A'27)**, Service Manager, Guarantee Radio Service Corporation, 1015 Chestnut St., Philadelphia, Pa. For mail: 1246 W. Lehigh Ave., Philadelphia, Pa.
- KELLEY, GEORGE W., JR. (A'14)**, Radio Engineer, Design Section, Navy Yard, Washington, D.C. For mail: 3 Taylor St., Chevy Chase, Md.
- KELLEY, LEO A. (A'27)**, International Communications Laboratories, 67 Broad St., New York, N.Y.
- KELLIHER, JOHN E. (A'29)**, Radio Service Manager, Sherman Clay and Company, 141-145 S. 1st St., San Jose, Calif. For mail: 398 N. 8th St., San Jose, Calif.
- KELLOGG, FRANK L. (A'30)**, Box 235, Larkspur, Calif.
- KELLOGG, LEONARD A. (A'25)**, District Sales Manager, Crosley Radio Corporation, Cincinnati, Ohio.

- KELLOGG, RICHARD B. (A'28)**, Assistant Electrical Engineer, Pacific Gas and Electric Company, 245 Market St., San Francisco, Calif.
- KELLOGG, WALTER D. (A'26)**, Engineer-in-Charge, Radio Station KGO, General Electric Company, Russ Bldg., San Francisco, Calif. For mail: 1810 San Ramon Ave., Berkeley, Calif.
- KELLOGG, WILLIAM M. (A'30)**, Radio Engineer, Bell Telephone Laboratories, Inc., 463 West St., New York, N.Y. For mail: 4 Station Rd., Madison, N.J.
- KELLOM, BERNARD (A'30)**, Chief Engineer, Broadcasting Station WLBZ, Maine Broadcasting Company, 100 Maine St., Bangor, Maine.
- KELLY, CHARLES M., JR. (A'12)**, Public Address Installation Supervisor, Electrical Research Products, Inc., 250 W. 57th St., New York, N.Y. For mail: 37 Albemarle Ave., New Rochelle, N.Y.
- KELLY, CLAUDE H. (A'28)**, General Manager, Research Service Laboratory, Concord, Calif. For mail: R.F.D. Route No. 2, Concord, Calif.
- KELLY, DALE (A'29)**, Engineer, R.C.A. Communications, Inc., Rocky Point, L.I., N.Y. For mail: 1465 Roosevelt Ave., Pelham Manor, N.Y.
- KELLY, DANIEL S. W. (A'23)**, Engineer, Allen-Bradley Company, 286 Greenfield Ave., Milwaukee, Wis. For mail: 129-13th St., Milwaukee, Wis.
- KELLY, EARL L. (A'27)**, Consulting Radio Engineer, 615 Peoria Life Bldg., Peoria, Ill. For mail: 6812 Dorchester, Chicago, Ill.
- KELLY, MERVIN J. (M'25)**, Research on Vacuum Tubes, Bell Telephone Laboratories, Inc., 463 West St., New York, N.Y.
- KELSEY, G. T. (A'30)**, Technical Journalist, Amalgamated Press, Ltd., Tallis House, Tallis St., London, E.C. 4, England. For mail: 128 Coldershaw Rd., West Ealing, London, W. 13, England.
- KELSEY, ELIZABETH L. (A'30)**, Radio Department, Lyon and Healy, 243 S. Wabash Ave., Chicago, Ill. For mail: 1300 N. Dearborn St., Chicago, Ill.
- KELSEY, PHILIP C. (A'30)**, Partner, Kelsey and Benner Company, Main St., Ivoryton, Conn.
- KELSO, RUPERT E. (A'26)**, Kelo Electric Company, Arvada, Colo. For mail: P.O. Box 96, Arvada, Colo.
- KELTERBORN, W. H. (A'27)**, Radio Tube Engineering, Canadian Westinghouse Company, Ltd., Aberdeen Ave., Hamilton, Ont., Canada.
- KEMPF, FRANK J. (A'29)**, Electro-Acoustical Engineer, National Sound Service Bureau, Inc., 723-7th Ave., New York, N.Y. For mail: 425 S. Ashland Blvd., Chicago, Ill.
- KEMPTON, WALTER D. (A'27)**, Service Manager and Partner, Radio Service Shop, 924 Chapala St., Santa Barbara, Calif.
- KENNEDY, DAVID WAYNE (A'30)**, Control Supervisor, National Broadcasting Company, Inc., 111 Sutter St., San Francisco, Calif.
- KENNEDY, DOUGLAS (A'30)**, Instructor, Los Angeles Junior College, Los Angeles, Calif.
- KENNEDY, EDWARD J. (A'31)**, Installer, Erickson Electric Company, 2756 Diversey Pkwy., Chicago, Ill. For mail: 206 E. Grantley Ave., Elmhurst, Ill.
- KENNEDY, FRANK M. (A'31)**, Don Lee Broadcasting System, 7th and Bixel, Los Angeles, Calif. For mail: 139 S. Carr Dr., Glendale, Calif.
- KENNEDY, HAROLD E. (A'28)**, Television Engineer, National Broadcasting Company, Inc., Empire State Bldg., New York, N.Y. For mail: 154 Union Ave., Rutherford, N.J.
- KENNEDY, JAMES P. (A'27)**, Manager and Proprietor, J. P. Kennedy's Radio Service, 418 W. LaSalle St., South Bend, Ind.
- KENNEDY, JOHN C. (A'28)**, Chief Engineer, Radio Station KMCS, 622 Commercial Exchange Bldg., 8th and Olive, Los Angeles, Calif. For mail: 103 N. Alta Vista Blvd., Los Angeles, Calif.
- KENNEDY, M. F. (A'30)**, Engineer-in-Charge, c/o Firestone Plantation Company, Monrovia, Liberia. For mail: Mount View, Jamesboro Ave., Limerick, Ireland.
- KENNEDY, T. R., JR. (A'27)**, Radio News Department, *New York Times*, Times Annex Bldg., New York, N.Y. For mail: 601 W. 112th St., New York, N.Y.
- KENNEDY, WILLIAM A. (J'27-A'30)**, Radio Inspector, New York Edison Company, Rm. 8458, 4 Irving Pl., New York, N.Y. For mail: 688-8th Ave., New York, N.Y.
- KENNELLY, ARTHUR E. (A'12-M'13-F'28)**, Professor Emeritus, Harvard University and Massachusetts Institute of Technology, Cambridge, Mass.
- KENNEY, M. W. (M'28)**, Electrical Engineer, In Charge of Radio Laboratory, Allen-Bradley Company, 1326 S. 2nd St., Milwaukee, Wis. For mail: 2976 N. 24th Pl., Milwaukee, Wis.
- KENNY, MATTHEW (A'15)**, Machinery Division, Navy Yard, Brooklyn, N.Y.
- KENRICK, GLEASON W. (A'23-M'29)**, Assistant Professor of Electrical Engineering, Tufts College, Mass.
- KENT, GEORGE C. (A'31)**, Salesman, Armour and Company, 17-19 Dederick St., Kingston, N.Y. For mail: 56 Crane St., Kingston, N.Y.
- KENT, JAMES M. (A'27)**, Teacher and Engineer, Kansas City School District, Manual Training High School, Kansas City, Mo. For mail: 3241 Wabash Ave., Kansas City, Mo.
- KENT, ROSCOE (A'14)**, Manager, Municipal Department, De Forest Radio Company, Passaic, N.J. For mail: P.O. Box 142, Passaic, N.J.
- KEOGH, RAYMOND J. (A'27)**, Radio Engineer, Story and Clark Radio Corporation, 175 N. Michigan Ave., Chicago, Ill. For mail: 3829 Fulton St., Chicago, Ill.
- KEPLER, O. L. (A'30)**, Chemist, Los Angeles Soap Company, 617 E. 1st St., Los Angeles, Calif. For mail: 200 N. Garfield Ave., Glendale, Calif.
- KERR, JOHN (A'30)**, Principal, Caledonian Wireless College, 22 Walker St., Edinburgh, Scotland.
- KERRIGAN, JOHN (A'31)**, Radio Engineer, RCA Victor Company, Inc., Camden, N.J. For mail: 3755 King Ave., Camden, N.J.
- KERRISON, HARLAND R. (A'31)**, Technical Wireless Instructor, Newcastle School, 3 Gallowgate, Newcastle-on-Tyne, England. For mail: 15 Dutchess Dr., Scotswood-on-Tyne, Northumberland, England.

MEMBERSHIP (Alphabetical)

- KERSTA, LAURENCE G. (A'29), Transmission Research Department, Bell Telephone Laboratories, Inc., 463 West St., New York, N.Y. For mail: 22 Ward St., Hackensack, N.J.
- KERWIEN, ARTHUR E., JR. (A'29), Bell Telephone Laboratories, Inc., Deal, N.J.
- KESHEIMER, EUGENE V. (A'30), Inspection Engineer, Crosley Radio Corporation, 3401 Colerain Ave., Cincinnati, Ohio.
- KESTER, ARTHUR S. (A'31), Technician, Jenkins and Adair, Inc., 3333 Belmont Ave., Chicago, Ill. For mail: 3350 N. Halsted St., Chicago, Ill.
- KESTER, CECIL D. (A'31), Chief Radio, S.S. President Grant, American Mail Line, Pier 41, Seattle, Wash. For mail: 509 Pearl St., Snohomish, Wash.
- KETCHUM, ROBERT W. (A'30), Electrician, Traffic Signal Division, City of Los Angeles, 517 S. Hill St., Los Angeles, Calif. For mail: 2711 Alsace Ave., Los Angeles, Calif.
- KEYES, EDWIN F. (A'15), Graduate Student, California Institute of Technology, Pasadena, Calif. For mail: 79 N. Catalina Ave., Pasadena, Calif.
- KIDD, ANDREW (A'30), Radio Engineer, Crosley Radio Corporation, Cincinnati, Ohio.
- KIEBERT, MARTIN P., JR. (A'31), Student, University of Idaho, Moscow, Idaho. For mail: 1104 S. Harrison, Moscow, Idaho.
- KIENZLE, D. R. (A'29), Radio Engineer, 4916 Chestnut St., Philadelphia, Pa.
- KIERNAN, EARL F. (J'22-A'24), Chief Technician, Radio Station KFXM, Lee Brothers Broadcasting Company, California Hotel Bldg., San Bernardino, Calif.
- KIERLUFF, WILLIAM E. (A'30-M'30), Engineer, Crosley Radio Corporation, Cincinnati, Ohio.
- KIESHAUER, FRED E. (A'31), Manager, Turner Radio Shop, Inc., 212 Liberty St., Warren, Pa.
- KILHEFFER, LAWRENCE D. (A'31), Development of Test Equipment, General Motors Radio Corporation, Dayton, Ohio. For mail: R.D. No. 1, Osborn, Ohio.
- KILGORE, G. ROSS (A'30), Research Engineer, Research Department, Westinghouse Electric and Manufacturing Company, East Pittsburgh, Pa.
- KILGOUR, CHARLES E. (A'25-M'30), Chief Engineer, Crosley Radio Corporation, Cincinnati, Ohio. For mail: 2617 University Ct., Cincinnati, Ohio.
- KILLEM, MORRIS (A'30), Service Engineer, Northern Electric Company, Ltd., 131 Simcoe St., Toronto, Ont., Canada. For mail: 15 Churchill Ave., Toronto, Ont., Canada.
- KILMER, T. W., JR. (A'25), Plant Department, New York Telephone Company, 1775 Grand Concourse, New York, N.Y. For mail: 438 W. 116th St., New York, N.Y.
- KIMBALL, GARDNER W. (A'27), Technical Representative, RCA Victor Company, Inc., Camden, N.J. For mail: 85 E. Stratford Ave., Lansdowne, Pa.
- KIMBERLY, HARBERT D. (A'30), Student, College of Engineering, University of Nebraska, Lincoln, Neb. For mail: 1222 Nelson St., Lincoln, Neb.
- KIMBLE, EARLE B. (A'31), Service Manager, Radio Department, Pudney Brothers, 338 Lundas St., London, Ont., Canada. For mail: 336 Oakland Ave., London, Ont., Canada.
- KIMPARA, ATSUSHI (A'25), Radio Engineer, Komuka, Tokyo-Teishin-Kyoku, Tokyo, Japan.
- KIMURA, ROKURO (A'30), Radio Engineer, Teishinsho Denkishikenjo, Osaka, near Tokyo, Japan.
- KINASE, MATSUNAGA (M'25), Laboratory, Japanese Broadcasting Corporation, Kinutamura, near Tokyo, Japan.
- KINCAID, OWEN D. (A'29), Service Manager, Willis Company, 104 Wick Ave., Youngstown, Ohio. For mail: 190 W. LaCede Ave., Youngstown, Ohio.
- KINDT, MARK (A'31), Service Manager, New England Distributing Company, 708 Beacon St., Boston, Mass. For mail: 127 New Salem St., Wakefield, Mass.
- KING, ARCHIE P. (A'30), Member of Technical Staff, Bell Telephone Laboratories, Inc., Box 107, Red Bank, N.J. For mail: R.F.D. No. 1, Box 63A, Red Bank, N.J.
- KING, CARY J., JR. (A'30), Lieutenant, Signal Supply Officer, U. S. Army, Schofield Barracks, Hawaii.
- KING, FRANCIS N. (A'28), Chief Engineer, Radio Station WIBX, Inc., 925 First National Bank Bldg., Utica, N.Y. For mail: 918 Symonds Pl., Utica, N.Y.
- KING, FRANK (A'15-M'30), Consulting Engineer, Amy, Aceves and King, 55 W. 42nd St., New York, N.Y.
- KING, HOWARD D. (A'26), RCA Victor Company, Inc., 235 Montgomery St., San Francisco, Calif.
- KING, RONALD (A'30), Department of Electrical Engineering, University of Wisconsin, Madison, Wis. For mail: 11 E. Gilman St., Madison, Wis.
- KING, SEABORN O., JR. (A'31), Service Manager, Banes, Inc., 107 Peachtree St., Atlanta, Ga. For mail: 1533 Melrose Dr., S.W., Atlanta, Ga.
- KING, W. MILTON (A'30), Electro-Acoustical Engineer, National Sound Service Bureau, 723-7th Ave., New York, N.Y. For mail: 28 W. 70th St., New York, N.Y.
- KINLEY, CLIFFORD B. (A'26), Assistant Radio Engineer, Office of Chief Signal Officer, War Department, Munitions Bldg., Washington, D.C. For mail: 2700 Q St., N.W., Washington, D.C.
- KINMAN, THOMAS H. (M'29), Radio Engineer, British Thomson-Houston Company, Engineering Laboratory, Rugby, England. For mail: "Ladbroke" House, Bilton Rd., Rugby, England.
- KINNEAR, DONALD R. (A'29), Plant Maintenance, Bell Telephone Company of Canada, Hudson Office, Toronto 12, Ont., Canada. For mail: 1331 Avenue Rd., Toronto 12, Ont., Canada.
- KINNEY, E. S., JR. (A'29), Partner, Kinney Brothers, 1307 Fern St., San Diego, Calif.
- KINNIER, DONALD (A'30), Engineer, Philco Radio Company, Tioga and C Sts., Philadelphia, Pa. For mail: 4926 Rubicon Ave., Philadelphia, Pa.
- KINOSHITA, SEIJI (A'31), Radio Engineer, Hiroshima Broadcasting Station JOFK, Hiroshima, Japan. For mail: Haramura Asagun, Hiroshima Prefecture, Japan.
- KINSLEY, CARL (M'16), Consulting Engineer, Research and Development Laboratory,

MEMBERSHIP (Alphabetical)

- United States Steel Corporation, Lincoln Highway, Kearny, N.J. For mail: 842 Cedar Ter., Westfield, N.J.
- KINSMAN, WARREN D. (A'28), 53 William St., Chicopee Falls, Mass.
- KINTER, DEANE S. (A'27), Radio Editor, *The Plain Dealer*, Cleveland, Ohio. For mail: 3622 Lindholm Rd., Cleveland, Ohio.
- KINTNER, SAMUEL M. (M'13-F'15), Vice President, Westinghouse Electric and Manufacturing Company, East Pittsburgh, Pa.
- KIRBY, OTTO I. (A'29), Radio Technician, J. L. Hudson Company, Detroit, Mich. For mail: 2923 Kirby St. W., Detroit, Mich.
- KIRBY, SAMUEL S. (A'27), Associate Physicist, Radio Section, U. S. Bureau of Standards, Washington, D.C.
- KIRCHER, REYMOND (A'30), Technical Employee, Bell Telephone Laboratories, Inc., 463 West St., New York, N.Y.
- KIRCHHOFF, WILLARD J. (A'31), Control Operator, Radio Stations WMCA-WPCH, 1697 Broadway, New York, N.Y. For mail: 381 E. 151st St., New York, N.Y.
- KIRDAHY, EMIL (A'29), 154 Congress St., Brooklyn, N.Y.
- KIRK, WALTER C. (A'30), Radio Tube Engineer, Ken-Rad Corporation, Owensboro, Ky. For mail: 122 E. 21st St., Owensboro, Ky.
- KIRKE, HAROLD L. (M'25), Radio Engineer, British Broadcasting Corporation, Ltd., 2 Savoy Hill, London, W.C. 2, England.
- KIRKLAND, ROBERT D. (A'31), Engineer, Mackay Radio and Telegraph Company, 22 Battery St., San Francisco, Calif.
- KIRKMAN, R. A. (A'31), Director of Technical Development, Royal Aircraft Establishment, Farnborough, Hants, England. For mail: 30 Manor Rd., Farnborough, Hants, England.
- KISHPAUGH, ARTHUR W. (A'20-M'30), Member of Technical Staff, Bell Telephone Laboratories, Inc., 463 West St., New York, N.Y.
- KISSEL, ALFRED L. (A'24), 1121 Bedford Ave., Brooklyn, N.Y.
- KISSINGER, J. HERBERT (A'21), Instructor, Boys' High School, Practical Arts Bldg., Reading, Pa. For mail: 243 Jameson Pl., Reading, Pa.
- KITCHEN, JAMES P. (A'26), Editor, *Irish Radio News*, 179 Pierce St., Dublin, Ireland. For mail: 3 Charlemont Ter., Dun Laoghaire County, Dublin, Ireland.
- KITCHIN, HOWARD WILLIAM (A'14-M'26), Lieutenant Commander, U. S. Navy, Officer-in-Charge, U. S. Naval High Power Radio Station, Annapolis, Md.
- KITCHIN, J. E. (A'28), Technician, Marine Department, Radio Branch, Vancouver, B.C., Canada. For mail: 4387 St. Catherine St., Vancouver, B.C., Canada.
- KIYOTA, Y. (A'30), Radio Engineer, Japan Wireless Telegraph Company, Marunouchi, Tokyo, Japan.
- KJELSDEN, T. F. (A'31), Alex. Jensen, Ltd., Howitzvej 11, Copenhagen, Denmark. For mail: Ejerstedgade 16 St. Tv., Copenhagen, Denmark.
- KLAPPENBACH, W. (A'31), Student, Radio Electricite Section, Ecole Supérieure d'Electricite, c/o La Nation, Rue Edouard VII, Paris, France. For mail: 1 Rue Octave, Fevillet, Paris, France.
- KLEESE, WILLIAM (A'29), Engineer, The Texas Company, Chrysler Bldg., New York, N.Y.
- KLEIN, HELEN (A'29), Engineering Department, Crosley Radio Corporation, 3401 Colerain Ave., Cincinnati, Ohio. For mail: 3881 Reading Rd., Cincinnati, Ohio.
- KLEIN, ISRAEL (A'24), Science Editor, NEA Service, Inc., 1200 W. 3rd St., Cleveland, Ohio.
- KLEIN, NORMAN E. (A'31), Radio Operator and Radio Mechanic, c/o Boeing Air Transport, Oakland, Calif.
- KLEIN, RENE H. (M'20), 18 Crediton Hill, W. Hempstead, London, N.W. 6, England.
- KLEIN, WILLIAM S. (A'29), Senior in Electrical Engineering, Oregon State College, Corvallis, Ore. For mail: Box 23, Corvallis, Ore.
- KLEINKAUF, JAMES D. (J'30), Engineer, Bell Telephone Laboratories, Inc., 463 West St., New York, N.Y. For mail: 92 Park Ave., East Orange, N.J.
- KLEIST, ALFRED H. (A'26), 3735 W. Hilda Pl., Milwaukee, Wis.
- KLEIST, WALTER A. (J'17-A'17), Engineer, Pacific Telephone and Telegraph Company, Portland, Ore.
- KLEMM, ROBERT CARL, JR. (A'29), Watchmaker, Morrow and Company, 366 High St., Holyoke, Mass. For mail: 49 Cleveland St., Holyoke, Mass.
- KLENK, JULIUS G. (A'28), Projection Engineer, Warner Brothers Lindley Theatre, 4902 N. 5th St., Philadelphia, Pa. For mail: 7162 Gillespie St., Philadelphia, Pa.
- KLINE, ROBERT L. (A'28), Technician, Kladag Radio Laboratories, Kline Bldg., Kent, Ohio. For mail: 880 Bryce Rd., Kent, Ohio.
- KLINESTIVER, GORDON H. (A'31), Radio Engineer, Sylvania Products Company, Emporium, Pa. For mail: Warner House, Emporium, Pa.
- KLINGELHOEFFER, ROYDEN H. (A'31), General Manager, International Resistance Company, Ltd., 74 Wellington St., W., Toronto, Ont., Canada.
- KLOSNER, MORRIS (J'20-A'21), 720 Hunts Point Ave., New York, N.Y.
- KLUGE, MYRON E. (J'31), Chief Engineer, Radio Station KCKY, Scottsbluff, Neb.
- KLUMB, HARVEY J. (A'26), Director, Electric Laboratory, Rochester Gas and Electric Corporation, 89 East Ave., Rochester, N.Y.
- KLUTH, WILLIAM J., JR. (A'29), Technician and Serviceman, Ellis Music Company, Nevada, Mo.
- KNAACK, FRANK E. (A'26), Maintenance Engineer, Radio Stations WMAC-WPCH, Knickerbocker Broadcasting Company, Inc., 1629 Broadway, New York, N.Y. For mail: 47 Poplar Ave., Silver Beach Gardens, New York, N.Y.
- KNAPP, GILBERT P., JR. (A'31), Installation and Service Engineer, RCA Photophone, Inc., 261 N. Broad St., Philadelphia, Pa. For mail: c/o RCA Photophone, Repr., National Theatre, Richmond, Va.
- KNAPP, HAROLD D. (A'29), Radio Engineer, RCA Victor Company, Inc., Camden, N.J. For mail: 2431 Merchantville Ave., N., Merchantville, N.J.

- KNAPP, JOSEPH F. (A'25)**, Vice President, Publication Corporation, 580-5th Ave., New York, N.Y.
- KNAPP, KENNETH G. (A'31)**, Engineer, Bell Telephone Laboratories, Inc., 180 Varick St., New York, N.Y.
- KNERR, G. RUSSELL (A'29)**, Secretary and Service Manager, Knerr, Inc., 1008 N. 3rd St., Harrisburg, Pa.
- KNIFFEN, LESLIE D. (A'30)**, Northern Electric Company, Ltd., 637 Craig St., W., Montreal, P.Q., Canada.
- KNIGHT, ARTHUR W. (A'25)**, 4 Highfield Rd., Rosebank, Cape Province, South Africa.
- KNIGHT, CHARLES (A'30)**, Chief Operator, Radio Station WOD, Magnolia Petroleum Company, Beaumont, Tex.
- KNIGHT, DONALD M. (A'29)**, 5615 Horger Ave., Dearborn, Mich.
- KNIGHT, FRANK (J'29-A'29)**, General Clerk, Rowntree, Ltd., 72 Sterling Rd., Toronto, Ont., Canada. For mail: 86 Geoffrey St., Toronto, Ont., Canada.
- KNIGHT, GAYLORD A. (A'28)**, Radio Service, Bayless Hardware Company, Athens, Tenn. For mail: 12 Euclid Ave., Athens, Tenn.
- KNIGHT, J. B., JR. (A'29)**, Engineer, Federal Telegraph Company, 200 Mount Pleasant Ave., Newark, N.J. For mail: 45 River Dr., Passaic, N.J.
- KNIGHT, OCTAVIUS (A'26)**, Patent Lawyer, Knight Brothers, 2 Rector St., New York, N.Y.
- KNIGHT, ROBERT W. (A'31)**, Engineer, RCA Victor Company, Inc., Camden, N.J. For mail: 403 Conly Ave., West Collingswood, N.J.
- KNIGHT, SIDNEY G. (A'26)**, Les Laboratoires Standard, 46 Avenue de Breteuil, Paris 7^e, France.
- KNIGHT, WINFIELD W. (A'25)**, Radio Inspector, Radio Office, Naval Aircraft Factory, Navy Yard, Philadelphia, Pa. For mail: 328 S. 8th St., Darby, Pa.
- KNIGHTS, ALEXANDER H. (A'26)**, Engineer, RCA Photophone, Inc., 438 W. 37th St., New York, N.Y. For mail: 863 Williams Ave., Teaneck, N.J.
- KNIPP, CHARLES T. (M'25)**, Professor of Experimental Electricity, Department of Physics, University of Illinois, Urbana, Ill.
- KNOLL, LLOYD M. (A'13-M'16)**, Professor of Physics, Central High School, Philadelphia, Pa. For mail: 6120 Carpenter St., West Philadelphia, Pa.
- KNOPP, ERNEST (A'26)**, Experimental Department, H. O. Boehme, Inc., 117 E. 24th St., New York, N.Y. For mail: 2285 Andrews Ave., New York, N.Y.
- KNOTT, WILLIAM M. (A'25)**, Radio Engineer, Bell Telephone Laboratories, Inc., 463 West St., New York, N.Y.
- KNOUF, RALPH J. (A'26)**, Transformer Corporation of America, Ogden and Keeler Sts., Chicago, Ill.
- KNOWLES, EDWARD P., JR. (A'14)**, Radio Operator, Capitol Broadcasting Company, Radio Station WOAX, Trenton, N.J. For mail: 59 Colonial Ave., Trenton, N.J.
- KNOWLES, HUGH S. (A'25)**, Superintending Engineer, Jensen Radio Manufacturing Company, 6601 S. Laramie St., Chicago, Ill. For mail: 423 Blackhawk St., Chicago, Ill.
- KNOWLES, J. G. (A'26)**, Civil Service, Lockyards, Newark St., Greenock, Scotland.
- KNOWLES, JEROME H., JR. (A'28)**, Northeast Harbor, Maine.
- KNOWLTON, EUGENE W. (A'27)**, Foreman, Federal Radio Corporation, 1738 Elmwood Ave., Buffalo, N.Y. For mail: P.O. Box 919, Buffalo, N.Y.
- KNOWLTON, ROBERT G. (A'27)**, Radio Service, 121-125 Merrimack St., Haverhill, Mass. For mail: 4 Hawthorne St., Bradford, Mass.
- KNOX, MARTIN E. (A'31)**, Assistant Radio Engineer, Holmes Jordan Radio Company, 2484 University Ave., St. Paul, Minn. For mail: 2100 Fairmount St., S.E., Minneapolis, Minn.
- KNUTSON, HENRY C. I. (A'30)**, Instructor in Electrical Engineering, Lehigh University, Bethlehem, Pa.
- KOBAYASHI, KICKIJIRO (A'28)**, Engineer, Electric Research Products, Inc. (Western Electric Company), Tokyo, Japan. For mail: No. 556 Koenji Suginami, Tokyo, Japan.
- KOBAYASHI, M. (A'27)**, Radio Engineer, Nippon Musen Denshin Kaisha, Shutchojo, Karia, Aichiken, Japan.
- KOBAYASHI, S. (A'30)**, Japan Wireless Telegraph Company, Tomiokacho, Fukushima, Japan.
- KOBER, PAUL A. (A'25)**, Chief Engineer, Television Laboratories, Inc., 360-7th Ave., New York, N.Y. For mail: 1 Gregory Ave., West Orange, N.J.
- KOBLIHA, FRANCIS E. (J'31)**, Technical Assistant, Bell Telephone Laboratories, Inc., 463 West St., New York, N.Y.
- KOCH, EARL L. (A'25)**, Consulting Engineer, 2307 Farwell Ave., Chicago, Ill.
- KOCH, J. WESLEY (J'29)**, Technician, Program Service Company, Lincoln, Neb. For mail: 1422 G St., Lincoln, Neb.
- KOCH, WINFIELD R. (A'26)**, RCA Victor Company, Inc., Camden, N.J. For mail: 220 Cooper St., Camden, N.J.
- KOCHAKIAN, LEO (A'31)**, 42 Grove St., Haverhill, Mass.
- KOECHER, W. P. (A'22)**, Engineer-in-Charge, Test Set Design Division, Ken-Rad Corporation, Owensboro, Ky. For mail: Route No. 5, Owensboro, Ky.
- KOEHLER, GLENN (A'27)**, Assistant Professor of Electrical Engineering, Electrical Laboratory, University of Wisconsin, Madison, Wis.
- KOEHNE, IRA C. (A'31)**, Patent Lawyer, 8801 Georgia Ave., Silver Spring, Md.
- KOERNER, LAWRENCE F. (A'29)**, Electrical Engineer, Bell Telephone Laboratories, Inc., 463 West St., New York, N.Y.
- KOERNER, RAYMOND S. (A'31)**, Proprietor, Radio Consulting and Service, 731 Locust Ave., Clarksburg, W.Va.
- KOFES, ALBERT (M'29)**, Doctor Engineering, Reinsburgstr. 178a, Stuttgart, Germany.
- KOHLER, E., JR. (A'31)**, Communications Engineer, Museum of Science and Industry, 300 W. Adams St., Chicago, Ill. For mail: 6028 Kimbark Ave., Chicago, Ill.
- KOHLI, HOMER J. (A'30)**, Science Teacher, Chatham High School, Chatham, Ohio. For mail: Medina, Ohio.
- KOHNO, S. (A'31)**, Engineer, Sapporo Broadcasting Company, Sapporo, Japan.

- KOLAR, EDWARD F. (A'31)**, Laboratory Assistant, Jenkins and Adair, Inc., 3333 Belmont Ave., Chicago, Ill. For mail: 2445 S. Spaulding Ave., Chicago, Ill.
- KOLB, WALTER R. (A'27)**, Partner, Kolb and Crawford, 129 Wolf's Lane, Pelham, N.Y. For mail: 407-7th Ave., Pelham, N.Y.
- KOLKS, RICHARD H. (A'29)**, Electrical Engineer, Union Gas and Electric Company, 2311 Muriel Ct., Cincinnati, Ohio.
- KOLO, R. E. (A'27)**, Transmission Engineer, Cincinnati and Suburban Telephone Company, Cincinnati, Ohio. For mail: 314 Park Ave., Newport, Ky.
- KOLSTER, CHARLES C. (M'28)**, Supervisor of Radio, U. S. Department of Commerce, Custom House, Boston, Mass. For mail: 18 Farragut Ave., West Somerville, Mass.
- KOLSTER, FREDERICK A. (A'12-M'13-F'16)**, Research Engineer, International Communications, Inc., 67 Broad St., New York, N.Y.
- KOMM, PAUL M. (A'23)**, Chief Engineer, Thordarson Electrical Manufacturing Company, 500 Huron St., Chicago, Ill. For mail: 6533 W. 26th Pl., Berwyn, Ill.
- KONKLE, PHIL (A'28)**, Radio Engineer, RCA Victor Company, Inc., Camden, N.J. For mail: 1601 Sycamore St., Haddon Heights, N.J.
- KONO, T. (M'29)**, Major, Imperial Japanese Army, Tokyo, Japan. For mail: Rikugun Tsushin Gakko, Koenji, Suginami-Machi, Tokyo, Japan.
- KOON, CECIL L. (A'29)**, Proprietor, Onslow Hardware Company, Onslow, Iowa.
- KORB, ALFRED (A'31)**, 340 Vernon Ave., Brooklyn, N.Y.
- KORNTVED, GEORGE W. (A'27)**, Radio Interference Engineer, Radio and Music Trades Association of Southern California, 234 Chamber of Commerce Bldg., Los Angeles, Calif.
- KORTES, GEORGE T. (A'27)**, Radio Electrician, U. S. Coast Guard, c/o Commander, Norfolk Division, Custom House, Norfolk, Va.
- KOS, SIMON F. (M'19)**, Engineering Department, G.P.O., Pretoria, South Africa.
- KOSAR, WILLIAM S. (A'30)**, Radioman, U.S.S. S-14, Coco Solo, Canal Zone.
- KOSHIKAWA, A. (A'30)**, Engineer, Broadcasting Station JOIK, near Sapporo City, Japan.
- KOSHIKAWA, Y. (A'29)**, Radio Engineer, Tokyo Central Broadcasting Station, Atagoyama, Tokyo, Japan.
- KOTERA, WILLIAM J. (A'27)**, Radio Operator, Radio Station WOW, Omaha, Neb.
- KOTZUM, JOSEPH H. (A'31)**, 735 Flatbush Ave., Brooklyn, N.Y.
- KOUCHNERKAVICH, THOMAS A. (A'30)**, Department of Development and Research, American Telephone and Telegraph Company, 195 Broadway, New York, N.Y.
- KOUTNIK, J. A. (A'29)**, Collector, U. S. Post Office, Hawthorne Station, Chicago, Ill. For mail: 3020 S. Hamlin Ave., Chicago, Ill.
- KOVELL, GEORGE W. (A'30)**, Radio Operator, Radio Station WTAQ, Eau Claire, Wis. For mail: P.O. Box 93, Eau Claire, Wis.
- KOWALCZIK, WILLIAM J. (A'30)**, Radio Engineer, Westinghouse Electric and Manufacturing Company, Chicopee Falls, Mass. For mail: 11 Tacoma St., Springfield, Mass.
- KOYAMA, KUMENOSUKE (A'27)**, Radio Engineer, Nippon Musen Denshin Kaisha, Haranomachi, Fukushima, Japan.
- KRAEMER, G. I. (M'30)**, Engineer and Manufacturer, 16 Rue de Chateaudun, Asnieres, Seine, France.
- KRAFT, VINCENT I. (A'15)**, Manager, American Radio Telephone Company, 218 Bigelow Bldg., Seattle, Wash.
- KRAHL, WALTER L. (M'28)**, Chief Engineer, Arcturus Radio Company, 28 Longworth St., Newark, N.J. For mail: 73 Orange Rd., Montclair, N.J.
- KRAMER, ANDREW W. (A'27)**, Associate Editor, Power Plant Engineering, 53 W. Jackson Blvd., Chicago, Ill. For mail: 7929 Harvard Ave., Chicago, Ill.
- KRAMER, JOHN F. (A'31)**, Secretary-Treasurer, Western College of Radio, 735 Larkin St., San Francisco, Calif.
- KRAMER, V. J. (A'29)**, Radio Repair, T. E. Swann Company, 706 W. 2nd St., Oklahoma City, Okla. For mail: 124 W. 6th St., Oklahoma City, Okla.
- KRANZ, FREDERICK W. (A'23)**, Chief Engineer, Magnavox Company, Beuter Rd., Fort Wayne, Ind. For mail: 2527 West Dr., Fort Wayne, Ind.
- KRANZ, HERMAN E. (M'23)**, Vice President, Charge of Engineering, Grigsby-Grinnow Company, 2060 N. Kolmar Ave., Chicago, Ill. For mail: 325 Cottage Hill Ave., Elmhurst, Ill.
- KRATOKVIL, FRANK M. (A'29)**, Assistant U. S. Radio Inspector, Office of Supervisor of Radio, 2909 David Stott Bldg., Detroit, Mich.
- KRATZ, LUTHER M. (A'30)**, 1911 Oak Hill Ave., Youngstown, Ohio.
- KRAUS, CHARLES N. (A'31)**, Proprietor, Radio Laboratory, 67 Pearl Ave., East Providence, R.I. For mail: 92 Keene St., Providence, R.I.
- KRAUSE, C. K. (A'30)**, Operating Engineer, Duquesne Light Company, 435-6th Ave., Pittsburgh, Pa. For mail: 1541 Princess Ave., Pittsburgh, Pa.
- KREBS, WILLIAM N. (A'29)**, Radio Engineer, Commercial Communications Section, Federal Radio Commission, Washington, D.C. For mail: 2811 Chelsea Ter., Baltimore, Md.
- KRETCHMAR, G. G. (A'27)**, Professor of Physics, Walla Walla College, College Place, Wash. For mail: College Place, Wash.
- KREUZER, BARTON (A'29)**, Research Engineer, RCA Photophone, Inc., 153 E. 24th St., New York, N.Y.
- KRIVITSKY, GEORGE (A'29)**, Scottville, Mich.
- KRIZ, JOSEPH (A'27)**, High Frequency Stations, 911-13th St., N.W., Washington, D.C.
- KROGER, F. H. (M'13-F'28)**, Radio Engineer, Radio Corporation of America, 66 Broad St., New York, N.Y.
- KROGER, H. B. (A'30)**, Transmitting Section, De Forest Radio Company, Passaic, N.J. For mail: 376 Paulson Ave., Passaic, N.J.
- KRONENWETTER, HAROLD G. (A'30)**, Maud Muller Apartments, Dayton, Ohio.

- KROUPA, HENRY F. (A'31), Testboard Supervisor, American Telephone and Telegraph Company, Rm. 1203, 24 Walker St., New York, N.Y. For mail: Box 53, Smithtown Ave. and E. Golf St., Bohemia, L.I., N.Y.
- KRUEGER, ALFRED (A'29), Final Test Alignment, Grigsby-Grunow Company, 4540 Armitage Ave., Chicago, Ill. For mail: 2141 Gunderson Ave., Berwyn, Ill.
- KRUEGER, OTTO J. (A'29), Engineering Department, Marathon Battery Company, Wausau, Wis. For mail: 618-1st St., Wausau, Wis.
- KRUGER, BERNARD (A'29), B. Kruger and Company, 500 N. Huntley Dr., West Hollywood, Calif.
- KRUGER, LEON (A'31), B. Kruger and Company, 123 W. 18th St., Los Angeles, Calif. For mail: 500 Huntley Dr., West Hollywood, Calif.
- KRUMING, ADOLF OSCAR (A'31), Graduate Student, McGill University, Montreal, P.Q., Canada. For mail: 456 Pine Ave., Montreal, P.Q., Canada.
- KRUSE, CHARLES C. (A'30), Treasurer, Wirtz Company, 226 W. Meinecke Ave., Milwaukee, Wis.
- KRUSE, ROBERT S. (A'18-M'26), Consultant, 103 Meadowbrook Rd., West Hartford, Conn.
- KRUSE, SIGURD (A'30), Dalagatan 78 A, Stockholm, Sweden.
- KUHN, ALFRED S. (A'12), President and Treasurer, H. Loeb and Company, Inc., 354-4th Ave., New York, N.Y. For mail: 25 E. 86th St., New York, N.Y.
- KUMON, AKITADA (A'31), Assistant Engineer, Broadcasting Corporation of Japan, Shiseikaikan, Tokyo, Japan.
- KUNC, FRANK (A'29), Engineer, H. O. Boehme, Inc., 117 E. 24th St., New York, N.Y.
- KUNICKY, BARNEY F. (A'29), 2355-33rd St., Astoria, L.I., N.Y.
- KUNINS, MORRIS K. (A'30), Radio Inspector in Charge, Radio Division, U. S. Department of Commerce, 514 Federal Bldg., Buffalo, N.Y.
- KUNKLE, CHARLES F. (A'30), Manager, Radio Service Laboratories, 218 High St., Flemington, Pa.
- KUNO, T. (A'29), Research Staff, Vacuum Tube Department, Research Laboratory, Tokyo Electric Company, Kawasaki, Japan.
- KUNTZE, EMMET L. (A'30), Engineer, Bell Telephone Laboratories, Inc., 463 West St., New York, N.Y. For mail: 140-70 Ash Ave., Flushing, L.I., N.Y.
- KUNZ, H. L. (A'29), Manager, Radio Sales, Sangamo Electric Company, Springfield, Ill.
- KURAMOCHI, SHAJU (A'25), Musengakari Communication Department, Tokyo, Japan.
- KURDZIEL, JOHN F. (A'31), Private Research, 3800 Archer St., Philadelphia, Pa.
- KURLBAUM, GEORG (A'30), Telefunken Gesellschaft fuer drahtlose Telegraphie, Vertriebs-Abteilung, Hallesches Ufer 12-13, Berlin, SW 11, Germany. For mail: Peter Lenne Str. 32, Berlin-Dahlem, Germany.
- KURTZ, CLYDE R. (A'29), Radio Salesman, Rauhofer Radio Electric Company, 1014 Hamilton St., Allentown, Pa. For mail: 921 Turner St., Allentown, Pa.
- KUSAKARI, T. (A'27), Bachelor of Engineering, Nippon Musen Denshin Kaisha, 2-18 Marunouchi, Kojimachi, Tokyo, Japan.
- KUSAMA, KANKITI (A'30), Electrical Engineer, Nippon Electric Power Company, 1 Soze-cho, Osaka, Japan. For mail: Hirano, Mikage, near Kobe, Japan.
- KUSUNOSE, YUZIRO (A'25), Electrotechnical Laboratory, Ministry of Communications, Osaki, Tokyo, Japan.
- KUTHE, HERMAN K. (A'31), Tube Engineer, National Union Radio Corporation, 57 State St., Newark, N.J. For mail: Brooklake Rd., Chatham, N.J.
- KUTSCHER, LOUIS F. (A'26), District Radio Supervisor, General Electric Company, 24 W. 40th St., New York, N.Y. For mail: Garden City Rd., Norton, Conn.
- KUWAJIMA, T. (A'29), Research Staff, Vacuum Tube Department, Research Laboratory, Tokyo Electric Company, Kawasaki, Japan.
- KYNASTON, B. H. J. (A'28), Managing Director, Harmonic Radio Company, Ltd., Nottingham, England.
- KYNNERSLEY, CHARLES (A'27), C. C. Meredith and Coy, 45 Jarvis St., Toronto, Ont., Canada. For mail: 38 Beresford Ave., Toronto, Ont., Canada.

L

- LACK, FREDERICK R. (A'20), Bell Telephone Laboratories, Inc., 463 West St., New York, N.Y.
- LACOMBE, CARLOS G. (A'25), Engineer, Companhia Internacional do Brasil, Rua da Alfandega 50, Rio de Janeiro, Brazil.
- LADNER, ALAN W. (A'23), Marconi Works, Chelmsford, Essex, England.
- LADNER, HENRY (A'31), Electrical Engineer, American Telephone and Telegraph Company, 195 Broadway, New York, N.Y.
- LAFORE, JOHN A., JR. (A'30), Radioman, American Telephone and Telegraph Company, Nectong, N.J. For mail: Penn Valley Farm, Narberth, Pa.
- LAGASSE, ALBERT (A'29), Production Engineer, Radio Tubes Division, Grigsby-Grunow Company, 2020 N. Austin Ave., Chicago, Ill. For mail: 1508 N. Kildare Ave., Chicago, Ill.
- LAHMAN, WILFORD C. (A'29), Vice President, Wolcott Lahman Company, Wilmette, Ill. For mail: 729 MacLean Ave., Kenilworth, Ill.
- LAINHART, VAUGHN (A'31), Electrician, Endicott Johnson Corporation, Maine, N.Y.
- LAKOTOS, EMORY (A'28), Engineer, Transformer Group, Bell Telephone Laboratories, Inc., 463 West St., New York, N.Y.
- LAKE, DANIEL A. (A'31), Radio Service Engineer, 2174 Davidson Ave., New York, N.Y.
- LAKE, THORNTON G. (J'27), Radio Service, 1020 Kirby St., Lake Charles, La.
- LAKER, EDWIN F. (A'30), Communications Superintendent, Eastern Air Transport, Inc., Box 208, Hapeville, Ga. For mail: 846 Virginia Ave., Hapeville, Ga.
- LA MANTIA, PHILIP VINCENT (J'30), Proprietor, Radio Repair Shop, 2512 Pine Ave., Niagara Falls, N.Y.

- LAMARQUE, JAMES W. (A'24), Graybar Electric Company, 401 Hudson St., New York, N.Y. For mail: 109 Davis Ave., White Plains, N.Y.
- LAMB, G. F. (A'28), 427 N. Tracy Ave., Bozeman, Mont.
- LAMB, HAROLD A. (A'29), Electrical Engineer, Western Electric Company, Inc., Chicago, Ill. For mail: 1706 N. Mayfield Ave., Chicago, Ill.
- LAMB, JAMES J. (A'28), Technical Editor, QST Magazine, 38 La Salle Rd., West Hartford, Conn.
- LAMB, WILLIAM H. (A'25), Radio Engineer, National Bldg., St. Mary's Parsonage, Manchester, England. For mail: 1 Watford Rd., Burnage, Manchester, England.
- LAMPEY, JOSEPH J. (A'31), Radio Serviceman, Kolster Radio Corporation, 200 Mount Pleasant Ave., Newark, N.J. For mail: 250 S. 7th St., Newark, N.J.
- LAMPKIN, GUY F. (A'26), 146 W. McMillan St., Cincinnati, Ohio.
- LAMSON, HORATIO W. (A'15-M'27), Engineer, General Radio Company, 30 State St., Cambridge, Mass. For mail: 72 Oakland Ave., Arlington Heights, Mass.
- LAND, JOHN R. (M'27), Telegraph and Telephone Department, Nukualofa, Tonga, Friendly Islands. For mail: Nukualofa, Tonga, Friendly Islands.
- LANDALE, S. E. A. (A'29), Development Department, Marconi International Marine Communications Company, Ltd., 62 High St., London, S.W. 13, England. For mail: 62 Pont St., London, S.W. 1, England.
- LONDON, VERNON D. (A'27-M'29), Assistant Chief Engineer, Charge of Radio, Grigsby-Grunow Company, 4540 Armitage Ave., Chicago, Ill. For mail: 288 Maple Ave., Elmhurst, Ill.
- LANDONE, BROWN (A'28), President, Landone Villa Land, Inc., Stickle Pond Rd., Newton, N.J. For mail: Newton, N.J.
- LANE, C. F. (M'30), London Manager, J. Dyson and Company, Ltd., St. Stephen's House, 2 Coleman St., London, E.C. 2, England. For mail: Shrublands, 7 Paxford Rd., North Wembley, Middlesex, England.
- LANE, C. V. (A'30), Supervisor, Croydon Airport Radio, Croydon, England. For mail: "Arnwood," Bradmore Way, Coulsdon, Surrey, England.
- LANE, FREDERICK A. (A'21), Engineering Department, American Gas and Electric Company, 30 Church St., New York, N.Y.
- LANE, HENRY M. (A'26-M'29), Instructor, Massachusetts Institute of Technology, Cambridge, Mass. For mail: 350 Lake St., Belmont, Mass.
- LANE, HOWARD D. (A'25), Research Engineer, Diascope Corporation, 2425-17th St., San Francisco, Calif.
- LANG, CONNIE (A'31), 1801 Alta Vista Dr., Alhambra, Calif.
- LANG, LOUIS B. (A'31), Radio Electrician, U. S. Lighthouse Service, Foot of Mount Elliot Ave., Detroit, Mich. For mail: 2260 Lothrop Ave., Detroit, Mich.
- LANG, WALTER T. (A'28), Engineer, Bell Telephone Laboratories, Inc., 463 West St., New York, N.Y. For mail: 27 Mulberry St., Rhinebeck, N.Y.
- LANGDELL, HENRY R. (A'28), R.F.D. No. 4, P.O. Box 82, Eau Claire, Wis.
- LANGDON, G. G. (A'28), American Gas and Electric Company, 30 Church St., New York, N.Y.
- LANGE, EDWARD H. (A'24), 4301 Maine Ave., Baltimore, Md.
- LANGENDAM, S. G. C. (A'29), Engineer, Nederlandsche Seintsesteller Fabriek, Hilversum, Holland.
- LANGEVIN, CARL C. (M'29), Manager, General Radio Company, 274 Brannan St., San Francisco, Calif.
- LANGHAMMER, CHARLES F. (A'31), Assistant Airway Engineer, Airways Division, U. S. Department of Commerce, St. George, S.I., N.Y. For mail: 191 Bement Ct., West New Brighton, S.I., N.Y.
- LANGLEY, HORACE E. (A'31), Assistant to Trade Consul, British Consulate General, 44 Whitehall St., New York, N.Y.
- LANGLEY, RALPH H. (A'12-M'16-F'29), Consulting Engineer, 165 Broadway, New York, N.Y. For mail: 47 Cassilis Ave., Bronxville, N.Y.
- LANGRICK, PAUL D. (A'26), President, Langrick Radio Engineering Service, 1141 West Blvd., Los Angeles, Calif.
- LANGSTAFF, HORACE (A'30), Radio Engineer, C. Pratts and Sons, Ltd., Commercial Bank Bldg., Bradford, York, England.
- LANPHERE, MERLE (A'27), Radio Dealer, Belmont Radio Service, 115 Palouse St., Wenatchee, Wash.
- LANTERMAN, WALTER F. (A'26), Transmission Engineer, National Broadcasting Company, Inc., Merchandise Mart, Chicago, Ill. For mail: 909 Argyle St., Chicago, Ill.
- LAPHAM, EVAN G. (A'31), Assistant Radio Engineer, U. S. Bureau of Standards, Washington, D.C. For mail: 4831-36th St., N.W., Washington, D.C.
- LAPHAM JAMES B. (A'27), Partner, Mills and Latham, Nanaimo, B.C., Canada. For mail: Spencer Rooms, Nanaimo, B.C., Canada.
- LAPORT, EDMUND A. (A'25-M'27), Engineer, Radio Engineering Department, Westinghouse Electric and Manufacturing Company, Chicopee Falls, Mass.
- LARA, JOSE (A'26), Vice President, National Broadcasting Company of Cuba, Hotel Plaza, Havana, Cuba. For mail: Vistalegre 24 Vibora, Havana, Cuba.
- LAREW, WALTER B. (A'31), Lieutenant, Fort Monmouth, Oceanport, N.J.
- LAR RIEU, E. A. (A'30), Radio Technician, Sherman and Clay Company, 14th and Clay Sts., Oakland, Calif. For mail: 1624 E. 38th St., Oakland, Calif.
- LARSEN, C. W. (A'29), Engineer, Fox Film Corporation, Beverly Hills, Calif. For mail: 2214 Benecia Ave., West Los Angeles, Calif.
- LARSEN, CARL L. (A'29), Student, Coe Radio Institute, 829 Main St., Greenport, L.I., N.Y.
- LARSEN, D. AVERY (A'31), Radio Technician, Humphreys Radio Company, 502 Pine Ave., Long Beach, Calif. For mail: 6132 California Ave., Long Beach, Calif.
- LARSEN, JOHN (A'30), Radio Operator in Charge, Transcontinental and Western Air, Inc., Springfield, Mo. For mail: Municipal Airport, Springfield, Mo.
- LARSON, CLIFFORD L. (A'28), Walworth Company, Kewanee, Ill. For mail: 710 Elliott St., Kewanee, Ill.

- LARSON, JOHN M. (A'27), National Broadcasting Company, Inc., Merchandise Mart, Chicago, Ill.
- LARSON, ROBERT W. (A'29), Vacuum Tube Engineering Department, General Electric Company, Schenectady, N.Y.
- LASKY, PHILIP G. (A'22-A'23), Manager, Radio Station KDYL, Intermountain Broadcasting Corporation, 6th Floor, Ezra Thompson Bldg., Salt Lake City, Utah.
- LASSMAN, HENRY H. (A'26), Wireless Apparatus Manufacturers, East Ham Wireless Supplies, London, England. For mail: 429 Barking Rd., East Ham, E. 6, Essex, England.
- LAST, GEORGE O. (A'26), Installation Supervisor, Philco Radio Corporation, Clyde, Ohio.
- LATHROP, F. A. (A'27), Sound Engineer, Electrical Research Products, Inc., 250 W. 57th St., New York, N.Y. For mail: 1013 Kensington Ave., Flint, Mich.
- LATHROP, KENNETH A. (A'30), 2639 San Marcos Dr., Pasadena, Calif.
- LATHROPE, KENNETH W. (J'29-A'31), Junior Engineer, Victor Talking Machine Division, RCA Victor Company, Inc., Camden, N.J. For mail: P.O. Box 238, Magnolia, N.J.
- LATIMER, CHESTER W. (A'17-F'29), Operating Engineer, R.C.A. Communications, Inc., 66 Broad St., New York, N.Y.
- LAUBE, HERBERT W. (A'31), Electrical Engineer, Western Electric Company, Inc., 100 Central Ave., Kearny, N.J. For mail: 44 Sunnyside Ter., East Orange, N.J.
- LAUMAN, LOUIS F., JR. (J'31), 5831 De Giverville Ave., St. Louis, Mo.
- LAURIE, WILLIAM L. (A'24), Captain, Royal Canadian Signals, c/o Assistant Director of Signals, Elgin Bldg., Ottawa, Ont., Canada.
- LAVALLEE, J. A. (M'30), Superintendent, Westinghouse Electric and Manufacturing Company, Chicopee Falls, Mass. For mail: 120 Ardmore St., Springfield, Mass.
- LAVENDER, RAYMOND W. (J'31), John A. Lavender Company, 268 River St., Troy, N.Y. For mail: R.D. No. 3, Troy, N.Y.
- LAWLER, L. A. C. (A'28), Radio Consultant, 14 Regent St., London, S.W. 1, England. For mail: 71 Colborne Way, Worcester Park, Surrey, England.
- LAWRENCE, EDWARD (A'31), Works Manager, J. Dyson and Company (Works), Ltd., 5-7 Godwin St., Bradford, York, England. For mail: 116 Salt St., Bradford, York, England.
- LAWRENCE, HENRY E. (A'31), Professor of Physics, University of Rochester, River Campus, Rochester, N.Y.
- LAWRENCE, WALTER L. (A'29), Radio Research Engineer, Bell Telephone Laboratories, Inc., 463 West St., New York, N.Y.
- LAWRENZ, WILLIAM (A'30), Radio Engineer, Boeing Air Transport, Cheyenne, Wyo.
- LAWSON, C. J. F. (A'30), Engineer, British Broadcasting Corporation, Broadcasting House, Langham Pl., London, W. 1, England. For mail: 47 Blenheim Rd., North Harrow, England.
- LAWTHER, HARRY P., JR. (A'20), Telephone Engineer, Southwestern Bell Telephone Company, 1817 Hickory St., Dallas, Tex. For mail: 5124 Live Oak St., Dallas, Tex.
- LAWTON, HARVEY B. (A'27), Chief Electrical Engineer, Williams Oil-O-Matic Heating Corporation, Bloomington, Ill. For mail: 23 Harwood Pl., Bloomington, Ill.
- LAYCOCK, RICHARD F. (A'31), Technician, Lintell Radio, 9705 Cottage Grove Ave., Chicago, Ill. For mail: 2423 Pinkney St., Omaha, Neb.
- LAYNE, FRANK C. (A'30), Lieutenant, (jg) U. S. Navy, Asiatic Station, c/o Postmaster, Seattle, Wash.
- LAZAR, JOSEPH H. (A'30), Supervisor, Lazar and Sons, Inc., 2922 N. Albany Ave., Chicago, Ill.
- LAZARUS, BENJAMIN N. (A'28), 314 N. Broadway, North Tarrytown, N.Y.
- LAZICH, BRANKO (A'23), Union Switch and Signal Company, Swissvale, Pa. For mail: 1207 Braddock Ave., Pittsburgh, Pa.
- LEA, GEORGE (A'23), Assistant Maintenance Engineer, British Broadcasting Corporation, Brookmans Pk., Herts, England. For mail: "Westbury," Swanley Bar Lane, Potters Bar, Middlesex, England.
- LEA, NORMAN (A'31), Chief of Test Department, Marconi's Wireless Telegraph Company, Ltd., Chelmsford, Essex, England.
- LEACH, HARVEY B. (A'27), General Foreman, United Electric Light and Power Company, 514 W. 147th St., New York, N.Y. For mail: 660 Riverside Dr., New York, N.Y.
- LEAHY, JOHN E. (A'28), Assistant Radio Engineer, U. S. Naval Research Laboratory, Bellevue, Anacostia, D.C. For mail: 2620-33rd St., S.E., Washington, D.C.
- LEBEDEFF, GEORGE M. (A'30), Dewalt Hotel, 201 Levenworth St., San Francisco, Calif.
- LE BEL, C. J. (J'25-A'27), Electrical Engineer, Hygrade Sylvania Corporation, 60 Boston St., Salem, Mass. For mail: 12 Park St., Lynn, Mass.
- LEBLANC, WILLIAM A. (A'31), Radiotriician, Early Radio Service Company, 18 New Derby St., Salem, Mass.
- LEBOW, SAMUEL (A'30), Inspector, Service and Installation Department, RCA Telephone, Inc., 438 W. 37th St., New York, N.Y. For mail: 862 E. 169th St., New York, N.Y.
- LEBOWITZ, SAMUEL (A'31), Patent Attorney, Knight Brothers, National Press Bldg., 14th and F Sts., N.W., Washington, D.C.
- LECCHI, P. A. (A'31), Radio Engineer, Compagnia Generale di Elettricit , Via Borgognone 34, Milan, Italy. For mail: Via Settala 19, Milan, Italy.
- LEDERER, ERNEST A. (M'28), Chief Engineer, National Union Radio Corporation, 57 State St., Newark, N.J. For mail: 457 N. Walnut St., East Orange, N.J.
- LEDERHAUS, HERMAN WILLIAM (A'29), Bell Telephone Laboratories, Inc., 463 West St., New York, N.Y. For mail: 149-20-23rd Ave., Whitestone, L.I., N.Y.
- LEE, ALBERT G. (M'27-F'29), Engineering Department, G.P.O., Alder House, Aldersgate St., London, England.
- LEE, DONALD C. (A'30), Radio Department, Westinghouse Electric and Manufacturing Company, Chicopee Falls, Mass.
- LEE, DOUGLAS J. (A'30), Radio Station WSJS, Winston-Salem, N.C. For mail: 224 S. Green St., Winston-Salem, N.C.

- LEE, EMERY H. I. (A'18-M'23), U. S. Radio Inspector, Subtreasury Bldg., Pine and Nassau Sts., New York, N.Y.
- LEE, FAT CHANG (A'27), 557 W. 124th St., Apartment 21, New York, N.Y.
- LEE, GEORGE RICHARD (A'30), Radio Supply Company, 912 S. Broadway, New York, N.Y. For mail: 2810 Ross Ave., Alhambra, Calif.
- LEE, GILBERT C. (A'29), President, The Insto Company, Inc., 110 Center St., Los Angeles, Calif.
- LEE, SHEE MOU (A'24), Setang, Kashi, Chekiang, China.
- LEE, STANLEY A. (A'26), Captain, District Signal Officer, Headquarters, Military District, 10, Winnipeg, Manit., Canada.
- LEE, WALTER O. (A'28), Traffic Manager, Mackay Radio and Telegraph Company, Inc., Box 1025, Southampton, L.I., N.Y.
- LEE, WILLIAM JUSTICE (A'25-M'26), Lieutenant Commander, Office of Chief of Naval Operations, Navy Department, Washington, D.C.
- LEEB, HENRY L. (A'17-M'23), New York Trust Company, 100 Broadway, New York, N.Y. For mail: 5 Brookside Rd., South Orange, N.J.
- LEEDS, LAWRENCE M. (A'30), Rutgers University, New Brunswick, N.J. For mail: 149 Somerset St., New Brunswick, N.J.
- LEEKA, WARREN C. (A'27), Engineer, Ohio Bell Telephone Company, Dayton, Ohio. For mail: 818 Catalpa Dr., Dayton, Ohio.
- LEEMAN, ALVIN (J'27-A'28), Chief Engineer, Radio Station WKBH, 400 State St., La Crosse, Wis. For mail: P.O. Box 580, La Crosse, Wis.
- LEEMAN, WILSON (A'28), Radio Operator, Radio Station KFOR, Howard A. Shuman, Lindell Hotel, Lincoln, Neb. For mail: 3448 South St., Lincoln, Neb.
- LEFEBORE, ULRIC A. (A'31), Serviceman, 2221-3rd St., N.E. Minneapolis, Minn.
- LEFFERTS, B. (A'25), Design Engineer, United Research Corporation, Long Island City, L.I., N.Y. For mail: 1454 Grand Concourse, New York, N.Y.
- LEFFLER, RALPH H. (A'24), Chief Transmission Engineer, Radio Air Service Corporation, Cleveland, Ohio. For mail: R.D. No. 3, Box 85A, Brecksville, Ohio.
- LEFTWICH, E. H. (A'27), Radio Service Engineer, Sterchi Brothers Stores, Inc., Nashville, Tenn.
- LEHDE, PENDLETON E. (A'14-F'27), Radio and Electrical Engineer, 1812 Masonic Temple Bldg., New Orleans, La.
- LEHMAN, JAMES N. (A'29), Engineer, RCA Victor Company, Inc., Camden, N.J. For mail: 210 Washington Ter., Audubon, N.J.
- LEHNERT, FRANK H. (A'30), Radio Operator, Michigan Wireless Telegraph Company, Wyandotte, Mich. For mail: 4614 N. Kostner Ave., Chicago, Ill.
- LEHNHOFF, RAYMOND G. (A'22), Sales Engineer, Frigidaire Sales Corporation, 811 Race St., Cincinnati, Ohio. For mail: 322 Joselin Ave., Cincinnati, Ohio.
- LEHR, RUDOLPH (A'30), Engineer, RCA Victor Company, Inc., Camden, N.J. For mail: 711 Cooper St., Camden, N.J.
- LEIBE, FRANK A. (A'26), Engineer, Department of Development and Research, American Telephone and Telegraph Company, 195 Broadway, New York, N.Y. For mail: R.D. No. 5, Quakertown, Pa.
- LEIBING, JOSEPH K. (A'23), General Engineering Laboratory, General Electric Company, Schenectady, N.Y. For mail: R.D. No. 8, Box 150, Scotia, N.Y.
- LEIBOW, SAUL A. (A'29), Manager, Radio and Electric Division, Chain Hardware Company, 142 Washington St., Providence, R.I. For mail: 47 Doyle Ave., Providence, R.I.
- LEIBROOK, BRICE (A'30), Foreman, Crosley Radio Corporation, 3401 Colerain Ave., Cincinnati, Ohio. For mail: 2727 N. Bend Rd., Cincinnati, Ohio.
- LEIDY, W. J. (A'25), President, Chicago Transformer Corporation, 2626 W. Washington Blvd., Chicago, Ill.
- LEIGH, CHARLES W. (A'26), Radio Specialty Salesman, Van Ness Electric Company, 68 W. Lincolnway, Valparaiso, Ind.
- LEIGHTON, HAROLD W. (A'25), Engineer, California Service, Inc., 1233 S. Hope St., Los Angeles, Calif. For mail: 2993 S. Rimpau Blvd., Los Angeles, Calif.
- LEIST, LOWELL G. (A'31), 1124-12th St., N.W., Canton, Ohio.
- LEITCH, DONALD J. H. (J'26-A'28), Engineer and Secretary-Treasurer, Canadian Sound Engineering Company, Ltd., 158 Fort St., Winnipeg, Manit., Canada.
- LELAND, WALLACE H. (A'30), Dispatcher in Charge, Boeing Air Transport, Inc., Cheyenne, Wyo.
- LE MERT, RALPH D. (A'31), Radio Engineer, Pioneer Mercantile Company, 1526-32-20th St., Bakersfield, Calif. For mail: P.O. Box 1155, Bakersfield, Calif.
- LEMIEUX, CHARLES J. (A'31), Technician, Pilo' Radio and Tube Company, North Andover, Mass. For mail: 165 Railroad Ave., North Andover, Mass.
- LEMKIN, HAROLD J. (A'31), 400 S. College St., Angola, Ind.
- LEMMY, CLAUDE W. (A'31), Shift Officer, P.O. Radio Station, Rugby, Warwick, England.
- LEMMON, WALTER S. (A'14), President, Malone-Lemmon Products, Inc., Plainfield, N.J. For mail: Hotel Narragansett, 94th St. and Broadway, New York, N.Y.
- LEMOINE, A. S. (A'20), 17 Ynglingagatan, Stockholm, Sweden.
- LEMON, CECIL G. (A'27), Technical Supervisor, Tungram Electric Lamp Works, 72 Oxford St., London, W. 1, England. For mail: 19, Lena Gardens, Hammersmith, London, England.
- LENNERT, GEORGE R., JR. (A'30), Proprietor, Metropolitan Radio and Electric Company, Upper Darby, Pa. For mail: 264 Wembley Rd., Upper Darby, Pa.
- LENZ, CHARLES S. (A'17), Research and Consulting Engineer, The Lenz Crystal Corporation, Pasadena, Calif. For mail: c/o George E. Jupp, 3147 Country Club Rd., New York, N.Y.
- LEONARD, A. A. (A'30), Research Department, Philadelphia Storage Battery Company, Philadelphia, Pa. For mail: 159 Sylvania Ave., Glenside, Pa.
- LEONARD, PERCY A. (A'25), Engineer, Canadian Marconi Company, Town of Mount Royal, P.Q., Canada. For mail: 1444 Canora Rd., Town of Mount Royal, P.Q., Canada.

- LEONARD, SYDNEY L. (A'29), Supervisor, Inspection Department, Canadian Brandes Company, 207 Queens Quay, Toronto, Ont., Canada. For mail: 22 Chatham Ave., Toronto, Ont., Canada.
- LEONARD, S. EDWIN, JR. (A'26), Chief Engineer, WTAM, Inc., 1367 E. 6th St., Cleveland, Ohio. For mail: 3581 E. Scarborough Rd., Cleveland, Ohio.
- LEONHARDT, CHARLES C. (A'28), Radio Corporation of America, Cleveland, Ohio. For mail: 14 Olive St., Norwalk, Ohio.
- LEOSER, THOMAS S. (A'23-M'30), Altamont Ct., Morristown, N.J.
- LE QUESNE, CHARLES A. (A'12), Engineer of Buildings, New York Telephone Company, 101 Willoughby St., Brooklyn, N.Y. For mail: Hotel St. George, 51 Clark St., Brooklyn, N.Y.
- LESCARBOURA, AUSTIN C. (M'26), Technical Advertising and Publicity Counsel, Depot Sq., Croton-on-Hudson, N.Y. For mail: P.O. Box 666, Croton-on-Hudson, N.Y.
- LESIKAR, GEORGE (A'31), Private Work, 19 N. 29th St., Temple, Tex.
- LESLIE, FRANK (A'28), Recording Engineer, Paramount-Famous-Lasky Corporation, 6th and Pierce Aves., Astoria, L.I., N.Y. For mail: 20-62-8th Ave., Astoria, L.I., N.Y.
- LESLIE, FRED D. (A'25), Technical Director for Europe, Movietone News, Inc., 460 W. 54th St., New York, N.Y. For mail: 12 Rue Blanche, Paris, France.
- LESLIE, JOHN M. (A'27), Canadian Westinghouse Company, Metropolitan Bldg., Toronto, Ont., Canada.
- LETSINGER, R. PAUL (J'31), Radio Operator, Globe Wireless, Ltd., 311 California St., San Francisco, Calif. For mail: 16 Avila St., San Francisco, Calif.
- LEUTERITZ, HUGO C. (A'20), Communication Engineer, Pan American Airways, 122 E. 42nd St., New York, N.Y. For mail: 9120 Park Lane, S., Woodhaven, L.I., N.Y.
- LEUTZ, CHARLES R. (A'27-M'29), President, C. R. Leutz, Inc., Altoona, Pa. For mail: 24 Ascan Ave., Forest Hills, L.I., N.Y.
- LE VAN, JAMES D. (A'26), Chief Engineer, Raytheon, Inc., 292 Main St., Cambridge, Mass. For mail: 517 Belmont St., Belmont, Mass.
- LEVASSEUR, JULIEN J. (A'31), Lieutenant, U. S. Navy, U.S.S. Detroit, c/o Postmaster, San Francisco, Calif.
- LEVER, PHILIP R. E. (A'26), Proprietor, Lever's Radio Service, 53 E. King St., York, Pa. For mail: 49 E. King St., York, Pa.
- LEVIN, SAM (A'29), Radio and Electric Shop, 1532 S. Homan Ave., Chicago, Ill.
- LEVIN, SAMUEL A. (A'31), Electrical Engineer, Bell Telephone Laboratories, Inc., 180 Varick St., New York, N.Y.
- LEVINE, HARRY (A'29), Machine Assembly, Graham and Norton, 20th St. and 11th Ave., New York, N.Y. For mail: 269-15th St., Brooklyn, N.Y.
- LEVINE, I. B. (M'30), Research Engineer, Wired Radio, Inc., Ampere, N.J. For mail: 19 W. 16th St., New York, N.Y.
- LEVINE, LIONEL E. (A'31), South African Philips, Ltd., 51, St. George's St., Cape Town, South Africa.
- LE VINNESS, JOHN E. (A'28), Manager, Sunrise Radio Shop, 9318 Avenue L, Brooklyn, N.Y.
- LEVINGTON, ABIE (A'31), Radio Engineer, H. Polliack Company, 88 Eloff St., Johannesburg, South Africa. For mail: 23 York St., Berea, Johannesburg, Transvaal, South Africa.
- LEVINSON, NATHAN (M'25), Western Division Manager, Electrical Research Products, Inc., 7046 Hollywood Blvd., Hollywood, Calif. For mail: 1761 N. Van Ness Ave., Hollywood, Calif.
- LEVY, A. KINGDON (A'29), Kingdon Radio Company, 44 E. 87th St., New York, N.Y.
- LEVY, LESTER (A'29), Engineer, Radio Receptor Company, 106-7th Ave., New York, N.Y. For mail: 552 Parkside Ave., Brooklyn, N.Y.
- LEVY, LUCIEN (M'19), Administrator, Etablissements Radio-L.L., 5 Rue de Cirque, Paris, France.
- LEVY, MAURICE L. (A'29), Engineer, Stromberg-Carlson Telephone Manufacturing Company, 100 Carlson Rd., Rochester, N.Y. For mail: 1392 Monroe Ave., Rochester, N.Y.
- LEVY, MORTIMER N. (A'23), Sales Engineer, Gross-Brennan, Inc., 205 E. 42nd St., New York, N.Y.
- LEWELLING, RAYMOND (A'26), Electrical Engineer, St. Helena, Calif.
- LEWINSKI, CASIMIR (J'30), Research Engineer, Radio Institute, 5 Zimorowicza, Warsaw, Poland. For mail: 7 Natolinska, Warsaw, Poland.
- LEWIS, BENJAMIN (A'31), Radio Specialist, 106 Norlands Lane, Widnes, Lancashire, England.
- LEWIS, EARL B. (A'26), President, Hartford Battery Sales Corporation, Milldale, Conn. For mail: 16 Woodruff St., Southington, Conn.
- LEWIS, EARL W. (A'27), Radio Engineer, Stephens College, Columbia, Mo.
- LEWIS, ELMER H. (A'14), Partner, A. C. Lopez and Company, 245-5th Ave., New York, N.Y. For mail: 1812 Clay Ave., New York, N.Y.
- LEWIS, EVAN J. (J'30), Technician, Pike Radio Service, 723 S. Spadra, Fullerton, Calif. For mail: 115 Brookdale Ave., Fullerton, Calif.
- LEWIS, FREDERICK W., JR. (A'30), Field Engineer, National Broadcasting Company, Inc., 711-5th Ave., New York, N.Y. For mail: Witherbee Ct., Pelham Manor, N.Y.
- LEWIS, GEORGE H. (A'12-M'15), Vice President, Arcturus Radio Tube Company, 720 Frelinghuysen Ave., Newark, N.J.
- LEWIS, HAROLD M. (A'19-M'26), Radio Engineer, Hazeltine Corporation, Bayside, L.I., N.Y. For mail: 242-36-54th Ave., Douglaston, L.I., N.Y.
- LEWIS, JOHN H., JR. (A'31), Radio Technologist-Experimenter, 634 E. 51st St., Chicago, Ill.
- LEWIS, JOHN R. (J'30), Student, Iowa State University, P.O. Box 1, Station A, Ames, Iowa.
- LEWIS, L. V. (A'13), Electrical Engineer, Union Switch and Signal Company, Swissvale, Pa. For mail: 216 Oakview Ave., Edgewood, Pa.
- LEWIS, OLIVER I. (A'29), Engineer, 297 Springton Rd., Upper Darby, Pa.

- LEWIS, VERGIL E. (A'30), Certified Radiotriician, Independent Radio Service, 792 Commercial St., El Centro, Calif.
- LEWIS, WILLIAM S. (A'26), Service Manager, Texas Radio Sales Company, 2120 Jackson St., Dallas, Tex.
- LEYDA, GEORGE D. (A'31), Proprietor, Electric and Radio Service, Edmonds, Wash.
- LEYH, WILLIAM D. (A'25), Radio Engineer, Radio Station WHN, Loew's State Theatre Bldg., Broadway and 45th St., New York, N.Y. For mail: 134-22-95th Ave., Richmond Hill, L.I., N.Y.
- LIBERMAN, HENRY C. (A'28), 1154 President St., Brooklyn, N.Y.
- LICHT, HENRY M. (A'26), Service Manager, Williams Hardware Company, Streator, Ill. For mail: 514 Powell St., Streator, Ill.
- LICHTENWALNER, HOWARD W. (J'31), Serviceman, C.W. Grammes Radio and Electrical Service, 315 N. Franklin St., Allentown, Pa. For mail: 2207 Allen St., Allentown, Pa.
- LIDBURY, F. A. (A'27), President, Oldbury Electro-Chemical Company, Niagara Falls, N.Y.
- LIEBERT, T. W. (M'21), Administrator, Nederlandsche Telegraaf Mij., Radio Holland, Zuiderweg, Tandjong Priok, Java.
- LIEBHART, GLENN R. (J'31), Radio Station WBBM, Glenview, Ill. For mail: 1055 N. Leamington Ave., Chicago, Ill.
- LIESMAN, FRANCIS J. (A'30), Service Department, Bright and Company, 8th and Elm Sts., Reading, Pa. For mail: 940 Elm St., Reading, Pa.
- LIGHT, FRANK B. (A'26), Superintendent, Croton Falls Lighting Corporation, Carmel, N.Y. For mail: Carmel, N.Y.
- LIGHTY, RUSSELL D. (A'27), Chief Engineer, WCIO Radio Corporation, 200 E. Milwaukee St., Janesville, Wis. For mail: Box 503, Janesville, Wis.
- LIMA, ANTONIO C. DA SILVA (A'30), 275 Rua de S. Clemente, Botafogo, Rio de Janeiro, Brazil.
- LIMBERG, RAYMOND A. (A'29), Field Engineer, National Broadcasting Company, Inc., Merchandise Mart, Chicago, Ill.
- LINCE, RENE (A'31), Valve Department, Lissen, Ltd., Worpel Rd., Isleworth, Middlesex, England. For mail: 7 Berkhamsted Ave., Wembley, Middlesex, England.
- LINDAUER, JOHN H. (A'31), Serviceman, "QRV" Radio Service, 140 Halsey St., Newark, N.J. For mail: 103 Jewett Ave., Jersey City, N.J.
- LINDEN, BERNARD H. (A'25), U. S. Supervisor of Radio, 328 Custom House, San Francisco, Calif.
- LINDMARK, ELMER S. (A'23), Assistant Personnel Manager, Standard Transportation Company, Rm. 1460, 26 Broadway, New York, N.Y.
- LINDNER, HERBERT G. (A'31), Member of Technical Staff, Bell Telephone Laboratories, Inc., 463 West St., New York, N.Y.
- LINDOW, IRVING L. (A'31), Receiving Engineer, R.C.A. Communications, Inc., Riverhead, L.I., N.Y.
- LINDSAY, MAXWELL H. A. (A'30), Radio Engineer, Bell Telephone Laboratories, Inc., 180 Varick St., New York, N.Y.
- LINDSAY, WALTER R. (A'31), Chief Engineer, Radio Station WMAQ, R.F.D. No. 1, Church Rd., Elmhurst, Ill.
- LINDSAY, W. W., JR. (A'24-M'26), Sound Recording Engineer, Fox Film Corporation, Fox Hills Studio, Beverly Hills, Calif. For mail: 1539 Ensley Ave., Los Angeles, Calif.
- LINDSEY, WILLIAM F. (A'31), Radio Operator, Pasadena Police Department, Pasadena, Calif. For mail: P.O. Box 533, Pasadena, Calif.
- LINDSTROM, ARTHUR J. (A'27), Radio Station WJZ, National Broadcasting Company, Inc., Bound Brook, N.J.
- LINE, F. M. (A'28), Service Repairman, Jacobs Electrical Company, Lima, Ohio. For mail: R.F.D. No. 1, Holland, Ohio.
- LINK, FRED M. (A'29), Development Engineer, Engineer-in-Charge, Transmitting and Power Audions, De Forest Radio Company, Passaic, N.J. For mail: 77 Pennington Ave., Passaic, N.J.
- LINK, LOUIS J. (A'30), Engineer, Radio Station WSUN, St. Petersburg, Fla. For mail: 832-14th St., N., St. Petersburg, Fla.
- LINNETT, DOUGLAS N. (A'29), Clark Executor Trustee and Agency Company, Ltd., of South Australia, Box 363D, G.P.O., Adelaide, South Australia. For mail: 42 Nelson St., St. Peters, South Australia.
- LINTZENICH, C. L. (A'28), Radio Station Operator, 405 W. Main St., Blytheville, Ark. For mail: 304 Davis Ave., Blytheville, Ark.
- LIPPINCOTT, DONALD K. (M'28), 57 Post St., San Francisco, Calif.
- LIPPINCOTT, ELLWOOD W. (A'31), Chief Engineer, Radio Station KUJ, Inc., Walla Walla, Wash. For mail: 416 S. 1st St., Walla Walla, Wash.
- LISCHKE, CARL C. (A'31), Marine Radio Inspector, Mackay Radio and Telegraph Company, 600-1st Ave., Seattle, Wash. For mail: 4042-51st Ave., S.W., Seattle, Wash.
- LISOR, DONALD J. (J'31), 3808 Harriet Ave., S., Minneapolis, Minn.
- LITCHFIELD, GORDON A. (A'23), Nottingham Radio Supplies, Ltd., Sherwood Bldgs., S. Sherwood St., Nottingham, England.
- LITTLE, D. S. (J'22-A'24), Superintendent, Great Lakes Division, Radiomarine Corporation of America, 1599 St. Clair Ave., Cleveland, Ohio. For mail: 14744 Braemer Dr., Cleveland, Ohio.
- LITTLE, DE MOTTE H. (A'31), Operator, Radio Station WBBM, Box 375, Glenview, Ill.
- LITTLE, DONALD G. (A'20-M'27-F'29), Chief Engineer, Chicopee Falls Works, Westinghouse Electric and Manufacturing Company, Chicopee Falls, Mass.
- LITTLE, NOEL C. (A'24), Professor of Physics, Bowdoin College, Brunswick, Maine. For mail: 8 College St., Brunswick, Maine.
- LITTLE, REGINALD J. (A'31), Radio Service, S. A. Caplan Radio Corporation, 296 College St., Toronto, Ont., Canada. For mail: 377 Brunswick Ave., Toronto, Ont., Canada.
- LITTLE, W. C. (A'30), Instructor, Department of Electrical Engineering, Queen's University, Kingston, Ont., Canada. For mail: Leamington, Ont., Canada.
- LITTLEFIELD, R. W. (A'30), c/o S. P. Brownell, Wells, Maine.

- LITTON, CHARLES V. (A'25), Engineer, Federal Telegraph Company, Palo Alto, Calif. For mail: Box 21, R.F.D. No. 2, Redwood City, Calif.
- LLEWELLYN, FREDERICK B. (A'23), Telephone Engineer, Bell Telephone Laboratories, Inc., 463 West St., New York, N.Y.
- LO, TSU ZUI (A'29), Professor of Electrical Engineering, Hunan University, Changsha, China. For mail: 3 Shui Hua Fang, Rue Lafayette, Shanghai, China.
- LOCK, M. J. (A'29), Engineer, Telefunken Gesellschaft für drahtlose Telegrafie, Hellesches Ufer 12, Berlin, S.W., Germany. For mail: Hildegardstr., 13 B., Berlin, Wilmersdorf, Germany.
- LOCKARD, MARSHALL R. (A'31), U. S. Army Signal Corps, 15th Service Company, Fort Monmouth, Oceanport, N.J.
- LOCKHART, HILDRED B. (A'30), Chief Engineer, Radio Station KGFI, Corpus Christi, Tex.
- LOCKNER, J. GLYNN (A'31), Service Manager, Lockner Brothers, 420 Columbia St., Utica, N.Y. For mail: 1303 Neilson St., Utica, N.Y.
- LOCKWOOD, EDWARD C. (A'29), Radio Service Manager, John Shillito Company, 7th and Race Sts., Cincinnati, Ohio. For mail: R9, College Hill, Cincinnati, Ohio.
- LODGE, EDMUND G. (A'31), Engineer, H. H. Eby Manufacturing Company, 22nd St. and Lehigh Ave., Philadelphia, Pa.
- LOFTIN, EDWARD H. (M'26), Consulting Engineer, 225 Broadway, New York, N.Y.
- LOFTIS, HOMER J. (A'27), Chief Engineer, Henrie Products Corporation, Tronton, Ohio. For mail: 1527 S. 5th St., Tronton, Ohio.
- LOGAN, E. WARREN, JR. (A'30), 610 W. 14th St., Little Rock, Ark.
- LOGAN, MASON A. (A'27), Member of Technical Staff, Bell Telephone Laboratories, Inc., 463 West St., New York, N.Y.
- LOHMANN, ROBERT S. (A'24), The York Supply Company, 527 E. 3rd St., Dayton, Ohio.
- LONG, EDWIN G. (A'30), Tropical Radio Telegraph Company, 321 St. Charles St., New Orleans, La.
- LONG, JOHN J., JR. (A'26-M'31), Chief Broadcast Engineer, Radio Station WHAM, Sagamore Hotel, Rochester, N.Y. For mail: 63 Sonora Pkwy., Brighton, N.Y.
- LONG, MARVIN (A'29), Engineering Assistant, Executive Operating, Bell Telephone Company of Pennsylvania, 1835 Arch St., Philadelphia, Pa. For mail: 6106 Master St., Philadelphia, Pa.
- LONG, MAURICE B. (A'23), Educational Director, Bell Telephone Laboratories, Inc., 463 West St., New York, N.Y.
- LOOMIS, ALFRED L. (M'28), Director, Loomis Laboratory, Tuxedo Park, N.Y. For mail: Tuxedo Park, N.Y.
- LOOMIS, MARY TEXANNA (M'27), President, Loomis Radio College, 405-9th St., N.W., Washington, D.C.
- LOONEY, DON B. (A'27), 424 Latterner Ave., Clarendon, Va.
- LOONEY, LESTER A. (A'31), Engineer, National Broadcasting Company, Inc., 711-5th Ave., New York, N.Y. For mail: 305-6th Ave., North Pelham, N.Y.
- LOOS, GEORGE F. (A'31), Radio Engineer and Technical Advisor, Guaranteed Accumulator Service, Ltd., 23 Broadway Parade, North Harrow, Middlesex, England. For mail: No. 7 Flat, Station Rd., Wealdstone, Middlesex, England.
- LOPEZ, MELCHOR, JR. (A'29), Proprietor, Casa Lopez, Conde del Serrallo 1, Apartado 77, Melilla, Spanish Morocco.
- LORCH, ALBERT (A'29), Electrical Engineering Department, Construction Bureau, Brooklyn Edison Company, Inc., 55 Johnson St., Brooklyn, N.Y. For mail: 201-14-50th Ave., Bayside, L.I., N.Y.
- LORCH, GEORGE H. (A'29), Patent Attorney, Wilson, Dowell, McCanna and Rehm, 1 LaSalle St., Chicago, Ill.
- LORD, HARRY R. (A'28), Arcade Bldg., Cambridge Springs, Pa.
- LORD, WILFRED F. (J'29), Operator, Radiomarine Corporation of America, 75 Varick St., New York, N.Y. For mail: P.O. Box 922, Lake Worth, Fla.
- LOTT, HARRY H. (A'30), Sound Equipment Service Engineer, Harry H. Lott Company, 1635 St. Agnes Ave., Utica, N.Y.
- LOTTER, JOHN G. (A'29), Lyon and Healy, Inc., 243 S. Wabash Ave., Chicago, Ill. For mail: 1145 Bryn Mawr Ave., Chicago, Ill.
- LOUCKS, IVAN H. (A'26), Junior Radio Inspector, Radio Division, U. S. Department of Commerce, 528 Post Office Bldg., Atlanta, Ga. For mail: 109 W. Dixie Ave., Marietta, Ga.
- LOUCKS, PHILIP G. (A'30), Lawyer, National Press Bldg., Washington, D.C.
- LOUGHLIN, WILLIAM D. (M'29), Vice President, Radio Frequency Laboratories, Boonton, N.J.
- LOUGHREN, ARTHUR V. (A'24-M'29), Engineer, RCA Victor Company, Inc., Camden, N.J.
- LOUNSBERRY, ISAAC R., JR. (A'23-M'25), Buffalo Broadcasting Corporation, Rand Bldg., Buffalo, N.Y.
- LOVATT, HAROLD S. (A'31), Electrical Engineer, RCA Radiotron Company, Inc., Harrison, N.J. For mail: 331 N. Grove St., East Orange, N.J.
- LOVE, BERT E. (A'31), Testboard Man, American Telephone and Telegraph Company, 1365 Cass Ave., Detroit, Mich. For mail: Box 249, Williamston, Mich.
- LOVE, HORACE J. (A'31), Chief Engineer, Sexton's (Electrical Engineers), Great James St., London, E.C. 1, England. For mail: 36 Blake Rd., Bowes Park, London N. 11, England.
- LOVEJOY, EDWIN W. (A'14-M'26), U. S. Supervisor of Radio, 7th Radio District, U. S. Department of Commerce, Radio Division, 1011 Exchange Bldg., Seattle, Wash.
- LOVELESS, LAWRENCE M. (A'28), Salesman, Barker, Rose and Kimball, Elmira, N.Y. For mail: Bath, N.Y.
- LOVELL, HERMAN J. (A'28), Radio Operator, Radio Station WKY, Oklahoma City, Okla.
- LOWE, CARR E. (A'29), Technician, Brunswick Radio Corporation, Muskegon, Mich. For mail: 1854 Sanford Ave., Muskegon, Mich.
- LOWMAN, CLAUDE (A'31), Testing Engineer, Hydro Electric Power Commission, 8 Strachan Ave., Toronto, Ont., Canada. For

- mail: 2477 Queen St., E., Apartment 8, Toronto, Ont., Canada.
- LOWRY, CHARLES A. (A'26-M'31), Plant Radio Engineer, De Forest Radio Corporation, Ltd., Toronto, Ont., Canada. For mail: 257 Jane St., Toronto, Ont., Canada.
- LOWRY, LEWIS R. (A'27), Member of Technical Staff, Bell Telephone Laboratories, Inc., Holmdel, N.J. For mail: 29A Brown Pl., Red Bank, N.J.
- LOYNES, OWEN H. (A'23), Telephone Engineer, American Telephone and Telegraph Company, Rm. 1540, 195 Broadway, New York, N.Y.
- LUBCKE, ERNST (M'30), Division Chief, Research Laboratory, Der Siemenswerke, Berlin-Siemensstadt, Germany. For mail: Halskesteig 5, Berlin-Siemensstadt, Germany.
- LUBCKE, HARRY R. (A'26), Director of Television Broadcasting, Don Lee, Inc., 1076 W. 7th St., Los Angeles, Calif. For mail: 1365 Edgecliff Dr., Los Angeles, Calif.
- LUCAS, EARLE F. (A'29), 33 Norman Rd., Newark, N.J.
- LUCAS, STANLEY M. (A'27), Vice President, In Charge of Engineering, Radio Station KFVR, Meyer Broadcasting Company, 320 Broadway, Bismarck, N.D.
- LUCEY, KENNETH (A'30), Radio Operator, S.S. Dorothy Luckenbach, c/o Luckenbach S.S. Company, Foot of 35th St., Brooklyn, N.Y.
- LUCIA, RAYMOND H. (A'27), Technical Staff, Stromberg-Carlson Company, Radio Station WHAM, Sagamore Hotel, Rochester, N.Y. For mail: 109 W. Chestnut St., East Rochester, N.Y.
- LUDLUM, W. F. (A'28), Proprietor, W. F. Ludlum Sound Equipment, 1318 Micheltoarena St., Los Angeles, Calif.
- LUDVIGSEN, LEONARD E. (J'30), Serviceman, 563 E. Larned St., Detroit, Mich. For mail: 306 Maryland Ave., Royal Oak, Mich.
- LUDWIG, SAMUEL C., JR. (J'31), Radio Serviceman, Langan Electric Company, 502 Willows Ave., Philadelphia, Pa. For mail: 801 S. St. Bernard St., Philadelphia, Pa.
- LUISI, JOHN (J'30), Stock Clerk, Ward Leonard Electric Company, Mount Vernon, N.Y. For mail: 4562 White Plains Ave., New York, N.Y.
- LUMB, FRANK J. (A'29), Proprietor, Radio Sales and Repair Shop, 10½ Pleasant St., Auburn, N.Y.
- LUNDAHL, TORE (A'26), Chief Engineer, Pacent Electric Company, Inc., 91-7th Ave., New York, N.Y.
- LUNDY, STANLEY R. (A'28), Sales Promotion, Kolster Radio, Ltd., 207 Queen's Quay, Toronto, Ont., Canada. For mail: 300 Kee-watin Ave., Toronto 12, Ont., Canada.
- LURIE, ELI M. (A'31), Chief Radio Engineer, Hotel New Yorker, 34th St. and 8th Ave., New York, N.Y. For mail: 18-05 Ditmars Blvd., Astoria, L.I., N.Y.
- LURRY, THOMAS M. (A'30), Electrical Engineering Student, University of Louisiana, Baton Rouge, La. For mail: 427 Asia St., Baton Rouge, La.
- LUSH, WILLIAM G. (A'20-M'27), Chief Engineer, Societe Pan-Continentale, 59 Boulevard Richard Wallace, Puteaux, Seine, France.
- LUSSIER, ELPHEGE ACHILLE (A'27), Maintaining Electrician, Woolco Realty Cor-poration, Woolworth Bldg., New York, N.Y. For mail: 7825-4th Ave., Brooklyn, N.Y.
- LUTTGENS, HOWARD C. (A'31), Division Engineer, National Broadcasting Company, Inc., Rm. 2022 Merchandise Mart, Chicago, Ill.
- LYCETT, ERIC L. (A'31), Radio Engineer, British Broadcasting Corporation, Broadcasting House, Piccadilly, Manchester, England.
- LYLE, CHARLES F. (J'30), Radio Engineer, Cleveland Stadium, Cleveland, Ohio. For mail: 1461 W. 77th St., Cleveland, Ohio.
- LYLE, HERBERT B. (A'24), Wireless Operator, Marconi International Marine Communications Company, Ltd., Strand, London, England. For mail: Rodwell, 4 Ambleside Rd., Willesden 1, London, N.W. 10, England.
- LYMAN, HARRY J. (A'30), Research Engineer, Television Laboratories, Inc., Philadelphia Storage Battery Company, Ontario and C Sts., Philadelphia, Pa.
- LYMAN, REGINALD P. (A'23-M'26), Instructor, U. S. Army Signal School, Fort Monmouth, Oceanport, N.J.
- LYNCH, ARTHUR H. (M'26), President, Lynch Manufacturing Company, 1775 Broadway, New York, N.Y. and Vice President, Stenode Corporation of America, 17 Damson St., Garden City, L.I., N.Y.
- LYNDON, WILLIAM L. (A'26), Transmitter Division Engineer, RCA Victor Company, Inc., Camden, N.J.
- LYNN, L. H. (A'29), Radio Engineer, General Electric Company, Schenectady, N.Y. For mail: 115 Elmer Ave., Schenectady, N.Y.
- LYNN, ROLAND A. (A'29), Development Group, National Broadcasting Company, Inc., 711-5th Ave., New York, N.Y. For mail: 37 Feronia Way, Rutherford, N.J.
- LYNN, WALLACE L. (A'31), President, Preston Development Company, 725-15th St. N., St. Petersburg, Fla.
- LYON, HARRY H. (A'14), Hyattsville, Md.
- LYONS, C. L. (M'27), Managing Director, Claude Lyons, Ltd., 76 Oldhall St., Liverpool, England. For mail: 8 York Ave., Selson Park, Liverpool, England.
- LYONS, WALTER (A'30), Demonstrator, Department of Physics, McGill University, Montreal, P.Q., Canada. For mail: 664 W. 161st St., New York, N.Y.

M

- MAC ADAM, MARK L. (A'26), Radio Technician, Radio Division, Massachusetts Department Public Safety, State Police Department, Framingham, Mass.
- MACALPINE, WILLIAM W. (A'29), Radio Engineer, International Communications Laboratories, 200 Mount Pleasant Ave., Newark, N.J. For mail: 196 N. Oraton Pkwy., East Orange, N.J.
- MACARTNEY, A. ROY (A'30), Engineer, Mutual Telephone Company, Honolulu, Hawaii.
- MAC CORNACK, EDWIN A. (A'30), Field Engineer, National Broadcasting Company, Inc., Merchandise Mart, Chicago, Ill. For mail: 417 Main St., Glen Ellyn, Ill.
- MAC COUN, TOWNSEND D. (A'24), 322A Plaza Rd., N., Fair Lawn, N.J.

- MAC DONALD, H. J. (J'29-A'29), Radioman, U. S. Navy, 12th District Headquarters, 100 Harrison St., San Francisco, Calif.
- MAC DONALD, W. A. (A'19-M'26), Chief Engineer, Hazeltine Service Corporation Laboratory, 333 W. 52nd St., New York, N.Y.
- MAC DONALD, WILLIAM W. (A'31), Technical Editor, *Radio Retailing*, 330 W. 42nd St., New York, N.Y. For mail: 6212 Saunders St., Rego Park, L.I., N.Y.
- MAC DOUGALL, ARTHUR (A'27), Metal Alloys and Engineering Specialties, 233 Broadway, New York, N.Y.
- MAC DOWELL, KARL P. (A'30), Aircraft Radio Technician, Western Air Express, Municipal Airport, Kansas City, Mo. For mail: 3145 Karnes Blvd., Kansas City, Mo.
- MACE, ROGER D. (A'31), Testboard Man, American Telephone and Telegraph Company, 2654 Locust St., St. Louis, Mo. For mail: 3944 Shaw Ave., St. Louis, Mo.
- MACEDO, FRANCIS J. (J'30), Designer, W. Marko, Cornhill St., Wellington, New Zealand. For mail: P.O. Box 945, Wellington, New Zealand.
- MAC FADDEN, WILFORD C. (A'19), Development Engineer, RCA Victor Company, Inc., Camden, N.J. For mail: Rhawn and Bingham Sts., Fox Chase, Philadelphia, Pa.
- MAC GREGOR, JOHN J. (A'29), Assistant Radio Engineer, U. S. Naval Research Laboratory, Bellevue, Anacostia, D.C. For mail: 2316-32nd St., S.E., Washington, D.C.
- MACHIORLETI, LOUIS (A'27), 648 Palisade Ave., West New York, N.J.
- MACHOTKA, SLAVOMIR, (J'27-A'29), The Texas Company, Drawer F., Houston, Tex.
- MACHUGH, WILLIAM L. (A'26), Trilling and Montague, Philadelphia, Pa. For mail: 1933 E. Dauphin St., Philadelphia, Pa.
- MAC INTOSH, JAMES (A'30), Engineering Branch, Posts and Telegraphs, Kuala Lumpur, Federated Malay States.
- MACINTOSH, WILLIAM (A'31), Best Manufacturing Company, 1200 Grove St., Irvington, N.J. For mail: 164 Myrtle Ave., Irvington, N.J.
- MACK, DAHL W. (A'28), Manager, Northeastern Radio Company, 302 Adams Ave., Scranton, Pa. For mail: Clarks Green, Pa.
- MACK, GEORGE (A'31), Radio Serviceman, 449 N. Ridgeway Ave., Chicago, Ill.
- MACKAY, WILLIAM ANDREW (A'27), 345 E. 33rd St., New York, N.Y.
- MACKIE, WILLIAM (A'28), Kelvinator Service Manager, Philip Werlein, Ltd., New Orleans, La. For mail: 715-2nd St., New Orleans, La.
- MACKEN, H. I. (A'29), Engineer, New York Telephone Company, 140 West St., New York, N.Y. For mail: 62 Westervelt Ave., New Brighton, S.I., N.Y.
- MACKENZIE, D. G. (J'27-A'29), Sound Manager, Gaumont British Picture Corporation, Ltd., New Gallery House, Regent St., London, W. 1, England. For mail: 4 Melrose Pl., Clifton, Bristol, England.
- MAC KENZIE, FRANK B. (A'30), Recording Engineer, Sound Department, Fox Movietone Studio, Beverly Hills, Calif. For mail: 10365 Hona Ave., West Los Angeles, Calif.
- MAC KEOWN, SAMUEL S. (M'29), Assistant Professor of Electrical Engineering, California Institute of Technology, Pasadena, Calif.
- MAC LEAN, KENNETH G. (A'30), Engineer, R.C.A. Communications, Inc., 66 Broad St., New York, N.Y. For mail: Box 427, Marion, Mass.
- MACLEAN, T. WENDELL (A'27), Radio Engineer, Washington Water Power Company, 825 Trent Ave., Spokane, Wash. For mail: 524 W. 17th Ave., Spokane, Wash.
- MACLELLAN, COLIN P. (A'30), Engineer, Broadcasting Station WJR, 2800 Fisher Bldg., Detroit, Mich.
- MAC LURCAN, CHARLES D. (A'26), Consulting Engineer, Pratten Bldg., 26 Jamieson St., Sydney, Australia.
- MAC MAHON, ALVIN E. (A'30), Engineer, Pacific Telephone and Telegraph Company, Rm. 1021, 140 New Montgomery St., San Francisco, Calif.
- MAC MILLAN, WILLIAM T. (A'31), Proprietor, Radio Service, 118 S. Queen St., Lancaster, Pa.
- MAC NABB, VERNON C. (A'25), Atwater Kent Manufacturing Company, Philadelphia, Pa. For mail: 5044 Erringer Pl., Philadelphia, Pa.
- MAC NAUGHTON, A. K. (A'25), Planning Engineer, Georgia Power Company, Gas Bldg., Atlanta, Ga.
- MACY, SPENCER A. (A'31), U. S. Navy, Radio Station NAZ, 2nd Brigade, Managua, Nicaragua.
- MA DAN, EDWIN M. (A'21-M'28), Consulting Engineer, 9027-199th St., Hollis, L.I., N.Y.
- MADDOX, CHARLES H. (M'13), Commander, U. S. Navy, Rm. 2626, Navy Department, Washington, D.C.
- MADDOX, FRANCIS E. (A'25), Manager, Radio Station WDBJ, Richardson Wayland Electric Company, 106 Church St., S.W., Roanoke, Va.
- MADGWICK, G. (M'28), c/o Newtons, 25 Kingston Rd., Wimbledon, London, England.
- MADSEN, CARL J. (A'28), Section Engineer, Communications Transmitter Section, Westinghouse Electric and Manufacturing Company, Chicopee Falls, Mass. For mail: 69 Osborne Ter., Springfield, Mass.
- MAEDA, M. (A'25), Japan Wireless Telegraph Company, Marunouchi, Tokyo, Japan.
- MAG, ANTHONY (A'23), Radio Fieldman, Duquesne Light Company, 435-6th Ave., Pittsburgh, Pa. For mail: 1027 Franklin Ave., Wilkesburg, Pa.
- MAGGS, PERCY J. (A'31), Waterworks Superintendent, Calgary Power Company, Wetaskiwin, Alta., Canada. For mail: Box 535, Wetaskiwin, Alta., Canada.
- MAGLY, JOHN W. (A'31), 2731 Vine St., Cincinnati, Ohio.
- MAGNESS, SCOTT A. (J'26-A'28), Member of Technical Staff, Bell Telephone Laboratories, Inc., 180 Varick St., New York, N.Y. For mail: Mayfair Ave., West Hempstead, L.I., N.Y.
- MAGNUSON, HERMAN A. C. (A'30), Probation Office, Los Angeles County, 137 N. Broadway, Los Angeles, Calif. For mail: 8643 Southgate Ave., Southgate, Calif.
- MAGOS, JOHN P. (A'24), Experimental Engineer, Crane Company, Works Office, Chicago, Ill. For mail: 7516 N. Hilldale Ave., Chicago, Ill.

- MAGRI, FRANK (A'31), Radio Serviceman, Ludwig Baumann and Company, 45 Pearson St., Long Island City, L.I., N.Y. For mail: 621 W. 188th St., New York, N.Y.
- MAHON, JAMES L. (A'31), Night Foreman, Jackson Bell Company, 1815 Venice Blvd., Los Angeles, Calif. For mail: 2907 Rosanna St., Los Angeles, Calif.
- MAHONE, GEORGE A. (A'30), 606 Continental Building, Baltimore, Md.
- MAHONEY, JOSEPH N. (M'19), Consulting Engineer, 615-77th St., Brooklyn, N.Y.
- MAIER, OSCAR C. (A'31), Lieutenant, Georgia School of Technology, Atlanta, Ga.
- MAIER, OTTO T. (A'27), Engineer, New Orleans Public Service, Inc., 317 Baronne St., New Orleans, La. For mail: 4550 S. Galvez St., New Orleans, La.
- MAINWARING, WALTER (A'31), Radio Engineer, The Garage, Oxenhope, Keighley, England. For mail: 9 Church St., Oxenhope, Keighley, England.
- MAJOR, A. R. (A'31), Proprietor, The Major Company, Baptist Temple Bldg., Iola, Kan. For mail: 219 S. Buckeye, Iola, Kan.
- MAKI, GEORGE J. (A'27), Proprietor, Juneau Radio Service Company, P.O. Box 1586, Juneau, Alaska.
- MAKINSON, GRANT E. (A'31), Transmission Man, American Telephone and Telegraph Company, 208 Portage Trail, Cuyahoga Falls, Ohio. For mail: 1539 Front St., Cuyahoga Falls, Ohio.
- MALAMPHY, MARK C. (A'30), Chief Geophysical Commission, Y.P.F., Argentine Government Oil Fields, Paseo Colon 922, Buenos Aires, Argentina.
- MALCOLM, JOHN (A'30), Supervisor, RCA Victor Company, Inc., Camden, N.J. For mail: 99 William St., East Orange, N.J.
- MALE, SAMUEL C. (A'27), Service Inspector, Western Electric Company, Ltd., Bush House, Aldwych, London, England. For mail: Western Electric Company, Ltd., Britannia House, 64 Wellington St., Leeds, York, England.
- MALLINSON, WILLIAM (A'30), Principle, J. W. Mallinson and Son, 120 Padiham Rd., Burnley, Lancashire, England.
- MALMSTROM, HELMER W. (A'30), Radio Service Technician, American Radio Supply Company, 1205-1st Ave., Seattle, Wash. For mail: 2511 East Grand, Everett, Wash.
- MALO, CHARLES D. (A'27), President, Malo Studios, 1745 E. Grand Blvd., Detroit, Mich. For mail: 5716 Crane Ave., Detroit, Mich.
- MALOFF, IOURY G. (M'27), Engineering Department, RCA Victor Company, Inc., Camden, N.J.
- MALONE, JAMES J. (M'19), Chief Inspector of Wireless, Postmaster General's Department, Melbourne, Australia.
- MALONE, WALTER J. (A'30), Nemo Supervisor, Radio Station WHAM, Stromberg-Carlson Telephone Company, 100 Carlson Rd., Rochester, N.Y. For mail: 236 Oxford St., Rochester, N.Y.
- MANCHESTER, RAYMOND M. (A'30), Service Engineer, Electrical Research Products, Inc., 1326 Circle Tower Bldg., Indianapolis, Ind.
- MANDERFELD, EMANUEL C. (A'26), Engineer, Sound Recording Department, Electrical Research Products, Inc., 7046 Hollywood Blvd., Hollywood, Calif.
- MANGELSDORF, F. (A'30), Instructor, Radio Operation and Maintenance, Oakland Public Schools, Central Trade School, Oakland, Calif. For mail: 3606 Woodruff Ave., Oakland, Calif.
- MANKE, ARTHUR G. (A'26), Engineer, Leeds and Northrop Company, Philadelphia, Pa. For mail: 2475-38th St., Long Island City, L.I., N.Y.
- MANLEY, EDWARD (A'27), 544 Cathedral Pkwy., New York, N.Y.
- MANLEY, LEE L. (M'31), Assistant Service Manager, RCA Photophone, Inc., 153 E. 24th St., New York, N.Y. For mail: RCA Photophone, Inc., 438 W. 37th St., New York, N.Y.
- MANLY, HAROLD P. (A'29), Raidotechnic Laboratory, 2012 Chestnut Ave., Wilmette, Ill.
- MANN, GEORGE F. (A'28), Radio Sales and Service, Ridgeway, Ont., Canada.
- MANN, GLENN R. (A'31), Radio Serviceman and Sound Technician, 501 N. Russell St., Champaign, Ill.
- MANN, HAYWARD K. (A'30), Instructor, Samuel Curtis Radio School, 673 Boylston St., Boston, Mass. For mail: 66 Bay State Rd., Boston, Mass.
- MANN, THEODORE H. (A'28), Sound Department, Fox Film Corporation, Beverly Hills, Calif. For mail: 822 Hartzell St., Pacific Palisades, Calif.
- MANNING, CHARLES T. (A'17-M'28), U. S. Radio Inspector, U. S. Department of Commerce, Radio Division, Subtreasury Bldg., Pine St., New York, N.Y. For mail: 14 Fairwoods Rd., Madison, N.J.
- MANNING, STANLEY R. (A'27), Public Address System and Radio Engineer, Michigan Bell Telephone Company, 1365 Cass Ave., Detroit, Mich. For mail: 5479 Stanton Ave., Detroit, Mich.
- MANNING, WILLIAM MONTAGU (A'29), Radio Engineer, W. M. Manning, 6 King's Rd., Guernsey, Channel Islands. For mail: Millbrook, King's Rd., Guernsey, Channel Islands.
- MANSELL, LIONEL H. (M'25), Radio Engineer, Wireless Supply Depot, Edith Walk, Malvern, England. For mail: Woodfield, Madresfield Rd., Malvern, Worcestershire, England.
- MANSON, RAY H. (M'23-F'30), Vice President and Chief Engineer, Stromberg-Carlson Telephone Manufacturing Company, 100 Carlson Rd., Rochester, N.Y. For mail: 373 Beresford Rd., Rochester, N.Y.
- MANUEL, JOHN G. (A'31), Radioman, Third Class, U.S.S. *Gresham*, Coast Guard, Mobile, Ala.
- MANWILLER, W. GUY (A'31), Engineering Department, RCA Victor Company, Inc., Camden, N.J. For mail: 546 White Horse Pike, Audubon, N.J.
- MAO, C. S. (A'30), 99 Garden Ter., Rue Pere Robert, Shanghai, China.
- MAPELSDEN, HAROLD H. (A'31), Designing Engineer, RCA Victor Company, Inc., Camden, N.J. For mail: Pleasant Valley Ave., Moorestown, N.J.
- MARCEAU, JULES P. (J'30), Electrical and Radio Engineer, Southern Canada Power Company, Ltd., 355 St. James St., W.,

- Montreal, P.Q., Canada. For mail: 5073 Bourbonniere, Montreal, P.Q., Canada.
- MARCH, PHILIP S. (A'27)**, Bell Telephone Laboratories, Inc., 180 Varick St., New York, N.Y. For mail: 125 Lincoln Ave., Apartment A-9, Newark, N.J.
- MARCO, FREDERICK, J. (A'24-M'28)**, Consulting Engineer, 2020 Farragut Ave., Ravenwood Sta., Chicago, Ill.
- MARCONI, GUGLIELMO (F'16)**, Marconi's Wireless Telegraph Company, Ltd., Marconi House, Strand, London, W.C. 2, England.
- MARCROFT, JAMES (A'31)**, Resident Engineer, Globe Wireless, Ltd., P.O. Box 382, Garden City, L.I., N.Y.
- MARCY, ROBERT J. (A'31)**, Technical Service Representative, RCA Victor Company Inc., Camden, N.J. For mail: 63 Linden Ave., East Orange, N.J.
- MARECK, ALBERT J. (A'31)**, First Class Radioman, U. S. Navy, U.S.S. *West Virginia*, c/o Postmaster, San Pedro, Calif.
- MARIER, EDWARD P. (A'30)**, 490 E. School St., Woonsocket, R.I.
- MARINO, ALGERI (A'30)**, Engineer, Aeronautic Service of Italy, Viale Mazzini 6, Rome, Italy.
- MARSH, WILLIAM S., JR. (A'30)**, Junior Radio Engineer, Research Laboratory, Signal Corps, Fort Monmouth, Oceanport, N.J. For mail: P.O. Box 293, Oceanport, N.J.
- MARRINAN, HORACE J. (J'30)**, Chief Operator, Radio Station KFXR, 1308 S. Pennsylvania, Oklahoma City, Okla. For mail: 1934 S.W., 11th St., Oklahoma City, Okla.
- MARRINER, ALFRED W. (A'29)**, Captain, Air Corps, U. S. Army, Director, Department of Communications, Air Corps Technical School, Chanute Field, Rantoul, Ill.
- MARRIOTT, ROBERT H. (M'12-F'15)**, Consulting Engineer, 1470 E. 18th St., Brooklyn, N.Y.
- MARRISON, W. A. (M'28)**, Engineer, Bell Telephone Laboratories, Inc., 463 West St., New York, N.Y.
- MARSAL, PAUL A. (A'23)**, Development Engineer, National Carbon Company, Inc., Cleveland, Ohio. For mail: 17621 Archdale Ave., Lakewood, Ohio.
- MARSH, ALBERT H. (A'31)**, Proprietor, Radio Service, 413 Lexington Ave., Rochester, N.Y.
- MARSH, CARLTON H. (J'26-A'27)**, Student, Georgia School of Technology, Atlanta, Ga. For mail: 786 Vernon Ave., Glencoe, Ill.
- MARSH, HALLOCK SNYDER (A'29)**, Receiving Engineer, R.C.A. Communications, Inc., Point Reyes, Calif. For mail: Inverness, Calif.
- MARSHALL, ALBERT E. (A'24)**, Consulting Chemical Engineer, Rm. 808, 501-5th Ave., New York, N.Y.
- MARSHALL, CHARLES E. (A'27)**, Research Department, Zenith Radio Corporation, 3620 Iron St., Chicago, Ill. For mail: 3553 N. Paulina St., Chicago, Ill.
- MARSHALL, CHARLES J. (J'31)**, Laboratory Assistant, Crosley Radio Corporation, 1329 Arlington St., Cincinnati, Ohio. For mail: 254 Melish Ave., Cincinnati, Ohio.
- MARSHALL, GEORGE E. (A'25)**, General Manager, George E. Marshall Company, Uptown Theatre Bldg., Wichita, Kan. For mail: 3424 E. Waterman St., Wichita, Kan.
- MARSHALL, J. A. (A'27)**, Chief Telegrapher, 21 Brunswick Sq., Camberwell, London, England.
- MARSLAND, STANLEY (A'31)**, Proprietor and Manager, Marsland Radio Service, 346 King St., West Kitchener, Ont., Canada. For mail: 23 De Kay St., Kitchener, Ont., Canada.
- MARSTEN, JESSE (A'18-M'25)**, Chief Engineer, International Resistance Company, 2006 Chestnut St., Philadelphia, Pa. For mail: 274 Avon Rd., Upper Darby, Pa.
- MARTEL, CHARLES W. (J'30-A'31)**, Student, Massachusetts Institute of Technology, Cambridge, Mass. For mail: 482 Westford St., Lowell, Mass.
- MARTENS, RAY L. (A'30)**, Vitaphone and Movietone Engineer, 208 N. Wells St., Chicago, Ill. For mail: 3303 S. Claremont Ave., Chicago, Ill.
- MARTIN, A. F. (A'30)**, Radio Engineer, Amalgamated Wireless Company, Parramatta Rd., Ashfield, New South Wales, Australia. For mail: 1 Julia St., Ashfield, New South Wales, Australia.
- MARTIN, DE LOSS K. (A'14-M'26)**, Engineer, Bell Telephone Laboratories, Inc., 180 Varick St., New York, N.Y. For mail: 28 Undercliff Ter., West Orange, N.J.
- MARTIN, DEVEREAUX (A'31)**, Radio Engineer, De Forest Radio Company, Passaic, N.J. For mail: 1 Park Ave., Fair Lawn, N.J.
- MARTIN, E. F. (A'28)**, Engineer, Illinois Bell Telephone Company, 208 W. Washington St., Chicago, Ill.
- MARTIN, GEORGE L. (A'29)**, 230 Roxford Rd., Syracuse, N.Y.
- MARTIN, H. B. (A'30)**, Radio Engineer, Radiomarine Corporation of America, 66 Broad St., New York, N.Y. For mail: 255-79th St., Brooklyn, N.Y.
- MARTIN, HUBERT C. (A'30)**, Proprietor, Radio Service, 20 Logan St., Marion, N.C. For mail: P.O. Box 154, Marion, N.C.
- MARTIN, J. DOUGLAS, JR. (J'29)**, Electrical Engineering Student, Missouri School of Mines and Metallurgy, Rolla, Mo. For mail: P.O. Box 477, Rolla, Mo.
- MARTIN, J. LAURANCE (A'30)**, Proprietor and Chief Operator, Radio Station WDAG, 605 E. 4th St., Amarillo, Tex. For mail: 140 Wayside Dr., Amarillo, Tex.
- MARTIN, JULIUS (M'13)**, Navy Yard, Portsmouth, N.H.
- MARTIN, LOUIS (A'25-M'31)**, Associate Editor, *Radio Craft*, 98 Park Pl., New York, N.Y. For mail: 121 Howard Ave., Brooklyn, N.Y.
- MARTIN, NORMAN A. (A'27)**, Attorney, Martin and Martin, Union Trust Bldg., New Castle, Pa.
- MARTIN, ORA F. (A'31)**, Frameman, American Bell Telephone Company, 600 E. Green St., Pasadena, Calif. For mail: 680 N. Breeze St., Route No. 1, Baldwin Park, Calif.
- MARTIN, PERRIN L. (A'31)**, Office Supply Salesman, Lowman and Hanford Company, 1514-3rd Ave., Seattle, Wash. For mail: 218-10th Ave. N., Seattle, Wash.
- MARTIN, RAY L. (A'31)**, Proprietor, Radio Repair Shop, 415-5th St., De Witt, Iowa.
- MARTIN, ROBERT D. (A'29)**, Assistant Manager, U. S. Frequency Monitoring Sta-

- tion, Grand Island, Neb. For mail: 2115 W. 1st St., Grand Island, Neb.
- MARTIN, V. G. (A'22)**, Radio Engineer, Stromberg-Carlson Telephone Manufacturing Company, 100 Carlson Rd., Rochester, N.Y. For mail: 48 Park Ave., Rochester, N.Y.
- MARTIN, W. H. (A'30)**, Local Transmission Development Engineer, American Telephone and Telegraph Company, 195 Broadway, New York, N.Y.
- MARTIN, WALTER H. (A'31)**, Chief Technician, W. E. Phillip, 1145-2nd St., San Diego, Calif. For mail: 2266 Ocean View Blvd., San Diego, Calif.
- MARTINO, ALPHONSE E. (A'29)**, Engineering Department, RCA Victor Company, Inc., Camden, N.J. For mail: 2030 E. Hazard St., Philadelphia, Pa.
- MARTLIEU, C. H. O. (A'31)**, Radio Engineer, 149-151 Water St., Halifax, N.S., Canada. For mail: 95 Morris St., Halifax, N.S., Canada.
- MARTYN, DAVID F. (A'30)**, Physicist, Research Board, c/o The University, Melbourne, N. 3, Australia.
- MARTZ, FORREST W. (J'30)**, Engineer and Operator, Cedar Rapids Broadcasting Corporation, Don Cook Bldg., Cedar Rapids, Iowa. For mail: 316 S. 12th St., Cedar Rapids, Iowa.
- MARUMO, NOBORU (A'25)**, Chief Engineer, Nohon Hosokiokai, Sendai Broadcasting Station, Haranomachi, Hosojo, Sendai, Japan.
- MARVIN, HARRY B. (M'31)**, Electrical Engineer, General Engineering Laboratory, General Electric Company, Schenectady, N.Y. For mail: 121 Woodland Ave., Schenectady, N.Y.
- MARX, FRANK (J'31)** Technical Supervisor, Knickerbocker Broadcasting Company, 1697 Broadway, New York, N.Y.
- MARZULLI, ANGELO N. (A'26)**, Assistant Professor of Engineering, University of Florida, Gainesville, Fla. For mail: 233 Garside St., Newark, N.J.
- MASALOVICS, J. A. (A'29)**, Radio Serviceman, Colonial Radio Corporation, 25 Wilbur Ave., Long Island City, L.I., N.Y. For mail: 353 Park Ave., Weehawken, N.J.
- MASER, HAROLD T. (A'29)**, Engineer, Research Laboratory, General Electric Company, Schenectady, N.Y. For mail: 111 Park Pl., Schenectady, N.Y.
- MASK, WINFRED B. (A'31)**, Engineer, Radio Station KMLB, Monroe, La. For mail: Box 893, Monroe, La.
- MASON, CURTIS W. (A'26)**, Engineer-in-Charge, Radio Station KFI-KECA, 1000 S. Hope St., Los Angeles, Calif. For mail: 4223 Latona Ave., Los Angeles, Calif.
- MASON, DALE P. (A'26)**, First Lieutenant, U. S. Army, Office Chief Signal Officer, Fort Meyer, Va.
- MASON, HOWARD F. (A'27)**, Instructor in Radio, Washington Technical Institute, 4th and Madison Sts., Seattle, Wash. For mail: 1436 W. 50th Ave., Seattle, Wash.
- MASSA, FRANK (A'30)**, Electro-Acoustic Engineer, RCA Victor Company, Inc., Camden, N.J.
- MASSART, RAYMOND E. (A'30)**, Technical Service Manager, Eastern Talking Machine Company, 509 Westminster St., Providence, R.I. For mail: 81 Union St., Woonsocket, R.I.
- MASSEY, ANDREW (A'30)**, Chief Engineer, Broadcast Station WPTF, Raleigh, N.C.
- MATES, T. JOAQUIN (A'28)**, 1411 N St., N.W., Washington, D.C.
- MATHERS, EARL S. (A'29)**, Assistant to System Chief Operator, Pennsylvania Water and Power Company, 1611 Lexington Bldg., Baltimore, Md.
- MATHES, R. E. (J'22-A'24)**, Engineering Department, R.C.A. Communications, Inc., 66 Broad St., New York, N.Y.
- MATHIS, CHARLES, JR. (J'31)**, Serviceman, Mims Radio Shop, 404 State Line Ave., Texarkana, Ark. For mail: Route No. 3, Box 305, Texarkana, Ark.
- MATHISON, GERALD (A'29)**, Commercial Radio Operator, 1009 Midland Ave., Midland, Mich.
- MATRES, TRINIDAD (M'27)**, Captain, de Corbeta Ministerio de Marina, Madrid, Spain.
- MATSUI, K. (A'29)**, Research Staff, Vacuum Tube Department, Research Laboratory, Tokyo Electric Company, Kawasaki, Japan.
- MATSUMURA, SADA O. (A'28)**, Research Engineer, Electrotechnical Laboratory, Ministry of Communications, Osaki, Tokyo, Japan.
- MATTHEWS, A. C., JR. (A'28)**, Freed Radio and Television Corporation, Long Island City, L.I., N.Y. For mail: 33-09-149th St., Flushing, L.I., N.Y.
- MATTHEWS, BASIL W. (A'30)**, Account Executive, Hanff-Metzger, Inc., Advertising Agents, 1501 Broadway, New York, N.Y. For mail: 9 Park View Ave., New Rochelle, N.Y.
- MATTHEWS, GEORGE D. (A'31)**, Sales Engineer, Peoples Gas, Light and Coke Company, 122 S. Michigan Ave., Chicago, Ill. For mail: 811 N. West St., Wheaton, Ill.
- MATTHEWS, P. H. (A'27)**, Western Electric Company, Ltd., Hope Gibbons Bldg., Dixon St., Wellington, New Zealand.
- MATTHEWS, WALTER I. (A'25)**, Receiving Engineer, R.C.A. Communications, Inc., Riverhead, L.I., N.Y. For mail: Box 1699, Riverhead, L.I., N.Y.
- MATTHIAS, LYNN H. (A'25)**, Research, Allen-Bradley Company, Milwaukee, Wis. For mail: 2300 Wisconsin Ave., Milwaukee, Wis.
- MATTIA, RALPH E. (A'29)**, Engineer, RCA Victor Company, Inc., Rm. 407, Camden, N.J. For mail: 765 S. 10th St., Philadelphia, Pa.
- MAUER, WILLIAM V. (J'26-A'27)**, Mauer Radio Laboratories, 60 S. Main St., Liberty, N.Y.
- MAUL, GILBERT E. (A'30)**, Research Engineer, Arcturus Radio Tube Company, 720 Frelinghuysen Ave., Newark, N.J. For mail: 651 Lincoln Ave., Orange, N.J.
- MAURAN, JOHN (A'25)**, RCA Photophone, Inc., 438 W. 37th St., New York, N.Y.
- MAURER, J. P. (A'30)**, Manager, Mechanical Engineering and Inspection, Rogers-Majestic Radio Corporation, Ltd., Toronto, Ont., Canada. For mail: 30 Woodlawn St., W., Toronto, Ont., Canada.
- MAWSON, JOHN T., JR. (A'28)**, Radio Service Engineer, 322 W. Hastings, Vancouver, B.C., Canada. For mail: 1043 Nootka St., Vancouver, B.C., Canada.
- MAXEY, HENRY J. (A'31)**, Chief Radio Engineer, Wireless Trade Service Company, 9 Cobourg Lane, Plymouth, England. For mail:

- 8 Southfield Ave., Paignton, Devon, England.
- MAXIM, HIRAM PERCY** (A'15), President, Maxim Silencer Company, P.O. Box 2102, Hartford, Conn.
- MAXWELL, GEORGE G.** (A'26), Supervisor of Transmitters, Buffalo Broadcasting Corporation, Rand Bldg., Buffalo, N.Y. For mail: Radio Station WKBW, R.F.D. No. 1, Tonawanda, N.Y.
- MAXWELL, JOHN F.** (A'28), 56 Mount Vernon St., Lawrence, Mass.
- MAY, ALBERT** (A'24), Instructor, Physics, Catholic University of America, Washington, D.C. For mail: 4315-12th Pl., N.E., Washington, D.C.
- MAY, FRANK DARRELL** (A'29), Production Test Engineer, Van Sicklen Corporation, Elgin, Ill. For mail: 326 W. Crawford St., Elkhart, Ind.
- MAYBERRY, ROBERT J.** (A'31), Staff Operator, Columbia Broadcasting System, Inc., 485 Madison Ave., New York, N.Y. For mail: Radio Station WABC, Wayne, N.J.
- MAYEA, LAWRENCE E.** (A'29), Radio Engineer, Radio Laboratory, U. S. Navy Yard, Bldg. 77, Philadelphia, Pa. For mail: 1031 E. Price St., Philadelphia, Pa.
- MAYER, ARTHUR W.** (A'14), President, A. W. Mayer Radio Company, 147 Massachusetts Ave., Boston, Mass. For mail: 7 Chestnut Sq., Jamaica Plain, Mass.
- MAYERS, HARVEY F.** (J'27-A'29), Radio Inspector, Western Electric Company, Inc., 16th and Glenwood Sts., Philadelphia, Pa. For mail: 6154 Haverford Ave., Philadelphia, Pa.
- MAYLOTT, CARLETON F.** (A'24), Engineer, Radio Department, Bell Telephone Laboratories, Inc., 180 Varick St., New York, N.Y. For mail: 55 Lincoln St., Jersey City, N.J.
- MAYNARD, J. E.** (A'29), Electrical Engineer, General Electric Company, Schenectady, N.Y. For mail: 860 Eastern Ave., Schenectady, N.Y.
- MAYNARD, RAYMOND K.** (A'25), Division Plant Supervisor, Pacific Telephone and Telegraph Company, 140 New Montgomery St., San Francisco, Calif.
- MAYO, ROYAL E.** (A'29), Electrical Engineer, Motor Department, General Electric Company, West Lynn, Mass. For mail: 87 Myrtle St., Lynn, Mass.
- MAZIK, JOHN, JR.** (A'26), 7217 Pine St., Upper Darby, Pa.
- MAZZOLA, JOSEPH R.** (A'30), Specifications Draftsman, Aerovox Wireless Corporation, 70 Washington St., Brooklyn, N.Y. For mail: 1627 W. 13th St., Brooklyn, N.Y.
- MC ALLISTER, JAMES D.** (A'31), Radio Serviceman, West Hills Radio Service, P.O. Box 277, Multnomah, Ore.
- MC ALLISTER, RALPH H.** (A'30), Representative, Anthracite Radio Company, Inc., Penn and Vine Sts., Scranton, Pa. For mail: 216 S. 20th St., Pottsville, Pa.
- MC ARDELL, WESLEY E.** (A'25), Teacher, Brooklyn Technical High School, Brooklyn, N.Y. For mail: Emerson Hill, Stapleton, S.I., N.Y.
- MC AULAY, WILLIAM H.** (A'30), 460 Milton Ave., San Bruno, Calif.
- MC CABE, LOUIS L.** (A'26), Radio Inspector, Radio Division, U. S. Department of Commerce, 326 Custom House, New Orleans, La.
- MC CABE, WILLIAM E.** (A'26), Proprietor, Emsee Radio Company, 1047 Crenshaw Blvd., Los Angeles, Calif.
- MC CACHREN, W. S.** (A'27), President, Pennsylvania Broadcasting System, 1110 Payne-Shoemaker Bldg., Harrisburg, Pa.
- MC CAFFRY, JAMES A.** (A'23), 8656 Dumbarton Rd., Detroit, Mich.
- MC CALL, KEITH E.** (A'27), Service Inspector, RCA Photophone, Inc., 1 Wood St., Pittsburgh, Pa. For mail: 20722 Woodstock Ave., Fairview Village, Cleveland, Ohio.
- MC CALLISTER, JAMES D.** (A'30), Radio Service Manager, West Penn Appliance Company, No. 2 Wood St., Pittsburgh, Pa. For mail: R.D. No. 2, Monongahela, Pa.
- MC CALLUM, C. C.** (A'30), Edison Swan Electric Company, 155 Charing Cross Rd., London, W.C. 2, England.
- MC CAMMON, DONALD** (J'29-A'30), Student, University of Kentucky, Lexington, Ky. For mail: c/o AEO, 433 E. Maxwell St., Lexington, Ky.
- MC CANDLISH, B. V.** (A'27), Commander, U. S. Naval War College, Newport, R.I.
- MC CANN, THOMAS A.** (A'30), Engineer, American Telephone and Telegraph Company, Rm. 1630, 195 Broadway, New York, N.Y.
- MC CANNE, LEE** (A'27), Radio Engineer, Stromberg-Carlson Telephone Manufacturing Company, 100 Carlson Rd., Rochester, N.Y. For mail: Harwood Farms, East Rochester, N.Y.
- MC CANNE, W. ROY** (M'27), President, Stromberg-Carlson Telephone Manufacturing Company, 1060 University Ave., Rochester, N.Y.
- MC CARROLL, GEORGE M.** (A'30), 601 Asia St., Baton Rouge, La.
- MC CARTHY, F. M.** (A'30), 5638 S. Washenaw Ave., Chicago, Ill.
- MC CARTNEY, MAX** (A'31), Proprietor, Radio Sales and Service, Diagonal, Iowa.
- MC CARTY, SIDNEY L.** (A'31), Highlands, N.C.
- MC CASH, PERRY V.** (A'30), Engineer, American Wire Recording Company, 160 N. Los Angeles St., Los Angeles, Calif. For mail: 3730 Arlington Ave., Los Angeles, Calif.
- MC CAULEY, GEORGE W.** (A'30), Vice President, Plane Speaker Corporation, 643 Graybar Bldg., New York, N.Y. For mail: 220 Front St., Mineola, L.I., N.Y.
- MC CAULEY, JOHN H.** (A'27), Construction and Development Department, United Radio and Electric Corporation, 500 Chancellor Ave., Irvington, N.J. For mail: 268 Conklin Ave., Hillside, N.J.
- MC CLARY, JAMES P.** (A'26), Sound Equipment Engineer, 15 Waldo Ave., Bloomfield, N.J.
- MC CLELLAND, HAROLD M.** (M'26), Captain, Air Corps, Rockwell Field, Coronado, Calif.
- MC CLUNG, C. A.** (A'31), Supervisor, RCA Victor Company, Inc., Camden, N.J. For mail: 1590 Kaighn Ave., Camden, N.J.
- MC COLLUM, HARRY J.** (A'30), Consulting Radio Expert, 130-2nd Ave., Long Branch, N.J.

- MC CONNELL, ROY E.** (A'30), Radio Service Manager, Fisher-Armstrong Company, 123 W. Broadway, Princeton, Ind.
- MC CONNELL, W. G.** (A'28), Design Engineer, De Forest Radio Tube Company, Passaic, N.J. For mail: 6 Burnham Pl., Radburn, N.J.
- MC CONNELL, W. J.** (A'30), St. Niven's Pl., 101 Rosebank St., Dundee, Scotland.
- MC CORMICK, HAMILTON L.** (A'31), Sound Equipment Engineer, Arma Engineering Company, Inc., 254-36th St., Brooklyn, N.Y. For mail: 38 Slocum Pl., Brooklyn, N.Y.
- MC CORVEY, AVIS** (A'30), Radio Service, Georgia Power Company, Atlanta, Ga. For mail: 123 Olympia Pl., Decatur, Ga.
- MCCULLOCH, GEORGE ROBERT** (J'27-A'30), Manager, Technical Adviser, Martins Wireless Stores, 34 Lydiard St., N., Ballarat, Victoria, Australia. For mail: 511 Havelock St., Ballarat, Victoria, Australia.
- MCCULLOUGH, FRANK S.** (A'30), Tube Laboratory, Heintz and Kaufman, Ltd., San Francisco, Calif. For mail: Menlo Park, Calif.
- MCCULLOUGH, MAURICE B.** (J'22-A'26), Component Parts Sales Manager, Engineering Products Division, RCA Victor Company, Inc., Camden, N.J.
- MCCUTCHEON, BRUNSON S.** (A'21-M'26), Consulting Engineer, Evening Post Bldg., 75 West St., Suite 1013, New York, N.Y.
- MCCUTCHEON, JOHN F.** (A'31), Serviceman, Ludwig Baumann and Company, 45 Pearson St., Long Island City, L.I., N.Y. For mail: 177-49-106th Rd., Jamaica, L.I., N.Y.
- MCCUTCHEON, WILLIAM A.** (A'31), Assistant Managing Director, Western Electric Company, Ltd., P.O. Box 605, Wellington, New Zealand.
- MC DANIEL, OTTO S.** (A'23), Transmission Engineer, Southwestern Bell Telephone Company, Rm. 1804, Telephone Bldg., St. Louis, Mo.
- MC DERMOTT, EUGENE** (A'25), Vice President and Treasurer, Geophysical Service, Inc., 1311 Republic Bank Bldg., Dallas, Tex.
- MC DERMOTT, JOHN J.** (A'30), Service Manager, Stone and Luke, Inc., 45-1st St., Hion, N.Y. For mail: R.F.D. No. 1, Cassville, N.Y.
- MC DONALD, ARTHUR S.** (M'23), Chief Engineer, Amalgamated Wireless, Ltd., 47 York St., Sydney, Australia.
- MCDONALD, DANIEL** (A'31), Engineer, "Birmingham Sound Reproducers," 40-41 Perry Park Rd., Blackheath, Birmingham, England. For mail: Highclere, Highfield Rd., Blackheath, Birmingham, England.
- MCDONALD, GEORGE F. H.** (A'24), 3 Curtis Rd., Hornchurch, Essex, England.
- MC DONNELL, WALTER J.** (A'31), Radio Operator, Great Lakes Broadcasting Company, Downers Grove, Ill.
- MC DONELL, WILLIAM J.** (A'29), U. S. Assistant Radio Inspector, 231 Federal Bldg., Room 231, Kansas City, Mo.
- MC DOWELL, ALBERT P., JR.** (A'27), Commonwealth Title Insurance and Trust Company, 1201 Chestnut St., Philadelphia, Pa. For mail: 41 Carpenter Lane, Mount Airy, Philadelphia, Pa.
- MC DOWELL, C. S.** (A'13-M'15), Captain, U. S. Navy, Inspector of Naval Material, 100 Harrison St., San Francisco, Calif.
- MC DOWELL, LAWRENCE W.** (A'31), Chief Engineer, Radio Station KFOX, 220 E. Anaheim St., Long Beach, Calif. For mail: 1901 Golden Ave., Long Beach, Calif.
- MC DOWELL, LOUISE S.** (M'23), Professor of Physics, Wellesley College, Wellesley, Mass. For mail: 28 Dover Rd., Wellesley, Mass.
- MCELDRATH, GEORGE** (M'29), Radio Broadcaster, National Broadcasting Company, Inc., 711-5th Ave., New York, N.Y.
- MCELROY, PAUL K.** (A'25-M'27-F'31), Production Engineer, General Radio Company, 30 State St., Cambridge, Mass. For mail: 65 Grozier Rd., Cambridge, Mass.
- MC FARLAND, DANIEL C.** (A'31), Watchmaker, McFarland and Lambert, 604 Banker's Trust Bldg., Norfolk, Va.
- MC FARLAND, WILLIAM F.** (A'31), Special Assistant, c/o Adjutant General, Topeka, Kan.
- MC FARLANE, M. L. D.** (A'26), Manager, Bartlane Department, News Syndicate Company, Inc., Rm. 828, 220 E. 42nd St., New York, N.Y.
- MC GARRY, JOHN** (A'30), U.S.S. Texas, c/o Postmaster, New York, N.Y.
- MC GARVEY, HAROLD R.** (A'29), Radio Sales and Service, H. R. McGarvey, 511 Court St., Pekin, Ill.
- MC GAUGHEY, P. C.** (A'31), Engineer, Service Division, RCA Victor Company, Inc., Camden, N.J. For mail: 9 Colliston Rd., Brighton, Mass.
- MC GONIGLE, WILLIAM J.** (J'29-A'29), Proprietor, 579 Franklin Ave., Brooklyn, N.Y. For mail: 140 Vanderbilt Ave., Brooklyn, N.Y.
- MC GRATH, JOSEPH L.** (A'27), Radio Quertes, Boston Globe, Washington St., Boston, Mass. For mail: 115 Clay St., Wollaston, Mass.
- MC GREGOR, ARTHUR M.** (J'27-A'29), Radio Engineer, Oak Leaves Broadcasting Company, 128 N. Crawford Ave., Chicago, Ill. For mail: 5412 W. Quincy St., Chicago, Ill.
- MC ILVAINE, ORAN T.** (M'27), President, Continental Electric Company, 200 S. 1st St., St. Charles, Ill. For mail: 808 Wilson St., Geneva, Ill.
- MC ILWAIN, KNOX** (A'31), Assistant Professor, Moore School of Electrical Engineering, 200 S. 33rd St., Philadelphia, Pa.
- MC ILWRAITH, CHARLES G.** (A'29), Senior Electrical Engineer, U. S. Coast and Geodetic Survey, Washington, D.C.
- MC INTOSH, FRANK H.** (J'25-A'28), Member of Technical Staff, Radio Development Department, Bell Telephone Laboratories, Inc., 180 Varick St., New York, N.Y.
- MC INTYRE, DANIEL G.** (A'29), Radio Manager and Engineer, Murdochs, Ltd., Park St., Sydney, Australia. For mail: "Glenroy," 19 Concord Rd., Strathfield, Australia.
- MC JILTON, DE WITT** (A'26), Radio Manufacturing, 2227 W. Adams St., Chicago, Ill.
- MC KAY, WILLIAM** (A'30), Radio Operator, Canadian Marconi Company, Quebec, P.Q., Canada. For mail: 68 Bougainville Ave., Quebec, P.Q., Canada.
- MC KAY, WILLIAM K.** (J'27-A'29), Serviceman, Maxwell Hardware Company, Oakland,

- Calif. For mail: 2287 Telegraph Ave., Berkeley, Calif.
- MC KECHNIE, JOHN S.** (A'31), Engineer, RCA Victor Company, Inc., Camden, N.J. For mail: 6060 Washington Ave., Merchantville, N.J.
- MC KEE, ADDISON L.** (A'31), Secretary and Treasurer, Anderson Broadcasting Corporation, 903 Meridian St., Anderson, Ind. For mail: Box 929, Anderson, Ind.
- MC KEEL, P. DE FORREST** (A'30), Radio Engineer, Radio Development Engineering Department, Westinghouse Electric and Manufacturing Company, East Pittsburgh, Pa.
- MC KESSON, LEWIS J.** (A'27), Engineer, Radio Corporation of the Philippines, Manila, Philippine Islands.
- MC KEWEN, J. D.** (A'29), Proprietor and Operator, Radio Station 4ZM, Charles Bagg and Company, Box 139, Dunedin, New Zealand.
- MCKICHAN, DONALD B.** (A'30), Engineer, Bell Telephone Company, Ltd., Temperance St., Toronto, Ont., Canada. For mail: 68 Langley Ave., Toronto, Ont., Canada.
- MCKIM, ROYAL W.** (A'31), President, McKim Electric Schools, Inc., 120 Ash St., Akron, Ohio. For mail: R.F.D. No. 1, Copley, Ohio.
- MCKINLEY, HOWARD W.** (A'26), Assistant Radio Engineer, Bureau of Lighthouses, Airways Division, Washington, D.C. For mail: 2121 H St., N.W., Washington, D.C.
- MCKINLEY, J. G.** (A'24), Assistant Radio Engineer, West Penn Electric Company, 14 Wood St., Pittsburgh, Pa.
- MCKINNEY, JOE H.** (A'29), U. S. Radio Inspector, City Hall Bldg., Miami, Fla.
- MCLAGAN, DONALD R.** (A'17), Electrical Engineer, Suite 1505, 21 E. 40th St., New York, N.Y.
- MCLAUGHLIN, HARRY R.** (A'30), Chief Radio Engineer, Canadian Airways, Ltd., Winnipeg, Manit., Canada. For mail: 60 Brock St., Winnipeg, Manit., Canada.
- MCLAUGHLIN, JAMES L.** (A'24-M'31), Chief Engineer, Aviation Radio Station, Inc., 29 W. 57th St., New York, N.Y.
- MCLAUGHLIN, THOMAS J.** (A'30), Radio Field Adjuster, Gimbel Brothers, 33rd St. and Broadway, New York, N.Y. For mail: 889 Jefferson Ave., Brooklyn, N.Y.
- MCLEAN, FRANCIS C.** (A'26), Engineering Department, Les Laboratories Standard, 46, Avenue de Breteuil, Paris 7^e, France.
- MCLEAN, PHILIP S.** (A'19), Patent Lawyer, 225 Broadway, New York, N.Y.
- MCLENNAN, MILES ARYAULT** (A'29), Development Engineer, RCA Victor Company, Inc., Camden, N.J.
- MCLENNAN, RODERICK ARTHUR** (M'29), 111 Hackthorne Rd., Cashmere Hills, Christchurch, New Zealand.
- MCLEOD, JOHN S.** (A'26), Managing Director, J. S. McLeod and Company, Ltd., 34 Great Moor St., Bolton, England. For mail: 48 Le Grandre St., Moorfield, Bolton, England.
- MCMAHON, ALVIN** (A'25), Field Supervisor, National Broadcasting Company, Inc., 1367 E. 6th St., Cleveland, Ohio.
- MCMASTER, A. J.** (A'30), President and Technical Director, G-M Laboratories, Inc., 1735 Belmont Ave., Chicago, Ill.
- MCMICHAEL, LESLIE** (M'20-F'25), L. McMichael, Ltd., Hastings House, Norfolk St., Strand, London, W.C. 2, England. For mail: Everest, Princes Park Ave., Golders Green, London, N.W., England.
- MC MILLAN, DONALD B.** (J'27), Canadian General Electric Company, 212 King St. W., Toronto, Ont., Canada. For mail: 82 Bowie Ave., 7, Fairbanks, Ont., Canada.
- MC MURTRY, CYRIL A. W.** (A'17), Vice President, McMurtry Hardware, Ltd., 621 Talbot St., St. Thomas, Ont., Canada. For mail: 39 Rosebery Pl., St. Thomas, Ont., Canada.
- MCNALLAN, WILBUR T.** (A'30), Engineering Aid, U. S. Lighthouse Service, Bureau of Lighthouses, U. S. Department of Commerce, Washington, D.C.
- MCNALLY, EUGENE C.** (J'28), 1306 S. Carson Ave., Tulsa, Okla.
- MCNALLY, JAMES O.** (J'24-A'26), Member of Technical Staff, Bell Telephone Laboratories, Inc., 463 West St., New York, N.Y.
- MCNAMARA, FRANCIS T.** (A'31), Assistant Professor of Electrical Engineering, Yale University, New Haven, Conn. For mail: 322 Thornton St., Hamden, Conn.
- MCNAMEE, B. F.** (A'20), Chief Production Engineer, Colin B. Kennedy Corporation, South Bend, Ind.
- MCNARY, JAMES C.** (J'22-A'27-M'28), Bell Telephone Laboratories, Inc., 463 West St., New York, N.Y.
- MCNEILL, GEORGE T.** (J'31), Assembly Foreman, Victor Talking Machine Company of Canada, Ltd., 4912 Sherbrooke St., W., Montreal, P.Q., Canada.
- MCNICOL, DONALD** (A'14-M'14-F'24), Editorial Director, Bryan Davis Publishing Company, 52 Vanderbilt Ave., New York, N.Y. For mail: 132 Union Rd., Roselle Park, N.J.
- MCSWEENEY, ROGER** (A'29), Engineering Department, International Telephone and Telegraph Corporation, 67 Broad St., New York, N.Y.
- MCWATERS, JOHN T.** (A'30), Dryden, N.Y.
- MCWILLIAM, ERIC A.** (A'26), Engineer, Marconi Wireless Telegraph Company, Drummondville Station, Drummondville, P.Q., Canada.
- MEACHAM, J. F. B.** (A'28), Proprietor, Radio Electric Company, 86-04-117th St., Richmond Hill, L.I., N.Y.
- MEAD, LEO R.** (A'29), Technician and Laboratory Assistant, Electrical Research Laboratories, Inc., 1731 W. 22nd St., Chicago, Ill. For mail: 5044 Princeton Ave., Chicago, Ill.
- MEAD, MILTON S., JR.** (A'23), General Electric Company, Schenectady, N.Y. For mail: 1410 Regent St., Schenectady, N.Y.
- MEAIL, HARRY R.** (A'28), Radio Engineer, General Electric Company, 1 River Rd., Schenectady, N.Y.
- MEANS, PAUL S.** (A'27), Radio Operator, c/o Globe Wireless, Ltd., Robert Dollar Bldg., San Francisco, Calif. For mail: 22 E. Valerio St., Santa Barbara, Calif.
- MEGAW, E. C. S.** (A'29), Research Engineer, Research Laboratories, General Electric Company, Ltd., Wembley, Middlesex, England.

- For mail: 88, Dollis Lane, London, N.W. 2, England.
- MEGERS, A. L.** (A'30), Maintenance Engineer, Tropical Radio Telegraph Company, Opa Locka, Fla. For mail: Opa Locka, Fla.
- MEINHARD, HERMAN** (A'25), Engineer, Zenith Radio Corporation, 3620 Iron St., Chicago, Ill. For mail: 5445 Ludlam Ave., Chicago, Ill.
- MEISSNER, A.** (M'14-F'15), Berlin-Dahlem, Im Schwarzen Grund 11, Berlin, S.W. 11, Germany.
- MEISSNER, EARL R.** (A'26), 2329 Carlton St., Berkeley, Calif.
- MELANG, BJORN L.** (A'27), 6047-6th Ave. N.E., Seattle, Wash.
- MELLON, RALPH E. P.** (J'28-A'30), Radio Dealer, 25 King St., Pottstown, Pa.
- MELLOR, WILLIAM N.** (A'27), Radio Engineer, Bell Telephone Laboratories, Inc., 463 West St., New York, N.Y. For mail: Rm. 802, 180 Varick St., New York, N.Y.
- MELROY, HARRY C.** (A'29), 40 Beauvoir Ave., Summit, N.J.
- MENARD, ALEXIS A.** (A'31), Engineer, The Camlin Hotel, 9th Ave. and Pine St., Seattle, Wash. For mail: 221 Belmont N., Seattle, Wash.
- MENARD, J. L.** (A'29), 7818 St. Denis St., Montreal, P.Q., Canada.
- MENDENHALL, HALLAM E.** (A'31), Engineer, Bell Telephone Laboratories, Inc., 463 West St., New York, N.Y.
- MEOLA, THOMAS D.** (A'31), Supervisor of Operation, R.C.A. Communications, Inc., Rocky Point, L.I., N.Y.
- MERCER, CHARLES J.** (M'30), Assistant Staff Engineer, British Post Office, Radio Section, Engineer-in-Chief's Office, G.P.O., London, England.
- MERDLER, LIONEL R.** (A'31), Radio Engineer, Standard Telephones and Cables, Ltd., London, N.W. 10, England. For mail: 18 Twyford Ave., London, W. 3, England.
- MEREDITH, C. C.** (A'25-M'30), 639 Bay St., Toronto, Ont., Canada.
- MEREDITH, WILLIAM B.** (A'29), Radio Engineer, Rosen Talking Machine Company, 11 School St., Boston, Mass. For mail: 75 Cottage St., Everett, Mass.
- MERKEL, HENRY F.** (A'27), Proprietor and Manager, Merkel Radio Engineering Service, 447 Fern St., Philadelphia, Pa.
- MERMAN, JOHN C.** (A'30), Radio Engineer, Philadelphia Storage Battery Company, Ontario and C Sts., Philadelphia, Pa. For mail: 8333 Jeanes St., Fox Chase, Philadelphia, Pa.
- MERRILL, HENRY M.** (A'31), Engineer, National Union Radio Corporation, 57 State St., Newark, N.J. For mail: 22 Park Ave., Caldwell, N.J.
- MERRITT, ERNEST** (M'15), Professor of Physics, Cornell University, Ithaca, N.Y. For mail: Rockefeller Hall, Cornell University, Ithaca, N.Y.
- MERTIE, J. B., JR.** (A'29), Geologist, U. S. Geological Survey, Washington, D.C. For mail: 110 Park Crest Dr., Sligo Park Hills, Silver Springs, Md.
- MESERVE, G. DONALD** (A'28), Advertising Manager, QST, 55 W. 42nd St., New York, N.Y. For mail: P.O. Box 252, Noroton Heights, Conn.
- MESERVE, WILBUR E.** (A'26), Instructor in Electrical Engineering, School of Electrical Engineering, Cornell University, Ithaca, N.Y.
- MESSER, HERBERT G.** (A'30), First Lieutenant, Signal Corps, Aircraft Radio Laboratory, Wright Field, Dayton, Ohio.
- MESSIER, JOSEPH L.** (A'31), Radio Electrician, Dominion Government, 66 Sault au Matelot, Quebec, P.Q., Canada.
- MESSNER, ROY L.** (A'24), Division Transmission Engineer, Pacific Telephone and Telegraph Company, 1414 K St., Sacramento, Calif.
- METCALF, DAVID E.** (A'30), Proprietor, Metcalf Radio Service, 1749 Magnolia Ave., Los Angeles, Calif.
- METZNER, MAXWELL W.** (A'30), Assistant Supervisor of Tests, Eric Works, General Electric Company, Erie, Pa. For mail: 1853 E. Lake Rd., Erie, Pa.
- MEUER, ANTHONY G.** (A'31), Radiotrician, Rudolph Wurplitz Company, 729 N. Broadway, Milwaukee, Wis. For mail: R.R. No. 4, Box 310, West Allis, Wis.
- MEVIUS, JOHN C.** (J'27-A'27), Technical Supervisor, Independence Broadcasting Company, Public Ledger Bldg., Philadelphia, Pa. For mail: 5135 N. Fairhill St., Philadelphia, Pa.
- MEYER, ALBERT** (A'29), Chief Engineer, Radio Station KGBZ, 715 Grant Ave., York, Neb. For mail: 420 W. 6th St., York, Neb.
- MEYER, HENRY E.** (A'30), Radio Engineer, National Broadcasting Company, Inc., 711-5th Ave., New York, N.Y. For mail: N. 23rd St., Kenilworth, N.J.
- MEYER, HENRY W.** (A'27), Equipment Installer, Western Electric Company, Inc., 397 Hudson St., New York, N.Y. For mail: 523 E. 147th St., New York, N.Y.
- MEYER, J. M.** (A'30), Radio Operator, Radio Station KTUE, Texas State Hotel, Houston, Tex.
- MEYER, R. B.** (A'29), Radio Engineer, U. S. Navy, U. S. Naval Research Laboratory, Bellevue, Anacostia, D.C.
- MEYER, WINSTON F.** (A'28), Radio Service and Repairman, Ridgeway Electric Company, 113 W. Stephenson St., Freeport, Ill. For mail: Route No. 1, Box 90, Freeport, Ill.
- MEYERS, CARL J.** (A'31), Chief Engineer, Radio Station WGN, Chicago Tribune, Rm. 1114 Tribune Tower, Chicago, Ill. For mail: 351 Algona Ave., Elgin, Ill.
- MEYROSE, HUBERT S.** (A'27), Technical Staff, Studios Stations WIAW, WSAI, and WRXAL, 1329 Arlington St., Cincinnati, Ohio.
- MEZGER, GEORGE** (A'25), District Plant Superintendent, American Telephone and Telegraph Company, Stratton Bldg., 103 Washington St., Albany, N.Y.
- MIAO, T. V.** (J'30), Student Engineer, Government Radio Administration of China, Shanghai, China. For mail: 1515 Hart Rd., Shanghai, China.
- MICHAEL, CHARLES** (A'27), Radio Operator, U. S. Airways Division, Municipal Airport, Chicago, Ill. For mail: 6252 S. Whipple St., Chicago, Ill.
- MICHAEL, DAVID F.** (A'29), Radio Operator, U. S. Department of Commerce, Air-

- ways Division, Washington, D.C. For mail: U. S. Airways Radio, Fargo, N.D.
- MICHAELIS, H. PAUL, JR. (A'31), Radio Serviceman, J. C. Holtby Radio, 24 S. Lansdowne Ave., Lansdowne, Pa. For mail: 155 Pen Blvd., East Lansdowne, Pa.
- MICHALENKA, ANDREW (A'31), Service Engineer, Research Products Engineering Department, Northern Electric Company, Ltd., 637 Craig St. W., Montreal, P.Q., Canada. For mail: Northern Electric Company, Ltd., 101 Grain Bldg., Saskatoon, Sask., Canada.
- MICHALIC, C. T. (A'28), Certified Radiotriician, 908 Morrell Ave., Burlingame, Calif.
- MICHALOWICZ, LEON V. (A'29), Planning Engineer, Western Electric Company, Inc., Hawthorne Station, Chicago, Ill. For mail: 5536 Windsor Ave., Chicago, Ill.
- MICHELIS, RUDOLPH P. (A'31), Student, R.C.A. Institutes, Inc., 222 N. Bank Dr., Chicago, Ill. For mail: 4824 Woodlawn Ave., Chicago, Ill.
- MICHELMAN, EDWARD A. (J'26-A'29), Assistant to Auditor, R.C.A. Institutes, Inc., 75 Varick St., New York, N.Y. For mail: 507 W. 113th St., New York, N.Y.
- MICHELSON, PETER (A'29), Radiotriician, Kingwood, W.Va.
- MICKEL, HARRY F. (A'31), Engineering Department, RCA Victor Company, Inc., Camden, N.J. For mail: 604 Avondale Ave., Haddonfield, N.J.
- MICKELSON, C. D. (A'27), Engineering Assistant, Research Bureau, Brooklyn Edison Company, 55 Johnson St., Brooklyn, N.Y. For mail: P.O. Box 1071, Sea Cliff, L.I., N.Y.
- MICKEY, LEROY (A'26), 3406 Quebec St., N.W., Washington, D.C.
- MIER, C. W. (A'28), Engineer, Southwestern Bell Telephone Company, Oklahoma City, Okla.
- MILES, LESTER F. (A'29), Chief Radio Engineer, Station WHP, Penn Broadcasting Company, Harrisburg, Pa. For mail: 151 Washington Ter., Lemoyne, Pa.
- MILES, PAUL D. (A'30), Assistant Engineer, Mackay Radio and Telegraph Company, Inc., 67 Broad St., New York, N.Y.
- MILES, WILLIAM E. (A'25), Manager, Code and Traffic Instruction Department, R.C.A. Institutes, Inc., 1154 Merchandise Mart, Chicago, Ill.
- MILLAR, J. Z. (A'30), 109 Toylesome Lane, Southampton, L.I., N.Y.
- MILLARD, ALFRED W. (A'30), Marine Radio Operator, S.S. *Olympic*, c/o White Star Line, 1 Broadway, New York, N.Y. For mail: 19, Flaxman Rd., London, S.E. 5, England.
- MILLEN, JAMES (J'24-A'25), General Manager, National Company, Inc., 61 Sheridan St., Malden, Mass. For mail: 84 Autumn St., Malden, Mass.
- MILLER, BURTON F. (J'24-A'26), Transmission Engineer, Columbia Pictures Corporation, Hollywood, Calif. For mail: 515 N. Larchmont Blvd., Hollywood, Calif.
- MILLER, CARL (A'28), Radio Engineer, Hygrade Sylvania Corporation, Emporium, Pa. For mail: 409 Vine St., Emporium, Pa.
- MILLER, CHARLES C. (A'27), Transmitter Engineer, Universal Broadcasting Company, 1321 Arch St., Philadelphia, Pa. For mail: 5107 N. 11th St., Philadelphia, Pa.
- MILLER, CHARLES E. (A'25), Box 973, Station C, Los Angeles, Calif.
- MILLER, DONALD H. (A'30), Western Manager, *Radio Retailing and Electronics*, McGraw-Hill Publishing Company, 520 N. Michigan Ave., Chicago, Ill. For mail: 4940 East End Ave., Chicago, Ill.
- MILLER, EDWIN C. (A'30), National Broadcasting Company, Inc., 711-5th Ave., New York, N.Y. For mail: 2560-35th St., Astoria, L.I., N.Y.
- MILLER, ERDENE K. (A'28), Teller, First National Bank, Bartlesville, Okla. For mail: 709 Wyandotte Ave., Bartlesville, Okla.
- MILLER, FRANCIS G. (A'29), Radio and Electrical Engineer, Bridge St., Murray Bridge, South Australia. For mail: Eleanor Ter., Murray Bridge, South Australia.
- MILLER, GEORGE A. (A'30), Electrical Inspector, Western Electric Company, Inc., Newark, N.J. For mail: 140 N. 15th St., East Orange, N.J.
- MILLER, GERALD B. (A'30), Radio Technician, Sales and Service Department, Radio Manufacturers Supply Company, 1000 S. Broadway, Los Angeles, Calif. For mail: 8208 Santa Monica Blvd., Los Angeles, Calif.
- MILLER, H. B. (A'31), Engineer, Radio Station WOR, 1440 Broadway, New York, N.Y. For mail: 23-55-24th St., Astoria, L.I., N.Y.
- MILLER, H. P., JR. (A'22-M'24), Radio Engineer, 37 Kenwood Pl., East Orange, N.J.
- MILLER, HAROLD R. (A'16), Radio Engineer, Westinghouse Electric and Manufacturing Company, Chicopee Falls, Mass. For mail: 34 Lincoln St., Chicopee Falls, Mass.
- MILLER, HOLMES C. (A'30), Radio Engineer, Independent Designer and Builder, 2612 Cowper St., Palo Alto, Calif. For mail: P.O. Box 105, Palo Alto, Calif.
- MILLER, HORACE G. (A'30), Radio Inventions, Inc., 41 Park Row, New York, N.Y.
- MILLER, J. PURNELL (A'26), RCA Victor Company, Inc., Camden, N.J. For mail: 2728 Harford Ave., Baltimore, Md.
- MILLER, JOHN C. (A'31), Chief Engineer, George Brown and Company, 45 George IV Bridge, Edinburgh, Scotland. For mail: 7 Mertoun Pl., Edinburgh, Scotland.
- MILLER, JOHN G. C. (A'27), Radio Engineer, Lockport Light, Heat and Power Company, 15 Main St., Lockport, N.Y. For mail: 25 Gelston St., Buffalo, N.Y.
- MILLER, JOHN H. (A'19-M'25), Chief Electrical Engineer, Jewell Electric Instrument Company, 1646 Walnut St., Chicago, Ill. For mail: 627 N. Grove Ave., Oak Park, Ill.
- MILLER, JOHN M. (A'17-F'20), Radio Engineer, Atwater Kent Manufacturing Company, 4700 Wissahickon Ave., Philadelphia, Pa.
- MILLER, JOSEPH ANTHONY (A'29), Chief Radioman, U. S. Navy, *U.S.S. Utah*, c/o Postmaster, New York, N.Y.
- MILLER, JOSEPH J. (A'31), Sample Check Laboratory, RCA Victor Company, Inc., Camden, N.J. For mail: 5130 Locust St., Philadelphia, Pa.
- MILLER, LEONARD H. (A'26), Radio Engineer, RCA Radiotron Company, Inc., 415 S. 5th St., Harrison, N.J.
- MILLER, LOUIS (A'29), Radio Service, 1219 Home Ave., Anderson, Ind.
- MILLER, MARVIN L. (A'17), Industrial Sales, Willard Storage Battery Company,

- 500-5th Ave., New York, N.Y. For mail: 145 Lincoln Rd., Brooklyn, N.Y.
- MILLER, OLIN F., JR. (A'31), Transmission Operator, Bay State Broadcasting Company, 1-2 Winter Pl., Boston, Mass. For mail: Radio Stations WNAC and WAAB, Squantum, Quincy, Mass.
- MILLER, PAUL E. (A'29), Radio Operator, Radio Station WIBO, 6312 Broadway, Chicago, Ill. For mail: 5514 George St., Chicago, Ill.
- MILLER, ROBERT F. E. (A'31), Electrical and Radio Engineer, 1 Highfield Ter., Romsey Rd., Winchester, Hants, England.
- MILLER, R. F. (A'18), College of Emporia, Emporia, Kan.
- MILLER, S. S. (A'31), Research Products Engineering Department, Northern Electric Company, Ltd., Montreal, P.Q., Canada.
- MILLER, SAMUEL C. (A'16-M'22), Managing Director, Tube Light Engineering Company, 427 W. 42nd St., New York, N.Y.
- MILLER, WAYNE (A'29), Instruction Manager, Operating Department, Western College of Radio, 735 Larkin St., San Francisco, Calif.
- MILLER, WILLIAM T. (A'27), Radio Advertising Manager, *Christian Science Monitor*, Back Bay Station, Boston, Mass. For mail: 25 Bothfield Rd., Newton Center, Mass.
- MILLION, JOHN W., JR. (M'27), Research Engineer, Utah Radio Products Company, 1737 S. Michigan Ave., Chicago, Ill. For mail: 6926 W. 31st St., Berwyn, Ill.
- MILLS, ELMER E. (A'26), Manufacturers Representative, Elmer E. Mills and Company, 38 S. Dearborn St., Chicago, Ill.
- MILLS, GILBERT H. (A'27), Broadcast Engineer, Manitoba Telephone System, Winnipeg, Manit., Canada. For mail: 100 Lenore St., Winnipeg, Manit., Canada.
- MILLS, JOHN (M'16-F'30), Director of Publications, Bell Telephone Laboratories, Inc., 463 West St., New York, N.Y.
- MILLS, VERN D. (A'30), National Broadcasting Company, Inc., Rm. 2017, Merchandise Mart, Chicago, Ill.
- MILLS, WILLIAM F. (A'25), Engineer-in-Charge, British Broadcasting Corporation, Ltd., Swansea, Wales. For mail: Nicholas Druslyn Rd., West Cross, Swansea, Wales.
- MILLS, WILLIAM P. (A'29), Radio Testman, RCA Victor Company, Inc., Jamaica Plain, Boston, Mass. For mail: 7 Gott St., Rockport, Mass.
- MILNOR, J. WILLARD (A'16-M'26), Research Engineer, Western Union Telegraph Company, 60 Hudson St., New York, N.Y.
- MIMNO, HARRY R. (A'31), Instructor in Physics, Cruft High Tension Laboratory, Harvard University, Cambridge, Mass. For mail: 34½ Shepard St., Cambridge, Mass.
- MIMS, MORRILL P. (A'31), Proprietor, Mims Radio Shop, 404 State Line Ave., Texarkana, Ark.
- MINGAY, O. F. (A'30), Managing Editor, *The Radio Retailer of Australia*, 24 Bond St., Sydney, New South Wales, Australia. For mail: Box 3765, G.P.O., Sydney, New South Wales, Australia.
- MINGINS, CHARLES R. (A'30), Instructor, High Frequency Laboratory, Department of Physics, Rockefeller Hall, Cornell University, Ithaca, N.Y.
- MINNIUM, BYRON B. (A'25), Director of Research, Radio Division, Stewart-Warner Speedometer Corporation, 1828 Diversey Pkwy., Chicago, Ill. For mail: 1424 Greenleaf Ave., Chicago, Ill.
- MINOR, ROBERT LEE (A'29), Technician, O. K. Houck Piano Company, Little Rock, Ark. For mail: 2615 Gaines St., Little Rock, Ark.
- MINTER, ROBERT W. (A'24), c/o Majestic Electric Company, Ltd., 11 St. Andrew St., Dublin, Irish Free State.
- MINTON, JOHN P. (F'23), Consulting Engineer, 8 Church St., White Plains, N.Y.
- MIRICK, C. B. (A'15-M'29), Radio Engineer, U. S. Naval Research Laboratory, Bellevue, Anacostia, D.C. For mail: 3314 Newark St., Washington, D.C.
- MIRK, D. BLAIR (A'25), Les Laboratoires Standard, 46, Avenue de Breteuil, Paris 7^e, France.
- MISENHEIMER, HARVEY N. (A'22-M'29), Engineer, American Telephone and Telegraph Company, Rm. 1607, 195 Broadway, New York, N.Y.
- MISENHEIMER, ROBERT G. (A'29), Engineer, Radio Station WOR, 131 Market St., Newark, N.J.
- MISIEK, WILLIAM (A'31), 148 Selkirk St., Buffalo, N.Y.
- MISTERLY, FRANK S. (A'30), Assistant Patent Attorney, Radio Corporation of America, 570 Lexington Ave., New York, N.Y. For mail: 140 Broadway, Lynbrook, L.I., N.Y.
- MITA, S. (A'29), Research Staff, Vacuum Tube Department, Research Laboratory, Tokyo Electric Company, Kawasaki, Japan. For mail: 59, Hitotsubugicho, Akasakaku, Tokyo, Japan.
- MITCHELL, CLAIR D. (A'23-M'27), Commercial Engineer, RCA Radiotron Company, Inc., 415 S. 5th St., Harrison, N.J. For mail: 210 Franklin St., Bloomfield, N.J.
- MITCHELL, G. A. (A'29), 1501 E. Harry St., Wichita, Kan.
- MITCHELL, ISAAC A. (A'31), Chief Engineer, Kenyon Transformer Company, Inc., 122 Cypress Ave., New York, N.Y.
- MITCHELL, JAMES A. (A'27), Electrical Engineer, Hartford Electric Light Company, 266 Pearl St., Hartford, Conn. For mail: Box 108, Nott St., Wethersfield, Conn.
- MITCHELL, JOHN A. (A'27), Chamber of Commerce, Anderson, S.C. For mail: P.O. Box 415, Anderson, S.C.
- MITCHELL, JOHN CHARLES (A'29), Proprietor and Manager, J. C. Mitchell High Grade Radio Apparatus, 918 Morton Ave., Chester, Pa.
- MITCHELL, JOSEPH H. (A'30), Operating Engineer, Radio Station WFLA-WSUN, Clearwater, Fla.
- MITCHELL, LEONARD W. (J'27-A'29), Barrister-at-Law, Mitchell and Taglietti, 506 Northern Ontario Bldg., Toronto 2, Ont., Canada. For mail: 20 Pinewood Ave., Toronto 10, Ont., Canada.
- MITCHELL, THEODORE R. (A'27), Manager, Radio Laboratory of Wichita, 326 S. Topeka St., Wichita, Kan. For mail: 1501 E. Harry St., Wichita, Kan.
- MITCHELL, WALTER L. (A'31), 11750 Evanston Ave., Seattle, Wash.

- MITCHEM, FRED M. (A'31), 306 S. Main St., Clinton, Mo.
- MITSUISHI, HIDE KADZU (A'26), Wireless Department, Nippon Yusen Kaisha, Tokyo, Japan.
- MITSUTAKE, KATSUMI (A'28), Radio Engineer, Komuka, Teishinbu, Taihoku, Formosa, Japan.
- MITTWOL, DAVID (J'30), Serviceman, Davaga, Inc., 326 W. 25th St., New York, N.Y. For mail: 2265-85th St., Brooklyn, N.Y.
- MIYAJI, TERUI (A'31), Research Laboratory, Vacuum Tube Department, Tokyo Electric Company, Kawasaki, Japan.
- MIYAUCHI, T. (A'29), Research Staff, Vacuum Tube Department, Research Laboratory, Tokyo Electric Company, Kawasaki, Japan.
- MIZELL, M. H. (A'26), Signal Battalion, Marine Barracks, Quantico, Va.
- MIZUHASHI, TOSAKU (A'30), Radio Engineer, Japan Wireless Telegraph Company, Marunouchi, Tokyo, Japan.
- MKITARIAN, LUTHER M. (A'28), Doctor of Dental Surgery, 26th St. and Westfield Ave., Camden, N.J.
- MOATZ, DANIEL R. (A'30), Radio Engineer, Westinghouse Electric and Manufacturing Company, Chicopee Falls, Mass.
- MOCKFORD, FREDERICK S. (A'19), Marconi's Wireless Telegraph Company, Ltd., Marconi House, Strand, London, W.C. 2, England. For mail: Kleinhuus, Burntwood Lane, Caterham-on-Hill, Surrey, England.
- MODRAK, PETER (A'23), Chief Engineer, State Telegraph and Telephone Works, Grochowska 30, Warsaw, Poland.
- MOEDER, WILLIAM D. (A'30), Instructor, College of Electrical Engineering, Cornell University, Ithaca, N.Y.
- MOERSHFELDER, HERBERT L. (A'31), General Sales Manager, Spaulding Fibre Company, Inc., Tonawanda, N.Y. For mail: 310 Wheeler St., Tonawanda, N.Y.
- MOFFET, LE ROY, JR. (A'29), 4343 Highland St., Downers Grove, Ill.
- MÖGEL, HANS I. (M'30), Oberpost Direction Berlin, Deutsche Reichspost, Berlin, Germany. For mail: Auguste Victoria Str. 16, Potsdam, Germany.
- MOGRIDGE, J. NAIRN (A'27), Chief Engineer, Radio Station CKPC, Preston, Ont., Canada. For mail: 54 Cambridge St., Galt, Ont., Canada.
- MOHAMMED, A. (A'31), Student, Electrical Communication, India Institute of Science, Bangalore, India.
- MOHLER, J. L. (A'31), Field Engineer, RCA Victor Company, Inc., Camden, N.J. For mail: 1816 N. Van Ness Ave., Hollywood, Calif.
- MOISES, GEORGE S. (A'31), Radio Service Manager, Golden Rule Radio, 563 W. 145th St., New York, N.Y. For mail: 600 W. 138th St., New York, N.Y.
- MOLER, A. R. (A'25), Chief Engineer, Midland Broadcasting Company, Kansas City, Mo. For mail: 1326 Kensington, Independence, Mo.
- MOLES, FRANK J. (A'29), Electrical Engineer, General Electric Company, Schenectady, N.Y. For mail: 129 Country Club Dr., R.F.D. No. 1, Schenectady, N.Y.
- MOLONY, JOHN D. (J'20-A'22), Switchman, Illinois Bell Telephone Company, 725 Madison St., Gary, Ind. For mail: 3853 Delaware St., Gary, Ind.
- MOLZEN, CHARLES F. (A'26), Dejur-Amsco Corporation, 95 Morton St., New York, N.Y.
- MOMMO, ERNEST J. (A'22), 11 Hennessy Pl., Irvington, N.J.
- MOMOTSUKA, K. (A'31), Engineer, Nagoya Broadcasting Station, Okehazama Hosojo, Arimatsucho Aichiken, Japan.
- MONTAGNES, HENRY (J'26-A'28), c/o Northern Electric Company, Ltd., 43-45 King William St., Hamilton, Ont., Canada.
- MONTCALM, S. R. (A'13-M'28), Radio Engineer, International Communications Laboratories, Inc., 200 Mount Pleasant Ave., Newark, N.J.
- MONTEITH, J. W. (A'30), Radio Technician, Parks and Hull, 1031 Cathedral St., Baltimore, Md. For mail: Linthicum Heights, Md.
- MONTGOMERY, A. PEERS (A'28), Engineer, A. H. Grebe and Company, 70 Van Wyck Blvd., Richmond Hill, L.I., N.Y. For mail: 118 Audley St., Kew Gardens, L.I., N.Y.
- MONTGOMERY, ALEXANDER W. (M'31), Telephone Engineer, International Telephone and Telegraph Laboratories, The Hyde, Hendon, London, England. For mail: 29, The Gardens, Vaughan Rd., Harrow, Middlesex, England.
- MONTGOMERY, J. LEONARD (A'31), Engineer, Pilot Radio and Tube Corporation, Lawrence, Mass. For mail: Box 146, Lawrence, Mass.
- MONTGOMERY, L. H., JR. (A'27), Chief Operator, WSM Broadcasting Station, National Life and Accident Insurance Company, Nashville, Tenn.
- MONTGOMERY, PHILIP (A'27), Aetna Fire Insurance Company, Hartford, Conn. For mail: 80 Outlook Ave., West Hartford, Conn.
- MONTGOMERY, WILLIAM C., JR. (A'30), Associate Engineer, Radio Station WSM, Union and 7th Sts., Nashville, Tenn.
- MOONEY, RAYMOND (A'27), Manager, Special Products Department, The Hammond Clock Company, 2911 N. Western Ave., Chicago, Ill. For mail: 769 Foxdale Ave., Winnetka, Ill.
- MOORE, ADAM H. (A'29), Junior Physicist, U. S. Naval Research Laboratory, Bellevue, Anacostia, D.C.
- MOORE, ERIC J. T. (M'27), c/o Royal Empire Society, Northumberland Ave., London W.C. 2, England.
- MOORE, EUGENE A. (A'27), Engineering Department, Fred W. Stein Radio Company, Atchison, Kan. For mail: 324 Santa Fe St., Atchison, Kan.
- MOORE, FRANK C. (A'27), Radio Supervisor, Inland Waterways Corporation, 320 Magazine St., New Orleans, La. For mail: 2805 Pine St., New Orleans, La.
- MOORE, GEORGE E. (A'31), Vacuum Tube Development, Department 327-D, Bell Telephone Laboratories, Inc., 463 West St., New York, N.Y.
- MOORE, HENRY H. (A'26), Manager, Federated Purchaser, 51 E. 3rd St., Mount Vernon, N.Y. For mail: 180 Lenox Rd., Brooklyn, N.Y.
- MOORE, J. BURTON (A'26), Superintendent of Radio, Wyandotte and Huron Transporta-

- tion Company, Wyandotte, Mich. For mail: 1113 Park Ave., Lincoln Park, Mich.
- MOORE, JAMES S. (A'29), Radio Technician, Lyon and Healy, Inc., 243 S. Wabash Ave., Chicago, Ill. For mail: 2416 Bryn Mawr Ave., Chicago, Ill.
- MOORE, JOHN B. (A'26), c/o R.C.A. Communications, Koko Head, Oahu, Hawaii.
- MOORE, JOHN T. (A'28), Radio Engineer, John Mills Sons, 63 Grainger St. W., Newcastle-on-Tyne, England. For mail: 23 Claremont Rd., Newcastle-on-Tyne, England.
- MOORE, RAYMOND C. (A'26), Ramor Studios, Long Beach, Calif. For mail: 907 Obispo Ave., Long Beach, Calif.
- MOORE, RAYMOND M. (A'23), Radio Technician, Earl C. Anthony, Inc., Radio Station KFI, 1000 Hope St., Los Angeles, Calif. For mail: 1627 N. Alvarado St., Los Angeles, Calif.
- MOORE, ROBERT M. (A'31), Transmission Engineer, Southern California Telephone Company, 740 S. Olive St., Los Angeles, Calif. For mail: 935 Palm Ter., Pasadena, Calif.
- MOORE, THOMAS H. (A'29), Service Engineer, P.O. Box 491, Charleston, W. Va.
- MOORE, WILLIAM H. (J'27-A'28), Radio Engineer, Canadian Marconi Company, Ltd., Montreal, P.Q., Canada. For mail: 400 Grosvenor Ave., Westmount, P.Q., Canada.
- MOORE, WILLIAM P. (A'27), Engineer-in-Charge, Broadcasting Station WDAE, Tampa Terrace Hotel, Tampa, Fla. For mail: 339 Platt Ave., Tampa, Fla.
- MOORHEAD, GEORGE H. (A'26), Supervising Radioman, Transpacific Communication Company, Ltd., 15 Dey St., New York, N.Y. For mail: Inverness, Calif.
- MORAN, H. G. (A'30), Lieutenant, U. S. Navy, U.S.S. Houston, c/o Postmaster, New York, N.Y.
- MORE, CLIFTON C. (A'29), Radio Engineer, RCA Victor Company, Inc., Camden, N.J. For mail: 609 W. Maple Ave., Merchantville, N.J.
- MORECROFT, J. H. (A'13-F'22), Professor, Department of Electrical Engineering, Columbia University, New York, N.Y. For mail: Linden Ave., Fontana, Calif.
- MOREE, W. (A'20), Kon. Inst. V.D. Marine, Den Helder, Holland.
- MOREHOUSE, T. B. (A'27), Patent Attorney, Pennie, Davis, Marvin and Edmonds, 165 Broadway, New York, N.Y. For mail: c/o Hazeltine Service Corporation, 333 W. 52nd St., New York, N.Y.
- MOREY, W. J. (A'28), Chief Engineer, All-American Radio Corporation, 4201 Belmont Ave., Chicago, Ill. For mail: 545 N. Central Ave., Chicago, Ill.
- MORGAN, BEN A. (A'31), Manager, Radio Division, The Tracy-Wells Company, 175 N. Front St., Columbus, Ohio.
- MORGAN, HOWARD K. (A'27), Radio Engineer, Pilot Radio and Tube Company, Lawrence, Mass. For mail: 56 Balmoral St., Shawsheen Village, Andover, Mass.
- MORGAN, JOHN T. (A'22), Secretary and Sales Manager, Charleston Electric Supply Company, Charleston, W. Va.
- MORI, NOBUMITSU (A'30), Engineer, Sending Station JO1K, Tsukisappu, Sapporo City, Hokkaido, Japan.
- MORIARTY, JAMES F. (M'30), Captain, Headquarters, U. S. Marine Corps, Washington, D.C.
- MORISON, BRUCE (A'29), Radio Engineer and Salesman, Messrs. Hubert Davies and Company, Ltd., P.O. Box 34, Salisbury, Southern Rhodesia, South Africa.
- MORITA, K. (A'29), Wireless Engineer, Kumamoto Broadcasting Station JOGK, Shimizu-Mura, near Kumamoto, Japan.
- MORITA, M. (A'30), Engineer, Japan Wireless Telegraph Company, Jiji Bldg., Yaesu-Machi, Kojimachiku, Tokyo, Japan. For mail: 18-2-chome, Marunouchi, Tokyo, Japan.
- MORIWAKI, KATSUMI (A'25), Yoshimura and Company, 53 Saichji-Machi, Shiva-Ku, Tokyo, Japan.
- MORRIS, ALFRED (A'31), Engineer, Radio Section, Engineer-in-Chief's Office, G.P.O., Alder House, Aldersgate St., London, E.C. 1, England.
- MORRIS, CARLETON D. (A'25-M'27), Vice President, Michigan Wireless Telegraph Company, Wyandotte, Mich. For mail: 1916 Tribune Tower, Chicago, Ill.
- MORRIS, GEORGE W. (A'19), Captain, Signal Corps, The Armory, 32nd and Lancaster Aves., Philadelphia, Pa.
- MORRIS, HEDLEY B. (A'28), Engineer-in-Charge, R.C.A. Communications, Inc., Riverhead, L.I., N.Y.
- MORRIS, JAMES E. (A'30), Radio Engineer, C-R Radio Corporation, 10 W. Republican St., Seattle, Wash.
- MORRIS, JAMES M. (A'28), Teaching Fellow in Physics, Oregon State College, 211 N. 16th St., Corvallis, Ore.
- MORRIS, JOHN F. (A'27), Studio Engineer, National Broadcasting Company, Inc., Merchandise Mart, Chicago, Ill. For mail: 537 Deming Pl., Chicago, Ill.
- MORRIS, LEON A. (A'28), 54 S. Oxford St., Brooklyn, N.Y.
- MORRIS, LLOYD P. (A'27), Special Research Assistant, Electrical Engineering Staff, University of Illinois, Urbana, Ill. For mail: 606 W. Elm St., Urbana, Ill.
- MORRIS, R. P. (A'30), Engineering Branch, Department of Posts and Telegraphs, Northern Rhodesia, South Africa. For mail: Post Office, Broken Hill, Northern Rhodesia, South Africa.
- MORRIS, ROBERT (A'26), Marine Radio Operator, Union Castle Mail S. S. Co., Ltd., Fenchurch St., London, England. For mail: S. View, Stag Rd., Sandown, Isle of Wight, England.
- MORRIS, ROBERT M. (A'26), Development Engineer, National Broadcasting Company, Inc., 711-5th Ave., New York, N.Y. For mail: 22 Mountain View Rd., Millburn, N.J.
- MORRIS, ROBERT S. (A'28), General Manager, Radio Station WSOC, Gastonia, N.C. For mail: 4138 S. Broad St., Gastonia, N.C.
- MORRIS, THOMAS J. (A'30), Radio Engineer, Knapp and Spencer Company, Sioux City, Iowa. For mail: 2202 S. Olive St., Sioux City, Iowa.
- MORRISON, COLIN W. (J'31), Clerical Cadet, Chief Engineer's Office, New Zealand Railways, Wellington, New Zealand. For mail: 27 Monro St., Seatoun, Wellington, New Zealand.
- MORRISON, E. J. W. (A'30), Laboratory, General Radio Company, 30 State St., Cam-

- bridge, Mass. For mail: 64 Spring Ave., Arlington, Mass.
- MORRISON, G. K. (A'30), Engineer, Federal Telegraph Company, 200 Mount Pleasant Ave., Newark, N.J.
- MORRISON, HOWARD (A'29), Member of Technical Staff, Bell Telephone Laboratories, Inc., 180 Varick St., New York, N.Y. For mail: 661 Lincoln Ave., Orange, N.J.
- MORRISON, JOHN F. (A'29), Technical Staff, Bell Telephone Laboratories, Inc., 463 West St., New York, N.Y. For mail: 153 Overlook Ave., Boonton, N.J.
- MORRISON, MONTFORD (M'19), Westinghouse X-Ray Company, Inc., 21-16-43rd Ave., Long Island City, L.I., N.Y.
- MORRISON, R. J. (A'30), 504 Union St., Hudson, N.Y.
- MORROW, LORENTZ A. (A'29), Representative, Penn Mutual Life Insurance Company, Springfield, Ohio. For mail: 218 Forest Ave., Springfield, Ohio.
- MORSE, ARTHUR H. (M'19), Erewhon Farm, P.O. Box 547, Monroe, N.Y.
- MORTON, ALFRED H. (M'28), European Manager, Radio Corporation of America, 156 Rue de L'Universite, Paris, France.
- MORTON, CLARENCE F. (A'28), Radio Service, 31 Princeton St., Lowell, Mass.
- MORTON, HOWARD J. (J'30), Equipment Man, Bell Telephone Company of Canada, Toll Office, Oshawa, Ont., Canada.
- MOSER, WILLIAM E. (A'31), Manager, Mackay Radio and Telegraph Company, Inc., Mackay Radio Station, Sayville, L.I., N.Y. For mail: P.O. Box 189, Sayville, L.I., N.Y.
- MOSES, JOHN P. (A'30), Radio Operations Department, Radio Station WBZ, Westinghouse Electric and Manufacturing Company, Bradford Hotel, Boston, Mass. For mail: 115 Newbury Ave., Atlantic, Mass.
- MOSS, STANLEY A. (A'30), Trouble Shooter, Philadelphia Storage Battery Company, Philadelphia, Pa. For mail: 2651 S. Fairhill St., Philadelphia, Pa.
- MOSS, TERRY L. (A'29), Teacher, Science and Mathematics, Cuba Schools, Cuba, Mo. For mail: Box 43, Cuba, Mo.
- MOTT, HAROLD E. (A'22), Manager and Chief Engineer, Engineering and Production Department, Rogers-Majestic Corporation, Ltd., Fleet St., Toronto, Ont., Canada.
- MOULDEN, ROY B. (A'27), Proprietor, Moulden's Radio Store, 108 W. Northcentral Ave., Tuscola, Ill.
- MOULLIN, E. B. (M'27), Engineering Laboratory, Oxford University, Parks Rd., Oxford, England.
- MOULTON, THEODORE S. (A'29), Accountant, American Paint and Varnish Manufacturers Association, Inc., 2201 New York Ave., N.W., Washington, D.C. For mail: 2115 Pennsylvania Ave., N.W., Washington, D.C.
- MOULTRIE, FRANK C. (A'30), Radio Engineer and Power-Transformer Winder, 37 Nasmith St., Toronto, Ont., Canada.
- MOURADIAN, H. (A'16), Toll Fundamental Engineer, Bell Telephone Company of Pennsylvania, 1835 Arch St., Philadelphia, Pa.
- MOUTOUX, EDWIN G. (A'31), Radio Operator, Bradley Transportation Company, Rogers City, Mich. For mail: 24 W. Louisiana St., Evansville, Ind.
- MOWRY, CHARLES E. (A'30), Technical Consultant, Evans and Bruce, 610-617 Crocker Bldg., San Francisco, Calif. For mail: 376-7th Ave., San Francisco, Calif.
- MOXON, ALFRED W. (A'27), Consulting Engineer, Panama Corporation, Ltd., Panama, Panama. For mail: 93½ Adams St., Rochester, N.Y.
- MUELLER, EUGENE L. (A'27), 8012 Kimbark Ave., Chicago, Ill.
- MUIRHEAD, JOHN E. (A'28), Engineer, Sanderson and Porter, 33 N. La Salle St., Chicago, Ill.
- MULHOLLAND, WILLIAM (A'29), Chief Electrician, Vickers-Armstrongs, Ltd., Powder Mill Lane, Dartford, Kent, England.
- MULKEY, DWIGHT L. (A'31), Lieutenant, Signal Corps Laboratory, Army War College, Washington, D.C.
- MULLANEY, DUDLEY A. (A'24), Vacuum Tube Engineer, General Electric Company, Schenectady, N.Y. For mail: 1633 Rugby Rd., Schenectady, N.Y.
- MULLANEY, HAROLD F. (A'30), Port Townsend, Wash.
- MULLANEY, JOHN R. (A'30), Radio Service Manager, 213 Exchange St., Bangor, Maine. For mail: 64 Ohio St., Bangor, Maine.
- MULLEN, JAMES F. (A'31), Proprietor, Radio Service, 679 Franklin Ave., Brooklyn, N.Y.
- MULLEN, JOSEPH A. (A'26), Engineering Division, Raytheon Manufacturing Company, Cambridge, Mass. For mail: 16 Mercier St., Ashmont, Mass.
- MULLEN, JOSEPH G. (A'30-M'30), General Manager, Brunswick Radio of Canada, Ltd., Hanna Ave., Toronto, Ont., Canada.
- MULLER, CARL W. (A'30), Radio Instructor, U. S. Air Corps, 46th Squadron, Randolph Field, Tex.
- MULLER, FRED (M'30), Marine Radio Superintendent, Tropical Radio Telegraph Company, Pier 3, North River, New York.
- MULLER, JOHN H. (A'30), Engineer-in-Charge, R.C.A. Communications, Inc., Kahuku, Oahu, Hawaii.
- MULLER, P. H. (A'30), Radio Operator, Radio Department, Dollar Steamship Company, Honolulu, Hawaii.
- MULLIN, JAMES W. (A'15-M'22), Engineer, Marconi Station, Drummondville, P.Q., Canada.
- MULLIN, LE ROY (A'31), Instructor, Department of Electrical Engineering, Syracuse University, Syracuse, N.Y. For mail: 253 Roosevelt Ave., Syracuse, N.Y.
- MUMFORD, ALBERT H. (A'28), Radio Section, P. O. Research Station, Dollis Hill, London, England. For mail: 27 Grendon Gardens, Wembley Park, Middlesex, England.
- MUMFORD, WILLIAM W. (A'30), Member of Technical Staff, Bell Telephone Laboratories, Inc., Holmdel, N.J. For mail: Box 107, Red Bank, N.J.
- MUMMA, ROBERT E. (A'31), Radio Designer, Electrical Test Department, General Motors Radio Corporation, Dayton, Ohio. For mail: 1615 Roosevelt St., Dayton, Ohio.
- MUMMERT, RUSSELL E. (J'27-A'30), Service Engineer, General Auto Supply Company, 124 S. Cameron St., Harrisburg, Pa. For mail: 307 Lewis St., Harrisburg, Pa.

- MUNDIE, EVAN M. (J'30), Tester, Westinghouse Electric and Manufacturing Company, Chicopee Falls, Mass. For mail: 152 Main St., Chicopee Falls, Mass.
- MUNRO, GEORGE H. (A'30), Radio Research Board, Melbourne University, Melbourne, N. 3, Victoria, Australia.
- MUNTON, JOHN D. (A'31), Manager, Communication Department, Atlantic Refining Company, 260 S. Broad St., Philadelphia, Pa.
- MUNZER, LOUIS F. (A'31), Engineer, R.C.A. Communications, Inc., Tuckerton, N.J. For mail: 133 E. Main St., Tuckerton, N.J.
- MURAI, FRED H. (J'30-A'32), Radiotrician, Nylan Brothers and Company, Ltd., 230 Merchants St., Honolulu, Hawaii. For mail: c/o J. T. MacIntyre, P.O. Box 2390, Honolulu, Hawaii.
- MURCEK, S. J. (J'31), Student, Bliss Electrical School, Box 172, Takoma Park, Washington, D.C. For mail: 312 Viola Ave., Duquesne, Pa.
- MURCHIE, JOHN (M'27), Manager, Wireless Department, James Watt Memorial College, Greenock, Scotland.
- MURDOCH, G. (A'29), Service Manager, Fletcher Brothers (Victoria), Ltd., 1110 Douglas St., Victoria, B.C., Canada. For mail: 1518 Cook St., Victoria, B.C., Canada.
- MURPHY, FRANK (A'29), Managing Director, Murphy Radio, Ltd., Broadwater Rd., Welwyn Garden City, Herts, England.
- MURPHY, WILLIAM H. (M'25), Research and Engineering Division, Office Chief Signal Officer, War Department, Washington, D.C. For mail: 1918 Park Rd. N.W., Washington, D.C.
- MURRAY, ALBERT F. (A'20-M'26), Division Engineer, Research Division, RCA Victor Company, Inc., Camden, N.J. For mail: Haddonfield Manor, Haddonfield, N.J.
- MURRAY, ALEXANDER H. (A'29), Radio Interference Fieldman, Duquesne Light Company, 435-6th Ave., Pittsburgh, Pa. For mail: 3810 Pier St., Pittsburgh, Pa.
- MURRAY, CHARLES J. (A'28), Rate Clerk, Pennsylvania Freight Office, Dover, Ohio. For mail: 252-2nd St., N.W., New Philadelphia, Ohio.
- MURRAY, HENRY (A'31), Radio Retailing and Service, Arlington, Wash.
- MURRAY, JOHN W. (A'30), Radio Telephone Operator, R.M.S. Olympic, c/o White Star Line, 1 Broadway, New York, N.Y. For mail: "The Shieling," Beech Rd., Headington, Oxford, England.
- MURRAY, ROBERT W. (A'30), Radio Technician, Station KHJ, Don Lee, Inc., 1076 W. 7th St., Los Angeles, Calif. For mail: 2404 Sylvan Lane, Glendale, Calif.
- MURRAY, WILLIAM A. (A'20), Associate Professor of Electrical Engineering, Michigan State College, East Lansing, Mich.
- MURRI, JOSEPH (A'27), Engineering Department, Philadelphia Storage Battery Company, Ontario and C Sts., Philadelphia, Pa. For mail: 3933 N. 7th St., Philadelphia, Pa.
- MUSCARI, PIETRO J. C. (A'28), Research Engineer, Radio Research Laboratory, Marietta, Ohio. For mail: 207 Curtis Ter., Marietta, Ohio.
- MUSTCHIN, NORMAN (A'29), Radio Sales and Service Engineer, Louis Hourell House of Radio, Victoria Rd., Swindon, England. For mail: 32 Prospect Hill, Swindon, Wilts, England.
- MUSTERMANN, H. G. A. (A'27), Engineer, Coldak Corporation, New York, N.Y. For mail: 8 Paulin Blvd., Leonia, N.J.
- MUTCH, W. W. (A'27-M'31), Research Engineer, Bell Telephone Laboratories, Inc., Holmdel, N.J. For mail: P.O. Box 107, Red Bank, N.J.
- MYERS, DELBERT (A'29), Serviceman, Clyde Julian and Son, Radio and Electric Company, Sweetser, Ind. For mail: P.O. Box 132, Sweetser, Ind.
- MYERS, GEORGE T. (A'28), Radio Engineer, British Broadcasting Corporation, Savoy Hill, London, England. For mail: "Parana," Elmbridge Rd., Wotton, Gloucester, England.
- MYERS, GILBERT B. (A'27), Lieutenant, U. S. Navy, Naval War College, Newport, R.I.
- MYERS, JAMES A. (A'29), Service Engineer, Ford-Myers Radio Service, 212 W. Capitol St., Jackson, Miss. For mail: 944 W. Capitol St., Jackson, Miss.
- MYERS, THEOBALD (A'29), Engineer, National Broadcasting Company, Inc., 711-5th Ave., New York, N.Y. For mail: 2740 Marion Ave., New York, N.Y.
- MYERS, WILLARD D. (A'28), Installation Engineer, Electrical Research Products, Inc., 250 W. 57th St., New York, N.Y. For mail: Greentown, Ohio.
- MYERS, WILLIAM H. (A'30), Engineer, Crosley Radio Corporation, Cincinnati, Ohio. For mail: 457 Riddle Rd., Cincinnati, Ohio.
- N
- NADIG, STANTON E. (A'27), Marine Estimator, Sun Shipbuilding Company, Chester, Pa. For mail: 742 Hanover Ave., Allentown, Pa.
- NAFZGER, LESTER H. (J'30), Chief Engineer, Radio Stations WAIU-WCAH, Columbus, Ohio. For mail: R.R. No. 1, Box 9-A, Westerville, Ohio.
- NAGAI, KENZO (A'29), Assistant Professor, Electrical Engineering Department, Tohoku Imperial University, Sendai, Japan. For mail: No. 52, Kita-2-bancho, Sendai, Japan.
- NAGAMURA, S. (A'31), Radio Engineer, Kanazawa Broadcasting Station JOJK, Kanazawa City, Ishikawaken, Japan.
- NAGAO, R. (A'29), Research Staff, Research Laboratory, Tokyo Electric Company, Kawasaki, Kamagawa-Ken, Japan.
- NAGASAKI, K. (A'31), Engineer, Broadcasting Station, Shimizu-Hosojio, near Kumamoto, Japan.
- NAGASE, HARUTOSHI (A'28), c/o Okura and Company, 53 New Broad St., London, E.C. 2, England.
- NAGATA, CHARLES N. (A'27), Partner, Valley Battery Company, Auburn, Wash. For mail: P.O. Box 815, Auburn, Wash.
- NAGOSHI, M. (A'30), Electrical Engineer, Japan Wireless Telegraph Company, Jiji Bldg., Marunouchi, Japan.
- NAGY, A. WHEELER (J'26-A'27), 319 Chauncey St., Astoria, L.I., N.Y.
- NAIMARK, BORIS S. (A'26), Free Lance Writer, 644 Riverside Dr., New York, N.Y.
- NAIR, W. EARL (A'30), Auto Mechanic and Electrician, District Motor Company, 1337-

- 14th St., N.W., Washington, D.C. For mail: 3919-1st St., S.E., Washington, D.C.
- NAKAGAMI, MINORU** (A'30), Radio Engineer, Japan Wireless Telegraph Company, Marunouchi, Tokyo, Japan.
- NAKAGAMI, T.** (M'20), Chief Radio Engineer, Direction General of Communication Engineering, Department of Communications, Tokyo, Japan. For mail: Sumiyosi 4, Nakano, Tokyo-fu, Japan.
- NAKAI, TOMOZO** (A'29), Research Engineer, Electrotechnical Laboratory, Ministry of Communications, Osaki-Machi, near Tokyo, Japan. For mail: Teishinsho Denki Shikenjo, Osaki-Machi, near Tokyo, Japan.
- NAKAJIMA, S.** (A'29), Radio Engineer, Naval Research Laboratory, Imperial Research Laboratory, Tokyo, Japan. For mail: 1512 Himonya, Hibusuma-Machi, Ebara-gun, Tokyo-fu, Japan.
- NAKAMURA, T.** (M'29), Commander, Imperial Japanese Navy, Inspector's Office, No. 1, Madison Ave., New York, N.Y.
- NALLY, EDWARD J.** (A'14), "Southwick," P.O. Box 19, Naponoch, N.Y.
- NAMBA, SHOHO** (A'29), Research Engineer, Electrotechnical Laboratory, Ministry of Communications, Osaki-Machi, near Tokyo, Japan. For mail: Teishinsho Denki Shikenjo, Osaki-Machi, near Tokyo, Japan.
- NAMBA, YASUKAZU** (A'25), Radio Engineer, Electrotechnical Laboratory, Denki-Shikenho, 4bu, Shimo-Osaki, Ebaragun, Tokyo, Japan. For mail: 15 Sakuragawacho, Shiba, Tokyo, Japan.
- NANCARROW, F. E.** (M'22), Engineer-in-Chief's Office, G.P.O., London, England. For mail: 72 Chambers Lane, London, N.W. 10, England.
- NANCE, CURTIS H.** (A'22-M'23), Manager, Radio Corporation of America, Pacific Bldg., Manila, Philippine Islands.
- NANGLE, W. O.** (A'25), Telephone and Telegraph Engineer, U. S. Signal Corps, Langley Field, Va. For mail: 922 Ontario St., Oak Park, Ill.
- NAPPER, CHARLES J.** (A'30), Radio Serviceman, Frank and Murry Company, 307-3rd St., S., St. Petersburg, Fla. For mail: 2435-1st Ave., S., St. Petersburg, Fla.
- NARDONE, AUGUST J.** (A'31), 7001-10th Ave., Brooklyn, N.Y.
- NATHNESS, SEMORE T.** (A'29), Proprietor, Nathness Radio Service, Menomonie, Wis. For mail: 320-13th Ave., W., Menomonie, Wis.
- NAUTH, EDGAR K.** (A'30), Radio Draftsman, King Manufacturing Company, 254 Rano St., Buffalo, N.Y. For mail: 656 La Salle Ave., Buffalo, N.Y.
- NAUTH, G. RAYMOND** (A'28), Manager, Radio Broadcast Division, British Empire Trade Commission, 158 Bay St., Toronto, Ont., Canada. For mail: 145 Glendenan Ave., Toronto, Ont., Canada.
- NEAL, GEORGE F.** (A'31), Engineer, RCA Victor Company, Inc., Camden, N.J. For mail: 165 Kendall Blvd., Oaklyn, N.J.
- NECKER, E. J.** (A'31), Radio Operator, Mackay Radio and Telegraph Company, Inc., 20 Broad St., New York, N.Y. For mail: 109-42 Lefferts Blvd., Ozone Park, L.I., N.Y.
- NEE, SANGTA** (A'25), Physics Department, National Central University, Nanking, China.
- NEELANDS, FREDERICK J.** (A'31), c/o Heintz and Kaufman, San Francisco, Calif. For mail: 4411 W. Juncau St., Seattle, Wash.
- NEELY, GUY MORTON** (A'30), Lieutenant, U.S.S. *Northampton*, c/o Postmaster, New York, N.Y.
- NEELY, NORMAN B.** (A'31), Chief Engineer, J. S. Cole—Radio Enterprises, 949 S. Flower St., Los Angeles, Calif. For mail: 1576 N. Avenue 47, Los Angeles, Calif.
- NEILL, FRANK R.** (A'27), Chartered Accountant, Jackson, McCann and Company, 37 Donegall Pl., Belfast, Ireland. For mail: "Chesterfield," Whitehead, County Antrim, Ireland.
- NEILSON, N. SMITH** (A'30), Student Engineer, General Motors Radio Corporation, Dayton, Ohio. For mail: 224 Lexington Ave., Dayton, Ohio.
- NEIMO, PETER J.** (A'30), Lieutenant, U. S. Navy, Communication Officer, U.S.S. *Destroyer Litchfield*, San Diego, Calif.
- NEIN, HARRY R.** (A'25), Engineer, American Telephone and Telegraph Company, 195 Broadway, New York, N.Y.
- NELMA, ARSENE** (A'29), Radiotrician, 845 Barrington St., Halifax, N.S., Canada.
- NELSON, C. L.** (A'30), Sound Projectionist, R. and R. Gulf Amusement Company, Corpus Christi, Tex. For mail: 1638-13th St., Corpus Christi, Tex.
- NELSON, CRESCENT F.** (M'31), General Electrician, Ocean Cables, Western Union Telegraph Company, Rm. 1724, 60 Hudson St., New York, N.Y.
- NELSON, EDWARD L.** (A'19-M'25), Radio Development Engineer, Bell Telephone Laboratories, Inc., 463 West St., New York, N.Y.
- NELSON, JAMES R.** (A'27-M'29), Radio Engineer, Raytheon Manufacturing Company, Newton, Mass.
- NELSON, ORRIN B.** (A'28), Radio Operator, Radio Station WTAQ, Eau Claire, Wis. For mail: P.O. Box 93, Eau Claire, Wis.
- NELSON, PARKER C.** (A'31), Assistant to Vice President, International Standard Electric Corporation, 67 Broad St., New York, N.Y.
- NELSON, PAUL H.** (A'31), Radio Engineer, Box 448, Wenatchee, Wash.
- NELSON, R. G.** (A'29), Service Engineer, RCA Photophone, Inc., New York, N.Y. For mail: Box 363, Cambridge, Ohio.
- NELSON, WALTER H.** (A'31), Radio Engineer, General Electric Company, Schenectady, N.Y. For mail: 1011 Union St., Schenectady, N.Y.
- NERGAARD, LEON S.** (A'29), Teaching Assistant, Physics Department, University of Minnesota, Minneapolis, Minn.
- NERHOOD, H. ELMER** (A'30), Proprietor, Nerhood Radio Company, 146 N. Howard St., Akron, Ohio. For mail: 580 Blanche St., Akron, Ohio.
- NESS, DELMER N.** (A'30), Radio Service Work, P.O. Box 466, Fairhope, Ala.
- NESTLERODE, BOYD W.** (A'20), Batterymen, Lutz Motor Company, Chicago and Jackson Aves., Freeport, Ill. For mail: 309 Walnut Ave., Freeport, Ill.
- NEUBAUER, EDWIN WILLIAM** (A'29), Supervising Engineer, Campbell-Norquist and Company, 427 Morrison St., Portland, Ore. For mail: 1344 E. Davis St., Portland, Ore.

- NEUERT, H. L.** (A'30), Technical Inspector, Electrical Research Products, Inc., 724 Union Trust Bldg., Cleveland, Ohio.
- NEVE, GORDON H.** (A'25), Australian General Electric Company, Ltd., G.P.O., Box 538F, Melbourne, Australia.
- NEVILLE, T. P.** (A'28), Patent Attorney, 463 West St., New York, N.Y.
- NEWBOLD, W. H.** (A'28), Advanced T.R.F. Development, RCA Victor Company, Inc., Camden, N.J. For mail: R.F.D. No. 1, Langhorne, Pa.
- NEWBY, RAYMOND W.** (A'27), Chief Engineer, Radio Station WABC-W2XE, Wayne, N.J. For mail: Box 312, Pompton Plains, N.J.
- NEWCOMB, ROBERT** (A'30), Sales and Technical Service, Radio Supply Company, 912-14 S. Broadway, Los Angeles, Calif. For mail: 824 Maltman St., Los Angeles, Calif.
- NEWCOMBE, JACK** (A'30), Radio Field Adjuster, John Wanamaker, 784 Broadway, New York, N.Y. For mail: 111 Grand Ave., Brooklyn, N.Y.
- NEWELL, GUY** (A'28), Radio Dispatcher, American Airways, Newark Airport, Newark, N.J. For mail: 1131 Hand Pl., Elizabeth, N.J.
- NEWELL, HOBART H.** (A'22-M'30), Assistant Professor, Experimental Electrical Engineering, Worcester Polytechnic Institute, Worcester, Mass.
- NEWHARD, STANLEY C.** (A'29), Proprietor, Radio Sales and Service, 639 Main St., Slatington, Pa.
- NEWHOUSE, RUSSELL C.** (A'30), Aircraft Radio Transmitter Development, Bell Telephone Laboratories, Inc., 463 West St., New York, N.Y. For mail: 33 Sidney Pl., Brooklyn, N.Y.
- NEWLAND, CHARLES W.** (A'30), Proprietor, East Grand Rapids Radio Shop, 2234 Wealthy St., S.E., Grand Rapids, Mich. For mail: 661 Crowell Ave., S.E., Grand Rapids, Mich.
- NEWMAN, DAVID H.** (M'28), Electrical Research Products, Inc., 7046 Hollywood Blvd., Hollywood, Calif.
- NEWMAN, JOHN R.** (A'28), Custom Set Builder, Silver-Marshall and Hammarlund-Roberts Service Station, P.O. Box 1827, Timmins, Ont., Canada.
- NEWMAN, JOSEPH S.** (A'20), President, Newman-Stern Company, E. 12th St., at Walnut Ave., Cleveland, Ohio.
- NEWMAN, WILMUR C.** (A'31), Service Manager, Motor Equipment Company, 214 W. Douglas, Wichita, Kan. For mail: 423 S. Estelle, Wichita, Kan.
- NEWNHAM, LEONARD E.** (A'27), Master and Lecturer, Stamshaw School and Municipal College, Portsmouth, England. For mail: St. Malo, 18 Baffins Rd., Copnor, Portsmouth, England.
- NEWTON, RAYMOND A.** (A'29), Vacuum Tube Engineer, Bldg. 37, General Electric Company, Schenectady, N.Y.
- NEWTON, WILLIAM E.** (A'31), Serviceman, Monroe Radio Company, 733 Monroe Ave., Rochester, N.Y. For mail: 158 S. Clinton, Rochester, N.Y.
- NEWTON, W. W.** (A'31), Electrical Engineering Student, Massachusetts Institute of Technology, Cambridge, Mass. For mail: 30 Trapelo Rd., Belmont, Mass.
- NICELY, RALPH N.** (A'22), General Commercial Engineer, Long Lines Department, American Telephone and Telegraph Company, 15 Dey St., New York, N.Y.
- NICHOLAS, W. H.** (A'30), Assistant Engineer, G.P.O., South Africa, Box 1077, Johannesburg, South Africa.
- NICHOLIDES, E.** (I'27-A'30), Laboratory Assistant, American Phonograph Corporation, 19 W. 44th St., New York, N.Y. For mail: 441 E. 161st St., New York, N.Y.
- NICHOLS, DWIGHT O.** (A'30), Chief Engineer, Sound Projection Company, 366 E. 63rd St., Chicago, Ill. For mail: 7358 S. Union Ave., Chicago, Ill.
- NICHOLS, ELDON** (A'29), Rm. 505, 40 Worth St., New York, N.Y.
- NICHOLS, FREDERICK A.** (A'28), Manager, Eaton Radio, Inc., 627-8th Ave., Greeley, Colo.
- NICHOLS, H. L.** (A'29), Foreman, Ferracute Machine Company, Bridgeton, N.J. For mail: 150 East Ave., Bridgeton, N.J.
- NICHOLS, HARRY J.** (A'29), Chief Engineer, General Motors Radio Corporation, Dayton, Ohio.
- NICHOLS, LEROY C.** (A'22), Weston Electric Institute Corporation, 50 Church St., New York, N.Y.
- NICHOLS, W. A.** (A'29), Electrical Engineer, Canadian National Telegraphs, Rm. 602, 347 Bay St., Toronto, Ont., Canada. For mail: 7 Delaware Ave., Toronto 4, Ont., Canada.
- NICHOLSON, E. J.** (A'22), Chief Engineer, Nicholson Electric Company, 1407 First North St., Syracuse, N.Y.
- NICHOLSON, JAMES K. A.** (M'29), Engineer-in-Charge, British Broadcasting Corporation, 54 New Bridge St., Newcastle-on-Tyne, Englarl. For mail: 5 Selborne Gardens, Newcastle-on-Tyne, England.
- NICKERSON, FRED W.** (A'29), Installation Engineer, Electrical Research Products, Inc., 250 W. 57th St., New York, N.Y.
- NICKLE, EMIL G.** (A'28), Tester, South Schenectady Radio Development Station, Schenectady, N.Y. For mail: 606 Pleasant St., Schenectady, N.Y.
- NICKLESS, WILLIAM H.** (A'29), Engineer, Perryman Electric Company, Inc., 30th St. and 50th Pl., North Bergen, N.J. For mail: 390 Oncrest Ave., Cliffside Park, N.J.
- NICOLAIDES, GEORGE** (A'31), Instructor of Radio, Western College of Radio, 735 Larkin St., San Francisco, Calif. For mail: 150-9th St., San Francisco, Calif.
- NIEDERT, GEORGE** (A'30), Publisher, George Banta Publishing Company, 52 Vanderbilt Ave., New York, N.Y. For mail: 105 Maple Ave., Glenbrook, Conn.
- NIELSON, H. V.** (A'25), BrunswickBalke-Collider Company, 726 Watchung Ave., Plainfield, N.J.
- NIELSON, JOHN E.** (A'25), Bell Telephone Laboratories, Inc., 463 West St., New York, N.Y.
- NIYA, TAKUJI** (A'27), Radio Engineer, Nippon Musen Denshin Kabushiki Kaisha, Jiji Bldg., Tomioka Shitsuchosho, Fukushima, Japan.
- NIKIRK, THOMAS E.** (A'27), Electrical Engineer, Transcontinental Western Air, Inc., 117 W. 9th St., Los Angeles, Calif. For mail: 311 N. Gladys Ave., Monterey Park, Calif.

- NIKONENKO, PAUL (A'27), Radio Department, Nathan-Dohrman Company, San Francisco, Calif. For mail: 1528 Broderick St., San Francisco, Calif.
- NILSON, ARTHUR R. (J'16-A'18-M'25), 33 Valley Rd., Larchmont, N.Y.
- NILSSON, G. ALB. (A'31), Chief Assistant, "Statens Maskin och Redskapsprovningssanstalter," Alnarp, Akaro, Sweden. For mail: Villa Bjorka, Lund, Sweden.
- NIMMCKE, FREDERICK E. (A'29), Radio Engineer, Bell Telephone Laboratories, Inc., 463 West St., New York, N.Y.
- NISHIDA, S. (A'31), Professor, Department of Physics, Kohnan-Kotogakko, near Kobe, Japan.
- NISLEY, PAUL H. (A'27), Research Engineer, Claude Neon National Laboratories, 30-20 Thompson Ave., Long Island City, L.I., N.Y. For mail: c/o Coldewey, 544 E. 83rd St., New York, N.Y.
- NIWA, YASUJIRO (A'25), Nippon Electric Company, 2 Mita-Shikoku-Machi, Shiba-Ku, Tokyo, Japan.
- NIXDORFF, SAMUEL P. (M'30), Engineer, General Electric Company, 1 River Rd., Schenectady, N.Y. For mail: 18 Hampton Ave., Schenectady, N.Y.
- NIXON, GEORGE M. (A'31), Engineer, Development Group, National Broadcasting Company, Inc., Rm. 1213, 711-5th Ave., New York, N.Y.
- NOBLE, DANIEL E. (A'25), Instructor, Connecticut Agricultural College Box 125, Storrs, Conn.
- NOBLE, HARRELL V. (A'31), Research Engineer, Power Tube Laboratory, MF5, Westinghouse Electric and Manufacturing Company, East Pittsburgh, Pa.
- NODEN, JOSEPH (A'27), Radio Engineer, Fern Villa, Coppice Rd., Willaston, Nantwich, England.
- NODINE, WESLEY I. (A'31), Radio Sales and Service Supervisor, Philadelphia Storage Battery Company, 311 Genesee Bldg., Buffalo, N.Y. For mail: 167 Summit St., Batavia, N.Y.
- NOEL, LIONEL S. (A'27), Chief Radio Engineer, Colonial Radio Corporation, 254 Rano St., Buffalo, N.Y. For mail: 399 Washington, Kenmore, N.Y.
- NOIZEUX, PIERRE (A'30), Chief Engineer, Transradio, 329 San Martin, Buenos Aires, Argentina.
- NOLAN, ARTHUR B. (A'27), Radio Department, American Airways, Love Field, Dallas, Tex.
- NOLAN, JAMES J. (M'26), Sales Engineer, Sprague Specialties Company, North Adams, Mass. For mail: 8 Winthrop Pl., Houghs Neck, Quincy, Mass.
- NOLAN, JOHN M. (A'27), Radio Serviceman, 334 Minnich Ave., New Philadelphia, Ohio.
- NOLTE, HENRY J. (A'18), Research Laboratory, General Electric Company, Schenectady, N.Y. For mail: 656 Rugby Rd., Schenectady, N.Y.
- NOPPER, CARLTON G. (A'30), Engineer, Radio Station WCAO, 811 W. Lanvale St., Baltimore, Md. For mail: 5211 St. Albans Way, Homeland, Baltimore, Md.
- NORDAHL, JOHN G. (A'27), Engineer, Bell Telephone Laboratories, Inc., 463 West St., New York, N.Y.
- NORDHAUS, CHARLES H. (A'25), Chief Inspector, Grigsby-Grunow Company, 5801 Dickens Ave., Chicago, Ill. For mail: 4908 Carmen Ave., Chicago, Ill.
- NORDSTROM, B. H. (A'30), Engineer, Bell Telephone Laboratories, Inc., 463 West St., New York, N.Y.
- NOREEN, CARL O. (A'30), Salesman, Radio Tube Service Company, Canton, Ohio. For mail: Box 105, Louisville, Ohio.
- NORRIS, EDWARD I. (J'30), Radio Serviceman, Norris Radio Service and Sales Company, 81 Eiffel Pl., Rochester, N.Y.
- NORRIS, FERRIS W. (A'30), Professor, Department of Electrical Engineering, University of Nebraska, Lincoln, Neb.
- NORTH, J. HAROLD (A'29), Technical Student, 725-13th St., N.W., Washington, D.C. For mail: R.F.D. No. 1, P.O. Box 41A, Annapolis, Md.
- NORTHOVER, HAROLD W. (A'24), Engineer and Superintendent, Sonora Corporation of Canada, Ltd., 179 King St., W., Toronto, Ont., Canada.
- NORTON, F. R. (A'31), Member of Technical Staff, Bell Telephone Laboratories, Inc., 463 West St., New York, N.Y.
- NORTON, JOHN E. (A'31), Master Control Engineer, Columbia Broadcasting System, Inc., 485 Madison Ave., New York, N.Y. For mail: 41 Virginia Ave., Jersey City, N.J.
- NORTON, KENNETH A. (A'29), Junior Physicist, U. S. Bureau of Standards, Washington, D.C.
- NORTON, THURMAN S. (A'30), 447 N. 5th St., Hamilton, Ohio.
- NORTON, LELAND D. (A'30), Director of Research, Dictaphone Corporation, 375 Howard Ave., Bridgeport, Conn.
- NORWOOD, VANDLE CLARENCE (A'29), Proprietor "Van, the Radio Man," 316 E. Riverside Dr., Evansville, Ind.
- NOTHNAGLE, GEORGE E. (A'24), Vice President, George E. Nothnagle and Son, Pauline St. Nichols, Bridgeport, Conn.
- NOTTAGE, WILLIAM H. (A'15), Joint Chief, Patent Department, Marconi's Wireless Telegraph Company, Ltd., London, W.C. 2, England. For mail: 18 Kings End, Ruislip, England.
- NOURSE, PHILIP R. (A'28), Engineer, Ad-O-Graph Corporation, 3620 W. 38th St., Chicago, Ill. For mail: 1434 N. Sedgwick St., Chicago, Ill.
- NOVAK, JOE J. (A'16), 4031 S. Campbell Ave., Chicago, Ill.
- NOWAK, VICTOR V. (A'27), Electrical Research Work, Nowak Optical Company, Inc., 1105 Broadway, Buffalo, N.Y.
- NOYES, ATHERTON, JR. (A'29), 112 Lakeview Ave., Cambridge, Mass.
- NOYES, ROBERT H. (A'29), Assistant Radio Engineer, U. S. Army Signal Corps, Aircraft Radio Laboratory, Wright Field, Dayton, Ohio.
- NUESSE, L. W. (A'31), Lieutenant, U.S.S. Milwaukee, New York, N.Y.
- NUGENT, THOMAS (A'27), Chief Radio Officer, S.S. California, Panama Pacific Line, Pier 61, North River, New York, N.Y.
- NUMRICK, FRED (J'30-A'31), Radio Service and Repair, 1844 S. 15th St., Springfield, Ill.

- NUNEZ, J. (A'29), Engineer, Universal Radio and Battery Service, 51 Milford St., Boston, Mass. For mail: 5 Hanson St., Boston, Mass.
- NUNN, E. D. (A'28), Vice President, Radio Parts Company, 313 W. State St., Milwaukee, Wis. For mail: 2115 E. Kenwood Blvd., Milwaukee, Wis.
- NYE, EARL C. (A'31), Manager, Instrument Service Laboratories, 3909 Russell Blvd., St. Louis, Mo.
- NYSTROM, RAYMOND A. (A'29), Radio Serviceman, M. Stienert and Sons Company, 1217 Main St., Springfield, Mass. For mail: 103 Dana St., Springfield, Mass.
- O
- OAKES, WILLIAM G. (A'31), Assistant Engineer Operator, Post and Telegraph Department, Kuala Lumpur, Federated Malay States.
- OBOUKHOFF, NICHOLAI M. (M'23), Research Professor of Electrical Engineering, Oklahoma Agricultural and Mechanical College, Stillwater, Okla.
- O'BRIEN, DANIEL L., JR. (A'28), Service Engineer, Electrical Research Products, Inc., 7046 Hollywood Blvd., Hollywood, Calif. For mail: 6060 Monroe Ave., Oakland, Calif.
- O'BRIEN, ELWIN J. (A'27), Student, State University of Iowa, Iowa City, Iowa. For mail: 408 Melrose Ave., Iowa City, Iowa.
- O'BRIEN, WILLIAM J. (A'27), Laboratory Assistant, Bremer-Tully Company, 656 Washington Blvd., Chicago, Ill. For mail: 1246 Newport Ave., Chicago, Ill.
- O'BRIGHT, ALVIN C. (A'29), Radio Service Engineer, Sparks-Withington Company, Jackson, Mich. For mail: Aladdin Hotel, Kansas City, Mo.
- O'BRYNE, BERNARD (A'30), Proprietor, Radio Shop, 265 E. King St., Toronto, Ont., Canada.
- O'BYRNE, LEO C. (A'27), 3532 W. Adams St., Chicago, Ill.
- O'CALLAGHAN, JEROME J. (A'28), Radio Engineer, Stewart-Warner Corporation, 1828 Diversey Pkwy., Chicago, Ill. For mail: 506 Oakdale Ave., Chicago, Ill.
- O'CONNELL, GERALD (A'27), Technician, O'Connell Radio Laboratories, 126½ Main St., Freeport, Ill.
- O'CONNELL, JAMES D. (A'30), Fort Monmouth, Oceanport, N.J.
- O'DAY, MARCUS (A'28), Assistant Professor, Physics Department, Reed College, Portland, Ore.
- O'DELL, CARL H. (A'30), 5325-9th Ave., Los Angeles, Calif.
- O'DONNELL, EDWARD T. (A'30), Radio Service, Edward T. O'Donnell Company, 37 Farragut Rd., South Boston, Mass.
- O'DONOHUE, JAMES P. (A'27), Chief Engineer, International Postal and Telegraph Cable Company, 67 Broad St., New York, N.Y.
- OETTING, O. W. A. (M'27), Engineer, Globe-Union Manufacturing Company, 14 Keefe Ave., Milwaukee, Wis.
- OGDEN, S. (A'30), Lissen, Ltd., Richmond, Surrey, England. For mail: 91 Mellitus St., Shepherds Bush, London, W. 12, England.
- OGG, GLEN R. (A'14), Chief Radio Electrician, U. S. Navy, U.S.S. Oglala, c/o Postmaster, Honolulu, Hawaii.
- OGG, JOHN GEORGE (A'23), Technical Officer, Royal Aircraft Establishment, Farnborough, Hants, England. For mail: 99 Highgate Lane, Farnborough, Hants, England.
- OGLOBLINSKY, GREGORY (M'30), Engineer, RCA Victor Company, Inc., Camden, N.J.
- OHL, RUSSELL S. (A'24-M'25), Radio Research, Bell Telephone Laboratories, Inc., 463 West St., New York, N.Y. For mail: Woodbine Ave., Foxwood Park, Little Silver, N.J.
- OKESON, HUGH BINGHAM (A'29), Radio Operator, Radio Station WHK, Standard Bank Bldg., Cleveland, Ohio. For mail: 4362 W. 58th St., Cleveland, Ohio.
- OLANDER, L. W. (A'30), Radio Engineer, Bell Telephone Laboratories, Inc., 463 West St., New York, N.Y.
- OLESEN, HAROLD L. (M'26), Electrical Engineer, Jewell Electrical Instrument Company, 1650 Walnut St., Chicago, Ill. For mail: 21 Ravine Forest Dr., Lake Bluff, Ill.
- OLIN, R. C. (A'30), 115 N. Hartman St., Portland, Ore.
- OLINGER, ROBERT (A'29), Technician, Radio Station WJBC, Kaskaskia Hotel, La Salle, Ill.
- OLIPHANT, WILLIAM D. (A'31), British Electrical and Allied Industries Research Association, 36-38 Kingsway, London, W.C. 2, England. For mail: "Midmar," 28 Grange Hill, Edgware, Middlesex, England.
- OLIVA LLAMUSI, FERNANDO (M'31), Lieutenant, Spanish Navy, Aire 20, Cartagena, Spain.
- OLIVE, GORDON W. (A'29), Technical Assistant, Radio Department, Canadian National Railways, Rm. 1003, 355 McGill, S., Montreal, P.Q., Canada.
- OLIVEIRA, A. MENEZES DE (M'20), Professor of Electrical Engineering, The Naval Academy, Rio de Janeiro, Brazil. For mail: 25, Rua Santa Clara, Capacabana, Rio de Janeiro, Brazil.
- OLIVER, GEORGE E. (A'23-M'26), Radio Engineer, Shortwave and Television Corporation, 70 Brookline Ave., Boston, Mass. For mail: 24 Queensberry St., Boston, Mass.
- OLKEN, HYMAN (A'31), Engineering Editor, Instruments Publishing Company, 3619 Forbes St., Pittsburgh, Pa. For mail: 5427 Kentucky Ave., Pittsburgh, Pa.
- OLMSTEAD, CHARLES B. (A'29), Broadcast Technician, Broadcasting Station KFVD, Culver City, Calif. For mail: 563 N. Hoover St., Los Angeles, Calif.
- OLMSTEAD, NOEL C. (A'27), Engineer, American Telephone and Telegraph Company, 195 Broadway, New York, N.Y.
- O'LOUGHLIN, BARTH W. (A'31), Operator, Alaska Cable System, Juneau, Alaska. For mail: Box 1498, Juneau, Alaska.
- OLSEN, EUGENE U. (A'31), Engineer, RCA Radiotron Company, Inc., 415 S. 5th St., Harrison, N.J. For mail: 14 Summit St., East Orange, N.J.
- OLSON, E. (A'30), Radio Engineer, Canadian Westinghouse Company, Hamilton, Ont., Canada. For mail: 121 Emerald St., S. Hamilton, Ont., Canada.
- OLSON, MARTIN N. (A'27), Radio Engineer, WDAY, Inc., 117 Broadway, Fargo, N.D.

- OLSON, MARVIN S. (A'25), Electrical Engineer, Carver Radio and Electrical Laboratory, Carver, Minn. For mail: P.O. Box 136, Carver, Minn.
- OMAN, NILS JOHANN (A'29), Engineer, Wired Radio, Inc., 4th Ave., Newark, N.J. For mail: 20 Boyden Pkwy., South Maplewood, N.J.
- OMER, GUY C., JR. (J'30), Chief Operator, Radio Station WREN, Jenny Wren Company, Lawrence, Kan. For mail: 546 Tennessee St., Lawrence, Kan.
- O'NEILL GEORGE D. (A'28), Radio Engineer, Hygrade Lamp Company, Salem, Mass. For mail: 93 Lovett St., Beverly, Mass.
- O'NEILL, JOHN P. (A'29), Engineer, Audio Power Development, RCA Victor Company, Inc., Camden, N.J. For mail: 216 E. Evergreen Ave., Chestnut Hill, Philadelphia, Pa.
- O'NEILL, R. F. (A'29), Assistant Engineer, Research Department, Marconi's Wireless Telegraph Company, Chelmsford, Essex, England. For mail: "Lindorel," 4th Ave., Chelmsford, Essex, England.
- ONO, TAKASHI (A'25), Radio Engineer, Musen Komukyoku, Department of Communications, Tokyo, Japan.
- ONUSKA, ANDREW (A'31), Engineering Department, RCA Victor Company, Inc., Camden, N.J. For mail: 261 Lawrie St., Perth Amboy, N.J.
- OODREYS, ARTHUR (A'29), Shop Superintendent, 729 S. Hill St., Los Angeles, Calif.
- OPPERMAN, KURT (A'31) Mechanic, c/o R.C.A. Communications, Inc., Riverhead, L.I., N.Y.
- ORAM, DONALD K. (A'24), Engineer, Hammarlund Manufacturing Company, Inc., 424 W. 33rd St., New York, N.Y. For mail: 84-33 Lefferts Blvd., Richmond Hill, L.I., N.Y.
- O'REILLY, C. (A'30), Engineer, International Telephone and Telegraph Laboratories, 46 Avenue de Breteuil, Paris 7, France.
- ORNER, RALPH J. (A'30), 823 Park Ave., Wilmette, Ill.
- ORNSTEIN, EUGENE (A'30), Service Manager, Transatlantic Radio, 75 Cortlandt St., New York, N.Y. For mail: 204 W. 106th St., New York, N.Y.
- ORNSTINE, GLENN C. (A'30), Radio Engineer, Broadcasting Department, Radio Station WQAN, *Scranton Times*, Scranton, Pa. For mail: 539 Collax Ave., Scranton, Pa.
- O'ROURKE, SYDNEY P. (J'29-A'30), Murgalli Estate, Hardypet P.O., Pollachi, South India.
- ORR, FRANCIS H. (A'31), 721 E. Laurel St., Compton, Calif.
- ORR, ROBERT W. (A'29), Engineering Department, RCA Victor Company, Inc., Camden, N.J.
- ORTH, JOHN T. (A'31), Operator, Radio Station WLVA, Lynchburg, Va. For mail: 4101 Fort Ave., Lynchburg, Va.
- ORTH, RICHARD T. (A'31), Development Engineer, Development Laboratory, RCA Radiotron Company, Inc., Harrison, N.J.
- OSBON, WILLIAM O. (A'30), Research Engineer, Westinghouse Electric and Manufacturing Company, Research Bldg., East Pittsburgh, Pa.
- OSBORN, BURR K. (A'26), Instructor in Electrical Engineering, Michigan State Col-
- lege, East Lansing, Mich. For mail: P.O. Box 817, East Lansing, Mich.
- OSBORN, EUGENE WILSON (A'29), Technical Assistant, Wireless Telegraph Company of South Africa, Ltd., Beam Wireless Station, Klipheuevel, Cape Providence, South Africa.
- OSBORN, PERRY H. (A'28), Radio Engineer, Westinghouse Electric and Manufacturing Company, East Pittsburgh, Pa. For mail: 325 Swissvale Ave., Edgewood Station, Pittsburgh, Pa.
- OSBORNE, HAROLD S. (A'14-M'29), Transmission Engineer, American Telephone and Telegraph Company, 195 Broadway, New York, N.Y.
- OSBORNE, ROBERT L. (A'27), Chief Engineer, Dongan Electric Manufacturing Company, 2987 Franklin St., Detroit, Mich. For mail: 4857 Marseilles Ave., Detroit, Mich.
- OSCANYAN, PAUL C., JR. (A'24), 270 Orchard Ter., Bogota, N.J.
- OSCHMANN, ADOLPH W. (A'28), Radio Engineer, Radio Station WQAN, *Scranton Times*, 149 Penn Ave., Scranton, Pa. For mail: 627 Connell St., Scranton, Pa.
- OSGOOD, ALBERT S. (A'20), Apprentice Photographer, 260 W. 99th St., New York, N.Y.
- OSGOOD, HARRY F. (A'31), Radio Engineer, RCA Victor Company, Inc., Camden, N.J. For mail: Kingsway Apartments, Haddonfield, N.J.
- O'SHAUGHNESSY, J. J. F. (M'20), Posts and Telegraphs, Accra, Gold Coast Colony, West Africa. For mail: The Royal Automobile Club, London, S.W. 1, England.
- O'SHEA, C. G. (A'31), Bell Telephone Laboratories, Inc., 180 Varick St., New York, N.Y. For mail: 1549 E. 36th St., Brooklyn, N.Y.
- O'SHEA, CHARLES J. (A'31), Radio Operator, Airways Division, U. S. Department of Commerce, Municipal Airport, East Boston, Mass. For mail: 48 Beaumont St., Dorchester, Mass.
- OSIATINSKY, L. (M'29), Managing Director, c/o S.I.R.A.C., Corso Italia 13, Milan, Italy.
- OSTERBROCK, W. C. (A'24), Associate Professor of Electrical Engineering, University of Cincinnati, Cincinnati, Ohio.
- OSTERLAND, EDMUND H. (J'29), Mountain Lakes, N.J.
- OSTERMEIER, C. H. (A'29), Proprietor and Manager, Sangamo Service Station, 2904 Cedric Ave., Pittsburgh, Pa.
- OSTRAND, ANSEL G. (A'31), Sales Engineer, S. B. Darmstadter, Rm. 632, 520 N. Michigan Ave., Chicago, Ill. For mail: 7533 Kingston Ave., Chicago, Ill.
- OSTRANDER, RUSSELL S. (J'29), Radio Operator, Radio Air Service Corporation, 1311 Terminal Tower, Cleveland, Ohio. For mail: 2337 Grandview Ave., Cleveland Heights, Ohio.
- OSTROVE, WILLIAM (A'27), Service Engineer, Radio Receptor Company, Inc., 106-7th Ave., New York, N.Y. For mail: 704 New Jersey Ave., Brooklyn, N.Y.
- OSWALD, ARTHUR A. (A'18-M'25-F'28), Member of Technical Staff, Bell Telephone Laboratories, Inc., 463 West St., New York, N.Y.

- OTANI, S. (A'29), Manager, Vacuum Tube Department, Tokyo Electric Company, Kawasaki, Japan.
- OTSUKA, Y. (A'29), Research Staff, Vacuum Tube Department, Research Laboratory, Tokyo Electric Company, Kawasaki, Japan.
- OTTEY, RAYMOND B. (A'31), Proprietor, Radio Service, 508-3rd St., West Fairview, Pa.
- OTTO, EMIL D. (A'31), Assistant Manager, Radio Department, Royal Eastern Electric Supply Company, 16-18 W. 22nd St., New York, N.Y. For mail: 17 Garden Pl., Westwood, N.J.
- OULD, RICHARD S. (A'19), 3747 Huntington St., Washington, D.C.
- OUTZEN, ANDREW N. (A'25), Superintendent, River Rouge Station, Detroit City Gas Company, 415 Clifford St., Detroit, Mich.
- OUZOUNIAN, HAIG (A'31), Motion Picture Operator, Noranda Theatre Company, Noranda, P.Q., Canada. For mail: P.O. Box 822, Rouyn, P. Q., Canada.
- OVERACKER, HORACE E. (A'23), Student, Electrical Engineering Department, Stanford University, Stanford University, Calif. For mail: 344 Tenmyson, Palo Alto, Calif.
- OVERHOLT, RALPH, JR. (A'29), Radio Engineer, RCA Victor Company, Inc., Camden, N.J. For mail: 7211 Thomas St., Pittsburgh, Pa.
- OVERMILLER, CLAIR M. (A'26), American Telephone and Telegraph Company, Rm. 501, 40 Worth St., New York, N.Y.
- OVERTON, GEORGE P. (A'30), Radio Operator, U. S. Airways, U. S. Department of Commerce, Airways Radio Station, Cheyenne, Wyo. For mail: U. S. Department of Commerce, Monitoring Station, Grand Island, Neb.
- OWADA, MANKITSU (A'28), Up-Keep Department, Nippon Yusen Kaisha, Marunouchi, Tokyo, Japan.
- OWEN, ROBERT H. (A'27), Station Engineer, Radio Station KDA, National Broadcasting Company, Inc., Denver, Colo. For mail: 1370 Krameria St., Denver, Colo.
- OWENS, RAYMOND B. (M'27), Associate Radio Engineer, U. S. Naval Research Laboratory, Bellevue, Anacostia, D.C.
- OWENS, RICHARD M. (A'26), 7621 Euclid Ave., Cleveland, Ohio.
- OWENS, ROBERT F. (A'29), Foreman, Wax Room, Grigsby-Grunow Company, 4540 Armitage Ave., Chicago, Ill. For mail: 2124 Hudson Ave., Chicago, Ill.
- OWNER, JOHN S. (A'26), The Radio Electric Stores, Birmingham, England. For mail: 135 Springfield Rd., Moseley, Birmingham, England.
- OXLEY, ALLAN B. (A'25), Chief Radio Engineer, The Williams Piano Company, Ltd., Oshawa, Ont., Canada.
- OXNER, EDWIN K. (A'14), Chief Engineer, High Frequency Laboratories, 3900 N. Claremont Ave., Chicago, Ill.
- P
- PACA, WILLIAM S. (A'29), Telephone Engineer, Box 514, Oil City, Pa.
- PACENT, LOUIS G. (A'12-M'15-F'27), President and Technical Director, Pacent Electric Company, Inc., 91-7th Ave., New York, N.Y.
- PACHOLKE, FRED (A'27), Engineer, Sparks-Withington Company, Jackson, Mich. For mail: 508 Winthrop Ave., Jackson, Mich.
- PACKARD, ALDEN C. (A'29), 140 W. 12th St., Claremont, Calif.
- PACKARD, CHARLES A. (A'31), Research Engineer, International Resistance Company, 2006 Chestnut St., Philadelphia, Pa. For mail: 6483 Malvern Ave., Philadelphia, Pa.
- PACKMAN, M. E. (A'13), P.O. Box 133, Valparaiso, Ind.
- PAELIG, THEODORE H. (A'30), P.O. and E. Department, National Broadcasting Company, Inc., Chicago, Ill. For mail: 216 S. Kildare Ave., Chicago, Ill.
- PAESSLER, ROBERT T. (A'27), President and Manager, Robert T. Paessler Company, Inc., 105 Coal Exchange Bldg., Wilkes-Barre, Pa.
- PAGE, NEWELL C. (A'12), Professor of Electricity, Massachusetts Institute of Technology, Cambridge, Mass. For mail: 28 Maxwell Rd., Winchester, Mass.
- PAGE, ROBERT M. (A'27), Junior Physicist, U. S. Naval Research Laboratory, Bellevue, Anacostia, D.C. For mail: 334 Raleigh St., S.E., Washington, D.C.
- PAINTING, JOHN A. (A'28), Radio Engineer, Charles M. Fern, 663 Manhattan Ave., Brooklyn, N.Y. For mail: 229 Nassau Ave., Brooklyn, N.Y.
- PAISLEY, S. ROY (A'26), Manager, Continental Carbon of Canada, Ltd., 89 Jarvis St., Toronto, Ont., Canada. For mail: 627 Glebeholme Blvd., Toronto, Ont., Canada.
- PALASKY, HAROLD (A'31), Radio Serviceman, Mager's Music Shop, 489 Central Ave., Cedarhurst, N.Y. For mail: 130-06 Liberty Ave., Richmond Hill, L.I., N.Y.
- PALERMO, A. J. (A'30), Instructor, Electrical Engineering Department, Union College, Schenectady, N.Y.
- PALES, FREDERICK A. (A'31), Supervisor, Technical Assistant, Beam Wireless Station, Skegness, Lincolnshire, England.
- PALMER, C. WALTER (A'28), Statistician, Western Electric Company, Inc., 100 Central Ave., Kearney, N.J. For mail: 31-31st St., Woodcliff, N.J.
- PALMER, EDWARD D. (J'27-A'29), Student Assistant, Aero Department, University of Michigan, Ann Arbor, Mich. For mail: 1217 Willard St., Ann Arbor, Mich.
- PALMER, ERIC H. (A'30), Director, Public Relations, A. H. Grebe and Company, Inc., 70 Van Wyck Blvd., Richmond Hill, L.I., N.Y. For mail: 305 Avenue C, W., Brooklyn, N.Y.
- PALMER, HARRIS C. (A'31), Graduate Student, Cornell University, Ithaca, N.Y. For mail: 407 E. Seneca St., Ithaca, N.Y.
- PALMER, JAMES (J'30), Engineer, Radio Engineering Laboratory, 3721 Crestline Rd., Fort Worth, Tex.
- PALMER, PIERRE S. (A'31), Manager, Radio Department, Peoples Light Company, 205 Perry St., Davenport, Iowa. For mail: 2503-13th Ave., Rock Island, Ill.
- PALMER, R. J. (A'29), Wireless Officer, Marconi Company, Lorraine, Maderia Rd., North End, Portsmouth, England.
- PALMER, ROBERT T. (A'29), Patent Attorney, Duell, Dunn and Anderson, 420 Lexington Ave., New York, N.Y.

- PALMER, ROLAND F. (A'25), Manager, Columbus Branch, North American Radio Sales Company, 1456 N. High St., Columbus, Ohio. For mail: 470 E. Butchtel Ave., Akron, Ohio.
- PANAGAKIS, HARRY (J'25-A'28), Wireless Specialist, "Beverly," Childwall Priory Rd., Liverpool, England.
- PANNILL, CHARLES JACKSON (F'29), Vice President, Radiomarine Corporation of America, 66 Broad St., New York, N.Y.
- PARENTI, ANTHONY M. (A'31), Shipper, American Sheet and Tin Plate Company, 362 Pkwy., Monessen, Pa.
- PARET, F. MURRAY (A'30), Head, Measurements Department, Cable Radio Tube Corporation, N. 9th St., Brooklyn, N.Y. For mail: 142 Sunset Ave., Verona, N.J.
- PARETO, JOAO V. (A'31), Operator, Receiving Station of Companhia Radio Internacional do Brazil, 50 Rua da Alfandega, Rio de Janeiro, Brazil. For mail: 180 Praia do Russell, Rio de Janeiro, Brazil.
- PARISEK, EDWARD E. (A'27), Development Engineer, Yaxley Manufacturing Company, 1528 W. Adams St., Chicago, Ill. For mail: 1511 Sedgwick St., Chicago, Ill.
- PARISH, EUGENE V. (A'30), Service Manager, The Bruce Company, Monroe and 2nd, Springfield, Ill. For mail: 1517 W. Grand Ave., S., Springfield, Ill.
- PARK, CHARLES W. (A'27), Radio Corporation of America, Bolinas, Calif.
- PARKER, A. RAYMOND (J'25-A'26), Radio Manager, S. Stern, 115 Fleet St., London, E.C. 4, England. For mail: 13 Cumberland Park, Acton, London, W. 3, England.
- PARKER, EVERT L. (A'26), Electrician, Electrical Department, Pacific Electric Railway, Los Angeles, Calif. For mail: 1731 La Senda Pl., South Pasadena, Calif.
- PARKER, OLIVER B. (A'23-M'30), Chief Engineer, Pacent Electric Company, 91-7th Ave., New York, N.Y. For mail: 46-07-260th St., Little Neck, L.I., N.Y.
- PARKER, R. D. (A'16), Engineer, American Telephone and Telegraph Company, 195 Broadway, New York, N.Y.
- PARKER, RAY H. (A'27), Transmission Engineer, Pacific Telephone and Telegraph Company, Rm. 524, 140 New Montgomery St., San Francisco, Calif. For mail: 5355 Poinsettia Ave., Richmond, Calif.
- PARKER, WILLIAM H., JR. (A'30), Engineering Student, Massachusetts Institute of Technology, Cambridge, Mass. For mail: 246 Broadway, Somerville, Mass.
- PARKES, A. W., JR. (A'30), Radio Engineer, Aircraft Radio Corporation, Boonton, N.J. For mail: Box 151, Boonton, N.J.
- PARKHURST, AUSTIN FLINT (M'12), Manager, Service Department, Cresley Radio Corporation, 3401 Colerain Ave., Cincinnati, Ohio. For mail: 5822 Hamilton Ave., Cincinnati, Ohio.
- PARKHURST, EDGAR L. (A'29), Radio Engineer, National Broadcasting Company, Inc., 111 Sutter St., San Francisco, Calif.
- PARKIN, JOHN, JR. (A'16), Manager, Parkin Manufacturing Company, Grand Ave., San Rafael, Calif.
- PARKIN, LOUIS S. (A'30), Chief Radio Operator, United Fruit Company, Radio Station, Almirante, Panama.
- PARKIN, THOMAS D. (A'19), Marconi's Wireless Telegraph Company, Ltd., New St., Chelmsford, England. For mail: The Haven, Mill Lane, Broomfield, near Chelmsford, England.
- PARKINSON, LEE D. (A'30), 105 N. Bird St., Coalgate, Okla.
- PARKINSON, TAINTOR (A'26), Student, University of Michigan, Ann Arbor, Mich. For mail: 932 Greenwood Ave., Ann Arbor Mich.
- PARNAGIAN, ARAM (A'28), Radio Service, Radio Station WNAC, Shepard Stores, Boston, Mass. For mail: 3 Milford St., Boston, Mass.
- PARR, CLIFFORD (A'31), Bookkeeper Parr's Rose Gardens, Freewater, Ore.
- PARRISH, ROBERT R. (A'29), Student, Loomis Radio College, Washington, D.C. For mail: 24 Silver St., Great Barrington, Mass.
- PARRY, ALBERT H. (A'28), Wireless Operator, British Marine Wireless Service, Marconi House, Strand, London, England. For mail: 35 Stockmoor Rd., West Derby, Liverpool, England.
- PARSONS, J. B. (A'27), President, Parsons Laboratories, Inc., 1471 Selby Ave., St. Paul, Minn.
- PARTELLO, MELVILLE C. (A'30), Lieutenant Commander, U. S. Navy, U.S.S. Helena, South China Patrol, c/o Postmaster, Seattle, Wash.
- PARTRIDGE, JOHN A. (A'31), Radio Engineer, British Broadcasting Corporation, Tatsfield, Kent, England.
- PASCHON, HANS E. (A'25), Radio Engineer, RCA Victor Company, Inc., Camden, N.J. For mail: 726 W. Maple Ave., Merchantville, N.J.
- PASQUET, JEAN E. (A'28), Educational Director, Music Department, D. H. Holmes Company, Ltd., 819 Canal St., New Orleans, La. For mail: 1222 Eagle St., New Orleans, La.
- PASSOW, EDWARD B. (A'31), Radio Engineer, Johnson Laboratories, 609 W. Lake St., Chicago, Ill. For mail: 2032 W. Roosevelt Rd., Chicago, Ill.
- PATA, YAROMIR J. (A'29), Service Manager, Hughes-Bozarth-Anderson Company, 15-21 E. Grand, Oklahoma City, Okla. For mail: 1615 N.W. 29th St., Oklahoma City, Okla.
- PATASNIK, D. (A'30), 344 Thatford Ave., Brooklyn, N.Y.
- PATEY, HAROLD W. (A'27), Manager, Great Lakes Radio Service, 136 Parkside Ave., Buffalo, N.Y.
- PATIENCE, A. MELBOURNE (A'23-M'28), Assistant Manager, Philco Products, Ltd., Toronto, Ont., Canada. For mail: 369 Briar Hill, Toronto, Ont., Canada.
- PATRON, ALFONSO E. (A'28), Radio Technician, Irving Radio Company, 1801 Irving St., San Francisco, Calif. For mail: 719 Scott St., San Francisco, Calif.
- PATTEE, JOHN R. (A'30), Proprietor, 5-13 Borden Ave., Long Island City, L.I., N.Y.
- PATTEN, STANLEY F. (A'27), Lieutenant, 11th Naval District Headquarters, San Diego, Calif.
- PATTERSON, EDWARD B. (A'24-M'30), Auditorium Equipments Engineer, RCA Victor Company, Inc., Camden, N.J. For mail: 6529 Rogers Ave., Merchantville, N.J.
- PATTERSON, FRANKLIN G. (A'27), General Engineering Laboratory, General Elec-

- tric Company, Schenectady, N.Y. For mail: 933 Norwood Ave., Schenectady, N.Y.
- PATTERSON, JOSEPH A. (A'29), Radio Service and Repairing, 3821 S. Kedzie Ave., Chicago, Ill.
- PAUL, BYRON R. (J'28-A'30), Operator, KOIN Broadcasting, Inc., New Heathman Hotel, Portland, Ore. For mail: 455 W. Park St., Portland, Ore.
- PAUL, ERNEST E. (A'27), Proprietor, The Philco Shop, 280 Castro St., Mountain View, Calif. For mail: 185 Briggs Ave., Sunnyvale, Calif.
- PAUL, GEORGE STEWART (A'29), Division Traffic Inspector, Western Union Telegraph Company, 427 S. LaSalle St., Chicago, Ill. For mail: 2043 W. 111th St., Chicago, Ill.
- PAULDING, HERBERT L. (A'28), Electrical Engineer, Dow Jones and Company, Inc., 453 W. 30th St., New York, N.Y. For mail: Great Neck Towers, Great Neck, L.I., N.Y.
- PAVLOW, NICHOLAS (A'29), Inspector, Frederick Loeser and Company, 484 Fulton St., Brooklyn, N.Y. For mail: 37 W. 10th St., New York, N.Y.
- PAWLEY, MYRON G. (A'30), Instructor in Mathematics, Colorado School of Mines, Golden, Colo. For mail: 1205-12th St., Golden, Colo.
- PAYETTE, WALTER S. (A'29), Radiotrician, Crokin-Levy and Company, 701 E. Main St., Norfolk, Va. For mail: 848 W. 49th St., Norfolk, Va.
- PAYNE, CHARLES C. (A'28), Dentist, 8 W. 40th St., New York, N.Y.
- PAYNE, ERIC A. (A'23), Engineer, Marconi Wireless Telegraph Company, Ltd., Chelmsford, England. For mail: Hill Crest, Honeywood Rd., Colchester, England.
- PAYNE, J. FRED, JR. (J'30), Student, Electrical Engineering, North Dakota State College, Fargo, N.D. For mail: 1133-12th St., N., Fargo, N.D.
- PAYNE, KENNETH (A'30), Gallatin, Mo.
- PAYNE, L. STANLEY (M'16), Engineer, Canadian Marconi Company, 11 St. Sacrament St., Montreal, P.Q., Canada.
- PEARCE, HARRY G. (A'26), Radio Operator, Airways Radio Station, U. S. Department of Commerce, Winslow, Ariz. For mail: 4168-2nd Ave., Los Angeles, Calif.
- PEARL, EUGENE S. (A'18-M'22), 705 Collings Ave., West Collingswood, N.J.
- PEARSON, ALFRED (A'31), Proprietor, A. Pearson, Electrical and Scientific Instrument Maker, 80a Newland Ave., Hull, East York, England.
- PEARSON, HERBERT B. (A'14), 40 Colonial Ct., Brooklyn, N.Y.
- PEARSON, LAURENCE H. (A'26), Electrical and Radio Engineer, Pearson Brothers, 54-56 Long Row, Nottingham, England. For mail: Ellesmere, 29 Thorncliffe Rd., Nottingham, England.
- PEARSON, OSCAR A. (M'28), Managing Engineer, Thordarson Electric Manufacturing Company, 500 W. Huron St., Chicago, Ill. For mail: 551 Belleforte Ave., Oak Park, Ill.
- PEASE, REGINALD M. (A'25-M'27), Bell Telephone Laboratories, Inc., 463 West St., New York, N.Y. For mail: 3201 Oxford Ave., New York, N.Y.
- PEAVEY, EVERETT A. (J'30), Radio Serviceman, 1753 E. Grand Ave., Des Moines, Iowa.
- PECK, EMERSON P. (A'22), Engineer, Buffalo, Niagara and Eastern Power Corporation, Electrical Bldg., Buffalo, N.Y.
- PECK, GEORGE T. (A'26), Research and Instruction Engineer, Post and Telegraphs Department, Kuala Lumpur, Federated Malay States.
- PECK, GORDON V. (A'26), Yale Electric Corporation, Pillary and Pearl Sts., Brooklyn, N.Y. For mail: 88 Monroe Pl., Brookfield, N.J.
- PECKHAM, J. H. (A'22), 16 Carter Rd., Lynn, Mass.
- PECKOSH, ANTONE J. (A'31), Test Maintenance Department, Grigsby-Grunow Company, 4540 Armitage Ave., Chicago, Ill. For mail: 692 Irving Park Blvd., Chicago, Ill.
- PECORINI, ROBERT R. (M'25), London General Omnibus Company, Ltd., London, S.W. 1, England. For mail: "Oakwood," Baddlesmere Rd., Tankerton, Kent, England.
- PECOUL, F. A. (A'29), Engineer, Radio Station WJCM, Great Southern Land Company, P.O. Box 117, Mississippi City, Miss.
- PEDERSEN, A. A. (A'31), Radio Engineer, All America Cables, Inc., Medellin, Colombia.
- PEDERSEN, GUNNAR V. C. (A'30), Radio Engineer, Les Laboratoires Standard, 46 Avenue de Breteuil, Paris 7^e, France.
- PEDERSEN, MARTIN P. (A'14), Lille Strandstraede 14, Copenhagen, Denmark.
- PEDERSEN, PEDER OLUF (F'15), Professor and Principal, Royal Technical College, Copenhagen, Denmark. For mail: Amalievej. 1, Copenhagen, Denmark.
- PEERENBOOM, CYRIL A. (A'29), Publisher, George Banta Publishing Company, Menasha, Wis. For mail: 526 Keyes St., Menasha, Wis.
- PEFFER, RALPH M. (A'22), Radio Jobber, 314 Chestnut St., Harrisburg, Pa.
- PEGRAM, GEORGE B. (A'12), Professor of Physics, Columbia University, New York, N.Y.
- PEIRCE, GEORGE H. (A'23), Chief Engineer, Radio Station WDSU, De Soto Hotel, New Orleans, La. For mail: Baronne Apartments, New Orleans, La.
- PELAEZ, CARLOS (A'31), Director, Instruction Department, Compania Telefonica Nacional de Espana, Calle Herrosilla 33, Madrid, Spain.
- PELTON, CECIL R. (A'31), Northern Radio Service, 1593 Bloor St., W., Toronto, Ont., Canada.
- PEMBER, HAROLD H. (A'14), Factory Insurance Association, Hartford, Conn. For mail: 14 Goshen St., Hartford, Conn.
- PENHALE, ARTHUR (A'31), Operator, 701 Union St., Valparaiso, Ind.
- PENICK, D. B. (A'29), Engineer, Bell Telephone Laboratories, Inc., 463 West St., New York, N.Y.
- PENNOCK, P. L., SR. (A'29), Proprietor, Radio Sales and Service, 3630 Market St., Youngstown, Ohio.
- PENROSE, L. A. (A'30), Radio Operator, Transcontinental and Western Air, Inc., Harrisburg Airport, Harrisburg, Pa.

- PENTHER, CARL JOSEPH (A'29), 1070 Aileen St., Oakland, Calif.
- PEOPLES, ARCHIE G. (A'31), Measuring and Equipment Section, Engineering Department, General Motors Radio Corporation, Dayton, Ohio. For mail: 3516 N. Main St., Dayton, Ohio.
- PERCIVAL, WILLIAM R. (A'31), Radio Research Engineer, Eclipse Radio Company, Bolton, England. For mail: 12 Scales St., Seedley, Manchester, England.
- PERCY, F. W. (A'24), Technician, Radio Electrical Service Laboratory, Tucson, Ariz. For mail: P.O. Box 375, University of Arizona Station, Tucson, Ariz.
- PEREIRA, FRANCIS E. D. (A'29), Superintendent, British Wireless Marine Service, 14 Commercial Rd., Hull, York, England. For mail: 36 Margaret St., Beverley Rd., Hull, York, England.
- PEREZ-PALACIO, ENRIQUE (A'31), Agriculture, Box 1789, Lima, Peru.
- PERKINS, GEORGE C. (A'30), Chief Design Engineer, Kolster Radio, Inc., 360 Thomas St., Newark, N.J. For mail: 365 Union St., Jersey City, N.J.
- PERKINS, GEORGE S. (A'31), Commercial Representative, Radio Station KFI-KECA, 1000 S. Hope St., Los Angeles, Calif. For mail: 455-25th St., Hermosa Beach, Calif.
- PERKINS, LAURENCE M. (A'27), Chief Engineer, Erie Resistor Corporation, 12th St., Erie, Pa.
- PERKINS, LUCIUS J. (A'23-M'30), Recording Director, Brunswick-Balke-Collender Company, 2481 Porter St., Los Angeles, Calif. For mail: 607 N. Mansfield Ave., Los Angeles, Calif.
- PERKINS, OLIVER D. (J'31), Radio Operator, Radio Station KOAC, Oregon State Agricultural College, Corvallis, Ore. For mail: 147 King's Rd., Milwaukie, Ore.
- PERKINS, WILLIAM M. (M'30), Engineer-in-Charge of Measurements, National Union Radio Corporation, 57 State St., Newark, N.J. For mail: 165 Franklin St., Bloomfield, N.J.
- PERLITZ, W. H. (A'30), Manager, Radio Department, Joseph F. Meyer Company, Houston, Tex. For mail: 2120 Blodgett Ave., Houston, Tex.
- PERRON, RAYMOND T. (A'31), Manufacturers Representative, R. T. Perron Sales Company, 32 Broadway, Providence, R.I. For mail: 242 Rugby St., Providence, R.I.
- PERROTTA, DOMINIC (A'31), 2140 W. Harrison St., Station D, Chicago, Ill.
- PERROW, F. A. P. (M'24), Chief Technical Assistant, Electricity Department, Port Elizabeth, South Africa.
- PERRY, HAROLD D. (A'22), Engineer, Acoustic Department, Electrical Research Products, Inc., 250 W. 57th St., New York, N.Y. For mail: 226 Halsey St., Brooklyn, N.Y.
- PERRY, IRVING D. (J'15-A'18), Engineering Assistant, Public Service Products Company, 80 Park Pl., Newark, N.J. For mail: 68 N. Pkwy., East Orange, N.J.
- PERRY, JAMES E. (A'31), District Manager, Columbia Wholesalers, Inc., 32 S. Paca St., Baltimore, Md. For mail: 314 Hazel Ave., Salisbury, Md.
- PERRY, ROBERT M. (A'31), Manager, Perry's Radio Service, 1929 Lakeshore Ave., Los Angeles, Calif.
- PERRY, WILLIAM A. (A'26), 383 King's Highway, Westport, Conn.
- PERRYMAN, G. H. (A'29), 950 Garrison Ave., Teaneck, N.J.
- PERSIO, LOUIS N. (A'30), Engineer, Radio Station WRAK, 442 Williams St., Williamsport, Pa.
- PERSONS, EDGAR N. (A'31), RCA Victor Company, Inc., Camden, N.J. For mail: 6212 Chestnut St., Philadelphia, Pa.
- PERSOON, ANDREW R. (A'31), Manager, H. Hoelet and Coy, Sydney, Australia. For mail: "Hallandia," Coronation Ave., Mosman, Sydney, Australia.
- PESSION, GIUSSEPPE (F'29), Director, General Posts and Telegraphs, Rome, Italy. For mail: Via Tevere No. 20, Rome, Italy.
- PETERS, C. W. (A'29), Chief Operator, Gulf Division, Radiomarine Corporation of America, New Orleans, La. For mail: 1716 Painter St., New Orleans, La.
- PETERS, JOHN L. (A'29), Engineer, National Union Radio Corporation, 57 State St., Newark, N.J. For mail: 59 Spruce St., Newark, N.J.
- PETERS, LEO J. (A'19), Gulf Research Laboratory, 327 Graft Ave., Pittsburgh, Pa.
- PETERS, VERN (A'28), Proprietor, Peters Radio and Electric Company, 114-4th Ave., Havre, Mont. For mail: P.O. Box 544, Havre, Mont.
- PETERSEN, CARL O. (A'31), Sound Employee, Paramount Sound News, Inc., 544 W. 43rd St., New York, N.Y.
- PETERSEN, F. T. (A'31), Chief Engineer, S.S. *Verona*, Oslo, Norway. For mail: 121 S. Gay St., Baltimore, Md.
- PETERSEN, HOWARD E. (A'24), Proprietor, Illinois Radio Appliance Company, Chicago, Ill. For mail: 1426 W. 70th St., Chicago, Ill.
- PETERSEN, JOHN C. (A'31), Radio Serviceman, Ludwig Baumann and Company, 45 Pearson St., Long Island City, L.I., N.Y. For mail: 857-58th St., Brooklyn, N.Y.
- PETERSEN, ROBERT L. (A'31), Junior Engineer, Meter and Test Department, United Electric Light and Power Company, 4 Irving Pl., New York, N.Y. For mail: 113 Greenvale Ave., Yonkers, N.Y.
- PETERSEN, THOMAS G. (A'19), Marconi's Wireless Company, Ltd., London, W.C. 2, England. For mail: 56 Whittington Rd., Bowes Park, London, N., England.
- PETERSON, ARTHUR C., JR. (A'29), Engineer, American Telephone and Telegraph Company, 195 Broadway, New York, N.Y. For mail: P.O. Box 261, Stanhope, N.J.
- PETERSON, ARTHUR W. (M'25), Lieutenant, U. S. Navy, Battleships Radio Officer, U.S.S. *West Virginia*, San Pedro, Calif.
- PETERSON, CHARLES W. (A'15-M'30), 13 Hillcrest Apartments, Mount Auburn, Cincinnati, Ohio.
- PETERSON, CORNELIUS (A'26), Instructor, R.C.A. Institutes, Inc., 75 Varick St., New York, N.Y.
- PETERSON, EUGENE (M'30), Electrical Engineer, Bell Telephone Laboratories, Inc., 180 Varick St., New York, N.Y.
- PETERSON, GLEN (A'31), Engineer, Bell Telephone Laboratories, Inc., 463 West St., New York, N.Y.

- PETERSON, HAROLD O. (A'22-M'31), R.C.A. Communications, Inc., 66 Broad St., New York, N.Y. For mail: 140 Moriches Rd., Riverhead, L.I., N.Y.
- PETERSON, HERBERT C. (J'31), 632 Wilson Ave., Salt Lake City, Utah.
- PETERSON, J. N. (A'31), Telephone Engineer, Western Electric Company, Inc., 100 Central Ave., Kearny, N.J. For mail: 485 W. 3rd Ave., Roselle, N.J.
- PETERSON, KENNETH C. (A'31), Radio Officer, S.S. *America*, Radiomarine Corporation of America, 75 Varick St., New York, N.Y.
- PETERSON, LLOYD E. (A'30), Vacuum Tube Engineer, R.C.A. Communications, Inc., Rocky Point, L.I., N.Y.
- PETERSON, TED R. (A'31), District Superintendent, c/o Florida Power and Light Company, Palatka, Fla. For mail: Box 456, Palatka, Fla.
- PETERSON, W. EARL (A'30), Radio Operator, Radiomarine Corporation of America, Eastern Division, New York, N.Y. For mail: 1008 Minnesota Ave., Gladstone, Mich.
- PETRY, C. A. (A'28), Member of Technical Staff, Bell Telephone Laboratories, Inc., 180 Varick St., New York, N.Y.
- PETRY, G. FREDERICK (A'31), Sales Engineer, Sprague Specialties Company, North Adams, Mass. For mail: 20 Clinton Ave., Merchantville, N.J.
- PETTENGILL, GEORGE W., JR. (A'26), Radio Engineer, RCA Victor Company, Inc., Camden, N.J. For mail: 214 S. Davis Ave., Audubon, N.J.
- PETTERSON, JUNIOR (A'31), Radio Field Engineer, General Electric Company, 614 Red Rock Bldg., Atlanta, Ga.
- PETTIT, ALBERT R. (A'29), Engineer, RCA Victor Company, Inc., Camden, N.J. For mail: 722 Grant Ave., West Collingswood, N.J.
- PETTS, RONALD G. (A'29), Technician and Manager, Radio Service Department, M. H. Housel and Company, 141 W. 4th St., Williamsport, Pa. For mail: 904 Railway St., Williamsport, Pa.
- PETTUS, W. K. (A'31), Sound Supervisor, Fox Theatres, Inc., 444 W. 56th St., New York, N.Y. For mail: 514 W. Englewood Ave., West Englewood, N.J.
- PETZING, ERWIN W. (A'19), 939 N. Drake Ave., Chicago, Ill.
- PEW, RICHARD K. (A'26), 1049 W. 92nd Pl., Chicago, Ill.
- PEZOPOULOS, K. (A'30), Lieutenant Commander, 1st Assistant Director, Radio Service, Greek Navy, Athens, Greece. For mail: Marne 47, Athens, Greece.
- PFAU, JOHN A. (A'31), Instructor Projectionist, Electrical Research Products, Inc., 250 W. 57th St., New York, N.Y. For mail: 1811 Kite Ave., Huntington, W.Va.
- PFAUTZ, CHRISTIAN E. (A'20), Assistant Manager, RCA Central Frequency Bureau, 66 Broad St., New York, N.Y. For mail: 266 Washington St., Hempstead, L.I., N.Y.
- PFEIFER, JOSEPH W. (A'26), Pfeifer and Walter, 811 E. Wisconsin Ave., Milwaukee, Wis. For mail: 2928 N. Humboldt Ave., Milwaukee, Wis.
- PFEIFF, FREDERICK J. (A'30), Service Engineer, Electrical Research Products, Inc., 250 W. 57th St., New York, N.Y. For mail: 56 Oak St., Ridgewood, N.J.
- PFEILER, LAWRENCE F. (A'26), Radio Engineer, Universal Wireless Communication Company, 4111 Ravenswood Ave., E., Chicago, Ill. For mail: 1816 N. 5th St., Sheboygan, Wis.
- PFLER, ROBERT A. (A'27), Technician, H. E. Car-e Radio Company, 3902 S. Grand Ave., Los Angeles, Calif. For mail: 6000 S. Citrus, Hyde Park Sta., Los Angeles, Calif.
- PHELAN, THOMAS H. (A'30), Engineer, National Broadcasting Company, Inc., 711-5th Ave., New York, N.Y. For mail: 460 Ovington Ave., Brooklyn, N.Y.
- PHELPS, BOYD (A'21), P.O. Box 247, Hicksville, L.I., N.Y.
- PHELPS, ROGER E. (A'28), Hobart St., Hingham, Mass.
- PHELPS, WALTER A. (A'19), Telephone Engineer, Bell Telephone Laboratories, Inc., 463 West St., New York, N.Y. For mail: 19 Academy Rd., Madison, N.J.
- PHILBRICK, LAWRENCE S. (A'27), Radio Engineer, J. Murdock Company, 347 Washington Ave., Chelsea, Mass. For mail: 51 Malvern St., Melrose, Mass.
- PHILLIPS, CHARLES F. (M'22), Chief Engineer, Burnlept Wireless, Ltd., London, S.E. 3, England. For mail: 17 Eliot Vale, Blackheath, London, S.E. 3, England.
- PHILLIPS, EDWARD I. (A'29), Manager, Eddiesons Electric Service Company, 12 Ward Pl., West Haven, Conn.
- PHILLIPS, FRANK A. (A'30), Radio Engineer, 151 Forest Rd., Hurtsville, New South Wales, Australia.
- PHILLIPS, HENRY B. (M'24), Professor of Mathematics, Massachusetts Institute of Technology, Cambridge, Mass.
- PHILLIPS, JOSEPH H., JR. (A'27), Secretary and Treasurer, Balsey and Phillips, Inc., Ltd., 1455 N. Gordon St., Hollywood, Calif.
- PHILLIPS, LLOYD B. (J'22-A'24), Hall, N.Y.
- PHILLIPS, MAURICE M. (A'31), Wireless Officer, British Wireless Marine Service, Commercial Rd., Hull, England. For mail: 6 High St., Feltham, Middlesex, England.
- PHILLIPS, R. G. (A'28), Radio Dealer, 15 E. Boardman St., Youngstown, Ohio. For mail: 1019 Hawthorne St., Youngstown, Ohio.
- PHILIPPSON, MAURICE (M'19), 57 Rue D'Arion, Brussels, Belgium.
- PICKARD, GREENLEAF W. (M'12-F'15), Consulting Engineer, 59 Dalton Rd., Newton Center, Mass.
- PICKARD, RICHARD W. (A'29), Development Department, National Broadcasting Company, Inc., 711-5th Ave., New York, N.Y. For mail: 44 Clifford St., East Orange, N.J.
- PICKEN, WILLIAM J. (A'14), Marconi's Wireless Telegraph Company, Marconi House, Strand, London, W.C. 2, England.
- PICKERING, HARRY (A'30), Radio Engineer, 308 Balby Rd., Doncaster, England.
- PICKETT, C. E. (A'29), Studio Engineer, National Broadcasting Company, Inc., Merchandise Mart, Chicago, Ill. For mail: 5527 Kimbark Ave., Chicago, Ill.
- PICKETT, EARL L. (A'27), Radio Interference Engineer, Mountain States Power Com-

- pany, Marshfield, Ore. For mail: North Bend, Ore.
- PICKETT, GLENN H. (A'26), Member of Engineering Staff, Judson Studios, Inc., 113 W. 57th St., New York, N.Y.
- PICKETT, HARRY D. (A'31), Junior Radio Inspector, Federal Radio Monitoring Station, Grand Island, Neb. For mail: 322 E. 3rd St., Grand Island, Neb.
- PICKLE, CHESLEY B. (J'31), Head Operator and Assistant Engineer, Honolulu Broadcasting Company, Box 1391, Honolulu, Hawaii.
- PIDGEON, HOWARD A. (M'29), Member, Technical Staff, Bell Telephone Laboratories, Inc., 463 West St., New York, N.Y. For mail: 26 Berkeley Rd., Maplewood, N.J.
- PIERCE, E. H. (A'30), Lieutenant, U. S. Navy, U.S.S. Texas, c/o Postmaster, New York, N.Y.
- PIERCE, FRANCIS E. (M'28), Captain, U. S. Marine Corps, 865 I Ave., Coronado, Calif.
- PIERCE, FRANKLIN W. (J'24-A'26), 2415-19th Ave., Rock Island, Ill.
- PIERCE, GEORGE W. (M'13-F'15), Rumford Professor of Physics and Director of Cruft High Tension Electric Laboratory, Harvard University, Cambridge, Mass. For mail: 7 Berkeley Pl., Cambridge, Mass.
- PIERCE, JAMES F. (A'30), Patent Lawyer, 1319 F St., N.W., Washington, D.C.
- PIERCE, NORMAN J. (A'30), Member, Technical Staff, Bell Telephone Laboratories, Inc., 463 West St., New York, N.Y.
- PIERCE, R. MORRIS (A'30), Assistant Engineer, Radio Station WGAR, Statler Hotel, Cleveland, Ohio. For mail: 1416 Lewis Dr., Lakewood, Ohio.
- PIERI, DONALD (M'20), Sales Engineer, Zenith Radio Corporation, Chicago, Ill. For mail: 330 Ridgewood Ave., Glen Ellyn, Ill.
- PIEROTTI, WILLIAM L. (A'26), Superintendent, Backus Novelty Company, Smethport, Pa. For mail: 201 Franklin St., Smethport, Pa.
- PIERREPONT, JOHN JAY (A'29), Lieutenant, Radio Officer, U. S. Navy, Cruiser Division 3, U.S.S. Concord, c/o Postmaster, New York, N.Y.
- PIERSALL, BRUCE (A'31), Technician, c/o Radio Station KDB, Santa Barbara, Calif.
- PIERSON, ISRAEL S. (A'31), Radio Engineer, RCA Victor Company, Inc., Camden, N.J. For mail: 105 Central Ave., Audubon, N.J.
- PIETY, RAYMOND G. (A'27), Engineer, Brandes Laboratories, Inc., 350 Thomas St., Newark, N.J.
- PIKE, OTIS W. (A'26-M'29), Vacuum Tube Engineering Department, General Electric Company, Schenectady, N.Y.
- PILKINGTON, E. J. (A'26), 10 Dana St., Cambridge, Mass.
- PILLING, THOMAS A. (A'30), Proprietor and Manager, Bronx Radio and Television Company, 3336 Decatur Ave., New York, N.Y.
- PILZECKER, ARTHUR (A'28), Express Clerk, Electric Railway Express, 524 Huron Ave., Toledo, Ohio. For mail: 1121 Moore St., Toledo, Ohio.
- PINEAU, NORMAN T. (A'28), 230 W. 41st St., Rm. 1001, New York, N.Y.
- PINGREE, SAMUEL J. (A'25), President, Pingree MacDonald Patents, 1328 S. Kinghighway, St. Louis, Mo.
- PINKMAN, HERBERT N. (A'31), Proprietor, Radio Service, 1417 E. Pine St., Seattle, Wash. For mail: 617-28th Ave., N., Seattle, Wash.
- PINKNEY, J. L. (A'29), Serviceman, Pinkney's Electric Shop, 9 Duncan St., San Francisco, Calif.
- PINNOCK, L. W. J. (A'23), Nottingham Radio Supplies, Sherwood Bldgs., S. Sherwood St., Nottingham, England.
- PIPE, GORDON E. (A'25), Chief Inspector, Rogers-Majestic Corporation, Ltd., Toronto, Ont., Canada. For mail: 335 Beresford Ave., Toronto, Ont., Canada.
- PIPE, ROBERT E. (A'28), Wireless Engineer, c/o Marconi Wireless Telegraph Company, New St., Chelmsford, Essex, England.
- PIPPY, GEORGE A. (A'31), Springhill, N.S., Canada.
- PIROTTE, PETE (A'29), Machinist Helper, Norfolk and Western Railway, Williamson, W.Va. For mail: P.O. Box 1253, Williamson, W.Va.
- PITT, WILLIAM (A'28), Capitalist, 816 Dwight Bldg., Kansas City, Mo.
- PITTEGER, ARTHUR W. (A'28), Laboratory Assistant, Boonton Research Corporation, Boonton, N.J.
- PITTS, A. B. (A'31), 255 Whitney Ave., New Haven, Conn.
- PITTS, FRANCIS D. (A'15), Radio Distributor, F. D. Pitts Company, 219-223 Columbus Ave., Boston, Mass.
- PLACE, SAMUEL W. (A'19), Radio Engineer, Atwater Kent Manufacturing Company, 4700 Wissahickon Ave., Philadelphia, Pa. For mail: 622 Stanbridge St., Norristown, Pa.
- PLANCK, R. M. (A'29), Development Engineer, Sparks-Withington Company, Jackson, Mich. For mail: 603 S. Grinnell St., Jackson, Mich.
- PLATTS, GEORGE F. (A'30), Electrical Engineering Student, Swift Hall, University of Cincinnati, Cincinnati, Ohio. For mail: 3027 Feltz Ave., Cincinnati, Ohio.
- PLEASANTON, ARCHIE W. (A'28), First Class Radioman, Coast Guard Depot, Curtis Bay, Md. For mail: Dover Plains, N.Y.
- PLEBANSKI, JOSEF (M'29), Chief Engineer and Technical Manager, Polish Marconi Company, Mokotow, Narbutta 29, Warsaw, Poland. For mail: Wspolna 32, Warsaw, Poland.
- PLETKA, JAMES (A'29), Designer and Builder of Test Equipment, Temple Corporation, 5253 W. 65th St., Chicago, Ill. For mail: 5115 S. Winchester Ave., Chicago, Ill.
- PLOTTS, ELLERY L. (A'31), Resident Engineer, Radio Station KYW, Westinghouse Electric and Manufacturing Company, East Pittsburgh, Pa. For mail: 2305 Straus Bldg., Chicago, Ill.
- PLUMMER, WILLIAM E. (A'30), Radio Development Engineer, Bell Telephone Laboratories, Inc., 463 West St., New York, N.Y.
- POCH, WALDEMAR J. (A'28), Engineer, RCA Victor Company, Inc., Camden, N.J. For mail: 301 Bank Ave., Riverton, N.J.
- POCOCK, HUGH S. (M'22), Electrical Engineer, Editor, *Wireless World*, Wireless Press, London, England. For mail: 43 Shoot Up Hill, London, N.W. 2, England.

- PODELL, SAMUEL (A'30), President, P. G. Music Service, Inc., 4 S. 9th Ave., Mount Vernon, N.Y. For mail: 220 Westchester Ave., Mount Vernon, N.Y.
- PODOLSKY, LEON (A'30), Engineer, RCA Victor Company, Inc., Bldg. 5, 6th Floor, Camden, N.J. For mail: 128 S. Salford St., Philadelphia, Pa.
- POHLMAN, G. ANTON (A'26), Toll Line Engineer, Pacific Telephone and Telegraph Company, Los Angeles, Calif. For mail: 1855 S. El Molino, San Marino, Calif.
- POLKINGHORN, FRANK A. (A'25), Member of Technical Staff, Bell Telephone Laboratories, Inc., 463 West St., New York, N.Y.
- POLLACK, DALE (J'30), Student, Electrical Engineering Department, Columbia College, New York, N.Y. For mail: 622 W. 114th St., New York, N.Y.
- POLLARD, LEON G. (A'26), Engineer, Western Union Telegraph Company, Water Mill, L.I., N.Y. For mail: 249 Little Plains Rd., Southampton, L.I., N.Y.
- POLLOCK, ALEXANDER (A'30), Service Manager, T. Eaton Company, Ltd., Toronto, Ont., Canada. For mail: 72 Bastedo Ave., Toronto, Ont., Canada.
- POLLOCK, C. A. (A'28), Grimes Radio Corporation, Kitchener, Ont., Canada. For mail: Benton St., Kitchener, Ont., Canada.
- POLLOCK, HARRY B. (A'31), Substation Operator, Potomac Electric Power Company, Washington, D.C. For mail: 4448 Greenwich Pkwy., N.W., Washington, D.C.
- POLYDOROFF, W. J. (M'24), Director of Research, Johnson Laboratories, Inc., 609 W. Lake St., Chicago, Ill.
- POMY, HERMAN J. (A'30), Neon Engineer, Federal Electric Company, 8700 S. State St., Chicago, Ill. For mail: 4133 Howard St., Western Springs, Ill.
- POND, EDWARD W. JR. (A'29), Serviceman, Pond and Williams, 2505 S. Hobson St., Philadelphia, Pa. For mail: 1604 Helena St., Allentown, Pa.
- PONSFORD, WALTER W. (A'28), Radio and Telegraph Specialist, Graybar Electric Company, 1910 Cherry St., Philadelphia, Pa.
- PONTO, AARON E. (A'26), Proprietor, Ponto Radio Service, 105 S. Race St., Neenah, Wis.
- POOLE, ROBERT J. (A'24), Radio Engineer, Bell Telephone Laboratories, Inc., 463 West St., New York, N.Y. For mail: 85 Washington Ave., Morristown, N.J.
- POOR, WALTER E. (A'29), Vice President, Hygrade Lamp Company, Salem, Mass. For mail: 27 Chestnut St., Salem, Mass.
- POORMAN, EDWIN H. (J'29), Technician, Pickwick Broadcasting Corporation, 214 S. Vermont Ave., Los Angeles, Calif. For mail: 1415 Bundy Dr., West Los Angeles, Calif.
- POPE, FIORE J. (A'31), Radio Engineer, RCA Photophone, Inc., 180 Michigan Ave., Chicago, Ill. For mail: 6718 Merrill Ave., Chicago, Ill.
- POPPELE, JACOB R. (A'30), Radio Engineer, Radio Station WOR, Newark, N.J. For mail: 99 Tuscan Rd., Maplewood, N.J.
- POPPELTON, JOHN (A'30), Technical Representative, T. Beadle, Ltd., 370 Cleethorpe Rd., Grimsby, Lincolnshire, England. For mail: 79 Fuller St., Cleethorpe, Lincolnshire, England.
- PORT, CLYDE G. (A'31), Manager, Radio Repair Department, Pipestone Tire and Battery Company, 113 S. Anna St., Pipestone, Minn. For mail: 103 E. French St., Pipestone, Minn.
- PORTER, HARRY F. (A'30), Electrical Engineer, Allegheny Steel Company, Brackenridge, Pa. For mail: 1117 Carlisle St., Tarentum, Pa.
- PORTER, R. A. (A'18), Professor of Physics, Syracuse University, Syracuse, N.Y. For mail: 861 Ostrom Ave., Syracuse, N.Y.
- PORTER, RALPH H. (A'14), Merchants National Bank, Salem, Mass. For mail: 253 Essex St., Salem, Mass.
- PORTER, ROLAND G. (A'26), Associate Professor of Electrical Engineering, School of Engineering, Northeastern University, Boston, Mass. For mail: 19 Woodbury St., Beverly, Mass.
- PORTER, SAMUEL (A'29), Radio Serviceman, 135 Nevada St., W., Detroit, Mich.
- PORTS, EARL G. (A'25), Communication Research Engineer, Radio Department, International Communication Laboratories, 200 Mount Pleasant Ave., Newark, N.J.
- POTEET, DANIEL P. (A'17), First Lieutenant, 18th F.A., Fort Sill, Okla.
- POTTER, JAMES L. (A'31), Instructor, Department of Electrical Engineering, State University of Iowa, Iowa City, Iowa. For mail: 232 S. Summit, Iowa City, Iowa.
- POTTER, MAX (A'29), Projectionist, Congress Theatre, St. John's Pl., Brooklyn, N.Y. For mail: 186 Hopkinson Ave., Brooklyn, N.Y.
- POTTER, MELVILLE R. (A'23), Service Manager, Allen-Cadillac Corporation, 910 Erie Blvd., E., Syracuse, N.Y. For mail: 140 Edge Hill Rd., Syracuse, N.Y.
- POTTER, M. L. (A'26), Amateur Experimente, 233 East Ave., Park Ridge, Ill.
- POTTEK, N. M. (A'30), Radio Development Laboratory, Canadian National Carbon Company, Ltd., 805 Davenport Rd., Toronto, Ont., Canada.
- POTTER, RALPH K. (A'25-M'26), Radio Engineer, Department of Development and Research, American Telephone and Telegraph Company, Rm. 1606-A, 195 Broadway, New York, N.Y.
- POTTER, ROBERT C. (J'27), Radio Repairman, Department 803, T. Eaton Company, Ltd., James St., Hamilton, Ont., Canada. For mail: 115 Hyde Park Ave., Hamilton, Ont., Canada.
- POTTER, WILLIAM S. (A'31), Engineer, Pittsburgh Equitable Meter Company, 400 N. Lexington Ave., Pittsburgh, Pa. For mail: 805 S. Braddock Ave., E. E., Pittsburgh, Pa.
- POTTS, EDWARD (A'29), Assistant Engineer, Radio Section, G. P. O., Alder House, Aldersgate St., London, E.C. 1, England. For mail: 4 Hollycroft Ave., Wembley, Middlesex, England.
- POTTS, JOHN H. (A'27), 41 Cypress Ave., Bogota, N.J.
- POULSEN, VALDEMAR (F'15), Doctor of Philosophy, Maltgaardsvej 6, Gentofte, Denmark.
- POULTER, ROBERT C. (A'30), Editor, *Radio Trade Builder*, 347 Adelaide St., W., Toronto, Ont., Canada. For mail: 27 Sherwood Ave., Toronto, Ont., Canada.

- POUND, ERNEST J.** (A'24), Technical Supervisor, L. McMichael, Ltd., Bucks, England. For mail: Kingstone House, Kingstone, Shrivensham, Berks, England.
- POUND, HARRIS D.** (A'28), 529 Dominion St., Winnipeg, Manit., Canada.
- POUNSETT, FRANK H. R.** (A'26), Radio Engineer, De Forest Radio Corporation, Carlaw Ave., Toronto, Ont., Canada. For mail: 36 Nursewood Rd., Toronto, Ont., Canada.
- POWDITCH, H. J.** (A'31), Porth House, Porth, St. Columb Minor, Cornwall, England.
- POWELL, EDWIN L.** (A'14-M'29), Vice President and Secretary, Charles R. Speaker and Company, Inc., Evening Star Bldg., Washington, D.C. For mail: 5425 Connecticut Ave., Washington, D.C.
- POWELL, LEVIN D.** (A'31), Letter Carrier, Post Office, Salisbury, Md. For mail: 104 W. London Ave., Salisbury, Md.
- POWELL, LOUIS H.** (J'27-A'30), Pacific Telephone and Telegraph Company, San Francisco, Calif. For mail: 34 Athens St., San Francisco, Calif.
- POWELL, RALPH C., JR.** (A'25), Consulting Engineer, 350 Madison Ave., New York, N.Y.
- POWER, LAWRENCE T.** (A'31), Radio Service Manager, Thompson and Holmes, Ltd., 171 Bluxome St., San Francisco, Calif. For mail: 2710 Hillegass Ave., Berkeley, Calif.
- POWERS, WALTER P.** (A'14-M'26), Secretary, U. S. Tool Company, Inc., Ampere, N.J.
- POWLES, FREDERICK T.** (A'30), Student Engineer, Radio Test Department, Bldg. 89, General Electric Company, Schenectady, N.Y. For mail: 1705 Campbell Ave., Schenectady, N.Y.
- PRAKIT, PHYA** (M'30), Director General, Post and Telegraph Department, Bangkok, Siam.
- PRAMSHEFER, THOMAS W.** (A'30), Shop Foreman, Aeolian Company, 780 E. 138th St., New York, N.Y. For mail: 317-24th St., Guttenburg, N.J.
- PRATT, FEARING** (A'24), Rate Engineer, New England Telephone and Telegraph Company, 234 Washington St., Providence, R.I. For mail: Hingham Center, Mass.
- PRATT, HARADEN** (A'14-M'17-F'29), Vice President and Chief Engineer, Mackay Radio and Telegraph Company, 67 Broad St., New York, N.Y.
- PRATT, P. W.** (A'25), 142 Garland St., Everett, Mass.
- PREECE, RICHARD, JR.** (A'26), E. 421-10th Ave., N., St. Petersburg, Fla.
- PRELL, GEORGE R.** (A'29), Manager, Radio Department, General Electric Corporation of Oklahoma, 127 E. California St., Oklahoma City, Okla. For mail: 10 E. 8th St., Oklahoma City, Okla.
- PRENTISS, HOWARD H.** (A'28), Superintendent, Newport District, Utica Gas and Electric Company, Newport, N.Y. For mail: Poland, N.Y.
- PRENTISS, JOHN G.** (A'28), Manager, Test and Inspection Department, Zenith Radio Corporation, 3620 Iron St., Chicago, Ill. For mail: 1236 E. 46th St., Chicago, Ill.
- PRESSLEY, JACKSON H.** (A'20-F'31), Chief Engineer, U. S. Radio and Television Corporation, Marion, Ind.
- PRICE, ERNEST E.** (A'31), Grocer, Capitol Grocery, 361 Coteau St., W., Moose Jaw, Sask., Canada.
- PRICE, H. STEWART** (A'12-M'26), Supervisor, Radio Development Department, Bell Telephone Laboratories, Inc., 180 Varick St., New York, N.Y. For mail: 845 West End Ave., New York, N.Y.
- PRICE, HAROLD W.** (A'28), Professor, Electrical Engineering, University of Toronto, Toronto, Ont., Canada. For mail: 474 Palmerston Blvd., Toronto, Ont., Canada.
- PRICE, HARRY J.** (A'30), Radio Engineer, Bell Telephone Laboratories, Inc., Whippany, N.J. For mail: 31 Glenwood Pl., East Orange, N.J.
- PRICE, LLOYD M.** (A'31), Chief Engineer, Radio Valve Company of Canada, 189 Dufferin St., Toronto, Ont., Canada.
- PRICE, ROLAND J. C.** (J'26-A'29), Junior Radio Electrician, Radio Branch, Department of Marine, Ottawa, Ont., Canada. For mail: 91 Wheeler Ave., Toronto, Ont., Canada.
- PRICKETT, NORMAN R.** (A'31), Partner, McGlynn's Radio Service, 994 St. Paul St., Rochester, N.Y. For mail: 158½ Park Ave., Rochester, N.Y.
- PRIEBE, FRANK** (A'28), Engineer, Vacuum Tube Division, RCA Victor Company, Inc., Camden, N.J. For mail: 403 Penn St., Camden, N.J.
- PRIEST, CONAN A.** (A'24), Designing Engineer, General Electric Company, Schenectady, N.Y. For mail: 1413 Hawthorne St., Schenectady, N.Y.
- PRIEST, WARD C.** (A'26), Professor of Physics, St. Lawrence University, Canton, N.Y. For mail: 41 Judson St., Canton, N.Y.
- PRIGGE, JOHN, JR.** (A'31), Instructor, Brooklyn Boys' Continuation School, 11 Bond St., Brooklyn, N.Y. For mail: 3921-7th Ave., Brooklyn, N.Y.
- PRILIK, MAX R.** (A'30), Empey Radio Laboratory, 1309 Thieriot Ave., New York, N.Y.
- PRINCE, FRANK W.** (A'25), Technician, Spokane Radio Company, 528-1st Ave., Spokane, Wash.
- PRINSKY, HAROLD B.** (A'30), Victor Talking Machine Company, Montreal, P.Q., Canada.
- PRITCHARD, CHARLES A.** (A'30), Radiotrician, Forsyth Radio and Electric Company, Forsyth, Mont. For mail: Box 851, Forsyth, Mont.
- PROBERT, EDWARD** (A'25), Assistant General Auditor, Shaffer Oil and Refining Company, Tulsa, Okla. For mail: 1811 S. Yorktown, Tulsa, Okla.
- PROBST, JOHN E.** (A'28), Radio Service, Humback's, 333 High St., Hamilton, Ohio. For mail: 533 Ridgclawn Ave., Hamilton, Ohio.
- PROEHL, ROBERT O.** (A'29), Research Engineer, Travler Manufacturing Corporation, 1818 Washington Ave., St. Louis, Mo. For mail: 3631 Bamberger St., St. Louis, Mo.
- PROSKAUER, JULIEN J.** (A'23), Chief Engineer, Trutone Radio Sales Company, 114 Worth St., New York, N.Y. For mail: 70 E. 96th St., New York, N.Y.
- PROVIS, JACK** (A'31), Construction Engineer, Radio Station KGIR, Butte, Mont. For mail: Box 315, Idaho Falls, Idaho.
- PROW, ALBERT H.** (A'30), Assistant Workroom Superintendent, Strawbridge and Clo-

- thier, Philadelphia, Pa. For mail: 1642 N. 59th St., Philadelphia, Pa.
- PRUCHA, ERNEST F.** (A'28), Radiotrician, Sales and Service, Howells Battery Company, Howells, Neb.
- PRUITT, WILBUR C.** (A'26), Engineer, Radio Station WTAM, 1367 E. 6th St., Cleveland, Ohio.
- PRYOR, GEORGE E.** (A'31), Proprietor, Radio Engineering, 69 Plasket Grove, East Ham, London, E. 6, England. For mail: 71 Winchelsea Rd., Tottenham, London, N. 17, England.
- PUHALSKI, DONALD** (A'29), Service Engineer, 7 E. St. Charles Rd., Lombard, Ill.
- PULLEY, ALBERT A.** (A'25), Radio Engineer, RCA Victor Company, Inc., Camden, N.J. For mail: 31 Cambridge Rd., Westmont, N.J.
- PULLEY, LESTER A.** (A'18), Test Apparatus Design Engineer, Western Electric Company, Inc., 100 Central Ave., Kearney, N.J. For mail: 406 W. 5th Ave., Roselle, N.J.
- PUMPHREY, WALTER H.** (A'14-M'15), Lawyer, 113 W. 57th St., New York, N.Y.
- PUPIN, MICHAEL I.** (F'15), Professor of Electro-Mechanics, Columbia University, New York, N.Y.
- PURSER, D. E.** (A'30), Office Manager, Cross, Purser, Bull, Ltd., 269 York St., London, Ont., Canada.
- PURSELL, CLARENCE V.** (A'14), Radio Research Engineer, 61 Old Morton St., Dorchester, Mass.
- PURZNER, WILLIAM H.** (J'30), Clerk, 24-26 W. 40th St., New York, N.Y. For mail: 66-14-58th Ave., Maspeth, L.I., N.Y.
- PUTNAM, ERLE T.** (A'26), Secretary-Treasurer, Vitrolite Construction Company, 407 E. Fort St., Detroit, Mich. For mail: 515 S. Chalmers Ave., Detroit, Mich.
- PUTNAM, JOHN P.** (A'25), Radio Engineer, General Industries Corporation, 220 Grove St., Waltham, Mass. For mail: 535 Beacon St. Boston, Mass.
- PUTNAM, RALPH E. A.** (A'28), International Communications Laboratories, Inc., 67 Broad St., New York, N.Y.
- PYE, HAROLD C.** (A'20), Research Engineer, Associated Electric Laboratories, Inc., 1027 W. Van Buren St., Chicago, Ill. For mail: 424 S. Taylor Ave., Oak Park, Ill.
- PYLE, KEMPSTER W.** (A'30), Chief Engineer, Radio Station KFBI, Millford, Kan.
- PYLE, WILLIAM D.** (A'24), President, Broadcasting Station KFXF, Colorado Radio Corporation, 202 Continental Oil Bldg., Denver, Colo.
- Q**
- QUAINTANCE, LELAND C.** (A'26), Radio Division, U. S. Department of Commerce, Washington, D.C. For mail: 732 Richmond Ave., Silver Spring, Md.
- QUEMENT, FRANK J.** (A'22), Commanding Officer, Section N. 4, Volunteer Communication Reserves, 12th Naval District, San Jose, Calif. For mail: 1348 Hanchett Ave., San Jose, Calif.
- QUIGLEY, JAMES H.** (A'29), Serviceman, Gerhardt Radio Electric Company, 1614 Stone St., Falls City, Neb. For mail: 2012 Abbott St., Falls City, Neb.
- QUIST, WILLIAM G.** (A'31), Research Laboratory Assistant, 1033 W. Van Buren St., Chicago, Ill. For mail: 5958 Iowa St., Chicago, Ill.
- R**
- RAAB, EDWIN** (A'30), Engineer-in-Charge, Radio Station WDDF, Flint Police Department, Flint, Mich. For mail: 614 Pierson St., Flint, Mich.
- RABINOWITZ, MEYER** (A'28), 4302 Ogden St., Philadelphia, Pa.
- RACLIFFE, CHARLES LIONEL** (A'29), Engineer, Station WGBS, Astoria, L.I., N.Y. For mail: 3044-23rd St., Astoria, L.I., N.Y.
- RAE, WILLIAM T.** (A'25), British Broadcasting Corporation, The Parsonage, Manchester, England.
- RAFFERTY, FRANK A.** (A'23-M'24), City Radio Engineer, Department of Police, Chicago, Ill. For mail: 8027 Maryland Ave., Chicago, Ill.
- RAGAN, THOMAS C.** (A'31), Lieutenant (jg), U. S. Navy, U.S.S. Saratoga, c/o Postmaster, San Pedro, Calif.
- RAMEY, PALMER T.** (A'31), Inspection and Estimating Engineer, Union Electric Light and Power Company, 6441 Page Ave., St. Louis, Mo. For mail: 39 Lewis Pl., St. Louis, Mo.
- RAMIREZ, EDUARDO GARCIA** (M'29), Lieutenant Commander, Spanish Royal Naval Commission, 64 Victoria St., London, S.W. 1, England.
- RAMM, CARL H.** (A'29), Grigsby-Grunow Company, 4540 Armitage Ave., Chicago, Ill. For mail: 5409 Agative Ave., Chicago, Ill.
- RAMSAY, ALAN N.** (A'26), Manager, Radio and Sound Equipment Division, Frazar and Company, Ltd., 7 Front St., San Francisco, Calif. For mail: 908 Lafayette St., Alameda, Calif.
- RAMSA, FRANK R. F.** (A'30), Chief Technician, Magneti Marelli, Milan, Italy. For mail: 24 Via del Conservatorio, Milan, Italy.
- RAMSAY, JOHN F.** (J'27-A'30), Buchanan House, Greenhead, Glasgow, Scotland.
- RAMSEY, R. R.** (M'26), Professor, Department of Physics, Indiana University, Bloomington, Ind. For mail: 615 E. 3rd St., Bloomington, Ind.
- RANDALL, DORUS P.** (A'19), Professor of Electrical Measurements, Syracuse University, Syracuse, N.Y. For mail: Box 28, University Station, Syracuse, N.Y.
- RANDALL, HARRIS K.** (A'25), Writer, 1114 Merchandise Mart, Chicago, Ill.
- RANDALL, J. CLAYTON** (M'28), Radio Engineer, Radio Station WTIC, Travelers' Insurance Company, 26 Grove St., Hartford, Conn. For mail: 400 Burnside Ave., East Hartford, Conn.
- RANDALL, MARCUS C.** (A'31), Manager, Technical Service Department, F. C. Healy and Company, 10 Finsbury St., London, E.C. 2, England. For mail: 351 Waustead Park Rd., Ilford, Essex, England.
- RANDLE, HERRIN E.** (A'30), Radio Operator, S.S. Samoa, c/o Mackay Radio Company, 730 S. Spring St., Los Angeles, Calif. For mail: 1331 E. Florence Ave., Los Angeles, Calif.
- RANDOLPH, GEORGE T.** (A'29), Service Manager, J. L. Perry Company, 305 Broadway, Nashville, Tenn. For mail: 1008-18th Ave., S., Nashville, Tenn.

- RANDOLPH, L. F. (A'29), RCA Radiotron Company, Inc., 415 S. 5th St., Harrison, N.J.
- RANFT, WILLIAM O. (A'27), Chief Operator, Radio Station WFBR, Baltimore, Md. For mail: 4205 Oakford Ave., Forest Park, Baltimore, Md.
- RANGER, RICHARD H. (A'19-M'21-F'28), Consulting Engineer, 574 Parker St., Newark, N.J.
- RANKIN, SAMUEL A. (A'26), Salesman, The Buescher Company, 1310 Huron Rd., Cleveland, Ohio. For mail: 593 Prindle St., Sharon, Pa.
- RANSOM, G. B. (A'28), Rm. 1251A, 15 Dey St., New York, N.Y.
- RAPAGNANI, PETER A. (A'26), Manager, Radio Department, 1203-1205 W. 3rd St., Chester, Pa. For mail: 927 W. 3rd St., Chester, Pa.
- RAPP, JOHN CYRIL (A'30), Radio Engineer, Radio Station KMA, Shenandoah, Iowa.
- RAPSON, ERNEST T. A. (A'31), Lecturer, Electrical Engineering, Municipal Technical College, Hull, York, England. For mail: "Lynton," 17 Silverdale Rd., Hull, York, England.
- RASER, EDWARD G. (A'25), Member of Firm, Raser and Kale Radio Specialists, 330 Concord Ave., Trenton, N.J. For mail: 315 Beechwood Ave., Trenton, N.J.
- RASKHODOFF, NICHOLAS (A'29), Engineer, Radio Division, United American Bosch Corporation, Springfield, Mass.
- RASMUSSEN, ROBERT (A'30), Chief Engineer, Broadcasting Station WLBW, Oil City, Pa. For mail: P.O. Box 318, Oil City, Pa.
- RATCHFORD, WILLIAM J. (A'26), Engineer, Canadian Marconi Company, Ltd., Marconi Station, Drummondville, P.Q., Canada.
- RATCLIFFE, J. A. (M'29), Sidney Sussex College, Cambridge, England.
- RATCLIFFE, L. G. (A'29), Radio Engineer, Wireless Station, Stony Hill, St. Andrew's, Jamaica.
- RATHBUN, HARRY (A'17), Associate Professor of Law, Stanford Law School, Stanford University, Calif. For mail: P.O. Box 2171, Stanford University, Calif.
- RATHNER, JACK (A'29), J. J. Rathner, 150 W. 72nd St., New York, N.Y.
- RATTS, BRUCE H. (J'29-A'30), Chief Control Engineer, Radio Station WOWO, Fort Wayne, Ind. For mail: 1240 W. Washington St., Fort Wayne, Ind.
- RAU, DAVID S. (A'22), Engineer-in-Charge, R.C.A. Communications, Inc., Marion, Mass.
- RAYBURN, GEOFFREY D. (A'25), Radio Operator, Texas Air Transport, Winburn Field, San Antonio, Tex. For mail: 735 Bailey Ave., San Antonio, Tex.
- RAYCOVE, SOTERIOUS A. (A'31), Proprietor, King Radio Shop, 426 King St., E., Toronto, Ont., Canada.
- RAYCROFT, LOUIS B. F. (A'28), Radio Sales Department, Electric Storage Battery Company, 19th St. and Allegheny Ave., Philadelphia, Pa. For mail: 6940 Cresheim Rd., Mount Airy, Philadelphia, Pa.
- RAYMENT, K. I. (A'30), Electrical and Radio Engineer, Messrs. Durrants, Ltd., Suffolk Rd., Lowestoft, Suffolk, England. For mail: Lynmouth, 32 Regent Rd., Lowestoft, Suffolk, England.
- RAYNER, HARRY (A'30), Electrical and Radio Engineer, c/o Messrs. P. and C. Garnett, Ltd., Warfe Works, Cleckheaton, York, England. For mail: 32 Grange Rd., Cleckheaton, York, England.
- READ, GEORGE T. (A'26), Engineer, Radio Station, WIK, Cleveland, Ohio. For mail: 2609 Mapledale Ave., S.W., Cleveland, Ohio.
- READ, OSWALD W. (A'31), Staff Operator, Columbia Broadcasting System, Inc., 485 Madison Ave., New York, N.Y. For mail: c/o Radio Station WABC, Wayne, N.J.
- READY, WILLIAM A. (A'25), President, National Company, Inc., Cambridge, Mass. For mail: 416 Clinton Rd., Brookline, Mass.
- REAGER, A. M. (A'30), Partner, Taylor-Reager Radio Company, 2840 E. Washington St., Indianapolis, Ind.
- REB, FRANK P. (A'25), Radio Operator, Radiomarine Corporation of America, 75 Varick St., New York, N.Y.
- REBER, SAMUEL (F'23), General Foreign Representative, Radio Corporation of America, 570 Lexington Ave., New York, N.Y.
- RECTOR, EDWIN W. (J'31), Operator, Radio Station WKZO, Burdick Hotel, Kalamazoo, Mich.
- REDEKER, HARRY E. (A'29), Chemist, Federal Telegraph Company, Palo Alto, Calif. For mail: 319 Ramona St., Palo Alto, Calif.
- REDFERN, FOREST P. (A'27), Radio Inspector, Radio Division, U. S. Department of Commerce, Subtreasury Bldg., New York, N.Y. For mail: 1570 E. 18th St., Brooklyn, N.Y.
- REDINGTON, EDMUND B. (A'30), 512 Clark St., Waverly, N.Y.
- REEBER, HERMAN E. (A'25), Engineering Department, RCA Victor Company, Inc., Camden, N.J. For mail: P.O. Box 62, Camden, N.J.
- REED, CLIFFORD J. (A'30), Laboratory Manager, Hartman Furniture Company, 3913 Wentworth Ave., Chicago, Ill. For mail: 11931 Eggleston Ave., Chicago, Ill.
- REED, JESS M. (A'30), 3760 Kelton Ave., Los Angeles, Calif.
- REED, PINCKNEY B. (A'30), Service Inspector, RCA Photophone, Inc., 154 Walton St., Atlanta, Ga. For mail: Imperial Hotel, Greenville, S.C.
- REES, DAVID (A'24), Maesgwyn, Neath Rd., Briton Ferry, South Wales.
- REES, H. G. P. (A'30), Director and Secretary, Movie-Signs, Ltd., 31 Elizabeth St., London, S.W. 1, England. For mail: 1 Warwick Pl. N., London, S.W. 1, England.
- REESOR, DELBERT A. (A'28), Broadcast Transmitter Sales Engineer, RCA Victor Company, Inc., 100 W. Monroe St., Chicago, Ill.
- REEVES, DAVID (A'31), Assistant Radio Engineer, U. S. Air Corps at Large, Air Corps Technical School, Chanute Field, Rantoul, Ill. For mail: 318 S. Chandler St., Rantoul, Ill.
- REEVES, E. H. (A'29), Speaker Development Engineer, Masland Manufacturing Corporation, Amber and Willard Sts., Philadelphia, Pa. For mail: 5416 Whitby Ave., Philadelphia, Pa.

- REEVES, J. RUSSELL (A'25), Engineer, Bell Telephone Laboratories, Inc., 463 West St., New York, N.Y.
- REEVES, THOMAS J. (A'30), Naval Communications Office, 641 Washington St., New York, N.Y.
- REGOTTAZ, JOSEPH M. (A'25), RCA Victor Company, Inc., Camden, N.J.
- REICH, HERBERT J. (A'26), Assistant Professor, Electrical Engineering Department, University of Illinois, Urbana, Ill. For mail: 707 S. Birch St., Urbana, Ill.
- REICHLEY, CHARLES A. (A'31), Service Manager, Block Brothers, Norristown, Pa. For mail: 3rd St., Perkasie, Pa.
- REID, A. J. (A'27), General Manager, Johnstown Automobile Company, 101-111 Main St., Johnstown, Pa. For mail: Franco Ave., Westmont, Johnstown, Pa.
- REID, HENRY L. (A'23), Henry L. Reid and Company, Atlanta, Ga. For mail: 800 Myrtle St., N.E., Atlanta, Ga.
- REID, IRL H. (A'20), Engineer-in-Charge, R.C.A. Communications, Inc., Point Reyes Station, Calif.
- REID, RALPH J. (A'28), Chief Engineer, Radio Station WCKY, Covington, Ky.
- REID, THOMAS A. (A'21), 2353 E. High St., Springfield, Ohio.
- REIFEL, HARRY (A'30), Assistant Radio Engineer, Wired Radio, Inc., Ampere, N.J. For mail: 140 Norwood St., Newark, N.J.
- REIHMAN, EARL F. (A'31), RCA Victor Company, Inc., Camden, N.J.
- REILING, PAUL A. (A'29), Member, Technical Staff, 463 West St., New York, N.Y.
- REINHART, SIDNEY M. (A'26), Proprietor, Long Branch Radio Service, 145 Broadway, Long Branch, N.J.
- REISS, PAUL E. (A'30), Installation Engineer, Central Sound Systems, 3015 Regent St., East St. Louis, Ill.
- REITER, FRANK P. (A'30), Chief Projectionist, Visual Education Division, Los Angeles City School, 609 F. W. Braun Bldg., 1240 S. Main St., Los Angeles, Calif. For mail: 1117 N. Commonwealth Ave., Los Angeles, Calif.
- REKART, ARTHUR F. (A'28), Chief Engineer, Radio Stations WOWO-WGL, Fort Wayne, Ind. For mail: 1629 Spring St., Fort Wayne, Ind.
- REMDE, JACK (A'28), Maintaining Working Standards, 1650 Walnut St., Chicago, Ill. For mail: 4945 N. Melvina Ave., Chicago, Ill.
- RENFRO, HAROLD E. (A'24), Radio Engineer, City Light Department, Seattle, Wash. For mail: 1837 Hamlin St., Seattle, Wash.
- RENKE, ADOLPH (A'29), Research Laboratory Assistant, Pacnet Electric Corporation, 91-7th Ave., New York, N.Y. For mail: 689 Lenox Rd., Brooklyn, N.Y.
- RENSHAW, JOHN B. (A'31), Managing Director, Star Radio, Pty., Ltd., 90 B. Prince's Ave., Benoni, Transvaal, South Africa. For mail: P.O. Box 208, Benoni, Transvaal, South Africa.
- RENTON, RALPH JAMES (A'29), U. S. Radio Inspector, U. S. Department of Commerce, Boston Custom House, Boston, Mass. For mail: 100 Bay View Ave., Quincy, Mass.
- REOCH, ALEXANDER E. (M'14-F'16), Vice President, RCA Photophone, Inc., 411-5th Ave., New York, N.Y.
- REPLOGLE, DELBERT E. (M'29), Vice President and Chief Engineer, De Forest Radio Company and Jenkins Television Corporation, Passaic, N.J. For mail: 443 Meadowbrook Ave., Ridgewood, N.J.
- RETTENMEYER, FRANCIS X. (A'26-M'29), Rm. 904, 180 Varick St., New York, N.Y. For mail: 41-06-50th St., Woodside, L.I., N.Y.
- RETTETTER, CLEO TRESSLER (A'30), Radio Engineer, Retter Radio Service Company, 30 W. Beechwood Ave., Dayton, Ohio.
- REUKEMA, LESTER EDWIN (A'30), Assistant Professor of Electrical Engineering, University of California, Mechanics Bldg., Berkeley, Calif. For mail: 2319 Oregon St., Berkeley, Calif.
- REUMAN, WILLIAM H. (A'25), President, Long Island Broadcasting Corporation, 4130-59th St., Woodside, L.I., N.Y.
- REUTHE, GUSTAV (M'17), Apartado 2016, Mexico, D.F.
- REVILLE, T. A., JR. (J'28), Radio Station W5VD, Route No. 3, Box 232, Amarillo, Tex.
- REYMER, STEPHEN E. (A'31), Junior Scientific Radio Aide, U. S. Bureau of Standards, Washington, D.C. For mail: 1466 Columbia Rd., N.W., Washington, D.C.
- REYNER, JOHN H. (M'25), Consulting Engineer, The Furzehill Laboratories, Boreham Wood, Herts, England.
- REYNOLDS, C. C. (A'29), Service Engineer, Thomas A. Edison, Inc., 909 Penn Ave., Pittsburgh, Pa. For mail: 7 Brushton Ave., Apartment 8, Pittsburgh, Pa.
- REYNOLDS, CLAY ELMER (A'29), 400 W. State St., Fremont, Ohio.
- REYNOLDS, F. T. (A'28), Chief Engineer, Reynolds Microphone Laboratories, 387 S. 1st St., San Jose, Calif.
- REYNOLDS, FRANK J. (A'30), Radio Distributor, 907 Florida Ave., Tampa, Fla.
- REYNOLDS, GEORGE E. (A'30), Technical Instructor, R.C.A. Institutes, Inc., Merchandise Mart Bldg., 222 N. Bank Dr., Chicago, Ill.
- REYNOLDS, JOHN L. (A'28), Consulting Engineer, Electrical Research Products, Inc., 250 W. 57th St., New York, N.Y.
- REYNOLDS, W. W. (A'30), U. S. Coast Guard, 14th and E Sts., N.W., Washington, D.C. For mail: 4408 Harrison St., N.W., Washington, D.C.
- RHOADES, A. L. (A'29), Elks' Club, Champaign, Ill.
- RHODES, L. G. E. (J'16-A'17), American Airways, Inc., Love Field, Dallas, Tex.
- RHYS-JONES, JOHN E. (A'28), Radio Engineer, Marconiophone Company, Telephone House, Tottenham Court Rd., London, England. For mail: 50 Callander Rd., S.E. 6, London, England.
- RICCOBONO, SEBASTIAN (A'28), Engineering Department, United Scientific Laboratories, 510-518-6th Ave., New York, N.Y. For mail: 896 Troy Ave., Brooklyn, N.Y.
- RICE, ARTHUR R. (A'31), Radio Engineer, Navy Department, Radio Material Office, Mare Island, Calif. For mail: 1040 Georgia St., Vallejo, Calif.
- RICE, CHESTER W. (A'16-M'26-F'28), Assistant Vice President, in Charge of Engineering, General Electric Company, 1 River

- Rd., Schenectady, N.Y. For mail: 3 Lowell Rd., Schenectady, N.Y.
- RICE, HAROLD E.** (A'28), Engineer, New England Telephone and Telegraph Company, 50 Oliver St., Boston, Mass. For mail: 11 James St., Portland, Maine.
- RICE, ROBERT E.** (A'31), Chief Engineer, International Sound Recording Corporation, 32 W. Randolph St., Chicago, Ill. For mail: 1804 W. Congress St., Chicago, Ill.
- RICH, C. E.** (A'29), Engineer, Cardon Corporation, Jackson, Mich. For mail: 303 W. High St., Jackson, Mich.
- RICH, F. L.** (A'28), Technician, Radio Department, Sanger Brothers, Dallas, Tex. For mail: 3932 Simpson St., Dallas, Tex.
- RICHARD, CHARLES W.** (A'21-M'26), Radio Engineer, Air Corps at Large, U. S. Army, Chanute Field, Rantoul, Ill. For mail: 416 E. Belle Ave., Rantoul, Ill.
- RICHARDS, AMYLE P.** (A'30), Research Engineer, The Baldwin Company, Cincinnati, Ohio. For mail: 206 Main Ave., Newport, Ky.
- RICHARDS, FOLKE** (A'29), Designer, Westinghouse Electric and Manufacturing Company, East Pittsburgh, Pa. For mail: 735 Franklin Ave., Pittsburgh, Pa.
- RICHARDS, HORACE JEROME** (A'29), Assistant Engineer, Inspection Development Branch, Western Electric Company, Inc., Kearny, N.J. For mail: 149 Burnside Ave., Cranford, N.J.
- RICHARDS, PAUL** (A'31), Service Manager, Maloney's Sport Shop, 193 Broadway, Bayonne, N.J. For mail: 5 Kelly Pkwy., Bayonne, N.J.
- RICHARDS, PHILIP A.** (A'29), Development Laboratory, RCA Radiotron Company, Inc., 415 S. 5th St., Harrison, N.J. For mail: 547 N. Grove St., East Orange, N.J.
- RICHARDS, W. S.** (A'29), Regional Service Manager, General Motors Radio Corporation, 804 Bendix Bldg., Los Angeles, Calif. For mail: 1467 Temple St., Los Angeles, Calif.
- RICHARDSON, A. G.** (A'25-M'29), 387a McDonough St., Brooklyn, N.Y.
- RICHARDSON, CHARLES L.** (M'25), Consulting Radio Engineer, 1230 Shaw St., Toronto, Ont., Canada.
- RICHARDSON, F. C.** (A'29), Radio Manager, Colmore Depot, 85 Station St., Birmingham, England. For mail: 48 Fitzjohn Ave., High Barnet, Herts, England.
- RICHARDSON, J. STUART** (A'30), Northern Electric Company, Ltd., 637 Craig St., W., Montreal, P.Q., Canada.
- RICHARDSON, L. WALTON** (A'24), Electrical Radio Engineer, General Electric Company, 1 River Rd., Schenectady, N.Y. For mail: 110 Seeley St., Scotia, N.Y.
- RICHARDSON, MARSTON S.** (A'26), Plant Inventory and Costs Engineer, Wisconsin Telephone Company, 722 N. Broadway, Milwaukee, Wis. For mail: 714-9th Ave., Wauwatosa, Wis.
- RICHARDSON, OTTO H.** (A'31), Operator, Radio Station KGCU, Mandan, N.D. For mail: 805-5th Ave., N.W., Mandan, N.D.
- RICHELIEU, C. C.** (A'31), First Operator, Radiomarine Corporation of America, Radio Station WRL, 927-9th Ave., W., Duluth, Minn. For mail: 726 W. 3rd St., Duluth, Minn.
- RICHIE, S. M.** (A'31), Junior Radio Engineer, U. S. Department of Commerce, c/o Superintendent of Lighthouses, Detroit, Mich.
- RICHMOND, HAROLD B.** (A'14-M'23-F'29), Treasurer, General Radio Company, 30 State St., Cambridge, Mass.
- RICHMOND, L. P.** (A'25), Associate Radio Engineer, U. S. Army Air Corps, Wright Field, Dayton, Ohio.
- RICKARD, CHARLES E.** (M'15), Deputy Engineer-in-Chief, Marconi's Wireless Telegraph Company, Ltd., Marconi House, Strand, London, England. For mail: 5 Baldwin Gardens, Acton, London, W., England.
- RICKER, NORMAN H.** (A'19), Consulting Physicist, P.O. Box 1619, Houston, Tex.
- RICKEY, LAWRENCE** (A'28), Engineer, RCA Photophone, Inc., 411-5th Ave., New York, N.Y. For mail: Wellington Hotel, North Adams, Mass.
- RIDD, WILLIAM T.** (A'31), Canadian National Railways, St. Henry Yards, Montreal, P.Q., Canada. For mail: 3462 Verdun Ave., Verdun, P.Q., Canada.
- RIDDEL, O. A.** (J'27-A'30), Radio Repairing and Experimental Work, 5783 Ridge Ave., Chicago, Ill.
- RIDDIOUGH, JOHN W.** (A'25), F. Riddiough and Son, Colonnade, Westgate, Bradford, England. For mail: Greenwood, The Oval, Guiseley, York, England.
- RIDDLE, ELMER R.** (A'29), Chief Engineer, Radio Corporation of the Philippines, Manila, Philippine Islands.
- RIDDLE, GEORGE E.** (J'30), Seventh Division, U.S.S. Medusa, c/o Postmaster, San Diego, Calif.
- RIDDLE, WILLIAM E.** (A'28), Proprietor, 9 Stevenson Lane, Saranac Lake, N.Y.
- RIDENOUR, WILLIAM S.** (J'29-A'30), Radiotrician, The Ideal Music Shop, 548 N. Gay St., Baltimore, Md. For mail: 204 N. Hilton St., Baltimore, Md.
- RIDER, JOHN F.** (A'23), Author and Radio Engineer, 1440 Broadway, New York, N.Y.
- RIDGEWAY, JOHN W.** (A'28), Assistant Manager, Radio Department, Edison Swan Electric Company, Ltd., 155 Charing Cross Rd., London, W.C. 2, England. For mail: "Threeways," Cathill Lane, Ockley, Surrey, England.
- RIDGWAY, JAMES L.** (A'27), Certified Public Accountant, Patterson and Ridgway, 74 Trinity Pl., New York, N.Y.
- RIDLING, CARROLL W.** (A'29), Radio Technician, Nunn Electric Company, 917 Scott St., Wichita Falls, Tex.
- RIEGER, WILLIAM** (A'27), Radioman, U.S.S. Vestal, c/o Postmaster, New York, N.Y.
- RIETH, HAROLD** (A'31), Proprietor, H. Rieth Radio Service, Goshen, Ind. For mail: 302 N. Main St., Goshen, Ind.
- RIETHMILLER, EARL R.** (A'29), Engineer, Cardon Corporation, Jackson, Mich. For mail: 434 Stewart Ave., Jackson, Mich.
- RIETZKE, EUGENE H.** (A'20-M'31), President, Capitol Radio Engineering Institute, Washington, D.C. For mail: Riggs Bank Bldg., 14th and Park Rd., N.W., Washington, D.C.
- RIPENBERGH, C. MORGAN** (A'31), Statistician, Chrysler Motors Corporation, 341

- Massachusetts Ave., Highland Park, Mich. For mail: 17208 Pierson Ave., Detroit, Mich.
- RIGGS, CLARE A.** (A'26), Sound Engineer, Warner Brothers Pictures, Inc., Warner Brothers First National Studios, Burbank, Calif. For mail: 3656 Valleybrink Rd., Los Angeles, Calif.
- RILEY, CONRAD D.** (A'27), Chief Radioman, U. S. Naval Communication Service, U.S.S. Louisville, c/o Postmaster, New York, N.Y.
- RINES, DAVID** (A'19), Lawyer, 20 Kilby St., Boston, Mass.
- RING, ANDREW D.** (A'26), Radio Engineer, Federal Radio Commission, Washington, D.C. For mail: 4817-36th St., Washington, D.C.
- RING, DOUGLAS H.** (A'31), Technical Staff, Bell Telephone Laboratories, Inc., Box 107, Red Bank, N.J.
- RING, EDWARD F.** (A'31), Engineer, Radio Station WTAX, Springfield, Ill. For mail: 822 S. Spring St., Springfield, Ill.
- RINGEL, ABRAHAM** (A'18-M'22), Acoustic Engineer, RCA Victor Company, Inc., Bldg. 6, Camden, N.J.
- RINGOLD, H. RUSSELL** (A'25), Line Assigner, Southern California Telephone Company, 433 S. Olive, Los Angeles, Calif. For mail: 1007 N. Havenhurst Dr., Hollywood, Calif.
- RIPLEY, HENRY P.** (A'22), Managing Director, Guy V. Laycock, Ltd., 12 Cloth Hall St., Huddersfield, England. For mail: 7 Regent Rd., Edgerton, Huddersfield, England.
- RIPPERE, R. OLIVER** (J'28-A'30), Telephone Engineer, Bell Telephone Laboratories, Inc., 463 West St., New York, N.Y. For mail: 1819 Newkirk Ave., Brooklyn, N.Y.
- RISHELL, GEORGE L.** (A'25), Vice President, Sylvania Products Company, Emporium, Pa.
- RISINGER, PAUL** (A'30), RCA Victor Company, Inc., Camden, N.J. For mail: 740 White Horse Pike, Audubon, N.J.
- RISLER, HAROLD D.** (A'28), Radio Engineer, Radio Station WPTF, Durham Life Insurance Company, Raleigh, N.C. For mail: Hughesville, Mo.
- RITLAND, HUBERT O.** (A'30), Assistant Professor, Mathematics, University of Idaho, Southern Branch, Pocatello, Idaho.
- RITTENHOUSE, JOSEPH P.** (A'30), Electrician, Smith Electric Construction Company, 2623-3rd St., N.E., Washington, D.C.
- RITTER, E. W.** (M'30), RCA Radiotron Company, Inc., Harrison, N.J.
- RITZAU, K.** (A'27), Vice President, National Geophysical Company, Houston, Tex. For mail: 2416 Milan St., Houston, Tex.
- RIU, AGUSTIN M.** (A'26), Radio Engineer, and Editor, Apartado 1058, Barcelona, Spain.
- RIVES, FRANK M.** (A'30), Radio Engineer, General Electric Company, Schenectady, N.Y. For mail: 215 Pawling Ave., Troy, N.Y.
- RIVES, TOM C.** (M'29), Captain, Signal Corps, Radio Aircraft Laboratories, Wright Field, Ohio.
- ROACH, HARRY J.** (J'31), Clerk, Box 2045, Carter Oil Company, 10th Floor, Exchange Bank Bldg., Tulsa, Okla. For mail: 2622 E. Archer, Tulsa, Okla.
- ROACH, JOHN C.** (A'31), 64 Webster St., Hartford, Conn.
- ROBB, FREDERICK G.** (A'28), Engineer, Marconi's Wireless Company, Ltd., Chelmsford, England. For mail: 8 W. Belvedere Rd., Danbury, Essex, England.
- ROBB, JOSEPH S.** (A'26), Engineer, Radio Condenser Company, Camden, N.J.
- ROBB, ROBERT J.** (A'22), President, Radio, Ltd., 202 Castle Bldg., Montreal, P.Q., Canada.
- ROBB, WILLIAM I.** (A'24), Branch Manager, Tungsram Electric Lamp Works, Milburn House, Newcastle-on-Tyne, England. For mail: "Maroda," Lilburn Gardens, Gosforth, Newcastle-on-Tyne, England.
- ROBERSON, CARL** (A'29), Serviceman, Krugers Radio and Electric Shop, Forsyth, Mont. For mail: Box 148, Forsyth, Mont.
- ROBERSON, ROBERT E.** (J'30), Student, Dodge Radio Institute, Valparaiso, Ind. For mail: Pittsboro, N.C.
- ROBERTS, EDWARD** (A'30), Manager, Radio Department, 48 E. Genesee St., Skaneateles, N.Y. For mail: 65 Genesee St., Skaneateles, N.Y.
- ROBERTS, HORACE, JR.** (A'30), Recording Engineer, Electrical Research Products, Inc., 250 W. 57th St., New York, N.Y. For mail: 2020 Valentine Ave., New York, N.Y.
- ROBERTS, R.** (A'30), Managing Director, R. Roberts, Ltd., 53 Newton St., Birmingham, England. For mail: "Croydon," Cremona Rd., Four Oaks, Warwickshire, England.
- ROBERTS, R. V.** (A'31), Public Service Official, Public Trust Office, Wellington, New Zealand. For mail: 39 Scarborough Ter., Wellington, New Zealand.
- ROBERTS, SHELDON** (A'31), Electrician, Columbus Railway Power and Light Company, Columbus, Ohio. For mail: 137 W. Goodale St., Columbus, Ohio.
- ROBERT, WALTER VAN B.** (A'22-F'29), Engineer, Patent Department, Radio Corporation of America, 233 Broadway, New York, N.Y. For mail: 155 Hodge Rd., Princeton, N.J.
- ROBERTSON, JOSEPH J. C.** (A'25), International Petroleum Company, Ltd., Talara, Peru. For mail: Apartado 38, Talara, Peru.
- ROBERTSON, N. C.** (A'30), Chief of Test, E. K. Cole, Ltd., London Rd., Leigh-on-Sea, Essex, England. For mail: 20 Oakleigh Park Dr., Leigh-on-Sea, Essex, England.
- ROBERTSON, WALTER J.** (J'30-A'31), Student, College of the Pacific, Stockton, Calif. For mail: 2015 S. California St., Stockton, Calif.
- ROBERTSON, WILLIAM G.** (A'31), Radio Engineering Department, His Master's Voice Company, 4912 Sherbrooke St., W., Montreal, P.Q., Canada.
- ROBIN, GILBERT** (A'31), Radio Service Engineer, 5900 Ellsworth Ave., Pittsburgh, Pa.
- ROBINSON, A. K.** (M'30), U. S. Radio Inspector, 2116 Smith Tower, Seattle, Wash. For mail: 4216 W. Findlay St., Seattle, Wash.
- ROBINSON, ALOYSIUS V.** (A'28), Inspector, Victor Talking Machine Company, Camden, N.J. For mail: 2409 E. Huntingdon St., Philadelphia, Pa.
- ROBINSON, FORREST D.** (A'28), Supervisor, Radiomarine Corporation of America,

- Chatham, Mass. For mail: Box 631, Chatham, Mass.
- ROBINSON, FREDERICK (A'27), P.O. Box 163, La Crescenta, Calif.
- ROBINSON, FREDERICK H. (A'24), Editor, *The Broadcaster and Wireless Retailer*, 93 Long Acrc, London, W.C. 2, England.
- ROBINSON, GORDON D. (A'19), U. S. Naval Academy, Annapolis, Md. For mail: 39 Southgate Ave., Annapolis, Md.
- ROBINSON, HARRIS A. (J'27-A'29), Student Engineer, RCA Victor Company, Inc., Camden, N.J. For mail: 4300 York Rd., Philadelphia, Pa.
- ROBINSON, JOSEPH M. (A'31), Radio Operator, Radiomarine Corporation of America, 75 Varick St., New York, N.Y. For mail: 1803 Washington Ave., New York, N.Y.
- ROBINSON, PHILIP F. (A'28), Plant Manager, Radio Stations WBZ-WBZA-WIXAZ, Westinghouse Electric and Manufacturing Company, Hotel Stalder, Boston, Mass. For mail: 153 Hollis Ave., Braintree, Mass.
- ROBINSON, R. J. (A'25), U. S. Navy Yard, Mare Island, Vallejo, Calif. For mail: 1036 York St., Vallejo, Calif.
- ROBINSON, R. ROWE (A'31), Proprietor, Radio Service Company, 11 Victoria Ave., Wanganui, New Zealand.
- ROBINSON, SAMUEL S. (A'14-M'14-F'15), The Bungalow, Hollywood Farm, Edgewater, Md.
- ROCHFORD, JOHN (A'23), RCA Victor Company, Inc., Front and Cooper Sts., Camden, N.J. For mail: 229 Hopkins Ave., Hadonfield, N.J.
- ROCKWELL, RONALD J. (A'25-M'31), Radio Engineer, Sound Department, Crosley Radio Corporation, Cincinnati, Ohio. For mail: 4051 Clifton Ave., Cincinnati, Ohio.
- ROCKWOOD, ALAN C. (A'25-M'30), Vacuum Tube Engineer, Hygrade Lamp Company, Salem, Mass.
- ROCKWOOD, G. H., JR. (A'31), Member of Technical Staff, Bell Telephone Laboratories, Inc., 463 West St., New York, N.Y. For mail: 563 Argyle Ave., Orange, N.J.
- RODDY, VINCENT S. (A'30), Laboratory Assistant, Case School of Applied Science, 11000 Euclid Ave., Cleveland, Ohio. For mail: 9117 Connecticut Ave., Cleveland, Ohio.
- RODER, HANS (M'29), Radio Engineer, General Electric Company, Schenectady, N.Y. For mail: 32 Engleman Ave., Scotia, N.Y.
- RODGERS, H. C. (A'30), Manager, "Radio Rodgers," 3911 Jefferson, Houston, Tex.
- RODRIGUEZ, ALEXANDER E. (A'26), Laboratory, Belmont Electric Clock Corporation, 2222 Diversey Blvd., Chicago, Ill. For mail: North Shore X-Ray Laboratory, 1005 Belmont Ave., Chicago, Ill.
- RODWIN, GEORGE (A'25), Engineer, Member of Technical Staff, Bell Telephone Laboratories, Inc., 463 West St., New York, N.Y. For mail: 217 Hamilton Ave., St. George, S.I., N.Y.
- ROE, DOUGLAS J. (A'28), Service Work, F.A.D. Andrea, Inc., 24 Orchard St., Long Island City, N.Y. For mail: 916 S. Lombard Ave., Oak Park, Ill.
- ROEBUCK, NEEL (A'30), Sound Engineer, H. J. Baier and Son, 3241 Warrensville Center Rd., Cleveland, Ohio. For mail: 8005 Dearborn Ave., Cleveland, Ohio.
- ROEDEL, LEROY W. F. (A'27), Radiologist, Engineering Division, Brunswick Radio of Canada, Ltd., Hanna Ave., Toronto, Ont., Canada.
- ROESCH, ROBERT E. (A'25), Electrical Engineer, Virginia Public Service Company, Alexandria, Va.
- ROETKEN, A. A. (A'29), Research Department, Bell Telephone Laboratories, Inc., 463 West St., New York, N.Y. For mail: 130 Prospect St., East Orange, N.J.
- ROGERS, ARTHUR H. E. (A'19-M'22), Creed and Company, Telegraph Engineers, Croyden, England. For mail: c/o National Provincial Bank, Arundel St., London, W.C. 2, England.
- ROGERS, EDWARD S. (M'27), Engineer, Standard Radio Manufacturing Corporation, 90 Chestnut St., Toronto, Ont., Canada.
- ROGERS, HAROLD A. (A'27), Engineer-in-Charge, Station CFCF, Rm. 28, Mount Royal Hotel, Montreal, P.Q., Canada.
- ROHNER, ARNOLD J. (A'30), Engineer, RCA Victor Company, Inc., Camden, N.J. For mail: 1304 Walnut Ave., West Collingswood, N.J.
- ROHRICH, GEORGE J. (A'26), Radio Instructor, National Radio Institute, 1223 Connecticut Ave., N.W., Washington, D.C. For mail: 521 Sheridan St., Washington, D.C.
- ROLF, BRUNO (A'30), First Meteorologist, Meteorological Bureau, Stockholm 8, Sweden. For mail: Alsten, Stockholm, Sweden.
- ROLLEFSON, KARL E. (M'28), 355 Central Ave., Highland Park, Ill.
- ROLLINS, GEORGE K. (A'29), U. S. Junior Radio Inspector, U. S. Monitoring Station, Grand Island, Neb. For mail: Box 231, Grand Island, Neb.
- ROLLO, W. SMITH (A'26), Engineer, Production Department, Otis Elevator Company, Yonkers, N.Y. For mail: 383 Warburton Ave., Yonkers, N.Y.
- ROMAN, FRANK E. (J'29), Operator, Westinghouse Radio Stations KYW-KFKX, R.F.D. No. 1, Wheaton, Ill.
- ROMANDER, HUGO (A'28), Engineer, International Communications Laboratories, Inc., 200 Mount Pleasant Ave., Newark, N.J.
- ROMEO, ANTHONY (A'29), Radio Serviceman, Abraham and Strauss Company, Fulton St., Brooklyn, N.Y. For mail: 1715 W. 13th St., Brooklyn, N.Y.
- ROMPEL, WALTER A. (J'31), P.O. Box 384, New Braunfels, Tex.
- ROOF, RAYMOND B. (A'25), Teacher, Battle Creek High School, Battle Creek, Mich. For mail: 185 Hubbard St., Battle Creek, Mich.
- ROORDA, J., JR. (A'27), Laboratory Engineer, Nederlandsche Seintoestellen Fabriek, Hilversum, Holland. For mail: Van Oldenbarnevelthaan, Hilversum, Holland.
- ROOT, LELAND B. (M'27), Engineer, General Amplifier Company, 27 Commercial Ave., Cambridge, Mass. For mail: 38 Woods Ave., Somerville, Mass.
- ROSA, WALTER P. (J'30), Radio Electrician, Heintz and Kaufman, Ltd., San Francisco, Calif. For mail: 133 Nevada St., San Francisco, Calif.
- ROSE, ARTHUR F. (M'24), Telephone Engineer, American Telephone and Telegraph Company, Rm. 1731-B, 195 Broadway, New York, N.Y.

- ROSE, CHARLES F. P. (A'22), Engineer, Bell Telephone Laboratories, 463 West St., New York, N.Y.
- ROSE, F. W. (A'28), Radiotrician, Jim Bryant Company, 1417 Douglas St., Victoria, B.C., Canada. For mail: 981 Cloverdale Ave., Victoria, B.C., Canada.
- ROSE, GEORGE M., JR. (A'31), Research Engineer, Research and Development Laboratory, RCA Radiotron Company, Inc., Harrison, N.J.
- ROSE, JOHN A. (A'28), 63 W. 73rd St., New York, N.Y.
- ROSE, JOSEPH K. (A'27), Radio Service Engineer, 7545 Yates Ave., Chicago, Ill.
- ROSE, SIDNEY (A'24), Electrician, Ontario Government, Canada. For mail: Sub. 10, London, Ont., Canada.
- ROSEBRUGH, THOMAS R. (A'15), Professor of Electrical Engineering, University of Toronto, Toronto, Ont., Canada. For mail: 92 Walmer Rd., Toronto, Ont., Canada.
- ROSENBAUM, JACOB (J'27), 1023 Dumont Ave., Brooklyn, N.Y.
- ROSENBERG, ALBERT L., JR. (A'31), Radio Engineer, RCA Victor Company, Inc., Camden, N.J. For mail: 16 Ormond St., Oaklyn, N.J.
- ROSENBERG, BERNARD L. (J'30-A'31), Station Operator, Radio Station WRVA, 22nd and Main Sts., Mechanicsville, Va. For mail: 2601 Stuart Ave., Richmond, Va.
- ROSENFELD, MILLARD (A'29), Apprentice Engineer, Union Switch and Signal Company, Swissvale, Pa. For mail: 535 Jeanette St., Wilkensburg, Pa.
- ROSENWALD, EDWIN D. (A'27), Radio Sales and Services, 154 State St., Boston, Mass.
- ROSER, CLARENCE O. (J'27-A'29), Plant Supervisors Staff, Wisconsin Telephone Company, 432 Broadway, Milwaukee, Wis. For mail: 1505 N. Franklin Pl., Milwaukee, Wis.
- ROSS, J. D. (A'28), Superintendent of Light and Power, Department of Lighting and Power, Seattle, Wash.
- ROSS, KENNETH B. (A'28), 4612 Clark St., Chicago, Ill.
- ROSS, M. F. (A'29), Proprietor, Ross Radio Service, 165 W. Covina Blvd., Covina, Calif.
- ROSS, RUSSELL H. (A'24), Assistant Engineer, Minnesota Power and Light Company, Duluth, Minn. For mail: 1830 Jefferson St., Duluth, Minn.
- ROSS, STEWART C. (A'29), Radio and Electric Shop, 1929 E. Monmouth St., Philadelphia, Pa.
- ROSSI, RALPH J. T. (A'26), Engineer in Charge of Construction, R.C.A. Communications, Inc., 66 Broad St., New York, N.Y.
- ROSSMAN, DONALD V. O. (A'30), Radio Engineer, General Electric Company, Schenectady, N.Y. For mail: 1062 Baker Ave., Schenectady, N.Y.
- ROSSO, THOMAS (A'28), 1933 E. Fairmount Ave., Baltimore, Md.
- ROTHERS, HERBERT C. (A'27), Assistant Professor, Department of Electrical Engineering, Stevens Institute of Technology, Hoboken, N.J.
- ROTH, ALBERT (M'30), Radio Engineer, Westinghouse Electric and Manufacturing Company, East Pittsburgh, Pa. For mail: 5529 Bryant St., Pittsburgh, Pa.
- ROTH, HAROLD B. (A'29), Equipment Man, American Telephone and Telegraph Company, 420-3rd Ave., S., Minneapolis, Minn. For mail: 4912-41st Ave., S., Minneapolis, Minn.
- ROTH, JESSE E. (A'17), Chicago District Inspector, Western Union Telegraph Company, 427 S. La Salle St., Chicago, Ill.
- ROTHBERG, JOSEPH (J'29-A'30), Technician, Paramount Radio and Sound Laboratory, 94 Portland St., Boston, Mass.
- ROTHER, HORST (M'29), Doctor of Engineering, Hallesches Ufer 12-13, Berlin, S.W. 11, Germany.
- ROTHENBERGER, WILLIAM L. (A'28), Sales Representative, RCA Radiotron Company, Inc., 134 Peachtree St., Atlanta, Ga.
- ROTHERA, W. F. (J'25-A'29), Studio Engineer, Radio Station CKGW, King Edward Hotel, Toronto, Ont., Canada. For mail: 46 Denison Rd., E., Weston, Ont., Canada.
- ROTHERMEL, EDWIN F. (A'31), Serviceman, L. F. Drummer, 223 Sunbury St., Minersville, Pa. For mail: 136 Westwood St., Minersville, Pa.
- ROTOLO, NICHOLAS V. (A'31), Radio Serviceman, Lauter Piano Company, 591-593 Broad St., Newark, N.J. For mail: 61 Sunset Ave., Newark, N.J.
- ROUCLERE, HAROLD (A'31), Radio Engineer, De Forest Radio Company, Manhattan and Factory Sts., Passaic, N.J. For mail: 123 S. Maple Ave., Ridgewood, N.J.
- ROUSH, GUY F. (A'30), Tube Development Engineer, RCA Radiotron Company, Inc., 415 S. 5th St., Harrison, N.J. For mail: 492 Prospect St., East Orange, N.J.
- ROWAN, F. C. (A'30), Wireless Operator and Electrician, Tropical Radio Telegraph Company, P.O. Box 488, Hialeah, Fla.
- ROWE, CHARLES R. (J'19-A'21-M'27), Wired Radio, Inc., Amere, N.J. For mail: 5 Owen Dr., Maplewood, N.J.
- ROWE, HOBART E. (A'30), Test Engineer, General Electric Company, 1 River Rd., Schenectady, N.Y. For mail: 13 State St., Schenectady, N.Y.
- ROWE, HORACE N. (A'31), Sound Engineer, 1725 N. 12th St., Toledo, Ohio. For mail: 319 W. Dudley St., Maumee, Ohio.
- ROWE, THOMAS L. (A'23), Chief Studio Engineer, Radio Station WLS, 1230 W. Washington Blvd., Chicago, Ill. For mail: 4324 N. Hermitage Ave., Chicago, Ill.
- ROWE, VICTOR G. (A'25), Junior Radio Inspector, U. S. Department of Commerce, San Francisco, Calif. For mail: 36 Cervantes Blvd., San Francisco, Calif.
- ROWLAND, EDGAR S. (J'24-A'27), Consulting Radio Engineer, 27 Upper Brownhill Rd., Murslin, Southampton, England.
- ROWLAND, STIRMAN (A'31), Radio Service Manager, Smith Radio Corporation, 10 S.E. 7th St., Evansville, Ind. For mail: 901 N. Lafayette Ave., Evansville, Ind.
- ROYAL, JAMES E. (A'31), Chief Electrician, Consolidation Coal Company, Carolina, W.Va. For mail: Box 236, Carolina, W.Va.
- ROYAL, ROSCOE (A'27), Designer and Manufacturer, Photo Electric Record and Responsive Devices, 2136 Indiana Ave., Chicago, Ill.
- ROYDEN, GEORGE T. (A'19-M'27), Division Engineer, Mackay Radio and Telegraph Company, Inc., 22 Battery St., San Francisco, Calif.

- ROYS, H. E. (A'27), Engineer, RCA Victor Company, Inc., Camden, N.J. For mail: 306 White Horse Pike, Haddon Heights, N.J.
- RUBENSTEIN, S. J. (A'30), Radio Section, Post and Telegraph Laboratory, Chief Telegraph Engineer's Branch, G.P.O., Wellington, New Zealand.
- RUCKER, FREDERICK (A'30), Chief Radioman, U. S. Navy, Naval Radio Station, Charleston, S.C. For mail: Box 8, Navy Yard, Charleston, S.C.
- RUDOVE, A. J. (A'31), Engineer, Radio Station WCOH, 35 S. Broadway, Yonkers, N.Y. For mail: 33 Hudson St., Yonkers, N.Y.
- RUEDY, RICHARD (A'30), Testing Engineer, Silver Radio Factory, Toronto, Ont., Canada. For mail: 8 Tormey St., Ottawa, Ont., Canada.
- RUNDQUIST, ELLIOT C. (A'22), Radio Engineer, Radio Corporation of America, Riverhead, L.I., N.Y.
- RUNGE, WILHELM T. (M'28), Dr. Ing. Oberingenieur, Telefunken Hallesches Ufer 12, Dessauerstr. 7, Berlin-Lanowitz, Germany.
- RUNYON, CARMAN R., JR. (A'18), Vice President, Burns Bros. New York, N.Y. For mail: 544 N. Broadway, Yonkers, N.Y.
- RUSCOE, CHARLES R. (A'29), Branch Manager, Abel Smeeton, Ltd., Box 1134, Wellington, New Zealand.
- RUSH, FLOYD M. (A'31), Radio Engineer, Radio Station KMED, Sparta Bldg., Medford, Ore.
- RUSH, JAMES (A'31), Technical Adviser, James Rush and Company, Radio House, Westgate Rd., Newcastle-on-Tyne, England. For mail: 7 Horsley Rd., High Heaton, Newcastle-on-Tyne, England.
- RUSH, WALTER A. (M'13-F'24), General Superintendent, Canadian Government Radio Service, Hunter Bldg., Ottawa, Ont., Canada. For mail: 200 Rideau Ter., Ottawa, Ont., Canada.
- RUSHING, WALLACE E. (A'28), Maintenance Engineer, Radio Station WTIC, Hartford, Conn.
- RUSKIN, HENRY (A'30), Ruskin Radio Service, 4236 N. Spaulding Ave., Chicago, Ill.
- RUSPOLI, EDMONDO (A'31), 6 Piazza Belle Arti, Rome, Italy.
- RUSS, GEORGE H. (A'29), Special Test Engineer, Westinghouse Electric and Manufacturing Company, Chicopee Falls, Mass. For mail: 136 Edendale St., Springfield, Mass.
- RUSS, JOHN A. (A'30), Assistant Radio Inspector, Radio Division, U. S. Department of Commerce, 2909 David Stott Bldg., Detroit, Mich.
- RUSSELL, ARTHUR H. K. (A'26), Barrister, Lester and Russel, Toronto 2, Ont., Canada. For mail: 424 Elton Ave., Toronto 10, Ont., Canada.
- RUSSELL, CECIL R. (M'18), Radio Engineer, 194 Oxford Ter., Christchurch, New Zealand. For mail: P.O. Box 606, Christchurch, New Zealand.
- RUSSELL, HERBERT J. (A'30), Research Department, Marconi Works, Chelmsford, Essex, England.
- RUSSELL, MERWYN A. (A'30), Radio Serviceman, Poe's Jewelry Store, 305 N. Main St., Rushville, Ind. For mail: P.O. Box 264, Rushville, Ind.
- RUSSELL, M. W. G. (M'29), Proprietor, Northeastern School of Wireless Telegraphy, Radio House, 6 York Rd., Bridlington, England.
- RUSSELL, ROBERT D. (A'27), Grove St., Wellesley, Mass.
- RUSSELL, W. G. (A'28), Radio Technician, Kolster Radio, Ltd., 207 Queens Quay, Toronto, Ont., Canada. For mail: 103 Queensbury Ave., Toronto, Ont., Canada.
- RUST, LESLIE W. (A'27), Edgerton, Minn.
- RUSZKIEWICZ, LEO (A'30), Chief Tester and Inspector, U.N.C., Ltd. and International Police Radio Corporation, 325 W. Huron St., Chicago, Ill. For mail: 4354 W. Thomas St., Chicago, Ill.
- RUTAN, PAUL D. (J'30), 12 Neversink Ave., Port Jervis, N.Y.
- RYALL, HENRY (J'29), Radio Service Expert, Stern and Company, Inc., 335 Forest Ave., Portland, Maine. For mail: 67 Bradley St., Portland, Maine.
- RYAN, FRANCIS M. (J'14-A'17-M'26), Radio Engineer, Bell Telephone Laboratories, Inc., 180 Varick St., New York, N.Y.
- RYAN, HARRIS J. (M'15), Emeritus Professor of Electrical Engineering, Stanford University, Stanford University, Calif. For mail: 525 Embarcadero Rd., Palo Alto, Calif.
- RYAN, LLOYD F. (J'29), 1210 Harney St., Vancouver, Wash.
- RYAN, M. JOHN (A'27), Proprietor, Ryan's Radio Shop, 1244 Elm St., Manchester, N.H.
- RYDER, JACK D. (A'29), Electrical Engineer, Bailey Meter Company, Cleveland, Ohio. For mail: 11448 Euclid Ave., Cleveland, Ohio.
- RYLEY, RAYMOND (A'28), Manager, Service and Repair Departments, Marshall-Wells, Ltd., Edmonton, Alta., Canada. For mail: 12011-85th St., Edmonton, Alta., Canada.
- RYPINSKI, MAURICE C. (A'20-M'28), 309 Lawn Ridge Rd., Orange, N.J.
- RZYMOWSKI, E. (A'23), Engineer, Ratumowa 11, Warsaw, Prago, Poland. For mail: Karpinskiego 1 m 30, Warsaw, Zolibozz, Poland.

S

- SACHS, BERNHARD A. (A'30), Instructor, Brooklyn Boys' Continuation School, 11 Bond St., Brooklyn, N.Y. For mail: 2270 Ocean Ave., Brooklyn, N.Y.
- SACIA, C. FRED (A'26), Engineer, Research Department, Bell Telephone Laboratories, Inc., 463 West St., New York, N.Y.
- SADENWATER, HARRY (A'14-M'26), Division Engineer, Special Apparatus Division, RCA Victor Company, Inc., Camden, N.J. For mail: 160 Rhoads Ave., Haddonfield, N.J.
- SADICK, ABRAHAM I. (A'31), Proprietor, Radio Sales and Service, 1090 Simpson St., New York, N.Y.
- SAGE, FREDERIC H. (A'29), 38-01-211th St., Bayside, L.I., N.Y.
- SAGLE, R. E. (A'31), Potter Ave., Roseville, Ohio.
- SAINE, HARRY (A'29), Chief Technician, Radio Station KQW, 87 E. San Antonio St., San Jose, Calif. For mail: 1148 Lincoln Ave., San Jose, Calif.
- ST. JAMES, ROBERT T. (M'26), 1135 S. Cicero Ave., Chicago, Ill.
- ST. LAURENT, HERBERT (A'26), Circuit Design and Tube Research, Heavy Labor-

- ories, Inc., Lake Whitney, New Haven, Conn.
- ST. LOUIS, A. R. (A'29), Asia Electric Company, 269 Broadway, Shanghai, China.
- SAITO, MASAO (A'28), Japan Wireless Telegraph Company, Shutocho, Yosami-Mura, Hekikai-Gun, Aichi-Ken, Japan.
- SAITOW, KENJI (A'25), 577 Nogatamachi Arai, near Tokyo, Japan.
- SAKAI, SADA O. (A'27), Radio Engineer, Japan Wireless Company, 18, 2-chome Marunouchi, Kojimachiku, Tokyo, Japan.
- SALMONS, GEORGE C. (A'30), 13109 Athens Ave., Lakewood, Ohio.
- SALT, WILLIAM D. (A'30), Radio Engineer, Service Department, Pye Radio, Ltd., Radio Works, Cambridge, England. For mail: 5 Coverdale Rd., Lancaster, Lancashire, England.
- SALTER, DAVID (A'23), Assistant Superintendent of Telegraphs, Radio Station VPN, Nassau, N.P., Bahamas.
- SALTMARSH, BEATRICE (J'23-A'25), Sandridge, near St. Albans, Herts, England.
- SALTON, LYNN V. (M'23), T. Eaton Company, Ltd., 801 Somerset Bldg., Winnipeg, Manit., Canada. For mail: 1164 Grosvenor Ave., Winnipeg, Manit., Canada.
- SALZBERG, BERNARD (J'25-A'30), Engineer, Research and Development Laboratory, RCA Radiotron Company, Inc., Harrison, N.J. For mail: 659 E. 165th St., New York, N.Y.
- SALZER, H. S. (A'27), Assistant Lighthouse Engineer, U. S. Department of Commerce, 224 Customs House Bldg., New Orleans, La. For mail: 6028 Catina St., New Orleans, La.
- SALZER, HERMAN M. (A'28), Technical Representative, Victor Division, RCA Victor Company, Inc., Camden, N.J. For mail: 305 S. Scott St., New Orleans, La.
- SALZMAN, DAVID (A'27), 580 Howard Ave., Brooklyn, N.Y.
- SAMMONS, FLOYD (A'27), Mountain States Telephone and Telegraph Company, Fort Collins, Colo.
- SAMOILOFF, LEON (A'28), B. and B. Engineering Company, 765 Union Ave., Bridgeport, Conn.
- SAMPSON, EDWARD J. F. (J'29), Proprietor, Brockton Radio Laboratory, 273 N. Main St., Brockton, Mass. For mail: 17 E. Ashland St., Brockton, Mass.
- SAMPSON, GEORGE L. (A'31), Manager, The Farm Fruit and Produce Company, 266 Washington St., Brookline, Mass. For mail: 8 Elm St., Brookline, Mass.
- SAMPSON, JOHN C. (A'30), Secretary and Treasurer, Sampson Industries, Inc., 4225 Olive, St. Louis, Mo. For mail: 4707 Wilcox, St. Louis, Mo.
- SAMS, E. E. (A'28), Second Operator, Station KGAR, Tucson, Ariz.
- SAMUEL, ARTHUR L. (A'24), Research Engineer, Bell Telephone Laboratories, Inc., 463 West St., New York, N.Y.
- SAMUELS, GEORGE J. (A'30), Colonial Radio Service Company, 124 Fort George Ave., New York, N.Y.
- SAMUELSON, CYRUS D. (J'31), 17-7th St., Wehawken, N.J.
- SANBORN, JOHN W. (A'28), Radio Engineering, International Telephone and Telegraph Corporation, 67 Broad St., New York, N.Y.
- SANDALLS, GEORGE T., JR. (J'15-A'17), Engineer, American Telephone and Telegraph Company, 195 Broadway, New York, N.Y. For mail: 203 Harwood Ave., North Tarrytown, N.Y.
- SANDERS, EDWIN R. (A'30), Engineer, Radio Station WTIC, Hartford, Conn. For mail: 55 Fairlawn St., West Hartford, Conn.
- SANDFORT, MARK (A'31), Engineer, Pacific Telephone and Telegraph Company, 140 New Montgomery St., San Francisco, Calif.
- SANDIFER, NORWOOD H. (J'31), Service Manager, Southern Radio Distributors, Inc., 113 S. Franklin St., Tampa, Fla. For mail: 3104 Florida Ave., Tampa, Fla.
- SANDORF, IRVING J. (A'29), Instructor, Electrical Engineering, University of Nevada, Reno, Nev.
- SANDRETTO, PETER C. (A'30), Radio Development, Bell Telephone Laboratories, Inc., 180 Varick St., New York, N.Y.
- SANDS, LEO G. (J'27), Electro-Acoustical Engineer, 2119 McDougall Ave., Everett, Wash.
- SANDS, WILLIAM F. (A'27), Laboratory, Atwater Kent Manufacturing Company, 4700 Wissahickon Ave., Germantown, Philadelphia, Pa. For mail: 739 Noble St., Norristown, Pa.
- SANMANN, EDGAR J. (A'28), Postal Employee, U. S. Post Office, Los Angeles, Calif. For mail: 1010 E. Columbia, Monterey Park, Calif.
- SANTOS, ANTHONY S. (A'14), Engineer, Kolster Radio, Inc., 67 Broad St., New York, N.Y.
- SAPHIR, FRANK (A'30), Chief Engineer, Radio Station WMRJ, 162-14 Jamaica Ave., Jamaica, L.I., N.Y. For mail: 10815-103rd Ave., Richmond Hill, L.I., N.Y.
- SARDANETA, RAYMUNDO (A'23), Radio Instructor, Oasis 53 Clavevia, Mexico, D.F.
- SARGEANT, CHARLES E. (A'27), Salesman, Supreme Instrument Corporation, 130 W. 42nd St., New York, N.Y. For mail: 69 W. 68th St., New York, N.Y.
- SARNOFF, DAVID (A'12-M'14-F'17), President, Radio Corporation of America, RCA Bldg., 570 Lexington Ave., New York, N.Y.
- SARTAIN, L. B., JR. (A'29), Installation Engineer, Electrical Research Products, Inc., 440 Hurt Bldg., Atlanta, Ga.
- SARVER, FRANK M. (A'28), General Sound Ltd., Tec-Art Studios, Melrose at Bronson Ave., Los Angeles, Calif. For mail: 1444 S. Cochran Ave., Los Angeles, Calif.
- SASAKI, TEI (A'29), Taiwan Sotokufu Kotsukioku Teishinbu Konuka, Wireless Section, 113 Tomonchio Taihoku, Formosa, Japan.
- SASAKI, TOSHIRO (A'25), Radio Engineer, Japan Wireless Telegraph Company, Jiji Bldg., Marunouchi, Tokyo, Japan. For mail: 784 Kichijoji, Musashino-Machi, Tokyo, Japan.
- SASS, ISIDORE (A'29), Teacher, Abraham Lincoln High School, Brooklyn, N.Y. For mail: 1859-62nd St., Brooklyn, N.Y.
- SATEREN, M. G. (A'27), Section Engineer, Westinghouse Electric and Manufacturing Company, East Springfield, Mass. For mail: 155 Boulevard, West Springfield, Mass.
- SATOH, HAJIME (A'31), Radio Engineer, Japan Wireless Telegraph Company, Ltd., Jiji Bldg., Marunouchi, Tokyo, Japan.

- SAUERWINE, CHARLES AUGUSTUS (A'29), Chief Operator, Broadcasting Station WCBA, 725 New St., Allentown, Pa.
- SAUNDERS, WILLIAM P. (A'23), Gimbel Brothers, Philadelphia, Pa. For mail: 251 Trent Rd., Penn Wynne, Philadelphia, Pa.
- SAUNDERS, WILLIAM W. (A'29), Federal Telegraph Company, 200 Mount Pleasant Ave., Newark, N.J.
- SAVILLE, HOMER F. (J'31), Proprietor, Homer F. Saville Company, 503 W. Main St., Blanchester, Ohio.
- SAWTELL, RAYMOND I. (A'30), Assistant Radio Engineer, Signal Corps, Aircraft Radio Laboratory, Wright Field, Dayton, Ohio. For mail: 2904 Kenmore Ave., Dayton, Ohio.
- SAWYER, GORDON E. (A'27), Recording Engineer, United Artists Studio, 1041 N. Formosa Ave., Hollywood, Calif. For mail: 727 N. Alta Vista Blvd., Hollywood, Calif.
- SAXTON, ALFRED H. (A'29), Division Engineer, National Broadcasting Company, Inc., 111 Sutter St., San Francisco, Calif.
- SAYEKI, MITSURU (M'16-F'16), Chief Engineer, Japan Wireless Telegraph Company, Nippon Musen Denshin, Kabushiki Kaisha, Jiji Bldg., Marunouchi, Kojimachi-Ku, Tokyo, Japan. For mail: 23 Kasymicho, Azabuku, Tokyo, Japan.
- SAZIE, ENRIQUE (A'30), Fontecilla 76-Casa F., Casilla 3396, Santiago, Chile.
- SCANLAN, RICHARD J. (A'26), 4883 Audubon Rd., Detroit, Mich.
- SCARR, HENRY F. (A'26), Scales Engineer, Western Electric Company, Inc., 195 Broadway, New York, N.Y. For mail: 15 Reading Ter., Radburn, Fair Lawn, N.J.
- SCELL, RUSSELL G. (A'25), Proprietor, Radio Inspection Service Company, 26 Allyn St., Hartford, Conn.
- SCHABBEHAR, EDWIN A. (A'29), Sound Employee, Paramount-Famous-Lasky Corporation, 6th and Pierce Sts., Long Island City, L.I., N.Y. For mail: 358 Village Ave., Rockville Centre, L.I., N.Y.
- SCHAEFER, CARL A., JR. (A'26), Electrical Engineer, Research Department, Buckeye Incubator Company, 1305 Innisfallen Ave., Springfield, Ohio. For mail: 1759 Walnut Ter., Springfield, Ohio.
- SCHAEFER, CARL T. (A'27), Proprietor and Manager, Radio Supply Shop, Honolulu, Hawaii. For mail: P.O. Box 3054, Honolulu, Hawaii.
- SCHAEFER, HAROLD W. (J'26), Radio Engineer, Hawley Products Company, St. Charles, Ill. For mail: 5628 Grace St., Chicago, Ill.
- SCHAFER, J. PETER (A'24-M'30), Bell Telephone Laboratories, Inc., P.O. Box 122, Deal, N.J. For mail: 1115-6th Ave., Neptune, N.J.
- SCHANKS, MAURICE J. (A'30), Serviceman, Bailey's Music House, 710-12 Sprague Ave., Spokane, Wash. For mail: 1203 E. Liberty Ave., Spokane, Wash.
- SCHANZ, JOHN A. (A'30), Examining Instructor, R.C.A. Institutes, Inc., 75 Varick St., New York, N.Y. For mail: 27 Nathan Davis Pl., New York, N.Y.
- SCHAPER, WILLIAM A. (A'30), 5419 Magnolia Ave., Chicago, Ill.
- SCHAULER, VINCENT A. (A'23), Projectionist of Sound Pictures, Loew's State Theatre, Broad St., Newark, N.J. For mail: 76 Church St., Millburn, N.J.
- SCHECHTER, JACK (A'27), 307 E. 170th St., New York, N.Y.
- SCHECHTER, LEO (J'29-A'30), Radio Operator, Transcontinental and Western Air, Inc., Lambert Field, St. Louis, Mo. For mail: 1935 Semple Ave., St. Louis, Mo.
- SCHER, GEORGE H., JR. (A'31), Technical Editor, Radio Call Book Magazine, 508 S. Dearborn St., Chicago, Ill. For mail: 5424 W. 64th St., Chicago, Ill.
- SCHEPFER, ROY J. (A'29), Serviceman, Shuler Supply Company, 741 St. Charles St., New Orleans, La. For mail: 717 Greenwood St., New Orleans, La.
- SCHELDORF, MARVEL W. (A'26), 429 Maple Ave., Westmont, N.J.
- SCHELDORF, RANALD D. (A'31), Engineer, RCA Victor Company, Inc., Camden, N.J. For mail: 306 White Horse Pike, Haddon Heights, N.J.
- SHELL, RICHARD, JR. (A'27), Chief Radio Operator, South Porto Rico Sugar Company, Ensenada, Porto Rico. For mail: Ensenada, Porto Rico.
- SHELLENG, JOHN C. (M'26-F'28), Member of Technical Staff, Bell Telephone Laboratories, Inc., 463 West St., New York, N.Y.
- SHELLENGER, N. C. (A'30), Chief Engineer, Chicago Telephone Supply Company, Elkhart, Ind.
- SCHENEMAN, HENRY WESLEY (A'29), Radio Serviceman, Bateman Radio Service Company, 1854 Arapahoe St., Denver, Colo. For mail: 907 Campbell Ave., Holyoke, Colo.
- SCHENKE, KURTISS P. (A'25), 60 Midwood St., Brooklyn, N.Y.
- SCHERMERHORN, J. L. (A'12), General Manager and Chief Engineer, American Transformer Company, 178 Emmet St., Newark, N.J.
- SCHIEBER, LEONARD B. (A'29), District Representative, 1327 N. Broad St., Philadelphia, Pa. For mail: 122 E. 5th St., Lansdale, Pa.
- SCHIELE, ANTON A. (A'25), Electron Engineering Company, 1812 Masonic Temple Bldg., New Orleans, La. For mail: 820 Bordeaux St., New Orleans, La.
- SCHILLING, JOHN T. (A'20), Managing Director, WHB Broadcasting Company, Hotel Baltimore, Kansas City, Mo. For mail: 425 Bellefontaine Ave., Kansas City, Mo.
- SCHLAACK, NORMAN F. (A'25), Bell Telephone Laboratories, Inc., New York, N.Y. For mail: P.O. Box 122, Deal, N.J.
- SCHLENKER, VESPER A. (A'28), Acoustical Engineer, Vitaphone Corporation, 1277 E. 14th St., Brooklyn, N.Y. For mail: 284 Birch Wood Ter., Orange, N.J.
- SCHLESINGER, LOUIS B. (A'29), Technician, Joseph Horne Company, 5866 Burfield Ave., Pittsburgh, Pa.
- SCHLUETER, EDWARD A. (A'26), Engineer, Thomas and Schluter, 2423 Santa Clara, Alameda, Calif. For mail: 3382-62nd Ave., Oakland, Calif.
- SCHMALZRIEDT, T. (A'26), Manager, Radio Department, S. S. Kresge Company, 1493 Woodward Ave., Detroit, Mich. For mail: 14239 Mark Twain Ave., Detroit, Mich.
- SCHMIDT, ERWIN (A'28), Radio Engineer, Radio Engineering Laboratories, Inc., 100

- Wilbur Ave., Long Island City, L.I., N.Y. For mail: 39-30-59th St., Woodside, L.I., N.Y.
- SCHMIDT, JOSEPH H. (A'26), Factory Service Manager, Kolster Radio Inc., 360 Thomas St., Newark, N.J. For mail: 36 Kingsley St., West Orange, N.J.
- SCHMIED, JAMES W. (A'19), Patent Attorney, Bell Telephone Laboratories, Inc., 463 West St., New York, N.Y.
- SCHMIT, DOMINIC F. (A'25), RCA Radio-tron Company, Inc., Harrison, N.J.
- SCHNEEBERGER, G. B. (A'27), Electrical Engineering Department, Cleveland Electrical Illuminating Company, P.O. Box 392, Cleveland, Ohio.
- SCHNEIDER, MENDELL (A'25), Radio Service Shop, 48 Delevan St., Rochester, N.Y.
- SCHNEIDER, ROBERT E. (A'30), Radio Inspector, Radiomarine Corporation of America, 75 Varick St., New York, N.Y. For mail: 362 Riverside Dr., New York, N.Y.
- SCHNEIDER, W. A. (M'28), Assistant Professor of Physics, Washington Square College, New York University, New York, N.Y.
- SCHNELL, F. H. (A'19-M'26), Chief, Engineering Staff, Radio and Television Institute, 2150 Lawrence Ave., Chicago, Ill. For mail: 4915 N. Sawyer Ave., Chicago, Ill.
- SCHNELL, LOUIS J. (A'25), Department of Electrical Engineering, University of Minnesota, Minneapolis, Minn. For mail: 531 Walnut St., S.E., Minneapolis, Minn.
- SCHNELL, WILLIAM J. (A'26), Chief Engineer, Electrical Research Laboratories, 1731 W. 22nd St., Chicago, Ill. For mail: 1514 Wisconsin Ave., Berwyn, Ill.
- SCHNOLL, NATHAN (A'25), Engineer, Polymet Manufacturing Corporation, 829 E. 134th St., New York, N.Y. For mail: 2010 Powell Ave., New York, N.Y.
- SCHNOOR, FREDERICK D. (A'31), Designing Engineer, RCA Victor Company, Inc., Camden, N.J. For mail: 41 Stratford Ave., Westmont, N.J.
- SCHOCK, HARVEY H. (A'31), Radio Service Department, Westinghouse Electric Supply Company, 6th and Spruce St., Reading, Pa. For mail: 311 W. Windsor St., Reading, Pa.
- SCHOCK, ROBERT E. (A'30), Radio Engineer, R.C.A. Communications, Inc., Riverhead, L.I., N.Y. For mail: 105 E. Main St., Riverhead, L.I., N.Y.
- SCHOEN, ARTHUR L. (A'26), Eastman Kodak Company, Rochester, N.Y. For mail: 110 Parkdale Ter., Rochester, N.Y.
- SCHOENBORN, FERDINAND (A'29), Foreman, Experimental Shop, Radio Corporation of America, Riverhead, L.I., N.Y.
- SCHOENE, RUSSELL L. (A'25-M'30), Radio Tube Engineer, U. S. Radio and Television Corporation, Marion, Ind. For mail: 39 Fulton St., Bloomfield, N.J.
- SCHOENFELD, K. (A'26), Engineer, E. A. Everett, 227 Borden Ave., Long Island City, L.I., N.Y. For mail: 428-20th St., West New York, N.J.
- SCHOENWOLF, FRED L. (A'25-M'29), Chief Engineer, Radio Station WKBI, Chicago, Ill. For mail: 1917 Warner Ave., Chicago, Ill.
- SCHOLLE, FREDERICK (A'18), Scholle Brothers, 5 Nassau St., New York, N.Y. For mail: 157 W. 57th St., New York, N.Y.
- SCHOLTEN, CHARLES H. (J'27-A'29), Frigidaire Serviceman, 1313 Marshall St., Manitowoc, Wis.
- SCHOLZ, CARL E. (M'26), International Telephone and Telegraph Corporation, 67 Broad St., New York, N.Y.
- SCHONERT, K. E. (A'30), Engineer, Radio Broadcasting Station WEBQ, Harrisburg, Ill. For mail: 305 W. Church St., Harrisburg, Ill.
- SCHOOLEY, HAROLD (A'28), Radio Service Engineer, W. H. S. Radio Service, Allentown, Pa.
- SCHOR, F. W. (A'29), Engineer, Grigsby-Grunow Company, Chicago, Ill. For mail: 6107 Glenwood Ave., Chicago, Ill.
- SCHOTEL, G. (M'28), Engineer, Technical Bureau of Colonial Office, Carel Van Bylandtlaan 12, The Hague, Holland. For mail: 142 Bentinck Straat 142, The Hague, Holland.
- SCHOU, CARL (A'20), Dronninggaards Alle, Holte, Denmark.
- SCHRADER, HAROLD J. (A'31), Radio Engineer, RCA Victor Company, Inc., Rm. 411, Bldg. 7, Camden, N.J.
- SCHRADER, WILLIAM A. (A'31), Senior in Electrical Engineering, Armour Institute of Technology, 3305 S. Michigan Ave., Chicago, Ill.
- SCHRAMM, FRED W. (A'25), Telephone Engineer, American Telephone and Telegraph Company, 195 Broadway, New York, N.Y.
- SCHRAMM, WILLIAM C. (A'27), Radio Service Engineer, Radio Parlor, Inc., 2671 Broadway, New York, N.Y. For mail: 21-37-36th St., Astoria, L.I., N.Y.
- SCHREGARDUS, DIRK (A'26), Transmission Engineer, Ohio Bell Telephone Company, 750 Huron Rd., Cleveland, Ohio.
- SCHPEIBER, ERNEST H. (A'28), Engineer, Southern California Telephone Company, 740 S. Olive St., Los Angeles, Calif.
- SCHREYER, T. E. (A'31), Operation Supervisor, National Broadcasting Company, Inc., Merchandise Mart, Chicago, Ill.
- SCHRYVER, HENRY A. (A'27), Engineer, Boydel Corporation, 2732 Broadway, Fort Wayne, Ind. For mail: 314 Arcadia Ct., Fort Wayne, Ind.
- SCHUBERT, FRED (J'30-A'30), 102-27-47th Ave., Corona, L.I., N.Y.
- SCHUETZ, ROBERT F. (J'28-A'28), Equipment Design Engineer, National Broadcasting Company, Inc., 711-5th Ave., New York, N.Y. For mail: 9406-34th Rd., Jackson Heights, L.I., N.Y.
- SCHULTES, MARTIN F. (A'26), Sales Manager, Radio Engineering Laboratories, Inc., 100 Wilbur Ave., Long Island City, L.I., N.Y. For mail: 252-16 Brattle Rd., Little Neck, L.I., N.Y.
- SCHULTZ, ARTHUR F. (A'29), Radio Service Supervisor, Philadelphia Storage Battery Company, 1669 Main St., Buffalo, N.Y. For mail: 7 Tennis St., Albany, N.Y.
- SCHULTZ, HARVEY R. (A'30), Engineering Staff, c/o Radio Station KFAB, Lincoln, Neb.
- SCHULTZ, JAMES (A'30), Operating Engineer, Radio Station WCAO, Monumental Radio Company, 811 W. Lanvale St., Baltimore, Md. For mail: 3621 Oakmont Ave., Baltimore, Md.

- SCHULTZ, PAUL C. (A'26), Engineer, Puffer Music Company, 42 S. California St., Stockton, Calif. For mail: Route No. 6, P.O. Box 95, Stockton, Calif.
- SCHULZE, HERI T. (A'28), Salesman, Birkel Music Company, Los Angeles, Calif. For mail: P.O. Box 2001, Hollywood, Calif.
- SCHUSTER, AMOS M. (A'31), Repairman, Commonwealth Edison Company, 2222 S. Throop St., Chicago, Ill. For mail: 1647 Edgewater Ave., Chicago, Ill.
- SCHWAB, CHARLES B. (A'25), Carrier Telephone Engineer, Ohio Public Service Company, Hanna Bldg., Cleveland, Ohio. For mail: 2443 Lincoln Way E., Massillon, Ohio.
- SCHWARTZ, LYLE H. (A'29), Bell Telephone Laboratories, Inc., Box 122, Deal, N.J.
- SCHWARZ, BERTRAM A. (M'29), Chief Engineer, De Forest Radio Corporation, Ltd., 245 Carlaw Ave., Toronto, Ont., Canada. For mail: The Eglinton Hunt Club, Toronto, Ont., Canada.
- SCHWARZ, HARVEY F. (A'28), Radio Engineer, Brunswick-Balke-Collender Company, Muskegon, Mich.
- SCHWARZENBACH, EARL E. (A'30), Radio Engineer, Westinghouse Electric and Manufacturing Company, East Pittsburgh, Pa. For mail: 327 Barnes St., Wilkinsburg, Pa.
- SCHWARZHAUPT, PAUL J. (M'26), Radio Engineer, General Electric Company, Schenectady, N.Y. For mail: 303 Ten Broeck St., Scotia, N.Y.
- SCHWENKER, ALFRED H. (A'31), Proprietor, Radio Sales and Service, 859 Hazelwood Ave., Schenectady, N.Y.
- SCHWERIN, PAUL (M'31), Chief Engineer, Perryman Electric Company, Inc., 4901 Hudson Blvd., North Bergen, N.J. For mail: 47 W. Pierrepont Ave., Rutherford, N.J.
- SCOFIELD, PHILIP F. (A'27-M'30), Chief Engineer, Heintz and Kaufman, Ltd., South San Francisco, Calif. For mail: 2310 Waverly St., Palo Alto, Calif.
- SCOFIELD, ROBERT W. (A'27), Assistant Engineer, New York and Queens Electric Light and Power Company, 40-22 Lawrence St., Flushing, L.I., N.Y.
- SCOTT, CARL A. (A'21), U.S.S. *Saratoga*, c/o Postmaster, San Pedro, Calif.
- SCOTT, F. (A'31), Draftman, RCA Victor Company, Inc., Camden, N.J. For mail: c/o Mr. John Fich, 9 Rutgers Ave., Jersey City, N.J.
- SCOTT, HERBERT J. (A'19), Engineer, Bell Telephone Laboratories, Inc., 463 West St., New York, N.Y.
- SCOTT, HOYT S. (A'23-M'29), Manager, Radio Engineer Service, Inc., 1306 Hayden Ave., Cleveland, Ohio. For mail: 17403 Harland Ave., Cleveland, Ohio.
- SCOTT, KENNETH L. (A'21), Chief of Permanent Magnet Development Department, Western Electric Company, Inc., Chicago, Ill. For mail: 4620 Wolf Rd., Western Springs, Ill.
- SCOTT, LEO L. (A'15), Traveling Auditor, Pacific Car Demurrage Bureau, 303 Wells Fargo Bldg., San Francisco, Calif. For mail: 166 Lake Ave., Piedmont, Calif.
- SCOTT, MILTON C., JR. (A'31), Engineer, Radio Station WIOU, Isle of Dreams Broadcasting Company, Miami Beach, Fla.
- SCOTT, WALTER F. (A'24), Assistant Engineer, New York Telephone Company, 1060 Broad St., Newark, N.J. For mail: 207 N. 11th St., Newark, N.J.
- SCOVILLE, GEORGE A. (A'27), Vice President and Sales Manager, Stromberg-Carlson Telephone Manufacturing Company, Rochester, N.Y.
- SCREECHFIELD, R. M. (A'29), Service Manager, Kansas City Distributing Corporation, Kansas City, Mo. For mail: 4232 Bellefontaine Ave., Kansas City, Mo.
- SCRUGGS, CLARENCE H. (A'30), Chief Radio Operator, S.S. *Mohawk*, Clyde-Mallory Line, Box 30, Bush Terminal P.O., Brooklyn, N.Y.
- SEABURY, RICHARD W. (M'26), President, Radio Frequency Laboratories, Inc., Bonton, N.J. For mail: 245 Rockaway St., Bonton, N.J.
- SEAL, H. ROBERT (A'29), Radio Engineer, Hancock Field, Santa Maria, Calif. For mail: P.O. Box 163, Menlo Park, Calif.
- SEALEY, F. W. (A'30), Junior Radio Electrician, Canadian Government Service, Esquimalt, B.C., Canada. For mail: 2227 Wenonah St., Vancouver, B.C., Canada.
- SEAMAN, GERALD C. (A'29), Receiving Engineer, Radio Corporation of America, Riverhead, L.I., N.Y. For mail: Jamesport, N.Y.
- SEAR, ARTHUR W. (A'30), Assistant Professor, Armour Institute of Technology, 3300 Federal Street, Chicago, Ill.
- SEARING, HUDSON R. (A'20), Assistant Electrical Engineer, United Electric Light and Power Company, 4 Irving Pl., New York, N.Y.
- SEARLE, REGINALD F. T. (A'30), Radio Engineer, P.O. Radio Research Station, Dollis Hill Lane, London, N.W. 2, England.
- SEARS, E. WILLIAM (A'31), Advertising Director, Schultz Baking Company, 118 W. 47th St., Kansas City, Mo.
- SEARS, GAROLD D. (J'29), 1220 N.W. 30th St., Oklahoma City, Okla.
- SEATON, STUART L. (A'29), Radio Operator and Observer, Carnegie Institute of Washington, Department of Terrestrial Magnetism, Washington, D.C.
- SEAVERSON, OSWALD I. (A'29), Electrical Engineer of Rectifier and Transformer Department, Union Switch and Signal Company, Swissvale, Pa. For mail: 301 South Ave., Wilkinsburg, Pa.
- SECAN, HARRY (A'28), Service Manager, New York Band Instrument Company, 125 Broadway, Brooklyn, N.Y. For mail: 140 Bushwick Ave., Brooklyn, N.Y.
- SECOR, HARRY W. (A'12), Consulting Electrical Engineer, Island Rd., Ramsay, N.J.
- SEEKAMP, WALTER J. (A'30), Technical Operator, American Telephone and Telegraph Company, Rm. 2426A, 24 Walker St., New York, N.Y. For mail: 124 E. 3rd St., Brooklyn, N.Y.
- SEELEY, S. WARD (A'26), Wynnewood, Pa.
- SEELEY, WALTER J. (A'22), Professor of Electrical Engineering, Duke University, Durham, N.C.
- SEFTON, EDWIN F. (A'31), Radio Serviceman, Ludwig Baumann and Company, 25 Pearson St., Long Island City, L.I., N.Y. For mail: 1755 Jarvis Ave., New York, N.Y.

- SEGAL, PAUL M. (A'26-M'29), Attorney, Donovan and Bond, 1010 Shoreham Bldg., Washington, D.C.
- SEGER, L. (A'31), Electrical Drafting, Radio Treatise Company, 1440 Broadway, New York, N.Y. For mail: 1751 Fillmore St., New York, N.Y.
- SEICHTER, MAX (A'31), Proprietor, Radio Service Shop, 430 E. 89th St., New York, N.Y.
- SEID, FRED C. (J'25-A'28), Radio Engineering Laboratories, Inc., 100 Wilbur Ave., Long Island City, L.I., N.Y. For mail: 620 Center St., North Bergen, N.J.
- SEIDLER, ABRAHAM (A'27), Engineer, Radio Receptor Company, Inc., 106-7th Ave., New York, N.Y. For mail: 26 York St., Malverne, L.I., N.Y.
- SEIDMAN, CHARLES (A'29), Factory Manager, Baltimore Radio Corporation, 725 Broadway, New York, N.Y. For mail: 315 E. 54th St., Brooklyn, N.Y.
- SEIELSTAD, HAROLD (A'28), Student, University of Wisconsin, Milwaukee, Wis. For mail: 1336 Lakepointe Ave., Detroit, Mich.
- SEILS, HARRY A. (A'28), Engineer, Radio Station WNAX, P.O. Box 355, Yankton, S.D. For mail: Hudson Apartment 1, Yankton, S.D.
- SEITZ, FRANK A., JR. (J'29), Consultant, Plant Department, Westchester Broadcasting Corporation, 100 Highland Ave., Yonkers, N.Y. For mail: 448 N. Broadway, Yonkers, N.Y.
- SEITZ, J. FRED (A'27), Salesman, Jewel Supply and Equipment Company, 34 S. Calvert St., Baltimore, Md. For mail: 2502 Dulaney St., Baltimore, Md.
- SEITZ, VALENTINE (A'27), Manager, Engineering Department, Cleveland Clinic, Euclid Ave. at 93rd St., Cleveland, Ohio.
- SELBY, EUGENE O. (A'28), Radio Engineer, RCA Victor Company, Inc., Camden, N.J. For mail: 320 Grove St., Haddonfield, N.J.
- SELIGSOHN, MAX (A'29), Service Manager, Certified Radio Laboratories, 509-61st St., Brooklyn, N.Y. For mail: 1644-52nd St., Brooklyn, N.Y.
- SELLERS, JACK D. (A'31), Transmission Man, American Telephone and Telegraph Company, Rm. 822, 1365 Cass Ave., Detroit, Mich. For mail: 14467 Mayfield Ave., Detroit, Mich.
- SELS, HOLLIS K. (A'18), Transmission and Substation Engineer, Electric Distribution Department, Public Service Electric Company, 80 Park Pl., Newark, N.J.
- SELVIDGE, HARNER (A'31), Student, Massachusetts Institute of Technology, Cambridge, Mass. For mail: 211 Thilly Ave., Columbia, Mo.
- SEMONI, ANTHONY J. (A'27), Consulting Radio Technician, 2181 Weller Way, Sacramento, Calif.
- SENAUKE, ALEXANDER (M'28), Assistant Director, Popular Science Institute, New York University, University Heights, New York, N.Y.
- SENIOR, DAVID B. (A'27), U. S. Engineering Department, Philadelphia, Pa. For mail: Garden Apartments, 6364 Germantown Ave., Philadelphia, Pa.
- SERGE, IGOR BOBROVSKY (M'26), Manager, Radio Division, Peter Smith Stamping Company, 10501 Haggerty Ave., Detroit, Mich.
- SERIG, HOWARD W. (A'29), Lieutenant, West Point, N.Y.
- SERRELL, ROBERT (A'28), Engineer, General Electric Company, Schenectady, N.Y. For mail: 1012 Wendell Ave., Schenectady, N.Y.
- SERREZE, VICTOR C. (A'30), P.O. Box 92, South Braintree, Mass.
- SERY, LESTER (A'26), Service Manager, Radio Shop of Elizabeth, 1035 Elizabeth Ave., Elizabeth, N.J. For mail: 629 Court St., Elizabeth, N.J.
- SETO, JOE N. (A'28), Isis Theatre, N. Szechuen Rd., Shanghai, China.
- SEYFERT, STANLEY S. (M'19), Acting Head, Department of Electrical Engineering, Lehigh University, Bethlehem, Pa.
- SEYMOUR, FRED M. (A'27), Proprietor, Seymour Radio Company, 3645 Nottingham Rd., Detroit, Mich.
- SHABINO, CLARKE L. (A'29), Secretary, Suburban Coal and Supply Company, 1124 Garfield St., Oak Park, Ill. For mail: 7219 Adams St., Forest Park, Ill.
- SHACKELFORD, B. E. (A'23-M'26), RCA Radiotron Company, Inc., Harrison, N.J. For mail: 377 Springdale Ave., East Orange, N.J.
- SHACKLETON, STANLEY M. (A'31), Proprietor, Wireless Retailer, St. Sampson's Sq., York, England.
- SHAFER, ALBERT G. (A'26), Inspection Superintendent, RCA Victor Company, Inc., Camden, N.J. For mail: 4410 Bond Ave., Arononink, Drexel Hill, Pa.
- SHAFER, ARTHUR B. (A'30), Proprietor, Radio Service Laboratory, 1221 Jefferson St., Memphis, Tenn.
- SHAFER, WILLIAM L. (A'23), Assistant Engineer, Bell Telephone Company of Pennsylvania, Pittsburgh, Pa. For mail: 271 Parker Dr., Mount Lebanon, Pittsburgh, Pa.
- SHAFFER, FRANK (J'29), 861-20th St., Merced, Calif.
- SHALKHAUSER, ERIC GEORGE (A'20-M'29), Chief Recording Engineer, C. L. Venable Studios, 702 S. Adams St., Peoria, Ill. For mail: 147 Cooper Ave., Peoria, Ill.
- SHAMHART, PAUL BOLTON (A'31), Assistant Business Manager, Chronicle and Staff-News, 204 W. Main St., Johnson City, Tenn. For mail: 1303 N. Roan St., Johnson City, Tenn.
- SHANAFELT, LYSLE O. (A'29), Engineer Service Department, E. T. Cunningham, Inc., 577 E. Illinois St., Chicago, Ill. For mail: 834 George St., Chicago, Ill.
- SHANDY, GEORGE P. (A'30-M'31), Direction Finder Supervisor, Radiomarine Corporation of America, 75 Varick St., New York, N.Y.
- SHANE, WILLIAM A. (A'31), Chief Engineer, Radio Station CKGW, R.R. No. 4, Bowmanville, Ont., Canada. For mail: Box 232, Bowmanville, Ont., Canada.
- SHANGRAW, CLAYTON C. (A'30-M'30), Radio Engineer, The Aviation Corporation, 122 E. 42nd St., New York, N.Y.
- SHANKLAND, ROBERT S. (A'29), Instructor in Physics, Case School of Applied Science, Cleveland, Ohio.

- SHANNON, FRANK J. (A'28), Engineer and Announcer, Radio Station WPEN, William Penn Broadcasting Company, Philadelphia, Pa. For mail: 260 Wembley Rd., Upper Darby, Pa.
- SHANNON, JOSEPH H. (M'16), Design Engineer, Radio Corporation of America, 66 Broad St., New York, N.Y.
- SHARADIN, FRANCIS A. (A'30), Manager, Radio Department, R.D. Sharadin Department Store, Kutztown, Pa. For mail: 183 Main St., Kutztown, Pa.
- SHARPE, MILBURNE O. (A'31), Student, University of Tennessee, Knoxville, Tenn. For mail: 1413 Highland Ave., Knoxville, Tenn.
- SHARPLESS, A. ROBERTS (A'19), Radio Engineer, U. S. Navy Yard, Philadelphia, Pa. For mail: 824 N. Drexel Ave., Drexel Hill, Pa.
- SHARPLESS, WILLIAM M. (A'28), Radio Engineer, Bell Telephone Laboratories, Inc., P.O. Box 107, Red Bank, N.J.
- SHAUGHNESSY, E. H. (M'20), Engineering Department, G.P.O., London, England.
- SHAW, A. C. (M'29), Engineer-in-Charge, London Station, British Broadcasting Corporation, Savoy Hill, London, W.C., England. For mail: 119 Headcorn Rd., Thornton Heath, Surrey, England.
- SHAW, DUDLEY (M'31), President and General Manager, Radio Station KFJF, National Radio Manufacturing Company, Security Bldg., Oklahoma, Okla.
- SHAW, H. B., JR. (A'30), Acting Research Engineer, North Carolina State Highway Commission, Box 247, Tarboro, N.C.
- SHAW, HENRY S. (A'17-M'21), Chairman of Board of Directors, General Radio Company, 30 State St., Cambridge, Mass. For mail: 136 High St., Exeter, N.H.
- SHAW, JAMES (J'28-A'30), Test Engineer, General Electric Company, Schenectady, N.Y. For mail: 304 Denton Ave., Lynbrook, L.I., N.Y.
- SHAW, ROBERT C. (A'29), Radio Research, Bell Telephone Laboratories, Inc., P.O. Box 122, Deal, N.J.
- SHAW, ROBERT E. (A'26), Radio Engineer, Cinch Manufacturing Corporation, 2335 W. Van Buren St., Chicago, Ill. For mail: 4906 W. Austin Ave., Chicago, Ill.
- SHAW, ROBERT M. (A'26), Lieutenant, Signal Supply Officer, Signal Corps, H.G.D., Honolulu, Hawaii.
- SHAW, SYDNEY COATES (J'30), Radio Department, All America Cables, Lima, Peru.
- SHAW, THEODORE S. (A'30), 126 N. Sparks St., Burbank, Calif.
- SHEA, RICHARD F. (A'29), Consulting Engineer, 27 Howard St., Arlington, Mass.
- SHEAFFER, CHARLES T. (A'31), 5th St., Verona, Pa.
- SHEFFER, OLAN N. (A'25), Stafford, N.Y.
- SHEFFIELD, H. M. (A'27), Specification Engineer, Engineering Department, Southwestern Bell Telephone Company, Dallas, Tex.
- SHELBY, R. E. (A'29), Laboratory Engineer, National Broadcasting Company, Inc., 711-5th Ave., New York, N.Y. For mail: 3459-89th St., Jackson Heights, L.I., N.Y.
- SHELDON, CLINTON C. (A'26), President, Sheldon Radio Company, 2631 W. Avenue 32, Los Angeles, Calif.
- SHELTON, RAYMOND W. (A'28), Shelton Radio Service Laboratories, 630 Broadway, Paducah, Ky. For mail: P.O. Box 410, Paducah, Ky.
- SHEN, PAO-GUAY (A'29), Van Yu Company, 722 Linal Rd., Nantao, Shanghai, China.
- SHEN, S. Z. (A'29), Radio Engineer, Bureau of International Electric Communications, Ministry of Communications, 565 Min Kou Rd., Shanghai, China. For mail: 10 Buckle Rd., Shanghai, China.
- SHEPARD, LEO (A'31), Radio Technician, Radio Station KXX, 5049 Gloria St., Sherman Oaks, Calif. For mail: 2056 Houston St., Los Angeles, Calif.
- SHEPARD, WAYNE D. (A'31), Inspector, RCA Photophone, Inc., 202 Orpheum Bldg., Seattle, Wash.
- SHEPARD, MAXWELL (J'28-A'30), Service Shop, 48 Flinders St., Adelaide, South Australia. For mail: Box 255C, G.P.O., Adelaide, Australia.
- SHERIDAN, RUSSEL J. (A'30), Michigan Bell Telephone Company, Detroit, Mich. For mail: 12554 Jane Ave., Detroit, Mich.
- SHERK, LYNN E. (A'31), Engineer, Tube Plant, Grigsby-Grunow Company, 2020 N. Austin Ave., Chicago, Ill. For mail: 5908 Superior St., Chicago, Ill.
- SHERMAN, JESSE B. (J'28), Radio Serviceman, Musical Products Distributing Company, 22 W. 19th St., New York, N.Y. For mail: 847 Manida St., New York, N.Y.
- SHERMAN, KENNETH S. (A'27), Radio Engineer, RCA Victor Company, Inc., Camden, N.J. For mail: 39 E. Madison Ave., Collingswood, N.J.
- SHERMAN, WARREN K. (A'28), Lieutenant, U. S. Navy, Radio Material Officer, 14th Naval District, Pearl Harbor, Honolulu, Hawaii.
- SHERMUND, RALPH C. (A'29-M'31), 2300-16th Ave., San Francisco, Calif.
- SHERWOOD, LESLIE F. (A'30), Engineer, Radio Station WIOD, Isle of Dreams Broadcasting Corporation, Miami Beach, Fla.
- SHESTACOVSKY, JOHN (A'27), Student, Columbia University, New York, N.Y. For mail: 195 Ocean Ave., Brooklyn, N.Y.
- SHIGA, T. (A'31), Engineer, c/o Sapporo Hosokyoku Nakajima Park, Sapporo, Japan.
- SHIMA, SHIGEO (A'30), 45 Takawawa, Minami-cho, Shiba, Tokyo, Japan.
- SHIMAYAMA, TSURUO (A'28), Radio Engineer, Kokura Hosokyoku, Kokurashi, Japan.
- SHINOHARA, KIYOTADA (A'31), Telephone Engineer, Ministry of Communications, Tokyo, Japan. For mail: 1229 Sekiuhara Ohimachi, near Tokyo, Japan.
- SHIPMAN, CHARLES H. (A'27), Clerk, The Dodd Company, 652 Huron Rd., Cleveland, Ohio. For mail: 14805 Ardenal Ave., East Cleveland, Ohio.
- SHIRCLIFF, EMMETT (A'30), Radiotriician, c/o McDonald Drug Store, 819 Main St., Woodward, Okla.
- SHIRE, LEO E. (A'27), Charge of Radio Telephone Equipment, Andian National Corporation, Ltd., Apartado 130, Cartagena, Colombia.

- SHIRK, KENNETH C. (J'26-A'28), Chief Operator, Radio Station KOIL, Mona Motor Oil Company, 12th Ave., and 6th St., Council Bluffs, Iowa. For mail: 2407 Evans St., Omaha, Neb.
- SHMIED, ERNEST A. (A'31), Proprietor, Radio Experiment Laboratory, 1804 W. Congress St., Chicago, Ill.
- SHODA, MASARU (A'31), Professor, Department of Physics, Kohnan-Kotogakkio, near Kobe, Japan.
- SHOMBER, H. B. (A'28), Radiotechnician, Ungar and Watson, Inc., 1363 1/2 S. Figueroa St., Los Angeles, Calif. For mail: 408 Wing St., Glendale, Calif.
- SHORE, ANAK (A'19), Engineer, Marconi's Wireless Telegraph Company, Ltd., Marconi House, Strand, London, W.C. 2, England. For mail: "Edeyrn," Longstamps Ave., Chelmsford, Essex, England.
- SHORE, HENRY (A'27-M'30), Design Engineer, R.C.A. Communications, Inc., 66 Broad St., New York, N.Y.
- SHORT, DONALD WILLIAM (A'29), Television Engineer, De Forest Radio Company, Passaic, N.J. For mail: 298 Innes Rd., Woodridge, N.J.
- SHORT, HERBERT M. (A'14-M'16), Managing Director, Canadian Marconi Company, 211 St. Sacrament St., Montreal, P.Q., Canada.
- SHORT, WILLIAM P. (A'29), Engineer, 393 Central Ave., Newark, N.J. For mail: 121 Clark St., Hillside, N.J.
- SHORTER, DONOVAN E. L. (A'31), Radio Engineer, c/o International Marine Company, Connaught House, Aldwych, London, England. For mail: Kenville, 93 Colin Park Rd., Colindale, London, N.W. 9, England.
- SHORTLAND, JAMES W. (A'27), Secretary and Treasurer, Radio Training Schools, Inc., 326 Broadway, New York, N.Y. For mail: 59 Downing St., Brooklyn, N.Y.
- SHOTWELL, HAROLD H. (J'16-A'18), Chief Engineer, Operadio Manufacturing Company, 13th and Indiana Aves., St. Charles, Ill. For mail: 630-4th Ave., N., St. Charles, Ill.
- SHRADER, TERRY M. (M'30), Radio Tube Development, RCA Radiotron Company, Inc., 415 S. 5th St., Harrison, N.J.
- SHREVE, A. FRENCH (A'29), Radio Serviceman, Equitable Sales Company, 620 Braddock Ave., Braddock, Pa. For mail: 1466 Kelton Ave., Dormont, Pittsburgh, Pa.
- SHROFF, T. R. (A'31), Student, Electrical Communications Department, India Institute of Science, Bangalore, India. For mail: Advance Mills, Ltd., Ahmedabad 1, India.
- SHUEY, PAUL F. (A'25), Radio Engineer, Westinghouse Electric and Manufacturing Company, East Pittsburgh, Pa. For mail: 214 Lehigh St., Swissvale, Pittsburgh, Pa.
- SHUHART, JOHN H. (A'25), Telephone Engineer, American Telephone and Telegraph Company, 195 Broadway, New York, N.Y. For mail: Valley Forge Rd., Phoenixville, Pa.
- SHULER, JOHN H. (A'28), Engineer, Westinghouse Electric and Manufacturing Company, Mansfield, Ohio. For mail: R.F.D. No. 2, Lexington, Ohio.
- SHULTISE, QUIDO M. (A'29), Radio Engineer, Sound Engineering Corporation, 20 N. Wacker Dr., Chicago, Ill. For mail: 6142 S. Spaulding St., Chicago, Ill.
- SHULTZ, E. PATTERSON (J'28-A'30), Engineer, RCA Photophone, Inc., 7000 Santa Monica Blvd., Hollywood, Calif.
- SHUSTER, EDMUND F. (J'26-A'30), Service Manager, Radio Service Company, 31 Hazel St., Wilkes-Barre, Pa.
- SHUTE, EMMET R. (M'25), General Superintendent of Traffic, Western Union Telegraph Company, 60 Hudson St., New York, N.Y.
- SHUZUI, SABURO (A'30), Japan Wireless Telegraph Company, Haranomachi, Fukushima Prefecture, Japan.
- SIDDALL, RICHARD (A'27), 1880 Wymore Ave., East Cleveland, Ohio.
- SIEBEN, CLARENCE M. (A'29), Manager, Testing Department, High Frequency Laboratories, 28 N. Sheldon St., Chicago, Ill. For mail: 1464 Larrabee St., Chicago, Ill.
- SIEBERT, GEORGE W., JR. (A'30), Radio Service Engineer, Paramount Radio Laboratories, 129-2nd Ave., Pelham, N.Y.
- SIEGEL, SAMUEL (M'28), President, Aerovox Wireless Corporation, 70 Washington St., Brooklyn, N.Y.
- SIEMENS, R. H. (A'30), Chief Engineer, Insuline Corporation of America, 78 Cortlandt St., New York, N.Y. For mail: 104-16-110th St., Richmond Hill, L.I., N.Y.
- SIGETY, LOUIS (J'27-A'30), Studio Engineer, National Broadcasting Company, Inc., 711-5th Ave., New York, N.Y. For mail: 33 W. 55th St., New York, N.Y.
- SIGLER, F. M. (A'31) Radio Service Man, Kansas Gas and Electric Company, Arkansas City, Kan.
- SIGMON, L. C. (A'29), 46 Albion Rd., Wollaston, Mass.
- SIGNER, R. M. (A'31), Lieutenant, VP-9B, Fleet Air Base, San Diego, Calif.
- SILBERSTEIN, RICHARD (A'30), 315 Central Park West, New York, N.Y.
- SILCOX, ALBERT S., JR. (A'28), Radio Service, 1325 S. Pittsburgh St., Connellsville, Pa.
- SILENT, HAROLD C. (A'19), Engineer, Electrical Research Products, Inc., 7046 Hollywood Blvd., Los Angeles, Calif.
- SILVER, B. J. (A'31), Senior Partner, The Punjab Automobile and Radio Company, 40, The Mall, Lahore, India.
- SILVER, BENJAMIN L. (A'20), Radio Engineer, 719-8th Ave., Brooklyn, N.Y.
- SILVER, MC MURDO (A'24), President, Silver-Marshall, Inc., 6401-51 W. 65th St., Chicago, Ill.
- SIMBORI, MASAYOSI (A'28), Radio Engineer, Japan Wireless Telegraph Company, Ltd., 18-2-chome, Marunouchi, Kojimachiku, Tokyo, Japan.
- SIMMONDS, E. J. (M'25), Barclays Bank, Ltd., Old Bank, Ascot, Berks, England.
- SIMMONS, GUY A., JR. (A'30), Transmission Man, American Telephone and Telegraph Company, 121 W. 7th St., Little Rock, Ark. For mail: 1920 Main St., Little Rock, Ark.
- SIMMONS, JOHN L. (A'31), Technical Assistant, Imperial and International Communications, Ltd., Wireless Beam Station, Tenney, Lincolnshire, England.
- SIMMONS, ROBERT A., JR. (J'31), Tester and Electrician, Arma Engineering Company,

- 254-36th St. Brooklyn, N.Y. For mail: 456-7th St., Brooklyn, N.Y.
- SIMONS, RUSSELL (A'30), Radio Sales and Service, 743 Morgan Ave., Drexel Hill, Pa. For mail: P.O. Box 4, Lansdowne, Pa.
- SIMPSON, ALEXANDER V. (A'23-M'26), Radio Engineer, 28 Westgate, Burnley, Lancashire, England.
- SIMPSON, BURTON T. (A'27), Director, State Institute Study of Malignant Diseases, 113 High St., Buffalo, N.Y.
- SIMPSON, EDMUND H. (A'30), Test Rack Operator, Department U, Westinghouse Air Brake Company, Wilmerding, Pa. For mail: 416 Welsh Ave., Wilmerding, Pa.
- SIMPSON, FREDERICK H., JR. (J'26-A'30), President, Universal Radio Laboratories, Inc., Box 51, Newark, N.J.
- SIMPSON, LEROY C. (J'28-A'30), Radio Engineer, General Electric Company, Schenectady, N.Y. For mail: 8 Mynderse St., Schenectady, N.Y.
- SIMPSON, ROBERT L. (A'30), Service Manager, Moses Stationery Company, Hilo, Hawaii.
- SIMPSON, STEPHEN H., JR. (A'30), Engineer, Radio Corporation of America, Riverhead, L.I., N.Y.
- SIMS, CLOYD G. (A'31), Chief Engineer, Radio Station WPAD, Paducah, Ky. For mail: 2017 Clark St., Paducah, Ky.
- SIMS, JAMES W. (A'27), General Merchandise, J. W. Sims and Company, LaGrange, Tenn.
- SIMS, LEONARD H. (A'31), 1901-10th St., Port Arthur, Tex.
- SINCLAIR, ALLAN (A'31), Engineer, Radio Station WCAM, City Hall, Camden, N.J. For mail: 3317 Pelham Pl., Camden, N.J.
- SINCLAIR, D. B. (J'30), Student, Massachusetts Institute of Technology, Cambridge, Mass. For mail: 205 Cambridge St., Winipeg, Manito, Canada.
- SINGER, EMANUEL (A'21), Radio Service and Maintenance Company, 1285 Madison Ave., New York, N.Y.
- SINGER, LOUIS (A'30), Sound Projectionist, Paramount Studios, Long Island City, L.I., N.Y. For mail: 3026 W. 23rd St., Coney Island, N.Y.
- SINGH, HARBAKSH (J'29), Wireless Station, Kuala Lumpur, Federated Malay States.
- SINGLETON, HAROLD C. (A'25), Operations Headquarters, Portland Airport, P.O. Box 3820, Portland, Ore.
- SINSHEIMER, ARTHUR (A'26), Radio Editor and Dealer, 8th Floor, 239 W. 39th St., New York, N.Y. For mail: 1155 Brooklyn Ave., Brooklyn, N.Y.
- SIOVAC, JOHN E. (A'29), Manager, Service Department, H. A. Heinsen and Company, 3027 E. 92nd St., Chicago, Ill. For mail: 7436 Kimbark Ave., Chicago, Ill.
- SIRMS, WISWALD J. (A'27), Technical Inspector, Electrical Research Products, Inc., 123 S. Broad St., Philadelphia, Pa. For mail: 1808 Beech Ave., LaMott Oak Lane P.O., Philadelphia, Pa.
- SIVIAN, LEON J. (A'18), Research Engineer, Bell Telephone Laboratories, Inc., 463 West St., New York, N.Y.
- SIVIGNY, ALFRED J. (A'31), Newton Electric Fixture Company, 274 Centre St., Newton, Mass. For mail: 67 Dalby St., Newton, Mass.
- SKELLS, DUDLEY K. (A'29), Service Manager, Skeels Brothers, 1752 Pilgrim Rd., Toledo, Ohio. For mail: Box 214, Station C, Toledo, Ohio.
- SKELLETT, A. MELVIN, (M'30), Radio Research Engineer, Bell Telephone Laboratories, Inc., P.O. Box 122, Deal, N.J.
- SKELTON, KENNETH W. (A'28), Radio Station WDAE, Tampa Terrace Hotel, Tampa, Fla.
- SKELTON, THOMAS H. (A'30), Broadcast Supervisor, Postmaster General's Department, 120-A Russell St., Melbourne, Australia. For mail: 157 Raglan St., Preston N. 18, Victoria, Australia.
- SKIFTER, HECTOR R. (A'31), Radio Engineer, Western Radio Engineering Company, 98 W. 3rd St., St. Paul, Minn. For mail: 562 Holly Ave., St. Paul, Minn.
- SKINKER, MURRAY F. (A'29), Assistant Director of Research, Brooklyn Edison Company, 55 Johnson St., Brooklyn, N.Y.
- SKINNER, CLIFTON ROSS (A'29), Manager, C. R. Skinner Manufacturing Company, 177 Golden Gate Ave., San Francisco, Calif.
- SKINNER, OSCAR E. (A'28), Manager, Wiamo Club, Wiamo, Mass. For mail: Dennis Port, Mass.
- SKIRROW, JOHN F. (M'27), Vice President and Chief Engineer, Postal Telegraph and Cable Company, 67 Broad St., New York, N.Y.
- SKLAR, H. LEE (A'31), Chief Engineer, Micamold Radio Corporation, 1087 Flushing Ave., Brooklyn, N.Y. For mail: 867 Hornaday Pl., New York, N.Y.
- SKOV, JENS INGVAR (A'20), Radiomarine Corporation of America, 227 Fries Ave., Wilmington, Calif.
- SLADE, BENJAMIN (A'31), Radio Engineer, Bell Telephone Laboratories, Inc., 180 Varick St., New York, N.Y.
- SLATER, F. ROBERT (A'26), Engineering Department, R.C.A. Communications, Inc., Bolinas, Calif.
- SLATER, FRED L. (A'31), Proprietor, Radio Repair Service, 2478 Elm Pl., New York, N.Y.
- SLATER, SAUL I. (J'23-A'26), Chief Engineer, Ergon Electric Corporation, 20 Bergen St., Brooklyn, N.Y. For mail: 130-31-29th St., Laurelton, L.I., N.Y.
- SLATTERY, JOHN J. (J'29-A'30), Assistant Engineer, Bell Telephone Laboratories, Inc., 463 West St., New York, N.Y. For mail: 100 Williamson Ave., Bloomfield, N.J.
- SLAVICK, HENRY WILLIAM (A'28), Director and Chief Engineer, Radio Station WMC, Memphis, Tenn.
- SLAVIN, SAMUEL B. (A'29), Transmitting Engineer, Radio Corporation of America, Bolinas, Calif. For mail: 2133 Hayes St., San Francisco, Calif.
- SLEE, JOHN A. (F'29), Assistant General Manager, Marconi International Marine Communications Company, Ltd., Marconi House, Strand, London, England. For mail: 92A Holland Rd., London, W. 14, England.
- SLEEPER, J. LLOYD (A'28), Service Manager, W. H. Collins Company, 1414 W. 7th St., Los Angeles, Calif. For mail: 2535 La Crescenta, Alhambra, Calif.
- SLOAN, FRANCIS V. (A'25-M'28), U.S. Radio Inspector, U. S. Department of Commerce, 2022 Engineering Bldg., Chicago, Ill.

- SLOCUM, WALTER E. (A'31), Radio Service Engineer, Independent Radio Service, 92 Early St., Providence, R.I.
- SLONAKER, L. V. (A'30), Junior Radio Engineer, Signal Corps Laboratories, Fort Monmouth, Oceanport, N.J.
- SLYFIELD, CHARLES O. (A'31), Sound Engineer, Disney Film Recording Company, 2719 Hyperion Ave., Los Angeles, Calif. For mail: 2203 W. 73rd St., Los Angeles, Calif.
- SMACK, JOHN C. (A'30), Assistant Manager, Industrial Division, S. S. White Dental Manufacturing Company, 152 W. 42nd St., New York, N.Y.
- SMALTS, FRANKLIN W. (A'30), Student Engineer, RCA Victor Company, Inc., Camden, N.J. For mail: 1606 Caton Ave., Brooklyn, N.Y.
- SMEBY, LYNNE C. (A'27), Chief Engineer, National Battery Station KSTP, St. Paul Hotel, St. Paul, Minn. For mail: 1512 W. Broadway, Minneapolis, Minn.
- SMILEY, WILLIAM A. (A'31), Consulting Radio Engineer, 440 Market St., Leinoyne, Pa.
- SMITH, ARTHUR (A'23), Director of Physics, Central Technical School, Toronto, Ont., Canada. For mail: 52 Parkway Ave., Toronto, Ont., Canada.
- SMITH, ARTHUR C. (A'30), Recording Engineer, Australasian Films, Ltd., Cinesound Studio, Ebley St., Waverley, New South Wales, Australia.
- SMITH, ARTHUR E. (A'15), Inspection Department, Bell Telephone Laboratories, Inc., 495 Hudson St., New York, N.Y. For mail: 44 Arthur St., Ridgefield Park, N.J.
- SMITH, ARTHUR Z. (A'29), Receiving Engineer, Radio Corporation of America, Riverhead, L.I., N.Y.
- SMITH, B. J. (A'28), Sales Manager, The Millar-Smith Radio Company, Ltd., 1168 St. Clair Ave., Toronto, Ont., Canada. For mail: 234 Glenholme Ave., Toronto, Ont., Canada.
- SMITH, BENJAMIN F. (A'31), Switchboard Engineer, Algoma Steel Corporation, Sault Ste. Marie, Ont., Canada. For mail: 180 Biggins Ave., Sault Ste. Marie, Ont., Can.
- SMITH, C. C. (A'28), Meter Department, Hydro Electric Power Commission, P.O. Box 160, Niagara Falls, Ont., Canada. For mail: 1792 Dorchester Rd., Niagara Falls, Ont., Canada.
- SMITH, C. BERNARD (A'26), Research Engineer, Echophone Manufacturing Company, 908 N. Formosa Ave., Los Angeles, Calif. For mail: 958 1/2 S. Kenmore Ave., Los Angeles, Calif.
- SMITH, C. RAVENHILL (A'31), Power Plant Engineer, c/o Florida Public Service Company, Avon Park, Fla. For mail: Box 742 Avon Park, Fla.
- SMITH, CARL E. (A'30), Graduate Student, Ohio State University, Columbus, Ohio. For mail: 318-17th Ave., Columbus, Ohio.
- SMITH, CHARLES S., JR. (A'25), Supervisor, Long Lines Maintenance, Pacific Telephone and Telegraph Company, Rm. 1504, 190 New Montgomery St., San Francisco, Calif.
- SMITH, COLIN W. (A'31), Technical Editor, *New Zealand Radio Record*, Box 1032, Wellington, New Zealand.
- SMITH, DAVID H. (A'28), Instructor, National Radio Institute, 1536 U St., N.W., Washington, D.C.
- SMITH, DELMAR E. (A'30), Engineer, American Telephone and Telegraph Company, Rm. 1118, 195 Broadway, New York, N.Y.
- SMITH, EDGAR H. (A'30), Newportville, Pa.
- SMITH, ERNEST F. (M'24), Superintendent of Substations, Commonwealth Edison Company, Rm. 506, 72 W. Adams St., Chicago, Ill.
- SMITH, F. E. (A'30), Technician, Compton Music Company, Inc., 239 E. Main St., Compton, Calif. For mail: 123B W. Olive St., Compton, Calif.
- SMITH, FRANK J. (A'28), Radio Inspector, U. S. Department of Commerce, 2909 David Stott Bldg., Detroit, Mich.
- SMITH, FRANKLIN S. (A'25), Consulting Engineer, Products Protection Corporation, New Haven, Conn. For mail: P.O. Box 904, New Haven, Conn.
- SMITH, FREDERICK A. (J'16-A'19), Radio Engineer, Canadian Marconi Company, 11 St. Sacramento St., Montreal, P.Q., Canada. For mail: P.O. Box 1690, Montreal, P.Q., Canada.
- SMITH, H. M. (A'31), Engineer, Doolittle and Falknor, Inc., 1306 W. 74th St., Chicago, Ill.
- SMITH, H. MILLARD (A'30), Vacuum Tube Engineer, Rm. 101, Bldg. 27, General Electric Company, Schenectady, N.Y. For mail: 62 Pershing Dr., Scotia, N.Y.
- SMITH, HAROLD (A'31), Proprietor, Radio Service, 1 Newby St., Crosshills, near Keighley, York, England.
- SMITH, HAROLD A. (A'31), Radio Engineer, General Electric Company, 1 River Rd., Schenectady, N.Y. For mail: 1405 Grand Blvd., Schenectady, N.Y.
- SMITH, HAROLD E. (A'28), Engineer, Radio Station WOKO, 800 South St., Peekskill, N.Y. For mail: Hotel Ten Eyck, Albany, N.Y.
- SMITH, HAROLD I. (A'28), Radio Engineer, 50 High St., Buxton, England.
- SMITH, HERBERT H. (A'29), Assistant Radio Inspector, Radio Division, U.S. Department of Commerce, 328 Custom House, San Francisco, Calif.
- SMITH, HOWARD L. (A'31), Radioman, 2nd Class, U. S. Navy, U. S. Naval Radio Station, 100 Harrison St., San Francisco, Calif. For mail: 256-A-5th Ave., San Francisco, Calif.
- SMITH, J. O. (A'20-M'26), Manager, Royalty Administration, RCA Photophone, Inc., 411-5th Ave., New York, N.Y. For mail: White Rd., Shore Acres, Mamaroneck, N.Y.
- SMITH, J. P. (A'29), Engineer, RCA Victor Company, Inc., Camden, N.J. For mail: 55 Grant Ave., Erlton, N.J.
- SMITH, JAMES E. (A'20-M'26), President, National Radio Institute, Washington, D.C. For mail: 1333 Fairmont St., N.W., Washington, D.C.
- SMITH, JAMES H. (A'26), Radio Engineer and Analytical Engineer, Radio Stores, Duke St., Dartmouth, Devon, England.
- SMITH, JEROME C. (A'31), Engineer, RCA Victor Company, Inc., Camden, N.J. For mail: 4618 Lafayette Ave., Merchantville, N.J.

- SMITH, JESSE H. (A'26), Lieutenant Commander, U. S. Navy, U.S.S. *Herbert*, c/o Postmaster, New York, N.Y.
- SMITH, JOHN S. (M'28), Superintendent, Liverpool District, Marconi International Marine Communications Company, Ltd., 22 Chapel St., Liverpool, England.
- SMITH, JOHN WESLEY (A'27), Radio Engineer, Bell Telephone Laboratories, Inc., Whippany, N.J.
- SMITH, K. R. (M'28), Manager, Sales Engineering Division, Brunswick Radio Corporation, 120 W. 42nd St., New York, N.Y.
- SMITH, KENNETH D. (A'31), Member of Technical Staff, Bell Telephone Laboratories, 463 West Street, New York, N.Y.
- SMITH, L. E. (J'26-A'28), Statistician, Research Department, Security-First National Bank of Los Angeles, 5th and Spring Sts., Los Angeles, Calif. For mail: 345 N. Painter Ave., Whittier, Calif.
- SMITH, LESTER D. (A'31), Engineer-in-Charge of Radio Equipment, Weston Electrical Instrument Corporation, 383 Frelinghuysen Ave., Newark, N.J. For mail: 429 Conant St., Hillside, N.J.
- SMITH, MALCOLM H. (A'14), Equipment Engineer, New England Telephone and Telegraph Company, Providence, R.I. For mail: 55 Edgemoor Rd., Providence, R.I.
- SMITH, MORTIMER O. (A'30), District Manager, RCA Photophone, Inc., Russ Bldg., San Francisco, Calif. For mail: 904 E. 19th St., Oakland, Calif.
- SMITH, OLIVER C. (A'27), Engineer, Pacific Telephone and Telegraph Company, 1200-3rd Ave., Seattle, Wash.
- SMITH, PAUL CLARENCE (A'29), Assistant Professor of Electrical Engineering, University of Akron, Akron, Ohio. For mail: 179 Ido Ave., Akron, Ohio.
- SMITH, PAUL S. (A'20), Foreman, Radio Service Department, Stewart-Warner Corporation, Chicago, Ill. For mail: 3119 N. Lockwood Ave., Chicago, Ill.
- SMITH, PHILLIP H. (A'30), Engineer, Bell Telephone Laboratories, Inc., P.O. Box 122, Deal, N.J.
- SMITH, R. G. (A'30), Superintendent, Technical Division, Shanghai Telephone Company, 24A Kiangse Rd., Shanghai, China.
- SMITH, REX B. (A'30), Proprietor, 600 South St., Sault Sainte Marie, Mich.
- SMITH, RICHARD L. (A'30), Radio Engineer, General Electric Company, Bldg. 89, 1 River Rd., Schenectady, N.Y. For mail: 1067 Willett St., Schenectady, N.Y.
- SMITH, SAMUEL, B. (A'27), Patent Attorney, Radio Corporation of America, 570 Lexington Ave., New York, N.Y.
- SMITH, SERENO E. (A'27), Engineer, WGAR Broadcasting Company, Inc., Hotel Statler, Cleveland, Ohio.
- SMITH, SIDNEY B. (A'14-M'18), Development Department, Marconi's Wireless Telegraph Company, Ltd., Marconi House, Chelmsford, Essex, England.
- SMITH, THEODORE A. (J'25-A'26), Sales Engineer, RCA Victor Company, Inc., 155 E. 24th St., New York, N.Y. For mail: 30 Heights Rd., Ridgewood, N.J.
- SMITH, THOMAS R. (A'31), Radio Supervisor, All America Cables, Granada, Nicaragua.
- SMITH, VICTOR G. (A'27), Assistant Professor of Electrical Engineering, Department of Electrical Engineering, University of Toronto, Toronto 5, Ont., Canada.
- SMITH, WADE H. (A'27), Sound Technician, RKO Studio, 780 N. Gower St., Hollywood, Calif. For mail: 839 Elwood St., West Hollywood, Calif.
- SMITH, WALTER C. (A'18), Assistant Protection Engineer, Michigan Bell Telephone Company, 1365 Cass Ave., Detroit, Mich. For mail: 1245 Lake Pointe Ave., Grosse Pointe Park, Mich.
- SMITH, WESLEY L. (A'30), Development Engineer, Transcontinental and Western Air, Inc., Graybar Bldg., New York, N.Y. For mail: 1 Doering Way, Cranford, N.J.
- SMITH, WILLIAM B. (A'31), Engineering Department, Utah Carter Radio, Ltd., 559 College St., Toronto, Ont., Canada.
- SMITH, WOLCOTT M. (A'31), Radio Service, Miller Sales and Service, Brattleboro, Vt.
- SMITH-HUTTON, H. H. (A'31), Lieutenant, U.S.S. *Houston*, c/o Postmaster, New York, N.Y.
- SMURAGLIA, F. (A'30), Engineer, Atwater Kent Manufacturing Company, 4700 Wissahickon Ave., Philadelphia, Pa. For mail: 413 N. Daggett St., Philadelphia, Pa.
- SMURTHWAITE, F. W. (A'27), Manufacturer, Radio Apparatus, 15A Onslow Gardens, Wallington, Surrey, England.
- SMYTHE, EDWIN H. (A'15-M'26), 1162 Monadnock Bldg., Chicago, Ill.
- SNAVELY, B. L. (A'29), Graduate Student, Princeton University, Princeton, N.J. For mail: 644 E. King St., Lancaster, Pa.
- SNEAD, SAM (A'25), Head of Radio Department, Extension Division, University of Wisconsin, 623 W. State St., Milwaukee, Wis. For mail: 3115 W. McKinley Blvd., Milwaukee, Wis.
- SNELL, HENRY C. (A'30), Radio Service and Repairs, 6 Rushbrooke Ave., Toronto, Ont., Canada.
- SNOOK, EDWARD T. (A'31), Engineer, British Broadcasting Corporation, 350 Strone Rd., Manor Park, London, E. 12, England.
- SNOOK, H. CLYDE (M'19), Consulting Engineer, Beechwood Apartments, Summit, N.J.
- SNOW, HAROLD A. (A'24), Radio Engineer, Radio Frequency Laboratories, Boonton, N.J.
- SNOW, LOUIS A. (A'27), Radio Engineer, Louis A. Snow and Company, 35 N. Ventura Ave., Ventura, Calif.
- SNOW, WILLIAM B. (A'26), Member of Technical Staff, Bell Telephone Laboratories, Inc., 463 West St., New York, N.Y.
- SNOWDEN, P. T. (A'30), Radio Engineer, L. Snowden and Son, 116 W. Jackson St., Macomb, Ill. For mail: 514 N. Lafayette St., Macomb, Ill.
- SNYDER, CHRISTOPHER L. (A'29), Radio Engineer, Philadelphia Storage Battery Company, C and Ontario Sts., Philadelphia, Pa.
- SNYDER, ELLSWORTH W. (A'30), Service Manager, Radio Electric Store, 14 W. High St., Springfield, Ohio.
- SNYDER, E. B. (M'30), Secretary, Ohio Insulator Company, 9th and Park Sts., Barberton, Ohio.

- SNYDER, NORMAN (A'26-M'30), Engineer, General Electric Company, Schenectady, N.Y. For mail: 1454 Glenwood Blvd., Schenectady, N.Y.
- SNYDER, REED E. (A'30), First Assistant Engineer, Radio Station WOC, 1002 Brady St., Davenport, Iowa. For mail: 2630 Arlington Ave., Davenport, Iowa.
- SNYDER, RICHARD L. (A'26), Engineer Radio Equipment Department, Bell Telephone Company of Pennsylvania, 1835 Arch St., Philadelphia, Pa.
- SNYDER, ROBERT E. (A'27), Salesman, United Screw and Bolt Corporation, W. 58th and Denison Ave., Cleveland, Ohio. For mail: 1690 Glenmont Rd., Cleveland, Ohio.
- SNYDER, ROY A. (A'29), Radio Diagnostician, Nailon Corporation, 108-110 Liberty St., Peoria, Ill.
- SNYDER, W. GILMAN, JR. (A'29), Plant Department, Pacific Telephone and Telegraph Company, Sacramento, Calif. For mail: 115 Court St., Jackson, Calif.
- SO, M. (M'30), Assistant Director, Research Laboratory, Tokyo Electric Company, Kawasaki, Kanagawaken, Japan. For mail: 1278 Omeri, Araishiku, Tokyo, Japan.
- SO, MANABA (A'29), Research Staff, Vacuum Tube Department, Research Laboratory, Tokyo Electric Company, Kawasaki, Japan.
- SODERHOLM, ARTHUR E. (A'26), Electrical Engineering, New York State Railways, 267 State St., Rochester, N.Y. For mail: 12 Congress Ave., Rochester, N.Y.
- SODERQUIST, CLEMENT J. (A'30), 39 Brunswick St., San Francisco, Calif.
- SOHON, HARRY (A'28), Instructor, Electrical Engineering School, Cornell University, Ithaca, New York.
- SOHOR, P. H. (A'25-M'28), Service Engineer, RCA Photophone, Inc., 438 W. 37th St., New York, N.Y. For mail: 245 Echo Pl., New York, N.Y.
- SOKOLCOW, DMITRI M. (M'29), Vice Director, Institut Radijotechniczny, Warsaw, Poland.
- SOLOMON, S. (A'30), Wired Radio, Inc., Ampere, N.J. For mail: P.O. Box 3, Ampere, N.J.
- SOMERS, BROCK A. (A'29), Barnet, Vt.
- SOMERS, RICHARD M. (A'29), Research Engineer, Thomas A. Edison, Inc., West Orange, N.J. For mail: 283 N. Centre St., Orange, N.J.
- SOMERSET, E. T. (A'29), G2DT, The Brackens, Deepdene Park, Dorking, Surrey, England.
- SOMERVILLE, HARRY V. (A'30), Technical Service Field Representative, RCA Victor Company, Inc., Camden, N.J. For mail: Box 730, Hartford, Conn.
- SOMMER, EMITT H. (J'14-A'16), Installation Supervisor, Philadelphia Storage Battery Company, Ontario and C Sts., Philadelphia, Pa. For mail: 519 Center St., Dunellen, N.J.
- SONGER, CLYDE K. (A'31), Photographer and Radiotriician, Morrow Art Shop, 112 E. Prairie Ave., Decatur, Ill. For mail: 2625 E. Garfield Ave., Decatur, Ill.
- SONKIN, DAVID (J'18-A'18-M'23), Sales Engineer and Assistant Sales Manager, Polymet Manufacturing Company, 829 E. 134th St., New York, N.Y. For mail: 1855 Loring Pl., New York, N.Y.
- SONNENBERG, JOHN H. (A'31), Prichs Motor Sales, Macomb St., Mount Clemens, Mich. For mail: 105 Grand Ave., Mount Clemens, Mich.
- SORENSEN, CARL P. (A'28), 3705 Byron St., Chicago, Ill.
- SORENSEN, LANFORD W. (A'31), Radio Shopman, Radio Manufacturers Supply Company, 1000 Broadway, Los Angeles, Calif. For mail: 821 S. Hope St., Los Angeles, Calif.
- SORKNESS, HARDUS (A'29), Radio Technician, Sorkness Super-Service Station, 311 E. Florida Ave., Hemet, Calif.
- SOSNOSKI, WALTER J. (A'31), General Manager, Sosnoski-Redington Radio Laboratory, 430 Cayuta Ave., Waverly, N.Y.
- SOUCY, CHESTER I. (A'26), Assistant Engineer-in-Charge, Research Products Engineering Department, Northern Electric Company, Ltd., 637 Craig St., W., Montreal, P.Q., Canada.
- SOULE, HAROLD (A'28), Transmission Engineer, Standard Sound Recording Company, 220 E. 38th St., New York, N.Y. For mail: 5 W. 75th St., New York, N.Y.
- SOUTHWORTH, G. C. (M'26), Engineer, American Telephone and Telegraph Company, 195 Broadway, New York, N.Y.
- SOWELL, GEORGE O. (A'29), Manager, Radio Laboratory, Kosciusko, Miss.
- SOWERS, NELSON E. (A'30), Member of Technical Staff, Bell Telephone Laboratories, Inc., P.O. Box 122, Deal, N.J.
- SPARROW, A. W. (A'29), Wireless Officer, Marconi International Marine Communications Company, Ltd., Marconi House, Strand, London, England. For mail: Branstons, Lincoln, England.
- SPATES, JAMES L. (A'31), Engineer, Pine Tree Broadcasting Corporation, 25 Broad St., Bangor, Maine. For mail: 249 Pine St., Bangor, Maine.
- SPEAR, WADE HAMPTON (A'30), Chief Operator, Radio Station KRCR, Enid, Okla.
- SPEED, RUSSELL B. (A'30), 2486 Tiebout Ave., New York, N.Y.
- SPEERS, JOHN C. (A'25), R. D. Speers Company, 329 W. 3rd St., Davenport, Iowa.
- SPEICHER, ELLSWORTH J. (A'28), Service Manager, Laundau's Music and Jewelry Store, 21 N. Main St., Pittston, Pa. For mail: 429 George Ave., Wilkes-Barre, Pa.
- SPEICHER, JOHN D. (A'20), Telephone Electrician, Installation Department, Western Electric Company, Inc., New York, N.Y. For mail: 9303-244th St., Bellerose, L.I., N.Y.
- SPEIRS, GEORGE E. (J'27-A'30), Radio Operator, United States Fleet, U. S. Bureau of Fisheries, Str. Albatross 2, Woods Hole, Mass.
- SPENCE, P. W. (A'22), Engineer, American Telephone and Telegraph Company, 195 Broadway, New York, N.Y.
- SPENCER, ALBERT H. (A'26), General Manager, Spencer Manufacturing Company, Aurora, Neb. For mail: Aurora, Neb.
- SPENCER, HERBERT L. (A'30), Vice President and Chief Engineer, Radio Station WGNF, Great Plains Broadcasting Company, Inc., North Platte, Neb. For mail: Box 434, North Platte, Neb.

- SPENCER, LEONARD (A'22-M'27), Chief Engineer, 980 St. Catherine St., W., Montreal, P.Q., Canada.
- SPENCER, MILLARD C. (A'16), Electrical Engineer, Crocker-Wheeler Electric Manufacturing Company, Ampere, N.J. For mail: 105 Park Ave., East Orange, N.J.
- SPHAR, CLARK H. (J'27-A'29), Federal Telegraph Company, Palo Alto, Calif. For mail: 790 Oak St., San Francisco, Calif.
- SPIES, MARK C. (A'27), Chief Engineer, Radio Station WJZ, Tuscola, Ill.
- SPIKE, J. EDWARD, JR. (A'29), Instructor of Physics, Jefferson Physical Laboratory, Harvard University, Cambridge, Mass. For mail: 70 Lake View Ave., Cambridge, Mass.
- SPILLER, CECIL CHARLES (J'29-A'31), 1446 Saltair Ave., West Los Angeles, Calif.
- SPINDLER, ROBERT E. (A'30), Manager, Service Department, Spindler Radio Sales, 517 Strong Ave., Stevens Point, Wis. For mail: 228 McCulloch St., Stevens Point, Wis.
- SPINNER, ROBERT F., JR. (A'30), Chief Test Engineer, Condenser Corporation of America, 259 Cornelison Ave., Jersey City, N.J. For mail: 480 Palisade Ave., Weehawken Heights, N.J.
- SPITALNY, MAX (A'31), Instructor, Brooklyn Boys' Continuation School, 11 Bond St., Brooklyn, N.Y. For mail: 395 Fort Washington Ave., New York, N.Y.
- SPITTLE, SAMUEL E. (A'30), Junior Radio Engineer, Signal Corps Laboratories, Fort Monmouth, Oceanport, N.J.
- SPITZER, EDWIN E. (A'28), Research Engineer, Research Laboratory, General Electric Company, Schenectady, N.Y. For mail: 155 Elmer Ave., Schenectady, N.Y.
- SPONSELLER, JOSEPH F. (A'31), Field Engineer, Columbia Broadcasting System, Inc., 485 Madison Ave., New York, N.Y. For mail: 68 Summit Ave., Jersey City, N.J.
- SPRAGUE, BARBARA RUSSELL (J'30), Radio Operator, Radio Station WKBS, Galesburg, Ill. For mail: 809 E. Main St., Galesburg, Ill.
- SPRAGUE, CLARENCE A. (A'14-M'16), Patent Attorney, Bell Telephone Laboratories, Inc., 463 West St., New York, N.Y.
- SPRAGUE, G. M. (A'30), Sound Technician, Metro-Goldwyn-Mayer Studios, Culver City, Calif. For mail: 2227 W. Merton Ave., Eagle Rock, Calif.
- SPRATLEY, CLIFFORD (A'31), Proprietor, Spratley Brothers, 8-9 Station Rd., Hayes, Middlesex, England.
- SPRAYBERRY, FRANK L. (A'28), Instructor, National Radio Institute, Washington, D.C.
- SQUIER, GEORGE O. (F'16), Major General, U. S. Army, Metropolitan Club, Washington, D.C.
- SREBROFF, CHARLES M. (A'24-M'28), Engineer-in-Charge, Radio Engineering Laboratories, Inc., 100 Wilbur Ave., Long Island City, L.I., N.Y. For mail: 186-24 Jordan Ave., Chapel Gardens, Hollis, L.I., N.Y.
- STACHURA, EDWARD J. (A'31), 149 Van Rensselaer St., Buffalo, N.Y.
- STACY, JOHN D. (A'31), Division Engineer, RCA Victor Company, Inc., Camden, N.J. For mail: 920 Mount Vernon Ave., Haddonfield, N.J.
- STADLER, ROBERT (J'31), Research Laboratory, Kellogg Switchboard and Supply Company, 1066 W. Adams St., Chicago, Ill. For mail: 2053 Howe St., Chicago, Ill.
- STAEGE, STEPHEN A. (A'21), Industrial Engineer, Westinghouse Electric and Manufacturing Company, East Pittsburgh, Pa. For mail: 6624 Beacon St., Pittsburgh, Pa.
- STAFFORD, J. W. (M'31), Instructor, Electrical Communication, Purdue University, Lafayette, Ind. For mail: 1815 Thompson St., Lafayette, Ind.
- STAGG, CARL (A'29), Assistant Supervisor, R.C.A. Communications, Inc., Riverhead, L.I., N.Y. For mail: 141 E. Main St., Riverhead, L.I., N.Y.
- STAGNARO, JOHN A. (A'27), Radio Engineer, Columbus Electric Company, 2121 Chestnut St., San Francisco, Calif. For mail: 1869 Stockton St., San Francisco, Calif.
- STAHL, BARTON E. (A'29), Station Engineer, National Broadcasting Company, Inc., National Press Bldg., Washington, D.C. For mail: 3308-14th St., Washington, D.C.
- STAHL, THEODORE H. (J'26-A'28), Radio Serviceman, P.O. Box 517, Birmingham, Mich.
- STAIR, DANIEL N. (A'25), Engineer-in-Charge, National Broadcasting Company, Inc., River Rd., Bound Brook, N.J.
- STAMFORD, NORMAN C. (A'30), Chelmsford College, Arbour Lane, Chelmsford, England.
- STANESBY, HAROLD (A'28), Assistant Engineer, Radio Section, P.O. Engineering Department, P.O. Research Station, Dollis Hill, London, N.W. 2, England. For mail: "Wynstone," Coldharbour Lane, Bushey, Herts, England.
- STANFORD, KENNETH J. (A'31), 230 Park Ave., New York, N.Y.
- STANGERT, JOSEPH C. (A'31), Engineering Department, RCA Victor Company, Inc., Camden, N.J. For mail: 832 Princeton Ave., Haddonfield, N.J.
- STANIER, DONALD M. (A'30), Operator, Radio Station KDKA, Saxonburg, Pa. For mail: Pittsburgh St., Saxonburg, Pa.
- STANKO, EDWARD (A'24), Installation and Service Survey Engineer, Electrical Research Products, Inc., 250 W. 57th St., New York, N.Y. For mail: Louis St., P.O. Box 68, Hyannis, Mass.
- STANLEY, OTIS J. (A'30), 3201-17th Ave., Rock Island, Ill.
- STANSBURY, MERVYN L. (A'31), Maintenance Man, New York Quotation Company, 52 Broadway, New York, N.Y. For mail: 9 W. Highway, Grand View, Nyack, N.Y.
- STANSEL, FRANK R. (A'26), Member of Technical Staff, Bell Telephone Laboratories, Inc., Whippany, N.J.
- STANSFIELD, SELWYN (J'26-A'29), Public Address Operator, Wardell Realty Company, 15 E. Kirby Ave., Detroit, Mich. For mail: 9440 Savery Ave., Detroit, Mich.
- STANTON, CLAIR F. (A'27), Test Standards Engineer, RCA Victor Company, Inc., Camden, N.J. For mail: 117 Cedar Ave., Woodlynne, N.J.
- STANTON, JAMES M. (A'29), District Service Engineer, Electrical Research Products, Inc., 1114 Continental Bank Bldg., Salt Lake

- City, Utah. For mail: 430-26th St., Ogden, Utah.
- STANWICK, CHARLES A. (A'15), 33 Beech St., East Orange, N.J.
- STANBUCK, W. D. L. (M'30), Radio Commissioner, Federal Radio Commission, Washington, D.C. For mail: The Jefferson, 1200-16th St., N.W., Washington, D.C.
- STARK, L. P. (A'29), City Electrician, Brady Water and Light Company, Brady, Tex. For mail: P.O. Box 1095, Brady, Tex.
- STARR, ALFRED R. (A'17), Radio Engineer, International Telephone and Telegraph Corporation, 67 Broad St., New York, N.Y. For mail: 326 W. 83rd St., New York, N.Y.
- STARR, ARTHUR T. (A'31), Instructor, Faraday House Engineering College, Southampton Row, London, W.C. 1, England. For mail: 35 Norland Sq., Holland Park Ave., London, W. 11, England.
- STARR, C. HARRY (A'26), c/o G. H. Wilcox, Windsor, N.S., Canada.
- STARR, TROY S. (A'26), Transmission Man, American Telephone and Telegraph Company, 44 Church St., Buffalo, N.Y. For mail: P.O. Box 96, Gerry, N.Y.
- STARRETT, JOHN S. (A'22), Radio Engineer, Circuit Applications, RCA Radiotron Company, Inc., Harrison, N.J. For mail: 7 Collingswood Rd., Livingston, N.J.
- STAUFFER, J. LUKE (A'27), Assistant Engineer, Pennsylvania Power and Light Company, Lancaster, Pa.
- STAUFFER, RAY EVERETT (J'29-A'30), Engineer, Radio Station WOC, 1002 Brady St., Davenport, Iowa.
- STAUFFER, WILLIAM J. (A'30), Chief Engineer, Radio Station CKPC, Preston, Ont., Canada. For mail: 332 Dundas St., Galt, Ont., Canada.
- STAUTNER, PAUL L. (A'30), Laboratory Assistant, Test Engineering Department, Crosley Radio Corporation, Arlington St., Cincinnati, Ohio. For mail: 3929 Grove Ave., Norwood, Ohio.
- STAYER, DAVID (A'29), Radio Engineer, RCA Victor Company, Inc., Camden, N.J. For mail: 31 Harvard Ave., Collingswood, N.J.
- STEAD, CLIFFORD (A'31), Marconi Wireless Telegraph Company, Ltd., Marconi House, Strand, London, W.C. 2, England. For mail: 78 Rainsford Rd., Chelmsford, Essex, England.
- STEANE, G. W. (A'30), "Pymble," Earle St., Mont Albert, Melbourne, Australia.
- STEATES, E. FRANCIS (A'30), Radio Tester, General Electric Company, Utica, N.Y. For mail: 11 Clark Pl., Utica, N.Y.
- STEEL, W. ARTHUR (M'19), Lieutenant Colonel, Chief of Radio Division, Research Laboratories, National Research Council of Canada, Sussex St., Ottawa, Ont., Canada. For mail: 214 Cobourg St., Ottawa, Ont., Canada.
- STEEN, J. RALPH (A'30), Chief Inspector, Sprague Specialties Company, Quincy, Mass. For mail: 286 Houghton St., North Adams, Mass.
- STEELE, JAMES A. (A'30), Service Manager, Tower Binford Electric and Manufacturing Company, 4th and Cary Sts., Richmond, Va. For mail: 4609 Devonshire Rd., Richmond, Va.
- STEERS, W. F. (A'31), Student Engineer, RCA Victor Company, Inc., Camden, N.J. For mail: 128 Walnut St., Audubon, N.J.
- STEFFENSEN, JAMES (A'30), Engineer, Radio Engineering Department, Danish State Postal and Telegraph Service, Centralpostbygningen, Copenhagen V., Denmark. For mail: Ehlersvej 8, Hellerup, Denmark.
- STEIGER, CHARLES H. (A'26), Service Department, Hall's Company, 222 Chestnut St., Harrisburg, Pa. For mail: 3658 Derry St., Harrisburg, Pa.
- STEIN, ADAM, JR. (M'15-F'17), P.O. Box 25, Silver Lake, Plymouth County, Mass.
- STEIN, HAROLD A. (A'29), Western Electric Manufacturing Company, 128 W. Lake St., Chicago, Ill. For mail: 139 Custer Ave., Evanston, Ill.
- STEINBERGER, ARTHUR W. (A'27), 150-47-87th Rd., Jamaica, L.I., N.Y.
- STEINBERGER, LOUIS (M'15), Inventor, 867 E. 14th St., Brooklyn, N.Y.
- STEINER, HAROLD R. (A'30), Crosley Radio Corporation, Cincinnati, Ohio. For mail: 155 Thurman St., Bluffton, Ohio.
- STEINER, HARRY C. (A'29), Vacuum Tube Engineering Department, General Electric Company, Schenectady, N.Y. For mail: 102 James St., Scotia, N.Y.
- STEINHAUSER, CLARENCE J. (A'29), Berco Coal Company, 10800 Devine St., Detroit, Mich.
- STELLWAGEN, FRANK W. (A'29), Engineer, A. H. Grebe and Company, Van Wyck Blvd., Richmond Hill, L.I., N.Y. For mail: 496 Foch Blvd., Mineola, L.I., N.Y.
- STELZER, ALPHONSE C. (A'31), Radio Engineer, Electrical Test Equipment Division, General Motors Radio Corporation, Dayton, Ohio. For mail: 638 Hodapp Ave., Dayton, Ohio.
- STEMPEL, WALDEMAR M. (A'15), Assistant Professor of Physics, Stevens Institute of Technology, Hoboken, N.J.
- STEPHENSON, JOSEPH W. (A'31), Control Operator, Radio Station WRVA, Richmond, Va. For mail: 3109 Lamb Ave., Richmond, Va.
- STEPHENSON, MARTIN A. (A'27), Radio Service Manager, Hutton and Jones, Inc., Plainville, Conn. For mail: 125 Broad St., Plainville, Conn.
- STERBA, E. J. (A'20), Radio Engineer, Bell Telephone Laboratories, Inc., Deal, N.J.
- STERKY, HAKON K. A. (A'25), Graduate Electrical Engineer, Svenska Radioaktiebolaget, 12 Alstromergatan, Stockholm, Sweden. For mail: 22 Norrbackagatan, Stockholm, Sweden.
- STERLING, GEORGE E. (A'27-M'28), Associate Radio Engineer, Radio Division, U. S. Department of Commerce, Fort McHenry, Baltimore, Md.
- STERLING, M. F. (A'30), Alliance Hotel, Alliance, Neb.
- STERNBERG, F. B. (A'27), Vice President, Rm. 300, Superb Bldg., 128 Market St., Newark, N.J.
- STERN, MORTON W. (A'16-M'25), President, Morton Radio Service, 139-17 Jamaica Ave., Jamaica, L.I., N.Y. For mail: 89-14 Sutphin Blvd., Jamaica, L.I., N.Y.
- STETSON, HARLAN T. (A'31), Director, Perkins Observatory, Delaware, Ohio.

- STEVENS, ARCHIE M. (A'12-M'25-F'31), Chief Engineer and Technical Director, Compania Internacional de Radio, Defensa 143, Buenos Aires, Argentina.
- STEVENS, CHESTER (A'31), Assistant Manager, Missouri Farmers Association, Ladonia, Mo. For mail: Laddonia, Mo.
- STEVENS, RONALD C. (J'28-A'29), Radio Technician, St. John, N.B., Canada. For mail: Westfield Centre P.O., Kings Co., N.B., Canada.
- STEVENS, WALDO W. (A'29), Associate Examiner, U. S. Patent Office, Washington, D.C. For mail: 1814 Jackson St., Woodridge, Washington, D.C.
- STEVENS, WILBUR C. (A'26), Partner, Radio Service and Supply Company, 608 Linden St., Scranton, Pa. For mail: 1211 Marion St., Scranton, Pa.
- STEVENS, WILLIAM J. (A'27), Proprietor, Radio Service and Repairs, 2436 Robert St., New Orleans, La.
- STEVENSON, W. B. (A'31), Division Engineer, RCA Victor Company, Inc., Camden, N.J. For mail: 23 Valleyview Ter., Moorestown, N.J.
- STEWART, ARTHUR C. (A'27), Manager, Radio Service Department, Beckley Ralston Company, 1801 S. Michigan Ave., Chicago, Ill. For mail: 3942 Eddy St., Chicago, Ill.
- STEWART, CHARLES H. (A'14-M'27), Vice President, American Radio Relay League, West Hartford, Conn. For mail: St. Davids, Pa.
- STEWART, G. EDWIN (A'28), Chief Recording Engineer, Paramount-Famous-Lasky Corporation, 6th and Pierce Aves., Astoria, L.I., N.Y. For mail: 40 Hillside Ave., Rockville Centre, L.I., N.Y.
- STEWART, JESSE A. (A'31), Chief Radioman, U. S. Coast Guard, 417 Custom House Bldg., San Francisco, Calif. For mail: 3916 Archmont Pl., Oakland, Calif.
- STEWART, JESSICA DEE (M'29), Patent Attorney, National Press Bldg., Washington, D.C.
- STEWART, RALPH B. (A'19-M'26), Patent Lawyer, National Press Bldg., Washington, D.C.
- STEWART, RONALD B. (A'28), Engineer, Electrical Research Products, Inc., 7046 Hollywood Blvd., Hollywood, Calif.
- STIFF, GEORGE F. (A'31), Operator, Radio Station CFRB, Rogers-Majestic Corporation, Aurora, Ont., Canada. For mail: 9 Cortleigh Blvd., Toronto, Ont., Canada.
- STILLHAMER, ARTHUR G. (A'23), Director, Research Laboratory and Radio Engineer, Strahl Laboratory, 705 N. East St., Bloomington, Ill.
- STINCHFIELD, J. M. (A'29), Engineering Department, E. T. Cunningham, Inc., 370-7th Ave., New York, N.Y. For mail: 231 Springfield Ave., Rutherford, N.J.
- STINES, CHARLES H. (A'31), Radio Service, Ludwig Baumann and Company, 45 Pearson St., Long Island City, L.I., N.Y. For mail: 526 W. 158th St., New York, N.Y.
- STINSON, LAWRENCE W. (A'29), Chief Operator, Broadcasting Station KVOO, Wright Bldg., Tulsa, Okla.
- STINSON, RONALD C. (A'31), Chief Technician, Radio Station WBAP, Carter Publications, Inc., 400 W. 7th St., Fort Worth, Tex. For mail: 4725 Birchman, Fort Worth, Tex.
- STOBBE, JOHN A. (A'28), Princeton University, Princeton, N.J. For mail: 654 E. 23rd St., Brooklyn, N.Y.
- STOCKER, ARTHUR C. (A'28), Radio Engineer, RCA Victor Company, Inc., Camden, N.J. For mail: 500-3rd Ave., Haddon Heights, N.J.
- STOCKER, HAROLD C. (A'31), Operator, c/o Radio Station WLW, Mason, Ohio. For mail: 104 E. Auburn Ave., Cincinnati, Ohio.
- STOCKTON, S. A. (A'31), Radio Engineer, Marconi Wireless Telegraph Company, Ltd., Chelmsford, Essex, England.
- STODDART, JOSEPH A. (A'31), Works Electrical Engineer, D. M. Davies Woodwork, Ltd., Trading Estate, Slough, Bucks, England. For mail: 12-1st Crescent, Gloucester Ave., Farnham Rd., Slough, Bucks, England.
- STODDARD, RALPH N. (A'31), General Engineering Department, Westinghouse Electric and Manufacturing Company, East Pittsburgh, Pa. For mail: Penn Lincoln Hotel, Wilkinsburg, Pa.
- STOEKLE, ERWIN R. (M'26), President, Central Radio Laboratories, 14-28 Keefe Ave., Milwaukee, Wis.
- STOKES, HOWARD S. (A'30), P.O. Box 5034, Cherrydale, Va.
- STOLLE, R. A. (A'29), Chief Engineer, Jackson-Bell Company, 6500 S. McKinley Ave., Los Angeles, Calif.
- STOLZENBACH, R. W. (A'29), Engineer, Radio Station WJR, Pontiac, Mich. For mail: 26 Delaware Dr., Pontiac, Mich.
- STONE, C. W. (A'27), Radio Operator, The Shepard Stores, Radio Station WNAC, Boston, Mass.
- STONE, CARRINGTON H. (A'14-M'25), Sales Manager, Jenkins and Adair, Inc., 3333 Belmont Ave., Chicago, Ill. For mail: 2815 Mildred Ave., Chicago, Ill.
- STONE, CLARENCE G., JR. (A'15), Professor of Physics, Columbia University, New York, N.Y. For mail: 304 S. 1st Ave., Mount Vernon, N.Y.
- STONE, ELLERY W. (A'14-M'16-F'24), Vice President, International Telephone and Telegraph Corporation, 67 Broad St., New York, N.Y. For mail: 1010-5th Ave., New York, N.Y.
- STONE, F. BYRON (A'28), Radiotron Engineering Section, RCA Victor Company, Inc., Camden, N.J. For mail: 306 White Horse Pike, Haddon Heights, N.J.
- STONE, G. EDGAR (A'26), Radio Engineer, Bludworth, Inc., 79-5th Ave., New York, N.Y. For mail: 212 William St., Boonton, N.J.
- STONE, JOHN STONE (M'13-F'15), Development and Research Department, American Telephone and Telegraph Company, 195 Broadway, New York, N.Y. For mail: 3100 Brant St., San Diego, Calif.
- STONER, FRANK E. (A'31), Officer-in-Charge, War Department, Message Center, Washington, D.C.
- STOOS, JOSEPH A. (A'29), Electrical Draftsman, Delta Star Electric Company, 2400 Block W. Fulton St., Chicago, Ill. For mail: R.F.D. No. 3, Naperville, Ill.
- STORCK, HOWARD C. (A'29), Proprietor, Columbus Radio Laboratory, 247 E. Livings-

- ton Ave., Columbus, Ohio. For mail: 694 Carpenter St., Columbus, Ohio.
- STORM, HANS OTTO (A'30), Radio Installation Engineer, All America Cables, Inc., Lima, Peru.
- STORMS, HENRY J. (A'29), Assistant Chief Operator, Western Union Telegraph Company, 808 W. Sprague Ave., Spokane, Wash. For mail: 4611 N. Jefferson St., Spokane, Wash.
- STORMZAND, HAROLD A. (A'31), Instructor, Cass Technical High School, Detroit, Mich.
- STORRY, THOMAS G. (A'27), Manager, Radio Engineering Department, Storrys, Ltd., 143 Eastbank St., Southport, Lancashire, England. For mail: 67 Virginia St., Southport, Lancashire, England.
- STOTLER, ALBERT (A'29), Instructor, Board of Education, 500 Park Ave., New York, N.Y. For mail: 3733-84th St., Jackson Heights, L.I., N.Y.
- STOVER, ARTHUR R., JR. (J'29), Radio Serviceman, Moses Melody Shop, 708 Main St., Little Rock, Ark. For mail: 723 Wright Ave., Little Rock, Ark.
- STRACHAN, GEORGE H. (A'31), Supervisor, Automatic Department, Mackay Radio and Telegraph Company, 1010 Chester Williams Bldg., Los Angeles, Calif. For mail: 920 S. Baldwin Ave., Arcadia, Calif.
- STRANDJORD, MILLARD F. (A'28), Service Engineer, RCA Photophone, Inc., 1706 Wyandotte St., Kansas City, Mo. For mail: 108 N. Madison Ave., Mason City, Iowa.
- STRASSER, EDWARD J. (A'30), Engineer, RCA Victor Company, Inc., Camden, N.J. For mail: 1002 Belmont Ave., Collingswood, N.J.
- STRASSMAN, IRVING (A'29), Technical Supervisor, WIP-WFAN Broadcasting Company, Philadelphia, Pa.
- STRATMAN, FRED W. (J'29), Transmission Man, American Telephone and Telegraph Company, 19th and Douglas Sts., Omaha, Neb. For mail: 4328 Erskine St., Omaha, Neb.
- STREICH, ROBERT J. (A'30), Receiving Engineer, Radio Corporation of America, Marshall, Calif. For mail: P.O. Box 86, Napa, Calif.
- STRELESKY, HERBERT J. (A'29), Service Engineer, RCA Photophone, Inc., 1706 Wyandotte St., Kansas City, Mo. For mail: 3530 W. 23rd Ave., Denver, Colo.
- STRIEBY, MAURICE E. (M'31), Transmission Systems Engineer, Bell Telephone Laboratories, Inc., 463 West St., New York, N.Y.
- STRINGFELLOW, WILLIAM (A'30), c/o Radio Station WSPD, Commodore Perry Hotel, Toledo, Ohio.
- STRNAD, JOSEPH (A'27), Chief of Technical Service, Ministry of Posts and Telegraphs, Smichov, Holeckova, 36, Prague, Czechoslovakia.
- STROEBEL, JOHN C., JR. (A'14-M'26), Manufacturer's Representative, 6229 Burwood Ave., Los Angeles, Calif.
- STROHL, WELLINGTON M. (A'31), Member of Technical Staff, Bell Telephone Laboratories, Inc., Box 97, Red Bank, N.J.
- STROMAYER, CHARLES F. (A'29), Director of Research, Cable Radio Tube Corporation, 230 N. 9th St., Brooklyn, N.Y.
- STRONG, CHARLES E. (A'25-M'27), Engineer, International Standard Electric Corporation, Connaught House, Aldwych, London, W.C. 2, England.
- STRONG, FOSTER G. (A'31), Radio Interference Engineer, Radio Trades Association of Southern California, 234 Chamber of Commerce Bldg., Los Angeles, Calif. For mail: 2017 Florida St., Long Beach, Calif.
- STROUD, RALPH J. (A'30), Assistant Radio Engineer, Schaffhauser Kiley Corporation, 401 N. Broad St., Philadelphia, Pa. For mail: 1458 E. Lyeonng St., Philadelphia, Pa.
- STROUT, EVERETT M. (A'29), 257 Crosat St., La Salle, Ill.
- STRUTHERS, FRANCIS W. (A'29), Assistant Radio Engineer, U. S. Naval Research Laboratory, Bellevue, Anacostia, D.C.
- STRUTHERS, G. A. (M'29), Engineer-in-Charge, Radio Station, Rugby, England.
- STUCKERT, E. M. (A'30), Radio Engineer, Westinghouse Electric and Manufacturing Company, Chicopee Falls, Mass. For mail: 93 Federal St., Springfield, Mass.
- STUEDLE, EMRY C. (A'26), Radio Operator, S.S. La Brea, Union Oil Company of California, Los Angeles, Calif. For mail: 2657 S. Budlong, Los Angeles, Calif.
- STUKEY, L. I. (A'30), Test Engineer, Griesby-Grunow Company, 692 Irving Park Blvd., Chicago, Ill.
- STURMAN, GEORGE G. (A'29), Chief Engineer, Central Radio Service, 10335 Hamilton Ave., Detroit, Mich.
- STURROCK, S. B. (A'30), Service Engineer, Research Products Engineering Department, Northern Electric Company, Ltd., 10215-102nd St., Edmonton, Alta., Canada.
- STURTEVANT, JAMES W. (A'25), Radio Service Manager, The Erner Electric Company, 143 W. 9th St., Cleveland, Ohio. For mail: 15220 Hilliard Rd., Lakewood, Ohio.
- STURTEVANT, MARK (A'27), 1864 W. 54th St., Cleveland, Ohio.
- STYLES, THOMAS J. (A'26), Assistant, E. H. Armstrong, 204 Philosophy Hall, Columbia University, New York, N.Y. For mail: 160-01-84th Dr., Jamaica, L.I., N.Y.
- SUADICANI, GUENTHER (M'28), Commander, German Navy, Koenigin Augustastr. 38/42, Berlin, W. 10, Germany. For mail: Marineleitung, Berlin, W. 10, Germany.
- SUARES, JOSE B. (A'28), 176 Prince St., Telok Anson, Federated Malay States.
- SUCKLE, BENJAMIN W. (A'31), Design Engineer, RCA Victor Company, Inc., Camden, N.J. For mail: 325 E. Albanus St., Philadelphia, Pa.
- SUGA, Y. (A'29), Research Staff, Vacuum Tube Department, Research Laboratory, Tokyo Electric Company, Kawasaki, Japan.
- SUGI, CHOHSUKE (A'31), Student, Tohoku Imperial University of Japan, Sendai, Japan. For mail: 22-5-chome, Hirakawacho, Kojimachi, Tokyo, Japan.
- SUGIYAMA, E. (A'30), Chief Engineer, Engineering Department, Bureau of Communications, Sendai, Japan. For mail: Komuka, Teishinkyoku, Sendai, Japan.
- SULLINGER, FERRIS W. (A'29), Assistant Communication Engineer, Pan American Airways, Inc., Miami, Fla.

- SULLIVAN, EDWARD S. (A'28), Engineer, General Electric Company, Bridgeport, Conn. For mail: 76 Baldwin Ave., Jersey City, N.J.
- SULLIVAN, FRANK T. (A'31), Junior Engineer, Pilot Radio and Tube Corporation, Lawrence, Mass. For mail: Y.M.C.A., Lawrence, Mass.
- SULLIVAN, J. R. (A'26), Chief Engineer, Radio Station WRR, Dallas, Tex.
- SUMI, M. (A'31), Research Laboratory, Tokyo Electric Company, Kawasaki, Japan.
- SUMMERFIELD, JAMES L. (A'31), Chief Inspector, The Gramophone Company, Ltd., Dagenham, Essex, England. For mail: "Poldhu" 2a, Salisbury Rd., Seven Kings, Essex, England.
- SUMMERS, JAMES W. (A'30), Service Engineer, RCA Victor Company, Inc., 274 Brannan St., San Francisco, Calif. For mail: 1061-62nd St., Oakland, Calif.
- SUMMERS, LLEWELYN L. B. (A'29), Radio Engineer, Radio Corporation of America, Rocky Point, L.I., N.Y. For mail: White-stone, L.I., N.Y.
- SUMMERS, R. H. J. (A'30), Cranford and Worlds Radio, Ltd., National Works, High Rd., Leyton, London, E. 10, England.
- SUNNERGREN, ARVID P. (A'28), Chief Electrical Designer, West Penn Power Company, Rm. 1304, West Penn Bldg., 14 Wood St., Pittsburgh, Pa.
- SURETTE, DENNIS C. (A'29), Proprietor, Dan's Radio Shop, 36 Washington Ave., Chelsea, Mass. For mail: 37 W. Eagle St., East Boston, Mass.
- SUTHERLAND, ALEXANDER (A'16), Division Superintendent, East Coast Radio Service, H. M. C. Dockyard, Halifax, N.S., Canada.
- SUTHERLAND, EDGAR F. (A'30), Radio Engineer, RCA Victor Company, Inc., Camden, N.J. For mail: Glenwood Ave., R.F.D. No. 1, Haddonfield, N.J.
- SUTHERLAND, GEORGE B. (A'25), West-alian Farmers, Ltd., Perth, West Australia. For mail: 36 Fairfield St., Mount Hawthorn, Perth, West Australia.
- SUTHERLAND, J. G. A. (M'29), Senior Electrical Engineer, United Engineers, Ltd., 19 Battery Rd., Singapore, Straits Settlements.
- SUTHERLIN, LEE (A'19-M'28), Radio Research Engineer, Westinghouse Electric and Manufacturing Company, East Pittsburgh, Pa. For mail: 124 Avenue A, Wilkensburg, Pa.
- SUTTON, RALPH E. (A'31), Resident Manager, Guam Division, Globe Wireless Ltd., Agana, Guam.
- SUTTON, ROBERT B. (J'30), Radio Operator, Box 973, Spokane, Wash.
- SUTTON, WILLIAM F. P. (A'23), Service Engineer, Kolster-Brandes, Ltd., Gray Works, Sidcup, Kent, England. For mail: "Baslow," Charlotte Sq., Rhiwbina, Glamorgan, Wales.
- SUYDAM, C. H. (A'29-M'29), Engineer, International Communication Laboratories, 200 Mount Pleasant Ave., Newark, N.J.
- SUZUKA, M. (A'31), Engineer, Research Laboratory, Japanese Broadcasting Corporation, Kinutamura, near Tokyo, Japan.
- SUZUKI, HISAO (A'29), Research Staff, Vacuum Tube Department, Research Laboratory, Tokyo Electric Company, Kawasaki, Japan.
- SUZUKI, T. (A'31), Engineer, Laboratory, Japanese Broadcasting Corporation, Kinutamura, near Tokyo, Japan.
- SVEEN, ERWING A. (A'28), 178 N. Lombard Ave., Oak Park, Ill.
- SVEGEL, PETER J., JR. (J'28), Student, Electrical Engineering, Carnegie Institute of Technology, Night School, Pittsburgh, Pa. For mail: 303 Maplewood Ave., Ambridge, Pa.
- SVENDSEN, A. V. (A'29), Director, McLeod and Svendsen, Ltd., Electrical Contractors, New Zealand. For mail: 87 East St., Fielding, New Zealand.
- SVENNINGSEN, KARL (A'29), Skamleback Radio, Post og Telegrafvaesenet, Faarevile St., Copenhagen, Denmark.
- SVOBODA, JAROMIR (M'26), Radio Engineer, Prague Ministry of Posts and Telegraphs, Prague, Czechoslovakia. For mail: Americka 11, Prague XII, Czechoslovakia.
- SWABEY, HENRY C. (A'30), Assistant Engineer, Radio Station CFRB, R.R. No. 2, Aurora, Ont., Canada.
- SWAIN, ROBERT R. (A'27), American Telephone and Telegraph Company, Rm. 1637, 195 Broadway, New York, N.Y.
- SWANEY, BERNARD H. (J'31), Apprentice, Department 76, General Electric Company, East Lake Rd., Erie, Pa. For mail: 528 W. 18th St., Erie, Pa.
- SWANSON, CARL R. (A'29), Radio Operator, M. M. Johnson Company, P.O. Box 163, Clay Center, Neb.
- SWANSON, JOHN W. (A'17-M'23), Vice President, Southern Radio Corporation, 26 Broadway, New York, N.Y. For mail: 212 W. Dudley Ave., Westfield, N.J.
- SWANSON, MERRILL J. (A'29), Engineer-in-Charge, Radio Station WRAC, Williamsport, Pa.
- SWANSON, MILTON A. (A'30), Assistant Radio Engineer, RCA Victor Company, Inc., Camden, N.J. For mail: 110 Pacific Ave., Collingswood, N.J.
- SWEDLUND, LLOYD E. (A'31), Engineer, Research Laboratory, Westinghouse Electric and Manufacturing Company, East Pittsburgh, Pa.
- SWEENEY, CLAUDE D. (A'26), Designing Engineer, Tri-Plex Manufacturing Company, Inc., 521 Kasota Bldg., Minneapolis, Minn.
- SWEENEY, DANIEL J. (A'30), Engineer, RCA Victor Company, Inc., Camden, N.J. For mail: 711 Cooper St., Camden, N.J.
- SWEENEY, HAROLD V. (A'29), Experimental Department, Atwater Kent Manufacturing Company, 4700 Wissalickon Ave., Philadelphia, Pa. For mail: 64 Ashland Ave., West Manayunk, Philadelphia.
- SWEENEY, WALTER M. (M'25), Managing Director, Essanay Manufacturing Company, Pty., Ltd., Melbourne, Australia. For mail: Box 1362, G.P.O., Melbourne, Australia.
- SWEENEY, CAREY P. (A'22), Engineer, Bell Telephone Laboratories, Inc., 463 West St., New York, N.Y.
- SWEIGHERT, D. V. (A'30), Box 574, Dayton, Ohio.
- SWENDSON, LYMAN G. (A'31), Student, University of Minnesota, Minneapolis, Minn. For mail: 1941 James St., St. Paul, Minn.
- SWIFT, WILLIAM C. G. (A'31), Engineer, Research Sound Department, Paramount

- News, Inc., 544 W. 43rd St., New York, N.Y. For mail: 37-20-81st St., Jackson Heights, L.I., N.Y.
- SWISHER, O. V. (A'28), Division Manager, RCA Photophone, Inc., 3932 S. Lincoln St., Chicago, Ill.
- SYKES, ROGER ALLEN, (A'29), Department 325-D, 463 West St., New York, N.Y.
- SYNNOTT, BURTON (A'31), Chief Engineering Bureau, Transmission and Distribution Department, New York Edison Company, 4 Irving Pl., New York, N.Y. For mail: 1240 Olmstead Ave., New York, N.Y.
- SYPPER, EDGAR L., JR. (A'30), Engineering Department, Wired Radio, Inc., Amper, N.J. For mail: 104-16-223rd St., Queens Village, L.I., N.Y.
- SZABO, PAUL (A'30), Radio Operator, Radiomarine Corporation of America, 224 E. Bay St., Savannah, Ga. For mail: 303 S. Adams St., Ludington, Mich.
- T
- TABER, HAROLD E. (A'24), Captain, Royal Canadian Signals, Department National Defence, Ottawa, Ont., Canada. For mail: c/o Director of Signals, Elgin Bldg., Ottawa, Ont., Canada.
- TABER, WILLIAM T. (A'25), Engineer, Design Speech Equipment, De Forest Radio Company, Passaic, N.J. For mail: 95 Waldo Ave., Bloomfield, N.J.
- TAGART, SAM W. (A'29), Radio Technician, Real Radio Service, Inc., 1928 W. Vliet St., Milwaukee, Wis. For mail: 1926 W. McKinley Ave., Milwaukee, Wis.
- TAGGART, DAVID (A'31), Manager, Ulster Rediffusion Service, Ltd., Main St., Bangor, County Down, Ireland. For mail: 88 Hamilton Rd., Bangor, County Down, Ireland.
- TAGGART, SAMUEL E. (A'29), Service Engineer, Grant Radio Company, 6521 S. Halstead St., Chicago, Ill. For mail: 4950 Prairie Ave., Chicago, Ill.
- TAGUCHI, MINORU (A'27), Radio Engineer, Japan Wireless Telegraph Company, Jiji Bldg., Marunouchi, Tokyo, Japan.
- TAKAMURA, S. (A'31), Radio Engineer, Laboratory, Japanese Broadcasting Corporation, Nihon Hosokyokai, Gijutsukenkyujo, Kinutamura, near Tokyo, Japan.
- TAKASE, J. Y. (A'31), Assistant Engineer, Radio Station JIPP, Teisin-Kanri-Rensuyo Museum, Siba, Tokyo, Japan.
- TAKAYA, MICHIIHIRO (A'30), Research Engineer, Teishinsho-Denki-Shikenjo, Osaki, near Tokyo, Japan.
- TAKEBAYASHI, K. (A'25), Radio Engineer, Department of Communications, Denukyoku, Tokyo, Japan.
- TAKEUCHI, H. (A'30), Radio Engineer, Japan Wireless Telegraph Company, Marunouchi, Tokyo, Japan. For mail: 419 Ikebukuro, near Tokyo, Japan.
- TALBOTT, EDWARD P. (A'30), Engineer, Broadcast Station KOB, New Mexico State College, State College, N.M. For mail: Mesilla Park, N.M.
- TALLEY, DAVID (A'26), Dial Maintenance Engineer, Rm. 500, New York Telephone Company, 101 Willoughby St., Brooklyn, N.Y. For mail: 2222 Avenue O, Brooklyn, N.Y.
- TALLMAN, CLARE LE ROY (A'30), Radioman, U. S. Naval Radio Station, Navy Yard, Brooklyn, N.Y.
- TALMAGE, WILBUR L. (A'30), Student, Dodge Radio Institute, Valparaiso, Ind. For mail: Custar, Ohio.
- TAMAI, I. (A'30), Electrical Engineer, Japan Wireless Telephone Company, Jiji Bldg., Marunouchi, Japan.
- TAMI, JOSEPH, JR. (A'29), Technical Representative, Victor Division, RCA Victor Company, Inc., Camden, N.J. For mail: 2621 Magnolia Ave., Los Angeles, Calif.
- TANAKA, YOSHIO (A'31), Radio Engineer, JOJK Nonoichi Sending Station, Nonoichimachi, Ishikawa-ken, Japan.
- TANCK, HENRY (A'26), R.C.A. Communications, Inc., Bolinas, Calif.
- TANIMURA, ISAO (A'30), Denki Shikenjo, Osaki, Tokyo, Japan.
- TANK, FRANZ (A'31), Professor of Physics, Physical Institute, Gloriastr. 35, Zurich, Switzerland.
- TANKE, HAROLD F. (A'29), Student, Purdue University, West Lafayette, Ind. For mail: 608 Waldron St., West Lafayette, Ind.
- TANNER, CHARLES J. (A'29), Service Supervisor, Ontario District, Northern Electric Company, Ltd., 637 Craig St., W., Montreal, P.Q., Canada. For mail: 1627 Graham Blvd., Montreal, P.Q., Canada.
- TANTON, JOHN H. (A'25), R. A. F. Camp, Halton, Bucks, England. For mail: 47A Akerman Rd., Brixton, London, S.W. 9, England.
- TARPLEY, RAYMOND E. (A'30), Research Engineer, Leeds and Northrup Company, 4901 Stenton Ave., Philadelphia, Pa.
- TARRANT, SAMUEL E. (A'31), Development Work, Eastman Kodak Company, Kodak Park, N.Y. For mail: 76 Rockingham St., Rochester, N.Y.
- TARZIAN, SARKES (A'27), Electrical Engineer, Atwater Kent Manufacturing Company, Germantown, Philadelphia, Pa. For mail: 3004 N. Howard St., Philadelphia, Pa.
- TASKER, JOSEPH M. (A'30), Radio and Sound Engineer, Hatry and Young, 203 Ann St., Hartford, Conn. For mail: 54 Rowe Ave., Hartford, Conn.
- TATE, JOSEPH R. (A'27), Radiotrician, 1 N. Main St., Harrisburg, Ill. For mail: P.O. Box 80, Harrisburg, Ill.
- TATNALL, JOSEPH S. (A'28), National Vulcanized Fibre Company, P.O. Box 1005, Wilmington, Del.
- TATREAU, LEON E. (A'26), Proprietor, Village Electric Shop, 1036 Broxton Ave., West Los Angeles, Calif. For mail: 2210 Glendon Ave., West Los Angeles, Calif.
- TAUBERT, W. HOWLAND (A'31), Manager, Insulation Division, Corning Glass Works, Corning, N.Y.
- TAUFENBACH, LESLIE E. (A'22-M'26), President, Western Radio, Inc., 1135 Wall St., Los Angeles, Calif.
- TAUSSIG, CHARLES W. (A'22), President, The American Molasses Company of New York, 111 Wall St., New York, N.Y.
- TAUSSIG, WILLIAM S. (A'29), Continental Baking Corporation, 285 Madison Ave., New York, N.Y. For mail: 1065 Lexington Ave., New York, N.Y.

- TAYLOR, A. HOYT (M'15-F'20)**, Superintendent of Radio Division, U. S. Naval Research Laboratory, Bellevue, Anacostia, D.C.
- TAYLOR, ALFRED O. (A'24)**, 96 Laburnum Grove, Portsmouth, Hants, England.
- TAYLOR, ALFRED R. (A'29)**, Lieutenant, U. S. Navy, U.S.S. Trenton, c/o Postmaster, New York, N.Y.
- TAYLOR, ARTHUR W. (A'31)**, Partner, Improved Radio Company, Lyford Rd., Reading, Berks, England. For mail: Linda Cottage, New Rd., Ascot, Berks, England.
- TAYLOR, CHARLES H. (M'13-F'15)**, Radio Corporation of America, 66 Broad St., New York, N.Y.
- TAYLOR, DALE L. (A'28)**, Manager, Radio Sales and Service, Wright Electric Company, Inc., 118 N. Main St., Elmira, N.Y. For mail: 104 Demarest Pkwy, Elmira, N.Y.
- TAYLOR, DONALD A. (A'31)**, 1814 Montpelier Ave., Dormont, Pittsburgh, Pa.
- TAYLOR, E. GORDON (M'30)**, Instructor, City College, New York, N.Y.
- TAYLOR, EDMUND R. (A'22)**, Telephone Engineer, American Telephone and Telegraph Company, 195 Broadway, New York, N.Y.
- TAYLOR, EUSTACE H. (A'31)**, Box 67, Herndon, Va.
- TAYLOR, FRANCIS WILLIAM (A'28)**, Assistant Manager, Warren Fish Company, Pensacola, Fla. For mail: 222 W. De Soto St., Pensacola, Fla.
- TAYLOR, HAWLEY O. (M'16)**, Professor of Physics, Wheaton College, Wheaton, Ill.
- TAYLOR, JOHN PRATT (A'29)**, Broadcast Transmitter Sales Engineer, Engineering Products Division, RCA Victor Company, Inc., Camden, N.J. For mail: Colwood Apartment 707-B, Richey and Woodlyne Aves., West Collingswood, N.J.
- TAYLOR, LAURENS A. (A'24)**, Development Department, General Electric Company, Schenectady, N.Y. For mail: 144 S. Country Club Dr., Schenectady, N.Y.
- TAYLOR, OTHO E. (A'30)**, 532 Broadway, Greenville, Ohio.
- TAYLOR, RUSSELL R. (A'30)**, Radio Operator, Stations WCBA and WSAW, 39-41 N. 10th St., Allentown, Pa. For mail: 814 Greenleaf St., Allentown, Pa.
- TAYLOR, S. GORDON (A'26)**, Technical Editor, *Radio News*, 381-4th Ave., New York, N.Y.
- TAYLOR, SAMUEL (A'29)**, Assistant to Inspector of Naval Material, General Electric Company, Schenectady, N.Y.
- TAYLOR, THEODORE (A'25)**, Engineer, Western Electric Company, Inc., Kearney, N.J. For mail: 338 Benson Pl., Westfield, N.J.
- TAYLOR, WILLIAM E. (A'31)**, Engineer, Baltimore Police Department, Falls Way, Baltimore, Md. For mail: 3608 Frankford Ave., Baltimore, Md.
- TAYLOR, W. H., JR. (A'19-M'21)**, Patent Lawyer, Pennie, Davis, Marvin and Edmunds, 165 Broadway, New York, N.Y.
- TEACHMAN, ALFRED E. (A'27)**, Manager, Radio Service Department, LaRoe's Radio Store, 283 Main St., Woonsocket, R.I. For mail: 25 Crawford St., Woonsocket, R.I.
- TEAGUE, T. T. (A'18-M'21)**, Lieutenant, Radio Engineer, Washington-Alaska Military Cable and Telegraph System, Ketchikan, Alaska.
- TEETER, ALBERT A. (A'24)**, Charles Pfizer Company, 81 Maiden Lane, New York, N.Y.
- TELAACK, THEODORE J. (A'28)**, President, National Radio Service Company, 756-758 Broadway, Buffalo, N.Y. For mail: 356 Hewitt Ave., Buffalo, N.Y.
- TELLMAN, HERBERT A. (A'30)**, Lieutenant, U. S. Navy, Navy Department, Washington, D.C. For mail: U. S. Naval Station, Key West, Fla.
- TEMPLE, JOHN M. (A'30)**, Consulting Radio Engineer, P.O. Box 388, Shreveport, La.
- TEMPLEMAN, DAVID (A'31)**, Service Manager, C. R. Rogers Company, 5434 Penn Ave., Pittsburgh, Pa. For mail: 109 N. Graham St., Pittsburgh, Pa.
- TEN CATE, ARTHUR C. (A'21)**, 7322 S. Laflin St., Chicago, Ill.
- TERAHATA, MATSUTARO (A'24)**, Engineering Section, Communications Bureau, Komuka, Teishinbu of Kotsukyo-Ku, Taihoku, Formosa, Japan.
- TERHUNE, J. A. (A'30)**, Lieutenant Commander, U. S. Naval Station, Guam, Marianas Islands.
- TERMAN, FREDERICK E. (A'25)**, Associate Professor of Electrical Engineering, Stanford University, Calif. For mail: 659 Salvatierra St., Stanford University, Calif.
- TERNOW, HELMUT G. (A'26)**, 1685 Sutter St., San Francisco, Calif.
- TERRELL, JOHN A. (A'19)**, Engineer, RCA Victor Company, Inc., Camden, N.J. For mail: 116 E. Palmer Ave., Collingswood, N.J.
- TERRELL, ROBERT L. (A'26)**, Operator, National Broadcasting Company, Inc., National Press Bldg., Washington, D.C. For mail: 801 Philadelphia Ave., Silver Spring, Md.
- TERRELL, W. D. (A'12-F'29)**, Director of Radio, U. S. Department of Commerce, 637 National Press Bldg., Washington, D.C.
- TERRILL, W. NESSLER (J'25-A'27)**, Radio Service Manager, Schwendler's, Inc., Utica, N.Y. For mail: 5 Emerson Ave., Utica, N.Y.
- TERRY, LAURENCE M. (A'26)**, Consulting Engineer, The Radio Laboratory, Aiken, S.C.
- TERVEN, LEWIS A. (A'24-M'26)**, West Penn Power Company, 14 Wood St., Pittsburgh, Pa.
- TESCH, WALTER L. (M'24)**, Chief Electrical Engineer, Victor Talking Machine Company of Japan, Ltd., P.O. Box 43, Yokohama, Japan.
- TETLEY, ROBERT C. (A'31)**, Seagoing Radio Operator, Wireless Telegraph Department, c/o Messrs. Siemens Brothers and Company, Ltd., Woolwich, London, S.E. 18, England. For mail: "The Moorings," Tins-hill Rd., Cookridge, Leeds, England.
- TEUNISSON, JOHN F. (A'27)**, Assistant Airways Traffic Supervisor, Airways Division, U. S. Department of Commerce, Airway Radio Station, Maywood, Ill.
- TEVIS, GRAHAM L. (A'29)**, Radio Operator, KMOX, The Voice of St. Louis, Hotel Mayfair, 8th and St. Charles Sts., St. Louis, Mo. For mail: 8224 Fairham Ave., University City, Mo.
- TEXIDO, PLATON (A'31)**, Radio Manufacturer and Distributor, Diputación 175, Barcelona, Spain. For mail: c/o F. del Carpio, 140 Cedar St., New York, N.Y.

- THEBERGE, ALBERT R. (A'29)**, Service Engineer, Electrical Research Products, Inc., 250 W. 57th St., New York, N.Y. For mail: 223 Hampshire St., Lawrence, Mass.
- THEREMIN, LEON (A'29)**, 37 W. 54th St., New York, N.Y.
- THIELEN, E. J. (J'21-A'26)**, Member of Technical Staff, Bell Telephone Laboratories, Inc., 463 West St., New York, N.Y. For mail: 1950 Andrews Ave., New York, N.Y.
- THIESSEN, ARTHUR E. (A'29-M'30)**, Engineer, General Radio Company, 30 State St., Cambridge, Mass.
- THINEMAN, EDWARD H. (A'30)**, Superintendent, The Real Equity Shop, 1428 N. Wells St., Chicago, Ill. For mail: 1329 N. Wells St., Chicago, Ill.
- THISTLEWHITE, ROBERT (A'30)**, Teacher, 1319 E. 38th St., Los Angeles, Calif. For mail: 1824 E. 38th St., Los Angeles, Calif.
- THOLSTRUP, HENRY (A'26)**, Radio Engineer, General Motors Radio Corporation, 1420 Wisconsin Blvd., Dayton, Ohio.
- THOMAS, CHARLES C. (A'29)**, Mackay Radio and Telegraph Company, San Francisco, Calif. For mail: 1119 Fulton St., Palo Alto, Calif.
- THOMAS, CHARLES F., JR. (A'30)**, Mechanical Designer of Radio Apparatus, Stewart-Warner Speedometer Corporation, 1826 W. Diversey Pkwy., Chicago, Ill. For mail: 2715 Kocensky Ave., Chicago, Ill.
- THOMAS, CHARLES V. (A'28)**, Radio Serviceman, Electrical Devices Company, 616 Linden St., Allentown, Pa. For mail: 806 Union St., Allentown, Pa.
- THOMAS, CLARENCE W. (A'28)**, Radio Electrician, Dominion Government Radio Service, 928 Old Esquimalt Rd., Esquimalt, B.C., Canada.
- THOMAS, EDWARD H. (A'29)**, Specialty Radiotechnician, 64 Linden St., Brooklyn, N.Y.
- THOMAS, EIONON (A'19)**, Broadcast Engineer, Marconi's Wireless Telegraph Company, Ltd., Marconi House, Strand, London, England. For mail: The Croft, Avenue Rd., Chelmsford, Essex, England.
- THOMAS, GEORGE G. (A'28)**, Assistant Division Engineer, RCA Victor Company, Inc., Camden, N.J. For mail: 35 Evergreen Lane, Haddonfield, N.J.
- THOMAS, GRIFF (A'31)**, Service Engineer, Victor Freed, 58-60-62 Cardiff St., Aberdare, Wales. For mail: "Glen-Moor," Penpark, Cardigan, Wales.
- THOMAS, HAROLD (A'29)**, Chief Engineer, Radio Station WEAN, Shepard Stores, Providence, R.I. For mail: 69 Wellesley Ave., North Providence, R.I.
- THOMAS, HARRY E. (A'28)**, Radio Production Engineer, United American Bosch Corporation, Springfield, Mass. For mail: 57 Federal St., Springfield, Mass.
- THOMAS, HUBERT E. (A'31)**, Receiving Engineer, R.C.A. Communications, Inc., Honolulu, Hawaii.
- THOMAS, J. C. (A'31)**, Proprietor, Radio Repair Shop, David City, Neb.
- THOMAS, JOSEPH D. (A'27)**, Radio Salesman, American Phonograph Company, 61 Hudson Ave., Albany, N.Y. For mail: 140 Grove Ave., Albany, N.Y.
- THOMAS, L. H. (A'30)**, Research Staff, British Radiostat Corporation, Ltd., 26 George St., Hanover Sq., London, W. 1, England. For mail: "Conway," 66 Ingram Rd., Thornton Heath, Surrey, England.
- THOMAS, MORRIS W. (A'27)**, Radio Engineer, *Wisconsin News*, 15 Michigan St., Milwaukee, Wis. For mail: 1589 N. Farwell Ave., Milwaukee, Wis.
- THOMAS, W. RAYMOND (A'29)**, Radio Doctor, Russells Point, Indian Lake, Ohio.
- THOMAS, WALTER J. (A'26)**, Proprietor, Walter J. Thomas and Company, 2030 W. Fort St., Detroit, Mich.
- THOMAS, WILLIAM A. (A'24-M'27)**, Consulting Engineer, 259 Milbank Ave., Greenwich, Conn.
- THOMAS, WILLIAM M. (A'26)**, Radio Electrician, U. S. Naval Research Laboratory, Bellevue, Anacostia, D.C.
- THOMASON, MARVIN (A'29)**, Chief Radio Tester, Kansas City Power and Light Company, Kansas City, Mo. For mail: Kearney, Mo.
- THOMPSON, ALBERT C. (A'25)**, American Telephone and Telegraph Company, Rm. 2021, 195 Broadway, New York, N.Y.
- THOMPSON, ALFRED E. (M'26)**, Radio Engineer, International Standard Electric Corporation, Aldwych, London, England. For mail: 37 Grove Rd., Surbiton, Surrey, England.
- THOMPSON, B. J. (A'29)**, Research Engineer, RCA Radiotron Company, Inc., 215 S. 5th St., Harrison, N.J.
- THOMPSON, CECIL (A'26)**, c/o "West Australian," P.O. Box D162, G.P.O., Perth, West Australia.
- THOMPSON, EDWARD PHILIP (A'29)**, Electrical Draftsman, International Telephone and Telegraph Corporation, 67 Broad St., New York, N.Y. For mail: 29 Cooper St., Babylon, L.I., N.Y.
- THOMPSON, F. S. (A'28)**, No. 2 Wireless Company, Sarafand, Palestine.
- THOMPSON, GORDON (A'30)**, Assistant Chief Engineer, Electrical Testing Laboratories, 80th St. and East End Ave., New York, N.Y.
- THOMPSON, JOHN H. (A'15)**, Chief Engineer, Canadian Marconi Company, 211 St. Sacramento St., Montreal, P.Q., Canada.
- THOMPSON, J. KENT (J'30-A'30)**, 12974 Emerson Ave., Lakewood, Ohio.
- THOMPSON, JOHN M. (J'27-A'30)**, Manager, Radio Service Department, Empire Gas and Electric Company, State St., Geneva, N.Y.
- THOMPSON, MILTON L. (A'26)**, Radio Engineer, De Forest Radio Corporation, 245 Carlaw Ave., Toronto, Ont., Canada. For mail: 398 Sammon Ave., Toronto, Ont., Canada.
- THOMPSON, REGINALD G. (A'30)**, Telegraph Operator, 306 Live Stock Exchange Bldg., Herr's Island, Pittsburgh, Pa.
- THOMPSON, ROBERT W. (A'31)**, Engineer, Radio Station WBCM, Tuscola Rd., Bay City, Mich. For mail: 1612 Second St., Bay City, Mich.
- THOMPSON, ROLAND F. (A'26)**, Laboratory Assistant, Atwater Kent Radio Manufacturing Company, 4700 Wissahickon Ave., Philadelphia, Pa. For mail: 264 W. Greenwood Ave., Lansdowne, Pa.

- THOMSEN, PAUL H.** (A'28), Radio Engineer, Jenkins Laboratories, 1519 Connecticut Ave., N.W., Washington, D.C. For mail: 903 Philadelphia Ave., Silver Spring, Md.
- THOMSETT, H. S.** (A'29), Post Office Engineering Department, Radio Section, Rugby, Warwicks, England.
- THOMSON, HOWARD M.** (J'29-A'31), Engineer, Bell Telephone Laboratories, Inc., 463 West St., New York, N.Y. For mail: American Telephone and Telegraph Company, Inc., Rm. 2012, 195 Broadway, New York, N.Y.
- THOMSON, JOHN MORTON** (A'26), Radio Engineer, Ferranti Electric, Ltd., 26 Noble St., Toronto 3, Ont., Canada. For mail: 171 John St., Weston, Ont., Canada.
- THORNE, FRANK D.** (A'29), Superintendent, Radio Station CFBO, P.O. Box 1225, St. John, N.B., Canada.
- THORNTON, HENRY P.** (A'27), Division Equipment Engineer, Postal Telegraph Company, Atlanta, Ga.
- THORPE, EDGAR O.** (A'31), Service Manager, Radio Department, Thorpe and Branchaud, Haileybury, Ont., Canada.
- THORPE, STEWART MELVILLE** (A'29), Teacher, Electrical Engineering, Technical Institute, Eastbourne, Sussex, England.
- THORSEN, ORVILLE T.** (A'29), 3547 Pierce Ave., Chicago, Ill.
- THOW, KEITH H.** (M'29), Radio and Carrier Telephone Engineer, Standard Telephones and Cables, Ltd., 24-26 Ballance St., Wellington, New Zealand. For mail: 50 Hallton St., Extension Kavori, Wellington, New Zealand.
- THRELKELD, HOWARD M.** (A'28), Field Engineer, Engineering Department, Grigsby-Grunow Company, 2060 N. Kolmar Ave., Chicago, Ill. For mail: 285 Santa Rosa Ave., San Francisco, Calif.
- THROPP, CHARLES H.** (A'30), Operator, Radiomarine Corporation of America, 75 Varick St., New York, N.Y.
- THRUN, ARTHUR G.** (A'31), Assistant Radio Engineer, Grigsby-Grunow Company, 2060 N. Kolmar Ave., Chicago, Ill. For mail: 5007 Barry Ave., Chicago, Ill.
- THRUSH, PAUL W.** (A'26), Chief Radioman, American Telephone and Telegraph Company, P.O. Box 445, Houlton, Maine. For mail: 71 North St., Houlton, Maine.
- THURSTON, GEORGE** (A'21), Engineer, Bell Telephone Laboratories, Inc., 463 West St., New York, N.Y.
- TICKUS, LOUIS J.** (J'31), Proprietor, L. J. Tickus Radio Service Laboratory, 609 S. Pine St., Nakomis, Ill.
- TIEDJE, JOHN Q.** (A'30), Engineer, RCA Victor Company, Inc., Camden, N.J. For mail: 110 E. Coulter Ave., Collingswood, N.J.
- TIERNEY, WALTER L.** (M'26), Radio Engineer, Bell Telephone Laboratories, Inc., 463 West St., New York, N.Y.
- TIFFANY, JOHN M.** (A'31), Staff Operator, Radio Station WABC, 485 Madison Ave., New York, N.Y. For mail: 15 Godfrey Ave., Roseland, N.J.
- TILDEN, MEARL W.** (A'31), 10318 Indiana Ave., Chicago, Ill.
- TILGNER, SHELTON R.** (J'29), Sanator, S.D.
- TILLET, JESSE** (A'29), Radio Service and Private Experimental Work, 113 Shady Lane, Lexington, Ky.
- TILLSON, BENJAMIN F.** (M'22), Consulting Engineer, 205 Park St., Montclair, N.J.
- TILTMAN, RONALD F.** (A'27), General Secretary, Radio Association, 22-23 Laurence Pountney Lane, London, E.C. 4, England. For mail: 17 Stucley Rd., Lampton, Hounslow, Middlesex, England.
- TIMMINGS, GEORGE H.** (A'28), 3206 Clifton Ave., Chicago, Ill.
- TINGEY, ROBERT** (M'21), Radio Engineer, 45 Nevein Square, Earl's Court, S.W. 5, England.
- TINGLEY, FREEMAN T.** (A'27), Professor of Electrical Engineering, Clemson College, Clemson College, S.C.
- TINNEY, FRANCIS B.** (A'24), Electrical Engineer, P.O. Box 134, Palo Alto, Calif.
- TINUS, WILLIAM C.** (A'31), Member, Technical Staff, Bell Telephone Laboratories, Inc., 180 Varick, New York, N.Y. For mail: 210-6th Ave., New York, N.Y.
- TISCHER, FRANK A.** (A'27), Radio Engineer, Ungar and Watson, Inc., 1363 1/2 S. Figueroa St., Los Angeles, Calif. For mail: P.O. Box 44-R1, Manhattan Beach, Calif.
- TISSHAW, HENRY S.** (M'26), Companhia Portuguesa, Radio Marconi, Rua S. Juliano, 131, Lisbon, Portugal.
- TITTLE, HULBERT C.** (A'27), Radio Engineer, Stewart-Warner Corporation, 1826 Diversey Pkwy., Chicago, Ill. For mail: 3839 Greenview Ave., Chicago, Ill.
- TKACH, GEORGE** (A'27), Certified Radio-trician and Custom Set Builder, Lakefield, Minn.
- TOBIN, LUCIEN C.** (A'31), Manager, Jewell Laboratory, 531 Call Bldg., San Francisco, Calif.
- TOBIYAMA, K.** (A'31), Radio Engineer, Japan Wireless Telegraph Company, Ltd., Jiji Bldg., Marunouchi, Tokyo, Japan.
- TODD, HAROLD C.** (A'27), Merchant, Iron and Steel, Rm. 3655, 120 Broadway, New York, N.Y. For mail: Fanwood, N.J.
- TODD, STEDMAN F.** (A'15), c/o Dr. B. F. Gray, Rm. 2418, 450 Sutter St., San Francisco, Calif.
- TODD, WILLIAM F.** (A'26), Consulting Engineer, 1408 Hughes St., Amarillo, Tex.
- TOLMIE, J. R.** (J'15-A'28), Engineer, Pacific Telephone and Telegraph Company, 838 Dexter Horton Bldg., Seattle, Wash. For mail: 615 Boren Ave., Seattle, Wash.
- TOLSON, W. A.** (M'28), Television Engineer, RCA Victor Company, Inc., Front and Cooper Sts., Camden, N.J.
- TOMBOULIAN, DIRAN H.** (A'31), Graduate Student, Department of Physics, Cornell University, Ithaca, N.Y.
- TOMCHUCK, JOHN** (J'29), Switchman, Michigan Bell Telephone Company, 1365 Cass Ave., Detroit, Mich. For mail: 6826 Linzee St., Detroit, Mich.
- TOMLINSON, FRANK** (A'26), Radio Engineer, Standard Telephones and Cables, Ltd., London, N.W. 9, England. For mail: "Dens-ton," 13 Needle Crescent, Hendon, London, N.W. 4, England.
- TOMLINSON, HARRY E.** (A'25), Sheet Metal Worker, Locomobile Company, Bridgeport, Conn. For mail: 52 Allen St., Bridgeport, Conn.

- TOMPKINS, K. P.** (A'30), Radio Service Manager, Hopkins Equipment Company, 418 W. Peachtree, Atlanta, Ga. For mail: 790 Myrtle St., N.E., Atlanta, Ga.
- TOMPSETT, F. J.** (A'29), Assistant Engineer, Research Department, Marconi's Wireless Telegraph Works, Chelmsford, England. For mail: 20 Hill Rd., Chelmsford, England.
- TOOMBS, ROY** (A'31), "White Haven," Crawford Ave., Wembley, Middlesex, England.
- TOTH, ALBERT F.** (A'22), Member of Technical Staff, Bell Telephone Laboratories, Inc., Rm. K-67, 463 West St., New York, N.Y.
- TOTH, EMERICK** (A'31), Receiver Engineer, High-Frequency Circuits, Wired Radio, Inc., Ampere, N.J. For mail: 76 Epipirt St., East Orange, N.J.
- TOURS, F. B.** (A'30), Lieutenant, c/o British Admiralty, Royal Navy. For mail: c/o Mrs. Charles H. Besley, 156 Park Ave., Hinsdale, Ill.
- TOWERS, ROBERT** (A'27), P.O. Radio Station, Baldock, Hertfordshire, England.
- TOWLSON, HAROLD G.** (A'31), 619 Terrace Pl., Schenectady, N.Y.
- TOWNE, ALFRED E.** (A'30), P.O. Box 277, Kelseyville, Calif.
- TOWNER, ORRIN W.** (A'24-M'29), Radio Installation Engineer, Bell Telephone Laboratories, Inc., 463 West St., New York, N.Y.
- TOWNSEND, FRANK T. G.** (M'26), Post Office Telephone Repeater Station, Aldeburgh, Suffolk, England. For mail: 19 Lee Rd., Aldeburgh, Suffolk, England.
- TOWNSEND, JAMES H.** (A'31), Marine Operator, Pocahontas Steamship Company, 1 Broadway, New York, N.Y. For mail: 178 E. 205th St., New York, N.Y.
- TOWNSEND, SAMUEL W.** (A'26), Chief Engineer, Radio Station WJAY-WALR, 1224 Huron Rd., Cleveland, Ohio. For mail: 79 Marvin Ave., Akron, Ohio.
- TOZER, WILLIAM C.** (A'28), District Engineer and Manager, Western Electricity Supply Company, Ltd., Electricity Office, Abingdon, Berks, England.
- TRACY, JOHN BYRON, JR.** (A'31), Manager, Radio Experimental Laboratories, 49 Broadway, Taunton, Mass.
- TRACY, KERMIT F.** (A'29), Engineer, Radio Station KLRA, Arkansas Broadcasting Company, Little Rock, Ark.
- TRAEGER, SAM H.** (A'30), Radio Service Engineer, Traeger Radio Laboratories, 1832-1834 S.W. 8th St., Miami, Fla.
- TRAGO, ROBERT A.** (A'26), Broadcast Engineer, Engineering Department, Columbia Broadcasting System, Inc., 485 Madison Ave., New York, N.Y.
- TRAINER, GEORGE T.** (A'28), Technical Inspector, Electrical Research Products, Inc., 123 S. Broad St., Philadelphia, Pa. For mail: 57 Glenwood Ave., Aldan, Delaware County, Pa.
- TRAPEUR, ROBERT E.** (A'31), Radio Electrician, U.S. Navy, U.S.S. Holland, c/o Postmaster, San Diego, Calif.
- TRAUGOTT, PAUL** (A'26), 2134 W. Erie Ave., Philadelphia, Pa.
- TRAUTWEIN, PAUL K.** (M'30), President and Treasurer, Marines Radio Service, Inc., 38 Park Pl., New York, N.Y. For mail: Parker Court Apartments, Bayside, L.I., N.Y.
- TRAVIS, CHARLES** (A'29), Engineer, License Division, Radio Corporation of America, 75 Varick St., New York, N.Y.
- TRAVIS, FRANCIS E.** (A'31), Radio Service Manager, Finke Furniture Company, 7 S.E. 7th St., Evansville, Ind. For mail: 1734 S. Elliott St., Evansville, Ind.
- TRAVIS, IRVEN A.** (A'29), Instructor, Moore School of Electrical Engineering, University of Pennsylvania, Philadelphia, Pa. For mail: 32 Bonsall Ave., Sharon Hill, Pa.
- TREFFRY, LAURENCE D.** (A'27), Special Engineer, Magnavox Company, 155 E. Ohio St., Chicago, Ill.
- TREMAIN, EARNEST L.** (A'31), Stone Cutter, Superior Stone, Victoria St., Kitchener, Ont., Canada. For mail: 28 Gordon Ave., Kitchener, Ont., Canada.
- TREMBLAY, JOSEPH** (A'29), Secretary-Treasurer and Service Manager, Chalifoux-Tremblay, Ltd., 7035 St. Laurent Blvd., Montreal, P.Q., Canada. For mail: 7060 St. Laurent Blvd., Montreal, P.Q., Canada.
- TREVEY, C. B.** (A'26), Chief Operator and Technician, Radio Station KFDN, Magnolia Petroleum Company, P.O. Box 798, Beaumont, Tex.
- TREVOR, BERTRAM** (A'29), Radio Engineer, R.C.A. Communications, Inc., Box 982, Riverhead, L.I., N.Y.
- TRIGGER, VERNON A.** (A'28), Engineer-in-Charge, Radio Stations WHJ-W-1NAZ, Springfield, Mass. For mail: 308 Page Blvd., East Springfield, Mass.
- TRINKLE, WILMER S.** (A'26), Sales and Publicity, L. P. Clark, 1207 Race St., Philadelphia, Pa. For mail: 1438 N. 13th St., Philadelphia, Pa.
- TRIPP, AUGUSTUS B.** (A'30), Development Engineer, Thomson Research Laboratory, General Electric Company, Lynn, Mass. For mail: 2 Jackson St., Cliftondale, Mass.
- TRIPPIER, FRANCIS J.** (A'25), Radio Operator, British Wireless Marine Service, Marconi House, Strand, London, W.C. 2, England. For mail: 22 Prospect Pl., Rylhill, near Wakefield, York, England.
- TRITTENBACH, JOHN M. P.** (A'25), Radio Division Head, Sears, Roebuck and Company, 10750 Grand River Ave., Detroit, Mich. For mail: 19333 Blake Ave., Detroit, Mich.
- TROEGLEN, KARL, JR.** (A'30), Plant Operator, Radio Station WIBW, Topeka, Kan. For mail: 422 Washburn Ave., Topeka, Kan.
- TROGNER, ARTHUR M.** (M'28), Radio Engineer, Wired Radio, Inc., Ampere, N.J. For mail: 20 Colonial Ter., Maplewood, N.J.
- TROLESE, LOUIS** (A'30), Technical Representative, RCA Victor Company, Inc., Camden, N.J. For mail: 700-22nd St., Richmond, Calif.
- TROTT, BARNET** (A'23), Engineer, Lang Radio Company, 767 E. 132nd St., New York, N.Y. For mail: 80 Winthrop St., Brooklyn, N.Y.
- TROUANT, VIRGIL E.** (A'26), Engineer-in-Charge, Radio Development Engineering Department, Westinghouse Electric and Manufacturing Company, East Pittsburgh, Pa. For mail: 822 Woodworth St., Wilkinsburg, Pa.
- TROUTBECK, WILFRID H.** (A'29), Engineer-in-Charge, Radio Broadcasting Laboratories, Standard Telephones and Cables Company, Ltd., The Hyde, Hendon, London.

England. For mail: 52 Eaton Ter., Westminster, London, S.W. 1, England.

TROWBRIDGE, O. H. (A'27), Educational Counselor, R.C.A. Institutes, Inc., 75 Varick St., New York, N.Y. For mail: 1396 Park Lane, Pelham Manor, N.Y.

TROXLER, LUCIEN J., JR. (A'17), Radio Engineer, Hazeltine Service Corporation, 333 W. 52nd St., New York, N.Y. For mail: 163-03-32nd Ave., Flushing, L.I., N.Y.

TRUAX, JOHN (A'27), Brokerage, George W. Sumers Company, 42 Broadway, New York, N.Y.

TRUESDALE, JAMES R. (A'31), Radio Service Manager, E. A. Bowman, Inc., 5115 John R. St., Detroit, Mich. For mail: 3490 Lincoln Ave., Detroit, Mich.

TRUM, ALEXANDER D. (A'27), Accountant, State Highway Department of Alabama, Montgomery, Ala. For mail: 33 Winthrop Court, Montgomery, Ala.

TRUMBULL, A. F. (A'29), Radio Mechanic, Communications Department, Boeing Air Transport, Oakland, Calif. For mail: 605 Marguerite Ave. N., Portland, Ore.

TRUMPY, JAY W. (J'28), Laboratory Assistant, H. H. Ely Manufacturing Company, 4710 Stenton Ave., Philadelphia, Pa. For mail: 5737 N. Lawrence St., Philadelphia, Pa.

TSAO, T. C. (A'29), Professor, College of Engineering, University of Chekiang, Hangchow, China.

TSAO, ZEUSON C. (A'28), Engineer, China Radio Corporation, 8 Rue du Marechal Foch, Tientsin, China.

TSIA, HOCK (A'28), Radio Engineer, China Radio Corporation, 8 Rue de Marechal Foch, Tientsin, China.

TSUJI, UICHOHO (A'30), Electrical Engineer, Fukuokahosokyoku, Inabacho, Fukuoka City, Japan.

TSUMURA, KAZUO (A'28), Radio Engineer, Japan Wireless Telegraph Company, Jiji Bldg., Marunouchi, Tokyo, Japan. For mail: Nihon Musen Densin Kaisha, Yosami-Mura Iekikikai-Gun, Aichiken, Japan.

TSUSHIMA, YONEKICHI (A'26), Chief Radio Operator, Wireless Department, Nippon Yusen Kaisha, Marunouchi, Tokyo, Japan.

TUCCI, THOMAS JOSEPH (J'30-A'30), Radio Dealer, T. and T. Radio Service Company, 1715 Snyder Ave., Philadelphia, Pa. For mail: 1621 Christian St., Philadelphia, Pa.

TUCK, H. P. (A'30), Lecturer, Electrical Engineering, University of Tasmania, Hobart, Tasmania.

TUCKER, CARLTON E. (A'31), Associate Professor, Electrical Engineering, Massachusetts Institute of Technology, Cambridge A, Mass.

TUCKER, DURWARD J. (A'30), Engineer, Southwestern Bell Telephone Company, 809 Telephone Bldg., Dallas, Tex. For mail: Box 181, S.M.U., Dallas, Tex.

TUCKER, G. LLOYD (A'28), Radio Operator, Chicago Police Radio, Chicago, Ill. For mail: 519 Oakwood Ave., Highland Park, Ill.

TUCKER, MORRIS H. (A'30), Contact Engineer, Colonial Radio Corporation, 25 Wilbur Ave., Long Island City, L.I., N.Y. For mail: 1621-65th St., Brooklyn, N.Y.

TUCKER, MURRAY E. (A'28), 41 Park Row, New York, N.Y. For mail: 7 Helen Ave., West Orange, N.J.

TUCKER, WILLIAM E. (A'30), Radio Transmitter Engineer, General Electric Company, Schenectady, N.Y. For mail: 1738 Albany St., Schenectady, N.Y.

TUCKERMAN, LUCIEN P. (A'25), Electrical Engineer, Kolster Radio, Inc., 360 Thomas St., Newark, N.J. For mail: 3518 Farragut Rd., Brooklyn, N.Y.

TUEL, A. Y. (A'28), Vice President and General Manager, Mackay Radio and Telegraph Company, 67 Broad St., New York, N.Y.

TUGGLE, GRANVILLE D. (A'30), Sales and Service, Citizens' Electric Company, Hot Springs, Ark.

TULAUSKAS, LEONARD (A'31), Chief Radio Engineer, United Air Cleaner Corporation, 9705 Cottage Grove Ave., Chicago, Ill. For mail: 9323 Rhodes Ave., Chicago, Ill.

TUMLESON, JAMES F. (A'30), Radioman, Third Class, U. S. Navy, U. S. Naval Radio Station, Bar Harbor, Maine.

TURENNE, WILFRED J. (A'26), Factory Manager, Lectrodi Corporation, 186 Market St., Lynn, Mass. For mail: 59 Holton St., Danvers, Mass.

TURLE, EDGAR H. (M'25), Chief Electrical Engineer, H. J. Cash and Company, Ltd., Caxton House, Westminster, London, S.W. 1, England. For mail: Deerhurst, Beckenham, Kent, England.

TURNER, ALFRED H. (A'30), Laboratory Assistant, RCA Victor Company, Inc., Front and Cooper Sts., Camden, N.J. For mail: 202 Burrwood Ave., Collingswood, N.J.

TURNER, ALVA (A'22), Assistant Professor of Physics, Hunter College, 68th St. and Park Ave., New York, N.Y.

TURNER, C. G. (A'28), Chief Engineer, Melodian Company of America, Independence, Mo. For mail: 4012 Roanoke Rd., Kansas City, Mo.

TURNER, GEORGE S. (A'22-M'28), U. S. Assistant Supervisor of Radio, 2022 Engineering Bldg., Chicago, Ill.

TURNER, H. M. (A'14-M'20), Associate Professor of Electrical Engineering, Yale University, New Haven, Conn.

TURNER, HARRY E. (A'23), 7040 Woodlawn Ave., Chicago, Ill.

TURNER, J. GLEN (J'30-A'31), Television Technician, Don Lee, Inc., 7th and Bixel Sts., Los Angeles, Calif. For mail: 332 E. 60th St., Los Angeles, Calif.

TURNER, LAURENCE B. (A'24), Cambridge University, Cambridge, England. For mail: 47 Bateman St., Cambridge, England.

TURNER, RUSSEL S. (A'29), Radio Inspector, Radiomarine Corporation of America, Cleveland, Ohio. For mail: c/o Radiomarine Corporation of America, 9402 Ewing Ave., South Chicago, Ill.

TURPIN, ROGER (A'31), Consulting Engineer, de ces Etabliss et de la Compagnie Nationale de Radiodiffusion, Paris, France. For mail: 10 Rue de Langeac, Paris 15^{eme}, France.

TURVEY, HENRY C. (A'28), Consultant, Jessop and Turvey, Electrical Engineers, Ecclesall, Sheffield, England. For mail: 42 Huntley Rd., Ecclesall, Sheffield, England.

TUSKA, CLARENCE D. (A'14), Radio Engineer, Atwater Kent Manufacturing Company, Philadelphia, Pa. For mail: 717 W. Mount Airy Ave., Philadelphia, Pa.

TUSTIN, JOHN L. (A'26), Proprietor, Tustin Radio and Electric Company, 428 Sutter St., San Francisco, Calif.

TUTTLE, CLARENCE W. (A'23), Vice President, Colonial Radio Corporation, 25 Wilbur Ave., Long Island City, L.I., N.Y. For mail: 22 E. 38th St., New York, N.Y.

TUTTLE, WILLIAM N. (A'26), Engineer, General Radio Company, 30 State St., Cambridge, Mass.

TYKOCINER, J. T. (M'21), Research Engineer, Electrical Engineering Department, University of Illinois, Urbana, Ill.

TYLER, KENNETH G. (A'28), Radio Operator, Radio Station WJAG, Norfolk, Neb. For mail: 1216 Norfolk Ave., Norfolk, Neb.

TYNAN, THOMAS E. (A'29), Radio Service Manager, W. S. Nott Company, 201 N. 3rd St., Minneapolis, Minn. For mail: 915 Queen Ave., N., Minneapolis, Minn.

TYSSE, HENRY L. (A'30), Manager, Radio Service Department, Meyer Music House, 17 W. 8th St., Holland, Mich. For mail: 162 E. 24th St., Holland, Mich.

TYZZER, HOWARD J. (A'20), 24 Ames St., Lawrence, Mass.

U

UENO, SHUZO (A'27), Radio Research Laboratory, Japan Broadcasting Association, Kinutamura, near Tokyo, Japan.

UHLIG, ERICH (A'31), Draftsman, RCA Victor Company, Inc., Camden, N.J. For mail: 130 New Jersey Rd., Brooklawn, N.J.

ULEMAN, TURRELL (J'31), Radio Operator, Radio Stations WSBT-WFAM, South Bend Tribune, South Bend, Ind. For mail: 236 E. Broadway, South Bend, Ind.

ULLRICH, EDWARD H. (M'26), Engineer, Les Laboratoires Standard, 46 Avenue de Breteuil, Paris 7^e, France.

ULREY, DAYTON (A'28), Research Physicist, Westinghouse Electric and Manufacturing Company, East Pittsburgh, Pa. For mail: Forest Hills Rd., Wilkinsburg, Pa.

UMBACH, WALTER R. (A'27), Superintendent, Radio Tube Manufacturing, Westinghouse Lamp Company, Bloomfield, N.J. For mail: 5 Pierson Pl., Glen Ridge, N.J.

UNDERHILL, CHARLES R., JR. (J'16-A'20), Installation and Service Engineer, RCA Photophone, Inc., 7 Wood St., Pittsburgh, Pa. For mail: 2527-8th Ave., Altoona, Pa.

UNDERWOOD, CLIFFORD C. (A'26), Radio Engineer, Canadian Westinghouse Company, Ltd., Hamilton, Ont., Canada. For mail: 95 Melrose Ave. S., Hamilton, Ont., Canada.

UNDERWOOD, ERNEST G. (A'28), Technical Director, Don Lee, Inc., Station KIII, 1076 W. 7th St., Los Angeles, Calif. For mail: 579 Ellis Ave., Inglewood, Calif.

UNDERWOOD, NORMAN B. (J'30), Engineer, Radio Station WSPD, Commodore Perry Hotel, Toledo, Ohio. For mail: 358 W. Oakland Ave., Toledo, Ohio.

UNRUH, FRANKLIN T. (A'28), Junior Radio Operator, U. S. Department of Commerce (Airways), Dallas, Tex. For mail: 2503 Lovers Lane, Dallas, Tex.

UPHAM, STUART W. (A'30), 3443 Holmes St., Kansas City, Mo.

UPP, CHARLES B. (A'30), Radio Engineer, Westinghouse Electric and Manufacturing Company, East Pittsburgh, Pa.

UREY, GEORGE M. (A'29), District Service Manager, RCA Photophone, Inc., 411-5th Ave., New York, N.Y. For mail: 202 Orpheum St., Seattle, Wash.

USSELMAN, GEORGE L. (A'20), Radio Engineer, Radio Corporation of America, Rocky Point, L.I., N.Y.

UZMANN, GEORGE J. (A'25-M'26), Engineer, Dubilier Condenser Corporation, 4377 Bronx Blvd., New York, N.Y. For mail: 439-78th St., Brooklyn, N.Y.

V

VACEK, GEORGE J. (A'30), Radiotrician, 223 N. Curley St., Baltimore, Md.

VAIL, LESLIE G. (A'28), Radio Sales and Service, Orient, N.Y.

VAILL, EDWARD W. (A'24), Partner, Sheffield and Betts, 80 Maiden Lane, New York, N.Y.

VALENTINE, FRANCIS B. (A'30), Tester, Westinghouse Electric and Manufacturing Company, Chicopee Falls, Mass. For mail: 46 Osborne Ter., Springfield, Mass.

VALENTINE, FORREST C. (A'30), Salesman, General Cable Corporation, 4377 Chamber of Commerce Bldg., Cincinnati, Ohio.

VALENTINE, RUSSELL D. (A'27), 3706-69th St., Woodside, L.I., N.Y.

VANACORE, THOMAS (A'28), 120 W. 123rd St., New York, N.Y.

VAN ALSTYNE, A. J. (A'30), Draftsman, Radio Department, General Electric Company, Bldg. 89, 1 River Rd., Schenectady, N.Y. For mail: 448-3rd St., Schenectady, N.Y.

VAN ANTWERP, MAX C. (A'26), Transmission Man, American Telephone and Telegraph Company, 214 N. Main St., Rockford, Ill. For mail: P.O. Box 36, Pecatonica, Ill.

VAN BOCKERN, JOHN H. (A'30), Radio Service Manager, Greenfield Auto Company, Lennox, S.D. For mail: Box 332, Lennox, S.D.

VAN BROCKLIN, WILLIAM S. (A'22), Radio Dealer, 1036 South St., Rosindale, Mass.

VANCE, H. C. (M'30), RCA Victor Company, Inc., 100 W. Monroe St., Chicago, Ill. For mail: 4718 Washington St., Downers Grove, Ill.

VANDEN MEERSCH, A. J. (A'31), Instructor, University of Ghent, Ghent, Belgium. For mail: St. Pieters Aalststraat 22, Ghent, Belgium.

VAN DER BIJL, HENDRIK J. (M'17-F'28), Chairman, Electricity Supply Commission, Box 1091, Johannesburg, South Africa. For mail: 67 Harley St., Yoeville, Johannesburg, South Africa.

VAN DER BILT, CORNELIUS L. (A'25), Professor, Technical University, Delft, Holland. For mail: Wassenaarscheweg 126, The Hague, Holland.

VANDERPOEL, FLOYD L. (A'12), Litchfield, Conn.

VAN DER POL, BALTH., JR. (M'20-F'29), 12 Jan Smitzlaan, Eindhoven, Holland.

VAN DER WOUDE, FRITZ (A'31), Chief Engineer, General Industries Company, P.O. Box 366, Elyria, Ohio.

VAN DOEREN, C. A. (A'29), Installation Engineer, Electrical Research Products, Inc., 130 N. Wells St., Chicago, Ill. For mail: 3323 E. 8th St., Tulsa, Okla.

- VAN DUYN, EUGENE D. (A'28), Technical Representative, Kolster Radio, Inc., 67 Broad St., New York, N.Y. For mail: 41 Waldo Ave., East Rockaway, L.I., N.Y.
- VAN DYCK, ARTHUR F. (A'13-M'19-F'25), Radio Corporation of America, RCA Bldg., 570 Lexington Ave., New York, N.Y. For mail: 14 Martin Rd., Bryn Mawr Knolls, Yonkers, N.Y.
- VAN DYKE, KARL S. (A'15-M'26), Professor of Physics, Scott Laboratory, Wesleyan University, Middletown, Conn.
- VANEK, LAWRENCE J. (A'28), Auto-Radio Technician, Crosley Radio Corporation, 3401 Colerain Ave., Cincinnati, Ohio. For mail: 3009 Scioto St., Cincinnati, Ohio.
- VAN GUNDT, CLARENCE (A'29), Serviceman, 2727 Walnut Ave., Kansas City, Mo. For mail: 5828 E. 12th St., Kansas City, Mo.
- VAN HEININGEN, WILLARD A. (J'27-A'30), Operator, Radio Station WCAC, Connecticut Agricultural College, Storrs, Conn. For mail: Danbury Rd., Wilton, Conn.
- VAN HORN, J. C. (A'15-M'26), Vice President, In Charge of Resident Schools, R.C.A. Institutes, Inc., 1211 Chestnut St., Philadelphia, Pa.
- VAN LOAN, CULLEN G. (A'25), Radio Dealer, W. A. Roosevelt Company, La Crosse, Wis. For mail: P.O. Box 461, La Crosse, Wis.
- VAN MEEL, G. M. (A'31), Head of Repeater Department, Bell Telephone Manufacturing Company, Boulevard de la Woluwe, Antwerp, Belgium. For mail: Heide F. 80, Calmpthout, Belgium.
- VAN NICE, JOHN H. (A'31), Technical Editor, *WCFL Radio Magazine*, 623 S. Wabash Ave., Chicago, Ill. For mail: 914 W. Crescent Ave., Park Ridge, Ill.
- VAN NIMAN, ROY T. (J'25-A'28), c/o L. B. Crandall, Mansfield, Conn.
- VAN PELT, JOHN (A'31), Radio Serviceman, Ludwig Baumann and Company, 45 Pearson St., Long Island City, L.I., N.Y. For mail: 922 Summit Ave., c/o Jones, New York, N.Y.
- VANSANT, F. T. (A'30), Engineer, Bell Telephone Laboratories, Inc., 463 West St., New York, N.Y.
- VAN SICKLE, GEORGE W. (A'27), Engineer, Secretary and Treasurer, Van-Ashe Radio Company, 10th and Walnut Sts., St. Louis, Mo.
- VAN SICKLE, MELVIN (A'28), Engineer, Kolster Radio, Ltd., 207 Queens Quay, Toronto, Ont., Canada.
- VAN SICKLE, R. E. (A'29), Shop Superintendent, Sampson Electric Company, 3201 S. Michigan Ave., Chicago, Ill. For mail: 7728 Calumet Ave., Chicago, Ill.
- VAN THIEL, JAN (A'27), Radiotechnician and Engineer, National Hotel, Jackson, Calif.
- VAN WHY, FORBES W. (A'24-M'28), Chief Engineer, Pacific Western Broadcast Federation, P.O. Box 1111, Hollywood, Calif.
- VARLEY, WILLIAM E. (A'31), Radio Engineer, Frequency Standard Laboratory, Marconi's Wireless Telegraph Company, Ltd., Chelmsford, England. For mail: 28 Van Dieman Rd., Chelmsford, England.
- VARNY, HERBERT G. (A'31), Shoemaker, Boyd-Welsh Shoe Company, 4400 Newstead Ave., St. Louis, Mo. For mail: 1509 Hickory St., St. Louis, Mo.
- VASUDEVA, D. N. (A'30), Lecturer in Physics, Government College, Dharmasala, Punjab, India.
- VAUGHAN, CARROLL B. (A'28), Box 110, Grand Central Annex, New York, N.Y.
- VAUGHAN, FRANK P. (A'18), Engineer and Manager, Vaughan Electric Company, Ltd., 94 Germain St., St. John, N.B., Canada.
- VAUGHAN, KENNETH A. (A'29), Radio Service Engineer, Radio Service Laboratories, 507 South St., Johnstown, Pa.
- VEAZIE, EDMUND A. (A'31), Bell Telephone Laboratories, Inc., 395 Hudson St., New York, N.Y.
- VEDY, L. G. (A'30), Lecturer in Physics, Department of Physics, The University, Reading, England.
- VEIRUP-JENSEN, J. G. (A'23), Superintendent, Colin B. Kennedy Company, 140-2nd St., San Francisco, Calif. For mail: 232 Lytton Ave., Palo Alto, Calif.
- VELASCO, JOSE M. (A'22), Manager, Radio Department, C. A. Richards, Inc., 304 E. 45th St., New York, N.Y. For mail: 730 E. 236th St., New York, N.Y.
- VENABLE, RICHARD NEEL (A'29), Radio Service Engineer, Cushman-Cushman, Inc., 53 W. 56th St., New York, N.Y. For mail: 235 Wadsworth Ave., New York, N.Y.
- VENNES, H. J. (M'26), Transmission Engineer, Northern Electric Company, Ltd., 121 Shearer St., Montreal, P.Q., Canada.
- VENTURINI, ANTHONY (A'31), Engineer, Viale Abuzzi 34, Milan, Italy.
- VERDAM, NICHOLAS H. (M'21), Office of Wireless Service of Dutch East Indies, Bandoeng, Java.
- VERDIGI, JOHN R. (A'31), Serviceman, Ludwig Baumann and Company, 45 Pearson St., Long Island City, L.I., N.Y. For mail: 10-11-34th Ave., Long Island City, L.I., N.Y.
- VERKLEY, B. M. (A'29), Maintenance Department, Union Gas and Electric Company, Cincinnati, Ohio. For mail: 467 Riddle Rd., Cincinnati, Ohio.
- VERMAN, LAL C. (A'28), Katra Kanayan, Amritsar, India.
- VERMILLION, CHARLES O. (A'30), Chief Draftsman, Wired Radio, Inc., Amper, N.J. For mail: 78 Leslie St., East Orange, N.J.
- VERMILYA, IRVING (M'26), President, New Bedford Broadcasting Company, New Bedford, Mass. For mail: New Bedford Hotel, New Bedford, Mass.
- VERNON, BASIL H. (A'24), Second Engineer, British Broadcasting Corporation, Broadcasting House, Piccadilly, Manchester, England. For mail: 47 Winstanley Rd., Sale, Cheshire, England.
- VERRALLS, J. MAYNARD (A'29), Technical Adviser, Philip Brown, Ltd., 1 Livery St., Birmingham, England.
- VEVERKA, R. E. (A'30), Radio Service Manager, A. Hospe Company, 1421 Farnam St., Omaha, Neb. For mail: 3071 S. 32nd St., Omaha, Neb.
- VICKERS, C. A. (A'30), Trouble Shooter, Crosley Radio Corporation, Cincinnati, Ohio. For mail: 2301 Vine St., Cincinnati, Ohio.
- VICTOREEN, CHARLES J. (M'31), 6751 Jeffery Ave., Chicago, Ill.
- VICTOREEN, JOHN A. (A'24-M'27), President, Victoreen Instrument Company, 5806 Hough Ave., Cleveland, Ohio.

- VIERLING, GUSTAV (A'29), Chief Engineer, Radio Transandino, Foelsch and Company, Esmeralda No. 2, Valparaiso, Chile. For mail: Casilla 1652, Valparaiso, Chile.
- VINCENT, ALMON M. (A'31), 510 Custom House, San Francisco, Calif.
- VITTELLARO, FRANK L. (A'30), U.N.C., Ltd., Orleans Huron Bldg., Chicago, Ill. For mail: 1330 N. Parkside Ave., Chicago, Ill.
- VOEGLIN, ELMO (A'29), Radio Repair Shop, 335 Seguin St., Algiers, La. For mail: 437 Seguin St., New Orleans, La.
- VOGEL, ERWIN WILLIAM (A'28), Radio Research Engineer, Standard Radio Research Laboratories, Inc., 4606 Clarendon Rd., Brooklyn, N.Y.
- VOGEL, PHILIP J. (A'31), Radio Supervisor, American Hawaiian Steamship Company, Pier 26, 215 Market St., San Francisco, Calif.
- VOGELSANG, GEORGE E. (A'30), Manager, Engineering Laboratory, Crosley Radio Corporation, Cincinnati, Ohio. For mail: Mount Washington, Cincinnati, Ohio.
- VOIGHT, RICHARD J. (A'25), Radio Engineer, Voight Radio Service Company, 1427 Marlboro St., Sandusky, Ohio.
- VOIGT, GEORGE (J'27-A'30), 117-19-168th St., Locust Manor, Jamaica, L.I., N.Y.
- VOLKENANT, GORDON W. (J'25-A'29), Sparks-Withington Company, Jackson, Mich.
- VOLKMANN, JOHN E. (A'29), Acoustic Engineer, RCA Photophone, Inc., 153 E. 24th St., New York, N.Y.
- VON ARDENNE, MANFRED (J'27-A'29), Radio Engineer, Yungfernstieg 19, Berlin-Lichterfelde-Ost, Germany.
- VON DOENHOFF, ALBERT E. (J'31), Student, Columbia University, New York, N.Y. For mail: 251 W. 102nd St., New York, N.Y.
- VOORHAAR, FREDERICK R. (A'25), Engineering Department, Operadio Manufacturing Company, St. Charles, Ill. For mail: 407 S. 6th St., St. Charles, Ill.
- VORIS, DON LEA (A'30), Instructor, Modern School of Radio Service, 1112 1/2-4th Ave., Seattle, Wash. For mail: R.R. No. 2, Bellevue, Wash.
- VOROJEIKEN, I. N. (A'31), Development Engineer, Colonial Radio Corporation, 254 Rano St., Buffalo, N.Y. For mail: 181 Royal Ave., Buffalo, N.Y.
- VOSE, CHARLES H. (A'25), Engineer, RCA Victor Company, Inc., Camden, N.J. For mail: Glenwood Ave., R.F.D. No. 1, Haddonfield, N.J.
- VOSE, GEORGE E. (A'30), Engineer, Radio Station WOR, 131 Market St., Newark, N.J. For mail: 23 Oxford Ter., West Orange, N.J.
- VREELAND, FREDERICK K. (M'16-F'26), Research Engineer, 521 River St., Hoboken, N.J. For mail: Vreeland Corporation, 90 West St., New York, N.Y.

W

- WADDELL, GEORGE G. (A'26), P.O. Box 128, West Liberty, Ill.
- WADE, ARTHUR (A'31), Radio Engineer, 9 Carlton Rd., Burnley, Lancs., England.
- WADE, C. F. NEWTON (A'19-M'26), Jessleton, British North Borneo.
- WADE, DAVID (J'25-A'29), Radio Service Department, Victor Talking Machine Company, Lenior St., Montreal, P.Q., Canada. For mail: 440 Moffat Ave., Verdun, P.Q., Canada.
- WADSWORTH, C. A. (A'30), Division Engineer, RCA Victor Company, Inc., Camden, N.J. For mail: 252 Marion Ave., Haddonfield, N.J.
- WADSWORTH, HERBERT A. (A'30), Civil Servant, Radio Section, Post Office Engineering Department, H.M. Radio Station, Hillmorton, Rugby, England. For mail: "Parkfield," Kingsley Ave., The Paddock, Rugby, England.
- WAGENER, W. HALL (A'27), Proprietor, Wagener Radio Service, 1-15 Hertel Ave., Buffalo, N.Y.
- WAGENER, WINFIELD G. (A'29), Radio Engineer, Federal Telegraph Company, 200 Mount Pleasant Ave., Newark, N.J.
- WAGNER, HARRY S. (A'28), W. Main St., Clinton, N.J.
- WAGNER, KARL W. (F'27), Director, Heinrich Hertz Institut für Schwingungsforschung, Berlin, Germany. For mail: 1 Franklinstrasse, Berlin, N.W. 87, Germany.
- WAINWRIGHT, ALBERT (A'28), Chief Electrician, Skurray's, Ltd., Swindon, Wiltshire, England. For mail: Normandy, 29 Evelyn St., Swindon, Wiltshire, England.
- WAINWRIGHT, STUART F. (A'26), #22 Ontario St., Burbank, Calif.
- WAITE, AMORY H., JR. (A'30), Laboratory Assistant, Shortwave and Television Laboratory, 70 Brookline Ave., Boston, Mass. For mail: 125 W. Elm Ave., Wollaston, Mass.
- WAITE, D. (A'30), Technical Instructor, Belfast School of Telegraphy, 81 Donegal Pass, Belfast, North Ireland. For mail: 128 University Ave., Belfast, North Ireland.
- WAITE, GRIFFIN G. (A'30), Electrical Engineer, Sangamo Electric Company of Canada, 183 George St., Toronto, Ont., Canada.
- WAITE, SAMUEL A. (A'22), Box 37, Northbridge, Mass.
- WALANKA, M. R. (A'25), Manager, Radio Department, Bowman and Company, Harrisburg, Pa. For mail: 3238 Green S., Harrisburg, Pa.
- WALD, DAVID (A'26), President, United Scientific Laboratories, Inc., 113-4th Ave., New York, N.Y.
- WALDO, GEORGE V. (A'27), Student in Electrical Engineering, Alabama Polytechnic Institute, Auburn, Ala. For mail: P.O. Box 2034, Auburn, Ala.
- WALGREN, C. A. (A'27), Engineering Department, Raymond Brothers, Impact Pulverizer Company, 1319 Branch St., Chicago, Ill. For mail: 1714 Foster Ave., Chicago, Ill.
- WALKER, C. L. (A'26), Inspection Engineer, Radio Engineering Department, United American Bosch Magneto Company, Springfield, Mass. For mail: 68 Federal St., Springfield, Mass.
- WALKER, C. ROBERT (A'26), Technical Employee, American Telephone and Telegraph Company, 15 Dey St., New York, N.Y. For mail: 65 Summit Ave., Jersey City, N.J.
- WALKER, CHARLES M. (A'30), Engineering Department, Champion Radio Manufacturing Company, 21 Holten St., Danvers, Mass.

- WALKER, FRANK (A'27), Coöperative Radio Service, Taulbee and Walker, 65 S. Main St., Winchester, Ky.
- WALKER, GEORGE S. D. (A'31), "Ballymaccus," Kinsale, Irish Free State.
- WALKER, GUY P. (A'29), Junior Physicist, U. S. Naval Research Laboratory, Bellevue, Anacostia, D.C.
- WALKER, HAROLD (A'30), Research Laboratory, Philadelphia Storage Battery Company, Philadelphia, Pa. For mail: 1343 St. Vincent St., Philadelphia, Pa.
- WALKER, HAROLD S. (A'21), Development and Research Engineer, British Broadcasting Corporation, London, W.C. 2, England. For mail: Park Lodge, 9 The Butts, Brentford, Middlesex, England.
- WALKER, JAMES H. (A'31), Electrical Engineer, E. O. Dorsch Electric Company, 1418 Pine St., St. Louis, Mo. For mail: 5020a Mardel Ave., St. Louis, Mo.
- WALKER, NOLAN S. (A'29), Chief Engineer, Ohio Broadcasting Company, 319 Tuscarawas St., Canton, Ohio. For mail: East Sparta, Ohio.
- WALKER, RAYMOND E. (A'29), c/o W. P. Fuller Company, South San Francisco, Calif.
- WALKER, ROBERT M. (A'27), 6749 Sycamore Ave., Seattle, Wash.
- WALKER, VERL G. (A'31), Service Manager, Palmer Music House, 234 E. Main St., Medford, Ore. For mail: 721 Alder St., Medford, Ore.
- WALL, LEAVELL D. (A'27), Transmission Tester, Southwestern Bell Telephone Company, San Antonio, Tex. For mail: 1202 McKinley Ave., San Antonio, Tex.
- WALLACE, ALEX T. (A'23), 75, The Mall, Southgate, N. 14, England.
- WALLACE, DAVID R. (A'26), President, Wallace Radio Institute, 103 W. 13th St., Oklahoma City, Okla.
- WALLACE, DONALD C. (A'25), District Manager, Kolster Radio, Inc., 360 Thomas St., Newark, N.J. For mail: 4214 Country Club Dr., Long Beach, Calif.
- WALLACE, G. A. (A'29), Assistant Professor of Electrical Engineering, McGill University, Engineering Bldg., Montreal, P.Q., Canada.
- WALLACE, GORDON S. (A'17), Toll Supervisor, New England Telephone and Telegraph Company, 125 Milk St., Rm. 708, Boston, Mass. For mail: 15 Bothwell Rd., Brighton, Mass.
- WALLACE, H. EDWARD (A'28), 151 Sip Ave., Jersey City, N.J.
- WALLACE, J. M. (A'16), Radiotechnician, 148 Springhurst Ave., Toronto 3, Ont., Canada.
- WALLACE, JAMES D. (A'29), Assistant Physicist, Radio Division, U. S. Naval Research Laboratory, Bellevue, Anacostia, D.C.
- WALLACE, L. E. (A'29), Proprietor, L. E. Wallace Radio Service, 300 S. 6th St., McGee, Ark.
- WALLACE, MARCEL (A'30), Consulting Engineer, 10, Rue Pergolèse, Paris, (16e), France.
- WALLACE, MARTIN J. (A'28), RCA Victor Company, Inc., 200 Cornell Rd., Audubon, N.J.
- WALLACE, MILTON W. (A'30), Laboratory Assistant, Radio Receptor Company, Inc., 106-7th Ave., New York, N.Y. For mail: 5 S. Maple Ave., East Orange, N.J.
- WALLACE, O. C. S., JR. (A'30), Commercial Pilot, Canadian Airways, Ltd., St. Hubert Airport, Montreal, P.Q., Canada. For mail: Rm. 803, Lewis Bldg., 465 St. John St., Montreal, P.Q., Canada.
- WALLACE, P. H. (A'30), Engineer, Kingman Electrical Service, P.O. Box 451, Kingman, Ariz.
- WALLACE, RICHARD H. (A'31), Wireless Operator, Spurn Lightship, Humber Conservancy, Whitefriargate, Hull, England. For mail: 51 Grafton St., Beverley Rd., Hull, England.
- WALLACH, MOSES U. (A'26), Secretary, J. and J. Wallach, 330-334 E. 59th St., New York, N.Y.
- WALLER, PAUL (A'30), Manager, Radio Service Department, Hollenberg Music Company, 315 W. Capitol Ave., Little Rock, Ark. For mail: 922 N. Hughes St., Success Heights, Little Rock, Ark.
- WALLGREN, ALRIC E. (A'28), 18 Arthur St., Woodfords, Portland, Maine.
- WALLIN, HARRY E. (A'30), Technical Engineer, Stewart-Warner Corporation, 1826 Diversey Pkwy., Chicago, Ill. For mail: 3353 Belle Plaine Ave., Chicago, Ill.
- WALLS, HOY J. (M'28), Radio Engineer, Bureau of Lighthouses, U. S. Department of Commerce, Washington, D.C. For mail: 6619 Summit Ave., Chevy Chase, Md.
- WALMSLEY, THOMAS (M'26), Engineer-in-Charge, Engineer-in-Chief's Office, Radio Section, Alder House, London, E.C. 1, England.
- WALSH, ARTHUR L. (A'28), Vice President, Thomas A. Edison Inc., Orange, N.J. For mail: 332 Redmond Rd., South Orange, N.J.
- WALSH, HAROLD E. (A'26), Assistant Radio Engineer, Radio Branch, Department of Marines, Dominion Government, Ottawa, Ont., Canada.
- WALSH, LINCOLN (A'27), Consulting Engineer, 34 Dehart Pl., Elizabeth, N.J.
- WALSH, PHILIP S. (A'30), Proprietor, The Radio Hospital, 135 Franklin St., Fall River, Mass.
- WALSH, SAM CHARLES (A'30), Sales Engineer, Cleveland Talking Machine Company, 4300 Euclid Ave., Cleveland, Ohio. For mail: P.O. Box 7, Norwalk, Ohio.
- WALTER, JOHN C. (A'30), Assistant Engineer, Wired Radio, Inc., Ampere, N.J.
- WALTER, L. B. (A'30), Chief of Mechanical Designing, Western Electric Company, Inc., Hawthorne Station, Chicago, Ill. For mail: 633 Spring Rd., Elmhurst, Ill.
- WALWORTH, LAURANCE A. (A'31), Radio and Electricity Instructor, McKinley High School, Honolulu, Hawaii. For mail: 2737 Ferdinand Ave., Honolulu, Hawaii.
- WANG, SHERMAN R. (A'30), Graduate Student, Harvard University, Cambridge, Mass. For mail: 56 Boylston St., Cambridge, Mass.
- WANG, TWEN-SHANG (J'31), Assistant Engineer, Asia Electric Company, 269 Broadway, Shanghai, China. For mail: 81 Rue du Consulat, Shanghai, China.
- WANG, Y. M. (A'30), Franklin Hall, Cornell University, Ithaca, N.Y.
- WANN, RICHARD H. (A'30), Assistant Engineer, Lazar and Sons, Inc., 1970 Milwaukee Ave., Chicago, Ill. For mail: 4825 Hutchinson St., Chicago, Ill.

- WARD, CHARLES (A'29), Radio Superintendent, Ontario Forestry Branch, Parliament Bldg., Toronto, Ont., Canada.
- WARD, CHESTER W. (A'31), Radio Technician, Meiklejohn Company, 297 Weybosset St., Providence, R.I. For mail: 24 Berkeley St., East Providence, R.I.
- WARD, DONALD H. (A'23), Superintendent, Radio Division, Sparks-Withington Company, E. Ganson St., Jackson, Mich. For mail: 1019-4th St., Jackson, Mich.
- WARD, DONALD O. (A'28), Service Manager, Haas Electric Sales Company, 512 Huron Ave., Cleveland, Ohio. For mail: 1875 Lampson Rd., Cleveland, Ohio.
- WARD, G. PEARSON (A'28), Manager, Radio Department, Martin Brothers Piano Company, Springfield, Mo.
- WARD, LLOYD S. (A'26), Manager, L. S. Ward Radio Service, 1121-18th St., Rockford, Ill.
- WARD, ZANGWILL (A'30), Engineer, Central Broadcasting Station of Kumintang, Nanking, China.
- WARDLE, PAUL G. (A'31), Electrical Engineer, The Gramophone Company, Ltd., Hayes, Middlesex, England. For mail: 27 Grange Park, Ealing, London W. 5, England.
- WARDLOW, H. VANCE (A'31), P.O. Box 676, San Carlos, Calif.
- WARE, ALBERT S. (A'31), Radioman, U. S. Navy, Communication Office, Naval Air Station, Coronado, Calif. For mail: 4465-50th St., San Diego, Calif.
- WARE, PAUL (A'17), Consulting Engineer, Princeton, N.J.
- WARE, WILLIAM (A'28), Inspector, Post Office Radio Station, Portishead, Somerset, England. For mail: Church Rd., N., Portishead, Somerset, England.
- WAREING, HERBERT F. (A'22-M'31), Radio Engineer, City of Milwaukee Police Radio Station, 12th and Vine Sts., Milwaukee, Wis. For mail: 4425 N. 30th St., Milwaukee, Wis.
- WARFIELD, T. JACKSON, S. (A'31), Clerk, Wilmington Trust Company, Wilmington, Del. For mail: 1327 W. 8th St., Wilmington, Del.
- WARING, JOHN T. (A'31), Radio Engineer, Hotel Montclair, 49th St. and Lexington Ave., New York, N.Y.
- WARNE, VEARN J. (A'31), Radio Technician, Radio Manufacturing Supply Company, 1000 S. Broadway, Los Angeles, Calif. For mail: 1578 W. 50th St., Los Angeles, Calif.
- WARNER, BARNEY H. (J'26-A'28), Proprietor, Warner Radio Service, 111 S. Washington St., Wilkes-Barre, Pa. For mail: 14 N. Grant St., Wilkes-Barre, Pa.
- WARNER, FREDERICK P. (A'29), Radio Engineer, 220 Folly Lane, Swinton, Manchester, England.
- WARNER, H. J. (M'28), Technical Officer, Royal Aircraft Establishment, Farnborough, Hants, England. For mail: Ruetra, Elm Grove Rd., S. Farnborough, Hants, England.
- WARNER, JOHN C. (A'19-M'26), Manager, Research and Development Laboratory, RCA Radiotron Company, Inc., 415 S. 5th St., Harrison, N.J.
- WARNER, KENNETH B. (A'18-M'22), Secretary and Editor, American Radio Relay League, Hartford, Conn. For mail: 282 Fern St., West Hartford, Conn.
- WARNER, SYDNEY E. (A'30), Instructor of Electrical Engineering, Rensselaer Polytechnic Institute, Troy, N.Y.
- WARREN, ANDREW J. (A'31), Proprietor, Warren's Radio Shop, 3719 Avenue Q., Galveston, Tex.
- WARREN, A. C. (A'29), Assistant Engineer, Radio Section, G.P.O., London, E.C. 1, England.
- WARREN, CHARLES E., JR. (A'30), 187 Ocean Ave., Woodmere, L.I., N.Y.
- WARREN, CHESTER L. (A'29), Engineer, Radio Division, Weston Electrical Instrument Corporation, 614 Frelinghuysen Ave., Newark, N.J. For mail: 1024 Prospect St., Hillside, N.J.
- WARREN, GEORGE R. (A'30), Engineer and Service Manager, McCoy's Music Shop, 408 De Kalb St., Norristown, Pa. For mail: 621 De Kalb St., Norristown, Pa.
- WARREN, S. REID, JR. (A'29), Research Assistant to Professor Weyl, Moore School of Electrical Engineering, University of Pennsylvania, Philadelphia, Pa. For mail: 200 S. 33rd St., Philadelphia, Pa.
- WARREN, WILLIAM A. (A'27), Hulley, Ulster County, N.Y.
- WARWOOD, W. E. (A'28), Laboratory Assistant, DeForest Radio Corporation, 245 Carlaw Ave., Toronto, Ont., Canada. For mail: 333 Bedford Park Ave., Toronto, Ont., Canada.
- WASSERVOGEL, GUNTHER (A'29), Engineer and Manufacturer, Alexandrienstr., 105-6, Berlin, S.W. 68, Germany. For mail: Bayreuther Str., 13, Berlin, W. 30, Germany.
- WATARU, SUGIYAMA (A'30), Engineer, Sending Station JO1K, Sapporo, Japan. For mail: Sapporo Hosokiyoku, Tsukisappu Hosokyo, Sapporo, Japan.
- WATERMAN, EDWARD C. (A'31), 3339 Hopkiss St., Oakland, Calif.
- WATERMAN, FRANK N. (A'12-M'15), St. Paul Bldg., 220 Broadway, New York, N.Y.
- WATERMAN, WILLIAM (A'31), Engineer, Insuline Corporation of America, 25 Park Pl., New York, N.Y. For mail: 3018 Heath Ave., New York, N.Y.
- WATERS, JAMES S. (A'28), Instructor in Electrical Engineering, Rice Institute, Houston, Tex.
- WATERS, JOHN E. (A'26), Doctor, Dental Surgery, Bank of Italy Bldg., Anaheim, Calif. For mail: R.R. No. 2, Box 12C, Orange, Calif.
- WATSON, CECIL (A'29), Electrical and Wireless Engineer, Watson and Childs, 7 City Rd., Winchester, Hants, England. For mail: 37 Brassey Rd., Winchester, Hants, England.
- WATSON, GEORGE H. (A'19), 6 Windborough Rd., Carshalton, Surrey, England.
- WATSON, HERBERT M. (A'31), Radio Sales and Service, C. R. Alexander, 1119 Mac Donald Ave., Richmond, Calif. For mail: 1609 Penn. Ave., Richmond, Calif.
- WATSON, J. E. (A'30), Silver-Marshall, Ltd., Toronto, Ont., Canada. For mail: 57 Sherwood Ave., Toronto, Ont., Canada.
- WATSON, PAUL E. (A'28), Chief Engineer, Radio Section, Signal Corps Laboratories, Fort Monmouth, Oceanport, N.J. For mail: 64 Grand Ave., Long Branch, N.J.
- WATT, WILLIAM H. (A'31), Engineer, RCA Victor Company, Inc., Camden, N.J.

- For mail: 304 Crest Ave., Haddon Heights, N.J.
- WATERSON, HAROLD E.** (F'30), Wireless Telegraph Engineer, Egyptian State Telegraphs, Cairo, Egypt. For mail: 4 Rue Cheops, Heliopolis, Cairo, Egypt.
- WATTS, D. E.** (A'27), Radio Development, General Electric Company, Bldg. 77, Schenectady, N.Y.
- WATTS, E. GERALD** (J'26-A'28), 8 Old Military Rd., Saranac Lake, N.Y.
- WATTS, HAROLD F.** (A'27), Radio Operator, Radio Station KFEQ, Robidoux Hotel, St. Joseph, Mo. For mail: 1102 Elwood St., St. Joseph, Mo.
- WATTS, IVOR B.** (J'27-A'30), Sales Engineer, American Transformer Company, 172 Emmet St., Newark, N.J. For mail: 53 Beech St., Nutley, N.J.
- WATTSON, HARRY B.** (A'29), Radio Engineer, Radio Corporation of America, 66 Broad St., New York, N.Y. For mail: Box 35, 1 Eric Ave., Rutherford, N.J.
- WAUD, EUGENE C.** (A'28), Engineer, New York Fire Insurance Rating Organization, Buffalo Division, 840 Marine Trust Bldg., Buffalo, N.Y. For mail: 235 Huntington Ave., Buffalo, N.Y.
- WAUGH, GEORGE T.** (A'31), Engineer, Ken-Rad Corporation, Owensboro, Ky. For mail: 106 W. 3th St., Owensboro, Ky.
- WAYNICK, ARTHUR H.** (A'30), Radio Expert, American Radio and Television League, 1314 Broadway, Detroit, Mich. For mail: 774 Casgrain, Detroit, Mich.
- WEAGANT, ROY A.** (M'13-F'15), Electrical Engineer, 233 Broadway, New York, N.Y. For mail: 101 Forest Rd., Douglas Manor, L.I., N.Y.
- WEARE, JOHN** (A'28), Technical Director, Boston Broadcasting Company, 5 Winthrop Sq., Boston, Mass. For mail: 22 Farrar St., Cambridge, Mass.
- WEATHERFORD, RICHARD V.** (A'31), Experimental Engineer, N. B. Neely and R. V. Weatherford Radio Laboratory, 5152 York Blvd., Los Angeles, Calif.
- WEAVER, CHESTER E.** (A'30), Research Engineer, General Laboratories of California, Inc., 929 Pacific Mutual Bldg., Los Angeles, Calif. For mail: 145 N. Kenwood St., Glendale, Calif.
- WEAVER, HENRY RAY** (A'30), Technician and Serviceman, F. J. Reynolds, 907 Florida Ave., Tampa, Fla.
- WEAVER, KARL S.** (A'29), Radio Engineer, Development Laboratory, RCA Radiotron Company, Inc., Harrison, N.J. For mail: 18 Austin Pl., Bloomfield, N.J.
- WEAVER, RAYMEN E.** (A'26), Mechanic, City of Akron Fire Department, No. 5 Shop, Buchtel Ave., Akron, Ohio. For mail: 1349 Killingly St., Akron, Ohio.
- WEBB, JAMES H.** (A'27), Managing Director, British School of Telegraphy, 179 Clapham Rd., London, S.W. 9, England.
- WEBB, J. S.** (A'17), Associate Professor, Department of Radio Engineering, University of Minnesota, Minneapolis, Minn.
- WEBER, ARNOLD K.** (A'31), Section Leader, Drafting Receivers, RCA Victor Company, Inc., Camden, N.J. For mail: 25 Emerald Ave., Westmount, N.J.
- WEBER, C. A. M.** (A'30), Manager, Small Motor Engineering Department, Westing-
- house Electric and Manufacturing Company, Page Blvd., Springfield, Mass.
- WEBER, CARL F.** (A'26), Service Department, National Radio Institute, 1536 U St. N.W., Washington, D.C. For mail: 1420 Harvard St., Washington, D.C.
- WEBER, HAROLD C.** (A'27), Assistant Professor, Massachusetts Institute of Technology, Cambridge, Mass. For mail: 160 Brook Rd., Mattapan, Mass.
- WEBER, H. S.** (A'29), Secretary and Treasurer, The Kramer-Weber Company, 313 Factory St., Dover, Ohio.
- WEBER, PAUL** (A'25), Serviceman, 2027 Ralph St., Brooklyn, N.Y.
- WEBER, RENNIE I.** (A'28), Standard Radio Manufacturing Corporation, Ltd., 90 Chestnut St., Toronto, Ont., Canada. For mail: 1352 Bathurst St., Toronto, Ont., Canada.
- WEBER, WALTER** (A'29), Assistant Chief Engineer, Station WBMS, 970 Bergenline Ave., Union City, N.J. For mail: 169 Zabriske St., Jersey City, N.J.
- WEBRE, ANDREW S.** (A'28), Student, Louisiana State University, Baton Rouge, La. For mail: 830 North St., Baton Rouge, La.
- WEBSTER, ALLAN** (A'30), Technical Department, Amalgamated Wireless Asia, Ltd., P.O. Box 830, Wellington, New Zealand.
- WEBSTER, BETHUEL M., JR.** (A'29), Attorney and Counselor at Law, Donovan and Raichle, 41 Broad St., New York, N.Y.
- WEBSTER, E. M.** (A'30), Lieutenant Commander, U. S. Coast Guard, Washington, D.C.
- WEBSTER, GLENN E.** (A'30), Radio Engineer, 825 W. South St., Salina, Kan.
- WEBSTER, ROBERT** (A'31), Instructor, Wireless Department, James Watt Memorial College, Greenock, Scotland. For mail: c/o Mrs. Macneilage, 27 Forsyth St., Greenock W., Scotland.
- WECKEL, WILSON E.** (A'22), 2118 Tuscarawas St., W., Canton, Ohio.
- WEED, C. BRONSON** (A'27), 224 St. Ronan St., New Haven, Conn.
- WEEDEN, EDWARD H.** (A'27), Associate Professor of Electrical Engineering, MacKenzie College, Sao Paulo, Brazil.
- WEEDEN, WILLIAM N.** (A'26), Electro-Acoustic Consultant, 1 Alden Pl., Bronxville, N.Y.
- WEEKS, MILES W.** (A'26), Insurance Broker, O'Brien, Russell and Company, Boston, Mass. For mail: 40 Norfolk Rd., Chestnut Hill, Brookline, Mass.
- WEEKS, NORMAN E.** (A'24), Engineer, Transmission and Protection Methods and Results Department, New York Telephone Company, 360 Bridge St., Brooklyn, N.Y. For mail: 78 Liberty Ave., Rockville Center, L.I., N.Y.
- WEEKS, PAUL T.** (A'19-M'28), Engineer, Raytheon Manufacturing Company, 238 Main St., Cambridge, Mass.
- WEEKS, ROBERT H.** (A'26), 226 N. Jackson St., Waukegan, Ill.
- WEESE, R.** (A'30-M'31), General Manager, Erie Resistor of Canada, Ltd., 47-49 Bathurst St., Toronto, 2 Ont., Canada.
- WEGNER, CHARLES W.** (J'28-A'30), Station Engineer, Universal Wireless Communications Company, Drawer 291, Plainfield, Ill. For mail: 3725 N. Tripp Ave., Chicago, Ill.

- WEIBLE, NORMAN R.** (A'30), Technical Employee, American Telephone and Telegraph Company, Ocean Gate, N.J. For mail: 120 Frazer Ave., Collingswood, N.J.
- WEIBLER, CARLETON T.** (A'29), Chief Engineer, John E. Fast and Company, 3123 N. Crawford Ave., Chicago, Ill. For mail: 410-7th St., S., St. Charles, Ill.
- WEIGAND, JOSEPH S.** (A'28), Assistant Radio Material Officer, Radio Laboratory, U. S. Navy Yard, 16th Naval District, Cavite, Philippine Islands.
- WEIGEL, RICHARD C.** (A'27), Manager, Radio Department, Stough and Lucas, 141 W. Market St., York, Pa. For mail: 238 W. Market St., York, Pa.
- WEIGHT, H. AUBREY** (A'27), Service Engineer, Attwells Binfield and Company, Reading, England. For mail: Kynance, Winkers, Berks, England.
- WEIK, ADOLPH L.** (A'28), Operator, Marine Radio Station, Mackay Radio and Telegraph Company, Box 1025, Southampton, L.I., N.Y.
- WEILAND, CHRISTIAN F.** (A'29), Associate Editor, *Engineering Index*, 29 W. 39th St., New York, N.Y. For mail: 260 Seaman Ave., New York, N.Y.
- WEILER, HAROLD** (A'30), Service Manager, Goldsmith Music Company, 601-9th Ave., New York, N.Y. For mail: 514 E. 138th St., New York, N.Y.
- WEILMINSTER, CHARLES** (A'27), Servicing Engineer, 8722 Jamaica Ave., Woodhaven, L.I., N.Y. For mail: 135-09-120th Ave., Ozone Park, L.I., N.Y.
- WEIMER, EARL W.** (A'27), Washington Ave., Chantel, Ct., Wheeling, W. Va.
- WEINBERG, SIDNEY** (J'29), General Production Manager, United Scientific Laboratories, Inc., 510-6th Ave., New York, N.Y. For mail: 24 Bay 31st St., Brooklyn, N.Y.
- WEINBERGER, JULIUS** (A'13-F'25), Engineer-in-Charge, Research Department, RCA Photophone, Inc., 151 E. 24th St., New York, N.Y.
- WEINER, MAX J.** (A'31), Operator in Charge, Radio Station WODA, O'Dea Temple of Music, 115 Ellison St., Paterson, N.J. For mail: 280 E. 24th St., Paterson, N.J.
- WEINFELDT, SIDNEY** (A'30), Engineer, Arcturus Radio Tube Company, Newark, N.J. For mail: 278 Orange Ave., Irvington, N.J.
- WEINHOEPEL, KARL L.** (A'31), 551 Caudwell Ave., New York, N.Y.
- WEINTRAUB, DANIEL H.** (A'30), Proprietor, Radio Service, 865 E. 167th St., New York, N.Y.
- WEINWURM, ROBERT** (A'22), Service Engineer, Freed-Eisenmann Radio Corporation, Junius St. and Liberty Ave., Brooklyn, N.Y. For mail: 109-41-125th St., Richmond Hill, L.I., N.Y.
- WEIR, F. TORRES** (A'28), Manager, Radio Station KQW, 311 California St., San Francisco, Calif. For mail: 2263 Market St., San Francisco, Calif.
- WEIR, HAROLD G.** (A'28), Radio Service Manager, Aikenhead Hardware Company, 17-21 Temperance St., Toronto, Ont., Canada.
- WEIR, IRWIN R.** (A'25), Radio Engineer, General Electric Company, Schenectady, N.Y. For mail: Box 764, Schenectady, N.Y.
- WEISBROTH, SAM** (A'30), Polymet Manufacturing Corporation, 829 E. 134th St., New York, N.Y. For mail: 260 Brook Ave., New York, N.Y.
- WEISE, RICHARD C.** (A'31), 835 N. Newkirk St., Philadelphia, Pa.
- WEISS, EARL** (J'28), In Charge of Technical Department, Schwegler Brothers, 393 Ellicott St., Buffalo, N.Y. For mail: 274 Kingsley St., Buffalo, N.Y.
- WEISS, GLOVER** (A'30), Proprietor, Glover Weiss Company, 106 E. Forsyth St., Jacksonville, Fla.
- WEISS, TOBIAS** (A'28), District Sales Manager, 4073 N. Prospect Ave., Milwaukee, Wis.
- WEISSMANTEL, C. H.** (A'27), Assisting Radio Engineer, Electron Radio Laboratories, 3047 N. Roby St., Chicago, Ill. For mail: 6911 "C" Middleton St., Huntington Park, Calif.
- WELBON, ROY E.** (A'31), S.S. Texas States Steamship Company, Statesline, Portland, Ore.
- WELDON, JAMES O.** (A'26), Chief Engineer, Radio Station XER, Villa Acuna, Coahuila, Mexico. For mail: Box 707, Del Rio, Tex.
- WELLER, EARL SELWYN** (J'29), Radio Serviceman, 224 Van Buren St., Litchfield, Ill.
- WELLS, DANIEL W.** (A'27), General Foreman, Quality Division, RCA Victor Company, Inc., Camden, N.J. For mail: 215-9th Ave., Haddon Heights, N.J.
- WELLS, HARRY W.** (A'30), 105 E. Thornapple St., Chevy Chase, Md.
- WELLS, JAMES E.** (A'31), Proprietor, Radio Service Company, Box 992, Raymond, Wash.
- WELLS, JOHN M.** (A'26), Manager, Standards Department, American Optical Company, Southbridge, Mass.
- WELLS, LAWRENCE V.** (A'29), Radio Service, Henkel's Radio Shop, 121 W. Washenaw St., Lansing, Mich. For mail: 325 Smith Ave., Lansing, Mich.
- WELLS, MARTIN M.** (A'29), R.F.D. No. 2, Bellefontaine, Ohio.
- WELLS, W. BRUCE** (A'28), Radio Inspector, Radio Material Office, U. S. Navy Yard, Pearl Harbor, Honolulu, Hawaii.
- WELMAN, VICTOR A.** (A'30), Service Manager, Motion Picture Operators, 750 Prospect Ave., Cleveland, Ohio.
- WELSH, FRED E.** (A'29), Advertising Designer, 170 Spring St., Rochester, N.Y.
- WELSH, ROBERT R.** (A'30), Engineer, Receiver Development, RCA Victor Company, Inc., Camden, N.J. For mail: 13 E. Haddon Ave., Oaklyn, N.J.
- WELSHER, CARL E.** (A'26), Technical Supervisor, Electrical Research Products, Inc., 250 W. 57th St., New York, N.Y. For mail: 134 Lincoln Blvd., Kenmore, N.Y.
- WEND, CLYDE G.** (A'31), Operator, Radio Station WHBU, Anderson, Ind. For mail: 1121 Central Ave., Anderson, Ind.
- WENDELL, EDWARD N.** (A'26), Engineer, International Telephone and Telegraph Corporation, 67 Broad St., New York, N.Y.
- WENDLER, EDWARD A.** (A'31), 5736 Field Ave., Detroit, Mich.

WENDLER, ERWIN H., JR. (J'29-A'30), Radio Engineer and Talking Movies, 175 Rathbone Ave., Mount Clemens, Mich.

WENGEL, RAYMOND W. (A'28), Engineer, Geophysical Exploration Company, P.O. Box 1225, Little Rock, Ark.

WENSLEY, ROY J. (A'27), General Engineer, Meter Engineering Department, Westinghouse Electric and Manufacturing Company, Plane and Orange Sts., Newark, N.J. For mail: 55 Randolph Pl., South Orange, N.J.

WENSTROM, WILLIAM H. (A'25), First Lieutenant, Signal Corps, U. S. Army, Fort Monmouth, Oceanport, N.J.

WENTZEL, AMANDUS G., JR. (J'22-A'25), Chief Electrician, Essex Rubber Company, Trenton, N.J. For mail: 318 Gardner Ave., Trenton, N.J.

WERSEN, DAVID T. (A'29), P.O. Box 506, Culver City, Calif.

WESANEN, THEODORE E. (A'31), Radio Technician, Marshall Wells Company, Lake Ave., S., Duluth, Minn. For mail: 4309 Dodge St., Duluth, Minn.

WESSELMAN, EUGENE (A'27), Assistant Radio Engineer, Rudolph Wurlitzer Manufacturing Company, North Tonawanda, N.Y. For mail: 600 Falls Blvd., North Tonawanda, N.Y.

WEST, GLENN EDWIN (M'29), Assistant Professor, Electrical Engineering Department, Purdue University, Lafayette, Ind.

WEST, KENNETH A. (A'31), Engineer, RCA Victor Company, Inc., Camden, N.J. For mail: 39 Harrison Ave., Erlton, N.J.

WEST, L. E. (A'27), 4850 Riverside Ave., Riverside, Calif.

WEST, WILLIAM H. (J'23-A'26), Chief Engineer, Voice of St. Louis, Inc., Radio Station KMOX, 401 S. 12th Blvd., St. Louis, Mo. For mail: 7541 Lynn Ave., St. Louis, Mo.

WESTCOTT, PHILIP S. (A'24), Advisory Engineer, Nipponophone Company, Ltd., P.O. Box 6, Kawasaki, Japan.

WESTENDORP, W. P. (A'29), Research Laboratory, General Electric Company, Schenectady, N.Y.

WESTEREN, SIDNEY E. (A'30), Service Manager, Poultney, Vt.

WESTERVELD, F. (A'30), Buitenrustlaan 25, Haarlem, Holland.

WESTERVELT, H. P. (A'23), Division Transmission and Projection Engineer, Michigan Bell Telephone Company, Menominee, Mich.

WESTLUND, J. V. (A'29), Westlund and Leadke, 118 N. 1st St., Rockford, Ill.

WESTMAN, HAROLD P. (J'24-A'25-M'30), Secretary, Institute of Radio Engineers, 33 W. 39th St., New York, N.Y. For mail: 5 S. Chestnut St., Hempstead Gardens, L.I., N.Y.

WESTON, FRANCIS B. (J'30-A'31), Draftsman, Trumbull Electric Manufacturing Company, Plainville, Conn. For mail: 24 Chapman St., Hartford, Conn.

WESTON, IRVING L. (A'29), Radio Inspector, Custom House, Radio Division, U. S. Department of Commerce, Boston, Mass.

WESTON, JOHN L. (A'26), 55 N. 21st St., East Orange, N.J.

WEYL, CHARLES N. (M'25), University of Pennsylvania, Philadelphia, Pa. For mail:

255 Harvey St., Germantown, Philadelphia, Pa.

WHALE, GORDON S. (A'26), Professor of Wireless, North Wales Wireless College, Colwyn Bay, Wales.

WHAN, LOREN H., JR. (A'27), 1622 Houston St., Manhattan, Kan.

WHANNEL, RAYMOND L. (A'27), Chief Engineer, Radio Station WTAX, Inc., Abraham Lincoln Hotel, Springfield, Ill. For mail: 1544 W. Cook St., Springfield, Ill.

WHEELER, CHARLES H. J. (A'30), Shift Engineer, British Broadcasting Corporation, North Regional Transmitter, Morrside Edge, Slaithwaite, Huddersfield, England.

WHEELER, C. M. (A'28), Engineer, De Forest Radio Company, Passaic, N.J. For mail: 926 Grove St., Clifton, N.J.

WHEELER, EDMUND F. (A'27), Engineer-in-Charge, British Broadcasting Corporation, North Regional Transmitters, Slaithwaite, near Huddersfield, England.

WHEELER, FREDERICK (J'29), Engineer, Radio Station WREN, The Jenny Wren Company, 546 Massachusetts St., Lawrence, Kan. For mail: 1024 Alabama St., Lawrence, Kan.

WHEELER, HAROLD A. (A'27-M'28), Engineer, Hazeltine Corporation, 209-71-26th Ave., Bayside, L.I., N.Y. For mail: 18 Melbourne Rd., Great Neck, L.I., N.Y.

WHEELER, HARVEY T. (J'27-A'29), Radio Technician, Radio Station KPRC, 2204 Post Dispatch Bldg., Houston, Tex.

WHEELER, LYNDE P. (F'28), Physicist, U. S. Naval Research Laboratory, Bellevue, Anacostia, D.C.

WHEELER, WALTER R. (A'26), Exide, Battery and Radio Shop, Bishop, Calif. For mail: P.O. Box 233, Bishop, Calif.

WHELAN, DOW O. (A'25-M'31), President, R.C.A. Institutes, Inc., 75 Varick St., New York, N.Y. For mail: 504 Avondale Ave., Haddonfield, N.J.

WHIDDEN, IRA P. (A'28), Proprietor, Whidden's Radio and Television Service, 14 E. San Antonio St., San Jose, Calif. For mail: 60 Cleveland Ave., San Jose, Calif.

WHISTON, R. WILLIAM (A'26), Radio Service, Electric Lighting Supply Company, 216 W. 3rd St., Los Angeles, Calif. For mail: 1808 Buckingham Rd., Los Angeles, Calif.

WHITAKER, JAMES N. (A'27), Assistant Engineer, Engineering Department, Radio Corporation of America, 66 Broad St., New York, N.Y. For mail: 95 Highland Ave., Bronxville, Manor, N.Y.

WHITE, CHARLES P. (A'25), Radio Operator, Radiomarine Corporation of America, 292 Pequot Ave., New London, Conn. For mail: 154 Inslee Pl., Elizabeth, N.J.

WHITE, EDWIN L. (A'24-M'31), Engineer, Federal Radio Commission, Washington, D.C. For mail: 6804 Meadow Lane, Chevy Chase, Md.

WHITE, F. W. G. (A'30), Research Student, St. John's College, Cambridge, England.

WHITE, HERBERT G. (A'24), 120 Leigh Rd., Leigh-on-Sea, Essex, England.

WHITE, J. W. (A'30), Engineer, Colonial Radio Corporation, Rano and Crowley Sts., Buffalo, N.Y. For mail: 52 Park Ave., Tonawanda, N.Y.

WHITE, JOSEPH P. (A'31), Storeman, Department of Hospitals, Seaview Hospital, Staten Island, N.Y.

WHITE, KARL K. (J'29), Station KVOO, Tulsa, Okla.

WHITE, KENNETH E. (A'28), Engineer, Photo-Electric Research Laboratory Corporation, 7th Ave. and 48th St., New York, N.Y. For mail: P.O. Box 112, Shiloh, Ohio.

WHITE, MILTON (A'24), Service Engineer, R. H. McMann, Inc., 12 Warren St., New York, N.Y. For mail: 1258-84th St., Brooklyn, N.Y.

WHITE, NATHANIEL (A'30), Radio Engineer, R.C.A. Communications, Inc., Riverhead, L.I., N.Y.

WHITE, R. JORDAN (A'28), Field Representative, Transitone Auto Radio Corporation, Philadelphia, Pa. For mail: Box 334, Okmulgee, Okla.

WHITE, RAY H. (A'29), Radio Communications Laboratory, United Air Lines, Oakland Airport, Oakland, Calif. For mail: 1614 Lincoln Ave., Alameda, Calif.

WHITE, ROBERT F. (A'30), Radio Operator, Radio Station RXC, Tropical Radio Telegraph Company, Panama City, Panama.

WHITE, W. L. (A'30), Shift Engineer, c/o Radio Corporation of America, Rocky Point, L.I., N.Y.

WHITE, WILLIAM C. (A'15-M'25), Manager, Vacuum Tube Engineering Section, General Electric Company, Schenectady, N.Y.

WHITEHEAD, JESSE C. (A'25), Assistant Engineer, Radio Corporation of America, Camden, N.J. For mail: 720 W. Maple Ave., Merchantville, N.J.

WHITEHOUSE, JOSEPH E. (A'25), Residency Engineer, Stations WLW-WSAI, Crosley Broadcasting Stations, Mason, Ohio.

WHITELOCK, LELAND D. (A'30), Research Engineer, Union Switch and Signal Company, Swissvale, Pa.

WHITLOCK, FRED (A'27), Development Engineer, Sparks-Withington Company, Jackson, Mich.

WHITMAN, VERNON E. (A'31), Engineer, Hazeltine Service Corporation, 210th St. and 26th Ave., Bayside, L.I., N.Y.

WHITMER, ROBERT M. (A'29), Engineer, Bell Telephone Laboratories, Inc., 180 Varick St., New York, N.Y.

WHITMORE, WALTER R. (A'27), Field Service Representative, De Forest Crosley Radio Corporation, 245 Carlaw Ave., Toronto, Ont., Canada. For mail: 8 Kent Rd., Toronto, Ont., Canada.

WHITNAH, R. B. (J'28), Proprietor and Operator, Radio Station W-9DBT, 307 W. Tarkio St., Clarinda, Iowa.

WHITTAKER, EDMUND (A'29), Chief Engineer, West Coast Features, Inc., Los Angeles, Calif. For mail: 715 S. St. Andrews Pl., Los Angeles, Calif.

WHITTEMORE, L. E. (A'16-M'25-F'27), Engineer, Department of Development and Research, American Telephone and Telegraph Company, 195 Broadway, New York, N.Y.

WHITTEN, LESLIE H. (A'31), Radio Sales Specialist, Graybar Electric Company, 714-12th St., N.W., Washington, D.C.

WHITTEN, SYLVESTER (A'31), Engineer, Pacific Telephone and Telegraph Company, 140 New Montgomery St., San Francisco, Calif.

WHITTERTON, RAY (A'28), 219 Hawthorne Ave., Palo Alto, Calif.

WHITTIER, ELLERTON W. (A'18), Laboratory Assistant and Assistant Treasurer, Atlantic Precision Instrument Company, 61 Sheridan St., Malden, Mass. For mail: 22 Orchard Ter., Arlington, Mass.

WHITTINGTON, R. LESLIE (A'31), Radio Service Manager, George C. Alchin, Ltd., Simcoe and Bond Sts., Oshawa, Ont., Canada. For mail: 644 Simcoe St., Oshawa, Ont., Canada.

WICHERN, LEONARD (A'27), Service Engineer, Colonial Radio Corporation, 25 Wilbur Ave., Long Island City, L.I., N.Y. For mail: 765 Anderson Ave., Grantwood, N.J.

WICKERSHEIM, LYLE W. (A'19), Engineer, Bell Telephone Laboratories, Inc., 463 West St., New York, N.Y. For mail: 28 Terrace Ave., West Orange, N.J.

WICKERY, JOHN B. (A'30), Research Engineer, Manhattan Engineering Company, Ulster Park, N.Y.

WICKIZER, GILBERT S. (A'28), Radio Engineer, Radio Corporation of America, Riverhead, L.I., N.Y.

WICKS, FRANK W. (A'19), Chief Instructor, British School of Telegraphy, 179 Clapham Rd., London, S.W. 9, England. For mail: 13 Cambridge Rd., Bromley, Kent, England.

WICKS, REGINALD P. (A'24), Research Engineer, Gramophone Company, Hayes, Middlesex, England. For mail: 72 Cromwell Rd., Hayes, Middlesex, England.

WIDELL, E. GIDEON (M'26), Research Chemist, RCA Radiotron Company, Inc., Harrison, N.J. For mail: 5 E. Hill St., Bloomfield, N.J.

WIDMANN, ERWIN (A'29), Radio Engineer, Wired Radio, Inc., Ampere, N.J. For mail: 2076-66th St., Brooklyn, N.Y.

WIEBACH, WILLIAM T. (A'29), Chief Engineer, United Reproducer Company, 421 Lyell Ave., Rochester, N.Y. For mail: 207 Avenue C, Rochester, N.Y.

WIEGREFE, ELMER J. (A'30), Radiotriician, National Pfanstiel Radio Corporation, Waukegan, Ill. For mail: 3341 Berceau Ave., Chicago, Ill.

WIESMANN, EDWARD T. (J'27-A'30), Electrical Worker, Radio Station IBEW, Sargent Engineering Company, 406 Thaw Bldg., Pittsburgh, Pa. For mail: 1368 Herman St., N.S., Pittsburgh, Pa.

WIGGINS, WALLACE S. (A'31), Route No. 3, Box 139, Whittier, Calif.

WIINIKKA, ARTHUR O. (J'30), Student, Northeastern University, Fitchburg, Mass. For mail: 29 Nutting St., Fitchburg, Mass.

WILBER, DELBERT J. (A'26), Sales Engineer, Scintilla Magneto Company, Inc., 48 Sherman Ave., Sidney, N.Y. For mail: 5 Weir St., Sidney, N.Y.

WILBUR, DONALD A. (A'30), Engineering Research, University of Michigan, Ann Arbor, Mich.

WILBUR, EDWIN C. (A'26), Field Engineer, National Broadcasting Company, Inc., 711-5th Ave., New York, N.Y. For mail: 108 Park Terrace, East, New York, N.Y.

WILCOX, ERNEST C. (A'19), President, Connecticut Telephone and Electric Com-

- pany, Meriden, Conn. For mail: 658 Colony St., Meriden, Conn.
- WILCOX, G. M. (A'21)**, Professor of Physics, Armour Institute of Technology, 33rd and Federal Sts., Chicago, Ill. For mail: 5225 Ingleside Ave., Chicago, Ill.
- WILCOX, JAY V. (A'31)**, Radio Operator, Radio Station WREN, Jenny Wien Company, Hotel Bellerive, Armour and Warwick Bldgs., Kansas City, Mo. For mail: 1014 W. 37th St., Kansas City, Mo.
- WILCOX, NATHAN (A'27)**, Control Room Engineer, Radio Station WMT, Waterloo, Iowa.
- WILCOX, ROBERT L. (A'28)**, Service Manager, Reburn Radio Stores, Inc., 2929 Market St., Wilmington, Del. For mail: 632 N. Grant Ave., Wilmington, Del.
- WILD, SYDNEY J. (A'29)**, Chief of Test Department, Sherman and Clay Company, Inc., 14th and Clay Sts., Oakland, Calif. For mail: 1609 Grand Ave., Oakland, Calif.
- WILDER, MARSHALL P. (A'28)**, Engineer, Shortwave and Television Corporation, 70 Brookline Ave., Boston, Mass. For mail: 37 Hillside Rd., Wellesley, Mass.
- WILDES, KARL L. (A'24)**, Assistant Professor of Electrical Engineering, Massachusetts Institute of Technology, Rm. 4-205, Cambridge, Mass.
- WILDMAN, THOMAS S. (A'27)**, Radio Operator, Radio Station WOC, 1002 Brady St., Davenport, Iowa. For mail: 2617 Tremont Ave., Davenport, Iowa.
- WILKENS, BERNARD T. (A'28)**, Chief Engineer, Radio Station WKBN, Central YMCA Bldg., Youngstown, Ohio.
- WILKIE, HARRY (A'29)**, Radio Engineer, Signal Corps, Fort Shafter, Honolulu, Hawaii.
- WILKIE, J. MC KENZIE (A'30)**, Technical Representative, The Mullard Wireless Service Company, 93-95 Wakeloo St., Glasgow, Scotland. For mail: c/o Donaldson, 39 Minard Rd., Shawlands, Glasgow, Scotland.
- WILKINS, A. F. (A'30)**, Research Engineer, Radio Research Station, Slough, Bucks, England. For mail: Bowood, London Rd., Datchet, Windsor, England.
- WILKINSON, ALLAN E. (A'27)**, Power Engineer, Bell Telephone Company of Canada, Toronto, Ont., Canada. For mail: 53 Triller Ave., Toronto, Ont., Canada.
- WILKINSON, GORDON O. (A'25)**, Experimental Work, Ardmore, Pa. For mail: Laurel and Wister Rds., Ardmore, Pa.
- WILKINSON, LEE A. (A'30)**, Radio Operator, Radio Station WFAA, Baker Hotel, Dallas, Tex. For mail: 218 Alcalde St., Dallas, Tex.
- WILKINSON, L. G. (A'27)**, Manager, Radio Department, Grigsby-Grunow-Hinds Company, 4540 Armitage Ave., Chicago, Ill. For mail: 3111 Grove Ave., Berwyn, Ill.
- WILLARD, GERALD W. (A'31)**, Member of Technical Staff, Bell Telephone Laboratories, Inc., 463 West St., New York, N.Y.
- WILLARD, JOSEPH M. (A'27)**, Radio Engineer, RCA Victor Company, Inc., Camden, N.J. For mail: 712 Blythe Ave., Drexel Hill, Pa.
- WILLARD, WALTER C. (A'30)**, Sales Engineer, 718 Columbia St., Newport, Ky.
- WILLERS, THEODORE H., SR. (A'27)**, Engineer, Electrical Research Products, Inc., 367 Main St., Buffalo, N.Y. For mail: P.O. Box 338, Auburn, N.Y.
- WILLES, EMERSON T. (A'29)**, American Telephone and Telegraph Company, Houlton, Maine. For mail: 10 Green St., Houlton, Maine.
- WILLET, G. RUSH (A'31)**, Chief Engineer, Sound Engineering Corporation, 20 N. Wacker Dr., Chicago, Ill.
- WILLGING, LOUIS F. (A'30)**, Radio Engineer, Crosley Radio Corporation, Arlington St., Cincinnati, Ohio. For mail: 1953 Elm St., Norwood, Ohio.
- WILLHOFFT, FREDERICK O. (A'25)**, Consulting Engineer, 11 W. 42nd St., New York, N.Y.
- WILLIAMS, AARON F. (A'31)**, Engineer, RCA Victor Company, Inc., Bldg. 6, Camden, N.J.
- WILLIAMS, ALBERT J., JR. (A'30)**, Development Engineer, Leeds and Northrup Company, 4901 Stenton Ave., Philadelphia, Pa.
- WILLIAMS, CECIL G. (A'26)**, Proprietor, British Radio Manufacturing Company, 9 S. Castle St., Liverpool, England. For mail: 86 Rullerton Rd., Wallasey, Cheshire, England.
- WILLIAMS, CHARLES E. (J'15-M'24)**, Radio Engineer, Navy Department, Puget Sound, Bremerton, Wash. For mail: 2340 Delmar Dr., Seattle, Wash.
- WILLIAMS, CHARLES HADDON (A'29)**, Assistant Radio Engineer, U. S. Naval Research Laboratory, Bellevue, Anacostia, D.C.
- WILLIAMS, GERALD R. (A'31)**, Principal Airways Keeper, U. S. Department of Commerce, Adair, Iowa.
- WILLIAMS, GURDON H. (A'24)**, Charge of Electrical Tests Materials, Test Methods and Equipment Division, RCA Victor Company, Inc., Camden, N.J.
- WILLIAMS, HOLLIE (A'28)**, Engineer, Ohio Bell Telephone Company, 750 Huron Rd., Cleveland, Ohio. For mail: 2175 Middlefield Rd., Cleveland Heights, Ohio.
- WILLIAMS, HOWARD F. (A'30)**, Chief Radio Operator, c/o Radiomarine Corporation of America, 75 Varick St., New York, N.Y.
- WILLIAMS, HOWARD M. (J'26-A'28)**, 1260 S. Columbine, Denver, Colo.
- WILLIAMS, JAMES (A'28)**, Stromberg-Carlson Telephone Manufacturing Company, 211 Geary Ave., Toronto, Ont., Canada. For mail: 45 Beaty Ave., Toronto, Ont., Canada.
- WILLIAMS, LAURENCE P. (A'31)**, Superintendent, Tropical Radio Telegraph Company, Hingham, Mass.
- WILLIAMS, N. H. (A'30)**, Professor of Physics, University of Michigan, East Physics Bldg., Ann Arbor, Mich. For mail: 1020 Olivia Ave., Ann Arbor, Mich.
- WILLIAMS, RALPH R. (A'31)**, P.O. Box 351, San Diego, Calif.
- WILLIAMSON, FREDERICK E. (A'27)**, Engineer, Dial Maintenance Division, Illinois Bell Telephone Company, 212 W. Washington St., Chicago, Ill. For mail: 535 Deming Pl., Chicago, Ill.
- WILLIAMSON, R. H. (A'31)**, Radio Engineer, Rm. 111, Bldg. 89, General Electric Company, Schenectady, N.Y. For mail: 842 Union St., Schenectady, N.Y.

- WILLING, WILLIAM P. (A'29)**, Radio Adjuster, Public Service Company of Northern Illinois, 1610 S. 1st Ave., Maywood, Ill. For mail: 610 N. Grove Ave., Oak Park, Ill.
- WILLIS, EDWARD N. (J'26-A'27)**, 2658-30th St., Santa Monica, Calif.
- WILLIS, ELLSWORTH D. (A'26)**, Radio Instructor, Boys' Vocational School, 400 N. Penn Ave., Lansing, Mich.
- WILLIS, F. H. (A'26)**, American Telephone and Telegraph Company, Rm. 2012, 195 Broadway, New York, N.Y.
- WILLIS, FREDERICK C. (A'20)**, Member of Technical Staff, Electrical Research Products, Inc., 250 W. 57th St., New York, N.Y. For mail: Passaic Ave., R.F.D., West Caldwell, N.J.
- WILLIS, JAMES S. (A'30)**, Lieutenant, West Point, N.Y.
- WILLITS, ANDREW A. (A'28)**, Willis Radio Service, 700 S. 20th St., Fort Dodge, Iowa.
- WILLOUGHBY, JOHN A. (A'19-M'29)**, Radio Engineer, Federal Radio Commission, National Press Bldg., Washington, D.C. For mail: 2272 Cathedral Ave., Washington, D.C.
- WILLS, DAVID C. (A'22)**, Western Electric Company, Inc., Chicago, Ill. For mail: 224 Herrick Rd., Riverside, Ill.
- WILLS, HARRY L. (M'27)**, Consulting Engineer, 1006 William-Oliver Bldg., Atlanta, Ga.
- WILLS, STANLEY (A'31)**, Sales Representative, Messrs. Wall and Attwood, 47-49 Crasswell St., Portsmouth, Hants, England. For mail: Highbury Estate, 74 Highbury Grove, Cosham, Hants, England.
- WILLSON, ABNER R. (A'22)**, General Manager, Majestic Distributing Company, Seattle, Wash. For mail: 8055-14th Ave., N.E., Seattle, Wash.
- WILLSON, CLARENCE L. (A'27)**, 508 Norman Ave., Arcadia, Calif.
- WILLSON, P. L. (A'28)**, Proprietor, Willson Radio Laboratory, 1415 E. 15th St., Tulsa, Okla.
- WILM, CARL F. (A'29)**, Tester, Grigsby-Grunow Company, 5891 Dickens Ave., Chicago, Ill. For mail: 4542 N. Kenneth Ave., Chicago, Ill.
- WILMOTTE, R. M. (M'29)**, Consulting Engineer, 41 Park Row, New York, N.Y. For mail: 25 W. 10th St., New York, N.Y.
- WILSON, A. J. (A'28)**, 1621 Ohio St., Quincy, Ill.
- WILSON, C. T. R. (A'24)**, Assistant Engineer, Marconi Beam Receiving Station, Canadian Marconi Company, Yamachiche, P.Q., Canada.
- WILSON, CHARLES, MCC., JR. (A'30)**, Laboratory Technician, Scientific Crime Detection Laboratory, 469 E. Ohio St., Chicago, Ill.
- WILSON, CLIFFORD A. (A'25)**, Canadian Marconi Company, Ltd., 211 St. Sacramento St., Montreal, P.Q., Canada.
- WILSON, DONALD B. (A'31)**, Development Laboratory, RCA Radiotron Company, Inc., Harrison, N.J. For mail: 127 W. 96th St., New York, N.Y.
- WILSON, FRANK (M'31)**, Engineer-in-Charge, Post Office Radio Station, Portishead, Somerset, England. For mail: "Oak Stile" Hillcrest Rd., Redcliffe Bay, Portishead, Bristol, Somerset, England.
- WILSON, GEORGE F. (A'23)**, Radio Inspector, Navy Yard, Puget Sound, Bremerton, Wash. For mail: 613 Veneta Ave., Bremerton, Wash.
- WILSON, GEORGE H. (A'31)**, Proprietor, Radio Service, 1425 Penn Ave., Scranton, Pa.
- WILSON, GUY E. (A'19)**, Electrical Engineer, Ash, Howard, Needles and Tammen, Consulting Engineers, 1012 Baltimore Ave., Kansas City, Mo. For mail: 7511 Oak St., Kansas City, Mo.
- WILSON, H. WARDEN (A'29)**, Field Engineer, National Broadcasting Company, Inc., 711-5th Ave., New York, N.Y.
- WILSON, JAMES C. (A'30)**, President, Radio College of Canada, Ltd., 310a Yonge St., Toronto, Ont., Canada.
- WILSON, JAMES R. (A'31)**, Vacuum Tube Engineer, Bell Telephone Laboratories, Inc., 395 Hudson St., New York, N.Y. For mail: Mountain Lakes, N.J.
- WILSON, LEON T. (M'22)**, Department of Development and Research, American Telephone and Telegraph Company, 195 Broadway, New York, N.Y.
- WILSON, M. DEAN (A'31)**, Vacuum Tube Engineer, Sylvania Products Company, Emporium, Pa. For mail: 520 Vine St., Emporium, Pa.
- WILSON, PERCY (A'30)**, Principal, Board of Education, 10A Soho Sq., London, W. 1, England. For mail: 48 Clarendon Rd., Putney, London, S.W. 15, England.
- WILSON, ROBERT F. (J'31)**, Student, Yale University, New Haven, Conn. For mail: 261 Sickles Ave., New Rochelle, N.Y.
- WILSON, S. EARLE (A'27)**, President, Texas and Southern Petroleum Company, P.O. Box 40, Rockland, Tex.
- WILSON, WALTER B. (A'29)**, 156 Grinnell St., New Bedford, Mass.
- WILSON, WILLIAM (M'26-F'28)**, Assistant Director of Research, Bell Telephone Laboratories, Inc., 463 West St., New York, N.Y.
- WILSON, WILLIAM P. (A'27)**, Research Department, Marconi's Wireless Telegraph Company, Ltd., Essex, England.
- WILTSE, GEORGE V. (M'31)**, U. S. Radio Inspector, Radio Division, U. S. Department of Commerce, 1012 Exchange Bldg., Seattle, Wash. For mail: 3910 Densmore Ave., Seattle, Wash.
- WIMBERLY, W. BEN (J'28)**, Control Operator, Radio Station WJAG, Capitol Hotel, Amarillo, Tex. For mail: 512 W. Seventh, Amarillo, Tex.
- WINANS, PAUL V. (A'31)**, Receiving Engineer, R.C.A. Communications, Inc., Riverhead, L.I., N.Y. For mail: 57 Moriches Rd., Riverhead, L.I., N.Y.
- WINANS, ROSWELL R. (A'30)**, 10 Hatfield St., Caldwell, N.J.
- WINCHELL, ALFRED M. (J'25-A'27)**, Radio Service, R.F.D. No. 1, Waterbury, Conn.
- WINCHELL, HENRY T. (A'31)**, Chief Engineer, Radio Station WOQ, 917 Tracy Ave., Kansas City, Mo.
- WINCHELL, WALTER H. (A'28)**, Service Engineer, RCA Photophone, Inc., 261 N. Broad St., Philadelphia, Pa.

- WING, ARTHUR K., JR. (J'28-A'30), Junior Engineer, Kolster Radio Corporation, 360 Thomas St., Newark, N.J. For mail: 857 E. 18th St., Brooklyn, N.Y.
- WINNEGAR, W. A. (A'27), Instructor of Radio, Heald's Engineering College, Sutter and Larkin Sts., San Francisco, Calif. For mail: 725 Ellis St., San Francisco, Calif.
- WINNER, LEWIS (A'25), Director, The Lewis Winner Bureau, 105 W. 40th St., New York, N.Y. For mail: 3235 Hull Ave., New York, N.Y.
- WINNER, WILLIAM LANE, JR. (M'29), Radio Engineer, U. S. Army, Ninth Corps Area, Signal Office, Presidio of San Francisco, Calif.
- WINNINGHAM, HAROLD W. (A'28), Sales Engineer, North Coast Electric Company, 206-3rd Ave., S., Seattle, Wash. For mail: 4012 E. 38th St., Seattle, Wash.
- WINSTEAD, THEODORE BERNARD (A'29), Tarboro, N.C.
- WINTER, CHARLES W., JR. (A'31), Radio Technician, Pan American Airways, Inc., Miami, Fla. For mail: Box 236, Miami Springs, Fla.
- WINTERBOTTOM, WILLIAM A. (A'15-M'28), Vice President and General Manager, R.C.A. Communications, Inc., 66 Broad St., New York, N.Y.
- WINTRINGHAM, WILLIAM T. (A'26), Telephone Engineer, American Telephone and Telegraph Company, 195 Broadway, New York, N.Y.
- WISE, CLARENCE E. (A'31), Radio Operator, Radio Station WOWO, Fort Wayne, Ind. For mail: 1930 Oakland St., Fort Wayne, Ind.
- WISE, JAMES O. (A'29), Meter and Radio Interference Engineer, Public Service Company of Oklahoma, Tulsa, Okla.
- WISE, ROGER M. (A'26-M'30), c/o Sylvania Products Company, Emporium, Pa. For mail: 307 E. 4th St., Emporium, Pa.
- WISEGARVER, ORTON H. (A'29), Cinevoal Engineer, RCA Photophone, Inc., 411-5th Ave., New York, N.Y. For mail: Hotel Mayfair, Kansas City, Mo.
- WISEMAN, WILLIAM W. (A'29), Chief Radioman, U. S. Naval Research Laboratory, Bellevue, Anacostia, D.C. For mail: The Chastleton, 16th at R St., N.W., Washington, D.C.
- WISHART, WILLIAM R. (A'28), Operating Radio Laboratory, Wishart Radio Laboratories, 55 Tacoma St., Rochester, N.Y.
- WISNER, FRED L. (A'27), Associate Radio Engineer, U. S. Navy, 11th Naval District, San Diego, Calif. For mail: 1346-30th St., San Diego, Calif.
- WISSMANN, JOSEPH T. (A'27), Recording Engineer, The Vitaphone Corporation, 1277 E. 14th St., Brooklyn, N.Y. For mail: Rockland Ave., New Springville, S.I., N.Y.
- WISTRUP, CARL A. (A'31), Designing Engineer, RCA Victor Company, Inc., Camden, N.J. For mail: 224 Burrwood Ave., Collingswood, N.J.
- WITKOWSKI, JOSEPH F. (A'23), Principal, School of Telephone and Telegraph Engineering, International Correspondence Schools, Scranton, Pa.
- WITTSTRUCK, HAROLD H. (A'28), P.O. Box 158, Route No. 1, Largo, Fla.
- WITTY, W. M. (A'28), Field Service Engineer, RCA Victor Company, Inc., Santa Fe Bldg., Dallas, Tex. For mail: 2991 N. Fitzhugh Ave., Dallas, Tex.
- WOCKEY, PETER F. (J'26-A'29), 409 W. Courtland St., Philadelphia, Pa.
- WOLCOTT, C. FREDERICK (J'26-A'28), President, Wolcott-Laluman Company, P.O. Box 67, Wilmette, Ill. For mail: 2144 Chestnut Ave., Wilmette, Ill.
- WOLF, BENJAMIN (A'13-M'15), Manager, U. S. Department of Commerce, Radio Monitoring Station, Grand Island, Neb.
- WOLF, CLARENCE, JR. (J'27-A'30), Vice President and Treasurer, French-Wolf Paint Products Corporation, Bristol, Pa. For mail: 1521 N. 16th St., Philadelphia, Pa.
- WOLF, EDWIN A. (A'28), Manager, Wolf Service Laboratory, 115 Church St., West Roxbury, Mass.
- WOLF, LESTER J. (A'24), Monitoring Station, Grand Island, Neb.
- WOLF, R. C. (A'31), District Manager, Curtis Publishing Company, 1006 Washington Ave., Houston, Tex. For mail: 3720 Fannin St., Houston, Tex.
- WOLFF, IRVING (A'27), Physicist, RCA Victor Company, Inc., Camden, N.J.
- WOLLERT, BERTIL (A'31), Hedemora, Sweden.
- WOLTZEN, LLOYD J. (A'31), 333 Grant Ave., San Francisco, Calif.
- WONG, C. LINDHYMN (A'31), Manager, Pender Market Service Station, 26 Pender St., E., Vancouver, B.C., Canada. For mail: 2827 Clarke Dr., Vancouver, B.C., Canada.
- WOOD, EDWIN T. (A'31), Orlo Vista, Orange County, Fla.
- WOOD, ERIC (A'31) Radio Manager, Messrs. Blackburns, The Arcade, Dewsbury, York, England. For mail: 56 Accommodation Rd., Leeds, England.
- WOOD, HOMER D. (A'31), Radio Operator, Radiomarine Corporation, 32 N. 5th St., Philadelphia, Pa.
- WOOD, LEONARD C. (A'31), Student, Dodge Radio Institute, Valparaiso, Ind.
- WOOD, MERRILL A. (A'26), Proprietor, Wood Radio and Electrical Service, Rochester, N.Y. For mail: 175 Winbourne Rd., Rochester, N.Y.
- WOOD, RAYMOND A. (A'31), Receiving Engineer, c/o R.C.A. Communications, Inc., Point Reyes, Calif.
- WOOD, RAYMOND A. (A'30), Sound Projection Department, Paramount-Publix Corporation, New York, N.Y. For mail: 10 Tallard Pl., Poughkeepsie, N.Y.
- WOOD, ROBERT H. (A'24-M'26), Radio Engineer, British Broadcasting Company, Ltd., 2 Savoy Hill, London, W.C. 2, England.
- WOOD, STANFORD J. (A'24), Recorder, Vitaphone Corporation, Hollywood, Calif. For mail: 186 Pacific Ave., Pacific Grove, Calif.
- WOOD, WILLIAM FORREST (A'30), Field St., R.F.D. No. 1, Naugatuck, Conn.
- WOODBRIDGE, FRANK L. (A'31), Proprietor, Radio Engineering, 10 Broadway, Beaconsfield, Bucks, England. For mail: The Beacons, Reynolds Rd., Beaconsfield, Bucks, England.

- WOODBURY, E. (A'30), Patent Attorney, Lyon and Lyon Law Offices, 708 National City Bank Bldg., Los Angeles, Calif.
- WOODBURY, STEPHEN E. (A'25), Research Engineer, United Shoe Machinery Corporation, Beverly, Mass. For mail: 18 James St., Beverly, Mass.
- WOODCOCK, CLAY D. (A'30), Proprietor, Electric and Radio Service, 506 Edgewood Ave., Trafford, Pa.
- WOODCOCK, N. A. (A'14), Radio Engineer, The Allen D. Cardwell Manufacturing Corporation, 87 Prospect St., Brooklyn, N.Y. For mail: 4260 Broadway, New York, N.Y.
- WOODCOCK, THOMAS W. (A'31), Chauffeur, Philadelphia Gas Works Company, 31st and Passyunk Ave., Philadelphia, Pa. For mail: 1934 S. 56th St., Philadelphia, Pa.
- WOODHEAD, H. C. (A'28), Rugby Radio Station, Rugby, Warwick, England.
- WOODROW, JAMES A. S. (A'26), Proprietor, Woodrow Radio Company, 166 Prospect St., Cambridge, Mass.
- WOODROW, WILLIAM (A'15), Instructor, Vocational School for Boys and Evening Trade School, Board of Education, 138th St. and 5th Ave., New York, N.Y. For mail: 904 Ogden Ave., Highbridge, New York, N.Y.
- WOODRUFF, ALBERT E. (A'26), Physicist, Associated Electric Laboratories, Inc., 1033 W. Van Buren St., Chicago, Ill. For mail: 614 S. Cuyler Ave., Oak Park, Ill.
- WOODRUFF, B. H. (A'26), President, Woodruff and Company, Meridian, Miss. For mail: P.O. Box 178, Meridian, Miss.
- WOODRUFF, EUGENE C. (M'29), Professor, Electrical Railways Engineering, Pennsylvania State College, 234 W. Fairmount Ave., State College, Pa.
- WOODS, A. A. (A'13), 643 Roscoe St., Chicago, Ill.
- WOODS, DAVID C. (A'30), Radio Operator, Station WRVA, Larus and Brother Company, 22nd and Main Sts., Richmond, Va. For mail: 1104 Fourquare Lane, Highland Park, Richmond, Va.
- WOODS, T. DEWITT (A'29), Consulting Radio Engineer, Radio Engineering and Appliance Corporation, Monona, Iowa. For mail: P.O. Box 282, McGregor, Iowa.
- WOODS, WILLIAM A. (A'30), Member of Technical Staff, Bell Telephone Laboratories, Inc., Rm. 908, 180 Varick St., New York, N.Y. For mail: 76 Roosevelt Ave., East Orange, N.J.
- WOODWARD, BRUCE J. (A'26), Radio Service, Burcher and Schiessler, 513 S. Main St., Honesdale, Pa. For mail: Adella, Wayne County, Pa.
- WOODWARD, CLARENCE H. (A'25), Manager, Adjustment Department, Silver-Marshall, Inc., 6401 W. 65th St., Chicago, Ill. For mail: 657 N. Austin Blvd., Chicago, Ill.
- WOODWARD, JOHN D. (A'31), Radio Development Department, Bell Telephone Laboratories, Inc., 180 Varick St., New York, N.Y.
- WOODWARD, LEWIS A. (A'31), Radio Engineer, H. W. Sullivan, Ltd., Leo St., Peckham, S.E. 15, England. For mail: 42 Leigham Court Dr., Leigh-on-Sea, Essex, England.
- WOODWARD, PERCY J. (M'16), Engineer-in-Charge, Beam Wireless Station, Dorchester, Dorset, England.
- WOODWARD, V. M. (A'28), Radio Operator, Airways Radio Station, Municipal Airport, Cleveland, Ohio.
- WOODWORTH, FRED B. (A'29), Engineer, Bell Telephone Laboratories, Inc., 463 West St., New York, N.Y. For mail: 71 Leslie St., East Orange, N.J.
- WOODWORTH, JOHN L. (A'28), Radio Engineering Department, General Electric Company, 1 River Rd., Schenectady, N.Y. For mail: 1113 Union St., Schenectady, N.Y.
- WOODWORTH, SAMUEL (A'31), General Manager, Broadcasting Station WFBL, Onondaga Hotel, Syracuse, N.Y. For mail: 810 Seeley Rd., Syracuse, N.Y.
- WOOLARD, E. W. (A'29), Proprietor, Radio Sales Company, 116 N. William St., Henderson, N.C. For mail: Henderson, N.C.
- WOOLDRIDGE, ALLEN C. (A'30), Radio Engineer, Wired Radio, Inc., 4th Ave. and 13th St., Newark, N.J. For mail: 90 Williams St., East Orange, N.J.
- WOOLEY, W. C. (A'29), Moloney Electric Company, 5390 Kingshighway, N.W., St. Louis, Mo.
- WOOLVERTON, R. B. (A'13-M'13-F'15), Captain, Signal Corps, Assistant Signal Officer, 9th Corps Area, U. S. Army, Presidio of San Francisco, Calif.
- WORDEN, RALPH P. (A'20), Radio Editor, Cleveland News, Cleveland, Ohio. For mail: 2171 Elbur Ave., Lakewood, Ohio.
- WOREL, FRANK (A'27), Engineering Assistant, Michigan Bell Telephone Company, Detroit, Mich. For mail: 3104 Maybury Gd. Ave., Detroit, Mich.
- WORLEY, JACOB M. (A'31), Vice President, Steve Worley Motor Company, Inc., 211-213 N.W. 7th St., Richmond, Ind. For mail: 620 Pearl St., Richmond, Ind.
- WORRELL, HOWARD S. (A'26), Consulting Engineer, 100 E. Montgomery Ave., Ardmore, Pa.
- WORRELL, RICHARD A. (A'28), Agriculture Work, Box 5, Brighton Station, Rochester, N.Y.
- WORST, J. S. (A'29), Radio Engineer and Manager, E. and S. Radio Service, 8120 Wade Park Ave., Cleveland, Ohio. For mail: 1280 Norwood Rd., N.E., Cleveland, Ohio.
- WORTHEN, CHARLES E. (A'28), Assistant Engineer, General Radio Company, Cambridge, Mass.
- WORTHLEY, HERBERT O. (A'31), Radio Operator, Radio Corporation of America, Harbor Bldg., Atlantic Ave., Boston, Mass. For mail: 2 Park Ave., Malden, Mass.
- WORTLEY-TALBOT, JOHN R. (A'31), Doctor, Broadlands House, Churston Ferrers, Devon, England.
- WOUNG, S. S. (A'31), Instructor, College of Engineering, University of Chekiang, Hangchow, China.
- WRATHALL, L. R. (A'31), Member of Technical Staff, Bell Telephone Laboratories, Inc., 463 West St., New York, N.Y.
- WRIGHT, DELMAR (A'31), Communications Engineer, Western Region, Transcontinental and Western Air, Inc., Kansas City, Mo. For mail: 417 Winchester, Glendale, Calif.
- WRIGHT, ERIC P. (A'30), Supervising Engineer, Research Section, Postmaster General's Department, 360 Post Office Pl., Melbourne, Victoria, Australia.

- WRIGHT, HARRY M. (A'27), Teacher of Science, Board of Education, New York, N.Y. For mail: 652 Southern Blvd., New York, N.Y.
- WRIGHT, HERBERT (A'31), Proprietor, Wright's Wireless and Electrical Stores, 30 Bordage St., Guernsey, Channel Islands. For mail: Bridge House, St. Sampson's, Guernsey, Channel Islands.
- WRIGHT, J. WARREN (A'23), Radio Division, Bureau of Engineering, Navy Department, Washington, D.C.
- WRIGHT, MARSHALL C. (A'26), 32 Cypress St., Providence, R.I.
- WRIGHT, OLIVER (A'26), Resident Engineer, American Telephone and Telegraph Company, Lawrenceville, N.J.
- WRIGHT, SYDNEY R. (A'24-M'28), Manager, Radio Department, Hy. Hollingdrake and Son, Ltd., 65 Prince St., Stockport, Cheshire, England. For mail: Greenway, Lees Rd., Bramhall, Cheshire, England.
- WRIGHT, WILFORD C. (J'29), Student, Dodge Radio Institute, Valparaiso, Ind. For mail: Harbor Springs, Mich.
- WRIGHT, WILLIAM S. (A'31), Radio Engineer, The Hammarlund Manufacturing Company, Inc., 424 W. 33rd St., New York, N.Y. For mail: 221 W. 34th St., New York, N.Y.
- WROUGHTON, THOMAS H. (A'26), Automobile and Wireless Engineer, High St., Swardlincote, near Burton-on-Trent, England.
- WU, FRANK TIN SIK (A'30), Manager, Radio Department, Wing On Company, Hongkong, China. For mail: c/o Sam Cheong Company, 40 Wing On St., Hongkong, China.
- WU, S. W. (A'31), c/o Mr. T. S. Ling, Transcontinental Radio Station, Chenju, Shanghai, China.
- WULLENWEBER, MILTON O. (A'27), Mills Novelty Company, Chicago, Ill. For mail: 94 Eugene Ave., Kenmore, N.Y.
- WUNDERLICH, H. A. F., JR. (J'25-A'29), Engineer, Ward Leonard Electric Company, Mount Vernon, N.Y. For mail: 1034 St. John Ave., New York, N.Y.
- WUNDERLICH, NORMAN E. (A'23-M'26), Victoria Hotel, 7th Ave. at 51st St., New York, N.Y.
- WYBORN, R. B. (A'30), Wireless Engineer, Marconi's Wireless Telegraph Company, Ltd., Chelmsford, England. For mail: 13 Salisbury Ave., Colchester, Essex, England.
- WYCKOFF, RALPH D. (M'29), Research Engineer, Gulf Research Laboratories, 327 Craft Ave., Pittsburgh, Pa.
- WYLES, DAVID G. (A'20-M'23), Technical Manager, Philips Lamps, Australia, Ltd., 354 Post Office Pl., Melbourne, Australia.
- WYMAN, RAYMOND C. (A'27), Technician, 51 Central Ave., Medford, Mass.
- WYMORE-SHIEL, IVY J. (A'31), Junior Physicist, U. S. Bureau of Standards, Washington, D.C. For mail: 986 Todd Rd., N.E., Atlanta, Ga.
- WYNNE, WALTER M. (A'24), Lieutenant Commander, U. S. Navy, U.S.S. Evans, c/o Postmaster, New York, N.Y.
- Y
- YAGI, HISETSUGU (M'16-F'24), Professor of Electrical Engineering, College of Engineering, Tohoku Imperial University, Sendai, Japan.

- YAKOVLEV, A. (A'30), Engineer, Allunion Electrical Corporation, Maroseika, Moscow, U.S.S.R. For mail: 52, Prichalnaia Naberezhnaia, Moscow 17, U.S.S.R.
- YALDEN, ABBITT G. (A'31), Radio Operator and Radiotrician, U. S. Naval Radio Station, Tutuilla, Samoa.
- YAMAGUCHI, T. (A'30), Student, Electrical Engineering Department, Tohoku Imperial University of Japan, Sendai, Japan. For mail: 55 Hamaguchi-cho, Sumiyoshi-ku, Osaka, Japan.
- YAMAGUCHI, USABURO (A'28), Radio Engineer, Japan Wireless Telegraph Company, Ltd., Jiji Bldg., 2-18 Marunouchi, Tokyo, Japan.
- YAPP, WILLIAM G. (A'28), Managing Director, Wireless, Electrical and Battery Engineers, 14a Market Ave., Vereeniging, Transvaal, South Africa.
- YARMACK, JOHN E. (A'30), Development Engineer, Hever Products Company, Inc., 197 Grove St., Bloomfield, N.J.
- YATES, CLARENCE C. (A'26), Engineering Department, Southwestern Bell Telephone Company, Kansas City, Mo. For mail: 4022 Warwick, Kansas City, Mo.
- YATES, RAYMOND FRANCIS (A'21-M'26), President, Homcraft Studios, Inc., 75 Wiesner Bldg., Rochester, N.Y. For mail: 419 Grider St., Buffalo, N.Y.
- YEATES, EPHRAIM LE ROY (A'27), 1253 Sherman Ave., Salt Lake City, Utah.
- YECK, F. A. (A'31), Draftsman, Patent Department, Wired Radio, Inc., Ampere, N.J. For mail: 17 Gifford Ave., Jersey City, N.J.
- YENOLI, DOMINICK J. (A'29), Service Department, F. A. D. Andrea, Inc., Jackson Ave., Orchard and Queen Sts., Long Island City, L.I., N.Y. For mail: 146-64 Shore Ave., Jamaica, L.I., N.Y.
- YERIAN, CARLOS S. (A'30), Test Man, Radio Test Department, General Electric Company, Schenectady, N.Y. For mail: 217 Alexander Ave., Scotia, N.Y.
- YEUTTER, C. S. (A'31), Transmission Research Engineer, Bell Telephone Laboratories, Inc., 463 West St., New York, N.Y.
- YODER, LEO E. (A'29), Engineer, Radio Stations WBAA-W9XG, Purdue University, Lafayette, Ind. For mail: Box 454, West Lafayette, Ind.
- YODER, RAYMOND S. (A'25), Engineer, Lear Developments, Inc., Chicago, Ill. For mail: 4881 N. Paulina St., Chicago, Ill.
- YOKOYAMA, EITARO (M'17), Electrotechnical Laboratory, Ministry of Communications, Osaka, Tokyo-fu, Japan. For mail: Kiharayama 1621, Ohnori, near Tokyo, Japan.
- YOKOYAMA, H. (A'31), Engineer, Laboratory, Japanese Broadcasting Corporation, Kinutamura, near Tokyo, Japan.
- YOKOYAMA, TETSUMI (A'28), c/o Radio Broadcasting Corporation of Japan, Uchiyama-shita-cho, Kojimachi-Ku, Tokyo, Japan.
- YOLLES, JACOB (A'29), Research Engineer, c/o Technidyne Corporation, 644 Broadway, New York, N.Y. For mail: 2361-64th St., Brooklyn, N.Y.
- YOSHIRO, KURODA (A'25), Instructor, Radio Section, Department of Communications, Tokyo, Japan. For mail: 448 Tokumochi, Ikegami-Mura, Ebaragun, Tokyo-fu, Japan.
- YOSHITISHI, TANABE (A'30), Engineer, Kumamoto Broadcasting Station, Kumamoto, Japan.
- YOUNG, ALEXANDER D. (A'31), Radio Operator, Anchor Line, Glasgow, Scotland. For mail: 20 E. Crawford St., Greenock, Scotland.
- YOUNG, ALFRED W. (A'28), Managing Director, Bath Electrics, Ltd., Foxcombe Rd. Works, Bath, England. For mail: Warwick Villa, Kennington Rd., Bath, England.
- YOUNG, ARTHUR M. (A'31), Marconi Wireless Telegraph Company, Ltd., Chelmsford, England. For mail: Elndido, Priests Lane, Shenfield, Essex, England.
- YOUNG, CHARLES J. (A'23), 1065 Avon Rd., Schenectady, N.Y.
- YOUNG, CHARLES S. (A'29), Inductive Coordination Engineer, Pennsylvania Power and Light Company, Allentown, Pa. For mail: 204 S. Fulton St., Allentown, Pa.
- YOUNG, CHARLES W. (A'31), Student Engineer, Signal Department, Peiping Liaoning Railway, Hsinho, North China.
- YOUNG, D. A. (A'30), Radio Service Manager, The Tracy-Wells Company, 175 N. Front St., Columbus, Ohio. For mail: 914 Ellsworth Ave., Columbus, Ohio.
- YOUNG, FRANK A. (A'20), Chief Engineer, Connecticut Telephone and Electric Company, Meriden, Conn. For mail: 523 W. Main St., Meriden, Conn.
- YOUNG, JOHN W. (A'27), Radio Engineer, U. S. Navy, Navy Department, Bureau of Engineering, Washington, D.C. For mail: P.O. Box 35, Balboa, Canal Zone.
- YOUNG, LEO C. (A'19-M'29), Radio Engineer, U. S. Naval Research Laboratory, Bellevue, Anacostia, D.C. For mail: 1018 Douglas St., N.E., Washington, D.C.
- YOUNG, M. D. (A'30), Engineer, City of Winnipeg, Hydro Electric System, 54 Princess St., Winnipeg, Manit., Canada. For mail: 399 Beaverbrook St., Winnipeg, Manit., Canada.
- YOUNG, OWEN D. (M'22-F'28), Chairman of the Board of Directors, General Electric Company, 120 Broadway, New York, N.Y.
- YOUNG, SUMNER B. (J'16-A'19), Attorney, Prendergast and Flannery, 705 First National Soo Line Bldg., Minneapolis, Minn. For mail: 2309-1st Ave., S., Minneapolis, Minn.
- YOUNG, WILLIAM M. K. (A'27), Chief Clerk, Norris Grain Company, 940 Board of Trade Bldg., Kansas City, Mo.
- YOUNGBLOOD, ISAAC J. (A'31), Philadelphia Storage Battery Company, Ontario and C Sts., Philadelphia, Pa. For mail: 3510 Malta St., Philadelphia, Pa.
- YOUNGS, HOWARD E. (A'26), R.D. No. 2, North East, Pa.
- YOUNGSTROM, NELS C. (A'26), Member of Technical Staff, Bell Telephone Laboratories, Inc., 463 West St., New York, N.Y.
- YULE, T. M. (A'30), Radio Engineer and Operator, c/o N'Changa Copper Mines, Via Ndola, Northern Rhodesia, South Africa.
- YURGIONAS, JOHN A. (J'26-A'29), Test and Inspection Department, Visameter Corporation, Western Ave., Los Angeles, Calif. For mail: 853-8th St., Manhattan Beach, Calif.
- YURT, F. X. (A'30), Radio Serviceman, 103 Antwerp St., Brighton, Mass.

Z

- ZACEK, AUGUST (M'29), Professor of Physics, Charles University, Prague II, U Karlova 5, Czechoslovakia.
- ZALUSKEY, EUGENE R. (A'27), Technician, Radio Engineering Service, 2134-1st Ave., Seattle, Wash. For mail: 8237 Stroud Ave., Seattle, Wash.
- ZANDONINI, ELIZABETH M. (A'28), Radio Aid, Radio Laboratory, U. S. Bureau of Standards, Washington, D.C. For mail: 3633 Everett St., N.W., Washington, D.C.
- ZATORSKY, E. F. (A'25), c/o Paramount-Famous-Lasky Corporation, 6th and Pierce Aves., Astoria, L.I., N.Y.
- ZEE, LIANG (A'24), Radio Engineer, Ministry of Communications, Peking China. For mail: Lili, Soochow, Kiangsu, China.
- ZEHR, NICHOLAS J. (A'27), Radio Engineer, c/o Voice of St. Louis, Hotel Mayfair, St. Louis, Mo. For mail: 1538 Bradford Ave., St. Louis, Mo.
- ZEIDLK, WILLIAM J. (A'29), Service Engineer, Electrical Research Products, Inc., 1428 Allen Bldg., Dallas, Tex.
- ZEIGER, LOUIS B. (A'30), Purchasing Agent, General Talking Pictures Corporation, 1452-55th St., Brooklyn, N.Y.
- ZEIGLER, T. W. (A'27), First Assistant Manager, L. K. Liegetts Drug Store, Corner Connecticut and Florida Aves., N.W., Washington, D.C. For mail: 1535 P St., N.W., Washington, D.C.
- ZENNECK, JONATHAN (M'13-F'15), Professor, Technische Hochschule, Muenchen, Germany.
- ZERN, REBER T. (A'30), Laboratory Assistant, Atwater Kent Manufacturing Company, Philadelphia, Pa. For mail: Trooper, Pa.
- ZIEGLER, FREDERICK J. (A'18), The Wil-lows, Woodmere, L.I., N.Y.
- ZIMBER, RAYMOND M. (A'30), Manager, Development and Specification Department, De Forest Radio Company, Passaic, N.J. For mail: 104 Warwick St., Bloomfield, N.J.
- ZIMMERMAN, ARTHUR G. (A'29), Radio Engineer, RCA Victor Company, Inc., Camden, N.J. For mail: 237 Stratford Ave., Westmont, N.J.
- ZIMMERMAN, GEORGE E. (A'26), Supervisor, Radio Station KPRC, Houston Post Dispatch, Houston, Tex.
- ZIMMERMAN, ROBERT F. (A'28), Radio Engineer, General Motors Radio Corporation, Dayton, Ohio. For mail: 267 Park Dr., Dayton, Ohio.
- ZINSER, HENRY (A'30), Machine Development Department, National Carbon Company, Inc., Berea Rd. and E. 117th St., Cleveland, Ohio. For mail: 3997 W. 226th St., Rocky River P.O., Cleveland, Ohio.
- ZOTTU, PAUL D. (A'31), Special Assistant, Wesleyan University, Wesleyan Station, Middletown, Conn.
- ZUEV, VITALY V. (A'28), Chief of Technical Commercial Department, Philips South American Export Company, 1451, Rivaldavia, Buenos Aires, Argentina. For mail: Rivaldavia 1447, Buenos Aires, Argentina.
- ZURIAN, P. D. (J'27-A'29), Chief Engineer, Press Wireless, Inc., P.O. Box 292, Hicksville, L.I., N.Y. For mail: 135 Terrace Ave., Hempstead, L.I., N.Y.

MEMBERSHIP (Alphabetical)

ZWEIGER, OWEN (J'27), 1259 S. Harcourt Ave., Los Angeles, Calif.
 ZWICKER, HOWARD H. (A'31), Radio Operator, Radiomarine Corporation of America, 426 Atlantic Ave., Boston, Mass. For mail: 635 Broadway, Everett, Mass.

ZWORYKIN, VLADIMIR K. (M'30), Research Engineer, RCA Victor Company, Inc., Camden, N.J. For mail: 416 Warwick Rd., Haddonfield, N.J.

ALABAMA
 Anniston
 Gray, John M. (A)
 Auburn
 Waldo, George V. (A)
 Birmingham
 Bell, John C. (A)
 Duran, Albert E. (A)
 Fairhope
 Ness, Delmer N. (A)
 Mobile
 Griffith, M. H. (A)
 Helt, Scott (A)
 Manuel, John G. (A)
 Montgomery
 Hallman, L. B., Jr. (A)
 Trum, Alexander D. (A)
 Pratt City
 Hassler, W. Dan (A)
 Tuscaloosa
 Hamilton, Sam (A)

ARIZONA
 Flagstaff
 Bannister, M. W. (A)
 Phoenix
 Grigg, James W. (A)
 Kingman
 Wallace, P. H. (A)
 Prescott
 De Witt, Harold (A)
 Tucson
 Percy, F. W. (A)
 Sams, E. E. (A)

ARKANSAS
 Blytheville
 Lintzenich, C. L. (A)
 Conway
 Cordrey, E. E. (M)
 Fayetteville
 Albrecht, Harold D. (A)
 Fort Smith
 Barry, James A. (A)
 Hot Springs
 Tuggle, Granville D. (A)
 Little Rock
 Beem, Raymond M. (A)
 Boone, Virgil (A)
 Harington, Conrad F. (A)
 Logan, E. Warren, Jr. (A)
 Minor, Robert Lee (A)
 Simmons, Guy A., Jr. (A)
 Stover, Arthur R., Jr. (J)
 Tracy, Kermit F., Jr. (A)
 Waller, Paul (A)
 Wengel, Raymond W. (A)
 McGehee
 Wallace, L. E. (A)

CATALOG OF MEMBERSHIP

December 31, 1931

Arranged Geographically

UNITED STATES

Texarkana
 Mathis, Charles, Jr. (J)
 Mims, Morrill P. (A)

CALIFORNIA
 Alameda
 Daniels, Harold H. (A)
 Jackson, Chester M. (A)
 Ramsay, Alan N. (A)
 White, Ray H. (A)
 Alhambra
 Greger, J. G. (A)
 Grimes, William F. (A)
 Lang, Connie (A)
 Lee, George Richard (A)
 Sleeper, J. Lloyd (A)
 Altadena
 Johnson, Paul F. (M)
 Arcadia
 Strachan, George H. (A)
 Willson, Clarence L. (A)
 Artesia
 Corcoran, E. M. (A)
 Corcoran, George L. (A)
 Bakersfield
 Lemert, Ralph D. (A)
 Baldwin Park
 Martin, Ora F. (A)
 Bell
 Anderson, Edward R. (A)
 Berkeley
 Armer, Austin A. (A)
 Davis, Daryl D. (A)
 Greves, George L. (A)
 Halloran, A. H. (M)
 Hartz, J. Ernest (A)
 Heinrich, Mortimer (J)
 Jones, Frank C. (A)
 Kellogg, Walter D. (A)
 McKay, William K. (A)
 Meissner, Earl R. (A)
 Power, Lawrence T. (A)
 Reukema, Lester E. (A)
 Beverly Hills
 Balsley, James R. (A)
 Bishop
 Wheeler, Walter R. (A)
 Bollinas
 Park, Charles W. (A)
 Slater, F. Robert (A)
 Tanck, Henry (A)
 Burbank
 Beatty, W. E. (A)
 Chini, Carl J. (A)
 Shaw, Theodore S. (A)
 Wainwright, Stuart F. (A)
 Burlingame
 Michalic, C. T. (A)
 Carlsbad
 Elser, F. Johnson (A)
 Claremont
 Packard, Alden C. (A)

Compton
 Orr, Francis H. (A)
 Smith, F. E. (A)
 Concord
 Kelly, Claude H. (A)
 Coronado
 McClelland, Harold M. (M)
 Pierce, Francis E. (M)
 Covina
 Ross, M. F. (A)
 Culver City
 Adams, Marvyn S. (A)
 Burns, G. Austin (A)
 Figgins, Frank M. (A)
 Wersen, David T. (A)
 Eagle Rock
 Ford, Walter B. (A)
 Sprague, G. M. (A)
 El Centro
 Cook, John W. (A)
 Irely, Earl R. (A)
 Lewis, Vergil E. (A)
 El Segundo
 Hart, William J. (A)
 Folsom City
 Brown, Elmer L. (A)
 Fontana
 Morecroft, J. H. (F)
 Fresno
 Foin, Owen F., Jr. (J)
 Gifford, Delbert K. (A)
 Fullerton
 Atherton, Malcolm J. V. (A)
 Lewis, Evan J. (J)
 Glendale
 Bowles, Theodore C. (A)
 Clement, Jack D. (A)
 Eilers, John (J)
 Ellis, George D. (A)
 Engen, Ralph E. (A)
 Kennedy, Frank M. (A)
 Kepler, O. L. (A)
 Murray, Robert W. (A)
 Shomler, H. B. (A)
 Weaver, Chester E. (A)
 Wright, Delmar (A)
 Hemet
 Sorkness, Hardus (A)
 Hermosa Beach
 Cooper, Harold G. (A)
 Perkins, George S. (A)
 Hollywood
 Blackburn, John F. (A)
 Brockway, Don C. (A)
 Campbell, Carleton W. (A)
 Cooper, George R. (A)
 Cunningham, Lodge (A)
 de Forest, Lee (F)
 Dering, Fred J. (A)
 Fox, Bert M. (J)
 Goldsmith, Lloyd T. (A)

CALIFORNIA (Continued)

- Hansen, Edmund H. (M)
Hart, Roy H. (M)
Heineman, John T. (A)
Hill, Arthur P. (M)
Hilliard, John K. (M)
Holden, Dale S. (A)
Huffman, Charles E. (A)
Levinson, Nathan (M)
Manderfeld, Emanuel C. (A)
Miller, Burton F. (A)
Mohler, J. L. (A)
Newman, David H. (M)
Phillips, Jos. H., Jr. (A)
Ringold, H. Russell (A)
Sawyer, Gordon E. (A)
Schultz, E. Patterson (A)
Schulze, Heri T. (A)
Stewart, Ronald B. (A)
Van Why, Forbes W. (M)
- Huntington Park
Dalton, Stuart P. (A)
Weissmantel, C. H. (A)
- Inglewood
Brittain, Louis B. (A)
Curran, George W. (A)
Underwood, Ernest G. (A)
- Inverness
Canfield, N. A. (A)
Case, Myron D. (A)
Culley, Lester D. (A)
Marsh, Hallock Snyder (A)
Moorhead, George H. (A)
- Jackson
Snyder, W. Gilman, Jr. (A)
Van Thiel, Jan (A)
- Kelseyville
Towne, Alfred E. (A)
- La Canada
Benioff, Hugo (A)
- La Crascenta
Robinson, Frederick (A)
- La Habra
Inns, Stephen (A)
- Larkspur
Kellogg, Frank L. (A)
- Long Beach
Brown, James H. (A)
Edgar, J. Clifton (A)
Gray, William (A)
Howell, Roger A. (A)
Larsen, D. Avery (A)
McDowell, Lawrence W. (A)
Moore, Raymond C. (A)
Strong, Foster G. (A)
Wallace, Donald C. (A)
- Los Angeles
Adams, Walter L. (A)
Albin, Frederick G. (A)
Alverson, James G. (A)
Andersen, H. W. (A)
Anderson, Henry A. (A)
Appleton, Harry (A)
Barnette, Allen F. (A)
Boring, Harold M. (A)
Bradley, John C. (A)
Brown, J. Kenneth (A)
Bryan, William J. (A)
Buffinger, W. G. (A)
Bumbaugh, Harold L. (A)
- Burke, Harold E. (A)
Campbell, William N. (A)
Chapple, James M. (A)
Coblentz, Orhan R. (A)
Coe, Ernest W. (A)
Collins, Edward M. (A)
Cook, Robert O. (A)
Currie, Burton Alex. (A)
Cutler, Kenneth W. (A)
Davis, Harold (A)
Dickson, H. L. (A)
Dreher, Carl (F)
Edgecomb, A. J. (A)
Estep, Carl R. (J)
Farran, Dean (A)
Felstead, Charles F. (A)
Fenton, A. Norwood (A)
Fetterhoff, Milton J. (A)
Findley, Thomas J. (A)
Flickinger, J. H. (A)
Gioga, Peter C. (A)
Grove, Howard G. (A)
Hagen, B. W. R. (A)
Hankins, Marvin J. (A)
Heather, Harold (A)
Hecht, Royal H. (A)
Hooker, Donald E. (A)
Hopkins, Stephen (A)
Houdyshell, Lowell B. (A)
Howard, L. W. (A)
Howe, Franklin Joachim (A)
Hubbard, Wyman B. (A)
Hughes, Emmett N. (A)
Jakosky, John Jay (M)
Karl, Otto G. (A)
Kennedy, Douglas (A)
Kennedy, John C. (A)
Ketchum, Robert W. (A)
Kornitved, George W. (A)
Langrick, Paul D. (A)
Lee, Gilbert C. (A)
Leighton, Harold W. (A)
Lindsay, W. W., Jr. (M)
Lubcke, Harry R. (A)
Ludlum, W. F. (A)
Mahon, James L. (A)
Mason, Curtis W. (A)
McCabe, William E. (A)
McCash, Perry V. (A)
Metcalf, David E. (A)
Miller, Charles E. (A)
Miller, Gerald B. (A)
Moore, Raymond M. (A)
Neely, Norman B. (A)
Newcomb, Robert (A)
Odell, Carl H. (A)
Olmstead, Charles B. (A)
Oodrys, Arthur (A)
Pearce, Harry G. (A)
Perkins, Lucius J. (M)
Perry, Robert M. (A)
Pfeiger, Robert A. (A)
Randle, Herrin E. (A)
Reed, Jess M. (A)
Reiter, Frank P. (A)
Richards, W. S. (A)
Riggs, Clare A. (A)
Sarver, Frank M. (A)
Schreiber, Ernest H. (A)
Sheldon, Clinton C. (A)
Shepard, Leo (A)
Silent, Harold C. (A)
Slyfield, Charles O. (A)
- Smith, C. Bernard (A)
Sorensen, Lanford W. (A)
Stolle, R. A. (A)
Stroebel, John C., Jr. (M)
Stuedle, Emry C. (A)
Tami, Joseph, Jr. (A)
Tatreault, Leon E. (A)
Taufenbach, Leslie E. (M)
Thistlewhite, Robert (A)
Turner, J. Glen (A)
Warne, Vearn J. (A)
Weatherford, Richard V. (A)
Whiston, R. William (A)
Whittaker, Edmund (A)
Woodbury, E. (A)
Zwinger, Owen (A)
- Manhattan Beach
Frank A. Tischer (A)
Yurgionas, John A. (A)
- Menlo Park
McCullough, Frank S. (A)
Seal, H. Robert (A)
- Merced
Shaffer, Frank (J)
- Monrovia
Barnard, T. A. (J)
- Monterey
Brokaw, Hal R. (A)
- Monterey Park
Alker, Charles (A)
Nikirk, Thomas E. (A)
Sanmann, Edgar J. (A)
- Napa
Streich, Robert J. (A)
- Oakland
Allen, Preston D. (A)
Brearty, Lawrence S. (A)
Brodie, Alfred H. (A)
Gilbertson, Bernard (A)
Hucke, Herbert M. (A)
Klein, Norman E. (A)
Lar Rieu, E. A. (A)
Mangelsdorf, F. (A)
O'Brien, Daniel L., Jr. (A)
Penther, Carl Joseph (A)
Schlueter, Edward A. (A)
Smith, Mortimer O. (A)
Stewart, Jesse A. (A)
Summers, James W. (A)
Waterman, Edward C. (A)
Wild, Sydney J. (A)
- Olympia
Kaufman, Arthur W. (A)
- Orange
Charbonneau, I. H. (A)
Waters, John E. (A)
- Pacific Grove
Wood, Stanford J. (A)
- Pacific Palisades
Eiler, E. E. (M)
Mann, Theodore H. (A)
- Palo Alto
Beal, Ralph R. (A)
Brolly, A. H. (A)
Brower, William M. (M)
Brown, Archibald S. (A)
Clayton, John M. (M)

CALIFORNIA (Continued)

- Elliott, H. F. (M)
Frey, R. C. (A)
Fuller, Leonard E. (F)
Green, Irving L. (A)
Jensen, Sven (A)
Julien, Ira F. (M)
Miller, Holmes C. (A)
Overacker, Horace E. (A)
Redeker, Harry E. (A)
Ryan, Harris J. (M)
Scofield, Philip F. (M)
Thomas, Charles C. (A)
Tinney, Francis B. (A)
Veirup-Jensen, J. G. (A)
Whitern, Ray (A)
- Pasadena
Blatterman, Headlee L. (A)
Bradshaw, Robt. C. (A)
Brown, Howell C. (A)
Cook, Ronald P. (A)
Dodge, Richard M. (A)
Felch, H. F. (A)
Hoover, Herbert, Jr. (A)
Hopkins, John S. (A)
Hopper, Francis L. (A)
Howes, Edgar T. (A)
Keyes, Edwin F. (A)
Lathrop, Kenneth A. (A)
Lindsey, William F. (A)
MacKeown, S. S. (M)
Moore, Robert M. (A)
- Piedmont
Scott, Leo L. (A)
- Pine Knot
Betterley, Jack A. (A)
- Point Reyes Station
Reid, Irl H. (A)
Wood, Raymond A. (A)
- Redwood City
Litton, Charles V. (A)
- Richmond
Parker, Ray H. (A)
Trolese, Louis (A)
Watson, Herbert M. (A)
- Rivera
Barlow, Roy G. (A)
- Riverside
West, L. E. (A)
- Sacramento
Hayden, J. W. (A)
Messner, Roy L. (A)
Semoni, Anthony J. (A)
- St. Helena
Lewelling, Raymond (A)
- San Bernardino
Kiernan, Earl F. (A)
- San Bruno
McAulay, Wm. H. (A)
- San Carlos
Wardlow, H. Vance (A)
- San Diego
Burnett, William L. (A)
Clark, Thomas F. (A)
Doig, John H. (A)
Gruenewald, Harold C. (A)
Kinney, E. S., Jr. (A)
Martin, Walter H. (A)
Naimo, Peter J. (A)
Patten, Stanley F. (A)
Riddle, George E. (J)
Signer, R. M. (A)
- Stone, John Stone (F)
Trapeur, Robert E. (A)
Ware, Albert S. (A)
Williams, Ralph R. (A)
Wisner, Fred L. (A)
- San Francisco
Baldwin, Robert S. (A)
Bear, William P. (A)
Bender, John A. (A)
Benson, Francis S. (A)
Blake, Robert I. (A)
Bogardus, Henry L. (M)
Bradley, John T. (M)
Bradshaw, Lynwood (A)
Brewington, Carl W. (A)
Clark, Kenneth G. (A)
Clark, Robert W. (A)
Cole, Charles H. (A)
Cone, Donald I. (A)
Connolly, Norman C. (A)
Coombs, Clyde F. (A)
Cormack, Alan N. (A)
Daily, Harold C. (A)
Danforth, Richard S. (A)
Danielson, Ernest G. (A)
Dewey, Fred L. (M)
Farnsworth, Philo T. (A)
Fass, Sydney J. (A)
Fenner, Paul R. (A)
Fletcher, Earle S. (M)
Franklin, Lyman T. (A)
Freiermuth, Vincent J. (A)
Gary, L. A. (A)
Gould, George B. (A)
Greene, Harry A. (A)
Hanscom, W. W. (M)
Hart, Arthur H. (A)
Heeder, M. E. (A)
Heintz, Ralph M. (F)
Held, Herman E. (A)
Henry, Franklin M. (A)
Hoffman, Samuel O. (A)
Huehl, R. M. (A)
Kaufman, Jack (A)
Kellogg, Richard B. (A)
Kennedy, David W. (A)
King, Howard D. (A)
Kirkland, Robert D. (A)
Kramer, John F. (A)
Lane, Howard D. (A)
Langevin, Carl C. (M)
Lebedeff, George M. (A)
Letsinger, R. Paul (J)
Levasseur, J. J. (A)
Linden, Bernard H. (A)
Lippincott, Donald K. (M)
MacDonald, H. J. (A)
MacMahon, Alvin E. (A)
Maynard, Raymond K. (A)
McDowell, C. S. (M)
Miller, Wayne (A)
Mowry, Charles E. (A)
Nicolaidis, George (A)
Nikonenko, Paul (A)
Parkhurst, Edgar L. (A)
Patron, Alfonso E. (A)
Pinkney, J. L. (A)
Powell, Louis H. (A)
Rosa, Walter F. (J)
Rowe, Victor G. (A)
Royden, George T. (M)
Sandfort, Mark (A)
Saxton, Alfred H. (A)
Shermund, Ralph C. (M)
Skinner, Clifton R. (A)
Slavin, Samuel B. (A)
Smith, Chas. S., Jr. (A)
- Smith, Herbert H. (A)
Smith, Howard L. (A)
Soderquist, Clement J. (A)
Sphar, Clark H. (A)
Stagnaro, John A. (A)
Ternow, Helmut G. (A)
Threlkeld, Howard M. (A)
Tobin, Lucien C. (A)
Todd, Stedman F. (A)
Tustin, John L. (A)
Vincent, Almon M. (A)
Vogel, Philip J. (A)
Walker, Raymond E. (A)
Weir, F. Torres (A)
Whitten, Sylvester (A)
Winnegar, W. A. (A)
Winner, Wm. L., Jr. (M)
Woltzen, Lloyd J. (A)
- San Gabriel
Ashbrook, Roy B. (A)
- San Jose
Booker, Eugene R. (M)
Cozzens, Bradley (A)
Engwicht, Harry (A)
Gillmeister, Frederick W. (A)
Kelliher, John E. (A)
Queument, Frank J. (A)
Reynolds, F. T. (A)
Saine, Harry (A)
Whidden, Ira P. (A)
- San Marino
Pohlman, G. Anton (A)
- San Mateo
Brown, James F. (A)
- San Pedro
Bailey, William B. (A)
Bassler, Carl J. (A)
Booth, Howard A. (A)
Brown, L. D. (A)
Carlson, Carl E. (A)
Derry, F. R. (A)
Dugan, Paul F. (A)
Foley, Joseph H. (A)
Homsy, John H. (A)
Johnson, V. (A)
Mareck, Albert J. (A)
Peterson, Arthur W. (M)
Ragan, Thomas C. (A)
Scott, Carl A. (A)
- San Rafael
Parkin, John, Jr. (A)
- Santa Ana
Beisel, Keith (A)
- Santa Barbara
Kempton, Walter D. (A)
Means, Paul S. (A)
Piersall, Bruce (A)
- Santa Cruz
Fisher, E. H. (A)
- Santa Monica
Best, Albert O. (A)
Willis, Edward N. (A)
- Saratoga
Cattell, Gilbert W. (A)
- Southgate
Griffith, M. H. (A)
Magnuson, Herman A. (A)
C. (A)
- South Pasadena
Parker, Evert L. (A)
- South San Francisco
Woolverton, R. B. (F)
- Stanford University
Byrne, Paul F. (A)

CALIFORNIA (Continued)

Rathbun, Harry (A)
Terman, Frederick E. (A)

Stockton
Clarkson, Chas. N. (A)
Holt, Phny E. (A)
Robertson, Walter J. (A)
Schulz, Paul C. (A)

Sunnyvale
Paul, Ernest E. (A)

Tuolumne
Elliott, William H. (A)

Vallejo
Rice, Arthur R. (A)
Robinson, R. J. (A)

Van Nuys
Black, Robert (A)
Chesney, Alonzo P. (A)

Venice
Aves, Fred J. (J)
Du Vall, Charles (A)
Gleason, Sterling (A)

Ventura
Snow, Louis A. (A)

West Hollywood
Freericks, Bernard (A)
Kruger, Bernard (A)
Kruger, Leon (A)
Smith, Wale H. (A)

West Los Angeles
Larsen, C. W. (A)
MacKenzie, Frank B. (A)
Poorman, Edwin H. (J)
Spiller, Cecil Chas. (A)

Whittier
Eagle, Roy D. (J)
Smith, L. E. (A)
Wiggins, Wallace S. (A)

Wilmington
Blank, S. A. (A)
Skov, Jens Ingvard (A)

COLORADO

Arvada
Kelso, Rupert E. (A)

Boulder
Cartwright, Randle V. (A)
Dieckman, William (J)

Colorado Springs
Blair, Wiley, Jr. (A)
Harvey, Francis M. (A)

Delta
Fulghum, Chas. K. (A)

Denver
Earnhart, Glen W. (M)
Giese, Raymond C. (M)
Grove, William C. (A)
Johnson, Harry A. (A)
Owen, Robert H. (A)
Pyle, William D. (A)
Strelsky, Herbert J. (A)
Williams, Howard M. (A)

Fort Collins
Sammons, Floyd (A)

Golden
Pawley, Myron G. (A)

Greeley
Isberg, Reuben (J)
Nichols, Frederick A. (A)

Holyoke
Scheneman, Henry Wesley (A)

Pictou
Anderson, William A. (A)

Pueblo
Coday, Wm. A., Jr. (A)
Finch, Joseph E. (A)

Seibert
Fingado, Francis H. (A)

Yuma
Beehler, Elmer G. (A)

CONNECTICUT

Bridgeport
Austin, Kirby B. (A)
Bishop, Nathaniel (A)
Chopsky, Peter A. (A)
Crossland, Henry A. (A)
Gimmy, Norman H. (A)
Gravlin, Lee F. (A)
Ham, Frank M. (A)
Harrington, Carlton E. (J)

Norton, Leland D. (A)
Nothnagle, Geo. E. (A)
Samoiloff, Leon (A)
Tomlinson, Harry E. (A)

Bristol
Dreyer, Harry W. (M)

East Hartford
Gray, J. Birnie (A)
Randall, J. Clayton (M)

Elmwood
Battley, E. L. (A)

Glenbrook
Niedert, George (A)

Greenwich
Thomas, Wm. A. (M)

Hamden
McNamara, Francis T. (A)

Hartford
Bourne, Roland B. (M)
Coe, Robert S. (A)
Handy, Francis E. (A)
Maxim, Hiram P. (A)
Pember, Harold H. (A)
Roach, John C. (A)
Rushing, Wallace E. (A)
Seeli, Russell G. (A)
Somerville, Harry V. (A)
Tasker, Joseph M. (A)
Weston, Francis B. (A)

Ivoryton
Kelsey, Philip C. (A)

Kensington
Edgerly, Albert H. (A)

Litchfield
Vanderpoel, Floyd L. (A)

Mansfield
Van Niman, Roy T. (A)

Meriden
Wilcox, Ernest C. (A)
Young, Frank A. (A)

Middletown
Cady, Walter G. (F)
Van Dyke, Karl S. (M)
Zottu, Paul D. (A)

Millford
Hadden, Harold L. (A)

Mount Carmel
Croteau, Carlton W. (A)

Naugatuck
Wood, Wm. Forrest (A)

New Britain
Johnston, Douglas A. (A)

New Haven
Doolittle, Franklin M. (M)
Fish, George R. (A)
Gubin, Samuel (A)
Pitts, A. B. (A)
St. Laurent, Herbert (A)
Smith, Franklin S. (A)
Turner, H. M. (M)
Weed, C. Bronson (A)

Noroton
Kutscher, Louis F. (A)

Noroton Heights
Meserve, G. Donald (A)

Norwich
Hubbard, James L. (A)

Plainville
Jones, H. Garfield (A)
Stephenson, Martin A. (A)

Seymour
Dana, Alan S. (A)

Southington
Lewis, Earl B. (A)

Springdale
Cowan, Edward J. (A)

Stamford
Carlson, Einar C. (A)

Storrs
Noble, Daniel E. (A)

Waterbury
Bennett, Morris H. (A)
Buckley, Francis P. (A)
Greenblatt, Louis (A)
Winchell, Alfred M. (A)

West Hartford
De Soto, Clinton B. (A)
Grammer, George (A)
Hebert, Arthur A. (M)
Houldson, Clyde J. (A)
Jackson, Albert H. (A)
Kruse, Robert S. (M)
Lamb, James J. (A)
Montgomery, Philip (A)
Sanders, Edwin R. (A)
Warner, Kenneth B. (M)

West Haven
Phillips, Edward I. (A)

Westport
Hanson, Oscar B. (M)
Perry, William A. (A)

Wethersfield
Carini, Louis (J)
Mitchell, James A. (A)

Wilton
Van Heiningen, Willard A. (A)

Windsor
Kecilly, Delbar P. (A)

DELAWARE

Wilmington
Bisbee, Robert H. (A)
Boylan, E. Braundt (A)
Casey, K. K. V. (A)
Fearing, Justin L. (A)
Henning, Clarence I. B. (A)
Tatnall, Joseph S. (A)
Warfield, T. Jackson S. (A)
Wilcox, Robert L. (A)

DISTRICT OF COLUMBIA

Anacostia
Cogswell, W. P. (A)
Cooper, Orville T. (A)
Gebhard, Louis A. (A)
Granger, Harold (A)
Howitt, Nathan (A)
Meyer, R. B. (A)
Moore, Adam H. (A)
Owens, Raymond B. (M)
Struthers, Francis W. (A)
Taylor, A. Hoyt (F)
Thomas, William M. (A)
Walker, Guy P. (A)
Wallace, James D. (A)
Wheeler, Lynde P. (F)
Williams, Charles Had- don (A)

Tacoma Park
Aurynger, John J. (A)

Washington
Arps, Mervin W. (M)
Austin, Louis W. (F)
Backus, Cyrus D. (M)
Bailey, Stuart L. (A)
Barron, J. H., Jr. (M)
Bender, Louis B. (M)
Berkner, Lloyd V. (A)
Bertonis, Peter W. (A)
Black, Joel Cantrell (J)
Bower, Ward E. (A)
Boyer, William P. (A)
Bradford, Henry K. (A)
Burger, Clarence W. (A)
Burgess, Warren B. (M)
Burke, David J., Jr. (A)
Burke, James W. (A)
Butman, Carl H. (M)
Caldwell, Louis G. (M)
Chamberlain, Robert R. (A)
Chromy, B. J. (A)
Cole, Martin (A)
Cohen, Louis (F)
Cole, G. C. (A)
Colvin, Ruel (A)
Corderman, Wm. P. (A)
Corrigan, James T. (A)
Craven, T. A. M. (F)
Crawford, David M. (A)
Culver, Clarence C. (M)
Curtis, Westley F. (A)
Davis, Chester L. (M)
Davis, R. K. (A)
Davis, Thomas M. (M)
Day, John F. (A)
Diamond, Harry (M)
Doremus, Cornelius W. (A)
Dorsey, Herbert G. (M)
Dow, J. B. (M)
Downey, W. E. (M)
Drury, Paul O. (A)
Ferguson, Theo. P. (A)
Fox, Benjamin (A)
Fugazzi, Frank J. (A)
Gilliland, Theo. R. (A)
Greaves, V. Ford (F)
Greeley, Philip H. (A)
Groselose, S. K. (A)
Guthrie, F. P. (M)
Hall, E. L. (A)
Hardesty, G. K. C. (J)
Harris, Richard P. (A)
Hastings, Harris F. (A)

Hatter, Angerean A. (A)
Heaton, Vincent E. (A)
Heron, Louis M. (M)
Hinemon, John H., Jr. (A)
Hogg, Wm. S., Jr. (M)
Holden, Ellis Gray (A)
Holt, Laurence J. (A)
Hooper, S. C. (F)
Hromada, Joseph C. (A)
Jackson, William E. (A)
Jansky, C. M., Jr. (F)
Jenkins, C. Francis (A)
Jett, Ewell K. (A)
Johnson, Albert E. (A)
Jolliffe, Charles B. (F)
Judson, Elbert B. (A)
Kalbfleisch, Albert C., Jr. (A)
Kaplan, Jacob (A)
Kaufman, Joseph (M)
Kinley, Clifford B. (A)
Kirby, Samuel S. (A)
Kriz, Joseph (A)
Lapham, Evan G. (A)
Leahy, John E. (A)
Lebowitz, Samuel (A)
Lee, Wm. Justice (M)
Loomis, Mary T. (M)
Loueks, Philip G. (A)
MacGregor, John J. (A)
Maddox, Charles H. (M)
Mates, T. Joaquin (A)
May, Albert (A)
McIlwraith, Chas. G. (A)
McKinley, Howard W. (A)
McNallan, Wilbur T. (A)
Mickey, Leroy (A)
Mirick, C. B. (M)
Moriarty, James F. (M)
Moulton, Theo. S. (A)
Mulkey, Dwight L. (A)
Murphy, Wm. H. (M)
Nair, W. Earl (A)
Norton, Kenneth A. (A)
Ould, Richard S. (A)
Page, Robert M. (A)
Pierce, James F. (A)
Pollock, Harry B. (A)
Powell, Edwin L. (M)
Reymer, Stephen E. (A)
Reynolds, W. W. (A)
Rietzke, Eugene H. (M)
Ring, Andrew D. (A)
Rittenhouse, Jos. P. (A)
Rohrich, George J. (A)
Seaton, Stuart L. (A)
Segal, Paul M. (M)
Smith, David H. (A)
Smith, James E. (M)
Sprayberry, Frank L. (A)
Squier, George O. (F)
Stahl, Barton E. (A)
Starbuck, W. D. L. (M)
Stevens, Waldo W. (A)
Stewart, Jessica Dee (M)
Stewart, Ralph B. (M)
Stoner, Frank E. (A)
Terrell, W. D. (F)
Weber, Carl F. (A)
Webster, E. M. (A)
Whitten, Leslie H. (A)
Willoughby, John A. (M)
Wiseman, William W. (A)
Wright, J. Warren (A)
Young, Leo C. (M)
Zandonini, Elizabeth M. (A)
Zeigler, T. W. (A)

FLORIDA

Avon Park
Smith, C. Ravenhill (A)

Clearwater
Mitchell, Joseph H. (A)

Hialeah
Allston, William F. (A)
Angle, G. B. (A)
Corrigan, C. J. (A)
Rowan, F. C. (A)

Jacksonville
Cooper, John C., Jr. (A)
Weiss, Glover (A)

Key West
Tellman, Herbert A. (A)

Lake Worth
Lord, Wilfred F. (J)

Large
Wittstruck, Harold H. (A)

Miami
Adams, George G. (A)
Borton, F. W. (A)
Gilbert, John C. (A)
McKinney, Joe H. (A)
Sullinger, Ferris W. (A)
Traeger, Sam H. (A)

Miami Beach
Dutton, Laurence E. (A)
Scott, Milton C., Jr. (A)
Sherwood, Lesle F. (A)

Miami Springs
Winter, Chas. W., Jr. (A)

Opa Locka
Meggers, A. L. (A)

Orange County
Wood, Edwin T. (A)

Orlando
Green, Chas. M., Jr. (A)

Ortega
Baukat, Henry W. (M)

Palatka
Peterson, Ted R. (A)

Pensacola
Harrower, J. C. (A)
Taylor, Francis Wm. (A)

St. Petersburg
Fill, John V. (J)
Green, Albert A. (A)
Johnson, Carl C. (A)
Link, Louis J. (A)
Lynn, Wallace L. (A)
Napper, Charles J. (A)
Preece, Richard, Jr. (A)

South Jacksonville
Grange, Gifford (A)

Tampa
Moore, William P. (A)
Reynolds, Frank J. (A)
Sandifer, Norwood H. (J)
Skelton, Kenneth W. (A)
Weaver, Henry Ray (A)

GEORGIA

Atlanta
Barker, Howard J. (J)
Brewin, Robert R. (A)
Clemans, Hershel L. (A)
Cochrane, Melvin R. (A)
Cook, J. M. (A)
Daugherty, C. F. (A)
Dobbs, Harry F. (A)
Gardberg, Joseph (A)

GEORGIA (Continued)

Gray, Floyd E. (A)
 Holey, Walter J. (A)
 Holliday, F. S. (A)
 King, Seaborn O., Jr. (A)
 MacNaughton, A. K. (A)
 Maier, Oscar C. (A)
 Petterson, Junior (A)
 Reid, Henry L. (A)
 Rothenberger, William L. (A)
 Sartain, L. B., Jr. (A)
 Thornton, Henry P. (A)
 Tompkins, K. P. (A)
 Wills, Harry L. (M)
 Wymore-Spiel, Ivy J. (A)
 Avondale Estates
 Bangs, Philip C. (A)
 Cedartown
 Burke, Jas. M., Jr. (J)
 Commerce
 Hood, Sam (J)
 Decatur
 McCorvey, Avis (A)
 Hapeville
 Laker, Edwin F. (A)
 Macon
 Breedlove, Bernard H. (A)
 Marietta
 Loucks, Ivan H. (A)
 Royston
 Berryman, Forrest G. (A)
 Savannah
 Carlson, C. O. (J)
 Donovan, James R. (A)
 Statesboro
 Blitch, James D. (A)
 IDAHO
 American Falls
 Brose, Fred O. (A)
 Boise
 De Remer, C. W. (M)
 Holcomb, E. Russell (A)
 Grangeville
 Greene, Warren L. (A)
 Idaho Falls
 Provis, Jack (A)
 Moscow
 Kiebert, Martin P., Jr. (A)
 Pocatello
 Davis, Glenwood (A)
 Ritland, Hubert O. (A)
 Sandpoint
 Johnson, Oscar E. (A)
 Twin Falls
 Belleville, Logan (A)
 ILLINOIS
 Arlington Heights
 Hines, Albert D. (A)
 Beardstown
 Barregarye, Laurence H. (J)

Berwyn

Burns, Elmer E. (A)
 Durham, J. B. (A)
 Hawkins, John B. (A)
 Komm, Paul M. (A)
 Krueger, Alfred (A)
 Million, John W., Jr. (M)
 Schnell, William J. (A)
 Wilkinson, L. G. (A)
 Bloomington
 Lawton, Harvey B. (A)
 Stillhamer, Arthur G. (A)
 Blue Island
 Damm, George J., Jr. (A)
 Brookfield
 Courter, H. L. (A)
 Canton
 Ingersoll, Wm. P. (A)
 Champaign
 Fortner, Obed D. (A)
 Hollister, James B. (A)
 Fetterman, D. M. (A)
 Fischer, Andrew, Jr. (A)
 Fisher, Frank E. (A)
 Flick, A. A. (A)
 Forbes, Allan C. (M)
 Forsberg, Otto J. (A)
 Fortington, Wm. H. (M)
 Fox, John E. (A)
 Frankel, Mortimer (M)
 Freeman, Ernest H. (M)
 Freimann, Frank (A)
 Friday, Wilbur L. (A)
 Fritzel, Joseph (A)
 Gallagher, Daniel F. (A)
 Gay, Paul F. (A)
 Gill, William (A)
 Glassman, George (A)
 Glover, Ralph P. (A)
 Goldman, Stanley (A)
 Goltzen, J. N. (A)
 Graef, Henry H. (A)
 Gray, Kline (A)
 Gruskin, George (A)
 Gustafson, Melvin F. (A)
 Halligan, Wm. J. (A)
 Heusman, Robt. M. (A)
 Blom, Roy (A)
 Boes, W. W. (A)
 Bradshaw, Edwin (A)
 Braun, W. C. (A)
 Bridgman, Francis K. (A)
 Brittin, Frank L. (M)
 Bronson, G. E. (A)
 Burger, Emil S. (A)
 Burkwest, Leonard G. (A)
 Burns, Robert P. (A)
 Campbell, Robert H. (A)
 Canon, Hartman B. (A)
 Carney, Louis Paul (A)
 Carter, A. J. (M)
 Casciato, Dominick (A)
 Cassens, Fred Benj. (A)
 Chadwick, Ray E. (A)
 Chan, George S. (A)
 Cherne, Leo J. (A)
 Church, John F. (M)
 Clausing, Le Roy M. E. (A)
 Clough, Kendall (A)
 Cohen, Theodore (A)
 Cole, William K. (A)
 Courchene, Homer B. (A)
 Crosssett, Edward C. (A)

Cubert, Joseph R. (A)
 Cumming, George (A)
 Dalton, Robert E. (A)
 Deeley, Paul M. (M)
 De Forest, M. J. (A)
 Douglas, James M. (A)
 Du Buclet, Sidonio L. (A)
 Dudley, Beverly (A)
 Duncan, Don C. (A)
 Dutton, Glenn H. (A)
 Dymond, Clifton (A)
 Edelman, Phillip E. (A)
 Edwards, Charles (A)
 Eells, M. Merwin (A)
 Elam, David L. (A)
 Elliot, Philip T. (A)
 Ellis, Robt. Marcus (A)
 Eppstein, Ralph M. (A)
 Erwood, John (A)
 Esmaker, John B. (A)
 Estey, F. Clifford (A)
 Falknor, Frank B. (M)
 Fast, John E. (A)
 Fernandez, Dan T. (A)
 Fetterman, D. M. (A)
 Fischer, Andrew, Jr. (A)
 Fisher, Frank E. (A)
 Flick, A. A. (A)
 Forbes, Allan C. (M)
 Forsberg, Otto J. (A)
 Fortington, Wm. H. (M)
 Fox, John E. (A)
 Frankel, Mortimer (M)
 Freeman, Ernest H. (M)
 Freimann, Frank (A)
 Friday, Wilbur L. (A)
 Fritzel, Joseph (A)
 Gallagher, Daniel F. (A)
 Gay, Paul F. (A)
 Gill, William (A)
 Glassman, George (A)
 Glover, Ralph P. (A)
 Goldman, Stanley (A)
 Goltzen, J. N. (A)
 Graef, Henry H. (A)
 Gray, Kline (A)
 Gruskin, George (A)
 Gustafson, Melvin F. (A)
 Halligan, Wm. J. (A)
 Heusman, Robt. M. (A)
 Blom, Roy (A)
 Boes, W. W. (A)
 Bradshaw, Edwin (A)
 Braun, W. C. (A)
 Bridgman, Francis K. (A)
 Hauser, Albert (A)
 Hayes, H. D. (M)
 Helman, Rolf A. (A)
 Hill, James H. (A)
 Hillegas-Baird, L. S. (A)
 Hitzzenhammer, A. De V. (A)
 Hoag, J. Barton (M)
 Holm, Edward A. (A)
 Holmquist, Carl T. (A)
 Holst, Wendell L. (M)
 Hoover, Richard T. (A)
 Howard, C. M. (M)
 Huffman, Kenneth C. (A)
 Hume, J. Malcolm (A)
 Isenberg, Rudolph (A)
 Israel, Dorman D. (M)
 Izenstark, Maurice J. (A)
 Jacob, Frederick N. (A)
 Jelen, Matt J. (A)
 Jenkins, J. Elliott (M)
 Jensen, Peter L. (A)
 Johnson, E. O. (A)
 Johnson, Leslie E. (A)

ILLINOIS (Continued)

Johnston, Ivan F. (A)
 Kara, Alexander R. (A)
 Karpuk, A. S. (A)
 Kayner, Harry J. (A)
 Keim, Jacob A. (A)
 Kelly, Earl L. (A)
 Kelsey, Elizabeth L. (A)
 Kempf, Frank J. (A)
 Keogh, Raymond J. (A)
 Kester, Arthur S. (A)
 Knouf, Ralph J. (A)
 Knowles, Hugh S. (A)
 Koch, Earl L. (A)
 Kohler, E., Jr. (A)
 Kolar, Edward F. (A)
 Koutnik, J. A. (A)
 Kramer, Andrew W. (A)
 Lagasse, Albert (A)
 Lamb, Harold A. (A)
 Lanterman, Walter F. (A)
 Larson, John M. (A)
 Lazar, Joseph H. (A)
 Lehnert, Frank H. (A)
 Leidy, W. J. (A)
 Levin, Sam (A)
 Lewis, John H., Jr. (A)
 Liebhart, Glenn R. (J)
 Limberg, R. A. (A)
 Lorch, George H. (A)
 Lotter, John G. (A)
 Lutgens, Howard C. (A)
 Mack, George (A)
 Magos, John P. (A)
 Marco, Frederick J. (M)
 Marshall, Charles E. (A)
 Martens, Ray L. (A)
 Martin, E. F. (A)
 McCarthy, F. M. (A)
 McGregor, Arthur M. (A)
 McJilton, De Witt (A)
 McMaster, A. J. (A)
 Mead, Leo R. (A)
 Meinhard, Herman (A)
 Michael, Charles (A)
 Michalowicz, Leon V. (A)
 Michelis, Rudolph P. (A)
 Miles, William E. (A)
 Miller, Donald H. (A)
 Miller, Paul E. (A)
 Mills, Elmer E. (A)
 Mills, Vern D. (A)
 Minnium, Byron B. (A)
 Moore, James S. (A)
 Morey, W. J. (A)
 Morris, Carleton D. (M)
 Morris, John F. (A)
 Mueller, Eugene L. (A)
 Muirhead, John E. (A)
 Nichols, Dwight O. (A)
 Nordhaus, Chas. H. (A)
 Nourse, Philip R. (A)
 Novak, Joe J. (A)
 O'Brien, William J. (A)
 O'Byrne, Leo C. (A)
 O'Callaghan, Jerome J. (A)
 Ostrand, Ansel G. (A)
 Owens, Robert F. (A)
 Oxner, Edwin K. (A)
 Paelig, Theodore H. (A)
 Parisek, Edward E. (A)
 Passow, Edward B. (A)
 Patterson, Joseph A. (A)
 Paul, Geo. Stewart (A)
 Peckoshi, Antone J. (A)
 Perrotta, Dominic (A)
 Petersen, Howard E. (A)
 Petzing, Erwin W. (A)
 Pew, Richard K. (A)
 Pickett, C. E. (A)
 Pletka, James (A)
 Plotts, Ellery L. (A)
 Polydoroff, W. J. (M)
 Pope, Fiore J. (A)
 Prentiss, John G. (A)
 Quist, William G. (A)
 Rafferty, Frank A. (M)
 Ramm, Carl H. (A)
 Randall, Harris K. (A)
 Reed, Clifford J. (A)
 Reesor, Delbert A. (A)
 Remde, Jack (A)
 Reynolds, George E. (A)
 Rice, Robert E. (A)
 Riddel, O. A. (A)
 Rodriguez, Alexander E. (A)
 Rose, Joseph K. (A)
 Ross, Kenneth B. (A)
 Roth, Jesse E. (A)
 Rowe, Thomas L. (A)
 Royal, Roscoe (A)
 Ruskin, Henry (A)
 Ruszkiewicz, Leo (A)
 St. James, Roscoe T. (M)
 Schaefer, Harold W. (J)
 Schaper, William A. (A)
 Scherer, Geo. H., Jr. (A)
 Schnell, F. H. (M)
 Schoenwolf, Fred L. (M)
 Schor, F. W. (A)
 Schrader, Wm. A. (A)
 Schreyer, T. E. (A)
 Schuster, Amos M. (A)
 Sear, Arthur W. (A)
 Shanafelt, Lysle O. (A)
 Shaw, Robert E. (A)
 Sherk, Lynn E. (A)
 Shmied, Ernest A. (A)
 Shultise, Quido M. (A)
 Sieben, Clarence M. (A)
 Silver, McMurdo (A)
 Siovic, John E. (A)
 Sloan, Francis V. (M)
 Smith, Ernest F. (M)
 Smith, H. M. (A)
 Smith, Paul S. (A)
 Smythe, Edwin H. (M)
 Sorenson, Carl P. (A)
 Stadler, Robert (J)
 Stewart, Arthur C. (A)
 Stone, Carrington H. (M)
 Stukey, L. I. (A)
 Swisher, O. V. (A)
 Taggart, Samuel E. (A)
 Ten Cate, Arthur C. (A)
 Thinegan, E. H. (A)
 Thomas, Chas. F., Jr. (A)
 Thorsen, Orville T. (A)
 Thrun, Arthur G. (A)
 Tilden, Mearl W. (A)
 Timmings, Geo. H. (A)
 Tittle, Hulbert C. (A)
 Trefry, Lawrence D. (A)
 Tulauskas, Leonard (A)
 Turner, George S. (M)
 Turner, Harry E. (A)
 Van Sichel, R. E. (A)
 Victoreen, Chas. J. (M)
 Vittellaro, Frank L. (A)
 Walgren, C. A. (A)
 Wallin, Harry E. (A)
 Wann, Richard H. (A)
 Wegner, Chas. W. (A)
 Wiegrefe, Elmer J. (A)
 Wilcox, G. M. (M)
 Willet, G. Rush (A)
 Williamson, F. E. (A)

Wilm, Carl F. (A)
 Wilson, Charles McC., Jr. (A)
 Woods, A. A. (A)
 Woodward, Clarence H. (A)
 Yoder, Raymond S. (A)
 Cicero
 Kailus, Peter C. (A)
 Decatur
 Songer, Clyde K. (A)
 Deerfield
 Carment, James M. (A)
 De Kalb
 Clark, Bayard H. (A)
 Downers Grove
 Allen, Justus (A)
 Johnson, Arthur R. (A)
 McDonnell, Walter J. (A)
 Moffet, I. C. Roy, Jr. (A)
 Vance, H. C. (M)
 East St. Louis
 Reiss, Paul E. (A)
 Elgin
 Kadow, A. C. (A)
 Meyers, Carl J. (A)
 Elmhurst
 Hercher, F. J. (A)
 Kennedy, Edward J. (A)
 Kranz, Herman E. (M)
 Landon, Vernon D. (M)
 Lindsay, Walter R. (A)
 Walter, L. B. (A)
 Evanston
 Butow, Alvin J. (A)
 Christopherson, Frederick (A)
 Clarke, R. E. (A)
 Fisk, Lawrence S. (A)
 Stein, Harold A. (A)
 Forest Park
 Ewald, Fred J., Jr. (A)
 Shabino, Clarke L. (A)
 Freeport
 Meyer, Winston F. (A)
 Nestlerode, Boyd W. (A)
 O'Connell, Gerald (A)
 Galesburg
 Sprague, Barbara R. (J)
 Geneva
 Anderson, C. Albin (A)
 McIlvaine, Oran T. (M)
 Glencoe
 Marsh, Carlton H. (A)
 Glen Ellyn
 MacCoanack, Edwin A. (A)
 Pieri, Donald (M)
 Glenview
 Little, De Motte H. (A)
 Harrisburg
 Schonert, K. E. (A)
 Tate, Joseph R. (A)
 Highland Park
 Rolfeison, Karl E. (M)
 Tucker, G. Lloyd (A)
 Hinsdale
 Armstrong, H. M. (A)
 Browne, Theo. C. (M)
 Doyle, E. J. (A)
 Hill, Frederick A. (A)
 Tours, F. B. (A)
 Kenilworth
 Lahman, Wilford C. (A)

ILLINOIS (Continued)

Kewanee
Larson, Clifford L. (A)

La Grange
Beckley, John G. (A)
Engst, Norbert K. (A)
Hofert, Fred A. (A)

Lake Bluff
Olesen, Harold L. (M)

La Salle
Olinger, Robert (A)
Strout, Everett M. (A)

Litchfield
Weller, Earl Selwyn (J)

Lockport
Carter, O. M. (A)

Lombard
Puhalski, Donald (A)

Macomb
Eller, Walter H. (M)
Snowden, P. T. (A)

Marion
Alley, Kenneth G. (A)

Maywood
Kamin, Vernon A. (A)
Teunisson, John F. (A)

Moline
Aymar, Erwin (A)

Mount Prospect
Gustafson, Gilbert E. (A)

Naperville
Stoos, Joseph A. (A)

Nokomis
Tickus, Louis J. (J)

North Chicago
Dady, Arthur O. (A)

Oak Park
Albee, Norman E. (A)
Augustine, Roy W. (M)
Bluzat, Claude R. (A)
Chase, Leslie H. (A)
Miller, John H. (M)
Nangle, W. O. (A)
Pearson, Oscar A. (M)
Pye, Harold C. (A)
Roe, Douglas J. (A)
Sveen, Erwing A. (A)
Willing, William P. (A)
Woodruff, Albert E. (A)

Park Ridge
Butterfield, Roy O., Jr. (A)
Carr, J. O. (A)
Potter, M. L. (A)
Van Nice, John H. (A)

Paw Paw
Braflet, Donald H. (A)

Pecatonica
Van Antwerp, Max C. (A)

Pekin
McGarvey, Harold R. (A)

Peoria
Janssen, John F. (A)
Shalkhauser, Eric G. (M)
Snyder, Roy A. (A)

Quincy
Wilson, A. J. (A)

Rankin
Denton, Frank O. (A)

Rantoul
Allen, Forrest G. (A)

Arnold, Thomas E. (A)
Marriner, Alfred W. (A)
Reeves, David (A)
Richard, Chas. W. (M)

River Forest
Edwards, Geo. W. (A)

Riverside
Wills, David C. (A)

Rockford
Ferdinand, Harry P. (A)
Devine, William F. (A)
Hand, Carl A. (A)
Kalin, Albert (A)
Ward, Lloyd S. (A)
Westlund, J. V. (A)

Rock Island
Foley, Jack (J)
Palmer, Pierre S. (A)
Pierce, Franklin W. (A)
Stanley, Otis J. (A)

St. Charles
Baird, Robert E. (A)
Shotwell, Harold H. (A)
Voorhaar, F. R. (A)
Weibler, Carleton T. (A)

Savanna
Graham, George W. (A)

South Chicago
Kahn, Lamos (A)
Turner, Russel S. (A)

Springfield
Holtz, Frederick C. (A)
Kunz, H. L. (A)
Numrick, Fred (A)
Parish, Eugene V. (A)
Ring, Edward F. (A)
Whannel, R. L. (A)

Stockton
Hanson, Ralph L. (A)

Streator
Licht, Henry M. (A)

Sycamore
Boynnton, F. L. (A)

Tuscola
Moulden, Roy B. (A)
Spies, Marck C. (A)

Urbana
Abel, Adam E., Jr. (A)
Brown, Hugh A. (M)
Chapman, David E. (J)
Knipp, Charles T. (M)
Morris, Lloyd P. (A)
Reich, Herbert J. (A)
Tykociner, J. T. (M)

Villa Park
Jacker, Edward W. (A)

Waukegan
Cameron, Henry L., Jr. (A)
Herrmann, Albert, Jr. (J)
Weeks, Robert H. (A)

Western Springs
Detrick, Harold M. (A)
Pomy, Herman J. (A)
Scott, Kenneth L. (A)

West Liberty
Waddell, George G. (A)

Wheaton
Matthews, Geo. D. (A)
Roman, Frank E. (J)
Taylor, Hawley O. (M)

Wilmette
Burrows, Fred A. (A)

Howard, Austin A. (M)
Manly, Harold P. (A)
Orner, Ralph J. (A)
Wolcott, C. F. (A)

Winnetka
Gregory, Charlotte C. (A)
Hinson, Marcus W. (A)
Mooney, Raymond (A)

INDIANA

Albion
Evans, Harry R. (A)

Anderson
McKee, Addison L. (A)
Miller, Louis (A)
Wend, Clyde G. (A)

Angola
Johnson, H. Frank (A)
Lemkin, Harold J. (A)

Aurora
Achatz, Raymond V. (A)

Bloomington
Hershman, J. B. (A)
Ramsey, R. R. (M)

Crown Point
Hall, Fred F. (A)

Elkhart
Haselwood, W. E. (A)
May, Frank Darrell (A)
Shellenger, N. C. (A)

Evansville
Moutoux, Edwin G. (A)
Norwood, Vandle C. (A)
Rowland, Stirman (A)
Travis, Francis E. (A)

Fort Wayne
Campbell, Winiferd H. (A)
Cook, Edward H. (A)
Dempster, Burgess (A)
Fischer, Fred W. (A)
Jones, Richard B. (A)
Kranz, F. W. (A)
Ratts, Bruce H. (A)
Rekart, Arthur F. (A)
Schryver, Henry A. (A)
Wise, Clarence E. (A)

Gary
Gunther, W. J. (A)
Molony, John D. (A)

Goshen
Rieth, Harold (A)

Hobart
Barnes, Harry C. (J)

Indianapolis
Albershardt, Milton (A)
Barnett, Louis W. (A)
Dutton, Charles E. (A)
Garstang, Wm. W. (A)
Guthell, Charles M. (A)
Manchester, R. M. (A)
Reager, A. M. (A)

Kokomo
Dawson, Francis A. (A)

Lafayette
Stafford, J. W. (M)
West, Glenn Edwin (M)

Linnsburg
Doyel, Lee Conan (A)

Marion
Boji, Louis D. (A)
Emerson, Kenneth H. (A)
Foster, Dudley E. (A)

INDIANA (Continued)

Herrold, George V. (A)
Jarvis, Kenneth W. (M)
Pressley, Jackson H. (F)

Monroeville
Hoffman, Walter H. (A)

Morocco
Davis, Edmonston J. (A)

Oakland City
Harper, Everett L. (J)

Parker
Clark, Lee B. (A)

Princeton
McConnell, Roy E. (A)

Richmond
Worley, Jacob M. (A)

Rushville
Cox, Wallace (A)
Russell, Merwyn A. (A)

South Bend
Bouchard, I. H. (A)
Crockett, David R. (A)
Gebhardt, Paul B. (A)
Heimberger, Albert E. (A)
Henry, Charles C. (A)
Kahn, Albert R. (A)
Kennedy, James P. (A)
McNamee, B. F. (A)
Uleman, Turrell (J)

Sweetser
Myers, Delbert (A)

Terre Haute
Hunter, Theo. A. (A)

Tipton
Gaiser, Martin (J)

Valparaiso
Briggs, Lawrence W. (A)
Bringhurst, Elden S. (A)
Cummings, Wilbur H. (A)
Leigh, Charles W. (A)
Packman, M. E. (A)
Penhale, Arthur (A)
Wood, Leonard C. (A)

Wabash
Freeman, Stephen, Jr. (A)

Westfield
Brown, Wilfred E. (A)

West Lafayette
Barragan, Milo B. (A)
Tanke, Harold F. (A)
Yoder, Leo E. (A)

IOWA

Adair
Williams, Gerald R. (A)

Ames
Andersen, Donald (J)
Lewis, John R. (J)

Cedar Rapids
Collins, Arthur A. (J)
Fink, Jack (A)
Hajny, George F. (A)
Martz, Forrest W. (J)

Clarinda
Whitnah, R. B. (J)

Council Bluffs
Fisher, H. R. (A)

Davenport
Ehlers, Paul (A)
Elliott, Frank W. (A)
Snyder, Reed E. (A)

Speers, John C. (A)
Stauffer, Ray E. (A)
Wildman, Thos. S. (A)

Des Moines
Anderson, J. Sumner (A)
Haigh, M. C. (A)
Hoselton, Frank B. (A)
Hutchison, Sam T. (A)
Peavey, Everett A. (J)

De Witt
Martin, Ray L. (A)

Diagonal
McCartney, Max (A)

Douds
Greenfield, Daniel C. (J)

Eatherville
Center, Edgar R. (A)

Fort Dodge
Willits, Andrew A. (A)

Iowa City
Griffith, Paul E. (A)
O'Brien, Elwin J. (A)
Potter, James L. (A)

Mason City
Strandjord, Millard F. (A)

McGregor
Woods, T. De Witt (A)

Monticello
Burrichter, Donald E. (J)

Oakdale
Crozier, W. D. (A)

Onslow
Koon, Cecil L. (A)

Shenandoah
Coonley, F. A. W. (A)
Rapp, John Cyril (A)

Sioux City
Coates, Frank M. (A)
Morris, Thomas J. (A)

Wapello
Fry, Lloyd L. (A)

Waterloo
Wilcox, Nathan (A)

KANSAS

Abilene
Brewer, Noble E. (A)

Arkansas City
Sigler, F. M. (A)

Atchison
Moore, Eugene A. (A)

Ellis
Harrison, Louis A. (A)

Emporia
Miller, R. F. (A)

Fort Scott
Hess, Howard H. (A)

Independence
Elliott, Ralph W. (A)

Iola
Major, A. R. (A)

Kansas City
Francis Thomas L. (A)

Lawrence
Omer, Guy C., Jr. (J)
Wheeler, Frederick (J)

Leavenworth
Hageman, Oliver C. (A)

Manhattan
Allen, John H. (J)

Bueche, Harry S. (A)
Compton, Robin D. (A)
Delamater, Frank A. (J)
Whan, Loren H., Jr. (A)

Milford
Pyle, Kempster W. (A)

Salina
Webster, Glenn E. (A)

Topeka
Beasley, William A. (A)
Cook, John W. (A)
McFarland, Wm. F. (A)
Troeglen, Karl, Jr. (A)

Wichita
Byers, Harrison O. (A)
Demuth, G. W. (J)
Marshall, George E. (A)
Mitchell, G. A. (A)
Mitchell, Theo. R. (A)
Newman, Wilbur C. (A)

Winfield
Baden, Martin W. (A)

KENTUCKY

Ashland
Carr, Edward M. (A)

Covington
Bryant, William (A)
Heffernan, S. K. (A)
Reid, Ralph J. (A)

Hopkinsville
Grimwood, Fred O. (A)

Lexington
McCammon, Donald (A)
Tillett, Jesse (A)

Louisville
Graft, J. Emmet (A)

Newport
Kolo, R. E. (A)
Richards, Amyle P. (A)
Willard, Walter C. (A)

Owensboro
Bain, George W. (A)
River, Carl J. (A)
Field, Robert W. (A)
Kirk, Walter C. (A)
Koechel, W. P. (A)
Waugh, George T. (A)

Paducah
Shelton, R. W. (A)
Sims, Cloyd G. (A)

Winchester
Walker, Frank (A)

LOUISIANA

Baton Rouge
Carleton, Thomas F. (A)
Lurry, Thomas M. (A)
McCarroll, Geo. M. (A)
Webre, Andrew S. (A)

Lake Charles
Lake, Thornton G. (J)

Monroe
Mask, Winfred B. (A)

New Orleans
Adler, Leonard E. (A)
Chateau, Arthur (A)
Christy, Edmund H. (A)
Clemmons, Wallace A. (A)
Collins, John F. (A)
Courtenay, Justin A. (A)
Deiler, Theodore G. (M)

LOUISIANA (Continued)

du Treil, L. J. N. (M)
 Gallo, Louis J. (M)
 Goldstein, Henry R. (A)
 Hart, M. E. (A)
 Hilgedick, W. C. (A)
 Hymel, L. F. (A)
 Jones, Edward T. (M)
 Jordan, Chester H. (A)
 Lehde, Pendleton E. (F)
 Long, Edwin G. (A)
 Macke, William (A)
 Mater, Otto T. (A)
 McCabe, Louis L. (A)
 Moore, Frank C. (A)
 Pasquet, Jean E. (A)
 Peirce, George H. (A)
 Peters, C. W. (A)
 Salzer, H. S. (A)
 Salzer, Herman M. (A)
 Scheffer, Roy J. (A)
 Schiele, Anton A. (A)
 Stevens, William J. (A)
 Voegtlin, Elmo (A)

Shreveport
 Claycomb, Hugh (A)
 Temple, John M. (A)

MAINE

Bangor
 Gustin, Richard W. (A)
 Hertz, Leslie C. (A)
 Kellom, Bernard (A)
 Mullaney, John R. (A)
 Spates, James L. (A)

Bar Harbor
 Tumlison, James F. (A)

Brunswick
 Little, Noel C. (A)

Houlton
 Thrush, Paul W. (A)
 Willes, Emerson T. (A)

Northeast Harbor
 Knowles, Jerome H., Jr. (A)

Orono
 Creamer, W. J., Jr. (A)

Portland
 Collins, Lewis R. (A)
 Rice, Harold E. (A)
 Ryall, Henry (J)
 Wallgren, Alric E. (A)

Rockland
 Fickett, Louis W. (A)

South Portland
 Cobb, Stanley W. (A)

Wells
 Littlefield, R. W. (A)

MARYLAND

Aberdeen
 Brown, W. Craig (A)

Annapolis
 Howard, David G. (A)
 Giet, G. Robert (M)
 Kitchin, Howard W. (M)
 North, J. Harold (A)
 Robinson, Gordon D. (A)

Baltimore
 Allen, John E. (A)
 Allner, Frederick A. (A)
 Bassford, Sydney W., Jr. (A)
 Berman, Henry O. (A)
 Clark, Lloyd W. (A)

Cohen, Hyman A. (A)
 Collins, Laurence H. (A)
 Cooke, Gerald W. (A)
 Dudley, Charles B., Jr. (A)
 Eckels, August E. (A)
 Ellert, Charles A. (A)
 Fetsch, Jos. T., Jr. (A)
 Goldstein, Maxwell K. (A)
 Graf, Herman, Jr. (A)
 Hannah, George M. (A)
 Harris, Clifford C. (A)
 Herndon, Landon C. (M)
 Houston, G. Porter, III (A)
 Krebs, William N. (A)
 Lange, Edward H. (A)
 Mahone, George A. (A)
 Mathers, Earl S. (A)
 Miller, J. Purnell (A)
 Nopper, Carlton G. (A)
 Petersen, F. T. (A)
 Ranit, William Q. (A)
 Ridenour, Wm. S. (A)
 Rosso, Thomas (A)
 Schultz, James (A)
 Seitz, J. Fred (A)
 Sterling, George E. (M)
 Taylor, William E. (A)
 Vacek, George J. (A)

Bethesda

Rush, George P. (M)
 Hanson, Malcolm P. (M)

Chevy Chase

Brady, John B. (M)
 Dellinger, J. H. (F)
 Gross, Gerald C. (M)
 Kelley, Geo. W., Jr. (A)
 Walls, Hoy J. (M)
 Wells, Harry W. (A)
 White, Edwin L. (M)

Curtis Bay

Dillow, Arthur P. (A)

Edgewater

Robison, Samuel S. (F)

Hyattsville

Eisenhauer, Harry D. (A)

Lyon, Harry H. (A)

Linthicum Heights

Monteith, J. W. (A)

Salisbury

Perry, James E. (A)

Powell, Levin D. (A)

Silver Spring

Koehne, Ira C. (A)

Mertie, J. B., Jr. (A)

Quaintance, Leland C. (A)

Terrell, Robert L. (A)

Thomsen, Paul H. (A)

MASSACHUSETTS

Allston
 Becker, Carl Wm. (A)
 Cook, Wilbert H. (A)

Andover
 Morgan, Howard K. (A)

Arlington
 Benham, Harold J. (A)
 Morrison, E. J. W. (A)
 Shea, Richard F. (A)
 Lamson, Horatio W. (M)

Arlington Heights
 Dallin, Edwin B. (M)

Lamson, Horatio W. (M)

Ashmont
 Mullen, Joseph A. (A)

Atlantic
 Brown, George W. (A)
 Heap, Sheldon S. (A)
 Moses, John P. (A)

Auburndale
 Clapp, James K. (M)

Belmont
 Anthony, A. W., Jr. (A)
 Dolbear, Benj. L. (M)
 Gleason, Harold H. (A)
 Grant, Lawrence E. (A)
 Lane, Henry M. (M)
 Le Van, James D. (A)
 Newton, W. W. (A)

Beverly
 Appleton, Samuel (A)
 Colby, Edward B. (A)
 Engel, Francis H. (M)
 O'Neill, George D. (A)
 Porter, Roland G. (A)
 Woodbury, Stephen E. (A)

Boston
 Baird, Hollis S. (A)
 Baldwin, Frank H. (A)
 Baudino, Joseph E. (A)
 Bauer, Paul S. (A)
 Beakes, William E. (M)
 Black, Oliver M. (A)
 Boyden, Davis S. (A)
 Butt, Harvey R. (A)
 Cabot, George E. (M)
 Campbell, Donald W. (A)

Carson, Walter E. (A)
 Christides, Stratis C. (A)
 Chubb, William M. (A)
 Cumming, L. Gordon (A)
 De Mars, Paul A. (M)
 Emery, Ralph C. (A)
 Harris, C. C. (M)
 Haskins, Rupert L. (A)
 Hayes, Hammond V. (A)

Hurd, Volney D. (A)
 Mann, Hayward K. (A)
 Nunez, F. J. (A)
 Oliver, George E. (M)
 Parnagian, Aram (A)
 Pitts, Francis D. (A)
 Putnam, John P. (A)
 Rines, David (A)
 Rosenwald, Edwin D. (A)

Rothberg, Joseph (A)
 Stone, C. W. (A)
 Weston, Irving L. (A)

Bradford
 Knowlton, Robert G. (A)

Braintree
 Robinson, Philip F. (A)

Brighton
 Atwood, Ralph F. (A)
 McGaughey, P. C. (A)
 Wallace, Gordon S. (A)
 Yurt, F. X. (A)

Brockton
 Sampson, E. J. F. (J)

Brookline
 Cabot, Sewell (M)
 Fitts, Lincoln W. (A)
 Ready, William A. (A)

MASSACHUSETTS (Cont.)

Sampson, George L. (A)
 Weeks, Miles W. (A)

Cambridge
 Arnold, Prescott N. (A)
 Barrow, W. L. (A)
 Batchelder, Laurence (A)
 Bousquet, Arthur G. (A)
 Bowles, Edward L. (M)
 Burke, Charles T. (M)
 Chaffee, E. Leon (F)
 Crawford, John D. (A)
 Dawes, Howard H. (A)
 Eastham, Melville (F)
 Fahnestock, Harris, Jr. (A)

Gager, F. Malcolm (A)
 Garceau, Ernest L. (A)
 Herve, John P. (A)
 Hickman, Roger W. (A)
 Hisamoto, Masyauki (A)
 Hok, Gunnar (A)
 Horton, J. Warren (F)
 Hunt, Frederick V. (A)
 Ide, John M. (A)
 Jacobson, Larry (J)
 Jen, C. K. (A)
 Johnson, Montgomery H., Jr. (A)

Karplus, Eduard (A)
 Kear, Frank G. (M)
 Knelly, Arthur E. (F)
 McElroy, Paul K. (F)
 Mimno, Harry R. (A)
 Noyes, Atherton, Jr. (A)
 Phillips, Henry B. (M)
 Pierce, George W. (F)
 Pilkington, E. J. (A)
 Richmond, Harold B. (F)
 Spike, J. E., Jr. (A)
 Thessen, Arthur E. (M)
 Tucker, Carlton E. (A)
 Tuttle, William N. (A)
 Wang, Sherman R. (A)
 Wear, John (A)
 Weeks, Paul T. (M)
 Wildes, Karl L. (A)
 Woodrow, Jas. A. S. (A)
 Worthen, Chas. E. (A)

Chatham
 Robinson, Forrest D. (A)

Chestnut Hill
 Dellenbaugh, F. S., Jr. (M)

Chicopee Falls
 Davis, R. L. (A)
 Eldredge, Frank E. (M)
 Ellsworth, Wm. C. (A)
 Gough, John H. (A)
 Harlow, Fred G. (A)
 Kinsman, Warren D. (A)
 Laport, Edmund A. (M)
 Lee, Donald C. (A)
 Little, Donald G. (F)
 Miller, Harold R. (A)
 Moatz, Daniel R. (A)
 Mundie, Evan M. (J)

Cliftondale
 Tripp, Augustus B. (A)

Cohasset
 Gagnebin, Wm. B. (A)

Concord
 Hall, Henry D. (A)

Danvers
 Turenne, Wilfred J. (A)
 Walker, Charles M. (A)

Dennis Port
 Skinner, Oscar E. (A)

Dorchester

Barry, Francis J. (A)
 Berkowitz, Louis (J)
 Chessler, Maxwell A. (A)
 Clarke, Ralph S. (A)
 Feldman, Sarley M. (A)
 Freedman, John L. (A)
 Hardy, Carroll N. (A)
 O'Shea, Charles J. (A)
 Purssell, Clarence V. (A)

East Boston
 Surette, Dennis C. (A)

East Pepperell
 Hills, Eugene K. (J)

East Springfield
 Hurff, Joseph L. (A)
 Trigger, Vernon A. (A)

Everett
 Meredith, Wm. B. (A)
 Pratt, P. W. (A)
 Zwicker, Howard H. (A)

Fall River
 Bowen, Harold C. (A)
 Walsh, Philip S. (A)

Fitchburg
 Wiimikka, Arthur O. (J)

Framingham
 Forbes, Eugene D. (F)
 Macadam, Mark L. (A)

Gloucester
 Adams, John C. (A)
 Hammond, John Hays, Jr. (M)
 Hoyt, Edward C. (J)

Great Barrington
 Barkley, Howard F. (A)
 Parrish, Robert R. (A)

Hamilton
 Dane, Francis W. (M)

Haverhill
 Dyer, John Newton (J)
 Kochakian, Leo (A)

Hingham
 Phelps, Roger E. (A)
 Williams, Laurence P. (A)

Hingham Center
 Pratt, Fearing (A)

Holyoke
 Klemm, Robt. C., Jr. (A)

Hudson
 Groves, Ernest F. (A)

Hyannis
 Stanko, Edward (A)

Hyde Park
 Gould, Wm. B., III (A)

Jamaica Plain
 Canner, William (A)
 Hazard, Willis G. (A)
 Mayer, Arthur W. (A)

Lawrence
 Frank, Charles W. (A)
 Geloso, John (A)
 Maxwell, John F. (A)
 Montgomery, J. Leonard (A)

Lexington
 Bowker, Winthrop H. (A)
 Chute, Dudley H. (A)
 Johnson, Charles A. (A)

Lowell
 Martel, Charles W. (A)
 Morton, Clarence F. (A)

Lynn
 Abrahams, S. L. (A)
 Le Bel, C. J. (A)
 Mayo, Royal E. (A)
 Peckham, J. H. (A)

Malden
 Bacon, Dana H. (A)
 Millen, James (A)
 Worthley, Herbert O. (A)

Mansfield
 Dean, Leon W. (A)

Marion
 MacLean, Kenneth G. (A)
 Rau, David S. (A)

Mattapan
 Weber, Harold C. (A)

Medford
 Cook, Bernard L. (A)
 Wyman, R. C. (A)

Melrose
 Hubbard, Beverly R. (A)
 Jenson, Warren F. (A)
 Philbrick, Laurence S. (A)

Milford
 Corbett, Walter E. (A)

Milton
 Hoard, Norman F. (A)

Needham
 Keim, J. D. (A)

New Bedford
 Catterall, John (A)
 Hodgdon, Herbert J. (A)
 Vermilya, Irving (M)
 Wilson, Walter B. (A)

Newton
 Briggs, Thomas H., IV (A)
 Colby, Chas. C., Jr. (A)
 Nelson, James R. (M)
 Sivigny, Alfred J. (A)

Newton Center
 Miller, William T. (A)
 Pickard, Greenleaf W. (F)

North Adams
 Rickey, Lawrence (A)
 Steen, J. Ralph (A)

North Andover
 Lemieux, Charles J. (A)

North Attleboro
 Barret, Herman R. (A)

Northbridge
 Waite, Samuel A. (A)

North Weymouth
 Hollis, Hammond H. (A)
 Imlach, George (A)

Oak Bluffs
 Horne, William P. (A)

Osterville
 Chesbro, Albert L. (A)

Oxford
 Browning, Elliot A. (J)

Quincy
 Miller, Olin F., Jr. (A)

MASSACHUSETTS (Cont.)

- Nolan, James J. (M)
Renton, Ralph Jas. (A)
- Revere
Gelardi, Matthew (A)
- Rockport
Mills, William P. (A)
- Roslindale
Van Brocklin, William S. (A)
- Rowley
Hoopes, Thomas T. (A)
- Roxbury
Ashenden, G. K., Jr. (A)
Gerber, Nathan (A)
Giro, Daniel J. (A)
- Salem
Bolan, Robert S. (A)
Chagnon, M. L. (A)
Hamilton, Hugh, Jr. (A)
Leblanc, William A. (A)
Poor, Walter E. (A)
Porter, Ralph H. (A)
Rockwood, Alan C. (M)
- Siasconset
Holden, Harry H. (A)
- Silver Lake
Stein, Adam, Jr. (F)
- Somerville
Parker, Wm. H., Jr. (A)
Root, Leland B. (M)
- South Boston
O'Donnell, E. T. (A)
- South Braintree
Serreze, Victor C. (A)
- Southbridge
Wells, John M. (A)
- South Dartmouth
Chinn, Howard A. (A)
Hendricks, Paul S. (A)
Houghton, Henry G., Jr. (A)
- Springfield
Applegate, Homer E. (A)
Beard, J. Gregson (M)
Bock, Ashley P. (M)
Bond, M. E. (A)
Bowmaster, J. M. (A)
Boyd, Bruce (A)
Bruce, Birger (A)
Bruce, Ragnar (A)
Cameron, J. A. (A)
Cole, Neil D. (A)
Cotter, William F. (A)
Creaser, Isaiah (A)
Curtis, Leslie F. (M)
Cushing, T. Frank (A)
Der Bedrossyan, Mark (A)
French, Benedict V. K. (M)
Garvey, Edmond (A)
Gilliatt, Leland W. (A)
Greis, W. Karl (A)
Henderson, Ken L. (A)
Hewinson, Earl G. (A)
Holt, Hillis W. (A)
Hutcheson, John A. (M)
Kowalczyk, Wm. J. (A)
Lavallee, J. A. (M)
Madsen, Carl J. (A)
Nystrom, R. A. (A)
Raskhodoff, Nicholas (A)
Russ, George H. (A)
Stuckert, E. M. (A)
- Thomas, Harry E. (A)
Valentine, Francis B. (A)
Walker, C. L. (A)
Weber, C. A. M. (A)
- Stow
Kaulback, Harold D. (A)
- Swampscott
Humphrey, Stanley M. (A)
- Taunton
Tracy, John B., Jr. (A)
- Tufts College
Harrison, Jamison R. (A)
Kendrick, Gleason W. (M)
- Wakefield
Kindt, Mark (A)
- Waltham
Anderson, Homer G. (A)
Grenier, Henry N. (A)
- Watertown
Bareiss, Max (M)
Field, Robert F. (M)
- Wellesley
McDowell, Louise S. (M)
Russell, Robert D. (A)
Wilder, Marshall P. (A)
- Wellesley Farms
Hills, Chas. E., Jr. (A)
- West Millbury
Day, Ralph P. (A)
- Weston
Bent, Arthur E. (A)
- West Roxbury
Wolf, Edwin A. (A)
- West Somerville
Dillaby, Edwin F. (A)
Ekstrand, E. B. (A)
Kolster, Charles C. (M)
- West Springfield
Hallein, John, Jr. (A)
Sateren, M. G. (A)
- Williamstown
Clark, R. U. (A)
- Winchester
Allen, Albert (A)
Browning, Glenn H. (M)
Burgoyne, Roger M. (A)
Page, Newell C. (A)
- Wollaston
Greene, Lloyd C. (A)
Hoffman, E. F. (A)
McGrath, Jos. L. (A)
Sigmon, L. C. (A)
Waite, Amory H., Jr. (A)
- Woods Hole
Speirs, George E. (A)
- Worcester
Anderson, Paul E. (A)
Bates, Lee A. (A)
Cohen, Monte (A)
Gleason, Albert E. (A)
Godfrey, James S. (A)
Gruzin, Herman A. (J)
Hakam, Samuel (A)
Joseph, J. Bernard (A)
Newell, Hobart H. (M)

MICHIGAN

- Ann Arbor
Campbell, Geo. R. (A)
Chipman, Stuart E. (A)
Fuller, Lyman D. (A)

- Holland, Lewis N. (A)
Palmer, Edward D. (A)
Parkinson, Taintor (A)
Wilbur, Donald A. (A)
Williams, N. H. (A)
- Battle Creek
Doty, W. E. (A)
Fay, Lewis C. (A)
Roof, Raymond B. (A)
- Bay City
Carpenter, Ralph H. (A)
Thompson, Robt. W. (A)
- Bessemer
Faulh, William B. (A)
- Birmingham
Stahl, Theodore H. (A)
- Dearborn
Knight, Donald M. (A)
- Detroit
Adams, Richard A. (A)
Almas, Stan L. (A)
Baxter, Charles E. (A)
Bennett, Donald P. (A)
Blett, E. Barton (A)
Blumenthal, Raymond W. (A)
Bond, Orville J. (A)
Bradley, F. W. (A)
Brown, Jesse E. (M)
Buchanan, Arthur B. (A)
Byram, F. Cameron (A)
Carter, George W. (M)
Clark, Ralph L. (A)
Clark, Thomas E. (M)
Courtis, Reginald P. (A)
Davis, Chester (A)
Davis, Irving C. (A)
Densteadt, Edwin C. (A)
Evans, Richard C. (A)
Faulkner, Douglas (A)
Firestone, Samuel (A)
Friedenthal, Andrew (A)
Gasparovitch, Stephen (A)
Gildemeyer, F. H. (A)
Goldman, Sherman (A)
Green, Walter M. (A)
Griva, John (A)
Grote, Ernest A. (A)
Grove, George A. (A)
Haire, A. F. (A)
Harding, Lawrence M. (A)
Hoffman, Walter R. (A)
Howey, William J. (A)
Jackson, C. H. (A)
Joy, Henry B. (A)
Kaserman, Frank S. (A)
Kirby, Otto I. (A)
Kratokvil, Frank M. (A)
Lang, Louis B. (A)
Macellan, Colin P. (A)
Malo, Charles D. (A)
Manning, Stanley R. (A)
McCaffry, James A. (A)
Osborne, Robert L. (A)
Oubteen, Andrew N. (A)
Porter, Samuel (A)
Putnam, Erle T. (A)
Richie, S. M. (A)
Riemenbergh, C. Morgan (A)
Russ, John A. (A)
Scanlan, Richard J. (A)
Schmalzriedt, T. (A)
Seielstad, Harold (A)
Sellers, Jack D. (A)
Serge, Igor B. (M)
Seymour, Fred M. (A)

MICHIGAN (Continued)

- Sheridan, Russel J. (A)
Smith, Frank J. (A)
Stansfield, Selwyn (A)
Steinhauser, Clarence J. (A)
Stormzand, Harold A. (A)
Sturman, George G. (A)
Thomas, Walter J. (A)
Tomchuck, John (J)
Trittenbach, John M. P. (A)
Truesdale, James R. (A)
Waynick, Arthur H. (A)
Wendler, E. A. (A)
Worel, Frank (A)
- East Lansing
Murray, William A. (A)
Osborn, Burr K. (A)
- Fenton
Dobbs, F. W. (A)
- Flint
Blanford, Edwin C. (A)
Fallain, Frank D. (A)
Lathrop, F. A. (A)
Raab, Edwin (A)
- Frankfort
Hopper, C. L. (A)
- Gladstone
Peterson, W. Earl (A)
- Grand Rapids
Andres, Lloyd J. (A)
Goebel, Eugene S. (A)
Newland, Chas. W. (A)
- Grosse Pointe Park
Smith, Walter C. (A)
- Harbor Springs
Wright, Willford C. (J)
- Highland Park
Byerlay, H. Le Roy (A)
Collins, Frederick V. (A)
Glatzel, Earle D. (A)
Gould, Howard S. (A)
- Holland
Tysse, Henry L. (A)
- Jackson
Atkins, Carl Edward (J)
Bailey, Neil (A)
Gottier, Thomas L. (A)
Pacholke, Fred (A)
Planck, R. M. (A)
Rich, C. E. (A)
Riethmiller, Earl R. (A)
Volkenant, Gordon W. (A)
Ward, Donald H. (A)
Whitlock, Fred (A)
- Kalamazoo
Evans, Nicholas O. (A)
Fetzer, John E. (M)
Rector, Edwin W. (J)
- Lansing
Barnwell, Walter J. (A)
Graham, Herbert T. (A)
Wells, Lawrence V. (A)
Willis, Ellsworth D. (A)
- Lincoln Park
Moore, J. Burton (A)
- Ludington
Fenton, Kenneth G. (J)
Szabo, Paul (A)
- Manistee
Halliday, Lew R. (A)
- Menominee
Westervelt, H. P. (A)
- Midland
Mathison, Gerald (A)
- Mount Clemens
Sonnenberg, John H. (A)
Wendler, Erwin H., Jr. (A)
- Muskegon
Fonger, C. Irwin (A)
Hewitt, C. Tefft (A)
Lowe, Carr E. (A)
Schwarz, Harvey F. (A)
- Oxford
Capron, E. S. (A)
- Pontiac
Clark, Robert K. (A)
Stolzenbach, R. W. (A)
- Port Huron
Brown, Kenneth L. (A)
Fountain, J. Clarence (A)
- Royal Oak
Ludvigsen, Leonard E. (J)
- Sault Sainte Marie
Smith, Rex B. (A)
- Scottville
Krivitsky, George (A)
- South Haven
Arthur, Ralph L. (A)
Bennett, Maurice C. (A)
Crossley, Alfred (M)
Hansen, Leland S. (A)
Hollands, Louis C. (A)
Jorgenson, Harold (A)
- Williamston
Love, Bert E. (A)
- Ypsilanti
Augustus, Lee, M. (A)
- MINNESOTA
- Anoka
Collier, George X. M. (A)
- Baudette
Gjelhaug, John A. (A)
- Bemidji
Distad, Merrill (A)
- Carver
Olson, Marvin S. (A)
- Chisholm
Ambrozich, John L. (A)
- Duluth
Richelieu, C. C. (A)
Ross, Russell H. (A)
Wesanen, Theo. E. (A)
- Edgerton
Rust, Leslie W. (A)
- Hopkins
Fuxa, Albert E. (A)
- Lakefield
Tkach, George (A)
- Minneapolis
Braun, C. M. (A)
Brooke, Robert O. (J)
Carney, Philip G. (A)
Cooke, Lawrence S. (A)
Edwards, Henry W. (A)
Fleming, Myron N. (A)
Gibbs, Earl (A)
Grogan, Leslie E. (A)
Hawley, Douglass (A)
James, V. Norval (J)
Knox, Martin E. (A)
Lefebore, Ulric A. (A)
- Lisior, Donald J. (J)
Nergaard, Leon S. (A)
Roth, Harold B. (A)
Schnell, Louis J. (A)
Smeby, Lynne C. (A)
Sweeney, Claude D. (A)
Tynan, Thomas E. (A)
Webb, J. S. (A)
Young, Sumner B. (A)
- Northfield
Culver, Charles A. (M)
- Pipestone
Port, Clyde G. (A)
- Ponsford
Cox, Hector S. (J)
- Rochester
Biltz, Francis J. (A)
- St. Paul
Coil, Neil B. (A)
Hance, Kenneth M. (A)
Heiser, Edwin S. (A)
James, Clinton W. (A)
Parsons, J. B. (A)
Skifter, Hector R. (A)
Swendsen, Lyman G. (A)
- Virginia
Haata, Theodore (A)
- Waseca
Johnson, Edgar F. (A)
- MISSISSIPPI
- Cleveland
Gibbon, Quincy D. (A)
- Corinth
Essary, William M. (A)
- Fondren
George, Edward M. (A)
- Greenwood
Fausett, Floyd (A)
- Indianola
Johnson, Vivion A. (A)
- Jackson
Drake, Chester E. (A)
Myers, James A. (A)
- Kosciusko
Sowell, George O. (A)
- Meridian
Woodruff, B. H. (A)
- Mississippi City
Pecoul, F. A. (A)
- MISSOURI
- Cape Girardeau
Hirsch, Oscar C. (A)
- Clinton
Mitchem, Fred M. (A)
- Columbia
Lewis, Earl W. (A)
Selvidge, Harner (A)
- Cuba
Moss, Terry L. (A)
- Gallatin
Payne, Kenneth (A)
- Grant City
Eggers, Earl L. (A)
- Hannibal
Cox, T. Alfred (J)
- Hughesville
Rissler, Harold D. (A)
- Independence
Brennan, J. W. (A)
Church, Arthur B. (A)
Moler, A. R. (A)

- MISSOURI (Continued)**
Jefferson City
 Corwin, Willis P. (A)
 Fish, Clarence A. (A)
Kansas City
 Bradbury, G. V. (A)
 Cook, Ellis C. (A)
 Cook, Frank W. (A)
 Dodds, Leonard F. (A)
 Fouts, Avery L. (A)
 Goldenberg, Henry E. (A)
 Hodge, Albert Wm. (A)
 Jones, George I. (A)
 Joyce, Gilbert B. (J)
 Kent, James M. (A)
 MacDowell, Karl P. (A)
 McDonnell, Wm. I. (A)
 Obright, Alvin C. (A)
 Pitt, William (A)
 Schilling, John T. (A)
 Screechfield, R. M. (A)
 Sears, E. William (A)
 Turner, C. G. (A)
 Upham, Stuart W. (A)
 Van Gundy, Clarence (A)
 Wilcox, Jay V. (A)
 Wilson, Guy E. (A)
 Winchel, Henry T. (A)
 Wisegarver, Orton H. (A)
 Yates, Clarence C. (A)
 Young, Wm. M. K. (A)
Kearney
 Thomason, Marvin (A)
Kirksville
 Davis, Robert J. (A)
Ladonia
 Stevens, Chester (A)
Mendota
 Davis, Glen A. (A)
Nevada
 Kluth, Wm. J., Jr. (A)
Robertson
 Gray, Harold E. (M)
Rolla
 Frame, Floyd H. (A)
 Martin, J. Douglas, Jr. (J)
St. Joseph
 Abercrombie, Julius B. (A)
 Bauer, Fritz (A)
 Watts, Harold F. (A)
St. Louis
 Althoff, F. E. (A)
 Bergtold, A. L. (A)
 Browning, Roy H. (A)
 Bush, Walter S. (A)
 Ferris, Harry J. (A)
 Fillmore, Francis A. (A)
 Fowler, D. W. (A)
 Fritz, Harry R. (A)
 Goodberlet, Edward (A)
 Hicks, Herbert J. (A)
 Humphreys, Irl W. (A)
 Lauman, Louis F., Jr. (J)
 Mace, Roger D. (A)
 McDaniel, Otto S. (A)
 Nye, Earl C. (A)
 Pingree, Samuel J. (A)
 Proehl, Robert O. (A)
 Ramey, Palmer T. (A)
 Sampson, John C. (A)
 Schechter, Leo (A)
 Van Sickle, Geo. W. (A)
 Varney, Herbert G. (A)
 Walker, James H. (A)
 West, William H. (A)
 Woolley, W. C. (A)
 Zehr, Nicholas J. (A)
Springfield
 Larsen, John (A)
 Ward, G. Pearson (A)
University City
 Glasgow, Roy S. (M)
 Tevis, Graham L. (A)
Waldron
 Barker, L. T. (A)
MONTANA
Anaconda
 Antonich, Peter L. (A)
Bozeman
 Lamb, G. F. (A)
Butte
 Craney, E. B. (A)
 Cronter, Leslie E. (A)
Forsyth
 Pritchard, Charles A. (A)
 Roberson, Carl (A)
Havre
 Peters, Vern (A)
NEBRASKA
Alliance
 Sterling, M. F. (A)
Aurora
 Spencer, Albert H. (A)
Carleton
 Damm, Fred (A)
Clay Center
 Hertel, Roger H. (J)
 Swanson, Carl R. (A)
David City
 Thomas, J. C. (A)
Falls City
 Chesley, Arthur D. (A)
 Quigley, James H. (A)
Grand Island
 Anderson, Adolph (A)
 Ball, I. Dale (A)
 Edwards, S. W. (M)
 Jensen, George L. (A)
 Martin, Robert D. (A)
 Overton, George P. (A)
 Pickett, Harry D. (A)
 Rollins, George K. (A)
 Wolf, Benjamin (M)
 Wolf, Lester J. (A)
Howells
 Prucha, Ernest F. (A)
Lincoln
 Brackett, Richard T. (A)
 Harvey, H. C. (A)
 Jensen, John C. (M)
 Jensen, Robert R. (J)
 Kimberly, Harbert D. (A)
 Koch, J. Wesley (J)
 Leeman, Wilson (A)
 Norris, Ferris W. (A)
 Schultz, Harvey R. (A)
Norfolk
 Tyler, Kenneth G. (A)
North Platte
 Flebbe, Walter E. (A)
 Spencer, Herbert L. (A)
Omaha
 Badgerow, Bert E. (A)
 Crawford, J. B. (A)
 Diehl, Charles B. (A)
 Henry, Gordon I. (J)
 Herold, Joseph L. (A)
 Kotera, William J. (A)
 Laycock, Richard F. (A)
 Shirik, Kenneth C. (A)
 Stratman, Fred W. (J)
 Veverka, R. E. (A)
Scottsbluff
 Kluge, Myron E. (J)
Wahoo
 Anderson, Roland A. (A)
York
 Meyer, Albert (A)
NEVADA
Reno
 Sandorf, Irving J. (A)
NEW HAMPSHIRE
Claremont
 Hodge, V. W. (A)
Concord
 Evans, Carl B. (J)
 Holmes, Arnold (A)
Exeter
 Shaw, Henry S. (M)
Gorham
 Dodge, Joseph B. (A)
Manchester
 Ryan, M. John (A)
Northwood Ridge
 Gray, Alfred R. (A)
Portsmouth
 Martin, Julius (M)
Sunapee
 Graves, William S. (A)
Tilton
 Booth, Howard M. (M)
Woodsville
 Enderle, Jackson J. (A)
NEW JERSEY
Allenhurst
 Hickley, Thomas J. (A)
Alwood
 Hoffman, Henry J. (A)
Ampere
 Cassell, Joseph L. (A)
 Goshaw, Irl R. (A)
 Harris, Charles S. (A)
 Hund, August (F)
 Powers, Walter P. (M)
 Solomon, S. (A)
 Walter, John C. (A)
Asbury Park
 Honnell, Pierre M. (A)
Atlantic City
 Flett, William J. (A)
 Helmuth, Charles F. (A)
Audubon
 Creighton, Robt. R. (A)
 De Haven, Thos. V. (A)
 Dutton, Watson P. (A)
 Dyson, H. R. (A)
 Fisher, Norman (A)
 Geyh, Charles P. (A)
 Lehman, James N. (A)
 Manwiller, W. Guy (A)
 Pettengill, George W., Jr. (A)
 Pierson, Israel S. (A)
 Risinger, Paul (A)
 Steers, W. F. (A)
 Wallace, Martin J. (A)

- NEW JERSEY (Continued)**
Bayonne
 Richards, Paul (A)
Belleville
 Brigham, Cecil E. (M)
 Katzen, Morris (A)
Bloomfield
 Banks, Charles R. (A)
 Beidleman, Howard B. (A)
 Born, W. Theodore (A)
 Boyson, Carl V. (A)
 Caughey, Wm. K. (A)
 Cox, Alfred (A)
 Cunliffe, Paul R. (A)
 Dingley, E. N., Jr. (A)
 Haines, Donald G. (A)
 Hall, Norman C. (A)
 Hanson, Ernest R. (A)
 Henry, T. J. (A)
 Hoffman, W. Hollis (A)
 Hussey, Luther W. (A)
 Isler, Samuel (M)
 Kannenstine, Fabian M. (A)
 McClary, James P. (A)
 Mitchell, Clair D. (M)
 Peck, Gordon V. (A)
 Perkins, Wm. M. (M)
 Schoene, Russell L. (M)
 Slattery, John J. (A)
 Taber, William T. (A)
 Weaver, Karl S. (A)
 Widell, E. Gideon (M)
 Yarmack, John E. (A)
 Zimmer, Raymond M. (A)
Bogota
 Gilcher, V. J. (A)
 Oscanyan, Paul C., Jr. (A)
 Potts, John H. (A)
Boonton
 Albert, William H. (A)
 Ballantine, Stuart (F)
 Cobb, Howard L. (A)
 Coriell, Peter C. (A)
 Drake, F. H. (M)
 Ferris, Malcolm (M)
 Haas, John G. (A)
 Hughes, Everett J. (A)
 Hull, L. M. (F)
 Loughlin, Wm. D. (M)
 Morrison, John F. (A)
 Parkes, A. W., Jr. (A)
 Pittenger, Arthur W. (A)
 Seabury, Richard W. (M)
 Snow, Harold A. (A)
 Stone, G. Edgar (A)
Bound Brook
 Gullans, John H. (A)
 Haggmann, Nicklaus (A)
 Lindstrom, Arthur J. (A)
 Stair, Daniel N. (A)
Bridgeton
 Nichols, H. L. (A)
Brooklawn
 Uhlig, Erich (A)
Caldwell
 Cole, Arthur B. (M)
 Eberhard, Lawrence E. (A)
 Hotopp, Alfred H., Jr. (M)
 Merrill, Henry M. (A)
 Winans, Roswell R. (A)
Camden
 Ackerman, Milton J. (A)
 Anderson, Pierson A. (M)
 Artz, T. Maurice (A)
 Baker, W. R. G. (F)
 Barton, Fred C. (A)
 Bloomenthal, Sidney (A)
 Bokovoy, Sam A. (A)
 Boucheron, Pierre H. (M)
 Brail, Stephen L. (A)
 Burnison, James W. (A)
 Carlson, Wendell L. (A)
 Castor, Amasea H. (A)
 Creager, F. L. (A)
 Cummings, John J. (A)
 Darlington, Edgar T. (A)
 Davis, Chester E. (A)
 Demmer, A. H. (A)
 Dickey, Edward T. (M)
 Douthit, M. L. (A)
 Engstrom, Elmer W. (A)
 Garrett, Charles R. (A)
 Gerber, Paul D. (A)
 Goodrich, Robert R., II (A)
 Gunther, Clarence A. (A)
 Haigis, C. D. (A)
 Hansen, John C. (A)
 Hardin, L. L., Jr. (A)
 Hargrave, W. A. (A)
 Hoch, Arthur L. (A)
 Holden, Harold C. (A)
 Hughes, Michael S. (A)
 Hutcho, Francis J. (A)
 Johnson, Esmond E. (A)
 Jones, L. F., III. (A)
 Karcher, Edmund M. (A)
 Kerrigan, John (A)
 Koch, Winfield R. (A)
 Lehr, Rudolph (A)
 Loughren, Arthur V. (M)
 Lyndon, William L. (A)
 Maloff, Ioury G. (M)
 Massa, Frank (A)
 McClung, C. A. (A)
 McCullough, Maurice B. (A)
 McLennan, Miles Ar-yault (A)
 Mkytarian, Luther M. (A)
 Ogloblinsky, Gregory (M)
 Orr, Robert W. (A)
 Priebe, Frank (A)
 Reeber, Herman E. (A)
 Regottaz, Joseph M. (A)
 Reihman, Earl F. (A)
 Ringel, Abraham (M)
 Robb, Joseph S. (A)
 Schrader, Harold J. (A)
 Sinclair, Allan (A)
 Sweeney, Daniel J. (A)
 Tolson, W. A. (M)
 Williams, Aaron F. (A)
 Williams, Gurdon H. (A)
 Wolff, Irving (A)
Carlstadt
 Fuelling, Paul W. (A)
Cartaret
 Cox, George C. (A)
Cedar Grove
 Holborn, Fred. A. (M)
Chatham
 Kuthie, Herman K. (A)
Clementon
 Attmore, William B. (A)
Cliffside
 Dana, David W. (A)
Cliffside Park
 Nickless, William H. (A)
 Clifton
 Wheeler, C. M. (A)
 Clinton
 Wagner, Harry S. (A)
 Collingswood
 Allen, Hugh E. (M)
 Barbee, Virgil A. (A)
 Barton, Loy E. (M)
 Bedford, A. V. (A)
 Beers, G. Lisle (M)
 Bell, Richard (A)
 Berglund, E. B. (A)
 Boswell, James R. (A)
 Cerveny, J. P. (A)
 Cunningham, Thomas D. (A)
 Curtiss, Arthur N. (A)
 Daley, Raymond E. J. (A)
 Gihring, Herman E. (A)
 Grundmann, Gustave L. (A)
 Gunby, O. B. (A)
 Huddwalker, Wm. T. (A)
 Iams, Harley (A)
 James, Wallace McN. (A)
 Sherman, Kenneth S. (A)
 Stayer, David (A)
 Strasser, Edward J. (A)
 Swanson, Milton A. (A)
 Terrell, John A. (A)
 Tiedje, John O. (A)
 Turner, Alfred H. (A)
 Weible, Norman R. (A)
 Wistrup, Carl A. (A)
Cranford
 Briggs, Loyd A. (M)
 Richards, Horace J. (A)
 Smith, Wesley L. (A)
Deal
 Decino, Alfred (A)
 Eberhardt, Geo. M. (A)
 Ferrell, Enoch B. (M)
 Goodall, Wm. M. (A)
 Kerwien, Arthur E., Jr. (A)
 Schlaack, Norman F. (A)
 Schwartz, Lyle H. (A)
 Shaw, Robert C. (A)
 Skellett, A. Melvin (M)
 Smith, Phillip H. (A)
 Sowers, Nelson E. (A)
 Sterba, E. J. (A)
Denville
 Harlan, Edwin W. (A)
Dunellen
 Sommer, Emmitt H. (A)
East Orange
 Ackerman, Rudolph W. (M)
 Akers, Dallas C. (A)
 Bagnall, Vernon B. (A)
 Bohner, Chance E. (A)
 Borgeson, Carl A. (A)
 Brach, Leon S. (M)
 Brigham, Cyril A. (A)
 Brooke, E. F. (A)
 Brown, Bayne (A)
 Butler, H. R. (A)
 Canfield, Wilson R. (A)
 Clarry, Harold E. (A)
 Crawford, J. Wm. (A)
 Curtis, Austen M. (M)
 Curtis, R. C. (A)
 Dannals, Earl W. (M)
 Davenport, Ralph W. (A)
 Duncan, R. D., Jr. (M)
 Edison, Theo. M. (A)
 Gawler, Henry C. (M)
 Gerns, William H. (M)

NEW JERSEY (Continued)

- Green, Ralph W. (A)
Hiller, Harry E. (A)
Kahn, Frederick J. (M)
Kleinkauf, James D. (J)
Laube, Herbert W. (A)
Lederer, Ernest A. (M)
Lovatt, Harold S. (A)
Macalpine, Wm. W. (A)
Malcolm, John (A)
Marcy, Robert J. (A)
Miller, George A. (A)
Miller, H. P., Jr. (M)
Olsen, Eugene U. (A)
Perry, Irving D. (A)
Pickard, Richard W. (A)
Price, Harry J. (A)
Richards, Philip A. (A)
Roetken, A. A. (A)
Roush, Guy F. (A)
Shackelford, B. E. (M)
Spencer, Millard C. (A)
Stanwick, Chas. A. (A)
Toth, Emerick, (A)
Vermillion, Chas. O. (A)
Wallace, Milton W. (A)
Weston, John L. (A)
Woods, William A. (A)
Woodworth, Fred B. (A)
Woodriddle, Allen C. (A)
- Elizabeth
Brick, Frank R., Jr. (M)
Jatlow, J. L. (A)
Newell, Guy (A)
Sery, Lester (A)
Walsh, Lincoln (A)
White, Charles P. (A)
- Englewood
Ashton, John E. (A)
Emanuel, John H. (A)
Gillett, Glenn D. (M)
- Erlton
Briggs, Joseph A. (A)
Currier, Stuart E. (A)
Smith, J. P. (A)
West, Kenneth A. (A)
- Fair Lawn
Barry, Bert (A)
MacCoun, Townsend D. (A)
Martin, Devereaux (A)
Scarr, Henry F. (A)
- Fanwood
Hall, Clifford A. (A)
Todd, Harold C. (A)
- Freehold
Englund, Carl R. (F)
Hampton, Ernest C. (A)
- Glen Ridge
Clavier, A. G. (M)
Dart, Harry F. (M)
Grabo, Irving C. (A)
Umbach, Walter R. (A)
- Glen Rock
Clark, Louis E. (A)
- Gloucester
Hayes, Earl David (J)
- Grantwood
Herbst, John A. (A)
Wichern, Leonard (A)
- Guttenberg
Pramshofer, Thomas W. (A)
- Hackensack
Kersta, Laurence G. (A)
- Haddonfield
Aceto, Louie (A)
- Albright, Robert B. (A)
Barnes, John L. (A)
Blodgett, Edw. D. (A)
Brokaw, Charles A. (A)
Carpenter, Glenn W. (A)
Coleman, John B. (M)
Collins, Frank J. (A)
Cunningham, David H. (A)
Diehl, William F. (M)
Fithian, William S. (A)
Gertsch, Elmer P. (A)
Holmes, Ralph S. (A)
Norton, John E. (A)
Perkins, George C. (A)
Scott, F. (A)
Sponseller, Joseph F. (A)
Sullivan, Edward S. (A)
Walker, C. Robert (A)
Wallace, H. Edward (A)
Weber, Walter (A)
Yeck, F. A. (A)
- Jersey City
Benin, Zolmon (A)
Bremer, Harry A. (A)
Drews, Ernest (A)
Gross, Ralph (A)
Hanks, Alfred J. (A)
Holmes, George R. (A)
Lindauer, John H. (A)
Maylott, Carleton F. (A)
Norton, John E. (A)
Perkins, George C. (A)
Scott, F. (A)
Sponseller, Joseph F. (A)
Sullivan, Edward S. (A)
Walker, C. Robert (A)
Wallace, H. Edward (A)
Weber, Walter (A)
Yeck, F. A. (A)
- Kenilworth
Meyer, Henry E. (A)
- Lakehurst
Coulter, Howard N. (M)
Johnsen, C. M. (M)
- Lawrenceville
Ernst, Murray C. (A)
Gilman, George W. (A)
Wright, Oliver (A)
- Leonia
Mustermann, H. G. A. (A)
- Linden
Holetz, Alexander C. (A)
- Little Falls
Farnsworth, D. W. (A)
- Little Silver
Ohi, Russell S. (M)
- Livingston
Starrctt, John S. (A)
- Long Branch
Goodwin, Edwin A. (A)
Harris, Henry (A)
Herson, Jacob S. (A)
McCollum, Harry J. (A)
Reinhart, Sidney M. (A)
Watson, Paul E. (A)
- Lyndhurst
Kannenberg, Walter F. (A)
- Madison
De Coutouly, G. C. (A)
Kellogg, Wm. M. (A)
Manning, Chas. T. (M)
Phelps, Walter A. (A)
- Magnolia
Lathrope, Kenneth W. (A)
- Maplewood
Barkley, William J. (M)
Biele, Charles E. (A)
Bohn, William C. (A)
Cunningham, Frederick W. (M)
Darrow, Leo H. (A)
Du Vall, Frank B. (A)
Pidgeon, Howard A. (M)
Poppele, Jacob R. (A)
Rowe, Charles R. (M)
Troegner, Arthur M. (M)
- Merchantville
Ballard, Randall C. (A)
Billings, Horace P. (A)
Braden, Rene A. (A)
Brooks, N. M. (A)
Cone, F. E. (A)
Ellinwood, Carl W. (A)
Frenz, Harry J. (A)
- Mommo, Ernest J. (A)
Weinfeldt, Sidney (A)

NEW JERSEY (Continued)

- Hopkins, A. R. (A)
Hurley, Henry C. (A)
Jones, H. Rossiter (A)
Knapp, Harold D. (A)
McKechnie, John S. (A)
More, Clifton C. (A)
Paschon, Hans E. (A)
Patterson, E. B. (M)
Petty, G. Frederick (A)
Smith, Jerome C. (A)
Whitehead, Jesse C. (A)
- Metuchen
Bohlke, W. Hollander (A)
- Millburn
Morris, Robert M. (A)
Schauler, Vincent A. (A)
- Montclair
Charton, Paul W. (A)
De Long, Oscar A., Jr. (A)
Gano, Alfred S. (A)
Gorton, Roland Elmer (A)
Jacobus, Richard A. (A)
Krahl, Walter L. (M)
Tillson, Benj. F. (M)
- Moorestown
Ballentine, Edwin C. (M)
Mapelsen, Harold H. (A)
Stevenson, W. B. (A)
- Morristown
Leoser, Thomas S. (M)
Poole, Robert J. (A)
- Mountain Lakes
Asserson, Raymond (M)
Flannagan, Coke (M)
Osterland, Edmund H. (J)
Wilson, James R. (M)
- Mount Ephraim
Fitzsimons, Frank (A)
- Neptune
Schlafer, J. Peter (M)
- Newark
Barnes, T. Dana (A)
Bostad, John (A)
Browning, S. D. (A)
Cerstvik, Stephen (A)
Chun, Herbert H. (A)
Clement, Lewis M. (F)
Dauber, Arthur O. F. (A)
De Cola, Rinaldo (A)
Dolosh, Frank J. (A)
Donovan, Daniel R. (A)
Feindel, Abbot (A)
Glauber, John J. (A)
Goodwin, W. Nelson, Jr. (M)
Gordon, Malcolm K., Jr. (A)
Hardwick, Ambrose H. (M)
Herold, Edward W. (A)
Hesclton, Chas. C. (M)
Hooven, Morris D. (A)
Horle, Lawrence C. F. (F)
Lampey, Joseph J. (A)
Lewis, George H. (M)
Lucas, Earle F. (A)
March, Philip S. (A)
Marzulli, Angelo N. (A)
Montcalm, S. R. (M)
Morrison, G. K. (A)
- Peters, John L. (A)
Piety, Raymond G. (A)
Ports, Earl G. (A)
Ranger, Richard H. (F)
Reifel, Harry (A)
Romander, Hugo (A)
Rotolo, Nicholas V. (A)
Saunders, Wm. W. (A)
Schermerhorn, J. L. (A)
Scott, Walter F. (A)
Seis, Hollis K. (A)
Simpson, Frederick H., Jr. (A)
Sternberg, F. B. (A)
Suydam, C. H. (M)
Wagener, Winfield G. (A)
- New Brunswick
Hull, Charles E. (A)
Kahn, Louis (A)
Leeds, Lawrence M. (A)
- Newton
Landone, Brown (A)
- North Arlington
Collins, John (A)
- North Bergen
Seid, Fred C. (A)
- Nutley
Jones, Dramin D. (A)
Watts, Ivor B. (A)
- Oaklyn
Allen, John P. (A)
Bunday, Dale L. (A)
Byler, Henry W. (A)
Fowler, Lester T. (A)
Harding, Henry B. (A)
Holst, Paul F. G. (A)
Neal, George F. (A)
Rosenberg, Albert L., Jr. (A)
Welsh, Robert R. (A)
- Oceanport
Cohn, Ralph I. (A)
Hayden, Gilbert (A)
Horn, Tyree R. (A)
Larew, Walter H. (A)
Lockard, Marshall R. (A)
Lyman, Reginald P. (M)
Marks, Wm. S., Jr. (A)
O'Connell, James D. (A)
Slonaker, L. V. (A)
Spittle, Samuel E. (A)
Wenstrom, Wm. H. (A)
- Oradell
Brackett, Harold H. (A)
- Orange
Hauck, Vernon D. (A)
Maul, Gilbert E. (A)
Morrison, Howard (A)
Rockwood, G. H., Jr. (A)
Rypinski, Maurice C. (M)
Schlenker, Vesper A. (A)
Somers, Richard M. (A)
- Palmyra
Austin, John W. (A)
- Passaic
Albright, Arthur W. (A)
Bishop, William T. (A)
Ekstrom, Emmett J. (A)
Henderson, Roy A. (A)
Himoe, Clifford E. (A)
Kent, Roscoe (A)
Knight, J. B., Jr. (A)
Kroger, H. B. (A)
Link, Fred M. (A)
- Paterson
Franck, Ernest W. (A)
- Gold, Herman (A)
Grant, Mark S. (A)
Kearns, Henry E. (A)
Weimer, Max J. (A)
- Penns Grove
Douglass, Wm. A. (A)
- Perth Amboy
Onuska, Andrew (A)
- Plainfield
Boise, Everett B. (A)
Coxhead, Harry B. (M)
Cumming, Kenneth N. (M)
Nielsen, H. V. (A)
- Pompton Lakes
Misenheimer, Robert G. (A)
- Pompton Plains
Newby, Raymond W. (A)
- Princeton
Roberts, Walter Van B. (F)
Ware, Paul (A)
- Radburn
McConnell, W. G. (A)
- Rahway
Gibson, Robert D. (A)
Houck, Harry W. (M)
Hubbard, Chas. W. (A)
- Ramsey
Secor, Harry W. (A)
- Red Bank
Beck, Alfred C. (A)
Bruce, Edmond (M)
Crawford, Arthur B. (A)
Feldman, Carl B. (A)
Hollywood, John M. (J)
Jansky, Karl G. (A)
King, Archie P. (A)
Lowry, Lewis R. (A)
Mumford, Wm. W. (A)
Mutch, W. W. (M)
Ring, Douglas H. (A)
Sharpless, Wm. M. (A)
Strohl, Wellington M. (A)
- Ridgefield Park
Fleming, Joseph W. (A)
Smith, Arthur E. (A)
- Ridgewood
Affel, Herman A. (A)
Bondy, Hugo Alois, Jr. (A)
Engel, G. C. (A)
Felix, Edgar (M)
Fish, Edward H. (A)
Pfeiff, Frederick J. (A)
Replogle, Delbert E. (M)
Ronclere, Harold (A)
Smith, Theodore A. (A)
- Riverton
Beach, Chester L. (A)
Conron, William H. (A)
Goodenow, Grude J. (A)
Poch, Waldemar J. (A)
- Rochelle Park
Gibson, Robert (A)
- Roseland
Tiffany, John M. (A)
- Roselle
Guber, Fred H. (A)
Peterson, J. N. (A)
Pulley, Lester A. (A)
- Roselle Park
McNicol, Donald (F)

- NEW JERSEY (Continued)**
- Rumson
Friis, H. T. (F)
- Rutherford
Gage, David H. (M)
Kennedy, Harold E. (A)
Lynn, Roland A. (A)
Schwerin, Paul (M)
Stinchfield, J. M. (A)
Watson, Harry B. (A)
- Short Hills
Harkins, Philip B. (A)
- South Maplewood
Oman, Nils Johann (A)
- South Orange
Field, W. Thayer (A)
Leeb, Henry L. (M)
Walsh, Arthur L. (A)
Wensley, Roy J. (A)
- Springfield
Hantzsch, Ralph E. (M)
- Stanhope
Billiams, Frank J. (A)
Peterson, Arthur C., Jr. (A)
- Summit
Fairchild, F. Earle (A)
Humphrey, Hartley C. (A)
Melroy, Harry C. (A)
Snook, H. Clyde (M)
- Teaneck
Knights, A. H. (A)
Perryman, G. H. (A)
- Trenton
Donohue, E. F. (A)
Kale, Samuel S. (A)
Knowles, Edward P., Jr. (A)
Raser, Edward G. (A)
Wentzel, Amandus G., Jr. (A)
- Tuckerton
Munzer, Louis F. (A)
- Union
Edwards, Joseph B. (A)
- Union City
Erhard, John A. (A)
Hudson, Julius (A)
- Upper Montclair
Du Mont, Allen B. (F)
Godley, Paul F. (A)
Hallborg, H. E. (F)
- Verona
Heyman, Nicholas (A)
Paret, F. Murray (A)
- Wayne
Mayberry, Robert J. (A)
Read, Oswald W. (A)
- Weehawken
Masalkovics, J. A. (A)
Samuelson, Cyrus D. (J)
- Weehawken Heights
Spinner, Robt. F., Jr. (A)
- West Caldwell
Willis, Frederick C. (A)
- West Collingswood
Knight, Robert W. (A)
Pearl, Eugene S. (M)
Pettit, Albert R. (A)
Rohner, Arnold J. (A)
Taylor, John Pratt (A)
- West Englewood
Pettus, W. K. (A)
- Westfield
Kinsley, Carl (M)
Swanson, John W. (M)
Taylor, Theodore (A)
- West Long Branch
Burrows, Charles R. (A)
- Westmont
Batchelor, Harold (A)
Bradbury, Burke (M)
Clark, Edwin L. (A)
Pulley, Albert A. (A)
Scheldorf, Marvel W. (A)
Schnoor, F. D. (A)
Weber, Arnold K. (A)
Zimmerman, Arthur G. (A)
- West New York
Campbell, Augustus G. (A)
Machiorletti, Louis (A)
Schoenfeld, K. (A)
- West Orange
Kohler, Paul A. (A)
Martin, De Loss K. (M)
Schmidt, Joseph H. (A)
Tucker, Murray E. (A)
Vose, George E. (A)
Wickersheim, Lyle W. (A)
- Westwood
Otto, Emil D. (A)
- Whippany
Doherty, Wm. H. (A)
Hensel, W. G. (A)
Smith, John Wesley (A)
Stansel, Frank R. (A)
- Woodcliff
Palmer, C. Walter (A)
- Woodlynne
Stanton, Clair F. (A)
- Woodridge
Short, Donald Wm. (A)
- Wyckoff
Frey, Robert H. (A)
- NEW MEXICO**
- Mesilla Park
Talbot, Edward P. (A)
- Roswell
Falconi, Louis (A)
- NEW YORK**
- Albany
Corey, James H. (A)
Kaiser, Fred J. (A)
Mezger, George (A)
Schultz, Arthur F. (A)
Smith, Harold E. (A)
Thomas, Joseph D. (A)
- Amityville, L.I.
Browne, Walram S. (A)
Holland, Jesse W. (A)
- Andes
Gray, De Wayne R. (J)
- Ardsey
Ayer, Oliver G. (A)
- Astoria, L.I.
Berhley, Fred (A)
Campbell, Mark E. (A)
Champness, Thos. J. (A)
Gerlach, Gerald G. (A)
Greene, George J. (A)
Greene, Harry A. (A)
Kunicky, Barney F. (A)
Leslie, Frank (A)
Lurie, Eli M. (A)
- Miller, Edwin C. (A)
Miller, H. B. (A)
Nagy, A. Wheeler (A)
Racliffe, Chas. L. (A)
Schraun, Wm. C. (A)
Zatorsky, E. F. (A)
- Auburn
Lumb, Frank J. (A)
Willers, Theodore H., Sr. (A)
- Babylon, L.I.
Thompson, E. P. (A)
- Batavia
Nodine, Wesley I. (A)
- Bath
Loveless, Lawrence M. (A)
- Bayside, L.I.
Case, Nelson P. (M)
Dean, C. E. (A)
Lorch, Albert (A)
Sage, Frederick H. (A)
Trautwein, Paul K. (M)
Whitman, Vernon E. (A)
- Bellaire, L.I.
Brennan, John B., Jr. (A)
- Bellerose, L.I.
Speicher, John D. (A)
- Binghamton
Adams, William E. (A)
Craft, James A. (A)
Gilbert, Lester H. (A)
- Bohemia, L.I.
Kroupa, Henry F. (A)
- Brighton
Long, John J., Jr. (M)
- Brightwaters, L.I.
Camp, V. F. (A)
- Bronxville
Langley, Ralph H. (F)
Weeden, William N. (A)
- Bronxville Manor
Whitaker, James N. (A)
- Brooklyn
Adachi, William Y. (A)
Alexander, Louis (A)
Asch, Moe (A)
Bartal, Otto (A)
Baum, Sydney H. (A)
Baunach, Edward L. (A)
Berner, Aaron (A)
Berry, James L. (A)
Berry, Robert C. (A)
Blanc, Victor (A)
Bower, James (A)
Brandt, Kristian (A)
Brimberg, Isaac (A)
Bristow, F. R. (A)
Bullock, Walter H. (A)
Burns, George D. (A)
Buzalski, Thos. J. (A)
Callahan, John L. (M)
Callighieris, John S. (A)
Castle, Donald H. (A)
Charlat, Arnold (J)
Chinitz, Edward (A)
Christman, Charles (A)
Coe, Alfred (A)
Cohen, Samuel (M)
Coke, Charles B. (A)
Cole, Fred S. (A)
Colpitts, A. B. (A)
Cook, Arthur L. (A)
Culley, Pawson (A)
De Mann, William (A)
De Myer, Harold (A)

- NEW YORK (Continued)**
- Dresdner, Harold D. (A)
Dummett, H. W. (A)
Dunn, Lawrence J. (M)
Ellingham, Irving (A)
Evans, Porter H. (F)
Felthousen, A. (A)
Ferrotta, Joseph L. (A)
Fishberg, Sidney (A)
Florez, Hermann A. (A)
Fogel, Mortimer H. (A)
French, James B. (A)
Gardner, Leroy H. (A)
Gaydos, George J. (A)
Gerel, Alexander (A)
Gillule, William J. (A)
Glaser, Edward M. (A)
Glaser, Marcus (A)
Goddard, F. M. (A)
Greibach, Emil H. (A)
Gruetzke, Charles P. E., Jr. (A)
Haas, Milton J. (J)
Hadden, Weston (A)
Hajim, Jack (A)
Hammer, Robert H. (A)
Hartley, John H. (A)
Hausmann, Erich (M)
Haynes, Nat (A)
Heymann, Joseph (A)
Hines, Joseph (A)
Hintz, Robert T. (A)
Hughes, Wm. P., Jr. (A)
Inskip, Leonard S. (A)
Jaeger, Harold (A)
Jahl, Edwin (A)
Johnson, R. Stanley (A)
Katz, David (A)
Katzin, Martin (A)
Kayser, Herbert (A)
Kenny, Matthew (A)
Kirdahy, Emil (A)
Kissel, Alfred L. (A)
Korb, Alfred (A)
Kotzum, Joseph H. (A)
Lequesne, Chas. A. (A)
Levine, Harry (A)
Le Viness, John E. (A)
Levy, Lester (A)
Liberman, Henry C. (A)
Lucey, Kenneth (A)
Lussier, Ephege A. (A)
Mahoney, Jos. N. (M)
Marriott, Robert H. (F)
Martin, H. B. (A)
Martin, Louis (M)
Mazzola, Joseph R. (A)
McCormick, Hamilton L. (A)
McGonigle, Wm. J. (A)
McLaughlin, Thomas J. (A)
Miller, Marvin L. (A)
Mittwol, David (J)
Moore, Henry H. (A)
Morris, Leon A. (A)
Mullen, James F. (A)
Nardone, August J. (A)
Newcombe, Jack (A)
O'Shea, C. G. (A)
Ostrove, William (A)
Painting, John A. (A)
Palmer, Eric H. (A)
Patanski, D. (A)
Pearson, Herbert B. (A)
Perry, Harold D. (A)
Petersen, John C. (A)
Phelan, Thomas H. (A)
Potter, Max (A)
Prigge, John, Jr. (A)
Redfern, Forest F. (A)

- Renke, Adolph (A)
Riccobono, Sebastian (A)
Richardson, A. G. (M)
Ripperer, R. Oliver (A)
Romeo, Anthony (A)
Rosenbaum, Jacob (J)
Sachs, Bernhard A. (A)
Salzman, David (A)
Sass, Isidore (A)
Schenke, Kurtiss P. (A)
Scruggs, Clarence H. (A)
Secan, Harry (A)
Seekamp, Walter J. (A)
Seidman, Charles (A)
Shestacovsky, John (A)
Shortland, Jas. W. (A)
Siegel, Samuel (M)
Silver, Benjamin L. (A)
Simmons, Robert A., Jr. (J)
Sinsheimer, Arthur (A)
Skinner, Murray F. (A)
Smalts, Franklin W. (A)
Steinberger, Louis (M)
Stobbe, John A. (A)
Stromeyer, Charles F. (A)
Talley, David (A)
Tallman, Clare Le Roy (A)
Thomas, Edward H. (A)
Hintz, Barnett (A)
Tucker, Morris H. (A)
Tuckerman, Lucien P. (A)
Urmann, George J. (M)
Vogel, Erwin Wm. (A)
Weber, Paul (A)
Weinberg, Sidney (J)
White, Milton (A)
Widmann, Erwin (A)
Wing, Arthur K., J. (A)
Yolles, Jacob (A)
Zeiger, Louis B. (A)
- Buffalo**
- Andriatch, Nicholas D. (A)
Bergman, Howard J. (J)
Bickelman, John E. (A)
Blinzler, Richard F. (A)
Brown, Stanley W. (M)
Burbank, Jerome (A)
Crom, Geo. C., Jr. (M)
Cutting, Fulton (F)
Fiedler, Oscar W. (A)
Freidman, Sam (A)
Hayslett, L. E. (A)
Hector, L. Grant (A)
Hemedinger, Willard (A)
Huntsinger, F. J. (A)
Johnson, James A. (A)
Knowlton, Eugene W. (A)
Kunins, Morris K. (A)
Lounsberry, Isaac R., Jr. (M)
Miller, John C. G. (A)
Misiak, William (A)
Nauth, Edgar K. (A)
Nowak, Victor V. (A)
Patey, Harold W. (A)
Peck, Emerson P. (A)
Simpson, Burton T. (A)
Stachura, Edward J. (A)
Telaak, Theodore J. (A)
Vorojeikin, I. N. (A)
Wagener, W. Hall (A)
Waul, Eugene C. (A)
Weiss, Earl (J)
Yates, Raymond F. (M)
- Canandaigua**
Goering, Raymond A. (A)
- Canton**
Priest, Ward C. (A)
- Carmel**
Light, Frank B. (A)
- Cassville**
McDermott, John J. (A)
- College Point, L.I.**
Corbett, Clifford W. (J)
Hoehlein, Fred W. (A)
- Coney Island**
Singer, Louis (A)
- Corning**
Gage, Henry Phelps (A)
Taubert, W. Howland (A)
- Corona, L.I.**
Schubert, Fred (A)
- Croton-on-Hudson**
Lescarbours, Austin C. (M)
- Dongan Hills, S.I.**
Grimes, David (M)
- Douglas Manor, L.I.**
Weagant, Roy A. (F)
- Douglasston, L.I.**
Lewis, Harold M. (M)
- Dover Plains**
Pleasanton, Archie W. (A)
- Dryden**
McWatters, John T. (A)
- East Rochester**
Lucia, Raymond H. (A)
McCamee, Lee (A)
- East Rockaway, L.I.**
Carter, Frank L. (A)
Van Duynce, Eugene D. (A)
- Edgemere, L.I.**
Caudner, William (A)
- Elmhurst, L.I.**
Content, Edward J. (A)
Haines, Howard J. (A)
- Elmira**
Jenkins, Harold F. (A)
Taylor, Dale L. (A)
- Floral Park, L.I.**
Densham, Robert S. (A)
- Flushing, L.I.**
Barber, Alfred W. (A)
Bouck, Zeh (M)
Cook, Ellsworth D. (A)
Darrow, John A., Jr. (A)
Dreisbach, Robt. H. (A)
Farrington, John F. (F)
Kuntze, Emmet L. (A)
Matthews, A. C., Jr. (A)
Schofield, Robert W. (A)
Troxler, Lucien J., Jr. (A)
- Forest Hills, L.I.**
Bonanno, Joseph J. (A)
Canavaciol, Frank E. (A)
Leutz, Charles R. (M)
- Garden City, L.I.**
Dewhirst, Thornton P. (A)
Henney, J. K. (M)
Howe, Willard C. (A)
Lynch, Arthur H. (M)
Marcroft, James (A)

- NEW YORK (Continued)**
- Geneva**
Biles, Frank V. (A)
Thompson, John M. (A)
- Gerry**
Starr, Troy S. (A)
- Grahamsville**
Gillette, K. G. (A)
- Grant City, S.I.**
Emerson, Chas. W., Jr. (A)
- Great Neck, L.I.**
Freed, Joseph D. R. (F)
Paulding, Herbert L. (A)
Wheeler, Harold A. (M)
- Greece**
Clarke, Maurice M. (A)
- Greenport, L.I.**
Boerum, Henry S. (A)
- Jackson Heights, L.I.**
Larsen, Carl L. (A)
- Hall**
Phillips, Lloyd B. (A)
- Hamburg**
Hartloff, Gordon S. (A)
- Hamilton**
Goode, Kenneth H. (A)
- Hartsdale**
Keene, K. W. (A)
- Hastings-on-Hudson**
Baker, Judd O. (A)
- Hempstead, L.I.**
Crane, Edwin S. (A)
Pfautz, Christian E. (A)
Zurian, P. D. (A)
- Hempstead Gardens, L.I.**
Westman, Harold P. (M)
- Hicksville, L.I.**
Baker, Thomas S. (A)
Phelps, Boyd (A)
- Hollis, L.I.**
Batcher, Ralph R. (M)
Caputo, Nicholas J. (A)
Ma Dan, Edwin M. (M)
Srebroff, Chas. M. (M)
- Hudson**
Morrison, R. J. (A)
- Huntington, L.I.**
Flessel, Frank B., Jr. (J)
- Hurley**
Warren, William A. (A)
- Ithaca**
Ballard, William C. (M)
Bostwick, Wm. E. (A)
Grover, Horace J. (A)
Merritt, Ernest (M)
Meserve, Wilbur E. (A)
Mingins, Charles R. (A)
Moeder, William D. (A)
Palmer, Harris C. (A)
Sohon, Harry (A)
Tombouliau, Diran H. (A)
Wang, Y. M. (A)
- Jackson Heights, L.I.**
Abbott, Donald (A)
Bylander, J. Clifford (A)
Hasting, Gerald M. (A)
Hickman, C. Nichols (A)
Kampf, E. P. (A)
Schuetz, Robert F. (A)
Shelby, R. E. (A)
Stotler, Albert (A)
Swift, Wm. C. G. (A)
- Jamaica, L.I.**
Bernhardt, E. E. (A)
Bevitt, William D. (A)
Blauxox, Joseph D. (A)
Glasscock, Glen R. (A)
McCUTCHEON, John F. (A)
Steinberger, Arthur W. (A)
Sterns, Morton W. (M)
Styles, Thomas J. (A)
Voigt, George (A)
Yenoli, Dominick J. (A)
- Jamesport**
Colvin, R. S. (A)
Seaman, Gerald C. (A)
- Jamestown**
Beaumont, Wm. F. (A)
- Johnstown**
Ennis, Joel B., Jr. (A)
- Kenmore**
Cote, Omer E. (A)
Fichtel, F. Carl (A)
Noel, Lionel S. (A)
Welscher, Carl E. (A)
Wullenweber, Milton O. (A)
- Kew Gardens, L.I.**
Montgomery, A. Peers (A)
- Kingston**
Kent, George C. (A)
- Larchmont**
Nilson, Arthur R. (M)
- Laurelton, L.I.**
Slater, Saul I. (A)
- Liberty**
Mauer, William V. (A)
- Little Neck, L.I.**
Bohman, Victor A. (A)
Parker, Oliver B. (M)
Schultes, Martin F. (A)
- Lockport**
Connette, T. W. (A)
Fiedler, Leroy (A)
- Long Island City, L.I.**
Carter, E. Finley (A)
Dinga, Emil (A)
Dolid, Abraham (A)
Duttera, W. S. (A)
Holzinger, Theo. E. (A)
Manke, Arthur G. (A)
Morrison, Montford (M)
Pattée, John R. (A)
Verdigi, John (A)
- Lynbrook, L.I.**
Fedotoff, Nicholas V. (A)
Misterly, Frank S. (A)
Shaw, James (A)
- Maine**
Lainhart, Vaughn (A)
- Malverne, L.I.**
Seidler, Abraham (A)
- Mamaroneck**
Herdman, Wm. P. (A)
Smith, J. O. (M)
- Maspeth, L.I.**
Purzner, William H. (J)
- Middletown**
Callender, Edwin R. (A)
Dempsey, Wm. E. (A)
- Midland Beach, S.I.**
Bon, John M. (A)
- Mineola, L.I.**
McCauley, Geo. W. (A)
- Stellwagen, Frank W. (A)**
- Mitchell Field, L.I.**
Clute, Frank H. (A)
- Monroe**
Morse, Arthur H. (M)
- Monticello**
Fleischer, A. P. (A)
- Mount Vernon**
Anderson, J. E. (A)
Bernard, Herman (A)
Fletcher, Louis D., Jr. (A)
Ka Dell, Harold W. (A)
Podell, Samuel (A)
Stone, Clarence G., Jr. (A)
- Napanoch**
Nally, Edward J. (A)
- New Brighton, S.I.**
Macken, H. L. (A)
- New City**
Doellner, LeRoy J. (A)
- New Rochelle**
Annucci, Louis M. (A)
Cantor, Arthur B. (A)
Ciolfari, Bernard (A)
Kelly, Chas. M., Jr. (A)
Matthews, Basil W. (A)
Wilson, Robert F. (J)
- New York**
Adams, Ira J. (M)
Adams, Quinton (M)
Aiken, Charles B. P. (A)
Allcutt, E. Burton (A)
Allen, Gilbert D. (A)
Allyn, R. S. (A)
Almquist, Milton L. (A)
Alpern, Dwight K. (A)
Alvarado, Michael A. (A)
Alverson, George S. (A)
Amy, Ernest V. (M)
Anderson, Clifford N. (A)
Anderson, Edwin C. (A)
Anderson, Herbert L. (J)
Andrews, Joseph F. (M)
Ansley, Arthur C. (A)
Appel, Henry W. (A)
Armstrong, E. H. (F)
Arnold, John W. (A)
Ashby, A. L. (A)
Atkin, Robert (A)
Aull, Wilson, Jr. (M)
Babcock, Stuart M. (A)
Bailey, Arnold B. (A)
Bailey, Austin (M)
Bain, J. C. (A)
Bair, Ralph S. (A)
Barnes, James C. (A)
Bartlett, Kenneth R. (A)
Batcheller, Arthur (M)
Batsel, Max C. (F)
Bauer, Brunton (A)
Behner, Herbert C. (M)
Beltz, Willis H. (A)
Bemis, Edwin W. (A)
Bemis, Isabel S. (A)
Berhalter, Joseph J. (A)
Betts, Philander H. (A)
Beverage, Harold H. (F)
Beyer, Haim (A)
Beyer, Raymond G. (A)
Binns, John R. (A)
Bird, J. Raymond (A)
Black, Donald M. (A)
Black, K. Charlton (M)
Blackmar, Abel E., Jr. (A)

NEW YORK (Continued)

- Blackwell, Otto B. (F)
Blan, Michael (A)
Blenheim, Wm. J. (M)
Block, Wesley S., Jr. (A)
Boehme, H. O. (M)
Boesche, F. W. (A)
Bonett, David J. (A)
Borislavsky, Michael A. (A)
Bostwick, L. G. (A)
Bown, Ralph (F)
Bradshaw, David Y. (A)
Brady, Leslie R. (A)
Brainson, William (A)
Brake, Paul (J)
Brothers, James T. (A)
Brown, Charles J. (A)
Brown, D. S. (A)
Brown, Wm. A. R. (A)
Bruck, Herman (A)
Bruggeman, John T. (A)
Bucher, E. E. (F)
Buckler, John J. (A)
Budenbom, Horace T. (A)
Bullard, William R. (A)
Burghard, G. E. (M)
Burton, Everett T. (A)
Butterfield, Charles E. (M)
Buttner, Harold H. (M)
Byrnes, Irving F. (A)
Cahill, William J. (A)
Caldwell, O. H. (M)
Campbell, Chas. H. (A)
Campbell, John A. (A)
Capen, William H. (M)
Carlton, Roger C. (A)
Carson, John R. (M)
Cass, Lewis S. (A)
Caum, Harold J. (A)
Chaffee, Joseph G. (A)
Challenger, Ansel (A)
Challenor, Geo. A. (A)
Chamberlain, Adolph B. (M)
Chernow, Morris (A)
Chu, Quong Y. (J)
Clark, C. R. (M)
Cockaday, Laurence M. (A)
Coggeshall, Ivan S. (M)
Cohan, Edwin K. (M)
Cohn, Hugo (M)
Cole, Burton R. (A)
Coles, Francis A. (A)
Colpitts, Edwin H. (F)
Conley, S. D. (A)
Conviser, Harry (A)
Cooper, C. B. (A)
Corbett, Edward L. (A)
Core, Christopher W. (A)
Corwin, Charles I. (A)
Cousins, Van Meter (A)
Cowan, Frank A. (M)
Cowles, Laurence G. (A)
Crite, Mitchel (A)
Crosby, George L. (M)
Crosby, Gordon J. (A)
Curry, Walter A. (A)
Custer, Charles J. (A)
Dale, George V. (A)
Danz, Herman (A)
Danziger, Harold I. (M)
Daspit, L. Randall (A)
Deakin, Gerald (A)
Della Corte, Joseph P. (A)
Demarest, Chas. S. (M)
- De Pasquale, Ray H. (A)
Desnoes, Arnold B. (A)
De Sousa, Geo. S. (M)
DeWitt, John H. (A)
Diaz, Ernesto (A)
Dietrich, Frederick (A)
Dietsch, Carl G. (A)
Dietze, Eginhard (A)
Dodge, Frank R. (A)
Dow, M. Thornton (A)
Downing, Richard E. (A)
Dubilier, William (F)
Duggan, John (A)
Duncan, Rudolph L. (M)
Dunham, John S. (A)
Dunlap, Orrin E., Jr. (M)
Dunn, Gano (F)
Dunning, John R. (A)
Durkee, Lincoln (A)
Easton, J. H. (A)
Edwards, Robert B. (A)
Egert, Samuel S. (A)
Eldridge, H. W. (A)
Eller, Keith B. (A)
Foyang, Thomas T. (A)
Erstad, Johannes (A)
Espenschied, Lloyd (F)
Everett, Lynn C. (M)
Facey, John W. (A)
Farrand, C. L. (F)
Fay, Clifford E. (A)
Feldstein, M. A. (A)
Fielding, Charles F. (M)
Filmer, Walter L., Jr. (A)
Finch, William G. H. (M)
Finlay, Robert C. S. (A)
Fischer, Herbert B. (A)
Fischer, Leonard O. (A)
Fish, Arthur S. (M)
Fisher, Theodore (A)
Flaum, Joe (J)
Flythe, Thomas Y. (J)
Forster, Kenneth L. (A)
Frank, James, Jr. (A)
Fredendall, Beverly (A)
Frederick, Halsey A. (M)
Friend, Halton H. (A)
Frimerman, Frank (A)
Furia, John J. (A)
Gannett, Danforth K. (M)
Garner, Melvin E. (J)
Garofalo, Frank (A)
Gati, Bela (A)
Geoghegan, Eamonn D. (A)
Gerstein, M. George (J)
Gibson, Nesbit (A)
Gilbert, John J. (A)
Giovanni, Frank (A)
Girard, E. J. (A)
Goldsmith, Alfred N. (F)
Graham, Frank H. (A)
Graham, William A. (M)
Graveson, Geo. L. (A)
Green, Ashbel (A)
Green, Estill I. (A)
Green, William (A)
Greene, Paul A. (M)
Greenstein, Philip (A)
Greiff, Victor (M)
Greig, John W. (A)
Griffiths, Clarence M. (A)
Gritzner, Fred A. (A)
Grover, Harry G. (M)
Grunwald, Werner J. (A)
Guid, Baldwin (M)
- Gutoff, Boris M. (A)
Guy, Raymond F. (M)
Haldane-Duncan, B. (A)
Hallenstein, Nathan A. (A)
Halligan, Clair W. (A)
Hanley, John F. (A)
Harley, John B. (A)
Harness, Sam A. (A)
Harnett, Daniel E. (A)
Harper, A. E. (M)
Harrison, Chas. I. (A)
Harrison, Perry (A)
Hartley, Ralph V. L. (F)
Hartman, Chas. D. (A)
Harvey, Lester M. (M)
Hauffe, Otto (A)
Heberlein, Arthur A. (A)
Hedges, Ellsworth J. (A)
Heindel, Harold J. (A)
Heising, R. A. (F)
Hemberger, E. F., Jr. (A)
Henline, Henry H. (M)
Herber, John C. (A)
Herbert, Harold R. (M)
Herschey, Arthur W. (A)
Heuschkel, Paul J. (A)
Hight, Stuart C. (A)
Hiller, Nicolai H., Jr. (A)
Hineline, Harris D. (M)
Hirsch, Harry (A)
Hogan, John V. L. (F)
Holcombe, Henry W. (M)
Holden, C. F. (M)
Honaman, R. Karl (A)
Hopfenberg, Jos. A. (A)
Horn, Charles W. (F)
Hornung, Julius L. (A)
Horscroft, Richard G. (A)
Hough, Clinton W. (A)
Hovgaard, Ole M. (M)
Howard, Edward J. (A)
Howell, Clifford A. (A)
Howell, James P. (A)
Howell, Walter J. (M)
Hubbard, Frank A. (A)
Hudack, John M. (A)
Hunkins, Harold R. (A)
Huntley, Kenneth L. (A)
Hutchison, Miller (M)
Isele, Harold Adolph (A)
Jacobs, Louis (A)
Jameson, Malcolm F. (A)
Jamross, Rudolph (A)
Janke, Alfred H. (M)
Jarabin, Frank G. (A)
Jean, Robert P. (A)
Jensen, A. G. (M)
Jewett, F. B. (F)
Johnson, J. Kelly (A)
Johnson, Kenneth S. (M)
Johnson, Reverdy (A)
Johnston, John P. (M)
Johnston, Thos. F. (A)
Jones, August F. (A)
Jones, Lester L. (F)
Kahn, Morton B. (A)
Kalb, Robert M. (A)
Kaplan, Arthur A. (A)
Keim, Llewellyn B. (A)
Kelley, Leo A. (A)
Kelly, Mervin J. (M)
Kennedy, T. R., Jr. (A)
Kennedy, Wm. A. (A)
Kilmer, T. W., Jr. (A)
King, Frank (M)

NEW YORK (Continued)

King, W. Milton (A)
Kircher, Raymond (A)
Kirchhoff, Willard J. (A)
Kishpaugh, Arthur W. (M)
Klesse, William (A)
Klosner, Morris (A)
Knaack, Frank E. (A)
Knapp, Joseph F. (A)
Knapp, Kenneth G. (A)
Knight, Octavius (A)
Knopp, Ernest (A)
Knott, William M. (A)
Kobliha, Francis E. (J)
Koerner, Lawrence F. (A)
Kolster, F. A. (F)
Kouchnerkavich, Thomas A. (A)
Kreuzer, Barton (A)
Kroger, F. H. (F)
Kuhn, Alfred S. (A)
Kunc, Frank (A)
Lack, Frederick R. (A)
Ladner, Henry (A)
Lakatos, Emory (A)
Lake, Daniel A. (A)
Lane, Frederick A. (A)
Langdon, G. G. (A)
Langley, Horace E. (A)
Latimer, Chester W. (F)
Lawrence, Walter L. (A)
Leach, Harvey B. (A)
Lebow, Samuel (A)
Lee, Emery H. I. (M)
Lee, Fat Chang (A)
Lefferts, B. (A)
Lemmon, Walter S. (A)
Lenz, Charles S. (A)
Levin, Samuel A. (A)
Levine, I. B. (M)
Levy, A. Kingdon (A)
Levy, Mortimer N. (A)
Lewis, Elmer H. (A)
Lindmark, Elmer S. (A)
Lindner, Herbert G. (A)
Lindsay, Maxwell H. A. (A)
Llewellyn, F. B. (A)
Loflin, Edward H. (M)
Logan, Mason A. (A)
Long, Maurice B. (A)
Loynes, Owen H. (A)
Luisi, John (J)
Lundahl, Tore (A)
Lyons, Walter (A)
MacDonald, Wm. A. (M)
MacDougall, Arthur (A)
Mackay, Wm. A. (A)
Magri, Frank (A)
Manley, Edward (A)
Manley, Lee L. (M)
Marrison, W. A. (M)
Marshall, Albert E. (A)
Martin, W. H. (A)
Marx, Frank (J)
Mathes, R. E. (A)
Mauran, John (A)
McCann, Thomas A. (A)
McCutchen, Brunson S. (M)
McElrath, George (M)
McFarlane, M. L. D. (A)
McGarry, John (A)
McIntosh, Frank H. (A)
McLagan, Donald R. (A)
McLaughlin, Jas. L. (M)
McLean, Philip S. (A)
McNally, James O. (A)
McNary, James C. (M)

McSweeney, Roger (A)
Mellor, William N. (A)
Mendenhall, Hallam E. (A)
Meyer, Henry W. (A)
Michelman, E. A. (A)
Miles, Paul D. (A)
Miller, Horace G. (A)
Miller, Jos. Anthony (A)
Miller, Samuel C. (M)
Mills, John (F)
Milnor, J. Willard (M)
Misenheimer, Harvey N. (M)
Mitchell, Isaac A. (A)
Moises, George S. (A)
Molzen, Charles F. (A)
Moore, George E. (A)
Moran, H. G. (A)
Morehouse, T. B. (A)
Muller, Fred (M)
Myers, Theobald (A)
Naimark, Boris S. (A)
Nakamura, T. (M)
Neely, Guy Morton (A)
Nein, Harry R. (A)
Nelson, Crescent F. (M)
Nelson, Edward L. (M)
Nelson, Parker C. (A)
Neville, T. P. (A)
Newhouse, Russel C. (A)
Nicely, Ralph N. (A)
Nicholides, E. (A)
Nichols, Eldon (A)
Nichols, Leroy C. (A)
Nickerson, Fred W. (A)
Nielsen, John E. (A)
Nimmcke, Fred E. (A)
Nisley, Paul H. (A)
Nixon, George M. (A)
Nordahl, John G. (A)
Nordstrom, B. H. (A)
Norton, F. R. (A)
Nuesse, Louis W. (A)
Nugent, Thomas (A)
O'Donohue, Jas. P. (A)
Olander, L. W. (A)
Olmstead, Noel C. (A)
Ornstein, Eugene (A)
Osborne, Harold S. (M)
Osgood, Albert S. (A)
Oswald, Arthur A. (F)
Overmiller, Clair M. (A)
Pacent, Louis G. (F)
Palmer, Robert T. (A)
Pannill, Charles J. (F)
Parker, R. D. (A)
Pavlow, Nicholas (A)
Payne, Charles C. (A)
Pease, Reginald M. (M)
Pegram, George B. (A)
Penick, D. B. (A)
Petersen, Carl O. (A)
Peterson, Cornelius (A)
Peterson, Eugene (M)
Peterson, Glen (A)
Peterson, Kenneth C. (A)
Petry, C. A. (A)
Pickett, Glenn H. (A)
Pierce, E. H. (A)
Pierce, Norman J. (A)
Pierrepont, John Jay (A)
Pilling, Thomas A. (A)
Pineau, Norman T. (A)
Plummer, Wm. E. (A)
Polkinghorn, Frank A. (A)
Pollack, Dale (J)
Potter, Ralph K. (M)
Powell, Ralph C., Jr. (A)

Pratt, Haraden (F)
Price, H. Stewart (M)
Prilik, Max R. (A)
Proskauer, Julien J. (A)
Pumphrey, Walter H. (M)
Pupin, M. I. (F)
Putnam, Ralph E. A. (A)
Ranson, G. B. (A)
Rathner, Jack (A)
Reb, Frank F. (A)
Reber, Samuel (F)
Reeves, J. Russell (A)
Reeves, Thomas J. (A)
Reiling, Paul A. (A)
Reoch, Alexander E. (F)
Reynolds, John L. (A)
Rider, John F. (A)
Ridgway, James L. (A)
Rieger, William (A)
Riley, Conrad D. (A)
Roberts, Horace, Jr. (A)
Robinson, Jos. M. (A)
Rose, Arthur F. (M)
Rose, Charles F. P. (A)
Rose, John A. (A)
Rossi, Ralph J. T. (A)
Ryan, Francis M. (M)
Sacia, C. F. (A)
Sadick, Abraham I. (A)
Salzberg, Bernard (A)
Samuel, Arthur L. (A)
Samuels, George J. (A)
Sanborn, John W. (A)
Sandretto, Peter C. (A)
Santos, Anthony S. (A)
Sargeant, Charles E. (A)
Sarnoff, David (F)
Schanz, John A. (A)
Schechter, Jack (A)
Schelleng, John C. (F)
Schmied, James W. (A)
Schneider, Robt. E. (A)
Schneider, W. A. (M)
Schnoll, Nathan (A)
Scholle, Frederick (A)
Scholz, Carl E. (M)
Schramm, Fred W. (A)
Scott, Herbert J. (A)
Searing, Hudson R. (A)
Selton, Edwin F. (A)
Seger, L. (A)
Seichter, Max (A)
Senauke, Alexander (M)
Shandy, George P. (M)
Shangraw, Clayton S. (M)
Shannon, Joseph H. (M)
Sherman, Jesse B. (J)
Shore, Henry (M)
Shute, Emmet R. (M)
Sigety, Louis (A)
Silberstein, Richard (A)
Singer, Emanuel (A)
Sivian, Leon J. (A)
Skirrow, John F. (M)
Sklar, H. Lee (A)
Slade, Benjamin (A)
Slater, Fred L. (A)
Smack, John C. (A)
Smith, Delmar E. (A)
Smith, Jesse H. (A)
Smith, K. R. (M)
Smith, Kenneth D. (A)
Smith, Samuel B. (A)
Smith-Hutton, H. H. (A)
Snow, William B. (A)
Sohor, P. H. (M)
Sonkin, David (M)
Soule, Harold (A)
Southworth, G. C. (M)

NEW YORK (Continued)

Speed, Russell B. (A)
Spence, P. W. (A)
Spitalny, Max (A)
Sprague, Clarence A. (M)
Stanford, Kenneth J. (A)
Starr, Alfred R. (A)
Stines, Charles H. (A)
Stone, Elery W. (F)
Strieby, Maurice E. (M)
Swain, Robert R. (A)
Sweeny, Carey P. (A)
Sykes, Roger A. (A)
Synnott, Burton (A)
Taussig, Charles W. (A)
Taussig, William S. (A)
Taylor, Alfred R. (A)
Taylor, Charles H. (F)
Taylor, E. Gordon (M)
Taylor, Edmund R. (A)
Taylor, S. Gordon (A)
Taylor, W. H., Jr. (M)
Teeter, Albert A. (A)
Texido, Platon (A)
Theremin, Leon (A)
Thielen, E. J. (A)
Thompson, Albert C. (A)
Thompson, Gordon (A)
Thomson, Howard M. (A)
Thropp, Charles H. (A)
Thurston, George (A)
Tierney, Walter L. (M)
Tinus, William C. (A)
Toth, Albert F. (A)
Towner, Orrin W. (M)
Townsend, Jas. H. (A)
Trago, Robert A. (A)
Travis, Charles (A)
Truax, John (A)
Tuel, A. Y. (A)
Turner, Alva (A)
Tuttle, Clarence W. (A)
Vaill, Edward W. (A)
Vanacore, Thomas (A)
Van Pelt, John (A)
Vansant, F. T. (A)
Vaughan, Carroll B. (A)
Vezzie, Edmund A. (A)
Velasco, Jose M. (A)
Venable, Richard N. (A)
Volkman, John E. (A)
Von Doenhoff, Albert E. (J)
Vreeland, F. K. (F)
Wald, David (A)
Wallach, Moses U. (A)
Waring, John T. (A)
Waterman, F. N. (M)
Waterman, William (A)
Webster, Bethuel M., Jr. (A)
Weiland, Christian F. (A)
Weiler, Harold (A)
Weinberger, Julius (F)
Weinhoepfel, Karl L. (A)
Weintraub, D. H. (A)
Weisbroth, Sam (A)
Wendell, Edward N. (A)
Whitmer, Robt. M. (A)
Whittemore, L. E. (F)
Wilbur, Edwin C. (A)
Willard, Gerald W. (A)
Willhoff, F. O. (A)
Williams, Howard F. (A)
Willis, F. H. (A)
Wilmotte, R. M. (M)
Wilson, Donald B. (A)
Wilson, H. Warden (A)
Wilson, Leon T. (M)
Wilson, William (F)

Winner, Lewis (A)
Winterbottom, William A. (M)
Wintringham, William T. (A)
Woodcock, N. A. (A)
Woodrow, William (A)
Woodward, John D. (A)
Wrathall, L. R. (A)
Wright, Harry M. (A)
Wright, William S. (A)
Wunderlich, H. A. F., Jr. (A)
Wunderlich, Norman E. (M)
Wynne, Walter M. (A)
Yeutter, C. S. (A)
Young, Owen D. (F)
Youngstrom, Nels C. (A)
Niagara Falls
Günther, George (A)
La Mantia, Philip V. (J)
Lidbury, F. A. (A)
North Pelham
Looney, Lester A. (A)
Siebert, Geo. W., Jr. (A)
North Tarrytown
Lazarus, Benj. N. (A)
Sandalls, Geo. T., Jr. (A)
North Tonawanda
Closson, Luke E. (A)
Hayes, Wilber A. (A)
Hesse, Henry R. (A)
Wesselman, Eugene (A)
Nyack
Stansbury, Mervyn L. (A)
Orient
Vail, Leslie G. (A)
Ossining
Akin, Robt. M., Jr. (A)
Gowen, Robert F. (M)
Ozone Park, L.I.
Bulzoni, Albert L. (J)
Eklund, Gus (A)
Necker, E. J. (A)
Weilminster, Charles (A)
Pearl River
Baker, Carl I. (M)
Pelham
Kolb, Walter R. (A)
Pelham Manor
Kelly, Dale (A)
Lewis, F. W., Jr. (A)
Trowbridge, O. H. (A)
Poland
Prentiss, Howard H. (A)
Port Jefferson, L.I.
Carter, Philip S. (A)
Dow, Orville E. (A)
Hansell, Clarence W. (M)
Port Jervis
Gibbons, Joseph W. (A)
Rutan, Paul D. (J)
Port Washington, L.I.
Fultz, Miles E. (A)
Hafner, Gilbert (A)
Poughkeepsie
Boyle, Frank A. (A)
Fischer, Fred F. (A)
Wood, Raymond A. (A)
Queens Village, L.I.
Sypher, Edgar L., Jr. (A)

Rego Park, L.I.
Günther, Frank A. (M)
MacDonald, Wm. W. (A)
Rhinebeck
Lang, Walter T. (A)
Richmond Hill, L.I.
Beach, Ernest W. (A)
Berry, Finley L. (A)
Gordon, Malcolm J. (A)
Grebe, Alfred H. (F)
Heins, Henry F. (A)
Jacobs, Frank (A)
Leyh, William D. (A)
Meacham, J. F. B. (A)
Oram, Donald K. (A)
Palasky, Harold (A)
Saphir, Frank (A)
Siemens, R. H. (A)
Weinwurt, Robert (A)
Riverhead, L.I.
Ashmore, J. W. (A)
Bond, Elmer F. (A)
Braaten, Arthur M. (A)
Callahan, Edward P. (A)
Crosby, Murray G. (A)
George, Ralph W. (A)
Goddard, Dewitt R. (A)
Lindow, Irving L. (A)
Matthews, Walter I. (A)
Morris, Hedley B. (A)
Opperman, Kurt (A)
Peterson, Harold O. (M)
Rundquist, Elliot C. (A)
Schock, Robert E. (A)
Schoenborn, F. (A)
Simpson, Stephen H., Jr. (A)
Smith, Arthur Z. (A)
Stagg, Carl (A)
Trevor, Bertram (A)
White, Nathaniel (A)
Wickizer, Gilbert S. (A)
Winans, Paul V. (A)
Rochester
Albright, Gordon E. (A)
Anderson, Roy S. (J)
Bachofer, C. Leonard (A)
Balling, Alfred W. (A)
Brown, Gordon P. (A)
Brown, Howard A. (A)
Bullis, Ormond P. (A)
Dwyer, Vincent J. (A)
Esten, Perry W. (A)
Friedler, Dewey P. (A)
Gardner, Kenneth J. (A)
Gordon, Harry E. (A)
Graham, Virgil M. (M)
Greenman, Roger B. (A)
Hanover, Edward A. (A)
Harrison, Walter M. (J)
Hitchcock, Joseph F. (A)
Huntington, Maurice B. (A)
Kaiker, Earl C. (A)
Klumb, Harvey J. (A)
Lawrence, Henry E. (A)
Levy, Maurice L. (A)
Malone, Walter J. (A)
Manson, Ray H. (F)
Marsh, Albert H. (A)
Martin, V. G. (A)
McCanne, W. Roy (M)
Moxon, Alfred W. (A)
Newton, William E. (A)
Norris, Edward I. (J)
Prickett, Norman R. (A)
Schneider, Mendell (A)
Schoen, Arthur L. (A)
Seoville, George A. (A)

NEW YORK (Continued)

- Soderholm, Arthur E. (A)
Tarrant, Samuel E. (A)
Welsh, Fred E. (A)
Wiebach, William T. (A)
Wishart, William R. (A)
Wood, Merrill A. (A)
Worrell, Richard A. (A)
- Rockville Center, L.I.
Cardwell, Allen D. (A)
Fluharty, Wm. G. (A)
Hinnners, Frank A. (F)
Schabbehar, Edwin A. (A)
Stewart, G. Edwin (A)
Weeks, Norman E. (A)
- Rocky Point, L.I.
Boerner, Thomas J. (A)
Clifton, B. S. Y. (M)
Conklin, James W. (A)
Draigh, Canton V. (A)
Goldstine, Hallan E. (A)
Goodfellow, David H. (A)
Henry, R. S. (A)
Meola, Thomas D. (A)
Peterson, Lloyd E. (A)
Usselman, George L. (A)
- Rome
Fitch, J. Alton (A)
- St. Albans, L.I.
Baldwin, Chester P. (A)
Barth, Bruno B. (A)
Ehlert, Fred C. (A)
Grainger, Maurice J. (A)
- St. George, S.I.
Dinsdale, Alfred (M)
Rodwin, George (A)
- St. James, L.I.
Flathman, Edward (J)
- Saranac Lake
Riddle, William E. (A)
Watts, E. Gerald (A)
- Sayville, L.I.
Hart, Frank A. (A)
Moser, William E. (A)
- Scarsdale
Appel, Jos. H., Jr. (A)
Drew, Charles E. (M)
Herdman, Raymond C. (A)
- Schenectady
Acheson, Marcus A. (A)
Alexanderson, E. F. W. (F)
Andrews, Paul D. (M)
Anson, C. T. (A)
Ayer, Raymond B. (A)
Becker, Stewart (A)
Berejkoff, Anatol P. (A)
Berg, Ernest J. (A)
Brockman, Francis C. (A)
Broughton, W. G. (A)
Brown, William W. (M)
Cottrell, McKenzie (A)
Crippen, Eugene C. (A)
Crosby, Howard M. (A)
Darlington, Eugene S. (A)
David, William R. (A)
De Nardo, Federigo (A)
Dewalt, K. C. (A)
Dickinson, Theo. M. (A)
Dodge, Albert O. (A)
Dome, Robert B. (A)
Durkee, K. M. (A)
Eldridge, F. B. (A)
Eveleth, Laurence Nelson (A)
- Farrell, John J. (A)
Fitch, William A. (A)
Ford, Warren A. (A)
French, Henry G. (A)
Frink, Frederick W. (A)
Fritschel, Eugene H. (A)
Frost, E. (A)
Fulton, R. (A)
Fyler, George W. (A)
Graf, Alois W. (A)
Grover, F. W. (M)
Hall, Whitman N. (A)
Henyan, George W. (A)
Hoxie, Charles A. (A)
Jacklin, Norman L. (A)
Jackson, Henry W. (M)
Johnson, T., Jr. (M)
Kaar, Ira J. (M)
Larson, Robert W. (A)
Lynn, L. H. (A)
Marvin, Harry B. (M)
Maser, Harold T. (A)
Maynard, J. E. (A)
Mead, Milton S., Jr. (A)
Meahl, Harry R. (A)
Moles, Frank J. (A)
Mullaney, Dudley A. (A)
Nelson, Walter H. (A)
Newton, Raymond A. (A)
Nickle, Emil G. (A)
Nixdorff, Samuel P. (M)
Nolte, Henry J. (A)
Palermo, A. J. (A)
Patterson, Franklin G. (A)
Pike, Otis W. (M)
Powles, Frederick T. (A)
Priest, Conan A. (A)
Rice, Chester W. (F)
Rossman, Donald V. O. (A)
Rowe, Hobart E. (A)
Schwenker, Alfred H. (A)
Serrell, Robert (A)
Simpson, Leroy C. (A)
Smith, Harold A. (A)
Smith, Richard L. (A)
Snyder, Norman (M)
Spitzer, Edwin E. (A)
Taylor, Laurens A. (A)
Taylor, Samuel (A)
Towson, Harold G. (A)
Tucker, William E. (A)
Van Alstyne, A. J. (A)
Watts, D. E. (A)
Weir, Irwin R. (A)
Westendorp, W. F. (A)
White, William C. (M)
Williamson, R. H. (A)
Woodworth, John L. (A)
Young, Charles J. (A)
- Scottia
Clarke, Varro J. (A)
Cummings, Alan P. (A)
Fick, Clifford G. (A)
Jensen, Richard C. (A)
Leibing, Joseph K. (A)
Richardson, L. Walton (A)
Roder, Hans (M)
Schwarzaupt, Paul J. (M)
Smith, H. Millard (A)
Steiner, Harry C. (A)
Yerian, Carlos S. (A)
- Sea Cliff, L.I.
Mickelson, C. D. (A)
- Sidney
Wilber, Delbert J. (A)
- Skaneateles
Roberts, Edward (A)
- Slaterville Springs
Bull, Edward M. (A)
- Snyder
Ellinger, Albert E. (A)
- Southampton, L.I.
Buckingham, Wm. D. (A)
Hayes, James D. (A)
Hayward, Walter (A)
Homer, Edward C. (A)
Lee, Walter O. (A)
Millar, J. Z. (A)
Pollard, Leon G. (A)
Weik, Adolph L. (A)
- South Richmond Hill, L.I.
Kahn, Alfred (A)
- Springfield Gardens, L.I.
Graf, William (A)
- Stafford
Sheffer, Olan N. (A)
- Stapleton, S.I.
McArdell, Wesley E. (A)
- Staten Island
De Rosa, Louis A. (J)
White, Joseph P. (A)
Wissmann, Jos. T. (A)
- Suffern
Ennis, Fred E. (A)
- Sunnyside, L.I.
Forrest, Gerard E. (A)
- Syracuse
Blaich, J. Ray (A)
Hall, Victor E. (A)
Hild, George E. (A)
Martin, George L. (A)
Mullin, Leroy A. (A)
Nicholson, E. J. (A)
Porter, R. A. (A)
Potter, Melville R. (A)
Randall, Dorus P. (A)
Woodworth, Samuel (A)
- Tonawanda
Maxwell, George G. (A)
Moersfelder, Herbert L. (A)
White, J. W. (A)
- Troy
Hadley, Raymond F. (A)
Harris, Hiram D. (A)
Lavender, Raymond W. (J)
Rives, Frank M. (A)
Warner, Sydney E. (A)
- Tuxedo Park
Loomis, Alfred L. (M)
- Ulster Park
Wickery, John B. (A)
- Utica
Allen, Raymond H. (A)
Howlett, Chas. A., Jr. (J)
King, Francis N. (A)
Lockner, J. Glynn (A)
Lott, Harry H. (A)
Steates, E. Francis (A)
Terrill, W. Nessler (A)
- Water Mill, L.I.
Corwith, Howard P. (M)
- Watervliet
Barron, Alfred (A)
- Waverly
Redington, Edmund B. (A)
Sosnoski, Walter J. (A)
- Westbury, L.I.
Eldredge, Earle E. (A)

NEW YORK (Continued)

- West Hempstead, L.I.
Magness, Scott A. (A)
- West New Brighton, S.I.
Bedford, George W. (A)
Langhammer, Charles F. (A)
- West Point
Gillette, E. C., Jr. (A)
Serig, Howard W. (A)
Willis, James S. (A)
- White Plains
Arcand, Wilfred E. (J)
Bailey, William M. (M)
Griggs, Elmer V. (A)
Halstead, Wm. S. (A)
Lamarque, Jas. W. (A)
Minton, John (F)
- Whitestone, L.I.
Lederhaus, Herman William (A)
Summers, Llewellyn L. B. (A)
- Williamsville
Hopkins, Nelson S. (A)
- Winfield, L.I.
Haug, Joseph (A)
- Woodhaven, L.I.
Cooper, Gustavus A. (A)
Leuteritz, Hugo C. (A)
- Woodmere, L.I.
Birkhahn, Robert C. (A)
Warren, Charles F., Jr. (A)
Ziegler, Frederick J. (A)
- Woodside, L.I.
Asch, Marcus (A)
Goldner, Jack H. (A)
Haas, Paul (A)
Rettenmeyer, Francis X. (M)
Reuman, William H. (A)
Schmidt, Erwin (A)
Valentine, Russell D. (A)
- Yonkers
Craig, Albert C. (A)
Enders, Charles F. (A)
Grey, Charles C. (A)
Petersen, Robert L. (A)
Rollo, W. Smith (A)
Rudove, A. J. (A)
Runyon, Carman R., Jr. (A)
Seitz, Frank A., Jr. (J)
Van Dyck, Arthur F. (F)
- NORTH CAROLINA
Chapel Hill
Bernstein, Julius (A)
Charlotte
Gluck, E. J. (A)
Durham
Seeley, Walter J. (A)
Fort Bragg
Allen, Otis T. (A)
Gastonia
Morris, Robert S. (A)
Henderson
Woolard, E. W. (A)
Highlands
McCarty, Sidney L. (A)
Marion
Martin, Hubert C. (A)
Pittsboro
Roberson, Robert E. (J)
- Raleigh
Massey, Andrew (A)
- Saluda
Johnson, Roy L. (A)
- Tarboro
Shaw, H. B., Jr. (A)
Winstead, Theo. B. (A)
- Washington
Jowdy, Mitchell (A)
- Winston-Salem
Hedrick, Phil F., Jr. (A)
Lee, Douglas J. (A)
- NORTH DAKOTA
Bismarck
Lucas, Stanley M. (A)
- Fargo
Hetland, Julius M. (A)
Michael, David F. (A)
Olson, Martin N. (A)
Payne, J. Fred, Jr. (J)
- Grand Forks
Dettman, Robert A. (J)
Garard, Earl A. (A)
Jenkins, David R. (A)
- Langdon
Charrier, George M. (A)
- Mandan
Richardson, Otto H. (A)
- OHIO
Akron
Aitkenhead, John, Jr. (A)
Campbell, O. V. (A)
Curtis, James O. (A)
Dinger, Harold E. (A)
Hood, Norman R. (A)
Kappus, Paul B. (A)
Nerhood, H. Elmer (A)
Palmer, Roland F. (A)
Smith, Paul Clarence (A)
Townsend, S. W. (A)
Weaver, Rayman E. (A)
- Ashtabula
Andrus, Roy E. (A)
- Athens
Green, Darrell B. (A)
- Barberton
Austin, A. O. (F)
Hillebrand, W. A. (M)
Snyder, E. B. (M)
- Bellefontaine
Wells, Martin M. (A)
- Berea
Anderson, Raymond T. (A)
- Blanchester
Saville, Homer F. (J)
- Blue Ash
Chapman, Robert T. (A)
- Bluffton
Steiner, Harold R. (A)
- Brecksville
Lefler, Ralph H. (A)
- Cambridge
Nelson, R. G. (A)
- Canton
Herbruck, Wm. M. (A)
Leist, Lowell G. (A)
Weckel, Wilson E. (A)
- Cincinnati
Aughenbaugh, William K. (A)
Austin, Edward (M)
- Boyle, H. G. (A)
Bussard, E. J. II. (M)
Chamberlain, Paul (A)
Chambers, Jos. A. (M)
Craig, Palmer H. (A)
Crosley, Powell, Jr. (M)
Crowe, Merwin E. (A)
Drake, Robert L. (A)
Felix, Clarence G. (A)
Glessner, Jack M. (A)
Gohsen, Richard C. (A)
Grosselinger, W. H. (A)
Heina, William M. (A)
Hentz, Elmer G. (A)
Hoffman, Ralph (A)
Johnston, F. E. (M)
Kellogg, Leonard A. (A)
Kesheimer, Eugene V. (A)
Kidd, Andrew (A)
Kierulff, William E. (M)
Kilgour, Charles E. (M)
Klein, Helen (A)
Kolks, Richard H. (A)
Lampkin, Guy F. (A)
Lehnhoff, Raymond G. (A)
Leibrock, Brice (A)
Lockwood, E. C. (A)
Magly, John W. (A)
Marshall, Charles J. (J)
Meyrose, Hubert S. (A)
Myers, William H. (A)
Osterbrook, W. C. (A)
Parkhurst, Austin F. (M)
Peterson, Charles W. (M)
Platts, George F. (A)
Rockwell, Ronald J. (M)
Stocker, Harold C. (A)
Valentine, Forrest C. (A)
Vanek, Lawrence J. (A)
Verkley, B. M. (A)
Vickers, C. A. (A)
Vogelsang, Geo. E. (A)
- Clayton
Jones, Carl C. (A)
- Cleveland
Ackerman, E. K. (A)
Akers, William F. (A)
Alston, Vernon C. (A)
Baldwin, Preston De Grauw (A)
Benkelman, Glen F. (A)
Benzon, C. G. (A)
Bowditch, Fred T. (A)
Bowman, Leon F. (A)
Butler, Roy (A)
Calkins, William G. (A)
Canady, Donald Ray (A)
Carlton, Raymond A. (A)
Curl, Van C. (A)
David, Bruce W. (M)
Daymude, John F. (A)
Disbrow, John D. (A)
Domizi, Dante (A)
Donaldson, Robt. O. (A)
Dorazil, A. F. (A)
Dorn, Harry P. (A)
Eberle, Wilbert H. (A)
Engholm, Bernard A. (M)
Gay, Paul Stead (A)
Gorecki, Joseph M. (J)
Gove, Edward L. (A)
Hannum, J. C. (A)
Hunt, Louis W. (A)
Jenkins, Myron Z. (A)
Kaehni, Frank J. (A)
Kintner, Deane S. (A)
Klein, Israel (A)

- OHIO (Continued)**
- Leonard, S. Edwin, Jr. (A)
 Little, D. S. (A)
 Lyle, Charles F. (J)
 McCall, Keith E. (A)
 McMahon, Alvin (A)
 Neuert, H. L. (A)
 Newman, Joseph S. (A)
 Okeson, Hugh B. (A)
 Owens, Richard M. (A)
 Pruitt, Wilbur C. (A)
 Read, George T. (A)
 Roddy, Vincent S. (A)
 Roebuck, Neel (A)
 Ryder, Jack D. (A)
 Schneberger, G. B. (A)
 Schregardus, Dirk (A)
 Scott, Hoyt S. (M)
 Seitz, Valentine (A)
 Shankland, Robt. S. (A)
 Smith, Sereno E. (A)
 Snyder, Robert E. (A)
 Victoreen, John A. (M)
 Sturtevant, Mark (A)
 Ward, Donald O. (A)
 Welman, Victor A. (A)
 Woodward, V. M. (A)
 Worst, J. S. (A)
 Zinser, Henry (A)
- Cleveland Heights**
 Baier, Arthur H. (A)
 Farnham, Ralph E. (A)
 Ostrander, Russell S. (J)
 Williams, Hollie (A)
- Clyde**
 Last, George O. (A)
- Columbus**
 Beer, Richard M. (A)
 Bidlack, Cecil S. (A)
 De Weese, Herbert William (A)
 Everitt, William L. (M)
 Higgy, Robert C. (A)
 Johnston, Geo. D. (A)
 Morgan, Ben A. (A)
 Roberts, Sheldon (A)
 Smith, Carl E. (A)
 Storck, Howard C. (A)
 Young, D. A. (A)
- Conneaut**
 Hirsimaki, Eeli N. (J)
- Copley**
 McKim, Royal W. (A)
- Custar**
 Talmage, Wilbur L. (A)
- Cuyahoga Falls**
 Makinson, Grant E. (A)
- Dayton**
 Anderson, J. E. (A)
 Apuli, John Arne (A)
 Barbulesco, Constantin D. (M)
 Bell, Floyd W. (A)
 Bickel, Howard I. (A)
 Bossard, Gishbert L. (M)
 Braden, Paul F. (J)
 Brump, H. L. (A)
 Byrd, Nevin C. (A)
 Coe, James C. (A)
 Colvin, Raymond A. (A)
 Cooper, William H. (A)
 Copp, Roy S. (A)
 Cotter, Edwin M. (A)
 Desch, Joseph R. (A)
 Eaton, W. G. (M)
 Eckert, Clarence C. (A)
 Filgate, John T. (A)
- Forbes, Henry C. (M)
 Franzwa, F. J. (A)
 Friedman, Harry (A)
 Gerstle, John (A)
 Glendenning, D. B. (A)
 Harmon, W. S. (A)
 Hendricks, Lester A. (A)
 Jackson, Paul F. (A)
 Kronenwetter, Harold G. (A)
 Leeka, Warren C. (A)
 Lohmann, Robert S. (A)
 Messer, Herbert G. (A)
 Mumma, Robert E. (A)
 Neilson, N. Smith (A)
 Nichols, Harry J. (A)
 Noyes, Robert H. (A)
 Peoples, Archie G. (A)
 Retter, Cleo T. (A)
 Richmond, L. P. (A)
 Rives, Tom C. (M)
 Sawtell, Raymond I. (A)
 Stelzer, Alphonse C. (A)
 Sweighert, D. V. (A)
 Tholstrup, Henry (A)
 Zimmerman, Robt. F. (A)
- Delaware**
 Stetson, Harlan T. (A)
- Dover**
 Weber, H. S. (A)
- East Cleveland**
 Beasley, Ira E. (A)
 Shipman, Charles H. (A)
 Siddall, Richard (A)
- East Sparta**
 Walker, Nolan S. (A)
- Elyria**
 van der Woude, Fritz (A)
- Fremont**
 Reynolds, Clay E. (A)
- Gambier**
 Cottrell, Casper L. (A)
 Jaues, Robert B. (A)
- Greentown**
 Myers, Willard D. (A)
- Greenville**
 Taylor, Otho E. (A)
- Hamilton**
 Norton, Thurman S. (A)
 Probst, John E. (A)
- Holland**
 Line, F. M. (A)
- Indian Lake**
 Thomas, W. Raymond (A)
- Ironton**
 Loftis, Homer J. (A)
- Kent**
 Kline, Robert L. (A)
- Killbuck**
 Hammontrce, Alvin W. (A)
- Lakewood**
 Barone, Salvatore A. (A)
 Hamman, G. B. (A)
 Hanson, Earl C. (A)
 Hoff, Henry B. (J)
 Marsal, Paul A. (A)
 Pierce, R. Morris (A)
 Salmons, George C. (A)
 Sturtevant, Jas. W. (A)
 Thompson, J. Kent (A)
 Worden, Ralph P. (A)
- Lexington**
 Shuler, John H. (A)
- Lorain**
 Fox, Robert A. (A)
- Louisville**
 Noreen, Carl O. (A)
- Marietta**
 Muscari, Pietro J. C. (A)
- Mason**
 Whitehouse, Jos. E. (A)
- Massillon**
 Ax, Leland S. (A)
 Schwab, Charles B. (A)
- Maumee**
 Rowe, Horace N. (A)
- Medina**
 Kohli, Homer J. (A)
- Mingo Junction**
 Crisante, Aldo (A)
- Mount Gilead**
 Ashbaugh, Edwin C. (A)
- Mount Liberty**
 Bishop, Chester K. (A)
- New Philadelphia**
 Murray, Charles J. (A)
 Nolan, John M. (A)
- Niles**
 Coleman, Robert M. (A)
- North Canton**
 Boger, Clair E. (A)
- Norwalk**
 Leonhardt, Chas. C. (A)
 Walsh, Sam Charles (A)
- Norwood**
 Blair, Russell M. (M)
 Dwyer, Robert J. (A)
 Stautner, Paul L. (A)
 Willging, Louis F. (A)
- Osborn**
 Killheffer, Lawrence D. (A)
- Port Clinton**
 Anderson, Gilbert J. C. (A)
- Portsmouth**
 Brake, Basil H. (A)
 Byers, James Clifton (A)
 Jackson, Sylvan E. (A)
- Roseville**
 Sagle, R. E. (A)
- Sandusky**
 Voight, Richard J. (A)
- Shiloh**
 White, Kenneth E. (A)
- Springfield**
 Bushong, Victor L. (A)
 Morrow, Lorentz A. (A)
 Reid, Thomas A. (A)
 Schaefer, Carl A., Jr. (A)
 Snyder, Ellsworth W. (A)
- Toledo**
 Barris, H. Allen (A)
 Bitter, A. Romeyn (A)
 Browne, Merton S. (A)
 Dupuis, Ernest F. (J)
 Foley, J. W. B. (A)
 Pilzecker, Arthur (A)
 Skeels, Dudley K. (A)
 Stringfellow, Wm. (A)
 Underwood, Norman B. (J)
- Wapakoneta**
 Copeland, Herman A. (A)
- Westerville**
 Nafzger, Lester H. (J)

- OHIO (Continued)**
- Youngstown**
 Kincaid, Owen D. (A)
 Kratz, Luther M. (A)
 Pennock, P. L., Sr. (A)
 Phillips, R. G. (A)
 Wilkens, Bernard T. (A)
- OKLAHOMA**
- Bartlesville**
 Eastman, Fred T. (A)
 Miller, Erdene K. (A)
- Boise City**
 Abshere, Lilburn O. (A)
- Coalgate**
 Parkinson, Lee D. (A)
- Chelsea**
 Jones, Varnakale L. (A)
- Enid**
 Edwards, Lyman M. (A)
 Spear, Wade H. (A)
- Fort Sill**
 Beckley, S. A. (A)
 Potetz, Daniel P. (A)
- Oklahoma City**
 Allen, Roy (A)
 Bathe, Charles E. (A)
 Chapman, Alan B. (A)
 Downey, C. E. (A)
 Ehret, Kenneth M. (A)
 Herrmann, Frank (A)
 Kramer, V. J. (A)
 Lovell, Herman J. (A)
 Marrinan, Horace J. (J)
 Mier, C. W. (A)
 Pata, Yaromir J. (A)
 Prell, George R. (A)
 Sears, Garold D. (J)
 Shaw, Dudley (M)
 Wallace, David R. (A)
- Okmulgee**
 White, R. Jordan (A)
- Shawnee**
 Barron, Arthur J. (A)
- Stillwater**
 Oboukhoff, Nicholai M. (M)
- Tulsa**
 Banks, J. Vernon (A)
 Bowen, Leonard R. (A)
 Carpenter, Hugh (A)
 Green, W. G. (A)
 Jones, Burle R. (A)
 McNally, Eugene C. (J)
 Probert, Edward (A)
 Roach, Harry J. (J)
 Stinson, Lawrence W. (A)
 Van Doeren, C. A. (A)
 White, Karl K. (J)
 Willson, P. L. (A)
 Wise, James O. (A)
- Tuttle**
 Coates, B. Franklin (A)
- Woodward**
 Shircliff, Emmett (A)
- OREGON**
- Bend**
 Beatty, Dwight L. (A)
- Corvallis**
 Albert, Arthur L. (A)
 Feikert, Grant S. (A)
 Jordan, Jacob (A)
 Klein, William S. (A)
 Morris, James M. (A)
- Freewater**
 Parr, Clifford (A)
- Medford**
 Rush, Floyd M. (A)
 Walker, Verl G. (A)
- Milwaukie**
 Perkins, Oliver D. (J)
- Multnomah**
 McAllister, Jas. D. (A)
- North Bend**
 Pickett, Earl L. (A)
- Portland**
 Cotton, Richard J. (A)
 Crupper, Homer L. (A)
 Deardorff, Ralph W. (A)
 Janacek, Karl R. (A)
 Kleist, Walter A. (A)
 Neubauer, Edwin W. (A)
 O'Day, Marcus (A)
 Olin, R. C. (A)
 Paul, Byron R. (A)
 Singleton, Harold C. (A)
 Trumbull, A. F. (A)
 Welbon, Roy E. (A)
- PENNSYLVANIA**
- Adelphi**
 Woodward, Bruce J. (A)
- Aldan**
 Earle, Ralph P. (A)
 Trauner, George T. (A)
- Alden**
 Cooley, Elihu H. (A)
- Allentown**
 Bowman, Chas. W. (A)
 Brown, Henry J. (A)
 Clauss, Fred W. (A)
 Eckert, Byron H. (A)
 Grammes, Clarence W. (A)
 Hardner, Francis J. (A)
 Hilliard, Winfield E. (J)
 Keck, Kenneth K. (A)
 Kurtz, Clyde R. (A)
 Lichtenwalner, Howard W. (J)
 Nadig, Stanton E. (A)
 Pond, E. W., Jr. (A)
 Sauerwine, Charles Augustus (A)
 Taylor, Russell R. (A)
 Thomas, Charles V. (A)
 Young, Charles S. (A)
- Allenwood**
 Schooley, Harold (A)
- Altoona**
 Douglas, Earl C. (A)
 Feld, John (A)
 Gable, Robert B. (A)
 Underhill, Charles R., Jr. (A)
- Ambridge**
 Svegel, Peter J., Jr. (J)
- Ardmore**
 Wilkinson, Gordon O. (A)
 Worrell, Howard S. (A)
- Avalon**
 Allen, James G. (M)
- Bangor**
 Bruschi, Lewis John (A)
- Bellefonte**
 Fritgen, Edward N. (A)
- Bellevue**
 Armor, James C. (A)
 Bonbar, C. Floyd (A)
- Bethlehem**
 Bertolet, Benneville S. (A)
 Hottel, C. W. (A)
 Knutson, Henry C. (A)
 Seyfert, Stanley S. (M)
- Bradford**
 Francis, Thomas C. (A)
- Brownstown**
 Harnish, Ray M. (A)
- Cambridge Springs**
 Lord, Harry R. (A)
- Carrolltown**
 Brophy, Francis Joseph, Jr. (A)
- Chester**
 Mitchell, John C. (A)
 Rapagnani, Peter A. (A)
- Chestnut Hill**
 O'Neill, John P. (A)
- Childs**
 Faling, Cecil L. (A)
- Clarks Green**
 Mack, Dahl W. (A)
- Connellsville**
 Craig, Jack (J)
 Silcox, Albert S., Jr. (A)
- Danville**
 Deaner, Haydon M. (A)
- Darby**
 Knight, Winfield W. (A)
- Drexel Hill**
 Brandt, William A. (A)
 Shafer, Albert G. (A)
 Sharpless, A. Roberts (A)
 Willard, Joseph M. (A)
- Duquesne**
 Murcek, S. J. (J)
- Easton**
 Beans, Floyd L. (A)
 Deutschman, Borah H. (A)
 Hatch, Ray D. (A)
- East Pittsburgh**
 Chubb, Lewis W. (M)
 Conrad, Frank (F)
 Evans, Walter C. (M)
 Hanna, Clinton R. (M)
 Hitchcock, R. C. (M)
 Kilgore, G. Ross (A)
 Kintner, Samuel M. (F)
 McKeel, P. De Forrest (A)
 Noble, Harrell V. (A)
 Osbon, William O. (A)
 Swedlund, Lloyd E. (A)
 Upp, Charles B. (A)
- Edgewood**
 Lewis, L. V. (A)
- Elkins Park**
 Herr, Bruce R. (A)
- Emporium**
 Ackman, H. E. (A)
 Hayward, John B. (A)
 Huchberger, Alfred P. (A)
 Jones, Walter R. (A)
 Klineshaver, Gordon H. (A)
 Miller, Carl (A)
 Rishell, George L. (A)
 Wilson, M. Dean (A)
 Wise, Roger M. (M)
- Eric**
 Jordan, Ralph E. (A)

PENNSYLVANIA (Cont.)

Metzner, Maxwell W. (A)
Perkins, Laurence M. (A)
Swaney, Bernard H. (J)
Etna
Johnstone, R. S. (A)
Exeter Boro
Ferroni, Joseph A. (A)
Flemington
Kunkle, Charles F. (A)
Fox Chase
MacFadden, Wilford C. (A)
Meriman, John C. (A)
Fullerton
Bachman, Edwin J. (A)
Germantown
Weyl, Charles N. (M)
Glenside
Leonard, A. A. (A)
Greensburg
Hawk, William K. (A)
Harrisburg
Bauer, Warren (A)
Beachley, Vance E. (A)
Detweiler, Jay E. (A)
Drumheiser, Andrew W. (A)
Gardner, Wm. L., Jr. (A)
Grim, Clare R. (A)
Hall, Thomas, Jr. (A)
Hardy, George E. (A)
Heckman, J. W. (A)
Knerr, G. Russell (A)
McCachren, W. S. (A)
Mummert, Russell E. (A)
Peffer, Ralph M. (A)
Penrose, L. A. (A)
Steiger, Charles H. (A)
Walanka, M. R. (A)
Highland Park
Greenwald, Arthur A. (A)
Holmesburg
Berrien, Paul H. (A)
Honesdale
Burlein, Lester F. (A)
Hummelstown
Cassady, P. H. (A)
Irwin
Brook, Alf (A)
Johnsburg
Baldwin, Arthur V. (A)
Carson, William G. (A)
Johnstown
Reid, A. J. (A)
Vaughan, Kenneth A. (A)
Kane
Beatty, Rue T. (A)
Keiser
Coroniti, Samuel C. (A)
Kingston
Brown, Ralph M. (A)
Kutztown
Sharadin, Francis A. (A)
Lancaster
Geise, Julius C., Jr. (A)
MacMillan, Wm. T. (A)
Snively, B. L. (A)
Stauffer, J. Luke (A)
Langhorne
Newbold, W. H. (A)
Lansdale
Schieber, Leonard B. (A)

Lansdowne
Kimball, Gardner W. (A)
Michaelis, H. Paul, Jr. (A)
Simons, Russell (A)
Thompson, Roland F. (A)
Lemoyne
Miles, Lester F. (A)
Smiley, William A. (A)
Media
Delbert, Simon, Jr. (A)
Merion
Dolan, William R. (A)
Milton
Butler, Wilson M. (A)
Minersville
Rothermel, Edwin F. (A)
Monessen
Parenti, Anthony M. (A)
Monongahela
McCallister, Jas. D. (A)
Morton
Greathhead, Arthur W. (A)
Mount Airy
Blackwood, Geo. C. (A)
Brown, Reynolds D., Jr. (A)
Ehret, Cornelius D. (F)
Ellinwood, Kenneth M. (A)
McDowell, Albert P., Jr. (A)
Raycroft, Louis B. F. (A)
Mount Carmel
Gross, Benjamin F. (A)
Narberth
Bates, Clifford W. (A)
Ford, John R. (A)
Lafore, John A., Jr. (A)
New Bethlehem
Collett, Paul (A)
New Castle
Martin, Norman A. (A)
New Cumberland
Fager, Bradford M. (A)
Newportville
Smith, Edgar H. (A)
Norristown
Davis, George C. (A)
Hausmann, Ernest O. (A)
Place, Samuel W. (A)
Sands, William F. (A)
Warren, George R. (A)
North East
Youngs, Howard E. (A)
Oak Lane
Sirms, Wiswald J. (A)
Oakmont
Best, Victor C. (A)
Oil City
Inler, Glenn M. (A)
Paca, William S. (A)
Rasmussen, Robert (A)
Palmyra
Balsbaugh, Clair L. (A)
Perkasie
Reichley, Charles A. (A)
Philadelphia
Airston, Alexander J. (A)
Apker, Charles L. (A)
Bartlett, Millard C. (A)
Bechler, W. C., Jr. (A)

Bell, George D. (A)
Benge, J. R. (A)
Bloom, Walter (A)
Bonn, Norman E. (A)
Bosco, Joseph F. (J)
Bowers, Frank L. (A)
Breuer, John (A)
Brewster, Grant (A)
Bromley, John E., Jr. (A)
Brown, H. Wilbur (A)
Burnside, Don G. (A)
Carpovale, Peter (A)
Chambers, Carl C. (A)
Clark, Charles F. (A)
Cohen, Fred (A)
Cordova, F. B. (A)
Cowles, E. E. (A)
Cummings, B. Ray (M)
Da Costa, Robt. C. (A)
Deal, Harmon B. (M)
Doyle, E. D. (A)
Dunn, James C. (A)
Earnshaw, David P. (A)
Eby, Hugh H. (A)
Eby, John B. (A)
Eckert, Edward J. (A)
Ellis, William G. (M)
Eskuchen, Frank G. (A)
Etkin, Harry (A)
Filderson, Joseph (A)
Fisher, Roy S. (A)
Fossett, Fred E. (A)
Frederick, Andrew (A)
Frederick, Calvin M. (A)
Freedman, H. J. (A)
Frigar, John, III (A)
Geist, Henry J. (A)
Gengenbach, Albert W. (A)
Giannini, Gabriel (A)
Gilbert, Walter E. (A)
Gillen, John James (A)
Godsho, Albert P. (A)
Guinan, John J. (A)
Guzik, Nicholas J. (A)
Hagan, Edward J. (A)
Haines, Joseph, Jr. (A)
Heitman, Charles E., Jr. (A)
Helfenstein, Edwin (A)
Higgins, Harold R. (A)
Hills, Jos. Melville (A)
Hofberg, Alf H. (A)
Holland, Walter E. (M)
Hollister, Kenneth R. (A)
Holtzler, Ralph M. (A)
Huttenloeh, Robt. M. (A)
Ingham, James, Jr. (A)
Karcher, Donald (A)
Karker, Anthony S., Jr. (A)
Kearney, L. E. (A)
Keller, Paul A. (A)
Kienzie, D. R. (A)
Kinnier, Donald (A)
Klenk, Julius G. (A)
Kurdziel, John F. (A)
Lodge, Edmund G. (A)
Long, Marvin (A)
Ludwig, Samuel C., Jr. (J)
Lyman, Harry J. (A)
MacHugh, Wm. L. (A)
MacNabb, Vernon C. (A)
Martino, Alphonso E. (A)
Mattia, Ralph F. (A)
Mayea, Lawrence E. (A)
Mayers, Harvey F. (A)
McIlwain, Knox (A)
Merkel, Henry F. (A)

PENNSYLVANIA (Cont.)

Mevius, John C. (A)
Miller, Charles C. (A)
Miller, John M. (F)
Miller, Joseph J. (A)
Morris, George W. (A)
Moss, Stanley A. (A)
Mouradian, H. (A)
Munton, John D. (A)
Murri, Joseph (A)
Packard, Charles A. (A)
Persons, Edgar N. (A)
Podolsky, Leon (A)
Ponsford, Walter W. (A)
Prow, Albert H. (A)
Rabinowitz, Meyer (A)
Reeves, E. H. (A)
Robinson, Aloysius V. (A)
Robinson, Harris A. (A)
Ross, Stewart C. (A)
Saunders, Wm. P. (A)
Senior, David B. (A)
Smuraglia, F. (A)
Snyder, Christopher L. (A)
Snyder, Richard L. (A)
Strassman, Irving (A)
Stroud, Ralph J. (A)
Suckle, Benj. W. (A)
Tarpley, Raymond E. (A)
Tarzian, Sarkes (A)
Traugott, Paul (A)
Trinkle, Wilmer S. (A)
Trumpy, Jay W. (J)
Tucci, Thos. Jos. (A)
Tuska, Clarence D. (A)
Van Horn, J. C. (M)
Walker, Harold (A)
Warren, S. Reid, Jr. (A)
Weise, Richard C. (A)
Williams, Albert J., Jr. (A)
Winchell, Walter H. (A)
Wockey, Peter F. (A)
Wolf, Clarence, Jr. (A)
Wood, Homer D. (A)
Woodcock, Thos. W. (A)
Youngblood, Isaac J. (A)
Phoenixville
Shuhart, John H. (A)
Pittsburgh
Baumgarten, Frank A. (A)
Buerger, Charles B. (A)
Buzzard, A. J. (A)
Clark, Clarence M. (A)
Clary, Howard L. (A)
Cruikshank, Omar T. (A)
Diamond, Hyman (A)
Dill, George C. (A)
Douglass, Edgar J. (J)
Douglass, Robert H. (A)
Goodboy, George O. (A)
Gorham, Robert C. (A)
Griffith, Roy T. (A)
Haller, George L. (A)
Krause, C. K. (A)
McKinley, J. G. (A)
Murray, A. H. (A)
Osborn, Perry H. (A)
Ostermeier, C. H. (A)
Overholt, Ralph, Jr. (A)
Peters, Leo J. (A)
Potter, William S. (A)
Reynolds, C. C. (A)
Richards, Folke (A)
Robin, Gilbert (A)
Roth, Albert (M)

Schlesinger, Louis B. (A)
Shafer, William L. (A)
Shreve, A. French (A)
Staege, Stephen A. (A)
Sunnergren, Arvid P. (A)
Taylor, Donald A. (A)
Templeman, David (A)
Tervens, Lewis A. (M)
Thompson, Reginald G. (A)
Wiesmann, E. T. (A)
Wyckoff, Ralph D. (M)
Pottstown
Fisher, Charles H. (A)
Mellon, Ralph E. P. (A)
Pottsville
McAllister, Ralph H. (A)
Quakertown
Bartholomew, Robert G. (A)
Leibe, Frank A. (A)
Reading
Albert, William V. (A)
Good, Horace D. (A)
Hornberger, Jos. E. (A)
Kissinger, J. Herbert (A)
Liesman, Francis J. (A)
Schock, Harvey H. (A)
Ridgway
Anderson, Thure C. (A)
Rosemont
Forstall, Edward L. (A)
St. Davids
Stewart, Charles H. (M)
St. Marys
Abbott, Harald W. (A)
Saxenburg
Stanier, Donald M. (A)
Schuylkill Haven
Eiler, Donald L. (A)
Schwenkville
Benner, Harold S. (A)
Scranton
Beizer, Harold (A)
Dolph, Stanley E. (A)
Irving, Ira M. (A)
Ornstine, Glenn C. (A)
Oschmann, Adolph W. (A)
Stevens, Wilbur C. (A)
Wilson, George H. (A)
Witkowski, Jos. F. (A)
Sharon
Rankin, Samuel A. (A)
Sharon Hills
Travis, Irven A. (A)
Slatington
Newhard, Stanley C. (A)
Smethport
Biever, Fred H. (A)
Pierotti, William L. (A)
Souderton
Frederick, Albert P. (A)
State College
Woodruff, Eugene C. (M)
Swarthmore
Fussell, Lewis (A)
Hayes, Ralph S. (A)
Swissvale
Bossart, Paul N. (A)
Carothers, William D. (A)
McL. (A)
Gregory, S. D. (A)
Lazich, Branko (A)
Shuey, Paul F. (A)
Whitelock, Leland D. (A)

Tamaqua
Delp, Paul L. (A)
Tarentum
Porter, Harry F. (A)
Trafford
Woodcock, Clay D. (A)
Trooper
Zern, Reber T. (A)
Tyrone
Kearney, Henry B., Jr. (A)
Upper Darby
Chamberlain, Newton M. (A)
Frazier, Howard S. (M)
Lenhart, George R., Jr. (A)
Lewis, Oliver I. (A)
Marsten, Jesse (M)
Mazik, John, Jr. (A)
Shannon, Frank J. (A)
Verona
Sheaffer, Charles T. (A)
Warren
Gruning, John E. (A)
Kieshauer, Fred E. (A)
Wayne
Adelberger, Paul J. (A)
Wesleyville
Dutton, George L. (A)
West Fairview
Ottey, Raymond B. (A)
West Manayunk
Sweeney, Harold V. (A)
West Oak Lane
Hettrich, John H. (A)
West Philadelphia
Caulton, Cyrus O. (A)
Eaton, Geo. W., Jr. (A)
Knoll, Lloyd M. (M)
Wilkes-Barre
Paessler, Robert T. (A)
Shuster, Edmund F. (A)
Speicher, Ellsworth J. (A)
Warner, Barney H. (A)
Wilkinsburg
Armstrong, Ralph W. (A)
Davis, Selden I. (A)
Dieffenbacher, C. C. (A)
Furth, Ernest L. (A)
Harmon, R. N. (A)
Harness, Leroy R. (A)
Johns, Francis J. (A)
Mag, Anthony (A)
Rosenfeld, Millard (A)
Schwarzenback, Earl E. (A)
Seaverson, Oswald I. (A)
Stoddard, Ralph N. (A)
Sutherland, Lee (M)
Trouant, Virgil E. (A)
Ulrey, Dayton (A)
Williamsport
Persio, Louis N. (A)
Petts, Ronald G. (A)
Swanson, Merrill J. (A)
Wilmerding
Irlam, William (A)
Simpson, Edmund H. (A)
Wynnewood
Secley, S. Ward (A)
York
Lever, Philip R. E. (A)
Weigel, Richard C. (A)

RHODE ISLAND

Cranston
Bargamian, John (A)
Brewster, O. H. (A)

East Providence
Andrews, Howard L. (A)
Ward, Chester W. (A)

Eden Park
Cumerford, Arthur S. (A)

Newport
McCandlish, B. V. (A)
Myers, Gilbert B. (A)

North Providence
Thomas, Harold (A)

Pawtucket
Appleby, Bertie (A)

Providence
Bellem, Lewis S., Jr. (A)
Huddy, Franklin S. (A)
Kraus, Charles N. (A)
Leibow, Saul A. (A)
Perron, Raymond T. (A)
Slocum, Walter E. (A)
Smith, Malcolm H. (A)
Wright, Marshall C. (A)

Woonsocket
Heroux, George A. (A)
Marier, Edward P. (A)
Massart, R. E. (A)
Teachman, Alfred E. (A)

SOUTH CAROLINA

Aiken
Terry, Laurence M. (A)

Anderson
Mitchell, John A. (A)

Charleston
Hooper, Albert (A)
Rucker, Frederick (A)

Clemson College
Garrison, Paul J. (A)
Tingley, Freeman T. (A)

Greenville
Reed, Pinckney B. (A)

Pomaria
Hipp, Richard, Jr. (A)

Spartanburg
Etheredge, George W., Jr. (A)

SOUTH DAKOTA

Brookings
Crothers, H. M. (A)

Lennox
Van Bockern, John H. (A)

Pierre
Craig, Robert B. (A)

Rapid City
Halley, Samuel R. (A)
Kammerman, John O. (A)

Sanator
Tilgner, Shelton R. (J)

Yankton
Bowyer, Robt. A., Jr. (A)
Seils, Harry A. (A)

TENNESSEE

Athens
Knight, Gaylord A. (A)

Bristol
Jellicorse, Harold L. (A)

Chattanooga
Eiselein, J. E. (A)
George, Everett E. (A)

Johnson City
Shamhart, Paul B. (A)

Knoxville
Adcock, S. E. (A)
Garant, Edward C. (A)
Sharpe, Milburne O. (A)

La Grange
Sims, James W. (A)

Memphis
Cowles, John W., Jr. (A)
Shafer, Arthur B. (A)
Slavick, Henry Wm. (A)

Nashville
Campbell, John S. (A)
Leftwich, E. H. (A)
Montgomery, L. H., Jr. (A)
Montgomery, William C., Jr. (A)
Randolph, George T. (A)

Saltillo
Berry, James S. (A)

TEXAS

Albany
Codington, Jerome H. (A)

Amarillo
Berg, Arthur A. E. (A)
Martin, J. Laurance (A)
Reville, T. A., Jr. (J)
Todd, William F. (A)
Wimberly, W. Ben (J)

Beaumont
Bryan, William J. (A)
Bush, Charles R. (A)
Daniels, Paul H. (A)
Gower, S. Gifford (A)
Green, John J. (A)
Knight, Charles (A)
Trevey, C. B. (A)

Brady
Stark, L. P. (A)

Brownsville
Crosas, Ernesto G. (A)
Jackson, Frank P. (A)

College Station
Dillingham, H. C. (A)

Corpus Christi
Dunn, Earl C. (A)
Lockhart, Hildred B. (A)
Nelson, C. L. (A)

Dallas
Adler, Benjamin (A)
Crabtree, Alfred E. (A)
Cullum, A. Earl, Jr. (A)
Ellis, W. C. (A)
Feickert, Carl A. (A)
Glass, Robert Z. (A)
Harrison, L. E. (A)
Hayes, Thomas P. (A)
Hull, Blake D. (A)
Jackson, N. H. (A)
Johnson, Wm. D. (A)
Lawther, Harry P., Jr. (A)
Lewis, William S. (A)
McDermott, Eugene (A)
Nolan, Arthur B. (A)
Rhodes, L. G. E. (A)
Rich, F. L. (A)
Sheffield, H. M. (A)
Sullivan, J. R. (A)
Tucker, Durward J. (A)

Unruh, Franklin T. (A)
Wilkinson, Lee A. (A)
Witty, W. M. (A)
Zeidlik, William J. (A)

Del Rio
Weldon, James O. (A)

Denton
Fain, Edgar A. (A)
Groves, Wayland M. (A)

El Paso
Harold, George (A)

Fort Worth
Abey, Robert E. (A)
Branch, William E. (M)
Carpenter, Chas. I. (A)
Currie, W. Otho (A)
Golder, Frank E. (A)
Palmer, James (J)
Stinson, Ronald C. (A)

Galveston
Dickey, J. W. (A)
Warren, Andrew J. (A)

Giddings
Biar, L. E. (A)

Houston
Carter, Wm. H., Jr. (A)
De Bardeleben, John F. (A)
Dupree, E. M. (M)
Hoskins, Laban A. (A)
Hunt, J. W. (A)
Machotka, Slavomir (A)
Meyer, J. M. (A)
Perlitz, W. H. (A)
Ricker, Norman H. (A)
Ritzau, K. (A)
Rodgers, H. C. (A)
Waters, James S. (A)
Wheeler, Harvey T. (A)
Wolf, R. C. (A)
Zimmerman, Geo. E. (A)

Kerens
Hulan, A. G. (A)

Lubbock
Abbutt, William H. (A)

Mount Enterprise
Furlow, John T. (A)

New Braunfels
Rompel, Walter A. (J)

Plano
Hays, Howard D. (A)

Port Arthur
Sims, Leonard H. (A)

Randolph Field
Muller, Carl W. (A)

Rockland
Wilson, S. Earle (A)

San Angelo
Jones, Frank M. (A)

San Antonio
Finter, Clyde V. (A)
Hallam, John T. (A)
Hyman, Kenneth R. (J)
Rayburn, Geoffrey D. (A)
Wall, Leavell D. (A)

Stamford
Billingsley, Jos. B. (A)

Temple
Lesikar, George (A)

Waco
Cole, Roy H. (A)
De Jarnette, W. Y. (A)

Wichita Falls
Ridling, Carroll W. (A)

UTAH

Ogden
Stanton, James M. (A)

Salt Lake City
Baldwin John M. (A)
Farnum, Willis H. (A)
Harris, Leland D. (A)
Lasky, Philip G. (A)
Peterson, Herbert C. (J)
Yeates, Ephraim Le Roy (A)

Spanish Forks
Fullmer, Don A. (A)

VERMONT

Barnet
Somers, Brock A. (A)

Brattleboro
Smith, Wolcott M. (A)

Northfield
Howes, Douglas E. (A)

Poultney
Westeren, Sidney E. (A)

VIRGINIA

Alexandria
Cooper, Donald H. (A)
Dowie, James A. (M)
Roesch, Robert E. (A)

Arlington
Dresser, O. C. (A)
Fredricks, John E. (A)

Cherrydale
Stokes, Howard S. (A)

Clarendon
Looney, Don B. (A)

Clifton Station
Harris, R. Turner (J)

Danville
Boland, John N. (J)
Clarke, Allen S. (A)

Farmville
Harrison, Charles W., Jr. (J)

Fort Meyer
Mason, Dale P. (A)

Hampton
Akre, Roland O. S. (A)

Herndon
Taylor, Eustace H. (A)

Louisa
Bullock, John W. (J)

Lynchburg
Heiser, Albert E. (A)
Henry, Neil E. (A)
Orth, John T. (A)

Norfolk
Foley, W. R. (A)
Kortes, George T. (A)
McFarland, D. C. (A)
Payette, Walter S. (A)

Portsmouth
Baart, John C. (A)

Quantico
Hawthorne, W. G. (A)
Mizell, M. H. (A)

Richmond
Auckerman, U. H. (A)
Eubank, Robert N. (A)
Harrison, William B., Jr. (A)
Havens, Wilbur M. (A)
Knapp, Gilbert P., Jr. (A)
Rosenberg, Bernard L. (A)

Steere, James A. (A)
Stephenson, Jos. W. (A)
Woods, David C. (A)

Roanoke
Avery, Robert D. (J)
Maddox, Francis E. (A)

Rosslyn
Billups, Robert W. (A)

WASHINGTON

Arlington
Murray, Henry (A)

Auburn
Nagata, Charles N. (A)

Bellevue
Voris, Don Lea (A)

Bremerton
Jorgenson, A. A. (A)
Cooper, Lowell (M)
Wilson, George F. (A)

College Place
Kretchmar, G. G. (A)

Edmonds
Hammond, W. Murray (A)
Leyda, George D. (A)

Everett
Eckstrom, Herbert E. (A)
Malnstrom, Helmer W. (A)
Sands, Leo G. (J)

Gig Harbor
Berkheimer, R. H. (A)

Mount Vernon
Hannaford, Harold W. (A)

Port Townsend
Mullaney, Harold F. (A)

Pullman
Hatfield, Lester N. (A)

Raymond
Wells, James E. (A)

Seattle
Austin, Leslie C. (A)
Bach, Roy O. (A)
Baker, Earl W. (A)
Begg, W. E. (A)
Berge, Sigfred F. (A)
Bouson, Herbert H. (M)
Brown, N. D. (A)
Burleigh, John A. (A)
Dailey, Arthur C. (A)
Du Marce, Herman (A)
Eastman, Austin V. (A)
Estes, Fred B. (A)
Fitzpatrick, Geo. W. (A)
Foster, Nick H. (A)
Francis, Oliver T. (A)
Gable, M. (A)
Gleason, Robert J. (A)
Gunston, A. D. (A)
Hackett, Paul J. (A)
Haig, James H. (A)
Halstead, Canute (A)
Hamlin, Frank E. (A)
Henrich, Walter A. (A)
Highleyman, Richard (M)
Huber, Louis R. (A)
Hurlbut, Harold C. (A)
Iversen, J. Vee (A)
Kraft, Vincent I. (A)
Layne, Frank C. (A)
Lischke, Carl C. (A)
Lovejoy, Edwin W. (M)
Martin, Perrin L. (A)
Mason, Howard F. (A)

Melang, Bjorn L. (A)
Menard, Alexis A. (A)
Mitchell, Walter L. (A)
Morris, James E. (A)
Neelands, F. J. (A)
Partello, Melville C. (A)
Pinkman, Herbert N. (A)
Renfro, Harold E. (A)
Robinson, A. K. (M)
Ross, J. D. (A)
Shepard, Wayne D. (A)
Smith, Oliver C. (A)
Tolmie, J. R. (A)
Urey, George M. (A)
Walker, Robert M. (A)
Williams, Chas. E. (M)
Willson, Abner R. (A)
Wiltse, George V. (M)
Wunningham, Harold W. (A)
Zalusky, Eugene R. (A)

Snohomish
Kester, Cecil D. (A)

Spokane
Drobigo, Leo (A)
Dunnigan, Frank A. (A)
Johnson, Carl A. (A)
MacLean, T. Wendell (A)
Prince, Frank W. (A)
Schanks, Maurice J. (A)
Storms, Henry J. (A)
Sutton, Robert B. (J)

Vancouver
Ryan, Lloyd F. (J)

Walla Walla
Lippincott, Elwood W. (A)

Wenatchee
Lanphere, Merle (A)
Nelson, Paul H. (A)
Moore, Thomas H. (A)
Morgan, John T. (A)

WEST VIRGINIA

Carolina
Royal, James E. (A)

Charleston
Berry, Henry P. (A)

Clarksburg
Chorpening, Geo. B. (A)
Koerner, Raymond S. (A)

Fayetteville
Goddard, John B. (J)

Hinton
Criser, Robert J. (A)

Huntington
Derond, Bernard (A)
Gilfilen, Louis J. (A)
Pfau, John A. (A)

Institute
Evans, James C. (A)

Kingwood
Michelson, Peter (A)

Morgantown
Colwell, Robert C. (M)

Wheeling
Bundy, Glen G. (A)
Weimer, Earl W. (A)

Williamson
Pirrotte, Pete (A)

WISCONSIN

Chilton
Gielhart, Bernard R. (A)

Eau Claire
Kovell, George (A)

WISCONSIN (Continued)
Langdell, Henry R. (A)
Nelson, Orrin B. (A)
Janesville
Lighty, Russell D. (A)
La Crosse
Jenks, Leslie E. (A)
Leeman, Alvin (A)
Van Loan, Cullen G. (A)
Lodi
Evert, W. E. (A)
Madison
Austin, Otto C. (A)
Bennett, Edward (F)
Brown, George H. (A)
Buchanan, Orrin R. (A)
King, Ronald (A)
Koehler, Glenn (A)
Manitowoc
Scholten, Charles H. (A)
Menasha
Peerenboom, Cyril A. (A)
Menomonie
Nathness, Semore T. (A)
Milwaukee
Bogenberger, John W., Jr. (A)
Borek, John J. (A)
Bratford, Charles P. (A)
Charbonneau, Allan P. (A)
Cordes, Edwin L. (A)
Deland, Robert E. (A)
Gainer, William P. (A)
Gellerup, D. W. (A)
Giard, E. A. (A)
Golding, Robert M. (A)
Halinton, Harry (A)
Hansen, Russell C. (A)
Hjermstad, Hans U. (A)
Holman, Henry (A)
Hostetler, Amos C. (A)
Hough, William E. (A)
Irving, Emmanuel (A)
Kaetel, Herbert C. (A)
Kaul, William (A)
Kelly, Daniel S. W. (A)
Kennedy, M. W. (M)
Kleist, Alfred H. (A)
Kruse, Charles C. (A)
Matthias, Lynn H. (A)
Nunn, E. D. (A)
Oetting, O. W. A. (M)
Pfeifer, Joseph W. (A)
Roser, Clarence O. (A)
Snead, Sam (A)
Stockle, Erwin R. (M)
Tagart, Sam W. (A)
Thomas, Morris W. (A)
Wareing, Herbert F. (M)
Weiss, Tobias (A)
Neenah
Ponto, Aaron E. (A)
Racine
Dally, Roy (A)
Host, Raymond H. (A)
Rewey
Carpenter, Archie V. (A)
Sheboygan
Peiler, Lawrence F. (A)
Stevens Point
Brickson, Herbert O. (A)
Spindler, Robert E. (A)
Superior
Bridges, W. C. (A)

Washington Island
Gunnlaugson, Jacob (J)
Waukesha
Hebal, William H. (A)
Wausau
Krueger, Otto J. (A)
Wauwatosa
Richardson, Marston S. (A)
West Allis
Meuer, Anthony G. (A)
Whitewater
Haag, Merlin W. (A)
WYOMING
Cheyenne
Fisher, Joseph J. (A)
Hungerford, N. C. (A)
Lawrenz, William (A)
Leland, Wallace H. (A)

ALASKA

Hannon, John P. (A)
Hoke, Vergne L. (A)
Maki, George J. (A)
O'Loughlin, Barth W. (A)
Teague, T. T. (M)

ARGENTINA

Acuna, Segundo P. (A)
Del Pozo, Luis (A)
Hayes, George W. (A)
Hoffman, Ross B. (A)
Malamphy, Mark C. (A)
Noizeux, Pierre (A)
Stevens, Archie M. (F)
Zuev, Vitaly V. (A)

AUSTRALIA

Adams, Charles H. (A)
Bailey, E. G. (A)
Bardin, William F. (M)
Barthold, Godfrey L. (A)
Bauer, A. T. (A)
Baxter, E. W. (A)
Bearup, T. W. (M)
Cherry, Richard O. (A)
Elliott, Frank E. (A)
Fisk, Ernest T. (F)
Fitts, Rupert A. (A)
Goldfinch, H. R. (A)
Grace, A. (A)
Green, Alfred L. (A)
Gronow, William R. (A)
Hayman, William G. (A)
Hooke, Lionel A. (M)
Hooper, Edgar M. (A)
Hutchings, Allan T. (A)
Israel, Bertram F. (A)
Jackson, Alfred C. (A)
Linnett, Douglas N. (A)
Maclurcan, Charles D. (A)
Malone, James J. (M)
Martin, A. F. (A)
Martyn, David F. (A)
McCullough, Geo. R. (A)
McDonald, Arthur S. (M)
McIntyre, Daniel G. (A)
Miller, Frances G. (A)
Mingay, O. F. (A)
Muuro, George H. (A)
Neve, Gordon H. (A)
Persson, Andrew R. (A)
Phillips, Frank A. (A)
Shepherd, Maxwell (A)
Skelton, Thomas H. (A)
Smith, Arthur C. (A)

Steane, G. W. (A)
Sutherland, George B. (A)
Sweeney, Walter M. (M)
Thompson, Cecil (A)
Wright, Eric P. (A)
Wyles, David G. (M)

AUSTRIA

Ehrlich, Karl (A)

BAHAMAS

Cruikshank, John M. (A)
Salter, David (A)

BARBADOS

Archer, Thomas A. (A)

BELGIUM

Embrechts, A. C. (A)
Philippson, Maurice (M)
Vanden Meersche, A. J. (A)
Van Meel, G. M. (A)

BERMUDA

Gady, John W. (A)

BOLIVIA

Houston, Philip M. (A)

BRAZIL

Barzee, George W. (A)
Borges, V. A. (A)
Braggio, J. C. (A)
Cesar, Amaral (A)
Freire, Alvaro (A)
Keir, John (M)
Lacombe, Carlos G. (A)
Da Silva Lima, Antonio C. (A)
De Oliveira, A. Menezes (M)
Pareto, Joao V. (A)
Weeden, Edward H. (A)

BRITISH GUIANA

Fung, John Hamilton (A)

BRITISH NORTH BORNEO

Wade, C. F. Newton (M)

CANADA**ALBERTA**

Clayton, William P. (A)
Duncan, James E. (A)
Field, Percy A. (A)
Freeman, John T. (A)
Maggs, Percy J. (A)
Ryley, Raymond (A)
Sturrock, S. B. (A)

BRITISH COLUMBIA

Bain, J. R. (A)
Barclay, Hugh N. (A)
Bunn, E. (A)
Filtess, Arthur W. (A)
Gilbert, George (A)
Hawkins, Leslie S. (M)
Insulander, Clarence H. M. (A)
Irvine, Basil (A)
Kitchin, J. E. (A)

BRITISH COLUMBIA (Continued)

Lapham, James B. (A)
Mawson, John T., Jr. (A)
Murdoch, G. (A)
Rose, F. W. (A)
Sealey, F. W. (A)
Thomas, Clarence W. (A)
Wong, C. Lindhymn (A)

MANITOBA

Bennett, Gordon S. (A)
Ellinthorpe, J. W. (A)
Grimes, H. B. (A)
Lee, Stanley A. (A)
Leitch, Donald J. H. (A)
McLaughlin, Harry R. (A)
Mills, Gilbert H. (A)
Pound, Harris D. (A)
Salton, Lynn V. (M)
Sinclair, D. B. (J)
Young, M. D. (A)

NEW BRUNSWICK

Foster, Leonard (A)
Stevens, Ronald C. (A)
Thorne, Frank D. (A)
Vaughan, Frank P. (A)

NORTHWEST TERRITORY

Hastings, K. Stuart (A)

NOVA SCOTIA

Martieu, C. H. O. (A)
Nelma, Arsene (A)
Pippy, George A. (A)
Starr, C. Harry (A)
Sutherland, A. (A)

ONTARIO

Ainsworth, A. L. (A)
Ainsworth, Harold (A)
Amos, William G. (J)
Anderson, J. F. (A)
Andres, Paul G. (A)
Bailey, Ambrose L. (A)
Baldwin, Charles O. (A)
Baldwin, George O. (A)
Barber, Walter G. (A)
Bayne, R. R. (A)
Bennett, Hugh (A)
Bergeron, Rosario (A)
Blackburn, Wesley (J)
Blakely, Robt. John (A)
Blessing, G. W. (A)
Bowers, E. J. (A)
Boyd, John W. G. (A)
Brown, Alvin H. (A)
Burrill, Charles M. (M)
Caton, William A. (A)
Choat, William F. (A)
Choate, Herbert R. (A)
Chipsham, K. M. (A)
Cluff, Harold D. (A)
Cochrane, Ian D. (A)
Cooper, Alfred S. (J)
Cooper, Ashton B. (A)
Cooper, J. R. (A)
Copeland, Wm. H. (A)
Creswick, E. A. (A)
Crofts, Cecil T. (A)
Cronk, Harold W. (A)
Dalton, F. K. (M)
Daly, Edmund (A)
Davis, Joseph A. (A)
De Grave, Claude (A)
Dewar, John A. (A)
Dibblee, John (A)

Dick, N. J. (A)
Diwell, Harry (A)
Doan, George F. (A)
Dow, John (A)
Dresser, Carl C. (A)
Dynes, Clarence W. (J)
Edes, Noel H. (A)
Edwards, Charles P. (F)
Emes, Karl C. (A)
Erwin, Raymond W. (A)
Evans, George L. (A)
Fichter, Ludwig (A)
Fiegehen, Maurice G. (A)
Field, George S. (A)
Footte, Geoffrey E. (A)
Ford, J. S. (A)
Fowler, Walter D. (A)
Fox, Florian J. (A)
Fraser, D. M. (A)
Gaby, Frederick A. (A)
Geiger, Douglas G. (A)
Geldert, George M. (A)
Gillingham, A. (A)
Goldhamer, Saul A. (A)
Goodspeed, Lynnore S. (A)

Graham, Burwell (A)
Grant, Eric A. (A)
Grant, Ingol M. (A)
Green, Garnett L. (A)
Gurd, Ronald H. (A)
Hackbusch, Ralph A. (M)
Hamilton, Henry E. S. (A)

Hayman, E. David (A)
Heilig, Carl G. (A)
Henderson, J. P. (M)
Hepburn, Dugald (M)
Hewson, J. H. (A)
Hill, Orville (A)
Hodsoll, Martin (A)
Hollinsworth, V. J. (A)
Holm, Henry R. (A)
Hunt, Bertram D. (A)
Irwin, L. D. (A)
Jackson, Leslie (A)
Kelterborn, W. H. (A)
Killem, Morris (A)
Kimble, Earle B. (A)
Kinnear, Donald R. (A)
Klingehoeffer, Royden H. (A)

Knight, Frank (A)
Kynnersley, Charles (A)
Laurie, William L. (A)
Leonard, Sydney L. (A)
Leslie, John M. (A)
Little, Reginald J. (A)
Little, W. C. (A)
Lowman, Claude (A)
Lowry, Charles A. (M)
Lundy, Stanley R. (A)
Mann, George F. (A)
Marsland, Stanley (A)
Maurer, J. P. (A)
McKichan, Donald B. (A)
McMillan, Donald B. (J)
McMurtry, Cyril A. W. (A)

Meredith, C. C. (M)
Mitchell, Leonard W. (A)
Mogridge, J. Nairn (A)
Montagnes, Henry (A)
Morton, Howard J. (J)
Mott, Harold E. (A)
Moultre, Frank C. (A)
Mullen, Joseph G. (M)
Nauth, G. Raymond (A)
Newman, John R. (A)
Nichlos, W. A. (A)
Northover, Harold W. (A)

O'Byrne, Bernard (A)
Olson, E. (A)
Oxley, Allan B. (A)
Paisley, S. Roy (A)
Patience, A. Melbourne (M)
Pelton, Cecil R. (A)
Pipe, Gordon E. (A)
Pollock, Alexander (A)
Pollock, C. A. (A)
Potter, N. M. (A)
Potter, Robert C. (J)
Poulter, Robert C. (A)
Pounsett, Frank H. R. (A)
Price, Harold W. (A)
Price, Lloyd M. (A)
Price, Roland J. C. (A)
Purser, D. E. (A)
Raycove, Soterious A. (A)

Richardson, Chas. L. (M)
Roedell, Leroy W. F. (A)
Rogers, Edward S. (M)
Rose, Sidney (A)
Rosebrugh, Thos. R. (A)
Rothera, W. F. (A)
Ruedy, Richard (A)
Rush, Walter A. (F)
Russell, Arthur H. K. (A)
Russell, W. G. (A)
Schwarz, Bertram A. (M)
Shane, William A. (A)
Smith, Arthur (A)
Smith, B. J. (A)
Smith, Benjamin F. (A)
Smith, C. C. (A)
Smith, Victor G. (A)
Smith, William B. (A)
Snell, Henry C. (A)
Stauffer, William J. (A)
Steel, W. Arthur (M)
Stiff, George F. (A)
Swabey, Henry C. (A)
Taber, Harold E. (A)
Thompson, Milton L. (A)
Thomson, John M. (A)
Thorpe, Edgar O. (A)
Tremain, Earnest L. (A)
Underwood, Clifford C. (A)

Van Sickle, Melvin (A)
Waite, Griffin G. (A)
Wallace, I. M. (A)
Walsh, Harold E. (A)
Ward, Charles (A)
Warwood, W. E. (A)
Watson, J. E. (A)
Weber, Rennie I. (A)
Weese, R. (M)
Weir, Harold G. (A)
Whitmore, Walter R. (A)
Whittington, R. Leslie (A)
Wilkinson, Allan E. (A)
Williams, James (A)
Wilson, James C. (A)

QUEBEC

Acton, Edward H. (A)
Andrae, Robert T. (A)
Andresen, Sigurd (A)
Bailey, F. A. A. (A)
Barbour, John H. (A)
Barrow, F. A. (A)
Bird, C. H. R. (A)
Blais, Alphy L. (A)
Cann, John O. G. (F)
Carrick, William E. (A)
Chauvin, Stanley (A)
Clarke, J. L. (A)

QUEBEC (Continued)

Comach, Stanley I. (A)
 Conroy, Joseph M. (A)
 Cooper, Samuel J. (A)
 Desaulniers, Russell R. (A)
 Downs, Walter P. (A)
 East, Lawrence A. W. (A)
 Eve, Harry (A)
 Farmer, Eric W. (A)
 Fenwick, James R. (A)
 Goldin, Hyman C. (A)
 Gowan, Hubert S. (A)
 Higgins, H. H. (A)
 Hodgson, Edward (A)
 Howe, A. E. (A)
 Jaederholm, Henrik W. (A)
 Kniffen, Leslie D. (A)
 Kruming, Adolf O. (A)
 Leonard, Percy A. (A)
 Marceau, Jules P. (J)
 McKay, William (A)
 McNeill, George T. (J)
 McWilliam, Eric A. (A)
 Menard, J. L. (A)
 Messier, Joseph L. (A)
 Miller, S. S. (A)
 Moore, William H. (A)
 Mullin, James W. (M)
 Olive, Gordon W. (A)
 Ouzounian, Haig (A)
 Payne, L. Stanley (M)
 Prinsky, Harold B. (A)
 Ratchford, Wm. J. (A)
 Richardson, J. Stuart (A)
 Ridd, William T. (A)
 Robb, Robert J. (A)
 Robertson, Wm. G. (A)
 Rogers, Harold A. (A)
 Short, Herbert M. (M)
 Smith, Frederick A. (A)
 Soucy, Chester I. (A)
 Spencer, Leonard (M)
 Tanner, Charles J. (A)
 Thompson, John H. (A)
 Tremblay, Joseph (A)
 Vennes, H. J. (M)
 Wade, David (A)
 Wallace, G. A. (A)
 Wallace, O. C. S., Jr. (A)
 Wilson, C. T. R. (A)
 Wilson, Clifford A. (A)

SASKATCHEWAN
 Barbar, Orville B. (J)
 Carter, Reginald F. (A)
 Michalenka, Andrew (A)
 Price, Ernest E. (A)

CANAL ZONE
 Bullock, Gilbert D. (A)
 Campbell, Walter H. (M)
 Fisher, Carroll S. (A)
 Grunman, F. W. (J)
 Hixson, John Pope (A)
 Kosar, William S. (A)
 Young, John W. (A)

CHANNEL ISLANDS
 Bennett, F. T. (A)
 Manning, Wm. M. (A)
 Wright, Herbert (A)

CHILE
 Brito, Alberto R. (M)
 Diamond, Harvey (A)
 Sazie, Enrique (A)
 Vierling, Gustav (A)

CHINA

Chang, Ting Chin (M)
 Chen, C. C. (A)
 Chen, C. Mayo (A)
 Chen, Shujen (A)
 Chen, Ying-Chien (A)
 Chiang, P. C. (A)
 Chien, F. C. (A)
 Chiu, Tsunyi (J)
 Chu, Chih Teih (A)
 Chu, K. T. (A)
 Chu, Yun (J)
 Chung, Chi Fah (A)
 Ede, Frank C. (A)
 Fung, Huo-Siu (J)
 Harmer, Leslie B. (A)
 Harris, Arthur L. (M)
 Hsu, C. L. (J)
 Hsu, Philip H. (A)
 Hwang, Ju-Tsu (J)
 Lee, Shee Mou (A)
 Lo, Tsu Zui (A)
 Mao, C. S. (A)
 Miao, T. V. (J)
 Nee, Sangta (A)
 St. Louis, A. R. (A)
 Seto, Joe N. (A)
 Shen, Pao-Guay (A)
 Shen, S. Z. (A)
 Smith, R. G. (A)
 Tsao, T. C. (A)
 Tsao, Zeuson C. (A)
 Tsia, Hoek (A)
 Wang, Twen-Shang (J)
 Ward, Zangwill (A)
 Wong, S. S. (A)
 Wu, Frank Tin Sik (A)
 Wu, S. W. (A)
 Young, Charles W. (A)
 Zee, Liang (A)

COLOMBIA

Caicedo, A. D. (A)
 Hill, H. F. (A)
 Pedersen, A. A. (A)
 Shire, Leo E. (A)

COSTA RICA

Carazo, Louis A. (A)
 Carranza, Jose J. (M)

CUBA

Gonzales, Jorge L. (A)
 Jones, Frank H. (A)
 Lara, Jose (A)

CZECHOSLOVAKIA

Kafka, H. L. (A)
 Strnad, Joseph (A)
 Svoboda, Jaromir (M)
 Zacek, August (M)

DENMARK

Bertzow, Johannes A. (A)
 Bramslev, Gunnar (A)
 Christensen, Jens P. (A)
 Heegaard, F. D. (A)
 Hellstrom, G. (A)
 Jorgensen, Laurits (A)
 Kjeldsen, T. F. (A)
 Pedersen, Martin P. (A)
 Pedersen, Peder Oluf (F)
 Poulsen, Valdemar (F)
 Schou, Carl (A)
 Steffensen, James (A)
 Svenningsen, Karl (A)

EAST AFRICA

Dennis, Frank L. (A)
 Gordinho, T. J. (A)

EGYPT

Debarro, Francis (A)
 Watterson, Harold E. (F)

ENGLAND

BEDFORD

Hodgson, Alan D. (A)

BERKSHIRE

Herbert, P. (A)
 Hill, Ernest N. (A)
 Pound, Ernest J. (A)
 Simmonds, E. J. (M)
 Taylor, Arthur W. (A)
 Tozer, William C. (A)
 Vedy, L. G. (A)
 Weight, H. Aubrey (A)

BUCKINGHAM

Bainbridge-Bell, L. H. (A)
 Diver, Frederick G. (A)
 Herd, James F. (M)
 Stoddart, Joseph A. (A)
 Wilkins, A. F. (A)
 Woodbridge, Frank L. (A)

CAMBRIDGE

Barnes, H. M. (A)
 Ratcliffe, J. A. (M)
 Turner, Laurence B. (A)
 White, F. W. G. (A)

CHESHIRE

Cleator, P. E. (A)
 Flagg, Leonard B. (A)
 Hall, Albert (M)
 Jones, Arthur G. (A)
 Jones, Ernest (A)
 Keegan, William (A)
 Noden, Joseph (A)
 Vernon, Basil H. (A)
 Williams, Cecil G. (A)
 Wright, Sydney R. (M)

CORNWALL

Powditch, H. J. (A)

CUMBERLAND

Elliott, Isaac (A)

DERBY

Franklin, T. Bedford (A)
 Hulme, Arnold B. (A)
 Smith, Harold I. (A)

DEVON

Foord, Henry D. G. (M)
 Maxey, Henry J. (A)
 Smith, James H. (A)
 Wortley-Talbot, John R. (A)

DURHAM

Glover, Harry (A)
 Hall, Norman (A)
 Joice, W. S. (A)

DORSET

Chapman, E. T. (A)
 Harper, Edgar (M)

DORSET (Continued)

Harris, Raymond (A)
 Woodward, Percy J. (M)

ESSEX

Abraham, F. X. J. (A)
 Amey, S. H. (A)
 Bevis, James (A)
 Bradfield, Geoffrey (A)
 Chesterton, Arthur J. (M)
 Ditcham, Wm. T. (M)
 Evans, Edward H. (A)
 Green, Ernest (A)
 Griffiths, Herbert V. (A)
 Harries, John H. O. (A)
 Heightman, D. W. (J)
 Keeling, Charles H. (A)
 Ladner, Alan W. (A)
 Lassman, Henry H. (A)
 Lea, Norman (A)
 Mc Donald George F. H. (A)
 O'Neill, R. F. (A)
 Parkin, Thomas D. (A)
 Payne, Eric A. (A)
 Pipe, Robert E. (A)
 Randall, Marcus C. (A)
 Robb, Frederick G. (A)
 Robertson, N. C. (A)
 Russell, Herbert J. (A)
 Shore, Anak (A)
 Smith, Sidney B. (M)
 Stamford, Norman C. (A)
 Stead, Clifford (A)
 Stockton, S. A. (A)
 Summerfield, Jas. L. (A)
 Thomas, Finion (A)
 Tompsett, F. J. (A)
 Varley, William E. (A)
 White, Herbert G. (A)
 Wilson, William P. (A)
 Woodward, Lewis A. (A)
 Wyborn, R. B. (A)
 Young, Arthur M. (A)

GLOUCESTER

Aldrich, Gordon H. (A)
 Andrews, W. A. (M)
 Angell, Douglas H. (A)
 Bates, Cyril R. (A)
 Brown, William G. (A)
 Courtenay-Price, George (A)
 Healey, Oliver (A)
 Irving, Donald H. (A)
 Mackenzie, D. G. (A)
 Myers, George T. (A)

HAMPSHIRE

Catt, James E. (M)
 Chapman, J. P. J. (A)
 Corney, William D. (A)
 Dockree, George E. (A)
 Kirkman, R. A. (A)
 Miller, Robert F. E. (A)
 Newham, Leonard E. (A)
 Ogg, John George (A)
 Palmer, R. J. (A)
 Rowland, Edgar S. (A)
 Taylor, Alfred O. (A)
 Warner, H. J. (M)
 Watson, Cecil (A)
 Wills, Stanley (A)

HERTFORDSHIRE

Bartlett, A. C. (A)
 Clarke, George E. (A)
 Gausden, P. (A)
 Murphy, Frank (A)
 Reyner, John H. (M)

Richardson, F. C. (A)
 Saltmarsh, Beatrice (A)
 Staesby, Harold (A)
 Towers, Robert (A)

ISLE of WIGHT

Morris, R. (A)

KENT

Ball, George F. (A)
 Bartlett, Wallace A. (A)
 Binyon, Basil (M)
 Burnham, Walter W. (F)
 Mulholland, William (A)
 Partridge, John A. (A)
 Pecorini, Robert R. (M)
 Turle, Edgar H. (M)
 Wicks, Frank W. (A)

LANCASHIRE

Anderson, George (A)
 Ashwin, Cecil W. H. (A)
 Bailey, Walter H. (M)
 Baird, Frederick (A)
 Cohen, Samuel H. (A)
 Coulton, Arthur (A)
 Critchley, Walter H. (A)
 Davy, Francis G. (A)
 Dolovitz, Ronald (A)
 Evans, Alfred (A)
 Evans, Young W. P. (M)
 Gardiner, Wm. J. (A)
 Gorman, Robert (A)
 Stead, Donald (A)
 Harvey, Lionel (M)
 Hodkinson, Henry (A)
 Jackson, Willie (M)
 Jeffery, Jack H. (A)
 Lamb, William H. (A)
 Lewis, Benjamin (A)
 Lycett, Eric L. (A)
 Lyons, C. L. (M)
 Mallinson, William (A)
 McLeod, John S. (A)
 Panagakis, Harry (A)
 Parry, Albert H. (A)
 Percival, William R. (A)
 Rae, William T. (A)
 Salt, William (A)
 Simpson, A. V. (M)
 Smith, John S. (M)
 Storry, Thomas G. (A)
 Wade, Arthur (A)
 Warner, F. E. (A)

LEICESTER

Atkinson, Cyril T. (A)
 Charles, Ernest E. (A)
 Diggles, A. J. (A)

LINCOLN

Clarke, Douglas F. (A)
 Frankis, Ernest E. (A)
 Pales, Frederick A. (A)
 Poppleton, John (A)
 Simons, John L. (A)
 Sparrow, A. W. (A)

LONDON

Albiston, Wm. A. (A)
 Allan, J. T. (A)
 Allinson, Cyril P. (A)
 Amis, Frederick H. (M)
 Ayres, Frederick (A)
 Barker, Percy L. (A)
 Barnard, Roy M. (A)
 Baxter, Henry W. (A)
 Beer, H. G. (A)
 Bewick, W. (A)
 Bird, Sydney S. (A)

Boyd, W. Forbes (A)
 Bruce, James R. (A)
 Bulgin, Arthur F. (M)
 Burgess, A. G. (A)
 Burrows, Francis E. (A)
 Carter, F. C. (A)
 Casperd, Christopher C. (A)
 Clark, Robert C. (A)
 Cohen, Isaac J. (A)
 Cook, Alfred B. (A)
 Coppings, Wm. H. (A)
 Crampton, Wm. J. (M)
 Crawford, Cecil G. (A)
 Dawe, Frank W. (A)
 De Wardt, Robt. G. (M)
 Downing, Geo. E. C. (A)
 Dowsett, Harry M. (M)
 Drinkwater, Eric W. (J)
 Eckersley, P. P. (F)
 Elwell, Cyril F. (F)
 Emerson, R. Waldo (A)
 Emery, E. J. (M)
 Erdman, H. (A)
 Faulkner, Harry (M)
 Fuller, J. Conrad (M)
 Galbraith, R. A. H. (A)
 Galloway, C. Hadfield (A)
 Gambrell, Horace W. (M)
 Gee, Harry T. P. (A)
 Gill, Archibald J. (M)
 Goord, H. V. (A)
 Gracie, John A. (A)
 Graham, C. (A)
 Griffiths, W. H. F. (M)
 Hambling, Arthur W. (A)
 Hamilton, D. (A)
 Hannah, W. J. (A)
 Harris, Percy W. (M)
 Hawkins, John H. (A)
 Henderson, John T. (A)
 Hinderlich, Albert (A)
 Hoar, Harold G. (A)
 Hogben, Bernard T. (A)
 Holzman, Louis (A)
 Horn, C. O. (A)
 Howard, C. A. (A)
 Howard, J. L. (A)
 Hughes, Leslie E. C. (A)
 Hughes, Lionel J. (A)
 Jacobsen, Bent B. (A)
 Jarratt, G. H. (A)
 Jones, Arthur B. (A)
 Kelsey, G. T. (A)
 Kirke, Harold L. (M)
 Klein, Rene H. (M)
 Landale, S. E. A. (A)
 Lee, Albert G. (F)
 Lemon, Cecil G. (A)
 Love, Horace J. (A)
 Lyle, Herbert B. (A)
 Madgwick, G. (M)
 Marconi, Guglielmo (F)
 Marshall, J. A. (A)
 McCallum, C. C. (A)
 McMichael, Leslie (F)
 Megaw, E. C. S. (A)
 Mercer, Charles J. (M)
 Merdler, Lionel R. (A)
 Millard, Alfred W. (A)
 Moore, Eric J. T. (M)
 Morris, Alfred (A)
 Nagase, Harutoshi (A)
 Nancarrow, F. E. (M)
 Ogden, S. (A)
 O'Shaughnessy, J. J. F. (M)
 Parker, A. Raymond (A)

LONDON (Continued)

Petersen, Thos. G. (A)
Phillips, Charles F. (M)
Picken, William J. (A)
Pocock, Hugh S. (M)
Pryor, George E. (A)
Ramirez, E. G. (M)
Rees, H. G. P. (A)
Rhys-Jones, John E. (A)
Rickard, Charles E. (M)
Robinson, F. H. (A)
Rogers, Arthur H. E. (M)
Searle, Reginald F. T. (A)
Shaughnessy, E. H. (M)
Shorter, Donovan E. L. (A)
Slee, John A. (F)
Snook, Edward T. (A)
Starr, Arthur T. (A)
Strong, Charles E. (M)
Summers, R. H. J. (A)
Tanton, John H. (A)
Tingey, Robert (M)
Tomlinson, Frank (A)
Troutbeck, Wilfrid H. (A)
Walmsley, Thomas (M)
Wardle, Paul G. (A)
Warren, A. C. (A)
Webb, James H. (A)
Wilson, Percy (A)
Wood, Robert H. (M)

MIDDLESEX

Appleton, Edward V. (F)
Appleton, Wm. A. (M)
Axten, Bernard J. (A)
Baskett, Frederick J. (A)
Bate, James R. T. (A)
Booth, Charles F. (A)
Brown, Walter J. (M)
Connell, W. H. (A)
Dack, Allan J. S. (A)
Dack, John H. A. (A)
Fayers, Alfred A. (A)
Floyd, William F. (A)
Greig, James (A)
Gurney, Albert A. (A)
Henderson, Francis A. (A)
Holmes, Robert (A)
Howse, H. A. G. (M)
James, William P. (A)
Lane, C. F. (M)
Lawson, C. J. F. (A)
Lea, George (A)
Lince, Rene (A)
Loos, George F. (A)
Montgomery, Alexander W. (M)
Mumford, Albert H. (A)
Nottage, Wm. H. (A)
Oliphant, Wm. D. (A)
Phillips, Maurice M. (A)
Potts, Edward (A)
Spratley, Clifford (A)
Tiltman, Ronald F. (A)
Toombs, Roy (A)
Walker, Harold S. (A)
Wallace, Alex T. (A)
Wicks, Reginald P. (A)

MONMOUTH

Cam, Frank A. (A)

NORFOLK

Bennington, T. W. (A)
Cooper, G. R. (A)

NORTHAMPTON

Calver, Frank N. (M)
Cross, A. (J)

NORTHUMBERLAND

Dunstan, A. S. (A)
Kerrison, Harland R. (A)
Moore, John T. (A)
Nicholson, James K. A. (M)
Robb, William I. (A)
Rush, James (A)

NOTTINGHAM

Kynaston, B. H. J. (A)
Litchfield, Gordon A. (A)
Pearson, Laurence H. (A)
Pinnock, L. W. J. (A)

OXFORD

Moullin, E. B. (M)
Murray, John W. (A)

SOMERSET

Hinks, Geoffrey D. (A)
Ware, William (A)
Wilson, Frank (M)
Young, Alfred W. (A)

STAFFORD

Harvey, Herbert J. (A)
Wroughton, Thos. H. (A)

SUFFOLK

Rayment, K. I. (A)
Townsend, Frank T. G. (M)

SURREY

Agate, Carlton S. (M)
Carpenter, Rupert E. H. (M)
Chandler, Chas. K. (A)
Clear, K. Y. (A)
Cobb, F. Arthur (M)
Coursey, Philip R. (A)
Cox, C. F. (A)
Curtis, Francis C. (A)
Cushion, L. (A)
Danninger, Louis (A)
Dedman, Ernest A. (A)
Dorte, Phillip N. (A)
Dryland, Alan G. (M)
Forbes, F. D. (A)
Hall, Basil (J)
Hall, Roland C. (A)
Henderson, Walter B. (A)
Hermes, Lawrence W. (A)
Holbeach, Wm. M. (A)
Howard, C. G. (A)
Jordan, James R. (A)
Joseph, J. (M)
Lane, C. V. (A)
Lawler, L. A. C. (A)
Mockford, F. S. (A)
Ridgeway, John W. (A)
Shaw, A. C. (M)
Smurtwaite, F. W. (A)
Somerset, E. T. (A)
Thomas, L. H. (A)
Thompson, Alfred E. (M)
Watson, George H. (A)

SUSSEX

Everett, Lionel E. B. (M)
Thorpe, Stewart M. (A)

WARWICK

Adams, Frank S. (A)
Cooper, J. A. (A)
Everest, Augustine R. (A)

Hinton, Norman P. (M)
Jones, Frank E. B. (A)
Kinman, Thos. H. (M)
Lemney, Claude W. (A)
McDonald, Daniel (A)
Owner, John S. (A)
Roberts, R. (A)
Struthers, G. A. (M)
Thomsett, H. S. (A)
Verralls, J. Maynard (A)
Wadsworth, Herbert A. (A)
Woodhead, H. C. (A)

WILTSHIRE

Cooper, W. H. B. (J)
Mustchin, Norman (A)
Wainwright, Albert (A)

WORCESTER

Mansell, Lionel H. (M)

YORKSHIRE

Andrewartha, H. C. (A)
Ault, Harold B. (A)
Bagshaw, Geo. W. (A)
Bever, Anthony J. M. (A)
Booler, Ernest (A)
Brenchley, C. C. (A)
Drake, George P. (A)
Fell, Herbert (A)
Fennessy, John R. (A)
Firth, Roy (A)
Flintham, Herbert (A)
Fox, Paul X. (A)
Glossop, Arthur A. (A)
Hayward, W. R. (A)
Hewetson, Geoffrey B. (J)

Holmes, Cyril T. (A)
Langstaff, Horace (A)
Lawrence, Edward (A)
Mainwaring, Walter (A)
Male, Samuel C. (A)
Pearson, Alfred (A)
Pereira, Francis E. D. (A)
Pickering, Harry (A)
Rapsom, Ernest T. A. (A)
Rayner, Harry (A)
Riddiough, John W. (A)
Ripley, Henry P. (A)
Russell, M. W. G. (M)
Schackleton, Stanley M. (A)
Smith, Harold (A)
Tetley, Robert C. (A)
Trippier, Francis J. (A)
Turvey, Henry C. (A)
Wallace, Richard H. (A)
Wheeler, Chas. H. J. (A)
Wheeler, Edmund F. (A)
Wood, Eric (A)

FEDERATED
MALAY STATES

Cadman, Claude G. (M)
Carson, Andrew H. (A)
Gee, Walter C. (M)
Higgins, Percy V. (A)
MacIntosh, James (A)
Oakes, William G. (A)
Peck, George T. (A)
Singh, Harbaksh (J)
Suarez, Jose B. (A)

FRANCE

Armstrong, L. J. Heaton (A)
Behm, Ludwig, F. (A)
Berche, P. (A)
Bethenod, J. F. J. (A)
Campbell, Howard E. (M)
Chettel, Alexis M. (M)
de Bellescize, Henri J. J. M. (M)
de Bozas, Guy du Bourg (A)
Delbord, Y. L. (A)
Deloraine, F. M. (M)
Ferrie, General (F)
Gavoëret, George (A)
Goyder, C. W. (A)
Gray, Richard E. (A)
Hazzeltine, Louis A. (F)
Higonnet, Rene A. (A)
Hummel, Jean Emile (A)
Kahn, P. O. (A)
Klappenbach, W. (A)
Knight, Sidney G. (A)
Kraemer, G. I. (M)
Leslie, Fred D. (A)
Levy, Lucien (M)
Lush, William G. (M)
McLean, Francis C. (A)
Mirk, D. Blair (A)
Morton, Alfred H. (M)
O'Reilly, C. (A)
Pedersen, Gunnar V. C. (A)
Turpin, Roger (A)
Ullrich, Edward H. (M)
Wallace, Marcel (A)

FRIENDLY
ISLANDS

Land, John R. (M)

GERMANY

Barkhausen, H. (F)
Fassbender, Heinrich (F)
Gothe, Albrecht (A)
Hertweck, C. (A)
Kofes, Albert (M)
Kurlbaum, Georg (A)
Lock, M. J. (A)
Lübcke, Ernst (M)
Meissner, A. (F)
Mögel, Hans I. (M)
Rothe, Horst (M)
Runge, Wilhelm T. (M)
Suadicani, Guenther (M)
von Ardenne, M. (A)
Wagner, Karl W. (F)
Wasservogel, Günther (A)
Zenneck, Jonathan (F)

GREECE

Goumarides, A. D. (A)
Pezopoulos, K. (A)

GUAM

Sutton, Ralph E. (A)
Terhune, J. A. (A)

HAWAII

Almberg, Clarence H. (J)
Armagost, Harold C. (A)
Balch, J. A. (M)
Borthwick, Jas. H. (A)
Branch, L. W. (M)

Clark, George W. (A)
Day, Laurence E. (A)
Eller, Willard H. (A)
Fickas, Merwin J. (A)
Fiechtner, Theo. G. (A)
Finch, James L. (M)
Green, Preston W. (A)
Hill, Otis (A)
Janitschke, E. O. (A)
Kaneko, George T. (A)
Keller, Edward B. (A)
King, Cary J., Jr. (A)
Macartney, A. Roy (A)
Moore, John B. (A)
Muller, John H. (A)
Muller, P. H. (A)
Murai, Fred H. (A)
Ogg, Glenn R. (A)
Pickle, Chesley B. (J)
Schaefer, Carl T. (A)
Shaw, Robert M. (A)
Sherman, Warren K. (A)
Simpson, Robert L. (A)
Thomas, Hubert E. (A)
Walworth, Laurance A.
Wells, W. Bruce (A)
Wilkie, Harry (A)

HOLLAND

Bouman, H. J. J. (A)
Breimer, S. H. (A)
De Graaff, Antonius (A)
de Miranda, J. Rodrigues (A)
Hummeling, William G. A. M. (A)
Langendam, S. G. C. (A)
Moree, W. (A)
Roorda, J., Jr. (A)
Schotel, G. (M)
van der Bilt, C. L. (A)
van der Pol, Balh, Jr. (F)
Westerveld, F. (A)

HUNGARY

Alker, T. F. (M)
Detsky, Charles F. (A)

INDIA

Asithana, Rajendra Prasad (A)
Chapman, Thos. J. (A)
Cornfield, M. (A)
De Burgh, Desmond H. (M)
Dighe, K. S. (A)
Doraswamy, M. N. (A)
Enon, Ernest R. (A)
Ghosh, B. N. (J)
Hawes, R. Nesbit (M)
Hesse, Cecil N. (A)
Kantebet, S. R. (M)
Mohammed, A. (A)
O'Rourke, Sydney P. (A)
Shroff, T. R. (A)
Silver, B. J. (A)
Vasudeva, D. N. (A)
Verman, Lal C. (A)

IRELAND

Edgeworth, Kenneth E. (M)
Jamison, Alexander (A)
Kennedy, M. F. (A)
Kitchen, James P. (A)
Neill, Frank R. (A)
Taggart, David (A)
Waite, D. (A)

IRISH FREE STATE

Dunphy, Thomas O. (A)
Ferguson, John D. (M)
Minter, Robert W. (A)
Walker, Geo. S. D. (A)

ISLE OF MAN

Horne, Tom (A)

ITALY

Bacchini, Cesare (A)
Banti Alessandro (A)
Buttolo, Romeo L. (A)
Ducati, Adriano C. (A)
Guarnieri, Gaetano Monti (A)
Leechi, P. A. (A)
Marino, Algeri (A)
Osiatunsky, L. (M)
Pession, Giuseppe (F)
Ramsay, Frank R. F. (A)
Ruspoli, Edmondo (A)
Venturini, Anthony (A)

JAMAICA

Ratliff, L. G. (A)

JAPAN

Akamatsu, Kaworu (A)
Akutsu, Shinji (A)
Akuzawa, Siro (A)
Amari, S. (A)
Anazawa, Chubei (A)
Arakawa, Daitato (A)
Arisaka, Iwao (A)
Endo, K. (A)
Fujikura, Keijiro (A)
Fujimoto, Tadashi (M)
Fukushima T. (A)
Hagio, N. (A)
Hamada, Shigenori (A)
Hashida, K. (A)
Hashimoto, Chuji (A)
Hashimoto, S. (A)
Hayasi, Tatuo (A)
Hijikata, S. (A)
Hirose, M. (A)
Horiguchi, Jiro (A)
Iimura, H. (A)
Inaoka, Yoshio (A)
Inada, Sannosuke, M.
Inada, Shigetaro (A)
Inanami, Sueo (A)
Ishikawa, S. (A)
Iso, E. (A)
Itow, Yutaka (A)
Iwakata, Hideo (A)
Iyoki, O. (A)
Jimbo, S. (A)
Kamio, K. (A)
Kanayama, Toyosaku (A)
Kanko, Go (A)
Kanno, Gengo (A)
Kato, Kenzo (A)
Kato, Y. (A)
Kawahara, Takewo (A)
Kimpura, Atsushi (A)
Kimura, Rokuro (A)
Kinase, Matsunaga (M)
Kinoshita, Seiji (A)
Kiyota, Y. (A)
Kobayashi, Kichijiro (A)
Kobayashi, M. (A)
Kobayashi, S. (A)
Kohno, S. (A)
Kono, T. (M)
Koshikawa, A. (A)
Koshikawa, Y. (A)

JAPAN (Continued)

Koyama, Kumesosuke (A)
 Kumon, Akitada (A)
 Kuno, T. (A)
 Kuramochi, Shōju (A)
 Kusakari, T. (A)
 Kusama, Kankiti (A)
 Kusunose, Yuziro (A)
 Kuwajima, T. (A)
 Maeda, M. (A)
 Marumo, Noboru (A)
 Matsui, K. (A)
 Matsumura, Sadao (A)
 Mita, S. (A)
 Mitsusishi, Hide K. (A)
 Mitsutake, Katsumi (A)
 Miyaji, Terui (A)
 Miyachi, T. (A)
 Mizuhashi, Tosaku (A)
 Momotsuka, K. (A)
 Mori, Nobumitsu (A)
 Morita, K. (A)
 Morita, M. (A)
 Moriwaiki, Katsumi (A)
 Nagai, Kenzo (A)
 Nagamura, S. (A)
 Nagao, R. (A)
 Nagasaki, K. (A)
 Nagoshi, M. (A)
 Nakagami, Minoru (A)
 Nakagami, T. (M)
 Nakai, Tomozo (A)
 Nakajima, S. (A)
 Namba, Shogo (A)
 Namba, Yasukazu (A)
 Niya, Takuji (A)
 Nishida, S. (A)
 Niwa, Yasujiro (A)
 Ono, Takashi (A)
 Otani, S. (A)
 Otsuka, Y. (A)
 Owada, Mankitsu (A)
 Saito, Masao (A)
 Saitow, Kenji (A)
 Sakai, Sadao (A)
 Sasaki, Tei (A)
 Sasaki, Toshiro (A)
 Satoh, Hajime (A)
 Sayeki, Mitsuru (F)
 Shiga, T. (A)
 Shima, Shigeo (A)
 Shimayama, Tsuruo (A)
 Shinohara, Kiyotada (A)
 Shoda, Masaru (A)
 Shuzi, Saburo (A)
 Simbōri, M. (A)
 So, M. (M)
 So, Manabu (A)
 Suga, Y. (A)
 Sugi, Chohsuke (A)
 Sugiyama, E. (A)
 Sumi, M. (A)
 Suzuka, M. (A)
 Suzuki, Hisao (A)
 Suzuki, T. (A)
 Taguchi, Minoru (A)
 Takamura, S. (A)
 Takase, J. Y. (A)
 Takaya, Michihiro (A)
 Takebayashi, K. (A)
 Takeuchi, H. (A)
 Tamai, I. (A)
 Tanaka, Yoshio (A)
 Tanimura, Isao (A)
 Terahata, Matsutaro (A)
 Tesch, Walter L. (M)
 Tobiyama, K. (A)
 Tsuji, Uichoro (A)
 Tsumura, Kazuo (A)
 Tsushima, Yonekichi (A)

Ueno, Shuzo (A)
 Wataru, Sugiyama (A)
 Westcott, Phillips S. (A)
 Yagi, Hidetsugo (F)
 Yamaguchi, T. (A)
 Yamaguchi, Usaburo (A)
 Yokoyama, Eitaro (M)
 Yokoyama, H. (A)
 Yokoyama, Tetsumi (A)
 Yoshino, Kuroda (A)
 Yoshitishi, Tanabe (A)

JAVA

Liebert, T. W. (M)
 Verdam, Nicholas H. (M)

LATVIA

Feldman, Nicholas (A)

MEXICO

Bourgeois, Allen B. (A)
 Cota, Pedro N. (A)
 De Mello, William (A)
 De Perez, Jose (A)
 De Tarnava, C. Jr. (A)
 Escrich, James P. (A)
 Fernandez, Manuel A. (A)
 Reuthe, Gustav (M)
 Sardaneta, Raymundo (A)

NEWFOUNDLAND

Galgay, William F. (A)

NEW ZEALAND

Anderson, A. D. (A)
 Baggs, A. D. (A)
 Barnett, M. A. F. (A)
 Bingham, John M. (A)
 Blackwell, Wm. J. (A)
 Bradley, Ernest A. (A)
 Brent, Herbert C. (M)
 Brooks, J. R. (A)
 Buchanan, D. W. (A)
 Budd, Leonard W. (A)
 Clarkson, T. R. (A)
 Dawson, Wilfred M. (A)
 Gibbs, R. J. (A)
 Grant, R. L. C. (A)
 Harlow, Frank E. (A)
 Harrison, Walter L. (A)
 Hurrell, Leslie W. (A)
 Jack, Robert (A)
 Johnson, Edward C. (A)
 Macedo, Francis J. (J)
 Matthews, P. H. (A)
 McCutcheon, William A. (A)
 McKewen, J. D. (A)
 McLennan, Roderick Arthur (M)
 Morrison, Colin W. (J)
 Roberts, R. V. (A)
 Robinson, R. Rowe (A)
 Rubenstein, S. J. (A)
 Ruscoe, Charles R. (A)
 Russell, Cecil R. (M)
 Smith, Colin W. (A)
 Svendsen, A. V. (A)
 Thow, Keith H. (M)
 Webster, Allan (A)

NICARAGUA

Macy, Spencer A. (A)
 Smith, Thomas R. (A)

PALESTINE

Instrall, Reginald C. (A)
 Thompson, F. S. (A)

PANAMA

Jones, Roys C. (A)
 Parkin, Louis S. (A)
 White, Robert F. (A)

PERU

Anderson, L. N. (A)
 Angus, G. W. (A)
 Hansen, Elmer (A)
 Perez-Palacio, Enrique (A)
 Robertson, Jos. J. C. (A)
 Shaw, Sydney Coates (J)
 Storm, Hans Otto (A)

POLAND

Groszkowski, J. (M)
 Lewinski, Casimir (J)
 Modrak, Peter (A)
 De Perez, Jose (A)
 Plebanski, Josef (M)
 Rzymowski, E. (A)
 Sokolcow, Dmitri M. (M)

PHILIPPINES

Feliciano, Fidencio A. (A)
 Grupe, Emilio (A)
 Hill, Guy (F)
 McKesson, Lewis J. (A)
 Nance, Curtis H. (M)
 Riddle, Elmer R. (A)
 Weigand, Joseph S. (A)

PORTO RICO

Agusty, Joaquin (A)
 Behr, F. J. (F)
 Schell, Richard, Jr. (A)

PORTUGAL

Borges, Francisco B. (A)
 Tishshaw, Henry S. (M)

SAMOA

Yalden, Abbott G. (A)

SCOTLAND

Allan, Ernest J. (A)
 Armour, Christian D. (A)
 Beveridge, John A. (M)
 Bird, R. J. (M)
 Carnie, Ben (A)
 Chadder, E. G. (A)
 Edwards, R. M. (A)
 Fleming, Samuel (A)
 Fox, John D. (A)
 Hotine, Leslie (M)
 Kerr, John (A)
 Knowles, Miss J. G. (A)
 McConnell, W. J. (A)
 Miller, John C. (A)
 Murchie, John (M)
 Ramsay, John F. (A)
 Webster, Robert (A)
 Wilkie, J. McKenzie (A)
 Young, A. D. (A)

SIAM

Prakit, Phya (M)

SOUTH AFRICA

Adendorff, Gerald V. (M)
 Allaway, G. N. P. (M)
 Anolick, J. (A)
 Baris, Isidore (A)
 Barnett, Eric E. (A)
 Brickhill, G. A. (A)
 Chenik, Aaron (A)
 Cumming, Noel D. (M)
 Dunbar, James (A)
 Gilmour, Peter (A)
 Hendry, J. S. (A)
 Jacobs, Alwyn J. (A)
 Jephcott, Ernest L. (A)
 Knight, Arthur W. (A)
 Kos, Simon F. (M)
 Levine, Lionel E. (A)
 Levington, Abie (A)
 Morison, Bruce (A)
 Morris, R. P. (M)
 Nicholas, W. H. (A)
 Osborn, Eugene W. (A)
 Perrow, F. A. P. (M)
 Renshaw, John B. (A)
 Van Der Bijl, Hendrik J. (F)
 Yapp, William G. (A)
 Yule, T. M. (A)

SPANISH MOROCCO

Lopez, Melchor (A)

STRAITS SETTLEMENTS

George, Philip H. F. (A)
 Sutherland, J. G. A. (M)

SPAIN

Alonso, Julio (A)
 Crespo, Jose (M)
 Cuervo, Luis S. (A)
 De Urgoiti, Ricardo M. (A)
 Escolano, Manuel (M)
 Fernandez, Jose de Pedro (A)
 Matres, Trinidad (M)
 Oliva-Llamusi, Fernando (M)
 Pelaez, Carlos (A)
 Riu, Agustin M. (A)

SWEDEN

Elmquist, Torsten (A)
 Fransson, Frans J. (A)
 Kruse, Sigurd (A)
 Lemoine, A. S. (A)
 Nilsson, G. Alb (A)
 Rolf, Bruno (A)
 Sterky, Hakon K. A. (A)
 Wollert, Bertil (A)

SWITZERLAND

Anselmi, S. C. (A)
 Guggenheim, S. (A)
 Tank, Franz (A)

TASMANIA

Brooker, Vivian M. (A)
 Tuck, H. P. (A)

U.S.S.R. (RUSSIA)

Chernyshoff, Alex. (A)
 Gladkov, Cyril A. (A)
 Kacourine, Serge N. (A)
 Yakovlev, A. (A)

VENEZUELA

Imle, John F. (A)

WALES

Carson, John M. (A)
 Davies, I. Tegwyn (A)
 Hawkeswood, A. E. (A)
 Jimman, Arthur M. (A)
 Mills, William F. (A)
 Rees, David (A)
 Sutton, Wm. F. P. (A)
 Thomas, Griff (A)
 Whale, Gordon S. (A)

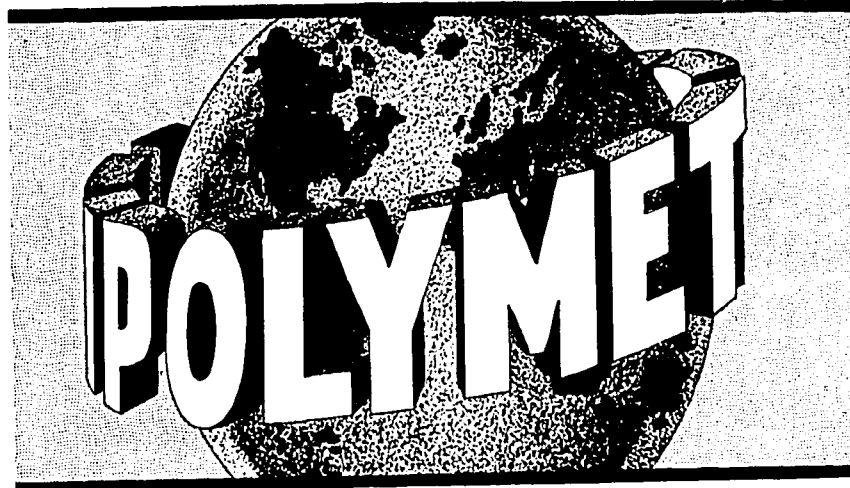

Polymet Products

"STANDARD OF THE INDUSTRY"

World-known and World-accepted

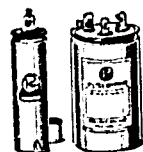

Condensers

- Paper
- Electrolytic
- Mica

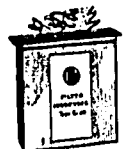

Resistors

Volume Controls



Transformers

Choke Units

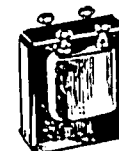

Coil Windings

Both manufacturers' and service requirements are assured prompt attention.

Catalog on request.

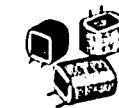

POLYMET MANUFACTURING CORP.

World's Largest Manufacturers of Radio Essentials

829-839 East 134th Street, New York City

Sales Representatives in all leading cities of the United States and in all principal countries of the world.



Special sales department for export, located at the address above, is prepared to cooperate closely with overseas manufacturers for their parts requirements.

SHAKEPROOF

Multiple
Locking
Defeats
Vibration

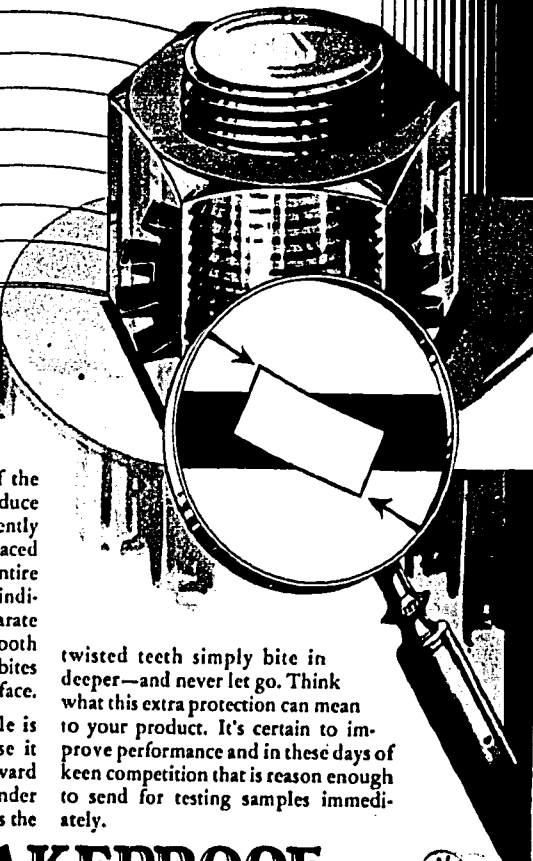

THE patented twisted teeth of the Shakeproof Lock Washer produce a locking force that assures permanently tight connections. These teeth, spaced at regular intervals around the entire circumference of the washer, act individually to form a series of separate locks. And what's more—each tooth is a double action lock because it bites into both the nut and the work surface.

This Multiple Locking principle is vibration's greatest enemy because it will successfully resist any backward movement of the nut and even under the most intense strains and stresses the

twisted teeth simply bite in deeper—and never let go. Think what this extra protection can mean to your product. It's certain to improve performance and in these days of keen competition that is reason enough to send for testing samples immediately.

U. S. Patents:
1,419,564
1,604,122
1,697,954
1,782,387

Other patents pending.

Foreign patents.

SHAKEPROOF
Lock Washer Company

{Division of Illinois Tool Works}

2543 N. Keeler Ave.

Chicago, Ill.



"It's the
Twisted
Teeth
that LOCK!"

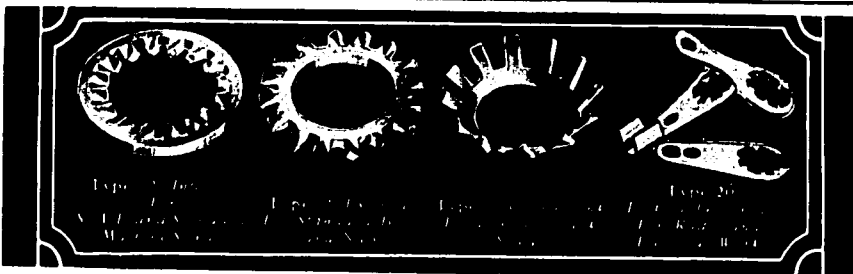

Shakeproof representatives are located in the following cities

New York City	Philadelphia	Boston	Pittsburgh	Schenectady	Cleveland
Detroit	Toledo	Cincinnati	Birmingham, Ala.	Dallas, Texas	Milwaukee
Los Angeles	Seattle	San Francisco	Toronto, Ontario, Canada		

PREMIER CRYSTAL

Are Dependable for Quality,
Output, and Performance

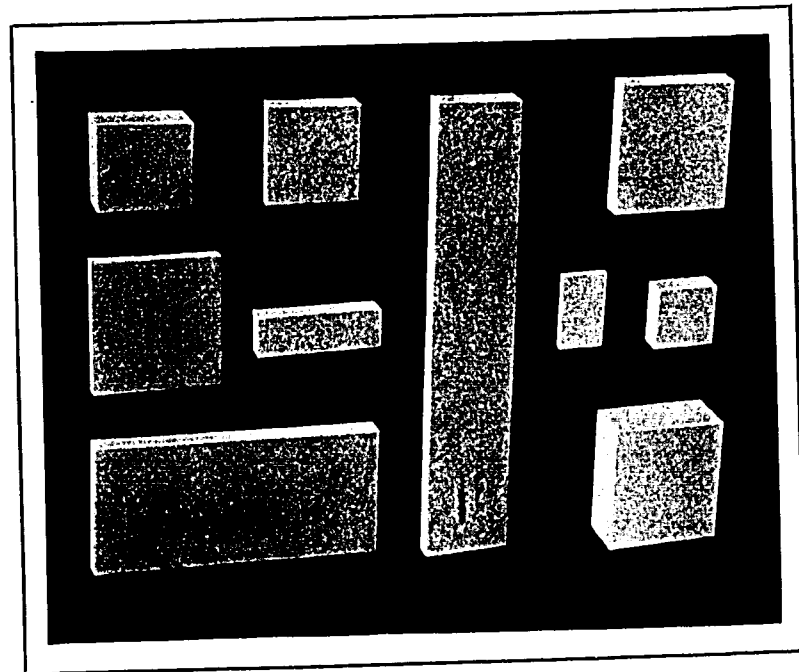

Finished CRYSTALS of all descriptions

CRYSTAL BARS, PLATES and BLANKS ground to any specifications

CRYSTALS for amateurs

All PREMIER PRODUCTS are made from finest quality selected Brazilian quartz

Your inquiries solicited—Prompt service

PREMIER CRYSTAL LABORATORIES, Inc.

55 PARK ROW, NEW YORK CITY

AEROVOX HI-FARAD DRY ELECTROLYTIC CONDENSER

**THE MODERN HIGH
CAPACITY CONDENSER
500 VOLTS PEAK
LONG LIFE • LOW COST**



The advanced processes and features in design, combined with the special electrolyte employed in Hi-Farad DRY Electrolytic Condensers insure efficient and reliable performance in all modern filter and bypass circuits. Hi-Farad condensers are made in a wide variety of types, sizes, capacities and voltage characteristics to meet various requirements.

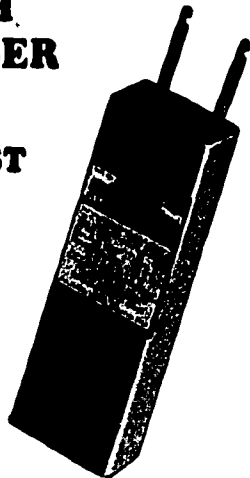

AN AEROVOX CONDENSER AND RESISTOR FOR EVERY USE

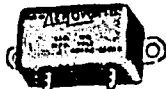

METAL CASE
CONDENSERS

The AeroVox line includes the most complete line of condensers and resistors in the radio and electrical industries. No matter what your requirements are for fixed and tapped condensers or resistors, you are sure to find AeroVox units suited to your needs. In addition, we are equipped to supply special types and sizes of condensers and resistors to meet manufacturers individual requirements.



CARBON
RESISTORS



CARTRIDGE
CONDENSERS



PYROHM
RESISTORS



MOULDED BAKELITE
MICA CONDENSERS

Write for new 1932 catalog. Also ask to receive the AeroVox Research Worker, a monthly periodical which will be helpful and interesting to you.

AEROVOX WIRELESS CORP.

70 Washington Street, Brooklyn, N. Y.

IV

The Perfected
**HAMMARLUND
MIDGET
CONDENSER**
Resists Vibration!

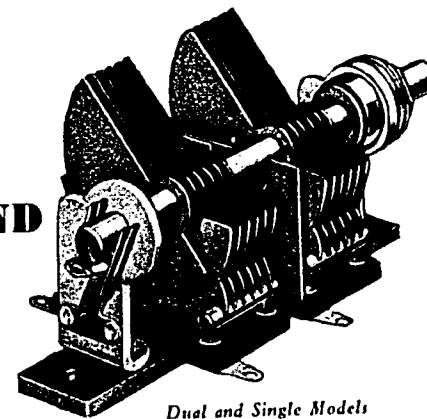

Dual and Single Models

THE Hammarlund Midget Condenser is ideal for airplane or automobile receivers, where the utmost reliability, compactness and immunity from vibration are essential.

High capacity and wide-range—20 to 325 mmf. per section. Soldered brass plates, rugged frame, accurately fitted bearings, double four-point bronze wiping contact firmly rivetted against vibration. Isolantite insulation.

Dual and single unit models. Straight line or "Midline" tuning curve. Baseboard or one-hole mounting.

Ideal for tuning Short-Wave Receivers.

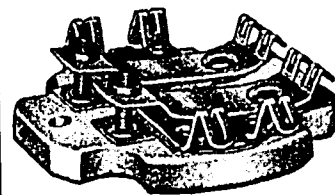

For Precise Tuning of
**INTERMEDIATE
TRANSFORMERS**

Specially tested isolantite base mounts inside transformer shield.

Self-aligning phosphor-bronze adjustable spring plates, double rivetted. Selected mica insulation.

Proved design—will not change in resistance or capacity from humidity, temperature or vibration.

Three ranges in single or double models—10 to 70 mmf.—70 to 140 mmf.—140 to 220 mmf.

Mail coupon for sample and quotations

For Better Radio
Hammarlund
PRECISION
PRODUCTS

HAMMARLUND MANUFACTURING COMPANY
424-438 West 33rd St., New York, N.Y.
Please send us sample of Intermediate Fre-
quency Transformer Tuning Condenser
 Midget Condenser and quotations.
Name.....
Address.....
..... Y13-32

V

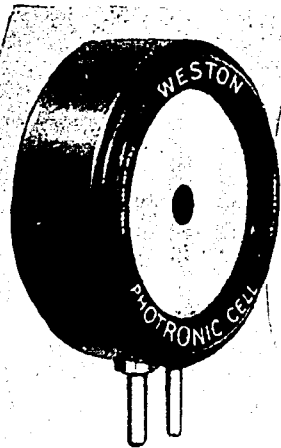

PHOTRONIC CELL



SENSITIVE RELAY

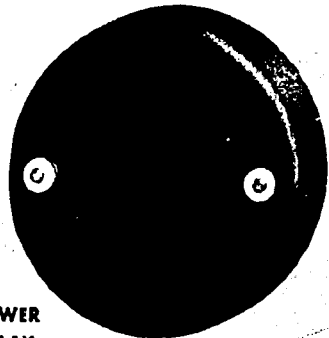

POWER RELAY

now
a Complete
PHOTO-ELECTRIC RELAY

at a New

LOW COST

Now you can experiment with light sensitive cells—make them work at a fraction of previous costs. The new Weston Photronic Cell uses no battery, no amplifier. It operates relays directly. Highly sensitive, its current output is about 1.4 micro-amperes per foot-candle. No dark current.

The Photronic Cell has unlimited life—no deterioration, no replacement. A marked advance over previous standards.

For the experimenter, Weston recommends its Model 601 Photronic Relay. It controls 100 watts. It consists of a Photronic Cell, a Model 634 Weston Miniature Relay, and a Power Relay. Used with dry cells to actuate power relay. Model 601 Photronic Relay is a complete operating unit, permitting hundreds of interesting and practical experiments.

WRITE TODAY for FREE Booklet showing ten Photronic Relay experiments. Wiring diagrams included.

WESTON

ELECTRICAL INSTRUMENT CORPORATION

589 FRELINGHUYSEN AVENUE NEWARK, N. J.

**MERSHONS
MUST BE BETTER**

BECAUSE MORE
FINE RADIO SETS
ARE EQUIPPED
WITH MERSHON
ELECTROLYTIC
CONDENSERS THAN
ANY OTHER KIND

Magnavox Engineers welcome consultation with
Radio Manufacturers

Magnavox Company Ltd.

General Offices and Factory:
Fort Wayne, Indiana



Subsidiaries:
The Magnavox Company
Electro Formation, Inc.
Magnavox (Great Britain) Ltd.
Magnavox (Australia) Ltd.

DeJur-Amsco

FINE PRODUCTS FOR TEN YEARS

For ten years this organization has held a preeminent position in the radio industry as a parts manufacturer. Our customers are located throughout the civilized world. Because of our long and varied experience and the stability of our organization, it is our belief we are in a better position to meet the requirements of set makers than any other manufacturer in the field.

DIALS

Our dials, friction and direct drive and full and sector vision, meet all electrical and eye value requirements of the modern receiver. Special high ratio dials for short wave work.

VARITORS

Small semi-fixed condensers that answer several requirements in the modern receiver.

ESCUTCHEONS

DeJur-Amsco Escutcheons are accessories that contribute the final touch of beauty to the modern receiver.

PILOT LIGHTS

One of the small but nevertheless fundamental parts of the modern receiver that measures up to DeJur-Amsco's requirements for electrical efficiency.

POWER RHEOSTATS

For heavy duty work in both the radio and electronic fields, manufacturers find that DeJur-Amsco Power Rheostats meet their most exacting requirements.

TUNING CONDENSERS

Our tuning condensers are highly efficient and are made in a variety of electrical and mechanical designs. Single and multiple gangs—1 to 5. Special condensers for short wave receivers.

OSCILLATOR TRACKING CONDENSERS

DeJur-Amsco special Oscillator Tracking Condensers simplify single control superheterodyne design and eliminate the expensive and unsatisfactory padding requirements.

Write for catalog illustrating and describing the complete line of DeJur-Amsco radio parts and accessories.

DeJur-Amsco CORPORATION
95 MORTON ST., NEW YORK CITY

The Institute of Radio Engineers

Incorporated

33 West 39th Street, New York, N. Y.

APPLICATION FOR ASSOCIATE MEMBERSHIP

(Application forms for other grades of membership are obtainable from the Institute)

To the Board of Direction

Gentlemen:

I hereby make application for Associate membership in the Institute of Radio Engineers on the basis of my training and professional experience given herewith, and refer to the members named below who are personally familiar with my work.

I certify that the statements made in the record of my training and professional experience are correct, and agree if elected, that I will be governed by the constitution of the Institute as long as I continue a member. Furthermore I agree to promote the objects of the Institute so far as shall be in my power, and if my membership shall be discontinued will return my membership badge.

.....
(Sign with pen)

.....
(Address for mail)

.....
(Date)

.....
(City and State)

References:

(Signature of references not required here)

Mr. Mr.

Address Address

City and State City and State

Mr.

Address

City and State

The following extracts from the Constitution govern applications for admission to the Institute in the Associate grade:

ARTICLE II—MEMBERSHIP

Sec. 1: The membership of the Institute shall consist of: * * * (c) Associates, who shall be entitled to all the rights and privileges of the Institute except the right to hold any elective office specified in Article V. * * *

Sec. 4: An Associate shall be not less than twenty-one years of age and shall be a person who is interested in and connected with the study or application of radio science or the radio arts.

ARTICLE III—ADMISSION AND EXPULSIONS

Sec. 2: * * * Applicants shall give references to members of the Institute as follows: * * * for the grade of Associate, to three Fellows, Members, or Associates; * * * Each application for admission * * * shall embody a full record of the general technical education of the applicant and of his professional career.

ENTRANCE FEE SHOULD ACCOMPANY APPLICATION

THE CRC SOCKET LINE Includes

THE "500" SERIES—

For extremely economical production—unique design permits almost unlimited size and shape possibilities with acceptable electrical characteristics.

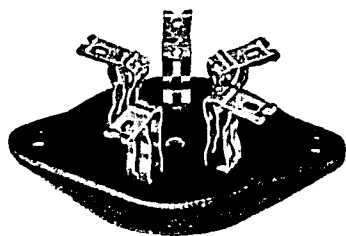

THE "600" SERIES—

The quality socket of the CRC line—unusually rugged, reinforced contacts providing accessibility for fast and accurate production—mechanically and electrically correct.

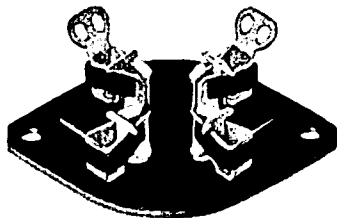

THE "800" SERIES—

providing the same kind and amount of spring reinforced contact as the 600 series and with the same mechanical and electrical correctness, all in a more economical form.

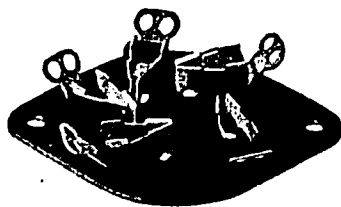

SPECIAL DESIGNS—

Whether your problem calls for mogul sockets, special contacts, odd sizes, shapes and terminal arrangements or for the creation of an entirely new idea CRC will solve it.

CENTRAL RADIO CORPORATION
BELOIT, WISCONSIN

PRECISION ENGINEERING

*What it Means
in Radio Tubes*

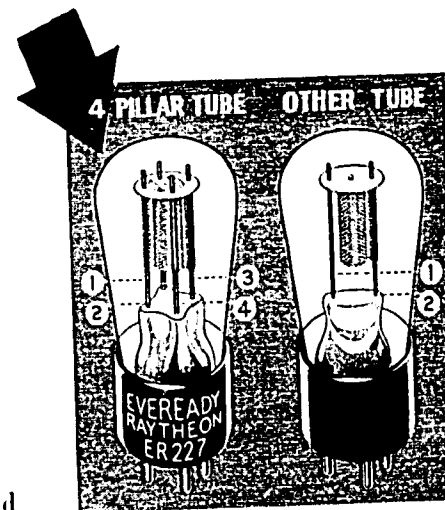

THE MODERN highly sensitive and selective radio receiver requires, for maximum performance, tubes having the following qualifications:

1. Standard electrical characteristics.
2. Uniformly good Mutual Conductance or amplifying ability.
3. Uniformly good undistorted power output.
4. Standard and uniform input, inter-electrode and output capacities.
5. Freedom from AC hum.
6. Freedom from microphonic and noise tendencies.
7. Very low gas, grid emission and leakage currents under normal operating conditions.
8. Uniformly defined Mutual Conductance—control grid characteristics.
9. Uniform Plate current cut-off.
10. Good Mutual Conductance—Life characteristics.
11. Good mechanical strength in tube structure.

Such tubes are the result of constant research and development, painstaking inspection and complete control during manufacture and careful inspection and test before shipment.

However, much of this precision engineering may go for naught, if the tube structure is not sufficiently rugged to withstand the jars and vibration caused by shipment and operation.

In order to preserve the precision designed and built into the tube, all Eveready Raytheon tubes employ the well-known patented 4-Pillar construction shown in the illustration.

For further information on Eveready Raytheon 4-Pillar radio tubes, please write the nearest Division Office.

**EVEREADY
RAYTHEON**

TRADE MARKS

NATIONAL CARBON COMPANY, Inc.

General Offices: New York, N. Y.

Branches: Chicago, Kansas City, New York, San Francisco

Unit of
Union Carbide and **UCC** Carbon Corporation

Alphabetical Index to Advertisements

Aerovox Wireless Corp.	A	IV
Central Radio Corporation	C	XII
DeForest Radio Co.	D	XVIII
DeJur-Amsco Products Corp.		VIII
Gilby Wire Company	G	XVI
Hammarlund Mfg. Co.	H	V
I. R. E.	I	IX, X
Isolantite Incorporated		Inside Back Cover
Magnavox Co., Ltd.	M	VII
Micarta Fabricators, Inc.		XI
National Carbon Co., Inc.	N	XIII
Paper Tube Company, The	P	XVII
Polymet Mfg. Corp.		I
Premier Crystal Laboratories, Inc.		III
Scovill Manufacturing Co.	S	XV
Shakeproof Lock Washer Co.		II
Weston Electrical Instrument Corporation	W	VI

TRANSLATING Theory into Practice

THE Scovill Manufacturing Company is an organization with unusual ability to take paper plans and interpret them into practical products. Radio manufacturers have long found us successful in cooperating on their developments and inventions . . . in producing according to their ideas anything from a simple screw to a complete radio condenser.

Scovill is pre-eminently fitted to perform these services for the radio industry by virtue of its unusual facilities. A tremendous

plant such as ours can achieve quantity output without sacrificing quality. An order can be completed on short notice without lowering standards of precision. We have only to point to our record of past accomplishments as an indication of what we can do.

It is very probable that you would benefit by turning over some of your production problems to us. We should be glad to show you how we can help you simplify operations, cut costs, and improve the quality of your product.

Scovill



Scovill Manufacturing Company
Waterbury, Connecticut

Boston Providence New York Philadelphia Atlanta
Syracuse Detroit Chicago Cincinnati
San Francisco Los Angeles in Europe: The Hague, Holland

RADIO ENGINEERS

REALIZE AND APPRECIATE QUALITY AND PRECISION

The Gilby Wire Company has been able to keep abreast on new developments due to its policy of engineering methods applied to manufacture. Precision and highest quality is the result.

Existing trade conditions have never altered "GW" Quality. Look for the "GW" trade mark. It's your assurance of the finest wire that can be drawn. "GW" will meet the strictest specifications.

You can obtain the economies and results of years of developments in metallurgy and engineering practice by using the products and technical facilities of the Gilby Wire Company.

Manufacturing

RADIO TUBE FILA-
MENT
GRID WIRE
PLATE MATERIALS
CARBONIZE NICKEL
RESISTANCE WIRE
TOPHET A
TOPHET C
CUPRON
MANGANIN
NICKEL WIRE & SHEET
ENAMELED
SILK & COTTON
COVERED

GILBY WIRE COMPANY

Wilbur B. Driver, President

NEWARK, NEW JERSEY

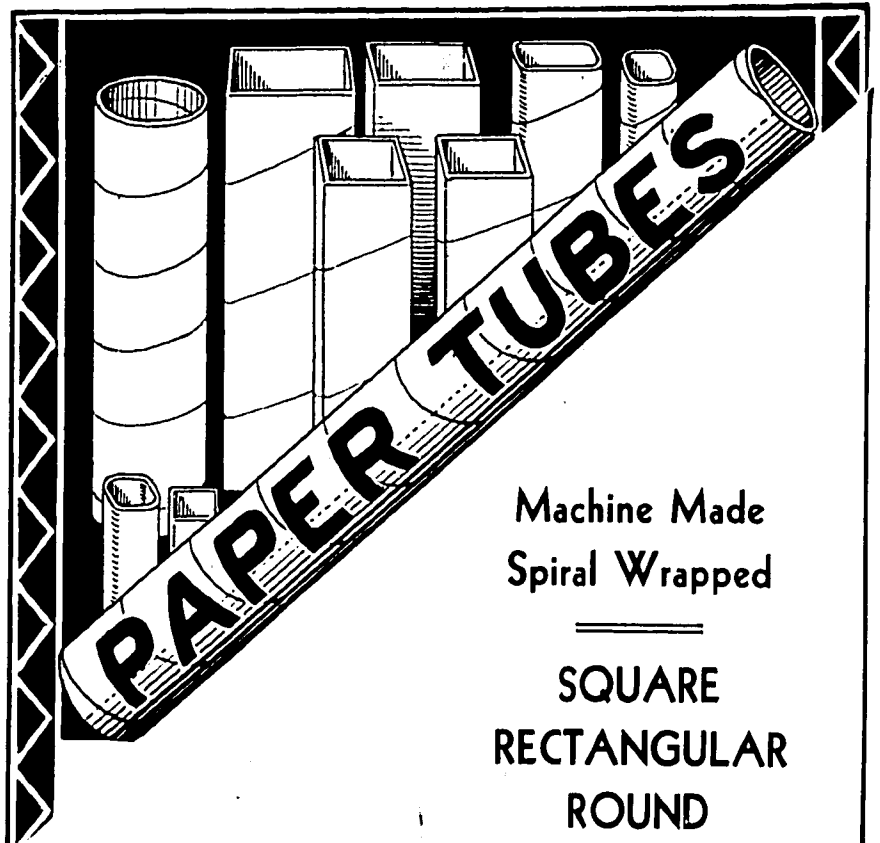

Machine Made
Spiral Wrapped

SQUARE
RECTANGULAR
ROUND

STRONG-RIGID-EXACT

THIS tubing is built up layer by layer, with each lamination securely cemented to the next. It is so wrapped to give side walls greatest possible strength.

The paper (or fibre) stock used is manufactured under a process during which magnetic extractors remove all metallic matter. Likewise, the cement-

ing materials are carefully selected and tested for winding requirements.

High dielectric test, rigidity and freedom from blisters are other features of this tubing.

Sizes—from $\frac{1}{4}$ " to $2\frac{3}{4}$ " ID—square or round corners, wall thickness required.

THE PAPER TUBE COMPANY

Manufacturers of Spiral-Wrapped Tubing for the Electrical Industry

1718-20 N. DAMEN AVE.



CHICAGO, ILLINOIS

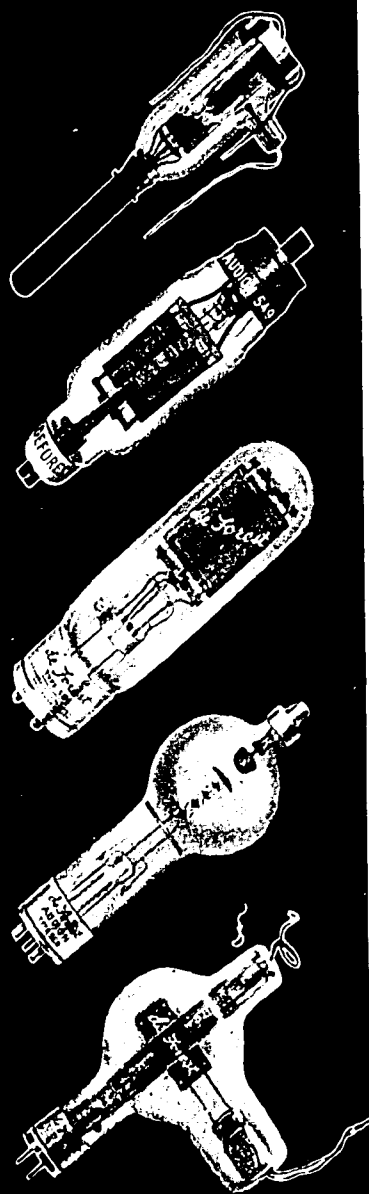

de Forest
(AUDIONS)
**RECEIVING AND
TRANSMITTING TUBES**

An Audion for Every Need

SINCE 1906, when Lee DeForest gave the world its practical vacuum tube, DeForest engineers have engaged in unremitting research and development.

A quarter century of pioneering continues. Original work in every phase of tube theory, tube design, tube production and tube application characterizes the products of the DeForest Radio Company.

There is a DeForest Audion of every standard and special type to meet every need. Each Audion is the DeForest version of a given type, incorporating obvious refinements and improvements. In addition, the DeForest engineers work out the most practical applications for their Audions, even to complete DeForest transmitters and allied equipment. Only in this manner can the heritage of true pioneering be justified and maintained.



*After all, there's no substitute for
26 years' experience*



Write for literature on DeForest receiving and transmitting audions, as well as transmitting equipment, frequency control and monitoring units, television equipment and other items of particular interest to you.

De Forest Radio Company
Passaic, New Jersey
