

# IRE DICTIONARY

OF ELECTRONICS TERMS  
AND SYMBOLS



**IRE DICTIONARY  
OF ELECTRONICS TERMS  
AND SYMBOLS**

# IRE DICTIONARY

OF

Electronics Terms and Symbols



COMPILED FROM IRE STANDARDS

Published by

THE INSTITUTE OF RADIO ENGINEERS, INC.

1 East 79th Street, New York 21, N.Y.

1961

## **ADDITIONAL COPIES**

of this Dictionary may be purchased from  
the Institute of Radio Engineers, 1 East 79 Street  
New York 21, N.Y., at the following prices:  
IRE Members \$5.20, Non-members \$10.40.

*Copyright © 1961 by*  
**THE INSTITUTE OF RADIO ENGINEERS, INC.**  
*Printed in U.S.A.*

## Table of Contents

Preface .....	vii
IRE Standards Covered by the Dictionary .....	viii

### *Dictionary of Terms*

Definitions of Terms .....	1
----------------------------	---

### *Dictionary of Symbols*

Letter Symbols for Electron Tubes .....	169
Letter Symbols for Semiconductor Devices .....	171
Graphical and Letter Symbols for Feedback Control Systems .....	174
Graphical Symbols for Semiconductor Devices .....	175
Graphical Symbols for Electrical Diagrams .....	180
Index to Graphical Symbols .....	222

## Preface

During the past 18 years, The Institute of Radio Engineers, through its Technical Committees and its Standards Committee, has produced 37 IRE Standards dealing with electronics terminology and symbology. Over the years these Standards have appeared singly in the PROCEEDINGS OF THE IRE and, prior to 1949, as separate pamphlets. This Dictionary brings together under one cover all the definitions and symbols which were contained in those Standards and were still in force in December, 1959.

The first part of the Dictionary provides an alphabetical list of approximately 3700 technical terms and their IRE Standard definitions. The code number in parentheses at the end of each definition identifies the Standard from which it was taken and corresponds to the list of Standards and their numbers given in the following section. Some terms are used in more than one field and consequently have been defined in more than one IRE Standard. Where the definitions differ, each is listed under a separate entry with the term repeated.

The second part of the Dictionary comprises reprints of five IRE Standards dealing with letter and graphical symbols. The material appears, therefore, in five sections, as indicated in the Table of Contents.

## IRE Standards Covered By The Dictionary

A list of the IRE Standards from which this Dictionary was compiled is given below in two parts, one for definitions of terms and the other for letter and graphical symbols. The code numbers given below for each Standard correspond to the code numbers which appear at the end of each definition in the Dictionary to identify its source.

### *Definitions of Terms*

<i>Standard No.</i>	<i>Title and Where Published</i>
48 IRE 2, 11, 15.S1	Standards on Antennas, Modulation Systems, and Transmitters: Definitions of Terms, 1948 (Separate Report)
53 IRE 2.S1	Standards on Antennas and Waveguides: Definitions of Terms, 1953 (December, 1953, PROC. IRE)
55 IRE 2.S1	Standards on Antennas and Waveguides: Definitions for Waveguide Components, 1955 (September, 1953, PROC. IRE)
54 IRE 3.S1	Standards on Audio Techniques: Definitions of Terms, 1954 (July, 1954, PROC. IRE)
58 IRE 3.S1	Standards on Audio Techniques: Definitions of Terms, 1958 (December, 1958, PROC. IRE)
50 IRE 4.S1	Standards on Circuits: Definitions of Terms in Network Topology, 1950 (January, 1951, PROC. IRE)
53 IRE 4.S1	Standards on Circuits: Definitions of Terms in the Field of Linear Varying Parameter and Nonlinear Circuits, 1953 (March, 1954, PROC. IRE)
51 IRE 6.S1	Standards on Electroacoustics: Definitions of Terms, 1951 (May, 1951, PROC. IRE)
50 IRE 7.S1	Standards on Electron Tubes: Definitions of Terms, 1950 (April, 1950, PROC. IRE)
54 IRE 7.S1	Standards on Electron Devices: Definitions of Terms Related to Phototubes, 1954 (August, 1954, PROC. IRE)
54 IRE 7.S2	Standards on Electron Devices: Definitions of Semiconductor Terms, 1954 (October, 1954, PROC. IRE)
56 IRE 7.S3	Standards on Electron Tubes: TR and ATR Tube Definitions, 1956 (August, 1956, PROC. IRE)

<i>Standard No.</i>	<i>Title and Where Published</i>
57 IRE 7.S2	Standards on Electron Tubes: Definitions of Terms, 1957 (July, 1957, PROC. IRE)
50 IRE 8.S1	Standards on Electronic Computers: Definitions of Terms, 1950 (March, 1951, PROC. IRE)
56 IRE 8.S1	Standards on Electronic Computers: Definitions of Terms, 1956 (September, 1956, PROC. IRE)
59 IRE 8.S1	Standards on Static Magnetic Storage: Definitions of Terms, 1959 (March, 1959, PROC. IRE)
42 IRE 9.S1	Standards on Facsimile: Definitions of Terms, 1942 (Separate Report)
56 IRE 9.S1	Standards on Facsimile: Definitions of Terms, 1956 (June, 1956, PROC. IRE)
55 IRE 10.S1	Standards on Industrial Electronics: Definitions of Industrial Electronics Terms, 1955 (September, 1955, PROC. IRE)
53 IRE 11.S1	Standards on Modulation Systems: Definitions of Terms, 1953 (May, 1953, PROC. IRE)
58 IRE 11.S1	Standards on Information Theory: Definitions of Terms, 1958 (September, 1958, PROC. IRE)
54 IRE 12.S1	Standards on Radio Aids to Navigation: Definitions of Terms, 1954 (February, 1955, PROC. IRE)
59 IRE 12.S1	Standards on Navigation Aids: Direction Finder Measurements, 1959 (August, 1959, PROC. IRE)
52 IRE 17.S1	Standards on Receivers: Definitions of Terms, 1952 (December, 1952, PROC. IRE)
51 IRE 20.S1	Standards on Pulses: Definitions of Terms—Part I, 1951 (June, 1951, PROC. IRE)
51 IRE 20.S2	Standards on Transducers: Definitions of Terms, 1951 (August, 1951, PROC. IRE)
52 IRE 20.S1	Standards on Pulses: Definitions of Terms—Part II, 1952 (May, 1952, PROC. IRE)
55 IRE 22.S1	Standards on Television: Definitions of Color Terms, 1955 (June, 1955, PROC. IRE)
55 IRE 23.S1	Standards on Television: Definitions of Television Signal Measurement Terms, 1955 (May, 1955, PROC. IRE)
45 IRE 24.S1	Standards on Radio Wave Propagation: Definitions of Terms Relating to Guided Waves, 1945 (Separate Report)
50 IRE 24.S1	Standards on Wave Propagation: Definitions of Terms, 1950 (November, 1950, PROC. IRE)
55 IRE 26.S2	Standards on Terminology for Feedback Control Systems, 1955 (January, 1956, PROC. IRE)

### ***Letter and Graphical Symbols***

<i>Standard No.</i>	<i>Title and Where Published</i>
54 IRE 21.S1	Standards on Graphical Symbols for Electrical Diagrams, 1954 (June, 1954, PROC. IRE)



*Standard No.*

*Title and Where Published*

- \*57 IRE 21.S1 Standards on Letter Symbols and Mathematical Signs, 1948  
(August, 1957, PROC. IRE)
- 57 IRE 21.S3 Standards on Graphical Symbols for Semiconductor Devices,  
1957 (December, 1957 PROC. IRE)
- 55 IRE 26.S1 Standards on Graphical and Letter Symbols for Feedback Con-  
trol Systems, 1955 (November, 1955, PROC. IRE)
- 56 IRE 28.S1 Standards on Letter Symbols for Semiconductor Devices, 1956  
(July, 1956, PROC. IRE)

\* Only the portion dealing with electron tube letter symbols is included in the Dictionary.

## **Definitions of Terms**

## A

**Absolute Delay.** In *Loran* the interval of time between the transmission of a signal from the "A" Station, and transmission of the next signal from the "B" Station. (54 IRE 12.S1)

**Absorption.** The irreversible conversion of the energy of a radio wave into other forms of energy as a result of its interaction with matter. (50 IRE 24.S1)

**Absorption Loss.** That part of the transmission loss due to the dissipation or conversion of sound energy into other forms of energy (e.g., heat), either within the medium or attendant upon a reflection. (51 IRE 6.S1)

**Absorption Modulation.** A system for producing amplitude modulation of the output of a radio transmitter by means of a variable-impedance device inserted in or coupled to the output circuit. (48 IRE 2, 11, 15.S1)

**Accelerating Electrode.** An *Electrode* to which a potential is applied to increase the velocity of the electrons or ions in the beam. (57 IRE 7.S2)

**Acceleration.** The time rate of change of velocity. (51 IRE 6.S1)

**Acceptor (in a Semiconductor).** See *Impurity, Acceptor*. (54 IRE 7.S2)

**Accessible Terminal.** A network node that is available for external connections. (50 IRE 4.S1)

**Access Time.** A time interval which is characteristic of a storage unit, and is essentially a measure of the time required to communicate with that unit. Many definitions of the beginning and ending of this interval are in common use. (56 IRE 8.S1)

**Accumulator.** A device which stores a number and which, on receipt of another number, adds it to the number already stored and stores the sum.

*Note:* The term is also applied to devices which function as described but which also have other properties.

(56 IRE 8.S1)

**Accuracy.** The quality of freedom from mistake or error, that is, of conformity to truth or to a rule. Accuracy is distinguished from *Precision* as in the following example: A six-place table is more precise than a four-place table. However, if there are errors in the six-place table, it may be either more or less accurate than the four-place table. (56 IRE 8.S1)

**Accuracy (in Direction Finding).** The correctness of an indication in terms of its deviation from the true value of the quantity indicated when the probability that this deviation will be exceeded is less than a stated value. (59 IRE 12.S1)

**AC Erasing Head.** In magnetic recording, one which uses alternating current to produce the magnetic field necessary for erasing.

*Note:* AC erasing is achieved by subjecting the medium to a number of cycles of a magnetic field of a decreasing magnitude. The medium is, therefore, essentially magnetically neutralized.

(51 IRE 6.S1)

**AC Magnetic Biasing.** In magnetic recording, magnetic biasing accomplished by the use of an alternating current, usually well above the signal frequency range. (51 IRE 6.S1)

**Acetate Disks.** Mechanical recording disks, either solid or laminated, which are made of acetate compounds. (51 IRE 6.S1)

**Achromatic Locus (Achromatic Region).** Chromaticities which may be acceptable reference standards under circumstances of common occurrence are represented in a chromaticity diagram by points in a region which may be called the "achromatic locus."

*Note:* The boundaries of the achromatic locus are indefinite, depending on the tolerances in any specific application. Acceptable reference standards of illumination (commonly referred to as "white light") are usually represented by points close to the locus of Planckian radiators having temperatures higher than about 2000°K. While any point in the achromatic locus may be chosen as the reference point for the determination of dominant wavelength, complementary wavelength and purity for specification of object colors, it is usually advisable to adopt the point representing the chromaticity of the luminator. Mixed qualities of illumination, and luminators with chromaticities represented very far from the Planckian locus, require special consideration. Having selected a suitable reference point, dominant wavelength may be determined by noting the wavelength corresponding to the intersection of the spectrum locus with the straight line drawn from the reference point through the point representing the sample. When the reference point lies between the sample point and the intersection, the intersection indicates the complementary wavelength. Any point within the achromatic locus, chosen as a reference point, may be called an "achromatic point." Such points have also been called "white points."

(55 IRE 22.S1)

**Acoustic.<sup>1</sup>** When used as a qualifying term

<sup>1</sup> This usage of "acoustic" and "acoustical" as modifiers agrees with the commonly accepted usage of "electric" and "electrical." In the science of mechanics, however, the term "mechanical" is the only modifier in common use.

## Acoustical

denotes containing, producing, arising from, actuated by, or carrying sound, or designed to carry sound and capable of doing so.

*Examples:* acoustic horn, transducer, energy, wave, impedance.

(51 IRE 6.S1)

**Acoustical.<sup>1</sup>** When used as a qualifying term denotes related, pertaining to, or associated with sound, but not having its properties or characteristics.

*Examples:* acoustical engineer, school, glossary, unit.

(51 IRE 6.S1)

## Acoustic Generator

source been located at *B*.

(51 IRE 6.S1)

**Acoustical Units.** In acoustics, the centimeter-gram-second (cgs) system of units has been and is at present predominantly used, but some practical units such as English and metric system units of length are also being used, and the watt is commonly being employed for designating acoustic power. In recent years, there has been a trend toward adoption of the rationalized meter-kilogram-second system of units in many fields of science and engineering. It would, of course, be

TABLE I

CONVERSION OF PRESENT ACOUSTICAL UNITS INTO MKS UNITS

Quantity	Dimension	Present Unit	MKS Unit	Conversion Factor*
Sound velocity (particle velocity)	$LT^{-1}$	cm per second	meter per second	$10^{-2}$
Volume velocity	$L^2T^{-1}$	cubic cm per second	cubic meter per second	$10^{-6}$
Sound energy	$ML^2T^{-2}$	erg	joule	$10^{-7}$
Force	$MLT^{-2}$	dyne	newton	$10^{-5}$
Sound pressure (sound-energy density)	$ML^{-1}T^{-2}$	microbar	newton per square meter	$10^{-1}$
Sound-energy flux (sound power of source)	$ML^2T^{-3}$	erg per second	watt	$10^{-7}$
Sound intensity (specific sound-energy flux)	$MT^{-3}$	erg per second per square cm	watt per square meter	$10^{-3}$
Acoustic impedance (resistance, reactance)	$ML^{-1}T^{-1}$	watt per square cm acoustical ohm	mks acoustical ohm	$10^4$ $10^6$
Specific acoustic impedance	$ML^{-2}T^{-1}$	acoustical ohm Xsquare cm	mks acoustical ohm† Xsquare meter	10
Mechanical impedance (resistance, reactance)	$ML^{-1}$	mechanical ohm	mks mechanical ohm†	$10^{-3}$

\* Multiply the magnitude expressed in present units by the tabulated conversion factor to obtain magnitude in mks units.

† MKS acoustical ohm and mks mechanical ohm are proposed terms.

**Acoustical Ohm.<sup>2</sup>** An acoustic resistance, reactance, or impedance has a magnitude of one acoustical ohm when a sound pressure of 1 microbar produces a volume velocity of 1 cubic centimeter per second. (51 IRE 6.S1)

**Acoustical Reciprocity Theorem.** In an acoustic system comprising a fluid medium having bounding surfaces  $S_1, S_2, S_3, \dots$ , and subject to no impressing body forces, if two distributions of normal velocities  $v_n'$  and  $v_n''$  of the bounding surfaces produce pressure fields  $p'$  and  $p''$ , respectively, throughout the region, then the surface integral of  $(p''v_n' - p'v_n'')$  over all the bounding surfaces  $S_1, S_2, S_3, \dots$ , vanishes.

*Note:* If the region contains only one simple source, the theorem reduces to the form ascribed to Helmholtz, viz., in a region as described, a simple source at *A* produces the same sound pressure at another point *B* as would have been produced at *A* had the

highly desirable if, in place of the present diversity and mixture of scientific units, a single system of units could be universally used. While the mks units so far have not been employed in acoustics, if there is a trend toward their universal adoption, the workers in the field of acoustics will want to follow suit. For this reason, Table I for the conversion of present acoustical units into mks units is being presented. (51 IRE 6.S1)

**Acoustic Compliance.<sup>3</sup>** The reciprocal of acoustic stiffness. Its dimensions are  $M^{-1}L^4T^2$ . (51 IRE 6.S1)

**Acoustic Dispersion.** The separation of a complex sound wave into its various frequency components, usually caused by a variation with frequency of the wave velocity of the medium. The rate of change of the velocity with frequency is used as a measure of the dispersion. (51 IRE 6.S1)

**Acoustic Generator.** A transducer which converts electric, mechanical, or other forms of

<sup>2</sup> See Note 2 under *Acoustic Impedance*.

energy into sound. (51 IRE 6.S1)

**Acoustic Horn (Horn).** A tube of varying cross section having different terminal areas which provide a change of acoustic impedance and control of the directivity pattern. (51 IRE 6.S1)

**Acoustic Impedance.** The acoustic impedance of a sound medium on a given surface lying in a wave front is the complex quotient of the sound pressure (force per unit area) on that surface by the flux (volume velocity, or linear velocity multiplied by the area), through the surface. When concentrated rather than distributed impedances are considered, the impedance of a portion of the medium is defined by the complex quotient of the pressure difference effective in driving that portion, by the flux (volume velocity). The acoustic impedance may be expressed in terms of mechanical impedance, acoustic impedance being equal to the mechanical impedance divided by the square of the area of the surface considered. The commonly used unit is the acoustical ohm.

*Note 1:* Velocities in the direction along which the impedance is to be specified are considered positive.

*Note 2:* The terms and definitions to which this note is appended pertain to single-frequency quantities in the steady state, and to systems whose properties are independent of the magnitudes of these quantities.

(51 IRE 6.S1)

**Acoustic Interferometer.** An instrument for measuring the velocity or frequency of sound waves in a liquid or gas by observing the variations of sound pressure in a standing wave established in the medium between a sound source and a reflector, as the reflector is moved or the frequency is varied. (51 IRE 6.S1)

**Acoustic Mass (Acoustic Inertance).** The quantity which, when multiplied by  $2\pi$  times the frequency, gives the acoustic reactance associated with the kinetic energy of the medium. The commonly used unit is the gram per centimeter to the fourth power. Its dimensions are  $ML^{-4}$ . (51 IRE 6.S1)

**Acoustic Pickup (Sound Box).** A device which transforms groove modulations directly into acoustic vibrations. (51 IRE 6.S1)

**Acoustic Radiating Element.** A vibrating surface in a transducer which can cause or be actuated by sound waves. (51 IRE 6.S1)

**Acoustic Radiometer.** An instrument for measuring sound intensity by determining the unidirectional steady-state pressure caused by the reflection or absorption of a sound wave at a boundary. (51 IRE 6.S1)

**Acoustic Reactance.**<sup>2</sup> The imaginary component of the acoustic impedance. The com-

monly used unit is the acoustical ohm. (51 IRE 6.S1)

**Acoustic Refraction.** The variation of the direction of sound transmission due to spatial variation of the wave velocity in the medium. (51 IRE 6.S1)

**Acoustic Resistance.**<sup>2</sup> The real component of the acoustic impedance. The commonly used unit is the acoustical ohm. (51 IRE 6.S1)

**Acoustics.** The science of sound including its production, transmission, and effects. (51 IRE 6.S1)

**Acoustic Scattering.** The irregular and diffuse reflection or diffraction of sound in many directions.

*Note:* Scattering frequently occurs when the reflecting surfaces or bodies are small compared with the wave-length of sound; in certain cases the reflecting bodies may be small inhomogeneities in the medium.

(51 IRE 6.S1)

**Acoustic Stiffness.**<sup>2</sup> The quantity which, when divided by  $2\pi$  times the frequency, gives the acoustic reactance associated with the potential energy of the medium or its boundaries. The unit commonly used is the dyne per centimeter to the fifth power. Its dimensions are  $ML^{-4}T^{-2}$ . (51 IRE 6.S1)

**Acoustic Transmission System.** An assembly of elements adapted for the transmission of sound (51 IRE 6.S1)

**Active Transducer.** See *Transducer, Active*. (58 IRE 3.S1)

**Actuating Transfer Function.** In a feedback control loop, the transfer function which relates a loop actuating signal to the corresponding loop input signal. (55 IRE 26.S2)

**Adcock Antenna.** A pair of vertical antennas separated by a distance of one-half wavelength or less, and connected in phase opposition to produce a radiation pattern having the shape of a figure of eight. (48 IRE 2, 11, 15.S1)

**Adder.** A device which can form the sum of two or more numbers or quantities. (56 IRE 8.S1)

**Adder, Algebraic.** An adder which can form an algebraic sum. (50 IRE 8.S1)

**Address.** An expression, usually numerical, which designates a particular location in a *Storage* or *Memory* device or other source or destination of information. See also *Instruction Code*. (56 IRE 8.S1)

**Address Part.** In an instruction, any part that is usually an *Address*. See also *Instruction Code*. (56 IRE 8.S1)

**ADF.** A designation for an *Automatic Direction Finder* originally designed for use on board aircraft. (54 IRE 12.S1)

**A-Display (also A-Scan or A-Scope).** In *Radar*, a *Display* in which *Targets* appear as

## Adjacent-Channel Attenuation

vertical deflections from a line representing a time base. *Target* distance is indicated by the horizontal *Position* of the deflection from one end of the time base. The amplitude of the vertical deflection is a function of the signal intensity. (54 IRE 12.S1)

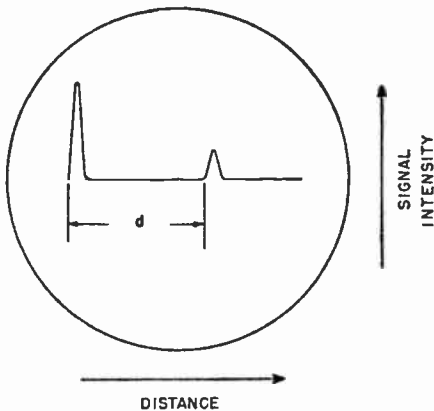

**Adjacent-Channel Attenuation.** See *Selectance*. (52 IRE 17.S1)

**Adjacent-Channel Interference.** *Interference* in which the extraneous power originates from a signal of assigned (authorized) type in an adjacent channel. (52 IRE 17.S1)

**Admittance.** See:

*Driving-Point Admittance (between the  $j$ th Terminal and the Reference Terminal of an  $n$ -Terminal Network)*

*Electrode Admittance (of the  $j$ th Electrode of an  $n$ -Electrode Electron Tube)*

*Gap Admittance, Circuit*

*Gap Admittance, Electronic*

*Interelectrode Transadmittance ( $j$ - $l$  Interelectrode Transadmittance of an  $n$  Electrode Electron Tube) Short-Circuit Driving-Point Admittance (of the  $j$ th Terminal of an  $n$ -Terminal Network)*

*Short-Circuit Driving-Point Admittance (of the  $j$ th Terminal of an  $n$ -Terminal Network)*

*Short-Circuit Feedback Admittance (of an Electron-Tube Transducer)*

*Short-Circuit Forward Admittance (of an Electron-Tube Transducer)*

*Short-Circuit Input Admittance (of an Electron-Tube Transducer)*

*Short-Circuit Output Admittance (of an Electron-Tube Transducer)*

*Short-Circuit Transfer Admittance (from the  $j$ th Terminal to the  $l$ th Terminal of an  $n$ -Terminal Network)*

*Transfer Admittance (from the  $j$ th Terminal*

## Alternator Transmitter

*to the  $l$ th Terminal of an  $n$ -Terminal Network)*

(57 IRE 7.S2)

**Advance Ball.** In mechanical recording, a rounded support (often sapphire) attached to a cutter which rides on the surface of the recording medium so as to maintain a uniform mean depth of cut and correct for small irregularities of the disk surface. (51 IRE 6.S1)

**Aelight.** A glow lamp employing a cold cathode and a mixture of permanent gases in which the intensity of illumination varies with the applied signal voltage. (51 IRE 6.S1)

**Aerophare.** In air operations a name for *Radio Beacon*. (54 IRE 12.S1)

**Aided Tracking.** A tracking system in which the manual correction of the tracking error automatically corrects the rate of motion of the tracking mechanism. (54 IRE 12.S1)

**AI Radar (Airborne Intercept).** An airborne *Radar* used for searching for and tracking other aircraft. (54 IRE 12.S1)

**Airborne Radar.** A radar set providing information in an aircraft about the relative position of fixed identification points or other aircraft. (49 IRE 12.S1)

**Air Conduction.** The process by which sound is conducted to the inner ear through the air in the outer ear canal as part of the pathway. (51 IRE 6.S1)

**Airport Surface Detection Equipment (ASDE).** A *Radar* for observation of the *Positions* of aircraft on the surface of an airport. (54 IRE 12.S1)

**Airport Surveillance Radar (ASR).** A *Radar* operating at or near an airport, and used for observation of the *Positions* of airborne aircraft. It is primarily employed in the control and organizing of local traffic. (54 IRE 12.S1)

**Air-Position Indicator (API).** An airborne computing system which presents a continuous indication of the aircraft *Position* on the basis of *Aircraft-Heading*, *Air Speed* and elapsed time. (54 IRE 12.S1)

**Air Speed.** The rate of motion of a *Vehicle* relative to the air mass. (54 IRE 12.S1)

**Alford Loop.** A multielement antenna, having approximately equal and in-phase currents uniformly distributed along each of its peripheral elements, producing a substantially circular radiation pattern in the plane of polarization (originally developed as a four-element, horizontally polarized VHF loop antenna). (54 IRE 12.S1)

**Algebraic Adder.** See *Adder, Algebraic*. (50 IRE 8.S1)

**Alternator Transmitter.** A radio transmitter

## Altimetric Flare-Out

which utilizes power generated by a radio-frequency alternator. (48 IRE 2, 11, 15.S1)

**Altimetric Flare-Out.** A nonunique descent path in which the rate of descent is reduced as the touchdown point is approached. The rate reduction is a function of the altimetric measurement of height above ground. (54 IRE 12.S1)

**Altitude.** Vertical distance above sea level. (49 IRE 12.S1)

**Ambient Temperature.** The temperature of the surrounding medium, such as gas or liquid, which comes into contact with the apparatus. (48 IRE 2, 11, 15.S1)

**Ambiguity.** In *Navigation*, the condition obtaining when *Navigation Coordinates* define more than one point, *Direction*, *Line of Position*, or *Surface of Position*. (54 IRE 12.S1)

**AM to FS Converter.** See *Transmitting Converter*, *Facsimile*. (56 IRE 9.S1)

**Amplification.** General transmission term used to denote an increase of *Signal* magnitude. (54 IRE 3.S1)

**Amplification Factor.** The  $\mu$  Factor for a specified *Electrode* and the *Control Grid* of an *Electron Tube* under the condition that the *Anode Current* is held constant.

*Note 1:* In a *Triode* this becomes the  $\mu$  Factor for the *Anode* and *Control-Grid* electrodes.

*Note 2:* In multielectrode tubes connected as *Triodes* the term *Anode* applies to the combination of *Electrodes* used as the *Anode*.

(57 IRE 7.S2)

**Amplifier.** A device which enables an input *Signal* to control a *Source* of power, and thus is capable of delivering at its output an enlarged reproduction of the essential characteristics of the *Signal*.

*Note:* Typical amplifying elements are electron tubes, transistors, and magnetic circuits.

See also:

*Class-A Amplifier*

*Class-AB Amplifier*

*Class-B Amplifier*

*Class-C Amplifier.*

(59 IRE 7.S2; 58 IRE 3.S1)

**Amplifier, Bridging.** An *Amplifier* with an *Input Impedance* sufficiently high that its input may be bridged across a circuit without substantially affecting the *Signal Level* of the circuit across which it is bridged. (58 IRE 3.S1)

**Amplifier, Clipper.** An *Amplifier* designed to limit the instantaneous value of its output to a predetermined maximum. (58 IRE 3.S1)

**Amplifier, Distribution.** A *Power Amplifier* designed to energize a speech or music dis-

## Amplitude vs Frequency Response

tribution system and having sufficiently low *Output Impedance* so that changes in *Load* do not appreciably affect the output voltage. (58 IRE 3.S1)

**Amplifier, Isolation.** An *Amplifier* employed to minimize the effects of a following circuit on the preceding circuit. (58 IRE 3.S1)

**Amplifier, Line.** An *Amplifier* which supplies a *Program* transmission line or a system with a *Signal* at a specified *Level*. (58 IRE 3.S1)

**Amplifier, Monitoring.** A *Power Amplifier* used primarily for evaluation and supervision of a *Program*. (58 IRE 3.S1)

**Amplifier, Peak Limiting.** See *Peak Limiter*. (58 IRE 3.S1)

**Amplifier, Power.** An *Amplifier* which drives a utilization device, such as a loudspeaker. (58 IRE 3.S1)

**Amplifier, Program.** See *Amplifier, Line*. (58 IRE 3.S1)

**Amplifier, Torque.** See *Torque Amplifier*. (50 IRE 8.S1)

**Amplitude Balance Control.** In *Navigation*, that portion of a system which may be varied to adjust the relative output levels of two related signals. Originally used in ILS and later in *Loran*. (54 IRE 12.S1)

**Amplitude Discriminator.** A circuit, the output of which is a function of the relative magnitudes of two signals. (54 IRE 12.S1)

**Amplitude Distortion (old usage).** A type of distortion that occurs in an amplifier or other device when the amplitude of the output is not exactly a linear function of the input amplitude.

See also *Amplitude-Frequency Distortion*, *Distortion*, *Harmonic*, *Harmonic Distortion*, *Distortion*, *Intermodulation and Waveform-Amplitude Distortion*.

(48 IRE 2, 11, 15.S1; 53 IRE 4.S1; 58 IRE 3.S1)

**Amplitude-Frequency Distortion.** Distortion due to an undesired amplitude-frequency characteristic.

*Note 1:* The usual desired characteristic is flat over the frequency range of interest.

*Note 2:* Also sometimes called *Amplitude Distortion* or *Frequency Distortion*.

See also *Distortion*, *Amplitude-Frequency*. (53 IRE 4.S1; 58 IRE 3.S1)

**Amplitude-Frequency Response.** The variation of *Gain*, *Loss*, *Amplification*, or *Attenuation* as a function of frequency.

*Note:* This response is usually measured in the region of operation in which the transfer characteristic of the system or component is essentially linear.

(58 IRE 3.S1)

**Amplitude vs Frequency Response Char-**

- acteristic. The variation with frequency of the gain or loss of a device or a system. (48 IRE 2, 11, 15.S1)
- Amplitude-Modulated Transmitter.** A transmitter which transmits an amplitude-modulated wave.  
*Note:* In most amplitude-modulated transmitters, the frequency is stabilized. (48 IRE 2, 11, 15.S1)
- Amplitude Modulation (AM).** Modulation in which the amplitude of a carrier is the characteristic varied. (52 IRE 17.S1; 53 IRE 11.S1)
- Amplitude-Modulation Noise Level.** The noise level produced by undesired amplitude variations of a radio-frequency signal in the absence of any intended modulation. (48 IRE 2, 11, 15.S1)
- Amplitude Range.** The ratio, usually expressed in decibels, between the upper and lower limits of *Program* amplitudes which contain all significant energy contributions. (58 IRE 3.S1)
- Amplitude Response (Camera Tubes).** See *Square-Wave Response*. (57 IRE 7.S2)
- Amplitude Response Characteristic (Camera Tubes).** See *Square-Wave Response Characteristic*. (57 IRE 7.S2)
- Analog (in Electronic Computers).** A physical system on which the performance of measurements yields information concerning a class of mathematical problems. (56 IRE 8.S1)
- Analog Computer.** A physical system together with means of control for the performance of measurements (upon the system) which yield information concerning a class of mathematical problems. (56 IRE 8.S1)
- And-Circuit.** Synonym for *And-Gate*. (56 IRE 8.S1)
- And-Gate.** A gate whose output is energized when and only when every input is in its prescribed state. An *And-Gate* performs the function of the logical "and." (56 IRE 8.S1)
- Angle.** See:  
*Angle, Maximum-Deflection*  
*Bunching Angle (in an Electron Stream)*  
*Effective Bunching Angle (Reflex Klystrons)*  
*Optimum Bunching Angle*  
*Transit Angle.*  
(57 IRE 7.S2)
- Angle of Elevation.** The angle measured at the observer between the horizontal plane and the line to the object. (49 IRE 12.S1)
- Angle, Maximum-Deflection.** The maximum plane angle subtended at the *Deflection Center* by the usable *Screen* area.  
*Note:* In this term the hyphen is frequently omitted.
- (57 IRE 7.S2)
- Angle Modulation.** Modulation in which the angle of a sine-wave carrier is the characteristic varied from its normal value.  
*Note:* Phase and frequency modulation are particular forms of angle modulation. (53 IRE 11.S1)
- Angle or Phase of a Sine Wave.** The measure of the progression of the wave in time or space from a chosen instant or position.  
*Note 1:* In the expression for a sine wave, the angle or phase is the value of the entire argument of the sine function.  
*Note 2:* In the representation of a sine wave by a rotating vector, the angle or phase is the angle through which the vector has progressed. (53 IRE 11.S1)
- Angular Deviation Loss.** Of a transducer used for sound emission or reception, an expression, in decibels, of the ratio of the reference response observed on the principal axis to the transducer response at a specified angle from the principal axis. See also *Directivity Pattern (Directional Response Pattern) (Beam Pattern)*. (51 IRE 6.S1)
- Angular Deviation Sensitivity.** The ratio of change of *Course* indication to the change of angular displacement from the *Course Line*. (54 IRE 12.S1)
- Angular Frequency.** The frequency expressed in radians per second. It is equal to the frequency in cycles per second multiplied by  $2\pi$ . (50 IRE 24.S1)
- Angular Resolution.** The ability of a *Radar* to distinguish between two *Targets* solely by the measurement of angles. It is generally expressed in terms of the minimum angle by which *Targets* must be spaced to be separately distinguishable. (54 IRE 12.S1)
- Angular Width.** See *Course Width*. (54 IRE 12.S1)
- Anode (Electron Tubes).** An *Electrode* through which a principal stream of electrons leaves the interelectrode space. (57 IRE 7.S2)
- Anode Breakdown Voltage (Gas Tubes).** See *Breakdown Voltage (of an Electrode of a Gas Tube)*. (57 IRE 7.S2)
- Anode Current.** See *Electrode Current*. (57 IRE 7.S2)
- Anode Strap (Magnetrons).** A metallic connector between selected anode segments of a *Multicavity Magnetron*, principally for the purpose of *Mode Separation*. (57 IRE 7.S2)
- Anode Voltage.** See *Electrode Voltage*. (57 IRE 7.S2)
- Anode Voltage Drop.** See *Tube Voltage Drop*. (57 IRE 7.S2)
- A-N Radio Range.** A *Radio Range* provid-



## Antenna

ing four radial *Lines of Position* identified aurally as a continuous tone resulting from the interlocking of equal amplitude "A" and "N" International Morse code letters. The sense of deviation from these lines is indicated by deterioration of the steady tone into audible A or N code signals. (54 IRE 12.S1)

**Antenna.** A means for radiating or receiving radio waves. (52 IRE 17.S1)

**Antenna Array.** A system of antennas coupled together for the purpose of obtaining directional effects. (48 IRE 2, 11, 15.S1)

**Antenna Cross Talk.** A measure of undesired power transfer through space from one antenna to another.

*Note:* Numerically, antenna cross talk is the ratio of the power received by one antenna to the power transmitted by the other, usually expressed in decibels.

(48 IRE 2, 11, 15.S1)

**Antenna Effect.** In navigation systems employing antennas, any output signals due to the directional array acting as a nondirectional antenna (also called height effect).

*Note:* In usual direction finding practice on ground waves *Antenna Effect* would be manifested: If in phase, by an angular displacement of the nulls from 180° displacement; if in quadrature, by a residual signal obscuring the nulls. The in-phase effect is often used to eliminate the 180° ambiguity, i.e., to permit *Sense* finding.

(54 IRE 12.S1)

**Antenna Resistance.** The quotient of the power supplied to the entire antenna circuit by the square of the effective antenna current referred to a specified point.

*Note:* Antenna resistance is made up of such components as radiation resistance, ground resistance, radio-frequency resistance of conductors in the antenna circuit, and equivalent resistance due to corona, eddy currents, insulator leakage, and dielectric power loss.

(48 IRE 2, 11, 15.S1)

**Anti-Clutter Circuits.** In *Radar*, circuits which attenuate undesired reflections to permit detection of *Targets* otherwise obscured by such reflections. (54 IRE 12.S1)

**Antinoise Microphone.** A microphone with characteristics which discriminate against acoustic noise. (51 IRE 6.S1)

**Anti-TR Switch.** A gas-discharge switch, employed when a common transmitting and receiving antenna is used, which automatically decouples the transmitter from the antenna during the receiving period. (54 IRE 12.S1)

**Aperture (of a Unidirectional Antenna).** That portion of a plane surface near the antenna, perpendicular to the direction of

## Arc-Through

maximum radiation, through which the major part of the radiation passes. (48 IRE 2, 11, 15.S1)

**Aperture Illumination.** The field distribution in amplitude and phase over the aperture. (48 IRE 2, 11, 15.S1)

**Apparent Bearing.** The direction of arrival of the signal with respect to some reference direction. (59 IRE 12.S1)

**Applicator (Applicator Electrodes), (Dielectric Heating usage).** Appropriately shaped conducting surfaces between which is established an alternating electric field for the purpose of producing *Dielectric Heating*. (55 IRE 10.S1)

**Applicator Impedance, Loaded (Dielectric Heating usage).** See *Loaded Applicator Impedance*. (55 IRE 10.S1)

**Applicator Impedance, Unloaded (Dielectric Heating usage).** See *Unloaded Applicator Impedance*. (55 IRE 10.S1)

**Applied Shock.** Any excitation which, if applied to a system, would produce shock motion within the system. (51 IRE 6.S1)

**Approach Navigation.** *Navigation* during the time that the approach to a dock or runway is of immediate importance. (54 IRE 12.S1)

**Approach Path.** That portion of the *Flight Path* in the immediate vicinity of a landing area where such *Flight Path* terminates at the touchdown point. (54 IRE 12.S1)

**Arc.** A discharge of electricity through a gas, normally characterized by a voltage drop approximately equal to the ionization potential of the gas. (57 IRE 7.S2)

**Arc-Back.** The flow of a principal electron stream in the reverse direction owing to the formation of a *Cathode Spot* on an *Anode*, which results in a failure of the rectifying action. (57 IRE 7.S2)

**Arc Converter.** A form of oscillator utilizing an electric arc as the generator of alternating or pulsating current. (48 IRE 2, 11, 15.S1)

**Arc-Drop Loss (Gas Tubes).** The product of the instantaneous values of *Tube Voltage Drop* and current averaged over a complete cycle of operation. (57 IRE 7.S2)

**Arc-Drop Voltage (Gas Tubes).** See *Tube Voltage Drop*. (57 IRE 7.S2)

**Arc Loss (Switching Tubes).** The decrease in radio-frequency power measured in a matched termination when a *Fired Tube*, mounted in a series or shunt junction with a waveguide, is inserted between a matched generator and the termination. In the case of a *Pre-TR Tube*, a matched output termination is also required for the tube. (57 IRE 7.S2)

**Arc-Through (Multielectrode Gas Tubes).**

## A and R Display

The loss of control resulting from the flow of a principal electron stream in the normal direction during a scheduled nonconducting period. (57 IRE 7.S2)

**A and R Display** (also **A and R Scan** or **A and R Scope**). See *Display*. (54 IRE 12.S1)

**Arithmetic Element**. Synonym for *Arithmetic Unit*. (56 IRE 8.S1)

**Arithmetic Organ**. See *Arithmetic Element*. (50 IRE 8.S1)

**Arithmetic Unit**. That part of a computer which performs arithmetic operations. (56 IRE 8.S1)

**Arm**. See *Branch*. (50 IRE 4.S1)

**Articulation (Per Cent Articulation) and Intelligibility (Per Cent Intelligibility)**.

Of a communication system, the percentage of the speech units spoken by a talker or talkers that is understood correctly by a listener or listeners.

The word "articulation" is customarily used when the contextual relations among the units of the speech material are thought to play an unimportant role; the word "intelligibility" is customarily used when the context is thought to play an important role in determining the listener's perception.

*Note 1:* It is important to specify the type of speech material and the units into which it is analyzed for the purpose of computing the percentage. The units may be fundamental speech sounds, syllables, words, sentences, and so forth.

*Note 2:* The per cent articulation or per cent intelligibility is a property of the entire communication system; talker, transmission equipment or medium, and listener. Even when attention is focused upon one component of the system (e.g., a talker, a radio receiver), the other components of the system should be specified.

(51 IRE 6.S1)

**Artificial Antenna (Dummy Antenna)**. A device which has the necessary impedance characteristics of an antenna and the necessary power-handling capabilities, but which does not radiate or receive radio waves. (48 IRE 2, 11, 15.S1)

**Artificial Ear**. A device for the measurement of earphones which presents an acoustic impedance to the earphones equivalent to the impedance presented by the average human ear. It is equipped with a microphone for measurement of the sound pressures developed by the earphone. (51 IRE 6.S1)

**Artificial Line**. A network which simulates the electrical characteristic of a *Transmission Line*. (53 IRE 2.S1)

**Artificial Load**. A dissipative but essentially

## Attenuation

nonradiating device having the impedance characteristics of an antenna, transmission line, or other practical utilization circuit. (48 IRE 2, 11, 15.S1)

**Artificial Voice**. A small loudspeaker mounted in a shaped baffle which is proportioned to simulate the acoustical constants of the human head. The artificial voice is used for calibrating and testing close-talking microphones. (51 IRE 6.S1)

**A-Scan**. See *Display*. (54 IRE 12.S1)

**A-Scope**. See *Display*. (54 IRE 12.S1)

**Aspect Ratio**. In television, the ratio of the frame width to the frame height. (52 IRE 17.S1)

**ASR**. See *Airport Surveillance Radar*. (54 IRE 12.S1)

**"A" Station**. In *Loran*, the designation applied to the transmitting station of a pair, the signal of which always occurs less than half a repetition period after the next preceding signal and more than half a repetition period before the next succeeding signal of the other station of the pair, designated a *"B" Station*. (54 IRE 12.S1)

**Astigmatism (Electron Optical)**. In an *Electron-Beam Tube*, a focus defect in which electrons in different axial planes come to focus at different points. (57 IRE 7.S2)

**Atmospheric Duct**. An almost horizontal layer in the troposphere, extending from the level of a local minimum of the modified refractive index as a function of height, down to the level where the minimum value is again encountered, or down to the earth's surface if the minimum value is not encountered again. (50 IRE 24.S1)

**Atmospheric Radio Wave**. A radio wave that is propagated by reflections in the atmosphere. It may include either or both of the components, ionospheric wave and tropospheric wave. (50 IRE 24.S1)

**ATR (Anti-Transmit-Receive) Tube**. A gas-filled radio-frequency switching tube used to isolate the transmitter during the interval for pulse reception. (57 IRE 7.S2)

**Attack Time**. The interval required, after a sudden increase in input. *Signal* amplitude to a system or component, to attain a specified percentage (usually 63 per cent) of the ultimate change in *Amplification* or *Attenuation* due to this increase. (58 IRE 3.S1)

**Attenuation**. General transmission term used to denote a decrease of *Signal* magnitude. (58 IRE 3.S1)

**Attenuation (of Radio Waves)**. Of a quantity associated with a traveling wave in a homogeneous medium, the decrease with distance in the direction of propagation.

*Note:* In a diverging wave, attenuation in-

## Attenuation

cludes the effect of divergence.

(50 IRE 24.S1)

**Attenuation (in a Waveguide).** Of a quantity associated with a traveling waveguide wave, the decrease with distance in the direction of propagation.

*Note:* Attenuation of power is usually measured in terms of db or db per unit length.

(53 IRE 2.S1)

**Attenuation Band (of a Uniconductor Waveguide).** See *Rejection Band*. (53 IRE 2.S1)

**Attenuation Constant.** Of a *Traveling Plane Wave* at a given frequency, relative rate of decrease of amplitude of a field component (or of voltage or current) in *Direction of Propagation* in nepers per unit length. (53 IRE 2.S1)

**Attenuation Equalizer.** A device for altering the total transmission loss of a circuit for various frequencies in order to make substantially equal the total transmission loss for all frequencies within a certain range. (42 IRE 9.S1)

**Attenuation-Frequency Distortion (or Attenuation Distortion or Amplitude-Frequency Distortion).** The form of wave distortion in which the relative magnitudes of the different frequency components of the wave are changed. (42 IRE 9.S1)

**Attenuation Ratio.** The magnitude of the propagation ratio. (50 IRE 24.S1)

**Attenuator.** An adjustable passive device for reducing the amplitude of a *Signal* without introducing appreciable distortion. (58 IRE 3.S1)

**Attenuator Tube.** A gas-filled radio-frequency switching tube in which a gas discharge, initiated and regulated independently of radio-frequency power, is used to control this power by reflection or absorption. (57 IRE 7.S2)

**Attenuator, Waveguide.** A waveguide device for the purpose of producing attenuation by any means, including absorption and reflection. (55 IRE 2.S1)

**Audio Frequency.** Any frequency corresponding to a normally audible sound wave.

*Note 1:* Audio frequencies range roughly from 15 to 20,000 cycles per second.

*Note 2:* The word "audio" may be used as a modifier to indicate a device or system intended to operate at audio frequencies, e.g., "audio amplifier."

(51 IRE 6.S1; 52 IRE 17.S1; 58 IRE 3.S1)

**Audio-Frequency Harmonic Distortion.** The generation in a system of integral multiples of a single audio-frequency input signal. (48 IRE 2, 11, 15.S1)

**Audio-Frequency Noise.** Any electrical dis-

## Automatic Direction Finder

turbance in the *Audio-Frequency* range introduced from a source extraneous to the *Signal*. (58 IRE 3.S1)

**Audio-Frequency Peak Limiter.** A circuit used in an audio-frequency system to cut off peaks that exceed a predetermined value. (48 IRE 2, 11, 15.S1)

**Audio-Frequency Response.** See *Amplitude-Frequency Response*. (58 IRE 3.S1)

**Audiogram (Threshold Audiogram).** A graph showing hearing loss, per cent hearing loss, or per cent hearing as a function of frequency. (51 IRE 6.S1)

**Audiometer.** An instrument for measuring hearing acuity. Measurements may be made with speech signals, usually recorded, or with tone signals.

*Note:* Specifications for a pure tone audiometer for general diagnostic purposes are covered by "Proposed American Standard Specification for Audiometers for General Diagnostic Purposes, Z24.5/158."

(51 IRE 6.S1)

**Audio Oscillator.** A non-rotating device for producing *Audio-Frequency* alternating current, the frequency of which is determined by the characteristics of the device. (58 IRE 3.S1)

**Audio Spectrum.** The continuous range of frequencies extending from the lowest to the highest *Audio Frequency*. (58 IRE 3.S1)

**Auditory Sensation Area.** 1) The region enclosed by the curves defining the threshold of feeling and the threshold of audibility as functions of frequency. 2) The part of the brain (temporal lobe of the cortex) which is responsive to auditory stimuli. (51 IRE 6.S1)

**Aural Harmonic.** A harmonic generated in the auditory mechanism. (51 IRE 6.S1)

**Aural Radio Range.** A *Radio Range* station providing *Lines of Position* by virtue of aural identification or comparison of signals at the output of a receiver. See *A-N Radio Range*. (54 IRE 12.S1)

**Aural Transmitter.** The radio equipment used for the transmission of the aural (sound) signals from a television broadcast station. (48 IRE 2, 11, 15.S1)

**Automatic Chart-Line Follower.** A device which automatically derives error signals proportional to the deviation of the track of a *Vehicle* from a predetermined *Course Line* drawn on a chart. (54 IRE 12.S1)

**Automatic Check.** See *Check, Automatic*. (56 IRE 8.S1)

**Automatic Direction Finder.** A *Direction Finder* which automatically and continuously provides a measure of the *Direction* of arrival of the received signal. Data are usually displayed visually. (54 IRE 12.S1)

## Automatic Frequency Control

**Automatic Frequency Control.** An arrangement whereby the frequency of an oscillator is automatically maintained within specified limits. (48 IRE 2, 11, 15.S1)

**Automatic Gain Control (AGC).** A process by which *Gain* is automatically adjusted as a function of input or other specified parameter. (58 IRE 3.S1)

**Automatic Gain Control, Instantaneous.** See *Instantaneous Automatic Gain Control*. (54 IRE 12.S1)

**Automatic Grid Bias.** Grid-bias voltage provided by the difference of potential across resistance(s) in the grid or cathode circuit by grid or cathode current or both. (48 IRE 2, 11, 15.S1)

**Automatic Pilot (Autopilot).** Equipment which automatically stabilizes the attitude of a *Vehicle* about its pitch, roll, and yaw axes. (54 IRE 12.S1)

**Automatic Track-Follower.** See *Automatic Chart-Line Follower*. (54 IRE 12.S1)

**Automatic Tracking.** Tracking in which a servomechanism automatically follows some characteristic of the signal. (54 IRE 12.S1)

**Automatic Volume Control (AVC).** A process by which a substantially constant output *Volume* is automatically maintained in a system or component. (58 IRE 3.S1)

**Autopilot Coupler.** In *Navigation*, the means used to link the *Navigation* system receiver output to the *Automatic Pilot*. (54 IRE 12.S1)

**Autoradar Plot.** See *Chart Comparison Unit*. (54 IRE 12.S1)

**Autoregulation Induction Heater.** An induction heater in which a desired control is effected by the change in characteristics of a magnetic charge as it is heated at or near its *Curie Point*. (55 IRE 10.S1)

**Available Conversion Gain (of a Conversion Transducer).** See *Gain, Available Conversion (of a Conversion Transducer)*. (57 IRE 7.S2)

**Available Conversion Power Gain (of a Conversion Transducer).** The ratio of the Available output-frequency power from the output terminals of the transducer to the available input-frequency power from the driving generator with terminating conditions specified for all frequencies which may affect the result.

*Note 1:* This applies to outputs of such magnitude that the conversion transducer is operating in a substantially linear condition.

*Note 2:* The maximum available conversion power gain of a conversion transducer is obtained when the input termination admittance, at input frequency, is the conjugate of the input-frequency driving-point

## Available Power Gain

admittance of the conversion transducer.

(51 IRE 20.S2)

**Available Line.** The portion of the scanning line which can be used specifically for *Picture Signals*. (56 IRE 9.S1)

**Available Power.** Of a linear source of electric energy, the quotient of the mean square of the open-circuit terminal voltage of the source divided by four times the resistive component of the impedance of the source. (51 IRE 20.S2)

**Available Power (of a Linear Source of Electric Energy).** The power which a *Source* is capable of delivering into its *Conjugate Impedance*.

*Note:* Available Power is equal to the quotient of the mean square of the open-circuit terminal voltage of the *Source* divided by four times the resistive component of the impedance of the *Source*.

(58 IRE 3.S1)

**Available Power (at a Port).** The maximum power which can be transferred from the *Port* to a load.

*Note:* At a specified frequency, maximum power transfer will take place when the impedance of the load is the conjugate of that of the source. The source impedance must have a positive real part.

(57 IRE 7.S2)

**Available Power Efficiency.** Of an electroacoustic transducer used for sound reception, the ratio of the electric power available at the electric terminals of the transducer to the acoustic power available to the transducer.

*Note 1:* For an electroacoustic transducer which obeys the reciprocity principle, the available power efficiency in sound reception is equal to the transmitting efficiency.

*Note 2:* In a given narrow frequency band the available power efficiency is numerically equal to the fraction of the open-circuit mean-square thermal noise voltage present at the electric terminals which is contributed by thermal noise in the acoustic medium.

(51 IRE 6.S1)

**Available Power Gain (of a Linear Transducer).** The ratio of the available power from the output terminals of the transducer, under specified input termination conditions, to the available power from the driving generator.

*Note:* The *Maximum Available Power Gain* of an electric transducer is obtained when the input termination admittance is the conjugate of the driving-point admittance at the input terminals of the transducer. It is sometimes called "completely matched power gain."

(51 IRE 20.S2)

## Available Power Gain

**Available Power Gain (of a Two-Port Linear Transducer).** See *Gain, Available Power (of a Two-Port Linear Transducer)*. (57 IRE 7.S2)

**Available Power Gain, Maximum (of a Two-Port Linear Transducer).** See *Gain, Available Power, Maximum (of a Two-Port Linear Transducer)*. (57 IRE 7.S2)

**Available Power Response.** Of an electro-acoustic transducer used for sound emission, the ratio of the mean-square sound pressure apparent at a distance of 1 meter in a specified direction from the effective acoustic center of the transducer to the available electric power from the source. The available power response is usually expressed in decibels above the reference response of 1 microbar squared per watt of available electric power.

*Note 1:* The sound pressure apparent at a distance of 1 meter is determined by multiplying the sound pressure observed at a remote point where the sound field is spherically divergent by the ratio of the distance of that point, in meters, from the effective acoustic center of the transducer, to the reference distance of 1 meter.

*Note 2:* The available power response is a function not only of the transducer but also of some source impedance, either actual or hypothetical, the value of which must be specified.

(51 IRE 6.S1)

**Avalanche.** The cumulative process in which charged particles accelerated by an electric field produce additional charged particles through collision with neutral gas molecules or atoms. (57 IRE 7.S1)

**Average Absolute Pulse Amplitude.** The average of the absolute value of the instantaneous amplitude taken over the pulse duration.

*Note:* By "absolute value" is meant the arithmetic value regardless of algebraic sign. (51 IRE 20.S1)

**Average Electrode Current.** The value obtained by integrating the instantaneous *Electrode Current* over an averaging time and dividing by the averaging time. (57 IRE 7.S2)

**Average Information Content (per Symbol) (Information Rate from a Source, per Symbol).** The average of the *Information Content per Symbol* emitted from a source.

*Note:* The terms *Entropy* and *Negentropy* are sometimes used to designate *Average Information Content*.

(58 IRE 11.S1)

**Average Power Output of an Amplitude-**

## Background Returns

**Modulated Transmitter.** The radio-frequency power delivered to the transmitter output terminals averaged over a modulation cycle. (48 IRE 2, 11, 15.S1)

**Average Pulse Amplitude.** The average of the instantaneous amplitude taken over the pulse duration. (51 IRE 20.S1)

**Average Transinformation (of Output Symbols and Input Symbols).** *Transinformation* averaged over the ensemble of pairs of transmitted and received symbols. (58 IRE 11.S1)

**Axial Ratio.** The ratio of the major axis to the minor axis of the *Polarization Ellipse*.

*Note:* This is preferred to *Ellipticity* because mathematically *Ellipticity* is 1 minus the reciprocal of the *Axial Ratio*.

(53 IRE 2.S1)

**Azimuth.** See *Bearing*. (54 IRE 12.S1)

**Azimuth Marker.** See *Calibration Markers*. (54 IRE 12.S1)

**Azimuth-Stabilized PPI.** A PPI on which the reference *Bearing* remains fixed with respect to the indicator, regardless of the *Vehicle* orientation. (54 IRE 12.S1)

## B

**Babble.** The aggregate *Crosstalk* from a large number of channels. (58 IRE 3.S1)

**BABS (Blind Approach Beacon System).** A *Radar* instrument low-approach system in which airborne equipment interrogates a ground *Transponder*. Distance from the *Transponder* and *Position* with respect to the *Center Line* of the runway is presented on an "L" *Type Display* in the aircraft. (54 IRE 12.S1)

**Backed Stamper.** In mechanical recording, a thin metal stamper which is attached to a backing material, generally a metal disk of desired thickness. (51 IRE 6.S1)

**Background Counts (Radiation Counters).** *Counts* caused by *Radiation* coming from sources other than that to be measured. (57 IRE 7.S1)

**Background Noise (in Receivers).** The noise in the absence of signal modulation on the carrier. (52 IRE 17.S1)

**Background Noise (in Recording).** In recording and reproducing, the total system noise independent of whether or not a signal is present. The signal is not to be included as part of the noise. (51 IRE 6.S1)

**Background Noise (in Transmitters).** Noise due to audible disturbances of periodic and/or random occurrence. (48 IRE 2, 11, 15.S1)

**Background Returns (Radar).** See *Clutter*. (54 IRE 12.S1)

## Backplate

**Backplate (Camera Tubes).** The *Electrode* to which the stored charge image is capacitively coupled. (57 IRE 7.S2)

**Back Porch.** That portion of a *Composite Picture Signal* which lies between the trailing edge of a horizontal sync pulse and the trailing edge of the corresponding blanking pulse.

*Note:* The *Color Burst*, if present, is not considered part of the *Back Porch*.

(55 IRE 23.S1)

**Back Scatter—Deprecated.** A general term for *Echoes* which may include both *Clutter* and desired *Echoes* from a *Target*. (54 IRE 12.S1)

**Back-Scattering Coefficient B (Echoing Area).** For an incident plane wave  $B$  is  $4\pi$  times the ratio of the reflected power per unit solid angle ( $\Phi_r$ ) in the direction of the source divided by the power per unit area ( $W_4$ ) in the incident wave:

$$B = 4\pi \frac{\Phi_r}{W_4} = 4\pi r^2 \frac{W_r}{W_4}$$

where  $W_r$  is the power per unit area at distance  $r$ .

*Note:* For large objects, the back-scattering coefficient of an object is approximately the product of its interception area by its scattering gain in the direction of the source, where the interception area is the projected geometrical area and the scattering gain is the reradiated power gain relative to an isotropic radiator.

(48 IRE 2, 11, 15.S1)

**Back-Shunt Keying.** A method of keying a transmitter in which the radio-frequency energy is fed to the antenna when the telegraph key is closed and to an artificial load when the key is open. (48 IRE 2, 11, 15.S1)

**Backward Wave (Traveling-Wave Tubes).** A wave whose group velocity is opposite to the direction of electron-stream motion. (56 IRE 7.S1; 57 IRE 7.S2)

**Back Wave.** A signal emitted from a radio-telegraph transmitter during spacing portions of the code characters. (48 IRE 2, 11, 15.S1)

**Baffle.** A shielding structure or partition used to increase the effective length of the external transmission path between two points in an acoustic system as, for example, between the front and back of an electroacoustic transducer.

*Note:* In the case of a loudspeaker, a baffle is often used to increase the acoustic loading of the diaphragm.

(51 IRE 6.S1)

## Balanced Termination

**Balanced (Push-Pull) Amplifier.** An amplifier circuits in which there are two identical signal branches connected so as to operate in phase opposition and with input and output connections each balanced to ground. (48 IRE 2, 11, 15.S1)

**Balanced Amplifier Circuit.** An *Amplifier* circuit in which there are two identical transmission paths usually connected so as to operate with the waves in the two paths in phase opposition. (58 IRE 3.S1)

**Balanced Circuit.** A circuit, the two sides of which are electrically alike and symmetrical with respect to a common reference point, usually ground. (58 IRE 3.S1)

**Balanced Currents (on a Balanced Line).** Currents flowing in the two conductors of a *Balanced Line* which, at every point along the line, are equal in magnitude and opposite in direction. (53 IRE 2.S1)

**Balanced Line (Two-Conductor).** A *Transmission Line* consisting of two conductors in the presence of ground capable of being operated in such a way that when the voltages of the two conductors at all transverse planes are equal in magnitude and opposite in polarity with respect to ground, the currents in the two conductors are equal in magnitude and opposite in direction.

*Note:* A *Balanced Line* may be operated under unbalanced conditions and the aggregate then does not form a *Balanced Line System*.

(53 IRE 2.S1)

**Balanced Line System.** A system consisting of generator, *Balanced Line*, and load adjusted so that the voltages of the two conductors at all transverse planes are equal in magnitude and opposite in polarity with respect to ground.

*Note:* *Balanced Line System* is frequently shortened to *Balanced Line*. Care should be taken not to confuse this abbreviated terminology with the standard definition of *Balanced Line*.

(53 IRE 2.S1)

**Balanced Modulator.** A modulator, specifically a push-pull circuit, in which the carrier and modulating signal are so introduced that after modulation takes place the output contains the two sidebands without the carrier. (48 IRE 2, 11, 15.S1)

**Balanced Oscillator.** Any oscillator in which the impedance centers of the tank circuits are at ground potential and the voltages between either end and their centers are equal in magnitude and opposite in phase. (48 IRE 2, 11, 15.S1)

**Balanced Termination.** For a system or network having two output terminals, a load pre-

## Balanced Voltages

senting the same impedance to ground for each of the output terminals. (53 IRE 2.S1)

**Balanced Voltages (on a Balanced Line).** Voltages (relative to ground) on the two conductors of a *Balanced Line* which, at every point along the line, are equal in magnitude and opposite in polarity. (53 IRE 2.S1)

**Band (in Electronic Computers).** A group of *Tracks* on a magnetic drum. (56 IRE 8.S1)

**Band-Elimination Filter.** See *Filter, Band-Elimination*. (58 IRE 3.S1)

**Band-Pass Filter.** See *Filter, Band-Pass*. (58 IRE 3.S1)

**Band-Pass Tube (TR and Pre-TR Tubes).** See *Broad-Band Tube (TR and Pre-TR Tubes)*. (57 IRE 7.S2)

**Band Pressure Level.** The band pressure level of a sound for a specified frequency band is the effective sound pressure level for the sound energy contained within the band. The width of the band and the reference pressure must be specified.

*Note:* When measuring thermal noise, the standard deviation of the sound pressure readings will not exceed about 10 per cent if the product of the bandwidth in cycles per second and the integration time in seconds exceeds 20.

(51 IRE 6.S1)

**Bandwidth (of an Antenna).** The range of frequencies within which its performance, in respect to some characteristic, conforms to a specified standard. (48 IRE 2, 11, 15.S1)

**Bandwidth (of a Device).** The range of frequencies within which performance, with respect to some characteristic, falls within specific limits. (52 IRE 17.S1)

**Bandwidth (of a Wave).** The least frequency interval outside of which the power spectrum of a time-varying quantity is everywhere less than some specified fraction of its value at a reference frequency.

*Caution:* This definition permits the spectrum to be less than the specified fraction within the interval.

*Note:* Unless otherwise stated, the reference frequency is that at which the spectrum has its maximum value.

(52 IRE 17.S1)

**Bandwidth, Facsimile.** In a given *Facsimile System*, the difference in cycles per second between the highest and the lowest frequency components required for adequate transmission of the *Facsimile Signals*. (56 IRE 9.S1)

**Bar Generator.** In television, the generator of pulses which are uniformly spaced in time and are synchronized to produce a stationary bar pattern on a television screen. (52 IRE 17.S1)

**Barkhausen-Kurz Oscillator.** An oscillator

## B-Display

of the retarding-field type in which the frequency of oscillation depends solely upon the electron-transit time within the tube. (48 IRE 2, 11, 15.S1)

**Barrier (in a Semiconductor)—Obsolete.** See *Depletion Layer*. (54 IRE 7.S2)

**Base (of Number System).** See *Positional Notation*. (56 IRE 8.S1)

**Baseband.** In a carrier (or *Subcarrier*) wire or radio transmission system, the band of frequencies occupied by the signal before it modulates the carrier (or *Subcarrier*) frequency to form the transmitted line or radio signal.

*Note:* The signal in the *Baseband* is usually distinguished from the line or radio signal by ranging over distinctly lower frequencies, which at the lower end relatively approach or may include dc (zero frequency). In the case of a *Facsimile Signal* before modulation on a *Subcarrier*, the *Baseband* includes dc.

(56 IRE 9.S1)

**Base Electrode (of a Transistor).** An *Ohmic* or *Majority Carrier Contact* to the *Base Region*. (54 IRE 7.S2)

**Baseline.** In *Navigation* the line joining the two points between which electrical phase or time is compared in determining *Navigation Coordinates*. (For two ground stations this will be the line joining the two stations, and in the case of a rotating collector system it is the line joining the two sides of the collector.) (54 IRE 12.S1)

**Base Region.** The interelectrode region of a *Transistor* into which *Minority Carriers* are injected. (54 IRE 7.S2)

**Basic Frequency.** Of an oscillatory quantity having sinusoidal components with different frequencies, the frequency of the component considered to be the most important.

*Note:* In a driven system, the basic frequency would, in general, be the driving frequency, and in a periodic oscillatory system, it would be the fundamental frequency.

(51 IRE 6.S1)

**Basic Repetition Rate.** In *Loran*, the lowest *Pulse Repetition Rate* of each of the several sets of closely-spaced *Repetition Rates* employed by *Loran*. (54 IRE 12.S1)

**Bass Boost.** A deliberate adjustment of the *Amplitude-Frequency Response* of a system or component to accentuate the lower *Audio Frequencies*. (58 IRE 3.S1)

**Baud.** A unit of signalling speed. The speed in bauds is the number of code elements per second. (53 IRE 11.S1)

**B-Display (also B-Scan or B-Scope).** In *Radar*, a rectangular *Display* in which *Targets* appear as *Blips* with *Bearing* indicated

## Beam Alignment

by the horizontal coordinate and distance by the vertical coordinate. (54 IRE 12.S1)

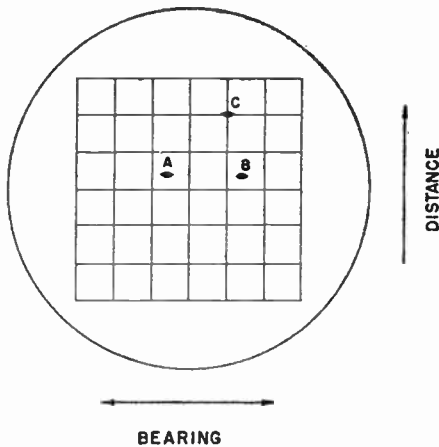

**Beam Alignment (Camera Tubes).** An adjustment of the electron beam, performed on tubes employing *Low-Velocity Scanning*, to cause the beam to be perpendicular to the *Target* at the *Target* surface. (57 IRE 7.S2)

**Beam Bending (Camera Tubes).** Deflection of the scanning beam by the electrostatic field of the charges stored on the *Target*. (57 IRE 7.S2)

**Beam-Deflection Tube.** An *Electron-Beam Tube* in which current to an output *Electrode* is controlled by the transverse movement of an electron beam. (57 IRE 7.S2)

**Beam-Indexing Color Tube.** A *Color Picture Tube* in which a signal, generated by an electron beam after deflection, is fed back to a control device or element in such a way as to provide an image in color. (57 IRE 7.S2)

**Beam Modulation, Percentage (Image Orthicons).** One hundred times the ratio of 1) the *Signal Output Current* for highlight illumination on the tube to 2) the *Dark Current*. (57 IRE 7.S2)

**Beam Power Tube.** An *Electron-Beam Tube* in which use is made of directed electron beams to contribute substantially to its power-handling capability, and in which the *Control Grid* and the *Screen Grid* are essentially aligned. (57 IRE 7.S2)

**Bearing.** A *Direction* at a reference point, expressed as the angle in the horizontal plane between a *Reference Line* and the line joining the reference point to another point, usually measured clockwise from the *Reference Line*.

*Note:* In *Navigation*, the terms *Azimuth* and *Bearing* have the same meaning; however,

## Bend, Waveguide

the term *Bearing* is preferred for terrestrial *Navigation* and the term *Azimuth* is preferred for celestial *Navigation*.

(54 IRE 12.S1)

**Bearing Accuracy (in Direction Finding).**

The correctness of DF indication expressed as the deviation (of the indicated bearing from the direction of arrival of the signal) whose probability of being exceeded is less than some stated value. (59 IRE 12.S1)

**Bearing Accuracy, Instrumental DF.** The

systematic component of *Bearing Accuracy*. The deviations involved include such factors as structure and imbalance among elements of the *DF Antenna System*, goniometer, balanced modulator of the DF equipment itself, etc., and errors in the calibration of the indicating system. It does not include errors due to distortions of the signal field caused by effects exterior to the DF equipment, nor does it include offsets which can be corrected by a fixed displacement of the indicator scale. (59 IRE 12.S1)

**Bearing Error Curve (DF Equipment).** A

plot of the *Instrumental Bearing Errors* vs indicated bearings. (59 IRE 12.S1)

**Bearing Error Curve (DF Installation).** A

plot of the combined *Instrumental Bearing Error (DF Equipment)* and site error vs indicated bearings. (59 IRE 12.S1)

**Bearing Offset, Indicated.** The difference

between the indicated and apparent bearings of a number of signal sources, substantially uniformly distributed in azimuth. (59 IRE 12.S1)

**Bearing Reciprocal (in Direction Finding).**

The opposite direction to a bearing. (59 IRE 12.S1)

**Beating.** A phenomenon in which two or more

periodic quantities of different frequencies produce a resultant having pulsations of amplitude. (52 IRE 17.S1)

**Beat Note.** The wave of difference frequency

created when two sinusoidal waves of different frequencies are supplied to a nonlinear device. (52 IRE 17.S1)

**Bcl.** The fundamental division of a logarithmic

scale for expressing the ratio of two amounts of power, the number of bels denoting such a ratio being the logarithm to the base 10 of this ratio.

*Note:* With  $P_1$  and  $P_2$  designating two amounts of power and  $N$  the number of bels denoting their ratio,  $N = \log_{10} (P_1/P_2)$  bels. (48 IRE 2, 11, 15.S1)

**Bend.** In a rectilinear navigational system the

departure of a defined *Course Line* from a straight line. (54 IRE 12.S1)

**Bend, Waveguide.** A section of waveguide



## Benito

in which the direction of the longitudinal axis is changed. (55 IRE 2.S1)

**Benito.** A CW navigational system in which the distance to an aircraft is determined on the ground by a phase-difference measurement of an audio signal transmitted from the ground and retransmitted by the aircraft. *Bearing* information is obtained by ground direction-finding of the aircraft signals. (54 IRE 12.S1)

**Bias Telegraph Distortion.** Distortion in which all mark pulses are lengthened (positive bias) or shortened (negative bias). It may be measured with a steady stream of "unbiased reversals," square waves having equal-length mark and space pulses. The average lengthening or shortening gives true bias distortion only if other types of distortion are negligible. (48 IRE 2, 11, 15.S1)

**Biconical Antenna.** An antenna formed by two conical conductors, having a common axis and vertex, and excited at the vertex. When the vertex angle of one of the cones is  $180^\circ$ , the antenna is called a discone. (48 IRE 2, 11, 15.S1)

**Bidirectional Microphone.** A microphone in which the response predominates for sound incidences of  $0^\circ$  and  $180^\circ$ . See also *Principal Axis*. (51 IRE 6.S1)

**Bidirectional Pulse.** A *Pulse* in which the variation from the normally constant value occurs in both directions. (52 IRE 20.S1)

**Bidirectional Pulses.** Pulses, some of which rise in one direction and the remainder in the other direction. (48 IRE 2, 11, 15.S1)

**Bidirectional Pulse Train.** A *Pulse Train*, some *Pulses* of which rise in one direction and the remainder in the other direction. (52 IRE 20.S1)

**Bilateral-Area Track.** A photographic sound track having the two edges of the central area modulated according to the signal. (51 IRE 6.S1)

**Bilateral Transducer.** A transducer capable of transmission simultaneously in both directions between at least two terminations. (51 IRE 20.S2)

**Binary.** See *Positional Notation*. (56 IRE 8.S1)

**Binary Cell.** An elementary unit of storage which can be placed in either of two stable states. (56 IRE 8.S1)

**Binary Code.** Any *Code* employing two distinguishable types of *Code Elements*. (58 IRE 11.S1)

**Binary-Coded-Decimal System.** A system of number representation in which each decimal digit is represented by a group of binary digits (e.g., *Excess-Three Code*). (56 IRE 8.S1)

**Binary Digit.** A digit of a binary number.

## Black Transmission

See also *Memory Capacity* or *Storage Capacity*. (50 IRE 8.S1)

**Binary Number System.** See *Positional Notation*. (56 IRE 8.S1)

**Binary Point.** See *Point*. (56 IRE 8.S1)

**Binder.** A resinous material which causes the various materials of a record compound to adhere to one another. (51 IRE 6.S1)

**Bit (in Electronic Computers).** 1) An abbreviation of "binary digit." 2) A single *Character* of a *Language* employing exactly two distinct kinds of characters. 3) A unit of storage capacity. The capacity, in bits, of a storage device is the logarithm to the base two of the number of possible states of the device. See also *Storage Capacity*. (56 IRE 8.S1)

**Bit (Information Theory).** A unit of *Information Content* equal to the *Information Content* of a *Message* the *a priori* probability of which is one-half.

*Note:* If, in the definition of *Information Content*, the logarithm is taken to the base two, the result will be expressed in *Bits*. (58 IRE 11.S1)

**Black Compression (Black Saturation).** The reduction in gain applied to a *Picture Signal* at those *Levels* corresponding to dark areas in a picture with respect to the gain at that *Level* corresponding to the midrange light value in the picture.

*Note 1:* The gain referred to in the definition is for a signal amplitude small in comparison with the total peak-to-peak *Picture Signal* involved. A quantitative evaluation of this effect can be obtained by a measurement of *Differential Gain*.

*Note 2:* The over-all effect of *Black Compression* is to reduce contrast in the low lights of the picture as seen on a monitor. (55 IRE 23.S1)

**Black Level.** That *Level* of the *Picture Signal* corresponding to the maximum limit of *Black Peaks*. (55 IRE 23.S1)

**Black Peak.** A peak excursion of the *Picture Signal* in the black direction. (55 IRE 23.S1)

**Black Recording.** In an amplitude-modulation system, that form of *Recording* in which the maximum received power corresponds to the maximum *Density* of the *Record Medium*. In a frequency-modulation system, that form of *Recording* in which the lowest received frequency corresponds to the maximum *Density* of the *Record Medium*. (56 IRE 9.S1)

**Black Signal.** The signal at any point in a *Facsimile System* produced by the *Scanning* of a maximum *Density* area of the *Subject Copy*. (56 IRE 9.S1)

**Black Transmission.** In an amplitude-modu-

## Black and White

lation system, that form of transmission in which the maximum transmitted power corresponds to the maximum *Density* of the *Subject Copy*. In a frequency-modulation system, that form of transmission in which the lowest transmitted frequency corresponds to the maximum *Density* of the *Subject Copy*. (56 IRE 9.S1)

**Black and White.** See *Monochrome*. (55 IRE 22.S1)

**Blanked Picture Signal.** The signal resulting from blanking a *Picture Signal*.

*Note:* Adding *Sync Signal* to the *Blanked Picture Signal* forms the *Composite Picture Signal*.

(55 IRE 23.S1)

**Blanking Level.** That *Level* of a *Composite Picture Signal* which separates the range containing picture information from the range containing synchronizing information.

*Note:* The *Setup* region is regarded as picture information.

(55 IRE 23.S1)

**Blanking Signal.** A wave constituted of recurrent pulses, related in time to the scanning process, used to effect blanking.

*Note:* In television, this signal is composed of pulses at line and field frequencies, which usually originate in a central sync generator and are combined with the *Picture Signal* at the pickup equipment in order to form the *Blanked Picture Signal*. The addition of *Sync Signal* completes the *Composite Picture Signal*. The blanking portion of the *Composite Picture Signal* is intended primarily to make the return trace on a picture tube invisible. The same blanking pulses or others of somewhat shorter duration are usually used to blank the pickup device also.

(55 IRE 23.S1)

**Blemish (Charge-Storage Tubes).** An imperfection of the storage surface which produces a spurious output. (57 IRE 7.S2)

**Blind Speed.** In *Radar* MTI, the *Radial* velocity of a moving *Target* which traverses one-half wavelength, or multiples thereof, between successive pulses. (54 IRE 12.S1)

**Blinking.** In pulse systems, a method of providing information by modifying the signal (at its source) so that the signal presentation on the *Display* alternately appears and disappears; e.g., in *Loran* means for indicating that a station is malfunctioning. (54 IRE 12.S1)

**Blip (PIP).** On a *Radar Display* a deflection, or a spot of contrasting luminescence, caused by the presence of a *Target*. (54 IRE 12.S1)

**Block.** A group of *Words* considered as a unit. (56 IRE 8.S1)

<sup>2</sup> See Note 2 under *Acoustic Impedance*.

## Boundary Marker

**Blocked Impedance.**<sup>2</sup> Of a transducer, the impedance at the input when the impedance of the output system is made infinite.

*Note:* For example, in the case of an electromechanical transducer, the blocked electric impedance is the impedance measured at the electric terminals when the mechanical system is blocked or clamped; the blocked mechanical impedance is measured at the mechanical side when the electric circuit is open-circuited.

(51 IRE 6.S1)

**Blocking (Squegging) Oscillator.** An electron-tube oscillator operating intermittently with grid bias increasing during oscillation to a point where oscillations stop, then decreasing until oscillation is resumed.

*Note:* Squegge rhymes with wedge.

(48 IRE 2, 11, 15.S1)

**Blooming.** An increase in the *Blip* (spot) size caused by an increase in signal intensity. *Blooming* may be employed in navigational systems with intensity modulation *Displays* for the purpose of conveying information. (54 IRE 12.S1)

**Blur (in Null-Type DF Systems).** In null-type systems, the output (including noise) at the bearing of minimum response expressed as a percentage of the output at the bearing of maximum response. (59 IRE 12.S1)

**Bobbin Core.** See *Tape-Wound Core*. (59 IRE 8.S1)

**Bobbin Height.** See *Tape-Wound Core*. (59 IRE 8.S1)

**Bobbin I.D.** See *Tape-Wound Core*. (59 IRE 8.S1)

**Bobbin O.D.** See *Tape-Wound Core*. (59 IRE 8.S1)

**Bone Conduction.** The process by which sound is conducted to the inner ear through the cranial bones. (51 IRE 6.S1)

**Bootstrap Circuit.** A single-stage amplifier in which the output load is connected between the negative end of the plate supply and the cathode, the signal voltage being applied between the grid and the cathode. The name "bootstrap" arises from the fact that a change in grid voltage changes the potential of the input source with respect to ground by an amount equal to the output signal. (48 IRE 2, 11, 15.S1)

**Boresighting.** In radio the process of aligning a directional antenna system by an optical procedure. (54 IRE 12.S1)

**Borrow.** See *Carry*. (56 IRE 8.S1)

**Boundary Marker.** In an *Instrument Landing System (ILS)* a VHF radio marker facility which is installed near the approach end of the landing runway and on, or near, the

## Boundary

*Localizer Course Line* to provide a fix. (54 IRE 12.S1)

**Boundary, P-N.** A surface in the transition region between P-type and N-type material at which the *Donor* and *Acceptor* concentrations are equal. (54 IRE 7.S2)

**Branch (Arm) (in Circuits).** A portion of a network consisting of one or more two-terminal elements in series. (50 IRE 4.S1)

**Branch (in Computing).** Synonym for *Conditional Jump*. (56 IRE 8.S1)

**Branch Point.** See *Node*. (50 IRE 4.S1)

**Breakdown (in a Gas Tube).** A runaway increase in an *Electrode Current*. (57 IRE 7.S2)

**Breakdown Transfer Characteristic (Gas Tubes).** A relation between the *Breakdown Voltage* of an *Electrode* and the current to another *Electrode*. (57 IRE 7.S2)

**Breakdown Voltage (of an Electrode of a Gas Tube).** The voltage of an *Electrode* at which *Breakdown* occurs to that *Electrode*.

*Note 1:* The *Breakdown Voltage* is a function of the other *Electrode Voltages* or currents and of the environment.

*Note 2:* In special cases where the *Breakdown Voltage* of an *Electrode* is referred to an *Electrode* other than the *Cathode*, this reference *Electrode* shall be indicated.

*Note 3:* This term should be used in preference to "Pickup Voltage," "Firing Voltage," "Starting Voltage," etc., which are frequently used for specific types of *Gas Tubes* under specific conditions.

*Note 4:* See *Critical Grid Voltage (Multi-electrode Gas Tubes)*.

(57 IRE 7.S2)

**Break-In Keying.** A method of operating a radiotelegraph communication system in which the receiver is capable of receiving signals during transmission spacing intervals. (48 IRE 2, 11, 15.S1)

**Break Point.** A place in a *Routine* at which a special instruction is inserted which, if desired, will cause a digital computer to stop for a visual check of progress. (56 IRE 8.S1)

**Bridged-T Network.** A T network with a fourth branch connected across the two series arms of the T, between an input terminal and an output terminal. (50 IRE 4.S1)

**Bridge Rectifier.** A full-wave rectifier with four rectifying elements or groups of elements connected as in a bridge circuit. (48 IRE 2, 11, 15.S1)

**Bridging.** The shunting of one electrical circuit by another. (54 IRE 3.S1; 58 IRE 3.S1)

**Bridging Amplifier.** See *Amplifier, Bridging*. (58 IRE 3.S1)

**Bridging Gain.** The ratio of the power a *Transducer* delivers to a specified *Load Im-*

## Brightness

*pedance* under specified operating conditions, to the power dissipated in the reference impedance across which the input of the *Transducer* is bridged.

*Note 1:* If the input and/or *Output Power* consist of more than one component, such as multifrequency *Signal* or *Noise*, then the particular components used and their weighting must be specified.

*Note 2:* This *Gain* is usually expressed in decibels.

(54 IRE 3.S1; 58 IRE 3.S1)

**Bridging Loss.** The ratio of the power dissipated in the reference impedance across which the input of a *Transducer* is bridged, to the power the *Transducer* delivers to a specified *Load Impedance* under specified operating conditions.

*Note 1:* If the input and/or *Output Power* consist of more than one component, such as multifrequency *Signal* or *Noise*, then the particular components used and their weighting must be specified.

*Note 2:* This *Loss* is usually expressed in decibels.

*Note 3:* In telephone practice this term is synonymous with the *Insertion Loss* resulting from bridging an impedance across a circuit.

(54 IRE 3.S1; 58 IRE 3.S1)

**Brightness.** The attribute of visual perception in accordance with which an area appears to emit more or less light.

*Note:* Luminance is recommended for the photometric quantity which has been called "brightness." Luminance is a purely photometric quantity. Use of this name permits "brightness" to be used entirely with reference to the sensory response. The photometric quantity has been often confused with the sensation merely because of the use of one name for two distinct ideas. Brightness will continue to be used, properly, in non-quantitative statements, especially with reference to sensations and perceptions of light. Thus, it is correct to refer to a brightness match, even in the field of a photometer, because the sensations are matched and only by inference are the photometric quantities (luminances) equal. Likewise, a photometer in which such matches are made will continue to be called an "equality-of-brightness" photometer. A photoelectric instrument, calibrated in foot-lamberts, should not be called a "brightness meter." If correctly calibrated, it is a "luminance meter." A troublesome paradox is eliminated by the proposed distinction of nomenclature. The luminance of a surface may be doubled, yet it will be permissible to say that the brightness is not

## Brightness Signal—Deprecated

doubled, since the sensation which is called "brightness" is generally judged to be not doubled.

(55 IRE 22.S1)

**Brightness Signal—Deprecated.** See *Luminance Signal*. (55 IRE 22.S1)

**Broad-Band Tube (TR and Pre-TR Tubes).** A gas-filled fixed-tuned tube incorporating a band-pass filter of geometry suitable for radio-frequency switching. (57 IRE 7.S2)

**Broadside Array.** An antenna array whose direction of maximum radiation is perpendicular to the line or plane of the array according as the elements lie on a line or plane. A uniform broadside array is a linear array whose elements contribute fields of equal amplitude and phase. (48 IRE 2, 11, 15.S1)

**B-Scope.** A cathode-ray indicator in which a signal appears as a spot with bearing as the horizontal coordinate and distance as the vertical coordinate. (49 IRE 12.S1)

**"B" Station.** In *Loran* the designation applied to the transmitting station of a pair, the signal of which always occurs more than half a repetition period after the next succeeding signal and less than half a repetition period before the next preceding signal from the other station of the pair, designated an "*A*" Station. (54 IRE 12.S1)

**Buffer (in Computers).** 1) An isolating circuit used to avoid reaction of a driven circuit on the corresponding driving circuit. 2) A storage device used to compensate for a difference in rate of flow of information or time or occurrence of events when transmitting information from one device to another. (56 IRE 8.S1)

**Buffer Amplifier.** An amplifier in which the reaction of output-load-impedance variation on the input circuit is reduced to a minimum for isolation purposes. (48 IRE 2, 11, 15.S1)

**Bunching.** The action in a velocity-modulated electron stream that produces an alternating convection-current component as a direct result of the differences of electron transit time produced by the *Velocity Modulation*. See:

*Optimum Bunching*

*Overbunching*

*Reflex Bunching*

*Space-Charge Debunching*

*Underbunching.*

(56 IRE 7.S1; 57 IRE 7.S2)

**Bunching Angle (in an Electron Stream).** In a given *Drift Space*, the average *Transit Angle* between the processes of *Velocity Modulation* and energy extraction at the same or different gaps. See also *Effective Bunching Angle (Reflex Klystrons)*. (56 IRE 7.S1; 57 IRE 7.S2)

## Capacitance

**Bunching, Optimum.** See *Optimum Bunching*. (57 IRE 7.S2)

**Bunching Parameter.** One-half the product of 1) the *Bunching Angle* in the absence of *Velocity Modulation* and 2) the depth of *Velocity Modulation*.

*Note:* In a reflex klystron the *Effective Bunching Angle* must be used.

(56 IRE 7.S1; 57 IRE 7.S2)

**Burnishing Surface.** In mechanical recording, the portion of the cutting stylus directly behind the cutting edge which smooths the groove. (51 IRE 6.S1)

**Bus (in Electronic Computers).** One or more conductors which are used as a path for transmitting information from any of several sources to any of several destinations. (56 IRE 8.S1)

**Butt Joint.** A connection between two waveguides which provides physical contact between the ends of the waveguides in order to maintain electrical continuity. (55 IRE 2.S1)

## C

**Cable.** A *Transmission Line* or group of *Transmission Lines* mechanically assembled in compact flexible form. (53 IRE 2.S1)

**Cake Wax.** A thick disk of wax upon which an original mechanical disk recording may be inscribed. (51 IRE 6.S1)

**Calibration Markers.** In *Radar*, calibration marks on the *Display* to delineate *Bearing*, distance, height, or time. (54 IRE 12.S1)

**Camera Tube.** An *Electron Tube* for the conversion of an optical image into an electrical signal by a scanning process. (57 IRE 7.S2)

**Cancellation Ratio.** In a *Radar* MTI system, the ratio of a fixed *Target* signal voltage after MTI cancellation to the voltage of the same *Target* without MTI cancellation. (54 IRE 12.S1)

**Cancelled Video.** In a *Radar* MTI system, the video output remaining after the cancellation process. (54 IRE 12.S1)

**Candle.** The unit of luminous intensity. One candle is defined as the luminous intensity of 1/60-square centimeter of a blackbody radiator operating at the temperature of solidification of platinum. Values for standards having other spectral distributions are derived by the use of accepted luminosity factors. (55 IRE 22.S1)

**Candlepower.** Luminous intensity expressed in *Candles*. (55 IRE 22.S1)

**Capacitance.** See:

*Cathode Interface (Layer) Capacitance*

*Electrode Capacitance (n-Terminal Electron Tubes)*

*Gap Capacitance, Effective*

## Capacitor Pickup

*Input Capacitance (n-Terminal Electron Tubes)*

*Interelectrode Capacitance (j-l Interelectrode Capacitance  $C_{jl}$  of an n-Terminal Electron Tube)*

*Output Capacitance (n-Terminal Electron Tubes)*

*Short-Circuit Input Capacitance (n-Terminal Electron Tubes)*

*Short-Circuit Output Capacitance (n-Terminal Electron Tubes)*

*Short-Circuit Transfer Capacitance (Electron Tubes)*

*Signal Electrode Capacitance*

*Target Capacitance (Camera Tubes).*

(57 IRE 7.S2)

**Capacitor Pickup.** A phonograph pickup which depends for its operation upon the variation of its electric capacitance. (51 IRE 6.S1)

**Carbon Microphone.** A microphone which depends for its operation upon the variation in resistance of carbon contacts. (51 IRE 6.S1)

**Carbon Pressure Recording.** That type of *Electromechanical Recording* in which a pressure device acts upon carbon paper to register upon the *Record Sheet*. (56 IRE 9.S1)

**Carrier (in Modulation).** A wave suitable for being modulated.

*Note:* Examples of carriers are a sine wave, a recurring series of pulses, or a direct current.

(53 IRE 11.S1)

**Carrier (in a Semiconductor).** In a semiconductor, a mobile *Conduction Electron* or *Hole*. (54 IRE 7.S2)

**Carrier-Amplitude Regulation.** The change in amplitude of the carrier wave in an amplitude-modulated transmitter when modulation is applied under conditions of symmetrical modulation.

*Note:* The term "carrier shift," often applied to this effect, is deprecated.

(48 IRE 2, 11, 15.S1)

**Carrier Beat.** The undesirable heterodyne of signals each synchronous with a different stable reference oscillator causing a pattern in received copy. Where one or more of the oscillators is fork controlled, this is called *Fork Beat*. (56 IRE 9.S1)

**Carrier-Controlled Approach System (CCA).** An aircraft carrier *Radar* system providing information by which aircraft approaches may be directed via radio-communications. (54 IRE 12.S1)

**Carrier Frequency.** In a periodic carrier, the reciprocal of its period.

*Note:* The frequency of a periodic pulse

## Carry

carrier often is called the pulse-repetition frequency (PRF).

(53 IRE 11.S1)

**Carrier-Frequency Pulse.** A carrier, amplitude modulated by a *Pulse*. The amplitude of the modulated carrier is zero before and after the *Pulse*.

*Note:* Coherence of the carrier (with itself) is not implied.

(52 IRE 20.S1)

**Carrier-Frequency Range of a Transmitter.** The continuous range of frequencies within which the transmitter may be adjusted for normal operation. A transmitter may have more than one carrier-frequency range. (48 IRE 2, 11, 15.S1)

**Carrier-Frequency Stability of a Transmitter.** A measure of the ability of a transmitter to maintain an assigned average frequency. (48 IRE 2, 11, 15.S1)

**Carrier Noise Level (Residual Modulation).** The noise level produced by undesired variations of a radio-frequency signal in the absence of any intended modulation. (48 IRE 2, 11, 15.S1)

**Carrier-to-Noise Ratio.** The ratio of the magnitude of the carrier to that of the noise after selection and before any nonlinear process such as amplitude limiting and detection.

*Note:* This ratio is expressed many different ways, for example, in terms of peak values in the case of impulse noise and in terms of root-mean-square values in the case of random noise. In special cases other measures of carrier and noise may be used, but their use should be clearly stated.

(53 IRE 11.S1)

**Carrier Suppression.** That method of operation in which the carrier wave is not transmitted. (48 IRE 2, 11, 15.S1)

**Carrier Wave.** A wave generated at a point in the transmitting system and modulated by the signal. (42 IRE 9.S1)

**Carry.** 1) A signal, or expression, produced as a result of an arithmetic operation on one digit place of two or more numbers expressed in *Positional Notation* and transferred to the next higher place for processing there. 2) Usually a signal or expression as defined in 1) above which arises in adding, when the sum of two digits in the same digit place equals or exceeds the *Base* of the number system in use. If a carry into a digit place will result in a carry out of the same digit place, and if the normal adding circuit is bypassed when generating this new carry, it is called a **High-Speed Carry**, or **Standing-on-Nines Carry**. If the normal adding circuit is used in such a case, the carry is called a **Cascaded Carry**. If a carry resulting from

the addition of carries is not allowed to propagate (e.g., when forming the partial product in one step of a multiplication process), the process is called a **Partial Carry**. If it is allowed to propagate, the process is called a **Complete Carry**. If a carry generated in the most significant digit place is sent directly to the least significant place (e.g., when adding two negative numbers using nines complements) that carry is called an **End-Around Carry**. 3) In direct subtraction, a signal or expression as defined in 1) above which arises when the difference between the digits is less than zero. Such a carry is frequently called a **Borrow**. 4) The action of forwarding a carry. 5) The command directing a carry to be forwarded. (56 IRE 8.S1)

**Cascade (in Circuits)**. See *Tandem*. (50 IRE 4.S1)

**Cascaded Carry**. See *Carry*. (56 IRE 8.S1)

**Cathode (Electron Tubes)**. An *Electrode* through which a primary stream of electrons enters the interelectrode space. See also:

*Cold Cathode*

*Filament*

*Hot Cathode (Thermionic Cathode)*

*Indirectly Heated Cathode (Equipotential Cathode, Unipotential Cathode)*

*Ionic-Heated Cathode*

*Photocathode*

*Semitransparent Photocathode*.

(57 IRE 7.S2)

**Cathode Coating Impedance**. The impedance, excluding the *Cathode Interface (Layer) Impedance*, between the base metal and the emitting surface of a coated *Cathode*. (57 IRE 7.S2)

**Cathode Current**. See *Electrode Current*. (57 IRE 7.S2)

**Cathode Follower**. A circuit in which the output load is connected in the cathode circuit of an electron tube and the input is applied between the control grid and the remote end of the cathode load.

*Note*: The circuit is characterized by low output impedance, high input impedance, and gain less than unity.

(48 IRE 2, 11, 15.S1)

**Cathode Glow**. A luminous layer which covers all or part of the *Cathode* in a *Glow-Discharge Tube*. (57 IRE 7.S2)

**Cathode Heating Time (Gas Tubes)**. The time required for a *Cathode* to attain operating temperature under stated operating conditions. (57 IRE 7.S2)

**Cathode Heating Time (Vacuum Tubes)**. The time required for the time rate of change of the *Cathode Current* to reach maximum value.

*Note 1*: All *Electrode Voltages* are to remain

constant during measurement. The tube *Elements* must all be at room temperature at the start of the test.

*Note 2*: See *Operation Time*.

(57 IRE 7.S2)

**Cathode Interface (Layer) Capacitance**.

A capacitance which, in parallel with a suitable resistance, forms an impedance approximating the *Cathode Interface Impedance*.

*Note*: Because the *Cathode Interface Impedance* cannot be represented accurately by the two-element RC circuit, this value of capacitance is not unique.

(57 IRE 7.S2)

**Cathode Interface (Layer) Impedance**. An impedance between the *Cathode* base and coating.

*Note*: This impedance may be the result of a layer of high resistivity or a poor mechanical bond between the *Cathode* base and coating.

(57 IRE 7.S2)

**Cathode Interface (Layer) Resistance**. The low-frequency limit of *Cathode Interface Impedance*. (57 IRE 7. S2)

**Cathode Luminous Sensitivity (of a Multiplier Phototube)**. The quotient of photocathode current by incident luminous flux.

*Note 1*: The term photocathode current as here used does not include the dark current.

(54 IRE 7.S1)

**Cathode Modulation**. Amplitude modulation accomplished by application of the modulating voltage to the cathode circuit. (48 IRE 2, 11, 15.S1)

**Cathode Preheating Time**. The minimum period of time during which the heater voltage should be applied before the application of other *Electrode* voltages. (57 IRE 2, 11, 15.S1)

**Cathode Pulse Modulation**. Modulation produced in an amplifier or oscillator by application of externally generated pulses to the cathode circuit. (48 IRE 2, 11, 15.S1)

**Cathode-Ray Tube**. An *Electron-Beam Tube* in which the beam can be focused to a small cross section on a surface and varied in position and intensity. (57 IRE 7.S2)

**Cathode Spot (of an Arc)**. An area, on the *Cathode* of an *Arc*, from which the electron emission density is extremely high. (57 IRE 7.S2)

**Cavitation**. The formation of local cavities in a liquid as a result of the reduction of total pressure. (51 IRE 6.S1)

**Cavity Resonator (in Waveguides)**. A resonator formed by a volume of dielectric bounded by reflecting walls. (55 IRE 2.S1)

**Cavity Resonator Frequency Meter**. A cavity resonator used to determine frequency

## CCA

of an electromagnetic wave. (55 IRE 2.S1)  
**CCA.** See *Carrier-Controlled Approach System*. (54 IRE 12.S1)  
**C-Display** (also *C-Scan* or *C-Scope*). In

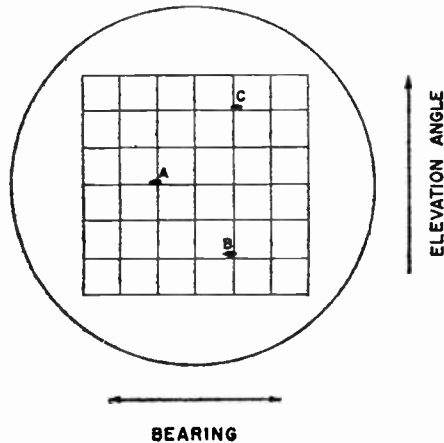

*Radar*, a rectangular *Display* in which *Targets* appear as *Blips* with *Bearing* indicated by

TABLE II  
 SOME JUST INTERVALS  
 (See *Just Scale*)

Name of Interval	Frequency Ratio	Cents
Unison	1:1	
Semitone	16:15	111.731
Minor tone or lesser whole tone	10:9	182.404
Major tone or greater whole tone	9:8	203.910
Minor third	6:5	315.641
Major third	5:4	386.314
Perfect fourth	4:3	498.045
Augmented fourth	45:32	590.224
Diminished fifth	64:45	609.777
Perfect fifth	3:2	701.955
Minor sixth	8:5	813.687
Major sixth	5:3	844.359
Harmonic minor seventh	7:4	968.826
Grave minor seventh	16:9	996.091
Minor seventh	9:5	1017.597
Major seventh	15:8	1088.269
Octave	2:1	1200.000

TABLE III

SOME SMALL INTERVALS

Name of Interval	Description	Frequency Ratio	Cents
Comma of Didymus	Excess of greater whole tone over lesser whole tone	81:80	21.506
Comma of Pythagoras	Excess of 12 Pythagorean fifths over 7 octaves	531441:524882	23.460
Skhisma	Excess of Pythagorean over Didymean comma (almost exactly equal to the difference between a Pythagorean and an equally tempered perfect fifth)	32805:32768	1.954

## Chain

the horizontal coordinate and *Angles of Elevation* by the vertical coordinate. (54 IRE 12.S1)

**Cell (in Computers).** An elementary unit of storage (e.g., binary cell, decimal cell). (56 IRE 8.S1)

**Cell, Binary.** See *Binary Cell*. (50 IRE 8.S1)

**Cell-Type Tube (TR, ATR, and Pre-TR Tubes).** A gas-filled radio-frequency switching tube which operates in an external resonant circuit. A tuning mechanism may be incorporated in either the external resonant circuit or the tube. (57 IRE 7.S2)

**Cent (in Acoustics).** The interval between two sounds whose basic frequency ratio is the twelve-hundredth root of two.

TABLE IV

EQUALLY TEMPERED INTERVALS  
 (See *Equally Tempered Scale*)

Name of Interval	Frequency Ratio	Cents
Unison	1:1	0
Minor second or semitone	1.059463:1	100
Major second or whole tone	1.122462:1	200
Minor third	1.189207:1	300
Major third	1.259921:1	400
Perfect fourth	1.334840:1	500
Augmented fourth		
Diminished fifth	1.414214:1	600
Perfect fifth	1.498307:1	700
Minor sixth	1.587401:1	800
Major sixth	1.681793:1	900
Minor seventh	1.781797:1	1000
Major seventh	1.887749:1	1100
Octave	2:1	1200

*Note:* The interval, in cents, between any two frequencies is 1200 times the logarithm to the base 2 of the frequency ratio. Thus 1200 cents = 12 equally tempered semitones = 1 octave.

(51 IRE 6.S1)

**Center Frequency.** The average frequency of the emitted wave when modulated by a symmetrical signal. (48 IRE 2, 11, 15.S1)

**Center Line.** The locus of the points equidistant from two reference points or lines. (54 IRE 12.S1)

**Chain.** A network of similar stations operating

## Challenge

as a group for determination of *Position* or for furnishing navigational information over an area greater than can be covered by a single station. (54 IRE 12.S1)

**Challenge.** See *Interrogation*. (54 IRE 12.S1)  
**Challenger.** See *Interrogator-Responder*. (54 IRE 12.S1)

**Channel.** A combination of transmission media and equipment capable of receiving *Signals* at one point and delivering related *Signals* at another point. (58 IRE 11.S1)

**Channel (in Electronic Computers).** That portion of a storage medium which is accessible to a given reading station. See also *Track*. (56 IRE 8.S1)

**Channel Capacity.** The maximum possible *Information Rate* through a *Channel* subject to the constraints of that *Channel*.

*Note:* *Channel Capacity* may be either per second or per symbol.  
(58 IRE 11.S1)

**Channeling.** The utilization of a modulation-frequency band for the simultaneous transmission from two or more communication channels in which the separation there between is accomplished by the use of carriers or subcarriers, each in a different discrete frequency band forming a subdivision of the main band.

*Note:* This covers a special case of multiplex transmission.  
(42 IRE 9.S1)

**Channel, Melting.** See *Melting Channel*. (55 IRE 10.S1)

**Channel, Radio.** See *Radio Channel*. (52 IRE 17.S1)

**Channel Utilization Index.** The ratio of the *Information Rate (per second)* through a *Channel* to the *Channel Capacity (per second)*. (58 IRE 11.S1)

**Character (in Electronic Computers).** One of a set of elementary marks or events which may be combined to express information.

*Note:* A group of characters, in one context, may be considered as a single character in another, as in the *Binary-Coded-Decimal System*.

(56 IRE 8.S1)

**Characteristic.** See:

*Breakdown Transfer Characteristic (Gas Tubes)*

*Constant-Current Characteristic*

*Control Characteristic (Gas Tubes)*

*Counting-Rate-vs-Voltage Characteristic*

*Decay Characteristic*

*Diode Characteristic (Multielectrode Tubes)*

*Dynamic Characteristic (Electron Tubes)*

*Electrode Characteristic*

*Emission Characteristic*

*Grid Characteristic*

## Characteristic Impedance

*Grid-Drive Characteristic*

*Knee of Transfer Characteristic (Image Orthicons)*

*Load (Dynamic) Characteristic (Electron Tubes Connected in a Specified Operating Circuit at a Specified Frequency)*

*Persistence Characteristic (Camera Tubes)*  
*Persistence Characteristic (Decay Characteristic) (of a Luminescent Screen)*

*Spectral Characteristic (of a Luminescent Screen)*

*Spectral Sensitivity Characteristic (Camera Tubes or Phototubes)*

*Square-Wave Response Characteristic (Camera Tubes)*

*Static Characteristic (Electron Tubes)*

*Transfer Characteristic*

*Transfer Characteristic (Camera Tubes)*.  
(57 IRE 7.S2)

**Characteristic Impedance (of a Circular Waveguide).** For the dominant ( $TE_{11}$ ) mode of a lossless circular *Uniconductor Waveguide* at a specified frequency above the *Cut-Off Frequency*, 1) the ratio of the square of the rms voltage along the diameter where the electric vector is a maximum to the total power flowing when the guide is match terminated, 2) the ratio of the total power flowing and the square of the total rms longitudinal current flowing in one direction when the guide is match terminated, 3) the ratio of the rms voltage along the diameter where the electric vector is a maximum to the total rms longitudinal current flowing along the half surface bisected by this diameter when the guide is match terminated.

*Note 1:* Under definition 1) the power  $W = V^2/Z_{(w,v)}$  where  $V$  is the voltage, and  $Z_{(w,v)}$  the characteristic impedance defined in 1).

*Note 2:* Under definition 2) the power  $W = I^2/Z_{(w,i)}$  where  $I$  is the current and  $Z_{(w,i)}$  the characteristic impedance defined in 2).

*Note 3:* The characteristic impedance  $Z_{(v,i)}$  as defined in 3) is the geometric mean of the values given by 1) and 2). Definition 3) can be used also below the *Cut-Off Frequency*.

(53 IRE 2.S1)

**Characteristic Impedance (of a Rectangular Waveguide).** For the dominant ( $TE_{10}$ ) mode of a lossless rectangular *Uniconductor Waveguide* at a specified frequency above the *Cut-Off Frequency*, 1) the ratio of the square of the rms voltage between midpoints of the two conductor faces normal to the electric vector and the total power flowing when the guide is match terminated, 2) the ratio of the



total power flowing and the square of the rms longitudinal current flowing on one face normal to the electric vector when the guide is match terminated, 3) the ratio of the rms voltage between midpoints of the two conductor faces normal to the electric vector and the total rms longitudinal current flowing on one face when the guide is match terminated.

*Note 1:* Under definition 1) the power  $W = V^2/Z_{(w,v)}$  where  $V$  is the voltage, and  $Z_{(w,v)}$  the characteristic impedance defined in 1).

*Note 2:* Under definition 2) the power  $W = I^2/Z_{(w,i)}$  where  $I$  is the current and  $Z_{(w,i)}$  the characteristic impedance defined in 2).

*Note 3:* The characteristic impedance  $Z_{(v,i)}$  as defined in 3) is the geometric mean of the values given by 1) and 2). Definition 3) can be used also below the *Cut-Off Frequency*.

(53 IRE 2.S1)

**Characteristic Impedance (of a Two-Conductor Transverse Line).** For a *Traveling Transverse Electromagnetic Wave*, the ratio of the complex voltage between the conductors to the complex current on the conductors in the same transverse plane with the sign so chosen that the real part is positive. (53 IRE 2.S1)

**Characteristic Telegraph Distortion.** Distortion which does not affect all signal pulses alike, the effect on each transition depending upon the signal previously sent, due to remnants of previous transitions or transients which persist for one or more pulse lengths. Lengthening of the mark pulse is positive, and shortening, negative. Characteristic distortion is measured by transmitting "biased reversals," square waves having unequal mark and space pulses. The average lengthening or shortening of mark pulses, expressed in per cent of unit pulse length, gives a true measure of characteristic distortion only if other types of distortion are negligible. (48 IRE 2, 11, 15.S1)

**Characteristic Wave Impedance.** For a traveling *Electromagnetic Wave* at a given frequency, the ratio at a point of the complex magnitude of the transverse electric vector to that of the transverse magnetic vector with the sign so chosen that the real part is positive. (53 IRE 2.S1)

**Charge (Induction Heating).** See *Load (Induction and Dielectric Heating usage)*. (55 IRE 10.S1)

**Charge-Storage Tube.** A *Storage Tube* in which information is retained on a surface in the form of electric charges. (57 IRE 7.S2)

**Chart-Comparison Unit.** A device for the

simultaneous viewing of a navigational *Position* presentation and a navigational chart in such a manner that one appears superimposed upon the other. (54 IRE 12.S1)

**Check.** A process of partial or complete testing of 1) the correctness of machine operations, 2) the existence of certain prescribed conditions within the computer, or 3) the correctness of the results produced by a *Routine*. A check of any of these conditions may be made automatically by the equipment or may be programmed. See also *Marginal Checking; Verification*. (56 IRE 8.S1)

**Check, Automatic.** A *Check* performed by equipment built into the computer specifically for that purpose, and automatically accomplished each time the pertinent operation is performed. Sometimes referred to as a built-in check. **Machine Check** can refer to an automatic check, or to a *Programmed Check* of machine functions. (56 IRE 8.S1)

**Check Digits.** See *Check, Forbidden-Combination*. (56 IRE 8. S1)

**Check, Forbidden-Combination.** A *Check* (usually an *Automatic Check*) which tests for the occurrence of a nonpermissible code expression. A **Self-Checking Code** (or **Error-Detecting Code**) uses code expressions such that one (or more) error(s) in a code expression produces a forbidden combination. A **Parity Check** makes use of a self-checking code employing binary digits in which the total number of 1's (or 0's) in each permissible code expression is always even or always odd. A check may be made for either even parity or odd parity. A **Redundancy Check** employs a self-checking code which makes use of redundant digits called **Check Digits**. (56 IRE 8.S1)

**Check Point.** See *Way Point*. (54 IRE 12.S1)

**Check Problem.** See *Check, Programmed*. (56 IRE 8.S1)

**Check, Programmed.** A *Check* consisting of tests inserted into the program of the problem and accomplished by appropriate use of the machine's instructions. A **Mathematical Check** (or *Control*) is a programmed check of a sequence of operations which makes use of the mathematical properties of that sequence. A **Check Routine** or **Check Problem** is a routine or problem which is designed primarily to indicate whether a fault exists in the computer, without giving detailed information on the location of the fault. See also *Diagnostic Routine; Test Routine*. (56 IRE 8.S1)

**Check Routine.** See *Check, Programmed*. (56 IRE 8.S1)

**Check, Selection.** A *Check* (usually an *Automatic Check*) to verify that the correct reg-

ister, or other device, is selected in the performance of an instruction. (56 IRE 8.S1)

**Check, Transfer.** A *Check* (usually an *Automatic Check*) on the accuracy of the transfer of a word. (56 IRE 8.S1)

**Cheese Antenna.** A cylindrical parabolic reflector enclosed by two plates perpendicular to the cylinder, so spaced as to permit the propagation of more than one mode in the desired direction of polarization. It is fed on the focal line. (48 IRE 2, 11, 15.S1)

**Chip.** In mechanical recording, the material removed from the recording medium by the recording stylus while cutting the groove. (51 IRE 6.S1)

**Choke Joint.** A connection between two waveguides which provides effective electrical continuity without metallic continuity at the inner walls of the waveguide. (55 IRE 2.S1)

**Chroma (Munsell Chroma).** The dimension of the Munsell system of color which corresponds most closely to *Saturation*.

*Note:* *Chroma* is frequently used, particularly in English works, as the equivalent of *Saturation* (q.v.).

(55 IRE 22.S1)

**Chromaticity.** The color quality of light definable by its *Chromaticity Coordinates*, or by its *Dominant* (or *Complementary*) *Wavelength* and its *Purity* taken together. (55 IRE 22.S1)

**Chromaticity Coordinate.** The ratio of any one of the *Tristimulus Values* of a sample to the sum of the three *Tristimulus Values*. (55 IRE 22.S1)

**Chromaticity Diagram.** A plane diagram formed by plotting one of the three *Chromaticity Coordinates* against another.

*Note:* The most common *Chromaticity Dia-*

*gram* at present is the *CIE* (*x, y*) diagram plotted in rectangular coordinates.

(55 IRE 22.S1)

**Chromaticity Flicker.** That *Flicker* which results from fluctuation of *Chromaticity* only. (55 IRE 22.S1)

**Chrominance.** The colorimetric difference between any *Color* and a reference *Color* of equal *Luminance*, the reference *Color* having a specified *Chromaticity*.

*Note 1:* In three-dimensional color space, *Chrominance* is a vector which lies in a plane of constant *Luminance*. In that plane it may be resolved into components, called chrominance components.

*Note 2:* In color television transmission, for example, the *Chromaticity* of the reference color may be that of a specified *White*.

(55 IRE 22.S1)

**Chrominance Components.** See *Chrominance*. (55 IRE 22.S1)

**Chrominance Demodulator.** A demodulator used in color television reception for deriving video frequency *Chrominance Components* from the *Chrominance Signal* and a sine wave of *Chrominance Subcarrier* frequency. (55 IRE 22.S1)

**Chrominance Modulator.** A modulator used in color television transmission for generating the *Chrominance Signal* from the video frequency *Chrominance Components* and the *Chrominance Subcarrier*. (55 IRE 22.S1)

**Chrominance Primary.** A *Transmission Primary* which is one of two whose amounts determine the *Chrominance* of a *Color*.

*Note:* *Chrominance Primaries* have zero *Luminance* and are nonphysical.

(55 IRE 22.S1)

**Chrominance Signal (Carrier Chrominance Signal).** The sidebands of the modulated *Chrominance Subcarrier* which are added to the *Monochrome Signal* to convey color information. (55 IRE 22.S1)

**Chrominance Subcarrier.** The carrier whose modulation sidebands are added to the *Monochrome Signal* to convey color information. (55 IRE 22.S1)

**CIE.** Abbreviation for "Commission Internationale de l'Eclairage."

*Note:* These are the initials of the official French name of the "International Commission on Illumination." This translated name is approved for usage in English-speaking countries, but at its 1951 meeting the Commission recommended that only the initials of the French name be used. The initials "ICI" which have been used commonly in this country are deprecated because they conflict with an important trademark registered in England and because the

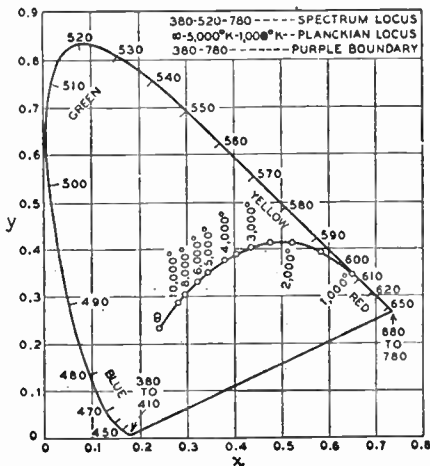

## Circuit

initials of the name translated into other languages are different.

(55 IRE 22.S1)

**Circuit.** A network providing one or more closed paths. (50 IRE 4.S1)

**Circuit Efficiency (of the Output Circuit of Electron Tubes).** The ratio of 1) the power at the desired frequency delivered to a load at the output terminals of the output circuit of an oscillator or amplifier to 2) the power at the desired frequency delivered by the electron stream to the output circuit. (56 IRE 7.S1; 57 IRE 7.S2)

**Circuit Gap Admittance.** See *Gap Admittance, Circuit.* (57 IRE 7.S2)

**Circular Electric Wave.** A *Transverse Electric Wave* for which the lines of electric force form concentric circles. (53 IRE 2.S1)

**Circularly Polarized Wave.** An electromagnetic wave for which the electric and/or the magnetic field vector at a point describes a circle.

*Note:* This term is usually applied to transverse waves.

(50 IRE 24.S1)

**Circular Magnetic Wave.** A *Transverse Magnetic Wave* for which the lines of magnetic force form concentric circles. (53 IRE 2.S1)

**Circular Scanning.** Scanning in which the direction of maximum radiation generates a plane or a right circular cone whose vertex angle is close to 180°. (48 IRE 2, 11, 15.S1)

**Circulating Register (or Memory).** A register (or memory) consisting of a means for delaying information and a means for regenerating and reinserting the information into the delaying means. (56 IRE 8.S1)

**Class-A Amplifier.** An amplifier in which the *Grid Bias* and alternating *Grid Voltages* are such that *Anode Current* in a specific tube flows at all times.

*Note:* The suffix 1 is added to the letter or letters of the class identification to denote that *Grid Current* does not flow during any part of the input cycle. The suffix 2 is used to denote that current flows during some part of the cycle.

(57 IRE 7.S2)

**Class-AB Amplifier.** An amplifier in which the *Grid Bias* and alternating *Grid Voltages* are such that *Anode Current* in a specific tube flows for appreciably more than half but less than the entire electrical cycle.

*Note:* The suffix 1 is added to the letter or letters of the class identification to denote that *Grid Current* does not flow during any part of the input cycle. The suffix 2 is used to denote that current flows during some part of the cycle.

(57 IRE 7.S2)

## Clearance

**Class-A Modulator.** A Class-A amplifier which is used specifically for the purpose of supplying the necessary signal power to modulate a carrier. (48 IRE 2, 11, 15.S1)

**Class-A Push-Pull Sound Track.** A class-A push-pull photographic sound track consists of two single tracks side by side, the transmission of one being 180° out of phase with the transmission of the other. Both positive and negative halves of the sound wave are linearly recorded on each of the two tracks. (51 IRE 6.S1)

**Class-B Amplifier.** An amplifier in which the *Grid Bias* is approximately equal to the cutoff value so that the *Anode Current* is approximately zero when no existing *Grid Voltage* is applied, and so that *Anode Current* in a specific tube flows for approximately one half of each cycle when an alternating grid voltage is applied.

*Note:* The suffix 1 is added to the letter or letters of the class identification to denote that *Grid Current* does not flow during any part of the input cycle. The suffix 2 is used to denote that current flows during some part of the cycle.

(57 IRE 7.S2)

**Class-B Modulator.** A Class-B amplifier which is used specifically for the purpose of supplying the necessary signal power to modulate a carrier. (48 IRE 2, 11, 15.S1)

**Class-B Push-Pull Sound Track.** A Class-B push-pull photographic sound track consists of two tracks side by side, one of which carries the positive half of the signal only, and the other the negative half. During the inoperative half cycle, each track transmits little or no light. (51 IRE 6.S1)

**Class-C Amplifier.** An amplifier in which the *Grid Bias* is appreciably greater than the cutoff value so that the *Anode Current* in each tube is zero when no alternating *Grid Voltage* is applied, and so that *Anode Current* in a specific tube flows for appreciably less than one half of each cycle when an alternating *Grid Voltage* is applied.

*Note:* The suffix 1 is added to the letter or letters of the class identification to denote that *Grid Current* does not flow during any part of the input cycle. The suffix 2 is used to denote that current flows during some part of the cycle.

(57 IRE 7.S2)

**Clear.** To restore a storage or memory device to a prescribed state, usually that denoting zero. See also *Reset.* (56 IRE 8.S1)

**Clearance.** 1) In *Navigation*, the *Depth of Modulation* differences at various *Elevation Angles* or *Bearings*. 2) In *Instrument Landing Systems*, the deviation indicator current

produced at various elevations or *Bearings*. (54 IRE 12.S1)

**Clipper.** A transducer which gives output only when the input exceeds a critical value. (48 IRE 2, 11, 15.S1)

**Clipper Amplifier.** See *Amplifier, Clipper*. (58 IRE 3.S1)

**Clipper Limiter.** A transducer which gives output only when the input lies above a critical value and a constant output for all inputs above a second higher critical value.

*Note:* This is sometimes called an amplitude gate, or slicer.

(48 IRE 2, 11, 15.S1)

**Clock.** A primary source of synchronizing signals. (56 IRE 8.S1)

**Close-Talking Microphone.** A microphone designed particularly for use close to the mouth of the speaker. (51 IRE 6.S1)

**Cloud Pulse (Charge-Storage Tubes).** The output resulting from *Space-Charge* effects produced by the turning on or off of the electron beam. (57 IRE 7.S2)

**Clutter.** In *Radar* the display of a conglomeration of unwanted echoes. (54 IRE 12.S1)

**Coarse Chrominance Primary.** In the color television system at present standardized for broadcasting in the United States, that one of the two *Chrominance Primaries* which is associated with the lesser transmission bandwidth. (55 IRE 22.S1)

**Coaxial Antenna.** An antenna comprised of a quarter wavelength extension to the inner conductor of a coaxial line and a radiating sleeve which in effect is formed by folding back the outer conductor of the coaxial line for approximately one-quarter wavelength. (48 IRE 2, 11, 15.S1)

**Coaxial (or Concentric) Transmission Line.** A *Transmission Line* consisting of two coaxial cylindrical conductors. (53 IRE 2.S1)

**Cochannel Interference.** Interference between two signals of the same type in the same radio channel. (52 IRE 17.S1)

**Code.** A set of transformation rules to be applied to *Messages* or *Signals*.

*Note:* *Code* is sometimes used in a colloquial sense to denote the set of *Code Characters* used by a *Code*.

(58 IRE 11.S1)

**Code (in Electronic Computers).** 1) A system of *Characters* and rules for representing information. 2) Loosely, the set of characters resulting from the use of a code. 3) To prepare a *Routine* in *Machine Language* for a specific computer. 4) To encode; to express given information by means of a code. See also *Language*. (56 IRE 8.S1)

**Code Character.** The representation of a dis-

crete value or symbol in accordance with a *Code*. (58 IRE 11.S1)

**Code Distinguishability.** The quality of a coded *Radio Beacon* which permits it to be distinguished from all other emissions from the beacon such as those giving distance. (54 IRE 12.S1)

**Coded Program.** A description of a procedure for solving a problem by means of a digital computer. It may vary in detail from a mere outline of the procedure to an explicit list of instructions coded in the machine's language. See *Program*. (50 IRE 8.S1)

**Code Element.** One of a finite set of parts of which the characters in a given *Code* may be composed. (58 IRE 11.S1)

**Code, Instruction.** See *Instruction Code*. (50 IRE 8.S1)

**Coder.** See *Pulse Coder*. (49 IRE 12.S1)

**Coder, Pulse-Duration.** In *Navigation* a device which generates a code by the varying of the pulse lengths. (54 IRE 12.S1)

**Coding Delay.** In a *Loran* system, an arbitrary time delay in the transmission of pulse signals from the "B" *Station* to permit the resolution of ambiguity that occurs in certain cases.

*Note:* The term *Coding* as applied to the delaying of an action in a *Radio Navigation* system after the time when another phenomenon takes place purely for reasons of improving the instrumentation problem is deprecated. The term *Suppressed Time Delay* accurately expresses what is being accomplished and should be employed instead.

(54 IRE 12.S1)

**Coercive Force, *H<sub>c</sub>*.** The magnetizing force at which the magnetic flux density is zero when the material is in a *Symmetrically Cyclically Magnetized Condition*.

*Note:* Coercive force is not a unique property of a magnetic material, but is dependent upon the conditions of measurement.

(59 IRE 8.S1)

**Coercivity.** The property of a magnetic material measured by the *Coercive Force* corresponding to the *Saturation Induction* for the material.

*Note:* This is a quasi-static property only.

(59 IRE 8.S1)

**Cohered Video.** In *Radar* MTI, video signal output employed in a *Coherent System*. (54 IRE 12.S1)

**Coherent Oscillator.** In MTI an oscillator which has as its function the provision of a reference by which changes in the radio-frequency phase of successive received pulses may be recognized. (54 IRE 12.S1)

**Coherent System.** In *Navigation*, a system in

which the signal output is obtained by demodulating the received signal after mixing with a local signal having a fixed-phase relation to that of the transmitted signal to permit use of the information carried by the phase of the received signal. (54 IRE 12.S1)

**COHO.** Abbreviation for a *Coherent Oscillator*. (54 IRE 12.S1)

**Coincident-Current Selection.** The selection of a magnetic cell for reading or writing, by the simultaneous application of two or more currents.

The **Selection Ratio** is the least ratio of a magnetomotive force used to select a cell to the maximum magnetomotive force used which is not intended to select a cell. A **Partial-Read Pulse** is any one of the currents applied which cause selection of a cell for reading. A **Partial-Write Pulse** is any one of the currents applied which cause selection of a cell for writing.

An **Undisturbed-Zero Output** is a *Zero Output* of a magnetic cell to which no *Partial-Write Pulses* have been applied since that cell was last selected for reading. An **Undisturbed-One Output** is a *One Output* of a magnetic cell to which no *Partial-Read Pulses* have been applied since that cell was last selected for writing. A **Disturbed-Zero Output** is a *Zero Output* of a magnetic cell to which *Partial-Write Pulses* have been applied since that cell was last selected for reading. A **Disturbed-One Output** is a *One Output* of a magnetic cell to which *Partial-Read Pulses* have been applied since that cell was last selected for writing. A **Partial-Select Output** is 1) the voltage response of an unselected magnetic cell produced by the application of *Partial-Read Pulses* or *Partial-Write Pulses* or 2) the integrated voltage response of an unselected magnetic cell produced by the application of *Partial-Read Pulses* or *Partial-Write Pulses*.

A **One-to-Partial-Select Ratio** is the ratio of a *One Output* to a *Partial-Select Output*. **Delta** is the difference between a *Partial-Select Output* of a magnetic cell in a *One State* and a *Partial-Select Output* of the same cell in a *Zero State*. (59 IRE 8.S1)

**Cold Cathode.** A *Cathode* whose operation does not depend on its temperature being above the ambient temperature. (57 IRE 7.S2)

**Cold-Cathode Tube.** An *Electron Tube* containing a *Cold Cathode*. (57 IRE 7.S2)

**Collector.** An *Electrode* that collects electrons or ions which have completed their functions within the tube. (57 IRE 7.S2)

**Color.** The characteristics of light other than spatial and temporal inhomogeneities.

*Note 1:* The measure of color is three-dimensional. One of the many ways of measuring color is in terms of *Luminance*, *Dominant Wavelength*, and *Purity*.

*Note 2:* Inhomogeneities, for example, particular distributions and variations of light, and characteristics of objects which are revealed by variations such as gloss, lustre, sheen, texture, sparkle, opalescence, and transparency, are not included among the color characteristics of objects.

(55 IRE 22.S1)

**Color Breakup.** Any fleeting and partial separation of a color picture into its *Display Primary* components caused by a rapid change in the condition of viewing.

*Note:* Illustrations of rapid changes in the condition of viewing are: 1) fast movement of the head, 2) fast interruption of the line of sight, 3) blinking of the eyes.

(55 IRE 22.S1)

**Color Burst.** That portion of the *Composite Color Signal*, comprising a few cycles of a sine wave of *Chrominance Subcarrier* frequency, which is used to establish a reference for demodulating the *Chrominance Signal*. (55 IRE 22.S1)

**Color Carrier.** See the preferred term *Chrominance Subcarrier*. (55 IRE 22.S1)

**Color Cell.** In a repeating pattern of phosphors on the *Screen* of a *Color Picture Tube*, the smallest area containing a complete set of all the primary colors contained in the pattern.

*Note:* If the cells are described by only one dimension as in the line type of *Screen*, the other dimension is determined by the resolution capabilities of the tube.

(57 IRE 7.S2)

**Color Center (Color Picture Tubes).** A point or region (defined by a particular color-selecting electrode and *Screen* configuration) through which an electron beam must pass in order to strike the phosphor array of one primary color.

*Note:* This term is *not* to be used to define the *Color Triad* center of a *Color Picture Tube Screen*.

(57 IRE 7.S2)

**Color Coder.** In color television transmission, an apparatus for generating the *Color Picture Signal* (and possibly the *Color Burst*) from camera signals and the *Chrominance Subcarrier*. (55 IRE 22.S1)

**Color Contamination.** An error of color rendition due to incomplete separation of paths carrying different color components of the picture.

*Note:* Such errors can arise in the optical, electronic, or mechanical portions of a color

## Color Coordinate

television system as well as in the electrical portions.

(55 IRE 22.S1)

**Color Coordinate Transformation.** Computation of the *Tristimulus Values* of the *Colors* in terms of one set of primaries from the *Tristimulus Values* of the same *Colors* in another set of primaries.

*Note:* This computation may be performed electrically in a color television system.

(55 IRE 22.S1)

**Color Decoder.** In color television, an apparatus for deriving the signals for the color display device from the *Color Picture Signal* and the *Color Burst*. (55 IRE 22.S1)

**Color-Difference Signal.** An electrical signal which when added to the *Monochrome Signal* produces a signal representative of one of the *Tristimulus Values* (with respect to a stated set of *Primaries*) of the transmitted *Color*. (55 IRE 22.S1)

**Color Encoder.** See *Color Coder*. (55 IRE 22.S1)

**Color Field Corrector.** A device located external to the tube producing an electric or magnetic field which affects the beam after deflection as an aid in the production of uniform color fields. (57 IRE 7.S2)

**Color Flicker.** That *Flicker* which results from fluctuation of both *Chromaticity* and *Luminance*. (55 IRE 22.S1)

**Color Fringing.** Spurious *Chromaticity* at boundaries of objects in the picture.

*Note:* *Color Fringing* can be caused by the change in relative position of the televised object from field to field or by misregistration and, in the case of small objects, may even cause them to appear separated into different colors.

(55 IRE 22.S1)

**Colorimetry.** The techniques for the measurement of *Color* and for the interpretation of the results of such measurements. (55 IRE 22.S1)

**Color Match.** The condition in which the two halves of a structureless photometric field are judged by the observer to have exactly the same appearance.

*Note:* A *Color Match* for the *Standard Observer* may be calculated.

(55 IRE 22.S1)

**Color Mixture.** *Color* produced by the combination of *light* of different *Colors*.

*Note 1:* The combination may be accomplished by successive presentation of the components, provided the rate of alternation is sufficiently high, or the combination may be accomplished by simultaneous presentation, either in the same area or on adjacent areas, provided they are small enough and

## Color Signal

close enough together to eliminate pattern effects.

*Note 2:* A *Color Mixture* as here defined is sometimes denoted as an **Additive Color Mixture**, to distinguish it from combinations of dyes, pigments, and other absorbing substances. Such mixtures of substances are sometimes called **Subtractive Color Mixtures**, but might more appropriately be called **Colorant Mixtures**.

(55 IRE 22.S1)

**Color-Mixture Data.** See *Tristimulus Values*, the preferred term. (55 IRE 22.S1)

**Color Picture Signal.** The electrical signal which represents complete color picture information, excluding all synchronizing signals.

*Note:* One form of color picture signal consists of a monochrome component plus a sub-carrier modulated with chrominance information.

(55 IRE 22.S1)

**Color Picture Tube.** An *Electron Tube* used to provide an image in color by the scanning of a *Raster* and by varying the intensity of excitation of phosphors to produce light of the chosen primary colors. (57 IRE 7.S2)

**Color Plane (Multibeam Color Picture Tubes).** A surface approximating a plane containing the *Color Centers*. (57 IRE 7.S2)

**Color Purity Magnet.** A magnet in the neck region of a *Color Picture Tube* to alter the electron beam path for the purpose of improving color purity. (57 IRE 7.S2)

**Color-Selecting-Electrode System.** A structure containing a plurality of openings mounted in the vicinity of the *Screen* of a *Color Picture Tube*, the function of this structure being to cause electron impingement on the proper *Screen* area by using either masking, focusing, deflection, reflection, or a combination of these effects.

*Note:* For examples, see *Shadow Mask*; *Focusing and Switching Grille*.

(57 IRE 7.S2)

**Color-Selecting-Electrode System Transmission.** The fraction of incident primary electron current which passes through the *Color-Selecting-Electrode System*. (57 IRE 7.S2)

**Color Signal.** Any signal at any point in a color television system, for wholly or partially controlling the *Chromaticity* values of a color television picture.

*Note:* This is a general term which encompasses many specific connotations, such as are conveyed by the words, *Color Picture Signal*, *Chrominance Signal* carrier color signal, *Monochrome Signal* (in color television), etc.

(55 IRE 22.S1)

## Color Temperature

**Color Temperature.** Temperature of the complete (blackbody or Planckian) radiator required to produce the same *Chromaticity* as the light under consideration. (55 IRE 22.S1)

**Color Transmission.** In television, the transmission of a signal wave for controlling both the *Luminance* values and the *Chromaticity* values in a picture. (55 IRE 22.S1)

**Color Triad (of a Phosphor-Dot Screen).** A *Color Cell* of a three-color phosphor-dot screen. (57 IRE 7.S2)

**Color Triangle.** A triangle drawn on a *Chromaticity Diagram*, representing the entire range of chromaticities obtainable as additive mixtures of three prescribed *Primaries*, represented by the corners of the triangle. (55 IRE 22.S1)

**Colpitts Oscillator.** An oscillator in which the parallel-tuned tank circuit is connected between grid and plate, with the tank capacitance containing two voltage-dividing capacitors in series, with their common connection at cathode potential and the necessary feedback voltage being obtained across the grid-cathode capacitor. When the two voltage-dividing capacitances are the plate-to-cathode and the grid-to-cathode capacitances of the tube, the circuit is known as the ultra-audio oscillator. (48 IRE 2, 11, 15.S1)

**Column.** Synonym for *Place*. (56 IRE 8.S1)

**Combination Microphone.** A microphone consisting of a combination of two or more dissimilar microphones.

*Note.* Examples of combination microphones are: two oppositely phased pressure microphones acting as a gradient microphone, and a pressure microphone and a velocity microphone acting as a unidirectional microphone.

(51 IRE 6.S1)

**Command (in Computers).** 1) One of a set of several signals (or groups of signals) which occurs as a result of an *Instruction*; the commands initiate the individual steps which form the process of executing the instruction. 2) Synonym for *Instruction*. (56 IRE 8.S1)

**Command (in Control System).** An independent signal from which the dependent signals are controlled according to the prescribed system relationships. (55 IRE 26.S2)

**Commutation Factor (Gas Tubes).** The product of the rate of current decay and the rate of the inverse voltage rise immediately following such current decay.

*Note:* The rates are commonly stated in amperes per microsecond, and volts per microsecond. (57 IRE 7.S2)

**Companding.** A process in which compression is followed by expansion.

## Complementary Wavelength

*Note:* Companding is often used for noise reduction, in which case the compression is applied before the noise exposure and the expansion after the exposure.

(53 IRE 11.S1)

**Comandor.** The combination, in a transmission system of a *Compressor*, for transmitted *Signals* and an *Expander* for received *Signals*.

*Note:* The purpose of a *Comandor* is to improve the ratio of *Signal* to the interference entering the transmission path between *Compressor* and *Expander*.

(58 IRE 3.S1)

**Comparator.** A circuit which compares two signals and supplies an indication of agreement or disagreement. (50 IRE 8.S1)

**Compass Bearing.** The angle in the horizontal plane between the direction of magnetic north on the compass card and the line joining the observer and the object, usually measured clockwise. (49 IRE 12.S1)

**Compass Course.** The directing in the horizontal plane of intended travel with respect to the direction of magnetic north on the compass card, usually measured clockwise. (49 IRE 12.S1)

**Compass Heading.** The angle in the horizontal plane between the direction of magnetic north on the compass card and the line along which the vehicle is pointing, usually measured clockwise. (49 IRE 12.S1)

**Compatibility.** That property of a color television system which permits substantially normal monochrome reception of the transmitted signal by typical unaltered monochrome receivers. (55 IRE 22.S1)

**Complement.** 1) A number whose representation is derived from the finite *Positional Notation* of another by one of the following rules: a) True complement—Subtract each digit from one less than the base; then add 1 to the least significant digit, executing all carries required. b) Base minus one's complement—Subtract each digit from one less than the base (e.g., "9's complement" in the base 10, "1's complement" in the base 2, etc.). 2) To form the complement of a number.

*Note:* In many machines, a negative number is represented as a complement of the corresponding positive number.

(56 IRE 8.S1)

**Complementary Wavelength.** The wavelength of light of a single frequency, which matches the reference standard light when combined with a sample color in suitable proportions.

*Note 1:* The wide variety of purples which have no dominant wavelengths, including

## Complete Carry

nonspectral violet, purple, magenta, and nonspectral red colors, are specified by use of their complementary wavelengths.

*Note 2:* Refer to *Dominant Wavelength*.

(55 IRE 22.S1)

**Complete Carry.** See *Carry*. (56 IRE 8.S1)

**Complex Target.** In *Radar*, a *Target* composed of a number of reflecting surfaces which in aggregate are smaller in all dimensions than the resolution capabilities of the *Radar*. (54 IRE 12.S1)

**Complex Tone.** 1) A sound wave produced by the combination of simple sinusoidal components of different frequencies. 2) A sound sensation characterized by more than one pitch. (51 IRE 8.S1)

**Composite Color Signal.** The color picture signal plus blanking and all synchronizing signals. (55 IRE 22.S1)

**Composite Color Sync.** The signal comprising all the sync signals necessary for proper operation of a color receiver. This includes the deflection of sync signals to which the color sync signal is added in the proper time relationship. (55 IRE 22.S1)

**Composite Controlling Voltage.** The voltage of the *Anode* of an *Equivalent Diode* combining the effects of all individual *Electrode Voltages* in establishing the *Space-Charge-Limited Current*. (57 IRE 7.S2)

**Composite Picture Signal.** The signal which results from combining a *Blanked Picture Signal* with the *Sync Signal*. (55 IRE 23.S1)

**Composite Pulse.** In pulse *Navigational* systems a pulse composed of a series of overlapping pulses received from the same source via several paths. (54 IRE 12.S1)

**Compound Horn.** An electromagnetic horn of rectangular cross section, the four sides of which diverge in such a way as to coincide with or to approach four planes, with the provision that the line of intersection of two opposite planes does not intersect the line of intersection of the remaining planes. The electromagnetic field in such a horn is not simply expressed in terms of a family of cylindrical coordinates or a family of spherical coordinates. (48 IRE 2, 11, 15.S1)

**Compound Target.** In *Radar*, a *Target* composed of a number of randomly, disposed reflecting surfaces the aggregate extent of which exceeds any of the dimensions of the *Pulse Packet*. (54 IRE 12.S1)

**Compression.** A process in which the effective gain applied to a signal is varied as a function of the signal magnitude, the effective gain being greater for small than for large signals. (53 IRE 11.S1)

**Compression (in Television).** The reduction in gain at one *Level* of a *Picture Signal*

## Conditional Information

with respect to the gain at another *Level* of the same signal.

*Note 1:* See also *Black Compression* and *White Compression*.

*Note 2:* The gain referred to in the definition is for a signal amplitude small in comparison with the total peak-to-peak *Picture Signal* involved. A quantitative evaluation of this effect can be obtained by a measurement of *Differential Gain*.

(55 IRE 23.S1)

**Compressional Wave.** A wave in an elastic medium which causes an element of the medium to change its volume without undergoing rotation.

*Note 1:* Mathematically, a wave whose intensity field has zero curl.

*Note 2:* A compressional plane wave is a longitudinal wave.

(51 IRE 6.S1)

**Compression Ratio (Gain or Amplification).** The ratio of 1) the magnitude of the gain (or amplification) at a reference signal level to 2) its magnitude at a higher stated signal level. (56 IRE 7.S1; 57 IRE 7.S2)

**Compressor.** A *Transducer* which, for a given input *Amplitude Range*, produces a smaller output range.

*Note:* One type of *Compressor* reduces the *Amplitude Range* as a linear function of the envelope of speech waves.

(58 IRE 3.S1)

**Computer.** 1) A machine for carrying out calculations. 2) By extension, a machine for carrying out specified transformations on information. (56 IRE 8.S1)

**Condensed-Mercury Temperature.** The temperature measured on the outside of the tube envelope in the region where the mercury is condensing in a glass tube, or measured at a designated point on a metal tube. (57 IRE 7.S2)

**Conditional Information Content (of a First Symbol Given a Second Symbol).** The negative of the logarithm of the conditional probability of the first symbol, given the second symbol.

*Note 1:* The choice of logarithmic base determines the unit of *Information Content*. See *Bit* and *Hartley*.

*Note 2:* The *Conditional Information Content* of an input symbol given an output symbol, averaged over all input-output pairs, is the *Equivocation*.

*Note 3:* The *Conditional Information Content* of output symbols relative to input symbols, averaged over all input-output pairs, has been called spread, prevarication, irrelevance, etc.

(58 IRE 11.S1)



**Conditional Jump.** An instruction which will cause the proper one of two (or more) addresses to be used in obtaining the next instruction, depending upon some property of one or more numerical expressions or other conditions. (56 IRE 8.S1)

**Conditional Transfer of Control.** Synonym for *Conditional Jump*. (56 IRE 8.S1)

**Condor.** A CW navigational system similar to *Benito*, which automatically measures *Bearing* and distance from a single ground station. The distance is determined by phase comparison and the *Bearing* by automatic *Direction Finding*. Distance and *Bearing* are displayed on a cathode-ray indicator. (54 IRE 12.S1)

**Conductance.** See:

*Conductance for Rectification*

*Conversion Transconductance (of a Heterodyne Conversion Transducer)*

*Electrode Conductance*

*Equivalent Conductance (ATR Tubes)*

*Equivalent Noise Conductance*

*Interelectrode Transconductance (j-l Interelectrode Transconductance.*

(57 IRE 7.S2)

**Conductance for Rectification.** The quotient of 1) the *Electrode* alternating current of low frequency by 2) the in-phase component of the *Electrode* alternating voltage of low frequency, a high-frequency sinusoidal voltage being applied to the same or another *Electrode* and all other *Electrode Voltages* being maintained constant. (57 IRE 7.S2)

**Conduction Band.** A range of states in the energy spectrum of a solid in which electrons can move freely. (54 IRE 7.S2)

**Conductivity Modulation (of a Semiconductor).** The variation of the conductivity of a semiconductor by variation of the charge *Carrier* density. (54 IRE 7.S2)

**Conductivity, N-type.** The conductivity associated with *Conduction Electrons* in a semiconductor. (54 IRE 7.S2)

**Conductivity, P-type.** The conductivity associated with *Holes* in a semiconductor. (54 IRE 7.S2)

**Cone of Nulls.** A conical surface formed by directions of negligible radiation. (48 IRE, 2, 11, 15.S1)

**Cone of Silence.** A conically shaped region above an antenna where, because of the configuration of the antenna system, the field strength is relatively low, e.g., the *Cone of Silence* above a *Radio Range* station. (54 IRE 12.S1)

**Conical Horn.** A horn whose cross-sectional area increases as the square of the axial length. (51 IRE 6.S1)

**Conical Scanning.** Scanning in which the di-

rection of maximum radiation generates a cone whose vertex angle is of the order of the beam width. Such scanning may be either rotating or nutating, according as the direction of polarization rotates or remains unchanged. (48 IRE 2, 11, 15.S1)

**Conjugated Impedances.** See *Impedances, Conjugate* (58 IRE 3.S1)

**Connected.** A network is connected if there exists at least one path, composed of branches of the network, between every pair of nodes of the network. (50 IRE 4.S1)

**Connector, Waveguide.** A mechanical device for electrically joining separable parts of a waveguide system. (55 IRE 2.S1)

**Consol.** See *Sonne*. (54 IRE 12.S1)

**Consolan.** See *Sonne*. (54 IRE 12.S1)

**Constant Amplitude Recording.** A mechanical recording characteristic wherein, for a fixed amplitude of a sinusoidal signal, the resulting recorded amplitude is independent of frequency. (51 IRE 6.S1)

**Constant-Current Characteristic.** The relation between the voltages of two *Electrodes* with the current to one of them as well as all other voltages maintained constant. (57 IRE 7.S2)

**Constant-Current (Heising) Modulation.** A system of amplitude modulation wherein the output circuits of the signal amplifier and the carrier-wave generator or amplifier are directly and conductively coupled by means of a common inductor which has ideally infinite impedance to the signal frequencies and which, therefore, maintains the common plate-supply current of the two devices constant. The signal-frequency voltage thus appearing across the common inductor appears also as modulation of the plate supply to the carrier generator or amplifier with corresponding modulation of the carrier output. (48 IRE 2, 11, 15.S1)

**Constant-Delay Discriminator.** See *Pulse-Demoder*. (54 IRE 12.S1)

**Constant Luminance Transmission.** That type of transmission in which the *Transmission Primaries* are a *Luminance Primary* and two *Chrominance Primaries*. (55 IRE 22.S1)

**Constant Velocity Recording.** A mechanical recording characteristic wherein, for a fixed amplitude of a sinusoidal signal, the resulting recorded amplitude is inversely proportional to the frequency. (51 IRE 6.S1)

**Contact, High Recombination Rate.** A semiconductor-semiconductor or metal-semiconductor contact at which thermal equilibrium *Carrier* densities are maintained substantially independent of current density. (54 IRE 7.S2)

**Contact, Majority Carrier (to a Semicon-**

- ductor**). An electrical contact across which the ratio of *Majority Carrier* current to applied voltage is substantially independent of the polarity of the voltage while the ratio of *Minority Carrier* current to applied voltage is not independent of the polarity of the voltage. (54 IRE 7.S2)
- Contact, Load**. See *Load Switch (Load Contactor)*. (55 IRE 10.S1)
- Contact Potential Difference**. The difference between the *Work Functions* of two materials, divided by the electronic charge. (57 IRE 7.S2)
- Contact Rectifier**. A rectifier consisting of two different solids in contact, in which rectification is due to greater conductivity across the contact in one direction than in the other. (48 IRE 2, 11, 15.S1)
- Content, Average Information**. See *Average Information Content*. (58 IRE 11.S1)
- Content, Conditional Information**. See *Conditional Information Content*. (58 IRE 11.S1)
- Continuous-Duty Rating**. The rating applying to operation for an indefinitely long time. (48 IRE 2, 11, 15.S1)
- Continuous Waves or CW**. Waves, the successive oscillations of which are identical under steady-state conditions. (48 IRE 2, 11, 15.S1)
- Control (in Computers)**. 1) Usually, those parts of a digital computer which effect the carrying out of instructions in proper sequence, the interpretation of each instruction, and the application of the proper signals to the arithmetic unit and other parts in accordance with this interpretation. 2) Frequently, one or more of the components in any mechanism responsible for interpreting and carrying out manually-initiated directions. Sometimes called manual control. 3) In some business applications of mathematics, a *Mathematical Check*. (56 IRE 8.S1)
- Control Characteristic (Gas Tubes)**. A relation between *Critical Grid Voltage* and *Anode Voltage*. (57 IRE 7.S2)
- Control Circuits**. The circuits of a digital computer which effect the carrying out of instructions in proper sequence, the interpretation of each instruction, and the application of the proper commands to the arithmetic element and other circuits in accordance with this interpretation. (50 IRE 8.S1)
- Control Electrode**. An *Electrode* used to initiate or vary the current between two or more *Electrodes*. (57 IRE 7.S2)
- Control-Electrode Discharge Recovery Time (Attenuator Tubes)**. The time required for the *Control-Electrode* discharge to deionize to a level such that a specified frac-

- tion of the *Critical High-Power Level* is required to ionize the tube. (57 IRE 7.S2)
- Control Grid**. A *Grid*, ordinarily placed between the *Cathode* and an *Anode*, for use as a *Control Electrode*. (57 IRE 7.S2)
- Controlled (Variable or Floating) Carrier**. A system of compound modulation wherein the carrier is amplitude-modulated by the signal frequencies in any conventional manner but, in addition, the carrier is also amplitude-modulated in accordance with the envelope of the signal, so that the percentage of modulation, or modulation factor, remains relatively constant regardless of the amplitude of the signal. (48 IRE 2, 11, 15.S1)
- Control Ratio (Gas Tubes)**. The ratio of the change in *Anode Voltage* to the corresponding change in *Critical Grid Voltage*, with all other operating conditions maintained constant. (57 IRE 7.S2)
- Control Track**. A supplementary sound track, usually placed on the same film with the sound track carrying the program material. Its purpose is to control, in some respect, the reproduction of the sound track. Ordinarily, it contains one or more tones, each of which, may be modulated either as to amplitude or frequency. (51 IRE 6.S1)
- Convection Current**. In an electron stream, the time rate at which charge is transported through a given surface. (56 IRE 7.S1; 57 IRE 7.S2)
- Convection-Current Modulation**. The time variation in the magnitude of the *Convection Current* passing through a surface, or the process of directly producing such a variation. (56 IRE 7.S1; 57 IRE 7.S2)
- Convergence (Multibeam Cathode-Ray Tubes)**. A condition in which the electron beams intersect at a specified point. (57 IRE 7.S2)
- Convergence, Dynamic (Multibeam Cathode-Ray Tubes)**. The process whereby the locus of the point of convergence of electron beams is made to fall on a specified surface during scanning. (57 IRE 7.S2)
- Convergence Electrode**. An *Electrode* whose electric field converges two or more electron beams. (57 IRE 7.S2)
- Convergence Magnet**. A magnet assembly whose magnetic field converges two or more electron beams. (57 IRE 7.S2)
- Convergence Plane (Multibeam Cathode-Ray Tubes)**. A plane containing the points at which the electron beams appear to experience a deflection applied for the purpose of obtaining *Convergence*. (57 IRE 7.S2)
- Convergence Surface (Multibeam Cathode-Ray Tubes)**. The surface generated by the point of intersection of two or more elec-

tron beams during the scanning process. (57 IRE 7.S2)

**Conversion Transconductance (of a Heterodyne Conversion Transducer).** The quotient of 1) the magnitude of the desired output-frequency component of current by 2) the magnitude of the input-frequency (signal) component of voltage when the impedance of the output external termination is negligible for all of the frequencies which may affect the result.

*Note:* Unless otherwise stated, the term refers to the cases in which the input-frequency voltage is of infinitesimal magnitude. All direct *Electrode Voltages* and the magnitude of the local-oscillator voltage must remain constant.

(57 IRE 7.S2)

**Conversion Transducer.** An electric transducer in which the input and the output frequencies are different.

*Note:* If the frequency-changing property of a *Conversion Transducer* depends upon a generator of frequency different from that of the input or output frequencies, the frequency and voltage or power of this generator are parameters of the *Conversion Transducer*.

(57 IRE 7.S2)

**Conversion Voltage Gain (of a Conversion Transducer).** See *Gain, Conversion Voltage (of a Conversion Transducer)*. (57 IRE 7.S2)

**Converter.** See *Heterodyne Conversion Transducer*. (51 IRE 20.S2)

**Converter, Facsimile.** A device which changes the type of modulation. (56 IRE 9.S1)

**Converter, Mercury Arc, Pool Cathode.** See *Pool Cathode Mercury Arc Converter*. (55 IRE 10.S1)

**Converter, Mercury Hydrogen Spark Gap.** See *Mercury Hydrogen Spark Gap Converter*. (55 IRE 10.S1)

**Converter, Quenched Spark Gap.** See *Quenched Spark Gap Converter*. (55 IRE 10.S1)

**Converter Tube.** An *Electron Tube* that combines the mixer and local-oscillator functions of a *Heterodyne Conversion Transducer*. (57 IRE 7.S2)

**Copy.** See *Transfer*. (56 IRE 8.S1)

**Core.** In mechanical recording, the central layer or basic support of certain types of laminated media. (51 IRE 6.S1)

**Coreless-Type Induction Heater or Furnace.** A device in which a charge is heated by induction and no magnetic core material links the charge.

*Note:* Magnetic material may be used else-

where in the assembly for *Flux Guiding* purposes.

(55 IRE 10.S1)

**Core-Type Induction Heater or Furnace.**

A device in which a *Charge* is heated by induction and a magnetic core links the inducing winding with the charge. (55 IRE 10.S1)

**Corner Reflector.** In *Radar*, three conducting surfaces mutually intersecting at right angles designed to return electromagnetic radiations toward their sources and used to render a *Position* more conspicuous to *Radar* observations. (54 IRE 12.S1)

**Corrected Compass Course.** Same as magnetic *Course*. (54 IRE 12.S1)

**Corrected Compass Heading.** Same as magnetic *Heading*. (54 IRE 12.S1)

**Correction.** See *Error*. (56 IRE 8.S1)

**Corrective Network (Shaping Network).**

An electrical network designed to be inserted in a circuit to improve its transmission properties, its impedance properties, or both. (42 IRE 9.S1)

**Cosecant-Squared Pattern.** An antenna field in which the signal-power pattern in the vertical plane, above a prescribed angle of elevation, varies as the square of the cosecant of the elevation angle.

*Note:* With a cosecant-squared pattern approximately uniform signal is obtained for *Echoes* received from objects at the same altitude, but at varying distances.

(54 IRE 12.S1)

**Count (Radiation Counters).** A single response of the counting system.

*Note:* See also *Tube Count*.

(57 IRE 7.S2)

**Count Down.** In a *Transponder*, the ratio of the number of interrogation pulses not answered to the total number interrogation pulses received by the *Transponder*. (54 IRE 12.S1)

**Counter.** 1) A device capable of changing from one to the next of a sequence of distinguishable states upon each receipt of an input signal. 2) Less frequently, an *Accumulator*. (56 IRE 8.S1)

**Counterpoise.** A system of wires or other conductors, elevated above and insulated from the ground, forming a lower system of conductors of an antenna. (48 IRE 2, 11, 15.S1)

**Counter, Ring.** A loop of interconnected bistable elements such that one and only one is in a specified state at any given time and such that, as input signals are counted, the position of the one specified state moves in an ordered sequence around the loop. (56 IRE 8.S1)

**Counter Tube, Externally Quenched.** A radiation-counter tube that requires the use

## Counter Tube

of an external quenching circuit to inhibit *Reignition*. (57 IRE 7.S2)

**Counter Tube, Gas-Filled, Radiation.** A *Gas Tube* used for detection of *Radiation* by means of gas ionization. (57 IRE 7.S2)

**Counter Tube, Gas-Flow.** A radiation-counter tube in which an appropriate atmosphere is maintained by a flow of gas through the tube. (57 IRE 7.S2)

**Counter Tube, Geiger-Mueller.** A radiation-counter tube operated in the *Geiger-Mueller Region*. (57 IRE 7.S2)

**Counter-Tube, Proportional.** A radiation-counter tube operated in the *Proportional Region*. (57 IRE 7.S2)

**Counter Tube, Self-Quenched.** A radiation-counter tube in which *Reignition* of the discharge is inhibited by internal processes. (57 IRE 7.S2)

**Counting Efficiency (Radiation-Counter Tubes).** The average fraction of the number of ionizing particles or quanta incident on the *Sensitive Volume* that produce *Tube Counts*. The operating conditions of the counter and the condition of irradiation must be specified. (57 IRE 7.S2)

**Counting-Rate-vs-Voltage Characteristic.** The relation between counting rate and voltage applied to a radiation-counter tube for constant *Radiation Intensity*. (57 IRE 7.S2)

**Coupler.** In *Navigation*, that portion of a navigational system which receives signals of one type from a *Sensor* and transmits signals of a different type to an *Actuator*; *i.e.*, a transducer. (54 IRE 12.S1)

**Coupling (Induction Heating Usage).** The percentage of the total magnetic flux produced by an inductor which is effective in heating a *Load* or *Charge*. (55 IRE 10.S1)

**Coupling Aperture (Coupling Hole, Coupling Slot).** Aperture in wall of waveguide or *Cavity Resonator* designed to transfer energy to or from an external circuit. (55 IRE 2.S1)

**Coupling Coefficient, Small Signal (for an Electron Stream).** The ratio of 1) the maximum change in energy of an electron traversing the *Interaction Space* to 2) the product of the *Peak Alternating Gap Voltage* by the electronic charge. (56 IRE 7.S1; 57 IRE 7.S2)

**Coupling Loop.** A conducting loop projecting into a waveguide or *Cavity Resonator*, designed to transfer energy to or from an external circuit. (55 IRE 2.S1)

**Coupling Probe.** A probe projecting into a waveguide or *Cavity Resonator* designed to transfer energy to or from an external circuit. (55 IRE 2.S1)

**Course.** 1) The intended direction of travel,

## Course Width

expressed as an angle in the horizontal plane between a *Reference Line* and the *Course Line*, usually measured clockwise from the *Reference Line*. 2) The intended direction of travel as defined by navigational facility.

*Note:* *Course* is also commonly used as a synonym for *Course Line*.

(54 IRE 12.S1)

**Course (Line) Computer.** The equipment which provides the means by which any arbitrary course line may be set up and flown, such as that used in connection with ODR and DME equipment. (49 IRE 12.S1)

**Course Error—Deprecated.** Deprecated, since it is identical with the more expressive term, *Drift Angle*. The angular difference between the *Course* and the *Course Made Good*. (54 IRE 12.S1)

**Course Error, Indicated.** See *Indicated Course Error*. (54 IRE 12.S1)

**Course Line.** The projection in the horizontal plane of the proposed *Path* of travel. (54 IRE 12.S1)

**Course Line Deviation.** The difference between the *Track* of a *Vehicle* and the *Course Line* expressed in terms of either angular or linear measurement.

*Note:* In common parlance navigators speak of deviating from *Course*; what is meant is that the *Track* deviates from the *Course Line*.

(54 IRE 12.S1)

**Course Made Good.** The resultant *Direction* of actual travel projected in the horizontal plane expressed as an angle from a *Reference Line* to a line extending in the *Direction* of actual travel, usually measured clockwise from the *Reference Line*. This is the equivalent of the *Bearing* of the *Vehicle* from the point of departure. (54 IRE 12.S1)

**Course Push (or Pull).** An erroneous deflection of the indicator of a navigational aid, produced by altering the attitude of the receiving antenna. (This effect is a manifestation of *Polarization Error* and results in an apparent displacement of the *Course Line*.) (54 IRE 12.S1)

**Course (Line) Selector.** An instrument providing means to select the course to be flown. (49 IRE 12.S1)

**Course Sensitivity.** The displacement (of the *Vehicle*) from the *Course Line* which produces a given change of course indication (usually full scale). (54 IRE 12.S1)

**Course Softening.** The intentional decrease in *Course Sensitivity* upon approaching a navigational aid such that the ratio of indicator deflection to linear displacement from the *Course Line* tends to remain constant. (54 IRE 12.S1)

**Course Width.** In *Navigation*, the arithmetic

## Coverage Diagram

sum of the plus and minus lateral deviations from the *Course Line* within which the *Course* defining parameters do not vary by a detectable amount. (See also *Course Sensitivity* and *Deviation Sensitivity*.) (54 IRE 12.S1)

**Coverage Diagram.** In *Navigation*, a diagram depicting the *Service Area*. (54 IRE 12.S1)

**Crab Angle.** In *Navigation*, the angular difference between *Course* and *Heading*, identical with *Drift Correction Angle*. (54 IRE 12.S1)

**Crest Factor of a Pulse.** The ratio of the peak-pulse amplitude to the root-mean-square pulse amplitude. (51 IRE 20.S1)

**Crest Factor of a Pulse Carrier.** The ratio of the peak-pulse amplitude to the root-mean-square amplitude. (48 IRE 2, 11, 15.S1)

**Critical Anode Voltage (Multielectrode Gas Tubes).** Synonymous with *Anode Breakdown Voltage (Gas Tubes)*. (57 IRE 7.S2)

**Critical Area.** An area of the subject copy whose dimensions along and across the direction of scanning are equal to the definition in these respective directions. (42 IRE 9.S1)

**Critical Field (Magnetrons).** The smallest theoretical value of steady magnetic flux density, at a steady *Anode Voltage*, that would prevent an electron emitted from the *Cathode* at zero velocity from reaching the *Anode*. (57 IRE 7.S2)

**Critical Frequency.** The limiting frequency below which a magneto-ionic wave component is reflected by, and above which it penetrates through, an ionospheric layer at vertical incidence. (50 IRE 24.S1)

**Critical Grid Current (Multielectrode Gas Tubes).** The *Grid Current* corresponding to the *Critical Grid Voltage*, before anode *Breakdown*.

*Note:* The *Critical Grid Current* is a function of the other *Electrode Voltages* or currents and of the environment.

(57 IRE 7.S2)

**Critical Grid Voltage (Multielectrode Gas Tubes).** The *Grid Voltage* at which anode *Breakdown* occurs.

*Note 1:* The *Critical Grid Voltage* is a function of the other *Electrode Voltages* or currents and of the environment.

*Note 2:* See *Breakdown Voltage (of an Electrode of a Gas Tube)*.

(57 IRE 7.S2)

**Critical High-Power Level (Attenuator Tubes).** The radio-frequency power level at which ionization is produced in the absence of a *Control-Electrode discharge*. (57 IRE 7.S2)

**Critical Voltage (Magnetrons).** The highest theoretical value of steady *Anode Voltage*,

## Crystal-Controlled Transmitter

at a given steady magnetic flux density, at which electrons emitted from the *Cathode* at zero velocity would fail to reach the *Anode*. (57 IRE 7.S2)

**Cross Coupling (in a Transmission Medium).** A measure of the undesired power transferred from one channel to another. (53 IRE 2.S1)

**Crossing Angle.** In *Navigation*, the angle at which two *Lines of Position* or *Course Lines* intersect. (54 IRE 12.S1)

**Cross Modulation (in General).** Modulation of a desired signal by an undesired signal. (52 IRE 17.S1)

**Cross Modulation (in Transmitters).** A type of intermodulation due to modulation of the carrier of the desired signal by an undesired signal. (48 IRE 2, 11, 15.S1)

**Cross Neutralization.** A method of neutralization used in push-pull amplifiers whereby a portion of the plate-cathode alternating-current voltage of each tube is applied to the grid-cathode circuit of the other tube through a neutralizing capacitor. (48 IRE 2, 11, 15.S1)

**Crossover Characteristic Curve.** In *Navigation*, the graphical representation of the indicator current variation with change of *Position* in the *Crossover Region*. (54 IRE 12.S1)

**Crossover Frequency.** As applied to electric dividing networks, the crossover frequency is the frequency at which equal electric powers are delivered to each of the adjacent frequency channels when all channels are terminated in the loads specified. See also *Transition Frequency (Crossover Frequency)*. (51 IRE 6.S1)

**Crossover Network.** A selective *Network* which divides its audio input into two or more frequency bands for distribution to loudspeakers. (58 IRE 3.S1)

**Crossover Region.** In an *Instrument Approach System*, a zone in space close to the *Localizer On-Course Line* or *Glide Slope* in which the pointer of the indicator is in a position between the full-scale indications. (54 IRE 12.S1)

**Cross Polarization.** The component of the electric field vector normal to the desired polarization component. (48 IRE 2, 11, 15.S1)

**Cross Section—Deprecated.** In *Radar*, a term used in referring to the equivalent echoing area of a *Target*. (54 IRE 12.S1)

**Crosstalk.** Electrical disturbances in a communication channel as a result of coupling with other communication channels. (58 IRE 3.S1)

**Crystal-Controlled Transmitter.** A transmitter whose carrier frequency is directly controlled by the electromechanical characteristics of a piece of material of crystalline struc-

## Crystal Cutter

ture. (48 IRE 2, 11, 15.S1)

**Crystal Cutter.** A cutter in which the mechanical displacements of the recording stylus are derived from the deformations of a crystal having piezoelectric properties. (51 IRE 6.S1)

**Crystal Loudspeaker (Piezoelectric Loudspeaker).** A loudspeaker in which the mechanical displacements are produced by piezoelectric action. (51 IRE 6.S1)

**Crystal Microphone (Piezoelectric Microphone).** A microphone which depends for its operation on the generation of an electric charge by the deformation of a body (usually crystalline) having piezoelectric properties. (51 IRE 6.S1)

**Crystal Oscillator.** A generator of alternating-current energy, the frequency of which is determined by the mechanical properties of a piezoelectric crystal. (48 IRE 2, 11, 15.S1)

**Crystal Pickup (Piezoelectric Pickup).** A phonograph pickup which depends for its operation on the generation of an electric charge by the deformation of a body (usually crystalline) having piezoelectric properties. (51 IRE 6.S1)

**Crystal Pulling.** A method of crystal growing in which the developing crystal is gradually withdrawn from a melt. (54 IRE 7.S2)

**Crystal-Stabilized Transmitter.** A transmitter employing automatic frequency control, in which the reference frequency is that of a crystal oscillator. (48 IRE 2, 11, 15.S1)

**Crystal-Video Receiver.** A receiver consisting of a crystal detector and a video amplifier. (54 IRE 12.S1)

**C-Scope.** A cathode-ray indicator in which a signal appears as a spot with bearing as the horizontal coordinate and elevation angle as the vertical coordinate. (49 IRE 12.S1)

**Cue Circuit.** A one-way communication circuit used to convey *Program* control information. (58 IRE 3.S1)

**Curie Point (Induction Heating usage).** The temperature in a ferromagnetic material above which the material becomes substantially nonmagnetic. (55 IRE 10.S1)

**Current.** See:

*Average Electrode Current*

*Convection Current*

*Critical Grid Current (Multielectrode Gas Tubes)*

*Dark Current*

*Electrode Current (Electron Tubes)*

*Electrode Dark Current (Camera Tubes or Phototubes)*

*Equivalent Noise Current*

*Fault Electrode Current*

*Field-Free Emission Current (of a Cathode)*

*Inflection-Point Emission Current*

## Cutoff Frequency

*Gas (Ionization) Current (Vacuum Tubes)*

*Inflection-Point Emission Current*

*Inverse Electrode Current*

*Peak Cathode Current (Steady State)*

*Peak Electrode Current*

*Preoscillation Current*

*Signal Output Current (Camera Tubes or Phototubes)*

*Space-Charge-Limited Current (Vacuum Tubes)*

*Starting Current of an Oscillator*

*Transfer Current (Gas Tubes).*

(57 IRE 7.S2)

**Current Amplification.** The ratio of the magnitude of the current in a specified *Load Impedance* connected to a *Transducer*, to the magnitude of the current in the input circuit of the *Transducer*.

*Note 1:* If the input and/or output current consist of more than one component, such as multifrequency *Signal* or *Noise*, then the particular components used and their weighting must be specified.

*Note 2:* By custom this *Amplification* is often expressed in decibels by multiplying its common logarithm by 20.

(54 IRE 3.S1; 58 IRE 3.S1)

**Current Amplification (Multiplier Phototubes).** The ratio of 1) the *Signal Output Current* to 2) the photoelectric signal current from the *Photocathode*. (57 IRE 7.S2)

**Current Attenuation.** The ratio of the magnitude of the current in the input circuit of a *Transducer*, to the magnitude of the current in a specified *Load Impedance* connected to the *Transducer*.

*Note 1:* If the input and/or output current consist of more than one component, such as multifrequency *Signal* or *Noise*, then the particular components used and their weighting must be specified.

*Note 2:* By custom this *Attenuation* is often expressed in decibels by multiplying its common logarithm by 20.

(54 IRE 3.S1; 58 IRE 3.S1)

**Current Generator.** A two-terminal circuit element with a terminal current independent of the voltage between its terminals.

*Note:* A *Current Generator* has zero internal admittance.

(57 IRE 7.S2)

**Cutoff Field (Magnetrons).** See *Critical Field (Magnetrons)*. (57 IRE 7.S2)

**Cutoff Frequency.** The frequency which delineates a pass band from an adjacent *Attenuation* band of a system or component. (58 IRE 3.S1)

**Cutoff Frequency (of a Uniconductor Waveguide).** For a given transmission mode in a nondissipative *Uniconductor Waveguide*,

## Cutoff Voltage

the frequency below which the propagation constant is real. (53 IRE 2.S1)

**Cutoff Voltage (Electron Tubes).** That *Electrode Voltage* which reduces the value of the dependent variable of an *Electron Tube* characteristic to a specified low value.

*Note:* A specific cutoff characteristic should be identified as follows: current-vs-grid-cutoff voltage, spot-brightness-vs-grid-cutoff voltage, etc.

(57 IRE 7.S2)

**Cutoff Voltage (Magnetrons).** See *Critical Voltage (Magnetrons)*. (57 IRE 7.S2)

**Cutoff Wavelength (of a Uniconductor Waveguide).** The ratio of the velocity of *Electromagnetic Waves* in free space to the *Cutoff Frequency*. (53 IRE 2.S1)

**Cut Paraboloidal Reflector.** A paraboloidal reflector which is not symmetrical with respect to its axis. (48 IRE 2, 11, 15.S1)

**Cut-Set.** A set of branches of a network such that the cutting of all the branches of the set increases the number of separate parts of the network, but the cutting of all the branches except one does not. (50 IRE 4.S1)

**Cutter.** An electromechanical transducer which transforms an electric input into a mechanical output, typified by mechanical motions which may be inscribed into a recording medium by a cutting stylus. (51 IRE 6.S1)

**Cutting Stylus.<sup>1</sup>** A recording stylus with a sharpened tip which, by removing material, cuts a groove into the recording medium. (51 IRE 6.S1)

**Cycle, Major.** See *Major Cycle*. (50 IRE 8.S1)

**Cycle, Minor.** See *Minor Cycle*. (50 IRE 8.S1)

**Cyclically Magnetized Condition.** A condition of a magnetic material when it has been under the influence of a magnetizing force varying between two specific limits until, for each increasing (or decreasing) value of the magnetizing force, the magnetic flux density has the same value in successive cycles. (59 IRE 8.S1)

**Cyclic Shift.** An operation which produces a *Word* whose *Characters* are obtained by a cyclic permutation of the characters of a given word. (56 IRE 8.S1)

**Cyclotron Frequency.** The frequency at which a charged particle traverses an orbit in a steady, uniform, magnetic field, and zero electric field. (57 IRE 7.S2)

**Cyclotron-Frequency Magnetron Oscilla-**

<sup>1</sup> Stylus is a term defining a pickup needle or holder furnished with a jewel or other abrasive-resistant tip. A stylus may or may not be arranged for convenient replacement.

## Dead Reckoning

**tions.** Those oscillations whose frequency is substantially the *Cyclotron Frequency*. (57 IRE 7.S2)

**Cylindrical Reflector.** A reflector which is a portion of a cylinder. This cylinder is usually parabolic, although other shapes may be used. (48 IRE 2, 11, 15.S1)

**Cylindrical Wave.** A wave whose equiphase surfaces form a family of coaxial or confocal cylinders. (50 IRE 24.S1)

## D

**Damped Waves.** Waves of which the amplitude of successive cycles, at the source, progressively diminishes. (48 IRE 2, 11, 15.S1)

**Dark Current (Camera Tubes or Phototubes).** See *Electrode Dark Current*. (57 IRE 7.S2)

**Dark Trace Tube.** A cathode-ray tube, of which the face is bright, and signals are displayed as dark traces or dark *Blips*. (54 IRE 12.S1)

**Data Handling Capacity.** In *Navigation*, the maximum number of unit situations that can be handled within a specified period without deteriorating the performance below certain minimum values. (54 IRE 12.S1)

**Data Stabilization.** In *Radar*, stabilization of the display of signals with respect to a selected reference regardless of changes in radar-carrying *Vehicle* attitude, e.g., *Azimuth-Stabilized PPI*. (54 IRE 12.S1)

**DBM.** A symbol for *Power Level* in decibels with reference to a power of 1 milliwatt (0.001 watt). (54 IRE 3.S1; 58 IRE 3.S1)

**DC Electron-Stream Resistance.** The quotient of *Electron-Stream Potential* and the direct-current component of stream current. (56 IRE 7.S1; 57 IRE 7.S2)

**DC Erasing Head.** In magnetic recording, one which uses direct current to produce the magnetic field necessary for erasing.

*Note:* DC erasing is achieved by subjecting the medium to a unidirectional field. Such a medium is, therefore, in a different magnetic stage than one erased by alternating current.

(51 IRE 6.S1)

**DC Magnetic Biasing.** In magnetic recording, magnetic biasing accomplished by the use of direct current. (51 IRE 6.S1)

**D-Display.** In *Radar*, a *C-Display* in which the *Blips* extend vertically to give a rough estimate of distance. (54 IRE 12.S1)

**DDM.** See *Difference in Depth of Modulation*. (54 IRE 12.S1)

**Dead Reckoning.** The procedure of advancing a known *Position* to give a *Position* at a later time by addition of one or more vec-

## Dead Room

tors representing *Courses* and distances.

*Note:* In air *Navigation*, it is customary to allow for wind when determining *Dead Reckoning Positions*; however, the best marine usage now excludes effects of wind, currents, etc., and considers a *Dead Reckoning Position* as one determined by advancing a known *Position* for *Course* steered and speed through the water. The expression "estimated position" is used in marine *Navigation* when allowance is made for wind and current.

(54 IRE 12.S1)

**Dead Room.** A room which is characterized by an unusually large amount of sound absorption. (51 IRE 6.S1)

**Dead Time (in Navigation Aids).** The minimum interval following a pulse during which a *Transponder*, or component circuit thereof, is incapable of repeating specified performance. (54 IRE 12.S1)

**Dead Time (Radiation Counters).** The time interval, after the start of a *Count*, during which a *Radiation Counter* is insensitive to further *Ionizing Events*.

*Note:* See also *Recovery Time*.

(57 IRE 7.S2)

**Decade.** The interval between any two quantities having the ratio of 10:1. (58 IRE 3.S1)

**Decalescent Point (of a metal).** The temperature at which there is a sudden absorption of heat as the metal is raised in temperature. (55 IRE 10.S1)

**Decay (Charge-Storage Tubes).** The reduction in magnitude of stored charge by any cause other than *Erasing*. (57 IRE 7.S2)

**Decay Characteristic.** See *Persistence Characteristic*. (57 IRE 7.S2)

**Decay Time (Charge-Storage Tubes).** The time interval during which the magnitude of the stored charge decays to a stated fraction of its initial value.

*Note:* The fraction is commonly  $1/e$ , where  $e$  is the base of natural logarithms.

(57 IRE 7.S2)

**Decca.** A CW radio aid to *Navigation* using multiple receivers to measure and indicate the relative phase difference of CW signals received from several synchronized radio stations. The system provides differential distance information from which *Position* can be determined. (54 IRE 12.S1)

**Decelerating Electrode (Electron-Beam Tubes).** An *Electrode* the potential of which provides an electric field to decrease the velocity of the beam electrons. (57 IRE 7.S2)

**Decibel.** The decibel is one-tenth of a bel, the number of decibels denoting the ratio of the two amounts of power being ten times the logarithm to the base 10 of this ratio. The

## Deflection Center

abbreviation db is commonly used for the term decibel.

*Note:* With  $P_1$  and  $P_2$  designating two amounts of power and  $n$  the number of decibels denoting their ratio,

$$n = 10 \log_{10} (P_1/P_2) \text{ decibels.}$$

When the conditions are such that ratios of currents or ratios of voltages (or analogous quantities in other fields) are the square roots of the corresponding power ratios, the number of decibels by which the corresponding powers differ is expressed by the following equations:

$$n = 20 \log_{10} (I_1/I_2) \text{ decibels,}$$

$$n = 20 \log_{10} (V_1/V_2) \text{ decibels}$$

where  $I_1/I_2$  and  $V_1/V_2$  are the given current and voltage ratios, respectively. By extension, these relations between numbers of decibels and ratios of currents or voltages are sometimes applied where these ratios are not the square roots of the corresponding power ratios; to avoid confusion, such usage should be accompanied by a specific statement of this application.

(48 IRE 2, 11, 15.S1)

**Decimal Number System.** See *Positional Notation*. (56 IRE 8.S1)

**Decimal Point.** See *Point*. (56 IRE 8.S1)

**Decineper.** One-tenth of a neper. (48 IRE 2, 11, 15.S1)

**Decoder (in Computers).** A network or system in which a combination of inputs is excited at one time to produce a single output. Sometimes called *Matrix*. (56 IRE 8.S1)

**Decoder (in Navigation Aids).** A circuit which responds to a particular coded signal and rejects others. (49 IRE 12.S1)

**De-Emphasis.** A process complementary to *Pre-Emphasis*. (52 IRE 17.S1; 53 IRE 11.S1; 58 IRE 3.S1)

**De-Emphasis Network.** A network inserted in a system in order to restore the pre-emphasized frequency spectrum to its original form. (48 IRE 2, 11, 15.S1)

**Definition.** Distinctness or clarity of detail or outline in a *Record Sheet*, or other reproduction. (56 IRE 9.S1)

**Deflecting Electrode.** An *Electrode* the potential of which provides an electric field to produce deflection of an electron beam. (57 IRE 7.S2)

**Deflecting Yoke.** An assembly of one or more coils, the current through which provides a magnetic field to produce deflection of an electron beam. (50 IRE 7.S1)

**Deflection Center.** The intersection of the forward projection of the electron path prior



## Deflection Factor

to deflection and the backward projection of the electron path in the field-free space after deflection. (57 IRE 7.S2)

**Deflection Factor (Cathode-Ray Tubes).** The reciprocal of the *Deflection Sensitivity*. (57 IRE 7.S2)

**Deflection Plane.** A plane perpendicular to the tube axis containing the *Deflection Center*. (57 IRE 7.S2)

**Deflection Sensitivity (Cathode-Ray Tubes).** The quotient of the displacement of the electron beam at the *Target* or *Screen* by the change in the magnitude of the deflecting field.

*Note:* *Deflection Sensitivity* is usually expressed in millimeters (or inches) per volt applied between the *Deflecting Electrodes*, or in millimeters (or inches) per ampere in the deflecting coil.

(57 IRE 7.S2)

**Deflection Yoke.** An assembly of one or more electromagnets to produce deflection of one or more electron beams. (50 IRE 7.S1)

**Deflection-Yoke Pull-Back.**

1) **Color.** The distance between the maximum possible forward position of the yoke and the position of the yoke to obtain optimum color purity.

2) **Monochrome.** The maximum distance the yoke can be moved along the tube axis without producing neck shadow.

(57 IRE 7.S2)

**Degeneration.** Same as negative feedback. (48 IRE 2, 11, 15.S1)

**Degrees of Freedom on a Mesh Basis.** See *Nullity*. (50 IRE 4.S1)

**Degrees of Freedom on a Node Basis.** See *Rank*. (50 IRE 4.S1)

**Deionization Time (Gas Tubes).** The time required for a tube to regain its pre-conduction characteristics after anode-current interruption.

*Note:* See also *Recovery Time*.

(57 IRE 7.S2)

**Delay Distortion.** That form of distortion which occurs when the rate of change of phase shift with frequency of a circuit or system is not constant over the frequency range required for transmission.

See also *Distortion*, *Delay* and *Envelope Delay Distortion*. (52 IRE 17.S1; 53 IRE 4.S1; 56 IRE 9.S1; 58 IRE 3.S1)

**Delayed PPI.** A PPI (*Plan Position Indicator*) in which the initiation of the time base is delayed. (54 IRE 12.S1)

**Delay Equalizer.** A corrective network which is designed to make the *Phase Delay* or *Envelope Delay* of a circuit or system substantially constant over a desired frequency range. (56 IRE 9.S1)

## Depth of Penetration

**Delay Line (in Electronic Computers).** 1)

Originally, a device utilizing wave propagation for producing a time delay of a signal.

2) Commonly, any device for producing a time delay of a signal. (56 IRE 8.S1)

**Delay-Line Memory.** Synonym for *Delay-Line Storage*. (56 IRE 8.S1)

**Delay-Line Register.** An acoustic or electric delay-line, usually one or an integral number of words long, together with input, output, and circulation circuits. (50 IRE 8.S1)

**Delay-Line Storage.** A storage or memory device consisting of a delay line and means for regenerating and reinserting information into the delay line. (56 IRE 8.S1)

**Delta.** See *Coincident-Current Selection*. (59 IRE 8.S1)

**Delta Network.** A set of three branches connected in series to form a mesh. (50 IRE 4.S1)

**Demodulation.** The process of recovering the modulating wave from a modulated carrier. (52 IRE 17.S1; 53 IRE 11.S1)

**Densitometer.** An instrument for the measurement of optical density (photographic transmission, photographic reflection, visual transmission, and so forth) of a material. (51 IRE 6.S1)

**Density (in Facsimile).** A measure of the light-transmitting or -reflecting properties of an area. It is expressed by the common logarithm of the ratio of incident to transmitted or reflected light flux.

*Note:* There are many types of *Density* which will usually have different numerical values for a given material; e.g., *Diffuse Density*, *Double Diffuse Density*, *Specular Density*. The relevant type of density depends upon the geometry of the optical system in which the material is used.

(56 IRE 9.S1)

**Depletion Layer (in a Semiconductor).** A region in which the mobile *Carrier* charge density is insufficient to neutralize the net fixed charge density of *Donors* and *Acceptors*. (54 IRE 7.S2)

**Depth of Heating (Dielectric Heating Usage).** The depth below the surface of a material in which effective *Dielectric Heating* can be confined when the *Applicator Electrodes* are applied adjacent to one surface only. (55 IRE 10.S1)

**Depth of Modulation.** In a radio guidance system obtaining directive information from two spaced lobes of a directional antenna system, the ratio of the difference in field strength of the two lobes to the field strength of the greater at a given point in space. (54 IRE 12.S1)

**Depth of Penetration (Induction Heating**

## Depth of Velocity Modulation

**Usage).** The thickness of a layer extending inward from the surface of a conductor, which has the same resistance to direct current as the conductor as a whole has to alternating current of a given frequency.

**Note:** This term is useful only in cases where the surface is substantially flat.

(55 IRE 10.S1)

**Depth of Velocity Modulation, Small-Signal.** The ratio of the peak amplitude of the *Velocity Modulation* of an electron stream, expressed in equivalent volts, to the *Electron-Stream Potential*. (56 IRE 7.S1; 57 IRE 7.S2)

**Desired Track.** See *Course Line*. (54 IRE 12.S1)

**Destination.** The point of intended arrival. (49 IRE 12.S1)

**Detail.** The square root of the ratio between the number of scanning lines per unit length and the definition in the direction of the scanning line.

**Note:** a) It is essential that the unit length be stipulated. b) For accurate comparisons this assumes that the definition in the two directions is not widely different.

(42 IRE 9.S1)

**Detection.** See *Demodulation*. (53 IRE 11.S1)

**Detector (in Receivers).** 1) A device to effect the process of detection. 2) A mixer in a superheterodyne receiver.

**Note:** In definition 2), the device is often referred to as a "first detector" and the device is not used for detection as defined above.

(52 IRE 17.S1)

**Deviation Distortion.** Distortion in an FM receiver caused by inadequate bandwidth, inadequate amplitude-modulation rejection, or inadequate discriminator linearity. (52 IRE 17.S1)

**Deviation, Frequency.** See *Frequency Deviation*. (52 IRE 17.S1)

**Deviation from Pulse Flatness.** The difference between the maximum and minimum amplitudes of a pulse divided by the maximum amplitude, all taken between the first and last knees of the pulse. (54 IRE 12.S1)

**Deviation Ratio.** In a frequency-modulation system, the ratio of the maximum design frequency deviation to the maximum design modulating frequency of the system. (53 IRE 11.S1)

**Deviation Sensitivity (in FM Receivers).** The least frequency deviation that produces a specified output power. (52 IRE 17.S1)

**Deviation Sensitivity (in Navigation Aids).** The rate of change of course indication with respect to the change of displacement from the *Course Line*. (54 IRE 12.S1)

## Dielectric Phase Angle

**Deviation Sensitivity, Angular.** See *Angular Deviation Sensitivity*. (54 IRE 12.S1)

**DF Antenna.** A *DF Antenna* may consist of a single loop, orthogonal loops, spaced differentially-connected dipoles or Adcock antennas, or any other antenna combination included in a *Direction Finder* for obtaining a phase or amplitude reference with respect to the received signal. (59 IRE 12.S1)

**DF Antenna System.** One or more *DF Antennas*, their combining circuits and feeder systems, together with the shielding and all electrical and mechanical items up to the termination at the receiver input terminals. (59 IRE 12.S1)

**DF Dummy Antenna.** An electrical network that simulates the impedance characteristics of the *DF Antenna*. (59 IRE 12.S1)

**DF Dummy Antenna System.** An electrical network which simulates the impedance characteristics of the *DF Antenna System*.

**Note:** When a signal generator is used to excite a *DF Dummy Antenna* or *DF Dummy Antenna System*, the generator impedance must be considered in the design of the *Dummy*.

(59 IRE 12.S1)

**DF Noise Level.** In the absence of the desired signals, the average power or rms voltage at any specified point in a *Direction Finder System*.

**Note:** In RF and audio channels, the *Noise Level, DF* is usually measured in terms of the power dissipated in a suitable termination. In a video channel, it is customarily measured in terms of voltage across a given impedance, or of the cathode-ray deflection. (59 IRE 12.S1)

**DF Sensitivity.** See *Sensitivity, DF*. (59 IRE 12.S1)

**Diagnostic Routine.** A *Routine* designed to locate either a malfunction in the computer or a mistake in coding. See also *Check, Programmed*. (56 IRE 8.S1)

**Dielectric Antenna.** An antenna which employs dielectric as the major component in producing the required radiation pattern. (48 IRE 2, 11, 15.S1)

**Dielectric Dissipation Factor.** The cotangent of the *Dielectric Phase Angle* of a dielectric material. (55 IRE 10.S1)

**Dielectric Heating.** The heating of a nonnially insulating material in an alternating electric field due to its internal losses. (55 IRE 10.S1)

**Dielectric Phase Angle.** The angular difference in phase between the sinusoidal alternating voltage applied to a dielectric and the component of the resulting alternating cur-

## Dielectric Power Factor

rent having the same period as the voltage. (55 IRE 10.S1)

**Dielectric Power Factor.** The cosine of the *Dielectric Phase Angle*. (55 IRE 10.S1)

**Dielectric Strength.** The maximum potential gradient that a material can withstand without rupture. (55 IRE 10.S1)

**Dielectric Waveguide.** A *Waveguide* consisting of a dielectric structure. (53 IRE 2.S1)

**Difference in Depth of Modulation (DDM).** In directive systems employing overlapping lobes with modulated signals (such as instrument low approach systems) a fraction obtained by subtracting from the percentage of modulation of the larger signal the percentage of modulation of the smaller signal and dividing by 100. (54 IRE 12.S1)

**Difference Detector.** A detector circuit in which the output is a function of the difference of the peak amplitudes or rms amplitude of the input waveforms. (54 IRE 12.S1)

**Difference Limen (Differential Threshold) (Just Noticeable Difference).** The increment in a stimulus which is just noticed in a specified fraction of the trials. The relative difference limen is the ratio of the difference limen to the absolute magnitude of the stimulus to which it is related. (51 IRE 6.S1)

**Difference Transfer Function.** In a feedback control loop, the transfer function which relates a loop difference signal to the corresponding loop input signal. (55 IRE 26.S2)

**Differential Gain (in Television).** In a video transmission system, the difference in the gain of the system in decibels for a small high-frequency sinewave signal at two stated *Levels* of a low-frequency signal on which it is superimposed.

*Note 1:* In this definition, *Level* is used in its second meaning as defined in this list.

*Note 2:* The two frequencies must be specified.

(55 IRE 23.S1)

**Differential Gain Control Circuit.** That portion of a system which adjusts the gain of a single radio receiver or circuit to obtain desired relative output levels from two or more sequential unequal input signals.

*Example:* The circuits in the *Loran* receiver which adjusts the gain between successive pulses.

(54 IRE 12.S1)

**Differential Phase (in Television).** In a video transmission system, the difference in phase shift through the system for a small high-frequency sinewave signal at two stated

## Diffuse Transmission Density

*Levels* of a low-frequency signal on which it is superimposed.

*Note 1:* In this definition, *Level* is used in its second meaning as defined in this list.

*Note 2:* The two frequencies must be specified.

(55 IRE 23.S1)

**Differentiating Network.** A network whose output is the time derivative of its input wave form.

*Note:* Such a network preceding a frequency modulator makes the combination a phase modulator; or, following a phase detector, it makes the combination a frequency detector. Its ratio of output amplitude to input amplitude is proportional to frequency, and its output phase leads its input phase by 90°.

(48 IRE 2, 11, 15.S1)

**Differentiator (Differentiating Circuit, Differentiating Network).** A transducer whose output wave form is the time derivative of its input wave form.

*Note:* Such a network preceding a frequency modulator makes the combination a phase-modulation modulator; or, following a phase-modulation detector, makes the combination a frequency-modulation detector. The ratio of output amplitude to input amplitude of a differentiator is proportional to frequency, and the output phase leads the input phase by 90°.

(53 IRE 11.S1)

**Differentiator (in Electronic Computers).** A device, usually of the analog type, whose output is proportional to the derivative of an input signal. (56 IRE 8.S1)

**Diffractioned Wave.** When a wave in a medium of certain propagation characteristics is incident upon a discontinuity or a second medium, the diffractioned wave is the wave component that results in the first medium in addition to the incident wave and the waves corresponding to the reflected rays of geometrical optics. (51 IRE 6.S1)

**Diffraction.** That process which produces a diffractioned wave. (51 IRE 6.S1)

**Diffuse Sound.** In a given region, sound which has uniform energy density and is such that all directions of energy flux at all parts of the region are equally probable. (51 IRE 6.S1)

**Diffuse Transmission Density.<sup>1</sup>** The value of the photographic transmission density obtained when the light flux impinges normally on the sample and all the transmitted flux

<sup>1</sup> For details of measurement and specifications see "American Standard Diffuse Transmission Density, Z38. 2.5-1946," or the latest edition thereof approved by the American Standards Association.

## Diffusion Constant

is collected and measured. (51 IRE 6.S1)

**Diffusion Constant (in a Homogeneous Semiconductor).** The quotient of diffusion current density by the charge *Carrier* concentration gradient. It is equal to the product of the *Drift Mobility* and the average thermal energy per unit charge of *Carriers*. (54 IRE 7.S2)

**Diffusion Length.** In a homogeneous semiconductor, the average distance to which *Minority Carriers* diffuse between generation and recombination. (54 IRE 7.S2)

**Digit.** See *Positional Notation*. (56 IRE 8.S1)

**Digit, Binary.** See *Binary Digit*. (50 IRE 8.S1)

**Digital Computer.** A computer which operates with information, numerical or otherwise, represented in a digital form. (56 IRE 8.S1)

**Digit, Sign.** See *Sign Digit*. (50 IRE 8.S1)

**Diode (Electron Tube).** A two-electrode *Electron Tube* containing an *Anode* and a *Cathode*.

*Note:* See also *Equivalent Diode*.

(57 IRE 7.S2)

**Diode Characteristic (Multielectrode Tubes).** The composite *Electrode* characteristic taken with all *Electrodes* except the *Cathode* connected together. (57 IRE 7.S2)

**Diode, Semiconductor.** A two-electrode *Semiconductor Device* having an asymmetrical voltage-current characteristic. (54 IRE 7.S2)

**Diplex Radio Transmission.** The simultaneous transmission of two signals using a common carrier wave. (48 IRE 2, 11, 15.S1)

**Dipole Antenna.** A straight radiator, usually fed in the center, and producing a maximum of radiation in the plane normal to its axis. The length specified is the over-all length.

*Note:* Common usage in microwave antennas considers a dipole to be a metal radiating structure which supports a line current distribution similar to that of a thin straight wire, a half wavelength long, so energized that the current has two nodes, one at each of the far ends.

(48 IRE 2, 11, 15.S1)

**Direct-Coupled Attenuation (TR, Pre-TR, and Attenuator Tubes).** The *Insertion Loss* measured with the *Resonant Gaps*, or their functional equivalent, short-circuited. (57 IRE 7.S2)

**Direct-Current Amplifier.** An amplifier capable of amplifying waves of infinitesimal frequency. (48 IRE 2, 11, 15.S1)

**Directed Reference Flight.** That type of *Stabilized Flight* which obtains control information from external signals which may be varied as necessary to direct the flight.

## Direction of Propagation

*Example:* Flight of a guided missile or a *Target* aircraft.

(54 IRE 12.S1)

**Direct Grid Bias.** The direct component of *Grid Voltage*.

*Note:* This is commonly called "grid bias."  
(57 IRE 7.S2)

**Direction.** The *Position* of one point in space relative to another without reference to the distance between them.

*Note:* *Direction* may be either three-dimensional or two-dimensional. *Direction* is not an angle but is often indicated in terms of its angular difference from a reference *Direction*.

(54 IRE 12.S1)

**Directional Antenna.** An antenna having the property of radiating or receiving radio waves more effectively in some directions than others. (48 IRE 2, 11, 15.S1)

**Directional Coupler.** A four-branch junction consisting of two waveguides coupled together in a manner such that a single traveling wave in either guide will induce a single traveling wave in the other, direction of latter wave being determined by direction of the former. (55 IRE 2.S1)

**Directional Homing.** The process of *Homing* wherein the navigational quantity maintained constant is the *Relative Bearing*. (54 IRE 12.S1)

**Directional Microphone.** A microphone the response of which varies significantly with the direction of sound incidence. (51 IRE 6.S1)

**Direction Finder (DF).** A radio aid to *Navigation* that determines the *Direction* of arrival of a radio signal by measuring the orientation of the wave-front or of the magnetic or electric vector of a radio wave. (54 IRE 12.S1)

**Direction-Finder Deviation—Deprecated.** The *Direction-Finder Deviation* is the difference between the observed radio *Bearing* and the corrected radio *Bearing*. (It is the sum of all known corrections to the indication of the *Direction Finder*.)

*Note:* This definition is deprecated because of the confusion with the increasing use of deviation as pertaining to errors in the mathematical sense.

(54 IRE 12.S1)

**Direction of Polarization.** For a linearly polarized wave, the direction of the electric vector. (50 IRE 24.S1)

**Direction of Propagation.** At any point in a homogeneous, isotropic medium, the direction of time average energy flow.

*Note 1:* In a *Uniform Waveguide* the direc-

tion of propagation is often taken along the axis.

*Note 2:* In the case of a uniform lossless *Waveguide* the direction of propagation at every point is parallel to the axis and in the direction of time average energy flow.

(53 IRE 2.S1)

**Directive Gain.** In a given direction,  $G_d$  times the ratio of the radiation intensity in that direction to the total power radiated by the antenna. (48 IRE 2, 11, 15.S1)

**Directivity.** The value of the directive gain in the direction of its maximum value. (48 IRE 2, 11, 15.S1)

**Directivity Factor.** 1) The directivity factor of a transducer used for sound emission is the ratio of the intensity of the radiated sound at a remote point in a free field on the principal axis to the average intensity of the sound transmitted through a sphere passing through the remote point and concentric with the transducer. The frequency must be stated.

*Note 1:* The point of observation must be sufficiently remote from the transducer for spherical divergence to exist.

*Note 2:* This definition may be extended to cover the case of finite frequency bands whose spectrum must be specified.

2) The directivity factor of a transducer used for sound reception is the ratio of the square of the electromotive force produced in response to sound waves arriving in a direction parallel to the principal axis to the mean square of the electromotive force that would be produced if sound waves having the same frequency and mean-square pressure were arriving at the transducer simultaneously from all directions with random phase. The frequency must be stated.

*Note 1:* For an electroacoustic transducer obeying the reciprocity principle, the directivity factor for sound reception is the same as for sound emission.

*Note 2:* This definition may be extended to cover the case of finite frequency bands whose spectrum must be specified.

*Note 3:* Directivity factor in acoustics is equivalent to directivity as applied to antennas.

(51 IRE 6.S1)

**Directivity Index (Directional Gain).** Of a transducer, an expression of the directivity factor in decibels, *viz.*, 10 times the logarithm to the base 10 of the directivity factor. (51 IRE 6.S1)

**Directivity Pattern (Directional Response Pattern) (Beam Pattern).** Of a transducer used for sound emission or reception, a description, often presented graphically, of

the response of the transducer as a function of the direction of the transmitted or incident sound waves in a specified plane and at a specified frequency.

*Note 1:* A complete description of the directivity pattern of a transducer would require three-dimensional presentation.

*Note 2:* The directivity pattern is often shown as the response relative to the maximum response.

(51 IRE 6.S1)

**Director.** A parasitic element located in the general direction of the major lobe of radiation. (48 IRE 2, 11, 15.S1)

**Direct Radiator Loudspeaker.** A loudspeaker in which the radiating element acts directly on the air. (51 IRE 6.S1)

**Direct Recording.** That type of *Recording* in which a visible record is produced, without subsequent processing, in response to the received signals. (56 IRE 9.S1)

**Direct Wave.** A wave that is propagated directly through space. (50 IRE 24.S1)

**Discharge.** See *Glow Discharge; Ignitor Discharge (Switching Tubes)*. (57 IRE 7.S2)

**Discrete Sentence Intelligibility.**<sup>1</sup> The per cent intelligibility obtained when the speech units considered are sentences (usually of simple form and content). (51 IRE 6.S1)

**Discrete Word Intelligibility.**<sup>1</sup> The per cent intelligibility obtained when the speech units considered are words (usually presented so as to minimize the contextual relation between them). (51 IRE 6.S1)

**Discriminator (General).** A circuit in which the output is dependent upon how an input signal differs in some aspect from a standard or from another signal. (54 IRE 12.S1)

**Discriminator (Specific).** A device in which amplitude variations are derived in response to frequency variations. (53 IRE 11.S1)

**Discriminator, Constant Delay.** See *Pulse-Mododer*. (54 IRE 12.S1)

**Discriminator, Pulse Duration.** See *Pulse Duration Discriminator*. (54 IRE 12.S1)

**Dish.** A colloquial term for a microwave antenna reflecting surface. (54 IRE 12.S1)

**Disk Recorder.** A mechanical recorder in which the recording medium has the geometry of a disk. (51 IRE 6.S1)

**Dispatcher (in Computer Work).** That part of a digital computer which performs the switching determining the sources and destinations for the transfer of words. (50 IRE 8.S1)

**Display.** In *Navigation* the pattern representing the output data of any navigational

<sup>1</sup> See notes under *Articulation (Per Cent Articulation) and Intelligibility (Per Cent Intelligibility)*.

## Display Primaries

system employing a graphic presentation. (54 IRE 12.S1)

**Display Primaries (Receiver Primaries).** The *Colors of constant Chromaticity* and variable *Luminance* produced by the receiver or any other display device which, when mixed in proper proportions, are used to produce other *Colors*.

*Note:* Usually three primaries are used: red, green, and blue.

(55 IRE 22.S1)

**Dissector Tube.** See *Image Dissector Tube*. (57 IRE 7.S2)

**Dissymmetrical Transducer (with Respect to Specified Terminations).** A transducer in which the interchange of at least one pair of specified terminations will change the transmission. (51 IRE 20.S2)

**Distance Mark.** In *Radar* technique, a calibrated mark on the *Radar Display* developed by a special signal generator and used in determining *Target* distance. (54 IRE 12.S1)

**Distance Measuring Equipment.** A radio aid to *Navigation* which provides distance information by measuring total round-trip time of transmission from an *Interrogator* to a *Transponder* and return. (54 IRE 12.S1)

**Distance Resolution.** The ability of a *Radar* to differentiate *Targets* solely by distance measurements. *Distance Resolution* is generally expressed as the minimum radial distance by which *Targets* must be separated to be separately distinguishable. (54 IRE 12.S1)

**Distortion.** An undesired change in waveform. (53 IRE 4.S1; 58 IRE 3.S1)

**Distortion, Amplitude.** See *Distortion, Harmonic* and *Distortion, Intermodulation*. (58 IRE 3.S1)

**Distortion, Amplitude-Frequency.** *Distortion* due to an undesired *Amplitude-Frequency Response* characteristic. (58 IRE 3.S1)

**Distortion, Barrel (Camera Tubes or Image Tubes).** A distortion which results in a monotonic decrease in radial magnification in the reproduced image away from the axis of symmetry of the electron optical system.

*Note:* For a *Camera Tube*, the reproducer is assumed to have no geometric distortion. (57 IRE 7.S2)

**Distortion, Delay.** That form of *Distortion* which occurs when the rate of change of phase shift with frequency of a circuit or system is not constant over the frequency range required for transmission. (58 IRE 3.S1)

**Distortion, Frequency.** See *Distortion, Amplitude-Frequency*. (58 IRE 3.S1)

**Distortion, Harmonic. Nonlinear Distortion**

## Distortion, Pincushion

characterized by the appearance in the output of harmonics of the fundamental frequency when the input wave is sinusoidal. (58 IRE 3.S1)

**Distortion, Intermodulation. Nonlinear Distortion** characterized by the appearance of frequencies in the output, equal to the sums and differences of integral multiples of the component frequencies present in the input wave.

*Note:* *Harmonic* components also present in the output are usually not included as part of the *Intermodulation Distortion*. When harmonics are included, a statement to that effect should be made. (58 IRE 3.S1)

**Distortion, Keystone (Camera Tubes).** A distortion such that the slope or the length of a horizontal line *Trace* or scan line is linearly related to its vertical displacement.

*Note:* A system having *Keystone Distortion* distorts a rectangular pattern into a trapezoidal pattern. (57 IRE 7.S2)

**Distortion, Nonlinear. Distortion** caused by a deviation from a linear relationship between the input and output of a system or component. (58 IRE 3.S1)

**Distortion, Per Cent Harmonic.** A measure of the *Harmonic Distortion* in a system or component, numerically equal to 100 times the ratio of the square root of the sum of the squares of the root-mean-square voltages (or currents) of each of the individual harmonic frequencies, to the root-mean-square voltage (or current) of the fundamental.

*Note:* It is practical to measure the ratio of the root-mean-square amplitude of the residual harmonic voltages (or currents), after elimination of the fundamental, to the root-mean-square amplitude of the fundamental and harmonic voltages (or currents) combined. This measurement will indicate *Per Cent Harmonic Distortion* with an error of less than 5 per cent if the magnitude of the *Distortion* does not exceed 30 per cent. (58 IRE 3.S1)

**Distortion, Phase.** See *Distortion, Phase-Frequency*. (58 IRE 3.S1)

**Distortion, Phase-Frequency.** *Distortion* due to a lack of direct proportionality of phase shift to frequency over the frequency range required for transmission.

*Note 1:* *Delay Distortion* is a special case. *Note 2:* This definition includes the case of a linear phase-frequency relation with zero-frequency intercept differing from an integral multiple of  $\pi$ . (58 IRE 3.S1)

**Distortion, Pincushion (Camera Tubes or**

**Image Tubes**). A distortion which results in a monotonic increase in radial magnification in the reproduced image away from the axis of symmetry of the electron optical system.

*Note:* For a *Camera Tube*, the reproducer is assumed to have no geometric distortion.

(57 IRE 7.S2)

**Distortion, S.** See *Distortion, Spiral*. (57 IRE 7.S2)

**Distortion, Spiral (in Camera Tubes or Image Tubes using Magnetic Focusing)**.

A distortion in which image rotation varies with distance from the axis of symmetry of the electron optical system. (57 IRE 7.S2)

**Distributed Constant (for a Waveguide)**.

A circuit parameter that exists along the length of a *Waveguide*.

*Note:* For a *Transverse Electromagnetic Wave* on a two-conductor *Transmission Line*, the distributed constants are series resistance, series inductance, shunt conductance and shunt capacitance per unit length of line.

(53 IRE 2.S1)

**Distribution Amplifier.** See *Amplifier, Distribution*. (58 IRE 3.S1)

**Distribution Coefficients.** The *Tristimulus Values* of *Monochromatic* radiations of equal power.

*Note:* Generally represented by overscored, lower case letters, such as  $\bar{x}$ ,  $\bar{y}$ ,  $\bar{z}$  in the *CIE* system.

(55 IRE 22.S1)

**Disturbance.** An undesired command. (55 IRE 26.S2)

**Disturbed-One Output.** See *Coincident-Current Selection*. (59 IRE 8.S1)

**Disturbed-Zero Output.** See *Coincident-Current Selection*. (59 IRE 8.S1)

**Divergence Loss.** That part of the transmission loss which is due to the divergence or spreading of the sound rays in accordance with the geometry of the system (*e.g.*, spherical waves emitted by a point source). (51 IRE 6.S1)

**Dividing Network (Loudspeaker Dividing Network).** See *Crossover Network*. (51 IRE 6.S1; 58 IRE 3.S1)

**DME (Distance Measuring Equipment).**

A radio aid to *Navigation* which provides distance information by measuring total round-trip time of transmission from an *Interrogator* to a *Transponder* and return. (54 IRE 12.S1)

**Dolerty Amplifier.** A particular arrangement of a radio-frequency linear power amplifier wherein the amplifier is divided into two sections whose inputs and outputs are connected by quarter-wave ( $90^\circ$ ) networks

and whose operating parameters are so adjusted that, for all values of the input signal voltage up to one-half maximum amplitude, Section No. 2 is inoperative and Section No. 1 delivers all the power to the load, which presents an impedance at the output of Section No. 1 that is twice the optimum for maximum output. At one-half maximum input level, Section No. 1 is operating at peak efficiency, but is beginning to saturate. Above this level, Section No. 2 comes into operation, thereby decreasing the impedance presented to Section No. 1, which causes it to deliver additional power into the load until, at maximum signal input, both sections are operating at peak efficiency and each section is delivering one-half the total output power to the load. (48 IRE 2, 11, 15.S1)

**Domestic Induction Heater.** A cooking device in which the utensil is heated by current, usually of commercial line frequency, induced in it by a primary inductor associated with it. (55 IRE 10.S1)

**Dominant Mode of Propagation (Transmission).** The *Mode of Propagation* of the *Dominant Wave*. (53 IRE 2.S1)

**Dominant Wave (in a Uniconductor Waveguide).** The *Electromagnetic Wave* which has the lowest *Cut-Off Frequency*. (53 IRE 2.S1)

**Dominant Wavelength.** The wavelength of light of a single frequency, which matches a color when combined in suitable proportions with a reference standard light.

*Note:* Light of a single frequency is approximated in practice by the use of a range of wavelengths within which there is no noticeable difference of color. Although this practice is ambiguous in principle, the dominant wavelength is usually taken as the average wavelength of the band used in the mixture with the reference standard matching the sample. Many different qualities of light are used as reference standards under various circumstances. Usually the quality of the prevailing illumination is acceptable as the reference standard in the determination of the dominant wavelength of the colors of objects.

(55 IRE 22.S1)

**Donor (in a Semiconductor).** See *Impurity, Donor*. (54 IRE 7.S2)

**Doping.** Addition of *Impurities* to a semiconductor or production of a deviation from stoichiometric composition, to achieve a desired characteristic. (54 IRE 7.S2)

**Doping Compensation.** Addition of *Donor Impurities* to a *P-Type Semiconductor* or of *Acceptor Impurities* to an *N-Type Semiconductor*. (54 IRE 7.S2)

## Doppler Effect

**Doppler Effect.** The phenomenon evidenced by the change in the observed frequency of a wave in a transmission system caused by a time rate of change in the effective length of the path of travel between the source and the point of observation. (51 IRE 6.S1)

**Doppler Shift.** The magnitude of the change in the observed frequency of a wave due to the *Doppler Effect*. The unit is the cycle per second. (51 IRE 6.S1)

**Doppler System.** In *Radar*, any system utilizing the *Doppler Effect* for obtaining information. (54 IRE 12.S1)

**Doppler System, Pulsed.** See *Pulsed Doppler System*. (54 IRE 12.S1)

**Dot-Sequential.** Pertaining to the association of the several primary colors in sequence with successive picture elements.

*Examples:* Dot-sequential pickup, dot-sequential display, dot-sequential system, dot-sequential transmission.

(55 IRE 22.S1)

**Double-Length Number.** A number having twice as many digits as are ordinarily used in a given computer. (56 IRE 8.S1)

**Double Pole-Piece Magnetic Head.** A magnetic head having two separate pole pieces in which pole faces of opposite polarity are on opposite sides of the medium. One or both of these pole pieces may be provided with an energizing winding. (51 IRE 6.S1)

**Double-Precision Number.** Synonym for *Double-Length Number*. (56 IRE 8.S1)

**Double-Sideband Transmitter.** A transmitter which transmits the carrier frequency and both sidebands resulting from the modulation of the carrier by the modulating signal. (48 IRE 2, 11, 15.S1)

**Downward Modulation.** Modulation in which the instantaneous amplitude of the modulated wave is never greater than the amplitude of the unmodulated carrier. (52 IRE 17.S1)

**D Region.** The region of the ionosphere up to about 90 kilometers above the earth's surface. (50 IRE 24.S1)

**Drift Angle.** The angular difference between the *Course* and the *Course Made Good*. (54 IRE 12.S1)

**Drift Correction Angle.** The angular difference between the *Course* and the *Heading*. (Sometimes called the *Crab Angle*.) (54 IRE 12.S1)

**Drift Mobility (in a Homogeneous Semiconductor).** The average drift velocity of *Carriers* per unit electric field.

*Note:* In general, the mobilities of electrons and holes are different.

(54 IRE 7.S2)

**Drift Rate (Voltage Regulators or Reference Tubes).** The slope at a stated time of

## Dual Modulation

the smoothed curve of *Tube Voltage Drop* with time at constant operating conditions. (57 IRE 7.S2)

**Drift Space.** In an *Electron Tube*, a region substantially free of externally applied alternating fields, in which a relative repositioning of the electrons takes place. (56 IRE 7.S1; 57 IRE 7.S2)

**Drive Pattern.** *Density* variation caused by periodic errors in the position of the *Recording Spot*. When caused by gears this is called *Gear Pattern*. (56 IRE 9.S1)

**Drive Pin.** In disk recording, a pin similar to the center pin, but located to one side thereof, which is used to prevent a disk record from slipping on the turntable. (51 IRE 6.S1)

**Drive-Pin Hole.** In disk recording, a hole in a disk record which accommodates the turntable drive pin. (51 IRE 6.S1)

**Drive Pulse.** A pulsed magnetomotive force applied to a magnetic cell from one or more sources. (59 IRE 8.S1)

**Driving-Point Admittance (between the  $j$ th Terminal and the Reference Terminal of an  $n$ -Terminal Network).** The quotient of 1) the complex alternating component  $I_j$  of the current flowing to the  $j$ th terminal from its external termination by 2) the complex alternating component  $V_j$  of the voltage applied to the  $j$ th terminal with respect to the reference point when all other terminals have arbitrary external terminations.

*Note:* In specifying the *Driving-Point Admittance* of a given pair of terminals of a network or transducer having two or more pairs of terminals, no two pairs of which contain a common terminal, all other pairs of terminals are connected to arbitrary admittances.

(57 IRE 7.S2)

**Driving Signals (in Television).** Signals that time the scanning at the pickup point.

*Note:* Two kinds of driving signals are usually available from a central sync generator. One is composed of *Pulses at Line Frequency* and the other is composed of *Pulses at Field Frequency*.

(55 IRE 23.S1)

**Drum Speed.** The angular speed of the transmitter or recorder drum.

*Note:* This speed is measured in revolutions per minute.

(56 IRE 9.S1)

**Dual Frequency Induction Heater or Furnace.** A heater in which the *Charge* receives energy by induction, simultaneously or successively, from a *Work Coil* or coils operating at two different frequencies. (55 IRE 10.S1)

**Dual Modulation.** The process of modulating



## Dual Networks

a common carrier wave or *Subcarrier* by two different types of modulation (e.g., amplitude- and frequency-modulation) each conveying separate information. (56 IRE 9.S1)

**Dual Networks.** See *Structurally Dual Networks*. (50 IRE 4.S1)

**Dubbing.** A term used to describe the combining of two or more sources of sound into a complete recording, at least one of the sources being a recording. See also *Rerecording*. (51 IRE 6.S1)

**Dummy Antenna.** A device which has the necessary impedance characteristics of an antenna and the necessary power-handling capabilities, but which does not radiate or receive radio waves.

*Note:* In receiver practice, that portion of the impedance not included in the signal generator is often called "dummy antenna." (52 IRE 17.S1)

**Dummy Load.** A dissipative but essentially nonradiating substitute device. (52 IRE 17.S1)

**Duplex Cavity (Radar).** See *TR Cavity (Radar)* (54 IRE 12.S1)

**Duplexing Assembly (Radar).** See *TR Switch*. (54 IRE 12.S1)

**Duplex Operation.** The operation of associated transmitting and receiving apparatus in which the processes of transmission and reception are concurrent. (48 IRE 2, 11, 15.S1)

**Duty Cycle.** The time interval occupied by a device on intermittent duty in starting, running, stopping, and idling. (48 IRE 2, 11, 15.S1)

**Duty Factor.** In a pulse carrier composed of pulses that recur at regular intervals, the product of the pulse duration and the pulse-repetition frequency. (48 IRE 2, 11, 15. S1)

**Duty Ratio.** In a pulse *Radar* or similar system the ratio of average to peak pulse power. (54 IRE 12.S1)

**Dynamic Characteristic (Electron Tubes).** See *Load Characteristic (Electron Tubes)*. (57 IRE 7.S2)

**Dynamic Range.** The ratio of the specified maximum *Signal Level* capability of a system or component to its *Noise Level*, usually expressed in decibels. (58 IRE 3.S1)

**Dynamic Sequential Control.** A method of operation in which a digital computer, as the computation proceeds, can alter instructions, or the sequence in which instructions are executed, or both. (50 IRE 8.S1)

**Dynatron Oscillation.** Oscillation produced by negative resistance due to secondary emission. (48 IRE 2, 11, 15.S1)

**Dynatron Oscillator.** A negative-resistance oscillator with negative resistance derived between plate and cathode of a screen-grid

## Echo

tube operating such that secondary electrons produced at the plate are attracted to the higher-potential screen grid. (48 IRE 2, 11, 15.S1)

**Dynode (Electron Tubes).** An *Electrode* which performs a useful function by means of *Secondary Emission*. (57 IRE 7.S2)

**Dynode Current.** See *Electrode Current*. (57 IRE 7.S2)

**Dynode Spots (Image Orthicons).** A spurious signal caused by variations in the *Secondary-Emission Ratio* across the surface of a *Dynode* which is scanned by the electron beam. (57 IRE 7.S2)

## E

**Earphone (Receiver).** An electroacoustic transducer intended to be closely coupled acoustically to the ear.

*Note:* The term "receiver" should be avoided when there is risk of ambiguity.

(51 IRE 6.S1)

**Earphone Coupler.** A cavity of predetermined shape which is used for the testing of earphones. It is provided with a microphone for the measurement of pressures developed in the cavity.

*Note 1:* Couplers generally have a volume of 6 cubic centimeters for testing regular earphones and a volume of 2 cubic centimeters for testing insert earphones.

*Note 2:* Specifications for couplers are given in the "Proposed American Standard Method for the Coupler Calibration of Earphones, Z24.9/186."

(51 IRE 6.S1)

**Eccentric Groove (Eccentric Circle).** In disk recording, a locked groove whose center is other than that of the disk record (generally used in connection with mechanical control of phonographs). (51 IRE 6.S1)

**Eccentricity.** In disk recording, the displacement of the center of the recording groove spiral, with respect to the record center hole. (51 IRE 6.S1)

**Echo.** A wave which has been reflected or otherwise returned with sufficient magnitude and delay to be perceived in some manner as a wave distinct from that directly transmitted. (51 IRE 6.S1; 58 IRE 3.S1)

**Echo (in Facsimile).** A wave which has been reflected at one or more points with sufficient magnitude and time difference to be perceived in some manner as a wave distinct from that of the main transmission. (56 IRE 9.S1)

**Echo (in Navigation Aids).** In *Radar*, the portion of energy of the transmitted pulse

## Echo Box

which is reflected to a receiver. (54 IRE 12.S1)

**Echo Box.** In *Radar*, a calibrated resonant cavity which stores part of the transmitted pulse power and gradually feeds this energy into the receiving system after completion of the pulse transmission. (54 IRE 12.S1)

**Echo, Second-Time-Around.** An *Echo* received after an interval exceeding the pulse repetition interval. (54 IRE 12.S1)

**Echo Suppressor.** In *Navigation*, a circuit which desensitizes the equipment for a fixed period after the reception of one pulse, for the purpose of rejecting delayed pulses arriving from indirect reflection *Paths*. (54 IRE 12.S1)

**E-Display** (also called *E-Scan* and *E-Scope*). In *Radar*, a rectangular *Display* in which *Targets* appear as *Blips* with distance indi-

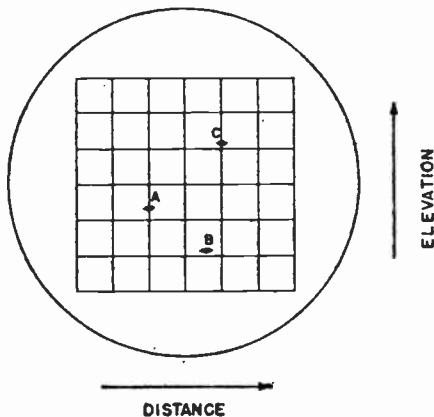

cated by the horizontal coordinate and elevation by the vertical coordinate. (54 IRE 12.S1)

**Effective Acoustic Center.** Of an acoustic generator, the point from which the spherically divergent sound waves, observable at remote points, appear to diverge. (51 IRE 6.S1)

**Effective Area.** The square of the wavelength multiplied by the power gain (or directive gain) in that direction, and divided by  $4\pi$ .

*Note:* When power gain is used, the effective area is that for power reception; when directive gain is used, the effective area is that for directivity.

(48 IRE 2, 11, 15.S1)

**Effective Band (in Facsimile).** The frequency band of a *Facsimile Signal* wave equal in width to that between zero frequency and *Maximum Keying Frequency*.

*Note:* The frequency band occupied in the

## Effective Sound Pressure

transmission medium will be in general be greater than the *Effective Band*.

(56 IRE 9.S1)

**Effective Band Width.** For a band-pass filter, the width of an assumed rectangular band-pass filter having the same transfer ratio at a reference frequency and passing the same mean-square value of a hypothetical current and voltage having even distribution of energy over all frequencies. (48 IRE 2, 11, 15.S1)

**Effective Bunching Angle (Reflex Klystrons).** In a given *Drift Space*, the *Transit Angle* that would be required in a hypothetical *Drift Space* in which the potentials vary linearly over the same range as in the given space and in which the bunching action is the same as in the given space. (56 IRE 7.S1; 57 IRE 7.S2)

**Effective Height (former usage).** In low-frequency applications, as applied to loaded or unloaded vertical antennas, the actual height of the vertical section multiplied by the ratio of the average current in that section to the input current. (48 IRE 2, 11, 15.S1)

**Effective Height (present usage).** The height of the antenna center of radiation above the effective ground level.

*Note:* For an antenna with symmetrical current distribution, the center of radiation is the center of distribution. For an antenna with asymmetrical current distribution, the center of radiation is the center of current moments when viewed from directions near the direction of maximum radiation.

(48 IRE 2, 11, 15.S1)

**Effective Percentage Modulation.** For a single, sinusoidal input component, the ratio of the peak value of the fundamental component of the envelope to the direct-current component in the modulated conditions, expressed in per cent.

*Note:* It is sometimes convenient to express percentage modulation in decibels below 100 per cent modulation.

(48 IRE 2, 11, 15.S1)

**Effective Radius of the Earth.** An effective value for the radius of the earth, which is used in place of the geometrical radius to correct for atmospheric refraction when the index of refraction in the atmosphere changes linearly with height.

*Note:* Under conditions of *Standard Refraction* the effective radius of the earth is  $8.5 \times 10^6$  meters, or  $4/3$  the geometrical radius.

(50 IRE 24.S1)

**Effective Sound Pressure (Root-Mean-Square Sound Pressure).** At a point, the root-mean-square value of the instantaneous

## Efficiency

sound pressures, over a time interval at the point under consideration. In the case of periodic sound pressures, the interval must be an integral number of periods or an interval long compared to a period. In the case of nonperiodic sound pressures, the interval should be long to make the value obtained essentially independent of small changes in the length of the interval.

*Note:* The term "effective sound pressure" is frequently shortened to "sound pressure."

(51 IRE 6.S1)

**Efficiency.** See:

*Circuit Efficiency (of the Output Circuits of Electron Tubes)*

*Efficiency (Radiation-Counter Tubes)*

*Electronic Efficiency*

*Electron-Stream Transmission Efficiency.*

(57 IRE 7.S2)

**Efficiency (Radiation-Counter Tubes).**

The probability that a *Tube Count* will take place with a specified particle or quantum incident in a specified manner. (57 IRE 7.S2)

**Efficiency, Load Circuit.** See *Load Circuit*

*Efficiency (Induction and Dielectric Heating usage).* (55 IRE 10.S1)

**Efficiency, Over-All Electrical.** See *Over-All Electrical Efficiency (Induction and Dielectric Heating usage).* (55 IRE 10.S1)

**E-H Tee.** A junction composed of a combination of *E* and *H-Plane Tee* junctions having a common point of intersection with the main guide. (55 IRE 2.S1)

**E-H Tuner.** An *E-H Tee* used for impedance transformation having two arms terminated in adjustable plungers. (55 IRE 2.S1)

**E Layer.** An ionized layer in the E region. (50 IRE 24.S1)

**Electra.** A specific *Radio Navigation* aid that provides a number (usually 24) of equisignal zones. *Electra* is similar to *Sonne* except that in *Sonne* the equisignal zones as a group are periodically rotated in *Bearing*. (54 IRE 12.S1)

**Electrical Distance.** The distance between two points expressed in terms of the duration of travel of an electromagnetic wave in free space between the two points.

*Note:* A convenient unit of *Electrical Distance* is the *Light Microsecond* or approximately 983 feet (300 meters). In the use of this unit, the *Electrical Distance* is numerically equal to the transmission time in microseconds.

(54 IRE 12.S1)

**Electrical Function Switch.** See *Function Switch*. (50 IRE 8.S1)

**Electrical Length.** The physical length expressed in wavelengths, radians, or degrees. (50 IRE 24.S1; 53 IRE 2.S1)

## Electroacoustical Reciprocity

**Electrical Noise.** Unwanted electrical energy other than cross talk present in a transinission system. (48 IRE 2, 11, 15.S1)

**Electric Dipole.** A pair of equal and opposite charges an infinitesimal distance apart.

*Note:* In electromagnetics, the term "dipole" is often applied to two equal and opposite oscillating charges an infinitesimal distance apart; in this sense, it is synonymous with an electric current element.

(48 IRE 2, 11, 15.S1)

**Electric Displacement Density.** *Electric Flux Density*. (50 IRE 24.S1)

**Electric Field.** A state of the medium in which stationary electrified bodies are subject to forces by virtue of their electrifications. (50 IRE 24.S1)

**Electric Field Strength.** The magnitude of the electric field vector.

*Note:* This term is sometimes called the electric field intensity, but such use of the word intensity is deprecated in favor of field strength, since intensity connotes power in optics and radiation.

(50 IRE 24.S1)

**Electric (Magnetic) Field Strength.** The magnitude of the electric (magnetic) field vector. (52 IRE 17.S1)

**Electric Field Vector.** At a point in an electric field, the force on a stationary positive charge per unit charge.

*Note:* This may be measured either in newtons per coulomb or in volts per meter. This term is sometimes called the *Electric Field Intensity* but such use of the work field intensity is deprecated since intensity connotes power in optics and radiation.

(53 IRE 2.S1)

**Electric Flux Density.** At a point, the vector whose magnitude is equal to the charge per unit area which would appear on one face of a thin metal plate introduced in the electric field at the point and so oriented that this charge is a maximum. The vector is normal to the plate from the negative to the positive face.

*Note:* The term *Electric Displacement Density* or *Electric Displacement* is also in use for this term.

(50 IRE 24.S1)

**Electric Transducer.** A transducer in which all of the waves concerned are electric. (51 IRE 20.S2)

**Electroacoustical Reciprocity Theorem.** For an electroacoustic transducer satisfying the reciprocity principle, the quotient of the magnitude of the ratio of the open-circuit voltage at the output terminals (or the short-circuit output current) of the transducer, when used as a sound receiver, to the free-field sound

pressure referred to an arbitrarily selected reference point on or near the transducer, divided by the magnitude of the ratio of the sound pressure apparent at a distance  $d$  from the reference point to the current flowing at the transducer input terminals (or the voltage applied at the input terminals), when used as a sound emitter, is a constant, called the "reciprocity constant," independent of the type or constructional details of the transducer.

*Note:* The reciprocity constant is given by

$$\left| \frac{M_o}{S_o} \right| = \left| \frac{M_s}{S_s} \right| = \frac{2d}{pf} \cdot 10^{-7},$$

where

$M_o$  = the open free-field voltage response, as a sound receiver, in open-circuit volts per microbar, referred to the arbitrary reference point on or near the transducer,

$M_s$  = the free-field current response in short-circuit amperes per microbar, referred to the arbitrary reference point on or near the transducer,

$S_o$  = the sound pressure produced at a distance  $d$  centimeters from the arbitrary reference point in microbars per ampere of input current,

$S_s$  = the sound pressure produced at a distance  $d$  centimeters from the arbitrary reference point in microbars per volt applied at the input terminals,

$f$  = the frequency in cycles per second,

$p$  = the density of the medium in grams per cubic centimeter,

$d$  = the distance in centimeters from the arbitrary reference point on or near the transducer to the point in which the sound pressure established by the transducer when emitting is evaluated.

(51 IRE 6.S1)

**Electroacoustic Transducer.** A transducer for receiving waves from an electric system and delivering waves to an acoustic system, or vice versa. (51 IRE 6.S1)

**Electrochemical Recording.** Recording by means of a chemical reaction brought about by the passage of signal-controlled current through the sensitized portion of the *Record Sheet*. (56 IRE 9.S1)

**Electrode (Electron Tubes).** A conducting *Element* that performs one or more of the functions of emitting, collecting, or controlling, by an electromagnetic field, the movements of electrons or ions. See:

*Accelerating Electrode*

*Anode (Electron Tubes)*

*Backplate (Camera Tubes)*

*Cathode*

*Collector*

*Color-Selecting-Electrode System*

*Control Electrode*

*Control Grid*

*Convergence Electrode*

*Decelerating Electrode (Electron-Beam Tubes)*

*Deflecting Electrode*

*Dynode (Electron Tubes)*

*Filament*

*Focusing Electrode*

*Grid*

*Ignitor Electrode*

*Intensifier Electrode*

*Modulating Electrode*

*Starter (Gas Tubes)*

*Target (Camera Tubes).*

(57 IRE 7.S2)

**Electrode (of a Semiconductor Device).** A element that performs one or more of the functions of emitting or collecting electrons or *Holes*, or of controlling their movement by an electric field. (54 IRE 7.S2)

**Electrode Admittance (of the  $j$ th Electrode of an  $n$ -Electrode Electron Tube).** The *Short-Circuit Driving-Point Admittance* between the  $j$ th *Electrode* and the reference point measured directly at the  $j$ th *Electrode*.

*Note:* To be able to determine the intrinsic electronic merit of an *Electron Tube*, the *Driving-Point* and *Transfer Admittance* must be defined as if measured directly at the *Electrodes* inside the tube. The definition of *Electrode Admittance* and *Electrode Impedance* are included for this reason.

(57 IRE 7.S2)

**Electrode Capacitance ( $n$ -Terminal Electron Tubes).** The capacitance determined from the *Short-Circuit Driving-Point Admittance* at that *Electrode*. (57 IRE 7.S2)

**Electrode Characteristic.** A relation between the *Electrode Voltage* and the current to a *Electrode*, all other *Electrode Voltages* being maintained constant. (57 IRE 7.S2)

**Electrode Conductance.** The real part of the *Electrode Admittance*. (57 IRE 7.S2)

**Electrode Current (Electron Tubes).** The net current from an *Electrode* into the interelectrode space.

*Note:* The terms *Cathode Current*, *Grid Current*, *Anode Current*, *Plate Current*, and so forth, are used to designate *Electrode Currents* for these specific *Electrodes*. Unless otherwise stated, an *Electrode Current* is measured at the available terminal.

(57 IRE 7.S2)

**Electrode-Current Averaging Time.** The

## Electrode Dark Current

time interval over which the current is averaged in defining the operating capabilities of the *Electrode*. (57 IRE 7.S2)

**Electrode Dark Current (Camera Tubes or Phototubes).** *Electrode Current* under specified conditions of *Radiation* shielding. (57 IRE 7.S2)

**Electrode Dissipation.** The power dissipated in the form of heat by an *Electrode* as a result of electron and/or ion bombardment. (57 IRE 7.S2)

**Electrode Impedance.** The reciprocal of the *Electrode Admittance*. (57 IRE 7.S2)

**Electrode Resistance.** The reciprocal of the *Electrode Conductance*.

*Note:* This is the effective parallel resistance and is not the real component of the *Electrode Impedance*.

(57 IRE 7.S2)

**Electrode Voltage.** The voltage between an *Electrode* and the *Cathode* or a specified point of a filamentary *Cathode*.

*Note:* The terms *Grid Voltage*, *Anode Voltage*, *Plate Voltage*, etc., are used to designate the voltage between these specific *Electrodes* and the *Cathode*. Unless otherwise stated, *Electrode Voltages* are understood to be measured at the available terminals.

(57 IRE 7.S2)

**Electrolytic Recording.** That type of electrochemical recording in which the chemical change is made possible by the presence of an electrolyte. (56 IRE 9.S1)

**Electromagnetic Wave.** A wave characterized by variations of electric and magnetic fields.

*Note:* *Electromagnetic Waves* are known as radio waves, heat rays, light rays, etc., depending on the frequency.

(50 IRE 24.S1; 53 IRE 2.S1)

**Electromechanical Recording.** *Recording* by means of a signal-actuated mechanical device. (56 IRE 9.S1)

**Electromechanical Transducer.** A transducer for receiving waves from an electric system and delivering waves to a mechanical system, or vice versa. (51 IRE 6.S1; 51 IRE 20.S2)

**Electrometer Tube.** A high-vacuum tube having a very low *Control-Electrode* conductance to facilitate the measurement of extremely small direct current or voltage. (57 IRE 7.S2)

**Electron-Beam Tube.** An *Electron Tube*, the performance of which depends upon the formation and control of one or more electron beams. (57 IRE 7.S2)

**Electron-Coupled Oscillator.** An oscillator employing a multigrad tube with the cathode and two grids operating in any conventional manner as an oscillator, and in which the

## Electron Multiplier

plate-circuit load is coupled to the oscillator through the electron stream. (48 IRE 2, 11, 15.S1)

**Electron Device.** A device in which conduction is principally by electrons moving through a vacuum, gas, or semiconductor. (57 IRE 7.S2)

**Electron Emission.** The liberation of electrons from an *Electrode* into the surrounding space. (57 IRE 7.S2)

**Electron Gun.** An *Electrode* structure which produces and may control, focus, deflect, and converge one or more electron beams. (57 IRE 7.S2)

**Electron-Gun Density Multiplication.** The ratio of the average current density at any specified aperture through which the stream passes to the average current density at the *Cathode* surface. (56 IRE 7.S1; 57 IRE 7.S2)

**Electronic.** Of or pertaining to devices, circuits, or systems utilizing electron devices.

*Examples:* electronic control, electronic equipment, electronic instrument, and electronic circuit.

(57 IRE 7.S2)

**Electronic Efficiency.** The ratio of 1) the power at the desired frequency delivered by the electron stream to the circuit in an oscillator or amplifier, to 2) the average power supplied to the stream. (56 IRE 7.S1; 57 IRE 7.S2)

**Electronic Gap Admittance.** See *Gap Admittance*, *Electronic*. (57 IRE 7.S2)

**Electronic Keying.** A method of keying whereby the control is accomplished solely by electronic means. (48 IRE 2, 11, 15.S1)

**Electronic Line Scanning.** That method of *Scanning* which provides motion of the *Scanning Spot* along the scanning line by electronic means. (56 IRE 9.S1)

**Electronic Microphone.** A microphone which depends for its operation on the generation of a voltage by the motion of one of the electrodes in an electron tube. (51 IRE 6.S1)

**Electronic Raster Scanning.** That method of *Scanning* in which motion of the *Scanning Spot* in both dimensions is accomplished by electronic means. (56 IRE 9.S1)

**Electronics.** That field of science and engineering which deals with *Electron Devices* and their utilization. (57 IRE 7.S2)

**Electronics (used as an adjective).** Of or pertaining to the field of electronics.

*Examples:* Electronics engineer, electronics course, electronics laboratory, and electronics committee.

(57 IRE 7.S2)

**Electron Multiplier.** A structure, within an *Electron Tube*, which employs secondary elec-

## Electrons, Conduction

tron emission from solids to produce current amplification. (57 IRE 7.S2)

**Electrons, Conduction.** The electrons in the *Conduction Band* of a solid, which are free to move under the influence of an electric field. (54 IRE 7.S2)

**Electron-Stream Potential.** At any point in an electron stream, the time average of the potential difference between that point and the electron-emitting surface. (56 IRE 7.S1; 57 IRE 7.S2)

**Electron-Stream Transmission Efficiency.** At an *Electrode* through which the electron stream passes, the ratio of 1) the average stream current through the *Electrode* to 2) the average stream current approaching the *Electrode*.

*Note:* In connection with multitransit tubes, the term "electron stream" should be taken to include only electrons approaching the *Electrode* for the first time.

(56 IRE 7.S1; 57 IRE 7.S2)

**Electron Tube.** An *Electron Device* in which conduction takes place by electrons moving through a vacuum or gaseous medium within a gas-tight envelope. (57 IRE 7.S2)

**Electron-Wave Tube.** An *Electron Tube* in which mutually interacting streams of electrons having different velocities cause a signal modulation to change progressively along their length. (56 IRE 7.S1; 57 IRE 7.S2)

**Electroponic Effect.** The sensation of hearing produced when an alternating current of suitable frequency and magnitude from an external source is passed through an animal. (51 IRE 6.S1)

**Electrostatic Actuator.** An apparatus constituting an auxiliary external electrode which permits the application of known electrostatic forces to the diaphragm of a microphone for the purpose of obtaining a primary calibration. (51 IRE 6.S1)

**Electrostatic Focusing.** A method of *Focusing* an electron beam by the action of an electric field. (57 IRE 7.S2)

**Electrostatic Loudspeaker (Capacitor Loudspeaker) (Condenser Loudspeaker).** A loudspeaker in which the mechanical forces are produced by the action of electrostatic fields. (51 IRE 6.S1)

**Electrostatic Memory.** A memory device utilizing electrostatic charge as the means of retaining information, involving usually a special type of cathode-ray tube together with associated circuits. (50 IRE 8.S1)

**Electrostatic Memory Tube.** An electron tube in which information is retained by means of electric charges. *Synonym:* *Storage Tube*. (50 IRE 8.S1)

**Electrostatic Microphone (Capacitor**

## Emission

**Microphone) (Condenser Microphone).** A microphone which depends for its operation upon variations of its electrostatic capacitance. (51 IRE 6.S1)

**Electrostatic Recording.** *Recording* by means of a signal-controlled electrostatic field. (56 IRE 9.S1)

**Electrothermal Recording.** That type of *Recording* which is produced principally by signal-controlled thermal action. (56 IRE 9.S1)

**Element (of a Circuit).** Any electrical device (such as inductor, resistor, capacitor, generator, line, electron tube) with terminals at which it may be directly connected to other electrical devices. (50 IRE 4.S1)

**Element (Electron Tubes).** A constituent part of the tube that contributes directly to its electrical operation. See *Storage Element (Charge-Storage Tubes)*. (57 IRE 7.S2)

**Element (of a Semiconductor Device).** Any integral part of the *Semiconductor Device* that contributes to its operation. (54 IRE 7.S2)

**Elemental Area.** Any segment of a *Scanning Line* of the *Subject Copy* the dimension of which along the line is exactly equal to the *Nominal Line Width*.

*Note:* Elemental area is not necessarily the same as the *Scanning Spot*.

(56 IRE 9.S1)

**Elements of a Fix.** The specific values of the *Navigation Co-ordinates* necessary to define a *Position*. (54 IRE 12.S1)

**Elliptically Polarized Wave.** At a given frequency an *Electromagnetic Wave* for which the component of the electric vector in a plane normal to the *Direction of Propagation* describes an ellipse. (53 IRE 2.S1)

**Ellipticity.** See note under *Axial Ratio*. (53 IRE 2.S1)

**Elongation.** The extension or elongation of the envelope of a signal due to the delayed arrival of certain of the multipath components. (42 IRE 9.S1)

**Embossing Stylus.**<sup>1</sup> A recording stylus with a rounded tip which displaces the material in the recording medium to form a groove. (51 IRE 6.S1)

**Emission.** See:

*Electron Emission*

*Field Emission*

*Field-Enhanced Photoelectric Emission*

*Field-Enhanced Secondary Emission*

*Field-Free Emission Current (of a Cathode)*

*Flection-Point Emission Current*

*Grid Emission*

<sup>1</sup> Stylus is a term defining a pickup needle or a holder furnished with a jewel or other abrasive-resistant tip. A stylus may or may not be arranged for convenient replacement.

*Inflection-Point Emission Current*  
*Reverse Emission (Back Emission) (Vacuum Tubes)*

*Schottky Emission*

*Secondary Emission*

*Secondary Grid Emission*

*Thermionic Emission*

*Thermionic Grid Emission (Primary Grid Emission).*

(57 IRE 7.S2)

**Emission Characteristic.** The relation between the emission and a factor controlling the emission such as temperature, voltage, or current of the *Filament* or heater. (57 IRE 7.S2)

**Emitter, Minority (of a Transistor).** An *Electrode* from which a flow of *Majority Carriers* enters the interelectrode region. (54 IRE 7.S2)

**Emitter, Minority (of a Transistor).** An *Electrode* from which a flow of *Minority Carriers* enters the interelectrode region. (54 IRE 7.S2)

**Enabling Pulse.** A pulse which prepares a circuit for some subsequent action. (54 IRE 12.S1)

**Encoder.** A network or system in which only one input is excited at a time and each input produces a combination of outputs. Sometimes called *Matrix*. (56 IRE 8.S1)

**End-Around Carry.** See *Carry*. (56 IRE 8.S1)

**End-of-Copy Signal.** A signal indicating termination of the transmission of a complete *Subject Copy*. (56 IRE 9.S1)

**End-Fire Array.** A linear array whose direction of maximum radiation is along the axis of the array. (48 IRE 2, 11, 15.S1)

**End Shield (Magnetrans).** A shield for the purpose of confining the *Space Charge* to the *Interaction Space*. (57 IRE 7.S2)

**Energy Gap (of a Semiconductor).** The energy range between the bottom of the *Conduction Band* and the top of the *Valence Band*. (54 IRE 7.S2)

**Entropy.** See *Average Information Content*. (58 IRE 11.S1)

**Envelope Delay (in Facsimile).** The time of propagation, between two points, of the envelope of a wave.

*Note:* The *Envelope Delay* is measured by the slope of the phase shift in cycles plotted against the frequency in cycles per second. If the system distorts the envelope, the *Envelope Delay* at a specified frequency is defined with reference to a modulated wave which occupies a frequency bandwidth approaching zero.

(56 IRE 9.S1)

**Envelope Delay (in Wave Propagation)-**

The time of propagation, between two points, of the envelope of a wave. It is equal to the rate of change with angular frequency of the difference in phase between these two points. It has significance over the band of frequencies occupied by the wave only if this rate is approximately constant over that band. (50 IRE 24.S1)

**Envelope Delay Distortion.** That form of distortion which occurs when the rate of change of phase shift with frequency of a circuit or system is not constant over the frequency range required for transmission.

*Note:* *Envelope Delay Distortion* is usually expressed as one-half the difference in microseconds between the maximum and minimum *Envelope Delays* existing between the two extremes of frequency defining the channel used.

(56 IRE 9.S1)

**E-Plane Bend.** For a rectangular uniconductor waveguide operating in the dominant mode, a bend in which the longitudinal axis of the guide remains in a plane parallel to the electric field vector throughout the bend. (55 IRE 2.S1)

**E-Plane Tee Junction.** For a rectangular uniconductor waveguide, a tee junction of which the electric field vector of the dominant wave of each arm is parallel to the plane of the longitudinal axes of the guides. (55 IRE 2.S1)

**Equal-Energy Source.** A light source for which the time rate of emission of energy per unit of wavelength is constant throughout the visible spectrum. (55 IRE 22.S1)

**Equalizer.** A passive device designed to compensate for an undesired amplitude-frequency and/or phase-frequency characteristic of a system or component. (58 IRE 3.S1)

**Equalizing Pulses.** *Pulses* at twice the *Line Frequency*, occurring just before and just after the vertical synchronizing *Pulses*.

*Note:* The *Equalizing Pulses* minimize the effect of line-frequency pulses on the interlace.

(55 IRE 23.S1)

**Equally Tempered Scale.** A series of notes selected from a division of the octave (usually) into 12 equal intervals. See also: *Cent, Table IV*. (51 IRE 6.S1)

**Equation Solver.** A computing device, often of the analog type, which is designed to: 1) solve systems of linear simultaneous (non-differential) equations, or 2) find the roots of polynomials, or both. (50 IRE 8.S1)

**Equiphase Surface.** Any surface in a wave over which the field vectors at the same instant are in the same phase or 180° out of phase. (50 IRE 24.S1)

## Equipphase Zone

**Equipphase Zone.** The region in space within which difference in phase of two radio signals is indistinguishable. (54 IRE 12.S1)

**Equipotential Cathode.** See *Indirectly Heated Cathode*. (57 IRE 7.S2)

**Equisignal Localizer.** A *Localizer* in which the *Localizer-On-Course* line is centered in a zone of equal amplitude of two transmitted signals and deviations from this zone are detectable as unbalance in the levels of these signals. (54 IRE 12.S1)

**Equisignal Zone.** The region in space within which the difference in amplitude of two radio signals (usually emitted by a single station) is indistinguishable. (49 IRE 12.S1)

**Equivalent Conductance (ATR Tubes).** The normalized conductance of the tube in its *Mount* measured at its resonance frequency.

*Note:* Normalization is with respect to the characteristic impedance of the transmission line at its junction with the tube *Mount*.

(57 IRE 7.S2)

**Equivalent Dark-Current Input (Phototubes).** The incident luminous flux required to give a *Signal Output Current* equal to the *Dark Current*. (57 IRE 7.S2)

**Equivalent Diode.** The imaginary *Diode* consisting of the *Cathode* of a *Triode* or multigrid tube is a virtual anode to which is applied a *Composite Controlling Voltage* such that the *Cathode Current* is the same as in the *Triode* or multigrid tube. (57 IRE 7.S2)

**Equivalent Noise Conductance.** A quantitative representation in conductance units of the spectral density of a *Noise-Current Generator* at a specified frequency.

*Note 1:* The relation between the *Equivalent Noise Conductance*  $G_n$  and the spectral density  $W_i$  of the *Noise-Current Generator* is

$$G_n = \pi W_i / (kT_0)$$

where  $k$  is Boltzmann's constant and  $T_0$  is the *Standard Noise Temperature*, 290°K, and  $kT_0 = 4.00 \times 10^{-21}$  watt-seconds.

*Note 2:* The *Equivalent Noise Conductance* in terms of the mean-square noise-generator current  $\bar{i}^2$  within a frequency increment  $\Delta f$  is

$$G_n = \bar{i}^2 / (4kT_0\Delta f).$$

(57 IRE 7.S2)

**Equivalent Noise Current.** A quantitative representation in current units of the spectral density of a *Noise-Current Generator* at a specified frequency.

*Note 1:* The relation between the *Equivalent Noise Current*  $I_n$  and the spectral density  $W_i$  of the *Noise-Current Generator* is

## Error

$$I_n = (2\pi W_i) / e$$

where  $e$  is the magnitude of the electronic charge.

*Note 2:* The *Equivalent Noise Current* in terms of the mean square noise-generator current  $\bar{i}^2$  within a frequency increment  $\Delta f$  is

$$I_n = \bar{i}^2 / (2e\Delta f).$$

(57 IRE 7.S2)

**Equivalent Noise Resistance.** A quantitative representation in resistance units of the spectral density of a *Noise-Voltage Generator* at a specified frequency.

*Note 1:* The relation between the *Equivalent Noise Resistance*  $R_n$  and the spectral density  $W_e$  of the *Noise-Voltage Generator* is

$$R_n = (\pi W_e) / (kT_0)$$

where  $k$  is Boltzmann's constant and  $T_0$  is the *Standard Noise Temperature*, 290°K, and  $kT_0 = 4.00 \times 10^{-21}$  watt-seconds.

*Note 2:* The *Equivalent Noise Resistance* in terms of the mean square noise-generator voltage  $\bar{e}^2$  within a frequency increment  $\Delta f$  is

$$R_n = \bar{e}^2 / (4kT_0\Delta f).$$

(57 IRE 7.S2)

**Equivocation.** The *Conditional Information Content* of an input symbol given an output symbol, averaged over all input-output pairs. (58 IRE 11.S1)

**Erase (Charge-Storage Tubes).** To charge or discharge *Storage Elements* to eliminate previously stored information. (57 IRE 7.S2)

**Erasing Head.** A device for obliterating any previous recordings. It may be used for pre-conditioning the magnetic media for recording purposes. (51 IRE 6.S1)

**Erasing Speed (Charge-Storage Tubes).** The rate of *Erasing* successive *Storage Elements*. (57 IRE 7.S2)

**E Region.** The region of the ionosphere between about 90 and 160 kilometers above the earth's surface. (50 IRE 24.S1)

**Error.** 1) In mathematics, the difference between the true value and a calculated or observed value. A quantity (equal in absolute magnitude to the error) added to a calculated or observed value to obtain the true value is called a *Correction*. 2) In a computer or data-processing system, any incorrect step, process, or result. In addition to the mathematical usage, in the computer field the term is also commonly used to refer to machine malfunctions as "machine errors" and to human mistakes as "human errors." It is fre-



quently helpful to distinguish between these as follows: errors result from approximations used in numerical methods; **Mistakes** result from incorrect programming, coding, data transcription, manual operation, etc.; **Malfunctions** result from failures in the operation of machine components such as gates, flip-flops, amplifiers, etc. (56 IRE 8.S1)

**Error-Detecting Code.** See *Check, Forbidden-Combination.* (56 IRE 8.S1)

**Error, Height—Deprecated.** See *Ionospheric Height Error.* (54 IRE 12.S1)

**Error, Instrumental.** In *Navigation*, the error due to the calibration, limited *Course Sensitivity* and other inaccuracies introduced in any portion of the system by the mechanism of translating pathlength differences into *Navigation Co-ordinate information.* (54 IRE 12.S1)

**Error, Round-Off.** See *Round-Off Error.* (50 IRE 8.S1)

**Error, Sky (Error, Sky-Wave)—Deprecated.** See *Ionospheric Error.* (54 IRE 12.S1)

**Error, Truncation.** See *Truncation Error.* (50 IRE 8.S1)

**Eureka.** The ground *Transponder of Rebecca-Eureka*, a secondary *Radar* system. (54 IRE 12.S1)

**Excess-Three Code.** A number *Code* in which the decimal digit *n* is represented by the four-bit binary equivalent of *n + 3*. See also *Binary-Coded-Decimal System.* (56 IRE 8.S1)

**Excitation (Drive).** A signal voltage applied to the control electrode of an electron tube. (48 IRE 2, 11, 15.S1)

**Excitation Purity (Purity).** The ratio of the distance from the reference point to the point representing the sample, to the distance along the same straight line from the reference point to the *Spectrum Locus* or to the *Purple Boundary*, both distances being measured (in the same direction from the reference point) on the *CIE Chromaticity Diagram.*

*Note:* The reference point is the point in the *Chromaticity Diagram* which represents the reference standard light mentioned in the definition of *Dominant Wavelength.*

(55 IRE 22.S1)

**Excited Field Loudspeaker.** A loudspeaker in which the steady magnetic field is produced by an electromagnet. (51 IRE 6.S1)

**Exciter.** The portion of a transmitting array, of the type which includes a reflector, which is directly connected with the source of power. (48 IRE 2, 11, 15.S1)

**Expander.** A *Transducer* which, for a given input *Amplitude Range*, produces a larger output range.

*Note:* One type of *Expander* increases the

*Amplitude Range* as a linear function of the envelope of speech waves.

(58 IRE 3.S1)

**Expansion.** A process in which the effective gain applied to a signal is varied as a function of the signal magnitude, the effective gain being greater for large than small signals. (53 IRE 11.S1)

**Exponential Flare-Out.** See *Altmetric Flare-Out.* (54 IRE 12.S1)

**Exponential Horn.** A horn whose cross-sectional area increases exponentially with axial distance.

*Note:* If

*S* = the area of a plane section normal to the axis of the horn at a distance *x* from the throat of the horn,

*S*<sub>0</sub> = the area of the plane section normal to the axis of the horn at the throat, and *m* = a constant which determines the rate of taper or flare of the horn,

then

$$S = S_0 e^{mx}$$

(51 IRE 6.S1)

**Exponential Transmission Line.** A two-conductor *Transmission Line* whose characteristic impedances vary exponentially with electrical length along the line. (53 IRE 2.S1)

**Externally Quenched Counter Tube.** See *Counter Tube, Externally Quenched.* (57 IRE 7.S2)

**External Termination (of the *j*th Terminal of an *n*-Terminal Network).** That passive or active two-terminal network which is attached externally between the *j*th terminal and the reference point. (57 IRE 7.S2)

**Extract.** To form a new *Word* by juxtaposing selected segments of given words. (56 IRE 8.S1)

**Extract Instruction.** In a digital computer, the instruction to form a new word by juxtaposing selected segments of given words. (50 IRE 8.S1)

**Extraordinary-Wave Component.** The magneto-ionic wave component in which the electric vector rotates in the opposite sense to that for the ordinary-wave component. See *Ordinary-Wave Component.* (50 IRE 24.S1)

**Extrinsic Properties (of a Semiconductor).** The properties of a semiconductor as modified by *Impurities* or *Imperfections* within the crystal. (54 IRE 7.S2)

## F

**F<sub>1</sub> Layer.** The lower of the two ionized layers normally existing in the *F Region* in the day hemisphere. (50 IRE 24.S1)

**F<sub>2</sub> Layer.** The single ionized layer normally existing in the *F Region* in the night hemi-

sphere and the higher of the two layers normally existing in the *F Region* in the day hemisphere. (50 IRE 24.S1)

**Facsimile (in Electrical Communications).** The process, or the result of the process, by which fixed graphic material including pictures or images is scanned and the information converted into signal waves which are used either locally or remotely to produce in record form a likeness (*Facsimile*) of the *Subject Copy*. (56 IRE 9.S1)

**Facsimile Receiver.** The apparatus employed to translate the signal from the communication channel into a facsimile record of the subject copy. (42 IRE 9.S1)

**Facsimile Recorder.** The part of the facsimile receiver in which the picture signal in its final form is systematically registered upon a record sheet as a facsimile of the subject copy. (42 IRE 9.S1)

**Facsimile Signal (Picture Signal).** A signal resulting from the *Scanning* process. (56 IRE 9.S1)

**Facsimile-Signal Level.** The maximum *Facsimile Signal* power or voltage (rms or dc) measured at any point in a *Facsimile System*.

*Note:* It may be expressed in decibels with respect to some standard value such as 1 milliwatt.

(56 IRE 9.S1)

**Facsimile System.** An integrated assembly of the elements used for *Facsimile*. (56 IRE 9.S1)

**Facsimile Transient.** A damped oscillatory transient occurring in the output of the system as a result of a sudden change in input. (56 IRE 9.S1)

**Facsimile Transmission.** The transmission of *Signal Waves* produced by the *Scanning* of fixed graphic material, including pictures, for reproduction in record form. (56 IRE 9.S1)

**Facsimile Transmitter.** The apparatus employed to translate the subject copy into signals suitable for delivery to the communication system. (42 IRE 9.S1)

**Factor.** See:

*Amplification Factor*

*Commutation Factor (Gas Tubes)*

*Deflection Factor (Cathode-Ray Tubes)*

*Gas Amplification Factor (Gas Phototubes)*

$\mu$ -Factor (of an *n-Terminal Electron Tube*)

*Noise Factor (Noise Figure) (of a Two-Port Transducer)*

*Noise Factor (Noise Figure), Average (of a Two-Port Transducer)*

*Noise Factor (Noise Figure), Spot*

*Rectification Factor*

*Trans- $\mu$ -Factor (Multibeam Electron Tubes)*

*Transrectification Factor.*

(57 IRE 7.S2)

**Fading.** The variation of radio field strength caused by changes in the transmission medium with time. (50 IRE 24.S1)

**False Course.** In *Navigation* normally providing one or more *Course Lines*, a spurious additional *Course Line* indication due to undesired reflections or to a maladjustment of equipment. (54 IRE 12.S1)

**Fan Beam.** A field pattern having an elliptically shaped cross section in which the ratio of the major to minor axes usually exceeds 3 to 1. (54 IRE 12.S1)

**Fan Marker.** A VHF radio facility having a vertically directed *Fan Beam* intersecting an airway to provide a fix. (54 IRE 12.S1)

**Fanned-Beam Antenna.** A unidirectional antenna so designed that transverse cross sections of the major lobe are approximately elliptical. (48 IRE 2, 11, 15.S1)

**Fast Groove (Fast Spiral).** In disk recording, an unmodulated spiral groove having a pitch that is much greater than that of the recorded grooves. (51 IRE 6.S1)

**Fast-Time-Constant Circuit.** In *Radar*, a circuit with short time-constant used to emphasize signals of short duration to produce discrimination against low frequency components of *Clutter*. (54 IRE 12.S1)

**Fault Electrode Current.** The current to an *Electrode* under fault conditions, such as *Arc-Backs* and load short circuits. (57 IRE 7.S2)

**F-Display (also called F-Scan or F-Scope).** In *Radar*, a rectangular *Display* in which a

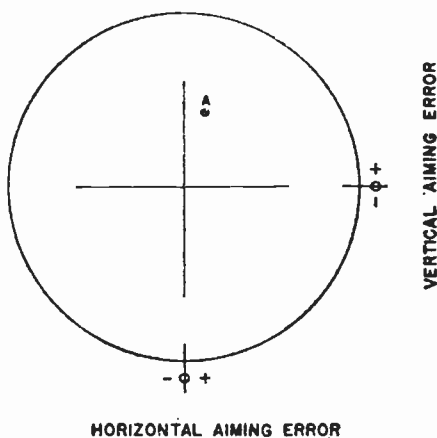

*Target* appears as a centralized *Blip* when the *Radar* antenna is aimed at it. Horizontal and vertical aiming errors are respectively

## Feedback

indicated by the horizontal and vertical displacement of the *Blip*. (54 IRE 12.S1)

**Feedback.** In a transmission system or a section thereof, the returning of a fraction of the output to the input. (48 IRE 2, 11, 15.S1)

**Feedback Control Loop.** A closed transmission path, which includes an active transducer and which consists of a forward path, a feedback path, and one or more mixing points arranged to maintain a prescribed relationship between the loop input signal and the loop output signal. (55 IRE 26.S2)

**Feedback Control System.** A control system, comprising one or more feedback control loops, which combines functions of the controlled signals with functions of the commands to tend to maintain prescribed relationships between the commands and the controlled signals. (55 IRE 26.S2)

**Feedback Control System, Linear.** A feedback control system in which the relationships between the pertinent measures of the system signals are linear. (55 IRE 26.S2)

**Feedback Control System, Nonlinear.** A feedback control system in which the relationships between the pertinent measures of the system input and output signals cannot be adequately described by linear means.

*Note:* A system can be either *Quasi-Linear* or *Nonlinear*, depending upon operating conditions and performance requirements.

(55 IRE 26.S2)

**Feedback Control System, Quasi-Linear.**

A feedback control system in which the relationships between the pertinent measures of the system input and output signals are substantially linear despite the existence of nonlinear elements.

*Note:* A system can be either *Quasi-Linear* or *Nonlinear*, depending upon operating conditions and performance requirements.

(55 IRE 26.S2)

**Feedback Oscillator.** An oscillating circuit, including an amplifier, in which the output is coupled in phase with the input, the oscillation being maintained at a frequency determined by the parameters of the amplifier and the feedback circuits such as LC, RC, and other frequency-selective elements. (48 IRE 2, 11, 15.S1)

**Feedback Path.** In a feedback control loop, the transmission path from the loop output signal to the loop feedback signal. (55 IRE 26.S2)

**Feedback Regulator.** A feedback control system which tends to maintain a prescribed relationship between certain system signals and other predetermined quantities.

*Note 1:* This definition is intended to point out the fact that some of the system signals

## Filament Current

in a regulator are adjustable reference signals.

*Note 2:* It should be noted that *Servomechanism* and *Regulator* are not mutually exclusive terms; their application to a particular system will depend on the method of operation of that system.

(55 IRE 26.S2)

**Feedback Transfer Function.** In a feedback control loop, the transfer function of the feedback path. (55 IRE 26.S2)

**Fermi Level.** The value of the electron energy at which the Fermi distribution function has the value one half. (54 IRE 7.S2)

**Fidelity.** The degree with which a system, or a portion of a system, accurately reproduces at its output the essential characteristics of the signal which is impressed upon its input. (48 IRE 2, 11, 15.S1; 52 IRE 17.S1)

**Field (in Television).** One of the two (or more) equal parts into which a *Frame* is divided in *Interlaced Scanning*. (55 IRE 23.S1)

**Field Emission.** The liberation of electrons from a solid or liquid by a strong electric field at the surface. (57 IRE 7.S2)

**Field-Enhanced Photoelectric Emission.** The increased *Photoelectric Emission* resulting from the action of a strong electric field on the emitter. (57 IRE 7.S2)

**Field-Enhanced Secondary Emission.** The increased *Secondary Emission* resulting from the action of a strong electric field on the emitter. (57 IRE 7.S2)

**Field-Free Emission Current (of a Cathode).** The electron current emitted by a *Cathode* when the electric field at the surface of the *Cathode* is zero. (57 IRE 7.S2)

**Field Frequency.** The product of *Frame Frequency* multiplied by the number of *Fields* contained in one *Frame*. (55 IRE 23.S1)

**Field-Sequential.** Pertaining to the association of individual primary colors with successive fields.

*Examples:* Field-sequential pickup, field-sequential display, field-sequential system, field-sequential transmission.

(55 IRE 22.S1)

**Field Strength, Electric or Magnetic.** See *Electric (Magnetic) Field Strength*. (52 IRE 17.S1)

**Field Strength Meter.** A calibrated radio receiver for measuring field strength. (55 IRE 10.S1)

**Filament.** A *Cathode* of a *Thermionic Tube*, usually in the form of a wire or ribbon, to which heat may be supplied by passing current through it. This is also known as a filamentary cathode. (57 IRE 7.S2)

**Filament Current.** Current supplied to a filament to heat it. (50 IRE 7.S1)

## Filament Voltage

- Filament Voltage.** The voltage between the terminals of a filament. (50 IRE 7.S1)
- Filler.** In mechanical recording, the inert material of a record compound as distinguished from the binder. (51 IRE 6.S1)
- Filter.** A selective *Network* which transmits alternating currents of desired frequencies and substantially attenuates all others. (58 IRE 3.S1)
- Filter, Band-Elimination.** A *Filter* which attenuates alternating currents between given upper and lower *Cutoff Frequencies* and transmits substantially all others. (58 IRE 3.S1)
- Filter, Band-Pass.** A *Filter* which transmits alternating currents between given upper and lower *Cutoff Frequencies* and substantially attenuates all others. (58 IRE 3.S1)
- Filter, High-Pass.** A *Filter* which transmits alternating currents above a given *Cutoff Frequency* and substantially attenuates all others. (58 IRE 3.S1)
- Filter, Low-Pass.** A *Filter* which transmits alternating currents below a given *Cutoff Frequency* and substantially attenuates all others. (58 IRE 3.S1)
- Filter, Sound Effects.** A *Filter*, usually adjustable, designed to reduce the pass band of a system at low and/or high frequencies in order to produce special effects. (58 IRE 3.S1)
- Fine Chrominance Primary.** In the color television system at present standardized for broadcasting in the United States, that one of the two *Chrominance Primaries* which is associated with the greater transmission bandwidth. (55 IRE 22.S1)
- Fired Tube (TR, ATR, and Pre-TR Tubes).** The condition of the tube during which a radio-frequency *Glow Discharge* exists at either the *Resonant Gap*, *Resonant Window*, or both. (57 IRE 7.S2)
- Firing Time, High-Level (Switching Tubes).** See *High-Level Firing Time (Switching Tubes)*. (57 IRE 7.S2)
- Fishbone Antenna.** An antenna consisting of a series of coplanar elements arranged in collinear pairs, loosely coupled to a balanced transmission line. (48 IRE 2, 11, 15.S1)
- Fix.** Position determined without reference to any former *Position*. (54 IRE 12.S1)
- Fixed-Frequency Transmitter.** A transmitter designed for operation on a single carrier frequency. (48 IRE 2, 11, 15.S1)
- Fixed-Point System.** See *Point*. (56 IRE 8.S1)
- Fixed Transmitter.** A transmitter that is operated in a fixed or permanent location. (48 IRE 2, 11, 15.S1)
- Flag Alarm.** A semaphore-type indicator in

## Flip-Flop

- certain types of *Navigation* instruments to warn that the readings are unreliable. (54 IRE 12.S1)
- Flare-Out.** That portion of the *Approach Path* of an aircraft in which the vertical component is modified to lessen the impact of landing. (54 IRE 12.S1)
- Flat Leakage Power (TR and Pre-TR Tubes).** The peak radio-frequency power transmitted through the tube after the establishment of the steady-state radio-frequency discharge. (57 IRE 7.S2)
- Flat Spot.** In *Navigation*, a point of zero incremental *Deviation Sensitivity* occurring with the *Crossover Region*. (54 IRE 12.S1)
- Flection-Point Emission Current.** That value of current on the *Diode Characteristic* for which the second derivative of the current with respect to the voltage has its maximum negative value. This current corresponds to the upper flection point of the *Diode Characteristic*. (57 IRE 7.S2)
- Flicker.** In television, a fluttering sensation which results from the periodic fluctuation of *Light*.  
*Note:* Flicker frequencies usually lie in the range from a few cycles per second to a few tens of cycles per second. (55 IRE 22.S1)
- Flight Path.** A line in space planned for a *Vehicle*. (54 IRE 12.S1)
- Flight Path Computer.** A computer including all of the functions of a *Course-Line Computer* and, in addition, providing means for controlling the altitude of an aircraft in accordance with a desired plan of flight. (54 IRE 12.S1)
- Flight Path Deviation.** The difference between the *Flight Track* of an aircraft and the *Flight Path* expressed in terms of either angular or linear measurement. (54 IRE 12.S1)
- Flight-Path Deviation-Indicator.** An instrument providing a visual indication of deviation from a *Flight Path*. (54 IRE 12.S1)
- Flight-Path-Reference Flight.** That type of *Stabilized Flight* which obtains control information from a navigational system capable of providing *Heading* or altitude guidance, or both, with respect to a desired *Flight Path*.  
*Example:* Flight in which information derived from VOR, DME, ILS, and the like is fed into a conventional *Automatic Pilot*. (54 IRE 12.S1)
- Flight Track.** The *Path* in space actually traced by a *Vehicle*. *Flight Track* is the three-dimensional equivalent of *Track*. (54 IRE 12.S1)
- Flip-Flop.** 1) A device having two stable states and two input terminals (or types of input signals) each of which corresponds

## Floating-Point System

with one of the two states. The circuit remains in either state until caused to change to the other state by application of the corresponding signal. 2) A similar bistable device with an input which allows it to act as a single-stage binary *Counter*. (56 IRE 8.S1)

**Floating-Point System.** See *Point*. (56 IRE 8.S1)

**Flood Projection.** The optical method of *Scanning* in which the *Subject Copy* is flood-lighted and the *Scanning Spot* is defined in the path of the reflected or transmitted light. (56 IRE 9.S1)

**Flow Diagram (in Electronic Computers).** A graphical representation of a *Program* or a *Routine*. (56 IRE 8.S1)

**Flowed Wax.** A mechanical recording medium, in disk form, prepared by melting and flowing wax onto a metal base. (51 IRE 6.S1)

**Flutter.** In communication practice, 1) distortion due to variations in loss resulting from the simultaneous transmission of a signal at another frequency, 2) a similar effect due to phase distortion, or 3) distortion which occurs in sound reproduction as a result of undesired speed variations during the recording, duplicating, or reproducing. (52 IRE 17.S1)

**Flutter Echo.** A rapid succession of reflected pulses resulting from a single initial pulse. (51 IRE 6.S1)

**Flux Guide (Induction Heating usage).** Magnetic material to guide electromagnetic flux in desired paths.

*Note:* The guides may be used either to direct flux to preferred locations or to prevent the flux from spreading beyond definite regions.

(55 IRE 10.S1)

**Focusing.** The process of controlling the electron paths within one or more beams for the purpose of obtaining a desired image or current density distribution. (57 IRE 7.S2)

**Focusing Coil or Focusing Magnet.** An assembly producing a magnetic field for *Focusing* an electron beam. (57 IRE 7.S2)

**Focusing, Dynamic (Picture Tubes).** The process of *Focusing* in accordance with a specified signal in synchronism with scanning. (57 IRE 7.S2)

**Focusing Electrode.** An *Electrode* to which a potential is applied to control the cross-sectional area of the electron beam. (57 IRE 7.S2)

**Focusing and Switching Grille (Color Picture Tubes).** A *Color-Selecting-Electrode System* in the form of an array of wires including at least two mutually insulated sets of conductors in which the switching function is performed by varying the potential

## Force Factor

difference between them, and *Focusing* is accomplished by maintaining the proper average potentials on the array and on the phosphor *Screen*. (57 IRE 7.S2)

**Folded Dipole Antenna.** An antenna composed of two parallel, closely spaced dipole antennas connected together at their ends with one of the dipole antennas fed at its center. (48 IRE 2, 11, 15.S1)

**Footcandle.** A unit of *Illuminance* when the foot is taken as the unit of length. It is the *Illuminance* on a surface one square foot in area on which there is a uniformly distributed flux of one *Lumen*, or the *Illuminance* at a surface all points of which are at a distance of one foot from a uniform source of one *Candle*. (55 IRE 22.S1)

**Footlambert.** A unit of *Luminance* equal to  $1/\pi$  *Candle* per square foot, or to the uniform *Luminance* of a perfectly diffusing surface emitting or reflecting light at the rate of one *Lumen* per square foot.

*Note:* A *Footcandle* is a unit of incident light and a *Footlambert* is a unit of emitted or reflected light. For a perfectly reflecting and perfectly diffusing surface, the number of *Footcandles* is equal to the number of *Footlambers*.

(55 IRE 22.S1)

**Forbidden-Combination Check.** See *Check, Forbidden-Combination*. (56 IRE 8.S1)

**Force Factor.<sup>1</sup>** 1) The force factor of an electromechanical transducer is: a) the complex quotient of the force required to block the mechanical system divided by the corresponding current in the electric system; b) the complex quotient of the resulting open-circuit voltage in the electric system divided by the velocity in the mechanical system.

*Note 1:* Force factors 1)-a) and 1)-b) have the same magnitude when consistent units are used and the transducer satisfies the principle of reciprocity.

*Note 2:* It is sometimes convenient in an electrostatic or piezoelectric transducer to use the ratios between force and charge or electric displacement, or between voltage and mechanical displacement.

2) The force factor of an electroacoustic transducer is: a) the complex quotient of the pressure required to block the acoustic system divided by the corresponding current in the electric system; b) the complex quotient of the resulting open-circuit voltage in the electric system divided by the volume velocity in the acoustic system.

*Note:* Force factors 2)-a) and 2)-b) have the same magnitude when consistent units

<sup>1</sup> See Note 2 under *Acoustic Impedance*.

## Fork Beat

are used and the transducer satisfies the principle of reciprocity.

(51 IRE 6.S1)

**Fork Beat.** See *Carrier Beat*. (56 IRE 9.S1)  
**Forming, Electrical (Applied to Semiconductor Devices).** Process of applying electrical energy to a semiconductor device in order to modify permanently the electrical characteristics. (54 IRE 7.S2)

**Fortuitous Telegraph Distortion.** Distortion which includes those effects that cannot be classified as bias or characteristic distortion, and is defined as the departure, for one occurrence of a particular signal pulse, from the average combined effects of bias and characteristic distortion. Fortuitous distortion varies from one signal to another and is measured by a process of elimination over a long period. It is expressed in per cent of unit pulse. (48 IRE 2, 11, 15.S1)

**Forward Path.** In a feedback control loop, the transmission path from the loop actuating signal to the loop output signal. (55 IRE 26.S2)

**Forward Transfer Function.** In a feedback control loop, the transfer function of the forward path. (55 IRE 26.S2)

**Forward Wave (Traveling-Wave Tubes).** A wave whose group velocity is in the same direction as the electron stream motion. (56 IRE 7.S1; 57 IRE 7.S2)

**Four-Address Code.** See *Instruction Code*. (56 IRE 8.S1)

**Four-Pole.** See *Two-Terminal Pair Network*. (50 IRE 4.S1)

**Frame (in Facsimile).** A rectangular area, the width of which is the *Available Line* and the length of which is determined by the service requirements. (56 IRE 9.S1)

**Frame (in Television).** The total area, occupied by the picture, which is scanned while the *Picture Signal* is not blanked. (55 IRE 23.S1)

**Frame Frequency.** The number of times per second that the *Frame* is scanned. (55 IRE 23.S1)

**Framer.** A device for adjusting the equipment so that the recorded elemental area bears the same relation to the record sheet as the corresponding transmitted elemental area bears to the subject copy in the direction of line progression. (42 IRE 9.S1)

**Framing.** The adjustment of the picture to a desired position in the direction of line progression. (56 IRE 9.S1)

**Framing Signal.** A signal used for adjustment of the picture to a desired position in the direction of line progression. (56 IRE 9.S1)

**Fraunhofer Region.** That region of the field

## Free-Field Voltage Response

in which the energy flow from an antenna proceeds essentially as though coming from a point source located in the vicinity of the antenna.

*Note:* If the antenna has a well-defined aperture  $D$  in a given aspect, the Fresnel region in that aspect is commonly taken to exist at distances greater than  $2D^2/\lambda$  from the aperture,  $\lambda$  being the wavelength.

(48 IRE 2, 11, 15.S1)

**Free Field.** A field (wave or potential) in a homogeneous, isotropic medium free from boundaries. In practice, a field in which the effects of the boundaries are negligible over the region of interest.

*Note:* The actual pressure impinging on an object (e.g., electroacoustic transducer) placed in an otherwise free sound field will differ from the pressure which would exist at that point with the object removed, unless the acoustic impedance of the object matches the acoustic impedance of the medium.

(51 IRE 6.S1)

**Free-Field Current Response (Receiving Free-Field Sensitivity).** Of an electroacoustic transducer used for sound reception, the ratio of the current in the output circuit of the transducer when the output terminals are short-circuited to the free-field sound pressure existing at the transducer location prior to the introduction of the transducer in the sound field. The free-field current response is usually expressed in decibels, viz., 20 times the logarithm to the base 10 of the quotient of the observed ratio divided by the reference ratio, usually 1 ampere per microbar. The free-field response is defined for a plane progressive sound wave whose direction of propagation has a specified orientation with respect to the principal axis of the transducer. (51 IRE 6.S1)

**Free-Field Voltage Response (Receiving Voltage Sensitivity).** Of an electroacoustic transducer used for sound reception, the ratio of the voltage appearing at the output terminals of the transducer when the output terminals are open-circuited to the free-field sound pressure existing at the transducer location prior to the introduction of the transducer in the sound field. The free-field voltage response is usually expressed in decibels, viz., 20 times the logarithm to the base 10 of the quotient of the observed ratio divided by the reference ratio, usually 1 volt per microbar. The free-field response is defined for a plane progressive sound wave whose direction of propagation has a specified orientation with respect to the principal axis of the transducer. (51 IRE 6.S1)

## Free Impedance

**Free Impedance.**<sup>1</sup> Of a transducer, the impedance at the input of the transducer when the impedance of its load is made zero.

*Note:* The approximation is often made that the free electric impedance of an electro-acoustic transducer designed for use in water is that measured with the transducer in air.

(51 IRE 6.S1)

**Free Motional Impedance.**<sup>1</sup> Of a transducer, the complex remainder after the blocked impedance has been subtracted from the free impedance. (51 IRE 6.S1)

**Free Oscillations.** Oscillations that continue in a circuit or system after the applied force has been removed, the frequency of the oscillations being determined by the parameters in the system or circuit, commonly referred to as shock-excited oscillations. (48 IRE 2, 11, 15.S1)

**Free Progressive Wave (Free Wave).** A wave in a medium free from boundary effects. A free wave in a steady state can only be approximated in practice. (51 IRE 6.S1)

**Free-Running Frequency.** The frequency at which a normally synchronized oscillator operates in the absence of a synchronizing signal. (52 IRE 17.S1)

**F Region.** The region of the ionosphere above the *E Region*. (50 IRE 24.S1)

**Frequency Band.** A continuous range of frequencies extending between two limiting frequencies. (48 IRE 2, 11, 15.S1)

**Frequency Band of Emission (Communication Band).** The band of frequencies effectively occupied by that emission, for the type of transmission and the speed of signaling used. (48 IRE 2, 11, 15.S1)

**Frequency Conversion Transducer.** See *Conversion Transducer*. (51 IRE 20.S2)

**Frequency Departure.** The amount of variation of a carrier frequency or center frequency from its assigned value.

*Note:* The term "frequency deviation" which has been used for this meaning, is in conflict with this essential term as applied to phase and frequency modulation, and is therefore deprecated for future use in the above sense.

(48 IRE 2, 11, 15.S1; 52 IRE 17.S1)

**Frequency Deviation.** In frequency modulation, the peak difference between the instantaneous frequency of the modulated wave and the carrier frequency. (52 IRE 17.S1; 53 IRE 11.S1)

**Frequency Distortion.** See *Distortion, Amplitude-Frequency*. (53 IRE 4.S1)

**Frequency Divider.** See *Harmonic Conversion Transducer*. (51 IRE 20.S2)

<sup>1</sup> See Note 2 under *Acoustic Impedance*.

## Frequency-Shift Keying

**Frequency-Division Multiplex.** A device or process for the transmission of two or more signals over a common path by using a different frequency band for each signal. (53 IRE 11.S1)

**Frequency Doubler.** A device delivering output voltage at a frequency that is twice the input frequency. (48 IRE 2, 11, 15.S1)

**Frequency Interlace.** In television, the relationship of intermeshing between the frequency spectrum of an essentially periodic interfering signal and the spectrum of harmonics of the scanning frequencies, which relationship minimizes the visibility of the interfering pattern by altering its appearance on successive scans. (55 IRE 22.S1)

**Frequency-Modulated Transmitter.** One which transmits a frequency-modulated wave. (48 IRE 2, 11, 15.S1)

**Frequency Modulation (FM).** Angle modulation of a sine-wave carrier in which the instantaneous frequency of the modulated wave differs from the carrier frequency by an amount proportional to the instantaneous value of the modulating wave.

*Note:* Combinations of phase and frequency modulation are commonly referred to as "frequency modulation."

(52 IRE 17.S1; 53 IRE 11.S1)

**Frequency Multiplier.** A device delivering output voltage at a frequency that is an exact integral multiple of the input frequency. See also *Harmonic Conversion Transducer*. (48 IRE 2, 11, 15.S1; 51 IRE 20.S2)

**Frequency Pulling.** A change of the generated frequency of an oscillator caused by a change in load impedance. (56 IRE 7.S1; 57 IRE 7.S2)

**Frequency Range (of a Device).** The range of frequencies over which the device may be considered useful with various circuit and operating conditions.

*Note:* Frequency range should be distinguished from bandwidth, which is a measure of useful range with fixed circuits and operating conditions.

(56 IRE 7.S1; 57 IRE 7.S2)

**Frequency Record.** A recording of various known frequencies at known amplitudes, usually for the purpose of testing or measuring. (51 IRE 6.S1)

**Frequency Response.** See *Amplitude-Frequency Response*. (58 IRE 3.S1)

**Frequency-Response Equalization (Equalization).** The effect of all frequency discriminative means employed in a transmission system to obtain a desired over-all frequency response. (51 IRE 6.S1)

**Frequency-Shift Keying or FSK.** That form of frequency modulation in which the modu-

## Frequency Stabilization

lating wave shifts the output frequency between predetermined values corresponding to the frequencies of correlated sources. (53 IRE 11.S1)

**Frequency Stabilization.** The process of controlling the center frequency so that it differs from that of a reference source by not more than a prescribed amount. (48 IRE 2, 11, 15.S1)

**Frequency Swing.** In frequency modulation, the difference between the maximum and minimum design values of the instantaneous frequency. (53 IRE 11.S1)

**Frequency Tolerance of a Radio Transmitter.** The extent to which the carrier frequency of a transmitter may be permitted to depart from the frequency assigned. (48 IRE 2, 11, 15.S1)

**Frequency Tripler.** A device delivering output voltage at a frequency that is three times the input frequency. (48 IRE 2, 11, 15.S1)

**Fresnel Region.** The region between the antenna and the Fraunhofer region.

*Note:* If the antenna has a well-defined aperture  $D$  in a given aspect, the Fresnel region in that aspect is commonly taken to extend a distance  $2D^2/\lambda$  in that aspect,  $\lambda$  being the wavelength.

(48 IRE 2, 11, 15.S1)

**Front Porch.** That portion of a *Composite Picture Signal* which lies between the leading edge of the horizontal blanking *Pulse* and the leading edge of the corresponding sync *Pulse*. (55 IRE 23. S1)

**Front-to-Rear Ratio.** The ratio of the effectiveness of a directional antenna toward the front and toward the rear. (48 IRE 2, 11, 15.S1)

**Fruit Pulse (Fruit').** A *Pulse Reply* received as the result of interrogation of a transponder by interrogators not associated with the responder in question. (52 IRE 20.S1)

**FS to AM Converter.** See *Receiving Converter, Facsimile*. (56 IRE 9.S1)

**FTC.** Abbreviation for *Fast Time Constant*. (54 IRE 12.S1)

**Function Switch.** A network or system having a number of inputs and outputs and so connected that signals representing information expressed in a certain code, when applied to the inputs, cause output signals to appear which are a representation of the input information in a different code. (50 IRE 8.S1)

**Function Switch, Many-One.** A function switch in which a combination of the inputs is excited at one time to produce a corresponding single output. (50 IRE 8.S1)

<sup>1</sup> Deprecated.

## Gain, Available-Power

**Function Switch, One-Many.** A function switch in which only one input is excited at a time and each input produces a combination of outputs. (50 IRE 8.S1)

**Function Unit.** A device which can store a functional relationship and release it continuously or in increments. (50 IRE 8.S1)

**Fundamental Component.** The fundamental frequency component in the harmonic analysis of a wave. (53 IRE 4.S1)

**Fundamental Frequency.** The reciprocal of the period of a wave. (53 IRE 4.S1)

**Fundamental Tone.** 1) The component in a periodic wave corresponding to the fundamental frequency. (See *Fundamental Frequency*.) 2) The component tone of lowest pitch in a complex tone. (51 IRE 6.S1)

## G

**Gain (General) (Transmission Gain).**

General term used to denote an increase in *Signal* power in transmission from one point to another. *Gain* is usually expressed in decibels and is widely used to denote *Transducer Gain*. (54 IRE 3.S1; 58 IRE 3.S1)

**Gain (Specific).** See:

*Available Conversion Power Gain (of a Conversion Transducer)*

*Available Power Gain (of an Electric Transducer)*

*Insertion Power Gain (of an Electric Transducer)*

*Insertion Voltage Gain (of an Electric Transducer)*

*Conversion Voltage Gain (of a Conversion Transducer)*.

(50 IRE 7.S1)

**Gain of an Antenna (old usage).** The measured gain of one transmitting or receiving antenna over another is the ratio of the signal power one produces at the receiver input terminals to that produced by the other, the transmitting power level remaining fixed. (48 IRE 2, 11, 15.S1)

**Gain, Available Conversion (of a Conversion Transducer).** The ratio of 1) the available output-frequency power from the output terminals of the transducer to 2) the available input-frequency power from the driving generator.

*Note:* The maximum *Available Conversion Gain* of a *Conversion Transducer* is obtained when the input termination admittance, at input frequency, is the conjugate of the input-frequency *Driving Point Admittance* of the *Conversion Transducer*.

(57 IRE 7.S2)

**Gain, Available-Power (of a Two-Port Linear Transducer).** At a specified fre-



## Gain, Available-Power

quency, the ratio of 1) the available signal power from the output *Port* of the transducer, to 2) the available signal power from the input source.

*Note:* The available signal power at the output *Port* is a function of the match between the source impedance and the impedance of the input *Port*.

(57 IRE 7.S2)

**Gain, Available-Power, Maximum (of a Two-Port Linear Transducer).** The gain of the transducer at a specified frequency obtained when the transducer is conjugately matched to source and load.

*Note:* The *Maximum Available-Power Gain* is not defined unless both the input and output impedances of the two-port transducer have positive real parts for arbitrary passive input and output terminations.

(57 IRE 7.S2)

**Gain Control.** A device for adjusting the *Gain* of a system or component. (58 IRE 3.S1)

**Gain-Control, Temporal.** See *Temporal Gain-Control*. (54 IRE 12.S1)

**Gain, Conversion Voltage (of a Conversion Transducer).** The ratio of 1) the magnitude of the output-frequency voltage across the output termination, with the transducer inserted between the input-frequency generator and the output termination, to 2) the magnitude of the input-frequency voltage across the input termination of the transducer. (57 IRE 7.S2)

**Gain, Insertion (of a Two-Port Linear Transducer).** At a specified frequency, the ratio of 1) the actual signal power transferred from the output *Port* of the transducer to its load, to 2) the signal power which the same load would receive if driven directly by the source. (57 IRE 7.S2)

**Gain, Insertion Voltage (of an Electric Transducer).** The complex ratio of 1) the alternating component of voltage across the *External Termination* of the output with the transducer inserted between the generator and the output termination, to 2) the voltage across the *External Termination* of the output when the generator is connected directly to the output termination. (57 IRE 7.S2)

**Gain Time Control.** See *Sensitivity Time Control*. (54 IRE 12.S1)

**Gain, Transducer (of a Two-Port Linear Transducer).** At a specified frequency, the ratio of 1) the actual signal power transferred from the output *Port* of the transducer to its load, to 2) the available signal power from the source driving the transducer. (57 IRE 7.S2)

**Gain Turn Down.** In a *Transponder*, the

## Gamma Correction

automatic receiver gain control incorporated for the purpose of protecting the transmitter from overload. (54 IRE 12.S1)

**Galvanometer Recorder (for Photographic Recording).** A combination of mirror and coil suspended in a magnetic field. The application of a signal voltage to the coil causes a reflected light beam from the mirror to pass across a slit in front of a moving photographic film, thus providing a photographic record of the signal. (51 IRE 6.S1)

**Gamma (Film Recording).** The gamma of a photographic material is the slope of the straight-line portion of the *H and D Curve*. It represents the rate of change of photographic density with the logarithm of exposure. Gamma is a measure of the contrast properties of the film. Both gamma and density specifications are commonly used as controls in the processing of photographic film. (51 IRE 6.S1)

**Gamma (Picture or Camera Tubes).** The exponent of that power law which is used to approximate the curve of output magnitude vs input magnitude over the region of interest.

*Note:* For quantitative evaluation, it is customary to plot the log of the output magnitude (ordinate) vs the log of the input magnitude (abscissa), as measured from a point corresponding to some reference black level, and select a straight line which approximates this plot over the region of interest and takes its slope. If the plot departs seriously from linearity it cannot be adequately described by a single value of *Gamma*. Even when the plot is reasonably linear, the procedure for determining the approximation should be described.

(57 IRE 7.S2)

**Gamma (Television).** In television, the exponent of that power law which is used to approximate the curve of output magnitude vs input magnitude over the region of interest.

*Note:* For quantitative evaluation it is customary to plot the log of the output magnitude (ordinate) vs the log of the input magnitude (abscissa), as measured from a point corresponding to some reference black level, and select a straight line which approximates this plot over the region of interest and take its slope. If the plot departs seriously from linearity it cannot be adequately described by a single value of gamma. Even when the plot is reasonably linear the procedure for determining the approximation should be prescribed.

(55 IRE 22.S1)

**Gamma Correction.** The introduction of a

nonlinear output-input characteristic for the purpose of changing the effective value of *Gamma*. (55 IRE 22.S1)

**Gap.** See:

*Input Gap*

*Interaction Gap*

*Main Gap (Glow-Discharge Tubes)*

*Output Gap*

*Resonant Gap (TR Tubes)*

*Starter Gap (Gas Tubes).*

(57 IRE 7.S2)

**Gap Admittance, Circuit.** The admittance of the circuit at a gap in the absence of an electron stream. (56 IRE 7.S1; 57 IRE 7.S2)

**Gap Admittance, Electronic.** The difference between 1) the gap admittance with the electron stream traversing the gap and 2) the gap admittance with the stream absent. (56 IRE 7.S1; 57 IRE 7.S2)

**Gap Capacitance, Effective.** One half the rate of change with angular frequency of the resonator susceptance, measured at the gap, for frequencies near resonance. (56 IRE 7.S1; 57 IRE 7.S2)

**Gap Coding.** In *Navigation*, a process of communicating information by so interrupting the transmission of an otherwise regular signal that the interruptions form a telegraphic-type message. (54 IRE 12.S1)

**Gap Length.** In longitudinal magnetic recording, the gap length is the physical distance between adjacent surfaces of the poles of a magnetic head. (See *Magnetic Head.*)

*Note:* The effective gap length is usually greater than the physical length and can be experimentally determined in some cases. (51 IRE 6.S1)

**Gap Loading, Multipactor.** The *Electronic Gap Admittance*, resulting from a sustained *Secondary-Emission* discharge existing within a gap as a result of the motion of the secondary electrons in synchronism with the electric field in the gap. (56 IRE 7.S1; 57 IRE 7.S2)

**Gap Loading, Primary Transit-Angle.** The *Electronic Gap Admittance* that results from the traversal of the gap by an initially unmodulated electron stream.

*Note:* This is exclusive of *Secondary Emission* in the gap.

(56 IRE 7.S1; 57 IRE 7.S2)

**Gap Loading, Secondary Electron.** The *Electronic Gap Admittance* which results from the traversal of a gap by secondary electrons originating in the gap. (56 IRE 7.S1; 57 IRE 7.S2)

**Gas Amplification (Radiation-Counter Tubes).** The ratio of the charge collected to the charge liberated by the *Initial Ionizing Event*.

*Note:* See also *Methods of Testing*.

(57 IRE 7.S2)

**Gas Amplification Factor (Gas Phototubes).** The ratio of *Radiant* or *Luminous Sensitivities* with and without ionization of the gas. (57 IRE 7.S2)

**Gas (Ionization) Current (Vacuum Tubes).** A positive-ion current produced by collisions between electrons and residual gas molecules. (57 IRE 7.S2)

**Gaseous Tube Generator.** A power source comprising a gas-filled electron tube oscillator, a power supply, and associated control equipment. (55 IRE 10.S1)

**Gas-Filled Radiation-Counter Tube.** See *Counter Tube, Gas-Filled, Radiation.* (57 IRE 7.S2)

**Gas-Flow Counter Tube.** See *Counter Tube, Gas-Flow.* (57 IRE 7.S2)

**Gas Focusing.** A method of concentrating an electron beam by gas ionization within the beam. (57 IRE 7.S2)

**Gas Ratio.** The ratio of the ion current in a tube to the electron current that produces it. (57 IRE 7.S2)

**Gas Tube.** An *Electron Tube* in which the contained gas or vapor performs the primary role in the operation of the tube. (57 IRE 7.S2)

**Gate (in Electronic Computers).** A circuit having an output and a multiplicity of inputs so designed that the output is energized when and only when certain input conditions are met. See also *And-Gate; Or-Gate.*

*Note:* Sometimes "gate" is used for "and-gate."

(56 IRE 8.S1)

**Gating.** The process of selecting those portions of a wave which exist during one or more selected time intervals or which have magnitudes between selected limits. (53 IRE 11.S1)

**GCA (Ground-Controlled Approach).** A ground *Radar* system providing information by which aircraft approaches may be directed via radio communications. A GCA system consists of a PAR and an SRE. (54 IRE 12.S1)

**GCA (Ground-Controlled Approach).** A *Radar* system by means of which a controller may direct an aircraft to make an interception of another aircraft. (54 IRE 12.S1)

**G-Display (also called G-Scan or G-Scope).** In *Radar*, a rectangular *Display* in which a *Target* appears as a laterally centralized *Blip* when the *Radar* antenna is aimed at it in azimuth and wings appear to grow on the *Blip* as the distance to the *Target* is diminished. Horizontal and vertical aiming errors are respectively indicated by horizontal

## Gear Pattern

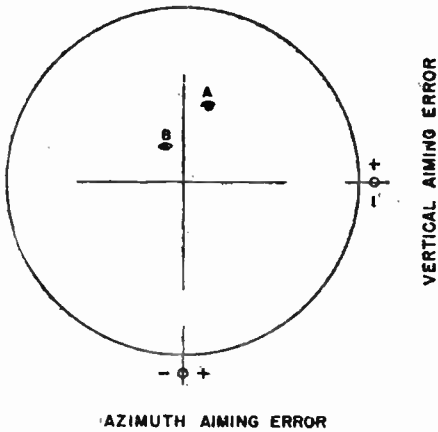

and vertical displacement of the *Blip*. (54 IRE 12.S1)

**Gear Pattern.** See *Drive Pattern*. (56 IRE 9.S1)

**GEE.** A VHF *Radio Navigation* system transmitting synchronized pulses. Hyperbolic *Lines of Position* are determined by the measurement of the difference in the time of arrival of these pulses. (54 IRE 12.S1)

**GEE-H.** A combination of the *GEE* and *H* systems of *Navigation*. (54 IRE 12.S1)

**Geiger-Mueller Counter Tube.** See *Counter Tube*, *Geiger-Mueller*. (57 IRE 7.S2)

**Geiger-Mueller Region (Radiation-Counter Tubes).** See *Region*, *Geiger-Mueller (Radiation-Counter Tubes)*. (57 IRE 7.S2)

**Geiger-Mueller Threshold (Radiation-Counter Tubes).** The lowest applied voltage at which the charge collected per isolated *Tube Count* is substantially independent of the nature of the *Initial Ionizing Event*. (57 IRE 7.S2)

**Generation Rate (in a Semiconductor).** The time rate of creation of electron-hole pairs. (54 IRE 7.S2)

**Generator.** See:  
*Current Generator*  
*Noise-Current Generator*  
*Noise-Voltage Generator*  
*Voltage Generator*.  
 (57 IRE 7.S2)

**Geodesic.** The shortest line between two points measured on any specified surface which includes the points. (54 IRE 12.S1)

**Geometrical Error.** In *Navigation*, 1) *Systematic Error* due to calibrating a system on the basis of spherical rather than oblate spheroidal earth; 2) sometimes used as a synonym for *Ionospheric Height Error*. (54 IRE 12.S1)

**Geometrical Factor.** In *Navigation*, the ratio

## Glue Line Heating

of the change in a navigational coordinate to the change in distance, taken in the direction of maximum navigational coordinate change. That is, the magnitude of the gradient of the navigational coordinate. (54 IRE 12.S1)

**Ghost Pulse.** See *Ghost Signals*. (54 IRE 12.S1)

**Ghost Signals.** 1) In *Loran* and *GEE*, identification pulses which appear on the display at less than full *Repetition Rate*; 2) in *Loran*, signals appearing on the *Display* which have a *Basic Repetition Rate* other than the *Basic Repetition Rate* being observed. (54 IRE 12.S1)

**Gill-Morrell Oscillator.** An oscillator of the retarding-field type in which the frequency of oscillation is dependent not only on electron-transit time within the tube, but also on associated circuit parameters. (48 IRE 2, 11, 15.S1)

**Glide-Path.** The *Path* used by an aircraft in approach procedures as defined by an instrument landing facility. (54 IRE 12, S1)

**Glide-Slope.** An inclined surface which includes a *Glide Path* and which is generated by an instrument-landing facility. (54 IRE 12.S1)

**Glide-Slope Angle.** See *Slope Angle*. (54 IRE 12.S1)

**Glide-Slope Deviation.** The difference between the projection in the vertical plane of the actual *Path* of movement of a *Vehicle* and the planned *Slope* for the *Vehicle*, expressed in terms of either angular or linear measurements. (54 IRE 12.S1)

**Glide-Slope Facility.** The means of providing a *Glide Slope*. (54 IRE 12.S1)

**Glide-Slope Sector.** In an equisignal *Glide-Slope*, the sector containing the *Glide-Slope*, the sector being bounded above and below by *Radial* lines from the *Glide-Slope* transmitter, along each of which *Radial* lines there exists a specified *Difference in Depth of Modulation*. (54 IRE 12.S1)

**Glow Discharge.** A discharge of electricity through a gas, characterized by 1) a space potential in the vicinity of the *Cathode* that is much higher than the ionization potential of the gas; 2) the presence of a *Cathode Glow*. (57 IRE 7.S2)

**Glow-Discharge Cold-Cathode Tube.** A gas tube that depends for its operation on the properties of a glow discharge. (50 IRE 7.S1)

**Glow-Discharge Tube.** A *Gas Tube* that depends for its operation on the properties of a *Glow Discharge*. (57 IRE 7.S2)

**Glue Line Heating (Dielectric Heating usage).** An arrangement of electrodes designed to give preferential heating to a thin

film of material of relatively high loss factor between alternate layers of relatively low loss factor. (55 IRE 10.S1)

**GPI.** See *Ground Position Indicator*. (54 IRE 12.S1)

**Gradient Microphone.** A microphone the output of which corresponds to a gradient of the sound pressure.

*Note:* Gradient microphones may be of any order as, for example, zero, first, second, and so forth. A pressure microphone is a gradient microphone of zero order. A velocity microphone is a gradient microphone of order one. Mathematically, from a directivity standpoint for plane waves, the rms response is proportional to  $\cos n\theta$ , where  $\theta$  is the angle of incidence, and  $n$  is the order of the microphone.

(51 IRE 6.S1)

**Grain.** Of photographic material, a small particle of metallic silver remaining in a photographic emulsion after development and fixing. In the agglomerate, these grains form the dark area of a photographic image. (51 IRE 6.S1)

**Graininess.** Of a photographic material, the visible coarseness under specified conditions due to silver grains in a developed photographic film. (51 IRE 6.S1)

**Grass.** In *Radar*, a descriptive colloquialism used to refer to the indication of *Noise* on an *A* or similar type *Display*. (54 IRE 12.S1)

**Grating Reflector.** An open-work metal structure designed to provide a good reflecting surface. (48 IRE 2, 11, 15.S1)

**Grid (of a Tube).** An *Electrode* having one or more openings for the passage of electrons or ions. See also:

*Control Grid*

*Screen Grid*

*Shield Grid*

*Space-Charge Grid*

*Suppressor Grid.*

(57 IRE 7.S2)

**Grid Bearing.** The angle, usually measured clockwise, between grid north and the initial direction of the arc of a great circle through an observer and a point. (49 IRE 12.S1)

**Grid Bias.** See *Direct Grid Bias*. (57 IRE 7.S2)

**Grid Characteristic.** See *Electrode Characteristic*. (57 IRE 7.S2)

**Grid-Controlled Mercury-Arc Rectifier.** A mercury-arc rectifier in which one or more electrodes are employed exclusively to control the starting of the discharge. (48 IRE 2, 11, 15.S1)

**Grid Course.** A direction of intended travel projected in the horizontal plane expressed as an angle from grid north, usually measured

clockwise. (49 IRE 12.S1)

**Grid Current.** See *Electrode Current*. (57 IRE 7.S2)

**Grid-Drive Characteristic.** A relation between electrical or light output and *Control-Electrode* voltage measured from cutoff. (57 IRE 7.S2)

**Grid Driving Power.** The average product of the instantaneous value of the *Grid Current* and the alternating component of the *Grid Voltage* over a complete cycle.

*Note:* This comprises the power supplied to the biasing device and to the *Grid*.

(57 IRE 7.S2)

**Grid Emission.** Electron or ion emission from a *Grid* of an *Electron Tube*. (57 IRE 7.S2)

**Grid Heading.** A direction in the horizontal plane expressed as an angle from *Grid North* to a line along which a vehicle is pointed, usually measured clockwise. (49 IRE 12.S1)

**Grid Modulation.** Modulation produced by the introduction of the modulating signal into the control-grid circuit of any tube in which the carrier is present. (48 IRE 2, 11, 15.S1)

**Grid Neutralization.** The method of neutralizing an amplifier in which a portion of the grid-cathode alternating-current voltage is shifted  $180^\circ$  and applied to the plate-cathode circuit through a neutralizing capacitor. (48 IRE 2, 11, 15.S1)

**Grid North.** An arbitrary reference direction used in connection with the *Grid System* of navigation. The reference direction is the top of a grid which, for polar navigation, is a grid of rectangular coordinates superimposed over the polar regions. One line on this grid coincides with the Greenwich Meridian. North of this grid is the direction upward on the chart, usually the direction of the North Pole from Greenwich. (49 IRE 12.S1)

**Grid Pulse Modulation.** Modulation produced in an amplifier or oscillator by application of one or more pulses to a grid circuit. (48 IRE 2, 11, 15.S1)

**Grid Voltage.** See *Electrode Voltage*. (57 IRE 7.S2)

**Groove.** In mechanical recording, the track inscribed in the record by the cutting or embossing stylus, including undulations or modulations caused by the vibration of the stylus. (51 IRE 6.S1)

**Groove Angle.** In disk recording, the angle between the two walls of an unmodulated groove in a radial plane perpendicular to the surface of the recording medium. (51 IRE 6.S1)

**Groove Diameter.** See *Tape-Wound Core*. (59 IRE 8.S1)

**Groove Shape.** In disk recording, the contour of the groove in a radial plane perpendicular

to the surface of the recording medium. (51 IRE 6.S1)

**Groove Speed.** In disk recording, the linear speed of the groove with respect to the stylus. (51 IRE 6.S1)

**Groove Width.** See *Tape-Wound Core*. (59 IRE 8.S1)

**Ground Clutter.** *Clutter* resulting from the ground or objects on the ground. (54 IRE, 12.S1)

**Ground Controlled Approach (GCA).** A ground radar system providing information by which aircraft approaches may be directed via radio communications. (49 IRE 12.S1)

**Ground Distance.** The mean sea-level great-circle component of distance from one point to another. (54 IRE 12.S1)

**Grounded-Cathode Amplifier.** An electron-tube amplifier with the cathode at ground potential at the operating frequency, with input applied between the control grid and ground, and the output load connected between plate and ground. (This is the conventional amplifier circuit.) (48 IRE 2, 11, 15.S1)

**Grounded-Grid Amplifier.** An electron-tube amplifier circuit in which the control grid is at ground potential at the operating frequency, with input applied between cathode and ground, and output load connected between plate and ground. The grid-to-plate impedance of the tube is in parallel with the load instead of acting as a feedback path. (48 IRE 2, 11, 15.S1)

**Grounded-Plate Amplifier (Cathode Follower).** An electron-tube amplifier circuit in which the plate is at ground potential at the operating frequency, with input applied between control grid and ground, and the output load connected between cathode and ground. (48 IRE 2, 11, 15.S1)

**Ground Equalizer Inductors.** Coils of relatively low inductance, placed in the circuit connected to one or more of the grounding points of an antenna to distribute the current to the various points in any desired manner. (48 IRE 2, 11, 15.S1)

**Ground Noise.** In recording and reproducing, the residual system noise in the absence of the signal. It is usually caused by inhomogeneity in the recording and reproducing media, but may also include amplifier noise such as tube noise or noise generated in resistive elements in the input of the reproducer amplifier system. (51 IRE 6.S1)

**Ground-Position Indicator (GPI).** A dead-reckoning tracer, similar to an air position indicator with provision for taking account of drift. (49 IRE 12.S1)

A computer, similar to an *Air Position*

*Indicator*, with provision for taking account of drift. (54 IRE 12.S1)

**Ground Return (Radar).** See *Ground Clutter*. (54 IRE 12.S1)

**Ground Speed.** In *Navigation*, the speed of a *Vehicle* along its track. (54 IRE 12.S1)

**Ground Surveillance Radar.** A radar set operated at a fixed point for observation and control of the position of aircraft or other vehicles in the vicinity. (49 IRE 12.S1)

**Ground System of an Antenna.** That portion of an antenna, closely associated with and including an extensive conducting surface, which may be the earth itself. (48 IRE 2, 11, 15.S1)

**Ground Wave.** A radio wave that is propagated over the earth and is ordinarily affected by the presence of the ground and the troposphere. The ground wave includes all components of a radio wave over the earth except ionospheric and tropospheric waves.

*Note:* The ground wave is refracted because of variations in the dielectric constant of the troposphere including the condition known as a surface duct.

(50 IRE 24.S1)

**Grouping (in Facsimile).** Periodic error in the spacing of *Recorded Lines*. (56 IRE 9.S1)

**Grouping (in Recording).** Nonuniform spacing between the grooves of a disk recording. (51 IRE 6.S1)

**Group Velocity.** Of a traveling plane wave, the velocity of propagation of the envelope of a wave occupying a frequency band over which the envelope delay is approximately constant. It is equal to the reciprocal of the rate of change of phase constant with angular frequency.

*Note:* Group velocity differs from phase velocity in a medium in which the phase velocity varies with frequency.

(50 IRE 24.S1)

**Guard Circle.** An inner concentric groove inscribed, on disk records, to prevent the pickup from being damaged by being thrown to the center of the record. (51 IRE 6.S1)

**Guided Wave.** A wave whose energy is concentrated near a boundary, or between substantially parallel boundaries, separating materials of different properties, and whose direction of propagation is effectively parallel to these boundaries. (50 IRE 24.S1)

## H

**H.** A *Radar* air-*Navigation*-system using an airborne *Interrogator* to measure distance from two ground *Responder-Beacons*.

*Note:* See *Shoran*. *H* is also a name applied to certain *Aerophares*.

(54 IRE 12.S1)

## Half Adder

**Half Adder.** A circuit having two input and two output channels for binary signals (0, 1) and in which the output signals are related to the input signals according to Table V. (So called because two half adders can be used in the construction of one binary Adder.) (56 IRE 8.S1)

TABLE V

Input To		Output From		
A	B	S	C	
0	0	0	0	A →
0	1	1	0	
1	0	1	0	
1	1	0	1	

### Half-Power Width of a Radiation Lobe.

In a plane containing the direction of the maximum of the lobe, the full angle between the two directions in that plane about the maximum in which the radiation intensity is one-half the maximum value of the lobe. (48 IRE 2, 11, 15.S1)

### Halftone Characteristic.

A relation between the *Density* of the recorded copy and the *Density of the Subject Copy*.  
*Note:* The term may also be used to relate the amplitude of the *Facsimile Signal* to the *Density of the Subject Copy* or the record copy when only a portion of the system is under consideration. In a frequency-modulation system an appropriate parameter is to be used instead of the amplitude. (56 IRE 9.S1)

### Hall Constant (of an Electrical Conductor).

The constant of proportionality  $R$  in the relation  $E_h = R J \times H$ , where  $E_h$  = transverse electric field (Hall field)

$J$  = current density

$H$  = magnetic field.

*Note:* The sign of the *Majority Carrier* can be inferred from the sign of the *Hall Constant*. (54 IRE 7.S2)

### Harmonic.

A sinusoidal component of a periodic wave. (53 IRE 4.S1)

### Harmonic Conversion Transducer (Frequency Multiplier, Frequency Divider).

A *Conversion Transducer* in which the output-signal frequency is a multiple or sub-multiple of the input frequency.

*Note 1:* In general, the output-signal amplitude is a nonlinear function of the input-signal amplitude.

*Note 2:* Either a *Frequency Multiplier* or a *Frequency Divider* is a special case of *Harmonic Conversion Transducer*. (51 IRE 20.S2; 57 IRE 7.S2)

## H-Display

**Harmonic Distortion.** Nonlinear distortion characterized by the appearance in the output of harmonics other than the fundamental component when the input wave is sinusoidal. See *Distortion, Harmonic*.

*Note:* Also sometimes called *Amplitude Distortion*.

(52 IRE 17.S1; 53 IRE 4.S1; 58 IRE 3.S1)

**Harmonic Leakage Power (TR and Pre-TR Tubes).** The total radio-frequency power transmitted through the *Fired Tube* in its *Mount* at frequencies other than the fundamental frequencies generated by the transmitter. (57 IRE 7.S2)

**Harmonic Series of Sounds.** One in which each basic frequency in the series is an integral multiple of a fundamental frequency. (51 IRE 6.S1)

**Hartley.** A unit of *Information Content* equal to the *Information Content* of a message, the *a priori* probability of which is one-tenth.

*Note:* If, in the definition of *Information Content*, the logarithm is taken to the base ten, the result will be expressed in *Hartleys*. (58 IRE 11.S1)

**Hartley Oscillator.** An oscillator in which the parallel-tuned tank circuit is connected between grid and plate, the inductive element of the tank having an intermediate tap at cathode potential, and the necessary feedback voltage obtained across the grid-cathode portion of the inductor. (48 IRE 2, 11, 15.S1)

### H and D Curve (Hurter and Driffield Curve).

A characteristic curve of a photographic emulsion which is a plot of density against the logarithm of exposure. It is used for the control of photographic processing, and for defining the response characteristics to light of photographic emulsions. (51 IRE 6.S1)

### H-Display (also H-Scan or H-Scope). In

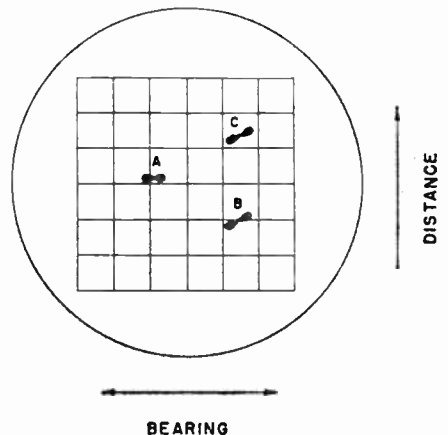

## Heading

## Hold

**Radar**, a *B-Display* modified to include indication of angle of elevation. The *Target* appears as two closely spaced *Blips* which approximate a short bright line, the slope of which is in proportion to the sine of the angle of elevation. (54 IRE 12.S1)

**Heading**. The horizontal *Direction* in which a *Vehicle* is directed, expressed as an angle between a *Reference Line* and the line extending in the *Direction* the *Vehicle* is headed, usually measured clockwise from the *Reference Line*. (54 IRE 12.S1)

**Hearing Loss (Deafness)**. The hearing loss of an ear at a specified frequency is the ratio, expressed in decibels, of the threshold of audibility for that ear to the normal threshold. See also "Proposed American Standard Specification for Audiometers for General Diagnostic Purposes, Z24.5/158." (51 IRE 6.S1)

**Hearing Loss for Speech**. The difference in decibels between the speech levels at which the average normal ear and the defective ear respectively reach the same intelligibility, often arbitrarily set at 50 per cent. (51 IRE 6.S1)

**Heater**. An electric heating *Element* for supplying heat to an indirectly heated *Cathode*. (57 IRE 7.S2)

**Heater Coil**. See *Load Coil (Induction Heating usage)*. (55 IRE 10.S1)

**Heater Current**. The current flowing through a heater. (50 IRE 7.S1)

**Heater Voltage**. The voltage between the terminals of a heater. (50 IRE 7.S1)

**Heater Warm-Up Time**. See methods of test (to be published). (57 IRE 7.S2)

**Heating Pattern**. The distribution of temperature in a *Load* or *Charge*. (55 IRE 10.S1)

**Heating Station**. Location which includes *Work Coil* or *Applicator* and its associated production equipment. (55 IRE 10.S1)

**Heating Time (Vacuum Tubes)**. See *Cathode Heating Time (Vacuum Tubes)*. (57 IRE 7.S2)

**Heat Loss**. The part of the *Transmission Loss* due to the conversion of electric energy into heat. (53 IRE 2.S1)

**Height Error**. See *Ionosphere Height Error*. (54 IRE 12.S1)

**Height Error, Ionospheric**. See *Ionospheric Height Error*. (54 IRE 12.S1)

**Height Markers (Radar)**. See *Calibration Markers*. (54 IRE 12.S1)

**Heptode**. A seven-electrode *Electron Tube* containing an *Anode*, a *Cathode*, a *Control Electrode*, and four additional *Electrodes* that are ordinarily *Grids*. (57 IRE 7.S2)

**Heterodyne Conversion Transducer (Con-**

**verter)**. A *Conversion Transducer* in which the output frequency is the sum or difference of 1) the input frequency and 2) an integral multiple of the local oscillator frequency.

*Note*: The frequency and voltage or power of the local oscillator are parameters of the *Conversion Transducer*. Ordinarily, the output-signal amplitude is a linear function of the input-signal amplitude over its useful operating range.

(51 IRE 20.S2; 57 IRE 7.S2)

**Hexadecimal**. See *Positional Notation*. (56 IRE 8.S1)

**Hexode**. A six-electrode *Electron Tube* containing an *Anode*, a *Cathode*, a *Control Electrode*, and three additional *Electrodes* that are ordinarily *Grids*. (57 IRE 7.S2)

**High-Frequency Induction Heater or Furnace**. A device for causing electric current flow in a *Charge* to be heated, the frequency of the current being higher than that customarily distributed over commercial networks. (55 IRE 10.S1)

**High-Level Firing Time (Switching Tubes)**. The time required to establish a radio-frequency discharge in the tube after the application of radio-frequency power. (57 IRE 7.S2)

**High-Level Modulation**. Modulation produced at a point in a system where the power level approximates that at the output of the system. (48 IRE 2, 11, 15.S1)

**High-Level Radio-Frequency Signal (TR, ATR, and Pre-TR Tubes)**. A radio-frequency signal of sufficient power to cause the tube to become fired. (57 IRE 7.S2)

**High-Level VSWR (Switching Tubes)**. The VSWR due to a *Fired Tube* in its *Mount* located between a generator and matched termination in the waveguide. (57 IRE 7.S2)

**High-Pass Filter**. See *Filter, High-Pass*. (58 IRE 3.S1)

**High-Speed Carry**. See *Carry*. (56 IRE 8.S1)

**High-Velocity Scanning**. See *Scanning, High-Velocity*. (57 IRE 7.S2)

**Hiss**. Random *Noise* in the *Audio-Frequency* range, having subjective characteristics analogous to prolonged sibilant sounds. (58 IRE 3.S1)

**H Network**. A network composed of five branches, two connected in series between an input terminal and an output terminal, two connected in series between another input terminal and output terminal, and the fifth connected from the junction point of the first two branches to the junction point of the second two branches. (50 IRE 4.S1)

**Hold (Charge-Storage Tubes)**. To maintain

## Holding Beam

*Storage Elements* at equilibrium potentials by electron bombardment. (57 IRE 7.S2)

**Holding Beam.** A diffuse beam of electrons for regenerating the charges retained on the dielectric surface of an electrostatic memory or storage tube. (50 IRE 8.S1)

**Hole.** A mobile vacancy in the electronic valence structure of a semiconductor which acts like a positive electronic charge with a positive mass. (54 IRE 7.S2)

**Homing.** 1) The process of approaching a desired point by maintaining constant some indicated navigational parameter (other than altitude). 2) In missile guidance, the use of radiation from a *Target* to establish a collision course. (54 IRE 12.S1)

**Horizontally Polarized Wave.** A linearly polarized wave whose electric field vector is horizontal. (50 IRE 24.S1)

**Horizontal Ring Induction Furnace.** A device for melting metal comprising an angular horizontally-placed open trough or *Melting Channel*, a primary inductor winding and a magnetic core which links the *Melting Channel* with the primary winding. (55 IRE 10.S1)

**Horn Loudspeaker.** A loudspeaker in which the radiating element is coupled to the medium by means of a horn. (51 IRE 6.S1)

**Horn Mouth.** Normally the end of a horn with the larger cross-sectional area. (51 IRE 6.S1)

**Horn Radiator.** A radiating element having the shape of a horn. (48 IRE 2, 11, 15.S1)

**Horn Throat.** Normally the end of a horn with the smaller cross-sectional area. (51 IRE 6.S1)

**Hot Cathode (Thermionic Cathode).** A *Cathode* that functions primarily by the process of *Thermionic Emission*. (57 IRE 7.S2)

**Hot-Cathode Tube.** An *Electron Tube* containing a *Hot Cathode*. (57 IRE 7.S2)

**Hot-Wire Microphone.** A microphone which depends for its operation on the change in resistance of a hot wire produced by the cooling or heating effects of a sound wave. (51 IRE 6.S1)

**H-Plane Bend.** For a rectangular uniconductor waveguide operating in the dominant mode, a bend in which the longitudinal axis of the guide remains in a plane parallel to the plane of the magnetic field vector throughout the bend. (55 IRE 2.S1)

**H-Plane Tee Junction.** For a rectangular uniconductor waveguide, a tee junction of which the magnetic field vector of the dominant wave of each arm is parallel to the plane of the longitudinal axes of the guides. (55 IRE 2.S1)

## Hydrophone

**Hue.** The attribute of color perception that determines whether it is red, yellow, green, blue, purple, or the like.

*Note 1:* This is a subjective term corresponding to the psychophysical term *Dominant* (or *Complementary*) *Wavelength*.

*Note 2:* White, black, and gray are not considered as being hues.

(55 IRE 22.S1)

**Hum.** Electrical disturbance at the power supply frequency or harmonics thereof. (52 IRE 17.S1; 58 IRE 3.S1)

**Hum Modulation.** Modulation of a radio-frequency or detected signal by hum. (52 IRE 17.S1)

**Hybrid Coil.** A single transformer which performs the essential function of a *Hybrid Set*. (58 IRE 3.S1)

**Hybrid Electromagnetic Wave (HEM Wave).** An *Electromagnetic Wave* having components of both the electric and magnetic field vectors in the *Direction of Propagation*. (53 IRE 2.S1)

**Hybrid Junction.** Waveguide arrangement with four branches which, when branches are properly terminated, has the property that energy can be transferred from any one branch into only two of the remaining three.

*Note:* In common usage, this energy is equally divided between the two branches.

(55 IRE 2.S1)

**Hybrid Set.** Two or more transformers interconnected to form a *Network* having four pairs of accessible terminals to which may be connected four impedances so that electrical energy introduced into the *Network* at any one pair of terminals ideally divides between two of the other pairs with no transfer of energy to the fourth. (58 IRE 3.S1)

**Hybrid Tee.** A *Hybrid Junction* composed of an *E-H Tee* with internal matching elements which is reflectionless for a wave propagating into the junction from any arm when the other three arms are match terminated. (55 IRE 2.S1)

**Hydrophone.** An electroacoustic transducer which responds to water-borne sound waves and delivers essentially equivalent electric waves.

*Note:* In a manner similar to the use of the adjective "line" in the definition of *Line Hydrophone* and *Line Microphone*, the adjectives "pressure," "velocity," "gradient," "omnidirectional," "unidirectional," "carbon," "capacitor," "crystal," "magnetic," "magnetostriction," "moving-coil," and "moving-conductor," when applied to a hydrophone, having meanings similar to those that apply in the case of a microphone.



## Hyperbolic Flare-Out

See also *Pressure Microphone*, and so forth. (51 IRE 6.S1)

**Hyperbolic Flare-Out.** A *Flare-Out* obtained by changing the *Glide Slope* from a straight line to a hyperbolic curve (at an appropriate distance) from touchdown. (54 IRE 12.S1)

**Hysteresis (of an Oscillator).** A behavior that may appear in an oscillator wherein multiple values of the output power and/or frequency correspond to given values of an operating parameter. (56 IRE 7.S1; 57 IRE 7.S2)

**Hysteresis (Radiation-Counter Tubes).** The temporary change in the *Counting-Rates vs Voltage Characteristic* caused by previous operation. (57 IRE 7.S2)

**Hysteresis Heater.** An induction device in which a *Charge* or a muffle about the *Charge* is heated principally by hysteresis losses due to a magnetic flux which is produced in it. *Note:* A distinction should be made between *Hysteresis Heating* and the enhanced *Induction Heating* in a *Magnetic Charge*. (55 IRE 10.S1)

**Hysteresis Loop.** For a magnetic material in a *Cyclically Magnetized Condition*, a curve (usually with rectangular coordinates) showing, for each value of the magnetizing force, two values of the magnetic flux density—one when the magnetizing force is increasing, the other when it is decreasing. (59 IRE 8.S1)

## I

**ICI—Deprecated.** See *CIE*. (55 IRE 22.S1)

**Iconoscope.** A *Camera Tube* in which a beam of high-velocity electrons scans a photoemissive mosaic which is capable of storing an electrical charge pattern. (57 IRE 7.S2)

**ICW.** (An abbreviation for “interrupted continuous wave.”) A continuous wave that is interrupted at a constant audio-frequency rate. (48 IRE 2, 11, 15.S1)

**Ideal Noise Diode.** A *Diode* that has an infinite internal impedance and in which the current exhibits *Full Shot Noise* fluctuations. (57 IRE 7.S2)

**Ideal Transducer.** See *Transducer, Ideal*. (58 IRE 3.S1)

**Ideal Transducer (for connecting a Specified Source to a Specified Load).** A hypothetical passive transducer which transfers the maximum possible power from the source to the load.

*Note:* In linear transducers having only one input and one output, and for which the impedance concept applies, this is equivalent to a transducer which 1) dissipates no energy and 2) when connected to the specified

## Ignitor-Current, Drift

source and load presents to each its conjugate impedance.

(51 IRE 20.S2)

**Ideal Transformer.** See *Transformer, Ideal*. (58 IRE 3.S1)

**Identification.** In *Radar*, the process of determining the identity of a particular displayed *Target* (Who are you?) or the determination of which, of a number of *Blips*, represents a specific *Target* (Where are you?). (54 IRE 12.S1)

**I-Display (also I-Scan or I-Scope).** In *Radar*, a *Display* in which a *Target* appears as a complete circle when the *Radar* antenna is correctly pointed at it and in which the radius of the circle is proportional to *Target* distance. When not correctly pointing at the

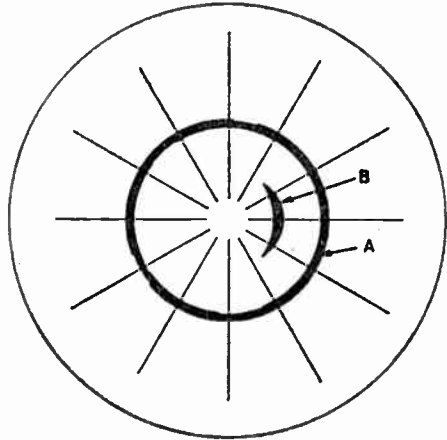

TWO TARGETS (A,B)  
AT DIFFERENT DISTANCES.  
RADAR AIMED ON TARGET A

*Target*, the circle reduces to a segment of a circle, the segment length being inversely proportional to the magnitude of the pointing error and its angular *Position* being reciprocal to the *Direction* of pointing error. (54 IRE 12.S1)

**IF.** See *Intermediate Frequency*. (52 IRE 17.S1)

**Ignitor.** See *Ignitor Electrode (Switching Tubes)*. (57 IRE 7.S2)

**Ignitor Current.** See *Electrode Current*. (57 IRE 7.S2)

**Ignitor-Current Temperature Drift (TR, Pre-TR, and Attenuator Tubes).** The variation in *Ignitor Electrode* current caused by a change in ambient temperature of the tube. (57 IRE 7.S2)

## Ignitor Discharge

**Ignitor Discharge (Switching Tubes).** A dc *Glow Discharge*, between the *Ignitor Electrode* and a suitably located *Electrode*, used to facilitate radio-frequency ionization. (57 IRE 7.S2)

**Ignitor Electrode (Switching Tubes).** An *Electrode* used to initiate and sustain the *Ignitor Discharge*. (57 IRE 7.S2)

**Ignitor Firing Time (Switching Tubes).** The time interval between the application of a direct voltage to the *Ignitor Electrode* and the establishment of the *Ignitor Discharge*. (57 IRE 7.S2)

**Ignitor Interaction (TR, Pre-TR, and Attenuator Tubes).** The difference between the *Insertion Loss* measured at a specified *Ignitor Current* and that measured at zero *Ignitor Current*. (57 IRE 7.S2)

**Ignitor Leakage Resistance (Switching Tubes).** The insulation resistance, measured in the absence of an *Ignitor Discharge*, between the *Ignitor Electrode* terminal and the adjacent radio-frequency *Electrode*. (57 IRE 7.S2)

**Ignitor Oscillations (TR, Pre-TR, and Attenuator Tubes).** Relaxation oscillations in the *Ignitor* circuit.

*Note:* If present, these oscillations may limit the tube's characteristics.  
(57 IRE 7.S2)

**Ignitor Voltage Drop (Switching Tubes).** The direct voltage between the *Cathode* and the *Anode* of the *Ignitor Discharge* at a specified *Ignitor Current*. (57 IRE 7.S2)

**Illuminance (Illumination).** The density of the luminous flux on a surface; it is the quotient of the flux by the area of the surface when the latter is uniformly illuminated. (55 IRE 22.S1)

**ILS (Instrument Landing System).** A system of *Radio Navigation* stations providing a means of instrument-low-approach utilizing a VHF *Localizer*, a UHF *Glide-Slope* station, and marker. (54 IRE 12.S1)

**Image Converter Tube.** See *Image Tube*. (57 IRE 7.S2)

**Image Dissector Tube (Dissector Tube).** A *Camera Tube* in which an electron image produced by a photoemitting surface is focused in the plane of a defining aperture and is scanned past that aperture. (57 IRE 7.S2)

**Image Frequency.** In heterodyne frequency converters in which one of the two sidebands produced by beating is selected; an undesired input frequency capable of producing the selected frequency by the same process.

*Note:* The word "image" implies the mirror-like symmetry of signal and image frequencies about the beating oscillator fre-

## Impedance, Iterative

quency or the intermediate frequency, whichever is the higher.

(52 IRE 17.S1)

**Image Iconoscope.** A *Camera Tube* in which an electron image is produced by a photoemitting surface and focused on one side of a separate storage *Target* which is scanned on the same side by an electron beam, usually of high-velocity electrons. (57 IRE 7.S2)

**Image Impedances.** See *Impedances, Image*. (58 IRE 3.S1)

**Image Orthicon.** A *Camera Tube* in which an electron image is produced by a photoemitting surface and focused on one side of a separate storage *Target* which is scanned on its opposite side by an electron beam, usually of low-velocity electrons. (57 IRE 7.S2)

**Image Ratio.** The ratio of 1) the field strength at the image frequency to 2) the field strength at the desired frequency, each field being applied in turn, under specified conditions, to produce equal outputs. (52 IRE 17.S1)

**Image Tube (Image Converter Tube).** An *Electron Tube* which reproduces on its fluorescent screen an image of an irradiation pattern incident on its photosensitive surface. (57 IRE 7.S2)

**Impedance. Sec:**

*Cathode Coating Impedance*

*Cathode Interface (Layer) Impedance*

*Electrode Impedance*

*Interaction Impedance (Traveling-Wave Tubes).*

(57 IRE 7.S2)

**Impedance Compensator.** A device designed to be associated with a transducer for the purpose of giving the impedance of the combination a desired characteristic with frequency over a desired frequency range. (42 IRE 9.S1)

**Impedance, Input.** The impedance presented by the *Transducer* to a *Source*. (58 IRE 3.S1)

**Impedance, Iterative.** That impedance which, when connected to one pair of terminals of a *Transducer*, produces an identical impedance at the other pair of terminals.

*Note 1:* It follows that the *Iterative Impedance* of a *Transducer* is the same as the impedance measured at the input terminals when an infinite number of identically similar *Transducers* are formed into an iterative or recurrent structure of infinite length by connecting the output terminals of the first *Transducer* to the input terminals of the second, the output terminals of the second to the input terminals of the third, etc.

*Note 2:* The *Iterative Impedances* of a four-terminal *Transducer*, are, in general, not

## Impedance, Load

equal to each other but for any symmetrical *Transducer* the *Iterative Impedances* are equal and are the same as the *Image Impedances*. The *Iterative Impedance* of a uniform line is the same as its characteristic impedance.

(58 IRE 3.S1)

**Impedance, Load.** The impedance presented by the *Load* to a *Transducer*. (58 IRE 3.S1)

**Impedance, Output.** The impedance presented by the *Transducer* to a *Load*. (58 IRE 3.S1)

**Impedances, Conjugate.** Impedances having resistive components which are equal, and reactive components which are equal in magnitude but opposite in sign. (58 IRE 3.S1)

**Impedances, Image.** The impedances which will simultaneously terminate all inputs and outputs of a *Transducer* in such a way that at each of its inputs and outputs the impedances in both directions are equal.

*Note:* The *Image Impedances* of a four-terminal *Transducer* are, in general, not equal to each other, but for any symmetrical *Transducer*, the *Image Impedances* are equal, and are the same as the *Iterative Impedances*.

(58 IRE 3.S1)

**Impedance, Source.** The impedance presented by the *Source* to a *Transducer*. (58 IRE 3.S1)

**Imperfection (of a Crystalline Solid).** Any deviation in structure from that of an ideal crystal.

*Note:* An ideal crystal is perfectly periodic in structure and contains no foreign atoms.

(54 IRE 7.S2)

**Improvement Threshold.** That value of carrier-to-noise ratio below which the signal-to-noise ratio decreases more rapidly than the carrier-to-noise ratio. (53 IRE 11.S1)

**Impulse Excitation.** A method of producing oscillator current in a circuit in which the duration of the impressed voltage is relatively short compared with the duration of the current produced. (48 IRE 2, 11, 15.S1)

**Impulse Noise.** Noise characterized by transient disturbances separated in time by quiescent intervals. The frequency spectrum of these disturbances must be substantially uniform over the useful pass band of the transmission system. (48 IRE 2, 11, 15.S1)

**Impurity (Chemical).** An atom within a crystal which is foreign to the crystal. (54 IRE 7.S2)

**Impurity, Acceptor (in a Semiconductor).** An impurity which may induce hole conduction. (54 IRE 7.S2)

**Impurity, Donor (in a semiconductor).**

## Induction Loudspeaker

An impurity which may induce electronic conduction. (54 IRE 7.S2)

**Impurity, Stoichiometric.** A crystalline imperfection arising from a deviation from stoichiometric composition. (54 IRE 7.S2)

**Incident Wave.** In a medium of certain propagation characteristics, a wave which impinges on a discontinuity or a medium of different propagation characteristics. (50 IRE 24.S1; 53 IRE 2.S1)

**Incoherent Scattering.** When radio waves encounter matter, a disordered change in the direction of propagation of the waves. (50 IRE 24.S1)

**Index of Cooperation, Scanning or Recording Line (in Facsimile).** In rectilinear *Scanning* or *Recording*, the product of the total length of a scanning or recording line by the number of scanning or recording lines per unit length.

*Note 1:* The International Index of Cooperation (diametral index of cooperation) is based on drum diameter and is defined by the International Radio Consultative Committee (CCIR). It is  $1/\pi$  times the *Scanning Line Index of Cooperation*.

*Note 2:* For a scanner and recorder to be compatible the *Indices of Cooperation* must be the same.

(56 IRE 9.S1)

**Indicated Course Error.** In *Navigation*, an instrumental error resulting in a discrepancy between the actual *Line of Position*, offered by a navigation facility, and the intended *Line of Position*. (54 IRE 12.S1)

**Indicator Tube.** An *Electron-Beam Tube* in which useful information is conveyed by the variation in cross section of the beam at a luminescent target. (57 IRE 7.S2)

**Indirectly Heated Cathode (Equipotential Cathode, Unipotential Cathode).** A *Cathode* of a *Thermionic Tube* to which heat is supplied by an independent *Heater Element*. (57 IRE 7.S2)

**Induced Current (Induction Heating usage).** Current in a conductor due to the application of a time-varying electromagnetic field. (55 IRE 10.S1)

**Induction-Conduction Heater.** A heating device in which electric current is conducted through but is restricted by induction to a preferred path in a charge. (55 IRE 10.S1)

**Induction Heating.** The heating of a nominally conducting material in a varying electromagnetic field due to its internal losses. (55 IRE 10.S1)

**Induction Loudspeaker.** A loudspeaker in which the current which reacts with the

## Induction Ring Heater

steady magnetic field is induced in the moving member. (51 IRE 6.S1)

**Induction Ring Heater.** A form of *Core-Type Induction Heater* adapted principally for heating electrically conducting *Charges* of ring or loop form, the core being open or separable to facilitate linking the *Charge*. (55 IRE 10.S1)

**Inductive (Shunt, Coil) Neutralization.** A method of neutralizing an amplifier whereby the feedback susceptance due to the plate-to-grid capacitance is cancelled by the equal and opposite susceptance of an inductor. (48 IRE 2, 11, 15.S1)

**Inflection-Point Emission Current.** That value of current on the *Diode Characteristic* for which the second derivative of the current with respect to the voltage is zero.

*Note:* This current corresponds to the inflection point of the *Diode Characteristic* and is, under suitable conditions, an approximate measure of the maximum space-charge-limited emission current.

(57 IRE 7.S2)

**Information Content (of a Message or a Symbol from a Source).** The negative of the logarithm of the probability that this particular *Message* or symbol will be emitted from the source.

*Note 1:* The choice of logarithmic base determines the unit of *Information Content*. See *Bit* and *Hartley*.

*Note 2:* The probability of a given *Message* or symbol being emitted may depend on one or more preceding *Messages* or symbols.

*Note 3:* The quantity has been called *Self-Information*.

(58 IRE 11.S1)

**Information Rate (through a Channel, per Second).** The product of the *Average Transinformation per Symbol* and the average number of symbols per second. (58 IRE 11.S1)

**Information Rate (through a Channel, per Symbol).** See *Average Transinformation*. (58 IRE 11.S1)

**Information Rate (from a Source, per Second).** The product of the *Average Information Content per Symbol* and the average number of symbols per second. (58 IRE 11.S1)

**Information Rate (from a Source, per Symbol).** See *Average Information Content*. (58 IRE 11.S1)

**Infrasonic Frequency (Subsonic Frequency—Deprecated).** A frequency lying below the audio-frequency range.

*Note:* The word "infrasonic" may be used as a modifier to indicate a device or system in-

## Insertion Gain

tended to operate at infrasonic frequencies. (51 IRE 6.S1)

**Inhibiting Input.** A *Gate* input which, if in its prescribed state, prevents any output which might otherwise occur. (56 IRE 8.S1)

**Inhibit Pulse.** A *Drive Pulse* that tends to prevent flux reversal of a magnetic cell by certain specified *Drive Pulses*. (59 IRE 8.S1)

**Initial Ionizing Event (Radiation-Counter Tubes).** An ionizing event that initiates a *Tube Count*. (57 IRE 7.S2)

**Ink Vapor Recording.** That type of *Recording* in which vaporized ink particles are directly deposited upon the *Record Sheet*. (56 IRE 9.S1)

**Input Capacitance (n-Terminal Electron Tubes).** The *Short-Circuit Transfer Capacitance* between the input terminal and all other terminals, except the output terminal, connected together.

*Note:* This quantity is equivalent to the sum of the *Interelectrode Capacitances* between the input *Electrode* and all other *Electrodes* except the output *Electrode*.

(57 IRE 7.S2)

**Input Equipment (in Computers).** The equipment used for introducing information into a computer. (50 IRE 8.S1)

**Input Gap.** An *Interaction Gap* used to initiate a variation in an electron stream. (56 IRE 7.S1; 57 IRE 7.S2)

**Input Impedance.** See *Impedance, Input*. (58 3.S1)

**Input Impedance of a Transmission Line.** The *Impedance* between the input terminals with the generator disconnected. (53 IRE 2.S1)

**Inscriber.** Input transcriber. (50 IRE 8.S1)

**Insert Earphones.** Small earphones which fit partially inside the ear. (51 IRE 6.S1)

**Insertion Gain.** Resulting from the insertion of a *Transducer* in a transmission system, the ratio of the power delivered to that part of the system following the *Transducer* to the power delivered to that same part before insertion of the *Transducer*.

*Note 1:* If the input and/or *Output Power* consist of more than one component, such as multifrequency *Signal* or *Noise*, then the particular components used and their weighting must be specified.

*Note 2:* This *Gain* is usually expressed in decibels.

*Note 3:* The "insertion of a *Transducer*" includes bridging of an impedance across the transmission system.

(54 IRE 3.S1; 58 IRE 3.S1)

**Insertion Gain (of a Two-Port Linear Transducer).** See *Gain, Insertion (of a Two-*

## Insertion Loss

*Port Linear Transducer*). (57 IRE 7.S2)

**Insertion Loss (General).** Resulting from the insertion of a *Transducer* in a transmission system, the ratio of the power delivered to that part of the system following the *Transducer*, before insertion of the *Transducer*, to the power delivered to that same part of the system after insertion of the *Transducer*.

*Note 1:* If the input and/or *Output Power* consist of more than one component, such as multifrequency *Signal* or *Noise*, then the particular components used and their weighting must be specified.

*Note 2:* This *Loss* is usually expressed in decibels.

*Note 3:* The "insertion of a *Transducer*" includes bridging of an impedance across the transmission system.

(54 IRE 3.S1; 58 IRE 3.S1)

**Insertion Loss (TR, Pre-TR, and Attenuator Tubes).** The decrease in power measured in a matched termination when the *Unfired Tube*, at a specified *Ignitor Current*, is inserted in the waveguide between a matched generator and the termination. (57 IRE 7.S2)

**Insertion Loss (Waveguide).** 1) The loss in load power due to the insertion of apparatus at some point in a transmission system. It is measured as the difference between the power received at the load before insertion of the apparatus and the power received at the load after insertion. 2) The ratio, expressed in decibels, of the power received at the load before insertion of the apparatus, to the power received at the load after insertion. (53 IRE 2.S1)

**Insertion Power Gain (of an Electric Transducer).** The ratio of 1) the power developed in the external termination of the output with the transducer inserted between generator and output termination to 2) the power developed in the external termination of the output with the generator connected directly to the output termination. (50 IRE 7.S1)

**Insertion Voltage Gain (of an Electric Transducer).** See *Gain, Insertion Voltage (of an Electric Transducer)*. (57 IRE 7.S2)

**Instantaneous Automatic Gain Control.** In *Radar*, that portion of a system that so automatically adjusts the gain of an amplifier for each pulse as to obtain a substantially constant output pulse peak amplitude with different input pulse peak amplitude, the adjustment being sufficiently fast to operate during the time a pulse is passing through the amplifier. (54 IRE 12.S1)

**Instantaneous Companding.** Companding in which the effective gain variations are

## Instruction Code

made in response to instantaneous values of the signal wave. (53 IRE 11.S1)

**Instantaneous Frequency.** The time rate of change of the angle of an angle-modulated wave. (53 IRE 11.S1)

**Instantaneous Power Output.** The rate at which energy is delivered to a load at a particular instant. (48 IRE 2, 11, 15.S1)

**Instantaneous Recording.** A recording which is intended for direct reproduction without further processing. (51 IRE 6.S1)

**Instantaneous Sampling.** The process for obtaining a sequence of instantaneous values of a wave. These values are called "instantaneous samples." (53 IRE 11.S1)

**Instantaneous Sound Pressure.** At a point, the total instantaneous pressure at that point minus the static pressure at that point. The commonly used unit is the microbar. (51 IRE 6.S1)

**Instruction.** See *Instruction Code*. (56 IRE 8.S1)

**Instruction Code.** An artificial *Language* for describing or expressing the instructions which can be carried out by a digital computer. In automatically sequenced computers, the instruction code is used when describing or expressing sequences of **Instructions**, and each instruction word usually contains a part specifying the operation to be performed and one or more *Addresses* which identify a particular location in storage. Sometimes an *Address Part* of an instruction is not intended to specify a location in storage but is used for some other purpose.

If more than one address is used, the code is called a **Multiple-Address Code**. In a typical instruction of a **Four-Address Code** the addresses specify the location of two operands, the destination of the result, and the location of the next instruction in the sequence. In a typical **Three-Address Code**, the fourth address specifying the location of the next instruction is dispensed with and the instructions are taken from storage in a preassigned order.

In a typical **One-Address** or **Single-Address Code**, the address may specify either the location of an operand to be taken from storage, the destination of a previously prepared result, or the location of the next instruction. The arithmetic element usually contains at least two storage locations, one of which is an accumulator. For example, operations requiring two operands may obtain one operand from the main storage and the other from a storage location in the arithmetic element which is specified by the operation part. (56 IRE 8.S1)

## Instrumental Error

**Instrumental Error (in Navigation).** See *Error, Instrumental*. (54 IRE 12.S1).

**Instrument Approach.** The process of making an approach to a landing by the use of *Navigation* instruments without direct visual reference to the terrain. (54 IRE 12.S1)

**Instrument Approach System.** In *Navigation*, a system furnishing guidance in the vertical and horizontal planes to aircraft during descent from an initial-approach altitude to a point near the ground. Completion of a landing requires guidance to touchdown by other means. (54 IRE 12.S1)

**Instrument Landing System.** As a general term: A system which provides, in the aircraft, the lateral, longitudinal and vertical guidance necessary for a landing. (54 IRE 12.S1)

**Integrating Network (Integrating Circuit, Integrator).** A transducer whose output waveform is the time integral of its input waveform.

*Note:* Such a network preceding a phase modulator makes the combination a frequency modulator; or, following a frequency-modulation detector, makes the combination a phase-modulation detector. The ratio of output amplitude to input amplitude of an integrator is inversely proportional to frequency, and the output phase lags the input phase by 90°.

(53 IRE 11.S1)

**Integrator (in Electronic Computers).** 1)

A device whose output is proportional to the integral of an input signal. 2) In certain digital machines, a device for numerically accomplishing an approximation to the mathematical process of integration. (56 IRE 8.S1)

**Intelligence Bandwidth.** The sum of the audio (or video) frequency bandwidths of the one or more channels. (48 IRE 2, 11, 15.S1)

**Intensifier Electrode.** An *Electrode* causing *Post Acceleration*. (57 IRE 7.S2)

**Intensity Level (Specific Sound-Energy Flux Level) (Sound-Energy Flux Density Level).** The intensity level, in decibels, of a sound is 10 times the logarithm to the base 10 of the ratio of the intensity of this sound to the reference intensity. The reference intensity shall be stated explicitly.

*Note:* In discussing sound measurements made with pressure or velocity microphones, especially in enclosures involving normal modes of vibration or in sound fields containing standing waves, caution must be observed in using the terms "intensity" and "intensity level." Under such conditions it is more desirable to use the terms "pressure level" or "velocity level" since the relation-

## Interelectrode Capacitance

ship between the intensity and the pressure or velocity is generally unknown.

(51 IRE 6.S1)

**Intensity Modulation.** In *Radar*, a process employed in certain types of *Display* by which the luminance of the signal indication is a function of the received signal-strength. (54 IRE 12.S1)

**Interaction Circuit Phase Velocity (Traveling-Wave Tubes).** The phase velocity of a wave traveling on the circuit in the absence of electron flow. (56 IRE 7.S1; 57 IRE 7.S2)

**Interaction Gap.** An *Interaction Space* between *Electrodes*. (56 IRE 7.S1; 57 IRE 7.S2)

**Interaction Impedance (Traveling-Wave Tubes).** A measure of the radio-frequency field strength at the electron stream for a given power in the interaction circuit. It may be expressed by the following equation:

$$K = \frac{E^2}{2\left(\frac{\omega}{v}\right)^2 P}$$

where  $E$  is the peak value of the electric field at the position of electron flow,  $\omega$  is the angular frequency,  $v$  is the *Interaction-Circuit Phase Velocity* and  $P$  is the propagating power. If the field strength is not uniform over the beam, an effective *Interaction Impedance* may be defined. (56 IRE 7.S1; 57 IRE 7.S2)

**Interaction Space.** A region of an *Electron Tube* in which electrons interact with an alternating electromagnetic field. (56 IRE 7.S1; 57 IRE 7.S2)

**Intercarrier Sound.** The method employed in those television receivers which make use of the television picture carrier and the associated sound carrier to produce a frequency-modulated signal whose center frequency is equal to the difference between the two carrier frequencies. (52 IRE 17.S1)

**Interdigital Magnetron.** A *Magnetron* having axial anode segments around the *Cathode*, alternate segments being connected together at one end, remaining segments connected together at the opposite end. (57 IRE 7.S2)

**Interelectrode Capacitance ( $j$ - $l$  Interelectrode Capacitance  $C_{jl}$  of an  $n$ -Terminal Electron Tube).** The capacitance determined from the *Short-Circuit Transfer Admittance* between the  $j$ th and the  $l$ th terminals.

*Note:* This quantity is often referred to as direct interelectrode capacitance.

(57 IRE 7.S2)

## Interelectrode Transadmittance

**Interelectrode Transadmittance (*j*-I Interelectrode Transadmittance of an *n*-Electrode Electron Tube).** The *Short-Circuit Transfer Admittance* from the *j*th electrode to the *l*th electrode. (57 IRE 7.S2)

**Interelectrode Transconductance (*j*-I Interelectrode Transconductance).** The real part of the *j*-I Interelectrode Transadmittance. (57 IRE 7.S2)

**Interference (General).** In a signal transmission system either extraneous power which tends to interfere with the reception of the desired signals, or the disturbance of signals which results. (52 IRE 17.S1)

**Interference (Induction or Dielectric Heating usage).** The disturbance of any electric circuit carrying intelligence, caused by the transfer of energy from an *Induction* or *Dielectric Heating* equipment. (55 IRE 10.S1)

**Interference Guard Bands.** The two bands of frequencies additional to, and on either side of, the communication band and frequency tolerance, which may be provided in order to minimize the possibility of interference. (48 IRE 2, 11, 15.S1)

**Interlaced Scanning.** A scanning process in which the distance from center to center of successively scanned lines is two or more times the nominal line width, and in which the adjacent lines belong to different *Fields*. (55 IRE 23.S1)

**Intermediate Frequency (IF).** The frequency in super-heterodyne reception resulting from a frequency conversion before demodulation. (52 IRE 17.S1)

**Intermediate-Frequency-Harmonic Interference (in Superheterodyne Receivers).** Interference due to radio-frequency-circuit acceptance of harmonics of an intermediate frequency signal. (52 IRE 17.S1)

**Intermediate-Frequency Interference Ratio.** See *Intermediate-Frequency Response Ratio*. (52 IRE 17.S1)

**Intermediate-Frequency Response Ratio.** The ratio of 1) the field strength at a specified frequency in the intermediate frequency band to 2) the field strength at the desired frequency, each field being applied in turn, under specified conditions, to produce equal outputs. (52 IRE 17.S1)

**Intermediate Subcarrier.** A carrier which may be modulated by one or more subcarriers and which is used as a modulating wave to modulate another carrier. (53 IRE 11.S1)

**Intermittent-Duty Rating.** The specified output rating of a device when operated for specified intervals of time other than con-

## Inverse Limiter

tinuous duty. (48 IRE 2, 11, 15.S1)

**Intermodulation.** The modulation of the components of a complex wave by each other in a nonlinear system (52 IRE 17.S1)

**Intermodulation Distortion.** See *Distortion, Intermodulation*. (58 IRE 3.S1)

**Internal Correction Voltage (Electron Tubes).** The voltage that is added to the *Composite Controlling Voltage* and is the voltage equivalent of such effects as those produced by initial electron velocity and *Contact Potential*. (57 IRE 7.S2)

**Interrogation.** Transmission of a radio signal or combination of signals intended to trigger a *Transponder* or group of *Transponders*. (54 IRE 12.S1)

**Interrogator.** The transmitting component of an *Interrogator-Responsor*. (54 IRE 12.S1)

**Interrogator-Responsor (IR).** A radio transmitter and receiver combined to interrogate a *Transponder* and display the resulting replies. (54 IRE 12.S1)

**Interval.** The interval between two sounds is their spacing in pitch or frequency, whichever is indicated by the context. The frequency interval is expressed by the ratio of the frequencies or by a logarithm of this ratio. (51 IRE 6.S1)

**Intrinsic Induction,  $B_i$ .** In a magnetic material for a given value of the magnetizing force, the excess of the normal flux density over the flux density in vacuum.

The equation for *Intrinsic Induction* is

$$B_i = B - \mu_0 H,$$

where  $\mu_0$  is the factor that expresses the ratio of magnetic flux density to magnetizing force in vacuum. (59 IRE 8.S1)

**Intrinsic Properties (of a Semiconductor).** The properties of a semiconductor which are characteristic of the pure, ideal crystal. (54 IRE 7.S2)

**Intrinsic Temperature Range (in a Semiconductor).** The temperature range in which the electrical properties of a semiconductor are essentially not modified by *Impurities* or *Imperfections* within the crystal. (54 IRE 7.S2)

**Inverse Electrode Current.** The current flowing through an *Electrode* in the direction opposite to that for which the tube is designed. (57 IRE 7.S2)

**Inverse Limiter.** A transducer, the output of which is constant for input of instantaneous values within a specified range and a linear or other prescribed function of the input for inputs above and below that range.

*Note:* This term describes a device used generally to remove the low-level portions

## Ionic-Heated Cathode

of signals from an output wave. It is sometimes used to eliminate the annoying effects of cross talk in a system at the expense of some distortion.

(53 IRE 11.S1)

**Ionic-Heated Cathode.** A *Hot Cathode* that is heated primarily by ionic bombardment of the emitting surface. (57 IRE 7.S2)

**Ionic-Heated-Cathode Tube.** An *Electron Tube* containing an *Ionic-Heated Cathode*. (57 IRE 7.S2)

**Ionization Current.** See *Gas Current*. (57 IRE 7.S2)

**Ionization Time (Gas Tubes).** The time interval between the initiation of conditions for and the establishment of conduction at some stated value of *Tube Voltage Drop*. (57 IRE 7.S2)

**Ionizing Event.** Any interaction by which one or more ions are produced. (57 IRE 7.S2)

**Ionosphere.** The part of the earth's outer atmosphere where ions and electrons are present in quantities sufficient to affect the propagation of radio waves.

*Note:* According to current opinion, the lowest level is approximately 50 kilometers above the earth's surface.

(50 IRE 24.S1)

**Ionospheric Error.** In *Navigation*, the total *Systematic* and *Random Error* resulting from the reception of the navigational signal after ionospheric reflections. It may be due to 1) variations in transmission paths, 2) nonuniform height of the ionosphere, or 3) nonuniform propagation within the ionosphere. (54 IRE 12.S1)

**Ionospheric Height Error.** In *Navigation*, the systematic component of the total *Ionospheric Error* due to the difference in geometrical configuration between ground paths and ionospheric paths. (54 IRE 12.S1)

**Ionospheric Wave.** A radio wave that is propagated by way of the ionosphere.

*Note:* This is sometimes called a *Sky Wave*. (50 IRE 24.S1)

**Ion Spot (Camera Tubes or Image Tubes).** The spurious signal resulting from the bombardment or alteration of the *Target* or *Photocathode* by ions. (57 IRE 7.S2)

**Ion Spot (on a Cathode-Ray-Tube Screen).** An area of localized deterioration of luminescence caused by bombardment with negative ions. (50 IRE 7.S1; 57 IRE 7.S2)

**IR.** See *Interrogator-Responsor*. (54 IRE 12.S1)

**Iris (Diaphragm).** In a waveguide, a conducting plate or plates, of thickness small compared to a wavelength, occupying a part of the cross section of the waveguide.

*Note:* When only a single mode can sup-

## Junction

ported an *Iris* acts substantially as a shunt admittance.

(55 IRE 2.S1)

**Isolation Amplifier.** See *Amplifier, Isolation*. (58 IRE 3.S1)

**Isolation Transformer.** See *Transformer, Isolation*. (58 IRE 3.S1)

**Iterative Impedance.** See *Impedance, Iterative*. (58 IRE 3.S1)

## J

**J Antenna.** A half-wave antenna, end fed by a parallel-wire quarter-wave section having the configuration of a J. (48 IRE 2, 11, 15.S1)

**J-Display.** In *Radar*, a modified *A-Display* in which the time base is a circle. The *Target* signal appears as a radial deflection from the time base. (54 IRE 12.S1)

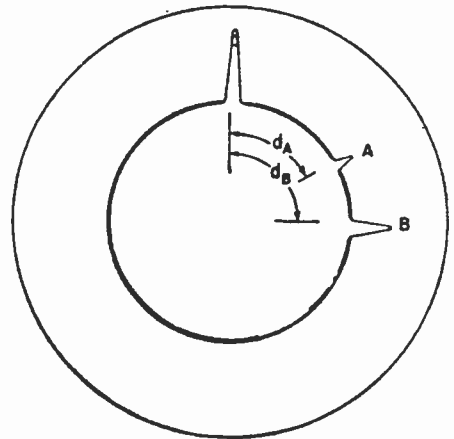

TWO TARGETS (A,B)  
AT DIFFERENT DISTANCES

**Jitter.** Small rapid variations in a waveform due to mechanical disturbances or to changes in the supply voltages, in the characteristic of components, etc. (54 IRE 12.S1)

**Jitter (in Facsimile).** Raggedness in the received copy caused by erroneous displacement of *Recorded Spots* in the direction of *Scanning*. (56 IRE 9.S1)

**Johnson Noise.** See *Thermal Noise*. (57 IRE 7.S2)

**Jump.** To (conditionally or unconditionally) cause the next instruction to be selected from a specified storage location. (56 IRE 8.S1)

**Junction (in a Semiconductor Device).** A region of transition between semiconducting regions of different electrical properties. (54 IRE 7.S2)



## Junction, Alloy

**Junction, Alloy (in a Semiconductor).** A junction formed by alloying one or more *Impurities* to a semiconductor crystal. (54 IRE 7.S2)

**Junction, Collector (of a Semiconductor Device).** A junction normally biased in the high-resistance direction, the current through which can be controlled by the introduction of *Minority Carriers*. (54 IRE 7.S2)

**Junction (Semiconductor), Diffused.** A junction which has been formed by the diffusion of an *Impurity* within a semiconductor crystal. (54 IRE 7.S2)

**Junction (Semiconductor), Doped.** A junction produced by the addition of an *Impurity* to the melt during crystal growth. (54 IRE 7.S2)

**Junction, Emitter (of a Semiconductor Device).** A junction normally biased in the low-resistance direction to inject *Minority Carriers* into an interelectrode region. (54 IRE 7.S2)

**Junction, Fused (in a Semiconductor).** A junction formed by recrystallization on a base crystal from a liquid phase of one or more components and the semiconductor. (54 IRE 7.S2)

**Junction (Semiconductor), Grown.** A junction produced during growth of a crystal from a melt. (54 IRE 7.S2)

**Junction, N-N (in a Semiconductor).** A region of transition between two regions having different properties in *n*-type semiconducting material. (54 IRE 7.S2)

**Junction, P-N (in a Semiconductor).** A region of transition between *p*- and *n*-type semiconducting material. (54 IRE 7.S2)

**Junction Point.** See *Node*. (50 IRE 4.S1)

**Junction, P-P (in a Semiconductor).** A region of transition between two regions having different properties in *p*-type semiconducting material. (54 IRE 7.S2)

**Junction (Semiconductor), Rate-Grown.** A *Grown Junction* produced by varying the rate of crystal growth. (54 IRE 7.S2)

**Just Scale.** A musical scale formed by taking three consecutive triads each having the ratio 4:5:6, or 10:12:15 (see *Cent*, Table II).

*Note:* By consecutive triads is meant triads such that the highest note of one is the lowest note of the other.

(51 IRE 6.S1)

## K

**K-Display (also K-Scan or K-Scope).** In *Radar*, a modified *A-Display* in which a *Target* appears as a pair of vertical deflections or *Blips* instead of a single deflection. When the *Radar* antenna is correctly pointed at the

## Knee of Transfer Characteristic

*Target* in azimuth, the *Blips* are of equal height. When not correctly pointed, the difference in *Blip* height is an indication of *Direction* and magnitude of azimuth pointing error. (54 IRE 12.S1)

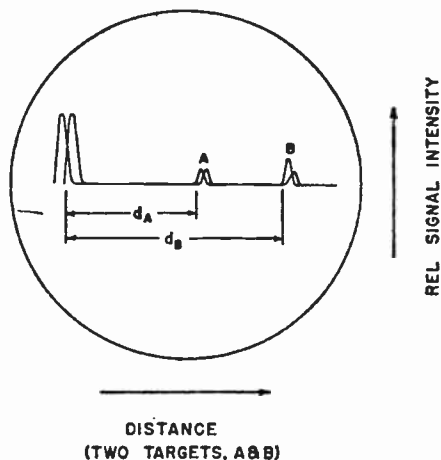

**Keep-Alive—Deprecated.** See *Ignitor*. (57 IRE 7.S2)

**Keep-Alive Circuit.** In a *TR* or *Anti-TR Switch*, a circuit for producing residual ionization for the purpose of reducing the initiation time of the main discharge. (54 IRE 12.S1)

**Kendall Effect.** A spurious pattern or other distortion in a facsimile record caused by unwanted modulation products arising from the transmission of a carrier signal and appearing in the form of a rectified *Baseband* that interferes with the lower sideband of the carrier.

*Note:* This occurs principally when the single sideband width is greater than half the *Facsimile* carrier frequency.

(56 IRE 9.S1)

**Keyer.** A device which changes the output of a transmitter from one value of amplitude or frequency to another in accordance with the intelligence to be transmitted.

*Note:* This applies generally to telegraphic keying.

(48 IRE 2, 11, 15.S1)

**Keying.** The forming of signals (such as those employed in telegraph transmission) by the modulation of a direct-current or other carrier between discrete values of some characteristic. (53 IRE 11.S1)

**Kink.** In *Navigation*, a point in a *Crossover Region* where the *Deviation Sensitivity* reverses sign. (54 IRE 12.S1)

**Knee of Transfer Characteristic (Image**

**Orthicons**). The region of maximum curvature in the *Transfer Characteristic*. (57 IRE 7.S2)

## L

### Lacquer Disks (Cellulose Nitrate Disks).

Mechanical recording disks usually made of metal, glass, or paper, and coated with a lacquer compound (often containing cellulose nitrate). (51 IRE 6.S1)

**Lacquer Original (Lacquer Master—Deprecated)**. An original recording on a lacquer surface for the purpose of making a master. (51 IRE 6.S1)

**Lacquer Recording**. Any recording made on a lacquer recording medium. (51 IRE 6.S1)

**Ladder Network**. A network composed of a sequence of H, L, T, or pi networks connected in tandem. (50 IRE 4.S1)

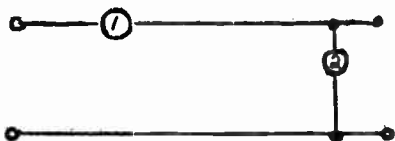

I network. The free ends are the left-hand terminal pair, and the junction point and one free end are the right-hand terminal pair.

**Lag (Camera Tubes)**. A persistence of the electrical-charge image for a small number of frames. (57 IRE 7.S2)

**Lambert**. A unit of *Luminance* equal to  $1/\pi$  *Candle* per square centimeter, and, therefore, equal to the uniform *Luminance* of a perfectly diffusing surface emitting or reflecting light at the rate of one *Lumen* per square centimeter. (55 IRE 22.S1)

**Laminated Record**. A mechanical recording medium composed of several layers of material. Normally, it is made with a thin face of surface material on each side of a core. (51 IRE 6.S1)

**LANAC (Laminar Navigation, Anti-Collision)**. An aircraft radio *Navigation* system consisting of airborne *Interrogator* and ground *Transponder* equipments with height-coding of the airborne *Interrogator Pulses*. (54 IRE 12.S1)

**Land**. The record surface between two adjacent grooves of a mechanical recording. (51 IRE 6.S1)

**Landing, Poor (Camera Tubes)**. See *Port-hole*. (57 IRE 7.S2)

**Lane**. In *Navigation*, the indicated navigational parameter of which is cyclic, the surface bounded by adjacent *Lines of Position* having the same value of the cyclic parameter. (54 IRE 12.S1)

### Language (in Electronic Computers).

1) A system consisting of a) a well-defined, usually finite, set of characters; b) rules for combining characters with one another to form words or other expressions; and c) a specific assignment of meaning to some of the words or expressions, usually for communicating information or data among a group of people, machines, etc. 2) A system similar to the above but without any specific assignment of meanings. Such systems may be distinguished from 1) above, when necessary, by referring to them as formal or uninterpreted languages. Although it is sometimes convenient to study a language independently of any meanings, in all practical cases at least one set of meanings is eventually assigned. See also *Code*; *Machine Language*. (56 IRE 8.S1)

**Lapel Microphone**. A microphone adapted to positioning on the clothing of the user. (51 IRE 6.S1)

**Lateral Recording**. A mechanical recording in which the groove modulation is perpendicular to the motion of the recording medium and parallel to the surface of the recording medium. (51 IRE 6.S1)

**Lattice**. In *Navigation*, a pattern of identifiable intersecting *Lines of Position* laid down in fixed *Positions* with respect to the transmitters that establish it. (54 IRE 12.S1)

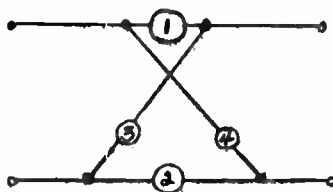

Lattice network. In the mesh 1, 2, 3, 4, the junction points between branches 4 and 1 and between branches 3 and 2 are the input terminals, and the junction points between branches 1 and 3 and between branches 2 and 4 are the output terminals.

**Lattice Network**. A network composed of four branches connected in series to form a mesh, two nonadjacent junction points serving as input terminals, while the remaining two junction points serve as output terminals. (50 IRE 4.S1)

**L-Display (also L-Scan or L-Scope)**. In *Radar*, a *Display* in which a *Target* appears as two horizontal *Blips*, one extending to the right and one to the left, from a central vertical time base. When the *Radar* antenna is aligned in azimuth at the *Target* both *Blips* are of equal amplitude. When not correctly pointed the relative *Blip* amplitude in-

## Leader Cable

icates the pointing error. The *Position* of the signal along the *Baseline* indicates *Target* distance. The *Display* may be rotated 90° when used for elevation instead of *Azimuth* aiming. (54 IRE 12.S1)

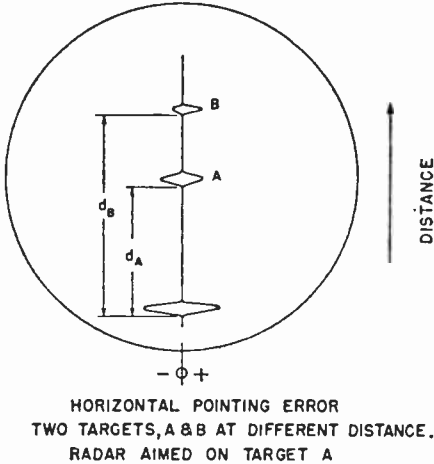

**Leader Cable.** A navigational aid in which the *Path* to be followed is defined by a magnetic field around a cable. (54 IRE 12.S1)

**Leading Edge.** The major portion of the rise of a *Pulse*. (55 IRE 23.S1)

**Leading Edge Pulse Time.** The time at which the instantaneous amplitude first reaches a stated fraction of the *Peak Pulse Amplitude*. (51 IRE 20.S1; 55 IRE 23.S1)

**Lead-In Groove (Lead-In Spiral).** In disk recording, a blank spiral groove at the beginning of a record generally having a pitch that is much greater than that of the recorded grooves. (51 IRE 6.S1)

**Lead-Out Groove (Throw-Out Spiral).** In disk recording, a blank spiral groove at the end of a recording generally of a pitch that is much greater than that of the recorded grooves and which is connected to either the locked or eccentric groove. (51 IRE 6.S1)

**Lead-Over Groove (Crossover Spiral).** In disk recording, a groove cut between recordings of small durations which enables the pickup stylus to travel from one cut to the next. (51 IRE 6.S1)

**Leakage Power (TR and Pre-TR Tubes).** The radio-frequency power transmitted through a *Fired Tube*. See *Flat Leakage Power (TR and Pre-TR Tubes)*; *Harmonic Leakage Power (TR and Pre-TR Tubes)*. (57 IRE 7.S2)

**Leakage Radiation.** In a transmitting system, radiation from anything other than the in-

## Light

tended radiating system. (48 IRE 2, 11, 15.S1)

**Left-Handed (Counter Clockwise) Polarized Wave.** An elliptically polarized transverse electromagnetic wave in which the rotation of the electric field vector is counter clockwise for an observer looking in the direction of propagation. (50 IRE 24.S1)

**Length of Scanning Line.** The length of the path traced by the scanning or recording spot in moving from a point on one line to a corresponding point on the next following line. (42 IRE 9.S1)

**Lens.** A structure transparent to radio waves and with a relative dielectric constant different from unity, designed in such manner as to produce a desired pattern. Such structures may employ dielectrics or metallic configurations. (48 IRE 2, 11, 15.S1)

**Level (in Audio).** The difference of a quantity from an arbitrarily specified reference quantity.

*Note:* The quantities of interest are often expressed in decibels, thus their difference is conveniently expressed as a ratio. Hence, *Level* is widely regarded as the ratio of the magnitude of a quantity to an arbitrary reference magnitude.

(54 IRE 3.S1; 58 IRE 3.S1)

**Level (Charge-Storage Tubes).** A charge value which can be stored in a given *Storage Element* and distinguished in the output from other charge values. (57 IRE 7.S2)

**Level (in Television).** 1) Signal amplitude measured in accordance with specified techniques.

*Note:* The recommended method is described in "IRE Standards on Methods of Measurement of Television Signal Levels," published in PROCEEDINGS OF THE IRE, volume 38, pages 551-561; May, 1950.

2) A specified position on an amplitude scale applied to a signal waveform.

*Note:* This definition is consistent with the use of the term in such definitions as *Reference White Level* and *Reference Black Level*.

(55 IRE 23.S1)

**Level Above Threshold (Sensation Level).** Of a sound, the pressure level of the sound in decibels above its threshold of audibility for the individual observer. (51 IRE 6.S1)

**Lifetime, Volume.** The average time interval between the generation and recombination of *Minority Carriers* in a homogeneous semiconductor. (54 IRE 7.S2)

**Light.** The aspect of radiant energy of which a human observer is aware through the visual sensations that arise from the stimulation of the retina of the eye. For the pur-

poses of engineering, light is visually evaluated radiant energy.

*Note 1:* Light is psychophysical, neither purely physical nor purely psychological. Light is not synonymous with radiant energy, however restricted, nor is it merely sensation.

*Note 2:* The present basis for the engineering evaluation of light consists of the color-mixture data  $\bar{x}$ ,  $\bar{y}$ ,  $\bar{z}$  adopted in 1931 by the International Commission on Illumination.

(55 IRE 22.S1)

**Light-Beam Pickup.** A phonograph pickup in which a beam of light is a coupling element of the transducer. (51 IRE 6.S1)

**Light Carrier Injection.** The method of introducing the carrier by periodic variation of the scanner light beam, the average amplitude of which is varied by the *Density* changes of the *Subject Copy*. (56 IRE 9.S1)

**Light-Microsecond.** The distance a light wave travels in free space in one-millionth of a second. See *Electrical Distance*. (54 IRE 12.S1)

**Light Modulation.** The method of introducing the carrier by periodic variation of the scanner light beam, the average amplitude of which is varied by the density changes of the subject copy. (42 IRE 9.S1)

**Light Modulator.** The combination of a source of light, an appropriate optical system, and a means for varying the resulting light beam (such as galvanometer or light valve), so that a sound track may be produced. (51 IRE 6.S1)

**Light Valve.** A device whose light transmission can be made to vary in accordance with an externally applied electrical quantity, such as voltage, current, electric field, magnetic field, or an electron beam. (51 IRE 6.S1)

**Limited Signal.** In *Radar*, a signal that is intentionally limited in amplitude by the dynamic range of the system. (54 IRE 12.S1)

**Limited Stability.** A property of a system characterized by stability when the input signal falls within a particular range and by instability when the signal falls outside this range. (53 IRE 4.S1)

**Limiter.** A transducer whose output is constant for all inputs above a critical value.

*Note:* A limiter may be used to remove amplitude modulation while transmitting angle modulation.

(48 IRE 2, 11, 15.S1; 52 IRE 17.S1)

**Limiting.** The action performed upon a signal by a limiter. (52 IRE 17.S1)

**Line Amplifier.** See *Amplifier, Line*. (58 IRE 3.S1)

**Linear Array.** An antenna array whose ele-

ments are equally spaced along a straight line. (48 IRE 2, 11, 15.S1)

**Linearity Region.** In an *Instrument Approach* and similar guidance system, that region in which the *Deviation Sensitivity* remains within specified values. (54 IRE 12.S1)

**Linearly Polarized Wave.** At a point in a homogeneous, isotropic medium, a transverse electromagnetic wave whose electric field vector at all times lies along a fixed line. (50 IRE 24.S1)

**Linear Power Amplifier.** A power amplifier in which the signal output voltage is directly proportional to the signal input voltage. (48 IRE 2, 11, 15.S1)

**Linear Rectifier.** A rectifier, the output current or voltage of which contains a wave having a form identical with that of the envelope of an impressed signal wave. (48 IRE 2, 11, 15.S1)

**Linear Transducer.** A transducer for which the pertinent measures of all the waves concerned are linearly related.

*Note 1:* By "linearly related" is meant any relation of linear character whether by linear algebraic equation or by linear differential equation or by other linear connection.

*Note 2:* The term "waves concerned" connotes actuating waves and related output waves, the relation of which is of primary interest in the problem at hand.

(51 IRE 20.S2)

**Linear Varying-Parameter Network.** A linear network in which one or more parameters vary with time. (53 IRE 4.S1)

**Line Frequency.** The number of times per second that a fixed vertical line in the picture is crossed in one direction by the scanning spot. Scanning during vertical return intervals is counted. (55 IRE 23.S1)

**Line Hydrophone.** A directional hydrophone consisting of a single straight line element, or an array of contiguous or spaced electroacoustic transducing elements disposed on a straight line, or the acoustic equivalent of such an array. (51 IRE 6.S1)

**Line Microphone.** A directional microphone consisting of a single straight line element, or an array of contiguous or spaced electroacoustic transducing elements, disposed on a straight line, or the acoustic equivalent of such an array. (51 IRE 6.S1)

**Line of Position (LOP).** The intersection of two *Surfaces of Position*. (54 IRE 12.S1)

**Line Stretcher.** A section of waveguide whose physical length is variable. (55 IRE 2.S1)

**Line or Trace (Cathode-Ray Tubes).** The path of the moving spot on the *Screen* or *Target*. (57 IRE 7.S2)

## Line Transformer

**Line Transformer.** See *Transformer, Line*. (58 IRE 3.S1)

**Lin-Log Receiver.** In *Radar*, a receiver having a linear amplitude response for small amplitude signals and a logarithmic response for large amplitude signals. (54 IRE 12.S1)

**Lip Microphone.** A microphone which is adapted for use in contact with the lip. (51 IRE 6.S1)

**Live Room.** A room which is characterized by an unusually small amount of sound absorption. (51 IRE 6.S1)

**L Network.** A network composed of two branches in series, the free ends being connected to one pair of terminals, and the junction point and one free end being connected to another pair of terminals. (50 IRE 4.S1)

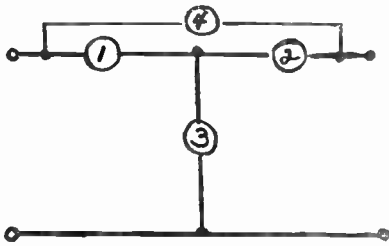

Bridge-T network branches 1, 2, and 3 comprise the T network and branch 4 is the fourth branch.

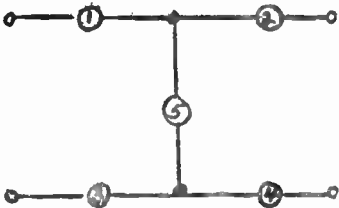

H network. Branches 1 and 2 are the first two branches between an input and an output terminal; branches 3 and 4 are the second two branches; and branch 5 is the branch between the junction points.

**Load (General).** 1) The device which receives *Signal* power from a *Transducer*. 2) The *Signal* power delivered by a *Transducer* (deprecated). (54 IRE 3.S1; 58 IRE 3.S1)

**Load (Induction and Dielectric Heating usage) (Charge).** The material to be heated. (55 IRE 10.S1)

**Load (Dynamic) Characteristic (of an Electron Tube Connected in a Specified Operating Circuit, at a Specified Frequency).** A relation between the instantaneous values of a pair of variables such as *Electrode Voltage* and current, when all direct *Electrode* supply voltages are maintained constant. (57 IRE 7.S2)

## Load Impedance Diagram

**Load Circuit (Induction and Dielectric Heating usage).** The network including leads connected to the output terminals of the generator.

*Note:* The load circuit consists of the coupling network and the load material at the proper position for heating.

(55 IRE 10.S1)

**Load Circuit (in Transmitters).** The complete circuit required to transfer power from a source, such as an electron tube, to a load. (48 IRE 2, 11, 15.S1)

**Load-Circuit Efficiency.** The ratio between useful power delivered by the load circuit to the load and the load- (anode-) circuit power input. (48 IRE 2, 11, 15.S1)

**Load Circuit Efficiency (Induction and Dielectric Heating usage).** The ratio of the power absorbed by the *Load* to the power delivered at the generator output terminals. (55 IRE 10.S1)

**Load-Circuit Power Input (Transmitters).** The power delivered to the load circuit. It is the product of the alternating component of the voltage across the load circuit, the alternating component of the current passing through it (both root-mean-square values), and the power factor associated with these two quantities. (48 IRE 2, 11, 15.S1)

**Load Coil (Induction Heating usage).** An electric conductor which, when energized with alternating current, is adapted to deliver energy by induction to a change to be heated. (55 IRE 10.S1)

**Loaded Applicator Impedance (Dielectric Heating usage).** The complex impedance measured at the point of application with the load material at the proper position for heating, at a specified frequency. (55 IRE 10.S1)

**Loaded Impedance.** Of a transducer, the impedance at the input of the transducer when the output is connected to its normal load. (51 IRE 6.S1)

**Loaded  $Q$  (Switching Tubes).** The *Unloaded  $Q$*  of the tube modified by the coupled impedances.

*Note:* As here used,  $Q$  is equal to  $2\pi$  times the energy stored at the resonance frequency divided by the energy dissipated per cycle in the tube, or for *Cell-Type Tubes*, in the tube and its external resonant circuit.

(57 IRE 7.S2)

**Load Impedance.** See *Impedance, Load*. (58 IRE 3.S1)

**Load Impedance Diagram (Oscillators).** A chart showing performance of the oscillator with respect to variations in the load impedance. Ordinarily, contours of constant power and of constant frequency are drawn

## Load Leads

on a chart whose coordinates are the components of either the complex load impedance or of the reflection coefficient.

*Note:* See *Rieke Diagram*.

(56 IRE 7.S1; 57 IRE 7.S2)

**Load Leads (Induction and Dielectric Heating usage).** The connections or transmission line between the power source or generator and *Load*, *Load Coil* or *Applicator*. (55 IRE 10.S1)

**Load Matching (Induction and Dielectric Heating usage).** The process of adjustment of the *Load Circuit* impedance to produce the desired energy transfer from the power source to the *Load*. (55 IRE 10.S1)

**Load Matching Network (Induction and Dielectric Heating usage).** An electric network for accomplishing *Load Matching*. (55 IRE 10.S1)

**Load Matching Switch (Induction and Dielectric Heating usage).** A switch in the *Load Matching Network* to alter its characteristics to compensate for some sudden change in the *Load* characteristics, such as passing through the *Curie Point*. (55 IRE 10.S1)

**Load Switch (Load Contactor).** The switch or contactor in an *Induction Heating* circuit which connects the high-frequency generator or power source to the *Heater Coil* or *Load Circuit*. (55 IRE 10.S1)

**Lead Transfer Switch.** A switch to connect a generator or power source optionally to one or another *Load Circuit*. (55 IRE 10.S1)

**Lobe Switching.** A means of *Direction* finding or giving in which a signal transmitted or received in a given *Direction* is amplitude-modulated as a function of *Direction* by varying or switching the shape of the antenna radiation-pattern as a function of time. Compare with *Simultaneous Lobing*. (54 IRE 12.S1)

**Local Control.** A system or method of radio-transmitter control whereby the control functions are performed directly at the transmitter. (48 IRE 2, 11, 15.S1)

**Localizer.** A radio facility which provides signals for use in lateral guidance of aircraft with respect to a runway centerline. (54 IRE 12.S1)

**Localizer On-Course Line.** A line in a vertical plane passing through a *Localizer* and on either side of which indications of opposite *Sense* are received. (54 IRE 12.S1)

**Localizer Sector.** In an *Equisignal Localizer*, the sector included between two *Radial* lines from the *Localizer* along each of which lines there exists the same specified *Difference in Depth of Modulation*. (54 IRE 12.S1)

## Long-Range Navigation

**Local Oscillator.** An oscillator whose output is mixed with a wave for frequency conversion. (52 IRE 17.S1)

**Local Oscillator Tube.** An *Electron Tube* in a *Heterodyne Conversion Transducer* to provide the local heterodyning frequency for a *Mixer Tube*. (57 IRE 7.S2)

**Locked Groove (Concentric Groove).** In disk recording, a blank and continuous groove at the end of modulated grooves whose function is to prevent further travel of the pickup. (51 IRE 6.S1)

**Lodar.** A *Direction Finder* with which the *Direction* of arrival of *Loran* signals is determined free of *Night Effect* by observing the separately distinguishable ground and skywave *Loran* signals on a cathode-ray oscilloscope and positioning a loop antenna so as to obtain a null indication of the component selected to be most suitable. (54 IRE 12.S1)

**Logic.** See *Logical Design*. (56 IRE 8.S1)

**Logical Design.** 1) The planning of a computer or data-processing system prior to its detailed engineering design. 2) The synthesizing of a network of *Logical Elements* to perform a specified function. 3) The result of 1) and 2) above, frequently called the **Logic** of the system, machine, or network. (56 IRE 8.S1)

**Logical Diagram.** In *Logical Design*, a diagram representing the *Logical Elements* and their interconnections without necessarily expressing construction or engineering details. (56 IRE 8.S1)

**Logical Element.** In a computer or data-processing system, the smallest building blocks which can be represented by operators in an appropriate system of symbolic logic. Typical logical elements are the and-gate and the flip-flop, which can be represented as operators in a suitable symbolic logic. (56 IRE 8.S1)

**Logical Operation.** 1) Any nonarithmetical operation. Examples are: *Extract*, logical (bit-wise) multiplication, *Jump*, data transfer, etc. 2) Sometimes, only those nonarithmetical operations which are expressible bit-wise in terms of the propositional calculus or a two-valued Boolean algebra. (56 IRE 8.S1)

**Logical Symbol.** A symbol used to represent a *Logical Element* graphically. (56 IRE 8.S1)

**Long-Distance Navigation Aid.** A navigational aid usable at distances beyond the radio line of sight. (54 IRE 12.S1)

**Longitudinal Magnetization.** In magnetic recording, magnetization of the recording medium in a direction essentially parallel to the line of travel. (51 IRE 6.S1)

**Long-Range Navigation.** Navigation at dis-

## Long-Wire Antenna

tances such that knowledge of position and objective alone are sufficient to permit determination of the proper course. (49 IRE 12.S1)

**Long-Wire Antenna.** A linear antenna which, by virtue of its considerable length in comparison with the operating wavelength, provides a directional radiation pattern. (48 IRE 2, 11, 15.S1)

**Loop.** See note under *Mesh*. (50 IRE 4.S1)

**Loop Actuating Signal.** The signal derived by mixing the loop input signal and the loop feedback signal. (55 IRE 26.S2)

**Loop, Alford.** See *Alford Loop*. (54 IRE 12.S1)

**Loop Antenna.** An antenna consisting of one or more complete turns of conductor and functioning by virtue of the circulatory current therein. (48 IRE 2, 11, 15.S1)

**Loop Difference Signal.** The output signal from a summing point of a feedback control loop produced by a particular loop input signal applied to that summing point.

*Note:* The loop difference signal is a specific type of loop actuating signal. (55 IRE 26.S2)

**Loop Error.** The desired value minus the actual value of the loop output signal. Application of the standard terminology to a typical block diagram is shown here. (55 IRE 26.S2)

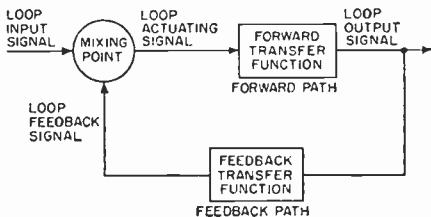

**Loop Error Signal.** The loop actuating signal in those cases in which it is the *Loop Error*. (55 IRE 26.S2)

**Loop Feedback Signal.** The signal derived as a function of the loop output signal and fed back to the mixing point for control purposes. (55 IRE 26.S2)

**Loop Input Signal.** An external signal applied to a feedback control loop. (55 IRE 26.S2)

**Loop Output Signal.** The controlled signal extracted from a feedback control loop. (55 IRE 26.S2)

**Loop Return Signal.** The signal returned via a feedback control loop to a summing point, in response to a loop input signal applied to

## Loudness

that summing point, and subtracting from the loop input signal.

*Note:* The loop return signal is a specific type of loop input signal.

(55 IRE 26.S2)

**Loop Transfer Function.** The transfer function of the transmission path formed by opening and properly terminating a feedback loop.

*Note:* One example of proper termination is a zero impedance generator driving the opened loop, and an output termination for the opened loop equal to the impedance facing the generator. (55 IRE 26.S2)

**Loop Transfer Ratio.** The transfer ratio of a loop return signal to the corresponding loop difference signal. (55 IRE 26.S2)

**LOP.** See *Line of Position*. (54 IRE 12.S1)

**Lorac.** In a *Navigation* system which determines a *Position Fix* by the intersection of *Lines of Position* each line being defined by the phase angle between a heterodyne beat frequency wave between CW signals from two widely-spaced transmitters; and a reference wave of the same frequency that is obtained by deriving the heterodyne beat of the same two CW signals at a fixed location and transmitting it to the receiver being located via a second radio frequency channel. (54 IRE 12.S1)

**Loran.** See *Lodar*. (54 IRE 12.S1)

**Loran.** A long-range pulsed hyperbolic radio aid to navigation whose position lines are determined by the measurement of the difference in the time of arrival of synchronized pulses. (49 IRE 12.S1)

**Loran Repetition Rate.** See *Repetition Rate*. (54 IRE 12.S1)

**Lorhumb Line.** In *Navigation*, a *Course Line* in a *Lattice* such that the derivative of one coordinate with respect to the other coordinate constantly equals the ratio of the difference of the coordinates at the beginning and end points of the *Course Line*. (54 IRE 12.S1)

**Loss.** See:

*Arc-Drop Loss (Gas Tubes)*

*Arc Loss (Switching Tubes)*

*Insertion Loss (TR, Pre-TR, and Attenuator Tubes).*

(57 IRE 7.S2)

**Loss (Transmission Loss).** General term used to denote a decrease in *Signal* power in transmission from one point to another. *Loss* is usually expressed in decibels. (54 IRE 3.S1; 58 IRE 3.S1)

**Loudness.** The intensive attribute of an auditory sensation in terms of which sound may

## Loudness Contours

be ordered on a scale extending from soft to loud.

*Note:* Loudness depends primarily upon the sound pressure of the stimulus, but it also depends upon the frequency and wave form of the stimulus.

(51 IRE 6.S1)

**Loudness Contours.** Curves which show the related values of sound pressure level and frequency required to produce a given loudness sensation for the typical listener. (51 IRE 6.S1)

**Loudness Level.** In phons, of a sound, numerically equal to the sound pressure level in decibels, relative to 0.0002 microbar, of a simple tone of frequency 1000 cycles per second which is judged by the listeners to be equivalent in loudness. (51 IRE 6.S1)

**Loudspeaker (Speaker) (Loud Speaker—Deprecated).** An electroacoustic transducer usually intended to radiate acoustic power effectively at a distance in air.

*Note:* The term “speaker” should be avoided when there is risk of ambiguity.

(51 IRE 6.S1; 52 IRE 17.S1)

**Loudspeaker System.** A combination of one or more loudspeakers and all associated baffles, horns, and dividing networks arranged to work together as a coupling means between the driving electric circuit and the acoustic medium. (51 IRE 6.S1)

**Loudspeaker Voice Coil.** The moving coil of a moving-coil loudspeaker. (51 IRE 6.S1)

**Low Clearance Area.** In an *Instrument Approach System*, any area containing only *Low Clearance Points*. (54 IRE 12.S1)

**Low Clearance Points.** In an *Instrument Approach System*, locations in space outside of the *Crossover Region* at which off-course indicator current is below some arbitrary value, usually the full-scale deflection. (54 IRE 12.S1)

**Lowest Useful High Frequency.** The lowest high frequency effective at a specified time for ionospheric propagation of radio waves between two specified points.

*Note:* This is determined by factors such as absorption, transmitter power, antenna gain, receiver characteristics, type of service, and noise conditions.

(50 IRE 24.S1)

**Low-Frequency Induction Heater or Furnace.** A device for inducing current flow of commercial power line frequency in a *Charge* to be heated. (55 IRE 10.S1)

**Low-Level Modulation.** Modulation produced at a point in a system where the power level is low compared with the power level at the output of the system. (48 IRE 2, 11, 15.S1)

**Low-Level Radio-Frequency Signal (TR,**

## Luminous Intensity

**ATR, and Pre-TR Tubes).** A radio-frequency signal with insufficient power to cause the tube to become fired. (57 IRE 7.S2)

**Low-Pass Filter.** See *Filter, Low-Pass*, (58 IRE 3.S1)

**Low-Velocity Scanning.** See *Scanning, Low-Velocity*. (57 IRE 7.S2)

**Lumen.** The unit of luminous flux. It is equal to the flux through a unit solid angle (steradian) from a uniform point source of one *Candle*, or to the flux on a unit surface all points of which at unit distance from a uniform point source of one *Candle*. (55 IRE 22.S1)

**Luminance.** The luminous intensity of any surface in a given direction per unit of projected area of the surface as viewed from that direction.

*Note:* See *Note under Brightness*.

(55 IRE 22.S1)

**Luminance Flicker.** That *Flicker* which results from fluctuation of *Luminance* only. (55 IRE 22.S1)

**Luminance Primary.** That one of a set of three *Transmission Primaries* whose amount determines the *Luminance* of a *Color*. (55 IRE 22.S1)

**Luminance Signal.** A signal wave which is intended to have exclusive control of the *Luminance* of the picture. (55 IRE 22.S1)

**Luminosity.** Ratio of *Luminous Flux* to the corresponding *Radiant Flux* at a particular wavelength. It is expressed in lumens per watt. (55 IRE 22.S1)

**Luminosity Coefficients.** The constant multipliers for the respective *Tristimulus Values* of any *Color*, such that the sum of the three products is the *Luminance* of the *Color*. (55 IRE 22.S1)

**Luminous Efficiency.** The ratio of the *Luminous Flux* to the *Radiant Flux*.

*Note:* Luminous efficiency is usually expressed in lumens per watt of radiant flux. It should not be confused with the term “efficiency” as applied to a practical source of light, since the latter is based upon the power supplied to the source instead of the radiant flux from the source. For energy radiated at a single wavelength, luminous efficiency is synonymous with *Luminosity*.

(55 IRE 22.S1)

**Luminous Flux.** The time rate of flow of light. (55 IRE 22.S1)

**Luminous Intensity (in any direction).** The ratio of the *Luminous Flux* emitted by a source or by an element of a source, in an infinitesimal solid angle containing this direction, to the solid angle.

*Note:* Mathematically, a solid angle must have a point at its apex; the definition of



## Luminous Sensitivity

*Luminous Intensity*, therefore, applies strictly only to a point source. In practice, however, *Light* emanating from a source whose dimensions are negligible in comparison with the distance from which it is observed may be considered as coming from a point. (55 IRE 22.S1)

**Luminous Sensitivity (of a Phototube).** The quotient of output current by incident luminous flux at constant electrode voltages.

*Note 1:* The term output current as here used does not include the dark current.

*Note 2:* Since luminous sensitivity is not an absolute characteristic but depends on the spectral distribution of the incident flux, the term is commonly used to designate the sensitivity to light from a tungsten-filament lamp operating at a color temperature of 2870° K.

(54 IRE 7.S1)

## M

**Machine Check.** See *Check Automatic*. (56 IRE 8.S1)

**Machine Language.** 1) A *Language*, occurring within a machine, ordinarily not perceptible or intelligible to persons without special equipment or training. 2) A translation or transliteration of 1) above into more conventional characters but frequently still not intelligible to persons without special training. (56 IRE 8.S1)

**Magic Tee.** See *Hybrid Tee*. (55 IRE 2.S1)

**Magnetic Armature Loudspeaker (Magnetic Loudspeaker—Deprecated).** A loudspeaker comprising a ferromagnetic armature actuated by forces of magnetic attraction. (51 IRE 6.S1)

**Magnetic Bearing.** The angle in the horizontal plane between the direction of magnetic north and a line joining the observer and the object, usually measured clockwise. (49 IRE 12.S1)

**Magnetic Biasing.** The simultaneous conditioning of the magnetic recording medium during recording by superposing an additional magnetic field upon the signal magnetic field.

*Note:* In general, magnetic biasing is used to obtain a substantially linear relationship between the amplitude of the signal and the remanent flux density in the recording medium.

(51 IRE 6.S1)

**Magnetic Course.** The direction in the horizontal plane expressed as the angle of intended travel with respect to the direction of magnetic north. (49 IRE 12.S1)

## Magnetic Recorder

**Magnetic Cutter.** A cutter in which the mechanical displacements of the recording stylus are produced by the action of magnetic fields. (51 IRE 6.S1)

**Magnetic Deviation.** Angular difference between compass reading and magnetic heading. (49 IRE 12.S1)

**Magnetic Field.** A state of the medium in which moving electrified bodies are subject to forces by virtue of both their electrifications and motion. (50 IRE 24.S1)

**Magnetic Focusing.** A method of *Focusing* an electron beam by the action of a magnetic field. (57 IRE 7.S2)

**Magnetic Head.** In magnetic recording, a magnetic head is a transducer for converting electric variations into magnetic variations for storage on magnetic media, for reconvert-ing energy so stored into electric energy or for erasing such stored energy. (51 IRE 6.S1)

**Magnetic Heading.** The angle in the horizontal plane between the direction of magnetic north and the line along which the vehicle is pointing, usually measured clockwise. (49 IRE 12.S1)

**Magnetic Plated Wire.** A magnetic wire having a core of nonmagnetic material and a plated surface of ferromagnetic material. (51 IRE 6.S1)

**Magnetic Powder-Coated Tape (Coated Tape).** A tape consisting of a coating of uniformly dispersed, powdered ferromagnetic material on a nonmagnetic base. (51 IRE 6.S1)

**Magnetic Powder-Impregnated Tape (Impregnated Tape) (Dispersed Magnetic Powder Tape).** A magnetic tape which consists of magnetic particles uniformly dispersed in a nonmagnetic material. (51 IRE 6.S1)

**Magnetic Printing (Magnetic Transfer) (Crosstalk<sup>1</sup>).** The permanent transfer of a recorded signal from a section of a magnetic recording medium to another section of the same or a different medium when these sections are brought into proximity. (51 IRE 6.S1)

**Magnetic Recorder.** Equipment incorporating an electromagnetic transducer and means for moving a ferromagnetic recording medium relative to the transducer for recording electric signals as magnetic variations in the medium.

*Note:* The generic term "magnetic recorder" can also be applied to an instrument which has not only facilities for recording electric signals as magnetic variations, but also for converting such magnetic variations back into electric variations.

(51 IRE 6.S1)

<sup>1</sup> Deprecated.

**Magnetic Recording.** *Recording* by means of a signal-controlled magnetic field. (56 IRE 9.S1)

**Magnetic Recording Head.** In magnetic recording, a magnetic head for transforming electric variations into magnetic variations for storage on magnetic media. (51 IRE 6.S1)

**Magnetic Recording Medium.** A magnetizable material used in a magnetic recorder for retaining the magnetic variations imparted during the recording process. It may have the form of a wire, tape, cylinder, disk, and the like. (51 IRE 6.S1)

**Magnetic Recording Reproducer.** Equipment for converting magnetic variations on magnetic recording media into electric variations. (51 IRE 6.S1)

**Magnetic Reproducing Head.** In magnetic recording, a magnetic head for converting magnetic variations on magnetic media into electric variations. (51 IRE 6.S1)

**Magnetic Tape.** A magnetic recording medium having a width greater than approximately 10 times the thickness. This tape may be homogeneous or coated. (51 IRE 6.S1)

**Magnetic Wire.** A magnetic recording medium, approximately circular in cross section. (51 IRE 6.S1)

**Magneto-Ionic Wave Component.** Either of the two elliptically polarized wave components into which a linearly polarized wave incident on the ionosphere is separated because of the earth's magnetic field. (50 IRE 24.S1)

**Magnetostriction Loudspeaker.** A loudspeaker in which the mechanical displacement is derived from the deformation of a material having magnetostrictive properties. (51 IRE 6.S1)

**Magnetostriction Microphone.** A microphone which depends for its operation on the generation of an electromotive force by the deformation of a material having magnetostrictive properties. (51 IRE 6.S1)

**Magnetostriction Oscillator.** An oscillator with the plate circuit inductively coupled to the grid circuit through a magnetostrictive element, the frequency of oscillation being determined by the magneto-mechanical characteristics of the coupling element. (48 IRE 2, 11, 15.S1)

**Magnetron.** An *Electron Tube* characterized by the interaction of electrons with the electric field of a circuit element in crossed steady electric and magnetic fields to produce ac power output.

See also:

*Interdigital Magnetron*  
*Multicavity Magnetron*  
*Multisegment Magnetron*

*Packaged Magnetron*  
*Rising-Sun Magnetron*  
*Split-Anode Magnetron.*

(55 IRE 10.S1; 57 IRE 7.S2)

**Magnetron Oscillator.** An electron tube in which electrons are accelerated by a radial electric field between the cathode and one or more anodes and by an axial magnetic field that provides a high-energy electron stream to excite the tank circuits. (48 IRE 2, 11, 15.S1)

**Main Bang.** Transmitted *Pulse*, within a radar system. (52 IRE 20.S1)

**Main Gap (Glow-Discharge Tubes).** The conduction path between a principal *Cathode* and a principal *Anode*. (57 IRE 7.S2)

**Major Cycle.** In a storage device which provides *Serial* access to storage positions, the time interval between successive appearances of a given storage position. (56 IRE 8.S1)

**Majority Carrier (in a Semiconductor).** The type of *Carrier* constituting more than half of the total number of *Carriers*. (54 IRE 7.S2)

**Major Lobe (Beam).** The radiation lobe containing the direction of maximum radiation. (48 IRE 2, 11, 15.S1)

**Malfunctor.** See *Error*. (56 IRE 8.S1)

**Marginal Checking.** A preventive maintenance procedure in which certain operating conditions, e.g., supply voltage or frequency, are varied about their normal values in order to detect and locate incipient defective units. See also *Check*. (56 IRE 8.S1)

**Marginal Testing.** Synonym for *Marginal Checking*. (56 IRE 8.S1)

**Marker.** In an instrument landing system, a radio facility providing a signal to designate a small area above it. (49 IRE 12.S1)

**Marking Wave (Keying Wave).** In telegraphic communication, the emission which takes place while the active portions of the code characters are being transmitted. (48 IRE 2, 11, 15.S1)

**Masking (Audio).** The amount by which the threshold of audibility of a sound is raised by the presence of another (masking) sound. The unit customarily used is the decibel. (51 IRE 6.S1; 52 IRE 17.S1)

**Masking Audiogram.** A graphical presentation of the masking due to a stated noise. This is plotted, in decibels, as a function of the frequency of the masked tone. (51 IRE 6.S1)

**Mask Microphone.** A microphone designed for use inside an oxygen or other type of respiratory mask. (51 IRE 6.S1)

**Master.** A metal part, normally derived from a disk recording by electroforming, which is a negative of the recording, i.e., a master

which has ridges instead of grooves and thus cannot be played with a pointed stylus. (51 IRE 6.S1)

**Master Clock.** The primary source of timing signals. (50 IRE 8.S1)

**Master Oscillator.** An oscillator so arranged as to establish the carrier frequency of the output of an amplifier. (48 IRE 2, 11, 15.S1)

**Master Routine.** See *Subroutine*. (56 IRE 8.S1)

**Master Station.** The station of a synchronized group of radio stations to which the emissions of other station or stations of the group are referred. (54 IRE 12.S1)

**Matched Termination (for a Waveguide).** A termination producing no *Reflected Wave* at any transverse section of the *Waveguide*. (53 IRE 2.S1)

**Matched Transmission Line.** See *Matched Waveguide*. (53 IRE 2.S1)

**Matched Waveguide.** A *Waveguide* having no *Reflected Wave* at any transverse section. (53 IRE 2.S1)

**Matching.** In navigation, the process of bringing two quantities into suitable positions for measurement of their relative value. (49 IRE 12.S1)

**Mathematical Check.** See *Check, Programmed*. (56 IRE 8.S1)

**Matrix (in Electronic Computers).** 1) Any logical network whose configuration is a rectangular array of intersections of its input-output leads, with elements connected at some of these intersections. The network usually functions as an *Encoder* or *Decoder*. 2) Loosely, any encoder, decoder, or *Translator*. (56 IRE 8.S1)

**Matrix (noun).** In color television, an array of coefficients symbolic of a *Color Coordinate Transformation*.

*Note:* This definition is consistent with mathematical usage.

(55 IRE 22.S1)

**Matrix (verb).** In color television, to perform a *Color Coordinate Transformation* by computation or by electrical, optical, or other means. (55 IRE 22.S1)

**Matrix Unit (Matrix Circuit).** A device which performs a color coordinate transformation by electrical, optical, or other means. (55 IRE 22.S1)

**Maximum Available Power Gain (of a Two-Port Linear Transducer).** See *Gain, Available Power, Maximum (of a Two-Port Linear Transducer)*. (57 IRE 7.S2)

**Maximum-Deviation Sensitivity (in FM Receivers).** Under maximum system deviation, the least signal input for which the output distortion does not exceed a specified limit. (52 IRE 17.S1)

**Maximum Distance.** The maximum distance at which a navigational system will function within its prescribed tolerance. (54 IRE 12.S1)

**Maximum Keying Frequency (Fundamental Scanning Frequency).** The frequency in cycles per second numerically equal to the *Spot Speed* divided by twice the *Scanning Spot X Dimension*. (56 IRE 9.S1)

**Maximum Modulating Frequency.** The highest *Picture Frequency* required for the *Facsimile* transmission system.

*Note:* The *Maximum Modulating Frequency* and the *Maximum Keying Frequency* are not necessarily equal.

(56 IRE 9.S1)

**Maximum Output (in Receivers).** The greatest average output power into the rated load regardless of distortion. (52 IRE 17.S1)

**Maximum Sensitivity (in FM Systems.)** The least signal input that produces a specified output power. (52 IRE 17.S1)

**Maximum Sound Pressure.** For any given cycle of a periodic wave, the maximum absolute value of the instantaneous sound pressure occurring during that cycle. The commonly used unit is the microbar.

*Note:* In the case of a sinusoidal sound wave this maximum sound pressure is also called the pressure amplitude.

(51 IRE 6.S1)

**Maximum System Deviation (FM Systems).** The greatest frequency deviation specified in the operation of the system.

*Note:* In the case of FM broadcast systems in the range from 88 to 108 megacycles per second, the maximum system deviation is 75 kilocycles per second.

(52 IRE 17.S1)

**Maximum Undistorted Output (Maximum Useful Output).** For sinusoidal input, the greatest average output power into the rated load with distortion not exceeding a specified limit. (52 IRE 17.S1)

**Maximum Usable Frequency.** The upper limit of the frequencies that can be used at a specified time for radio transmission between two points and involving propagation by reflection from the regular ionized layers of the ionosphere.

*Note:* Higher frequencies may be transmitted by sporadic and scattered reflections.

(50 IRE 24.S1)

**MCW.** (An abbreviation for "modulated continuous wave.") A form of emission in which the carrier is modulated by a constant audio-frequency tone. In telegraphic service, it is understood that the carrier is keyed. (48 IRE 2, 11, 15.S1)

## M-Display

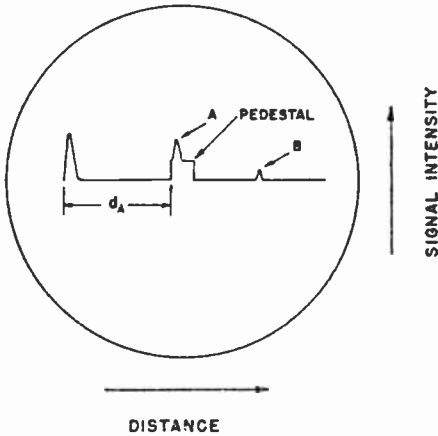

**M-Display (also M-Scan or M-Scope).** In *Radar*, a type *A-Display* in which *Target* distance is determined by moving an adjustable pedestal signal along the *Baseline* until it coincides with the horizontal *Position* of the *Target* signal deflections. The control which moves the pedestal is calibrated in distance. (54 IRE 12.S1)

**Mean Free Path.** For sound waves in an enclosure, the average distance sound travels between successive reflections in the enclosure. (51 IRE 6.S1)

**Mean Pulse Time.** The arithmetic mean of the leading edge pulse time and the trailing edge pulse time.

*Note:* For some purposes the importance of a pulse is that it exists (or is large enough) at a particular instant of time. For such applications the important quantity is the *Mean Pulse Time*. The *Leading Edge Pulse Time* and *Trailing Edge Pulse Time* are significant primarily in that they may allow a certain tolerance in timing. (51 IRE 20.S1)

**Mechanical Phonograph Recorder (Mechanical Recorder).** An equipment for transforming electric or acoustic signals into mechanical motion of approximately like form and inscribing such motion in an appropriate medium by cutting or embossing. (51 IRE 6.S1)

**Mechanical Transmission System.** An assembly of elements adapted for the transmission of mechanical power. (51 IRE 6.S1)

**Meissner Oscillator.** An oscillator in which the grid and plate circuits are inductively coupled through an independent tank circuit which determines the frequency. (48 IRE 2, 11, 15.S1)

**Mel.** A unit of pitch. By definition, a simple

## Message

tone of frequency 1000 cps, 40 db above a listener's threshold, produces a pitch of 1000 mels. The pitch of any sound that is judged by the listener to be  $n$  times that of the 1-mel tone is  $n$  mels. (51 IRE 6.S1)

**Melting Channel.** The restricted portion of the *Charge* in a *Submerged Resistor* or *Horizontal Ring Induction Furnace* in which the induced currents are concentrated to effect high energy absorption and melting of the *Charge*. (55 IRE 10.S1)

**Memory.** See *Storage*. (56 IRE 8. S1)

**Memory Capacity.** The maximum number of distinguishable stable states in which a memory device can exist is a measure of its capacity. It is customary to use the logarithm to the base two of that number as a numerical measure of the memory capacity. In this case, the unit of memory capacity is a binary digit.) Synonym for *Storage Capacity*. (50 IRE 8.S1; 56 IRE 8.S1)

**Memory, Circulating.** See *Circulating Memory*. (50 IRE 8.S1)

**Memory, Delay-Line.** See *Delay-Line Memory*. (50 IRE 8.S1)

**Memory, Electrostatic.** See *Electrostatic Memory*. (50 IRE 8.S1)

**Memory Tube—Deprecated.** See *Storage Tube*. (57 IRE 7.S2)

**Memory Tube, Electrostatic.** See *Electrostatic Memory Tube*. (50 IRE 8.S1)

**Mercury Arc Converter, Pool Cathode.** See *Pool Cathode Mercury Arc Converter*. (55 IRE 10.S1)

**Mercury Hydrogen Spark Gap Converter.** A spark gap generator or power source which utilizes the oscillatory discharge of a capacitor through an inductor and a spark gap as a source of radio-frequency power. The spark gap comprises a solid electrode and a pool of mercury in a hydrogen atmosphere. (55 IRE 10.S1)

**Mercury-Vapor Tube.** A *Gas Tube* in which the active gas is mercury vapor. (57 IRE 7.S2)

**Mesh.** A set of branches forming a closed path in a network, provided that if any one branch is omitted from the set, the remaining branches of the set do not form a closed path.

*Note:* The term *Loop* is sometimes used in the sense of *Mesh*.

(50 IRE 4.S1)

**Message.** 1) An ordered selection from an agreed set of symbols, intended to communicate information. 2) The original modulating wave in a communication system.

*Note:* *Definition* 1) is the sense in which

## Message Source

the term is used in communication theory; definition 2) is the sense in which the term is often used in engineering practice.

(58 IRE 11.S1)

**Message Source.** That part of a communication system where *Messages* are assumed to originate. (58 IRE 11.S1)

**MEW (Microwave Early Warning).** A particular high-power, long-range, early-warning *Radar* with a number of indicators, giving high resolution and large traffic handling capacity. (54 IRE 12.S1)

**Microbar, Dyne Per Square Centimeter (Barye) (Bar').** A unit of pressure commonly used in acoustics. One microbar is equal to 1 dyne per square centimeter.

*Note:* The term "bar" properly denotes a pressure of  $10^6$  dynes per square centimeter. Unfortunately, in acoustics the bar was used to mean 1 dyne per square centimeter. It is recommended, therefore, in respect to sound pressures that the less ambiguous terms "microbar" or "dyne per square centimeter" be used.

(51 IRE 6.S1)

**Microphone.** An electroacoustic transducer which responds to sound waves and delivers essentially equivalent electric waves. See also *Telephone Transmitter*. (51 IRE 6.S1; 52 IRE 17.S1)

**Microphonics. Audio-Frequency Noise** caused by mechanical vibration of elements in a system or component. (58 IRE 3.S1)

**Microphonism (Microphonics) (Electron Tubes).** The modulation of one or more of the *Electrode Currents* resulting from the mechanical vibration of a tube *Element*. (57 IRE 7.S2)

**Middle Marker.** A marker facility in an *ILS* which is installed approximately 3500 feet from the approach end of the runway on the *Localizer Course Line* to provide a fix. (54 IRE 12.S1)

**Minimum Distance.** The shortest distance at which a navigational system will function within its prescribed tolerances. (54 IRE 12.S1)

**Minimum Firing Power (Switching Tubes).** The minimum radio-frequency power required to initiate a radio-frequency discharge in the tube at a specified *Ignitor Current*. (57 IRE 7.S2)

**Minor Cycle.** In a storage device which provides *Serial* access to storage positions, the time interval between the appearance of corresponding parts of successive words. (56 IRE 8.S1)

<sup>1</sup> See Note 2 under *Acoustic Impedance*.

## Mode

**Minority Carrier (in a Semiconductor).**

The type of *Carrier* constituting less than half of the total number of *Carriers*. (54 IRE 7.S2)

**Minor Lobe.** Any lobe except the major lobe. (48 IRE 2, 11, 15.S1)

**Mixed Highs.** Those high-frequency components of the picture signal which are intended to be reproduced achromatically in a color picture. (55 IRE 22.S1)

**Mixer.** In a sound transmission, recording, or reproducing system, a device having two or more inputs, usually adjustable, and a common output, which operates to combine linearly in a desired proportion the separate input signals to produce an output signal.

*Note:* The term is sometimes applied to the operator of the above device.

(51 IRE 6.S1)

**Mixer (in Audio Techniques).** A device, having two or more inputs and a common output, which operates to combine linearly in a desired proportion the separate input *Signals* to produce an output *Signal*. (58 IRE 3.S1)

**Mixer Tube.** An *Electron Tube* that performs only the frequency-conversion function of a *Heterodyne Conversion Transducer* when it is supplied with voltage or power from an external oscillator. (57 IRE 7.S2)

**Mixing Point.** In a block diagram of a feedback control loop, a symbol indicating the relationship of one output to two or more inputs, such that the value of the output at any instant is a function of the values of the inputs at that instant.

*Note:* If a mixing device in practice contains dynamic elements, these shall be considered as transfer elements in one or more of the signal paths entering or leaving the mixing point.

(55 IRE 26.S2)

**Mobile Transmitter.** A radio transmitter designed for installation in a vessel, vehicle, or **Mistake.** See *Error*. (56 IRE 8.S1)

aircraft, and normally operated while in motion. (48 IRE 2, 11, 15.S1)

**Mobility.** See *Drift Mobility*. (54 IRE 7.S2)

**Mobility, Hall (of an Electrical Conductor).** The quantity  $\mu_H$  in the relation  $\mu_H = R\sigma$ , where  $R = \text{Hall Constant}$  and  $\sigma = \text{conductivity}$ . (54 IRE 7.S2)

**Mode.** A state of a vibrating system to which corresponds one of the possible resonance frequencies (or propagation constants).

*Note 1:* Not all dissipative systems have *Modes*.

*Note 2:* See *Modes, Degenerate*.

(56 IRE 7.S1; 57 IRE 7.S2)

**Mode Filter.** A selective device designed to pass energy along a waveguide in one or more modes of propagation and substantially reduce energy carried by other modes. (55 IRE 2.S1)

**Mode of an Oscillator.**

1) **Resonator Mode.** A condition of operation corresponding to a particular field configuration for which the electron stream introduces a negative conductance into the coupled circuit.

2) **Transit-Time Mode.** A condition of operation of an oscillator corresponding to a limited range of *Drift-Space Transit Angle* for which the electron stream introduces a negative conductance into the coupled circuit. (56 IRE 7.S1; 57 IRE 7.S2)

**Mode of Propagation (Transmission).** A form of propagation of guided waves that is characterized by a particular field pattern in a plane transversed to the *Direction of Propagation*, which field pattern is independent of position along the axis of the *Waveguide*.

*Note:* In the case of *Uniconductor Waveguides* the field pattern of a particular *Mode of Propagation* is also independent of frequency.

(53 IRE 2.S1)

**Mode Purity (ATR Tubes).** The extent to which the tube in its *Mount* is free from undesirable *Mode* conversion. (57 IRE 7.S2)

**Mod.** See *Pulse Coder*. (49 IRE 12.S1)

**Mode of Resonance.** A form of natural electromagnetic oscillation in a resonator, characterized by a particular field pattern which is invariant with time. (53 IRE 2.S1)

**Modes, Degenerate.** A set of *Modes* having the same resonance frequency (or propagation constant).

*Note:* The members of a set of *Degenerate Modes* are not unique.

(56 IRE 7.S1; 57 IRE 7.S2)

**Mode Separation (Oscillators).** The frequency difference between *Resonator Modes* of oscillation. (56 IRE 7.S1; 57 IRE 7.S2)

**Mode Transducer (Mode Transformer).** A device for transforming an *Electromagnetic Wave* from one *Mode of Propagation* to another. (51 IRE 20.S2; 53 IRE 2.S1)

**Mode Transformer.** See *Mode Transducer*. (51 IRE 20.S2)

**Modified Index of Refraction.** In the troposphere, the index of refraction at any height increased by  $h/a$ , where  $h$  is the height above sea level and  $a$  is the mean geometrical radius of the earth. When the index of refraction in the troposphere is horizontally stratified, propagation over a hypothetical flat earth through an atmosphere with the modified index of refraction is substantially equiv-

alent to propagation over a curved earth through the real atmosphere. (50 IRE 24.S1)

**Modulated Amplifier.** An amplifier stage in a transmitter in which the modulating signal is introduced and modulates the carrier. (48 IRE 2, 11, 15.S1)

**Modulated Wave.** A wave, some characteristic of which varies in accordance with the value of a modulating wave. (48 IRE 2, 11, 15.S1)

**Modulating Electrode.** An electrode to which a potential is applied to control the magnitude of the beam current. (50 IRE 7.S1)

**Modulating Signal (Modulating Wave).** A wave which causes a variation of some characteristic of a carrier. (52 IRE 17.S1)

**Modulating Wave.** A wave which causes a variation of some characteristic of a carrier. (53 IRE 11.S1)

**Modulation.** The process or result of the process whereby some characteristic of one wave is varied in accordance with another wave. (52 IRE 17.S1; 53 IRE 11.S1)

**Modulation Capability.** The maximum percentage modulation that is possible without objectionable distortion. (48 IRE 2, 11, 15.S1)

**Modulation Factor.** The ratio of the peak variation actually used to the maximum design variation in a given type of modulation.

*Note:* In conventional amplitude modulation the maximum design variation is considered that for which the instantaneous amplitude of the modulated wave reaches zero. (52 IRE 17.S1; 53 IRE 11.S1)

**Modulation Index.** In frequency modulation with a sinusoidal modulating wave, the ratio of the frequency deviation to the frequency of the modulating wave. (53 IRE 11.S1)

**Modulation Noise (Noise Behind the Signal).** The noise caused by the signal. The signal is not to be included as part of the noise.

*Note:* The term is used where the noise level is a function of the strength of the signal.

(51 IRE 6.S1)

**Modulator.** A device to effect the process of modulation. (53 IRE 11.S1)

**Moire (in Television).** The spurious pattern in the reproduced picture resulting from interference beats between two sets of periodic structures in the image.

*Note:* *Moirés* may be produced, for example, by interference between regular patterns in the original subject and the *Target Grid* in an *Image Orthicon*, between patterns in the subject and the line pattern and the pattern of phosphor dots of a *Color Picture Tube*, and between any of these patterns

## Mold

and the pattern produced by the chrominance signal.

(55 IRE 22.S1; 57 IRE 7.S2)

**Mold.** In disk recording, a mold is a metal part derived from a master by electroforming which is a positive of the recording, i.e., it has grooves similar to a recording and thus can be played in a manner similar to a record. (51 IRE 6.S1)

**Monitoring Amplifier.** See *Amplifier, Monitoring.* (58 IRE 3.S1)

**Monochromatic.** Referring to a negligibly small region of the spectrum. (55 IRE 22.S1)

**Monochrome.** Having only one *Chromaticity*, usually achromatic. (55 IRE 22.S1)

**Monochrome Signal.** 1) In monochromic television, a signal wave for controlling the *Luminance* values in the picture. 2) In color television, that part of the signal wave which has major control of the *Luminance* values of the picture, whether displayed in *Color* or in *Monochrome*. (55 IRE 22.S1)

**Monochrome Transmission.** In television, the transmission of a signal wave for controlling the *Luminance* values in the picture, but not the *Chromaticity values*. (55 IRE 22.S1)

**Monoscope.** A signal-generating *Electron-Beam Tube* in which a picture signal is produced by scanning an *Electrode* which has a predetermined pattern of *Secondary-Emission* response over its surface. (52 IRE 17.S1; 57 IRE 7.S2)

**Motional Impedance<sup>1</sup> (Loaded Motional Impedance).** Of a transducer, the complex remainder after the blocked impedance has been subtracted from the loaded impedance. (51 IRE 6.S1)

**Motorboating.** Oscillation in a system or component, usually manifested by a succession of pulses occurring at a sub-audio or low-audio repetition frequency. (58 IRE 3.S1)

**Motor Effect.** The repulsion force exerted between adjacent conductors carrying currents in opposite directions. (55 IRE 10.S1)

**Motor Field Induction Heater.** An *Induction Heater* in which the inducing winding typifies that of an induction motor of rotary or linear design. (55 IRE 10.S1)

**Mount (Switching Tubes).** The flange or other means by which the tube, or tube and cavity, are connected to a waveguide. (57 IRE 7.S2)

**Moving-Coil Loudspeaker (Dynamic Loudspeaker).** A moving-conductor loudspeaker in which the moving conductor is in the form of a coil conductively connected to the source of electric energy. (51 IRE 6.S1)

## Multichannel Radio Transmitter

**Moving-Coil Microphone (Dynamic Microphone).** A moving-conductor microphone in which the movable conductor is in the form of a coil. (51 IRE 6.S1)

**Moving-Coil Pickup (Dynamic Reproducer).** A phonograph pickup, the electric output of which results from the motion of a conductor or coil in a magnetic field. (51 IRE 6.S1)

**Moving-Conductor Loudspeaker.** A loudspeaker in which the mechanical forces result from magnetic reactions between the field of the current in a moving conductor and a steady magnetic field. (51 IRE 6.S1)

**Moving-Conductor Microphone.** A microphone, the electric output of which results from the motion of a conductor in a magnetic field. (51 IRE 6.S2)

**Moving Target Indicator (MTI).** A device which limits the *Display of Radar* information primarily to moving *Targets*. (54 IRE 12.S1)

**MTI.** See *Moving Target Indicator.* (54 IRE 12.S1)

**MTI Subclutter Visibility.** The gain in signal to *Clutter* power ratio produced by the MTI. (54 IRE 12.S1)

**MTI Target Visibility.** In *Radar MTI*, one factor in MTI circuit performance expressed as the ratio of the signal strength from a *Target* traveling at a specified radial velocity to the signal strength from the same *Target* when it is traveling at an optimum radial velocity. The factor applies only when the *Target* is not in *Clutter*. (54 IRE 12.S1)

**MTR (Multiple Track Range).** An adaptation of the *GEE* systems utilizing two closely-spaced synchronized pulse stations. The indicator in the aircraft has several predetermined time difference settings so that by their selection a number of approximately parallel *Tracks* may be flown. (54 IRE 12.S1)

**Mu-( $\mu$ )-Factor (*n*-Terminal Electron Tubes).** The ratio of the magnitude of an infinitesimal change in the voltage at the *j*th *Electrode* to the magnitude of an infinitesimal change in the voltage at the *l*th *Electrode* under the conditions that the current to the *n*th *Electrode* remains unchanged, and the voltages of all other *Electrodes* are maintained constant. (57 IRE 7.S2)

**Multicavity Magnetron.** A *Magnetron* in which the circuit includes a plurality of cavities. (57 IRE 7.S2)

**Multicellular Horn.** A cluster of horns with juxtaposed mouths which lie in a common surface. The purpose of the cluster is to control the directional pattern of the radiated energy. (51 IRE 6.S1)

**Multichannel Radio Transmitter.** A radio

<sup>1</sup> See Note 2 under *Acoustic Impedance.*

## Multielectrode Tube

transmitter having two or more complete radio-frequency portions capable of operating on different frequencies, either individually or simultaneously. (48 IRE 2, 11, 15.S1)

**Multielectrode Tube.** An *Electron Tube* containing more than three *Electrodes* associated with a single electron stream. (57 IRE 7.S2)

**Multifrequency Transmitter.** A radio transmitter capable of operating on two or more selectable frequencies, one at a time, using preset adjustments of a single radio-frequency portion. (48 IRE 2, 11, 15.S1)

**Multipath.** See *Multipath Transmission*. (56 IRE 9.S1)

**Multipath Transmission (Multipath).** The propagation phenomenon which results in signals reaching the radio receiving antenna by two or more paths.

*Note:* In *Facsimile*, *Multipath* causes *Jitter*. (56 IRE 9.S1)

**Multiple-Address (Instruction) Code.** An instruction in general consists of a coded representation of the operation to be performed and of one or more addresses of words in storage. The instructions of a multiple-address code contain more than one address. See *Instruction Code*. (50 IRE 8.S1; 56 IRE 8.S1)

**Multiple Course.** One of a family of *Lines of Position* defined by a navigational system, which may or may not be ambiguous, any one of which may be selected as a *Course Line*. (54 IRE 12.S1)

**Multiple Modulation.** A succession of processes of modulation in which the modulated wave from one process becomes the modulating wave for the next.

*Note:* In designating multiple-modulation systems by their letter symbols, the processes are listed in the order in which the signal intelligence encounters them. For example, PPM-AM means a system in which one or more signals are used to position modulate their respective pulse subcarriers which are spaced in time and are used to amplitude modulate a carrier. (53 IRE 11.S1)

**Multiple Sound Track.** Consists of a group of sound tracks, printed adjacently on a common base, independent in character but in a common time relationship, e.g., two or more have been used for stereophonic sound recording. (51 IRE 6.S1)

**Multiple Spot Scanning.** The method in which *Scanning* is carried on simultaneously by two or more *Scanning Spots*, each one analyzing its fraction of the total scanned area of the *Subject Copy*. (56 IRE 9.S1)

**Multiple Tube Counts (Radiation-Counter**

## Musical Echo

**Tubes).** Spurious *Counts* induced by previous *Tube Counts*. (57 IRE 7.S2)

**Multiple-Tuned Antenna.** A low-frequency antenna having a horizontal section with a multiplicity of tuned vertical sections. (48 2, 11, 15.S1)

**Multiple-Unit Tube.** An *Electron Tube* containing within one envelope two or more groups of *Electrodes* associated with independent electron streams.

*Note:* A *Multiple-Unit Tube* may be so indicated, for example: duodiode, duotriode, diode-pentode, duodiode-triode, duodiode-pentode, or triode-pentode. (57 IRE 7.S2)

**Multiplex Radio Transmission.** The simultaneous transmission of two or more signals using a common carrier wave. (48 IRE 2, 11, 15.S1)

**Multiplication Point.** A mixing point whose output is obtained by multiplication of its inputs. (55 IRE 26.S2)

**Multiplier.** A device which has two or more inputs and whose output is a representation of the product of the quantities represented by the input signals. (56 IRE 8.S1)

**Multiplier Phototube.** A *Phototube* with one or more *Dynodes* between its *Photocathode* and the output *Electrode*. (57 IRE 7.S2)

**Multisegment Magnetron.** A *Magnetron* with an *Anode* divided into more than two segments, usually by slots parallel to its axis. (57 IRE 7.S2)

**Multitrack Recording System.** A recording system which provides two or more recording paths on a medium, which may carry either related or unrelated recordings in common time relationship. (51 IRE 6.S1)

**Multivibrator.** A relaxation oscillator employing two electron tubes to obtain the in-phase feedback voltage by coupling the output of each to the input of the other through, typically, resistance-capacitance elements. The fundamental frequency is determined by the time constants of the coupling elements and may be further controlled by an external voltage. When such circuits are normally in a nonoscillating state and a trigger signal is required to start a single cycle of operation, the circuit is commonly called a one-shot, a flip-flop, or a start-stop multivibrator. (48 IRE 2, 11, 15.S1)

**Musa Antenna.** A "multiple-unit steerable antenna" consisting of a number of stationary antennas, the composite major lobe of which is electrically steerable. (48 IRE 2, 11, 15.S1)

**Musical Echo.** A flutter echo that is periodic and has a flutter frequency of which is in the audible range. (51 IRE 6.S1)



## Mutual Information

**Mutual Information.** See *Transinformation*. (58 IRE 11.S1)

## N

**Narrow-Band Axis.** In phasor representation of the *Chrominance Signal*, the direction of the phasor representing the *Coarse Chrominance Primary*. (55 IRE 22.S1)

**N-ary Code.** A *Code* employing *N* distinguishable types of *Code Elements*. (58 IRE 11.S1)

**Navaglobe.** A long-distance continuous-wave LF *Navigation* system of the amplitude-comparison type, providing *Bearing* information. (54 IRE 12.S1)

**Navar.** A coordinated series of *Radar* air *Navigation* and traffic-control aids utilizing transmissions at wavelengths of 10 centimeters and 60 centimeters to provide in the aircraft distance and *Bearing* from a given point, display of other aircraft in the vicinity, and commands from the ground; also providing on the ground a display of all aircraft in the vicinity, as well as their altitudes, identities, and means for transmitting certain commands. (54 IRE 12.S1)

**Nava-Rho.** A long-distance continuous wave LF *Navigation* system providing simultaneous *Bearing* and distance information. (54 IRE 12.S1)

**Navigation.** The process of directing a *Vehicle* to reach the intended destination. (54 IRE 12.S1)

**Navigational Parameter.** A visual or aural output of a navigational aid having a specific relation to *Navigation Coordinates*. (54 IRE 12.S1)

**Navigation Coordinate.** A quantity, the measurement of which serves to define a *Surface of Position* (or a *Line of Position* if one surface is already known) of a *Vehicle*. (54 IRE 12.S1)

**N-Display (also N-Scan or N-Scope).** In *Radar*, a *Display* similar to the type *K-Display* in which the *Target* appears as a pair of vertical deflections or *Blips* from the horizontal time base. *Direction* is indicated by the relative amplitude of the vertical deflections; *Target* distance is determined by moving an adjustable pedestal signal along the *Baseline* until it coincides with the horizontal *Position* of the vertical deflections. The pedestal control is calibrated in distance. (54 IRE 12.S1)

**Negative Feedback.** Feedback which results in decreasing the amplification. (48 IRE 2, 11, 15.S1)

**Negative Modulation.** In an amplitude-modulation system, that form of modulation in which the maximum transmitted power corresponds to the maximum density of the sub-

## Night Effect—Deprecated

ject copy. In a frequency-modulation system, it is that form of modulation in which the highest transmitter frequency corresponds to the maximum density of the subject copy. (42 IRE 9.S1)

**Negative-Resistance Oscillator.** An oscillator produced by connecting a parallel-tuned resonant circuit to a two-terminal negative-resistance device. (One in which an increase in voltage results in a decrease in current.) Dynatron and transitron oscillators are examples. (48 IRE 2, 11, 15.S1)

**Negative-Transconductance Oscillator.** An electron-tube oscillator in which the output of the tube is coupled back to the input without phase shift, the phase condition for oscillation being satisfied by the negative transductance of the tube. (48 IRE 2, 11, 15.S1)

**Negentropy.** See *Average Information Content*. (58 IRE 11.S1)

**Neper.** The fundamental division of a logarithmic scale for expressing the ratio between two currents or voltages, the number of nepers denoting such a ratio being the natural logarithm of this ratio. 1 neper equals 0.8686 . . . bels.

*Note:* With  $V_1$  and  $V_2$  designating two voltages and  $N$  the number of nepers denoting their ratio,

$$N = 1n(V_1/V_2) \text{ nepers.}$$

(48 IRE 2, 11, 15.S1)

**Network.** A combination of electrical elements. (50 IRE 4.S1)

**Neutralization.** A method of nullifying the voltage feedback from the output to the input circuits of an amplifier through the tube interelectrode impedances. Its principal use is in preventing oscillation in an amplifier by introducing a voltage into the input equal in magnitude but opposite in phase to the feedback through the interelectrode capacitance. (48 IRE 2, 11, 15.S1)

**Neutralizing Indicator.** An auxiliary device for indicating the degree of neutralization of an amplifier. (For example, a lamp or detector coupled to the plate tank circuit of an amplifier.) (48 IRE 2, 11, 15.S1)

**Neutralizing Voltage.** The alternating-current voltage specifically fed from the grid circuit to the plate circuits (or vice versa), deliberately made 180° out of phase with and equal in amplitude to the alternating-current voltage similarly transferred through undesired paths, usually the grid-to-plate tube capacitance. (48 IRE 2, 11, 15.S1)

**Night Effect—Deprecated.** In *Navigation*, a special case of *Polarization Error* occurring predominantly at night and so called because

it is usually associated with those frequencies at which the sky-waves are normally absorbed during the day time.

*Note:* This is a term which occurs chiefly in older literature and is deprecated in favor of more accurate modern terminology.

(54 IRE 12.S1)

**Node (Junction Point) (Branch Point) (Vertex).** A terminal of any branch of a network or a terminal common to two or more branches of a network. (50 IRE 4.S1)

**Noise.** Any extraneous electrical disturbance tending to interfere with the normal reception of a transmitted signal.

See:

*Audio-Frequency Noise*

*Johnson Noise*

*Shot Noise*

*Shot Noise, Full*

*Shot Noise, Reduced*

*Thermal Noise.*

(56 IRE 9.S1; 57 IRE 7.S2; 58 IRE 3.S1)

**Noise-Current Generator.** A *Current Generator*, the output of which is described by a random function of time.

*Note:* At a specified frequency, a *Noise-Current Generator* can often be adequately characterized by its mean-square current within the frequency increment  $\Delta f$ , or by its spectral density. If the circuit contains more than one *Noise-Voltage Generator* or *Noise-Current Generator*, the correlation coefficients among the generators must also be specified.

(57 IRE 7.S2)

**Noise Diode, Ideal.** See *Ideal Noise Diode*.

(57 IRE 7.S2)

**Noise Factor (Noise Figure).** Of a linear system at a selected input frequency, the ratio of 1) the total noise power per unit bandwidth (at a corresponding output frequency) available at the output terminals, to 2) the portion thereof engendered at the input frequency by the input termination, whose noise temperature is standard (290°K) at all frequencies. (See *Noise Temperature*.)

*Note 1:* For heterodyne systems there will be, in principle, more than one output frequency corresponding to a single input frequency, and vice versa; for each pair of corresponding frequencies a noise factor is defined.

*Note 2:* The phrase, "available at the output terminals" may be replaced by "delivered by the system into an output termination," without changing the sense of the definition.

(52 IRE 17.S1)

**Noise Factor (Noise Figure) (of a Two-Port Transducer).** At a specified input frequency the ratio of 1) the total noise power

per unit bandwidth at a corresponding output frequency available at the output *Port* to 2) that portion of 1) engendered at the input frequency by the input termination at the *Standard Noise Temperature* (290°K).

*Note 1:* For heterodyne systems there will be, in principle, more than one output frequency corresponding to a single input frequency, and vice versa; for each pair of corresponding frequencies a *Noise Factor* is defined.

*Note 2:* The phrase "available at the output *Port*" may be replaced by "delivered by system into an output termination."

*Note 3:* To characterize a system by a *Noise Factor* is meaningful only when the input termination is specified.

(57 IRE 7.S2)

**Noise Factor (Noise Figure), Average.** Of a linear system, the ratio of 1) the total noise power delivered by the system into its output termination when the noise temperature of its input termination is standard (290°K) at all frequencies to 2) the portion thereof engendered by the input termination. For heterodyne systems, portion 2) includes only that noise from the input termination which appears in the output via the principal frequency transformation of the system, and does not include spurious contributions such as those from image-frequency transformations.

*Note:* A quantitative relation between *Average Noise Factor*  $\bar{F}$  and *Spot Noise Factor*  $F(f)$  is

$$\bar{F} = \frac{\int_0^{\infty} F(f)G(f)df}{\int_0^{\infty} G(f)df},$$

where  $f$  is the input frequency and  $G(f)$  is the ratio of a) the signal power delivered by the system into its output termination to b) the corresponding signal power available from the input termination at the input frequency. For heterodyne systems, a) comprises only power appearing in the output via the principal frequency transformation of the system; in other words, power via image-frequency transformations is excluded.

(52 IRE 17.S1)

**Noise Factor (Noise Figure), Average (of a Two-Port Transducer).** The ratio of 1) the total noise power delivered by the transducer into its output termination when the *Noise Temperature* of its input termination is standard (290°K) at all frequencies, to 2)

## Noise Factor

that portion of 1) engendered by the input termination.

*Note 1:* For heterodyne systems, 2) includes only that noise from the input termination which appears in the output via the principal-frequency transformation of the system, and does not include spurious contributions such as those from an image-frequency transformation.

*Note 2:* A quantitative relation between the *Average Noise Factor*  $\bar{F}$  and the *Spot Noise Factor*  $F(f)$  is

$$\bar{F} = \frac{\int F(f)G(f)df}{\int G(f)df}$$

where  $f$  is the input frequency, and  $G(f)$  is the ratio of 1) the signal power delivered by the transducer into its output termination, to 2) the corresponding signal power available from the input termination at the input frequency. For heterodyne systems, 1) comprises only power appearing in the output via the principal-frequency transformation of the system: for example, power via image-frequency transformation is excluded.

*Note 3:* To characterize a system by an *Average Noise Factor* is meaningful only when the input termination is specified.

(57 IRE 7.S2)

**Noise Factor (Noise Figure), Spot.** See *Noise Factor (Noise Figure)*; *Noise Factor (Noise Figure) (of a Two-Port Transducer)*.

*Note:* This term is used where it is desired to emphasize that the *Noise Factor* is a point function of input frequency.

(57 IRE 17.S1; 57 IRE 7.S2)

**Noise Reduction.** In photographic recording and reproducing, a process whereby the average transmission of the sound track of the print (averaged across the track) is decreased for signals of low level and increased for signals of high level.

*Note:* Since the ground noise introduced by the sound track is less at low transmission, this process reduces film noise during soft passages. The effect is normally accomplished automatically.

(51 IRE 6.S1)

**Noise Temperature.** At a pair of terminals and at a specific frequency, the temperature of a passive system having an available noise power per unit bandwidth equal to that of the actual terminals. (52 IRE 17.S1)

**Noise Temperature (at a Port).** The temperature of a passive system having an available noise power per unit bandwidth equal

## Nonlinear Network

to that of the actual *Port*, at a specified frequency.

*Note:* See *Thermal Noise*.

(57 IRE 7.S2)

**Noise Temperature, Standard (Electron Tubes).** The standard reference temperature  $T_0$  for noise measurements is 290°K.

*Note:*  $kT_0/e = 0.0250$  volt, where  $e$  is the magnitude of the electronic charge and  $k$  is Boltzmann's constant.

(57 IRE 7.S2)

**Noise Temperature Standard (Receivers).**

The standard reference temperature  $T_0$  for noise measurements is taken as 290°K.

*Note:*  $kT_0/e = 0.0250$  volt, where  $e$  is the electron charge and  $k$  is Boltzmann's constant.

(52 IRE 17.S1)

**Noise-Voltage Generator.** A *Voltage Generator* the output of which is described by a random function of time.

*Note:* At a specified frequency, a *Noise-Voltage Generator* can often be adequately characterized by its mean-square voltage within the frequency increment  $\Delta f$  or by its spectral density. If the circuit contains more than one *Noise-Voltage Generator* or *Noise-Current Generator*, the correlation coefficients among the generators must also be specified.

(57 IRE 7.S2)

**Nominal Band.** The frequency band of a facsimile-signal wave equal in width to that between zero frequency and the maximum keying frequency.

*Note:* The frequency band occupied in the transmitting medium will in general be greater than the nominal band.

(42 IRE 9.S1)

**Nominal Line Width.** The average separation between centers of adjacent scanning or recording lines. (56 IRE 9.S1)

**Nondestructive Read.** A method of reading the magnetic state of a core without changing its state. (59 IRE 8.S1)

**Nonlinear Distortion.** Distortion caused by a deviation from a desired linear relationship between specified measures of the output and input of a system.

*Note:* The related measures need not be output and input values of the same quantity; e.g., in a linear detector the desired relation is between the output signal voltage and the input modulation envelope.

See *Distortion, Nonlinear*.

(52 IRE 17.S1; 53 IRE 4.S1; 58 IRE 3.S1)

**Nonlinear Network (Circuit).** A network (circuit) not specifiable by linear differential equations with time as the independent variable. (53 IRE 4.S1)

**Nonphysical Primary.** A *Primary* represented by a point outside the area of the *Chromaticity Diagram* enclosed by the *Spectrum Locus* and the *Purple Boundary*.

*Note:* Nonphysical primaries cannot be produced because they require negative power at some wave-lengths. However, they have properties which facilitate colorimetric calculation. *Tristimulus Values* based upon them are derived from *Tristimulus Values* based upon physical primaries.

(55 IRE 22.S1)

**Nonplanar Network.** A network which cannot be drawn on a plane without crossing of branches. (50 IRE 4.S1)

**Normalized Admittance.** The reciprocal of the *Normalized Impedance*. (53 IRE 2.S1)

**Normalized Impedance (with Respect to a Waveguide).** An impedance divided by the *Characteristic Impedance* of the *Waveguide*. (56 IRE 2.S1)

**Normalized Plateau Slope.** See *Plateau Slope, Normalized*. (57 IRE 7.S2)

**North-Stabilized PPI.** An *Azimuth-Stabilized PPI* on which the reference *Bearing* is North. (54 IRE 12.S1)

**Notation, Positional.** See *Positional Notation*. (50 IRE 8.S1)

**Note.** A conventional sign used to indicate the pitch, or the duration, or both, of a tone sensation. It is also the sensation itself or the vibration causing the sensation. The word serves when no distinction is desired between the symbol, the sensation, and the physical stimulus. (51 IRE 6.S1)

**N-Terminal Network.** A network with *N* accessible terminals. (50 IRE 4.S1)

**N-Terminal Pair Network.** A network with  $2N$  accessible terminals grouped in pairs. In such a network one terminal of each pair may coincide with a network node. (50 IRE 4.S1)

**Nth Harmonic.** The harmonic of frequency *N* times that of the fundamental component. (53 IRE 4.S1)

**Null.** In direction finding systems wherein the output amplitude is a function of the direction of arrival of the signal, or of the rotation in bearing of the response pattern of the *DF Antenna System*, the minimum output amplitude (ideally zero).

*Note:* The *Null* is frequently employed as a means of determining bearing. The term "minimum" is often used to indicate an imperfect *Null*.

(59 IRE 12.S1)

**Nullity (Degrees of Freedom on Mesh Basis).** The number of independent meshes that can be selected in a network. The nullity *N* is equal to the number of branches *B* minus the number of nodes *V* plus the num-

ber of separate parts *P*.  $N = B - V + P$ . (50 IRE 4.S1)

**Number.** 1) Formally, an abstract mathematical entity which is a generalization of a concept used to indicate quantity, direction, etc. In this sense a number is independent of the manner of its presentation. 2) Commonly: A representation of a number as defined above (e.g., the binary number "10110," the decimal number "3695," or a sequence of pulses). 3) An expression composed wholly or partly of digits which does not necessarily represent the abstract entity mentioned in the first meaning.

*Note:* Whenever there is a possibility of confusion between meaning 1) and meaning 2) or 3), it is usually possible to make an unambiguous statement by using "number" for meaning 1) and "numerical expression" for meaning 2) or 3).

(56 IRE 8.S1)

**Number, Double-Precision.** See *Double-Precision Number*. (50 IRE 8.S1)

**Number of Loops (in a Magnetically Focused Electron Beam).** The number of maxima in the beam diameter between the *Electron Gun* and the *Target*, or between a point on the *Photocathode* and the *Target*. (57 IRE 7.S2)

**Number 1 Mold (Mother) (Metal Positive).** A mold derived by electroforming from the original master. (51 IRE 6.S1)

**Number 2, Number 3, etc. Master.** A master produced by electroforming from a No. 1, No. 2, etc. mold. (51 IRE 6.S1)

**Number 2, Number 3, etc. Mold.** A mold derived by electroforming from a No. 2, No. 3, etc. master. (51 IRE 6.S1)

**Number System.** See *Positional Notation*. (56 IRE 8.S1)

**Nutating Feed.** In a tracking *Radar* an oscillating antenna feed for producing an oscillating deflection of the beam in which the plane of polarization remains fixed. (54 IRE 12.S1)

**Nutating Field.** The time variant three-dimensional field pattern of a directional or beam-producing antenna having a *Nutating Feed*. (54 IRE 12.S1)

O

**OBI (Omnibearing Indicator).** An instrument which presents an automatic and continuous indication of an *Omnibearing*. (54 IRE 12.S1)

**Oboe.** A particular *Radar Navigation* system consisting of two ground stations measuring distance to an air-borne *Transponder Beacon* and relaying information to the aircraft. (54 IRE 12.S1)

**OBS (Omnibearing Selector).** An instrument capable of being set manually to any desired *Bearing* of an *Omnirange* station and which controls a *Course Deviation Indicator*. (54 IRE 12.S1)

**Octal.** See *Positional Notation*. (56 IRE 8.S1)

**Octave.** The interval between any two frequencies having a ratio of 2:1. (58 IRE 3.S1)

**Octave-Band Pressure Level (Octave Pressure Level).** Of a sound, the band pressure level for a frequency band corresponding to a specified octave.

*Note:* The location of an octave-band pressure level on a frequency scale is usually specified as the geometric mean of the upper and lower frequencies of the octave.

(51 IRE 6.S1)

**Octode.** An eight-electrode *Electron Tube* containing an *Anode*, a *Cathode*, a *Control Electrode*, and five additional *Electrodes* that are ordinarily *Grids*. (57 IRE 7.S2)

**Octonary.** See *Positional Notation*. (56 IRE 8.S1)

**Off Center PPI.** In *Radar*, a *PPI (Plan Position Indicator)* which has the zero position of the time base, at a position other than the center of the *Display*, thus providing the equivalent of a larger *Display* for a selected portion of the service area. (54 IRE 12.S1)

**Offset Angle.** In lateral disk reproduction, the offset angle is the smaller of the two angles between the projections into the plane of the disk of the vibration axis of the pickup stylus and the line connecting the vertical pivot (assuming a horizontal disk) of the pickup arm with the stylus point. (51 IRE 6.S1)

**Offset-Course Computer.** An automatic computer which translates reference navigational coordinates into those required for a predetermined course. (49 IRE 12.S1)

**Off-Set Crossover Characteristic—Deprecated.** See *Crossover Characteristic Curve*. (54 IRE 12.S1)

**Ohmic Contact.** A contact between two materials, possessing the property that the potential difference across it is proportional to the current passing through. (54 IRE 7.S2)

**Omnibearing.** A *Bearing* indicated by a navigational receiver on transmissions from an *Omnirange*. (54 IRE 12.S1)

**Omnibearing Converter.** An electromechanical device which combines the omnibearing signal with vehicle heading information to furnish electrical signals for the operation of the pointer of a radio magnetic indicator. (49 IRE 12.S1)

**Omnibearing-Distance Facility.** A radio facility consisting of an *Omnidirectional Range* in combination with *Distance Measur-*

*ing Equipment (DME)*. (54 IRE 12.S1)

**Omnibearing-Distance Navigation (OBD).** Radio *Navigation* utilizing a polar coordinate system as a reference, making use of *Omnibearing-Distance Facilities*. See also *OBD*; *Rho-Theta*. (54 IRE 12.S1)

**Omnibearing Indicator.** An instrument providing automatic and continuous indication of the omnibearing. (49 IRE 12.S1)

**Omnibearing Selector.** An instrument capable of being set manually to any desired omnibearing, or reciprocal thereof, which controls a course line deviation indicator. (49 IRE 12.S1)

**Omnidirectional Antenna.** An antenna producing essentially constant field strength in azimuth and a directive radiation pattern in elevation. (48 IRE 2, 11, 15.S1)

**Omnidirectional Microphone (Nondirectional Microphone).** A microphone the response of which is essentially independent of the direction of sound incidence.

*Note:* It should be noted that, in this case, omnidirectional refers to elevation as well as azimuth. In radio antenna practice this is not necessarily the case.

(51 IRE 6.S1)

**Omnidirectional Range (Omnirange).** A radio facility providing *Bearing* information to or from such facilities at all *Azimuths* within its *Service Area*. (54 IRE 12.S1)

**Omnidistance.** The distance between the vehicle and an omnibearing-distance facility. (49 IRE 12.S1)

**Omnirange (or Omnidirectional Range).** A facility providing navigators with direct indication of the bearing of the omnirange facility from the vehicle. (49 IRE 12.S1)

**On-Course Curvature.** In *Navigation*, the rate of change of the indicated *Course* with respect to distance along the *Course Line* or *Path*. (54 IRE 12.S1)

**One-Address Code.** See *Instruction Code*. (56 IRE 8.S1)

**One Output.** See *One State*. (59 IRE 8.S1)

**One-to-Partial-Select Ratio.** See *Coincident Current Selection*. (59 IRE 8.S1)

**One State.** A state of a magnetic cell wherein the magnetic flux through a specified cross-sectional area has a positive value, when determined from an arbitrarily specified direction of positive normal to that area. A state wherein the magnetic flux has a negative value, when similarly determined, is a **Zero State**.

A **One Output** is 1) the voltage response obtained from a magnetic cell in a *One State* by a reading or resetting process or 2) the integrated voltage response obtained from a magnetic cell in a *One State* by a reading

## One-to-Zero Ratio

or resetting process. A **Zero Output** is 1) the voltage response obtained from a magnetic cell in a *Zero State* by a reading or resetting process or 2) the integrated voltage response obtained from a magnetic cell in a *Zero State* by a reading or resetting process. A ratio of a *One Output* to a *Zero Output* is a **One-to-Zero Ratio**.

A pulse, for example a *Drive Pulse*, is a **Write Pulse** if it causes information to be introduced into a magnetic cell or cells, or is a **Read Pulse** if it causes information to be acquired from a magnetic cell or cells. (59 IRE 8.S1)

**One-to-Zero Ratio.** See *One State*. (59 IRE 8.S1)

**Opacity.** Of an optical path, the reciprocal of transmission. See also *Transmission (Transmittance)*. (51 IRE 6.S1)

**Open Center PPI.** A *PPI (Plan Position Indicator)* in which the *Display* of the initiation of the time base precedes that of the transmitted pulse. (54 IRE 12.S1)

**Operand.** A word on which an operation is to be performed. (50 IRE 8.S1)

**Operating Characteristic.** See *Load Characteristic*. (57 IRE 7.S2)

**Operation.** 1) The activity resulting from an instruction. 2) The execution of a set of commands. (50 IRE 8.S1)

**Operation Code.** 1) The list of *Operation Parts* occurring in an *Instruction Code*, together with the names of the corresponding operations (e.g., "add," "unconditional transfer," "add and clear," etc.). 2) Synonym for *Operation Part* of an instruction. (56 IRE 8.S1)

**Operation Part.** In an instruction, the part that usually specifies the kind of operation to be performed, but not the location of the operands. See also *Instruction Code*. (56 IRE 8.S1)

**Operation Time.** The time after simultaneous application of all *Electrode Voltages* for a current to reach a stated fraction of its final value. Conventionally the final value is taken as that reached after a specified length of time.

*Note:* All *Electrode Voltages* are to remain constant during measurement. The tube *Elements* must all be at room temperature at the start of the test.

(57 IRE 7.S2)

**Optical Pattern (Christmas Tree Pattern).**

In mechanical recording, a pattern which is observed when the surface of a record is illuminated by a light beam of essentially parallel rays. (51 IRE 6.S1)

**Optimum Bunching.** The *Bunching* condition that produces maximum power at the

## Oscillator Starting Time

desired frequency in an *Output Gap*. (56 IRE 7.S1; 57 IRE 7.S2)

**Optimum Working Frequency.** The most effective frequency at a specified time for ionospheric propagation of radio waves between two specified points.

*Note:* In predictions of useful frequencies the optimum working frequency is commonly taken as 15 per cent below the monthly median value of the maximum usable frequency, for the specified time and path.

(50 IRE 24.S1)

**Or-Circuit.** Synonym for *Or-Gate*. (56 IRE 8.S1)

**Order.** 1) Synonym for *Instruction*. 2) Synonym for *Command*. 3) Loosely, synonym for *Operation Part*.

*Note:* The use of "order" in the computer field as a synonym for terms similar to the above is losing favor owing to the ambiguity between these meanings and the more common meanings in mathematics and business. (56 IRE 8.S1)

**Ordinary-Wave Component.** That magneto-ionic wave component deviating the least, in most of its propagation characteristics, relative to those expected for a wave in the absence of the earth's magnetic field. More exactly, if at fixed electron density, the direction of the earth's magnetic field were rotated until its direction is transverse to the direction of phase propagation, the wave component whose propagation is then independent of the magnitude of the earth's magnetic field. (50 IRE 24.S1)

**Organ.** A portion or subassembly of a computer which constitutes the means of accomplishing some inclusive operation or function, as: **Arithmetic Organ**. (50 IRE 8.S1)

**Or-Gate.** A gate whose output is energized when any one or more of the inputs is in its prescribed state. An or-gate performs the function of the logical "inclusive-or." (56 IRE 8.S1)

**Original Master (Metal Master) (Metal Negative) (Number 1 Master).** In disk recording, the master produced by electroforming from the face of a wax or lacquer recording. (51 IRE 6.S1)

**Orthicon.** A *Camera Tube* in which a beam of low-velocity electrons scans a photoemissive mosaic capable of storing an electrical-charge pattern. (57 IRE 7.S2)

**Oscillator.** A nonrotating device for producing alternating current, the output frequency of which is determined by the characteristics of the device. (48 IRE 2, 11, 15.S1; 52 IRE 17.S1)

**Oscillator Starting Time, Pulsed.** See

## Oscilloscope Tube

*Pulsed Oscillator Starting Time.* (52 IRE 20.S1)

### Oscilloscope Tube (Oscillograph Tube).

A *Cathode-Ray Tube* used to produce a visible pattern which is the graphical representation of electrical signals. (57 IRE 7.S2)

**Outer Marker.** A marker facility in an *ILS* which is installed at approximately 5 miles from the approach end of the runway on the *Localizer Course Line* to provide a fix. (51 IRE 12.S1)

**Output Capacitance (*n*-Terminal Electron Tubes).** The *Short-Circuit Transfer Capacitance* between the output terminal and all other terminals, except the input terminal, connected together. (57 IRE 7.S2)

**Output Equipment.** The equipment used for obtaining information from a computer. (50 IRE 8.S1)

**Output Gap.** An *Interaction Gap* by means of which usable power can be abstracted from an electron stream. (56 IRE 7.S1; 57 IRE 7.S2)

**Output Impedance.** See *Impedance, Output.* (58 IRE 3.S1)

**Output Power.** The power delivered by a system or component to its *Load*. (58 IRE 3.S1)

**Outscriber.** Output transcriber. (50 IRE 8.S1)

**Over-all Electrical Efficiency (Induction and Dielectric Heating usage).** The ratio of the power absorbed by the load material to the total power drawn from the supply lines. (55 IRE 10.S1)

**Overbunching.** The *Bunching* condition produced by the continuation of the *Bunching* process beyond the optimum condition. (56 IRE 7.S1; 57 IRE 7.S2)

**Overcutting.** In disk recording, the effect of excessive level characterized by one groove cutting through into an adjacent one. (51 IRE 6.S1)

**Overflow.** 1) The condition which arises when the result of an arithmetic operation exceeds the capacity of the number representation in a digital computer. 2) The *Carry* digit arising from this condition. (56 IRE 8.S1)

**Over Interrogation Control.** See *Gain Turn Down.* (54 IRE 12.S1)

**Overlap *X*.** The amount by which the *Recorded Spot X Dimension* exceeds that necessary to form a most nearly constant *Density* line.

*Note:* This effect arises in that type of equipment which responds to a constant *Density* in the *Subject Copy* by a succession of discrete *Recorded Spots*.

(56 IRE 9.S1)

**Overload Capacity.** The current, voltage, or

## Parabolic-Reflector Microphone

power level beyond which permanent damage occurs to the device considered. This is usually higher than the rated load capacity. (48 IRE 2, 11, 15.S1)

**Overload Point, Signal.** For any setting of receiver controls, and with an input signal increasing from any level within the linear operating range of the receiver, that input signal amplitude at which the ratio of output to the input first differs by 3 db from the ratio of output to input observed within the linear operating range. (59 IRE 12.S1)

**Overthrow (or Overshoot) Distortion.** The distortion resulting when the maximum amplitude of the signal wave front exceeds the steady-state amplitude of the signal wave. (42 IRE 9.S1)

**Overtone.** 1) A physical component of a complex sound having a frequency higher than that of the basic frequency. 2) A component of a complex tone having a pitch higher than that of the fundamental pitch.

*Note:* The term "overtone" has frequently been used in place of "harmonic," the *n*th harmonic being called the (*n* - 1)st overtone. There is, however, ambiguity sometimes in the numbering of components of a complex sound when the word overtone is employed. Moreover, the word "tone" has many different meanings so that it is preferable to employ terms which do not involve "tone" wherever possible.

See also *Partial*.

(51 IRE 6.S1)

### Overvoltage (Radiation-Counter Tubes).

The amount by which the applied voltage exceeds the *Geiger-Mueller Threshold*. (57 IRE 7.S2)

**O Wave.** *Ordinary-Wave Component.* (50 IRE 24.S1)

## P

**Packaged Magnetron.** An integral structure comprising a *Magnetron*, its magnetic circuit, and an output matching device. (57 IRE 7.S2)

**Pad.** A nonadjustable passive device for reducing the amplitude of a *Signal* without introducing appreciable *Distortion*. (58 IRE 3.S1)

**Pad Electrode.** One of a pair of electrode plates between which a *Load* is placed for *Dielectric Heating*. (55 IRE 10.S1)

**PAR (Precision Approach Radar).** A *Radar* system located on an airfield for observation of the *Position* of an aircraft with respect to an *Approach Path* and specifically intended to provide guidance to the aircraft in the *Approach*. (54 IRE 12.S1)

**Parabolic-Reflector Microphone.** A micro-

## Paraboloidal Reflector

phone employing a parabolic reflector to improve its directivity and sensitivity. (51 IRE 6.S1)

**Paraboloidal Reflector.** A reflector which is a portion of a paraboloid of revolution. (48 IRE 2, 11, 15.S1)

**Parallel (in Electronic Computers).** Pertaining to simultaneous transmission of, storage of, or logical operations on the parts of a word, character, or other subdivision of a word, using separate facilities for the various parts. (56 IRE 8.S1)

**Parallel Digital Computer.** One in which separate equipment is provided to operate (usually simultaneously) on the digits in each column. See also *Serial Arithmetic Unit*. (50 IRE 8.S1)

**Parallel Digital Computer.** One in which the digits are handled in parallel. Mixed serial and parallel machines are frequently called serial or parallel according to the way arithmetic processes are performed. An example of a parallel digital computer is one which handles decimal digits in parallel although it might handle the bits which comprise a digit either serially or in parallel. See also *Serial Digital Computer*. (56 IRE 8.S1)

**Parallel Elements.** 1) Two-terminal elements are connected in parallel when they are connected between the same pair of nodes. 2) Two-terminal elements are connected in parallel when any cut-set including one must include the others. (50 IRE 4.S1)

**Parallel Transmission.** The system of information transmission in which the characters of a word are transmitted (usually simultaneously) over separate lines, as contrasted to *Serial Transmission*. (50 IRE 8.S1)

**Parallel Two-Terminal Pair Networks.** Two-terminal pair networks are connected in parallel at the input or at the output terminals when their respective input or output terminals are in parallel. (50 IRE 4.S1)

**Parasitic Element.** A radiating element, not coupled directly to the feed line of the antenna, which materially affects the pattern of the antenna. (48 IRE 2, 11, 15.S1)

**Parasitic Oscillations.** Unintended self-sustaining oscillations, or transient impulses. (48 IRE 2, 11, 15.S1)

**Parity Check.** See *Check, Forbidden-Combination*. (56 IRE 8.S1)

**Partial.** 1) A physical component of a complex tone. 2) A component of a sound sensation which may be distinguished as a simple tone that cannot be further analyzed by the ear and which contributes to the character of the complex sound.

*Note 1:* The frequency of a partial may be either higher or lower than the *Basic Fre-*

## Peak Cathode Current

*quency* and may or may not be an integral multiple or submultiple of the *Basic Frequency*. If the frequency is not a multiple or submultiple, the partial is inharmonic.

*Note 2:* When a system is maintained in steady forced vibration at a *Basic Frequency* equal to one of the frequencies of the normal modes of vibration of the system, the partials in the resulting complex tone are not necessarily identical in frequency with those of the other normal modes of vibration.

(51 IRE 6.S1)

**Partial Carry.** See *Carry*. (56 IRE 8.S1)

**Partial-Read Pulse.** See *Coincident-Current Selection*. (59 IRE 8.S1)

**Partial-Select Output.** See *Coincident-Current Selection*. (59 IRE 8.S1)

**Partial-Write Pulse.** See *Coincident-Current Selection*. (59 IRE 8.S1)

**Particle Velocity.** In a sound wave, the velocity of a given infinitesimal part of the medium, with reference to the medium as a whole, due to the sound wave. The commonly used unit is the centimeter per second.

*Note:* The terms "instantaneous particle velocity," "effective particle velocity," "maximum particle velocity," and "peak particle velocity" have meanings which correspond with those of the related terms used for sound pressure.

(51 IRE 6.S1)

**Passive Transducer.** A transducer whose output waves are independent of any sources of power which is controlled by the actuating waves. See *Transducer, Passive*. (51 IRE 20.S2; 58 IRE 3.S1)

**Path.** In *Navigation*, a line connecting a series of points in space and constituting a proposed or traveled route. (54 IRE 12.S1)

**Path Length.** The length of a magnetic flux line in a core. In a toroidal core with nearly equal inside and outside diameters, the value

$$l_m = \frac{\pi}{2} (\text{O.D.} + \text{I.D.})$$

is commonly used. (59 IRE 8.S1)

**P-Display.** See *Plan Position Indicator (PPI)*. (54 IRE 12.S1)

**Peak Alternating Gap Voltage.** The negative of the line integral of the peak alternating electric field taken along a specified path across the gap.

*Note:* The path of integration must be stated.

(56 IRE 7.S1; 57 IRE 7.S2)

**Peak Cathode Current (Steady-State).** The maximum instantaneous value of a periodically recurring *Cathode Current*. (57 IRE 7.S2)



## Peak Electrode Current

**Peak Electrode Current.** The maximum instantaneous current that flows through an *Electrode*. (57 IRE 7.S2)

**Peak Flux Density,  $B_m$ .** The maximum flux density in a magnetic material in a specified *Cyclically Magnetized Condition*. (59 IRE 8.S1)

**Peak Forward Anode Voltage.** The maximum instantaneous *Anode Voltage* in the direction in which the tube is designed to pass current. (57 IRE 7.S2)

**Peak Inverse Anode Voltage.** The maximum instantaneous *Anode Voltage* in the direction opposite to that in which the tube is designed to pass current. (57 IRE 7.S2)

**Peak Limiter.** A device which automatically limits the magnitude of a *Signal* to a predetermined maximum value in accordance with a specified *Attack Time* and a specified *Recovery Time*. (58 IRE 3.S1)

**Peak Limiting Amplifier.** See *Peak Limiter*. (58 IRE 3.S1)

**Peak Magnetizing Force,  $H_m$  (Peak Field Strength).** The upper or lower limiting value of magnetizing force associated with a *Cyclically Magnetized Condition*. (59 IRE 8.S1)

**Peak Power Output.** The output power averaged over the radio-frequency cycle having the maximum peak value which can occur under any combination of signals transmitted. (48 IRE 2, 11, 15.S1)

**Peak Pulse Amplitude.** The maximum absolute peak value of the *Pulse* excluding those portions considered to be unwanted, such as spikes.

*Note:* Where such exclusions are made, it is desirable that the amplitude chosen be illustrated pictorially.

(51 IRE 20.S1; 55 IRE 23.S1)

**Peak Pulse Power.** The power at the maximum of a *Pulse* of power, excluding spikes. (52 IRE 20.S1)

**Peak Pulse Power, Carrier-Frequency.** The power averaged over that carrier-frequency cycle which occurs at the maximum of the pulse of power (usually one half the maximum instantaneous power). (52 IRE 20.S1)

**Peak-Signal Level.** An expression of the maximum instantaneous signal power or voltage as measured at any point in a facsimile system.

*Note:* This includes auxiliary signals.

(42 IRE 9.S1)

**Peak Sound Pressure.** For any specified time interval, the maximum absolute value of the instantaneous sound pressure in that interval. The commonly used unit is the microbar.

*Note:* In the case of a periodic wave, if the time interval considered is a complete period,

## Periodic Pulse Train

the peak sound pressure becomes identical with the maximum sound pressure.

(51 IRE 6.S1)

**Pencil Beam.** Emission, from an antenna, having the form of a narrow conical beam. (54 IRE 12.S1)

**Pencil-Beam Antenna.** A unidirectional antenna, so designed that cross sections of the major lobe by planes perpendicular to the direction of maximum radiation are approximately circular. (48 IRE 2, 11, 15.S1)

**Penetration Frequency.** See *Critical Frequency*. (50 IRE 24. S1)

**Pentode.** A five-electrode *Electron Tube* containing an *Anode*, a *Cathode*, a *Control Electrode*, and two additional *Electrodes* that are ordinarily *Grids*. (57 IRE 7.S2)

**Percentage Modulation.** The modulation factor expressed as a percentage. (48 IRE 2, 11, 15.S1; 52 IRE 17.S1; 53 IRE 11.S1)

**Per Cent Harmonic Distortion.** See *Distortion, Per Cent Harmonic*. (58 IRE 3.S1)

**Per Cent Hearing.** At any given frequency, 100 minus the per cent hearing loss at that frequency. (51 IRE 6.S1)

**Per Cent Hearing Loss (Per Cent Deafness).** At a given frequency, 100 times the ratio of the hearing loss in decibels to the number of decibels between the normal threshold levels of audibility and feeling.

*Note 1:* A weighted mean of the per cent hearing losses at specified frequencies is often used as a single measure of the loss of hearing.

*Note 2:* The American Medical Association has defined percentage loss of hearing for medicolegal use. (See the *Journal of the American Medical Association*, vol. 133, pp. 396-397; February 8, 1947.)

(51 IRE 6.S1)

**Per Cent Ripple.** The ratio of the effective (root-mean-square) value of the ripple voltage to the average value of the total voltage, expressed in per cent. (48 IRE 2, 11, 15.S1)

**Performance Chart (Magnetron Oscillators).** A plot on coordinates of applied *Anode Voltage* and *Current* showing contours of constant magnetic field, power output, and over-all efficiency. (56 IRE 7.S1; 57 IRE 7.S2)

**Periodic Electromagnetic Wave.** A wave in which the electric field vector is repeated in detail in either of two ways: 1) At a fixed point, after the lapse of a time known as the period; 2) At a fixed time, after the addition of a distance known as the wavelength. (50 IRE 24.S1)

**Periodic Pulse Train.** A *Pulse Train* made up of identical groups of *Pulses*, the groups repeating at regular intervals. (52 IRE 20.S1)

## Permanent Echo

**Permanent Echo.** In a primary *Radar* system a signal reflected from an object fixed with respect to the *Radar* site. (54 IRE 12.S1)

**Permanent Magnet Loudspeaker.** A moving-conductor loudspeaker in which the steady field is produced by means of a permanent magnet. (51 IRE 6.S1)

**Perpendicular Magnetization.** In magnetic recording, magnetization of the recording medium in a direction perpendicular to the line of travel, and parallel to the smallest cross-sectional dimension of the medium.

*Note:* In this type of magnetization, either single pole-piece or double pole-piece magnetic heads may be used.

(51 IRE 6.S1)

**Persistence Characteristic (Camera Tubes).** The temporal step response of a *Camera Tube* to illumination. See *Methods of Measurement*. (57 IRE 7.S2)

**Persistence Characteristic (Decay Characteristic) (of a Luminescent Screen).** A relation between luminance (or emitted radiant power) and time after excitation. (57 IRE 7.S2)

**Perveance.** The quotient of the space-charge-limited *Cathode Current* by the three-halves power of the *Anode Voltage* in a *Diode*.

*Note:* *Perveance* is the constant *G* appearing in the Child-Langmuir-Schottky equation

$$i_k = Ge_0^{3/2}.$$

When the term *Perveance* is applied to a *Triode* or multigrid tube, the *Anode Voltage*  $e_0$  is replaced by the *Composite Controlling Voltage*  $e'$  of the *Equivalent Diode*.

(57 IRE 7.S2)

**Phantom Target.** See *Echo Box*. (54 IRE 12.S1)

**Phase Constant.** Of a *Traveling Plane Wave* at a given frequency, the space rate of decrease of phase of a field component (or of the voltage or current) in the *Direction of Propagation* in radians per unit length. (53 IRE 2.S1)

**Phase Delay.** In the transfer of a single frequency wave from one point to another in a system, the time delay of a part of the wave identifying its phase.

*Note:* The *Phase Delay* is measured by the ratio of the total phase shift in cycles to the frequency in cycles per second.

(56 IRE 9.S1)

**Phase Deviation.** The peak difference between the instantaneous angle of the modulated wave and the angle of the sine-wave carrier. (53 IRE 11.S1)

**Phase Distortion.** See *Phase-Frequency Dis-*

## Phase-Shift Microphone

*ortion; Distortion, Phase-Frequency.* (53 IRE 4.S1; 56 IRE 9.S1; 58 IRE 3.S1)

**Phase-Frequency Distortion.** Distortion due to lack of direct proportionality of phase shift to frequency over the frequency range required for transmission.

*Note 1:* *Delay Distortion* is a special case.

*Note 2:* This definition includes the case of a linear phase-frequency relation with the zero frequency intercept differing from an integral multiple of  $\pi$ .

See *Distortion, Phase-Frequency*.

(53 IRE 4.S1; 56 IRE 9.S1); 58 IRE 3.S1)

**Phase vs Frequency Response Characteristic.** A graph or tabulation of the phase shifts occurring in an electrical transducer at several frequencies within a band. (48 IRE 2, 11, 15.S1)

**Phase Localizer.** A *Localizer* in which the *Localizer On-Course* line is centered in an *Equiphase Zone*, and right-left deviations from this zone are detectable as reversals of phase of one of the two radiated signals. (54 IRE 12.S1)

**Phase-Modulated Transmitter.** A transmitter which transmits a phase-modulated wave. (48 IRE 2, 11, 15.S1)

**Phase Modulation (PM).** Angle modulation in which the angle of a sine-wave carrier is caused to depart from the carrier angle by an amount proportional to the instantaneous value of the modulating wave.

*Note:* Combinations of phase and frequency modulation are commonly referred to as "frequency modulation."

(52 IRE 17.S1; 53 IRE 11.S1)

**Phase-Propagation Ratio.** The propagation ratio divided by its magnitude. (50 IRE 24.S1)

**Phaser.** A device for adjusting the equipment so that the recorded elemental area bears the same relation to the record sheet as the corresponding transmitted elemental area bears to the subject copy in the direction of the scanning line. (42 IRE 9.S1)

**Phase Recovery Time (TR and Pre-TR Tubes).** The time required for a *Fired Tube* to deionize to such a level that a specified phase shift is produced in the *Low-Level Radio-Frequency Signal* transmitted through the tube. (57 IRE 7.S2)

**Phase Shifter, Waveguide.** A device for adjusting the phase of a particular field component (or current or voltage) at output of device relative to the phase of that field component (or current or voltage) at the input. (55 IRE 2.S1)

**Phase-Shift Microphone.** A microphone employing phase-shift networks to produce directional properties. (51 IRE 6.S1)

## Phase-Shift Oscillator

**Phase-Shift Oscillator.** An oscillator produced by connecting any network having a phase shift of an odd multiple of  $180^\circ$  (per stage) at the frequency of oscillation, between the output and the input of an amplifier. When the phase shift is obtained by resistance-capacitance elements, the circuit is an *RC Phase-Shift Oscillator*. (48 IRE 2, 11, 15.S1)

**Phase-Tuned Tube (TR Tubes).** A fixed-tuned *Broad-Band TR Tube*, wherein the phase angle through and the reflection introduced by the tube are controlled within limits. (57 IRE 7.S2)

**Phase Velocity.** Of a *Traveling Plane Wave* at a single frequency, the velocity of an equiphase surface along the *Wave Normal*. (50 IRE 24.S1; 53 IRE 2.S1)

**Phasing.** The adjustment of picture position along the scanning line. (56 IRE 9.S1)

**Phasing Line.** That portion of the length of scanning line set aside for the phasing signal.  
*Note:* The phasing line may be expressed as a percentage of the length of scanning line.

(42 IRE 9.S1)

**Phasing Signal.** A signal used for adjustment of the picture position along the scanning line. (56 IRE 9.S1)

**Phi ( $\Phi$ ) Polarization.** The state of the wave in which the *E* vector is tangential to the lines of latitude of some given spherical frame of reference.

*Note:* The usual frame of reference has the polar axis vertical and the origin at or near the antenna. Under these conditions, a vertical dipole will radiate only theta ( $\theta$ ) polarization, and a horizontal loop will radiate only phi ( $\phi$ ) polarization.

(48 IRE 2, 11, 15.S1)

**Phon.** The unit of loudness level as specified in definition. *Loudness Level*. (51 IRE 6.S1)

**Phonograph Pickup (Mechanical Reproducer).** A mechanoelectric transducer which is actuated by modulations present in the groove of the recording medium and which transforms this mechanical input into an electric output.

*Note:* Where no confusion will result, the term "phonograph pickup" may be shortened to "pickup."

(51 IRE 6.S1)

**Phosphor.** A substance capable of luminescence. (50 IRE 7.S1)

**Photocathode.** An *Electrode* used for obtaining *Photoelectric Emission*. (57 IRE 7.S2)

**Photoelectric Emission.** The ejection of electrons from a solid or liquid electromagnetic radiation. See *Field-Enhanced Photo-*

## Photovaristor

*electric Emission*. (57 IRE 7.S2)

**Photographic Emulsion.** The light-sensitive coating on photographic film consisting usually of a gelatin containing silver halide. (51 IRE 6.S1)

**Photographic Recording.** Recording by the exposure of a photosensitive surface to a signal-controlled light beam or spot. (42 IRE 9.S1)

**Photographic Sound Recorder (Optical Sound Recorder).** Equipment incorporating means for producing a modulated light beam and means for moving a light-sensitive medium relative to the beam for recording signals derived from sound signals. (51 IRE 6.S1)

**Photographic Sound Reproducer (Optical Sound Reproducer).** A combination of light source, optical system, photoelectric cell, or other light-sensitive device such as a photoconductive cell, and a mechanism for moving a medium carrying an optical sound record (usually film), by means of which the recorded variations may be converted into electric signals of approximately like form. (51 IRE 6.S1)

**Photographic Transmission Density<sup>1</sup> (Optical Density).** The common logarithm of opacity. Hence, film transmitting 100 per cent of the light has a density of zero, transmitting 10 per cent a density of 1, and so forth. Density may be diffuse, specular, or intermediate. Conditions must be specified. (51 IRE 6.S1)

**Photometry.** The techniques for the measurement of *Luminous Flux* and related quantities.

*Note:* Such related quantities are *Luminous Intensity*, *Illuminance*, *Luminance*, *Luminosity*, etc.

(55 IRE 22.S1)

**Photomultiplier.** See *Multiplier Phototube*. (57 IRE 7.S2)

**Photosensitive Recording.** Recording by the exposure of a photosensitive surface to a signal-controlled light beam or spot. (56 IRE 9.S1)

**Phototube.** An *Electron Tube* that contains a *Photocathode* and has an output depending on the total *Photoelectric Emission* from the irradiated area of the *Photocathode*. (57 IRE 7.S2)

**Photovaristor.** A varistor in which the current voltage relation may be modified by illumination, e.g., cadmium sulphide or lead telluride. (54 IRE 7.S2)

<sup>1</sup>For details of measurement and specifications, see "American Standard Diffuse Transmission Density, Z38.2.5-1946," or the latest edition thereof approved by the American Standards Association.

## Pickup

**Pickup.** 1) A device that converts a sound, scene, or other form of intelligence into corresponding electric signals (e.g., a microphone, a television camera, or a phonograph pickup).

2) The minimum current, voltage, power, or other value at which a relay will complete its intended function. 3) Interference from a nearby circuit or system. (52 IRE 17.S1)

**Pickup Arm (Tone Arm).** A pivoted arm arranged to hold a pickup. (51 IRE 6.S1)

**Pickup Cartridge.** The removable portion of a pickup containing the electromechanical translating elements and the reproducing stylus. (51 IRE 6.S1)

**Pickup Factor, DF Antenna System.** An index of merit expressed as the quotient of the voltage across the receiver input impedance divided by the signal field-strength to which the antenna system is exposed, the direction of arrival and polarization of the wave being such as to give maximum response. (59 IRE 12.S1)

**Pickup Spectral Characteristic.** The set of spectral responses of the device, including the optical parts, which converts radiation to electric signals, as measured at the output terminals of the pickup tubes.

*Note:* Because of nonlinearity, the *Spectral Characteristics* of some kinds of pickup tubes depend upon the magnitude of *Radiance* used in the measurement.

(55 IRE 22.S1)

**Pickup Tube—Deprecated.** See *Camera Tube*. (57 IRE 7.S2)

**Picture Black (or "Black").** The signal at any point in a facsimile system produced by the scanning of a selected area of subject copy having maximum density. (42 IRE 9.S1)

**Picture Frequencies.** The frequencies which result solely from *Scanning Subject Copy*.

*Note:* This does not include frequencies which are part of a modulated carrier signal.

(56 IRE 9.S1)

**Picture Inversion.** A process which causes reversal of the black and white shades of the *Recorded Copy*. (56 IRE 9.S1)

**Picture Signal (Facsimile).** See *Facsimile Signal*. (56 IRE 9.S1)

**Picture Signal (TV).** The signal resulting from the scanning process. (55 IRE 23.S1)

**Picture Tube (Kinescope).** A cathode-ray tube used to produce an image by variation of the beam intensity as the beam scans a raster. (50 IRE 7.S1)

**Picture White (or "White") (Facsimile).** The signal at any point in a facsimile system produced by the scanning of a selected area of subject copy having minimum density. (42 IRE 9.S1)

## Pitch

**Pierce Oscillator.** An oscillator in which a piezoelectric crystal is connected between the plate and the grid of a tube, in what is basically a Colpitts oscillator with voltage division provided by the grid-to-cathode and the plate-to-cathode capacitances of the circuit. (48 IRE 2, 11, 15.S1)

**Pill-Box Antenna.** A cylindrical parabolic reflector enclosed by two plates perpendicular to the cylinder, so spaced as to permit the propagation of only one mode in the desired direction of polarization. It is fed on the focal line. (48 IRE 2, 11, 15.S1)

**Pilotage.** The process of directing the movement of a *Vehicle* by reference to recognizable landmarks or soundings. Observations of these may be by optical, aural, mechanical or electronic means. (54 IRE 12.S1)

**Pi ( $\pi$ )—Mode (Magnetrons).** The *Mode* of operation for which the phases of the fields of successive *Anode* openings facing the *Interaction Space* differ by  $\pi$  radians. (57 IRE 7.S2)

**Pinch Effect.** The result of an electromechanical force that constricts, and sometimes momentarily ruptures, a molten conductor carrying current at high density. (55 IRE 10.S1)

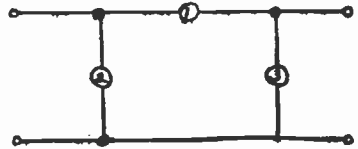

**Pi network.** The junction point between branches 1 and 2 forms an input terminal, that between branches 1 and 3 forms an output terminal, and that between branches 2 and 3 forms a common input and output terminal.

**Pi Network.** A network composed of three branches connected in series with each other to form a mesh, the three junction points forming an input terminal, an output terminal, and a common input and output terminal, respectively. (50 IRE 4.S1)

**PIP.** See *Blip*. (54 IRE 12.S1)

**PIP Matching.** See *PIP-Matching Display*. (54 IRE 12.S1)

**PIP-Matching Display.** In *Navigation*, a *Display* in which the received signal appears as a pair of *Blips*, the comparison of the characteristics of which provides a measure of the desired quantity. (See, for example, *K*, *L*, or *N-Display*.) (54 IRE 12.S1)

**Pistonphone.** A small chamber equipped with a reciprocating piston of measurable displacement which permits the establishment of a known sound pressure in the chamber. (51 IRE 6.S1)

**Pitch.** That attribute of auditory sensation in

## Pitch Attitude

terms of which sounds may be ordered on a scale extending from low to high, such as a musical scale.

*Note 1:* Pitch depends primarily upon the frequency of the sound stimulus, but it also depends upon the sound pressure and wave form of the stimulus.

*Note 2:* The pitch of a sound may be described by the frequency of that simple tone, having a specified sound pressure or loudness level, which seems to the average normal ear to produce the same pitch.

(51 IRE 6.S1)

**Pitch Attitude.** The angle between the longitudinal axis of the vehicle and the horizontal. (49 IRE 12.S1)

**Place.** In *Positional Notation*, a position corresponding to a given power of the base. A digit located in any particular place is a coefficient of a corresponding power of the base. (56 IRE 8.S1)

**Planar Network.** A network which can be drawn on a plane without crossing of branches. (50 IRE 4.S1)

**Planckian Locus.** The locus of *Chromaticities* of Planckian (blackbody) radiators having various temperatures (see *Chromaticity Diagram*). (55 IRE 22.S1)

**Plane Earth Factor.** The ratio of the electric field strength that would result from propagation over an imperfectly conducting plane earth to that which would result from propagation over a perfectly conducting plane. (50 IRE 24.S1)

**Plane of Polarization.** For a plane polarized wave, the plane containing the electric field vector and the direction of propagation. (50 IRE 24.S1)

**Plane Polarized Wave.** At a point in a homogeneous isotropic medium, an electromagnetic wave whose electric field vector at all times lies in a fixed plane which contains the direction of propagation. (50 IRE 24.S1)

**Plane Wave.** A wave whose equiphase surfaces form a family of parallel planes. (50 IRE 24.S1)

**Plan Position Indicator (PPI).** 1) A cathode-ray indicator in which a signal appears on a radial line. Distance is indicated radially and bearing as an angle. (49 IRE 12.S1)

2) In *Radar* technique, a cathode-ray indicator on which *Blips* produced by signals from reflecting objects and *Transponders* are shown in plan *Position*, thus forming a manlike *Display*. (54 IRE 12.S1)

**Plate.** A common name for the principal *Anode* in an *Electron Tube*. (57 IRE 7.S2)

**Plateau (Radiation-Counter Tubes).** The portion of the *Counting-Rate-vs-Voltage Characteristic* in which the counting rate is sub-

## Plotting Board

stantially independent of the applied voltage. (57 IRE 7.S2)

**Plateau Length (Radiation-Counter Tubes).** The range of applied voltage over which the *Plateau* extends. (57 IRE 7.S2)

**Plateau Slope, Normalized (Radiation-Counter Tubes).** The ratio, at the midpoint of the *Plateau*, of 1) the increment of counting rate divided by the threshold counting rate, to 2) the increment of applied voltage divided by the threshold voltage. (57 IRE 7.S2)

**Plateau Slope, Relative (Radiation-Counter Tubes).** The quotient, at the midpoint of the *Plateau* of 1) the increment of counting rate by 2) the product of counting rate and applied voltage increment. (57 IRE 7.S2)

**Plate Characteristic.** See *Electrode Characteristic*. (57 IRE 7.S2)

**Plate Current.** See *Electrode Current*. (57 IRE 7.S2)

**Plate (Anode) Efficiency.** The ratio of load circuit power (alternating current) to the plate power input (direct current). 48 IRE 2, 11, 15.S1)

**Plate Keying.** Keying effected by interrupting the plate-supply circuit. (48 IRE 2, 11, 15.S1)

**Plate (Anode) Load Impedance.** The total impedance between anode and cathode exclusive of the electron stream. (48 IRE 2, 11, 15.S1)

**Plate (Anode) Modulation.** Modulation produced by introducing the modulating signal into the plate circuit of any tube in which the carrier is present. (48 IRE 2, 11, 15.S1)

**Plate Neutralization.** The method of neutralizing an amplifier in which a portion of the plate-cathode alternating-current voltage is shifted 180° and applied to the grid-cathode circuit through a neutralizing capacitor. (48 IRE 2, 11, 15.S1)

**Plate (Anode) Power Input.** The direct-current power delivered to the plate (anode) of an electron tube by the source of supply. It is the product of the mean anode voltage and the mean anode current. (48 IRE 2, 11, 15.S1)

**Plate (Anode) Pulse Modulation.** Modulation produced in an amplifier or oscillator by application of externally generated pulses to the plate circuit. (48 IRE 2, 11, 15.S1)

**Plate Voltage.** See *Electrode Voltage*. (57 IRE 7.S2)

**Playback.** An expression used to denote reproduction of a recording. (51 IRE 6.S1)

**Plotting Board.** A device which plots one or

more variables against one or more other variables. (50 IRE 8.S1)

**Plumbing.** In *Radar*, a colloquial expression for pipe-like waveguide circuit elements. (54 IRE 12.S1)

**Plunger, Waveguide.** In a waveguide, a longitudinally movable obstacle which reflects essentially all the incident energy. (55 IRE 2.S1)

**PM Erasing Head.** One which uses the fields of one or more permanent magnets for erasing. (51 IRE 6.S1)

**Pneumatic Loudspeaker.** A loudspeaker in which the acoustical output results from controlled variation of an air stream. (51 IRE 6.S1)

**Poid.** The curve traced by the center of a sphere when it rolls or slides over a surface having a sinusoidal profile. (51 IRE 6.S1)

**Point.** In *Positional Notation*, the *Character*, or the location of an implied symbol, which separates the integral part of a numerical expression from its fractional part. For example, it is called the **Binary Point** in binary notation and the **Decimal Point** in decimal notation. If the location of the point is assumed to remain fixed with respect to one end of the numerical expressions, a **Fixed-Point System** is being used. If the location of the point does not remain fixed with respect to one end of the numerical expressions, but is regularly recalculated, then a **Floating-Point System** is being used.

*Note:* A fixed-point system usually locates the point by some convention, while a floating-point system usually locates the point by expressing a power of the base.

(56 IRE 8.S1)

**Point, Binary.** See *Binary Point*. (50 IRE 8.S1)

**Point Contact.** Pressure contact between a semiconductor body and a metallic point. (54 IRE 7.S2)

**Point, Decimal.** See *Decimal Point*. (50 IRE 8.S1)

**Point, Radix.** See *Radix Point*. (50 IRE 8.S1)

**Polar Grid.** See *Grid*. (49 IRE 12.S1)

**Polarity of Picture Signal.** The sense of the potential of a portion of the signal representing a dark area of a scene relative to the potential of a portion of the signal representing a light area. Polarity is stated as "black negative" or "black positive." (55 IRE 23.S1)

**Polarization, Desired.** The polarization of the radio wave for which the *DF Antenna System* is designed.

*Note:* The *Desired Polarization* is ordinarily

either vertical or horizontal.

(59 IRE 12.S1)

**Polarization Ellipse (of a Field Vector).**

The locus of positions for variable time of the terminus of an instantaneous field vector of one frequency at a point in space. (53 IRE 2.S1)

**Polarization Error.** In *Navigation*, the error arising from the transmission or reception of a radiation having a polarization other than that intended for the system. (54 IRE 12.S1)

**Polarization Receiving Factor.** The ratio of the power received by an antenna from a given plane wave of arbitrary polarization to the power received by the same antenna from a plane wave of the same power density and *Direction of Propagation*, whose state of polarization has been adjusted for the maximum received power.

*Note:* It is equal to the square of the absolute value of the scalar product of the *Polarization Unit Vector* of the given plane wave with that of the radiation field of the antenna along the direction opposite to the *Direction of Propagation* of the plane wave. (53 IRE 2.S1)

**Polarization, Undesired.** Any polarization of the radio wave other than that for which the *DF Antenna System* is designed.

*Note:* When the *Desired Polarization* is vertical or horizontal, then the *Undesired Polarization* is horizontal or vertical, respectively.

(59 IRE 12.S1)

**Polarization Unit Vector (for a Field Vector).** At a point, a complex field vector divided by its magnitude.

*Note 1:* For a field vector of one frequency at a point, the *Polarization Unit Vector* completely describes the state of polarization, that is, the *Axial Ratio* and orientation of the polarization ellipse and the sense of rotation on the ellipse.

*Note 2:* A complex vector is one each of whose components is a complex number. The magnitude is the positive square root of the scalar product of the vector and its complex conjugate.

(53 IRE 2.S1)

**Polyplexer.** In *Radar*, equipment combining the functions of duplexing and *Lobe Switching*. (54 IRE 12.S1)

**Pool Cathode Mercury Arc Converter.** A frequency converter using a mercury arc power converter. (55 IRE 10.S1)

**POPI (Post Office Position Indicator).** A long-distance continuous-wave LF navigational system of the phase-comparison type providing *Bearing* information. In this system,

## Port

phase-difference between sequential transmissions on the single frequency is measured. (54 IRE 12.S1)

**Port.** A place of access to a system where energy may be supplied or withdrawn, or where system variables may be observed or measured.

*Note 1:* In any particular case, the *Ports* are determined by the way in which the system is used, and not by the structure alone.

*Note 2:* A designated pair of terminals is an example of a *Port*.

(57 IRE 7.S2)

**Portable Transmitter.** (Commonly used at present for *Transportable Transmitter*.) Preferred use of this term covers a transmitter which can be readily carried on a person and may or may not be operated while in motion.

*Note:* This includes the class of so-called "walkie-talkies," "handy-talkies," and "personal" transmitters.

(48 IRE 2, 11, 15.S1)

**Porthole (Poor Landing) (Camera Tubes).** A defect in a properly aligned *Camera Tube* employing *Low-Velocity Scanning*, resulting in an increase in *Target Cut-off Voltage*, and a decrease in sensitivity toward the corners of the picture. (57 IRE 7.S2)

**Position.** The location of a *Vehicle* as determined by specific values of three *Navigation Coordinates*. (54 IRE 12.S1)

**Positional Crosstalk (Multibeam Cathode-Ray Tubes).** The variation in the path followed by any one electron beam as the result of a change impressed on any other beam in the tube. (57 IRE 7.S2)

**Positional Notation.** One of the schemes for representing numbers, characterized by the arrangement of digits in sequence, with the understanding that successive digits are to be interpreted as coefficients of successive powers of an integer called the *Base* of the *Number System*.

In the *Binary Number System* the successive digits are interpreted as coefficients of the successive powers of the base two just as in the *Decimal Number System* they relate to successive powers of the base ten.

In the ordinary number systems each *Digit* is a *Character* which stands for zero or for a positive integer smaller than the base.

The names of the number systems with bases from 2 to 20 are: *Binary*, *Ternary*, *quaternary*, *quinary*, *senary*, *septenary*, *Octonary*, (also *Octal*), *novenary*, *decimal*, *undecimal*, *duodecimal*, *terdenary*, *quaterdenary*, *quindenary*, *Sexadecimal* (also *Hexadeci-*

## Power

*mal*), *septendecimal*, *octodenary*, *novedenary*, and *vicenary*. The *sexagenary* number system has the base 60. The commonly used alternative of saying "base-3," "base-4," etc., in place of *tenary*, *quaternary*, etc., has the advantage of uniformity and clarity.

*Note 1:* In the most common form of positional notation the expression

$$\pm a_n a_{n-1} \cdots a_2 a_1 a_0 \cdot a_{-1} a_{-2} \cdots a_{-m}$$

is an abbreviation for the sum

$$\pm \sum_{i=-m}^n a_i r^i$$

where the *Point* separates the positive powers from the negative powers, the  $a_i$  are integers ( $0 \leq a_i < r$ ) called "digits," and  $r$  is an integer, greater than one, called the "base."

*Note 2:* For some purposes special rules are followed. In one such usage the value of the base,  $r$ , is not constant. In this case, the digits are coefficients of successive products of a nonconstant sequence of integers.

(56 IRE 8.S1)

**Position of the Effective Short (Switching Tubes).** The distance between a specified reference plane and the apparent short circuit of the *Fired Tube* in its *Mount*. (56 IRE 7.S3; 57 IRE 7.S2)

**Positive Feedback.** Feedback which results in increasing the amplification. (48 IRE 2, 11, 15.S1)

**Positive Modulation (Facsimile).** In an amplitude-modulation system, that form of modulation in which the maximum transmitted power corresponds to the minimum density of the subject copy. In a frequency-modulation system, it is that form of modulation in which the highest transmitter frequency corresponds to the minimum density of the subject copy. (42 IRE 9.S1)

**Post Acceleration (Electron-Beam Tubes).** Acceleration of the beam electrons after deflection. (57 IRE 7.S2)

**Post, Waveguide.** In a waveguide, a cylindrical rod placed in a transverse plane of the waveguide and behaving substantially as a slant susceptance. (55 IRE 2.S1)

**Power.** See:

*Available Power (at a Port)*

*Flat Leakage Power (TR and Pre-TR Tubes)*

*Grid Driving Power*

*Harmonic Leakage Power (TR and Pre-TR Tubes)*

*Leakage Power (TR and Pre-TR Tubes)*

*Minimum Firing Power (Switching Tubes).*

(57 IRE 7.S2)

**Power Amplification.** See *Power Gain*. (54 IRE 3.S1)

**Power Amplifier.** See *Amplifier, Power*. (58 IRE 3.S1)

**Power Attenuation.** See *Power Loss*. (54 IRE 3.S1)

**Power, Carrier-Frequency, Peak Pulse.** See *Peak Pulse Power, Carrier-Frequency*. (52 IRE 20.S1)

**Power Gain.** The ratio of the power that a *Transducer* delivers to a specified *Load*, under specified operating conditions, to the power absorbed by its input circuit.

*Note 1:* If the input and/or *Output Power* consist of more than one component, such as multifrequency *Signal* or *Noise*, then the particular components used and their weighting must be specified.

*Note 2:* This *Gain* is usually expressed in decibels.

(58 IRE 3.S1)

**Power Gain (of an Antenna).** In a given direction,  $4\pi$  times the ratio of the radiation intensity in that direction to the total power delivered to the antenna. (48 IRE 2, 11, 15.S1)

**Power Gain (of a Two-Port Linear Transducer).** See *Gain, Power (of a Two-Port Linear Transducer)*. (57 IRE 7.S2)

**Power Level.** At any point in a transmission system, the difference of the measure of the steady-state power at that point from the measure of an arbitrarily specified amount of power chosen as a reference.

*Note:* The measures are often expressed in decibels, thus their difference is conveniently expressed as a ratio. Hence, *Power Level* is widely regarded as the ratio of the steady-state power at some point in a system to an arbitrary amount of power chosen as a reference.

(58 IRE 3.S1)

**Power Loss.** The ratio of the power absorbed by the input circuit of a *Transducer* to the power delivered to a specified *Load* under specified operating conditions.

*Note 1:* If the input and/or *Output Power* consist of more than one component, such as multifrequency *Signal* or *Noise*, then the particular components used and their weighting must be specified.

*Note 2:* This *Loss* is usually expressed in decibels.

(58 IRE 3.S1)

**Power, Peak Pulse.** See *Peak Pulse Power*. (52 IRE 20.S1)

**PPI.** See *Plan Position Indicator*. (54 IRE 12.S1)

**Preamplifier.** 1) An *Amplifier*, the primary function of which is to raise the output of a

low-level source to an intermediate *Level* so that the *Signal* may be further processed without appreciable degradation in the signal-to-noise ratio of the system.

*Note:* A *Preamplifier* may include provision for equalizing and/or mixing.

(58 IRE 3.S1)

2) In *Radar* an amplifier separated from the remainder of the receiver and located so as to provide the shortest possible input circuit *Path* from the antenna so as to avoid deterioration of the signal-to-noise ratio. (54 IRE 12.S1)

**Precision.** The quality of being exactly or sharply defined or stated. A measure of the precision of a representation is the number of distinguishable alternatives from which it was selected, which is sometimes indicated by the number of significant digits it contains. See also *Accuracy*. (56 IRE 8.S1)

**Predissociation.** A process by which a molecule that has absorbed energy dissociates before it loses energy by *Radiation*. (57 IRE 7.S2)

**Pre-Emphasis.** A process in a system designed to emphasize the magnitude of some frequency components with respect to the magnitude of others.

*Note:* *Pre-Emphasis* at the transmitting end of a system, in conjunction with *De-Emphasis* at the receiving end, is applied for the purpose of improving signal-to-noise ratio.

(52 IRE 17.S1; 53 IRE 11.S1; 58 IRE 3.S1)

**Pre-Emphasis Network.** A network inserted in a system in order to emphasize one range of frequencies with respect to another. (48 IRE 2, 11, 15.S1)

**Preform (Biscuit—Deprecated).** In disk recording, a preform is a small slab of record stock material as it is prepared for use in the record presses. (51 IRE 6.S1)

**Preoscillation Current.** See *Starting Current of an Oscillator*. (56 IRE 7.S1; 57 IRE 7.S2)

**Pressing.** In disk recording, a pressing is a record produced in a record-molding press from a master or stamper. (51 IRE 6.S1)

**Pressure Microphone.** A microphone in which the electric output substantially corresponds to the instantaneous sound pressure of the impressed sound waves.

*Note:* A pressure microphone is a gradient microphone (see *Gradient Microphone*) of zero order and is nondirectional when its dimensions are small compared to a wavelength.

(51 IRE 6.S1)

**Pressure Spectrum Level.** Of a sound at a specified frequency, the effective sound pres-



## Pre-TR Tube

sure level for the sound energy contained within a band 1 cycle per second wide, centered at the specified frequency. Ordinarily this has significance only for sound having a continuous distribution of energy within the frequency range under consideration. The reference pressure shall be explicitly stated. (See *Sound Pressure Level*.)

*Note:* Since, in practice, it is necessary to employ filters having an effective bandwidth greater than 1 cycle per second, the pressure spectrum level is, in general, a computed quantity. For a sound having a uniform distribution of energy, the computation can be made as follows: Let  $L_{ps}$  be the desired pressure spectrum level,  $p$  be the effective pressure measured through the filter system,  $p_0$  be reference sound pressure,  $\Delta f$  be the effective bandwidth of the filter system, and  $\Delta_0 f$  be the reference bandwidth (1 cycle per second), then

$$L_{ps} = 10 \log_{10} \left[ \frac{p^2 / \Delta f}{p_0^2 / \Delta_0 f} \right].$$

For computational purposes, if  $L_p$  is the band pressure level observed through the filter, the above relation reduces to

$$L_{ps} = L_p - 10 \log_{10} \frac{\Delta f}{\Delta_0 f}.$$

(51 IRE 6.S1)

**Pre-TR Tube.** A gas-filled radio-frequency switching tube used to protect the *TR Tube* from excessively high power and the receiver from frequencies other than the fundamental. (57 IRE 7.S1)

**PRF (Pulse Repetition Frequency).** See *Repetition Rate*. (54 IRE 12.S1)

**Primaries.** The *Colors* of constant *Chromaticity* and variable amount, which, when mixed in proper proportions, are used to produce or specify other *Colors*.

*Note:* Primaries need not be physically realizable.

(55 IRE 22.S1)

**Primary-Color Unit.** The area within a *Color Cell* occupied by one primary color. (57 IRE 7.S2)

**Primary Flow (of Carriers).** A current flow which is responsible for the major properties of the device. (54 IRE 7.S2)

**Primary Radar.** See *Radar*. (54 IRE 12.S1)

**Prime (Charge-Storage Tubes).** To charge or discharge *Storage Elements* to a potential suitable for writing. (57 IRE 7.S2)

**Priming Speed (Charge-Storage Tubes).** The rate of priming successive *Storage Elements*. (57 IRE 7.S2)

**Principal Axis.** Of a transducer used for

## Proximity Effect

sound emission or reception, a reference direction for angular coordinates used in describing the directional characteristics of the transducer. It is usually an axis of structural symmetry, or the direction of maximum response; but if these do not coincide, the reference direction must be described explicitly. (51 IRE 6.S1)

**Principal E Plane.** A plane containing the direction of maximum radiation and in which the electric vector everywhere lies in the plane. (48 IRE 2, 11, 15.S1)

**Principal H Plane.** A plane containing the direction of maximum radiation and in which the electric vector is everywhere normal to the plane while the magnetic vector lies in the plane. (48 IRE 2, 11, 15.S1)

**Problem, Check.** See *Check Problem*. (50 IRE 8.S1)

**Problem, Trouble Location.** See *Trouble Location Problem*. (50 IRE 8.S1)

**Program.** A sequence of audio signals transmitted for entertainment or information. (58 IRE 3.S1)

**Program (Computer).** 1) A plan for the solution of a problem. 2) Loosely, a synonym for *Routine*. 3) To prepare a program. (56 IRE 8.S1)

**Program Amplifier.** See *Amplifier, Line*. (58 IRE 3.S1)

**Program Level.** The measure of the *Program Signal* in an audio system expressed in *vu*. (58 IRE 3.S1)

**Programmed Check.** See *Check, Programmed*. (56 IRE 8.S1)

**Program Signal.** In audio systems and components, the complex electric waves corresponding to speech, music, and associated sounds, destined for audible reproduction. (54 IRE 3.S1)

**Propagation Constant.** Of a *Traveling Plane Wave* at a given frequency, the complex quantity whose real part is the *Attenuation Constant* in nepers per unit length and whose imaginary part is the *Phase Constant* in radians per unit length. (50 IRE 24.S1; 53 IRE 2.S1)

**Propagation Factor.** See *Propagation Ratio*. (50 IRE 24.S1)

**Propagation Ratio.** For a wave propagating from one point to another, the ratio of the complex electric field strength at the second point to that at the first point. (50 IRE 24.S1)

**Proportional Counter Tube.** See *Counter Tube, Proportional*. (57 IRE 7.S2)

**Proportional Region (Radiation-Counter Tubes).** See *Region, Proportional (Radiation-Counter Tubes)*. (57 IRE 7.S2)

**Proximity Effect.** The redistribution of cur-

rent in a conductor brought about by the presence of another conductor. (55 IRE 10.S1)

**Pulling Figure of an Oscillator.** The difference between the maximum and minimum frequencies reached by an oscillator when the phase angle of the reflection coefficient at the load impedance varies through 360° and the absolute value of this coefficient is constant and at a specified value, usually 0.20. (Voltage standing-wave ratio 1.5) (56 IRE 7.S1; 57 IRE 7.S2)

**Pulse.** A variation of a quantity whose value is normally constant; this variation is characterized by a rise and a decay, and has a finite duration.

*Note 1:* The word "pulse" normally refers to a variation in time; when the variation is in some other dimension, it shall be so specified, such as "space pulse."

*Note 2:* This definition is broad so that it covers almost any transient phenomenon. The only features common to all *Pulses* are rise, finite duration, and decay. It is necessary that the rise, duration, and decay be of a quantity that is constant (not necessarily zero) for some time before the pulse and has the same constant value for sometime afterwards. The quantity has a normally constant value and is perturbed during the *Pulse*. No relative time scale can be assigned.

(51 IRE 20.S1; 55 IRE 23.S1)

**Pulse Amplitude.** A general term indicating the magnitude of a pulse.

*Note 1:* For specific designation, adjectives such as average, instantaneous, peak, rms (effective), etc., should be used to indicate the particular meaning intended.

*Note 2:* *Pulse Amplitude* is measured with respect to the normally constant value unless otherwise stated.

(51 IRE 20.S1)

**Pulse Amplitude, Average.** See *Average Pulse Amplitude*. (51 IRE 20.S1)

**Pulse Amplitude, Average Absolute.** See *Average Absolute Pulse Amplitude*. (51 IRE 20.S1)

**Pulse-Amplitude Modulation (PAM).** Amplitude modulation of a pulse carrier. (51 IRE 20.S1)

**Pulse Amplitude, Peak.** See *Peak Pulse Amplitude*. (51 IRE 20.S1)

**Pulse Amplitude, RMS (Effective).** See *RMS (Effective) Pulse Amplitude*. (51 IRE 20.S1)

**Pulse Bandwidth.** The smallest continuous frequency interval outside of which the amplitude of the spectrum does not exceed a prescribed fraction of the amplitude at a specified frequency.

*Caution:* This definition permits the spectrum amplitude to be less than the prescribed amplitude within the interval.

*Note 1:* Unless otherwise stated, the specified frequency is that at which the spectrum has its maximum amplitude.

*Note 2:* This term should really be "Pulse Spectrum Bandwidth" because it is the spectrum and not the pulse itself that has a bandwidth. However, usage has caused the contraction and for that reason the term has been accepted.

(51 IRE 20.S1)

**Pulse, Bidirectional.** See *Bidirectional Pulse*. (52 IRE 20.S1)

**Pulse Carrier.** A pulse train used as a carrier (51 IRE 20.S1)

**Pulse, Carrier-Frequency.** See *Carrier-Frequency Pulse*. (51 IRE 20.S1)

**Pulse Code.** 1) A *Pulse Train* modulated so as to represent information. 2) Loosely, a code consisting of *Pulses*, such as Morse code, Baudot code, binary code. (52 IRE 20.S; 53 IRE 11.S1)

**Pulse-Code Modulation (PCM).** Modulation which involves a *Pulse Code*.

*Note:* This is a generic term, and additional specification is required for a specific purpose.

(52 IRE 20.S1; 53 IRE 11.S1)

**Pulse Coder.** A circuit which sets up a plurality of pulses disposed in an identifiable pattern. (49 IRE 12.S1)

**Pulsed Doppler System.** A pulsed *Radar* system which utilizes the *Doppler Effect* for obtaining information about the *Target* (not including simple resolution from fixed *Targets*). (54 IRE 12.S1)

**Pulse Decay Time.** The interval between the instants at which the instantaneous amplitude last reaches specified upper and lower limits, namely, 90 per cent and 10 per cent of the peak-pulse amplitude unless otherwise stated. (51 IRE 20.S1)

**Pulse Decay Time (Television).** The interval of time required for the trailing edge of a *Pulse* to decay from 90 per cent to 10 per cent of the *Peak Pulse Amplitude*. (55 IRE 23.S1)

**Pulse Delay, Receiver.** See *Transducer Pulse Delay*. (52 IRE 20.S1)

**Pulse Delay, Transducer.** See *Transducer Pulse Delay*. (52 IRE 20.S1)

**Pulse Delay, Transmitter.** See *Transducer Pulse Delay*. (52 IRE 20.S1)

**Pulse-Demoder (Constant-Delay Discriminator).** A circuit which responds only to pulse signals which have a certain spacing between pulses for which the device is ad-

## Pulsed Oscillator

justed. Contrast with *Pulse-Moder.* (54 IRE 12.S1)

**Pulsed Oscillator.** 1) An oscillator which is made to operate during recurrent intervals by self-generated or externally applied pulses. (48 IRE 2, 11, 15.S1)

2) An oscillator which generates a *Carrier-Frequency Pulse* or a train of *Carrier-Frequency Pulses.*

*Note:* These *Carrier-Frequency Pulses* may occur as the result of self-generated or externally applied *Pulses.*

(52 IRE 20.S1)

**Pulsed-Oscillator Starting Time.** The interval between the *Leading Edge Pulse Time* of the *Pulse* at the oscillator control terminals and the *Leading Edge Pulse Time* of the related output *Pulse.* (52 IRE 20.S1)

**Pulse Droop.** A distortion of an otherwise essentially flat-topped rectangular *Pulse* characterized by a decline of the *Pulse* top. (52 IRE 20.S1; 55 IRE 23.S1)

**Pulse Duration.** The time interval between the first and last instants at which the instantaneous amplitude reaches a stated fraction of the *Peak Pulse Amplitude.* (51 IRE 20.S1; 55 IRE 23.S1)

**Pulse Duration Coder.** See *Coder, Pulse Duration.* (54 IRE 12.S1)

**Pulse Duration Discriminator.** A circuit in which the sense and magnitude of the output is a function of the deviation of the pulse length from a reference. (54 IRE 12.S1)

**Pulse-Duration Modulation (Pulse-Length Modulation) (Pulse-Width Modulation).** A form of pulse-time modulation in which the duration of a pulse is varied.

*Note:* The terms "pulse-width modulation" and "pulse-length modulation" are also used to designate this system of modulation but the term "pulse-duration modulation" is preferred.

(51 IRE 20.S1; 53 IRE 11.S1)

**Pulse Duty Factor.** The ratio of the average pulse duration to the average pulse spacing.

*Note:* This is equivalent to the product of the average pulse duration and the pulse repetition rate.

(51 IRE 20.S1)

**Pulse Flatness, Deviation From.** See *Deviation From Pulse Flatness.* (54 IRE 12.S1)

**Pulse Forming Line.** In a *Radar* modulator a continuous line or ladder network whose parameters are selected to give a specified shape to the modulator pulse. (54 IRE 12.S1)

**Pulse Frequency Modulation (PFM).** A form of *Pulse Time Modulation* in which the *Pulse Repetition Rate* is the characteristic varied.

*Note:* A more precise term for "pulse fre-

## Pulse Modulator

quency modulation" would be "*Pulse Repetition-Rate* modulation."

(52 IRE 20.S1; 53 IRE 11.S1)

**Pulse Frequency Spectrum.** See *Pulse Spectrum.* (51 IRE 20.S1)

**Pulse, Ghost.** See *Ghost Signals.* (54 IRE 12.S1)

**Pulse Interleaving.** A process in which pulses from two or more sources are combined in time-division multiplex for transmission over a common path. (51 IRE 20.S1)

**Pulse Interrogation.** The triggering of a transponder by a *Pulse* or *Pulse Mode.*

*Note:* Interrogations by means of *Pulse Modes* may be employed to trigger a particular transponder or group of transponders.

(52 IRE 20.S1)

**Pulse Interval.** See *Pulse Spacing.* (51 IRE 20.S1)

**Pulse-Interval Modulation.** A form of pulse-time modulation in which the pulse spacing is varied. (51 IRE 20.S1; 53 IRE 11.S1)

**Pulse Jitter.** A relatively small variation of the *Pulse Spacing* in a *Pulse Train.*

*Note:* The jitter may be random or systematic, depending on its origin, and is generally not coherent with any *Pulse Modulation* imposed.

(52 IRE 20.S1)

**Pulse-Length Modulation.** See *Pulse-Duration Modulation.* (51 IRE 20.S1)

**Pulse Mode.** 1) A finite sequence of *Pulses* in a prearranged pattern used for selecting and isolating a communication channel. 2) the prearranged pattern. (52 IRE 20.S1)

**Pulse-Mode Multiplex.** A process or device for selecting channels by means of *Pulse Modes.*

*Note:* This process permits two or more channels to use the same carrier frequency.

(52 IRE 20.S1)

**Pulse-Moder.** A device for producing a pulse mode. Contrast with *Pulse-Demoder.* (54 IRE 12.S1)

**Pulse Mode, Spurious.** See *Spurious Pulse Mode.* (52 IRE 20.S1)

**Pulse Modulation.** 1) Modulation of a carrier by a *Pulse Train.*

*Note:* In this sense, the term is used to describe the process of generating *Carrier-Frequency Pulses.*

2) Modulation of one or more characteristics of a *Pulse Carrier.*

*Note:* In this sense, the term is used to describe methods of transmitting information on a *Pulse Carrier.*

(52 IRE 20.S1; 53 IRE 11.S1)

**Pulse Modulator.** A device which applies pulses to the element in which modulation takes place. (48 IRE 2, 11, 15.S1)

## Pulse Multiplex—Deprecated

**Pulse Multiplex—Deprecated.** See *Pulse-Mode Multiplex*. (52 IRE 20.S1)

**Pulse Packet.** In *Radar* the volume of space occupied by the *Radar* pulse energy. (54 IRE 12.S1)

**Pulse Phase Modulation (PPM).** See *Pulse-Position Modulation (PPM)*. (52 IRE 20.S1)

**Pulse-Position Modulation (PPM).** A form of pulse-time modulation in which the position in time of a pulse is varied. (51 IRE 20.S1; 53 IRE 11.S1)

**Pulse Power, Carrier-Frequency, Peak.** See *Peak Pulse Power, Carrier-Frequency*. (52 IRE 20.S1)

**Pulse Power, Peak.** See *Peak Pulse Power*. (52 IRE 20.S1)

**Pulse, Radio-Frequency.** See *Radio-Frequency Pulse*. (51 IRE 20.S1)

**Pulse Rate.** See *Repetition Rate*. (54 IRE 12.S1)

**Pulse Regeneration.** The process of restoring pulses to their original relative timings, forms, and/or magnitudes.

*Note:* In many devices, pulses may become distorted due to phase or amplitude distortion, limiting, or other processes. It is often desirable to restore the pulse to something resembling its original form before it has become so distorted that the original information which it contains is completely destroyed. This process is normally called pulse regeneration.

(51 IRE 20.S1)

**Pulse Repeater (Transponder).** A device used for receiving pulses from one circuit and transmitting corresponding pulses into another circuit. It may also change the frequency and wave forms of the pulses and perform other functions. (48 IRE 2, 11, 15.S1)

**Pulse Repetition Frequency.** The pulse repetition rate of a periodic pulse train. See *Repetition Rate* (51 IRE 20.S1; 54 IRE 12.S1)

**Pulse Repetition Period.** The reciprocal of the *Pulse Repetition Frequency*. (51 IRE 20.S1)

**Pulse Repetition Rate (PRF).** The average number of pulses per unit of time. See *Repetition Rate*. (51 IRE 20.S1; 54 IRE 12.S1)

**Pulse Reply.** The transmission of a *Pulse* or *Pulse Mode* by a transponder as the result of an interrogation. (52 IRE 20.S1)

**Pulse Rise Time.** The interval between the instants at which the instantaneous amplitude first reaches specified lower and upper limits, namely, 10 per cent and 90 per cent of the peak-pulse amplitude unless otherwise stated. (51 IRE 20.S1)

**Pulse Separation.** The interval between the

## Pulse Time, Leading Edge

*Trailing-Edge Pulse-Time* of one *Pulse* and the *Leading-Edge Pulse-Time* of the succeeding *Pulse*. (52 IRE 20.S1)

**Pulses, Equalizing.** See *Equalizing Pulses*. (54 IRE 20.S1)

**Pulse Shaper.** Any transducer used for changing one or more characteristics of a *Pulse*.

*Note:* This term includes *Pulse regenerators*. (52 IRE 20.S1)

**Pulse Shaping.** Intentionally changing the shape of a *Pulse*. (52 IRE 20.S1)

**Pulse, Single-Polarity.** See *Unidirectional Pulse*. (52 IRE 20.S1)

**Pulse Spacing (Pulse Interval).** The interval between the corresponding pulse times of two consecutive pulses.

*Note:* The term "pulse interval" is deprecated because it may be taken to mean the duration of the pulse instead of the space or interval from one pulse to the next. Neither term means the space *between* pulses.

(51 IRE 20.S1)

**Pulse Spectrum (Pulse Frequency Spectrum).** The frequency distribution of the sinusoidal components of the pulse in relative amplitude and in relative phase.

*Note:* The definition of this term was phrased to convey the idea that the spectrum is a complex (phasor) function of frequency and to express this function most nearly in a manner which corresponds to the method of measuring it (*i.e.*, measuring amplitude and phase separately).

(51 IRE 20.S1)

**Pulse Spike.** An unwanted pulse of relatively short duration superimposed on the main pulse.

*Note:* This term came into wide use in radar to define the first part of the pulse fed through a TR tube. This portion contains most of the pulse energy, has a duration about  $10^{-2}$  that of the rest of the pulse, and an amplitude up to  $10^6$  to  $10^9$  times that of the rest of the pulse. Seen on a cathode-ray tube, it looks like a spike sticking up from the pulse. By extension, the term has come to be applied to any *unwanted* pulse of relatively short duration superimposed on the wanted pulse.

(51 IRE 20.S1)

**Pulse Spike Amplitude.** The *Peak Pulse Amplitude of the Pulse Spike*. (52 IRE 20.S1)

**Pulse Tilt.** A distortion in an otherwise essentially flat-topped rectangular *Pulse* characterized by either a decline or a rise of the *Pulse Top*. (52 IRE 20.S1; 55 IRE 23.S1)

**Pulse Time, Leading Edge.** See *Leading Edge Pulse Time*. (51 IRE 20.S1)

## Pulse Time, Mean

**Pulse Time, Mean.** See *Mean Pulse Time*. (51 IRE 20.S1)

**Pulse-Time Modulation.** Modulation in which the time of occurrence of some characteristic of a pulse carrier is varied from the unmodulated value.

*Note:* This is a general term which includes several forms of modulation, such as pulse-duration, pulse-position, pulse-interval modulation. (51 IRE 20.S1; 53 IRE 11.S1)

**Pulse Time, Trailing Edge.** See *Trailing Edge Pulse Time*. (51 IRE 20.S1)

**Pulse Train.** A sequence of pulses. (51 IRE 20.S1)

**Pulse Train, Bidirectional.** See *Bidirectional Pulse Train*. (52 IRE 20.S1)

**Pulse Train, Periodic.** See *Periodic Pulse Train*. (52 IRE 20.S1)

**Pulse-Train Spectrum (Pulse-Train Frequency-Spectrum).** The frequency distribution of the sinusoidal components of the *Pulse Train* in amplitude and in phase angle. (52 IRE 20.S1)

**Pulse Train, Unidirectional.** See *Unidirectional Pulse Train*. (52 IRE 20.S1)

**Pulse Transmitter.** A pulse-modulated transmitter whose peak power-output capabilities are usually large with respect to average power-output rating. (48 IRE 2, 11, 15.S1)

**Pulse, Unidirectional.** See *Unidirectional Pulse*. (51 IRE 20.S1)

**Pulse Valley.** The part of the *Pulse* between two specified maxima.

*Note:* Unless otherwise specified, it is to be understood that the maxima are the first and the last. (52 IRE 20.S1)

**Pulse Width—Deprecated.** See *Pulse Duration*. (52 IRE 20.S1; 55 IRE 23.S1)

**Pulse-Width Modulation.** See *Pulse-Duration Modulation*. (51 IRE 20.S1)

**Purity (Excitation Purity).** The ratio of the distance from the reference point to the point representing the sample, to the distance along the same straight line from the reference point to the *Spectrum Locus* or to the *Purple Boundary*, both distances being measured (in the same direction from the reference point) on the *CIE Chromaticity Diagram*.

*Note:* The reference point is the point in the *Chromaticity Diagram* which represents the reference standard light mentioned in the definition of *Dominant Wavelength*. (55 IRE 22.S1)

**Purple Boundary.** The straight line drawn between the ends of the *Spectrum Locus* (see *Chromaticity Diagram*). (55 IRE 22.S1)

**Pushing Figure of an Oscillator.** The

## Quantization

change of oscillator frequency with a specified change in current, excluding thermal effects.

*Note:* See *Tuning Sensitivity, Electronic*. (56 IRE 7.S1; 57 IRE 7.S2)

**Push-Pull Amplifier Circuit.** See *Balanced Amplifier Circuit*. (58 IRE 3.S1)

**Push-Pull Currents.** *Balanced Currents*. (53 IRE 2.S1)

**Push-Pull Microphone.** A microphone which makes use of two like microphone elements actuated by the same sound waves and operating 180° out of phase. (51 IRE 6.S1)

**Push-Pull Oscillator.** A balanced oscillator employing two similar tubes in phase opposition. (48 IRE 2, 11, 15.S1)

**Push-Pull Voltages.** *Balanced Voltages*. (53 IRE 2.S1)

**Push-Push Circuit.** A circuit employing two similar tubes with grids connected in phase opposition and plates in parallel to a common load, and usually used as a frequency multiplier to emphasize even-order harmonics. (48 IRE 2, 11, 15.S1)

**Push-Push Currents.** Currents flowing in the two conductors of a *Balanced Line* which, at every point along the line, are equal in magnitude and in the same direction. (53 IRE 2.S1)

**Push-Push Voltages.** Voltages (relative to ground) on the two conductors of a *Balanced Line* which, at every point along the line, are equal in magnitude and have the same polarity. (53 IRE 2.S1)

**Pyramidal Horn.** An electromagnetic horn, the sides of which form a pyramid. The electromagnetic field in such a horn would be expressed basically in a family of spherical coordinates. (48 IRE 2, 11, 15.S1)

**Pythagorean Scale.** A musical scale such that the frequency intervals are represented by the ratios of integral powers of the numbers 2 and 3. (51 IRE 6.S1)

## Q

**Quadripole.** See *Two-Terminal Pair Network*. (50 IRE 4.S1)

**Quadrantal Error.** Angular error of a measured bearing caused by disturbances due to the characteristics of the vehicle or station. (49 IRE 12.S1)

**Quantization.** A process in which the range of values of a wave is divided into a finite number of smaller subranges, each of which is represented by an assigned or "quantized" value within the subrange.

*Note:* "Quantized" may be used as an adjective modifying various forms of modula-

## Quantization Distortion

tion, for example, quantized pulse-amplitude modulation.

(53 IRE 11.S1)

**Quantization Distortion (Quantization Noise).** Inherent distortion introduced in process of quantization. (53 IRE 11.S1)

**Quantization Level.** In quantization a particular subrange, or a symbol designating it. (53 IRE 11.S1)

**Quantization Noise.** See *Quantization Distortion*. (53 IRE 11.S1)

**Quantized Pulse Modulation.** Pulse modulation which involves quantization.

*Note:* This is a generic term, including pulse numbers modulation and pulse code modulation as specific cases.

(53 IRE 11.S1)

**Quantum Efficiency (Photocathodes).** The average number of electrons photoelectrically emitted from the *Photocathode* per incident photon of a given wavelength.

*Note:* The *Quantum Efficiency* varies with the wavelength, angle of incidence, and polarization of the incident *Radiation*.

(57 IRE 7.S2)

**Quenched Spark Gap Converter.** A spark gap generator or power source which utilizes the oscillatory discharge of a capacitor through an inductor and a spark gap as a source of radio frequency power. The spark gap comprises one or more closely-spaced gaps operating in series. (55 IRE 10.S1)

**Quenching (Radiation-Counter Tubes).**

The process of terminating a discharge in a *Radiation-Counter Tube* by inhibiting *Reignition*. (57 IRE 7.S2)

**Quieting Sensitivity (in FM Receivers).**

The least signal input for which the output signal-noise ratio does not exceed a specified limit. (52 IRE 17.S1)

## R

**Racon** (an abbreviation of *Radar Beacon*). A *Transponder* for *Interrogation* by a primary *Radar*. (54 IRE 12.S1)

**Radar.** A general name for radio detecting and ranging systems that determine the distance and usually the *Direction* of objects by the transmission and return of electromagnetic energy.

*Note:* The terms "*Primary Radar*" and "*Secondary Radar*" may be used when the return signals are, respectively, by reflection and by the transmission of a second signal as a result of triggering *Responder Beacon* by the incident signal.

(54 IRE 12.S1)

**Radar Equation.** A mathematical expression which relates the transmitted and received

## Radiating Element

powers and antenna gains of a *Primary Radar* system to the *Echo* area and distance of the *Radar Target*. (54 IRE 12.S1)

**Radar Performance Figure.** The ratio of the pulse power of the *Radar* transmitter, to the power of the minimum signal detectable by the receiver. (54 IRE 12.S1)

**Radar Pilotage Equipment.** Equipment utilizing *Primary Radar* techniques and carried on a *Vehicle* for the purpose of determining *Bearing* and distance of recognizable landmarks and for indicating the relative *Position* of other *Vehicles*. (54 IRE 12.S1)

**Radar Range Equation.** See *Radar Equation*. (54 IRE 12.S1)

**Radar Relay.** In *Radar*, an equipment for relaying the *Radar* video and appropriate synchronizing signals to a remote location. (54 IRE 12.S1)

**Radar Shadow.** In *Radar*, a region shielded from *Radar* illumination, by an intervening reflecting or absorbing medium; this region appearing as an area void of *Targets* on a *Radar Display*. (54 IRE 12.S1)

**Radar Transmitter.** The transmitter portion of a radio detecting and ranging system. (48 IRE 2, 11, 15.S1)

**Radial.** In *Navigation*, one of a number of radial *Lines of Position* defined by an azimuthal radio navigational facility, and identified in terms of the *Bearing* (usually magnetic) of all points on that line from the facility. (54 IRE 12.S1)

**Radial Time Base Display.** See *Plan Position Indicator*. (54 IRE 12.S1)

**Radial Transmission Line.** A pair of parallel conducting planes used for propagating uniform circularly cylindrical waves having their axes normal to the planes. (53 IRE 2.S1)

**Radiance.** The *Radiant Flux* per unit solid angle per unit of projected area of the source.

*Note:* The usual unit is the watt per steradian per square meter. This is the radiant analog of *Luminance*.

(55 IRE 22.S1)

**Radiant Flux.** The time rate of flow of radiant energy. (55 IRE 22.S1)

**Radiant Intensity.** The energy emitted per unit time, per unit solid angle about the direction considered; for example, watts per steradian. (55 IRE 22.S1)

**Radiant Sensitivity (of a Phototube).** The quotient of output current by incident radiant flux of a given wavelength at constant electrode voltages.

*Note:* The term output current as used here does not include the dark current.

(54 IRE 7.S1)

**Radiating Element.** A basic subdivision of

## Radiation

an antenna which in itself is capable of radiating or receiving radio-frequency energy. (48 IRE 2, 11, 15.S1)

**Radiation (Nuclear).** In nuclear work, the usual meaning of *Radiation* is extended to include moving nuclear particles, charged or uncharged. (57 IRE 7.S2)

**Radiation Counter.** An instrument used for detecting or measuring *Radiation* by a counting process. (57 IRE 7.S2)

**Radiation-Counter Tube.** See:

*Counter Tube, Externally Quenched*

*Counter Tube, Gas-Filled, Radiation*

*Counter Tube, Gas-Flow*

*Counter Tube, Geiger-Mueller*

*Counter Tube, Proportional*

*Counter Tube, Self-Quenched.*

(57 IRE 7.S2)

**Radiation Efficiency.** The ratio of the power radiated to the total power supplied to the antenna at a given frequency. (48 IRE 2, 11, 15.S1)

**Radiation Intensity.** In a given direction, the power radiated from an antenna per unit solid angle in that direction. (48 IRE 2, 11, 15.S1)

**Radiation Lobe.** A portion of the radiation pattern bounded by one or two cones of nulls. (48 IRE 2, 11, 15.S1)

**Radiation Loss.** That part of the *Transmission Loss* due to radiation of radio frequency power from a transmission system. (53 IRE 2.S1)

**Radiation Pattern.** A graphical representation of the radiation of the antenna as a function of direction. Cross sections in which radiation patterns are frequently given are vertical planes and the horizontal plane, or the principal electric and magnetic polarization planes. (48 IRE 2, 11, 15.S1)

**Radiation Resistance.** The quotient of the power radiated by an antenna by the square of the effective antenna current referred to a specified point. (48 IRE 2, 11, 15.S1)

**Radio-Autopilot Coupler.** Equipment providing means by which an electrical navigational signal will operate the automatic pilot to allow automatic flight. (49 IRE 12.S1)

**Radio Beacon.** A facility, usually a nondirectional radio transmitter, emitting identifiable signals intended for *Radio Direction Finding* observations. (54 IRE 12.S1)

**Radio Broadcasting.** Radio transmission intended for general reception. (48 IRE 2, 11, 15.S1)

**Radio Channel.** A band of radio frequencies allocated for a radio transmission. (52 IRE 17.S1)

**Radio Communication Circuit.** A radio system for carrying out one communication

## Radio Magnetic Indicator

at a time in either direction between two points. (48 IRE 2, 11, 15.S1)

**Radio Direction Finding.** *Radiolocation* in which only the *Direction* of a source of radio emission is determined by means of a directive receiving antenna system. (54 IRE 12.S1)

**Radio Field Strength.** The electric or magnetic field strength at a given location resulting from the passage of radio waves. In the case of a sinusoidal wave, the root-mean-square value is commonly used. Unless otherwise stated, it is taken in the direction of maximum. (50 IRE 24.S1)

**Radio Frequency.** A frequency at which coherent electromagnetic radiation of energy is useful for communication purposes. (50 IRE 24.S1; 52 IRE 17.S1)

**Radio-Frequency Alternator.** A rotating-type generator for producing radio-frequency power. (48 IRE 2, 11, 15.S1)

**Radio Frequency Converter.** A power source for producing electrical power at a frequency of 10 kc and above. (55 IRE 10.S1)

**Radio Frequency Generator—Electron Tube Type (Industrial and Dielectric Heating usage).** A power source comprising an electron tube oscillator, an amplifier if used, a power supply and associated control equipment. (55 IRE 10.S1)

**Radio-Frequency Pulse.** A radio-frequency carrier amplitude-modulated by a pulse. The amplitude of the modulated carrier is zero before and after the pulse.

*Note:* Coherence of the carrier (with itself) is not implied.

(51 IRE 20.S1)

**Radio-Frequency Signal, High-Level (TR, ATR, and Pre-TR Tubes).** See *High-Level Radio-Frequency Signal (TR, ATR, and Pre-TR Tubes)*. (57 IRE 7.S2)

**Radio-Frequency Signal, Low-Level (TR, ATR, and Pre-TR Tubes).** See *Low-Level Radio-Frequency Signal (TR, ATR and Pre-TR Tubes)*. (57 IRE 7.S2)

**Radio Horizon.** The locus of points at which direct rays from the transmitter become tangential to the earth's surface.

*Note:* On a spherical surface the horizon is a circle. The distance to the horizon is affected by atmospheric refraction.

(50 IRE 24.S1)

**Radiolocation.** Determination of one or more *Navigation Coordinates* made possible by the constant velocity of rectilinear propagation properties of Hertzian waves. (54 IRE 12.S1)

**Radio Magnetic Indicator (RMI).** An indicating instrument which presents a *Display* combining *Vehicle Heading*, *Relative Bearing*, *Magnetic Bearing* and *Omnibearing* of

## Radio Navigation

the radio station being utilized for *Navigation* purposes. (54 IRE 12.S1)

**Radio Navigation.** Navigation by means of radio signals. (49 IRE 12.S1)

**Radiophare.** See *Radio Beacon*.

*Note:* This term is identical with *Radio Beacon* and is commonly used in international terminology.

(54 IRE 12.S1)

**Radio Proximity Fuze.** A radio device contained in a missile to detonate it within predetermined limits of distance from a target by means of electromagnetic interaction with the target. (48 IRE 2, 11, 15.S1)

**Radio Range.** A radio facility which provides *Radial Lines of Position* by having special characteristics in its emissions recognizable as *Bearing* information and useful in lateral guidance of aircraft.

*Note:* The word "beacon" is used to designate a facility which emits signals not having the above special characteristics and from which *Bearing* information can be obtained only by having directional characteristics in the receiving equipment.

(54 IRE 12.S1)

**Radio Receiver.** A device for converting radio waves into perceptible signals. (52 IRE 17.S1)

**Radiosonde.** An automatic radio transmitter in the meteorological-aids service, usually carried on an aircraft, free balloon, kite, or parachute, which transmits meteorological data. (48 IRE 2, 11, 15.S1)

**Radio Transmitter.** A device for producing radio-frequency power, for purposes of radio transmission. (48 IRE 2, 11, 15.S1)

**Radio Wave Propagation.** The transfer of energy by electromagnetic radiation at frequencies lower than about  $3 \times 10^{12}$  cycles per second. (50 IRE 24.S1)

**Radix.** Synonym for *Base*. (56 IRE 8.S1)

**Radix Point.** The index which separates the digits associated with negative powers from those associated with the zero and positive powers of the base of the number system in which a quantity is represented. For example, *Binary Point*, *Decimal Point*. (50 IRE 8.S1)

**Radome.** A dielectric housing for an antenna. (48 IRE 2, 11, 15.S1)

**Radux.** A long-distance continuous-wave low-frequency navigational system of the phase comparison type providing hyperbolic *Lines of Position*. (54 IRE 12.S1)

**Rain Return.** In *Radar*, *Clutter* due to rain. (54 IRE 12.S1)

**Ramark.** A fixed facility which continuously emits a signal so that a *Bearing* indication appears on a *Radar Display*. (54 IRE 12.S1)

**Random Errors.** Those errors which can be

## Rayleigh Disk

predicted only on a statistical basis. (54 IRE 12.S1)

**Random (or Fluctuation) Noise.** Noise characterized by a large number of overlapping transient disturbances occurring at random. (48 IRE 2, 11, 15.S1)

**Range.** In *Navigation*, a *Radio Range*.

*Note:* In *Navigation*, the use of *Range* as a synonym for distance is deprecated.

(54 IRE 12.S1)

**Range Mark—Deprecated.** See *Distance Mark*. (54 IRE 12.S1)

**Range Resolution—Deprecated.** See *Distance Resolution*. (54 IRE 12.S1)

**Range, Visual-Aural.** See *VAR*. (54 IRE 12.S1)

**Range, Visual Radio.** The name applied to a specific four or six-course *Radio Range* which included a vibrating reed presentation.

*Note:* This facility is now obsolete, but the term has since been applied to other experimental *Radio Ranges* with visual presentations.

(54 IRE 12.S1)

**Rank (Degrees of Freedom of a Node Basis).** The number of independent cut-sets that can be selected in a network. The rank  $R$  is equal to the number of nodes  $V$  minus the number of separate parts  $P$ .  $R = V - P$ . (50 IRE 4.S1)

**Raster.** A predetermined pattern of scanning lines which provides substantially uniform coverage of an area. (57 IRE 7.S2)

**Raster Burn (Camera Tubes).** A change in the characteristics of that area of the *Target* which has been scanned, resulting in a spurious signal corresponding to that area when a larger or tilted *Raster* is scanned. (57 IRE 7.S2)

**Rate of Decay.** The time rate at which the sound pressure level (or velocity level, or sound-energy density level) is decreasing at a given point and at a given time. The practical unit is the decibel per second. (51 IRE 6.S1)

**Ratio.** See:

*Compression Ratio (Gain or Amplification)*

*Control Ratio (Gas Tubes)*

*Gas Ratio*

*Read-Around Ratio (Charge-Storage Tubes)*

*Secondary-Emission Ratio (Electrons)*

*Signal-to-Noise Ratio (Camera Tubes)*

*Transadmittance Compression Ratio.*

(57 IRE 7.S2)

**Raydist.** A *Navigation* system in which a *CW* signal emitted from a *Vehicle* is received at three or more ground stations; the received signals are compared in phase to determine the *Position* of the *Vehicle*. (54 IRE 12.S1)

**Rayleigh Disk.** A special form of acoustic



radiometer which is used for the fundamental measurement of particle velocity. (51 IRE 6.S1)

**RC Oscillator.** Any oscillator in which the frequency is determined by resistance-capacitance elements. (48 IRE 2, 11, 15.S1)

**RDF—Radio Direction Finding.** Formerly used by the British for *Radio Distance Finding*, that is, "Radar." (54 IRE 12.S1)

**Reactance Modulator.** A device, used for the purpose of modulation, whose reactance may be varied in accordance with the instantaneous amplitude of the modulating electromotive force applied thereto. This is normally an electron-tube circuit and is commonly used to effect phase or frequency modulation. (48 IRE 2, 11, 15.S1)

**Read.** To acquire information, usually from some form of storage. See also *Write*. (56 IRE 8.S1)

**Read (Charge-Storage Tubes).** To generate an output corresponding to the stored charge pattern. (57 IRE 7.S2)

**Read-Around Number (Charge-Storage Tubes).** The number of times *Priming*, *Writing*, *Reading*, or *Erasing* operations can be performed on *Storage Elements* adjacent to any given *Element* without loss of information from that *Element*.

*Note:* The sequence of operations should be specified. (57 IRE 7.S2)

**Read-Around Ratio (Charge-Storage Tubes)—Deprecated.** See *Read-Around Number*. (57 IRE 7.S2)

**Reading Speed (Charge-Storage Tubes).** The rate of *Reading* successive *Storage Elements*. (57 IRE 7.S2)

**Read Number (Charge-Storage Tubes).** The number of times a *Storage Element* is *Read* without rewriting. (57 IRE 7.S2)

**Read Pulse.** See *One State*. (59 IRE 8.S1)

**Ready-to-Receive Signal.** A signal sent back to the *Facsimile Transmitter* indicating that a *Facsimile Receiver* is ready to accept the transmission. (56 IRE 9.S1)

**Rebecca.** The airborne *Interrogator-Responder* of *Rebecca-Eureka*, a secondary *Radar* system. (54 IRE 12.S1)

**Recalescent Point (of a Metal).** The temperature at which there is a sudden liberation of heat as the metal is lowered in temperature. (55 IRE 10.S1)

**Receiver, Facsimile.** The apparatus employed to translate the signal from the communications channel into a *Facsimile* record of the *Subject Copy*. (56 IRE 9.S1)

**Receiver Gating.** The application of operating voltages to one or more stages of a receiver only during that part of a cycle of

operation when reception is desired. (54 IRE 12.S1)

**Receiver Primaries.** See *Display Primaries*. (55 IRE 22.S1)

**Receiver Pulse Delay.** See *Transducer Pulse Delay*. (52 IRE 20.S1)

**Receiving Converter, Facsimile (FS to AM Converter).** A device which changes the type of modulation from frequency shift to amplitude. (56 IRE 9.S1)

**Reciprocal Transducer.** A transducer in which the principle of reciprocity is satisfied. (51 IRE 20.S2)

**Recombination Rate, Surface.** The time rate at which free electrons and *Holes* recombine at the surface of a semiconductor. (54 IRE 7.S2)

**Recombination Rate, Volume.** The time rate at which free electrons and *Holes* recombine within the volume of a semiconductor (54 IRE 7.S2)

**Recombination Velocity (on a Semiconductor Surface).** The quotient of the normal component of the electron (*Hole*) current density at the surface by the excess electron (*Hole*) charge density at the surface. (54 IRE 7.S2)

**Recorded Spot.** The image of the *Recording Spot* on the *Record Sheet*. (56 IRE 9.S1)

**Recorded Spot X Dimension.** The effective *Recorded Spot* dimension measured in the direction of the recorded line.

*Note 1:* By effective dimension is meant the largest center-to-center spacing between *Recorded Spots* which gives minimum peak-to-peak variation of *Density* of the recorded line.

*Note 2:* This term applies to that type of equipment which responds to a constant *Density* in the *Subject Copy* by a succession of discrete *Recorded Spots*. (56 IRE 9.S1)

**Recorded Spot Y Dimension.** The effective *Recorded Spot* dimension measured perpendicularly to the recorded line.

*Note:* By effective dimension is meant the largest center-to-center distance between recorded lines which gives minimum peak-to-peak variation of *Density* across the recorded lines. (56 IRE 9.S1)

**Recorder, Facsimile.** That part of the *Facsimile Receiver* which performs the final conversion of electrical *Picture Signal* to an image of the *Subject Copy* on the *Record Medium*. (56 IRE 9.S1)

**Recording (in Facsimile).** The process of converting the electrical signal to an image on the *Record Medium*.

## Recording Channel

*Note:* See:

*Direct Recording*

*Electrochemical Recording*

*Electrolytic Recording*

*Electromechanical Recording*

*Electrostatic Recording*

*Electrothermal Recording*

*Ink Vapor Recording*

*Magnetic Recording*

*Photosensitive Recording.*

(56 IRE 9.S1)

**Recording Channel.** The term refers to one of a number of independent recorders in a recording system or to independent recording tracks on a recording medium.

*Note:* One or more channels may be used at the same time for covering different ranges of the transmitted frequency band, for multi-channel recording, or for control purposes. (51 IRE 6.S1)

**Recording Loss.** In mechanical recording, the loss in recorded level whereby the amplitude of the wave in the recording medium differs from the amplitude executed by the recording stylus. (51 IRE 6.S1)

**Recording Spot (in Facsimile).** The image area formed at the *Record Medium* by the *Facsimile Recorder*. (51 IRE 6.S1)

**Recording Stylus.**<sup>1</sup> A tool which inscribes the groove into the recording medium. (51 IRE 6.S1)

**Record Medium.** The physical medium on which the *Facsimile Recorder* forms an image of the *Subject Copy*. (56 IRE 9.S1)

**Record Sheet.** The medium which is used to produce a visible image of the *Subject Copy* in record form. The *Record Medium* and the *Record Sheet* may be identical. (56 IRE 9.S1)

**Recovery Time (Audio).** The interval required, after a sudden decrease in *Input Signal* amplitude to a system or component, to attain a specified percentage (usually 63 per cent) of the ultimate change in *Amplification* or *Attenuation* due to this decrease. (58 IRE 3.S1)

**Recovery Time (ATR Tubes).** The time required for a *Fired Tube* to deionize to such a level that the normalized conductance and susceptance of the tube in its *Mount* are within specified ranges.

*Note:* Normalization is with respect to the characteristic admittance of the transmission line at its junction with the tube *Mount*. (56 IRE 7.S3)

**Recovery Time (Gas Tubes).** The time required for the *Control Electrode* to regain

<sup>1</sup> Stylus is a term defining a pickup needle or a holder furnished with a jewel or other abrasive-resistant tip. A stylus may or may not be arranged for convenient replacement.

## Redundancy Check

control after *Anode Current* interruption.

*Note:* To be exact, the *Deionization* and *Recovery Time* of a *Gas Tube* should be presented as families of curves relating such factors as *Condensed-Mercury Temperature*, *Anode Current*, *Anode* and *Control Electrode* voltages, and control circuit impedance.

(57 IRE 7.S2)

**Recovery Time (Geiger-Mueller Counters).** The minimum time from the start of a counted pulse to the instant a succeeding pulse can attain a specified percentage of the maximum amplitude of the counted pulse. (57 IRE 7.S2)

**Recovery Time (TR and Pre-TR Tubes).** The time required for a *Fired Tube* to deionize to such a level that the attenuation of a *Low-Level Radio-Frequency Signal* transmitted through the tube is decreased to a specified value. (57 IRE 7.S2)

**Rectangular Scanning.** A two-dimensional sector scan in which a slow sector scan in one direction is superimposed on a rapid sector scan in a perpendicular direction. (48 IRE 2, 11, 15.S1)

**Rectification Factor.** The quotient of 1) the change in average current of an *Electrode* by 2) the change in amplitude of the alternating sinusoidal voltage applied to the same *Electrode*, the direct voltages of this and other *Electrodes* being maintained constant. (57 IRE 7.S2)

**Rectifier.** A device having an asymmetrical conduction characteristic which is used for the conversion of an alternating current into a current having a unidirectional component. (48 IRE 2, 11, 15.S1)

**Rectilinear Scanning.** The process of scanning an area in a predetermined sequence of narrow straight parallel strips. (42 IRE 9.S1)

**Recurrence Rate.** See *Repetition Rate*. (54 IRE 12.S1)

**Redistribution (Charge-Storage Tubes or Camera Tubes).** The alteration of charges on an area of a storage surface by secondary electrons from any other area of the surface. (57 IRE 7.S2)

**Redundancy (of a Source).** The amount by which the logarithm of the number of symbols available at the source exceeds the *Average Information Content per Symbol* of the source.

*Note:* The term *Redundancy* has been used loosely in other senses. For example, a source whose output is normally transmitted over a given channel has been called redundant, if the *Channel Utilization Index* is less than unity.

(58 IRE 11.S1)

**Redundancy Check.** See *Check, Forbidden*

## Reference Black Level

*Combination*. (56 IRE 8.S1)

**Reference Black Level.** The *Picture Signal Level* corresponding to a specified maximum limit for *Black Peaks*. (55 IRE 23.S1)

**Reference Direction.** The direction used as a reference for angular measurements. (49 IRE 12.S1)

**Reference Line.** A line passing through a reference point and an observer. (49 IRE 12.S1)

**Reference Test Field.** That field strength, in microvolts per meter, numerically equal to the *DF Sensitivity*. (59 IRE 12.S1)

**Reference Time,  $T_0$ .** An instant near the beginning of switching chosen as an origin for time measurements. It is variously taken as the first instant at which the instantaneous value of the *Drive Pulse*, the voltage response of the magnetic cell, or the integrated voltage response reaches a specified fraction of its peak pulse amplitude. (59 IRE 8.S1)

**Reference Volume.** The *Volume* which gives a reading of 0 *vu* on a *Standard Volume Indicator*. (54 IRE 3.S1; 58 IRE 3.S1)

**Reference White.** The light from a nonselective diffuse reflector which is lighted by the normal illumination of the scene.

*Note 1:* Normal illumination is not intended to include lighting for special effects.

*Note 2:* In the reproduction of recorded material, the word scene refers to the original scene.

(55 IRE 22.S1)

**Reference White Level.** The *Picture Signal Level* corresponding to a specified maximum limit for *White Peaks*. (55 IRE 23.S1)

**Reflected Wave.** When a wave in a medium of certain propagation characteristics is incident upon a discontinuity or a second medium, the wave component that results in the first medium in addition to the *Incident Wave*. (53 IRE 2.S1)

**Reflection Coefficient (of a Transition or Discontinuity).** For a transition or discontinuity between two transmission media, the *Reflection Coefficient* at a specified point in one medium which would be observed if the other medium were match terminated. (53 IRE 2.S1)

**Reflection Coefficient (in a Transmission Medium).** At a given frequency, at a given point, and for a given mode of transmission, the ratio of some quantity associated with the *Reflected Wave* to the corresponding quantity in the *Incident Wave*.

*Note:* The *Reflection Coefficient* may be different for different associated quantities, and the chosen quantity must be specified. The "voltage reflection coefficient" is most commonly used and is defined as the ratio of

## Regeneration

the complex electric field strength (or voltage) of the *Reflected Wave* to that of the *Incident Wave*.

(53 IRE 2.S1)

**Reflection Color-Tube.** A *Color Picture Tube* which produces an image by means of electron reflection techniques in the *Screen* region. (57 IRE 7.S2)

**Reflection Error.** In *Navigation*, the error due to the presence of wave energy reaching the receiver by virtue of undesired reflections. (54 IRE 12.S1)

**Reflection Loss.** 1) That part of the *Transition Loss* due to the reflection of power at the discontinuity. 2) The ratio in decibels of the power incident upon the discontinuity to the difference between the power incident upon and the power reflected from the discontinuity. (53 IRE 2.S1)

**Reflector (Antenna).** A parasitic element located in a direction other than the general direction of the major lobe of radiation. (48 IRE 2, 11, 15.S1)

**Reflector (in Tubes).** See *Repeller*. (57 IRE 7.S2)

**Reflex Baffle.** A loudspeaker baffle in which a portion of the radiation from the rear of the diaphragm is propagated forward after controlled shift of phase or other modification, the purpose being to increase the over-all radiation in some portion of the frequency spectrum. (51 IRE 6.S1)

**Reflex Bunching.** The *Bunching* that occurs in an electron stream that has been made to reverse its direction in the *Drift Space*. (56 IRE 7.S1; 57 IRE 7.S2)

**Refracted Wave.** That part of an *Incident Wave* which travels from one medium into a second medium. (50 IRE 24.S1; 53 IRE 2.S1)

**Refraction Error.** In *Navigation*, error due to bending of one or more wave paths by undesired refraction. (54 IRE 12.S1)

**Refraction Loss.** That part of the transmission loss due to refraction resulting from nonuniformity of the medium. (51 IRE 6.S1)

**Refractive Index.** Of a wave transmission medium, the ratio of the phase velocity in free space to that in the medium. (50 IRE 24.S1)

**Refractive Modulus.** In the troposphere, the excess over unity of the modified index of refraction, expressed in millionths. It is represented by  $M$  and is given by the equation

$$M = (n + h/a - 1)10^6,$$

where  $n$  is the index of refraction at a height  $h$  above sea level, and  $a$  is the radius of the earth. (50 IRE 24.S1)

**Regeneration (Charge-Storage Tubes).** The replacing of charge to overcome *Decay*

## Regeneration

effects, including loss of charge by *Reading*. (57 IRE 7.S2)

### Regeneration (in Electronic Computers).

In a storage device whose information storing state may deteriorate, the process of restoring the device to its latest undeteriorated state. See also *Rewrite*. (56 IRE 8.S1)

### Regeneration (in Transmitters).

Same as positive feedback. (48 IRE 2, 11, 15.S1)

### Regenerative Repeater.

A repeater which performs pulse regeneration.

*Note:* Although this term carries the unfortunate connotation of a repeater employing a regenerative, or feedback, amplifier, its use in the literature has been wide and specifically as given in this definition.

(53 IRE 11.S1)

### Region, Geiger-Mueller (Radiation-Counter Tubes).

The range of applied voltage in which the charge collected per isolated *Count* is independent of the charge liberated by the *Initial Ionizing Event*. (57 IRE 7.S2)

### Region of Limited Proportionality (Radiation-Counter Tubes).

The range of applied voltage below the *Geiger-Mueller Threshold* in which the *Gas Amplification* depends upon the charge liberated by the *Initial Ionizing Event*. (57 IRE 7.S2)

### Region, Proportional (Radiation-Counter Tubes).

The range of applied voltage in which the charge collected per isolated *Count* is proportional to the charge liberated by the *Initial Ionizing Event*.

*Note 1:* In this region the *Gas Amplification* is greater than unity and is independent of the charge liberated by the *Initial Ionizing Event*.

*Note 2:* The *Proportional Region* depends on the type and energy of the incident *Radiation*.

(57 IRE 7.S2)

### Register.

A device capable of retaining information, often that contained in a small subset (e.g., one *Word*) of the aggregate information in a digital computer. See also *Storage*. (56 IRE 8.S1)

### Register, Delay-Line

See *Delay-Line Register*. (50 IRE 8.S1)

### Register Length.

The number of characters which a register can store. (56 IRE 8.S1)

### Register, Static.

See *Static Register*. (50 IRE 8.S1)

### Regulation (Gas Tubes).

The difference between the maximum and minimum *Tube Voltage Drops* within a specified range of *Anode Current*. (57 IRE 7.S2)

### Reignition (Radiation-Counter Tubes).

A process by which multiple *Counts* are generated within a counter tube by atoms or molecules excited or ionized in the discharge

## Repeatability

accompanying a *Tube Count*. (57 IRE 7.S2)

**Rejection Band (of a Uniconductor Waveguide).** The frequency range below the *Cut-Off Frequency*. (53 IRE 2.S1)

**Relative Bearing.** A *Bearing* in which the *Direction of the Reference Line* is the *Heading of the Vehicle*. (54 IRE 12.S1)

**Relative Course.** See *Drift Angle*. (49 IRE 12.S1)

**Relative Heading.** The heading itself. "Relative" is superfluous. (49 IRE 12.S1)

**Relative Luminosity.** The ratio of the value of the *Luminosity* at a particular wavelength to the value at the wavelength of maximum *Luminosity*. (55 IRE 22.S1)

**Relative Plateau Slope (Radiation-Counter Tubes).** See *Plateau Slope, Relative (Radiation-Counter Tubes)*. (57 IRE 7.S2)

**Relative Redundancy (of a source).** The ratio of the *Redundancy* of the source to the logarithm of the number of symbols available at the source. (58 IRE 11.S1)

**Relative Refractive Index.** Of two media, the ratio of their refractive indices. (50 IRE 24.S1)

**Relative Response.** The ratio, usually expressed in decibels, of the response under some particular conditions to the response under reference conditions, which should be stated explicitly. (51 IRE 6.S1)

**Relative Velocity.** Of a point with respect to a reference frame, the time rate of change of a position vector of that point with respect to the reference frame. (51 IRE 6.S1)

**Relaxation Oscillator.** Any oscillator whose fundamental frequency is determined by the time of charging or discharging of a capacitor or inductor through a resistor, producing wave forms which may be rectangular or sawtooth. (48 IRE 2, 11, 15.S1)

**Relay Radar—Deprecated.** See *Radar Relay*. (54 IRE 12.S1)

**Remanence,  $B_d$ .** The magnetic flux density which remains in a magnetic circuit after the removal of an applied magnetomotive force.

*Note:* This should not be confused with *Residual Flux Density*. If the magnetic circuit has an air gap, the *Remanence* will be less than the *Residual Flux Density*.

(59 IRE 8.S1)

**Remote Control.** A system or method of radio-transmitter control whereby the control functions are performed from a distance, electrically, over intervening wire or radio circuits. (48 IRE 2, 11, 15.S1)

**Remote Line.** A *Program* transmission line between a remote-pickup point and the studio or transmitter site. (58 IRE 3.S1)

**Repeatability (Voltage Regulator, or Volt-**

## Repeller

**age Reference Tubes).** The ability of a tube to attain the same voltage drop at a stated time after the beginning of any conducting period.

*Note:* The lack of repeatability is measured by the change in this voltage from one conducting period to any other, the operating conditions remaining unchanged.

(57 IRE 7.S2)

**Repeller.** An *Electrode* whose primary function is to reverse the direction of an electron stream.

*Note:* The *Repeller* is sometimes called the *Reflector*.

(56 IRE 7.S1; 57 IRE 7.S2)

**Repetition Frequency.** See *Repetition Rate*. (54 IRE 12.S1)

**Repetition Rate.** The rate at which recurrent signals are transmitted. (54 IRE 12.S1)

**Repetition Rate, Basic.** See *Basic Repetition Rate*. (54 IRE 12.S1)

**Repetition Rate, Specific.** See *Specific Repetition Rate*. (54 IRE 12.S1)

**Reply.** In *Transponder* operation, a radio frequency signal or combination of signals transmitted as a result of an *Interrogation*. (54 IRE 12.S1)

**Reply Efficiency, Transponder.** See *Transponder Reply Efficiency*. (54 IRE 12.S1)

**Reproducing Stylus.**<sup>1</sup> A mechanical element adapted to following the modulations of a record groove and transmitting the mechanical motion thus derived to the pickup mechanism. (51 IRE 6.S1)

**Reproduction Speed.** The area of copy recorded per unit time. (56 IRE 9.S1)

**Rerecording.** The process of making a recording by reproducing a recorded sound source and recording this reproduction. See also *Dubbing*. (51 IRE 6.S1)

**Rerecording System.** An association of reproducers, mixers, amplifiers, and recorders capable of being used for combining or modifying various sound recordings to provide a final sound record. Recording of speech, music, and sound effects may be so combined. (51 IRE 6.S1)

**Reset.** 1) To restore a storage device to a prescribed state. 2) To place a binary cell in the initial or "zero" state. See also *Clear*. (56 IRE 8.S1)

**Reset Pulse.** A *Drive Pulse* which tends to reset a magnetic cell. (59 IRE 8.S1)

**Residual Error.** The sum of the *Random Errors* and the uncorrected *Systematic Errors*. (54 IRE 12.S1)

<sup>1</sup> Stylus is a term defining a pickup needle or a holder furnished with a jewel or other abrasive-resistant tip. A stylus may or may not be arranged for convenient replacement.

## Resonant Modes

**Residual Flux Density,  $B_r$ .** The magnetic flux density at which the magnetizing force is zero when the material is in a *Symmetrically Cyclically Magnetized Condition*.

*Note:* See also *Remanence*.

(59 IRE 8.S1)

**Resistance.** See:

*Cathode Interface (Layer) Resistance*

*Electrode Resistance*

*Equivalent Noise Resistance*.

(57 IRE 7.S2)

**Resolution.** The degree to which nearly equal values of a quantity can be discriminated. (49 IRE 12.S1)

**Resolution (in Television).** A measure of the ability to delineate picture detail.

*Note:* *Resolution* is usually expressed in terms of a number of *Lines* discriminated on a test chart. For a number of *Lines N* (normally alternate black and white lines) the width of each *Line* is  $1/N$  times the picture height.

(57 IRE 7.S2)

**Resolution, Structural (Color Picture Tubes).** The *Resolution* as limited by the size and shape of the *Screen* elements. (57 IRE 7.S2)

**Resolver.** Means for resolving a vector into two mutually perpendicular components. (50 IRE 8.S1)

**Resolving Power.** In a unidirectional antenna, the reciprocal of its beam width measured in degrees.

*Note:* The resolution of a directional radio system can be different from the resolving power of its antenna, since the resolution is affected by other factors.

(48 IRE 2, 11, 15.S1)

**Resolving Time.** The minimum time interval by which two events must be separated to be distinguishable in a *Navigation* system, by the time measurement alone. (54 IRE 12.S1)

**Resolving Time (Radiation Counters).** The minimum achievable pulse spacing between *Counts*.

*Note:* This quantity is a property of the combination of the tube and recording circuit.

(57 IRE 7.S2)

**Resonant Gap (TR Tubes).** The small region in a resonant structure interior to the tube, where the electric field is concentrated. (57 IRE 7.S2)

**Resonant-Line Oscillator.** An oscillator in which one or more sections of transmission line are employed as tanks. (48 IRE 2, 11, 15.S1)

**Resonant Modes in Cylindrical Cavities.** When a metal cylinder is closed by two metal surfaces perpendicular to its axis a cylindrical

cal cavity is formed. The resonant modes in this cavity are designated by adding a third subscript to indicate the number of half waves along the axis of the cavity. When the cavity is a rectangular parallelepiped the axis of the cylinder from which the cavity is assumed to be made should be designated since there are three possible cylinders out of which the parallelepiped may be made.

For  $TE_{m,n}$  or  $TM_{m,n}$  waves in hollow rectangular cylinders, the cutoff wavelength is

$$\lambda_c = 2/\sqrt{(m/a)^2 + (n/b)^2}$$

where  $a$  is the width of the guide along the  $x$  coordinate and  $b$  is the height of the guide along the  $y$  coordinate. (45 IRE 24.S1)

**Resonator Mode.** See *Mode of an Oscillator*. (56 IRE 7.S1; 57 IRE 7.S2)

**Resonator, Waveguide (Resonant Element).** A waveguide device primarily intended for storing oscillating electromagnetic energy. (55 IRE 2.S1)

**Resonant Window (Switching Tubes).** A resonant iris, sealed with a suitable dielectric material, and constituting a portion of the vacuum envelope of the tube. (56 IRE 7.S3)

**Responder Beacon.** See *Transponder*. (54 IRE 12.S1)

**Response.** See *Amplitude Response (Camera Tubes)*; *Square-Wave Response (Camera Tubes)*. (57 IRE 7.S2)

**Responsor.** The receiving component of an *Interrogator-Responsor*. (54 IRE 12.S1)

**Retained Image (Image Burn).** A change produced in or on the *Target* which remains for a large number of frames after the removal of a previously stationary light image and which yields a spurious electrical signal corresponding to that light image. (57 IRE 7.S2)

**Retarding-Field (Positive-Grid) Oscillator.** An oscillator employing an electron tube in which the electrons oscillate back and forth through a grid maintained positive with respect to the cathode and the plate. The frequency depends on the electron-transit time and may also be a function of the associated circuit parameters. The field in the region of the grid exerts a retarding effect which draws electrons back after passing through it in either direction. Barkhausen-Kurz and Gill-Morell oscillators are examples. (48 IRE 2, 11, 15.S1)

**Retention Time, Maximum (Charge-Storage Tubes).** The maximum time between *Writing* into and *Reading* an acceptable output from a *Storage Element*. (57 IRE 7.S2)

**Retentivity,  $B_{rs}$ .** The property of a material

which is measured by the *Residual Flux Density* corresponding to the *Saturation Induction* for the material. (59 IRE 8.S1)

**Retrace Line.** The line traced by the electron beam in a cathode-ray tube in going from the end of one line or field to the start of the next line or field. (52 IRE 17.S1)

**Return Loss.** 1) At a discontinuity in a transmission system, the difference between the power incident upon the discontinuity and the power reflected from the discontinuity. 2) The ratio in decibels of the power incident upon the discontinuity to the power reflected from the discontinuity. (53 IRE 2.S1)

**Return Transfer Function.** In a feedback control loop, the transfer function which relates a loop return signal to the corresponding loop input signal. (55 IRE 26.S2)

**Reverberation.** The persistence of sound at a given point, after direct reception from the source has stopped.

*Note:* This may be due 1) (as in the case of rooms) to repeated reflections from a small number of boundaries or to the free decay of the normal modes of vibration that were excited by the sound source; 2) (as in the case of underwater sound in the ocean) to scattering from a large number of inhomogeneities in the medium or reflection from bounding surfaces.

(51 IRE 6.S1)

**Reverberation Chamber.** An enclosure in which all of the surfaces have been made as sound-reflective as possible. Reverberation chambers are used for certain acoustic measurements. (51 IRE 6.S1)

**Reverberation Time.** For a given frequency, the time required for the average sound-energy density, originally in a steady state, to decrease after the source is stopped to one-millionth of its initial value (60 db).

*Note:* Usually the pressure level for the upper part of this range is measured and the result extrapolated to cover 60 db.

(51 IRE 6.S1)

**Reverberation Time Meter.** An instrument for measuring the reverberation time of an enclosure. (51 IRE 6.S1)

**Reverse Emission (Back Emission) (Vacuum Tubes).** The inverse *Electrode Current* from an *Anode* during that part of a cycle in which the *Anode* is negative with respect to the *Cathode*. (57 IRE 7.S2)

**Rewrite.** In a storage device whose information storing state may be destroyed by reading, the process of restoring the device to its state prior to reading. (56 IRE 8.S1)

**Rhombic Antenna.** An antenna composed of long-wire radiators comprising the sides of a

rhombus. The antenna usually is terminated in an impedance. The sides of the rhombus, the angle between the sides, the elevation, and the termination are proportioned to give the desired directivity. (48 IRE 2, 11, 15.S1)

**Rho Theta (Navigation System).** A polar coordinate *Navigation* system providing data with sufficient accuracy to permit the use of a computer which will provide arbitrary *Course Lines* anywhere within the coverage area of the system. (54 IRE 12.S1)

**Ribbon Microphone.** A moving-conductor microphone in which the moving conductor is in the form of a ribbon which is directly driven by the sound waves. (51 IRE 6.S1)

**Rieke Diagram (of Oscillator Performance).** A chart showing contours of constant power output and constant frequency drawn on a polar diagram whose coordinates represent the components of the complex reflection coefficient at the oscillator load. See *Load Impedance Diagram*. (56 IRE 7.S1; 57 IRE 7.S2)

**Right-Handed (Clockwise) Polarized Wave.** An elliptically polarized transverse electromagnetic wave in which the rotation of the electric field vector is clockwise for an observer looking in the direction of propagation. (50 IRE 24.S1)

**Ring Around.** 1) In *Secondary Radar*, the undesired triggering of a *Transponder* by its own transmitter. 2) In *Secondary Radar*, the triggering of a *Transponder* at all *Bearings* causing a ring presentation on a *PPI*. (54 IRE 12.S1)

**Ring Counter.** See *Counter, Ring*. (56 IRE 8.S1)

**Ring Head.** A magnetic head in which the magnetic material forms an enclosure with one of more air gaps. The magnetic recording medium bridges one of these gaps and is in contact with or in close proximity to the pole pieces on one side only. (51 IRE 6.S1)

**Ringing (in Facsimile).** See *Facsimile Transient*. (56 IRE 9.S1)

**Ringing (in Receivers).** An oscillatory transient occurring in the output of a system as a result of a sudden change in input. (52 IRE 17.S1)

**Ring Oscillator.** An arrangement of two or more pairs of tubes operating as push-pull oscillators around a ring, usually with alternate successive pairs of grids and plates connected to tank circuits. Adjacent tubes around the ring operate in phase opposition. The load is supplied by coupling to the plate circuits. (48 IRE 2, 11, 15.S1)

**Ring Time.** In *Radar*, the time during which the output of an *Echo Box* remains above a specified level. The *Ring Time* is used in

measuring the performance of *Radar* equipment. (54 IRE 12.S1)

**Ripple.** The ac component from a dc power supply arising from sources within the power supply.

*Note:* Unless otherwise specified, per cent ripple is the ratio of the root-mean-square value of the ripple voltage to the absolute value of the total voltage, expressed in per cent.

(52 IRE 17.S1)

**Ripple Voltage.** The alternating component of the unidirectional voltage from a rectifier or generator used as a source of direct-current power. (48 IRE 2, 11, 15.S1)

**Rising-Sun Magnetron.** A *Multicavity Magnetron* in which resonators of two different resonance frequencies are arranged alternately for the purpose of *Mode Separation*. (57 IRE 7.S2)

**RMI.** See *Radio Magnetic Indicator*. (54 IRE 12.S1)

**RMS (Effective) Pulse Amplitude.** The square root of the average of the square of the instantaneous amplitude taken over the pulse duration. (51 IRE 20.S1)

**Roll-Off.** A gradually increasing *Loss* or *Attenuation* with increase or decrease of frequency beyond the flat portion of the *Amplitude-Frequency Response* characteristic of a system or component. (58 IRE 3.S1)

**Roll Out (verb).** To read out of a storage device by simultaneously increasing by one the value of the digit in each column and repeating this  $r$  times (where  $r$  is the radix) and, at the instant the representation changes from  $(r - 1)$  to zero: 1) generating a particular signal, or 2) terminating a sequence of signals, or 3) originating a sequence of signals. (50 IRE 8.S1)

**Root-Sum-Square.** The square root of the sum of the squares.

*Note:* Commonly used to express the total harmonic distortion.

(52 IRE 17.S1)

**Rotary Generator (Induction Heating usage).** An alternating-current generator adapted to be rotated by a motor or prime mover. (55 IRE 10.S1)

**Rotating Joint.** A coupling for transmission of electromagnetic energy between two waveguide structures designed to permit mechanical rotation of one structure. (55 IRE 2.S1)

**Round Off (verb).** To delete less significant digits from a number and possibly apply some rule of correction to the part retained. (50 IRE 8.S1)

**Round-Off Error.** Error resulting from rounding off. (50 IRE 8.S1)

**Routine.** A set of instructions arranged in

proper sequence to cause a computer to perform a desired operation, such as the solution of a mathematical problem. (56 IRE 8.S1)

**RT Box—Deprecated.** See *Anti-TR Switch*. (54 IRE 12.S1)

**Rumble (Turntable Rumble).** Low-frequency vibration mechanically transmitted to the recording or reproducing turntable and superimposed on the reproduction. See *Turntable Rumble*. (51 IRE 6.S1; 52 IRE 17.S1)

## S

**Sabin (Square-Foot Unit of Absorption).**

A measure of the sound absorption of a surface. It is the equivalent of 1 square foot of a perfectly absorptive surface. (51 IRE 6.S1)

**Sampling Gate.** A device which extracts information from the input waveform only when activated by a *Selector Pulse*. (54 IRE 12.S1)

**Saturated Signal—Deprecated.** See *Saturating Signal* (54 IRE 12.S1)

**Saturating Signal.** In *Radar*, a signal of an amplitude greater than the dynamic range of the receiving system. (54 IRE 12.S1)

**Saturation.** The attribute of any color perception possessing a hue that determines the degree of its difference from the achromatic color perception most resembling it.

*Note 1:* This is a subjective term corresponding to the psychophysical term *Purity*.

*Note 2:* The description of saturation is not commonly undertaken beyond the use of rather vague terms, such as vivid, strong, and weak. The terms brilliant, pastel, pale, and deep, which are sometimes used as descriptive of saturation, have connotations descriptive also of *Brightness*.

(55 IRE 22.S1)

**Saturation Flux Density.** See *Saturation Induction*. (59 IRE 8.S1)

**Saturation Induction,  $B_s$ .** The maximum *Intrinsic Induction* possible in a material (see *Intrinsic Induction*). *Saturation Induction* is sometimes loosely referred to as *Saturation Flux Density*. (59 IRE 8.S1)

**SBA (Standard Beam Approach).** A VHF 40-mc continuous-wave low-approach system using a *Localizer* and markers. The two main signal lobes are tone-modulated with the Morse Code letters E and T, respectively. These modulations interlock to form a continuous "on-course" tone. The airborne equipment is instrumented for visual reference but the system may also be used aurally. (54 IRE 12.S1)

**Scale.** A musical scale is a series of notes symbols, sensations, or stimuli arranged from low to high by a specified scheme of

intervals, suitable for musical purposes. (51 IRE 6.S1)

**Scale Factor.** 1) In analog computing, a proportionality factor which relates the magnitude of a variable to its representation within a computer. 2) In digital computing, the arbitrary factor which may be associated with numbers in a computer to adjust the position of the radix point so that the significant digits occupy specified columns. (50 IRE 8.S1)

**Scanner.** That part of the *Facsimile Transmitter* which systematically translates the *Densities* of the *Subject Copy* into signal-wave form. (56 IRE 9.S1)

**Scanning (Antenna).** A periodic motion given to the major lobe of an antenna. (48 IRE 2, 11, 15.S1)

**Scanning (in Facsimile).** The process of analyzing successively the *Densities* of the *Subject Copy* according to the elements of a predetermined pattern.

*Note:* The normal *Scanning* is from left to right and top to bottom of the *Subject Copy* as when reading a page of print. Reverse direction is from right to left and top to bottom of the *Subject Copy*.

(56 IRE 9.S1)

**Scanning (in Navigation Aids).** A periodic motion given to the major lobe of an antenna.

*Note:* Definition of Antennas Committee.

(49 IRE 12.S1)

**Scanning Antenna Mount.** A mechanical support for an antenna which provides mechanical means for scanning or tracking with the antenna and means to take off information for indication and control. (48 IRE 2, 11, 15.S1)

**Scanning, High-Velocity.** The scanning of a *Target* with electrons of such velocity that the *Secondary-Emission Ratio* is greater than unity. (57 IRE 7.S2)

**Scanning Line Frequency.** See *Stroke Speed*. (56 IRE 9.S1)

**Scanning Line Length.** The total length of scanning line is equal to the *Spot Speed* divided by the *Scanning Line Frequency*.

*Note:* This is generally greater than the length of the *Available Line*.

(56 IRE 9.S1)

**Scanning Loss.** In a radar system, the reduction in sensitivity expressed in decibels due to scanning across a target compared with that obtained when the beam is directed constantly at the target. (48 IRE 2, 11, 15.S1)

**Scanning, Low-Velocity.** The scanning of a *Target* with electrons of velocity less than the minimum velocity to give a *Secondary-Emission Ratio* of unity. (57 IRE 7.S2)

**Scanning Spot X Dimension.** The effective



## Scanning Spot Y Dimension

scanning spot dimension measured in the direction of the scanning line on the *Subject Copy*.

*Note:* The numerical value of this will depend upon the type of system used.

(56 IRE 9.S1)

**Scanning Spot Y Dimension.** The effective scanning spot dimension measured perpendicularly to the scanning line on the *Subject Copy*.

*Note:* The numerical value of this will depend upon the type of system used.

(56 IRE 9.S1)

**Scatterband.** In pulse systems, the total bandwidth occupied by the frequency spread of numerous *Interrogations* operating on the same nominal radio frequency.

*Note:* The frequency spread is due to the fact that each *Interrogation* is a pulsed transmission, and to the additional fact that not all transmitters in the group are exactly on the nominal frequency.

(54 IRE 12.S1)

**Scattering Loss.** That part of the transmission loss which is due to scattering within the medium or due to roughness of the reflecting surface. (51 IRE 6.S1)

**Schottky Emission.** The increased *Thermionic Emission* resulting from an electric field at the surface of the *Cathode*. (57 IRE 7.S2)

**Scintillation** (also *Target Glint* or *Wander*). On a *Radar Display*, a rapid apparent displacement of the *Target* from its mean *Position*.

*Note:* This includes but is not limited to shift of effective reflection point on the *Target*.

(54 IRE 12.S1)

**Scope.** A cathode-ray oscilloscope. (Use of this term to mean *Display* is deprecated.) (54 IRE 12.S1)

**Scoring System.** For motion picture production, a recording system used for recording music to be reproduced in timed relationship with a motion picture. (51 IRE 6.S1)

**Screen (Cathode-Ray Tubes).** The surface of the tube upon which the visible pattern is produced. (57 IRE 7.S2)

**Screen Grid.** A *Grid* placed between a *Control Grid* and an *Anode*, and usually maintained at a fixed positive potential, for the purpose of reducing the electrostatic influence of the *Anode* in the space between the *Screen Grid* and the *Cathode*. (57 IRE 7.S2)

**Screen-Grid Characteristic.** See *Electrode Characteristic*. (57 IRE 7.S2)

**Screen-Grid Current.** See *Electrode Current*. (57 IRE 7.S2)

**Screen-Grid Modulation.** Modulation produced by introduction of the modulating sig-

## Selectance

nal into the screen-grid circuit of any multi-grid tube in which the carrier is present. (48 IRE 2, 11, 15.S1)

**Searchlighting.** The process of projecting a *Radar* beam continuously at an object. (54 IRE 12.S1)

**Search Radar.** A *Radar* primarily intended to display *Targets* as soon as possible after they enter the coverage area. (54 IRE 12.S1)

**Sea Return.** *Clutter* resulting from irregularities of the sea surface. (54 IRE 12.S1)

**Secondary Emission.** The ejection of electrons from a solid or liquid as a result of charged-particle impact. See *Field-Enhanced Secondary Emission*. (57 IRE 7.S2)

**Secondary-Emission Ratio (Electrons).** The average number of electrons emitted from a surface per incident primary electron. *Note:* The result of a sufficiently large number of events should be averaged to ensure that statistical fluctuations are negligible. (57 IRE 7.S2)

**Secondary Grid Emission.** *Electron Emission* from a *Grid* resulting directly from bombardment of its surface by electrons or other charged particles. (57 IRE 7.S2)

**Secondary Radar.** See *Radar*. (54 IRE 12.S1)

**Second-Channel Attenuation.** See *Selectance*. (52 IRE 17.S1)

**Second-Channel Interference.** *Interference*, in which the extraneous power originates from a signal of assigned (authorized) type in a channel two channels removed from the desired channel. (52 IRE 17.S1)

**Second-Time-Around Echo.** See *Echo, Second-Time-Around*. (54 IRE 12.S1)

**Sectionalized Vertical Antenna.** A vertical antenna which is insulated at one or more points along its length. The insertion of suitable reactances or applications of a driving voltage across the insulated points results in a modified current distribution giving a more desired radiation pattern in the vertical plane. (48 IRE 2, 11, 15.S1)

**Sectoral Horn.** An electromagnetic horn, two opposite sides of which are parallel and the two remaining sides of which diverge. The electromagnetic field in such a horn would be expressed basically in a family of cylindrical coordinates. (48 IRE 2, 11, 15.S1)

**Sector Display.** See *Display*. (54 IRE 12.S1)

**Sector Scanning.** Circular scanning in which but a portion of the plane or flat cone is generated. (48 IRE 2, 11, 15.S1)

**Selectance.** The reciprocal of the ratio of the sensitivity of a receiver tuned to a specified channel to its sensitivity at another channel separated by a specified number of channels from the one to which the receiver is tuned.

*Note 1:* Unless otherwise specified, select-

ance should be expressed as a voltage or field-strength ratio.

*Note 2:* Selectance is often expressed as "adjacent-channel attenuation" (ACA) or "second-channel attenuation" (2 ACA).

(52 IRE 17.S1)

**Selection Check.** See *Check, Selection*. (56 IRE 8.S1)

**Selection Ratio.** See *Coincident-Current Selection*. (59 IRE 8.S1)

**Selective Fading.** Fading which is different at different frequencies in a frequency band occupied by a modulated wave. (50 IRE 24.S1)

**Selectivity (of a Receiver).** That characteristic which determines the extent to which the receiver is capable of differentiating between the desired signal and disturbances of other frequencies. (52 IRE 17.S1)

**Selector Pulse.** A pulse which is used to identify for selection one event in a series of events. (54 IRE 12.S1)

**Self-Checking Code.** See *Check, Forbidden-Combination*. (56 IRE 8.S1)

**Self-Information.** See *Information Content*. (58 IRE 8.S1)

**Self-Instructed Carry.** A system of executing the carry process in which information is allowed to propagate to succeeding places as soon as it is generated and without receipt of a specific signal. See also *Cascaded Carry, Complete Carry, Partial Carry, Separately Instructed Carry, Standing on Nines Carry*. (50 IRE 8.S1)

**Self-Pulse Modulation.** Modulation effected by means of an internally generated pulse. For example, see *Blocking Oscillator*. (48 IRE 2, 11, 15.S1)

**Self-Quenched Counter Tube.** See *Counter Tube, Self-Quenched*. (57 IRE 7.S2)

**Semiconductor.** An electronic conductor, with resistivity in the range between metals and insulators, in which the electrical charge *Carrier* concentration increases with increasing temperature over some temperature range. Certain semiconductors possess two types of *Carriers*, namely, negative electrons and positive *Holes*. (54 IRE 7.S2)

**Semiconductor, Compensated.** A semiconductor in which one type of *Impurity* or *imperfection* (e.g., *donor*) partially cancels the electrical effects of the other type of *Impurity* or *Imperfection* (e.g., *acceptor*). (54 IRE 7.S2)

**Semiconductor Device.** An electron device in which the characteristic distinguishing electronic conduction takes place within a semiconductor. (54 IRE 7.S2)

**Semiconductor Device, Multiple Unit.** A semiconductor device having two or more

sets of electrodes associated with independent *Carrier* streams.

*Note:* It is implied that the device has two or more output functions which are independently derived from separate inputs, e.g., a duo-triode transistor.

(54 IRE 7.S2)

**Semiconductor Device, Single Unit.** A semiconductor device having one set of electrodes associated with a single *Carrier* stream.

*Note:* It is implied that the device has a single output function related to a single input.

(54 IRE 7.S2)

**Semiconductor, Extrinsic.** A semiconductor with electrical properties dependent upon *Impurities*. (54 IRE 7.S2)

**Semiconductor, Intrinsic.** A semiconductor whose electrical properties are essentially characteristic of the pure, ideal crystal. (54 IRE 7.S2)

**Semiconductor, N-Type.** An *Extrinsic Semiconductor* in which the *Conduction Electron* density exceeds the *Hole* density.

*Note:* It is implied that the net ionized *Impurity* concentration is *Donor* type.

(54 IRE 7.S2)

**Semiconductor, P-Type.** An *Extrinsic Semiconductor* in which the *Hole* density exceeds the *Conduction Electron* density.

*Note:* It is implied that the net ionized *Impurity* concentration is *Acceptor* type.

(54 IRE 7.S2)

**Semiremote Control.** A system or method of radio-transmitter control whereby the control functions are performed near the transmitter by means of devices connected to but not an integral part of the transmitter. (48 IRE 2, 11, 15.S1)

**Semitone (Half-Step).** The interval between two sounds whose basic frequency ratio is approximately equal to the twelfth root of two.

*Note:* The interval, in equally tempered semitones, between any two frequencies, is 12 times the logarithm to the base 2 (or 39.86 times the logarithm to the base 10) of the frequency ratio.

(51 IRE 6S.1)

**Semitransparent Photocathode (Camera Tubes or Phototubes).** A *Photocathode* in which radiant flux incident on one side produces *Photoelectric Emission* from the opposite side. (57 IRE 7.S2)

**Sending End Impedance.** The *Input Impedance* of a *Transmission Line*. (53 IRE 2.S1)

**Sense.** In *Navigation*, the relation of the change of the indication of a radio navigational facility to the change of the naviga-

## Sensing

tional parameter being indicated. Also the property of some navigational equipment permitting the resolution of 180° *Ambiguities*.

**Note:** As a specific illustrative example of the "relation" mentioned in the definition, one may assume that a particular navigational facility includes a zero-center meter. Assume further that the pilot of the vehicle observes that the pointer of this meter has deflected to the left. Shall this be interpreted as an instruction to the pilot, directing him to steer his vehicle to the *left*; or shall it be interpreted as an indication that the vehicle is already on the left-hand side of the *Course Line*, and should therefore be steered to the *Right* in order to correct the navigational error? The similar *Up-and-Down* ambiguity must also be resolved.

(54 IRE 12.S1)

**Sensing.** The process of determining the *Sense* of an indication. (54 IRE 12.S1)

**Sensitive Volume (Radiation-Counter Tubes).** That portion of the tube responding to specific *Radiation*. (57 IRE 7.S2)

**Sensitivity.** The least signal input capable of causing an output signal having desired characteristics. (52 IRE 17.S1)

**Sensitivity (of a Camera Tube).** The signal current developed per unit incident radiation density, (*i.e.*, per watt per unit area). Unless otherwise specified, the radiation is understood to be that of unfiltered incandescent source of 2870°K, and its density, which is generally measured in watts per unit area, may then be expressed in foot-candles. (50 IRE 7.S1)

**Sensitivity, Cathode Luminous (Photocathodes).** The quotient of *Photoelectric Emission* current from the *Photocathode* by the incident luminous flux, under specified conditions of illumination.

**Note 1:** Since *Cathode Luminous Sensitivity* is not an absolute characteristic but depends on the spectral distribution of the incident flux, the term is commonly used to designate the sensitivity to radiation from a tungsten-filament lamp operating at a color temperature of 2870°K.

**Note 2:** *Cathode Luminous Sensitivity* is usually measured with a collimated beam at normal incidence.

(57 IRE 7.S2)

**Sensitivity, Cathode Radiant (Photocathodes).** The quotient of the *Photoelectric Emission* current from the *Photocathode* by the incident radiant flux at a given wavelength, under specified conditions of irradiation.

**Note:** *Cathode Radiant Sensitivity* is usually

## Sensitivity, Radiant

measured with a collimated beam at normal incidence.

(57 IRE 7.S2)

**Sensitivity, DF.** That field strength, in microvolts per meter, to which the *DF Antenna System* is exposed at the DF site, which produces a ratio of signal-plus-noise to noise of 20 db in the receiver output, the direction of arrival of the signal being such as to produce maximum pickup in the *DF Antenna System* (see *Sensitivity at Maximum Response Position*, Section 1.2, 59 IRE 12.S1)

**Note:** If, because of equipment limitation, a 20-db signal-plus-noise to noise ratio cannot be attained, the sensitivity can be calculated by extrapolating from an attainable signal-plus-noise to noise ratio within the linear region.

(59 IRE 12.S1)

**Sensitivity, Illumination (Camera Tubes or Phototubes).** The quotient of *Signal Output Current* by the incident illumination, under specified conditions of illumination.

**Note 1:** Since *Illumination Sensitivity* is not an absolute characteristic but depends on the spectral distribution of the incident flux, the term is commonly used to designate the sensitivity to radiation from a tungsten-filament lamp operating at a color temperature of 2870°K.

**Note 2:** *Illumination Sensitivity* is usually measured with a collimated beam at normal incidence.

**Note 3:** See *Transfer Characteristic (Camera Tubes)*.

(57 IRE 7.S2)

**Sensitivity, Luminous (Camera Tubes or Phototubes).** The quotient of *Signal Output Current* by incident luminous flux, under specified conditions of illumination.

**Note 1:** Since *Luminous Sensitivity* is not an absolute characteristic but depends on the spectral distribution of the incident flux, the term is commonly used to designate the sensitivity to radiation from a tungsten-filament lamp operating at a color temperature of 2870°K.

**Note 2:** *Luminous Sensitivity* is usually measured with a collimated beam at normal incidence.

(57 IRE 7.S2)

**Sensitivity, Radiant (Camera Tubes or Phototubes).** The quotient of *Signal Output Current* by incident radiant flux at a given wavelength, under specified conditions of irradiation.

**Note:** *Radiant Sensitivity* is usually measured with a collimated beam at normal incidence.

(57 IRE 7.S2)

**Sensitivity Time Control** (also called **Gain-Time Control** or **Time-Gain**). That portion of a system which varies the amplification of a radio receiver in a predetermined manner as a function of time. (54 IRE 12.S1)

**Sensitometry**. The measurement of the light response characteristics of photographic film under specified conditions of exposure and development. (51 IRE 6.S1)

**Sensor**. That portion of a navigational system which perceives deviations from a reference and converts these deviations into signals. (54 IRE 12.S1)

**Separately Instructed Carry**. A system of executing the carry process in which carry information is allowed to propagate to succeeding places only on receipt of a specific signal. See also *Cascaded Carry*, *Complete Carry*, *Partial Carry*, *Self-Instructed Carry*, *Standing on Nines Carry*. (50 IRE 8.S1)

**Separate Parts of a Network**. The parts which are not connected. (50 IRE 4.S1)

**Serial**. Pertaining to time-sequential transmissions of, storage of, or logical operations on the parts of a word, using the same facilities for successive parts. (56 IRE 8.S1)

**Serial Arithmetic Unit**. One in which the digits of a number are operated on sequentially. See also *Parallel Arithmetic Unit*. (50 IRE 8.S1)

**Serial Digital Computer**. One in which the digits are handled serially. Mixed serial and parallel machines are frequently called serial or parallel according to the way arithmetic processes are performed. An example of a serial digital computer is one which handles decimal digits serially although it might handle the bits which comprise a digit either serially or in parallel. See also *Parallel Digital Computer*. (56 IRE 8.S1)

**Serial Transmission**. A system of information transmission in which the characters of a word are transmitted in sequence over a single line, as contrasted to *Parallel Transmission*. (50 IRE 8.S1)

**Series Elements**. 1) Two-terminal elements are connected in series when they form a path between two nodes of a network such that only elements of this path, and no other elements, terminate at intermediate nodes along the path. 2) Two-terminal elements are connected in series when any mesh including one must include the others. (50 IRE 4.S1)

**Series-Fed Vertical Antenna**. A vertical antenna which is insulated from ground and energized at the base. (48 IRE 2, 11, 15.S1)

**Series Tee Junction**. A *Tee Junction* having an equivalent circuit in which the impedance of the branch guide is predominantly in series

with the impedance of the main guide at the junction. (55 IRE 2.S1)

**Series Two-Terminal Pair Networks**. Two-terminal pair networks are connected in series at the input or at the output terminals when their respective input or output terminals are in series. (50 IRE 4.S1)

**Service Area**. The area within which a navigational aid is of use. (54 IRE 12.S1)

**Service Band**. A band of frequencies allocated to a given class of radio service. (48 IRE 2, 11, 15.S1)

**Servomechanism**. A feedback control system in which one or more of the system signals represent mechanical motion.

*Note*: It should be noted that *Servomechanism* and *Regulator* are not mutually exclusive terms; their application to a particular system will depend on the method of operation of that system.

(55 IRE 26.S2)

**Set**. 1) To place a storage device in a prescribed state. 2) To place a binary cell in the "one" state. (56 IRE 8.S1)

**Set Pulse**. A *Drive Pulse* which tends to set a magnetic cell. (59 IRE 8.S1)

**Setup**. In television, the ratio between *Reference Black Level* and *Reference White Level*, both measured from *Blanking Level*. It is usually expressed in per cent. (55 IRE 23.S1)

**Sexadecimal**. See *Positional Notation*. (56 IRE 8.S1)

**Shading (Camera Tubes)**. A brightness gradient in the reproduced picture, not present in the original scene, but caused by the tube. (57 IRE 7.S2)

**Shadow Factor**. The ratio of the electric field strength which would result from propagation over a sphere to that which would result from propagation over a plane, other factors being the same. (50 IRE 24.S1)

**Shadow Mask (Color Picture Tubes)**. A *Color-Selecting-Electrode System* in the form of an electrically conductive sheet containing a plurality of holes which uses masking to effect color selection. (57 IRE 7.S2)

**Shaped-Beam Antenna (Phase-Shaped)**. An unidirectional antenna whose major lobe differs materially from that obtainable from an aperture of uniform phase.

*Note*: A  $\text{cosec}^2\theta$  beam is a shaped beam whose intensity in some plane varies as  $\text{cosec}^2\theta$  over a prescribed range, where  $\theta$  is a polar angle in that plane. The half-power width in planes, perpendicular to this plane, is approximately constant for the prescribed range of  $\theta$ .

(48 IRE 2, 11, 15.S1)

**Shaping Network**. See *Corrective Network*. (42 IRE 9.S1)

**Shaving.** In mechanical recording, the process of removing material from the surface of a recording medium for the purpose of obtaining a new recording surface. (51 IRE 6.S1)

**Shear Wave (Rotation Wave).** A wave in an elastic medium which causes an element of the medium to change its shape without a change of volume.

*Note 1:* Mathematically, a wave whose velocity field has zero divergence.

*Note 2:* A shear plane wave in an isotropic medium is a transverse wave.

(51 IRE 6.S1)

**Shield.** Material used to suppress the effect of an electric or magnetic field within or beyond definite regions. (55 IRE 10.S1)

**Shielded Pair.** A two-wire *Transmission Line* surrounded by a metallic sheath. (53 IRE 2.S1)

**Shielded Transmission Line.** A *Transmission Line* whose elements essentially confine propagated electrical energy to a finite space inside a conducting sheath. (53 IRE 2.S1)

**Shield Grid (Gas Tubes).** A *Grid* which shields the *Control Grid* from electrostatic fields, thermal radiation, and deposition of thermionic emissive material, and which may also be used as an additional *Control Electrode*. (57 IRE 7.S2)

**Shift.** Displacement of an ordered set of characters one or more places to the left or right. If the characters are the digits of a numerical expression, a shift may be equivalent to multiplying by a power of the base. (56 IRE 8.S1)

**Shift, Cyclic.** See *Cyclic Shift* (50 IRE 8.S1)

**Shift Pulse.** A *Drive Pulse* which initiates shifting of characters in a register. (59 IRE 8.S1)

**Shock Excitation.** The type of excitation supplied by a voltage or current variation of relatively short duration. (48 IRE 2, 11, 15.S1)

**Shock Motion.** In a mechanical system, transient motion which is characterized by suddenness and by significant relative displacements. (51 IRE 6.S1)

**Shoran (Short Range Navigation).** A precision *Position* fixing system using a pulse transmitter and receiver on the *Vehicle* with two *Transponders* at fixed points. (54 IRE 12.S1)

**Short-Circuit Driving-Point Admittance (of the  $j$ th Terminal of an  $n$ -Terminal Network).** The *Driving-Point Admittance* between that terminal and the reference terminal when all other terminals have zero alternating components of voltage with respect to the reference point. (57 IRE 7.S2)

**Short-Circuit Feedback Admittance (of an Electron-Tube Transducer).** The *Short-Circuit Transfer Admittance* from the physically available output terminals to the physically available input terminals of a specified socket, associated filters, and tube. (57 IRE 7.S2)

**Short-Circuit Forward Admittance (of an Electron-Tube Transducer).** The *Short-Circuit Transfer Admittance* from the physically available input terminals to the physically available output terminals of a specified socket, associated filters, and tube. (57 IRE 7.S2)

**Short-Circuit Input Admittance (of an Electron-Tube Transducer).** The *Short-Circuit Driving-Point Admittance* at the physically available input terminals of a specified socket, associated filters, and tube. (57 IRE 7.S2)

**Short-Circuit Input Capacitance (of an  $n$ -Terminal Electron Tube).** The effective capacitance determined from the *Short-Circuit Input Admittance*. (57 IRE 7.S2)

**Short-Circuit Output Admittance (of an Electron-Tube Transducer).** The *Short-Circuit Driving-Point Admittance* at the physically available output terminals of a specified socket, associated filters, and tube. (57 IRE 7.S2)

**Short-Circuit Output Capacitance (of an  $n$ -Terminal Electron Tube).** The effective capacitance determined from the *Short-Circuit Output Admittance*. (57 IRE 7.S2)

**Short-Circuit Transfer Admittance (from the  $j$ th Terminal to the  $l$ th Terminal of an  $n$ -Terminal Network).** The *Transfer Admittance* from terminal  $j$  to terminal  $l$  when all terminals except  $j$  have zero complex alternating components of voltage with respect to the reference point. (57 IRE 7.S2)

**Short-Circuit Transfer Capacitance (Electron Tubes).** The effective capacitance determined from the *Short-Circuit Transfer Admittance*. (57 IRE 7.S2)

**Short-Distance Navigation Aid.** An aid useful primarily at distances within radio line-of-sight. (54 IRE 12.S1)

**Shot Noise, Full.** The fluctuation in the current of charge carriers passing through a surface at statistically independent times.

*Note 1:* Shot noise has a uniform spectral density  $W_i$  given by

$$W_i = \frac{eI_0}{2\pi}$$

where  $e$  is the charge of the carrier, and  $I_0$  is the average current.

*Note 2:* The mean-square noise current  $\bar{i}^2$  of

## Shot Noise, Reduced

*Full Shot Noise* within a frequency increment  $\Delta f$  is

$$\bar{i}^2 = 2eI_0\Delta f.$$

*Note 3:* The mean-square noise current  $\bar{i}^2$  within a frequency increment  $\Delta f$  associated with an average current  $I_0$  is often expressed in terms of *Full Shot Noise* through a *Shot Noise* reduction factor  $\Gamma^2$ , in general a function of frequency, by the formula:

$$\bar{i}^2 = \Gamma^2 2eI_0\Delta f.$$

When  $\Gamma^2 < 1$ ,  $\bar{i}^2$  is called *Reduced Shot Noise*.

(57 IRE 7.S2)

**Shot Noise, Reduced.** See *Shot Noise, Full*. (57 IRE 7.S2)

**Shot Noise Reduction Factor ( $\Gamma^2$ ).** See *Shot Noise, Full (Note 3)*. (57 IRE 7.S2)

**Shunt-Fed Vertical Antenna.** A vertical antenna connected to ground at the base and energized at a point suitably positioned above the grounding point. (48 IRE 2, 11, 15.S1)

**Shunt Tee Junction.** A *Tee Junction* having an equivalent circuit in which the impedance of the branch guide is predominantly in parallel with the impedance of the main guide at the junction. (55 IRE 2.S1)

**Sideband Attenuation.** That form of attenuation in which the transmitted relative amplitude of some component(s) of a modulated signal (excluding the carrier) is smaller than that produced by the modulation process. (48 IRE 2, 11, 15.S1)

**Sidebands.** 1) The frequency bands on both sides of the carrier frequency within which fall the frequencies of the wave produced by the process of modulation. 2) The wave components lying within such bands.

*Note:* In the process of amplitude modulation with a sine-wave carrier, the upper sideband includes the sum (carrier plus modulating) frequencies; the lower sideband includes the difference (carrier minus modulating) frequencies.

(52 IRE 17.S1; 53 IRE 11.S1)

**Side Frequency.** One of the frequencies of a sideband. (53 IRE 11.S1)

**Side Thrust.** In disk recording, the radial component of force on a pickup arm caused by the stylus drag. (51 IRE 6.S1)

**Signal.** 1) The physical embodiment of a *Message*. (58 IRE 11.S1)

2) a) A visual, audible, or other indication used to convey information. b) The intelligence, message, or effect to be conveyed over a communication system. c) A *Signal* wave. (54 IRE 3.S1; 58 IRE 3.S1)

## Significant Digits

**Signal Contrast (in Facsimile).** The ratio expressed in decibels between *White Signal* and *Black Signal*. (56 IRE 9.S1)

**Signal Electrode (of a Camera Tube).** An electrode from which the signal output is obtained. (50 IRE 7.S1)

**Signal Electrode Capacitance.** See *Electrode Capacitance (Note 3)*. (57 IRE 7.S2)

**Signal Frequency Shift.** In a frequency shift *Facsimile System*, the numerical difference between the frequencies corresponding to *White Signal* and *Black Signal* at any point in the system. (56 IRE 9.S1)

**Signal Level.** At any point in a transmission system, the difference of the measure of the *Signal* at the point from the measure of an arbitrarily specified *Signal* chosen as a reference.

*Note:* The measures of the *Signal* are often expressed in decibels, thus their difference is conveniently expressed as a ratio.

(54 IRE 3.S1; 58 IRE 3.S1)

**Signal-to-Noise Ratio.** The ratio of the value of the signal to that of the noise.

*Note 1:* This ratio is usually in terms of peak values in the case of impulse noise and in terms of the root-mean-square values in the case of the random noise.

*Note 2:* Where there is a possibility of ambiguity, suitable definitions of the signal and noise should be associated with the term; as, for example: peak-signal to peak-noise ratio; root-mean-square signal to root-mean-square noise ratio; peak-to-peak signal to peak-to-peak noise ratio, etc.

*Note 3:* This ratio is often expressed in decibels.

*Note 4:* This ratio may be a function of the bandwidth of the transmission system.

(48 IRE 2, 11, 15.S1)

**Signal-to-Noise Ratio (Camera Tubes).** The ratio of peak-to-peak *Signal Output Current* to rms noise in the output current. (57 IRE 7.S2)

**Signal Output Current (Camera Tubes or Phototubes).** The absolute value of the difference between output current and *Dark Current*. (57 IRE 7.S2)

**Signal-Wave Envelope.** The contour of a signal wave which is composed of a series of wave cycles. (42 IRE 9.S1)

**Sign Digit.** A character used to designate the algebraic sign of a number. (56 IRE 8.S1)

**Significant Digits.** The digits of a number can be ordered according to their significance; the significance of a digit is greater when it occupies a column corresponding to a higher power of the radix. The significant digits of a number are a set of digits from consecutive columns beginning with the most signifi-

cant digit different from zero and ending with the least significant digit whose value is known or assumed to be relevant. (50 IRE 8.S1)

**Simple Scanning.** Scanning of only one *Scanning Spot* at a time during the *Scanning* process. (56 IRE 9.S1)

**Simple Sound Source.** A source which radiates sound uniformly in all directions under free-field conditions. (51 IRE 6.S1)

**Simple Target.** In *Radar*, a *Target* having a reflecting surface, such that the amplitude of the reflected signal does not vary with the aspect of the *Target*; e.g., a metal sphere. (54 IRE 12.S1)

**Simple Tone (Pure Tone).** 1) A sound wave, the instantaneous sound pressure of which is a simple sinusoidal function of the time. 2) A sound sensation characterized by its singleness of pitch. (51 IRE 6.S1)

**Simplex Operation of a Radio System.** A method of operation in which communication between two stations takes place in one direction at a time.

*Note:* This includes ordinary transmit-receive operation, press-to-talk operation, voice-operated carrier and other forms of manual or automatic switching from transmit to receive.

(48 IRE 2, 11, 15.S1)

**Simulation.** The representation of physical systems by computers and associated equipment. (50 IRE 8.S1)

**Simultaneous Lobing.** In *Radar*, a *Direction-determining* technique utilizing the received energy to two concurrent and partially-overlapped signal lobes. The relative phase or the relative power of the two signals received from a *Target* is a measure of the angular displacement of the *Target* from the equi-phase or equisignal *Direction*. Compare with *Lobe Switching*. (54 IRE 12.S1)

**Sine Wave.** A wave which can be expressed as the sine of a linear function of time, or space, or both. (48 IRE 2, 11, 15.S1)

**Singing.** An undesired self-sustained oscillation in a system or component.

*Note:* This term implies oscillation at a frequency in or above the pass band of the system or component.

(48 IRE 2, 11, 15.S1; 58 IRE 3.S1)

**Singing Margin.** The difference in *Level*, usually expressed in decibels, between the *Singing Point* and the operating *Gain* of a system or component. (58 IRE 3.S1)

**Singing Point.** 1) In a closed transmission system, that adjustment of gain or phase, or both, at which singing will start. (48 IRE 2, 11, 15.S1)

2) The minimum value of *Gain* of a system

or component that will result in *Singing*. (58 IRE 3.S1)

**Single-Address (Instruction) Code.** An instruction in general consists of a coded representation of the operation to be performed and of one or more addresses of words in storage. The instructions of a single-address code contain only one address. See *Instruction Code*. (50 IRE 8.S1; 56 IRE 8.S1)

**Single-Ended Amplifier.** An amplifier in which each stage normally employs only one tube, or, if more than one tube is used, in which they are connected in parallel so that operation is asymmetric with respect to ground. (48 IRE 2, 11, 15.S1)

**Single-Ended Push-Pull Amplifier Circuit.** An *Amplifier* circuit having two transmission paths designed to operate in a complementary manner and connected so as to provide a single unbalanced output.

*Note:* This circuit provides push-pull operation without the use of a transformer.

(58 IRE 3.S1)

**Single-Polarity Pulse.** See *Unidirectional Pulse*. (52 IRE 20.S1)

**Single Pole-Piece Magnetic Head.** A magnetic head having a single pole piece on one side of the recording medium. (51 IRE 6.S1)

**Single-Sideband Modulation (SS, SSB).** Modulation whereby the spectrum of the modulating wave is translated in frequency by a specified amount either with or without inversion. (53 IRE 11.S1)

**Single-Sideband Transmission.** That method of operation in which one sideband is transmitted and the other sideband is suppressed. The carrier wave may be either transmitted or suppressed. (48 IRE 2, 11, 15.S1)

**Single-Sideband Transmitter.** A transmitter in which one sideband is transmitted and the other is effectively eliminated. (48 IRE 2, 11, 15.S1)

**Single-Tone Keying.** That form of keying in which the modulating wave causes the carrier to be modulated with a single tone for one condition, which may be either "marking" or "spacing," and the carrier is unmodulated for the other condition. (53 IRE 11.S1)

**Single Track (Standard Track).** A variable-density or variable-area sound track in which both positive and negative halves of the signal are linearly recorded. (51 IRE 6.S1)

**Sink (of an Oscillator).** The region of a *Rieke Diagram* where the rate of change of frequency with respect to phase of the reflection coefficient is maximum. Operation in this region may lead to unsatisfactory performance by reason of cessation or instability of oscillations. (56 IRE 7.S1; 57 IRE 7.S2)

**Sinusoidal Electromagnetic Wave.** In a homogeneous medium a wave whose electric field strength is proportional to the sine (or cosine) of an angle that is a linear function of time, or a distance, or of both. (50 IRE 24.S1)

**Site Error.** In *Navigation*, error due to the distortion in the radiated field by objects in the vicinity of the navigational equipment. (54 IRE 12.S1)

**Skew (in Facsimile).** The deviation of the received *Frame* from rectangularity due to asynchronism between *Scanner* and *Recorder*. Skew is expressed numerically as the tangent of the angle of this deviation. (56 IRE 9.S1)

**Skiatron.** 1) A dark trace oscilloscope tube (See *Dark Trace Tube*). 2) A *Display* employing an optical system with a *Dark Trace Tube*. (54 IRE 12.S1)

**Skin Depth.** For a conductor carrying currents at a given frequency as a result of the *Electromagnetic Waves* acting upon its surface, the depth below the surface at which the current density has decreased one neper below the current density at the surface.

*Note:* Usually the skin depth is sufficiently small so that for ordinary configurations of good conductors, the value obtained for a plane wave falling on a plane surface is a good approximation.

(53 IRE 2.S1)

**Sky Error—Deprecated.** See *Ionosphere Error*. (54 IRE 12.S1)

**Sky Wave.** See *Ionospheric Wave*.

**Sky-Wave Accuracy Pattern.** In *Navigation*, the plot of systematic iso-error due to sky wave on a geographic coordinate system. (54 IRE 12.S1)

**Sky-Wave Correction.** In *Navigation*, a correction for sky-wave propagation errors applied to measured *Position* data. The amount of the correction is established on the basis of an assumed *Position* and an assumed ionosphere height. (54 IRE 12.S1)

**Sky-Wave Station-Error.** In sky-wave synchronized *Loran* the error of station synchronization due to the effect of variations of the ionosphere on the time of transmission of the synchronizing signal from one station to the other. (54 IRE 12.S1)

**Slant Distance.** The distance between two points not at the same elevation. Used in contrast to *Ground Distance*. (54 IRE 12.S1)

**Slant Range—Deprecated.** See *Slant Distance*. (54 IRE 12.S1)

**Slave Station.** In *Navigation*, a station in which some characteristic of its emission is controlled by a *Master Station*. (54 IRE 12.S1)

**Slave Sweep.** A time base which is synchronized or triggered by a waveform from a source external to the time base. Used in navigational systems for displaying or utilizing the same information at different locations, or in displaying or utilizing different information with a common or related time base. (54 IRE 12.S1)

**Sleeve-Dipole Antenna.** A dipole antenna surrounded in its central portion by a coaxial sleeve. (48 IRE 2, 11, 15.S1)

**Sleeve Stub.** An antenna consisting of half of a sleeve-dipole antenna projecting from an extended metal surface. (48 IRE 2, 11, 15.S1)

**Slope (Navigation).** See *Glide Slope*. (54 IRE 12.S1)

**Slope Angle.** The angle in the vertical plane between the *Flight Path* and the horizontal. (54 IRE 12.S1)

**Slope Deviation.** The difference between the projection in the vertical plane of the actual path of movement of a vehicle and the planned slope for the vehicle expressed in terms of either angular or linear measurement. (49 IRE 12.S1)

**Slot Antenna.** A radiating element formed by a slot in a metal surface. (48 IRE 2, 11, 15.S1)

**Slug Tuner.** A *Waveguide Tuner* containing one or more longitudinally adjustable pieces of metal or dielectric. (55 IRE 2.S1)

**Slug Tuning.** A means for varying the frequency of a resonant circuit by introducing a slug of material into either the electric or magnetic fields or both. (48 IRE 2, 11, 15.S1)

**Small-Signal Forward Transadmittance.** The value of the *Forward Transadmittance* obtained when the input voltage is small compared to the beam voltage. (56 IRE 7.S1; 57 IRE 7.S2)

**Soft Spot—Deprecated.** See *Low Clearance Point*. (54 IRE 12.S1)

**Sonar.** A general name for sonic and ultrasonic underwater ranging, sounding and communication systems. (54 IRE 12.S1)

**Sone.** A unit of loudness. By definition, a simple tone of frequency 1000 cps, 40 db above a listener's threshold, produces a loudness of 1 sone. The loudness of any sound that is judged by the listener to be  $n$  times that of the 1-sone tone is  $n$  sones.

*Note 1:* A millisonne is equal to 0.001 sone.

*Note 2:* The loudness scale is a relation between loudness and level above threshold [See *Level Above Threshold (Sensation Level)*] for a particular listener. In presenting data relating loudness in sones to sound pressure level, or in averaging the loudness scales of several listeners, the thresholds (measured or assumed) should be specified.



*Note 3:* The term "loudness unit" has been used for the basic subdivision of a loudness scale based on group judgment on which a loudness level of 40 phons has a loudness of approximately 1000 loudness units. For example, see Fig. 1 of "American Standard for Noise Measurement, Z24.2—1942."

(51 IRE 6.S1)

**Sonne.** A *Radio Navigation* aid that provides a number of characteristic signal zones which rotate in a time sequence. A *Bearing* may be determined by observation (by interpolation) of the instant at which transition occurs from one zone to the following zone. (Also called *Consol.*) Compare with *Electra*. (54 IRE 12.S1)

**Sonne. 1)** An alteration in pressure, stress, particle displacement, particle velocity, and so forth, which is propagated in an elastic material, or the superposition of such propagated alterations. 2) Also, auditory sensation which is usually evoked by the alterations described above.

*Note:* In case of possible confusion, the terms "sound wave" or "elastic wave" may be used for concept 1), and the term "sound sensation" for concept 2).

(51 IRE 6.S1)

**Sound Absorption.** The process by which sound energy is diminished in passing through a medium or in striking a surface. (51 IRE 6.S1)

**Sound Absorption Coefficient (Acoustical Absorptivity).** The fraction of incident sound energy absorbed by the surface or medium.

*Note 1:* The surface is considered part of an infinite area.

*Note 2:* The value of the coefficient is a function of the angle of incidence of the sound.

(51 IRE 6.S1)

**Sound Analyzer.** A device for measuring the band pressure level or pressure spectrum level of a sound as a function of frequency. (51 IRE 6.S1)

**Sound Articulation (Per Cent Sound Articulation).<sup>1</sup>** The per cent articulation obtained when the speech units considered are fundamental sounds (usually combined into meaningless syllables). (51 IRE 6.S1)

**Sound Effects Filter.** See *Filter, Sound Effects*. (58 IRE 3.S1)

**Sound Energy.** Of a given part of a medium, the total energy in this part of the medium minus the energy which would exist in the same part of the medium with no sound waves present. (51 IRE 6.S1)

<sup>1</sup> See notes under *Articulation (Per Cent Articulation)* and *Intelligibility (Per Cent Intelligibility)*.

**Sound-Energy Density.** At a point, in a sound field, the sound energy contained in a given infinitesimal part of the medium divided by the volume of that part of the medium. The commonly used unit is the erg per cubic centimeter.

*Note 1:* The terms "instantaneous energy density," "maximum energy density," and "peak energy density" have meanings analogous to the related terms used for sound pressure.

*Note 2:* In speaking of average energy density in general, it is necessary to distinguish between the space average (at a given instant) and the time average (at a given point).

(51 IRE 6.S1)

**Sound Energy Flux.** The average rate of flow of sound energy for one period through any specified area. The commonly used unit is the erg per second. Expressed mathematically, the sound-energy flux  $J$  is

$$J = \frac{1}{T} \int_0^T p S v_a dt$$

where

$T$  = an integral number of periods or a time long compared to a period,

$p$  = the instantaneous sound pressure over the area  $S$ ,

$v_a$  = the component of the instantaneous particle velocity in the direction  $a$ , normal to the area  $S$ .

*Note:* In a medium of density,  $\rho$ , for a plane or spherical free wave having a velocity of propagation  $c$ , the sound-energy flux through the area  $S$ , corresponding to an effective sound pressure  $p$ , is

$$J = \frac{p^2 S}{\rho c} \cos \theta$$

where

$\theta$  = the angle between the direction of propagation of the sound and the normal to the area  $S$ .

(51 IRE 6.S1)

**Sound Field.** A region containing sound waves. (51 IRE 6.S1)

**Sound Intensity<sup>1</sup> (Specific Sound-Energy Flux) (Sound-Energy Flux Density).** In a specified direction at a point, the average rate of sound energy transmitted in the specified direction through a unit area normal to this direction at the point considered. The commonly used unit is the erg per second per

<sup>1</sup> See note under *Intensity Level*.

## Sound Level

square centimeter, but sound intensity may also be expressed in watts per square centimeter.

*Note 1:* The sound intensity in any specified direction  $a$  of a sound field is the sound-energy flux through a unit area normal to that direction. This is given by the expression

$$I_a = \frac{1}{T} \int_0^T p v_a dt$$

where

$T$  = an integral number of periods or a time long compared to a period,  
 $p$  = the instantaneous sound pressure,  
 $v_a$  = the component of the instantaneous particle velocity in the direction  $a$ .

*Note 2:* In the case of a free plane or spherical wave having the effective sound pressure  $p$ , the velocity of propagation  $c$ , in a medium of density  $\rho$ , the intensity in the direction of propagation is given by

$$I = \frac{p^2}{\rho c}$$

(51 IRE 6.S1)

**Sound Level.** At a point in a sound field, the weighted sound pressure level determined in the manner specified in the latest edition of "American Standard Sound Level Meters for Measurement of Noise and Other Sounds."

*Note 1:* The current edition of this standard is Z24.3—1944.

*Note 2:* The meter reading (in decibels) corresponds to a value of the sound pressure integrated over the audible frequency range with a specified frequency weighting and integration time.

See also *Sound Level Meter*.

(51 IRE 6.S1)

**Sound Level Meter.** An instrument including a microphone, an amplifier, an output meter, and frequency weighting networks for the measurement of noise and sound levels in a specified manner; the measurements are intended to approximate the loudness level which would be obtained by the more elaborate ear balance method.

*Note:* Specifications for sound-level meters for measurement of noise and other sounds are given in "American Standard Sound Level Meters for Measurement of Noise and Other Sounds, Z24.3—1944."

(51 IRE 6.S1)

**Sound Power of a Source.** The total sound energy radiated by the source per unit of time. The commonly used unit is the erg per

## Sound Transmission Coefficient

second but the power may also be expressed in watts. (51 IRE 6.S1)

**Sound Pressure Level.**<sup>1</sup> In decibels, of a sound, 20 times the logarithm to the base 10 of the ratio of the pressure of this sound to the reference pressure. The reference pressure shall be explicitly stated.

*Note 1:* The following reference pressures are in common use:

a)  $2 \times 10^{-4}$  microbar

b) 1 microbar.

Reference pressure a) has been in general use for measurements dealing with hearing and sound level measurements in air and liquids, while b) has gained widespread use for calibrations and many types of sound level measurements in liquids.

*Note 2:* It is to be noted that in many sound fields the sound pressure ratios are not proportional to the square root of corresponding power ratios and hence cannot be expressed in decibels in the strict sense; however, it is common practice to extend the use of the decibel to these cases.

(51 IRE 6.S1)

**Sound Probe.** A device for exploring a sound field without significantly disturbing the field in the region being explored.

*Note:* A sound probe may take the form of a small microphone or a small tubular attachment added to a conventional microphone.

(51 IRE 6.S1)

**Sound Recording System.** A combination of transducing devices and associated equipment suitable for storing sound in a form capable of subsequent reproduction. (51 IRE 6.S1)

**Sound Reflection Coefficient (Acoustical Reflectivity).** The sound reflection coefficient of a surface not a generator is the ratio of the rate of flow of sound energy reflected from the surface, on the side of incidence, to the incident rate of flow. Unless otherwise specified, all possible directions of incident flow are assumed to be equally probable. Also, unless otherwise stated, the values given apply to a portion of an infinite surface, thus eliminating edge effects. (51 IRE 6.S1)

**Sound Reproducing System.** A combination of transducing devices and associated equipment for reproducing recorded sound. (51 IRE 6.S1)

**Sound Track.** A narrow band, usually along the margin of a sound film, which carries the sound record. In some cases, a plurality of such bands may be used. (51 IRE 6.S1)

**Sound Transmission Coefficient (Acoustical Transmittivity).** Of an interface or

<sup>1</sup> See note under *Intensity Level*.

septum, the ratio of the transmitted to incident sound energy. The value of the coefficient is a function of the angle of incidence of the sound. (51 IRE 6.S1)

**Source.** The device which supplies *Signal* power to a *Transducer*. (54 IRE 3.S1; 58 IRE 3.S1)

**Source Impedance.** See *Impedance, Source*. (58 IRE 3.S1)

**Space Charge.** The net electric charge within a given volume. (57 IRE 7.S2)

**Space-Charge Debunching.** Any process in which the mutual interactions between electrons in the stream disperse the electrons of a bunch. (56 IRE 7.S1; 57 IRE 7.S2)

**Space-Charge Density.** The net electric charge per unit volume. (57 IRE 7.S2)

**Space-Charge Grid.** A *Grid*, usually positive, that controls the position, area, and magnitude of a potential minimum or of a *Virtual Cathode* in a region adjacent to the *Grid*. (57 IRE 7.S2)

**Space-Charge-Limited Current (Vacuum Tubes).** The current passing through an interelectrode space when a *Virtual Cathode* exists therein. (57 IRE 7.S2)

**Space Charge Region (Pertaining to Semiconductor).** A region in which the net charge density is significantly different from zero. See also *Depletion Layer*. (54 IRE 7.S2)

**Space Pattern.** A geometrical pattern appearing on a test chart designed for the measurement of geometric distortion.

*Note:* The RETMA Ball Chart is a specific example of a *Space Pattern*.

(55 IRE 23.S1)

**Spacing Wave (Back Wave).** In telegraphic communication, the emission which takes place between the active portions of the code characters or while no code characters are being transmitted. (48 IRE 2, 11, 15.S1)

**Spark-Gap Modulation.** A modulation process which produces one or more pulses or energy by means of a controlled spark-gap breakdown for application to the element in which modulation takes place. (48 IRE 2, 11, 15.S1)

**Spark Transmitter.** A radio transmitter which utilizes the oscillatory discharge of a capacitor through an inductor and a spark gap as the source of its radio-frequency power. (48 IRE 2, 11, 15.S1)

**Speaker.** See *Loudspeaker*. (52 IRE 17.S1)

**Specific Acoustic Impedance<sup>1</sup> (Unit Area Acoustic Impedance).** At a point in the medium, the complex ratio of sound pressure to particle velocity. (51 IRE 6.S1)

**Specific Acoustic Reactance.<sup>1</sup>** The imaginary

component of the specific acoustic impedance. (54 IRE 6.S1)

**Specific Acoustic Resistance.<sup>1</sup>** The real component of the specific acoustic impedance. (51 IRE 6.S1)

**Specific Repetition Rate.** In *Loran*, one of a set of closely spaced *Repetition Rates* derived from the basic rate and associated with a specific set of synchronized stations. (54 IRE 12.S1)

**Spectral Characteristic.** The set of spectral responses of the color separation channels with respect to wavelength.

*Note 1:* The channel terminals at which the characteristics apply must be specified and an appropriate modifier may be added to the term, such as pickup spectral characteristic or studio spectral characteristic.

*Note 2:* Because of nonlinearity, some *Spectral Characteristics* depend upon the magnitude of *Radiance* used in the measurement.

*Note 3:* Nonlinearizing and matrixing operations may be performed within the channels.

(55 IRE 22.S1)

**Spectral Characteristic (of a Luminescent Screen).** The relation between wavelength and emitted radiant power per unit wavelength interval.

*Note:* The radiant power is commonly expressed in arbitrary units.

(57 IRE 7.S2)

**Spectral Sensitivity Characteristic (Camera Tubes or Phototubes).** The relation between the *Radiant Sensitivity* and the wavelength of the incident *Radiation*, under specified conditions of irradiation.

*Note:* *Spectral Sensitivity Characteristic* is usually measured with a collimated beam at normal incidence.

(57 IRE 7.S2)

**Spectrum Locus.** The locus of points representing the *Chromaticities* of spectrally pure stimuli in a *Chromaticity Diagram*. (55 IRE 22.S1)

**Spherical-Earth Factor.** The ratio of the electric field strength that would result from propagation over an imperfectly conducting spherical earth to that which would result from propagation over a perfectly conducting plane. (50 IRE 24.S1)

**Spherical Hyperbola.** The locus of the points on the surface of a sphere having a specified constant difference in great circle distances from two fixed points on the sphere. (54 IRE 12.S1)

**Spherical Wave.** A wave whose equiphase surfaces form a family of concentric spheres. (50 IRE 24.S1)

<sup>1</sup> See Note 2 under *Acoustic Impedance*.

## Spike Leakage Energy

**Spike Leakage Energy (TR and Pre-TR Tubes).** The radio-frequency energy per pulse transmitted through the tube before and during the establishment of the steady-state radio-frequency discharge. (57 IRE 7.S2)

**Spill (Charge-Storage Tubes).** The loss of information from a *Storage Element* by *Redistribution*. (57 IRE 7.S2)

**Spinner.** Rotating part of a *Radar* antenna used to impart any subsidiary motion in addition to the primary slewing of the beam. (54 IRE 12.S1)

**Spiral Scanning.** Scanning in which the direction of maximum radiation describes a portion of a spiral. The rotation is always in one direction. (48 IRE 2, 11, 15.S1)

**Split-Anode Magnetron.** A *Magnetron* with an *Anode* divided into two segments, usually by slots parallel to its axis. (57 IRE 7.S2)

**Split Hydrophone.** A directional hydrophone in which electroacoustic transducing elements are so divided and arranged that each division may induce a separate electromotive force between its own electric terminals. (51 IRE 6.S1)

**Split Projector.** A directional projector in which electroacoustic transducing elements are so divided and arranged that each division may be energized separately through its own electric terminals. (51 IRE 6.S1)

**Spot.** The area instantaneously affected by the impact of an electron beam. See also *Ion Spot (on a Cathode-Ray-Tube Screen)*. (50 IRE 7.S1)

**Spot Projection.** The optical method of *Scanning* or *Recording* in which the *Scanning* or *Recording* spot is defined in the path of the reflected or transmitted light. (56 IRE 9.S1)

**Spot Speed.** The speed of the *Scanning* or *Recording* spot within the *Available Line*.

*Note:* This is generally measured on the *Subject Copy* or on the *Record Sheet*.

(56 IRE 9.S1)

**Spurious Pulse Mode.** An unwanted *Pulse Mode*, formed by the chance combination of two or more *Pulse Modes*, which is indistinguishable from a *Pulse Interrogation* or *Pulse Reply*. (52 IRE 20.S1)

**Spurious Radiation.** Any emission from a radio transmitter at frequencies outside of its communication band. (48 IRE 2, 11, 15.S1)

**Spurious Response Ratio.** The ratio of 1) the field strength at the frequency which produces the spurious response to 2) the field strength at the desired frequency, each field being applied in turn, under specified conditions, to produce equal outputs.

*Note:* *Image Ratio* and *Intermediate Fre-*

## Square-Wave Response

*quency Response Ratio* are special forms of *Spurious Response Ratio*.

(52 IRE 17.S1)

**Spurious Tube Counts (Radiation-Counter Tubes).** *Counts*, other than *Background Counts* and those caused directly by the *Radiation* to be measured.

*Note:* *Spurious Counts* are caused by failure of the *Quenching* process, electrical leakage, and the like. *Spurious Counts* may seriously affect measurement of *Background Counts*.

(57 IRE 7.S2)

**Sputtering (Cathode Sputtering).** A process sometimes used in the production of the metal master wherein the original is coated with an electric conducting layer by means of an electric discharge in a vacuum.

*Note:* This is done prior to electroplating a heavier deposit.

(51 IRE 6.S1)

**Squareness Ratio.** 1)  $B_r/B_m$ . For a material in a *Symmetrically Cyclically Magnetized Condition*, the ratio of the flux density at zero magnetizing force to the maximum flux density. 2)  $R$ . For a material in a *Symmetrically Cyclically Magnetized Condition*, the ratio of the flux density when the magnetizing force has changed half way from zero toward its negative limiting value, to the maximum flux density.

*Note:* Both of these ratios are functions of the maximum magnetizing force.

(59 IRE 8.S1)

**Square Wave.** A wave which alternately assumes two fixed values for equal lengths of time, the time of transition being negligible in comparison with the duration of each fixed value. (52 IRE 17.S1)

**Square-Wave Response (Camera Tubes).** The ratio of 1) the peak-to-peak signal amplitude given by a test pattern consisting of alternate black and white bars of equal widths to 2) the difference in signal between large-area blacks and large-area whites having the same illuminations as the black and white bars in the test pattern.

*Note:* *Horizontal Square-Wave Response* is measured if the bars run perpendicular to the direction of horizontal scan. *Vertical Square-Wave Response* is measured if the bars run parallel to the direction of horizontal scan.

(57 IRE 7.S2)

**Square-Wave Response Characteristic (Camera Tubes).** The relation between *Square-Wave Response* and the ratio of 1) a *Raster* dimension to 2) the bar width in the *Square-Wave Response* test pattern.

*Note:* Unless otherwise specified, the *Raster*

## Squeezable Waveguide

dimension is the vertical height.  
(57 IRE 7.S2)

**Squeezable Waveguide.** In *Radar*, a variable width uniconductor waveguide for shifting the phase of the radio-frequency wave traveling through it. (54 IRE 12.S1)

**Squeeze Track.** A variable density sound track wherein, by means of adjustable masking of the recording light beam and simultaneous increase of the electric signal applied to the light modulator, a track having variable width with greater signal-to-noise ratio is obtained. (51 IRE 6.S1)

**Squelch.** To automatically quiet a receiver by reducing its gain in response to a specified characteristic of the input. (52 IRE 17.S1)

**Squint.** In *Radar*, an ambiguous term, meaning either: 1) the angle between the two major lobe axes in a lobe switching antenna, or 2) the angular difference between the axis of antenna radiation and a selected geometric axis, such as the axis of the reflector. (54 IRE 12.S1)

**Squitter.** Random firing, intentional or otherwise, of the *Transponder* transmitter in the absence of *Interrogation*. (54 IRE 12.S1)

**SRE (Surveillance Radar Element).** The *Radar* of the *GCA* system used to direct traffic to a region where it may be observed by the *PAR Radar*. (54 IRE 12.S1)

**Stabilization.** In *Navigation*, maintenance of a desired orientation independent of the motion of the *Vehicle*. (54 IRE 12.S1)

**Stabilized Feedback.** Feedback employed in such a manner as to stabilize the gain of a transmission system or section thereof with respect to time or frequency or to reduce noise or distortion arising therein.

*Note:* The section of the transmission system may include amplifiers only, or it may include modulators.

(48 IRE 2, 11, 15.S1)

**Stabilized Flight.** That type of flight which obtains control information from inertia-stabilized references such as gyroscopes.

*Example:* Flight in which the lateral, longitudinal, and vertical attitudes of an aircraft are maintained constant by a conventional *Automatic Pilot*.

(54 IRE 12.S1)

**Stable Element.** In *Navigation*, an instrument or device which maintains a desired orientation independently of the motion of the *Vehicle*. (54 IRE 12.S1)

**Stage Efficiency.** The ratio of useful power delivered to the load (alternating current) and the plate power input (direct current). (48 IRE 2, 11, 15.S1)

**Stagger.** Periodic error in the position of the

## Standard Refraction

*Recorded Spot* along the recorded line. (56 IRE 9.S1)

**Stalo.** In *Radar MTI*, a highly stable local RF oscillator used for heterodyning signals to produce an intermediate frequency. (54 IRE 12.S1)

**Stamper.** A negative (generally made of metal by electroforming) from which finished pressings are molded. (51 IRE 6.S1)

**Standard Microphone.** A microphone the response of which is accurately known for the condition under which it is to be used. (51 IRE 6.S1)

**Standard Multiples.** The *Standard Multiples* of measurement shall be  $1 \times 10^n$  and  $3 \times 10^n$  for all pertinent (*i.e.*, positive, negative and zero) integral values of *n*. (59 IRE 12.S1)

**Standard Observer.** A hypothetical observer who requires standard amounts of *Primaries* in a *Color Mixture* to match every *Color*.

*Note:* Standard amounts of a particular set of primaries used by this observer can be computed, by established methods, from standard amounts of the standard (and usually nonphysical) primaries. The present standard primaries and standard amounts of them required to match various wavelengths of the spectrum were established in 1931 by the International Commission on Illumination.

(55 IRE 22.S1)

**Standard Output Levels (Audio).** The *Standard Output Levels*, into a *Standard Output Load*, shall be 0.006, 0.050 or 0.3 watt, depending upon the output capabilities of the equipment. (59 IRE 12.S1)

**Standard Output Load (Audio).** The *Standard Output Load (Audio)* shall be resistive and shall be of a value equal to the load into which the audio channel of the receiver is designed or specified to operate. (59 IRE 12.S1)

**Standard Pitch.** The standard pitch is based on the tone "A" of 440 cycles per second.

*Note 1:* With this standard the frequency of Middle C is 261.6 cycles per second (see Table VI, p. 140).

*Note 2:* Musical instruments are to be capable of complying with this standard when played where the ambient temperature is 22°C (72°F).

(51 IRE 6.S1)

**Standard Propagation.** The propagation of radio waves over a smooth spherical earth of uniform dielectric constant and conductivity, under conditions of standard refraction in the atmosphere. (50 IRE 24.S1)

**Standard Refraction.** The refraction which would occur in an idealized atmosphere in which the index of refraction decreases uni-

TABLE VI

FREQUENCIES OF THE TONES OF THE USUAL EQUALLY TEMPERED SCALE, ARRANGED BY CORRESPONDING PIANO KEY NUMBERS, AND BASED ON THE A OF 440 CYCLES PER SECOND

Note Name	Key No.	Freq. cps	Key No.	Freq. cps	Key No.	Freq. cps	Key No.	Freq. cps	Key No.	Freq. cps	Key No.	Freq. cps	Key No.	Freq. cps	Note Name
A	1	27.500	13	55.000	25	110.000	37	220.000	49	440.000	61	880.000	73	1760.000	A
A#-Bb	2	29.135	14	58.270	26	116.541	38	233.072	50	466.164	62	932.328	74	1864.665	A#-Bb
B	3	30.868	15	61.735	27	123.471	39	246.942	51	493.883	63	987.767	75	1975.533	B
C	4	32.703	16	65.406	28	130.813	40	261.626	52	523.251	64	1046.502	76	2093.005	C
C#-Db	5	34.648	17	69.296	29	138.591	41	277.183	53	554.365	65	1108.731	77	2217.461	C#-Db
D	6	36.708	18	73.416	30	146.832	42	293.665	54	587.330	66	1174.659	78	2349.318	D
D#-Eb	7	38.801	19	77.782	31	155.563	43	311.127	55	622.254	67	1244.508	79	2489.016	D#-Eb
E	8	41.203	20	82.407	32	164.814	44	329.628	56	659.255	68	1318.510	80	2637.021	E
F	9	43.654	21	87.307	33	174.614	45	349.228	57	698.456	69	1396.913	81	2793.826	F
F#-Gb	10	46.249	22	92.409	34	184.997	46	369.994	58	739.989	70	1479.978	82	2959.955	F#-Gb
G	11	48.999	23	97.999	35	195.998	47	391.995	59	783.991	71	1567.982	83	3135.964	G
G#-Ab	12	51.913	24	103.826	36	207.652	48	415.305	60	830.609	72	1661.219	84	3322.438	G#-Ab

formly with height at the rate of  $39 \times 10^{-6}$  per kilometer.

Note: Standard Refraction may be included in ground wave calculations by use of an effective earth radius of  $8.5 \times 10^6$  meters, or 4/3 the geometrical radius of the earth. (50 IRE 24.S1)

Standard Sea Water Conditions. Those of sea water at a static pressure of 1 atmosphere, a temperature of 15°C, and a salinity such that the velocity of propagation is exactly 1500 meters per second.

Note: Under these conditions, the following other properties are derived from experimental data:

Salinity<sup>1</sup> S = 31.60 parts per thousand, Density<sup>2</sup> ρ = 1.02338 grams per cubic centimeter,

Characteristic acoustic impedance, ρc =  $1.53507 \times 10^7$  cgs units,

Pressure spectrum level of thermal noise<sup>3</sup>

$10 \log_{10} (kT\rho c) = 82.17$  db below 1 microbar.

This Standard is adopted for the purpose of establishing consistent relationships between acoustical quantities which involve the properties of the sound medium. It is not intended for calibration of echo range or depth scales.

The standard values have been chosen to represent closely the average conditions on continental shelves except in tropical waters. The values likely to be encountered under actual conditions will usually lie between the limits given in Table VII, p. 141.

Hydrostatic pressure increases the velocity by 0.018 meter per second per meter of depth. It also increases the density by approximately 0.000045 gram per cm<sup>3</sup> per meter of depth.

(51 IRE 6.S1)

Standard Test Frequencies. The Standard Test Frequencies shall be the midfrequency and nominal limits of each tuning band of the DF receiver. Where the band-tuning ratio is less than one and one-half to one, two frequencies, approximately 10 per cent inside the nominal limits of the band coverage, will suffice. (59 IRE 12.S1)

Standard Volume Indicator. A device for the indication of Volume having the characteristics prescribed in ASA-C16.5. (54 IRE 3.S1; 58 IRE 3.S1)

<sup>1</sup> S. Kuwahara, "Velocity of sound in sea-water and calculation of the velocity for use in sonic sounding," *Hydrographic Review*, vol. 16, pp. 123-140; 1939.

<sup>2</sup> M. Knudsen, "Hydrographical Tables," Copenhagen, Denmark; 1901, 1931.

<sup>3</sup> Smithsonian Physical Tables," 8th ed.; 1934.

## Standard Wave Error

**Standard Wave Error.** The DF bearing error produced by a wave incident at 45°, having equal vertically- and horizontally-polarized electric fields, the relative phases of the two components being such as to produce the maximum DF bearing error. (59 IRE 12.S1)

**Standing On-Nines Carry.** See *Carry*. (56 IRE 8.S1)

**Standing Wave.** A wave in which, for any component of the field, the ratio of its instantaneous value at one point to that at any other point does not vary with time. (50 IRE 24.S1; 53 IRE 2.S1)

**Standing Wave Loss Factor.** The ratio of the *Transmission Loss* in an unmatched *Waveguide* to that in the same *Waveguide* when matched. (53 IRE 2.S1)

**Standing Wave Ratio.** At a given frequency in a *Uniform Waveguide*, the ratio of the maximum to the minimum amplitudes of corresponding components of the field (or the voltage or current) along the *Waveguide* in the *Direction of Propagation*.

*Note:* Alternatively, the *Standing Wave Ratio* may be expressed as the reciprocal of the ratio defined above.

(53 IRE 2.S1)

**Star Chain.** A radio *Navigation* transmitting system comprising a *Master Station* about which three (or more) slave stations are symmetrically located. (54 IRE 12.S1)

**Star Network.** A set of three or more branches with one terminal of each connected at a common node. (50 IRE 4.S1)

**Starter (Gas Tubes).** A *Control Electrode*, the principal function of which is to establish sufficient ionization to reduce the *Anode Breakdown Voltage*.

*Note:* This has sometimes been referred to as a "trigger *Electrode*."

(57 IRE 7.S2)

**Starter Breakdown Voltage (Gas Tubes).** See *Breakdown Voltage (of an Electrode of*

## Steady-State Oscillation

*a Gas Tube*). (57 IRE 7.S2)

**Starter Gap (Gas Tubes).** The conduction path between a *Starter* and the other *Electrode* to which starting voltage is applied. (57 IRE 7.S2)

**Starter Voltage Drop (Gas Tubes).** The *Starter* voltage during conduction to the *Starter*. (57 IRE 7.S2)

**Starting Current of an Oscillator.** The value of electron-stream current through an oscillator at which self-sustaining oscillations will start under specified conditions of loading. (56 IRE 7.S1; 57 IRE 7.S2)

**Start Record Signal.** A signal used for starting the process of converting the electrical signal to an image on the *Record Sheet*. (56 IRE 9.S1)

**Start Signal.** A signal which initiates the transfer of a *Facsimile* equipment condition from standby to active. (56 IRE 9.S1)

**Static Characteristic (Electron Tubes).** A relation between a pair of variables such as *Electrode Voltage and Electrode Current*, with all other voltages maintained constant. (57 IRE 7.S2)

**Staticizer.** A storage device for converting time sequential information into static parallel information. (56 IRE 8.S1)

**Static Pressure (Hydrostatic Pressure).** At a point in a medium, the pressure that would exist at that point with no sound waves present. In acoustics, the commonly used unit is the microbar. (51 IRE 6.S1)

**Static Register.** A register which retains information in static form. (50 IRE 8.S1)

**STC.** See *Sensitivity Time Control*. (54 IRE 12.S1)

**Steady-State Oscillation (Steady-State Vibration).** Steady-state oscillation exists in a system if the motion at each point is a periodic quantity.

*Note:* This is frequently a special case of forced oscillation.

(51 IRE 6.S1)

TABLE VII

REPRESENTATIVE WATER CONDITIONS

Salinity (parts per 1000)	Fresh Water		Sea Water			
	0		30		36	
Temperature (degrees Centigrade)	4	25	5	20	15	25
Velocity (meters per second)	1418.3	1493.2	1461.0	1513.2	1505.0	1523.8
Density (grams per cm <sup>3</sup> )	1.00000	0.99707	1.02375	1.02099	1.02677	1.02412
Characteristic Impedance ×10 <sup>-6</sup> (cgs units)	1.4183	1.4888	1.4957	1.5450	1.5453	1.5698

**Steerable Antenna.** A directional antenna whose major lobe can be readily shifted in direction. (48 IRE 2, 11, 15.S1)

**Stereophonic Sound System.** A sound system in which a plurality of microphones, transmission channels, and loudspeakers is arranged so as to provide a sensation of spatial distribution of the sound sources to the listener to the reproduction. (51 IRE 6.S1)

**Sticking Picture.** See *Retained Image*. (57 IRE 7.S2)

**Stirring Effect.** The circulation in a molten *Charge* due to the combined forces of *Motor* and *Pinch Effects*. (55 IRE 10.S1)

**Stop Record Signal.** A signal used for stopping the process of converting the electrical signal to an image on the *Record Sheet*. (56 IRE 9.S1)

**Stop Signal.** A signal which initiates the transfer of a *Facsimile* equipment condition from active to standby. (56 IRE 9.S1)

**Storage.** 1) The act of storing information. (See also *Store*.) 2) Any device in which information can be stored, sometimes called a **Memory** device. 3) In a computer, a section used primarily for storing information. Such a section is sometimes called a **Memory** or a *Store* (British).

*Note:* The physical means of storing information may be electrostatic, ferroelectric, magnetic, acoustic, optical, chemical, electronic, electrical, mechanical, etc., in nature.

(56 IRE 8.S1)

**Storage Capacity.** The amount of information that can be retained in a storage (or memory) device, often expressed as the number of *Words* that can be retained (given the number of digits, and the base, of the standard word).

When comparisons are made among devices using different bases and word lengths, it is customary to express the capacity in *Bits*. This number is obtained by taking the logarithm to the base 2 of the number of distinguishable states in which the storage can exist.

*Note:* The "storage (or memory) capacity of a computer" usually refers only to the principal internal storage section.

(56 IRE 8.S1)

**Storage Element (Charge-Storage Tubes).** An area of a storage surface which retains information distinguishable from that of adjacent areas.

*Note:* The *Storage Element* may be a discrete area or an arbitrary portion of a continuous storage surface.

(57 IRE 7.S2)

**Storage Time—Deprecated.** See *Decay*

*Time; Retention Time, Maximum.* (57 IRE 7.S2)

**Storage Tube.** An *Electron Tube* into which information can be introduced and then extracted at a later time. See *Electrostatic Memory Tube*. (50 IRE 8.S1; 57 IRE 7.S2)

**Store.** 1) To retain information in a device from which it can later be withdrawn. 2) To introduce information into such a device. 3) British synonym for *Storage*. (56 IRE 8.S1)

**Streaming.** The production of unidirectional flow currents in a medium, arising from the presence of sound waves. (51 IRE 6.S1)

**Strength of a Sound Source (Strength of a Simple Source).** The maximum instantaneous rate of volume displacement produced by the source when emitting a wave with sinusoidal time variation. (51 IRE 6.S1)

**Striation Technique.** A method for rendering sound waves visible by using their individual ability to refract light waves. (51 IRE 6.S1)

**Stroke Speed (Scanning or Recording Line Frequency).** The number of times per minute, unless otherwise stated, that a fixed line perpendicular to the direction of *Scanning* is crossed in one direction by a *Scanning* or *Recording Spot*.

*Note:* In most conventional mechanical systems this is equivalent to *Drum Speed*. In systems in which the *Picture Signal* is used while *Scanning* in both directions, the *Stroke Speed* is twice the above figure. (56 IRE 9.S1)

**Structurally Dual Networks.** A pair of networks such that their branches can be marked in one-to-one correspondence so that any mesh of one corresponds to a cut-set of the other. Each network of such a pair is said to be the dual of the other (see figure on p. 143). (50 IRE 4.S1)

**Structurally Symmetrical Network.** A network which can be arranged so that a cut through the network produces two parts that are mirror images of each other. (50 IRE 4.S1)

**Stub, Waveguide.** An auxiliary section of waveguide with an essentially nondissipative termination and joined at some angle with the main section of waveguide. (55 IRE 2.S1)

**Stylus Drag (Needle Drag).** An expression used to denote the force resulting from friction between the surface of the recording medium and the reproducing stylus. (51 IRE 6.S1)

**Stylus Force.** The vertical force exerted on a stationary recording medium by the stylus when in its operating position. (51 IRE 6.S1)

**Subcarrier.** A carrier which is applied as a



modulating wave to modulate another carrier. (53 IRE 11.S1; 56 IRE 9.S1)

**Subharmonic.** A sinusoidal quantity having a frequency which is an integral submultiple of the frequency of some other sinusoidal quantity to which it is referred. For example, a wave, the frequency of which is half the fundamental frequency of another wave, is called the second subharmonic of that wave. (48 IRE 2, 11, 15.S1)

**Subject Copy.** The material in graphic form which is to be transmitted for *Facsimile* reproduction. (56 IRE 9.S1)

**Submerged Resistor Induction Furnace.** A device for melting metal comprising a melting hearth, a depending *Melting Channel* closed through the hearth, a primary induction winding and a magnetic core which links the *Melting Channel* and the primary winding. (55 IRE 10.S1)

**Subprogram.** Part of a *Program*. (50 IRE 8.S1)

**Subroutine.** 1) In a *Routine*, a portion that causes a computer to carry out a well-defined mathematical or logical operation. 2) A routine which is arranged so that control may be transferred to it from a *Master Routine* and so that, at the conclusion of the subroutine, control reverts to the master routine. Such a subroutine is usually called a closed subroutine. A single routine may simultaneously be both a subroutine with respect to another routine and a master routine with respect to a third. Usually control is transferred to a single subroutine from more than one place in the master routine and the reason for using the subroutine is to avoid having to repeat the same sequence of instructions in different places in the master routine. (56 IRE 8.S1)

**Summing Point.** A mixing point whose output is obtained by addition, with prescribed signs, of its inputs. (55 IRE 26.S2)

**Supersonics.** The general subject covering phenomena associated with speed higher than the speed of sound (as in case of aircraft and projectiles traveling faster than sound).

*Note:* This term has been used in acoustics synonymously with "ultrasonics." Such usage is now deprecated.

(51 IRE 6.S1)

**Suppressed Time Delay.** A deliberate displacement of the zero of the time scale with respect to time of emission of a pulse in order to simulate electrically a geographical displacement of the true *Position* of a *Transponder*. (54 IRE 12.S1)

**Suppressor Grid.** A *Grid* that is interposed between two positive *Electrodes* (usually the *Screen Grid* and the *Anode*), primarily to reduce the flow of secondary electrons from one *Electrode* to the other. (57 IRE 7.S2)

**Surface Duct.** An atmospheric duct for which the lower boundary is the surface of the earth. (50 IRE 24.S1)

**Surface Noise.** In mechanical recording, the noise component in the electric output of a pickup due to irregularities in the contact surface of the groove. See also *Ground Noise*. (51 IRE 6.S1)

**Surface of Position.** Any surface defined by constant value of some *Navigation Coordinate*. (54 IRE 12.S1)

**Surge Electrode Current.** The recommended term is *Fault Electrode Current*. (50 IRE 7.S1)

**Surveillance Radar, Airport.** See *Airport Surveillance Radar*. (54 IRE 12.S1)

**Switching Coefficient,  $S_w$ .** The derivative

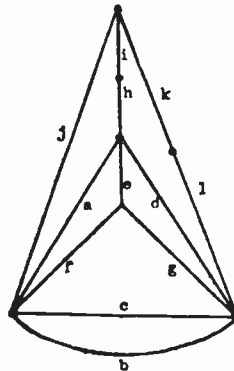
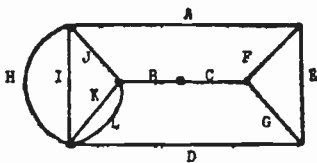

Structurally dual networks. For example, the mesh *EFG* in (a) corresponds to the cut-set *efg* in (b), the mesh *bc* in (b) to the cut-set *BC* in (a), and the mesh *JAEGCB* in (a) to the cut-set *jaegcb* in (b).

of applied magnetizing force with respect to the reciprocal of the resultant *Switching Time*. It is usually determined as the reciprocal of the slope of a curve of reciprocals of *Switching Times* vs values of applied magnetizing forces. The magnetizing forces are applied as step functions. (59 IRE 8.S1)

**Switching Times.** 1)  $T_1$ , the time interval between the *Reference Time* and the last instant at which the instantaneous voltage response of a magnetic cell reaches a stated fraction of its peak value. 2)  $T_2$ , the time interval between the *Reference Time* and the first instant at which the instantaneous integrated voltage response reaches a stated fraction of its peak value. (59 IRE 8.S1)

**Syllabic Comanding.** Comanding in which the effective gain variations are made at speeds allowing response to the syllables of speech but not to individual cycles of the signal wave. (53 IRE 11.S1)

**Syllable Articulation (Per Cent Syllable Articulation).**<sup>1</sup> The per cent articulation obtained when the speech units considered are syllables (usually meaningless and usually of the consonant-vowel-consonant type). (51 IRE 6.S1)

**Symmetrically Cyclically Magnetized Condition.** A condition of a magnetic material when it is in a *Cyclically Magnetized Condition* and the limits of the applied magnetizing forces are equal and of opposite sign, so that the limits of flux density are equal and of opposite sign. (59 IRE 8.S1)

**Symmetrical Network.** See *Structurally Symmetrical Network*. (50 IRE 4.S1)

**Symmetrical Transducer (with Respect to Specified Terminations).** A transducer in which all possible pairs of specified terminations may be interchanged without affecting transmission. (51 IRE 20.S2)

**Sync Compression.** The reduction in gain applied to the *Sync Signal* over any part of its amplitude range with respect to the gain at a specific reference level.

*Note 1:* The gain referred to in the definition is for a signal amplitude small in comparison with the total peak-to-peak *Composite Picture Signal* involved. A quantitative evaluation of this effect can be obtained by a measurement of *Differential Gain*.

*Note 2:* Frequently the gain at the *Level* of the peaks of sync pulses is reduced with respect to the gain at the *Levels* near the base of the sync pulses. Under some conditions, the gain over the entire *Sync Signal* region of the *Composite Picture Signal* may

be reduced with respect to the gain in the region of the *Picture Signal*.

(55 IRE 23.S1)

**Synchronization Error.** In *Navigation*, the error due to imperfect timing of two operations; this may or may not include signal transmission time. (54 IRE 12.S1)

**Synchronizing (in Facsimile).** The maintenance of predetermined speed relations between the *Scanning Spot* and the *Recording Spot* within each scanning line. (56 IRE 9.S1)

**Synchronizing (in Television).** Maintaining two or more scanning processes in phase. (55 IRE 23.S1)

**Synchronizing Signal (in Facsimile).** A signal used for maintenance of predetermined speed relations between the *Scanning Spot* and *Recording Spot* within each scanning line. (56 IRE 9.S1)

**Synchronous Gate.** A time gate wherein the output intervals are synchronized with an incoming signal. (53 IRE 11.S1)

**Synchronous Voltage (Traveling-Wave Tubes).** The voltage required to accelerate electrons from rest to a velocity equal to the phase velocity of a wave in the absence of electron flow. (56 IRE 7.S1; 57 IRE 7.S2)

**Sync Level.** The *Level* of the peaks of the *Sync Signal*. (55 IRE 23.S1)

**Sync Signal (Synchronizing Signal).** The signal employed for the synchronizing of scanning.

*Note:* In television, this signal is composed of *Pulses* at rates related to the line and field frequencies.

The waveform specified by the U. S. Monochrome Standards is shown in Fig. 12 of the IRE Standards on Television: Methods of Testing Television Receivers, 1948.

The signal usually originates in a central sync generator and is added to the combination of *Picture Signal* and *Blanking Signal*, comprising the output signal from the pickup equipment, to form the *Composite Picture Signal*. In a television receiver, this signal is normally separated from the *Picture Signal* and is used to synchronize the deflection generators.

(55 IRE 23.S1)

**Systematic Errors.** Those errors having an orderly character and which can be corrected by calibration. (54 IRE 12.S1)

## T

**Tailing (or Hangover).** 1) The excessive prolongation of the decay of the signal wave tail. (42 IRE 9.S1)

<sup>1</sup> See notes under *Articulation (Per Cent Articulation)* and *Intelligibility (Per Cent Intelligibility)*.

## Tandem

2) The excessive prolongation of the decay of the signal. (56 IRE 9.S1)

**Tandem (Cascade).** Two-terminal pair networks are in tandem when the output terminals of one network are directly connected to the input terminals of the other network. (50 IRE 4.S1)

**Tangential Wave Path.** In radio wave propagation over the earth, a path of propagation of a direct wave, which is tangential to the surface of the earth. The tangential wave path is curved by atmospheric refraction. (50 IRE 24.S1)

**Tank Circuit.** A circuit capable of storing electrical energy over a band of frequencies continuously distributed about a single frequency at which the circuit is said to be resonant, or tuned. The selectivity of the circuit is proportional to the ratio of energy stored in the circuit to the energy dissipated. This ratio is often called the  $Q$  of the circuit. (48 IRE 2, 11, 15.S1)

**Tapered Transmission Line.** See *Tapered Waveguide*. (53 IRE 2.S1)

**Tapered Waveguide.** A waveguide in which a physical or electrical characteristic changes continuously with distance along the axis of the guide. (55 IRE 2.S1)

**Taper, Waveguide.** A section of *Tapered Waveguide*. (55 IRE 2.S1)

**Tape Thickness.** See *Tape-Wound Core*. (59 8.S1)

**Tape Width.** See *Tape-Wound Core*. (59 IRE 8.S1)

**Tape-Wound Core.** A length of ferromagnetic tape coiled about an axis in such a way that one convolution falls directly upon the preceding convolution. The greater of the cross-sectional dimensions of the tape is the **Tape Width**, and the other is the **Tape Thickness**. A **Wrap** is one convolution of the tape about the axis. **Wrap Thickness** is the distance between corresponding points on two consecutive wraps, measured parallel to the **Tape Thickness**.

A **Bobbin Core** is a *Tape-Wound Core* in which the ferromagnetic tape has been wrapped on a form or bobbin which supplies mechanical support to the tape. The dimensions of a bobbin are illustrated in the diagram. The **Bobbin I.D.** is the center-hole diameter ( $D$ ) of the bobbin. The **Bobbin O.D.** is the over-all diameter ( $E$ ) of the bobbin. The **Bobbin Height** is the over-all axial dimension ( $F$ ) of the bobbin. The **Groove Diameter** is the diameter ( $G$ ) of the center portion of the bobbin on which the first tape *Wrap* is placed. The **Groove Width** is the axial dimension ( $H$ ) of the

## Teleran

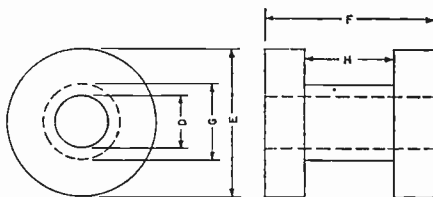

Dimensions of a bobbin.

bobbin measured inside the groove at the groove diameter. (59 IRE 8.S1)

**Target.** In *Radar*, 1) specifically an object of *Radar* search or surveillance, 2) broadly any discrete object which reflects energy back to the *Radar* equipment. (54 IRE 12.S1)

**Target (Camera Tubes).** A structure employing a storage surface which is scanned by an electron beam to generate a *Signal Output Current* corresponding to a charge-density pattern stored thereon.

*Note:* The structure may include the storage surface which is scanned by an electron beam, the *Backplate* and the intervening dielectric.

(57 IRE 7.S2)

**Target Capacitance (Camera Tubes).** The capacitance between the scanned area of the *Target* and the *Backplate*. (57 IRE 7.S2)

**Target Cutoff Voltage (Camera Tubes).** The lowest *Target Voltage* at which any detectable electrical signal corresponding to a light image on the sensitive surface of the tube can be obtained. (57 IRE 7.S2)

**Target Glint.** See *Scintillation*. (54 IRE 12.S1)

**Target Transmitter.** A source of radio frequency energy suitable for providing test signals at the test site.

**Target Voltage (in a Camera Tube with Low-Velocity Scanning).** The potential difference between the *Thermionic Cathode* and the *Backplate*. (57 IRE 7.S2)

**Tee Junction.** A junction of waveguides in which the longitudinal guide axes form a T. *Note:* The guide which continues through the junction is the main guide; the guide which terminates at a junction is the branch guide.

(55 IRE 2.S1)

**Telephone Receiver.** An earphone for use in a telephone system. See also *Earphone (Receiver)*. (51 IRE 6.S1)

**Telephone Transmitter.** A microphone for use in a telephone system. See also *Microphone*. (51 IRE 6.S1)

**Teleran.** (Television and Radar Naviga-

## Television Transmitter

tion System). 1) Television image of ground PPI and map and weather data are presented in the aircraft. (49 IRE 12.S1)

2) A *Radar Navigation* system in which the *Positions* of aircraft are determined by ground *Radar*, the *PPI* being televised, superimposed on a map, and transmitted to the aircraft. (54 IRE 12.S1)

**Television Transmitter.** The aggregate of such radio-frequency and modulating equipment as is necessary to supply to an antenna system modulated radio-frequency power by means of which all the component parts of a complete television signal (including audio, video, and synchronizing signals) are concurrently transmitted. (48 IRE 2, 11, 15.S1)

**TE<sub>m,n,p</sub> Resonant Mode in Cylindrical Cavity.** In a hollow metal cylinder closed by two plane metal surfaces perpendicular to its axis, the resonant mode whose transverse field pattern is similar to the TE<sub>m,n</sub> wave in the corresponding cylindrical *Waveguide* and for which *p* is the number of half-period field variations along the axis.

*Note:* When the cavity is a rectangular parallelepiped, the axis of the cylinder from which the cavity is assumed to be made should be designated since there are three such axes possible.

(53 IRE 2.S1)

**TE<sub>m,n</sub> Wave in Circular Waveguide.** In a hollow circular metal cylinder, the *Transverse Electric Wave* for which *m* is the number of axial planes along which the normal component of the electric vector vanishes, and *n* is the number of coaxial cylinders (including the boundary of the *Waveguide*) along which the tangential component of electric vector vanishes.

*Note 1:* TE<sub>0,n</sub> waves are *Circular Electric Waves* of order *n*. The TE<sub>01</sub> wave is the *Circular Electric Wave* with the lowest *Cut-Off Frequency*.

*Note 2:* The TE<sub>11</sub> wave is the *Dominant Wave*. Its lines of electric force are approximately parallel to a diameter.

Table VII gives the ratio of *Cut-Off Wavelengths* to diameters for TE<sub>m,n</sub> waves in hollow circular metal cylinders.

(53 IRE 2.S1)

TABLE VIII

<i>m</i> =	0	1	2	3	4	
<i>n</i> =	1	0.820	1.708	1.030	0.748	0.590
	2	0.448	0.59	0.468	0.382	0.338
	3	0.309	0.368	0.315	0.277	0.247
	4	0.2375	0.27	0.24	0.22	0.198
	5	0.1910	0.21	0.194	0.18	

## Temperature Coefficient

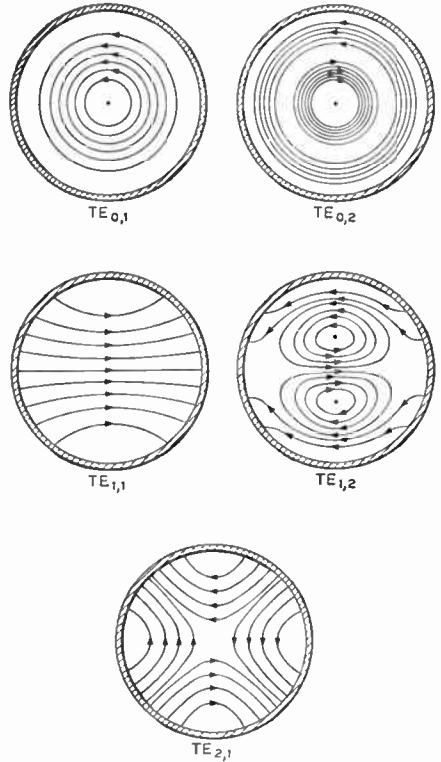

The *E* lines for some of the more elementary TE modes in circular *Waveguides*.

### TE<sub>m,n</sub> Wave in Rectangular Waveguide.

In a hollow rectangular metal cylinder, the *Transverse Electric Wave* for which *m* is the number of half-period variations of the electric field along the longer transverse dimension, and *n* is the number of half-period variations of the electric field along the shorter transverse dimension (see figure on page 147). (53 IRE 2.S1)

### Temperature. See:

*Condensed-Mercury Temperature Ignitor-Current Temperature Drift (TR, Pre-TR, and Attenuator Tubes)*

*Noise Temperature*

*Noise Temperature, Standard.*

(57 IRE 7.S2)

**Temperature Coefficient of Voltage Drop (Glow-Discharge Tubes).** The quotient of the change of *Tube Voltage Drop* (excluding any *Voltage Jumps*) by the change of ambient (or envelope) temperature.

*Note:* It must be indicated whether the quotient is taken with respect to ambient or envelope temperature. (57 IRE 7.S2)

**Temporal Gain Control.** See *Sensitivity Time Control*. (54 IRE 12.S1)

**Tenth-Power Width.** In a plane containing the direction of the maximum of a lobe, the full angle between the two directions in that plane about the maximum in which the radiation intensity is one-tenth the maximum value of the lobe. (48 IRE 2, 11, 15.S1)

**Terminal.** A point at which any element may be directly connected to one or more other elements. (50 IRE 4.S1)

**Terminal Pair.** An associated pair of accessible terminals, such as input pair, output pair, and the like. (50 IRE 4.S1)

**Ternary.** See *Positional Notation*. (56 IRE 8.S1)

**Ternary Code.** A *Code* employing three distinguishable types of *Code Elements*. (58 IRE 11.S1)

**Terrain Clearance Indicator** (sometimes called **Absolute Altimeter**). A device measuring the distance from an aircraft to the surface of the sea or ground. (49 IRE 12.S1)

**Terrain Echoes.** See *Ground Clutter*. (54 IRE 12.S1)

**Terrain Error.** In *Navigation*, the error resulting from the distortion in the radiated field by the nonhomogeneous characteristic of the terrain over which the radiation in question has propagated. (54 IRE 12.S1)

**Terrestrial-Reference Flight.** That type of *Stabilized Flight* which obtains control information from terrestrial phenomena.

*Example:* Flight in which basic information derived from the earth's magnetic field, atmospheric pressure, and the like is fed into a conventional *Automatic Pilot*. (54 IRE 12.S1)

**Test Routine.** 1) Usually a synonym for *Check Routine*. 2) Sometimes used as a general term to include both check routine and *Diagnostic Routine*. (56 IRE 8.S1)

**Tetrode.** A four-electrode *Electron Tube* containing an *Anode*, a *Cathode*, a *Control Electrode*, and one additional *Electrode* that is ordinarily a *Grid*. (57 IRE 7.S2)

**Thermal Noise.** The noise caused by thermal agitation in a dissipative body.

*Note:* The available thermal noise power  $N$ , from a resistor at temperature  $T$ , is  $N = kT\Delta f$ , where  $k$  is Boltzmann's constant and  $\Delta f$  is the frequency increment. (57 IRE 7.S2)

**Thermal Tuning Time (Cooling).** The time required to tune through a specified *Frequency Range* when the tuner power is instantaneously changed from the specified maximum to zero.

*Note:* The initial condition must be one of equilibrium. (56 IRE 7.S1; 57 IRE 7.S2)

**Thermal Tuning Time (Heating).** The time required to tune through a specified *Frequency Range* when the tuner power is instantaneously changed from zero to the specified maximum.

*Note:* The initial condition must be one of equilibrium. (56 IRE 7.S1; 57 IRE 7.S2)

**Thermionic Cathode.** See *Hot Cathode*. (57 IRE 7.S2)

**Thermionic Emission.** The liberation of electrons or ions from a solid or liquid as a result of its thermal energy. (57 IRE 7.S2)

**Thermionic Grid Emission (Primary Grid Emission).** Current produced by electrons thermionically emitted from a *Grid*. (57 IRE 7.S2)

**Thermionic Tube.** An *Electron Tube* in which the heating of one or more of the *Electrodes* is for the purpose of causing electron or ion emission. (57 IRE 7.S2)

**Thermistor.** An electron device which makes use of the change of resistivity of a semiconductor with change in temperature. (54 IRE 7.S2)

**Thermophone.** An electroacoustic transducer in which sound waves of calculable magnitude result from the expansion and contraction of the air adjacent to a conductor whose

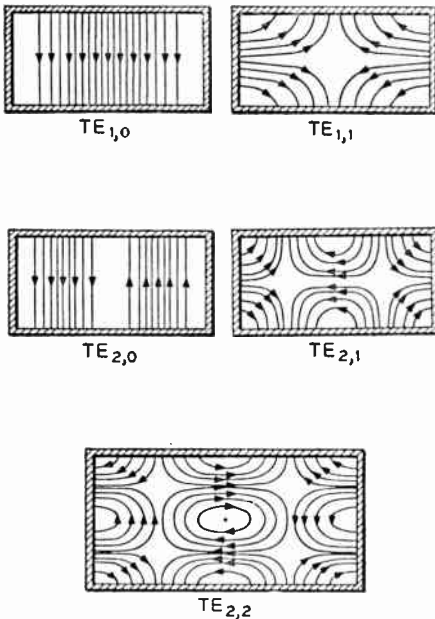

The *E* lines for some of the more elementary TE modes in rectangular *Waveguides*.

temperature varies in response to a current input.

*Note:* When used for the calibration of pressure microphones, a thermophone is generally used in a cavity the dimensions of which are small compared to a wavelength. (51 IRE 6.S1)

**Theta ( $\Theta$ ) Polarization.** The state of the wave in which the *E* vector is tangential to the meridian lines of some given spherical frame of reference.

*Note:* The usual frame of reference has the polar axis vertical and the origin at or near the antenna. Under these conditions, a vertical dipole will radiate only theta ( $\theta$ ) polarization and the horizontal loop will radiate only phi ( $\phi$ ) polarization. (48 IRE 2, 11, 15.S1)

**Three-Address Code.** See *Instruction Code*. (56 IRE 8.S1)

**Threshold of Audibility (Threshold of Detectability).** For a specified signal, the minimum effective sound pressure of the signal that is capable of evoking an auditory sensation in a specified fraction of the trials. The characteristics of the signal, the manner in which it is presented to the listener, and the point at which the sound pressure is measured must be specified.

*Note 1:* Unless otherwise indicated, the ambient noise reaching the ears is assumed to be negligible.

*Note 2:* The threshold may be expressed in decibels relative to 0.0002 microbar or to 1 microbar.

*Note 3:* Instead of the method of constant stimuli, which is implied by the phrase "in a specified fraction of the trials," another psychophysical method (which should be specified) may be employed. (51 IRE 6.S1)

**Threshold of Feeling (or Discomfort, Tickle, or Pain).** For a specified signal, the minimum effective sound pressure of that signal which in a specified fraction of the trials will stimulate the ear to a point at which there is the sensation of feeling (or discomfort, tickle, or pain).

*Note 1:* Characteristics of the signal and the measuring technique must be specified in every case.

*Note 2:* This threshold is customarily expressed in decibels relative to 0.0002 microbar or to 1 microbar. (51 IRE 6.S1)

**Threshold Field, *H*<sub>0</sub>.** The least magnetizing force in a direction which tends to decrease the *Remanence*, which, when applied either as a steady field of long duration or as a pulsed field appearing many times, will cause

a stated fractional change of *Remanence*. (59 IRE 8.S1)

**Threshold Signal.** In *Navigation* the smallest signal capable of effecting a recognizable change in positional information. (54 IRE 12.S1)

**Throat Microphone.** A microphone normally actuated by mechanical contact with the throat. (51 IRE 6.S1)

**Through Path.** In a feedback control loop, the transmission path from the loop input signal to the loop output signal. (55 IRE 26.S2)

**Through Transfer Function.** In a feedback control loop, the transfer function of the through path. (55 IRE 26.S2)

**Thump.** A low-frequency transient disturbance in a system or component characterized audibly by the onomatopoeic connotation of the word. (58 IRE 3.S1)

**Thyratron.** A *Hot-Cathode Gas Tube* in which one or more *Control Electrodes* initiate, but do not limit, the *Anode Current* except under certain operating conditions. (57 IRE 7.S2)

**Tilt.** The angle which an antenna axis forms with the horizontal. (49 IRE 12.S1)

**Tilt Angle.** In *Radar*, the angle between the axis of radiation in the vertical plane and a reference axis (normally the horizontal). (54 IRE 12.S1)

**Tilt Error.** In *Navigation*, the component of the ionospheric error due to nonuniform height. (54 IRE 12.S1)

**Timbre (Musical Quality).** That attribute of auditory sensation in terms of which a listener can judge that two sounds similarly presented and having the same loudness and pitch are dissimilar.

*Note:* Timbre depends primarily upon the spectrum of the stimulus, but it also depends upon the wave form, the sound pressure, and the frequency location of the spectrum of the stimulus. (51 IRE 6.S1)

**Time.** See:

*Control-Electrode Discharge Recovery Time (Attenuator Tubes)*

*Dead Time*

*Decay Time (Charge-Storage Tubes)*

*Deionization Time (Gas Tubes)*

*Electrode-Current Averaging Time*

*Heater Warm-Up Time*

*High-Level Firing Time (Switching Tubes)*

*Ignitor Firing Time (Switching Tubes)*

*Ionization Time (Gas Tubes)*

*Operation Time*

*Phase Recovery Time (TR and Pre-TR Tubes)*

*Recovery Time (ATR Tubes)*

*Recovery Time (Gas Tubes)*

# Time Discriminator

- Recovery Time (Geiger-Mueller Counters)
  - Recovery Time (TR and Pre-TR Tubes)
  - Resolving Time (Radiation Counters)
  - Retention Time, Maximum (Charge-Storage Tubes)
  - Storage Time (Charge-Storage Tubes)
  - Thermal Tuning Time (Cooling)
  - Thermal Tuning Time (Heating)
  - Tube Heating Time (Mercury-Vapor Tubes).
- (57 IRE 7.S2)

**Time Discriminator.** A circuit in which the sense and magnitude of the output is a function of the time difference of the occurrence, and relative time sequence, of two pulses. (54 IRE 12.S1)

**Time-Division Multiplex.** A device or process for the transmission of two or more signals over a common path by using successive time intervals for different signals. (53 IRE 11.S1)

**Time Gain Control.** See *Differential Gain Control*. (49 IRE 12.S1)

**Time Gate.** A transducer which gives output only during chosen time intervals. (53 IRE 11.S1)

**Time Pattern.** A picture tube presentation of horizontal and vertical lines or dot rows generated by two stable frequency sources operating at multiples of the line and field frequencies. (55 IRE 23.S1)

**Timer.** In *Navigational* equipment, the programming unit. (54 IRE 12.S1)

**Time-Variied Gain (TVG).** See *Sensitivity Time Control*. (54 IRE 12.S1)

**TM<sub>m,n</sub> Wave in Circular Waveguide.** In a hollow circular metal cylinder, the *Transverse Magnetic Wave* for which *m* is the number of axial planes along which the normal component of the magnetic vector vanishes, and *n* is the number of coaxial cylinders to which the electric vector is normal.

*Note:* TM<sub>0,n</sub> waves are *Circular Magnetic Waves* of order *n*. The TM<sub>01</sub> wave is the *Circular Magnetic Wave* with the lowest *Cut-Off Frequency*.

Table IX gives the ratio of *Cut-Off Wavelengths* to diameters for TM<sub>m,n</sub> waves in hollow circular metal cylinders. (53 IRE 2.S1)

TABLE IX

<i>m</i> =	0	1	2	3	4	5	
<i>n</i> =	1	1.307	0.820	0.613	0.483	0.414	0.358
	2	0.569	0.448	0.373	0.322	0.284	0.2547
	3	0.363	0.309	0.270	0.241	0.219	0.200
	4	0.267	0.2375	0.2127	0.1938		
	5	0.2106	0.1910	0.1750			

# TM<sub>m,n</sub> Wave

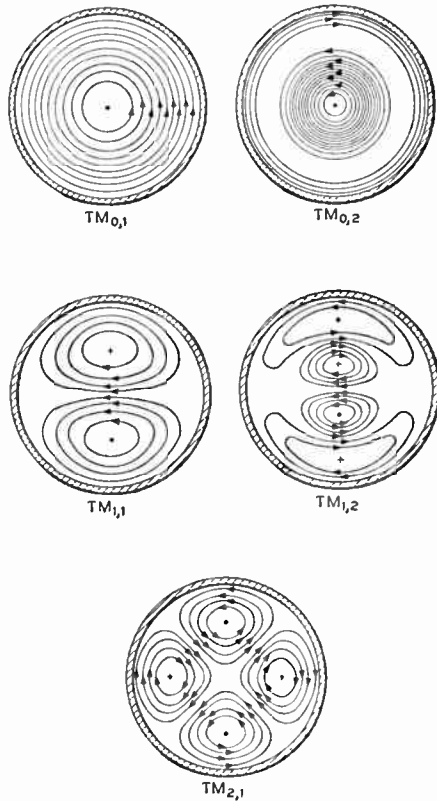

The H lines for the more elementary TM modes of transmission in circular *Waveguides*. The resonant wavelengths of cylindrical cavities are given by

$$\lambda_r = 1/\sqrt{(1/\lambda_c)^2 + (l/2c)^2}$$

where  $\lambda_c$  is the *Cut-Off Wavelength* for the transmission mode along the axis, *l* is the number of half-period variations of the field along the axis and *c* is the axial length of the cavity.

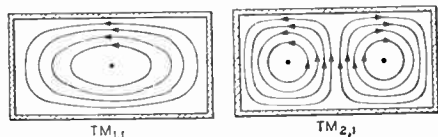

The H lines for the more elementary TM modes of transmission in rectangular *Waveguides*. The resonant wavelengths of cylindrical cavities are given by

$$\lambda_r + 1/\sqrt{(1/\lambda_c)^2 + (l/2c)^2}$$

where  $\lambda_c$  is the *Cut-Off Wavelength* for the transmission mode along the axis, *l* is the number of half-period variations of the field along the axis and *c* is the axial length of the cavity.

## TM<sub>m,n</sub> Wave

### TM<sub>m,n</sub> Wave in Rectangular Waveguide.

In a hollow rectangular metal cylinder, the *Transverse Magnetic Wave* for which  $m$  is the number of half-period variations of the magnetic field along the longer transverse dimension, and  $n$  is the number of half-period variations of magnetic field along the shorter transverse dimension. (53 IRE 2.S1)

### TM<sub>m,n,p</sub> Resonant Mode in Cylindrical Cavity.

In a hollow metal cylinder closed by two plane metal surfaces perpendicular to its axis, the resonant mode whose transverse field pattern is similar to the TM<sub>m,n</sub> wave in the corresponding cylindrical *Waveguide* and for which  $p$  is the number of half-period field variations along the axis.

*Note:* When the cavity is rectangular parallelepiped, the axis of the cylinder from which the cavity is assumed to be made should be designated since there are three such axes possible (see figure on p. 149.) (53 IRE 2.S1)

**T Network.** A network composed of three branches with one end of each branch connected to a common junction point, and with the three remaining ends connected to an input terminal, an output terminal, and a common input and output terminal, respectively. (50 IRE 4.S1)

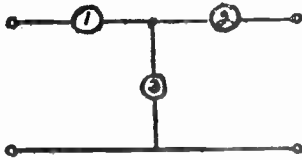

**T network.** One end of each of the branches 1, 2, and 3 is connected to a common point. The other ends of branches 1 and 2 form, respectively, an input and an output terminal, and the other end of branch 3 forms a common input and output terminal.

### Toe and Shoulder (of an *H* and *D* Curve).

The terms applied to the nonlinear portions of the *H* and *D* curve which lie, respectively, below and above the straight portion of this curve. (51 IRE 6.S1)

**To-From Indicator.** A *Sensing* device to show whether the numerical reading of an *Omnibearing* selector for an "on-course" indication of the *Course Line Deviation Indicator* and *Flight Path Deviation Indicator* represents the *Bearing* toward or away from an *Omnirange*. (54 IRE 12.S1)

**Tone.** 1) A sound wave capable of exciting an auditory sensation having pitch. 2) A sound sensation having pitch. (51 IRE 6.S1)

**Tone Localizer.** See *Equi-Signal Localizer*. (54 IRE 12.S1)

**Top-Loaded Vertical Antenna.** A vertical

## Track Homing

antenna so constructed that, because of its greater size at the top, there results a modified current distribution giving a more desirable radiation pattern in the vertical plane. A series reactor may be connected between the enlarged portion of the antenna and the remaining structure. (48 IRE 2, 11, 15.S1)

**Torque Amplifier.** A device possessing input and output shafts and supplying work to rotate the output shaft in positional correspondence with the input shaft without imposing any significant torque on the input shaft. (50 IRE 8.S1)

**Totally Unbalanced Currents (on a Balanced Line).** *Push-Push Currents*. (53 IRE 2.S1)

**Total Telegraph Distortion.** Telegraph transmission impairment, expressed in terms of time displacement of mark-space and space-mark transitions from their proper positions relative to one another, in per cent of the shortest perfect pulses called the unit pulse. (Time lag affecting all transitions alike does not cause distortion.) Telegraph distortion is specified in terms of its effect on code and terminal equipment. **Total Morse Telegraph Distortion** for a particular mark or space pulse is expressed as the algebraic sum of time displacements of space-mark and mark-space transitions determining the beginning and end of the pulses, measured in per cent of unit pulse. Lengthening of mark is positive, and shortening, negative. **Total Start-Stop Telegraph Distortion** refers to the time displacement of selecting-pulse transitions from the beginning of the start pulse expressed in per cent of unit pulse. (48 IRE 2, 11, 15.S1)

**Tracing Distortion.** The nonlinear distortion introduced in the reproduction of mechanical recording because the curve traced by the motion of the reproducing stylus is not an exact replica of the modulated groove. For example, in the case of a sine-wave modulation in vertical recording the curve traced by the center of the tip of a stylus is a poid. (51 IRE 6.S1)

**Track (in Electronic Computers).** That portion of a moving-type storage medium which is accessible to a given reading station; e.g., as on film, drum, tapes, or disks. See also *Band*. (56 IRE 8.S1)

**Track (Navigation).** The horizontal component of the *Path* actually followed by a *Vehicle*.

*Note:* Marine practice sometimes extends this term to include the horizontal component of intended *Path*.

(54 IRE 12.S1)

**Track Homing.** The process of following a



## Tracking

*Line of Position* known to pass through an objective. (54 IRE 12.S1)

**Tracking (Antenna).** A motion given to the major lobe of an antenna such that some preassigned moving target in space is always contained within the major lobe. (48 IRE 2, 11, 15.S1)

**Tracking (Navigation).** The process of keeping radar beams or the cross hairs of an optical system set on a target. (49 IRE 12.S1)

**Tracking (Receivers).** 1) The maintenance of proper frequency relations in circuits designed to be simultaneously varied by gang operation; 2) the process of keeping radio beams set on a target; 3) the following of a groove by a phonograph needle. (52 IRE 17.S1)

**Tracking Error.** In lateral mechanical recording, the angle between the vibration axis of the mechanical system of the pickup and a plane containing the tangent to the unmodulated record groove which is perpendicular to the surface of the recording medium at the point of needle contact. (51 IRE 6.S1)

**Trailing Edge.** The major portion of the decay of a *Pulse*. (55 IRE 23.S1)

**Trailing Edge Pulse Time.** The time at which the instantaneous amplitude last reaches a stated fraction of the peak pulse amplitude. (51 IRE 20.S1)

**Transadmittance.** See:

*Interelectrode Transadmittance*

*Small-Signal Forward Transadmittance*

*Transadmittance, Forward.*

(57 IRE 7.S2)

**Transadmittance Compression Ratio.** The ratio of the magnitude of the *Small-Signal Forward Transadmittance* of the tube to the magnitude of the *Forward Transadmittance* at a given input signal level. (56 IRE 7.S1; 57 IRE 7.S2)

**Transadmittance, Forward.** The complex quotient of 1) the fundamental component of the short-circuit current induced in the second of any two gaps and 2) the fundamental component of the voltage across the first. (56 IRE 7.S1; 57 IRE 7.S2)

**Transconductance.** As most commonly used, the *Interelectrode Transconductance* between the *Control Grid* and the *Anode*. At low frequencies, *Transconductance* is the slope of the *Control-Grid-to-Anode Transfer Characteristic*. See *Conversion Transconductance (of a Heterodyne Conversion Transducer)*; *Interelectrode Transconductance (j-l Interelectrode Transconductance)*.

(57 IRE 7.S2)

**Transcriber.** Equipment associated with a computing machine for the purpose of transferring input (or output) data from a record

## Transducer, Ideal

of information in a given language to the medium and the language used by a digital computing machine (or from a computing machine to a record of information). (56 IRE 8.S1)

**Transducer.** A device capable of being actuated by waves from one or more transmission systems or media and of supplying related waves to one or more other transmission systems or media. See:

*Conversion Transducer*

*Harmonic Conversion Transducer (Frequency Multiplier, Frequency Divider)*

*Heterodyne Conversion Transducer (Converter).*

(51 IRE 20.S2; 54 IRE 3.S1; 57 IRE 7.S2; 58 IRE 3.S1)

**Transducer, Active.** A *Transducer* whose output waves are dependent upon sources of power, apart from that supplied by any of the actuating waves, which power is controlled by one or more of these waves. (58 IRE 3.S1)

**Transducer Equivalent Noise Pressure (Equivalent Noise Pressure).** Of an electroacoustic transducer or system used for sound reception, the root-mean-square sound pressure of a sinusoidal plane progressive wave which, if propagated parallel to the principal axis of the transducer, would produce an open-circuit signal voltage equal to the root-mean-square of the inherent open-circuit noise voltage of the transducer in a transmission band having a bandwidth of 1 cycle per second and centered on the frequency of the plane sound wave.

*Note:* If the equivalent noise pressure of the transducer is a function of secondary variables, such as ambient temperature or pressure, the applicable value of these quantities should be stated explicitly.

(51 IRE 6.S1)

**Transducer Gain.** The ratio of the power that the *Transducer* delivers to a specified *Load* under specified operating conditions to the *Available Power* of a specified *Source*.

*Note 1:* If the input and/or *Output Power* consist of more than one component, such as multifrequency *Signal* or *Noise*, then the particular components used and their weighting must be specified.

*Note 2:* This *Gain* is usually expressed in decibels.

(51 IRE 20.S2; 54 IRE 3.S1; 58 IRE 3.S1)

**Transducer Gain (of a Two-Port Linear Transducer).** See *Gain, Transducer (of a Two-Port Linear Transducer)*. (57 IRE 7.S2)

**Transducer, Ideal (for Connecting a Specified Source to a Specified Load).** A hypothetical passive *Transducer* which

## Transducer Loss

transfers the maximum possible power from the source to the *Load*.

*Note:* In linear *Transducers* having only one input and one output, and for which the impedance concept applies, this is equivalent to a *Transducer* which 1) dissipates no energy and 2) when connected to the specified *Source* and *Load* presents to each its *Conjugate Impedance*.

(58 IRE 3.S1)

**Transducer Loss.** The ratio of the available power of a specified *Source* to the power that the *Transducer* delivers to a specified *Load* under specified operating conditions.

*Note 1:* If the input and/or *Output Power* consist of more than one component, such as multifrequency *Signal* or *Noise*, then the particular components used and their weighting must be specified.

*Note 2:* This *Loss* is usually expressed in decibels.

(51 IRE 20.S2; 54 IRE 3.S1; 58 IRE 3.S1)

**Transducer, Passive.** A *Transducer* whose output waves are independent of any sources of power which are controlled by the actuating waves. (58 IRE 3.S1)

**Transducer Pulse Delay.** The interval of time between a specified point on the input *Pulse* and a specified point on the related output *Pulse*.

*Note 1:* This is a general term which applies to the *Pulse Delay* in any transducer, such as receiver, transmitter, amplifier, oscillator, and the like.

*Note 2:* Specifications may require illustrations.

(52 IRE 20.S1)

**Transfer.** 1) To transmit, or *Copy*, information from one device to another. 2) To *Jump*. 3) The act of transferring. (56 IRE 8.S1)

**Transfer Admittance.** From one pair of terminals of an electrical transducer to another pair, at a specified frequency, the complex ratio of the current at the second pair of terminals to the electromotive force applied between the first pair, all pairs of terminals being terminated in any specified manner. (42 IRE 9.S1)

**Transfer Admittance (from the  $j$ th Terminal to the  $l$ th Terminal of an  $n$ -Terminal Network.** The quotient of 1) the complex alternating component  $I_l$  of the current flowing to the  $l$ th terminal from the  $l$ th external termination by 2) the complex alternating component  $V_j$  of the voltage applied to the  $j$ th terminal with respect to the reference point when all other terminals have arbitrary external terminations. (57 IRE 7.S2)

**Transfer Characteristic.** A relation between

## Transformer, Ideal

the voltage of one *Electrode* and the current to another *Electrode*, all other *Electrode Voltages* being maintained constant. (57 IRE 7.S2)

**Transfer Characteristic (Camera Tubes).** A relation between the illumination on the tube and the corresponding *Signal Output Current*, under specified conditions of illumination.

*Note 1:* See *Sensitivity, Illumination*.

*Note 2:* The relation is usually shown by a graph of the logarithm of the *Signal Output Current* as a function of the logarithm of the illumination.

(57 IRE 7.S2)

**Transfer Characteristics (in Electron Tubes).** A relation, usually shown by a graph, between the voltage of one electrode and the current to another electrode, all other electrode voltages being maintained constant. (52 IRE 17.S1)

**Transfer Check.** See *Check, Transfer*. (56 IRE 8.S1)

**Transfer (of Control), Conditional.** See *Conditional Transfer (of Control)*. (50 IRE 8.S1)

**Transfer Control.** Synonym for *Jump*. (56 IRE 8.S1)

**Transfer Current (Gas Tubes).** The current to one *Electrode* required to initiate *Breakdown* to another *Electrode*.

*Note:* The *Transfer Current* is a function of the voltage of the second *Electrode*.

(57 IRE 7.S2)

**Transfer Function.** A relationship between one system variable and another that enables the second variable to be determined from the first. (55 IRE 26.S2)

**Transfer Ratio.** 1) From one point to another in a transducer at a specified frequency, the complex ratio of the generalized force or velocity at the second point. (42 IRE 9.S1)

2) The transfer function from one system variable to another in a linear system, expressed as the ratio of the Laplace transform of the second variable to the Laplace transform of the first variable, assuming zero initial conditions. (55 IRE 26.S2)

**Transferred Information.** See *Transinformation*. (58 IRE 11.S1)

**Transfer (of Control), Unconditional.** See *Unconditional Transfer (of Control)*. (50 IRE 8.S1)

**Transformer, Ideal.** A hypothetical transformer which neither stores nor dissipates energy. Its self-inductances have a finite ratio and unity coefficient of coupling. Its self- and mutual impedances are pure inductances of infinitely great value. (58 IRE 3.S1)

## Transformer, Isolation

**Transformer, Isolation.** A transformer inserted in a system to separate one section of the system from undesired influences of other sections. (58 IRE 3.S1)

**Transformer, Line.** A transformer inserted in a system for such purposes as isolation, impedance matching or additional circuit derivatives. (58 IRE 3.S1)

**Transformer Loss.** The ratio of the power that would be delivered to a specified *Load Impedance* if an *Ideal Transformer* were substituted for the actual transformer, to the power delivered to the specified *Load Impedance* by the actual transformer, under the condition that the impedance ratio of the *Ideal Transformer* is equal to that specified for the actual transformer.

*Note 1:* If the input and/or *Output Power* consist of more than one component, such as multifrequency *Signal* or *Noise*, then the particular components used and their weighting must be specified.

*Note 2:* This *Loss* is usually expressed in decibels.

(54 IRE 3.S1; 58 IRE 3.S1)

**Transformer Loss—Deprecated.** The *Loss* which would be eliminated by the insertion, at any point in a transmission system, of an *Ideal Transformer* having an impedance ratio equal to the absolute value of the ratio of the impedances facing the actual transformer.

*Note:* This *Loss* is usually expressed in decibels.

(54 IRE 3.S1; 58 IRE 3.S1)

**Transformer, Waveguide.** A device, usually fixed, added to a waveguide for the purpose of impedance transformation. (55 IRE 2.S1)

**Transient Motion.** Any motion which has not reached or has ceased to be a steady state. (51 IRE 6.S1)

**Transformation (of an Output Symbol about an Input Symbol).** The difference between the *Information Content* of the input symbol and the *Conditional Information Content* of the input symbol given the output symbol.

*Note 1:* If  $x_i$  is an input symbol and  $y_j$  is an output symbol, the *Transinformation* is equal to

$$\begin{aligned} & [-\log p(x_i)] - [-\log p(x_i | y_j)] \\ &= \log \frac{p(x_i | y_j)}{p(x_i)} = \log \frac{p(x_i, y_j)}{p(x_i)p(y_j)} \end{aligned}$$

where  $p(x_i|y_j)$  is the conditional probability that  $x_i$  was transmitted when  $y_j$  is received, and  $p(x_i, y_j)$  is the joint probability of  $x_i$  and  $y_j$ .

*Note 2:* This quantity has been called *Trans-*

## Transitron, Oscillator

*ferred Information, Transmitted Information* and *Mutual Information*.

(58 IRE 11.S1)

**Transistor.** An active *Semiconductor Device* with three or more electrodes. (54 IRE 7.S2)

**Transistor, Conductivity Modulation.** A *Transistor* in which the active properties are derived from *Minority Carrier* modulation of the bulk resistivity of a semiconductor. (54 IRE 7.S2)

**Transistor, Filamentary.** A *Conductivity Modulation Transistor* with a length much greater than its transverse dimensions. (54 IRE 7.S2)

**Transistor, Junction.** A *Transistor* having a *Base Electrode* and two or more *Junction* electrodes. (54 IRE 7.S2)

**Transistor, Point-Contact.** A *Transistor* having a *Base Electrode* and two or more *Point-Contact* electrodes. (54 IRE 7.S2)

**Transistor, Point-Junction.** A *Transistor* having a *Base Electrode* and both *Point-Contact* and *Junction* electrodes. (54 IRE 7.S2)

**Transistor, Unipolar.** A *Transistor* which utilizes charge *Carriers* of only one polarity. (54 IRE 7.S2)

**Transit Angle.** The product of angular frequency and the time taken for an electron to transverse a given path. (56 IRE 7.S1; 57 IRE 7.S2)

**Transition Frequency (Crossover Frequency).** Of a disk recording system, the frequency corresponding to the point of intersection of the asymptotes to the constant amplitude and the constant velocity portions of its frequency response curve. This curve is plotted with output voltage ratio in decibels as the ordinate and the logarithm of the frequency as the abscissa. (51 IRE 6.S1)

**Transition Loss (in Audio Systems and Components).** At any point in a transmission system, the ratio of the *Available Power* from that part of the system ahead of the point under consideration to the power delivered to that part of the system beyond the point under consideration.

*Note 1:* If the input and/or *Output Power* consist of more than one component, such as multifrequency *Signal* or *Noise*, then the particular components used and their weighting must be specified.

*Note 2:* This *Loss* is usually expressed in decibels.

(54 IRE 3.S1; 58 IRE 3.S1)

**Transition Region.** The region, between two homogeneous semiconductor regions, in which the *Impurity* concentration changes. (54 IRE 7.S2)

**Transitron Oscillator.** A negative-transcon-

## Transit-Time Mode

ductance oscillator employing a screen-grid tube with negative transconductance produced by a retarding field between the negative screen grid and the control grid which serves as the anode. (48 IRE 2, 11, 15.S1)

**Transit-Time Mode.** See *Mode of an Oscillator*. (56 IRE 7.S1; 57 IRE 7.S2)

**Translation Loss (Playback Loss).** The loss in the reproduction of a mechanical recording whereby the amplitude of motion of the reproducing stylus differs from the recorded amplitude in the medium (51 IRE 6.S1)

**Translator.** A network or system having a number of inputs and outputs and so connected that signals representing information expressed in a certain code, when applied to the inputs, cause output signals to appear which are a representation of the input information in a different code. Sometimes called *Matrix*. (56 IRE 8.S1)

**Transmission (Transmittance).** Transmission, as applied to photographic recording, is the ratio of the light flux transmitted by the medium to the light flux incident upon it. Transmission may be either diffuse or specular. (51 IRE 6.S1)

**Transmission Band (of a Uniconductor Waveguide).** The frequency range above the *Cut-Off Frequency*. (53 IRE 2.S1)

**Transmission Coefficient (in a Transmission Medium).** At a given frequency, at a given point, and for a given *Mode of Transmission*, the ratio of some quantity associated with the resultant field, which is the sum of the *Incident* and *Reflected Waves*, to the corresponding quantity in the *Incident Wave*.  
*Note:* The *Transmission Coefficient* may be different for different associated quantities, and the chosen quantity must be specified. The "voltage transmission coefficient" is commonly used and is defined as the complex ratio of the resultant electric field strength (or voltage) to that of the *Incident Wave*. (53 IRE 2.S1)

**Transmission Gain (or "Gain").** A general term used to denote an increase in power in transmission from one point to another. Transmission gain is simply a negative transmission loss if both are expressed on the same logarithmic scale. Transmission gain is usually expressed in decibels. (42 IRE 9.S1)

**Transmission Level.** 1) The level of the signal power at any point in a transmission system which is the ratio of the power at that point to the power at some point in the system chosen as a reference point. This ratio is usually expressed in decibels. (48 IRE 2, 11, 15.S1)

## Transmitting Current Response

2) The ratio of the signal power at any point in a transmission system to the power at some point in the system chosen as a reference point. This ratio is usually expressed in decibels. (42 IRE 9.S1)

**Transmission Line.** A *Waveguide* consisting of two or more conductors. (53 IRE 2.S1)

**Transmission Loss.** 1) The power lost in transmission between one point and another. It is measured as the difference between the net power passing the first point and the net power passing the second. See *Standing Wave Loss Factor*. 2) The ratio in decibels of the net power passing the first point to the net power passing the second. (53 IRE 2.S1)

**Transmission Loss (or "Loss").** A general term used to denote a decrease in power in transmission from one point to another. Transmission loss is usually expressed in decibels. (42 IRE 9.S1)

**Transmission Primaries.** The set of three *Primaries*, either physical or nonphysical, so chosen that each corresponds in amount to one of the three independent signals contained in the *Color Picture Signal*.

*Note:* The *Chromaticities* of two possible sets of transmission primaries are: 1) those of the *Display Primaries (Receiver Primaries)*, 2) those of a specified *Luminance Primary* and two *Chrominance Primaries*. (55 IRE 22.S1)

**Transmitted Information.** See *Transinformation*. (58 IRE 11.S1)

**Transmitted Wave.** When a wave in a medium of certain propagation characteristics is incident upon a discontinuity or a second medium, the forward traveling wave that results in the second medium.

*Note:* In a single medium the *Transmitted Wave* is that wave which is traveling in the forward direction.

See *Refracted Wave*.

(50 IRE 24.S1; 53 IRE 2.S1)

**Transmitter, Facsimile.** The apparatus employed to translate the *Subject Copy* into signals suitable for delivery to the communication system. (56 IRE 9.S1)

**Transmitter Pulse Delay.** See *Transducer Pulse Delay*. (52 IRE 20.S1)

**Transmitting Converter, Facsimile (AM to FS Converter).** A device which changes the type of modulation from amplitude to frequency shift. (56 IRE 9.S1)

**Transmitting Current Response.** Of an electroacoustic transducer used for sound emission, the ratio of the sound pressure apparent at a distance of 1 meter in a specified direction from the effective acoustic center of the transducer to the current flowing at the electric input terminals. The transmitting

## Transmitting Efficiency

current response is usually expressed in decibels above a reference current response of 1 microbar per ampere.

*Note:* The sound pressure apparent at a distance of 1 meter is determined by multiplying the sound pressure observed at a remote point where the sound field is spherically divergent by the ratio of the distance of that point, in meters, from the effective acoustic center of the projector, to the reference distance of 1 meter.

(51 IRE 6.S1)

**Transmitting Efficiency (Projector Efficiency).** Of an electroacoustic transducer, the ratio of the total acoustic power output to the electric power input. In computing the electric power input, it is customary to omit any electric power supplied for polarization or bias. (51 IRE 6.S1)

**Transmitting Power Response (Projector Power Response).** Of an electroacoustic transducer used for sound emission, the ratio of the mean-square sound pressure apparent at a distance of 1 meter in a specified direction from the effective acoustic center of the transducer to the electric power input. The transmitting power response is usually expressed in decibels above a reference response of 1 microbar squared per watt of electric power input.

*Note:* The sound pressure apparent at a distance of 1 meter is determined by multiplying the sound pressure observed at a remote point where the sound field is spherically divergent by the ratio of the distance of that point, in meters, from the effective acoustic center of the projector, to the reference distance of 1 meter.

(51 IRE 6.S1)

**Transmitting Voltage Response.** Of an electroacoustic transducer used for sound emission, the ratio of the sound pressure apparent at a distance of 1 meter in a specified direction from the effective acoustic center of the transducer to the signal voltage applied at the electric input terminals. The transmitting voltage response is usually expressed in decibels above a reference voltage response of 1 microbar per volt.

*Note:* The sound pressure apparent at a distance of 1 meter is determined by multiplying the sound pressure observed at a remote point where the sound field is spherically divergent by the ratio of the distance of that point, in meters, from the effective acoustic center of the projector, to the reference distance of 1 meter.

(51 IRE 6.S1)

**Trans- $\mu$ -Factor (Multibeam Electron Tubes).** The ratio of 1) the magnitude of an

## Transverse Electromagnetic Wave

infinitesimal change in the voltage at the *Control Grid* of any one beam to 2) the magnitude of an infinitesimal change in the voltage at the *Control Grid* of a second beam. The current in the second beam and the voltage of all other *Electrodes* are maintained constant. (57 IRE 7.S2)

**Transponder.** A transmitter-receiver facility the function of which is to transmit signals automatically when the proper *Interrogation* is received. (54 IRE 12.S1)

**Transponder Beacon.** See *Transponder*. (54 IRE 12.S1)

**Transponder, Crossband.** In *Navigation*, a *Transponder* which replies in a different frequency band from that of the received *Interrogation*. (54 IRE 12.S1)

**Transponder Reply Efficiency.** The ratio of the number of replies emitted by a *Transponder* to the number of *Interrogations* which the *Transponder* recognizes as valid.

*Note:* The *Interrogations* recognized as valid include both those properly coded and those accidentally combined to form recognizable codes, the latter normally being computed statistically.

(54 IRE 12.S1)

**Transportable Transmitter.** A transmitter designed to be readily carried or transported from place to place, but which is not normally operated while in motion.

*Note:* This has been commonly called a "portable" transmitter, but the term transportable transmitter is preferred.

(48 IRE 2, 11, 15.S1)

**Transrectification Factor.** The quotient of the change in average current of an *Electrode* by the change in amplitude of the alternating sinusoidal voltage applied to another *Electrode*, the direct voltages of this and other *Electrodes* being maintained constant.

*Note:* Unless otherwise stated, the term refers to cases in which the alternating sinusoidal voltage is of infinitesimal magnitude.

(57 IRE 7.S2)

**Transverse-Beam Traveling-Wave Tube.** A *Traveling-wave Tube* in which the direction of motion of the electron beam is transverse to the average direction in which the signal wave moves. (56 IRE 7.S1; 57 IRE 7.S2)

**Transverse Electric Wave (TE Wave).** In a homogeneous isotropic medium, an *Electromagnetic Wave* in which the *Electric Field Vector* is everywhere perpendicular to the *Direction of Propagation*. (50 IRE 24.S1; 53 IRE 2.S1)

**Transverse Electromagnetic Wave (TEM Wave).** In a homogeneous isotropic medium,

## Transverse-Field Tube

an *Electromagnetic Wave* in which both the electric and magnetic field vectors are everywhere perpendicular to the *Direction of Propagation*. (50 IRE 24.S1; 53 IRE 2.S1)

**Transverse-Field Traveling-Wave Tube.** A *Traveling-Wave Tube* in which the traveling electric fields which interact with the electrons are essentially transverse to the average motion of the electrons. (56 IRE 7.S1; 57 IRE 7.S2)

**Transverse Magnetic Wave (TM Wave).** In a homogeneous isotropic medium, an *Electromagnetic Wave* in which the magnetic field vector is everywhere perpendicular to the *Direction of Propagation*. (50 IRE 24.S1; 53 IRE 2.S1)

**Transverse Magnetization.** In magnetic recording, magnetization of the recording medium in a direction perpendicular to the line of travel, and parallel to the greatest cross-sectional dimension. (51 IRE 6.S1)

**Traveling Plane Wave.** A plane wave each of whose frequency components has an exponential variation of amplitude and a linear variation of phase in the *Direction of Propagation*. (50 IRE 24.S1; 53 IRE 2.S1)

**Traveling-Wave Magnetron.** A *Traveling-Wave Tube* in which the electrons move in crossed static electric and magnetic fields which are substantially normal to the direction of wave propagation. (56 IRE 7.S1; 57 IRE 7.S2)

**Traveling-Wave Magnetron Oscillations.** Oscillations sustained by the interaction between the *Space-Charge* cloud of a *Magnetron* and a traveling electromagnetic field whose phase velocity is approximately the same as the mean velocity of the cloud. (57 IRE 7.S2)

**Traveling-Wave Tube.** An *Electron Tube* in which a stream of electrons interacts continuously or repeatedly with a guided electromagnetic wave moving substantially in synchronism with it, and in such a way that there is a net transfer of energy from the stream to the wave. See *Transverse-Beam Traveling-Wave Tube* and *Transverse-Field Traveling-Wave Tube*. (56 IRE 7.S1; 57 IRE 7.S2)

**Traveling-Wave-Tube Interaction Circuit.** An extended *Electrode* arrangement in a *Traveling-Wave Tube* designed to propagate an electromagnetic wave in such a manner that the traveling electromagnetic fields are retarded and extended into the space occupied by the electron stream.

*Note:* *Traveling-Wave Tubes* are often designated by the type of interaction circuit used, as in "Helix Traveling-Wave Tube."  
(56 IRE 7.S1; 57 IRE 7.S2)

## TR Switch

**TR Box.** See *TR Switch*. (54 IRE 12.S1)

**TR Cavity (Radar).** The resonant portion of a *TR Switch*. (54 IRE 12.S1)

**Treble Boost.** A deliberate adjustment of the *Amplitude-Frequency Response* of a system or component to accentuate the higher *Audio Frequencies*. (58 IRE 3.S1)

**Trec.** A set of connected branches including no meshes. (50 IRE 4.S1)

**Triad.** See *Triplet*. (54 IRE 12.S1)

**Tricon.** A *Radio Navigation* system in which the airborne receiver accepts pulses from a *Triplet* or chain of three stations pulsed in variable time sequence. The time sequences vary so that pulses arrive at the same time along *Paths* of various lengths. (54 IRE 12.S1)

**Trigatron.** An electronic switch in which conduction is initiated by the breakdown of an auxiliary gap. (54 IRE 12.S1)

**Trigger Level.** In a *Transponder*, the minimum input to the receiver which is capable of causing a transmitter to emit a reply. (54 IRE 12.S1)

**Triode.** A three-electrode *Electron Tube* containing an *Anode*, a *Cathode*, and a *Control Electrode*. (57 IRE 7.S2)

**Triplet.** In *Navigation*, three radio stations operated as a group for the determination of *Positions*. (54 IRE 12.S1)

**Tristimulus Values.** The amounts of the *Primaries* that must be combined to establish a match with the sample. (55 IRE 22.S1)

**Troposphere.** That part of the earth's atmosphere in which temperature generally decreases with altitude, clouds form, and convection is active.

*Note:* Experiments indicate that the troposphere occupies the space above the earth's surface to a height of about 10 kilometers.  
(50 IRE 24.S1)

**Tropospheric Wave.** A radio wave that is propagated by reflection from a place of abrupt change in the dielectric constant or its gradient in the troposphere.

*Note:* In some cases the ground wave may be so altered that new components appear to arise from reflections in regions of rapidly changing dielectric constants; when these components are distinguishable from the other components, they are called tropospheric waves.

(50 IRE 24.S1)

**Trouble-Location Problem.** A test problem whose incorrect solution supplies information on the location of faulty equipment; used after a check problem has shown that a fault exists. (50 IRE 8.S1)

**TR Switch.** A switch, frequently of the gas-discharge type, employed when a common

transmitting and receiving antenna is used, which automatically decouples the receiver from the antenna during the transmitting period. (54 IRE 12.S1)

**TR (Transmit-Receive) Tube.** A gas-filled radio-frequency switching tube used to protect the receiver in pulsed radio-frequency systems. (57 IRE 7.S2)

**True Bearing.** The angle measured clockwise between true north and the initial direction of an arc of a great circle through an observer and a point. (49 IRE 12.S1)

**True Course.** A direction of intended travel projected in the horizontal plane expressed as an angle measured clockwise from true north. (49 IRE 12.S1)

**True Heading.** A direction in the horizontal plane expressed as an angle measured clockwise from true north to a line along which a vehicle is pointed. (49 IRE 12.S1)

**True Homing.** The process of following a course such that the true bearing of a vehicle as seen from an objective is held constant. (49 IRE 12.S1)

**Truncation Error.** Error resulting from the approximation of operations in the infinitesimal calculus by operations in the calculus of finite differences. (50 IRE 8.S1)

**Tube.** See:

*ATR (Anti-Transit-Receive) Tube*  
*Attenuator Tube*  
*Beam-Deflection Tube*  
*Beam-Indexing Color Tube*  
*Beam-Power Tube*  
*Broad-Band Tube (TR and Pre-TR tubes)*  
*Camera Tube*  
*Cathode-Ray Tube*  
*Cell-Type Tube (TR, ATR, and Pre-TR Tubes)*  
*Charge-Storage Tube*  
*Cold-Cathode Tube*  
*Color Picture Tube*  
*Converter Tube*  
*Counter Tube*  
*Dissector Tube*  
*Electrometer Tube*  
*Electron-Beam Tube*  
*Electron Tube*  
*Electron-Wave Tube*  
*Externally-Quenched Counter Tube*  
*Fired Tube (TR, ATR, and Pre-TR Tubes)*  
*Gas-Filled Radiation-Counter Tube*  
*Gas-Flow Counter Tube*  
*Gas Tube*  
*Geiger-Mueller Counter Tube*  
*Glow-Discharge Tube*  
*Heptode*  
*Hexode*  
*Hot-Cathode Tube*  
*Iconoscope*

*Image Dissector Tube*

*Image Iconoscope*

*Image Orthicon*

*Image Tube*

*Indicator Tube*

*Ionic-Heated-Cathode Tube*

*Local Oscillator Tube*

*Magnetron*

*Memory Tube*

*Mercury-Vapor Tube*

*Mixer Tube*

*Monoscope*

*Multielectrode Tube*

*Multiple-Unit Tube*

*Multiplier Phototube*

*Multisegment Magnetron*

*Octode*

*Orthicon*

*Oscilloscope Tube (Oscillograph Tube)*

*Pentode*

*Phase-Tuned Tube (TR Tubes)*

*Photomultiplier*

*Phototube*

*Pickup Tube*

*Pre-TR Tube*

*Proportional Counter Tube*

*Reflection Color Tube*

*Self-Quenched Counter Tube*

*Storage Tube*

*Tetrode*

*Thermionic Tube*

*Thyratron*

*TR (Transmit-Receive) Tube*

*Transverse-Beam Traveling-Wave Tube*

*Transverse-Field Traveling-Wave Tube*

*Traveling-Wave Magnetron*

*Traveling-Wave Tube*

*Triode*

*Vacuum Tube*

*Variable- $\mu$  Tube*

*Vidicon*

*Voltage Reference Tube*

*Voltage Regulator Tube.*

(57 IRE 7.S2)

**Tube (Electron).** An electron device in which conduction by electrons take place through a vacuum or gaseous medium within a gas-tight envelope. (52 IRE 17.S1)

**Tube Count (Radiation-Counter Tubes).**

A terminated discharge produced by an ionizing event. (57 IRE 7.S2)

**Tube Heating Time (Mercury-Vapor Tubes).** The time required for the *Condensed-Mercury Temperature* to reach a specified value. (57 IRE 7.S2)

**Tube, Vacuum.** See *Vacuum Tube*. (52 IRE 17.S1)

**Tube Voltage Drop.** The *Anode Voltage* during the conduction period.

## Tuned-Grid Oscillator

*Note:* This voltage is not necessarily constant.

(57 IRE 7.S2)

**Tuned-Grid Oscillator.** An oscillator with frequency determined by a parallel-tuned tank in the grid circuit coupled to the plate to provide the required feedback. (48 IRE 2, 11, 15.S1)

**Tuned-Grid Tuned-Plate Oscillator.** An oscillator having parallel-tuned tanks in both plate and grid circuits, the necessary feedback being obtained by the plate-to-grid interelectrode capacitance. (48 IRE 2, 11, 15.S1)

**Tuned-Plate Oscillator.** An oscillator with frequency determined by a parallel-tuned tank in the plate circuit coupled to the grid to provide the required feedback. (48 IRE 2, 11, 15.S1)

**Tuner, Waveguide.** An adjustable device added to a waveguide for the purpose of impedance transformation. (55 IRE 2.S1)

**Tuning, Electronic.** The process of changing the operating frequency of a system by changing the characteristics of a coupled electron stream. Characteristics involved are, for example: velocity, density, or geometry. (56 IRE 7.S1; 57 IRE 7.S2)

**Tuning Probe.** An essentially lossless probe of adjustable penetration extending through the wall of the waveguide or *Cavity Resonator*. (55 IRE 2.S1)

**Tuning Range (Switching Tubes).** The *Frequency Range* over which the resonance frequency of the tube may be adjusted by the mechanical means provided on the tube or associated cavity. (57 IRE 7.S2)

**Tuning Range, Electronic.** The *Frequency Range* of continuous tuning between two operating points of specified minimum power output for an electronically tuned oscillator. *Note:* The reference points are frequently the half-power points, but should always be specified.

(56 IRE 7.S1; 57 IRE 7.S2)

**Tuning Rate, Thermal.** The initial time rate of change in frequency which occurs when the input power to the tuner is instantaneously changed by a specified amount.

*Note:* This rate is a function of the power input to the tuner as well as the sign and magnitude of the power change.

(56 IRE 7.S1; 57 IRE 7.S2)

**Tuning Sensitivity, Electronic.** At a given operating point, the rate of change of oscillator frequency with the change of the controlling electron stream. For example, this change may be expressed in terms of an *Electrode Voltage* or current.

## Two-Tone Keying

*Note:* See *Pushing Figure of an Oscillator*. (56 IRE 7.S1; 57 IRE 7.S2)

**Tuning Sensitivity, Thermal.** The rate of change of resonator equilibrium frequency with respect to applied thermal tuner power. (57 IRE 7.S2)

**Tuning Susceptance (ATR Tubes).** The normalized susceptance of the tube in its *Mount* due to the deviation of its resonance frequency from the desired resonance frequency.

*Note:* Normalization is with respect to the characteristic admittance of the transmission line at its junction with the tube *Mount*.

(57 IRE 7.S2)

**Tuning, Thermal.** The process of changing the operating frequency of a system by using a controlled thermal expansion to alter the geometry of the system. (56 IRE 7.S1; 57 IRE 7.S2)

**Tuning Time Constant, Thermal.** The time required for the frequency to change by a fraction  $(1-1/e)$  of the change in equilibrium frequency after an incremental change of the applied thermal tuner power.

*Note 1:* If the behavior is not exponential, the initial conditions must be stated.

*Note 2:* Here  $e$  is the base of natural logarithms.

(56 IRE 7.S1; 57 IRE 7.S2)

**Turntable Rumble.** Low-frequency vibration mechanically transmitted to the recording or reproducing turntable and superimposed on the reproduction. (52 IRE 17.S1)

**Turnstile Antenna.** An antenna composed of two dipole antennas, normal to each other, with their axes intersecting at their mid-points. Usually, the currents are equal and in phase quadrature. (48 IRE 2, 11, 15.S1)

**TVG (Time-Varied Gain).** See *Sensitivity Time Control*. (54 IRE 12.S1)

**Twist, Waveguide.** A waveguide section in which there is a progressive rotation of the cross section about the longitudinal axis. (55 IRE 2.S1)

**Two-Source Frequency Keying.** That form of keying in which the modulating wave switches the output frequency between predetermined values corresponding to the frequencies of independent sources. (53 IRE 11.S1)

**Two-Terminal Pair Network (Quadripole) (Four-Pole).** A network with four accessible terminals grouped in pairs. In such a network one terminal of each pair may coincide with a network node. (50 IRE 4.S1)

**Two-Tone Keying.** That form of keying in which the modulating wave causes the carrier to be modulated with one frequency for the "marking" condition and modulated with a



## Ultrasonic Coagulation

different frequency for the "spacing" condition. (53 IRE 11.S1)

## U

**Ultrasonic Coagulation.** The bonding of small particles into larger aggregates by the action of ultrasonic waves. (51 IRE 6.S1)

**Ultrasonic Cross Grating (Grating).** A space grating resulting from the crossing of beams of ultrasonic waves having different directions of propagation. This may be two- or three-dimensional. (51 IRE 6.S1)

**Ultrasonic Delay Line (Ultrasonic Storage Cell).** A contained medium (usually a liquid, e.g., mercury) in which use is made of the propagation time of sound to obtain a time delay of a signal. (51 IRE 6.S1)

**Ultrasonic Detector.** A device for the detection and measurement of ultrasonic waves.

*Note:* Such devices may be mechanical, electrical, thermal, or optical in nature.

(51 IRE 6.S1)

**Ultrasonic Frequency (Supersonic Frequency<sup>1</sup>).** A frequency lying above the audio frequency range. The term is commonly applied to elastic waves propagated in gases, liquids, or solids.

*Note:* The word "ultrasonic" may be used as a modifier to indicate a device or system intended to operate at ultrasonic frequencies.

(51 IRE 6.S1)

**Ultrasonic Generator.** A device for the production of sound waves of ultrasonic frequency. (51 IRE 6.S1)

**Ultrasonic Grating Constant.** The distance between diffracting centers of the sound wave which is producing particular light diffraction spectra. (51 IRE 6.S1)

**Ultrasonic Light Diffraction.** The formation of optical diffraction spectra when a beam of light is passed through a longitudinal wave field. The diffraction results from the periodic variation of the light refraction in the sound field. (51 IRE 6.S1)

**Ultrasonic Material Dispersion.** The production of suspensions or emulsions of one material in another due to the action of high-intensity ultrasonic waves. (51 IRE 6.S1)

**Ultrasonics.** The general subject of sound in the frequency range above about 15 kilocycles per second. (51 IRE 6.S1)

**Ultrasonic Space Grating (Grating).** A periodic spatial variation of the index of refraction caused by the presence of acoustic waves within the medium. (51 IRE 6.S1)

**Ultrasonic Stroboscope.** A light interrupter whose action is based on the modulation of a

## Unidirectional Antenna

light beam by an ultrasonic field. (51 IRE 6.S1)

**Unbalanced Circuit.** A circuit, the two sides of which are electrically unlike. (58 IRE 3.S1)

**Unconditional Jump.** An instruction which interrupts the normal process of obtaining instructions in an ordered sequence, and specifies the address from which the next instruction must be taken. (56 IRE 8.S1)

**Unconditional Transfer of Control.** Synonym for *Unconditional Jump*. (56 IRE 8.S1)

**Underbunching.** A condition representing less than optimum *Bunching*. (56 IRE 7.S1; 57 IRE 7.S2)

**Underlap.** The amount by which the effective height of the scanning spot falls short of the nominal width of the scanning line.

*Note:* When using a rectangular spot, underlap may be expressed as a percentage of the nominal width of scanning line.

(42 IRE 9.S1)

**Underlap X.** The amount by which the center-to-center spacing of the *Recorded Spots* exceeds the *Recorded Spot X Dimension*.

*Note:* This effect arises in that type of equipment which responds to a constant *Density* in the *Subject Copy* by a succession of a discrete *Recorded Spots*.

(56 IRE 9.S1)

**Underlap Y.** The amount by which the *Nominal Line Width* exceeds the *Recorded Spot Y Dimension*. (56 IRE 9.S1)

**Underthrow Distortion.** The distortion resulting when the maximum amplitude of the signal wave front is less than the steady-state amplitude which would be attained by a prolonged signal wave. (42 IRE 9.S1)

**Underwater Sound Projector.** A transducer used to produce sound in water.

*Note:* Where no confusion will result, the term "underwater sound projector" may be shortened to "projector."

(51 IRE 6.S1)

**Undisturbed-One Output.** See *Coincident-Current Selection*. (59 IRE 8.S1)

**Undisturbed-Zero Output.** See *Coincident-Current Selection*. (59 IRE 8.S1)

**Unfired Tube (TR, ATR, and Pre-TR Tubes).** The condition of the tube during which there is no radio-frequency *Glow Discharge* at either the *Resonant Gap* or *Resonant Window*. (57 IRE 7.S2)

**Uniconductor Waveguide.** A *Waveguide* consisting of a cylindrical metallic surface surrounding a uniform dielectric medium.

*Note:* Common cross-sectional shapes are rectangular and circular.

(53 IRE 2.S1)

**Unidirectional Antenna.** An antenna which

<sup>1</sup> Obsolete. See *Supersonics*.

has a single well-defined direction of maximum gain. (48 IRE 2, 11, 15.S1)

**Unidirectional Microphone.** A microphone which is responsive predominantly to sound incident from one hemisphere. (51 IRE 6.S1)

**Unidirectional Pulse.** A pulse in which pertinent departures from the normally constant value occur in one direction only.

*Note:* This is sometimes called "single-polarity" pulse, a term which is deprecated. (51 IRE 20.S1)

**Unidirectional Pulses.** Single-polarity pulses which all rise in the same direction. (48 IRE 2, 11, 15.S1)

**Unidirectional Pulse Train.** A *Pulse Train* in which all *Pulses* rise in the same direction.

*Note:* A *Unidirectional Pulse Train* may contain *Bidirectional Pulses*. (52 IRE 20.S1)

**Uniform Plane Wave.** A plane wave in which the electric and magnetic field vectors have constant amplitude over the equiphase surfaces.

*Note:* Such a wave can only be found in free space at an infinite distance from the source.

(50 IRE 24.S1)

**Uniform Waveguide.** A *Waveguide* in which the physical and electrical characteristics do not change with distance along the axis of the guide. (53 IRE 2.S1)

**Unilateral Area Track.** A sound track in which one edge only of the opaque area is modulated in accordance with the recorded signal. There may, however, be a second edge modulated by a noise reduction device. (51 IRE 6.S1)

**Unilateral Transducer.** A transducer which cannot be actuated at its outputs by waves in such a manner as to supply related waves to its inputs. (51 IRE 20.S2)

**Unipole (Isotropic Antenna).** A hypothetical antenna radiating or receiving equally in all directions. A pulsating sphere is a unipole for sound waves. In the case of electromagnetic waves unipoles do not exist physically but represent convenient reference antennas for expressing directive properties of actual antennas. (48 IRE 2, 11, 15.S1)

**Unipotential Cathode.** See *Indirectly Heated Cathode*. (57 IRE 7.S2)

**Unit.** A portion or subassembly of a computer which constitutes the means of accomplishing some inclusive operation or function, as *Arithmetic Unit*. (56 IRE 8.S1)

**Unloaded Applicator Impedance (Dielectric Heating usage).** The complex impedance measured at the point of application, without the *Load* material in position, at a specified frequency. (55 IRE 10.S1)

**Unloaded (Intrinsic)  $Q$  (Switching Tubes).** The  $Q$  of a tube unloaded by either the generator or the termination.

*Note:* As here used,  $Q$  is equal to  $2\pi$  times the energy stored at the resonance frequency divided by the energy dissipated per cycle in the tube or, for *Cell-Type Tubes*, in the tube and its external resonant circuit.

(57 IRE 7.S2)

**Unmodulated Groove (Blank Groove).** In mechanical recording, a groove made in the medium with no signal applied to the cutter. (51 IRE 6.S1)

**Useful Line.** See *Available Line*. (56 IRE 9.S1)

## V

**Vacuum Tube.** An *Electron Tube* evacuated to such a degree that its electrical characteristics are essentially unaffected by the presence of residual gas or vapor. (52 IRE 17.S1; 57 IRE 7.S2)

**Vacuum-Tube Amplifier.** An amplifier employing electron tubes to effect the control of power from the local source. (48 IRE 2, 11, 15.S1)

**Vacuum-Tube Transmitter.** A radio transmitter in which electron tubes are utilized to convert the applied electric power into radio-frequency power. (48 IRE 2, 11, 15.S1)

**Valence Band.** The range of energy states in the spectrum of a solid crystal in which lie the energies of the valence electrons which bind the crystal together. (54 IRE 7.S2)

**Value, Munsell.** The dimension of the Munsell system of object-color specification which indicates the apparent luminous transmittance or reflectance of the object on a scale having approximately equal perceptual steps under the usual conditions of observation. (55 IRE 22.S1)

**V Antenna.** A V-shaped arrangement of conductors, balanced-fed at the apex, and with included angle, length, and elevation proportioned to give the desired directivity. (48 IRE 2, 11, 15.S1)

**VAR (VHF Aural-Visual Range).** A special type of VHF range providing a pair of *Radial Lines of Position* which are reciprocal in *Bearing* and are displayed to the pilot on a zero-center, left-right indicator. This facility also provides a pair of reciprocal *Radial Lines of Position* located  $90^\circ$  from the above visually-indicated lines and these are presented to the pilot as aural A-N radio range signals. The A-N aural signals provide a means for differentiating between the two visually-indicated lines (and vice versa). (54 IRE 12.S1)

## Variable Area Track

**Variable Area Track.** A sound track divided laterally into opaque and transparent areas, a sharp line of demarcation between these areas forming an oscillographic trace of the wave shape of the recorded signal. (51 IRE 6.S1)

**Variable Density Track.** A sound track of constant width and usually, but not necessarily, of uniform light transmission on any instantaneous transverse axis and of which the average light transmission varies along the longitudinal axis in proportion to some characteristic of the applied signal. (51 IRE 6.S1)

**Variable-Inductance Pickup.** A phonograph pickup which depends for its operation on the variation of its inductance. (51 IRE 6.S1)

**Variable- $\mu$  Tube.** An *Electron Tube* in which the *Amplification Factor* varies in a predetermined way with *Control-Grid* voltage. (57 IRE 7.S2)

**Variable Reluctance Microphone (Magnetic Microphone).** A microphone which depends for its operation on variations in the reluctance of a magnetic circuit. (51 IRE 6.S1)

**Variable-Reluctance Pickup (Magnetic Pickup).** A phonograph pickup which depends for its operation on the variation in the reluctance of a magnetic circuit. (51 IRE 6.S1)

**Variable-Resistance Pickup.** A phonograph pickup which depends for its operation upon the variation of a resistance. (51 IRE 6.S1)

**Variation.** The angular difference between true and magnetic bearings. (49 IRE 12.S1)

**Varistor.** A two-electrode *Semiconductor Device* having a voltage-dependent nonlinear resistance. (54 IRE 7.S2)

**V-Beam Radar.** A *Volumetric Radar* system for the determination of distance, *Bearing* and height by the use of two *Fan Beams*. (54 IRE 12.S1)

**Vehicle.** That in or on which a person or thing is being or may be carried. (54 IRE 12.S1)

**Velocity.** Of a point, the time rate of change of a position vector of that point with respect to an inertial frame.

*Note:* In most cases the approximation is made that axes fixed to the earth constitute an inertial frame.

(51 IRE 6.S1)

**Velocity Level.<sup>1</sup>** In decibels, of a sound, 20 times the logarithm to the base 10 of the ratio of the particle velocity of the sound to the reference particle velocity. The reference particle velocity shall be stated explicitly.

<sup>1</sup> See note under *Intensity Level*.

## Vestigial-Sideband Transmitter

*Note:* It is to be noted that in many sound fields the particle velocity ratios are not proportional to the square root of corresponding power ratios and hence cannot be expressed in decibels in the strict sense; however, it is common practice to extend the use of the decibel to these cases.

(51 IRE 6.S1)

**Velocity Microphone.** A microphone in which the electric output substantially corresponds to the instantaneous particle velocity in the impressed sound wave.

*Note:* A velocity microphone is a gradient microphone (see *Gradient Microphone*) of order one, and it is inherently bidirectional. (51 IRE 6.S1)

**Velocity-Modulated Oscillator.** An electron-tube structure in which the velocity of an electron stream is varied (velocity-modulated) in passing through a resonant cavity called a buncher. Energy is extracted from the bunched electron stream at a higher energy level in passing through a second cavity resonator called the catcher. Oscillations are sustained by coupling energy from the catcher cavity back to the buncher cavity. (48 IRE 2, 11, 15.S1)

**Velocity Modulation.** The process whereby a time variation in velocity is impressed on the electrons of a stream; also the condition existing in the stream subsequent to such a process. (56 IRE 7.S1; 57 IRE 7.S2)

**Velocity Sorting.** Any process of selecting electrons according to their velocities. (56 IRE 7.S1; 57 IRE 7.S2)

**Verification.** The process of checking the results of one data transcription against the results of another data transcription. Both transcriptions usually involve manual operations. See also *Check*. (56 IRE 8.S1)

**Vertex.** See *Node*. (50 IRE 4.S1)

**Vertically Polarized Wave.** A linearly polarized wave whose magnetic field vector is horizontal. (50 IRE 24.S1)

**Vertical Recording.** A mechanical recording in which the groove modulation is in a direction perpendicular to the surface of the recording medium. (51 IRE 6.S1)

**Vestigial Sideband.** The transmitted portion of the sideband which has been largely suppressed by a transducer having a gradual cut-off in the neighborhood of the carrier frequency, the other sideband being transmitted without much suppression. (56 IRE 9.S1)

**Vestigial Sideband Transmission.** That method of signal transmission in which one normal sideband and the corresponding *Vestigial Sideband* are utilized. (56 IRE 9.S1)

**Vestigial-Sideband Transmitter.** A transmitter in which one sideband and a portion

## VHF Aural-Visual Range

of the other are intentionally transmitted. (48 IRE 2, 11, 15.S1)

**VHF Aural-Visual Range.** See *VAR*. (54 IRE 12.S1)

**VHF Omnirange.** See *VOR*. (54 IRE 12.S1)

**Vibration Meter (Vibrometer).** An apparatus for the measurement of displacement, velocity, or acceleration of a vibrating body. (51 IRE 6.S1)

**Vibrato.** A musical embellishment which depends primarily upon periodic variations of frequency which are often accompanied by variations in amplitude and wave form.

*Note:* The quantitative description of the vibrato is usually in terms of the corresponding modulation of frequency, amplitude, wave form, or all three.

(51 IRE 6.S1)

**Video.** A term pertaining to the bandwidth and spectrum position of the signal resulting from television scanning.

*Note:* In current usage, *Video* means a bandwidth in the order of megacycles, and a spectrum position that goes with a dc carrier. (52 IRE 17.S1; 55 IRE 23.S1)

**Video-Frequency Amplifier.** A device capable of amplifying such signals as comprise periodic visual presentation. (48 IRE 2, 11, 15.S1)

**Video Integration.** A method of utilizing the redundancy of repetitive signals to improve the output signal-to-noise ratio, by summing the successive video signals. (54 IRE 12.S1)

**Video Mapping.** A procedure whereby a chart of an area is electronically superimposed on a *Radar Display*. (54 IRE 12.S1)

**Video Stretching.** In *Navigation*, a procedure whereby the duration of a video pulse is increased. (54 IRE 12.S1)

**Vidicon.** A *Camera Tube* in which a charge-density pattern is formed by photoconduction and stored on that surface of the photoconductor which is scanned by an electron beam, usually of low-velocity electrons. (57 IRE 7.S2)

**Virtual Cathode.** The locus of such a space-charge-potential minimum that only a portion of the electrons approaching it is transmitted, the remainder being reflected. (57 IRE 7.S2)

**Virtual Height.** The apparent height of an ionized layer determined from the time interval between the transmitted signal and the ionospheric echo at vertical incidence, assuming that the velocity of propagation is the velocity of light in a vacuum over the entire path. (50 IRE 24.S1)

**Visibility Factor (Display Loss).** The ratio of the minimum signal input power detectable by ideal instruments connected to the output of a receiver, to the minimum signal

## Voltage Amplification

power detectable by a human operator through a *Display* connected to the same receiver.

*Note:* The *Visibility Factor* may include the scanning loss.

(54 IRE 12.S1)

**Visual-Aural Radio Range.** A radio range which provides aural sector identification and visual course indication. The visual course of this range defines the primary navigation course and is flown by visual means. The aural sector identification results in an aural course at 90° to the visual course. (49 IRE 12.S1)

**Visual Aural Range.** See *VAR*. (54 IRE 12.S1)

**Visual Radio Range.** Any range facility the course of which is flown by visual instrumentation not associated with aural reception. (49 IRE 12.S1)

**Visual Transmitter.** All parts of a television transmitter which handle picture signals, whether exclusively or not. (48 IRE 2, 11, 15.S1)

**Volatile.** A term descriptive of a storage medium in which information cannot be retained without continuous power dissipation.

*Note:* Storage devices or systems employing nonvolatile media may or may not retain information in the event of planned or accidental power removal.

(56 IRE 8.S1)

**Voltage. See:**

*Anode Breakdown Voltage (Gas Tubes)*

*Anode Voltage Drop*

*Breakdown Voltage (of an Electrode of a Gas Tube)*

*Composite Controlling Voltage*

*Critical Anode Voltage (Multielectrode Gas Tubes)*

*Critical Grid Voltage (Multielectrode Gas Tubes)*

*Critical Voltage (Magnetrons)*

*Cutoff Voltage (Electron Tubes)*

*Electrode Voltage*

*Ignitor Voltage Drop (Switching Tubes)*

*Internal Correction Voltage (Electron Tubes)*

*Overvoltage (Radiation-Counter Tubes)*

*Peak Alternating Gap Voltage*

*Peak Forward Anode Voltage*

*Peak Inverse Anode Voltage*

*Starter Breakdown Voltage (Gas Tubes)*

*Starter Voltage Drop (Gas Tubes)*

*Synchronous Voltage (Traveling-Wave Tubes)*

*Target Cut-off Voltage (Camera Tubes)*

*Target Voltage (in a Camera Tube with Low-Velocity Scanning)*

*Tube Voltage Drop.*

(57 IRE 7.S2)

**Voltage Amplification.** 1) The ratio of the

magnitude of the voltage across a specified *Load Impedance* connected to a *Transducer* to the magnitude of the voltage across the input of the *Transducer*.

*Note 1:* If the input and/or output voltage consist of more than one component, such as multifrequency *Signal* or *Noise*, then the particular components used and their weighting must be specified.

*Note 2:* By custom this *Amplification* is often expressed in decibels by multiplying its common logarithm by 20.

(51 IRE 20.S2; 54 IRE 3.S1; 58 IRE 3.S1)

2) The ratio of the voltage produced at the output terminals of an amplifier, as a result of the voltage impressed at the input, to the voltage impressed at the input. (48 IRE 2, 11, 15.S1)

**Voltage Attenuation.** The ratio of the magnitude of the voltage across the input of the *Transducer* to the magnitude of the voltage delivered to a specified *Load Impedance* connected to the *Transducer*.

*Note 1:* If the input and/or output voltage consist of more than one component, such as multifrequency *Signal* or *Noise*, then the particular components used and their weighting must be specified.

*Note 2:* By custom this *Attenuation* is often expressed in decibels by multiplying its common logarithm by 20.

(54 IRE 3.S1; 58 IRE 3.S1)

**Voltage Generator.** A two-terminal circuit element with a terminal voltage independent of the current through the element.

*Note:* A *Voltage Generator* has zero internal impedance.

(57 IRE 7.S2)

**Voltage Jump (Glow-Discharge Tubes).** An abrupt change or discontinuity in *Tube Voltage Drop* during operation.

*Note:* This may occur either during life under constant operating conditions or as the current or temperature is varied over the operating range.

(57 IRE 7.S2)

**Voltage Reference Tube.** A *Gas Tube* in which the *Tube Voltage Drop* is approximately constant over the operating range of current and relatively stable with time at fixed values of current and temperature. (57 IRE 7.S2)

**Voltage Regulator Tube.** A *Gas Tube* in which the *Tube Voltage Drop* is approximately constant over the operating range of current. (57 IRE 7.S2)

**Volume.** The magnitude of a complex *Audio-Frequency* wave in an electric circuit as measured on a *Standard Volume Indicator*. The *Volume* is expressed in *vu*. In addition,

the term *Volume* is used loosely to signify either the intensity of a sound or the magnitude of an *Audio-Frequency* wave. (54 IRE 3.S1; 58 IRE 3.S1)

**Volume Control.** See *Gain Control*. (58 IRE 3.S1)

**Volume Indicator.** See *Standard Volume Indicator*. (58 IRE 3.S1)

**Volume Limiter—Deprecated.** See *Peak Limiter*. (58 IRE 3.S1)

**Volume-Limiting Amplifier.** An amplifier containing an automatic device which functions when the input volume exceeds a predetermined level, and so reduces the gain that the output volume is thereafter maintained substantially constant notwithstanding further increase in the input volume. The normal gain of the amplifier is restored when the input volume returns below the predetermined limiting level. (48 IRE 2, 11, 15.S1)

**Volumetric Radar.** A *Radar* capable of producing three-dimensional *Position* data on a multiplicity of *Targets*.

*Note:* This definition includes but is not limited to volumetric scan.

(54 IRE 12.S1)

**Volume Velocity.** The rate of flow of the medium through a specified area due to a sound wave.

*Note:* The terms "instantaneous volume velocity," "effective volume velocity," "maximum volume velocity," and "peak volume velocity" have meanings which correspond with those of the related terms used for sound pressure.

(51 IRE 6.S1)

**VOR (VHF Omnidirectional Range).** A specific type of range operating at VHF and providing *Radial Lines of Position* in any *Direction* as determined by *Bearing* selection within the receiving equipment. This facility emits a nondirectional "reference" modulation and a rotating pattern which develops a "variable" modulation of the same frequency as the reference modulation. *Lines of Position* are determined by comparison of phase of the variable with that of the reference. (54 IRE 12.S1)

**Vowel Articulation (Per Cent Vowel Articulation).**<sup>1</sup> The per cent articulation obtained when the speech units considered are vowels (usually combined with consonants into meaningless syllables). (51 IRE 6.S1)

**VSWR, High-Level (Switching Tubes).** See *High-Level VSWR (Switching Tubes)*. (57 IRE 7.S2)

<sup>1</sup> See notes under *Articulation (Per Cent Articulation)* and *Intelligibility (Per Cent Intelligibility)*.

**vu.** A quantitative expression for *Volume* in an electric circuit.

*Note 1:* *vu* is pronounced "vee-you" and customarily written with lower case letters.

*Note 2:* The *Volume* in *vu* is numerically equal to the number of decibels which expresses the ratio of the magnitude of the waves to the magnitude of *Reference Volume*.

*Note 3:* The term *vu* should not be used to express results of measurements of complex waves made with devices having characteristics differing from those of the *Standard Volume Indicator*.

(58 IRE 3.S1)

## W

**Wander.** See *Scintillation*. (54 IRE 12.S1)

**Wave.** 1) A disturbance which is a function of time or space or both. (48 IRE 2, 11, 15.S1)

2) A physical activity in a medium such that at any point in the medium some of the associated quantities vary with time, while at any instant of time, they vary with position. (50 IRE 24.S1)

See *Backward Wave (Traveling-Wave Tubes)* and *Forward Wave (Traveling-Wave Tubes)*. (57 IRE 7.S2)

**Wave Antenna (Beverage Antenna).** A directional antenna composed of a system of parallel, horizontal conductors from one-half to several wavelengths long, and terminated to ground at the far end in its characteristic impedance. (48 IRE 2, 11, 15.S1)

**Waveform-Amplitude Distortion. Nonlinear Distortion** in the special case where the desired relationship is direct proportionality between input and output.

*Note:* Also sometimes called *Amplitude Distortion*.

(53 IRE 4.S1)

**Wave Front.** Of a signal-wave envelope, that part (in time or distance) between the initial point of the envelope and the point at which the envelope reaches its crest. (42 IRE 9.S1)

**Waveguide.** A system of material boundaries capable of guiding waves. (50 IRE 24.S1; 53 IRE 2.S1)

**Waveguide Wavelength.** For a *Traveling Plane Wave* at a given frequency, the distance along the guide between points at which a field component (or the voltage or current) differs in phase by  $2\pi$  radians. (53 IRE 2.S1)

**Wave Heating.** The heating of a material by energy absorption from a traveling electromagnetic wave. (55 IRE 10.S1)

**Wave Interference.** The variation of wave amplitude with distance or time, caused by

## White-to-Black Frequency Swing

the superposition of two or more waves.

*Note:* As most commonly used, the term refers to the interference of waves of the same or nearly the same frequency.

(50 IRE 24.S1)

**Wavelength.** In a periodic wave, the distance between points of corresponding phase of two consecutive cycles. The wavelength  $\lambda$  is related to the phase velocity,  $v$ , and the frequency,  $f$ , by  $\lambda = v/f$ . (50 IRE 24.S1)

**Wave Normal.** A unit vector normal to an equiphase surface with its positive direction taken on the same side of the surface as the *Direction of Propagation*. In isotropic media, the wave normal is in the *Direction of Propagation*. (50 IRE 24.S1; 53 IRE 2.S1)

**Wave Tail.** Of a signal-wave envelope, that part (in time or distance) between the termination of the steady-state value (or crest when the steady-state value is not reached) and the end of the envelope. (42 IRE 9.S1)

**Wax.** In mechanical recording, wax refers to a blend of waxes with metallic soaps. See also *Cake Wax*. (51 IRE 6.S1)

**Wax Original (Wax Master)—Deprecated.** An original recording on a wax surface for the purpose of making a master (51 IRE 6.S1)

**Way Point.** A selected point on a *Course Line* having some particular significance. (54 IRE 12.S1)

**Weighting.** The artificial adjustment of measurements in order to account for factors which, in the normal use of the device, would otherwise be different from the conditions during measurement. For example, background noise measurements may be weighted by applying factors or by introducing networks to reduce measured values in inverse ratio to their interfering effects. (48 IRE 2, 11, 15.S1)

**White.**

*Note:* In color television, the term *White* is used most commonly in the nontechnical sense. More specific usage is covered by the term *Achromatic Locus*, and this usage is explained in the *Note* under the term *Achromatic Locus*.

(55 IRE 22.S1)

**White-to-Black Amplitude Range.** In a positive amplitude-modulation facsimile system, the signal-voltage or -current ratio of picture white to picture black at any point in the system. In a negative amplitude-modulation system, it is the signal-voltage or -current ratio of picture black to picture white.

*Note:* This ratio is often expressed in decibels.

(42 IRE 9.S1)

**White-to-Black Frequency Swing.** In a fre-

quency-modulation facsimile system, the numerical difference between the signal frequencies corresponding to picture white and picture black at any point in the system. (42 IRE 9.S1)

**White Compression (White Saturation).** The reduction in gain applied to a *Picture Signal* at those *Levels* corresponding to light areas in a picture with respect to the gain at that *Level* corresponding to the midrange light value in the picture.

*Note 1:* The gain referred to in the definition is for a signal amplitude small in comparison with the total peak-to-peak *Picture Signal* involved. A quantitative evaluation of this effect can be obtained by a measurement of *Differential Gain*.

*Note 2:* The over-all effect of *White Compression* is to reduce contrast in the highlights of the picture as seen on a monitor. (55 IRE 23.S1)

**White Object.** An object which reflects all wavelengths of light with substantially equal high efficiencies and with considerable diffusion. (55 IRE 22.S1)

**White Peak.** A peak excursion of the *Picture Signal* in the white direction. (55 IRE 23.S1)

**White Recording.** In an amplitude-modulation system, that form of *Recording* in which the maximum received power corresponds to the minimum *Density* of the *Record Medium*. In a frequency-modulation system that form of *Recording* in which the lowest received frequency corresponds to the minimum *Density* of the *Record Medium*. (56 IRE 9.S1)

**White Signal.** The signal at any point in a *Facsimile System* produced by the *Scanning* of a minimum *Density* area of the *Subject Copy*. (56 IRE 9.S1)

**White Transmission.** In an amplitude-modulation system, that form of transmission in which the maximum transmitted power corresponds to the minimum *Density* of the *Subject Copy*. In a frequency-modulation system, that form of transmission in which the lowest transmitted frequency corresponds to the minimum *Density* of the *Subject Copy*. (56 IRE 9.S1)

**Whole Tone (Whole Step).** The interval between two sounds whose basic frequency ratio is approximately equal to the sixth root of two. (51 IRE 6.S1)

**Wide-Band Axis.** In phasor representation of the *Chrominance Signal*, the direction of the phasor representing the *Fine Chrominance Primary*. (55 IRE 22.S1)

**Wide-Band Improvement.** The ratio of the signal-to-noise ratio of the system in question

to the signal-to-noise ratio of a reference system.

*Note:* In comparing frequency-modulation and amplitude-modulation systems, the reference system usually is a double-sideband amplitude-modulation system with a carrier power, in the absence of modulation, which is equal to the carrier power of the frequency-modulation system.

(48 IRE 2, 11, 15.S1)

**Wide-Band Ratio.** The ratio of the occupied frequency bandwidth to the intelligence bandwidth. (48 IRE 2, 11, 15.S1)

**Williams-Tube Storage.** A type of electrostatic storage. (56 IRE 8.S1)

**Winding.** A conductive path, usually of wire, inductively coupled to a magnetic core or cell. When several windings are employed, they may be designated by the functions performed. Examples are: sense, bias, and drive windings. Drive windings include read, write, inhibit, set, reset, input, shift, and advance windings. (59 IRE 8.S1)

**Word (in Electronic Computers).** An ordered set of *Characters* which is the normal unit in which information may be stored, transmitted, or operated upon within a computer. (56 IRE 8.S1)

**Word Time.** Synonym for *Minor Cycle*. (56 IRE 8.S1)

**Work Coil.** See *Load Coil (Induction Heating usage)*. (55 IRE 10.S1)

**Work Function.** The minimum energy required to remove an electron from the Fermi level of a material into field-free space.

*Note:* *Work Function* is commonly expressed in electron volts.

(57 IRE 7.S2)

**Wow.** A low-frequency flutter. (52 IRE 17.S1)

**Wrap.** See *Tape-Wound Core*. (59 IRE 8.S1)

**Wrap Thickness.** See *Tape-Wound Core*. (59 IRE 8.S1)

**Wrap Width.** Synonym for *Tape-Width*. See *Tape-Wound Core*. (59 IRE 8.S1)

**Write.** To introduce information, usually into some form of storage. See also *Read*. (56 IRE 8.S1)

**Write (Charge-Storage Tubes).** To establish a charge pattern corresponding to the input. (57 IRE 7.S2)

**Write Pulse.** See *One State*. (59 IRE 8.S1)

**Writing Speed (Charge-Storage Tubes).** The rate of *Writing* on successive *Storage Elements*. (57 IRE 7.S2)

**Wye Junction.** A junction of waveguides such that the longitudinal guide axes form a Y. (55 IRE 2.S1)

## X-Y-Z

**X Wave.** See *Extraordinary-Wave Component*. (50 IRE 24.S1)

## Y Network

**Y Network.** A star network of three branches. (50 IRE 4.S1)

**Zero Output.** See *One State*. (59 IRE 8.S1)

**Zero State.** See *One State*. (59 IRE 8.S1)

**Zero-Subcarrier Chromaticity.** The *Chromaticity* which is intended to be displayed when the subcarrier amplitude is zero. (55 IRE 22.S1)

**Zero Time Reference.** The time reference of the schedule of events in a cycle of operation of a *Radar*. (54 IRE 12.S1)

**Z (Zone) Marker.** A VHF radio station designed to radiate vertically and used to define a zone above a *Radio Range* station. (54 IRE 12.S1)

**Zone Leveling (Pertaining to Semiconductor Processing).** The passage of one or more molten zones along a semiconductor body for

## Zoning

the purpose of uniformly distributing *Impurities* throughout the material. (54 IRE 7.S2)

**Zone (Z) Marker.** A VHF radio facility located at airways radio range stations to indicate position above such ranges. (49 IRE 12.S1)

**Zone Purification (Pertaining to Semiconductor Processing).** The passage of one or more molten zones along a semiconductor for the purpose of reducing the *Impurity* concentration of part of the ingot. (54 IRE 7.S2)

**Zoning (Stepping).** The displacement of various portions (called zones, or steps) of the lens or surface of the reflector so that the resulting phase front in the near field remains unchanged. (48 IRE 2, 11, 15.S1)



## **Graphical Symbols**



# LETTER SYMBOLS FOR ELECTRON TUBES\*

## 102. SPECIAL PRINCIPLES

### 102.1. Applications to Electrical Circuits

102.11. Instantaneous values of current, voltage, and power which vary with time are represented by the lower-case letter of the proper symbol.

Example:  $i, e, p, i_p, e_a$ .

102.12. Maximum, average, and root-mean-square values are represented by the upper-case letter of the proper symbol.

Example:  $I, E, P, I_p, E_p$ .

If necessary to distinguish between maximum, average, or root-mean-square values:

Maximum values may be represented by the subscript "m."

Example:  $E_m, I_m, E_{pm}$ .

Average values may be represented by the subscript "av."

Example:  $E_{av}, I_{pav}$ .

Root-mean-square or effective values may be represented by the upper-case letter without subscript.

Example:  $E, I, E_p, I_p$ .

### 102.2. Applications to Electron Tube Circuits

102.21. External. Values of resistance, impedance, admittance, etc., in the external circuit of an electrode may be represented by the upper-case symbols for the quantities with the proper electrode subscripts.

Example:  $R_j, Z_j, Y_j, R_p, Z_p, Y_p, C_{gp}$ .

102.22. Inherent. Values of resistance, impedance, admittance, etc., inherent in the tube may be represented by the lower-case symbol with the proper electrode subscripts.

Example:  $r_{jk}, z_j, y_j, r_p, z_p, y_p, c_{gp}$ .

### 102.3. Applications for Electron Tubes

102.31. Symbols for quantities in electrode circuits of electron tubes are developed from the proper quantity symbol and subscripts representing the electrodes concerned. When one of the electrodes concerned is the cathode, the subscript "k" may be omitted and the single subscript understood to mean "with respect to the cathode."

102.32. The electrode abbreviations to be used as subscripts are:

- $j$  general (convention for any electrode)
- $f$  filament
- $h$  heater
- $k$  cathode
- $g$  grid ( $c$  also used; see 102.36)
- $p$  plate or anode ( $b$  also used; see 102.36)
- $s$  metal shell, or other self-shielding envelope
- $d$  deflecting, reflecting, or repelling electrode (electrostatic type).

Example:  $e_{jk}, e_j, E_{pk}, E_p, C_{gp}$ .

102.33. Grid subscripts for multigrad tubes are developed by a numerical addition to the subscript. Grids are numbered according to position out from the cathode. When no numerical subscript appears, reference to the

control grid is assumed.

Example:  $e_{g1}, e_{g2}, c_{g1g2}, e_p$ .

102.34. Deflection electrode subscripts for cathode-ray tubes are developed by a numerical addition to the subscript.

Example:  $e_{d1d2}, e_{d1d3}, e_{d2d3}$ .

102.35. In a double-subscript symbol, when the direction of the relationship is significant, the first subscript should designate the electrode circuit in which the effect (product of the multiplying operation) is measurable; and the second subscript should designate the electrode circuit in which the cause (operand or multiplicand) is measurable. This subscript sequence conforms to the mathematical convention for writing determinants from a set of fundamental Kirchhoff's equations.

Example:  $g_{12}, g_{21}, g_{p2}, g_{2p}$ .

102.36. When necessary to distinguish between components of current and voltage encountered in electron-tube circuits, the following symbols may be used. Their application to the case of a tube having a small varying component in the plate circuit is illustrated in the accompanying diagram in Fig. 1.

102.361. Instantaneous current and voltage values of a varying component may be represented by lower-case symbols with the subscripts "g" and "p" for grid and plate, respectively.

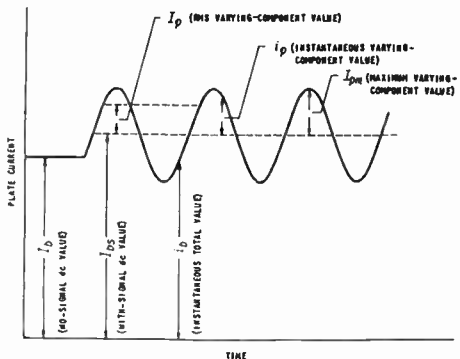

Fig. 1.

Example:  $e_p, i_p, e_{gp}$ .

102.362. Instantaneous total values of current and voltage (no-signal dc value plus varying-component value) may be represented by lower-case symbols and the subscripts "b" for plate and "c" for grid.

Example:  $i_b, e_c, i_{cb}$ .

102.363. Root-mean-square and maximum current and voltage values of a varying component may be represented by upper-case symbols and the subscripts given in 102.361.

Example:  $E_p, I_p, E_{gp}$ .

102.364. Values of current and voltage for the no-signal or static condition may be represented by upper-

\* Reprinted from "IRE Standards on Letter Symbols and Mathematical Signs, 1948 (57 IRE 21.51)"

## IRE Dictionary on Terms and Symbols

case symbols and the subscripts given in 102.362.

Example:  $E_{cb}$ ,  $I_b$ ,  $E_c$ .

102.365. Average values of current and voltage for the with-signal condition may be represented by the addition of the subscript "s" to symbols determined in accordance with 102.364.

Example:  $I_{bs}$ ,  $E_{cb_s}$ ,  $E_{bs}$ .

102.366. Supply voltages for electron tube elements may be represented by upper-case symbols and doubling the electrode subscripts indicated in 102.362 plus "ff" for the case of heater or filament supply.

Example:  $E_{ff}$ ,  $E_{cc}$ ,  $E_{bb}$ ,  $E_{cc}$ .



# LETTER SYMBOLS FOR SEMICONDUCTOR DEVICES\*

## 1. Electrical Quantities

### 1.1 Quantity Symbols

1.1.1 Instantaneous values of current, voltage, and power, which vary with time, are represented by the lower case letter of the proper symbol.  
Examples:  $i, v, i_e, v_{EB}$

1.1.2 Maximum, average (dc), and root-mean-square values are represented by the upper case letter of the proper symbol.  
Examples:  $I, V, I_e, V_{KB}$

### 1.2 Subscripts for Quantity Symbols

1.2.1 DC values and instantaneous total values are indicated by upper case subscripts.  
Examples:  $I_C, I_{C1}, v_{EB}, V_{EB}, P_C, P_C$

1.2.2 Varying component values are indicated by lower case subscripts.  
Examples:  $i_c, I_c, v_{cb}, V_{cb}, p_c, P_c$

1.2.3 If necessary to distinguish between maximum, average, or root-mean-square values; maximum or average values may be represented by the addition of a subscript  $m$  or  $av$ .  
Examples:  $i_{cm}, I_{cm}, I_{Cm}, I_{cav}, i_{CAV}$

1.2.4 Abbreviations to be used as subscripts. (For example, see Fig. 1 and Basic Symbols Chart 1.2.5.)

- $E, e$  = emitter electrode
- $B, b$  = base electrode
- $C, c$  = collector electrode
- $J, j$  = electrode, general
- $X, x$  = circuit node
- $M, m$  = maximum value
- $A, av$  = average value
- $Q$  = average (dc) value with signal applied.

### 1.2.5 Basic Symbols Chart (Table I)

TABLE I

SYMBOLS	
$i, v, p$	
$e$ $b$ $c$ $j$	Instantaneous Varying Component Value
$E$ $B$ $C$ $J$	Instantaneous Total Value
	$I, V, P$
	RMS or Effective Varying Component Value
	Average (dc) Value

### 1.3 The Subscript Sequence Conforms to the Mathematical Convention for Writing Determinants from a Set of Fundamental Kirchoff's Equations

1.3.1 The first subscript designates the electrode at which the current is measured, or where the electrode potential is measured with respect to the reference electrode, or circuit node, designated by the second subscript. (Conventional current flow into the electrode from the external circuit is positive.) When the reference electrode

or circuit node is understood, the second subscript may be omitted, where its use is not required to preserve the meaning of the symbol.

1.3.2 Supply voltage may be indicated by repeating the electrode subscript. The reference electrode may then be designated by the third subscript. Examples:  $V_{EB}, V_{CC}, V_{BB}, V_{EBB}, V_{CCB}, V_{BBC}$ .

1.3.3 In devices having more than one electrode of the same type, the electrode subscripts are modified by adding a number following the subscript and on the same line.  
Example:  $B2$

In multiple unit devices the electrode subscripts are modified by a number preceding the electrode subscript.  
Example:  $B2$

Wherever ambiguity might arise the complete electrode designations are separated by hyphens or commas.  
Example:  $V_{1C1-2C1}$

1.3.4 When necessary to distinguish between components of current or voltage the symbols may be used as shown in Fig. 1. The illustration shows a case where a small varying component is developed in the collector circuit of a transistor.

## 2. Electrical Parameters

### 2.1 Parameter Symbols

2.1.1 Values of four-pole matrix parameters, or other resistances, impedances, admittances, etc., inherent in the device, may be represented by the lower case symbol with the proper subscripts. Examples:  $h_{ib}, z_{fb}, y_{oe}, \alpha_{fb}, h_{TB}, \alpha_{FB}$

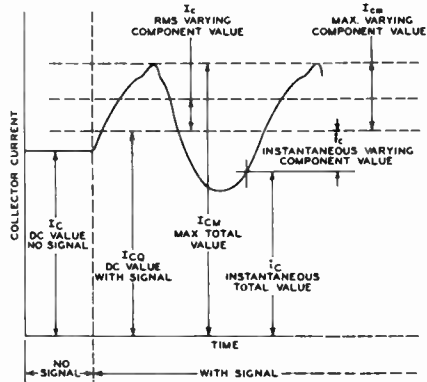

Fig. 1—Illustration of proper symbol usage.

2.1.2 Values of four pole matrix parameters or other resistances, impedances, admittances, etc., in the external circuits, may be represented by the upper case symbols with the appropriate subscripts.

\* Reprinted from "IRE Standards on Letter Symbols for Semiconductor Devices, 1956 (56 IRE 28.S1)"

# IRE Dictionary on Terms and Symbols

## 2.2 Subscript for Parameter Symbols

2.2.1 Static<sup>1</sup> values of parameters are indicated by the upper case subscript.

Examples:  $r_B$ ,  $h_{IB}$ ,  $\alpha_{FB}$

2.2.2 Small-signal values of parameters are indicated by the lower case subscript.

Examples:  $r_b$ ,  $y_c$ ,  $h_{ib}$ ,  $z_{ob}$ ,  $\alpha_{fb}$

2.2.3 The first subscript or subscript pair in matrix notation, identifies the element of the four-pole matrix.

$i$  or  $11$  = input

$o$  or  $22$  = output

$f$  or  $21$  = forward transfer

$r$  or  $12$  = reverse transfer

Examples:  $V_i = h_i I_i + h_r V_o$        $V_1 = h_{11} I_1 + h_{12} V_2$   
 $I_o = h_f I_i + h_o V_o$        $I_2 = h_{21} I_1 + h_{22} V_2$

*Note:* Voltage and current symbols in matrix notation are designated with a single digit subscript. The subscript 1 = input. The subscript 2 = output.

2.2.4 The second subscript or the subscript following the numeric pair identifies the circuit configuration. When the common electrode is understood, the second subscript may be omitted.

$e$  = common emitter

$b$  = common base

$c$  = common collector

$j$  = common electrode, general.

Examples: (common base)

$I_i = y_{ib} V_{ib} + y_{ob} V_{ob}$        $I_1 = y_{11b} V_{1b} + y_{12b} V_{2b}$

$I_o = y_{fb} V_{ib} + y_{ob} V_{ob}$        $I_2 = y_{21b} V_{1b} + y_{22b} V_{2b}$

<sup>1</sup> The static value is the slope of the line from the origin to the operating point on the appropriate characteristic curve.

2.2.5 Electrical parameters characterizing the behavior of a device with associated circuitry are designated by upper case symbols with an appropriate subscript; e.g.,  $Z_i$ ,  $Z_o$ . The termination may be indicated by an additional subscript such as:  $o$  = ac open circuit termination;  $s$  = ac short-circuit termination;  $a$  or other appropriate subscript for other terminations. This additional subscript may be omitted.

Examples:  $Z_{io}$ ,  $Z_{is}$ ,  $Z_{ia}$ ,  $Z_{i\ match}$

## 3. Letter Symbols in Alphabetical Order

The following list has been compiled according to the conventions set forth in Sections 1 and 2 of this Standard.

In general, the first symbol given for each electrical quantity or parameter illustrates the basic symbol with the subscript which designates the reference electrode or common electrode. (See Sections 1.3.1 and 2.2.5.) The transfer ratio of the current generator shunting the collector branch low-frequency equivalent circuit is shown in Fig. 2.

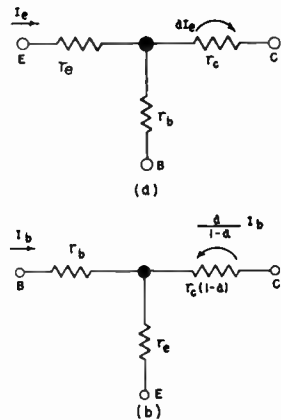

Fig. 2—Low frequency  $T$  equivalent circuit. (a) base common; (b) emitter common.

$\alpha_{FB}$ ,  $\alpha_{FB}$ ,  $\alpha_{FC}$ ,  $\alpha_{FR}$ .—The static value of the short-circuit forward current transfer ratio.<sup>2</sup>

$\alpha_f$ ,  $\alpha_{fb}$ ,  $\alpha_{fc}$ ,  $\alpha_{fr}$ .—The small-signal short-circuit forward current transfer ratio.<sup>2</sup>

$\alpha_R$ ,  $\alpha_{RB}$ ,  $\alpha_{RC}$ ,  $\alpha_{RR}$ .—The static value of the short-circuit reverse current transfer ratio.<sup>2</sup>

$\alpha_r$ ,  $\alpha_{rb}$ ,  $\alpha_{rc}$ ,  $\alpha_{rr}$ .—The small-signal short-circuit reverse current transfer ratio.<sup>2</sup>

<sup>2</sup> The algebraic sign of  $\alpha$  for the common base configuration is taken as positive in accordance with established usage, therefore  $\alpha_{fb} = -h_{fb} = -h_{21b}$ .

## Letter Symbols for Semiconductor Devices

$C_o, C_{ob}, C_{or}, C_{os}$ —The capacitance measured across the output terminals with the input open-circuited to ac.

$f_a, f_{ob}, f_{or}, f_{os}$ —The frequency at which the magnitude of the small-signal short-circuit forward current transfer ratio is 0.707 of the low-frequency value.

$h_F, h_{FB}, h_{FC}, h_{FE}$ —The static value of the short-circuit forward current transfer ratio.

$h_f, h_{fb}, h_{fc}, h_{fe}, h_{21}, h_{21b}, h_{21c}, h_{21e}$ —The small-signal short-circuit forward current transfer ratio.

$h_i, h_{iB}, h_{iC}, h_{iE}$ —The static value of the short-circuit input resistance.

$h_o, h_{ob}, h_{oc}, h_{oc}, h_{11}, h_{11b}, h_{11c}, h_{11e}$ —The small-signal value of the short-circuit input impedance.

$h_O, h_{OB}, h_{OC}, h_{OE}$ —The static value of the open-circuit output conductance.

$h_s, h_{sb}, h_{sc}, h_{se}, h_{22}, h_{22b}, h_{22c}, h_{22e}$ —The small-signal value of the open-circuit output admittance.

$h_K, h_{KB}, h_{KC}, h_{KE}$ —The static value of the open-circuit reverse voltage transfer ratio.

$h_r, h_{rb}, h_{rc}, h_{re}, h_{12}, h_{12b}, h_{12c}, h_{12e}$ —The small-signal value of the open-circuit reverse voltage transfer ratio.

$I_{HO}, I_{BEO}, I_{BCO}$ —The base current when the base is biased in the reverse (high resistance) direction with respect to the reference electrode and the other electrode(s) is dc open-circuited (to the reference electrode).

$I_{HS}, I_{BES}, I_{BCS}$ —The base current when the base is biased in the reverse (high resistance) direction with respect to the reference electrode and the other electrode(s) is dc short-circuited (to the reference electrode).

$I_{CO}, I_{CBO}, I_{CBO}$ —The collector current when the collector is biased in the reverse (high resistance) direction with respect to the reference electrode and the other electrode(s) is dc open-circuited (to the reference electrode).

$I_{CS}, I_{CES}, I_{CBS}$ —The collector current when the collector is biased in the reverse (high resistance) direction with respect to the reference electrode and the other electrode(s) is dc short-circuited (to the reference electrode).

$I_{EO}, I_{EBO}, I_{ECO}$ —The emitter current when the emitter is biased in the reverse (high resistance) direction with respect to the reference electrode and the other electrode(s) is dc open-circuited (to the reference electrode).

$I_{ES}, I_{ES}, I_{ES}$ —The emitter current when the emitter is biased in the reverse (high resistance) direction with respect to the reference electrode and the other electrode(s) is dc short-circuited (to the reference electrode).

$r_b$ —Resistance of the base branch of the low-frequency equivalent circuit shown in Fig. 2.

$r_c$ —Resistance of the collector branch of the low-frequency equivalent circuit shown in Fig. 2.

$r_e$ —Resistance of the emitter branch of the low-frequency equivalent circuit shown in Fig. 2.

$r_m$ —The product of  $a$  and  $r_e$  of the low-frequency equivalent circuit shown in Fig. 2.

$t_d$ —The ohmic delay time is the time interval between the rise of a pulse applied at the input terminals and the rise of the minority-carrier-generated pulse appearing at the output terminals.

$t_s$ —The storage time is the time interval between the fall of a pulse applied to the input terminals and the fall of the carrier-generated pulse at the output terminals.

$V_{CF}, V_{CHF}, V_{EF}, V_{EFF}, V_{CFF}, V_{CFF}, V_{BF}, V_{BEF}, V_{BCF}$ —The dc open-circuit voltage (floating potential) between the electrode indicated by the first subscript and the reference electrode when the other electrode is biased in the reverse (high resistance) direction with respect to the reference electrode.

$BV_{CO}, BV_{CBO}, BV_{CBO}, BV_{SO}, BV_{EBO}, BV_{ECO}, BV_{BO}, BV_{BBO}, BV_{BCO}$ —The breakdown voltage between the electrode indicated by the first subscript when it is biased in the reverse (high resistance) direction with respect to the reference electrode and the other electrode is open-circuited.

$\mu_f, \mu_{fb}, \mu_{fc}, \mu_{fe}$ —The small-signal open-circuit forward voltage-transfer ratio.

$\mu_r, \mu_{rb}, \mu_{rc}, \mu_{re}$ —The small-signal open-circuit reverse voltage-transfer ratio.

$\mu_F, \mu_{FB}, \mu_{FC}, \mu_{FE}$ —The static value of the open-circuit forward voltage-transfer ratio.

$\mu_K, \mu_{KB}, \mu_{KC}, \mu_{KE}$ —The static value of the open-circuit reverse voltage-transfer ratio.

$y_f, y_{fb}, y_{fc}, y_{fe}, y_{21}, y_{21b}, y_{21c}, y_{21e}$ —The small-signal short-circuit forward transfer admittance.

$y_i, y_{ib}, y_{ic}, y_{ie}, y_{11}, y_{11b}, y_{11c}, y_{11e}$ —The small-signal short-circuit input admittance.

$y_o, y_{ob}, y_{oc}, y_{oc}, y_{22}, y_{22b}, y_{22c}, y_{22e}$ —The small-signal short-circuit output admittance.

$y_r, y_{rb}, y_{rc}, y_{re}, y_{12}, y_{12b}, y_{12c}, y_{12e}$ —The small-signal short-circuit reverse transfer admittance.

$z_f, z_{fb}, z_{fc}, z_{fe}, z_{21}, z_{21b}, z_{21c}, z_{21e}$ —The small-signal open-circuit forward transfer impedance.

$z_i, z_{ib}, z_{ic}, z_{ic}, z_{11}, z_{11b}, z_{11c}, z_{11e}$ —The small-signal open-circuit input impedance.

$z_o, z_{ob}, z_{oc}, z_{oc}, z_{22}, z_{22b}, z_{22c}, z_{22e}$ —The small-signal open-circuit output impedance.

$z_r, z_{rb}, z_{rc}, z_{rc}, z_{12}, z_{12b}, z_{12c}, z_{12e}$ —The small-signal open-circuit reverse transfer impedance.

$z_{fs}, z_{fbs}, z_{fcs}, z_{fes}$ —(The reciprocal of  $y_f$ .) The small-signal short-circuit forward transfer impedance.

$z_{is}, z_{ibs}, z_{ics}, z_{ies}$ —The small-signal short-circuit input impedance.

$z_{os}, z_{obs}, z_{ocs}, z_{oes}$ —The small-signal short-circuit output impedance.

$z_{rs}, z_{rbs}, z_{rcs}, z_{res}$ —The small-signal short-circuit reverse transfer impedance (the reciprocal of  $y_r$ ).

# GRAPHICAL AND LETTER SYMBOLS FOR FEEDBACK CONTROL SYSTEMS\*

## II. GRAPHICAL SYMBOLS FOR BLOCK DIAGRAMS

### 2.1 Transfer Element



2.1.1 A transfer element represents the functional relationships ( $g_{12}$ ) between a single input signal ( $x_1$ ) and a single output signal ( $x_2$ ), in which the input signal, indicated by the arrow, is the independent variable.

### 2.2 Mixing Point



2.2.1 The indicated relationship is  $x_2 = f(x_1, x_3)$ .

### 2.3 Summing Point



2.3.1 The indicated relationships are  $x_3 = x_1 - x_4$  and  $x_5 = x_1 - x_2 + x_3 - x_4$ . A summing point is a special case of the mixing point and indicates the algebraic addition of two or more signals to produce one output signal. An algebraic sign should be indicated at the arrowhead for each signal to be added. If the number of input signals to be added is large the rectangular symbol should be used.

### 2.4 Multiplication Point



2.4.1 The indicated relationship is  $x_3 = x_1 x_2$ . A multiplication point is a special case of the mixing point.

### 2.5 Branch Point



2.5.1 A branch point, which indicates that a signal is distributed to two or more points in a block diagram is represented by a heavy dot. Example:

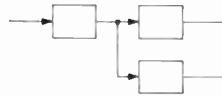

2.6 Graphical symbols added to a block diagram for mathematical purposes shall be shown dotted to indicate that they do not represent components of the physical system.

## III. STANDARD FOR LETTER SYMBOLS

### 3.1 Essential Features of the System of Symbols

#### 3.1.1 Signals

Signals are represented by a single letter symbol with a single subscript denoting its physical or mathematical meaning. The letter  $x$  has been chosen as the preferred symbol for generalized signals. Lower case represents the time domain. Upper case represents the complex frequency domain.

#### 3.2 Transfer Functions

Transfer functions are represented by a single letter symbol with a double subscript, the first letter or number of which is the subscript of the symbol for the input signal and the second of which is the subscript of the symbol for the output signal. The symbol  $g$  has been chosen. Lower case represents the time domain. Upper case represents the complex frequency domain.

## IV. EXAMPLES

4.1 Application of the standard graphical symbols and the standard form for letter symbols are illustrated in the typical block diagrams below:

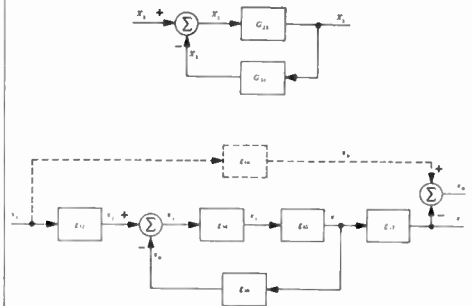

\* Reprinted from "IRE Standards on Graphical and Letter Symbols for Feedback Control Systems, 1955 (55 IRE 26.S1)"



# GRAPHICAL SYMBOLS FOR SEMICONDUCTOR DEVICES\*

## 1.0 BASIC RULES AND SYMBOL ELEMENTS

This section sets forth the basic rules and symbol elements for the construction of graphical symbols for semiconductor devices. See 1.17 for full details of graphical construction.

1.1 Semiconductor region with one ohmic connection. (In the illustration, the horizontal line indicates the base region and the vertical line indicates the ohmic connection.)



1.2 Semiconductor region with a plurality of ohmic connections. (In the illustrations, the horizontal line indicates base regions and the vertical lines indicate ohmic connections.)



1.3 Transition between *P* and *N* regions (either *P* to *N* or *N* to *P*). (Slant lines indicating transitions shall be appreciably shorter than collector and emitter lines. Note that the transition is along the horizontal line and that no ohmic connection is made to the slant line. See 2.9 and 2.11 as examples.)

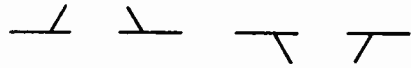

1.4 Intrinsic (*I*) region between regions of dissimilar conductivity type. (Slant lines indicating transitions shall be appreciably shorter than collector and emitter lines. Note that the transition is along the horizontal line and that no ohmic connection is made to the slant line. See 2.14 and 2.15 as examples.)



1.5 Intrinsic (*I*) region between regions of similar conductivity type. (Slant lines indicating transitions shall be appreciably shorter than collector and emitter lines. Note that the transition is along the horizontal line and that no ohmic connection is made to the slant line. See 2.16 and 2.17 as examples.)



1.6 *P* region on *N* region (rectifying junction).

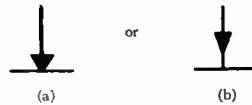

1.7 *P* emitter on *N* region. (The slant line with arrowhead represents the emitter and the horizontal line represents the *N* region.)



1.8 Plurality of *P* emitters on *N* region. (When possible, the electrodes on the symbol drawing should have the same relative order as the electrodes on the device.)

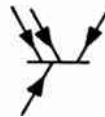

\* Reprinted from "IRE Standards on Graphical Symbols for Semiconductor Devices, 1957 (57 IRE 21.S3)"

## IRE Dictionary on Terms and Symbols

1.9 *N* region on *P* region (rectifying junction).

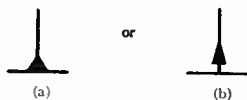

1.10 *N* emitter on *P* region. (The slant line with arrowhead represents the emitter and the horizontal line represents the *P* region.)



1.11 Plurality of *N* emitters on *P* region. (When possible, the electrodes on the symbol drawing should have the same relative order as the electrodes on the device.)



1.12 Collector on semiconductor region of dissimilar-conductivity type. (The slant line represents the collector, and the horizontal line does *not* undergo a transition at the point where the slant line meets it.)



1.13 Plurality of collectors on semiconductor region. (When possible, the electrodes on the symbol drawing should have the same relative order as the electrodes on the device.)



1.14 Collector separated from a region of opposite-conductivity type by an intrinsic region. The intrinsic region is the region between the slant lines, and the collector connection is made to the long solid slant line.



1.15 Collector separated from a region of the same conductivity type by an intrinsic region. The intrinsic region is the region between the slant lines.



1.16 The line enclosing the device symbol is for recognition purposes and its use is recommended.

1.17 Arrowheads on both *N*- and *P*-emitter symbols shall be of 45° included angle. They shall be filled and approximately half their length away from the semiconductor-region symbol. The emitter and collector symbols as well as the transition lines shall be drawn at approximately 60° to the semiconductor-region symbol.

1.18 The following device properties may be indicated with the aid of identifying letters placed within the enclosure or adjacent to the symbol.

- B* = breakdown device
- τ* = storage device
- T* = thermally actuated device
- λ* = light-actuated device.

It is recognized that all semiconductor devices are light and temperature sensitive and exhibit breakdown and storage characteristics. The letters listed above are to be used only if these properties are essential to the operation of the circuit.

### 2.0 GLOSSARY OF DEVICE SYMBOLS

In this section, a listing is made of some semiconductor devices, together with their graphical symbols. It is recognized that in many cases it is possible to develop other device symbols using the standard symbol elements shown in Section 1.0. In general, the angle at which a connecting lead is brought to a graphical symbol has no particular significance. Orientation, including a mirror-image presentation, does not change the meaning of a symbol.

## Graphical Symbols for Semiconductor Devices

2.1 *P-N-P* transistor (also *P-N-I-P* transistor, if omitting the intrinsic region will not result in ambiguity).

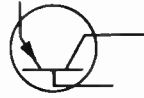

2.2 *N-P-N* transistor (also *N-P-I-N* transistor, if omitting the intrinsic region will not result in ambiguity).



2.3 *P*-type unijunction transistor (sometimes called double-base diode or filamentary transistor).



2.4 *N*-type unijunction transistor (sometimes called double-base diode or filamentary transistor).



2.5 *P*-type field-effects transistor.



2.6 *N*-type field-effects transistor.



2.7 *P-N-P-N* transistor (hook or conjugate-emitter connection).



2.8 *N-P-N-P* transistor (hook or conjugate-emitter connection).



## IRE Dictionary on Terms and Symbols

2.9 *P-N-P-N* transistor (remote base connection).



2.10 *N-P-N-P* transistor (remote base connection).



2.11 *P-N-P-N* transistor without base connection.



2.12 *P-N-P* tetrode.

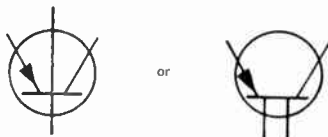

2.13 *N-P-N* tetrode.



2.14 *P-N-I-P* transistor with ohmic connection to the intrinsic region.



2.15 *N-P-I-N* transistor with ohmic connection to the intrinsic region.



2.16 *P-N-I-N* transistor with ohmic connection to the intrinsic region.



## Graphical Symbols for Semiconductor Devices

2.17 *N-P-I-P* transistor with ohmic connection to the intrinsic region.



2.18 *P-N* diode. (The arrowhead shall be of  $60^\circ$  included angle; the point of the arrowhead shall touch the adjacent element symbol.)

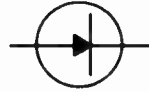

2.19 Breakdown *P-N* diode. (The arrowhead shall be of  $60^\circ$  included angle; the point of the arrowhead shall touch the adjacent element symbol.)

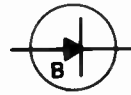

2.20 Bipolar voltage limiter. (The arrowhead shall be of  $60^\circ$  included angle; the point of the arrowhead shall touch the adjacent element symbol.)

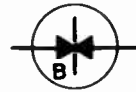

2.21 *P-I-N* triode.<sup>1</sup>

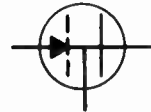

2.22 *P-I-N* diode.<sup>1</sup>

<sup>1</sup> It will be noted that these symbols do not exactly conform to the rules of Section 1.0. They are, in effect, the transition between the diode and the multielement-device symbols. Arrowheads shall be of  $60^\circ$  included angle; the point of the arrowhead shall touch the adjacent element symbol.



# GRAPHICAL SYMBOLS FOR ELECTRICAL DIAGRAMS\*

## 1. ADJUSTABLE

### CONTINUOUSLY ADJUSTABLE (Variable)

The shaft of the arrow is drawn at about 45 degrees across the body of the symbol.



## 2. AMPLIFIER

See also MACHINE, ROTATING (items 35.9.20 to 35.9.23).

### 2.1 General

The triangle is pointed in the direction of transmission.

Amplifier type may be indicated in the triangle by words, standard abbreviations, or a letter combination from the following list.

BDG	Bridging	MON	Monitoring
BST	Booster	PGM	Program
CMP	Compression	PRE	Preliminary
DC	Direct Current	PWR	Power
EXP	Expansion	TRQ	Torque
LIM	Limiting		

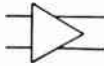
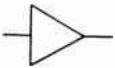

### 2.2 Applications

#### 2.2.1 Booster amplifier with two inputs

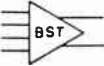
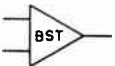

#### 2.2.2 Monitoring amplifier with two outputs

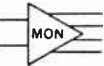

#### 2.2.3 Bridging amplifier with adjustable gain



#### 2.2.4 Program amplifier with associated attenuator

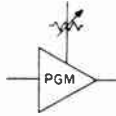

#### 2.2.5 Amplifier with associated power supply

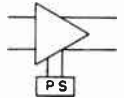
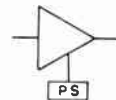

#### 2.2.6 Amplifier with external feedback path

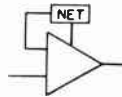

## 3. ANTENNA

### 3.1 General

Types or functions may be indicated by words or abbreviations adjacent to the symbol.



#### 3.1.1 Dipole



#### 3.1.2 Loop



#### 3.2 Counterpoise



\* Reprinted from "IRE Standards on Graphical Symbols for Electrical Diagrams, 1954 (51 IRE 21,S1)"

## Graphical Symbols for Electrical Diagrams

### 4. ARRESTER (Electric Surge, Lightning, etc.) GAP

#### 4.1 General



#### 4.2 Carbon block

*The sides of the rectangle are to be approximately in the ratio of 1 to 2 and the space between rectangles shall be approximately equal to the width of a rectangle.*



#### 4.3 Electrolytic or aluminum cell

*This symbol is not composed of arrowheads.*



#### 4.4 Horn gap



#### 4.5 Protective gap

*These arrowheads shall not be filled.*



#### 4.6 Sphere gap



#### 4.7 Valve or film element



#### 4.8 Multigap, general



#### 4.9 Application: gap plus valve plus ground. 2 pole



### 5. ATTENUATOR

See also PAD (item 42)

#### 5.1 General



#### 5.2 Balanced, general



#### 5.3 Unbalanced, general



### 6. BATTERY

The long line is always positive, but polarity may be indicated in addition.

Example:



#### 6.1 Generalized direct-current source



#### 6.2 One cell



#### 6.3 Multicell



#### 6.3.1 Multicell battery with 3 taps



#### 6.3.2 Multicell battery with adjustable tap

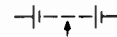

### 7. BREAKER, CIRCUIT

If it is desired to show the condition causing the breaker to trip, the relay-protective-function symbols in item 48.8 may be used alongside the breaker symbol.

Note—Single-line (one-line) symbols appear at the left, complete symbols at the right, and symbols suitable for both purposes are centered in each column.

# IRE Dictionary on Terms and Symbols

## 7.1 General

Note 1—Use appropriate number of single-line diagram symbols.



7.2 Air or, if distinction is needed, for alternating-current circuit breaker rated at 1,500 volts or less and for direct-current circuit breaker.



7.3 Circuit breaker, other than covered by item 7.2. The symbol in the "complete" column is for a 3-pole breaker.

Note 2—On a power diagram, the symbol may be used without other identification. On a composite drawing where confusion with the general symbol (item 25) may result, add the identifying letters CB inside or adjacent to the square.



7.3.1 On a connection or wiring diagram, a 3-pole single-throw circuit breaker (with terminals shown) may be drawn as shown below.



SEE NOTE 2

FOR CONNECTION OR WIRING  
DIAGRAM

## 7.4 Applications

7.4.1 3-pole circuit breaker with thermal overload device in all 3 poles.



7.4.2 3-pole circuit breaker with magnetic overload device in all 3 poles.



7.4.3 3-pole circuit breaker, drawout type

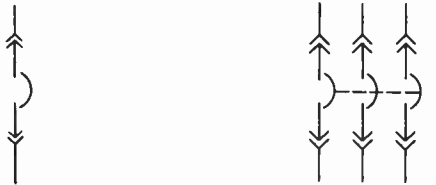

## 8. CAPACITOR

See also TERMINATION (item 59.4).

### 8.1 General

If it is necessary to identify the capacitor electrodes, the curved element shall represent the outside electrode in fixed paper-dielectric and ceramic-dielectric capacitors, the negative electrode in electrolytic capacitors, the moving element in adjustable and variable capacitors, and the low-potential element in feed-through capacitors.



8.1.1 Application: shielded capacitor



8.1.2 Application: adjustable or variable capacitor

If it is necessary to identify trimmer capacitors, the letter T should appear adjacent to the symbol.



8.1.3 Application: adjustable or variable capacitors with mechanical linkage of units



Note—Single-line (one-line) symbols appear at the left, complete symbols at the right, and symbols suitable for both purposes are centered in each column.



## Graphical Symbols for Electrical Diagrams

### 8.2 Continuously adjustable or variable differential capacitor

The capacitance of one part increases as the capacitance of the other part decreases.

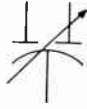

### 8.2.1 Phase-shifter capacitor

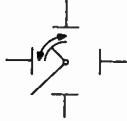

### 8.3 Split-stator capacitor

The capacitances of both parts increase simultaneously.



### 8.4 Shunt capacitor



### 8.5 Feed-through capacitor (with terminals shown on feed-through element)

Commonly used for bypassing high-frequency currents to chassis.



### 8.5.1 Application: feed-through capacitor between 2 inductors with third lead connected to chassis



### 8.6 Capacitance bushing for circuit breaker or transformer



### 8.6.1 Application: capacitance-bushing potential device

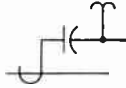

### 8.7 Application: coupling-capacitor potential device



## 9. CELL, PHOTOSENSITIVE (Semiconductor)

See also PHOTOTUBE (item 64.11.6).

$\lambda$  indicates that the primary characteristic of the element within the circle is designed to vary under the influence of light.

### 9.1 Asymmetrical photoconductive transducer (resistive)

*This arrowhead shall be solid.*



### 9.2 Symmetrical photoconductive transducer; selenium cell



### 9.3 Photovoltaic transducer; barrier photocell; blocking-layer cell



## 10. CHASSIS FRAME

(See also GROUND (item 28))

The chassis or frame is not necessarily at ground potential.



Note—Single-line (one-line) symbols appear at the left, complete symbols at the right, and symbols suitable for both purposes are centered in each column.

# IRE Dictionary on Terms and Symbols

## 11. COIL, BLOWOUT<sup>1</sup>

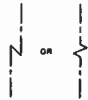

## 12. COIL, OPERATING

See also **INDUCTOR**; **WINDING** (item 31).

Note 3—The asterisk is not a part of the symbol. Always replace the asterisk by a device designation.

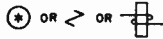

\* SEE NOTE 3

## 13. CONNECTION, MECHANICAL MECHANICAL INTERLOCK

The preferred location of the mechanical connection is as shown in the various applications, but other locations may be equally acceptable.

### 13.1 Mechanical connection (*short dashes*)



### 13.2 Mechanical connection or interlock with fulcrum (*short dashes*)



### 13.3 Mechanical interlock, other

INDICATE BY A NOTE

<sup>1</sup> The broken line --- indicates where line connection to a symbol is made and is not a part of the symbol.

## 14. CONNECTOR DISCONNECTING DEVICE

The connector symbol is not an arrowhead. It is larger and the lines are drawn at a 90-degree angle.

### 14.1 Female contact



### 14.2 Male contact



### 14.3 Connector assembly, movable or stationary portion; jack, plug, or receptacle

Note 4—Use appropriate number of contact symbols.



SEE NOTE 4

### 14.3.1 Commonly used for a jack or receptacle (usually stationary)



SEE NOTE 4 OR

### 14.3.2 Commonly used for a plug (usually movable)



SEE NOTE 4 OR

### 14.4 Separable connectors (engaged)



SEE NOTE 4 OR

#### 14.4.1 Application: engaged 4-conductor connectors; the plug has 1 male and 3 female contacts



#### 14.4.2 Application: engaged 4-conductor connectors; the plug has 1 male and 3 female contacts with individual contact designations shown in the complete-symbol column



### 14.5 Coaxial connectors

#### 14.5.1 Engaged coaxial connectors

Coaxial recognition sign may be added if necessary. See **PATH, TRANSMISSION** (items 43.1 and 43.8.2).



#### 14.5.1.1 If it is necessary to show that the outside conductor is carried through

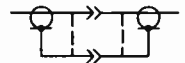

#### 14.5.1.2 If coaxial is connected to a single conductor

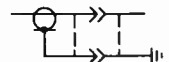

Note—Single-line (one-line) symbols appear at the left, complete symbols at the right, and symbols suitable for both purposes are centered in each column.

## Graphical Symbols for Electrical Diagrams

### 14.6 Communication switchboard-type connector

#### 14.6.1 2-conductor (jack)



#### 14.6.2 2-conductor (plug)



#### 14.6.3 3-conductor (jack) with 2 break contacts (normals) and 1 auxiliary make contact



#### 14.6.4 3-conductor (plug)



### 14.7 Communication switchboard-type connector with circuit normalled through

"Normalled" indicates that a through circuit may be interrupted by an inserted connector. As shown here, the inserted connector opens the through circuit and connects to the circuit towards the left.

Items 14.7.1 through 14.7.4 show 2-conductor jacks. The "normal" symbol is applicable to other types of connectors.



#### 14.7.1 Jacks with circuit normalled through one way



#### 14.7.2 Jacks with circuit normalled through both ways



#### 14.7.3 Jacks in multiple, one set with circuit normalled through both ways

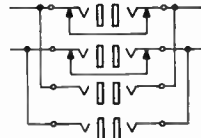

#### 14.7.4 Jacks with auxiliary contacts, with circuit normalled through both ways

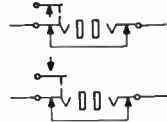
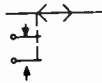

### 14.8 Connectors of the type commonly used for power-supply purposes (convenience outlets and mating connectors)

#### 14.8.1 Female contact



#### 14.8.2 Male contact



#### 14.8.3 2-conductor nonpolarized connector with female contacts



#### 14.8.4 2-conductor nonpolarized connector with male contacts



#### 14.8.5 2-conductor polarized connector with female contacts



#### 14.8.6 2-conductor polarized connector with male contacts



Note—Single-line (one-line) symbols appear at the left, complete symbols at the right, and symbols suitable for both purposes are centered in each column.

## IRE Dictionary on Terms and Symbols

14.8.7 3-conductor polarized connector with female contacts



14.8.8 3-conductor polarized connector with male contacts



14.8.9 4-conductor polarized connector with female contacts



14.8.10 4-conductor polarized connector with male contacts



14.9 Test blocks

14.9.1 Female portion with short-circuiting bar (with terminals shown)



14.9.2 Male portion (with terminals shown)



### 15. CONTACT, ELECTRIC

For build-ups or forms using electric contacts, see applications under CONNECTOR (item 14), RELAY (item 48), and SWITCH (item 56). See DRAFTING PRACTICES (item 0.2 e).

15.1 Fixed contact

15.1.1 Fixed contact for jack, key, relay, etc.



15.1.2 Fixed contact for switch



15.1.3 Fixed contact for momentary switch  
See SWITCH (items 56.8 and 56.10).



15.1.4 Sleeve



15.2 Moving contact

15.2.1 Adjustable or sliding contact for resistor, inductor, etc.



15.2.2 Locking



15.2.3 Nonlocking



15.2.4 Segment; bridging contact  
See SWITCH (items 56.12.3 and 56.12.4).



15.2.5 Vibrator reed



15.2.6 Vibrator split reed



15.2.7 Rotating contact (slip ring) and brush



Note—Single-line (one-line) symbols appear at the left, complete symbols at the right, and symbols suitable for both purposes are centered in each column.

## Graphical Symbols for Electrical Diagrams

### 15.3 Basic contact assemblies

The standard method of showing a contact is by a symbol indicating the circuit condition it produces when the actuating device is in the de-energized or nonoperated position. The actuating device may be of a mechanical, electrical, or other nature, and a clarifying note may be necessary with the symbol to explain the proper point at which the contact functions, for example, the point where a contact closes or opens as a function of changing pressure, level, flow, voltage, current, etc. In cases where it is desirable to show contacts in the energized or operated condition and where confusion may result, a clarifying note shall be added to the drawing.

Auxiliary switches or contacts for circuit breakers, safety enclosed trucks, removable circuit-breaker units, housings, enclosures, etc., may be designated as follows:

- (a) Closed when device is in energized or operated position,
- (b) Closed when device is in de-energized or non-operated position,
- (aa) Closed when operating mechanism of main device is in energized or operated position,
- (bb) Closed when operating mechanism of main device is in de-energized or nonoperated position.

As applied to a removable circuit-breaker unit, (a) is an auxiliary contact that is closed when the unit is in the connected position. As applied to a housing or enclosure, (a) is an auxiliary contact that is closed when the removable circuit-breaker unit is in the connected position. See latest issue of American Standard C37.2 for further details.

*In the parallel-line contact symbols shown below, the length of the parallel lines shall be approximately 1½ times the width of the gap (except for item 15.6).*

#### 15.3.1 Closed contact (break)



#### 15.3.2 Open contact (make)



#### 15.3.3 Transfer

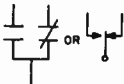

#### 15.3.4 Make-before-break



#### 15.4 Application: open contact with time closing (TC or TDC) feature

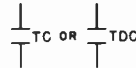

#### 15.5 Application: closed contact with time opening (TO or TDO) feature

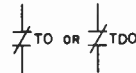

#### 15.6 Time sequential closing

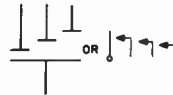

### 16. CONTACTOR

See also RELAY (item 48)

Fundamental symbols for contacts, coils, mechanical connections, etc., are the basis of contactor symbols and should be used to represent contactors on complete diagrams. Complete diagrams of contactors consist of combinations of fundamental symbols for control coils, mechanical connections, etc., in such configurations as to represent the actual device.

Mechanical interlocking should be indicated by notes.

#### 16.1 Manually operated 3-pole contactor



#### 16.2 Electrically operated 1-pole contactor with series blowout coil

Note 5—The asterisk is not a part of the symbol. Always replace the asterisk by a device designation.

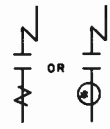

\* SEE NOTE 5

Note—Single-line (one-line) symbols appear at the left, complete symbols at the right, and symbols suitable for both purposes are centered in each column.

# IRE Dictionary on Terms and Symbols

- 16.3 Electrically operated 3-pole contactor with series blowout coils; 2 open and 1 closed auxiliary contacts (shown smaller than the main contacts)

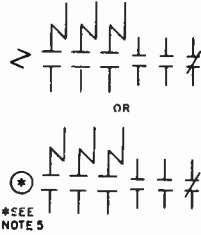

- 16.4 Electrically operated 1-pole contactor with shunt blowout coil

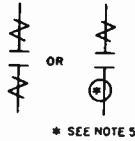

## 17. CORE

- 17.1 General or air core

If it is necessary to identify an air core, a note should appear adjacent to the symbol of the inductor or transformer.

NO SYMBOL

- 17.2 Magnetic core of inductor or transformer

Not to be used unless it is necessary to identify a magnetic core.

See INDUCTOR (item 31.2) and TRANSFORMER (item 63.2).



- 17.3 Core of magnet or relay

For use if representation of the core is necessary.

See MAGNET, PERMANENT (item 36) and RELAY (items 48.2 to 48.4 and 48.6, 48.7).



## 18. COUNTER, ELECTROMAGNETICALLY OPERATED MESSAGE REGISTER

- 18.1 General



- 18.2 With a make contact



## 19. COUPLER, DIRECTIONAL

Commonly used in coaxial and waveguide diagrams.

The arrows indicate the direction of power flow.

Number of coupling paths, type of coupling, and transmission loss may be indicated.

- 19.1 General



- 19.2 Applications

- 19.2.1 *E*-plane aperture coupling, 30-decibel transmission loss



- 19.2.2 Loop coupling, 30-decibel transmission loss

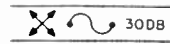

- 19.2.3 Probe coupling, 30-decibel transmission loss

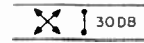

- 19.2.4 Resistance coupling, 30-decibel transmission loss

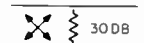

## 20. COUPLING

Commonly used in coaxial and waveguide diagrams.

- 20.1 Coupling by aperture with an opening of less than full waveguide size

Transmission loss may be indicated.

Note 6—The asterisk is not a part of the symbol. Always replace the asterisk by E, H, or HE, depending on the type of coupling.

E indicates that the physical plane of the aperture is perpendicular to the transverse component of the major *E* lines.

H indicates that the physical plane of the aperture is parallel to the transverse component of the major *E* lines.

HE indicates coupling by all other kinds of apertures.



\* SEE NOTE 6

Note—Single-line (one-line) symbols appear at the left, complete symbols at the right, and symbols suitable for both purposes are centered in each column.

## Graphical Symbols for Electrical Diagrams

20.1.1 Application: *E*-plane coupling by aperture to space



20.1.2 Application: *E*-plane coupling by aperture; 2 ends of transmission path available



20.1.3 Application: *E*-plane coupling by aperture; 3 ends of transmission path available



20.1.4 Application: *E*-plane coupling by aperture; 4 ends of transmission path available



20.2 Coupling by loop to space



20.2.1 Coupling by loop to guided transmission path



20.2.2 Application: coupling by loop from coaxial to circular waveguide with direct-current grounds connected



20.3 Coupling by probe to space  
See OPEN CIRCUIT (item 59.2).



20.3.1 Application: coupling by probe to a guided transmission path



20.3.2 Application: coupling by probe from coaxial to rectangular waveguide with direct-current grounds connected



### 21. DEVICE, AUDIBLE SIGNALING

21.1 Bell, general: telephone ringer

Note 7—If specific identification is required, the abbreviation AC or DC may be added within the square.



SEE NOTE 7



21.2 Buzzer



SEE NOTE 7



21.3 Horn; howler; loudspeaker; siren

21.3.1 General



21.3.2 If specific identification of loudspeaker parts is required, the following letter combinations may be added. The \* and ‡ are not part of the symbol.

- \*HN Horn
- \*HW Howler
- \*LS Loudspeaker
- \*SN Siren
- ‡EM Electromagnetic with moving coil (moving coil leads should be identified)
- ‡EMN Electromagnetic with moving coil and neutralizing winding (moving coil leads should be identified)

‡MG Magnetic armature

‡PM Permanent magnet with moving coil



OR



Note—Single-line (one-line) symbols appear at the left, complete symbols at the right, and symbols suitable for both purposes are centered in each column.

# IRE Dictionary on Terms and Symbols

## 22. DEVICE, VISUAL SIGNALING

### 22.1 Annunciator, general



### 22.1.1 Annunciator drop or signal, shutter or grid type



### 22.1.2 Annunciator drop or signal, ball type



### 22.1.3 Manually restored drop



### 22.1.4 Electrically restored drop

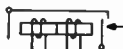

## 22.2 Communication switchboard-type lamp



## 22.3 Indicating, pilot, signaling, or switchboard light

See also GLOW LAMP (item 33.3).

If confusion with other circular symbols may occur, the D-shaped symbol should be used.

Note 8—To indicate the following characteristics, the specified letter or letters may be inserted within or placed adjacent to the D-shaped symbol.

A Amber G Green OP Opalescent W White  
 B Blue NE Neon P Purple Y Yellow  
 C Clear O Orange R Red

Note 9—The asterisk is not part of the circular symbol. Always add the letter or letters specified in Note 8 within or adjacent to the circle. To avoid confusion with meter or basic relay symbols, add suffix L or H, to the above letter or letters; for example, RL or RHL placed within or adjacent to the circle.



### 22.3.1 Application: green signal light



## 23. DIRECTION OF FLOW OF POWER, SIGNAL, OR INFORMATION

### 23.1 One-way

Note 10—The lower symbol is used if it is necessary to conserve space. The arrowhead in the lower symbol shall be filled.



OR

SEE NOTE 10

### 23.2 Both ways



OR

SEE NOTE 10

### 23.3 Application: one-way circuit element, general

Note 11—In all cases indicate the type of apparatus by appropriate words or letters in the rectangle.

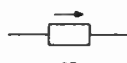

OR

SEE NOTE 11

## 24. DISCONTINUITY

A component that exhibits throughout the frequency range of interest the properties of the type of circuit element indicated by the symbol within the triangle.

Commonly used for coaxial and waveguide transmission.

### 24.1 Equivalent series element, general



### 24.1.1 Capacitive reactance



Note—Single-line (one-line) symbols appear at the left, complete symbols at the right, and symbols suitable for both purposes are centered in each column.



## Graphical Symbols for Electrical Diagrams

### 24.1.2 Inductive reactance

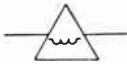

### 24.1.3 Inductance-capacitance circuit with infinite reactance at resonance

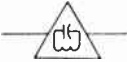

### 24.1.4 Inductance-capacitance circuit with zero reactance at resonance



### 24.1.5 Resistance



### 24.2 Equivalent shunt element, general



### 24.2.1 Capacitive susceptance



### 24.2.2 Conductance



### 24.2.3 Inductive susceptance



### 24.2.4 Inductance-capacitance circuit with infinite susceptance at resonance



### 24.2.5 Inductance-capacitance circuit with zero susceptance at resonance



## 25. ELEMENT, CIRCUIT (General)

Note 12—The asterisk is not a part of the symbol. Always indicate the type of apparatus by appropriate words or letters in the rectangle.



\* SEE NOTE 12

25.1 Accepted abbreviations in the latest edition of American Standard Z32.13 may be used in the rectangle.

25.2 The following letter combinations may be used in the rectangle.

CB	Circuit breaker	NET	Network
DIAL	Telephone dial	PS	Power supply
EQ	Equalizer	RU	Reproducing unit
FAX	Facsimile set		
FL	Filter	RG	Recording unit
FL-BE	Filter, band elimination	TEL	Telephone station
FL-BP	Filter, band pass	TPR	Teleprinter
FL-HP	Filter, high pass	TTY	Teletypewriter
FL-LP	Filter, low pass		

25.3 Additional letter combinations as follows may be employed, but the use of specific graphical symbols included elsewhere in this standard is preferred.

AR	Amplifier	OSC	Oscillator
AT	Attenuator	PAD	Pad
C	Capacitor	P	Plug
HS	Handset	HT	Receiver, headset
I	Indicating or switchboard lamp	K	Relay
L	Inductor	R	Resistor
LS	Loudspeaker	S	Switch or key switch
J	Jack	T	Transformer
MIC	Microphone	WR	Wall receptacle

## 26. ELEMENT, THERMAL

Thermomechanical transducer

### 26.1 Actuating device

May be either self or externally heated.

Note 13—Use appropriate number of single-line diagram symbols.



SEE NOTE 13

Note—Single-line (one-line) symbols appear at the left, complete symbols at the right, and symbols suitable for both purposes are centered in each column.

# IRE Dictionary on Terms and Symbols

26.2 Thermal cutout; flasher



SEE NOTE 13

26.3 Thermal relay

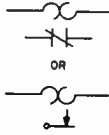

OR

26.4 Thermostat

Ambient-temperature-operated device.

26.4.1 With break contact



26.4.2 With make contact



26.4.3 With integral heater and transfer contacts



## 27. FUSE



SEE NOTE 14

Note 14—Use appropriate number of single-line diagram symbols.

27.1 Fusible element



SEE NOTE 14

27.2 High-voltage primary fuse cutout, dry



OR



SEE NOTE 14

27.3 High-voltage primary fuse cutout, oil



OR



SEE NOTE 14

27.4 With alarm contact

When fuse blows, alarm bus A is connected to power bus B. Letters are for explanation and are not part of the symbol.

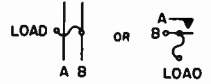

## 28. GROUND

See also CHASSIS; FRAME (item 10).



## 29. HANDSET OPERATOR'S SET

29.1 General



29.2 With push-to-talk switch



29.3 3-conductor handset



29.4 4-conductor handset



29.5 4-conductor handset with push-to-talk switch



Note—Single-line (one-line) symbols appear at the left, complete symbols at the right, and symbols suitable for both purposes are centered in each column.

# Graphical Symbols for Electrical Diagrams

## 29.6 Operator's set

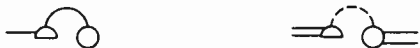

## 30. HYBRID

### 30.1 Hybrid, general

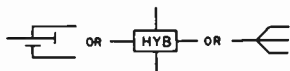

### 30.2 Hybrid, junction

Commonly used in coaxial and waveguide transmission.



### 30.3 Application: rectangular waveguide and coaxial coupling

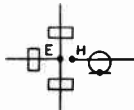

### 30.4 Hybrid, circular (basic)

Note 15—The asterisk is not a part of the symbol. Always replace the asterisk by E, H, or HE. E indicates that there is a principal E transverse field in the plane of the ring. H indicates that there is a principal H transverse field in the plane of the ring. HE shall be used for all other cases.

An arm that has coupling of a different type from that designated above shall be marked according to COUPLING (item 20.1).

Critical distances should be labeled in terms of guide wavelengths.



\* SEE NOTE 15

### 30.4.1 Application: 5-arm circular hybrid with principal coupling in the E plane and with 1-arm H coupling using rectangular waveguide

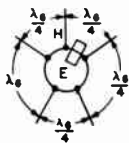

Note—Single-line (one-line) symbols appear at the left, complete symbols, at the right, and symbols suitable for both purposes are centered in each column.

## 31. INDUCTOR WINDING

See also TERMINATION (item 59.5).

### 31.1 General

Either symbol may be used in the following subparagraphs.

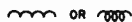

### 31.2 If it is desired especially to distinguish magnetic-core inductors



### 31.3 Tapped



### 31.4 Application: adjustable inductor



### 31.5 Application: adjustable or continuously adjustable inductor



### 31.6 Shunt inductor



### 31.7 Saturable-core inductor (reactor)

Polarity marks may be added to direct-current winding.

Explanatory words and arrow are not part of the symbol shown.



## IRE Dictionary on Terms and Symbols

### 32. KEY, TELEGRAPH

32.1 Simple



32.2 Simple with shorting switch



32.3 Open circuit or pole changing



### 33. LAMP

33.1 Ballast lamp; ballast tube

The primary characteristic of the element within the circle is designed to vary nonlinearly with the temperature of the element.



33.2 Fluorescent lamp

33.2.1 2-terminal



33.2.2 4-terminal



33.3 Glow lamp; cold-cathode lamp; neon lamp

33.3.1 Alternating-current type



33.3.2 Direct-current type

See also TUBE, ELECTRON (item 64.11.5.1)



33.4 Incandescent-filament illuminating lamp



33.5 Indicating lamp; switchboard lamp

See DEVICE, VISUAL SIGNALING (item 22).

### 34. LIMITER FOR POWER CABLE, CURRENT

The arrowheads in this case are filled.

Note 16—Use appropriate number of single-line diagram symbols.



SEE NOTE 16

### 35. MACHINE, ROTATING

35.1 Basic



35.2 Generator, general



35.3 Motor, general



35.4 Motor, multispeed

USE BASIC MOTOR SYMBOL AND NOTE SPEEDS

35.5 Rotating armature with commutator and brushes<sup>1</sup>



35.6 Wound rotor



35.7 Field, generator or motor

Either symbol of item 31.1 may be used in the following subparagraphs.

<sup>1</sup> The broken line --- indicates where line connection to a symbol is made and is not a part of the symbol.

35.7.1 Compensating or commutating



35.7.2 Series



35.7.3 Shunt, or separately excited



Note—Single-line (one-line) symbols appear at the left, complete symbols at the right, and symbols suitable for both purposes are centered in each column.

## Graphical Symbols for Electrical Diagrams

### 35.7.4 Permanent magnet



### 35.8 Winding symbols

Motor and generator winding symbols may be shown in the basic circle using the following representations.

#### 35.8.1 1-phase



#### 35.8.2 2-phase



#### 35.8.3 3-phase wye (ungrounded)



#### 35.8.4 3-phase wye (grounded)



#### 35.8.5 3-phase delta



#### 35.8.6 6-phase diametrical



#### 35.8.7 6-phase double-delta



### 35.9 Direct-current machines; applications

#### 35.9.1 Separately excited direct-current generator or motor<sup>1</sup>

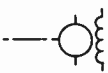

#### 35.9.2 Separately excited direct-current generator or motor with commutating and/or compensating field winding<sup>1</sup>

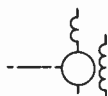

#### 35.9.3 Compositely excited direct-current generator or motor with commutating and/or compensating field winding<sup>1</sup>

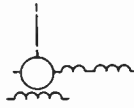

#### 35.9.4 Direct-current series motor or 2-wire generator<sup>1</sup>



#### 35.9.5 Direct-current series motor or 2-wire generator with commutating and/or compensating field winding<sup>1</sup>

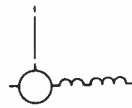

#### 35.9.6 Direct-current shunt motor or 2-wire generator<sup>1</sup>



<sup>1</sup>The broken line - - - indicates where line connection to a symbol is made and is not a part of the symbol.

#### 35.9.7 Direct-current shunt motor or 2-wire generator with commutating and/or compensating field winding<sup>1</sup>

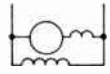
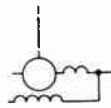

#### 35.9.8 Direct-current permanent-magnet-field generator or motor<sup>1</sup>



Note—Single-line (one-line) symbols appear at the left, complete symbols at the right, and symbols suitable for both purposes are centered in each column.

## IRE Dictionary on Terms and Symbols

35.9.9 Direct-current compound motor or 2-wire generator or stabilized shunt motor<sup>1</sup>



35.9.10 Direct-current compound motor or 2-wire generator or stabilized shunt motor with commutating and/or compensating field winding<sup>1</sup>

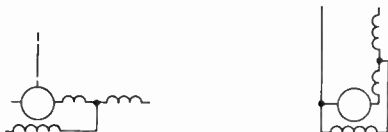

35.9.11 Direct-current 3-wire shunt generator<sup>1</sup>



35.9.12 Direct-current 3-wire shunt generator with commutating and/or compensating field winding<sup>1</sup>



35.9.13 Direct-current 3-wire compound generator<sup>1</sup>



35.9.14 Direct-current 3-wire compound generator with commutating and/or compensating field winding<sup>1</sup>



35.9.15 Direct-current balancer, shunt wound<sup>1</sup>

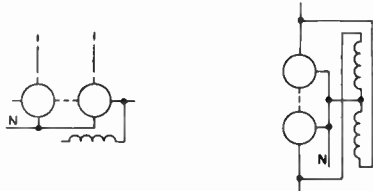

35.9.16 Direct-current balancer, compound wound<sup>1</sup>

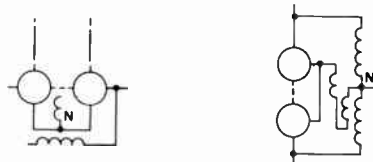

<sup>1</sup> The broken line - - - indicates where line connection to a symbol is made and is not a part of the symbol.

35.9.17 Dynamotor<sup>1</sup>



35.9.18 Double-current generator<sup>1</sup>



35.9.19 Acyclic generator (separately excited)<sup>1</sup>



35.9.20 Regulating generator (rotary amplifier) shunt wound with short-circuited brushes<sup>1</sup>



Note—Single-line (one-line) symbols appear at the left, complete symbols at the right, and symbols suitable for both purposes are centered in each column.

## Graphical Symbols for Electrical Diagrams

35.9.21 Regulating generator (rotary amplifier) shunt wound without short-circuited brushes<sup>1</sup>



35.9.22 Regulating generator (rotary amplifier) shunt wound with compensating field winding and short-circuited brushes<sup>1</sup>



35.9.23 Regulating generator (rotary amplifier) shunt wound with compensating field winding but without short-circuited brushes<sup>1</sup>



35.10 Alternating-current machines; applications

35.10.1 Squirrel-cage induction motor or generator, split-phase induction motor or generator, rotary phase converter, or repulsion motor<sup>1</sup>



35.10.2 Wound-rotor induction motor, synchronous induction motor, or induction generator<sup>1</sup>



35.10.3 Alternating-current series motor<sup>1</sup>



35.10.4 Alternating-current series motor with commutating and/or compensating field winding<sup>1</sup>



35.10.5 1-phase shaded-pole motor<sup>1</sup>



35.10.6 1-phase repulsion-start induction motor<sup>1</sup>



35.10.7 1-phase hysteresis motor<sup>1</sup>



35.10.8 Reluctance motor<sup>1</sup>



35.10.9 1-phase subsynchronous reluctance motor<sup>1</sup>



35.10.10 Magnetolectric generator, 1 phase<sup>1</sup>



35.10.11 Shunt-characteristic brush-shifting motor<sup>1</sup>



<sup>1</sup> The broken line --- indicates where line connection to a symbol is made and is not a part of the symbol.

Note—Single-line (one-line) symbols appear at the left, complete symbols at the right, and symbols suitable for both purposes are centered in each column.

## IRE Dictionary on Terms and Symbols

35.10.12 Series-characteristic brush-shifting motor with 3-phase rotor<sup>1</sup>



35.10.13 Series-characteristic brush-shifting motor with 6- or 8-phase rotor



35.10.14 Ohmic-drop exciter with 3- or 6-phase input



35.10.15 Ohmic-drop exciter with 3- or 6-phase input, with output leads



<sup>1</sup> The broken line - - - indicates where line connection to a symbol is made and is not a part of the symbol.

35.10.16 3-phase regulating machine



35.10.17 Phase shifter with 1-phase output  
See SHIFTER, PHASE (item 53).  
See TRANSFORMER (item 63).



35.10.18 Phase shifter with 3-phase output  
See SHIFTER, PHASE (item 53).  
See TRANSFORMER (item 63).



35.11 Alternating-current machines with direct-current field excitation; applications

35.11.1 Synchronous motor, generator, or condenser<sup>1</sup>



35.11.2 Synchronous motor, generator, or condenser with neutral brought out<sup>1</sup>



35.11.3 Synchronous motor, generator, or condenser with both ends of each phase brought out<sup>1</sup>



35.11.4 Double-winding synchronous generator, motor, or condenser<sup>1</sup>



35.11.5 Synchronous-synchronous frequency changer<sup>1</sup>



Note—Single-line (one-line) symbols appear at the left, complete symbols at the right, and symbols suitable for both purposes are centered in each column.



## Graphical Symbols for Electrical Diagrams

### 35.11.6 Synchronous induction frequency changer<sup>1</sup>



### 35.12 Alternating- and direct-current composite machines; applications

#### 35.12.1 Synchronous or regulating-pole converter<sup>1</sup>



<sup>1</sup> The broken line --- indicates where line connection to a symbol is made and is not a part of the symbol.

#### 35.12.2 Synchronous booster or regulating-pole converter with commutating and/or compensating field windings<sup>1</sup>



#### 35.12.3 Synchronous shunt-wound converter with commutating and/or compensating windings<sup>1</sup>



#### 35.12.4 Synchronous converter compound wound with commutating and/or compensating field windings<sup>1</sup>

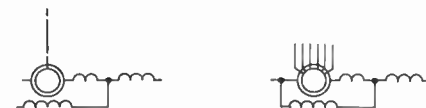

### 35.12.5 Motor converter<sup>1</sup>



## 36. MAGNET, PERMANENT

PM

## 37. METER INSTRUMENT

Note 17—The asterisk is not a part of the symbol. Always replace the asterisk by one of the following letter combinations, depending on the function of the meter or instrument, unless some other identification is provided in the circle and explained on the diagram.

A	Ammeter
AH	Ampere-hour meter
CMA	Contact-making (or breaking) ammeter
CMC	Contact-making (or breaking) clock
CMV	Contact-making (or breaking) volt-meter
CRO	Oscilloscope or cathode-ray oscillograph
D	Demand meter
DB	DB (decibel) meter
DBM	DBM (decibels referred to 1 milliwatt) meter
DTR	Demand-totalizing relay
F	Frequency meter
G	Galvanometer
GD	Ground detector
I	Indicating
M	Integrating
μA or U A	Microammeter
MA	Milliammeter
N	Noise meter
OHM	Ohmmeter
OP	Oil pressure
OSCG	Oscillograph, string
PH	Phase meter
PI	Position indicator
PF	Power-factor meter
RD	Recording demand meter
REC	Recording
RF	Reactive-factor meter
S	Synchroscope
TLM	Telemeter
T	Temperature meter
TT	Total time
VH	Varhour meter
V	Voltmeter
VA	Volt-ammeter
VAR	Varmeter
VI	Volume indicator
VU	Standard volume indicator
W	Wattmeter
WH	Watt-hour meter



\* SEE NOTE 17

Note—Single-line (one-line) symbols appear at the left, complete symbols at the right, and symbols suitable for both purposes are centered in each column.

# IRE Dictionary on Terms and Symbols

## 38. MICROPHONE



## 39. MOTION, MECHANICAL

39.1 Translation, one direction



39.2 Translation, both directions



39.3 Rotation, one direction



39.4 Rotation, both directions



39.5 Rotation designation (applied to a resistor)

CW indicates position of adjustable contact at the limit of clockwise travel viewed from knob or actuator end unless otherwise indicated.

Note 18—The asterisk is not a part of the symbol. Always add identification within or adjacent to the rectangle.

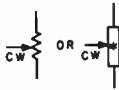

\* SEE NOTE 18

## 40. NETWORK

40.1 General



40.2 Network, low-voltage power



## 41. OSCILLATOR GENERALIZED ALTERNATING-CURRENT SOURCE



## 42. PAD

See also ATTENUATOR (item 5)

42.1 General



42.2 Balanced, general



42.3 Unbalanced, general



## 43. PATH, TRANSMISSION CONDUCTOR CABLE WIRING

43.1 Guided path, general

A single line represents the entire group of conductors or the transmission path needed to guide the power or the signal. For coaxial and waveguide work, the recognition symbol is used at the beginning and end of each kind of transmission path and at intermediate points as needed for clarity. In waveguide work, mode may be indicated.



43.2 Conductive path or conductor; wire



43.3 Air or space path



43.4 Dielectric path other than air

Commonly used for coaxial and waveguide transmission.



43.5 Crossing of paths or conductors not connected  
*The crossing is not necessarily at a 90-degree angle.*



Note—Single-line (one-line) symbols appear at the left, complete symbols at the right, and symbols suitable for both purposes are centered in each column.

## Graphical Symbols for Electrical Diagrams

### 43.6 Junction of paths or conductors

#### 43.6.1 Junction (if desired)



#### 43.6.1.1 Application: junction of different-size cables



### 43.6.2 Junction of connected paths, conductors, or wires



OR



OR ONLY IF REQUIRED  
BY SPACE LIMITATION



### 43.7 Associated conductors

#### 43.7.1 Pair (twisted unless otherwise specified)

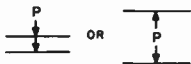

OR



#### 43.7.2 Triple (twisted unless otherwise specified)



#### 43.7.3 Quad



### 43.8 Assembled conductors; cable

Commonly used in communication diagrams.

#### 43.8.1 Shielded single conductor



#### 43.8.2 Coaxial cable

Coaxial transmission path

See note under item 43.1.



#### 43.8.3 2-conductor cable



#### 43.8.4 Shielded 2-conductor cable with shield grounded



#### 43.8.5 5-conductor cable



#### 43.8.6 Shielded 5-conductor cable



#### 43.8.6.1 Shielded 5-conductor cable with conductors separated on the diagram for convenience



#### 43.8.7 Cable underground or in conduit (*long dashes*)



#### 43.8.8 Grouping of leads

Normally, bend of line indicates direction of conductor joining cable.



OR

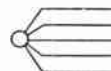

OR

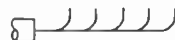

OR



Note—Single-line (one-line) symbols appear at the left, complete symbols at the right, and symbols suitable for both purposes are centered in each column.

## IRE Dictionary on Terms and Symbols

### 43.9 Alternate or conditional wiring

Not commonly used on power diagrams.

*The arrowheads in this case shall be solid.*

Note 19—A note shall explain the connections.



SEE NOTE 19

### 43.9.1 Application: 3 alternate paths

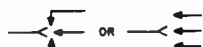

SEE NOTE 19

### 43.10 Associated or future (*short dashes*)



### 43.10.1 Application: associated or future amplifier



### 43.11 Waveguide

See note in item 43.1.

#### 43.11.1 Circular



#### 43.11.2 Rectangular



#### 43.11.3 Ridged



### 44. PICKUP (mechanoelectric)

Note 20—Suitable words or abbreviations may be written within or adjacent to the rectangle.



SEE NOTE 20

### 45. RECEIVER, TELEPHONE EARPHONE HEARING AID RECEIVER

See also HANDSET (item 29).

#### 45.1 General



#### 45.2 Headset, double



#### 45.3 Headset, single



### 46. RECTIFIER

#### 46.1 Electron-tube rectifier

See TUBE, ELECTRON (item 64).

#### 46.1.1 Pool-type-cathode power rectifier

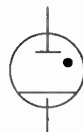

#### 46.2 Metallic rectifier; asymmetrical varistor; crystal diode; electrolytic rectifier

Arrow shows direction of forward (easy) current as indicated by direct-current ammeter.

*The arrowhead in this case shall be filled.*



#### 46.2.1 Full-wave bridge type

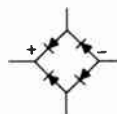

Note—Single-line (one-line) symbols appear at the left, complete symbols at the right, and symbols suitable for both purposes are centered in each column.

## Graphical Symbols for Electrical Diagrams

46.3 On connection or wiring diagrams, rectifier may be shown with terminals and polarity marking. Heavy line may be used to indicate nameplate or positive polarity end.



FOR CONNECTION OR WIRING  
DIAGRAM

47. **REGULATOR, SPEED** (Contact-making governor)  
Contacts open or closed as required; (shown here as closed).



### 48. RELAY

See also CONTACTOR (item 16)

Fundamental symbols for contacts, mechanical connections, coils, etc., are the basis of relay symbols and should be used to represent relays on complete diagrams.

The following letter combinations may be used with any relay symbol. The requisite number of these combinations may be used when a relay possesses more than one special feature.

- AC Alternating-current or ringing relay
- D Differential
- DB Double biased (biased in both directions)
- DP Dashpot
- EP Electrically polarized
- †FO Fast operate
- †FR Fast release
- MG Marginal
- NB No bias
- NR Nonreactive
- P Magnetically polarized using biasing spring, or having magnet bias
- SA Slow operate and slow release
- SO Slow operate
- SR Slow release
- SW Sandwich wound to improve balance to longitudinal currents

† Used where unusually fast operation or fast releasing is essential to the circuit operation.

The proper poling for a polarized relay shall be shown by the use of + and - designations applied to the winding leads. The interpretation of this shall be that current in the direction indicated shall move or tend to move the armature toward the contact shown nearest the core on the diagram. If the relay is equipped with numbered terminals, the proper terminal numbers shall also be shown.

48.1 Basic



48.2 Relay coil

Note 21—The asterisk is not a part of the symbol. Always replace the asterisk by a device designation.

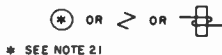

48.2.1 Semicircular dot indicates inner end of winding



48.3 Application: relay with transfer contacts

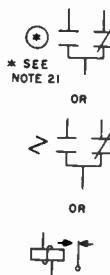

48.4 Application: 2-pole double-make



48.5 Application: 1-pole double-break



48.6 Application: polarized relay with transfer contacts



48.7 Application: polarized (no bias) marginal relay with transfer contacts



Note—Single-line (one-line) symbols appear at the left, complete symbols at the right, and symbols suitable for both purposes are centered in each column.

## IRE Dictionary on Terms and Symbols

### 48.8 Relay protective functions

The following symbols may be used to indicate protective functions, or device-function numbers (see latest edition of American Standard C37.2) may be placed in the circle or adjacent to the basic symbol.

#### 48.8.1 Over, general



#### 48.8.2 Under, general



#### 48.8.3 Direction, general; directional over



#### 48.8.4 Balance, general



#### 48.8.5 Differential, general



#### 48.8.6 Pilot wire, general



#### 48.8.7 Carrier current, general



#### 48.8.8 Operating quantity

The operating quantity is indicated by the following letters or symbols placed either on or above the center of the relay protective-function symbols shown above.

C *Current	GP Gas pressure	S Synchronism
Z Distance	φ Phase	T Temperature
F Frequency	W Power	V Voltage

\* The use of the letter may be omitted in the case of current and the absence of such letter presupposes that the relay operates on current.

#### 48.8.9 Ground relays

Relays operative on residual current only are so designated by attaching the ground symbol to the relay protective-function symbol. Note that the zero phase-sequence designation given below may be used instead when desirable.

### 48.8.10 Phase sequence quantities

Operation on phase-sequence quantities may be indicated by the use of the conventional subscripts 0, 1, and 2 after the letter indicating the operating quantity.

#### 48.8.11 Application

##### 48.8.11.1 Overcurrent



##### 48.8.11.2 Directional overcurrent



##### 48.8.11.3 Directional residual overcurrent



##### 48.8.11.4 Undervoltage



##### 48.8.11.5 Power directional



##### 48.8.11.6 Balanced current



##### 48.8.11.7 Differential current



##### 48.8.11.8 Distance



##### 48.8.11.9 Directional distance



##### 48.8.11.10 Overfrequency



Note—Single-line (one-line) symbols appear at the left, complete symbols at the right, and symbols suitable for both purposes are centered in each column.

## Graphical Symbols for Electrical Diagrams

### 48.8.11.11 Overtemperature



### 48.8.11.12 Phase balance



### 48.8.11.13 Phase rotation



### 48.8.11.14 Pilot wire, differential current



### 48.8.11.15 Pilot wire, directional comparison



### 48.8.11.16 Carrier pilot



### 48.8.11.17 Positive phase sequence undervoltage



### 48.8.11.18 Negative phase sequence overcurrent



### 48.8.11.19 Gas-pressure relay, Buchholz



### 48.8.11.20 Out of step



## 49. REPEATER

### 49.1 1-way repeater

Triangle points in the direction of transmission.



### 49.2 2-wire 2-way repeater



### 49.2.1 2-wire 2-way repeater with low-frequency bypass



### 49.3 4-wire 2-way repeater



## 50. RESISTOR

See also TERMINATION (item 59).

For resistors with nonlinear characteristics, see BALLAST LAMP (item 33.1), THERMISTOR (item 60), and VARISTOR (item 66).

Note 22—The asterisk is not a part of the symbol. Always add identification within or adjacent to the rectangle.

### 50.1 General

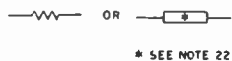

\* SEE NOTE 22

### 50.2 Tapped resistor

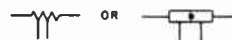

\* SEE NOTE 22

### 50.3 Application: with adjustable contact



\* SEE NOTE 22

Note—Single-line (one-line) symbols appear at the left, complete symbols of the right, and symbols suitable for both purposes are centered in each column.

# IRE Dictionary on Terms and Symbols

50.4 Application: adjustable or continuously adjustable (variable) resistor

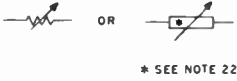

50.5 Heating resistor

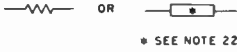

50.6 Instrument or relay shunt  
Connect instrument or relay to terminals in the box.



50.7 Shunt resistor

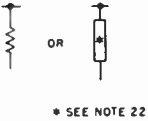

## 51. RESONATOR

Excluding piezoelectric and magnetostriction devices.

51.1 General

Commonly used for coaxial and waveguide transmission.



51.2 Applications

51.2.1 Resonator with mode suppression coupled by an *E*-plane aperture to a guided transmission path and by a loop to a coaxial path.



51.2.2 Tunable resonator having adjustable *Q* coupled by a probe to a coaxial system.

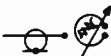

51.2.3 Tunable resonator with direct-current ground connected to an electron device and adjustably coupled by an *E*-plane aperture to a rectangular waveguide.

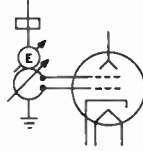

## 52. SHIELD SHIELDING (short dashes)

Normally used for electric or magnetic shielding. When used for other shielding, a note should so indicate. For typical applications see: CAPACITOR (item 8.1.1) PATH, TRANSMISSION (items 43.8.1, 43.8.4, and 43.8.6) TRANSFORMER (items 63.2.1 and 63.2.2) TUBE, ELECTRON (item 64.7)



## 53. SHIFTER, PHASE

For power circuits see MACHINE, ROTATING (items 35.10.17 and 35.10.18).

53.1 General



53.2 3-wire or 3-phase



53.2.1 Application: adjustable



## 54. SOUNDER, TELEGRAPH



## 55. SUPPRESSION, MODE

Commonly used in coaxial and waveguide transmission.



Note—Single-line (one-line) symbols appear at the left, complete symbols at the right, and symbols suitable for both purposes are centered in each column.



## Graphical Symbols for Electrical Diagrams

### 56. SWITCH

See also FUSE (item 27); CONTACT, ELECTRIC (item 15); and DRAFTING PRACTICES (item 0.2, paragraphs (e) and (g)).

Fundamental symbols for contacts, mechanical connections, etc., may be used for switch symbols.

The standard method of showing switches is in a position with no operating force applied. For switches that may be in any one of two or more positions with no operating force applied and for switches actuated by some mechanical device (as in air-pressure, liquid-level, rate-of-flow, etc., switches), a clarifying note may be necessary to explain the point at which the switch functions.

When the basic switch symbols in items 56.1 through 56.4 are shown on a diagram in the closed position, terminals must be added for clarity.

#### 56.1 Single throw, general



#### 56.2 Double throw, general



#### 56.2.1 Application: 2-pole double-throw switch with terminals shown



#### 56.3 Knife switch, general



#### 56.3.1 Application: 3-pole double-throw knife switch with auxiliary contacts and terminals



#### 56.3.2 Application: 2-pole field-discharge knife switch with terminals and discharge resistor

Note 23—The asterisk is not a part of the symbol. Always add identification within or adjacent to the rectangle.



• SEE NOTE 23

#### 56.4 Switch with horn gap



#### 56.5 Sector switch



#### 56.6 Push button, momentary or spring return

##### 56.6.1 Circuit closing (make)



##### 56.6.2 Circuit opening (break)



##### 56.6.3 Two-circuit



#### 56.7 Push button, maintained or not spring return

##### 56.7.1 Two circuit



#### 56.8 Switch, nonlocking: momentary or spring return

The symbols to the left are commonly used for spring buildups in key switches, relays, and jacks.

The symbols to the right are commonly used for toggle switches.

##### 56.8.1 Circuit closing (make)



##### 56.8.2 Circuit opening (break)



##### 56.8.3 Two-circuit

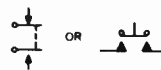

Note—Single-line (one-line) symbols appear at the left, complete symbols at the right, and symbols suitable for both purposes are centered in each column.

# IRE Dictionary on Terms and Symbols

## 56.8.4 Transfer

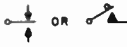

## 56.8.5 Make-before-break



## 56.9 Switch, locking

The symbols to the left are commonly used for spring buildups in key switches, relays, and jacks.

The symbols to the right are commonly used for toggle switches.

### 56.9.1 Circuit closing (make)



### 56.9.2 Circuit opening (break)



### 56.9.3 Transfer, 2-position



### 56.9.4 Transfer, 3-position



### 56.9.5 Make-before-break



## 56.10 Switch, combination locking and nonlocking

See also item 56.11.

Commonly used for toggle-switches.

## 56.10.1 3-position 1-pole circuit closing (make), off, momentary circuit closing (make)



## 56.10.2 3-position 2 pole: circuit closing (make), off, momentary circuit closing (make)



## 56.11 Switch, key-type, applications

### 56.11.1 2-position with locking transfer and break contacts



### 56.11.2 3-position with nonlocking transfer and locking break contacts

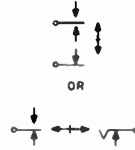

### 56.11.3 3-position, multicontact combination

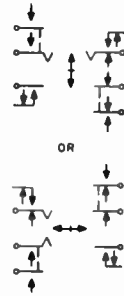

### 56.11.4 2-position, half of key switch normally operated, multicontact combination

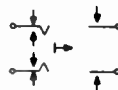

Note—Single-line (one-line) symbols appear at the left, complete symbols at the right, and symbols suitable for both purposes are centered in each column.



# IRE Dictionary on Terms and Symbols

56.12.11 Drum switch, sliding-contact type, typical example

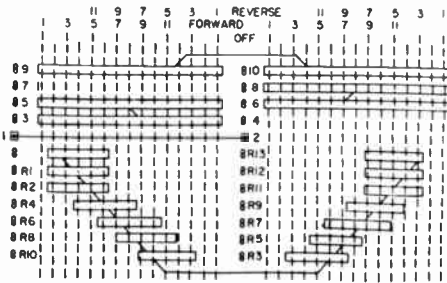

56.13 Switches with specific features

56.13.1 Key-operated lock switch  
Use appropriate standard symbol and add key designation or other information in note.

56.13.2 Limit switch  
Note 24—Identify by LS or other suitable note.

56.13.2.1 General  
Use appropriate standard symbol and identify by LS or other suitable note.

56.13.2.2 Track-type; circuit-opening contact



SEE NOTE 24

56.13.2.3 Lead-screw type; circuit-opening contacts



SEE NOTE 24

56.13.2.4 Rotary type

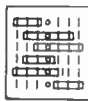

SEE NOTE 24

56.13.3 Mushroom-head safety feature  
Application to 2-circuit push-button switch.



56.13.4 Safety interlock

56.13.4.1 General  
If specific type identification is not required, use applicable standard symbol.

56.13.4.2 If specific type identification is required; circuit opening



56.13.4.3 If specific type identification is required; circuit closing



56.13.5 Hook switch



56.13.6 Dial switch, telephone type

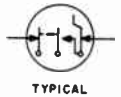

TYPICAL

56.13.7 Switch in evacuated envelope, 1-pole double-throw

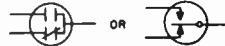

57. SYNCHRO  
SYNCHRO CONTROL TRANSFORMER  
SYNCHRO RECEIVER  
SYNCHRO TRANSMITTER



If identification is required, a letter combination from the following list shall be placed adjacent to the symbol to indicate the type of synchro.

CDX Control-differential synchro transmitter  
CT Synchro control transformer  
CX Synchro control transmitter  
TDR Torque-differential synchro receiver  
TDX Torque-differential synchro transmitter  
TR Torque-synchro receiver  
TX Torque-synchro transmitter

If the outer winding is rotatable in bearings, the suffix B shall be added to the above letter combinations.

Note—Single-line (one-line) symbols appear at the left, complete symbols at the right, and symbols suitable for both purposes are centered in each column.

## Graphical Symbols for Electrical Diagrams

57.1 Synchro control transformer  
Synchro receiver  
Synchro transmitter



57.2 Differential synchro receiver  
Differential synchro transmitter



### 58. TERMINAL, CIRCUIT

See also TUBE TERMINALS (item 64.12.2).



58.1 Terminal board or terminal strip with 4 terminals shown; group of 4 terminals

Number and arrangement as convenient.



### 59. TERMINATION

59.1 Cable termination

Line on left of symbol shown indicates cable.



59.2 Open circuit (open)

Not a fault.

Commonly used in coaxial and waveguide diagrams.



59.3 Short circuit (short)

Not a fault.

Commonly used in coaxial and waveguide diagrams.



59.3.1 Application: movable short



59.4 Terminating capacitor

Commonly used in coaxial and waveguide diagrams.

59.4.1 Application: series capacitor and path open



59.4.2 Application: series capacitor and path shorted



59.5 Terminating inductor

Commonly used in coaxial and waveguide diagrams.

59.5.1 Application: series inductor and path open



59.5.2 Application: series inductor and path shorted



59.6 Terminating resistor

Commonly used in coaxial and waveguide diagrams.



59.6.1 Application: series resistor and path open



59.6.2 Application: series resistor and path shorted



### 60. THERMISTOR

T indicates that the primary characteristic of the element within the circle is designed to vary with temperature.

60.1 General



60.2 With independent integral heater



### 61. THERMOCOUPLE

61.1 Dissimilar-metals device

Note—Single-line (one-line) symbols appear at the left, complete symbols at the right, and symbols suitable for both purposes are centered in each column.

# IRE Dictionary on Terms and Symbols

61.1.1 Temperature-measuring thermocouple



61.1.2 Current-measuring thermocouple

Explanatory words and arrows are not a part of the symbols shown.

61.1.2.1 Thermocouple with integral heater internally connected



61.1.2.2 Thermocouple with integral insulated heater



61.2 Semiconductor device

61.2.1 Temperature-measuring semiconductor thermocouple



61.2.2 Current-measuring semiconductor thermocouple



## 62. TRANSDUCER, MODE

Commonly used in coaxial and waveguide diagrams.

62.1 General



62.2 Application: transducer from rectangular to circular waveguide



62.3 Application: transducer from rectangular waveguide to coaxial with mode suppression and direct-current grounds connected

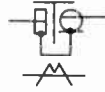

## 63. TRANSFORMER

63.1 General

Either winding symbol may be used. In the following subparagraphs, the left symbol is used.

Additional windings may be shown or indicated by a note.

For power transformers, use polarity marking  $H_1$ ,  $X_1$ , etc., from American Standard C6.1. For polarity markings on current and potential transformers, see items 63.16.1 and 63.17.1.

In coaxial and waveguide circuits, this symbol will represent a taper or step transformer without mode change.

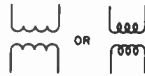

63.1.1 Application: transformer with direct-current ground connections and mode suppression between two rectangular waveguides

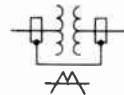

63.2 If it is desired especially to distinguish a magnetic-core transformer



63.2.1 Application: shielded transformer with magnetic core shown



63.2.2 Application: transformer with magnetic core shown and with a shield between windings. The shield is shown connected to the frame.



Note—Single-line (one-line) symbols appear at the left, complete symbols at the right, and symbols suitable for both purposes are centered in each column.

## Graphical Symbols for Electrical Diagrams

63.3 One winding with adjustable inductance



63.4 Each winding with separately adjustable inductance



63.5 Adjustable mutual inductor, constant-current transformer



63.6 With taps, 1-phase



63.7 Autotransformer, 1-phase



63.7.1 Adjustable



63.8 Step-voltage regulator or load-ratio control auto-transformer



63.9 Load-ratio control transformer with taps

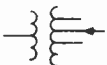

63.10 1-phase induction voltage regulator(s)

Number of regulators may be written adjacent to the symbol.

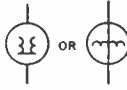

OR

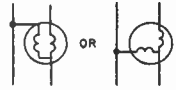

OR

63.11 Triplex induction voltage regulator



63.12 3-phase induction voltage regulator

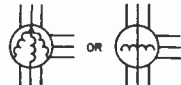

OR

63.13 1-phase 2-winding transformer



63.13.1 3-phase bank of 1-phase 2-winding transformers

See latest edition of American Standard C6.1 for interconnection conventions for complete symbols.



63.14 Polyphase transformer



OR

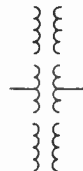

Note—Single-line (one-line) symbols appear at the left, complete symbols at the right, and symbols suitable for both purposes are centered in each column.

# IRE Dictionary on Terms and Symbols

63.15 1-phase 3-winding transformer



63.16 Current transformer(s)



63.16.1 Current transformer with polarity marking. Instantaneous direction of current into one polarity mark corresponds to current out of the other polarity mark.

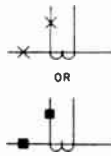

63.16.2 Bushing-type current transformer<sup>1</sup>



63.17 Potential transformer(s)

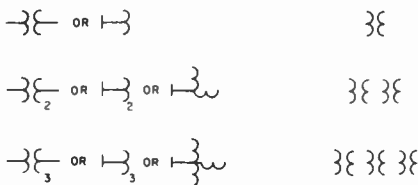

63.17.1 Potential transformer with polarity mark. Instantaneous direction of current into one polarity mark corresponds to current out of the other polarity mark.

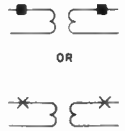

63.18 Outdoor metering device



63.19 Transformer winding connection symbols  
For use adjacent to the symbols for the transformer windings.

63.19.1 2-phase 3-wire, ungrounded



63.19.1.1 2-phase 3-wire, grounded



63.19.2 2-phase 4-wire



63.19.2.1 2-phase 5-wire, grounded



63.19.3 3-phase 3-wire, delta or mesh



63.19.3.1 3-phase 3-wire, delta, grounded



63.19.4 3-phase 4-wire, delta, ungrounded



63.19.4.1 3-phase 4-wire, delta, grounded



<sup>1</sup>The broken line --- indicates where line connection to a symbol is made and is not a part of the symbol.

Note—Single-line (one-line) symbols appear at the left, complete symbols at the right, and symbols suitable for both purposes are centered in each column.



## Graphical Symbols for Electrical Diagrams

63.19.5 3-phase, open-delta



63.19.5.1 3-phase, open-delta, grounded at common point



63.19.5.2 3-phase, open-delta, grounded at middle point of one transformer



63.19.6 3-phase, broken-delta



63.19.7 3-phase, wye or star, ungrounded



63.19.7.1 3-phase, wye, grounded neutral  
The direction of the stroke representing the neutral can be arbitrarily chosen.



63.19.8 3-phase 4-wire, ungrounded



63.19.9 3-phase, zigzag, ungrounded



63.19.9.1 3-phase, zigzag, grounded



63.19.10 3-phase, Scott or T



63.19.11 6-phase, double-delta



63.19.12 6-phase, hexagonal (or chordal)



63.19.13 6-phase, star (or diametrical)



63.19.13.1 6-phase, star, with grounded neutral



### 64. TUBE, ELECTRON



Tube-component symbols are shown first. These are followed by typical applications showing the use of these specific symbols in the various classes of devices such as thermionic, cold-cathode, and photoemissive tubes of varying structures and combinations of elements (triodes, pentodes, cathode-ray tubes, magnetrons, etc.).

Lines outside of the envelope are not part of the symbol but are electrical connections thereto.

*Connections between the external circuit and electron tube symbols within the envelope may be located as required to simplify the diagram.*

#### 64.1 Emitting electrode

64.1.1 Directly heated (filamentary) cathode

Note—Leads may be connected in any convenient manner to ends of the  provided the identity of the  is retained.



64.1.1.1 With tap

See note in item 64.10.3.

64.1.2 Indirectly heated cathode

Lead may be connected to either extreme end of the  or, if required, to both ends, in any convenient manner.



64.1.3 Cold cathode (including ionically heated cathode)



64.1.4 Photocathode



64.1.5 Pool cathode



Note—Single-line (one-line) symbols appear at the left, complete symbols at the right, and symbols suitable for both purposes are centered in each column.

## IRE Dictionary on Terms and Symbols

64.1.6 Ionically heated cathode with provision for supplementary heating  
See note in item 64.1.1



64.2 Controlling electrode

64.2.1 Grid (including beam-confining or beam-forming electrodes)



64.2.2 Deflecting electrodes (used in pairs); reflecting or repelling electrode (used in velocity-modulated tube)



64.2.3 Ignitor (in pool tubes) (should extend into pool)  
Starter (in gas tubes)



64.2.4 Excitor (contactor type)



64.3 Collecting electrode

64.3.1 Anode or plate (including collecting electrode and fluorescent target)



64.3.2 Target or X-ray anode  
*Drawn at about a 45-degree angle.*



64.4 Collecting and emitting electrode

64.4.1 Dynode



64.4.2 Alternately collecting and emitting

64.4.2.1 Composite anode-photocathode



64.4.2.2 Composite anode-cold cathode



64.4.2.3 Composite anode-ionically heated cathode with provision for supplementary heating

See note in item 64.1.1



64.5 Heater

See note in item 64.1.1



64.5.1 With tap

See item 64.10.3.

64.6 Envelope (shell)

The general envelope symbol identifies the envelope or enclosure regardless of evacuation or pressure. When used with electron-tube component symbols, the general envelope symbol indicates a vacuum enclosure unless otherwise specified. A gas-filled electron device may be indicated by a dot within the envelope symbol.

64.6.1 General

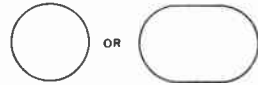

64.6.1.1 Split envelope

If necessary, envelope may be split.



64.6.2 Gas-filled

*The dot may be located as convenient.*



64.7 Shield

See item 64.10.10.

This is understood to shield against electric fields unless otherwise noted.

64.7.1 Any shield against electric fields that is within the envelope and that is connected to an independent terminal



Note—Single-line (one-line) symbols appear at the left, complete symbols at the right, and symbols suitable for both purposes are centered in each column.

## Graphical Symbols for Electrical Diagrams

### 64.7.2 Outside envelope of X-ray tube

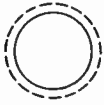

### 64.8 Coupling

See COUPLING (item 20) and PATH, TRANSMISSION (items 43.8.2 and 43.11).

#### 64.8.1 Coupling by loop (electromagnetic type)

Coupling loop may be shown inside or outside envelope as desired, but if inside it should be shown grounded.



### 64.9 Resonators (cavity type)

#### 64.9.1 Single-cavity envelope and grid-type associated electrodes



#### 64.9.2 Double-cavity envelope and grid-type associated electrodes



#### 64.9.3 Multicavity magnetron anode and envelope



### 64.10 General notes

64.10.1 If new symbols are necessary, they should be formed where possible from component symbols. For example, see DYNODE (item 64.4.1), which combines the anode and photocathode convention.

64.10.2 A connection to anode, dynode, pool cathode, photocathode, deflecting electrode, composite anode-photocathode, and composite anode-cold cathode shall be to the center of that symbol. Connection to any other electrode may be shown at either end or both ends of the electrode symbol.

64.10.3 A diagram for a tube having more than one heater or filament shall show only one heater or filament symbol  $\wedge$  unless they have entirely separate connections. If a heater or filament tap is made, either brought out to a terminal or internally connected to another element, it shall be connected at the vertex of the symbol, regardless of the actual division of voltage across the heater or filament.

64.10.4 Standard symbols, such as the inclined arrow for tunability and connecting dotted lines for ganged components, may be added to a tube symbol to extend the meaning of the tube symbol, provided such added feature or component is integral with the tube.

64.10.5 Electric components, such as resistors, capacitors, or inductors, which are integral parts of the tube and are important to its functional operation, shall be shown in the standard manner.

64.10.6 Multiple equipotential cathodes that are directly connected inside the tube shall be shown as a single cathode.

64.10.7 A tube having two or more grids tied internally shall be shown with symbols for each grid, except when the grids are adjacent in the tube structure. Thus, the diagram for a twin pentode having a common screen-grid connection for each section and for a converter tube having the No. 3 and No. 5 grids connected internally will show separate symbols for each grid. However, a triode where the control grid is physically in the form of two grid windings would show only one grid.

64.10.8 A tube having a grid adjacent to a plate but internally connected to the plate to form a portion of it shall be shown as having a plate only.

64.10.9 Associated parts of a circuit, such as focusing coils, deflecting coils, field coils, etc., are not a part of the tube symbol but may be added to the circuit in the form of standard symbols. For example, resonant-type magnetron with permanent magnet may be shown:

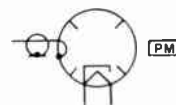

Note—Single-line (one-line) symbols appear at the left, complete symbols at the right, and symbols suitable for both purposes are centered in each column.

## IRE Dictionary on Terms and Symbols

64.10.10 External and internal shields, whether integral parts of tubes or not, shall be omitted from the circuit diagram unless the circuit diagram requires their inclusion.

64.10.11 In line with standard drafting practice, straight-line crossovers are recommended.

64.11 Typical applications

64.11.1 Triode with directly heated filamentary cathode and envelope connection to base terminal

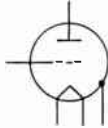

64.11.2 Equipotential-cathode pentode showing use of elongated envelope

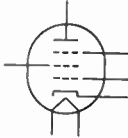

64.11.3 Equipotential-cathode twin triode illustrating elongated envelope and rule of item 64.10.3.

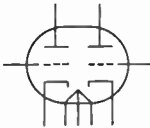

64.11.4 Typical wiring figure

This figure illustrates how tube symbols may be placed in any convenient position in a circuit.

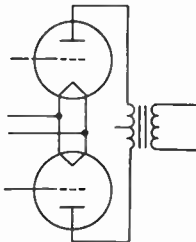

64.11.5 Cold-cathode gas-filled tube

64.11.5.1 Rectifier; voltage regulator for direct-current operation

See also GLOW LAMP (item 33.3).

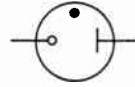

64.11.6 Phototube

64.11.6.1 Single-unit, vacuum type

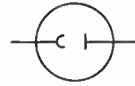

64.11.6.2 Multiplier type



64.11.7 Cathode-ray tube

64.11.7.1 With electric-field deflection



64.11.7.2 For magnetic deflection



64.11.8 Mercury-pool tube

See also RECTIFIER (item 46.1.1).

64.11.8.1 With ignitor and control grid

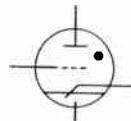

64.11.8.2 With excitor, control grid, and holding anode

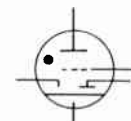

Note—Single-line (one-line) symbols appear on the left, complete symbols at the right, and symbols suitable for both purposes are centered in each column.

## Graphical Symbols for Electrical Diagrams

64.11.8.3 Single-anode pool-type vapor rectifier with ignitor

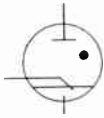

64.11.8.4 6-anode metallic-tank pool-type vapor rectifier with excitor, showing rigid-terminal symbol for control connection to tank (pool cathode is insulated from tank)

*Anode symbols are located as convenient.*

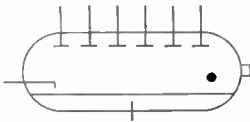

64.11.9 Magnetron

64.11.9.1 Resonant type with coaxial output

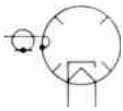

64.11.9.2 Transit-time split-plate type with stabilizing deflecting electrodes and internal circuit

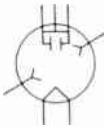

64.11.9.3 Tunable, aperture coupled

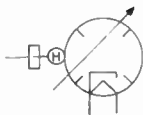

64.11.10 Velocity-modulation (velocity-variation) tube

64.11.10.1 Reflex klystron, integral cavity, aperture coupled

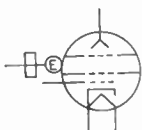

64.11.10.2 Double-cavity klystron, integral cavity, permanent external-ganged tuning, loop coupled (coupling loop may be shown inside if desired. See item 64.8.1)

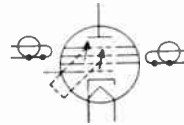

64.11.11 Transmit-receive (TR) tube

Gas filled, tunable integral cavity, aperture coupled, with starter.

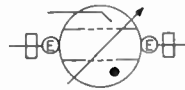

64.11.12 X-ray tube

64.11.12.1 With filamentary cathode and focusing grid (cup). The anode may be cooled by fluid or radiation.



64.11.12.2 With control grid, filamentary cathode, and focusing cup



64.11.12.3 With grounded electrostatic shield

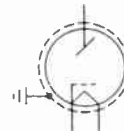

64.11.12.4 Double focus with rotating anode (see note in item 64.10.9)

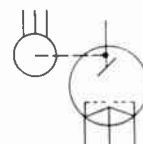

Note—Single-line (one-line) symbols appear at the left, complete symbols at the right, and symbols suitable for both purposes are centered in each column.

# IRE Dictionary on Terms and Symbols

64.11.12.5 With multiple accelerating electrode, electrostatically and electromagnetically focused (see note in item 64.10.9)

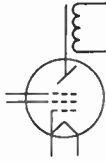

64.12 Basing and terminal connections for connection (wiring) diagrams

Not normally used for schematic diagrams.

64.12.1 Basing orientation symbols

64.12.1.1 For tubes with keyed bases  
Explanatory word and arrow are not a part of the symbol shown.



64.12.1.2 For tubes with bayonets, bosses, and other reference points



64.12.2 Tube terminals

The usage of the rigid-envelope-terminal symbol of item 64.12.2.2 includes the indication of any external metallic envelope or conducting coating or casing that has a contact area (as in cathode-ray tubes, metallic "pencil" tubes, etc.). However, where contact to such external metallic elements is made through a base terminal, a dot junction is employed as in item 64.12.3.1 to indicate that voltage applied to this base terminal may make the envelope alive.

Terminal symbols may be added to the composite device symbols where desired without changing the meaning or becoming a part of the symbol.

64.12.2.1 Base terminals

Explanatory words and arrows are not a part of the symbol.

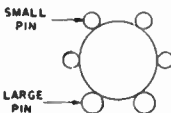

64.12.2.2 Envelope terminals

Explanatory words and arrows are not a part of the symbol.

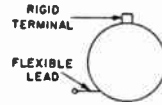

64.12.3 Applications

64.12.3.1 Triode with indirectly heated cathode and envelope connected to base terminal

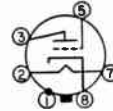

64.12.3.2 Triode-heptode with rigid envelope connection

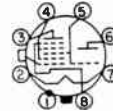

64.12.3.3 Ultra-high-frequency triode (disk-seal-tube type) with internal capacitor

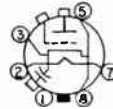

64.12.3.4 Rectifier with heater tap and envelope connected to base terminal

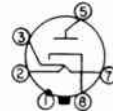

64.12.3.5 Equipotential-cathode twin triode with tapped heater

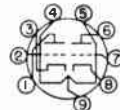

## 65. UNIT, PIEZOELECTRIC CRYSTAL



Note—Single-line (one-line) symbols appear at the left, complete symbols at the right, and symbols suitable for both purposes are centered in each column.

## Graphical Symbols for Electrical Diagrams

### 66. VARISTOR

See also RECTIFIER (item 46).

Electroelectrical transducer with nonlinear characteristics.

*The arrowheads in these cases are to be filled.*

#### 66.1 Asymmetrical; metallic rectifier

Arrow shows direction of forward (easy) current as indicated by direct-current ammeter.



#### 66.2 Symmetrical



### 67. VIBRATOR

67.1 Typical shunt drive (contacts as required) (with terminals shown)

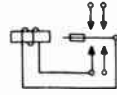

67.2 Typical separate drive (contacts as required) (with terminals shown)

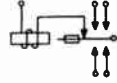

Note—Single-line (one-line) symbols appear at the left, complete symbols at the right, and symbols suitable for both purposes are centered in each column.

## INDEX TO GRAPHICAL SYMBOLS

1) *Feedback Control Systems, page 174.*

2) *Semiconductor Devices, pages 175-179.*

3) *Electrical Diagrams (itemised below), pages 180-221.*

<i>Description</i>	<i>Item</i>	<i>Description</i>	<i>Item</i>
adjustable	1	shunt	8.4
aerial	3	split-stator	8.3
air core	17.1	trimmer	8.1.2
air transmission path	43.3	terminating	59.4
alarm		carbon block	4.2
audible	21	cell	
contact, fuse with	27.4	aluminum	4.3
visual	22	battery	6.2
alternating-current generator	35	blocking-layer	9.3
alternating-current source, gen-	41	electrolytic	4.3
eralized		photosensitive	9
alternate wiring	43.9	selenium	9.2
aluminum cell	4.3	chassis	10
amplifier	2	circuit	
rotary	35.9.20-23	breaker	7 or 25.2
annunciator	22.1	element	25
antenna	3	open	59.2
aperture coupling	20.1	short	59.3
arrester		terminal	58
electric surge	4	circular hybrid	30
film element	4.7	circular waveguide	43.11.1
lightning	4	clock, contact-making	37
valve element	4.7	clockwise rotation	39.3
associated path or equipment	43.10	coaxial connector	14.5
attenuator	5	coaxial transmission path	43.1 or 43.8.2
audible signaling device	21	coil	
autotransformer	63.7-8	blowout	11
		loading	31
		operating	12
		repeating	63
		retardation	31
		condenser (capacitor)	8
		synchronous	35.11
		conductor	43
		connection, mechanical	13
		connector	14
		coaxial	14.5
		constant current transformer	63.5
		contact	
		assembly, basic	15.3
		electric	15
		fixed	15.1
		moving	15.2
		contactor	16
		continuously adjustable	1
		control transformer, synchro	57.1
		convenience outlet	14.8
		converter, synchronous	35.12
		core	17
		air	17.1
		magnetic	17.2
		magnet or relay	17.3
		counter	18
		counterpoise	3.2
		coupler, directional	19
		coupling capacitor potential de-	8.7
		vice	
		coupling (electric)	20
ballast lamp or tube	33.1		
barretter (thermistor)	60		
barrier photocell	9.3		
basic contact assemblies	15.3		
battery	6		
polarity	6		
bell	21.1		
bimetallic strip	26		
binding post	58		
block, carbon	4.2		
block, connecting	58.1		
blocking-layer cell	9.3		
blocks, test	14.9		
blowout coil	11		
board, terminal	58.1		
breaker, circuit	7 or 25.2		
bushing, capacitance	8.6		
bushing potential device	8.6.1		
buzzer	21.2		
cable	43		
cable, coaxial	43.8.2		
cable termination	59.1		
capacitance bushing	8.6		
capacitor	8		
differential	8.2		
feed-through	8.5		
phase-shifter	8.2.1		
potential device	8.7		



## Index to Graphical Symbols

<i>Description</i>	<i>Item</i>	<i>Description</i>	<i>Item</i>
crossing of paths	43.5	gap	4
crystal		horn	4.4
diode	46.2	protective	4.5
rectifier	46.2	sphere	4.6
unit, piezoelectric	65	generalized alternating-current	41
current limiter for power cable	34	source	
cutout, primary fuse	27.2-3	generalized direct-current source	6.1
cutout, thermal	26.2	generator	35
		glow lamp	33.3
device		governor	47
audible signaling	21	ground	28
coupling capacitor potential	8.7		
disconnecting	14	handset	29
outdoor-metering	63.18	headset	45
visual signaling	22	hearing aid	45
dial, telephone	25.2 or 56.13.6	heating resistor	50.5
differential capacitor	8.2	hook switch	56.13.5
differential synchro (receiver or transmitter)	57.2	horn	21.3
dipole antenna	3.1.1	gap	4.4
diode, crystal	46.2	howler	21.3
direct-current generator	35.9	hybrid	30
direct-current source, generalized	6.1	junction	30.2
direction of flow of power, signal, or information	23		
directional coupler	19	illuminating lamp, incandescent	33.4
disconnecting		filament	
device	14	indicating light	22.3
switch	56	induction voltage regulator	63.10-12
switch, fuse	27.2	inductor	31
discontinuity	24	saturable core	31.7
drop	22	shunt	31.6
dynamotor	35.9.17	terminating	59.5
		instrument	37
		shunt	50.6
		interlock, mechanical	13.2-3
		interlock, safety (electrical)	56.13.4
earphone	45		
electric contact	15	jack	14
electrolytic		junction of paths	43.6
capacitor	8	junction, hybrid	30
cell	4.3		
rectifier	46.2	key	
electron tube	64	operated lock switch	56.13.1
element		switch	56.11
circuit	25	telegraph	32
film	4.7		
fusible	27.1	lamp	33
thermal	26	ballast	33.1
valve	4.7	cold-cathode	33.3
envelope, electron tube	64.6	communication switchboard-	22.2
envelope, switch (evacuated)	56.13.7	type	
equalizer	25.2	fluorescent	33.2
facsimile set	25.2	glow	33.3
feed-through capacitor	8.5	incandescent-filament	33.4
field winding, generator or motor	35.7	illuminating	
film element, arrester	4.7	neon	33.3
filter	25.2	light; indicating pilot, signaling, or switchboard	22.3
fixed, contact	15.1	lightning arrester	4
flasher	26.2	limit switch	56.13.2
fluorescent lamp	33.2	limiter for power cable, current	34
frame	10	loop antenna	3.1.2
frequency changer	35.11.5-6	loop coupling	20.2
fusible element	27.1	loudspeaker	21.3
fuse	27		
fuse with alarm contact	27.4		
future path or equipment	43.10		

## IRE Dictionary on Terms and Symbols

<i>Description</i>	<i>Item</i>	<i>Description</i>	<i>Item</i>
machine, rotating	35	"pothead"	59.1
magnet core	17.3	"pot." (potential transformer)	63.17
magnet, permanent	36	power supply	25.2
magnetic core	17.2	probe coupling	20.3
magnetolectric generator	35.10.10	protective functions, relay	48.8
mechanical connection	13	protective gap	4.5
mechanical interlock	13	protector	4 or 27
metallic rectifier	46.2	push button (switch)	56.6-7
message register	18		
meter	37	quad	43.7.3
shunt	50.6	quantities, phase sequence	48.8.10
metering device, outdoor	63.18	quantity, relay operating	48.8.8
microphone	38	reactor	31
mode suppression	55	receiver, hearing aid	45
mode transducer	62	receiver, telephone	45
motion, mechanical	39	receptacle	14
motor	35	recording unit	25.2
compound-wound	35.9.9-10	rectangular waveguide	43.11.2
induction	35.10.1-2	rectifier	46
series	35.9.4-5 or 35.10.3-4	electrolytic	46.2
shunt	35.9.6-7	electron tube	64.11.8
synchronous	35.11	metallic	46.2
movable	39	reed, vibrator	15.2.5
short	59.3.1	register, message	18
moving contact (electric)	15.2	regulator	
multigap arrester	4.8	induction-voltage	63.10-12
		speed	47
neon lamp	33.3	step-voltage	63.8
neon light	22.3	relay	48
network	40 or 25.2	core	17.3
normals	14.7	demand totalizing	37
normalised connectors	14.7	protective functions	48.8
		shunt	50.6
open	59.2	thermal	26.3
operating coil	12	repeater	49
operating quantity, relay	48.8.8	repeating coil	63
operator's set	29.6	reproducer (pickup)	44
oscillator	41	reproducing unit	25.2
oscillograph, string	37	resistor	50
oscilloscope or cathode-ray oscillograph	37	heating	50.5
outdoor metering device	63.18	shunt	50.7
outlet, convenience	14.8	terminating	59.6
		resonator	51
pad	42	rheostat	39.5 or 50.3-4
pair, twisted	43.7.1	ridged waveguide	43.11.3
path, transmission	43	ringer, telephone	21.1
permanent magnet	36	rotary amplifier	35.9.20-23
phase sequence quantities	48.8.10	rotating machine	35
phase shifter	35.10.17-18 and 53	rotation designation	39.3-5
capacitor	8.2.1		
photocell, barrier	9.3	safety interlock (electrical)	56.13.4
photoconductive transducer	9.1-2	safety interlock (mechanical)	13
photosensitive cell	9	saturable-core inductor	31.7
phototube	64.11.6	selenium cell	9.2
photovoltaic transducer	9.3	selector switch	56.12
pickup	44	set, facsimile	25.2
polarity, battery	6	set, operator's	29.6
piezoelectric crystal unit	65	shield, shielding	52
pilot light	22.3	shifter, phase	35.10.17-18 and 53
plug	14	short	59.3
polarizing marks for current	63.16.1	movable	59.3.1
transformer		shunt	
polarizing marks for potential	63.17.1	capacitor	8.4
transformer		inductor	31.6
"pot." (adjustable resistor)	50.3 and 39.5	instrument, meter or relay	50.6
		resistor	50.7

## Index to Graphical Symbols

<i>Description</i>	<i>Item</i>	<i>Description</i>	<i>Item</i>
signaling device, audible	21	short circuit	59.3
signaling device, visual	22	test blocks	14.9
signaling light	22.3	thermal	
siren	21.3	cutout	26.2
slip ring	15.2.7	element	26
solenoid	12	relay	26.3
sounder, telegraph	54	thermistor	60
source of alternating current, general- eralized	41	thermocouple	61
source of direct current, general- ized	6.1	thermostat	26.4
speed regulator	47	transducer	
sphere gap	4.6	mode	62
split-stator capacitor	8.3	photoconductive	9.1-2
station, telephone	25.2	photovoltaic	9.3
step-voltage regulator	63.8	transformer	63
strip, bimetallic	26	constant-current	63.5
strip, terminal	58.1	current	63.16
surge arrester	4	potential	63.17
supply, power	25.2	waveguide	63.1
suppression, mode	55	transmitter, telephone	38
switch	56	trimmer capacitor	8.1.2
switchboard lamp, communica- tions type	22.2	triple, twisted	43.7.2
switchboard light	22.3	tube, ballast	33.1
switchhook	56.13.5	tube, electron	64
synchro	57	underground transmission path	43.8.7
taper, coaxial or waveguide	63.1	unit	
telegraph key	32	piezoelectric crystal	65
telegraph sounder	54	recording	25.2
telephone		reproducing	25.2
dial	25.2 or 56.13.6	vacuum tube	64
receiver	45	valve element arrester	4.7
ringer	21.1	"variable"	1
station	25.2	varistor	66
transmitter	38	vibrator	67
teleprinter	25.2	reed	15.2.5
teletypewriter	25.2	visual signaling device	22
terminal		voltage regulator, induction	63.10-12
board	58.1	voltage regulator, step	63.8
circuit	58	waveguide	43.11
electron tube	64.12.2	winding	31
strip	58.1	connection symbols, trans- former	63.19
terminating		field	35.7
capacitor	59.4	operating coil	12
inductor	59.5	rotating machine	35.8
resistor	59.6	transformer	63.1
termination		wiring	43
cable	59.1	alternate	43.9
open circuit	59.2	future	43.10









