

MARCH • 1955

Proceedings



OF THE **IRE**

B R Cole

55 SESSIONS
AND SYMPOSIA

704 ENGINEERING EXHIBITS

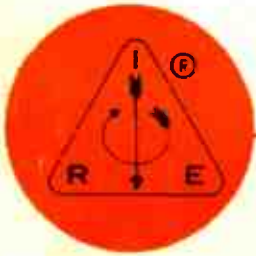

ANNUAL BANQUET
COCKTAIL PARTY
ANNUAL MEETING
WOMEN'S PROGRAM

1955 IRE

NATIONAL CONVENTION
AND ENGINEERING SHOW

MARCH 21-24 • NEW YORK
WALDORF ASTORIA HOTEL
AND KINGSBRIDGE ARMORY

CONVENTION PROGRAM, PAGE 347; WHAT TO SEE AT THE SHOW, PAGE 1A; TABLE OF CONTENTS FOLLOWS PAGE 128A.

The Institute of Radio Engineers

World Radio History

THE STANDARD OF COMPARISON FOR OVER 20 YEARS

HIGH FIDELITY TRANSFORMERS

FROM STOCK... ITEMS BELOW AND 650 OTHERS IN OUR CATALOGUE B.



TYPICAL UNITS

LINEAR STANDARD series

Linear Standard units represent the acme from the standpoint of uniform frequency response, low wave form distortion, thorough shielding and dependability. LS units have a guaranteed response within 1db. from 20 to 20,000 cycles.

Hum balanced coil structures and multiple alloy shielding, where required, provide extremely low inductive pickup.

These are the finest high fidelity transformers in the world. 85 stock types from milliwatts to kilowatts.

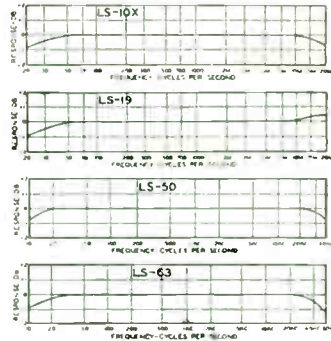

LS-10X Shielded Input
Multiple line (50, 200, 250, 500/600, etc.) to 50,000 ohms... multiple shielded.

LS-19 Plate to Two Grids
Primary 15,000 ohms.
Secondary 95,000 ohms C.T.

LS-50 Plate to Line
15,000 ohms to multiple line... +15 db. level.

LS-63 P.P. Plates to Voice Coil
Primary 10,000 C.T. and 6,000 C.T. suited to Williamson, MLF, ul. linear circuits.
Secondary 1.2, 2.5, 5, 7.5, 10, 15, 20, 30 ohms. 20 watts.



CASE	LS-1	LS-2	LS-3
Length	3 1/8"	4-7/16"	5-13/16"
Width	2 5/8"	3 1/2"	5"
Height	3 1/4"	4-3/16"	4-11/16"
Unit Wt.	3 lbs.	7.5 lbs.	15 lbs.

HIPERMALLOY series

This series provides virtually all the characteristics of the Linear Standard group in a more compact and lighter structure. The frequency response is within 1 db. from 30 to 20,000 cycles. Hipermalloy nickel iron cores and hum balanced core structures provide minimum distortion and low hum pickup. Input transformers, maximum level +10db. Circular terminal layout and top and bottom mounting.

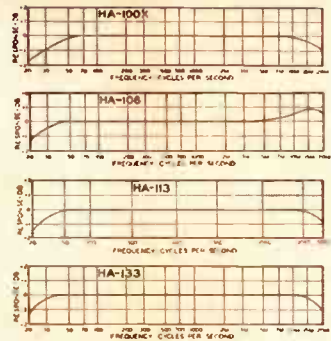

HA-100X Shielded Input
Multiple line to 60,000 ohm grid... tri-alloy shielding for low hum pickup.

HA-106 Plate to Two Grids
15,000 ohms to 135,000 ohms in two sections... +12 db. level.

HA-113 Plate to Line
15,000 ohms to multiple line... +12 db. level... 0 DC in primary.

HA-133 Plate (DC) to Line
15,000 ohms to multiple line... +15 db. level... 8 Ma. DC in primary.



Case	H-1	H-2
Length	2 3/4"	3-9/16"
Width	1-15/16"	2-13/16"
Height	3 1/8"	3 1/8"
Unit Weight	2 lbs.	5 lbs.

ULTRA COMPACT series

UTC Ultra Compact audio units are small and light in weight, ideally suited to remote amplifier and similar compact equipment. The frequency response is within 2 db. from 30 to 20,000 cycles. Hum balanced coil structure plus high conductivity die cast case provides good inductive shielding. Maximum operating level is +7db. Top and bottom mounting as well as circular terminal layout are used in this series as well as the ones described above.

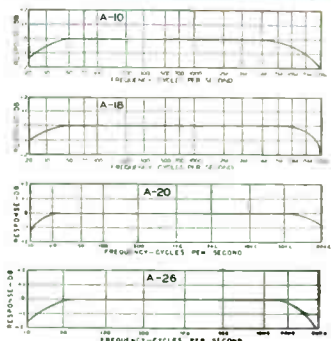

A-10 Line to Grid
Multiple line to 50,000 ohm grid.

A-18 Plate to Two Grids
15,000 ohms to 80,000 ohms, primary and secondary both split.

A-20 Mixing Transformer
Multiple line to multiple line for mixing mikes, lines, etc.

A-26 P.P. Plates to Line
30,000 ohms plate to plate, to multiple line.

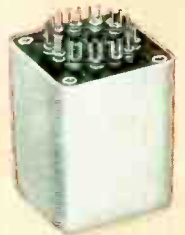

A CASE	
Length	1 1/2"
Width	1 1/2"
Height	2"
Unit Weight	1/2 lb.

OUNCER series

UTC Ouncer units are ideal for portable, concealed service, and similar applications. These units are extremely compact, fully impregnated and sealed in a drawn housing. Most items provide frequency response within 1 db. from 30 to 20,000 cycles. Maximum operating level 0 db. These units are also available in our stock P series which provide plug-in base. The O-16 is a new line to grid transformer using two heavy gauge hipermalloy shields for high hum shielding.

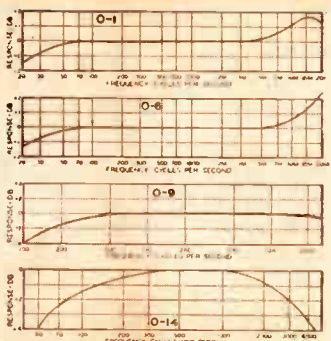

O-1 Line to Grid
Primary 50, 200/250, 500/600 ohms to 50,000 ohm grid.

O-6 Plate to Two Grids
15,000 ohms to 95,000 ohms C.T.

O-9 Plate (DC) to Line
Primary 15,000 ohms, Secondary 50, 200/250, 500/600.

O-14 50: 1 Line to Grid
Primary 200 ohms, Secondary .5 megohm for mike or line to grid.



OUNCER CASE	
Diameter	7/8"
Height	1-3/16"
Unit Weight	1 oz.

SPECIAL UNITS TO YOUR NEEDS

If you manufacture high fidelity gear, send your specifications for prices.

UNITED TRANSFORMER CO.

150 Varick Street, New York 13, N. Y. EXPORT DIVISION: 13 E. 40th St., New York 16, N. Y. CABLES: "ARLAB"

World Radio History

Calling All Radio Engineers



To Your 1955 IRE Convention and Radio Engineering Show



March 21-24
1955
New York City

**704 Exhibits at Kingsbridge
Armory and Palace**

TECHNICAL SESSIONS IN 1955

A complete program with abstracts of papers is given in this issue. See the "Technical Sessions" columns in the editorial section for data on history-making meetings you cannot afford to miss.

What to See at the Radio Engineering Show

WHERE

Exhibits in booths 1-100 are in Kingsbridge Palace, 350 yards south of Kingsbridge Armory on Jerome Avenue. Follow the string of yellow lights.

Booths 100-900 are in Kingsbridge Armory.

AGA Division, Elastic Stop Nut Corp. of America, 781 Airborne Ave.

Showing a complete line of Agastat time relays and time delay switches with delay switches with delay period range from 0.1 second to approximately 15 minutes. All operating and featuring new dial-head adjustment including operating demonstration of typical electronic industry application.

Ace Engineering & Machine Co., Inc., 501, 600, 601 Production Rd.

Exhibiting a unique cell type shielded enclosure to show versatility of Ace design. Also displaying a solid galvanized sheet enclosure easily adapted to outside use.

Acme Electronics Inc., 548, 550, 552 Components Ave.

See Aerovox Corp

Acro Manufacturing Co., 404 Electronics Ave.

Animated display showing Acro Switch principle. Also will feature several new switches including a heavy duty limit switch. Highlight will be demonstration of precision test methods.

Acro Products Co., 38 Palace.

Acrosound ultra-linear output transformers; Broad Band audio and supersonic transformers; Pulse transformers; Magnetic amplifiers; Specialty Power Frequency units. Custom transformer design and production to commercial and MIL specifications.

Actioncraft Products, 878 Audio Ave.

Exhibiting "PERMATAGS" the custom made split sleeve wire marker and a complete line of precision engraved dials, scales, and nameplates and laminated schematic diagrams.

Advance Electric & Relay Co., 759 Airborne Ave.

Will display a wide variety of relays for many applications. New items are "TQ," "SQ," "SO" and "MX" relays for varied industrial applications.

Advance Electronics Co., Inc.

787 Airborne Avenue

Ultra precision phase meters with unusual features. Exclusive circuits give exceptional stability. Also, fixed and variable delay lines, various electronic counters. All used in leading research centers.

AEROVOX

and the newest
**The FINEST Δ in
ELECTRONIC
COMPONENTS**

BOOTHS 548 — 550 — 552

(Continued on page 136A)

PROCEEDINGS OF THE I.R.E. March, 1955, Vol. 43, No. 3. Published monthly by the Institute of Radio Engineers, Inc., at 1 East 79 Street, New York 21, N.Y. Price per copy: members of the Institute of Radio Engineers \$1.00; non-members \$2.25. Yearly subscription price: to members \$9.00; to non-members in United States, Canada and U.S. Possessions \$18.00; to non-members in foreign countries \$19.00. Entered as second class matter, October 26, 1927, at the post office at Menasha, Wisconsin, under the act of March 3, 1879. Acceptance for mailing at a special rate of postage is provided for in the act of February 28, 1925, embodied in Paragraph 4, Section 412, P. L. and R., authorized October 26, 1927.

Table of Contents will be found following page 128A

World Radio History

**March
21-24**

The
Radio-Electronic
SPECTACULAR
of 1955!

**See!
Hear!**

**IRE
National Convention**



and

**Radio
Engineering Show**

At both the Waldorf-Astoria (convention headquarters) and Kingsbridge Armory, you'll attend what actually amounts to 22 conventions fused into one. Hundreds of scientific and engineering papers will be presented during the many technical sessions, a large number of which are organized by I R E professional groups. You'll meet with the industry's leaders—enjoy the finest meeting and recreational facilities in New York.

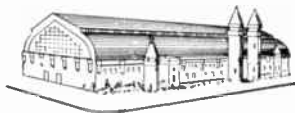

At the Kingsbridge Armory and Kingsbridge Palace, you'll walk through a vast panorama of over 700 exhibits, displaying the latest and the newest in radio-electronics. You'll talk shop with the industry's top manufacturers—enjoy the conveniences provided for you in the world's finest exhibition halls, easily reached by subway and special bus service.

Admission by registration only. \$1.00 for I R E members, \$3.00 for non-members. Social events priced extra.

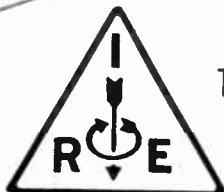

The Institute of Radio Engineers
1 East 79 Street, New York

7 out of **704***
good reasons why
you should attend
the **Radio
Engineering Show**



Hear...

vital research and engineering papers on computers, transistors, color TV, etc., subject-organized in 55 sessions.



Watch...

a computer balance a cane, making 20 corrective moves a second—at the IRE Show.



See...

the exhibits of 69 components vital to successful Automation. Or compare 21 different types of Transistors—and other subminiature components.



Check-up on...

"1955 Instrumentation" shown on Instruments Avenue. Exhibit grouping helps you see more on the Avenues named.

**Audio • Broadcast • Radar
Transistor • Television
Radio • Components • Microwave
Airborne • Production
Circuits • Computer • Electronics**



Meet...

all your friends. 39,302 attended IRE in 1954.

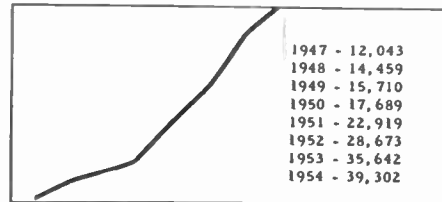

Enjoy...

The Convention's Social Events. It is good to mingle with your industry friends at IRE.



Get the facts...

faster and easier at exhibits and sessions than you could from weeks of your own "digging."

*Send for the 1954 Directory of 604 Exhibitors and list of 100 new exhibitors.

A **SNAP** FOR WIRING BOARD ASSEMBLIES

NEW Sprague Type 28D
Push-Lok* Electrolytic Capacitors
Give Fast, Fool-Proof Mounting

HERE'S THE BEST APPROACH yet to electrolytic capacitors for printed wiring board assemblies.

It's Sprague's new Type 28D Push-Lok Electrolytic. Just insert the connecting lugs through the slots in the wiring board, and the capacitor is held securely in place until the chassis is ready for dip soldering . . . so securely that solder gaps are eliminated. Spring action of the Push-Lok lugs is strong enough to hold relatively heavy capacitors in place, even when the board is carried sideways, or upside-down on a conveyor. Tab connections are always in close contact with the printed conductors. Yet, unlike other designs, no secondary operations are required for this fast and secure mounting.

Other advantages include:

Fool-Proof Positioning—A Push-Lok can only be inserted the right way. A wide index terminal is provided in the mounting ring to index the assembly on the chassis or other surface if desired.

The Ability to Print Wiring Boards on Both Sides—Shoulders on the Push-Lok lugs plus additional prongs keep the capacitors clear of the chassis.

Safety—Circular shield conforms with suggestions of Underwriters' Laboratories, Inc. Tools cannot be inserted easily between the bottom of the capacitor and the chassis.

FOR COMPLETE INFORMATION on these new Type 28D Push-Lok electrolytic capacitors, write for Engineering Bulletin to Sprague Electric Co., 235 Marshall Street, North Adams, Massachusetts.

*Push-Lok is a Trademark of the Sprague Electric Company



Sprague, on request, will provide you with complete application engineering service for optimum results in the use of electrolytic capacitors.

SPRAGUE

**WORLD'S LARGEST
CAPACITOR MANUFACTURER**

Export for the Americas: Sprague Electric International Ltd., North Adams, Mass. CABLE: SPREXINT

SEE US AT THE I.R.E. SHOW—247-249 Instruments Avenue

PROCEEDINGS OF THE I.R.E.

March, 1955

World Radio History

How your telephone call asks directions... and gets quick answers

Perforated steel cards, which give directions to the Long Distance dial telephone system, are easy to keep up to date. New information is clipped (1) and punched (2) by hand on a cardboard template. This guides the punch-press that perforates a steel card (3), and the two are checked (4). The new card is put into service in the card translator (5).

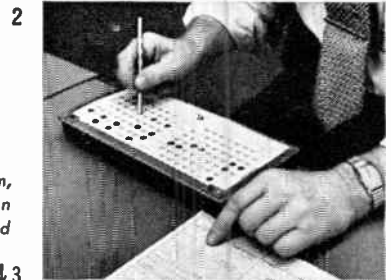
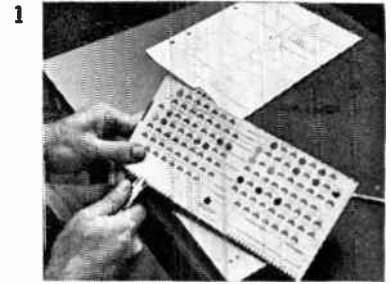

↓ 3



When the Bell System's latest dial equipment receives orders to connect your telephone with another in a distant city, it must find—quickly and automatically—the best route.

Route information is supplied in code—as holes punched on steel cards. When a call comes in, the dial system selects the appropriate card, then reads it by means of light beams and photo-transistors. Should the preferred route be in use the system looks up an alternate route.

It is a simple matter to keep thousands of cards up to date when new switching points are added or routing patterns are changed to improve service. New cards are quickly and easily punched with the latest information to replace out-of-date cards.

This efficient, flexible way of keeping your dial system up to the minute was devised by switching engineers of Bell Telephone Laboratories, who are continually searching for ways to improve service and to lower costs. Right now most of the Long Distance dialing is done by operators, but research is hastening the day when you will be able to dial directly to other telephones all over the nation.

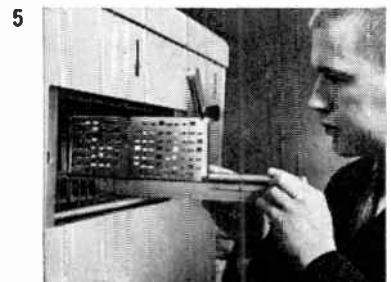
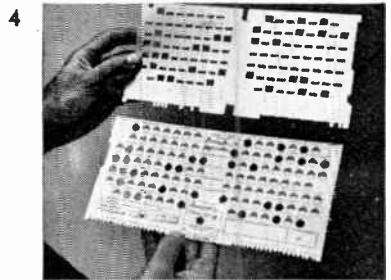

BELL TELEPHONE LABORATORIES

Improving telephone service for America provides careers for creative men in scientific and technical fields.



An Important Announcement to Industry-

SILICON **POWER** RECTIFIERS

AVAILABLE FOR THE FIRST TIME IN PRODUCTION QUANTITIES



★ These units are ideally suited for aircraft and guided missile requirements. Other typical applications that can benefit from their superior characteristics are power rectifiers in commercial equipment, magnetic amplifiers, clipping, meter protection and counter circuits. Anxiety over temperatures is completely eliminated when they are used in digital computers. Automation and control engineering suggest additional fields.

Performance:

1. Rectification Efficiency Over 99%
2. Forward Voltage Drops Averaging 1.5 Volts at 200 MA
3. Peak Inverse Voltages to 1,000 Volts
4. Operates Continuously up to 200°C.
5. Leakage Current as Low as 10-10 amperes
6. Rectification Ratios as High as 10°
7. Practically Flat Zener Characteristics

Characteristics:

1. HIGHEST EFFICIENCY
2. HIGH CURRENT
3. HIGH VOLTAGE
4. HIGH AMBIENT OPERATION
5. HERMETICALLY SEALED
6. SMALL IN SIZE
7. LIGHT IN WEIGHT
8. RUGGED - ALL WELDED
9. LOW FORWARD DROP
10. LOW LEAKAGE

Write for fully illustrated and informative Bulletin SR-18-3

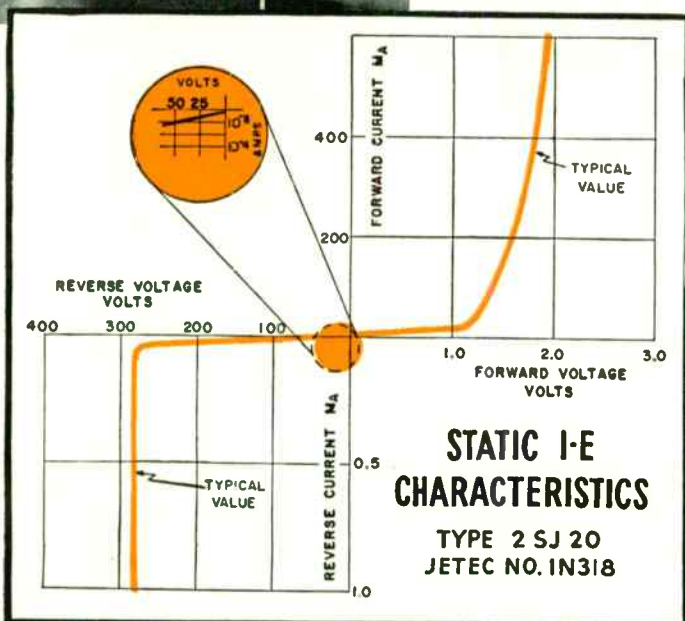
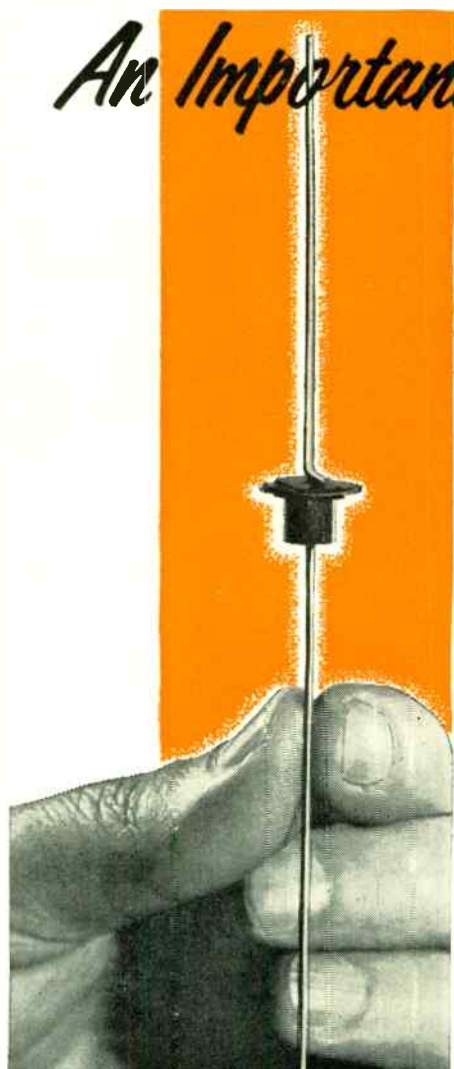

Jetec No.	TYPE	Forward Drop @ 200 MA	Forward Current Continuous	Power Current Peak	Peak Inverse
IN 316	2SJ5	2V Max	200 MA	2A	50V
IN 317	2SJ10	2V Max	200 MA	2A	100V
IN 318	2SJ20	2V Max	200 MA	2A	200V
IN 319	2SJ30	2V Max	200 MA	2A	350V
IN 320	2SJ50	2V Max	200 MA	2A	500V

Units with peak inverse rating of 850 volts available in sample quantities.

BOGUE

BOGUE ELECTRIC
MANUFACTURING COMPANY
PATERSON 3, NEW JERSEY



**Be there faster...
arrive fresh and relaxed!**

FLY UNITED
to the annual convention of
**THE INSTITUTE OF
RADIO ENGINEERS**

New York City, March 21-24

Take advantage of United's fast, dependable Mainliner flights direct to New York. You can take your choice of service: either luxurious First Class flights with delicious meals aloft, or thrifty Air Coach Mainliner flights with exclusive 2-abreast seating comfort. A round trip discount is offered on all First Class flights. Also, ask about the economical half-fare family plan.

Convenient day or night, 'round the clock schedules to 80 U. S. cities coast-to-coast! For expert trip planning and reservation assistance, call your nearest United office or authorized travel agent.

**There's a difference
when you travel in the
Mainliner manner**



Meetings with Exhibits

● As a service both to Members and the industry, we will endeavor to record in this column each month those meetings of IRE, its sections and professional groups which include exhibits.



March 21-24, 1955

Radio Engineering Show and I.R.E. National Convention, Kingsbridge Armory and Kingsbridge Palace, N.Y.C.

Exhibits: Mr. William C. Copp, Institute of Radio Engineers, 1475 Broadway, New York 36, N.Y.

April 15-16, 1955

Ninth Annual Spring Technical Conference, Cincinnati Section, IRE, Engineering Society of Cincinnati Bldg., Cincinnati, Ohio

Exhibits: Mr. Clyde G. Haehnle, Crosley Broadcasting Corp., 140 West Ninth St., Cincinnati 2, Ohio

April 27-29, 1955

Seventh Regional Technical Conference & Trade Show, Hotel Westward Ho, Phoenix, Ariz.

Exhibits: Mr. George McClarathan, 509 East San Juan Cove, Phoenix, Ariz.

May 9-11, 1955

National Conference on Aeronautical Electronics, Biltmore Hotel, Dayton, Ohio.

Exhibits: Mr. William Klein, 1472 Earham Drive, Dayton, Ohio

May 18-20, 1955

National Telemetering Conference, Morrison Hotel, Chicago, Ill.

Exhibits: Mr. Kipling Adams, General Radio Company, 920 S. Michigan Ave., Chicago, Ill.

June 2-3, 1955

I.R.E. Materials Symposium, Convention Hall, Philadelphia, Pa.

Exhibits: Mr. Merritt A. Rudner, United States Gasket Co., 611 North Tenth St., Camden 1, N.J.

Aug. 24-26, 1955

Western Electronic Show & Convention, Civic Auditorium, San Francisco, Calif.

Exhibits: Mr. Mal Mobley, 344 N. La Brea, Los Angeles 36, Calif.

Sept. 12-16, 1955

Tenth Annual Instrument Conference & Exhibit, Shrine Exposition Hall & Auditorium, Los Angeles, Calif.

Exhibits: Mr. Fred J. Tabery, 3443 So. Hill St., Los Angeles 7, Calif.

Note on Professional Group Meetings: Some of the Professional Groups conduct meetings at which there are exhibits. Working committeemen on these groups are asked to send advance data to this column for publicity information. You may address these notices to the Advertising Department, and of course listings are free to IRE Professional Groups.

WIDE RANGE
WIDE SWEEP-
Sweeping
OSCILLATOR

The
KAY
CALIBRATED
Mega-Sweep



- Continuously Tunable Thru Video VHF and UHF Frequencies, 50KC-950MC Range
- Sweep Widths to 40 MC
- Single Dial Tuning

Used with a standard cathode ray oscilloscope, the Kay Calibrated *Mega-Sweep* will display the response characteristic of wide band circuits over the frequency range of approximately 50 kc to 950 mc. It features a calibrated dial indication of the approximate output frequency. The center frequency of the sweeping output voltage may thus be set to an accuracy of about 10%. The calibrated *Mega-Sweep* is the ideal instrument for use in alignment of amplifiers and filters... also as an FM source of wide range for instructional and lab purposes.

SPECIFICATIONS

- Freq. Range:** 50 kc to 1000 mc.
Freq. Sweep: Sawtooth, adjustable to 40 mc. Repetition rate, 50 to 100 c/s.
RF Output: High, approx. 100 mv max. into open circuit. Low, 5 mv into open circuit.
RF Output Control: Microwave attenuator continuously variable to 26 db.
Output Waveform: Less than 5% harmonic distortion at max. output.
Meter: Provides crystal detector current for peak output.
Regulated Power Supply: 105-125 v., 50 to 60 cps. Power Input, 100 watts.

Send for Catalog 110-A

\$495 f.o.b. factory

KAY
SWEEPING OSCILLATORS
for every application



KAY
Mega-Sweep

Widest range of the Kay line of sweeping oscillators. Provides continuous frequency coverage up through UHF-TV bands - 50 kc to 1000 mc. Widely used in radar system development and in alignment and testing of TV and FM systems and components, as well as wide band IF and RF amplifiers and filters. Freq. range, 10 mc to 950 mc. Write for Catalog 100-A. Price, \$465 f.o.b. factory.

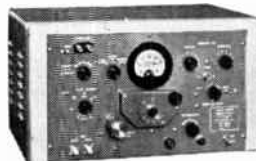

KAY
111-A CALIBRATED
Mega-Sweep

Higher output model calibrated *Mega-Sweep*, with zero level baseline. Higher output facilitates frequency response testing of UHF converters or tuners. Wider sweep width permits multi-channel response viewing. Zero level baseline is convenient means of measuring gain of test circuit.

SPECIFICATIONS

Frequency Range	Output Impedance	Output Voltage (Into Load)
1. 10 mc-950 mc	70 ohms unbalanced	0.15 Volts
2. 450 mc-900 mc	300 ohms balanced	0.3 Volts

Sweep Width: Continuously variable to approx. 40 mc max.

Write for Catalog 111-A

Price, \$575 f.o.b. factory

KAY 112-A CALIBRATED Mega-Sweep

Same as 111-A, except total frequency range is 800 mc to 1200 mc. Catalog 112-A. Price, \$575 f.o.b. factory.

KAY ELECTRIC COMPANY

14 MAPLE AVENUE PINE BROOK, N. J.

Dept. I-3



WAVEGUIDE BEND #557
WAVEGUIDE BEND #556



CIRCULAR WAVE GUIDE BEND #P600



LOW POWER TERMINATION #P540A
WAVEGUIDE 90° TWIST #558



MAGIC "T" TUNER #P559

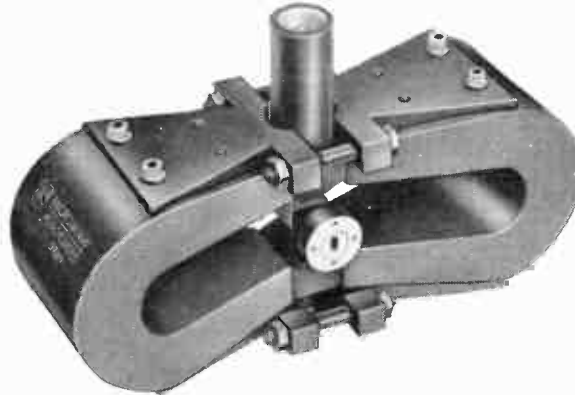

MAGNETRON #5789

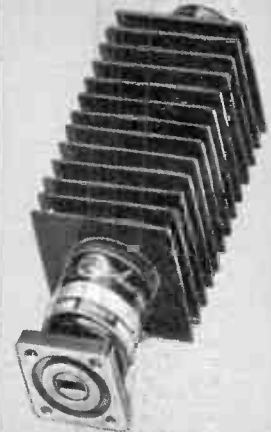

DUMMY LOAD #P537



FREQUENCY METER #P518

PLANNING MILLIMETER WAVE OPERATIONS?

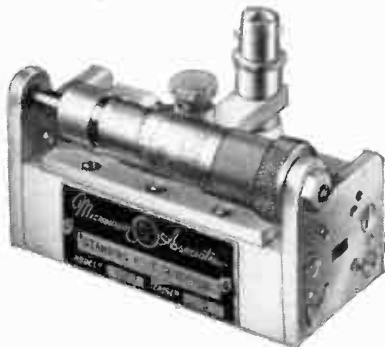

STANDING WAVE DETECTOR #1022

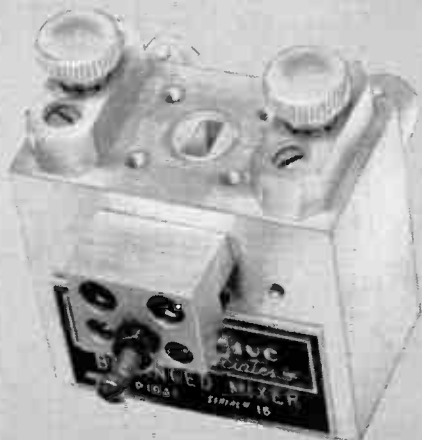

BALANCED MIXER #P1026

If you are working in the millimeter region — or are exploring it — you may be able to save considerable design and production time by acquainting yourself with our extensive experience, facilities and products in this field.

Available to you right now are over 40 items — components and test equipment — ready for you to incorporate in your designs and benches. Components for use in the 35 kmcs. band include slotted lines, frequency meters, loads and a spectrum analyzer adapter. If you are working with high resolution radar systems, we can furnish the long-life 40 KW 5789 magnetron, the 1N53 diode, complete duplexers, balanced mixers, echo boxes and many other components such as bends and transitions for operating circular wave guide in the low attenuation TE_{01} mode.

SEND FOR DATA Write for detailed specifications and catalog literature describing our millimeter components, magnetrons, TR and ATR tubes and silicon diodes.

If you have an interest in the millimeter waves, we would be pleased to give you the benefit of our experience to help you plan your operations in this region. **MICROWAVE ASSOCIATES, INC.**, 22 Cummington Street, Boston 15, Mass., Telephone COpley 7-4441.

 **MICROWAVE**
Associates INCORPORATED

See the
Bendix
 exhibit!

**RADIO ENGINEERING SHOW
 of the 1955
 I. R. E. NATIONAL CONVENTION**

March 21-24, 1955, Kingsbridge Armory
 Booth Nos. 128, 130, 132, 134, 136, 138, 140

**RED BANK
 DIVISION,
 Eatontown, N. J.**

**BENDIX RADIO
 DIVISION,
 Baltimore, Md.**

**CINCINNATI
 DIVISION,
 Cincinnati, Ohio**

**SCINTILLA
 DIVISION,
 Sidney, N. Y.**

**PIONEER-CENTRAL
 DIVISION,
 Davenport, Ia.**

**ECLIPSE-PIONEER
 DIVISION,
 Teterboro, N. J.**

**PACIFIC
 DIVISION,
 North Hollywood, Calif.**

The Bendix Divisions exhibiting at the 1955 Radio Engineering Show of the I.R.E. National Convention will be happy to discuss how they may apply their knowledge and experience to your specific problems.



for your product

whether it **PLAYS** or **COMPUTES**

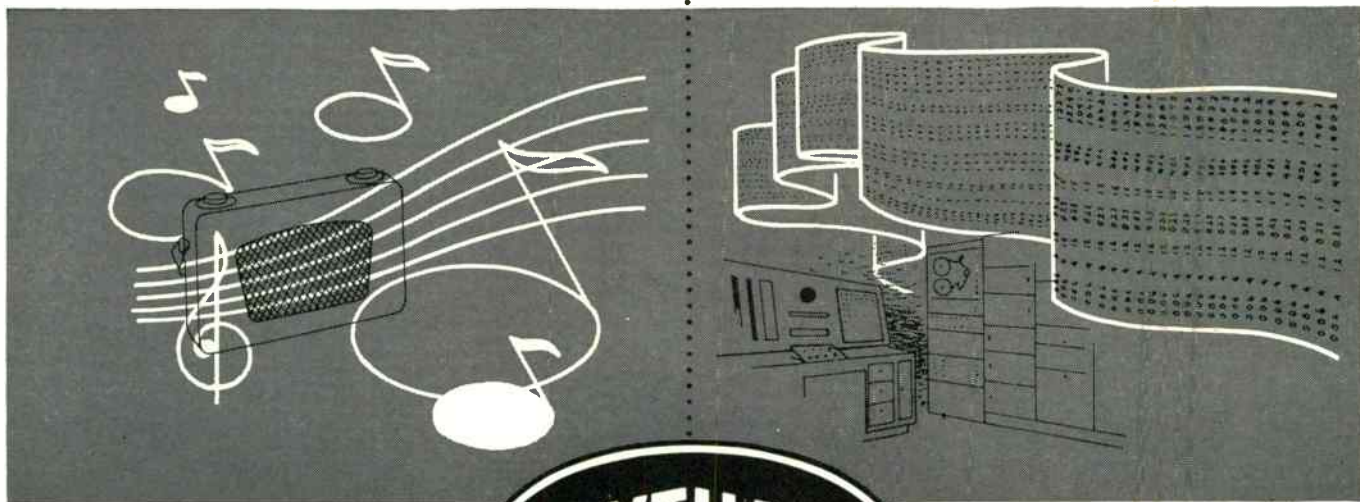

RF TRANSISTORS

RADIO APPLICATION

Raytheon RF Transistors create a whole new concept of portable radio convenience, performance and economy — portable radios that run for 500 hours on ordinary, low cost universally available flashlight batteries, and that *really* outperform most tube portables.

	CK760	CK761	CK762
Gain in db at 455 Kc.	32	33	33
Gain in db at 2000 Kc.	18	20	22

COMPUTER APPLICATION

Raytheon RF Transistors combine high alpha cutoff, fast rise time, the desired dissipation and voltage ratings and excellent base current amplification. They mark a milestone in computer development, design and progress.

	CK760	CK761	CK762
Rise time (μ secs)	0.05	0.04	0.02
Decay time (μ secs)	0.06	0.05	0.03

(measured in circuit which will be supplied on request)



Alpha frequency cutoff (megacycles)
 Collector capacitance ($\mu\mu$ fd)
 Extrinsic base resistance (max. ohms)

	CK760	CK761	CK762
Alpha frequency cutoff (megacycles)	5	10	20
Collector capacitance ($\mu\mu$ fd)	15	15	15
Extrinsic base resistance (max. ohms)	125	125	125

There are more — several times more
RAYTHEON TRANSISTORS
 in use than all other makes combined

COME IN AND TALK OVER THESE TRANSISTORS WITH US AT THE I.R.E. SHOW

**SUPERIOR
ELECTRICAL
RATINGS**

**SPECIALLY SELECTED
FOR
SPECIAL SERVICES**

**EXTENDED
TEMPERATURE
RATINGS
-50°C to +150°C**

**HERMETICALLY
SEALED**

**NEW
SMALL SIZE**



YOU GET THESE

when you specify these



SILICON DIODES

Charted here are some of the performance characteristics and features of four of these Silicon Diodes. Other characteristics can be supplied to your requirements. Other Raytheon Silicon, Gold Bonded Germanium and Point Contact Germanium Diodes are available. Complete data is yours for the asking.

IMPORTANT ADVANTAGES

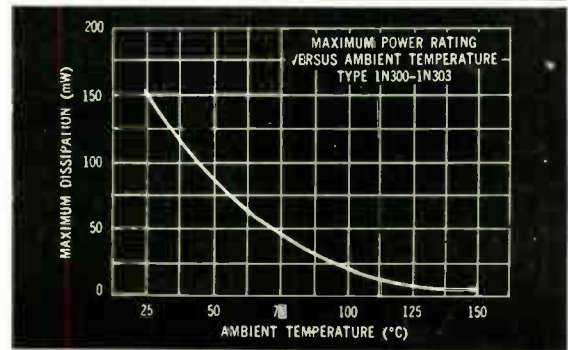
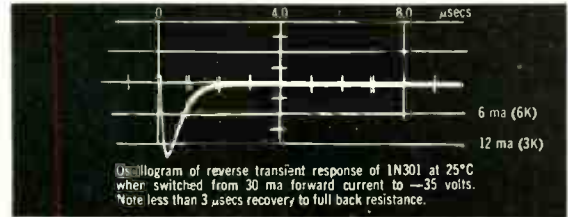

Diodes Shown Actual Size	Type	RATINGS AT 25°C AMBIENT						RATINGS AT 100°C AMBIENT		
		Minimum Forward Current @ +1.0 volt (mA)	Maximum Continuous Reverse Voltage (Volts)	Minimum Zener Voltage (@ 100 μA) Volts	Maximum Reverse Current @ -10V (μA)	Maximum Average Dissipation (mW)	Maximum Average Forward Current (mA)	Maximum Reverse Current @ -10V (μA)	Maximum Average Dissipation (mW)	Maximum Average Forward Current (mA)
	1N300 (CK733)	8.0	12	15	0.001	150	40	0.01	20	15
	1N301 (CK734)	5.0	60	70	0.01	150	35	0.2	20	12
	1N303 (CK738)	3.0	115	125	0.01	150	30	0.2	20	10
	1N302 (CK737)	1.0	215	225	0.01	150	25	0.2	20	8

RAYTHEON MANUFACTURING COMPANY



Semiconductor Division — Home Office: 35 Chapel St., Newton 28, Mass. SIGELow 4-7500

Excellence in Electronics

For application information write or call the Home Office or: 4935 West Fullerton Avenue, Chicago 39, Illinois, NATIONAL 2-2770

539 Fifth Avenue, New York 17, New York, PLaza 9-3900 • 522 South La Brea Ave., Los Angeles 36, California, WEbster 8-2831

RAYTHEON MAKES ALL THESE

RELIABLE SUBMINIATURE AND MINIATURE TUBES • SEMICONDUCTOR DIODES AND TRANSISTORS • NUCLEONIC TUBES • MICROWAVE TUBES • RECEIVING AND PICTURE TUBES

COME IN AND TALK OVER THESE DIODES WITH US AT THE I.R.E. SHOW

PROCEEDINGS OF THE I.R.E. March, 1955

HIGH ATTENUATION • CONTINUOUS DUTY • HERMETICALLY SEALED

FILTRON

SCREEN ROOM FILTERS



FILTRON TYPE FSR-502
500 VAC/DC
100 AMPS
Frequency Range 100G to 15,000 MC

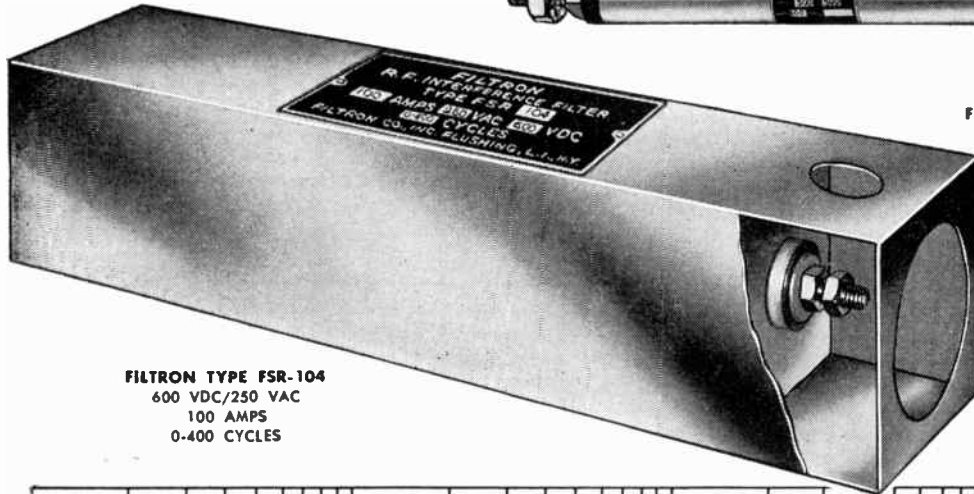

FILTRON TYPE FSR-104
600 VDC/250 VAC
100 AMPS
0-400 CYCLES

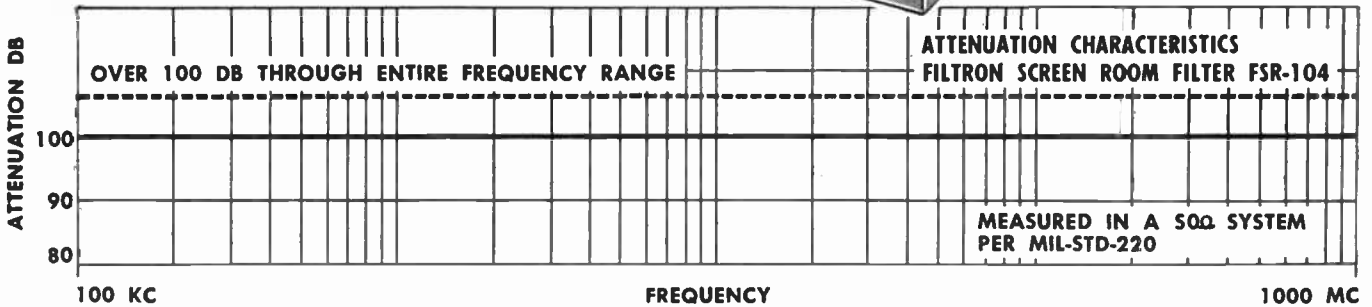

JUST OFF THE PRESS—Write for your copy

RADIO INTERFERENCE FILTER CATALOG

This 20 page catalog contains valuable data on FILTRON RADIO INTERFERENCE FILTERS for SCREEN ROOMS, INDUCTION HEATING EQUIPMENT, DIATHERMY SETS, X-RAY UNITS and other electrical interference-producing equipment. Included are illustrated installation recommendations, essential information on applications, attenuation characteristics and mechanical dimensions . . . Your copy gladly sent free upon request.



SALES REPRESENTATIVES

Screen room manufacturers specify and install FILTRON Screen Room Filters as standard equipment.

FILTRON Screen Room Filters are used in the majority of industrial, government and military screen rooms, to meet the requirements of specification MIL-S-4957, and wherever critical RF measurements are required.

FILTRON has over 40 types of Screen Room Filters available, ranging from 1 Amp to 1000 Amps, 28 VDC to 500 Volt AC/DC, 0 to 1000 cycles. Complete technical information available.

FILTRON RF Interference Filters are also specified in the latest types of Radar, Radio Transmitters, Receivers, Motor Generator Sets, Inverters, Aircraft, Electronic Systems, and numerous other "restricted" equipments.

When you have an RF Interference Filter problem, consult FILTRON—the most dependable name in RF Interference Filters.

G. S. Marshall Co., Pasadena, Cal. Holliday-Hathaway, Cambridge, Mass., Canaan, Conn.
Roy J. Magnuson, Chicago, Ill. Sales Offices at: New York, N. Y., Great Neck, N. Y.
Massey Associates, Inc., Narbeth, Pa., Rochester, N. Y., Binghamton, N. Y.
Washington, D. C. Waad-Ridge, N. J.

INTERFERENCE FREE

means

FILTERED
by

FILTRON co., inc. • FLUSHING, LONG ISLAND, NEW YORK

LARGEST EXCLUSIVE MANUFACTURERS OF RF INTERFERENCE FILTERS

Visit our booth 649 Circuits Avenue at the Radio Engineering Show

WHEN WRITING TO ADVERTISERS PLEASE MENTION — PROCEEDINGS OF THE I.R.E.

March, 1955

OHMITE "Brown Devil"®

RESISTORS have **BALANCED THERMAL EXPANSION!**

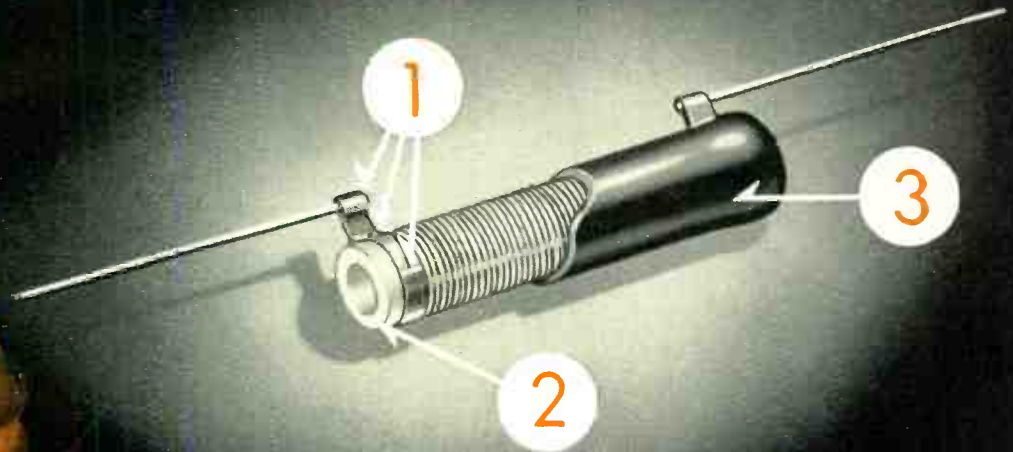

High-quality resistors for your tough jobs!

When you want a resistor that will stand up under high temperatures, specify Ohmite Brown Devils. They have been carefully designed to provide "balanced thermal expansion." All parts—core, resistance wire, vitreous enamel coating, and terminal band—have a thermal expansion that has been carefully matched. As a consequence, "Brown Devil" resistors expand and contract as a unit. This eliminates cracking of the enamel, keeps terminals firmly anchored, and prevents the entrance of moisture.

For many years, these superior Ohmite resistors have proved their reliability under the toughest service. Specify them on your next job.

PATENTED WELDED TERMINALS

1

Ohmite welded terminals provide a perfect and permanently stable electrical connection that is unaffected by vibration or high temperature.

HIGH TEMPERATURE STEATITE CORE

2

This strong, rugged steatite core has excellent electrical characteristics, and a coefficient of thermal expansion that matches the other resistor materials.

EXCLUSIVE HIGH TEMPERATURE VITREOUS ENAMEL

3

This special-formula enamel was developed by Ohmite after extensive research. Its thermal expansion is properly related to that of the steatite core, terminal, and resistance wire.

30th Anniversary

1925-1955

OVER 100,000,000 SOLD!

Be Right with

OHMITE®

RHEOSTATS

RESISTORS

TAP SWITCHES

OHMITE MANUFACTURING COMPANY, 3617 Howard Street, Skokie, Illinois (Suburb of Chicago)

World Radio History

MEASUREMENTS CORPORATION

Laboratory Standards

Throughout the world, Measurements' reputation for accuracy and reliability is your guarantee of satisfactory service.

STANDARD SIGNAL GENERATOR MODEL 65-B

FREQUENCY RANGE	OUTPUT RANGE	MODULATION
75 Kc.—30 Mc.	0.1 microvolt to 2.2 volts	AM, 0 to 100% 400 cycles or 1000 cycles External mod., 50-10,000 cycles

STANDARD SIGNAL GENERATOR MODEL 78

FREQUENCY RANGE	OUTPUT RANGE	MODULATION
15-25 Mc., 195-225 Mc. 15-25 Mc., 90-125 Mc. Other ranges on order	1 to 100,000 microvolts	AM, 8200-400 cycles 625-430 cycles Fixed at approximately 30%

STANDARD SIGNAL GENERATOR MODEL 78-FM

FREQUENCY RANGE	OUTPUT RANGE	MODULATION
86 Mc.—108 Mc.	1 to 100,000 microvolts	Deviation 0-300 Kc. 2 ranges FM, 400-8200 cycles External mod. to 15 Kc.

STANDARD SIGNAL GENERATOR MODEL 80

FREQUENCY RANGE	OUTPUT RANGE	MODULATION
2 Mc.—400 Mc.	0.1 to 100,000 microvolts	AM, 0 to 30% 400 cycles or 1000 cycles External mod. 50-10,000 cycles

STANDARD SIGNAL GENERATOR MODEL 82

FREQUENCY RANGE	OUTPUT RANGE	MODULATION
20 cycles to 200 Kc. 80 Kc. to 50 Mc.	0.50 volts 0.1 microvolt to 1 volt	Continuously variable 0-50% from 20 cycles to 20 Kc.

STANDARD SIGNAL GENERATOR MODEL 84

FREQUENCY RANGE	OUTPUT RANGE	MODULATION
300 Mc.—1000 Mc.	0.1 to 100,000 microvolts	AM, 0 to 30%, 400, 1000, or 2500 cycles. Internal pulse modulator. External mod., 50-30,000 cycles.

STANDARD SIGNAL GENERATOR MODEL 84-TV

FREQUENCY RANGE	OUTPUT RANGE	MODULATION
300 Mc. to 1000 Mc.	Continuously variable from 0.1 microvolt to 10 volt	Continuously variable 0 to 30% External modulation 20 to 20,000 cycles.

STANDARD SIGNAL GENERATOR MODEL 90

FREQUENCY RANGE	OUTPUT RANGE	MODULATION
20 Mc.—250 Mc.	0.3 microvolt to 0.1 volt	Continuously variable, 0 to 100% Sinusoidal modulation 30 cycles 5 mc. Composite TV modulation.

PULSE GENERATOR MODEL 79-B

FREQUENCY RANGE	PULSE WIDTH	OUTPUT
60 to 100,000 cycles	Continuously variable from 0.5 to 40 microseconds	Approx. 150 v. positive with respect to ground. "Sync Output" 35 v. positive with respect to ground.

SQUARE WAVE GENERATOR MODEL 71

FREQUENCY RANGE	WAVE SHAPE	OUTPUT
Continuously variable 6 to 100,000 cycles	Rise time less than 0.2 microseconds with negligible overshoot	Step attenuator: 75, 50, 25, 15, 10, 5 peak volts fixed and 0 to 2.5 volts continuously variable.

VACUUM TUBE VOLTMETERS

MODEL 62		
VOLTAGE RANGE	FREQUENCY RANGE	INPUT IMPEDANCE
0.1, 0.3, 0.30 and 0-100 volts AC or DC	30 cycles to over 150 Mc.	Approximately 7 mmfd.
MODEL 67		
VOLTAGE RANGE	FREQUENCY RANGE	INPUT IMPEDANCE
.0005 to 300 volts peak-to-peak	5 to 100,000 sine-wave cycles per second	1 megohm shunted by 30 mmfd.



**CRYSTAL
CALIBRATOR
MODEL 111**

**STANDARD
SIGNAL
GENERATOR
MODEL 80**

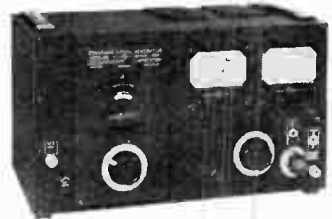

**MEGACYCLE
METER
MODEL 59**

V.H.F. FIELD STRENGTH METER MODEL 58

FREQUENCY RANGE	INPUT VOLTAGE RANGE
15 Mc. to 150 Mc.	1 to 100,000 microvolts in antenna. 1 to 100 microvolts on semi-logarithmic output meter, balanced resistance attenuator with ratios of 10, 100 and 1000 ahead of all tubes.

INTERMODULATION METER MODEL 31

INTERMODULATION RANGE	FREQUENCIES (CYCLES)	ANALYZER INPUT VOLTAGES
3%, 10% and 30% Full scale	LF: 60 cps HF: 3000 cps	Full scale ranges of 3, 10, 10 volts RMS

MEGACYCLE METERS MODELS 59LF-59-59UHF

FREQUENCY RANGE	FREQUENCY ACCURACY	MODULATION
0.1 Mc. to 4.5 Mc. 2.2 Mc. to 400 Mc. 430 Mc. to 940 Mc.	Within $\pm 2\%$	CW or 120 cycles fixed or approximately 30%. Provision for external modulation

CRYSTAL CALIBRATORS

MODEL 111		
FREQUENCY RANGE	FREQUENCY ACCURACY	HARMONIC RANGE
250 Kc.—1000 Mc.	0.002%	.25 Mc. Oscillator: 25-450 Mc. 1 Mc. Oscillator: 1-600 Mc. 10 Mc. Oscillator: 10-1000 Mc.
MODEL 111-B		
FREQUENCY RANGE	FREQUENCY ACCURACY	HARMONIC RANGE
100 Kc.—1000 Mc.	0.002%	1 Mc. Oscillator: 1-450 Mc. 1 Mc. Oscillator: 1-600 Mc. 10 Mc. Oscillator: 10-1000 Mc.



MEASUREMENTS CORPORATION

BOONTON NEW JERSEY



BELL SYSTEM'S NEWEST TELEPHONE DEVELOPMENTS

use **RAYTHEON**
filamentary
subminiature
tubes

The Bell System's new telephone answering set and new telephone for "hands-free" and conference use naturally require tubes of the utmost reliability. Raytheon Filamentary Subminiature Tubes qualified only after undergoing a long series of exacting tests by both Bell and Raytheon.

Low microphonics, low power requirements, high efficiency, long life and, above all, supreme reliability characterize the Raytheon Tubes in these newest telephone developments.

It will pay you to find out what Raytheon Filamentary Subminiatures can do to better the performance, convenience and economy of your electronic equipment.



RAYTHEON MANUFACTURING COMPANY

Excellence in Electronics

Receiving Tube Division • Kings • Prices 50¢ • Chapel St., Newt. • 55, Mass. Bigelow 4-7500

For application information write or call the Home Office, 4935 West Fullerton Avenue, Chicago 33, Illinois, National 3-2770

589 Fifth Avenue, New York 17, New York Plaza 9-3900 • 621 S. La Brea Ave., Los Angeles 36, California, WEbster 8-2857

RAYTHEON MAKES ALL THESE:

BELIEVABLE SUBMINIATURE AND MINIATURE TUBES • SEMICONDUCTOR DIODES AND TRANSISTORS • INCANDESCENT TUBES • MICROWAVE TUBES • RECEIVING AND PICTURE TUBES

COME IN AND TALK OVER THESE TUBES WITH US AT THE IRE SHOW

PROCEEDINGS OF THE I.R.E. March, 1955



TELEPHONE ANSWERING. When you aren't there, the automatic telephone answering set takes over, delivers previously dictated message in your voice, records caller's reply and plays it back to you at your convenience.



"HANDS-FREE" TALKING. Telephone set base has a built-in microphone — you talk without picking up handset. Tiny desk speaker amplifies the distant voice so that several persons in a group can listen to the conversation. For privacy, you lift the receiver, automatically shutting off the microphone and speaker. Small amplifier, not visible in the picture, furnishes power.



RAYTHEON FLAT PRESS Subminiature Tubes are the tubes with the **SEAL OF RELIABILITY** — the longer glass to metal seal that gives you these important advantages:

Glass heated only once — no button, low glass strain, no lead burning

Reentrant seal eliminates breakage from short bends

Leads completely tinned right to glass

Flat press with in-line leads for easier socketing, easier wiring, adaptability to printed circuits



Reliable, long-lived Raytheon Subminiature Tubes in these Bell equipments, illustrated above, were tested for dependable, trouble-free service over long periods.

CAPACITORS by General Electric

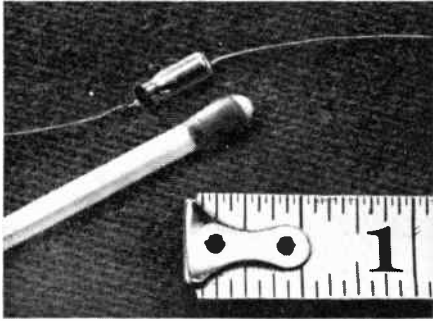

MICRO-MINIATURE

For low voltage d-c miniaturized electronic equipment (hearing aids, walkie-talkies, paging systems). Ideal for transistorized assemblies. Ratings 1-8 uf at 4 v. d-c, 1 uf at 8 v. d-c, 0.5 uf at 16 v. d-c. Tolerance -0 to +200%. Temp. range -20 to +50° C. BULLETIN GEA-6065.

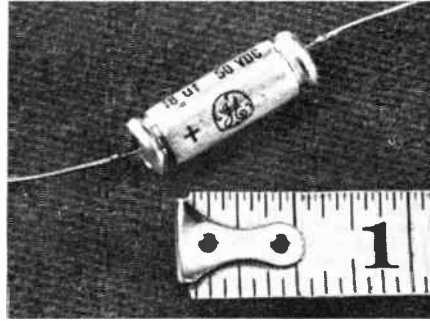

TANTALYTIC*

For electronic equipment requiring small size, low leakage current, long shelf life, wide temperature range. Plain or etched foil, and polar or non-polar types, suitable for a-c or d-c. Ratings 0.25-580 uf, 3.75-150 v. Tolerance =20% (plain foil), -15 to +75% (etched). Temp. range -55 to +85° C. BULLETIN GEC-808.

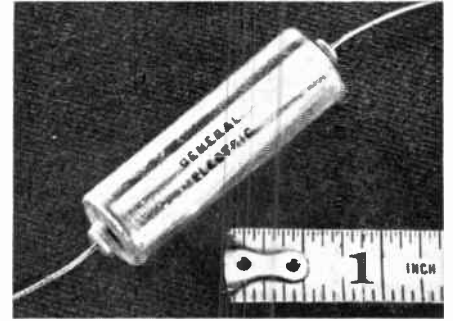

METAL-CLAD TUBULAR

For d-c uses where reliability under severe operating conditions is required (military electronic equipment). Ratings 0.001-1 uf at 100, 200, 300, 400 and 600 working v. d-c. (Can be applied to a-c circuits with adequate derating.) Tolerances =5, =10, or =20%. Temp. range -55 to +125° C. BULLETIN GEC-987.



PERMAFIL-IMPREGNATED

Designed to meet requirements of MIL-C-25A, characteristic K specifications, and are suitable for high-temperature operation. Ratings 0.05-1 uf at 400 v. d-c. Tolerance =10%. Temp. range -55 to +125° C. BULLETIN GEC-811.

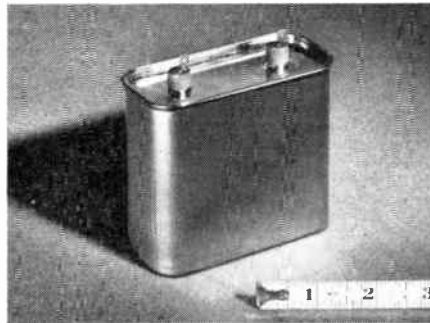

STANDARD COMMERCIAL

For motors, filters, communication equipment, luminous-tube transformers, industrial control. Ratings dual rated units (a-c or d-c) rated at 0.01-50 uf, at 236-660 v. a-c, 400-1500 v. d-c. Single rated units also available. Tolerance =10%. Temp. range -55 to +85° C. BULLETIN GEC-809.

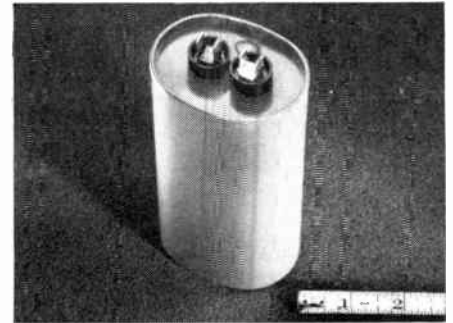

DRAWN-OVAL

For air conditioning and refrigeration equipment, fluorescent lamp ballasts, business machines, voltage stabilizers. Single, dual or triple-section types. Ratings 1-20 uf at 236-660 v. a-c, and 1-15 uf at 600-1500 v. d-c. Tolerance =10%. Temp. range -30 to +70° C. BULLETIN GEA-5777.

*Reg. trademark of General Electric Company.

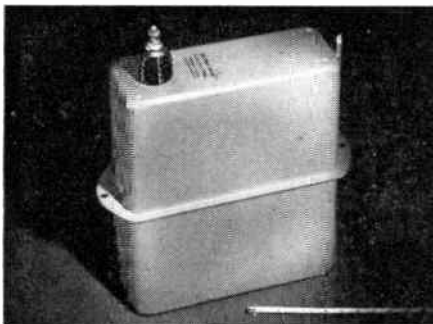

ENERGY STORAGE

For use in high magnetic fields and high intensity arc discharge. Ratings: may be built as high as 2000 joules (watt-seconds). Tolerance =10%. BULLETIN GEA-4646.

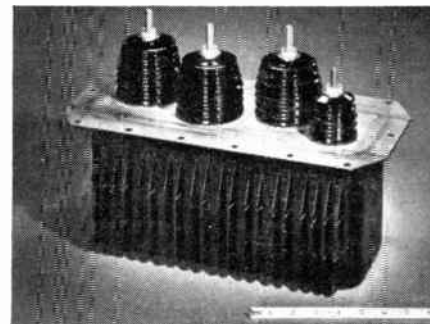

NETWORK

For guided missiles, aircraft, radar equipment. Ratings: built to user specifications. Temp. range -55 to +125° C, or to user specifications. BULLETIN GEA-4996.

NOTE: All capacitance tolerances are given at +25° C.

Progress Is Our Most Important Product

GENERAL  ELECTRIC

SEND COUPON BELOW for complete information about G-E capacitors.

General Electric Co.
Section B442-25
Schenectady 5, N. Y.

Please send me capacitor bulletins checked below.

- | | |
|-----------------------------------|----------------------------------|
| <input type="checkbox"/> GEA-4646 | <input type="checkbox"/> GEC-808 |
| <input type="checkbox"/> GEA-4996 | <input type="checkbox"/> GEC-809 |
| <input type="checkbox"/> GEA-5777 | <input type="checkbox"/> GEC-811 |
| <input type="checkbox"/> GEA-6065 | <input type="checkbox"/> GEC-987 |

Name.....

Position.....

Company.....

Address.....

City.....Zone.....State.....

Specify . . .

ALSiMAG[®] pressed ceramics

For Volume Production

The most complete automatic-press facilities in the industry. Small tablet presses, high-speed rotaries, huge hydraulics. Every imaginable machine for efficient production of simple or intricate ceramics in any quantity. Open dies for many designs.

For Superior Quality

No other source offers as wide a selection of versatile ceramic materials. Careful matching with requirements. Many special characteristic compositions developed for unusual applications. Latest gauging and testing equipment. Quality Control at every production step. Experienced personnel . . . unequaled "know how" in handling variables, gained from over 54 years of technical ceramic manufacture.

For Greatest Economy

Proven production methods . . . the right equipment for economical manufacture . . . thoroughly trained operators . . . all combined to give you the best possible ceramics at the lowest possible cost.

For Important "Extras"

When you specify ALSiMag, you receive many "extra" benefits. Redesign service . . . to insure the best possible design for economical manufacture and outstanding performance. Alert production staffs, constantly searching for improved equipment, improved methods. Engineering assistance from men of wide experience, competent to advise on problems in many fields. Continuous Research to anticipate your needs and solve your problems.

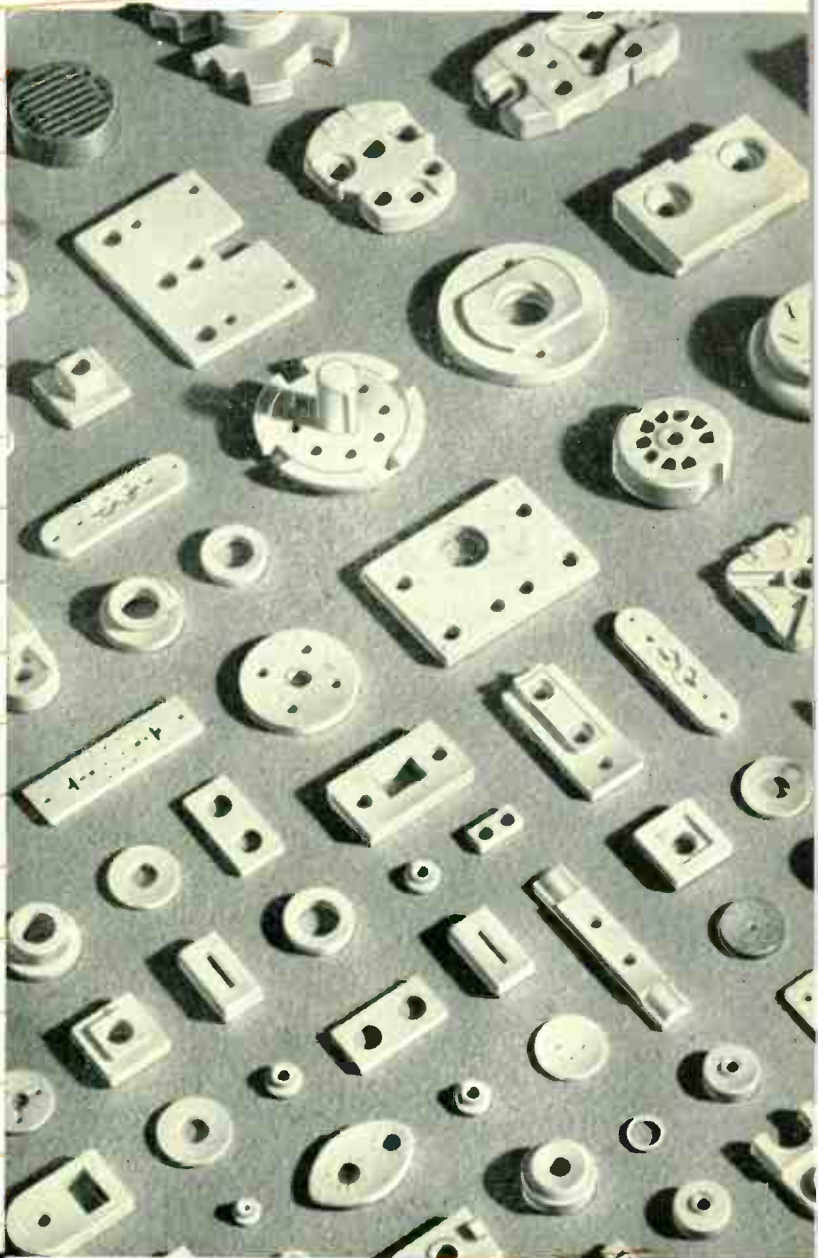

**SEND YOUR BLUEPRINT,
SKETCH OR SAMPLE. LET US PROVE WHAT
ALSiMAG CAN DO FOR YOU !**

Visit our Booth at the IRE Show,
124 Television Avenue

54TH YEAR OF CERAMIC LEADERSHIP

AMERICAN LAVA CORPORATION

CHATTANOOGA 5, TENNESSEE

A SUBSIDIARY OF MINNESOTA MINING
AND MANUFACTURING COMPANY

Branch offices in these cities (see your local telephone directory): Cambridge, Mass • Chicago, Ill. • Cleveland, Ohio • Dallas-Houston, Texas • Indianapolis, Ind. • Los Angeles, Calif. • Newark, N. J. • Philadelphia-Pittsburgh, Pa. • St. Louis, Mo. • South San Francisco, Calif. • Syracuse, N. Y. • Tulsa, Okla. Canada: Irvington Varnish & Insulator Div., Minnesota Mining & Mfg. Co. of Canada Ltd., 1390 Burlington Street East, Hamilton, Ontario, Phone Liberty 4-5735.

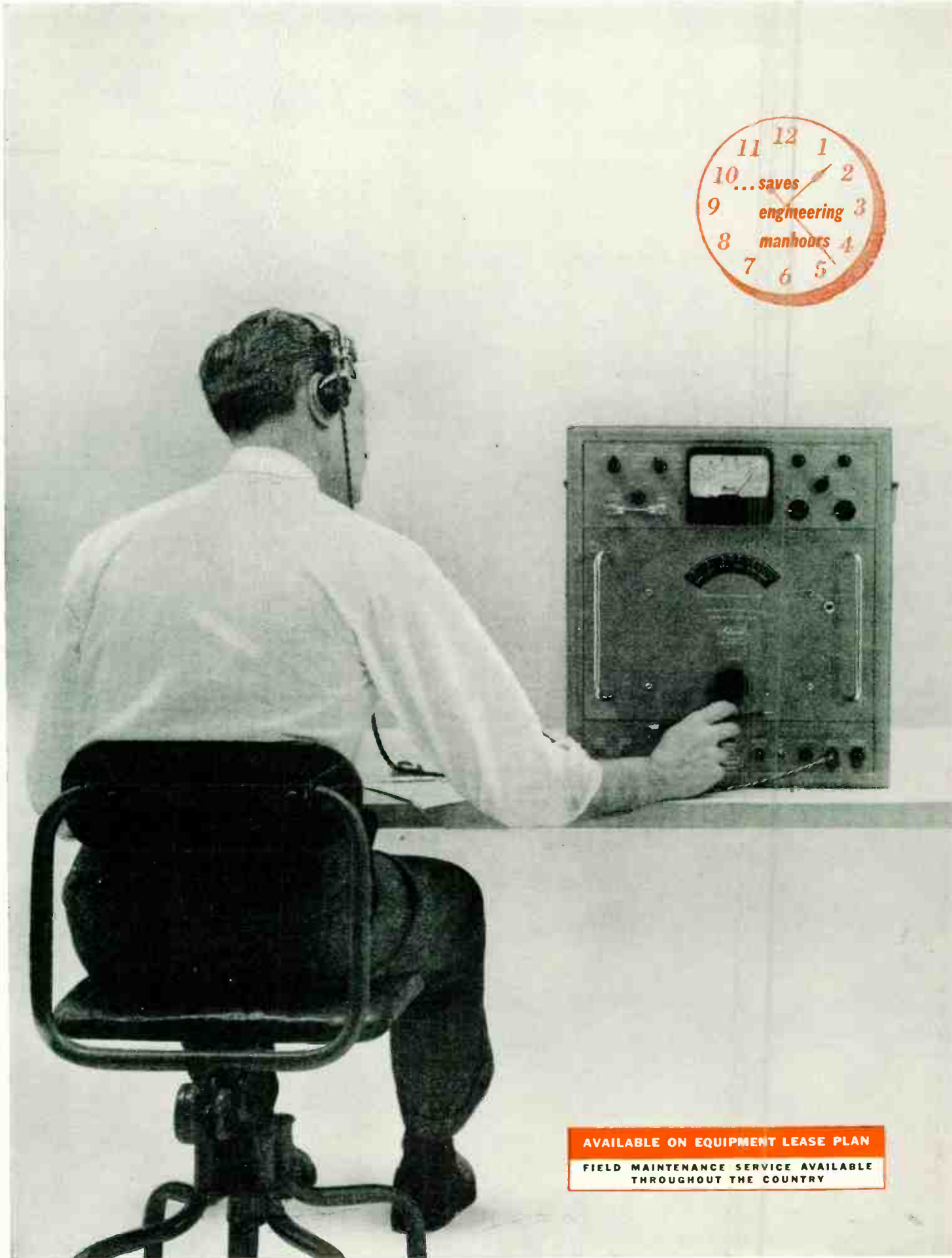

AVAILABLE ON EQUIPMENT LEASE PLAN
FIELD MAINTENANCE SERVICE AVAILABLE
THROUGHOUT THE COUNTRY

MICROWAVE FIELD INTENSITY RECEIVER **BROAD BAND 950—11,260 mcs**

- Four interchangeable RF Tuning Heads
- Uni-Dial Tuning
- Double Tuned RF Pre-Selection
- Signal-Lock Automatic Frequency Control
- All purpose AM, FM, Pulse

The new Polarad Model R Receiver is a fully integrated unit which combines reliability, ruggedness and simplicity of operation. Characterized by high sensitivity, low noise figure and excellent gain stability, this versatile instrument is ideal for communications, laboratory measurements, field intensity measurements, production testing, and automatic monitoring.

Range 950 to 11,260 mc with four (4) interchangeable, plug-in RF tuning units featuring direct reading UNI-DIAL control.

Low noise figure.

Excellent gain stability.

Automatic frequency control.

Direct reading output in db with provision for external metering and recording.

Separate audio and video channels.

Connectors for external IF attenuators.

High sensitivity and broadband tuning achieved with double tuned cavity preselector which tracks automatically with the local oscillator.

External type cavity klystron with non-contacting chokes. Klystron voltages regulated and automatically tracked with the oscillator.

SPECIFICATIONS:

Basic Receiver: Model R-B

Tuning Unit Frequency Ranges:

Model RL-T: 950 to 2,040 mc
Model RS-T: 1,890 to 4,320 mc
Model RM-T: 4,190 to 7,720 mc
Model RX-T: 7,260 to 11,260 mc

Signal Capabilities:
CW, AM, FM, Pulse

Sensitivity:
—80 dbm or better throughout
range on all models

Frequency Accuracy:
1%

IF Bandwidth:
3 mc

Image Rejection:
Greater than 60 db

Gain Stability with AFC:
2 db for 24 hour period

Automatic Frequency Control:
Pull-out range 10 mc off center

Recorder output:
1 ma full scale

Trigger output:
10 v. pulse across 100 ohms

Audio output:
5 v. undistorted across 500 ohms

FM Discriminator
Deviation Sensitivity:
.7 volts/mc

Skirt Selectivity:
60 db to 6 db bandwidth
ratio less than 5:1

IF Rejection:
50 db

Input AC Power:
105 to 125 v., 60 cps., 460 watts

Input Impedance: (ANT)
50 ohms



ELECTRONICS CORPORATION
43-20 34th STREET, LONG ISLAND CITY 1, N. Y.

REPRESENTATIVES • Albuquerque • Atlanta • Baltimore • Boston • Chicago • Cleveland • Fort Worth • Kansas City • Los Angeles • New York
Philadelphia • San Francisco • Seattle • St. Paul • Syracuse • Washington, D. C. • Canada, Arnprior Export: Rocke International Corporation

PLAIN FACTS ABOUT VIBRATION AND SHOCK MOUNTINGS

FOR AIRBORNE ELECTRONIC EQUIPMENT

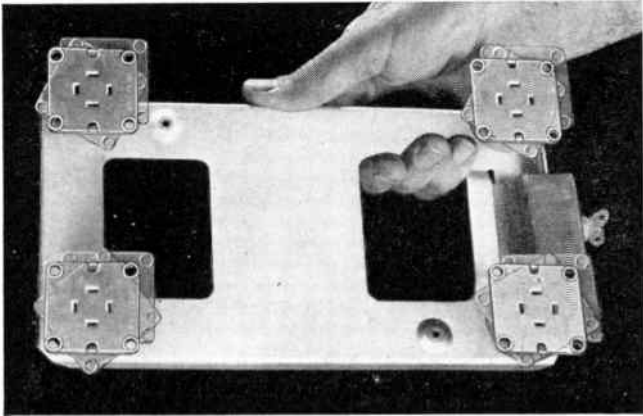

OUT-DATED UNIT MOUNT BASE

16 mounting holes and 16 bolts required.

Unit mountings may be improperly attached to the rack, and are very likely to be seriously misaligned during attachment to aircraft or missile structure.

Even minor discrepancies in spacing and attachment of unit mounts can defeat the whole purpose of the mounting base, and result in poor performance and deterioration of equipment.

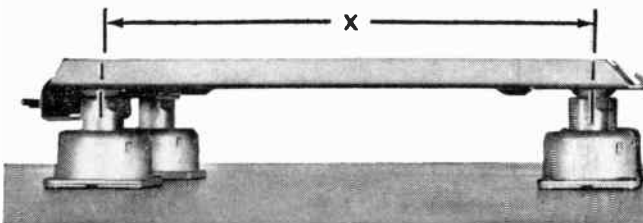

Excessive height required. Unit mount bulk imposes reduced spacing (X) between support centers, resulting in impaired stability (critical in lateral direction). Greater sway space required.

Well Designed Electronic Equipment,

If Poorly Mounted,

Too Often Operates Inefficiently and Unreliably

Failure also can result from use of inadequate mountings which are not engineered for the particular equipment and purpose. Conventional shock mounts or so called "isolators", reasonably effective when installed under ideal laboratory conditions, become dangerous trouble makers when installed by usual production line methods.

Attachment of a base plate to unit mounts to achieve spacing control is a makeshift arrangement resulting in excessive weight with no height reduction.

Failure also can result from obsolescent unit mounts employing internal rubber, organic or synthetic materials which deteriorate rapidly and are susceptible to temperature and environmental changes.

The importance of today's electronic equipment surely justifies the use of integrated mounting systems designed to meet specific problems rather than the unreliable application of assembled "catalogue" mounts.

USE OF ROBINSON ENGINEERED MOUNTING SYSTEMS results in:

- A. Reliable and uniform performance in every installation under all types of environmental conditions.
- B. Reduced cost through "de"ruggedization of equipment — substantial reduction of size and weight is possible by simplified and compact design.
- C. Simplified installation — only four attachment holes required—pre-spaced to save time and assure accuracy.

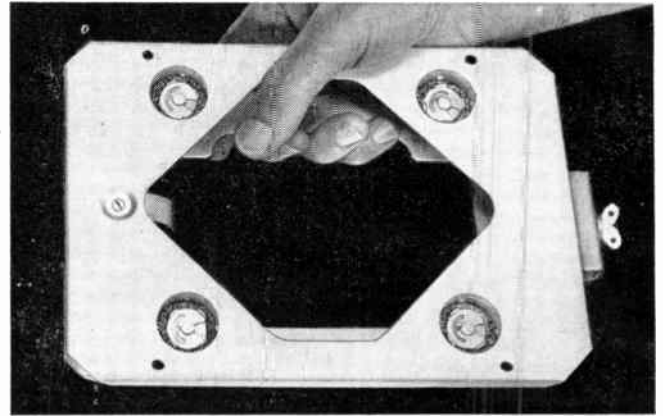

TODAY'S ENGINEERED MOUNTING SYSTEM

Only 4 mounting holes required.

Prespaced holes in a one piece base plate assure quick, accurate attachment. Relationship of all 4 holes is definitely fixed (holes spaced for interchangeability with unit mounts).

No installation errors or misalignment can occur to disturb the precise performance of the mounting system as checked and approved on acceptance tests.

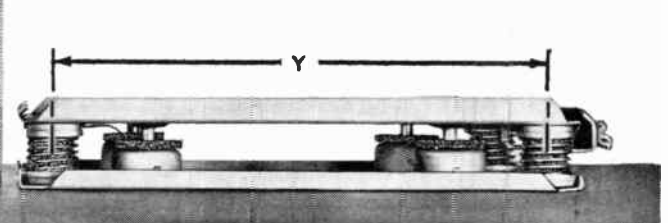

Note reduction in mounting height. Important space saved. Maximum spacing (Y) of resilient elements at extreme corners provides stability. Less sway space required.

Robinson All-Metal Engineered

Mounting Systems Assure Outstanding Performance and Reliability of Equipment

The Robinson concept of vibration and shock control is the design and application of 100% all-metal mounting systems. Engineered with careful understanding of the equipment to be protected and performance expected, Robinson mounting systems come to you completely manufactured, ready to receive the electronic equipment or instrument.

The integration of these mounting systems into the electronic equipment of aircraft and missiles results in reduction of elapsed design time and basic development cost.

Robinson Mountings utilize, as main resilient elements, metal wire cushions (MET-L-FLEX), exclusive with Robinson. This construction has been thoroughly proven by years of use in nearly all military and commercial aircraft.

Some other important characteristics of Robinson Mountings: inherent high damping, non-linear spring rate, performance unaffected by grease, oil, water, dust, extreme temperatures or environmental changes.

For full information about this new concept of vibration and shock control, write or wire today.



West Coast Engineering Office:

3006 Wilshire Boulevard, Santa Monica, California

QUIET QUIET QUIET QUIET

XLR is the designation of Cannon's all new audio cord connector . . . the most modern addition to the long line of distinguished Cannon Connectors featured on all top-quality microphones. It's really quiet, too!

New resilient insulator and specialized construction of socket contact assembly protects against disagreeable mechanical interference . . . noise problems encountered with many other type connectors when their cables are moved, pulled or subjected to shock.

Features streamline design, bright nickel finish, integral cable clamp, neoprene cable relief, and the time-tested Latch-Lock that Cannon pioneered on the first audio connectors. Available with three 15-amp. or four 10-amp. contacts. Available in panel receptable type, providing same continuous characteristics.

Available from distributors everywhere, or from the factory in production quantities.

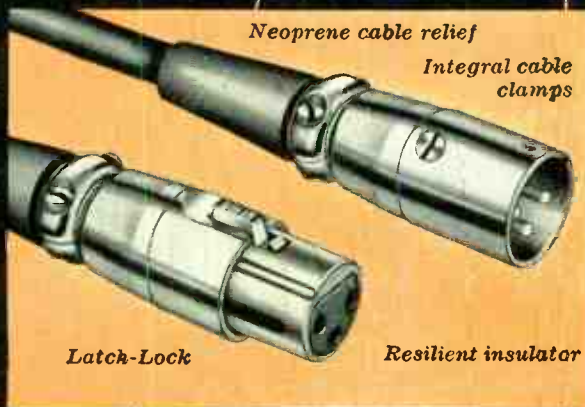
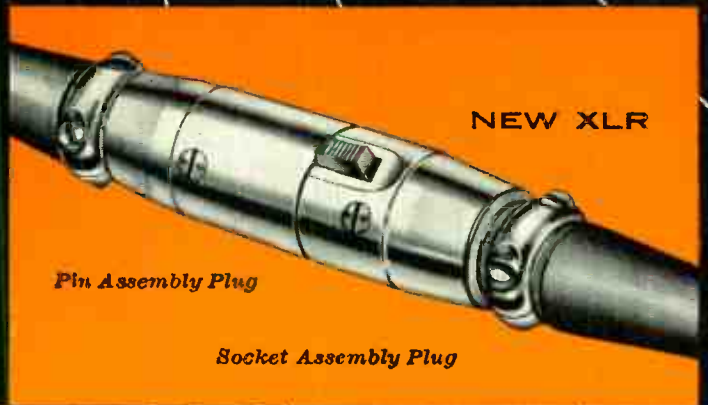

first in connectors



CANNON PLUGS

CANNON ELECTRIC COMPANY
3209 Humboldt St.,
Los Angeles 31, California

Please refer to Dept. 377

Factories in Los Angeles; East Haven; Toronto, Canada; London, England. Representatives in all principal cities. Distributors everywhere.

NOW
Measure

TRUE RMS

from 100 microvolts to 320 volts REGARDLESS OF WAVEFORM

WITH THE
BALLANTINE
MODEL 320
VOLTMETER

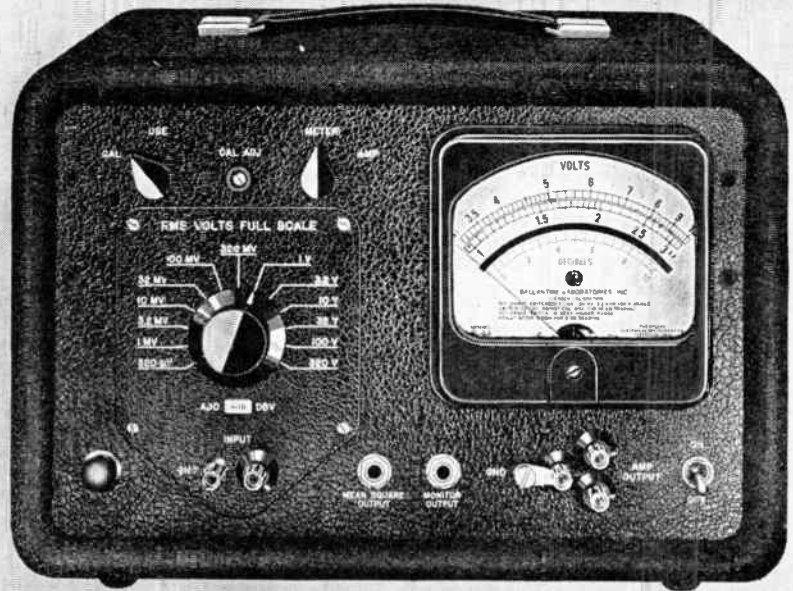
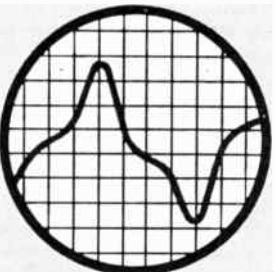
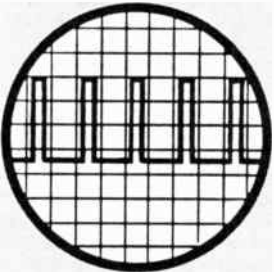
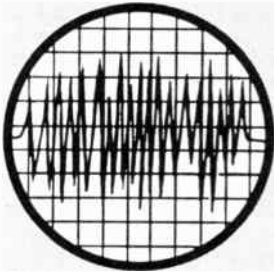
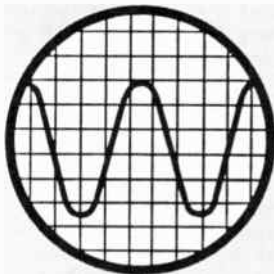

REPRESENTING:

A distinctly new departure in VTVM design.

FEATURING:

A built-in calibrator; — easily read 5-inch log meter; — immunity to severe overload; — useful auxiliary functions.

BRIEF SPECIFICATIONS:

- VOLTAGE RANGE:.....100 microvolts to 320 volts
- DECIBEL RANGE:.....-80 dbv to +50 dbv
- FREQUENCY RANGE:.....5 to 500,000 cycles per second
- ACCURACY:.....3% from 15 cps to 150KC; 5% elsewhere
Figures apply to all meter readings
- MAXIMUM CREST FACTORS:.....5 at full scale; 15 at bottom scale
- CALIBRATOR STABILITY:.....0.5% for line variation 105-125 volts
- INPUT IMPEDANCE:.....10 M Ω and 25 μ f, below 10 millivolts
10 M Ω and 8 μ f, above 10 millivolts
- POWER SUPPLY:.....105-125 volts; 50-420 cps, 75 watt
Provision for 210-250 volt operation
- DIMENSIONS: (Portable Model).....14 $\frac{3}{8}$ " wide, 10 $\frac{1}{8}$ " high, 12 $\frac{3}{8}$ " deep
Relay Rack Model is available
- WEIGHT:.....21 lbs., approximately

PRICE: \$325.

Write for the New Ballantine Catalog describing this and other instruments in greater detail.



BALLANTINE LABORATORIES, INC.

102 Fanny Road, Boonton, N.J.

Booth 245, Instruments Avenue, Radio Engineering Show



BASE BAND FREQUENCY SPECTRUM

ONLY

Collins

MICROWAVE

has MECHANICAL FILTERS

Collins mechanically-filtered multiplex equipment provides simultaneous transmission and reception for voice circuits. Each of these voice channels may contain up to 16 teletype, telemetering and supervisory control channels. The system employs proven bi-lateral, single sideband suppressed carrier transmission. Intelligence is transmitted only when a circuit is in use, thereby permitting statistical loading of the system to achieve a maximum signal-to-noise ratio on each channel. This method of multiplexing is simplified and made economical by the use of the Collins Mechanical Filter. The steep skirt attenuation of this filter permits use of upper and lower sidebands with suppressed carrier to be employed for transmission of two separate channels.



Collins microwave engineering staff is ready to assist you in planning and installing your microwave system.

**Visit Collins Booth
at the New York IRE Show
March 21-24**

Write Microwave Dept. A for descriptive literature.

SIX MORE REASONS FOR COLLINS

- Tubeless power supplies using magnetic amplifiers for regulation
- Built-in test facilities to expedite routine maintenance
- Only five tube types, including reflex klystron
- Operates in 6700 mc band using high gain, highly directive antennas and reflectors. No tower-mounted transmission lines
- Designed for reliable unattended operation, optional automatic switchover to standby equipment with fault alarm
- Facilities may be expanded at minimum cost

COLLINS RADIO COMPANY

Cedar Rapids, Iowa

261 Madison Ave., NEW YORK 16

1930 Hi-Line Dr., DALLAS 2

2700 W. Olive Ave., BURBANK

Collins Radio Company of Canada Ltd., 74 Sparks Street, OTTAWA, ONTARIO





... dependable **BUSS FUSES** help
protect the **Product** and your **Reputation**

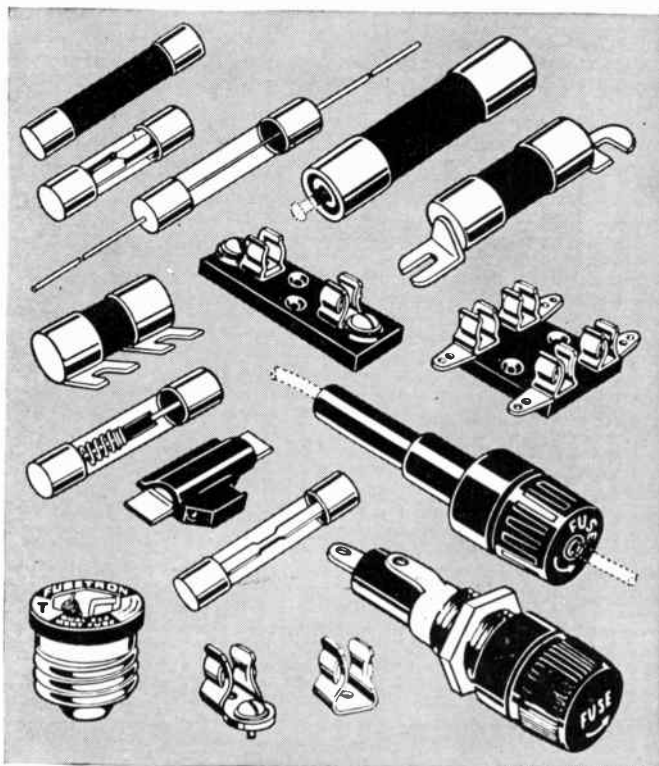

BUSS fuses are made to protect — not to blow needlessly. A sensitive electronic device tests every BUSS fuse normally used by the Electronic Industries. Any fuse not correctly calibrated, properly constructed and right in all physical dimensions is automatically rejected.

This careful testing is your assurance that BUSS fuses will open and protect equipment against damage when there is trouble on the circuit. If a poorly made fuse doesn't open when it should on an electrical fault, something else will burn out.

BUSS fuses also safeguard your good-will by eliminating needless blows. A useless shutdown caused by a faulty fuse blowing when trouble doesn't exist can be most irritating to your customer. It could jolt his confidence in you.

Surely it is wise to rely on fuses that help you avoid troubles by offering dependable protection under all service conditions.

Then, why not be sure your buying and stock records specify BUSS and FUSETRON fuses . . . you'll find it convenient to use BUSS as the one source for all your fuse needs.

Makers of a complete line of fuses for home, farm, commercial, electronic and industrial use.

BUSSMANN MFG. CO.

University at Jefferson,



(Division of McGraw Electric Co.)

St. Louis 7, Mo.

IRE-355

Build top performance into
YOUR PRODUCTS

Low cost Tenney test chambers
 will solve your high and low
 temperature problems

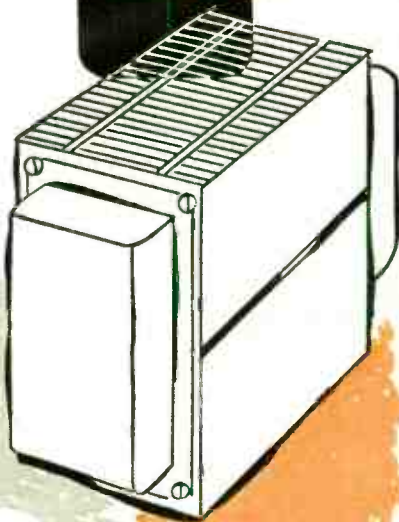

-100°F.
+200°F.

TDI-8
new low cost
**portable hi-lo
 dry ice chamber**

range -100°F. to +200°F.
 control accuracy $\pm 2^\circ\text{F}$.



cubic interior 8 cu. ft.
 exterior 36" H. x 52" W. x 33" D.
 dry ice capacity 50-70 pounds

Now you can check your products accurately at every stage with Tenney environmental test chambers... in research, product development, production, quality control.

This new TDI-8 HI-LO dry ice chamber is typical of the wide range of versatile, low-cost units developed by Tenney for manufacturers of electronic components, electrical equipment, instruments, plastics, metal parts, and a variety of diversified products for military or industrial applications.

With standard Tenney equipment you can simulate altitude, temperature (high and low), humidity, fungus, sand and dust, and combinations of these conditions.

More than 3,000 Tenney test chambers are in use in leading plants and laboratories throughout the country. Tenney has the largest specialized engineering staff in the industry to solve your individual environmental testing problems.

Write today for Bulletin TDI-8 covering the HI-LO dry ice chamber above... and for information on other Tenney test chambers to meet your exact specifications.



Tenney
ENGINEERING, INC.

1090 SPRINGFIELD ROAD, UNION, N. J.
 Plants: Union, N. J. and Baltimore, Md.

Member of Environmental Equipment Institute

SALES OFFICES: Baltimore; Chicago; Indianapolis;
 Kansas City; Los Angeles; New
 York; St. Louis; San Francisco;
 Ottawa, Canada.

Engineers and Manufacturers of Refrigeration and Environmental Equipment

© 1955

Multiple Unit Carbon Controls — in *New Cost-* *Saving Design*

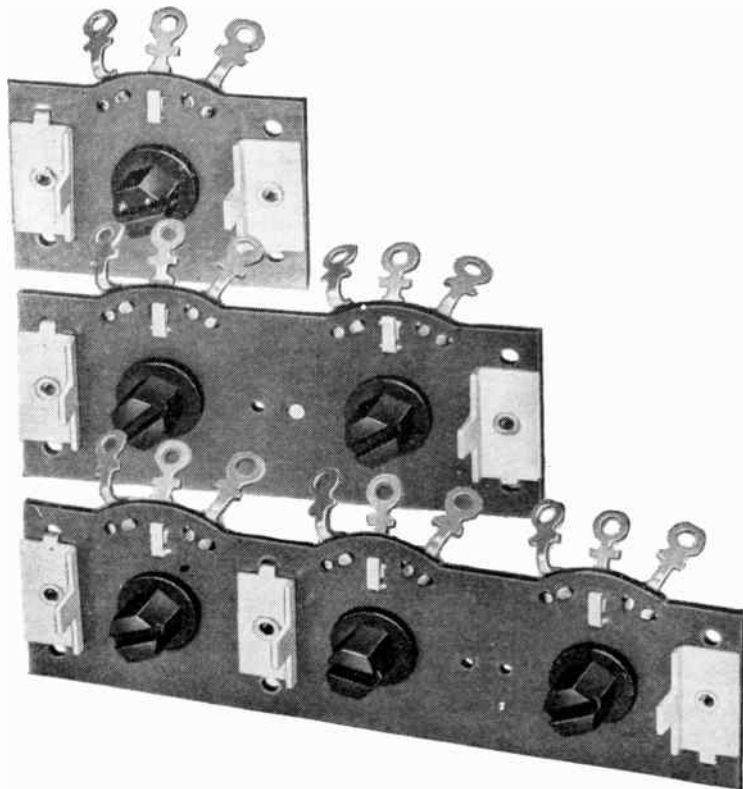

Resistance values: 250 ohms to 10 megohms, in a variety of tapers.

Shaft: Hex phenolic, with slotted end; lengths—zero up to $\frac{3}{8}$ " FMS in $\frac{1}{8}$ " increments.

Rear view shows simple, rugged design, with resistance wafer attached directly to phenolic panel.

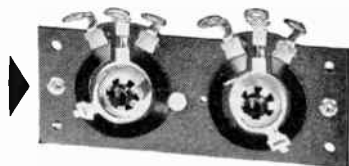

Parts distributors in all major cities stock Mallory standard components for your convenience.

Serving Industry with These Products:

Electromechanical—Resistors • Switches • Television Tuners • Vibrators
Electrochemical—Capacitors • Rectifiers • Mercury Batteries
Metallurgical—Contacts • Special Metals and Ceramics • Welding Materials

A COMPLETELY new type of carbon control just developed by Mallory offers opportunities for important savings in your production. Available in single, dual and triple units, this model features a unique strip-type phenolic panel construction that is particularly applicable to TV alignment controls.

SAVES PRODUCTION TIME . . .

A dual or triple unit can be mounted in no more time than your assemblers now need for a single control.

REDUCES COMPONENT COST . . .

The new simplified design makes it possible for Mallory to produce multiple units at costs materially lower than that for a corresponding number of conventional single controls.

FLEXIBLE DESIGN . . .

This unique design offers many adaptations . . . at low cost. Phenolic hex shaft with screw driver slot makes for ready adjustability and is supplied in $\frac{1}{8}$ " increments of zero to $\frac{3}{8}$ " FMS. Terminals can be solder lugs or wire wrap solderless type. Mounting arrangement can be holes for riveting or twist tabs. Resistances cover the range from 250 ohms to 10 megohms, with rotational stop provision.

Minimum spacing of shafts . . . $1\frac{1}{2}$ " between centers . . . is identical with that required for single controls. You can install the new units as direct replacements in many existing chassis and mounting plate designs. Special center spacings can, of course, be supplied.

Plan to take advantage of these new economies in the equipment you are now designing . . . and investigate the possibilities for using them in the products you are now manufacturing. For technical details, and for engineering assistance by Mallory specialists, write or call Mallory today.

Expect more . . . Get more from



Now —

More Uses From ONE Instrument

New L.f.E. Oscilloscope — Model 411

▶ PLUS LFE's New PLUG-IN feature which greatly increases the number of applications which can be serviced by one instrument. More X-axis flexibility and unmatched versatility — at lower overall cost.

Specifications

X-AXIS PLUG-IN ADAPTERS

Model(s) 1400, BASIC, with 500 to 5000 cps trigger generator.
1401, SWEEP DELAY, continuously variable from .5 μ sec. to .1 sec.
1402, VIDEO SWITCH
1403, GATED MARKER GENERATOR, 0.1 to 1000 μ sec.
1404, TV TRIGGER SHAPER, triggers on composite video signal.
1405, LONG SWEEPS, from .1 μ sec./cm. to 10 sec./cm.

BASIC SCOPE

Y-Axis Amplifier

Deflection Sensitivity — 15 mv./cm. p-p for both d-c and a-c (max.)
Max. Signal Voltage — 500 volts p-p
Frequency Response — d-c to 10 mc/sec. (3 db point)
Transient Response — Rise time (10% to 90%) — 0.035 μ sec.
Linearity of Deflection — Max. deflection, 5". At 2.5" unipolar deflection, maximum compression is 10%
Signal Delay — 0.25 μ sec.
Input Termination — 53, 72, or 93 ohms.
Input Impedance — 1 megohm, 30 μ f.

X-Axis

Sweep Time Range, calibrated — .1 μ sec./cm. to .1 sec./cm.
External Sweep Sensitivity — 2 volts/cm., p-p
Frequency Response — DC to 1 Mc., (3 db. point)
Triggers — Internal or External to 10 mc., 60 cps
DC Blanking.

OTHER FEATURES

Flat-face CRT Type 5-ABP1 (P7 or P11 optional) — Accelerating Potential 3000 — 4000 volts
Deflection Plates Accessible.
Power Requirements: 105-125 V., or 210-250 V., 50-60 cycles, 385 watts.
Dimensions: 13" w, 17 $\frac{1}{4}$ " h, 21" d.



LABORATORY FOR ELECTRONICS, INC.
75 Pitts Street Boston 14, Mass.

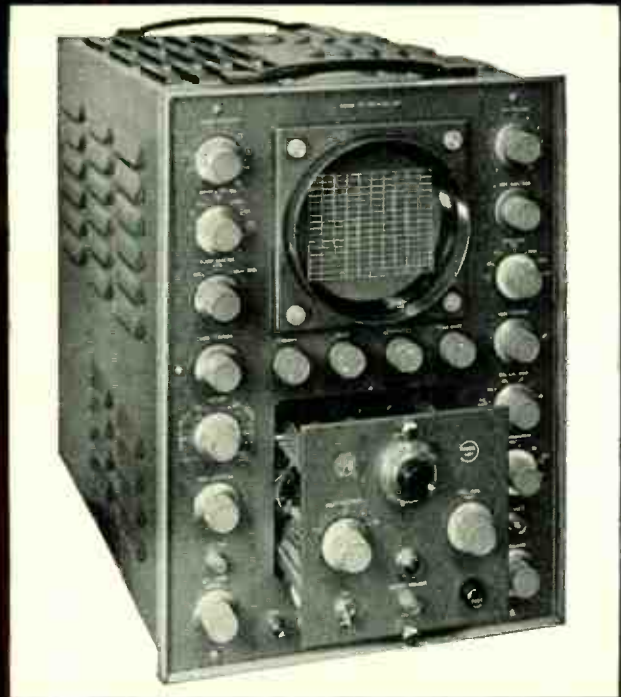

OSCILLOSCOPES • MAGNETOMETERS • COMPUTERS
SOLID DELAY LINES • SPAR • SPAR-S

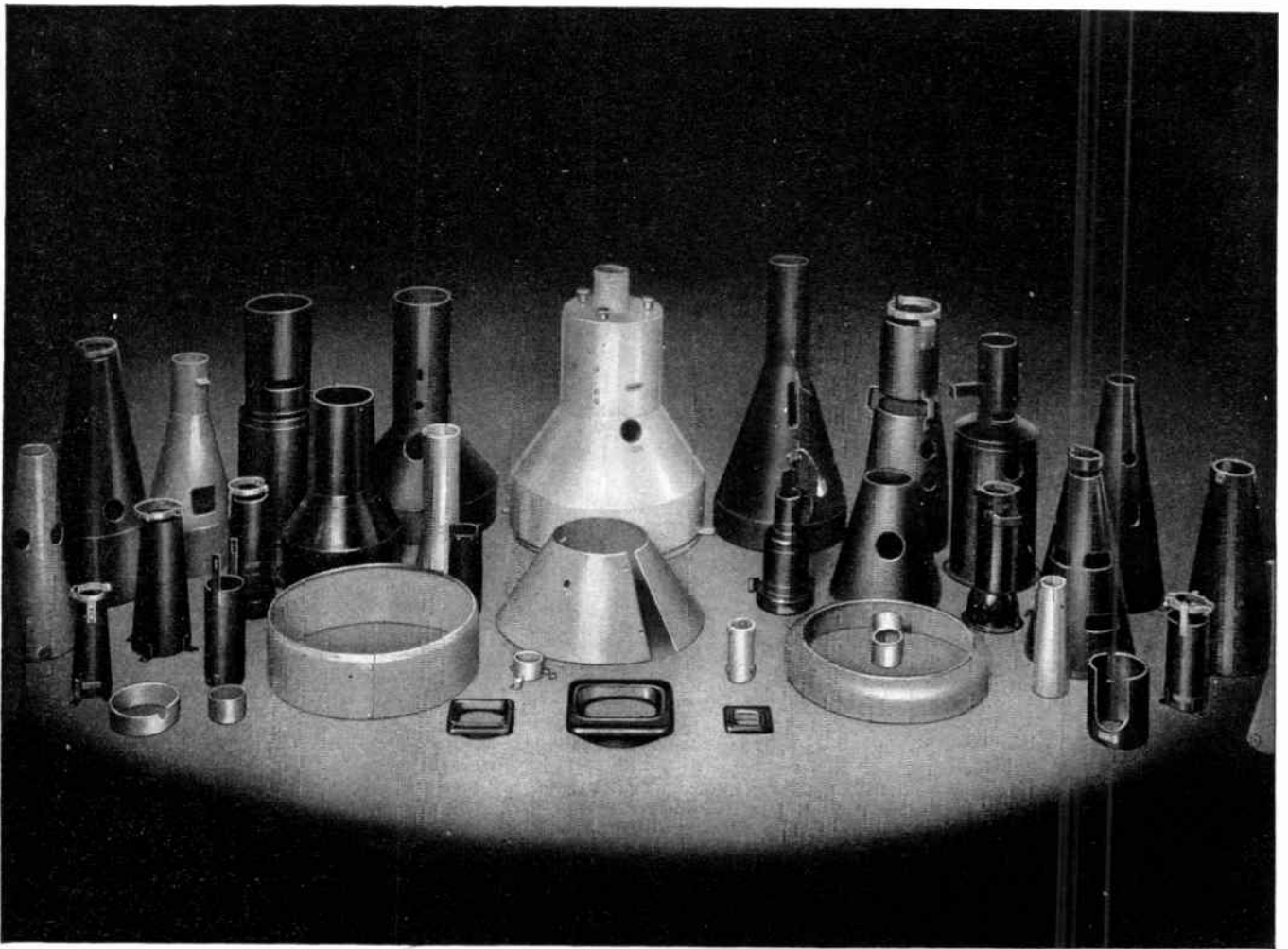

Designed for Application

Mu Metal Shields

The James Millen Mfg. Co. Inc. has for many years specialized in the production of magnetic metal cathode ray tube shields for the entire electronics industry, supplying magnetic metal shields to manufacturing companies, laboratories and research organizations. Stock shields are immediately available for all of the more popular sizes and types of cathode ray tubes as well as bezels for 2", 3" and 5" size tubes.

Many production problems, however, make desirable special shields designed in conjunction with the specialized requirement of the basic apparatus. Herewith, are illustrated a number of such custom built shields. Our custom design and fabrication department is at the service of our customers for the development and manufacture of magnetic metal shields of either nicoloi or mumetal for such specialized applications.

JAMES MILLEN

MAIN OFFICE



MFG. CO., INC.

AND FACTORY

MALDEN, MASSACHUSETTS, U. S. A.



6U8



5687



6AU4
GT



5881



6550

- OUTSTANDING IN DESIGN AND DEVELOPMENT
- VERSATILE AND RELIABLE IN PERFORMANCE
- ACCLAIMED BY THE ELECTRONICS INDUSTRY

Booth 746
I. R. E.
Convention

TUNG-SOL
dependable
ELECTRON TUBES

TUNG-SOL ELECTRIC INC., Newark 4, N. J.

SALES OFFICES: Atlanta, Chicago, Columbus, Culver City (Los Angeles), Dallas, Denver, Detroit, Montreal (Canada), Newark, Seattle.

TUNG-SOL MAKES All-Glass Sealed Beam Lamps, Signal Flashers, Picture Tubes, Radio, TV and Special Purpose Electron Tubes, and Semiconductor Products.

Now...

WITH

A.C.

RUGGEDIZED INSTRUMENTS,

ROLLER-SMITH

Provides One Source
for All Your Instruments

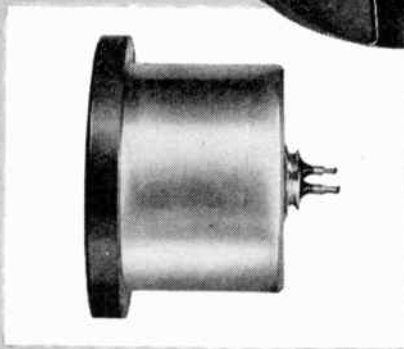
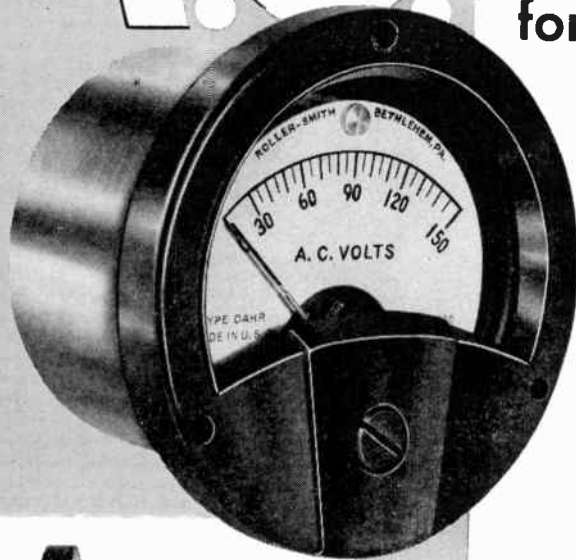

An extra feature—new "wrap around" shroud with gasket seal makes these meters as modern in appearance as they are dependable in performance. Precisely built, their neat functional form expresses the forward thinking of our engineers.

With the introduction of A.C. Ruggedized panel instruments, Roller-Smith has made their famous precision instrument line one of the most complete ever offered . . . one which provides you with a single source of supply for *all* your instrument needs.

Styled by leading industrial designers and featuring an eye-appealing "New Look," the A.C. Ruggedized line matches other Roller-Smith panel instruments and provides maximum readability, accuracy, and maintenance simplicity. Available in 2½" and 3½" hermetically sealed cases, these instruments conform to specification MIL-M-10304 (Sig. C). These A.C. Ruggedized instruments, like all other Roller-Smith products, are produced by master craftsmen with nearly 50 years of precision engineering and manufacturing experience. Whatever your instrument problem, consult us for a practical, economical solution.

Instrument Division
CORPORATION

1825 WEST MARKET STREET  BETHLEHEM, PENNSYLVANIA

Precision Products Since 1908

See these and other outstanding Roller-Smith products featuring the "new-look" at Booth 702 I. R. E. Show, Kingsbridge Army, New York City, March 21-24, 1955.



The world's largest producers
of wire-wound resistors
invites you to visit

BOOTH 444
at the
1955 I.R.E. SHOW

See **TRU-OHM POWER RHEOSTATS** and **TRU-OHM VITREOUS ENAMELED RESISTORS . . .** America's fastest growing rheostat and resistor lines . . . serving the original equipment manufacturer and the replacement markets.

If you cannot attend, drop us a line for our latest catalog



**TRU-OHM
PRODUCTS**

General Sales Office: **2800 N. Milwaukee Avenue, Chicago 18, Ill.**
Factory: **Warrington, Indiana**

"Largest producers of wire-wound resistors in the U.S.A."

MANUFACTURERS: Power Rheostats, Fixed Resistors, Adjustable Resistors, "Enameled" Resistors, "Tru-ohm" Resistors

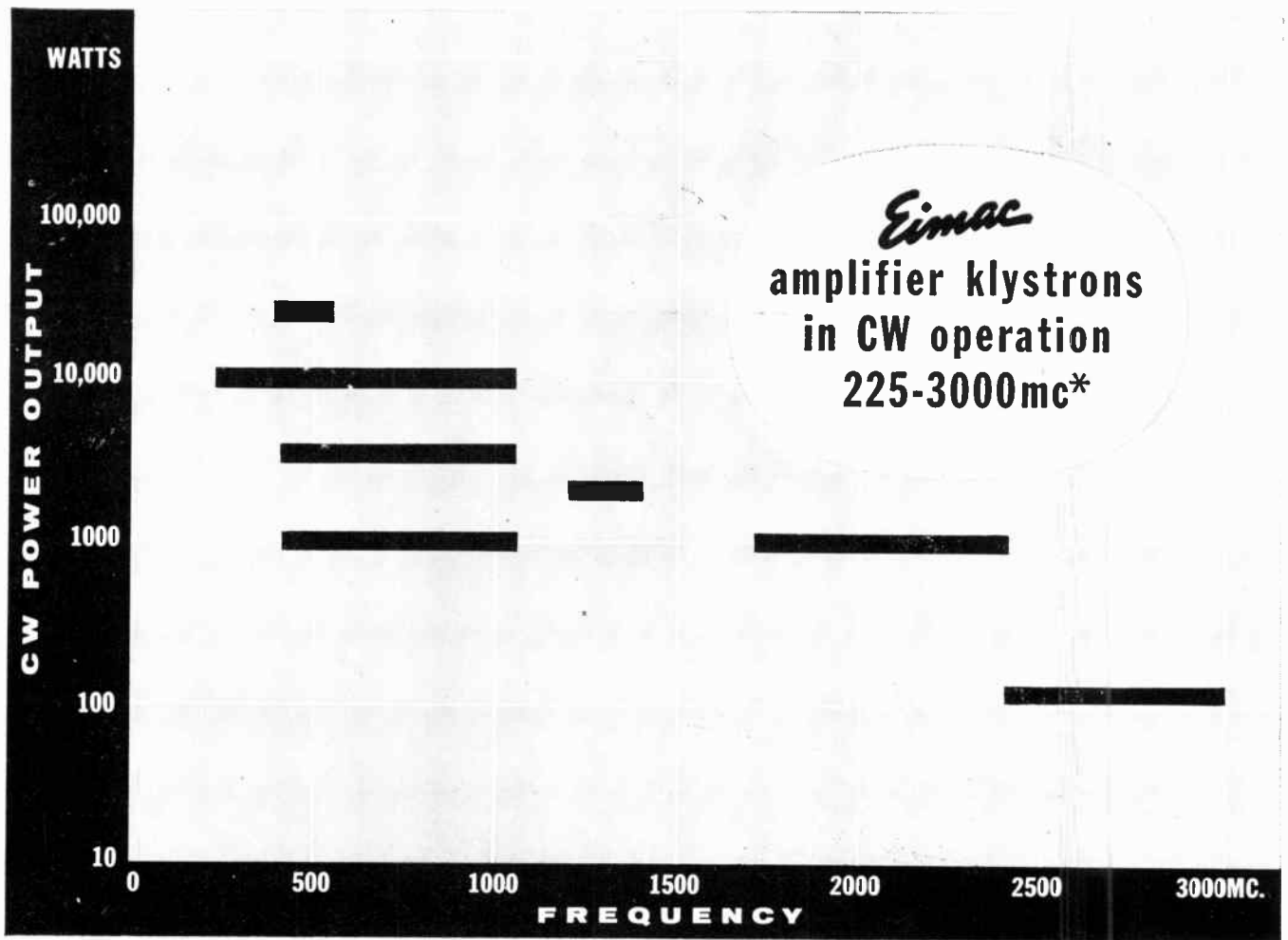

*Pulse ratings many times CW ratings are available on most Eimac klystrons.

Eimac amplifier klystrons are performance proved in extended range UHF and microwave communications systems

Eimac amplifier klystrons, performance proved in high power extended range microwave communications systems, now cover the spectrum from 225-3000mc. The Eimac 3K50,000L series, with 10kw/CW power output, power gains of over 1000 times, over 40% operational efficiency, long life and reliability, are typical of Eimac high power UHF klystrons. Of copper and ceramic construction, Eimac klystrons offer wide range tuning and easy

input and output coupling through the use of external resonant cavities which leave the vacuum system free of RF circuitry. Light weight, allowing easy installation and maintenance, plus simplified design, minimizing production and stockpiling problems, make Eimac klystrons more practical and economical than any other.

See the klystrons selected to pioneer high power extended range microwave communications systems by visiting the Eimac booths, 549-551, at the I.R.E. show in New York March 21-24. Management and Engineering representatives will be on hand to discuss Eimac tubes and their application.



EITEL-McCULLOUGH, INC.
SAN BRUNO, CALIFORNIA
THE WORLD'S LARGEST MANUFACTURERS OF TRANSMITTING TUBES

At the I.R.E. Show

YOU'LL

SEE

**MAXSON • LANGEVIN
UNIMAX • UNITED**



Engineers of these four companies will be available at Booths 620-622-624 on Circuits Avenue to answer your questions about

. . . electronics systems, airborne armament, ordnance equipment, and industrial instruments, developed and produced by **THE W. L. MAXSON CORPORATION**

. . . precision snap-acting switches, acceleration-sensitive switches, and accelerometers made by **UNIMAX Division of THE W. L. MAXSON CORPORATION**

. . . transformers, audio amplifiers and power supplies engineered and manufactured by the **LANGEVIN MANUFACTURING CORPORATION**

. . . electrical test equipment for aircraft designed and built by **UNITED MANUFACTURING COMPANY, Division of THE W. L. MAXSON CORPORATION**

MAXSON develops and manufactures systems, subsystems, and components in armament, navigation, electronics, and special devices.

Ask for facilities report.



THE W. L. MAXSON CORP.

460 WEST 34th STREET, NEW YORK 1, N. Y.

Plants at Oak Forge, Penn. and Long Island City and New York, N. Y.

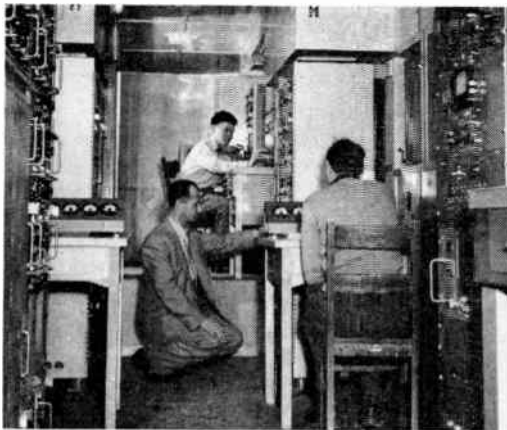

Inside this mobile ground station, test flights of the Avro Canada CF-100, RCAF all-weather interceptor for continental defense, are "seen" and "heard" with Ampex magnetic tape recorders.

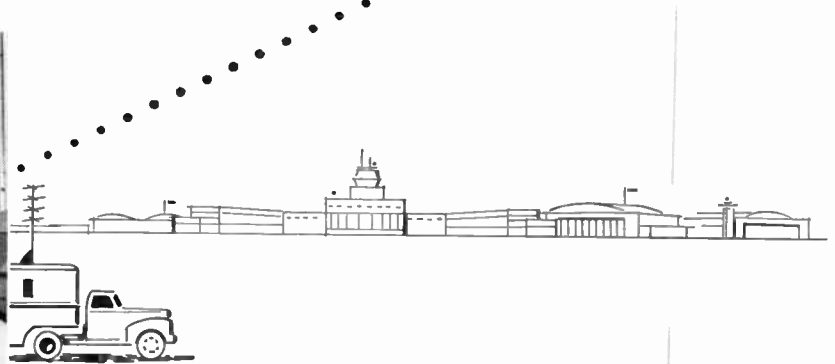

MAGNETIC TAPE RECORDING helps produce better designs faster

At Avro Canada, as at all major flight test locations in the United States, all test data transmitted by radio telemetry is permanently — completely — and accurately — recorded on magnetic tape. This involves 67 separate items of information **per second** — items such as temperature, pressure, revolutions, acceleration, yaw and roll. The data is "magnified" on playback at slow speed, permitting Avro engineers and aerodynamists to critically study each parameter in gas turbine and airframe designs.

AVRO USES AMPEX MAGNETIC TAPE RECORDERS

The Aircraft Division of Avro Canada, Malton, Ontario is one of the many diversified users of Ampex magnetic tape equipment for data recording.

Ampex recorders are widely preferred for special installations requiring broad frequency response, precise timing, extreme stability of tape motion, high shock resistance and reliable accuracy on transients. A wide variety of models are available featuring pulse width, frequency modulated and direct recording techniques . . . for airborne, mobile, rack-mount or console applications . . . in any frequency band from zero to 100,000 cycles per second.

Ampex 306 Recorder, 0 to 5,000 cps.

MAGNETIC RECORDING HAS MANY APPLICATIONS

Because magnetic tape data is convertible to any form (e.g.: oscillograph traces, scope reading, computer feeds, control signals or punched cards), many practical applications result. Examples are:

- Data Computing
- Machine Control
- Advanced Research
- Test Cycling
- Process Regulation

LET AMPEX EVALUATE YOUR SPECIAL NEEDS

Without obligation, find out whether "live memory" techniques can be applied to your operation, or ask for our 16-page illustrated bulletin. Contact your nearest Ampex representative, or write or wire Dept. G-1892.

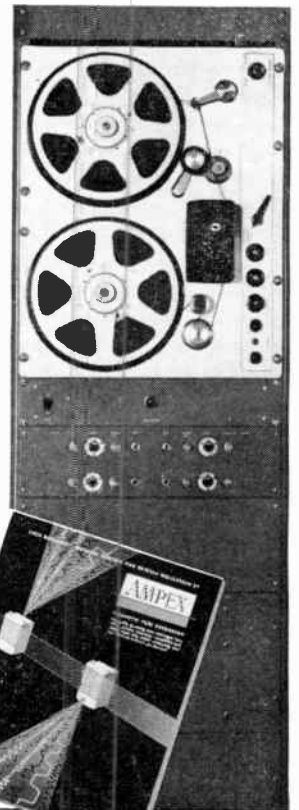

Signature of Perfection in Magnetic Recorders

934 CHARTER STREET, REDWOOD CITY, CALIFORNIA

BRANCH OFFICES: New York; Chicago; Atlanta; San Francisco; Dayton; College Park, Maryland (Washington, D.C. Area).

DISTRIBUTORS FOR AMPEX INSTRUMENTATION RECORDERS: Radio Shack, Boston; Bing Crosby Enterprises, Los Angeles; Southwestern Engineering & Equipment, Dallas and Houston; Canadian General Electric Company, Canada

Distributors of Ampex Audio Equipment listed in your phone directory.

TYPE 310 OSCILLOSCOPE SERIAL

It's New!
and this is its
ACTUAL SIZE

DC to 4 mc

23½ lbs.

\$595

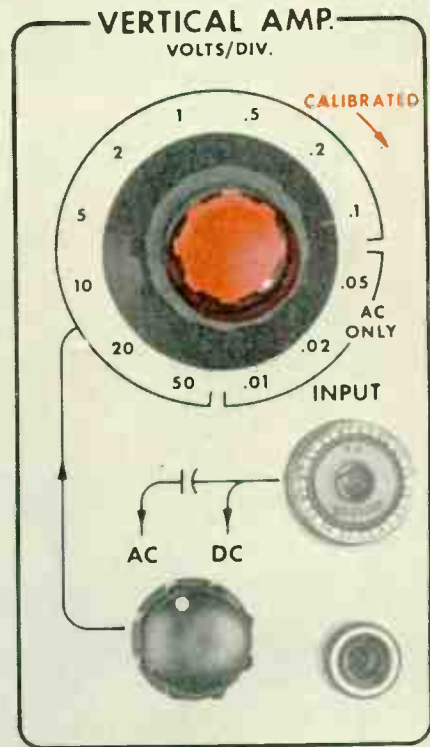

VERTICAL POSITION

HORIZONTAL POSITION

FOCUS

INTENSITY

SCALE ILLUM.

PWR. OFF

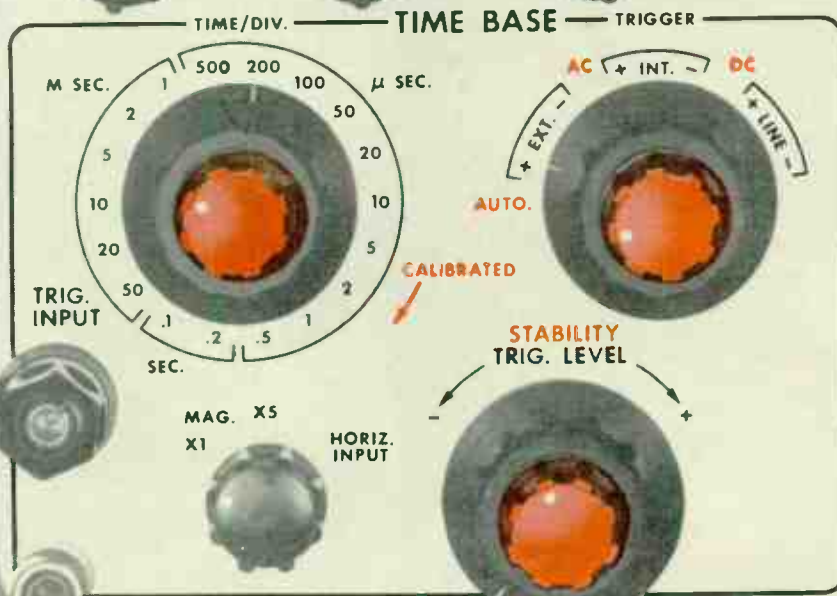

NON-CALIBRATED

TEKTRONIX, INC.,
PORTLAND, OREGON, U. S. A

DIMENSIONS 6¼" X 10" X 17"

See it... Try it... at the 1955 IRE Show.. Booth 129

Standard and Special Constructions—

AT THE IRE SHOW
BOOTH 2061
CIRCUIT AVENUE
Kingsbridge
Astoria
New York City
March 21-24, 1955

"HLT 500B"
120°C WIRE

NYLON
JACKETED
WIRES



CHESTER *plasticord-plasticote* WIRES & CABLES

— FOR EVERY
ELECTRICAL
AND
ELECTRONIC
NEED!

It pays to make CHESTER quality-engineered wire and cables your standard for both commercial and military requirements. Every foot of conductor bearing the Chester label is laboratory tested and service-proven to perform as specified. Chester extra-strength plastic coatings are made super-durable for longer life and smooth pliability assures the easier working qualities that speed wiring production.

NEW CHESTER BULLETINS

Complete data and specifications on quality conductors for all electronic wires and cables will be supplied promptly. Call or write, today!

MIL-W-5086 HOOK-UP WIRE

JAN.C-76 WIRES SRIR, SRHV, SRRF, WL
Solid Colors or Spiral Marking

TV LEAD-IN WIRES

LACQUERED WIRES

SHIELDED WIRES & CABLES

INSTRUMENT WIRES

COAXIAL CABLES

SPECIAL WIRES & CABLES
TO SPECIFICATIONS

"Chester"
says —

For Dependable Wiring,
Connect It with Chester!



CHESTER CABLE CORP.
CHESTER, NEW YORK

MECHANICAL INTEGRATORS

from FORD INSTRUMENT

for extreme
accuracy in
computing and variable
speed applications

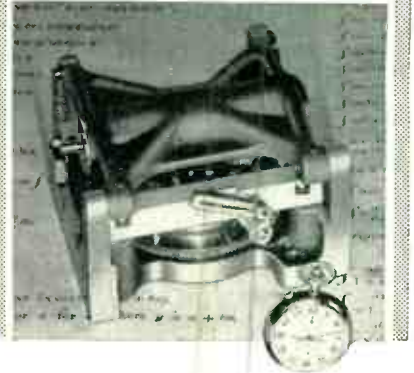

- STANDARD INTEGRATORS in 2½" and 5" disk diameters

FOR EARLY DELIVERY

- and a variety of SPECIALS, such as component and tangent integrators.

Ford Instrument's standard mechanical integrators utilize the Company's two-ball and disk low-friction design. Supplied with a patented ball roller tilt device which minimizes ball slip for all carriage positions, these integrators are high precision units for a wide variety of computing and variable speed drive applications.

FREE — Fully illustrated data bulletin gives specifications and performance information. Please address Dept. IRE



47



FORD INSTRUMENT COMPANY

Division of The Sperry Corporation
31-10 Thomson Ave.
Long Island City 1, N. Y.

Ford Instrument's standard components



Rate Generators



Differentials



Servo Motors



Telesyn Resolvers



Integrators



Telesyn Synchros

Better for you



*Pyramid will now
be listed in
Photofact folders.*

Pyramid has joined the select group of manufacturers who participate in this most valuable of all service aids to make available to you an immediate cross reference between the set manufacturer's part and the part number of the exact Pyramid equivalent.

You will find Pyramid capacitors as original components in sets bearing such famous brand names as

RCA • GE • CBS • Arvin • DuMont • Zenith • Raytheon • Emerson
Motorola • Sylvania • Packard-Bell • Hallicrafters • Westinghouse • Hoffman
and at leading parts distributors everywhere.

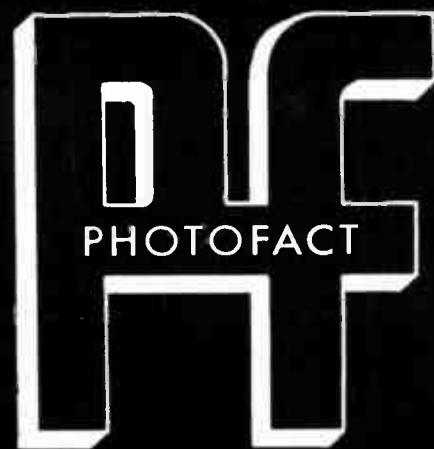

 **PYRAMID ELECTRIC CO., 1445 Hudson Boulevard, North Bergen, N. J.**

WHEN YOU SPECIFY...

TAPE WOUND CORES

SPECIFY...

MAGNETICS inc.

*Performance -
Guaranteed*

HERE'S WHY

Only Magnetics, Inc. "Performance-Guaranteed" Tape Wound cores are *guaranteed* to meet *your* performance specifications. These are truly the most economical tape wound cores offered to industry today, for their guaranteed performance effects major savings on your production line. *They are sold to you at no increase over standard core prices.*

When you specify "Performance-Guaranteed" Tape Wound Cores from Magnetics, Inc., you have your choice of the largest selection of standard tape wound cores offered by any manufacturer. In addition, the nationally renowned Magnetics Engineering and Development Department will design cores to meet your product needs as a completely free service.

Why not write us today, and put Guaranteed Performance to work for you?

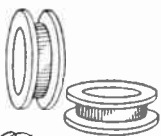

Performance - Guaranteed **BOBBIN CORES, TOO**

Tiny Bobbin Cores made with ultra-thin tape down to 0.000125" in thickness, and possessing very rectangular hysteresis loops under pulse conditions, are now available for the first time with the famous Performance-Guarantee. If temperature stability, low coercive value, high saturation density, and ability to switch from positive to negative saturation in a very few microseconds, are of value to you, it will pay you to investigate Magnetics, Inc. Bobbin Cores.

WANT THE COMPLETE STORY?

It's easy to get the detailed story . . . simply write on company letterhead. We'll send complete literature, containing specifications and design information.

MAGNETICS inc.

DEPT. 1-15, BUTLER, PENNSYLVANIA



INCOMPARABLE Frequency Stability...

for Airborne X-Band Radar Receivers

Now — at a New Low Cost — Varian announces the rugged VA-203 . . . most advanced reflex klystron ever developed for airborne radar and beacon local oscillator service. The exclusive brazed-on external tuning cavity provides frequency stability obtainable in no other klystron. This construction provides outstanding stability during shock, vibration and temperature cycling . . . takes punishing 50 to 100 G shocks and provides absolutely reliable operation at high altitude WITHOUT pressurization.

For Super-Rugged Service (Shocks to 250G) . . . Varian offers the VA-201 klystron. This tube is equipped with integral molded silastic leads, is similar to the VA-203 and performs with the same absolute reliability.

All these exclusive Varian features . . .

- ★ Unique brazed-on external tuning cavity assures exceptional frequency stability.
- ★ Reliable operation at low voltage and from poorly regulated power supplies.
- ★ Negligible microphonics.
- ★ Slow tuning rate . . . long tuning life . . . single shaft tuner adapts easily to motor tuning.
- ★ Withstands 50 to 100 G shocks (up to 250 G's for the VA-201)
- ★ VA-203 weighs less than 4 ounces. Both tubes mate directly to standard waveguide flanges.

GUARANTEED SPECIFICATIONS		
8500 to 9600 mc	VA-203	VA-201
Resonator Voltage	300 V	250 V
Heater Voltage	6.3 V	6.3 V
Heater Current	0.45 Amp	1.2 Amp
Power Output	20mW, Min	15mW, Min
Electronic Tuning Range	30 Mc, Min	30 Mc, Min
Vibration FM at 10 G	1 Mc, p-p, Max	0.2 Mc, p-p, Max

GET COMPLETE TECHNICAL DATA and specifications on the outstanding new VA-203 and its companion VA-201 . . . finest klystrons made for airborne radar. Write to our Applications Engineering Department today.

*SEE us at the
New York I.R.E. Show*

THE
MARK OF
LEADERSHIP

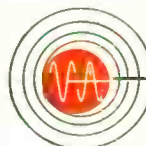

VARIAN associates

PALO ALTO 2, CALIFORNIA

Representatives in all principal cities

KLYSTRONS, TRAVELING WAVE TUBES, BACKWARD WAVE OSCILLATORS, R.F. SPECTROMETERS, MAGNETS, STALOS, U.H.F. WATERLOADS, MICROWAVE SYSTEM COMPONENTS, RESEARCH AND DEVELOPMENT SERVICES

PROCEEDINGS OF THE I.R.E. March, 1955

39A

IT'S GOOD FOR YOUR SYSTEM



BEFORE

tone up your spectrum with a **LITTON High Power MAGNETRON ISOLATOR**



AFTER

Use a Litton Magnetron Isolator to insure concentration of energy in the useful pass band of your system. Without this device mismatched loads coupled with long lines spread transmitted energy into unused portions of the spectrum, seriously impairing system performance. By employing the unidirectional properties of magnetically polarized ferrites at microwave frequencies, these new circuit elements isolate the microwave source from load reflections, permitting high power magnetrons or klystrons to operate satisfactorily into long lines terminated in poorly matched loads. With a particular VSWR usable length of line for stable magnetron operation may be increased four to five times by incorporating a Litton Load Isolator with isolation of 10 db or more.

In addition, Litton Magnetron Load Isolators ...

- Reduce frequency pulling.
- Provide broad band operation with high isolation.
- Present low input VSWR.
- Reduce moding.
- Decrease AFC requirements.
- Minimize variation in power output with changing loads.
- Require no separate cooling system.
- Require no external power supply.

New ferrite circuit elements are designed to improve system operation by minimizing long-line effects and other loading problems.

Developed and manufactured by specialists in the production of microwave systems and components, Litton Magnetron Isolators greatly improve tube performance.



LITTON MODEL X250
LITTON MODEL X-101
MAGNETRON LOAD ISOLATOR

for improved performance in high-power radar and other microwave systems.



LITTON MODEL X20L
LABORATORY LOAD ISOLATOR

for laboratory use, to obtain maximum performance from your "X" band test equipment.

CONDENSED SPECIFICATIONS

	X250	X101	X20L
Frequency Range	8.6-9.6 kmc	8.6-9.6 kmc	8.6-9.6 kmc
Isolation (minimum) (Attenuation in reverse direction)	10 db	10 db	18 db
Insertion Loss (maximum)	0.5 db	1 db	1.5 db
Power Handling Capacity	300 KW peak 300 W average	100 KW peak 100 W average	20 watts (output terminated)
Magnetic Field	Permanent magnet	Permanent magnet	Permanent magnet
Input VSWR (output terminated)	1.05 max.	1.10 max.	1.2 max.
Flange	UG-51 U	UG-39 U	UG-39 U*
Weight		Less than 2 lbs	

*Special flanging upon request.

Other precision products of the Litton Components Division include: Microwave Rotary Joints, multi-turn Potentiometers, single-turn Potentiometers, Metal Film Resistors, Delay Lines.

LITTON
industries

COMPONENTS DIVISION

Write for complete data and name of nearest representative...

336 N. FOOTHILL ROAD, BEVERLY HILLS, CALIFORNIA • CRESTVIEW 4-7344
215 S. FULTON AVE., MOUNT VERNON, NEW YORK • MOUNT VERNON 7-6609

color TV shadow masks

We are now delivering shadow masks, the precision heart of the color television tube, etched to specifications. Mass production methods, perfected during more than 40 years of precise metal etching experience, enable us to meet today's exacting demands for quality and delivery.

etched and electro formed precision parts

With the technical experience and production know-how gained in producing fine metal etching and in electro-forming, we are now manufacturing many components for the electronic industry. Some specifications call for fine mesh up to 1,000,000 holes per square inch. Send us your drawings for a prompt quotation.



BUCKBEE MEARS COMPANY

Lindeke Building
SAINT PAUL 1, MINNESOTA

1 to 5 ratio your quality insurance

- 21 INSPECTORS to each 100 production workers—a 1 to 5 ratio.
- ALL units thoroughly inspected on exacting custom equipment.
- UNIQUE inspection procedure for each application.

EXTREME MANUFACTURING ACCURACY

- EVERY gear cut with an AA hob and rolled against a master.
- EVERY final grind on every shaft run through a Sheffield comparator set by "jo" blocks.
- EVERY bearing bore checked with an air gauge and XX plug gauge.

A wide variety of rotating electrical components for electronic and airborne applications . . . designed and produced to your specifications. Send your requirements to OSTER design engineers. Write for "The Oster Story of Quality" today.



John Oster

MANUFACTURING CO.
AVIONIC DIVISION
RACINE, WISCONSIN

Your Rotating Equipment Specialist



MOTORS, AC DRIVE

FRACTIONAL H.P. MOTORS

FAST RESPONSE RESOLVERS

ACTUATORS

LOW INERTIA SERVO MOTORS

SYNCHRO DIFFERENTIALS

SERVO TORQUE UNITS

TWO-PHASE REFERENCE GENERATOR

MOTOR DRIVEN BLOWER AND FAN ASSEMBLIES



March 1955

Test Set

Electronic Measurements Corp., 280 Lafayette St., New York, N. Y., recently announced three instruments; Model 106 VTM; Model 500 rf signal generator; Model 208 tube tester for, basic radio and TV receiver servicing. Included without charge with this new offer are Model CRA picture tube adaptor for the Model 208, and two Model IS "Eye Level" instrument stands.

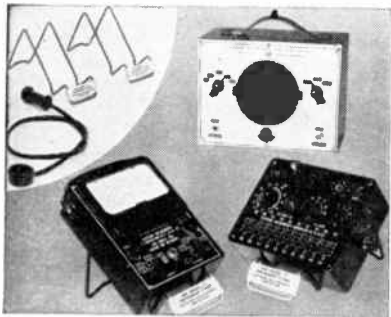

With the Model CRA, picture tubes can be checked in or out of sets and cartons. Price is \$68.55.

Potentiometer Elements

Helco Products Corp., 2041 Colorado Ave., Santa Monica, Calif., has announced plans to specialize in the manufacture of precision potentiometer elements as integral parts of the customer's product.

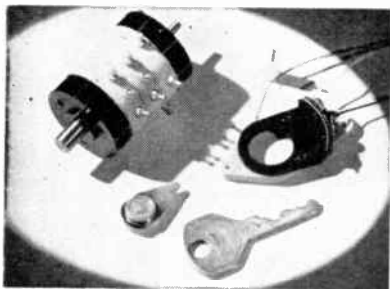

The company believes its increased specialized services will be an asset to instrument designers, resulting in more balanced design, saving in space and weight, reduced torque, closer alignment and better compliance with environmental and functional specification.

The company is currently producing precision potentiometer components for aircraft, electronic and instrument systems. All units are available with resistance wire 0.4 mil and up, with adjustable terminals and taps, of size and weight ideally suited for miniaturization. Ganged units are adjustable for both total length and electrical centers.

These manufacturers have invited PROCEEDINGS readers to write for literature and further technical information. Please mention your I.R.E. affiliation.

Ratio Meter

A new panel meter to indicate the ratio of two direct currents is being produced by Thomas A. Edison, Inc., Instrument Div., West Orange, N. J.



The instrument has a capacity to handle 50 ma in either coil and will accurately indicate a ratio on an input of 2 ma minimum. Scale tolerances are based on an angular tolerance of 1°.

The movement uses a pair of fixed coils surrounding a small alnico magnet attached to a pivoted pointer shaft. With equal current in both coils the pointer will indicate unity ratio (1). An increase in strength of one current over the other will pull the pointer right or left of center to indicate a ratio. Price is about \$43.00.

Transformer

Condenser Products Co., Div. New Haven Clock & Watch Co., 140 Hamilton St., New Haven, Conn., is introducing a high voltage oil immersed transformer for use in ac and high voltage test equipment and high voltage power supplies.

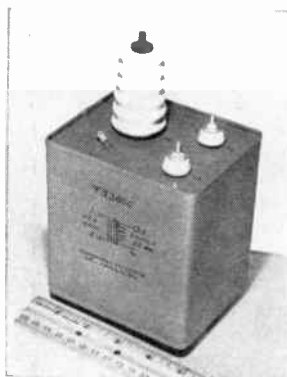

The company does not contemplate a standard line at this time and will limit its production to custom business including prototype and large production orders.

The transformers are made in both 60 and 400 cps types up to a 5 KVA power

level. Condenser Products impregnates these transformers with the conventional types of high dielectric strength transformer oils, as well as with silicone oil for high temperature uses.

Power Supply

Seven regulated current ranges from 1 ma to 1 ampere and four regulated voltage ranges from 10 volts to 100 volts.

The PS-171 power supply was developed by Scientific Specialties Corp., Brighton 35, (Boston) Mass., for use in transistor measurements. The regulated output current of 1 ampere maximum is high enough to accommodate power transistors.

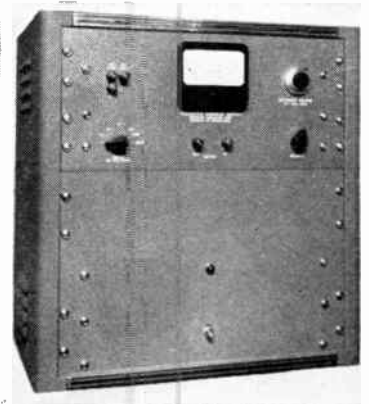

The instrument contains a high gain vacuum tube regulator circuit which is stabilized to keep the output current or voltage constant at dc and also maintains high output impedance (when used as a constant current supply) or low impedance (when used as a constant voltage supply). The above holds true even when a programming or sinusoidal signal whose frequency is as high as several hundred cycles is superimposed on the dc through terminal jacks provided.

Front panel meter indicates voltage or current output directly. Absolute accuracy is better than 0.25 per cent. Precise setting to 0.1 per cent is by a 10 turn Helipot. Regulation is better than 0.1 per cent for load changes from zero to full load and line voltage changes from 105 to 125 volts. Hum is below 0.05 per cent of full scale on all ranges.

Transistors

Metropolitan Overseas Supply Corp., 1133 Broadway, New York 10, N. Y., has been appointed distributor for the Siemens & Halske Aktiengesellschaft.

A new line of quality transistors for amplification and switching is available to the trade as a result of this merchandising venture.

Characteristics, ratings, and installation procedures are available from the distributor.

(Continued on page 46A)

DAVEN

advanced design brings you

"PLUG-IN"

ATTENUATION NETWORKS

Combining a wide range of attenuation with a "plug-in" feature for adjusting input and output impedance.

On Daven Series 690 Attenuation Networks, the exclusive "plug-in" feature permits input or output impedance to be changed to any value by substituting "plug-in" pads of the particular impedance desired.

These networks are intended for use in general laboratory and production testing. They are extremely rugged, flexible and reliable. They are available in either "T" or "Balanced H" circuits. A range of either 110 DB in 1 DB steps can be obtained on the 2-dial series, or a range of 111 DB in 0.1 DB steps on the 3-dial series. A special card type, non-inductive winding is used, giving a frequency range of from zero to 50 KC. These units may be used above 50 KC with only a slight decrease in accuracy. Resistor units are calibrated to $\pm 1.0\%$ accuracy and operate at a +20 DB (0.6 watt) maximum input level.

To insure low contact resistance and uniform contact pressure Daven patented "knee-action" switch rotors are used. Silver alloy rotors, slip-rings and contacts insure finest electrical performance. Daven's exclusive "plug-in" impedance Matching Networks are available in a wide range of impedance and loss.

Write for complete catalog data.

THE **DAVEN** co. 195 Central Ave., Newark 4, N. J.

Visit Daven at the I.R.E. Show
543 & 545 Components Avenue

Series 690

WORLD'S LARGEST MANUFACTURER OF ATTENUATORS

World Radio History

WINCHESTER ELECTRONICS, INC.

QUICK-DISCONNECTING SELF-ALIGNING

SERIES "QRE"

6, 12, 18, 24, 34, 208 Contacts



MINIATURE and SUB-MINIATURE ELECTRICAL CONNECTORS

The Accepted Standard for
QUALITY • COMPACTNESS • RUGGEDNESS
LIGHT WEIGHT • DEPENDABILITY

NEW Designs & Applications
 On display at the
 Radio Engineering Show
Booth 628
Circuits Avenue

SUB-MINIATURE SERIES "SMRE"

7, 14, 20, 26, 29, 34 Contacts

ACTUAL SIZE

HEAVY DUTY TYPES "200" to "900"

Used in "AN" Shells

1/4 ACTUAL SIZE

SERIES "M" MINIATURE

4, 5, 7, 9 Contacts

ACTUAL SIZE

SERIES "HM" HERMETIC PLUG (Round Hole)

Used with "M" Receptacles

ACTUAL SIZE

TYPES "RA" & "RB" WATERPROOF

4 or 9 Contacts

1/2 ACTUAL SIZE

SERIES "MRE" MINIATURE

7, 8, 9, 14, 18, 20, 21, 26, 34, 43, 50, 75 Contacts

1/2 ACTUAL SIZE

SERIES "HMRE" HERMETIC PLUG

Used with "MRE" Receptacles

ACTUAL SIZE

AIRCRAFT SERIES "A"

7, 10, 15, 18 Contacts

SERIES "K" RECEPTACLES

Used with Printed Circuit Cards

2, 3, 6, 10, 15, 18, 22 Contacts

1/2 ACTUAL SIZE

TYPE "B" MOISTURE PROOF

12, 14, 24 Contacts

1/2 ACTUAL SIZE

Many features are covered by our Patents: Nos. 161900, 162792, 2411861, 2466370, 2513080, 2526325, 2532538, 2633482 and 2659872.

.....

Wire or write for catalog of other types or advise your special requirements.

Winchester Electronics, Inc. Products and Designs are Available Only from Winchester Electronics, Inc.

WINCHESTER ELECTRONICS
 INCORPORATED

WEST COAST BRANCH:
 1729 Wilshire Boulevard, Santa Monica, California

NORWALK, CONNECTICUT

CRITICAL QUALITY CONTROL

Means the Finest in Frequency Control in

Midland CRYSTALS



Midland makes more frequency control crystals than anybody else. Millions are used in two-way communications thruout the world.

Only a product of the highest quality rates that kind of demand. That's why you know your Midland crystal will do a completely dependable job for you.

The quality of Midland crystals is assured by exacting tests and controls through every step of processing. It's quality you can stake your life on — as our men in the armed forces and law enforcement do every day.



Other standard types for various ranges. Specials developed and produced to individual requirements.

Whatever your crystal need — conventional or highly specialized... when it has to be exactly right, contact

Midland Manufacturing Co., Inc.
 3155 Fiberglas Road • Kansas City, Kansas
WORLD'S LARGEST PRODUCER OF QUARTZ CRYSTALS

New!

MULTI-PURPOSE

Sweep Signal Generator

4.5 to 120 mc.

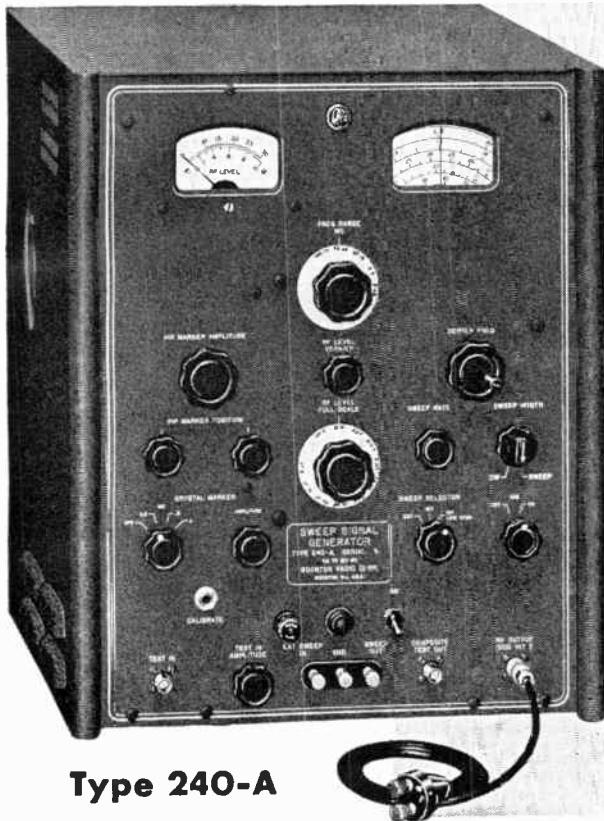

Type 240-A

The Sweep Signal Generator Type 240-A is a continuously-tuned, accurate CW Signal Generator with internal AM. The output voltage is continuously monitored, indicated and calibrated over a wide range. The CW Signal can be calibrated against an internal crystal. Electronic sweep circuits are included which produce an output signal having an AGC-controlled, constant-amplitude and a wide range of continuously-variable linear-frequency sweep widths. Two systems are included for frequency identification while sweeping. One of these is crystal controlled and the other is an interpolation system. An internal mixer adds the frequency identification information to the test receiver output signal prior to its connection to the display oscilloscope.

SPECIFICATIONS:

- RF FREQUENCY RANGE: 4.5 to 120 MC continuously variable in five ranges.
- RF FREQUENCY ACCURACY: $\pm 1\%$.
- RF OUTPUT VOLTAGE: 1 to 300,000 microvolts. 0.1 to 30,000 microvolts with external attenuator.
- AMPLITUDE MODULATION: Factory adjusted to 30% from internal 1000 cps oscillator.
- RANGE OF SWEEP WIDTHS: Continuously variable from $\pm 1\%$ of center frequency to ± 15 MC or $\pm 30\%$ of center frequency whichever is smaller.
- LINEARITY OF SWEPT RF FREQUENCY: Within 10% over middle 80% of sweep excursion, within 20% over remainder.

- A wide range of continuously variable linear-frequency sweep widths.
- Crystal controlled frequency identification.
- Adjustable frequency-interpolation pip marks.
- Internal mixer for forming composite display signal.
- Accurate continuously-tuned CW with choice of internal AM.
- Internal crystal calibrator for CW.
- Wide range of calibrated output voltage.

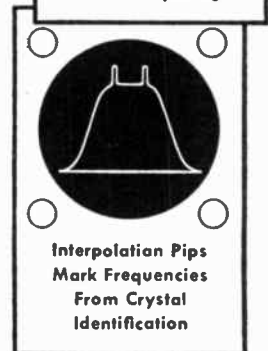
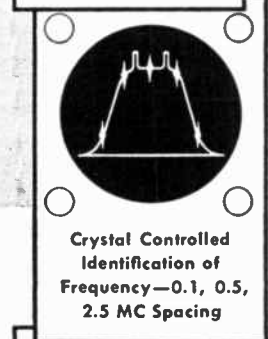
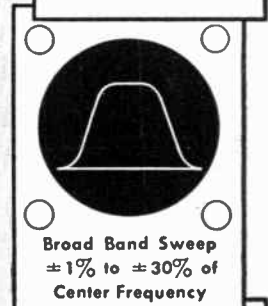
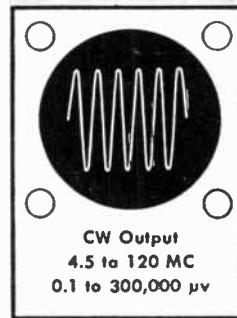

FLATNESS OF SWEPT RF OUTPUT: Within 7% under all conditions.

FREQUENCY IDENTIFICATION MARKS: Crystal frequency identification spaced 0.1, 0.5, 2.5 MC. Tuning dial identifies center mark. Two adjustable-position interpolation pip marks.

PRICE: \$1375.00 FOB BOONTON, N. J.



BOONTON RADIO

BOONTON · N · J · U · S · A ·

Corporation

Booths 225-227 Instruments Ave., Radio Engineering Show

PERKIN... HAS A STANDARD POWER SUPPLY FOR YOUR EVERY NEED
IMMEDIATE DELIVERY!!



PERKIN
TUBELESS!!
MAGNETIC AMPLIFIER
REGULATED DC
POWER SUPPLIES

MODEL
 MR 532-15
 5 TO 32 V.
 @ 15 AMP.
 (CONT.)



REGULATION: $\pm 1\%$ (a) from 5.32V DC (b) from 1.5 to 15 amps. (c) from 105-125V AC. (single phase, 60 cps.)

RIPPLE: 1% rms @ 32V and full load, increases to max. of 2% rms @ 5V and full load. **RESPONSE:** 0.2 sec.

METERS: 4 1/2" AM and VM; 2% accuracy.

MOUNTING: Cabinet or 19" rack panel.

FINISH: Baked Grey Wrinkle.

WEIGHT: 150 lbs.

DIMENSION: 22" x 17" x 14 1/2"

**\$524 w/o cabinet, \$549 w/cabinet.

MODEL
 M60 VMC
 0 TO 32 V.
 @ 25 AMP.
 (CONT.)



REGULATION: $\pm 1\%$ (a) at 28V DC; increases to 2% max. over the range 24-32V; does not exceed 2V regulation over the range 4-24V DC (b) from 1/10 full load to full load (c) at a fixed AC input of 115V.

RIPPLE: 1% rms @ 32V and full load; 2% rms max. @ any voltage above 4V.

AC INPUT: 115V, single phase, 60 cps.

FINISH: Baked Grey Wrinkle.

WEIGHT: 130 lbs.

DIMENSIONS: 22" x 15" x 14 1/2"

**\$439 w/o cabinet, \$474 w/cabinet.

MODEL
 MR 1040-30
 10 TO 40 V.
 @ 30 AMP.
 (CONT.)



REGULATION: $\pm 1\%$ (a) from 10 to 40V DC (b) from 100 to 130V AC (c) from 3 to 30 Amps DC. **RIPPLE:** 1% rms.

AC INPUT: 100-130V, 1 phase, 60 cycles.

RESPONSE: 0.2 sec. **METERS:** 4 1/2" AM and VM.

MOUNTING: Cabinet with 19" rack panel.

FINISH: Baked Grey Enamel.

WEIGHT: 200 lbs.

DIMENSIONS: 22" x 15" x 23"

**\$792 w/o cabinet, \$827 w/cabinet.

MODEL
 MR2432-100X
 24 TO 32 V.
 @ 100 AMP.
 (CONT.)



REGULATION: $\pm 1/2\%$ (a) from no load to full load. (b) from 24-32V DC. (c) for 230* (or 460) V $\pm 10\%$.

DC OUTPUT: 24-32V @ 100 amps.

AC INPUT: 230 or 460V $\pm 10\%$, 3 phase, 60 cycles.

RIPPLE: 1% rms. **RESPONSE TIME:** 0.2 sec.

MOUNTING: Cabinet or 19" rack panel.

WEIGHT: 250 lbs.

DIMENSIONS: 25" x 15" x 15"

*This unit will be supplied for 230V AC input unless 460V is specified.

**\$1,149 including meters and cabinet.

**All prices F.O.B., El Segundo. Terms: 1% — 10 days, Net 30. Phone collect for quantity discount.

ALSO AVAILABLE: Standard 6 and 115 volt models; Ground and Airborne Radar and Missile Power Supplies — Write for Perkin Bulletins.

PERKIN
ENGINEERING CORP.

345 KANSAS ST. • EL SEGUNDO, CALIF. • ORegon 8-7215 or EAstgate 2-1375



News-New Products

These manufacturers have invited PROCEEDINGS readers to write for literature and further technical information. Please mention your I.R.E. affiliation.
 (Continued from page 42A)

Graphic Recorder

Century Electronics Co., P.O. Box 648, Cocoa, Fla., has developed a direct writing recorder which was especially designed for the recording of low frequency telemetering data; however, applications have also been found in monitoring guided missile firing sequences, computers, etc. The standard telemetering recorder has four chart speeds compatible with data from commutated and low frequency continuous channels. Usable response can be obtained up to 100 cps with a Century compensated amplifier. Any number of chart speeds up to a maximum of eight may be furnished on special units.

The standard recorder includes three center-tapped pen motors and one dual polarity timing and event marker. When voltage sensitive paper is used, static data pens may be employed to record on-off functions. For some applications, a combination of dynamic and static marking pens are provided.

The recorder has adjustable static marking pens, and dual polarity timing-event marker. It is (8 1/2 x 8 1/2 x 16 inches in size). Models are available for voltage sensitive or heat sensitive chart paper. Information is plotted in rectilinear coordinates. These recorders are designed for multi-unit installation in standard racks, and a 30-channel recording system may be installed in approximately 48 inches of a standard rack.

Bobbin Winder

Geo. Stevens Mfg. Co., Inc., Pulaski Rd., at Peterson, Chicago 30, Ill., is now offering a screw feed bobbin and resistor winder featuring a new finger-tip resettable wire guide. Model 212-AM winds all types of random wound bobbin coils, solenoids, repeater coils, relay coils as well as space wound coils, resistors and distributed constant delay lines from 1/4 inch to 6 1/2 inches long and up to 4 inches outside diameter. Coils up to 12 1/2 inches long may be wound by specifying Model 212-AML.

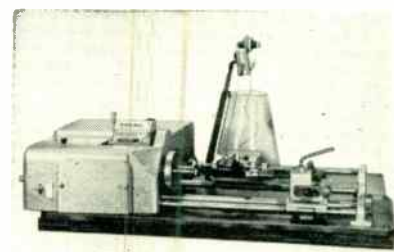

Upon completion of the winding cycle, the wire guide carriage can be instantly returned to the identical starting point by finger-tip pressure on the clutch release button. This action completely eliminates split nuts. The wire guide carriage is adaptable to multiple winding.

(Continued on page 48A)

Visit Our Booth No. 13 at Kingsbridge Palace, Nat'l IRE Convention, March 21-24



AMP Taper Tab
receptacles for wire
sizes 26 to 18

AMP Taper Pins
for wire sizes
26 to 16

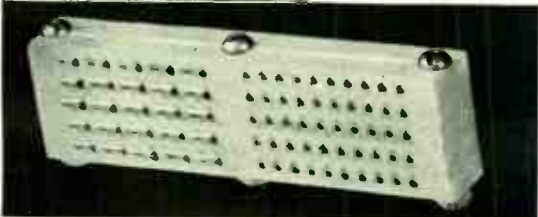
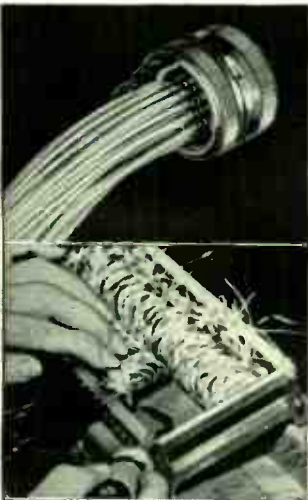
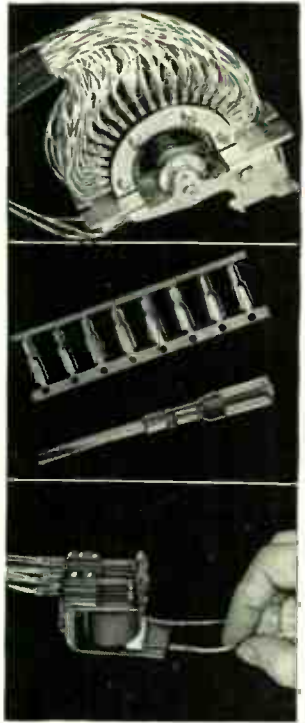
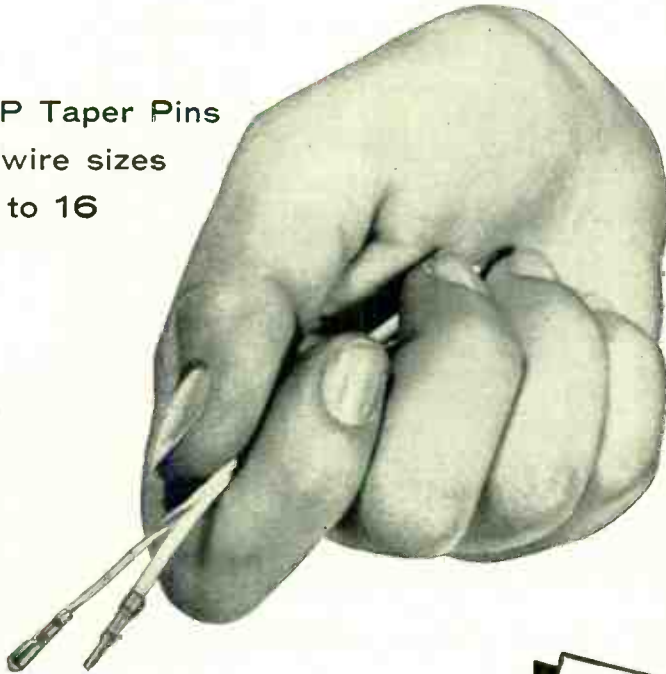

*You are cordially invited
to visit the AMP booth
at the I.R.E. show.
Booths 770 and 772*

less cube and cost

WITH ADDED RELIABILITY

Cubic restrictions have brought about a whole new concept of wire termination. The AMP Taper Technique with AMP taper pins, tab receptacles, blocks and modified miniature components will help you take full advantage of small wire, small insulation and small space for your wire terminations.

AMP Trade-Mark Reg. U. S. Pat. Off. © AMP

*Another example of AMP's
Creative Approach to Better Wiring*



Send today for your copy of our brochure, AMP's Creative Approach to Better Wiring.

AIRCRAFT-MARINE PRODUCTS, INC., 2100 Paxton Street, Harrisburg, Pa.
In Canada: AIRCRAFT-MARINE PRODUCTS OF CANADA, LTD., 1764 Avenue Road, Toronto 12, Ontario, Canada

New Bi-Directional Power Monitor



25 to 1,000 mc
10 to 500 watts
Only 2 plug-in elements

MODEL 164

Quickly measures incident or reflected power, simplifies matching loads to lines

New Sierra Model 164 is a compact, versatile, bi-directional monitor for intermittent or continuous measuring of incident or reflected power, or convenient and precise matching of loads to lines. The instrument offers unequalled measuring ease and economy, since only two plug-in elements are required for coverage of all frequencies 25 to 1,000 mc and wattages 10 to 500 watts. Two plug-in elements cover, respectively, 25 to 250 mc and 100 to 1,000 mc. Both have 4 power ranges: 10, 50, 100 and 500 watts. Accuracy is $\pm 5\%$ full scale on all ranges and frequencies. No auxiliary power is required to operate the instrument.

Because of its compact size and wide range, Model 164 is ideal for portable applications (mobile, aircraft, etc.) as well as laboratory use. It is supplied in a sturdy carrying case (one or both plug-in elements supplied as ordered) and both meter and directional coupler may be removed from the case for remote monitoring. The monitor may be equipped for most connectors normally employed with 50 ohm lines. A twist of the wrist selects incident or reflected power, or any power range, without requiring removal of power. No exchange of plug-in elements is necessary to read low levels of reflected power.

TENTATIVE SPECIFICATIONS

Power Ranges: 10, 50, 100 and 500 watts full scale direct reading.

Accuracy: $\pm 5\%$ of full scale on all power ranges and at all frequencies.

Insertion VSWR: Less than 1.08.

Frequency Ranges: 25 to 1,000 mc. Two plug-in elements.

Low Frequency Element: 25 to 250 mc.

High Frequency Element: 100 to 1,000 mc.

Impedance: 50 ohm coaxial line.

Data subject to change without notice.

sierra

3317



I.R.E. SHOW
Booth 711

Sierra Electronic Corporation

San Carlos 2, California, U. S. A.

Sales representatives in major cities

Manufacturers of Carrier Frequency Voltmeters, Wave Analyzers, Line Fault Analyzers, Directional Couplers, Wideband RF Transformers, Custom Radio Transmitters, VHF-UHF Detectors, Variable Impedance Wattmeters, Reflection Coefficient Meters.



News-New Products

(Continued from page 46A)

Conace and Kellogg Appointed by Sperry

Appointment of several men to key executive positions in the Sperry Gyroscope Company's new Aeronautical Equipment Division was announced today by H. C. Bostwick, division manager.



Conace

Kellogg

Sales manager of the new division is Frank Conace, former director of field service engineering. Spencer Kellogg, formerly department head of flight instrument engineering, assumes the responsibilities of engineering manager.

Time Delay Generator

The Model 1310A long time delay generator developed by Electro-Pulse, Inc., 11811 Major St., Culver City, Calif., provides controlled and continuously variable time delays over a range (20 μ s to 10 seconds delay).



The instrument is designed for wide use in pulse width and spacing measurements, control of gating circuits, geophysical and biological studies, and other timing applications.

Delay is covered in 5 decade ranges and controlled by a 10 turn potentiometer. Long term accuracy is 1 per cent of full scale for each range (0.5 per cent with standard modification available), and jitter is 0.01 per cent. Blocking oscillator pulses at the reference and delay termination are 0.5 microsecond wide, with an amplitude of at least 45 volts. Positive and negative variable width pulses (10 to 100,000 μ s in 4 decade ranges) are also available at the reference and delay points, variable in amplitude to 25 volts maximum. In addition a positive or negative pulse, variable in width from 20 μ s to 10 seconds is available.

Raytheon — World's Largest Manufacturer of Magnetrons and Klystrons

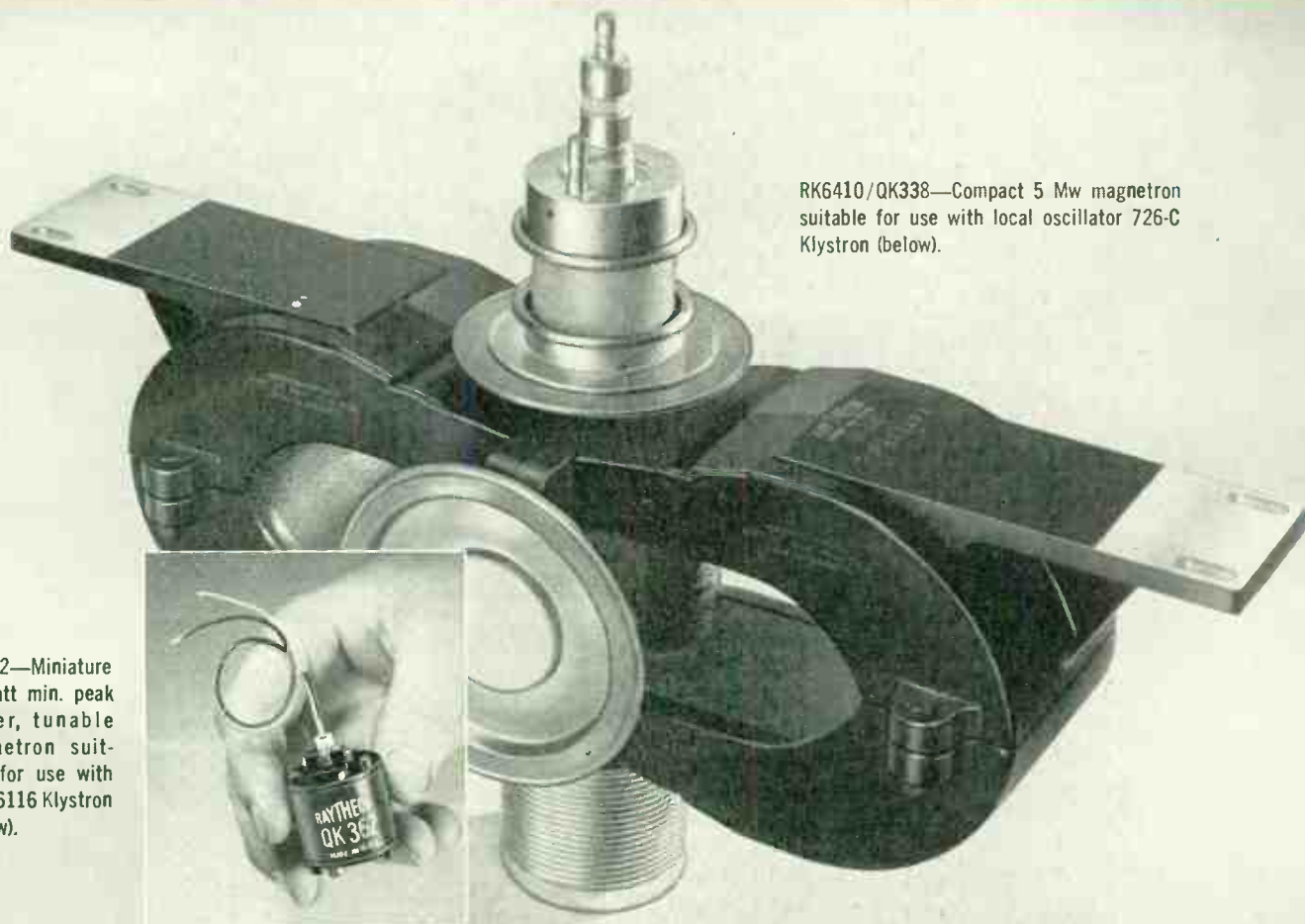

RK6410/QK338—Compact 5 Mw magnetron suitable for use with local oscillator 726-C Klystron (below).

QK362—Miniature 50-watt min. peak power, tunable magnetron suitable for use with type 6116 Klystron (below).

Mammoth or midget—and every type between

Raytheon makes high quality tubes for *all* your microwave requirements—over 200 magnetrons and klystrons from L-Band through K-Band in all power ranges—by far the largest, most complete line in the industry.

From the 50-watt minimum peak power,

X-Band QK362 for beacon use to the 5 megawatt RK6410/QK338 for long range radar, there are highly efficient Raytheon tube types to supply reliable service in your present or proposed systems—whether in standard or special applications.

Yours for the asking, data booklets on Raytheon Magnetrons, Klystrons and Special Purpose tubes. Write today.



6116 KLYSTRON



726-C KLYSTRON

Vibration, long life, rugged dependability are but a few of the factors considered in the design and manufacture of Raytheon Microwave Tubes. Check with Raytheon first for "proved performance pairs" of magnetrons and klystrons.



Excellence in Electronics

RAYTHEON MANUFACTURING COMPANY

Microwave and Power Tube Operations, Section PL 15, Waltham 54, Mass.,

See the complete Raytheon line at the I. R. E. Show

Kingsbridge Armory—Booths 145, 147, 149

Kingsbridge Palace—Booths 2, 4

BUDD•STANLEY specialists in microwave transmission components

announce

A REVOLUTIONARY NEW METHOD OF PRODUCING WAVE-GUIDE ASSEMBLIES

Exclusive UNITRONIC method developed and
perfected by our research engineers



produces waveguide assemblies
of a quality higher than your
specifications at *about half the cost.*

waveguides requiring complex
bends and tolerances never before
possible can now be produced
by the newly-perfected unitronic
method meeting your most
exacting precision requirements.

Quality
Economy
Dependability

SEE US AT BOOTH 681

I. R. E. SHOW

KINGSBRIDGE ARMORY • March 21st to 24th
New York

We shall be glad to send you complete details.
Write, wire or phone

BUDD•STANLEY CO. INC.

43-01 22nd St., Long Island City 1, N. Y.
Phone STillwell 6-1706
Cable Address "BUDDSTAN"

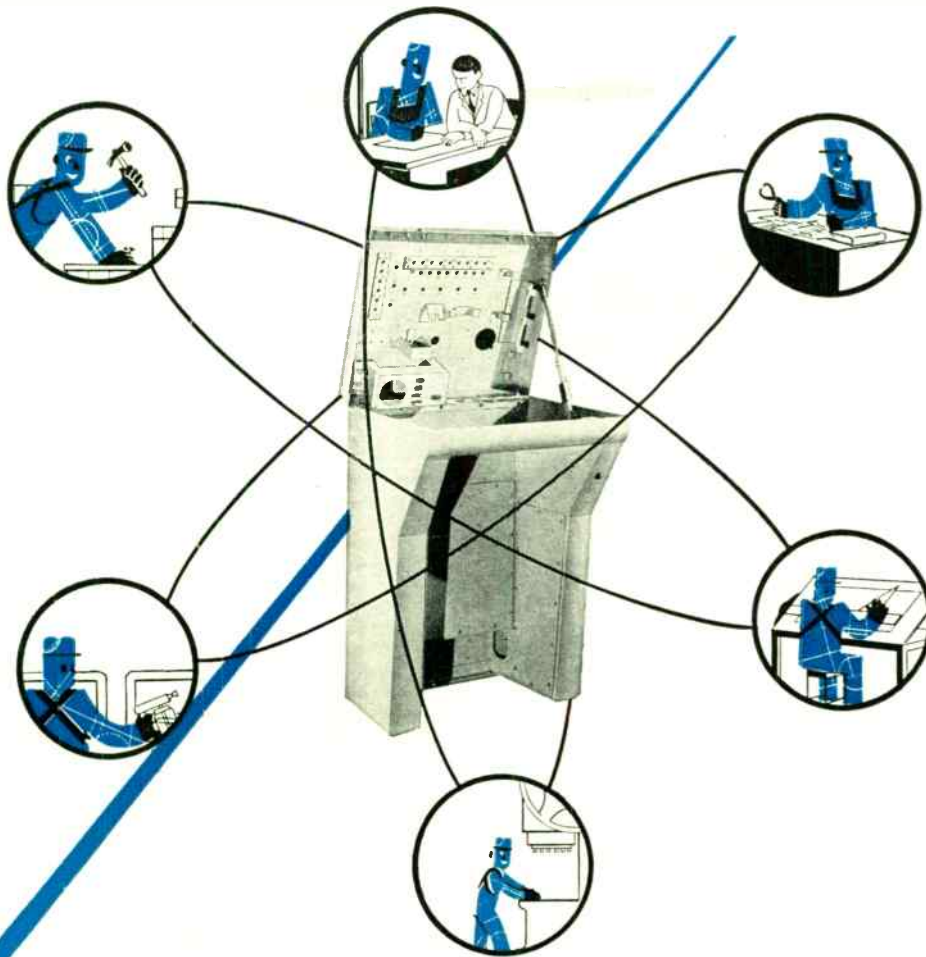

KARP enclosures

reflect your electronic skills within

Ask the Karp Man how you can benefit from Karp's 30 years of experience. See him at 349 Computer Ave., Radio Engineering Show, Kingsbridge Armory, Bronx, N. Y., March 21 thru 24...or, phone or write for descriptive literature.

When it comes to engineered sheet metal fabrications, Karp offers you top-quality enclosures, housings and chassis at economies that give your product a real competitive advantage without increasing the selling price. Our large collection of tools, dies and jigs keeps your tooling costs at rock-bottom. Karp "know-how" means that production techniques are individualized to each job, eliminating high costs, bottlenecks and delays to save you money. Yet each Karp fabrication is custom-built to highest quality, with assembly, fitting and bench work performed by skilled craftsmen proud of their work. And remember — At Karp, your job is never too large — or too small.



METAL PRODUCTS CO. • 223 63rd STREET, BROOKLYN 20, N. Y.
 Division of H & B American Machine Company, Inc.

- FACILITIES FOR ENGINEERED SHEET METAL FABRICATIONS:** in aluminum or steel • long run or short • spot, arc, gas or heliarc welding • any type finish
- Modern plant—3 city blocks long
 - Thousands of dies available
 - Most modern of sheet metal fabricating equipment
 - U. S. Air Force Certified Welding Facilities
 - Air-conditioned spray room...complete baking facilities
 - Complete sub-assembly facilities



In radio-electronics it costs less than postage...

to cover 40,000 buying points in the Annual IRE DIRECTORY in which a complex industry is organized, coded, simplified and "indexed for use." Men, firms, products — all are listed as vital working information for 35,000 IRE engineers and 5,000 purchasing agents and distributors who feed on facts to give their vast industry even greater growth.

Just look how little it costs!

Ad size	Cost	Cost per copy
1/6 page	\$ 80	1/5c
1/3 page	\$160	2/5c
2/3 page	\$320	4/5c
1 page	\$580 (color)*	1-1/2c
2 pages	\$1000	2-1/4c
4 pages	\$1600	4c
8 pages	\$2400	6c
12 pages	\$3000	7-1/2c
16 pages	\$3200	8c

} catalog
} section
} multiple
} pages in
} *4A colors

Because of its recognized service to engineers, because it is their industry encyclopedia, the IRE DIRECTORY is your basic selling medium in which one message works 365 days of the year.

IRE DIRECTORY advertisers who wish to enjoy "prestige position" in the 1956 edition must send engravings before May 1. Final closing for complete plates — June 15.

*Engineers are educated
to specify and buy!*

THE INSTITUTE OF RADIO ENGINEERS

THE IRE DIRECTORY

Advertising Department
1475 Broadway, New York 36, N. Y.



FCC ACTIONS*

To accommodate the ever-increasing demand for vehicular radio facilities in the domestic public, public safety, industrial and land transportation radio services, the Federal Communications Commission has invited comments by March 28 to its proposed rule making which would reduce channel separations for stations operating in these services in the 25-50 mc and 152-162 mc frequency bands. In addition, the FCC set forth new narrow band frequency stability and emission standards and amortization schedules for existing equipment. The proposal is to amend parts 2, 6, 10, 11 and 16 of the rules so as to list the frequencies in the 25-50 mc band with 20 kc separation (in lieu of the present 40 kc spacing) and also list land mobile service frequencies in the 152-162 mc band with 15 kc separation (reduced from the present 60 kc spacing). "Split channel" assignments in the latter band normally would be made only on an alternate 15 kc basis so as to provide 30 kc separation in the same local service area. However, the commission also invites comments on a 20 kc assignment plan for the 152-162 mc band, with resultant 40 kc separation of local assignments. If information received indicates that the 15 kc plan would not result in the most effective frequency utilization for that band, the 20 kc spacing will be adopted.

INDUSTRY STATISTICS

Fiscal year 1954 marked the twentieth anniversary of the Federal Communications Commission, and with the end of that year over 1.2 million broadcast authorizations in the radio field alone were on the commission's books. These authorizations cover the use of over 700,000 transmitters, it was revealed in the annual report for the fiscal year ending June 30. In the non-broadcast services, the commission reported the following outstanding authorizations at the end of the fiscal year: 46,000 marine stations with 44,000 transmitters, 40,000 aviation stations with 42,000 transmitters, 21,000 industrial stations with 146,000 transmitters, 15,000 public safety stations with 165,000 transmitters, 14,000 land transportation stations with 139,000 transmitters, 123,000 amateur stations with 116,000 transmitters; also over 1,600 common carrier radio stations, and nearly 600 experimental radio stations. In the broadcast field, authorizations neared the 6,000 mark in the following classifications: 2,697 commercial AM stations, 573 commercial TV stations, 39 educational TV stations, 569 commercial FM stations, 123 educational FM stations, 1,728 pickup, studio-transmitter links, and other auxiliary stations. FCC also reported that nearly 850,000 commercial radio operators and more than 120,000 amateur radio operators held permits on June 30.

* The data on which these NOTES are based were selected by permission from *Industry Reports*, issues of January 13 and 17, published by the Radio-Electronics-Television Manufacturers Association, whose helpfulness is gratefully acknowledged.

(Continued on page 57A)

DU MONT

If your specialized design requires cathode-ray tube characteristics beyond the capabilities of a standard RETMA tube, only disappointment or excessive cost can result from "making do" with a cathode-ray tube that only approximates design requirements. For such problems Du Mont special cathode-ray tubes—tailor-made to your specific requirements—provide the answer. Either by modifying an existing design or by developing a wholly new tube. Du Mont will create an indicating element to match your requirements *perfectly*. Moreover, the vast production facilities of Du Mont are at your disposal, so that whether your requirements are for a single tube, or for production quantities, Du Mont can DELIVER. And you may be sure that, regardless of the quantity, all tubes will be built to the same rigid specifications as the original hand-made model.

Cathode-ray Tubes TAILOR-MADE

Whether you require a special cathode-ray tube, or one of the complete line of standard, RETMA types, or one built to MIL-E-1 specifications, turn to Du Mont. The longest and most varied experience in this country in designing and building cathode-ray tubes of all types assure you the consistently high quality and reliability that have made Du Mont *THE* name in cathode-ray equipment for twenty-five years.

B1116P-; 21-inch rectangular electrostatic focus and magnetic deflection tube primarily for radar applications.

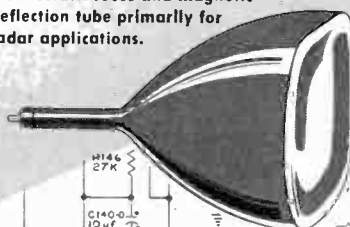

K1124P-; 5-inch square tube with 5 independent electron gun and deflection structures.

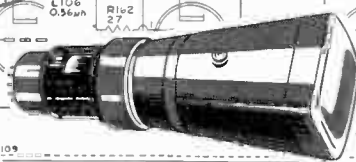

B1125P-; 5-inch radar tube with very short neck to meet stringent mechanical specifications.

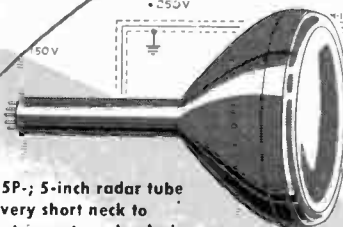

K1101P-; 4-inch electrostatic focus and deflection for ultra-high speed oscillography. Displays signals as high as 1000 mc.

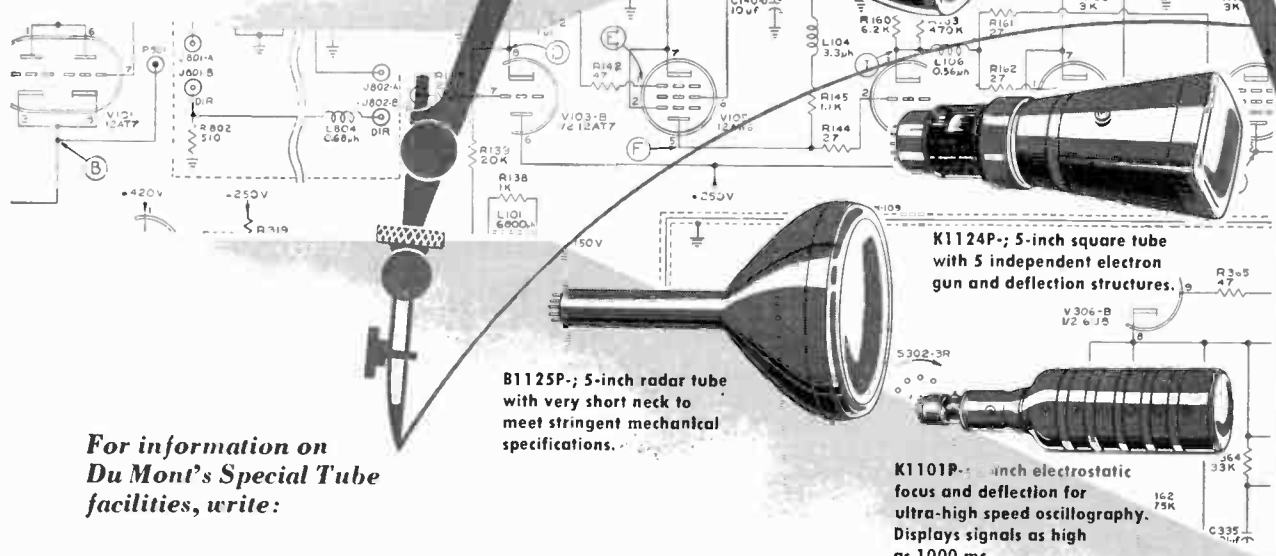

For information on Du Mont's Special Tube facilities, write:

TECHNICAL SALES DEPARTMENT, ALLEN B. DU MONT LABORATORIES, INC. 760 BLOOMFIELD AVENUE, CLIFTON, NEW JERSEY
See the Du Mont Exhibit at IRE Show Booths 264-266-268 SEE NEXT PAGE

IDENTICAL AMPLIFIERS IN NEW PRECISION CATHODE-RAY OSCILLOGRAPH

THE DU MONT TYPE 340



- Identical, sensitive X- and Y-amplifiers
- Amplifier response dc to 100 kc
- All potentials regulated for stability
- Hard-tube linear sweeps with beam gate
- Mono-accelerator cathode-ray tube for distortionless presentation

Yes, and also precision, simple operation, ruggedness, reliability, ease of maintenance all characterize the *new* Du Mont Type 340 which can well take its place as the oscillograph for those who require the *best* for their important studies.

Identical amplifiers, unexcelled in other commercial instruments, make the Type 340 a powerful tool for measuring electrical phase or mechanical resonance. Controls can be adjusted for less than 1° relative phase shift between

amplifiers below 100 kc. Distortion in amplifiers and sweeps is negligible. D-C stability sets new standards. Shifts in level are scarcely observable, even over long periods of operation. The Type 340 truly fits the needs of the discriminating engineer and scientist.

For further information on the Type 340 write to: Technical Sales Department, Allen B. Du Mont Laboratories, Inc., 760 Bloomfield Avenue, Clifton, New Jersey.

In less than a year you have seen a complete new line of precision instruments by Du Mont typified by:

Type 336 CRO dc to more than 20 mc, high brightness
Type 329 CRO dc to 10 mc, high voltage
Type 327 CRO dc to 5 mc, precision calibration
Type 324 CRO microvolt sensitivity, dc to 300 kc
Type 330 universal electronic switch: dc to 15 mc
Type 300 precision time calibrator

And now the Type 340 with identical amplifiers, dc to 100 kc — PRICE \$335.00

**TECHNICAL SALES DEPARTMENT
ALLEN B. DU MONT LABORATORIES, INC.,
760 BLOOMFIELD AVE., CLIFTON, N. J.**

DU MONT

See the Du Mont Exhibit at IRE Show Booths 264-266-268

WHEN WRITING TO ADVERTISERS PLEASE MENTION — PROCEEDINGS OF THE I.R.E.

March, 1955

Radar Tubes by Du Mont

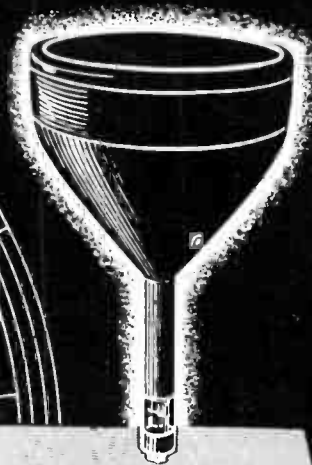

Now — Du Mont, whose brand has long been the hallmark of superior quality, reliability and performance, offers the most complete line of high-resolution cathode-ray tubes for radar. Below, in tabular form is listed a cross-section of types. However, the full story cannot be told here.

All tubes can be furnished with P7, P14, P19 or P21 screens. Other screens are available where special requirements must be met. Screens can be metallized on any tube, and metallization is recommended for operation above approximately 5000 volts, to provide optimum screen stability and to increase light output.

Du Mont facilities are set up to work closely with you. We are prepared to build, to your specifications, tubes which exactly match your needs in any size up to 30-inches in diameter.

For complete specifications on these or any Du Mont cathode-ray tubes, or for information on Du Mont special tubes, write to Technical Sales Department at address below.

Typical Radar Tubes Available From Du Mont (Not a Complete Listing)

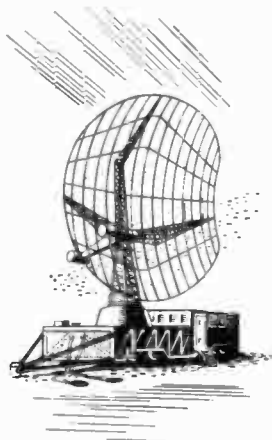

	TUBE TYPE	LENGTH (INCHES)	TYPICAL ANODE VOLTS	NO. LINES IN USEFUL DIAM.	TYPICAL LINE WIDTH (INCHES)
ELECTROSTATIC FOCUS Magnetic Deflection	5AHP—	11½	7,000	550	0.008
	7ABP—	13¼	7,000	650	0.009
	10UP—	17¾	10,000	900	0.01
	10WP—	16¾	10,000	650	0.014
	12ABP—	18¾	10,000	700	0.016
	B1116P— (Rectangular)	23¾	16,000	700	0.02
MAGNETIC FOCUS Magnetic Deflection	B1125P—	7 (seated)	8,000	450	0.01
	5FP-A	11½	5,000	450	0.01
	7BP—	13¼	7,000	550	0.01
	10KP—	17¾	9,000	650	0.015
	12DP-A	19¾	7,000	550	0.018
	12SP—	18¾	9,000	625	0.018
ELECTROSTATIC FOCUS Electrostatic Deflection	K1233P—	18	8,000	400	0.015
	K1137P— (Dual Beam)	24¾	7,500	725	0.015
	K1187P—	22¾	10,000	625	0.017

DU MONT

TECHNICAL SALES DEPARTMENT
ALLEN B. DU MONT LABORATORIES, INC.
760 BLOOMFIELD AVENUE, CLIFTON, NEW JERSEY

See the Du Mont Exhibit at IRE Show Booths 264-266-268

SEE NEXT PAGE

*Yours for the asking...
up-to-date listing of
New Instruments by*

DU MONT



We have been adding so rapidly to our new line of high-precision instruments, that we know any Du Mont catalog you may have is obsolete. A new 8-page quick-reference catalog that outlines in greater detail the new Du Mont line of high precision instruments is just off the press.

Get your copy now by writing to us at the address below.

Meanwhile, here is a brief review of these great new instruments, together with some of their more important characteristics.

TYPE	BANDWIDTH	SWEEP RANGE	SENSITIVITY	RECORDABLE WRITING RATE	APPLICATIONS
323	DC to 30% down at 10 MC	1 sec to 0.1 usec per major division	0.2 to 400 volts full scale	2.8 in/usec	Medium voltage, wide band, high-precision, quantitative oscillograph
324	DC to 30% down at 300 KC	1 sec/inch to 1 usec/inch	0.004 to 400 volts full scale	2.8 in/usec	Very high sensitivity (1.33 millivolt/inch) in the low frequency range
327	DC to 30% down at 5 MC	1 sec/inch to 1 usec/inch	.5 to 500 volts full scale	2.8 in/usec	Modest cost, highly linear, precision measurements at medium high frequencies
329	DC to 30% down at 10 MC	1 sec to 0.1 usec/major division	.2 to 400 volts full scale	35 in/usec	High precision, high accelerating potential for the ultimate in high-frequency measurements
340	DC to 30% down at 100 KC	2 to 30,000 cps	25 mv/in p-p	—	Identical X and Y amplifiers with negligible phase shift
341	DC to 30% down at 600 KC	2 to 30,000 cps	125 mv/in p-p	—	Identical X and Y amplifiers with negligible phase shift to 1 megacycle
336	DC to 30% down at 18 MC	1 sec to 0.1 usec/major division	.5 v/major division	35 in/usec	Superior instrument for advanced, precision high frequency measurements

ACCESSORY INSTRUMENTS

And don't forget these new accessory instruments, any of which may be used with *any* cathode-ray oscillograph.

TYPE	APPLICATIONS
300	Crystal-controlled time calibration pulses for use as accurate and dependable time-marker standard
325	TV line selector for converting any cathode-ray oscillograph into a video signal monitor
330	Electronic switch converts any single channel cathode-ray oscillograph to dual-channel or any a-c coupled oscillograph to d-c operation
332	Differential transformer control is complete unit for differential transformer operation
335	Strain gage control for use with any commercial strain-gage

TECHNICAL SALES DEPARTMENT, ALLEN B. DU MONT LABORATORIES, INC., 760 Bloomfield Ave., Clifton, New Jersey
See the Du Mont Exhibit at IRE Show Booths 264-266-268



(Continued from page 52A)

RETMA ACTIVITIES

A proposal that the Federal Communications Commission set up study groups on various types of spurious radiation with each group comprising FCC and industry engineers and a member of the commission is contained in the comments filed by Dr. W. R. G. Baker, Director of the Engineering Department, on behalf of RETMA on the FCC's proposed spurious radiation order (Docket 9288). Accompanying the general comments filed with the FCC were copies of the reports of seven task forces which have been working on particular aspects of the FCC proposed regulations. Dr. Baker commented as follows on these reports: "A review of these reports leads to the suggestion that any action taken at this time by the commission on the overall problem of spurious radiation might appropriately proceed to go as far as practical at this time and then put in place a definite continuing program to deal promptly and effectively with those areas as to which specific limits cannot now be established." Dr. Baker added that "there are areas in which task forces have found it necessary to conclude that specific recommendations are not possible at this time." The RETMA comments revealed that the task forces had encountered a relatively new phase of the spurious radiation problem involving the radiation characteristics of foreign broadcast receivers imported into this country. "The preliminary indication," Dr. Baker said, "is that several types of these receivers are of such a design as to create an unusually severe problem with respect to meeting any of the limits which have been under consideration in this docket and the attached proposals. Any further work done in this field should be organized so as to deal with this specific phase of the problem."

TECHNICAL

A flat, transparent television picture tube has been demonstrated by the Navy at the West Coast Electronics Laboratory of Willys Motors, Inc. The tube reportedly was developed under a Navy contract in connection with a long-range program for simplifying aircraft instruments. According to the Navy announcement, the new TV picture tube, invented by William Ross Aiken, Director of Research at the laboratory, is approximately the size and shape of a metropolitan city telephone book, is three inches in thickness, and consists of a phosphor screen sandwiched between glass plates. The tube functions by electronically exciting selected areas or spots on the phosphor screen. This is accomplished by the following means: an electronic beam is injected along a horizontal edge of the tube; this beam flows in a field-free region along the edge of the phosphor screen and adjacent to a row of transverse deflection plates. Through control of the voltages of these deflection plates, the beam is bent vertically at any desired place along the edge of the tube.

(Continued on page 59A)

Contributing to the progress of Electronics...

a Report on AMPHENOL since last year's IRE SHOW...

It's IRE Show and Convention time again -- and a good time to make a report on AMPHENOL's progress during the past year. Outstanding achievements in AN, RF and Blue Ribbon connectors are described on the following pages. In addition we can record the following new products:

CABLES -- new Aljak, an aluminum-jacketed coaxial cable; Subminiature coaxial cable that may be used with the new Subminax RF connectors; Triaxial cable for community tv systems; Noise-Free cable for laboratory applications.

CONNECTORS -- the 172 series of Hermetically Sealed receptacles, that mate with standard AN plugs, and the 165 series of Miniature AN-type connectors reached full production status. Both filled long time needs in their respective component classes. The 165 series is also now available for potting.

All new developments point up the value of AMPHENOL's continuing contribution to the progress of electronics -- a contribution that will be re-emphasized in the months ahead with the release of Printed Circuit connectors, components designed for automation and the announcements of other major developments.



AMERICAN PHENOLIC CORPORATION

chicago 50, illinois

In Canada: AMPHENOL CANADA LIMITED, Toronto



Frequency Meters

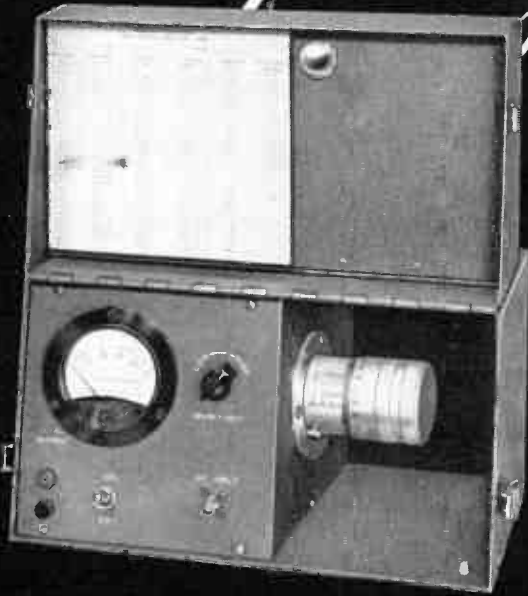

COMPLETELY
SELF-CONTAINED
FIELD TEST INSTRUMENTS

by

FREQUENCY STANDARDS

These precision-built field test instruments were designed by Frequency Standards to provide rapid and accurate means of frequency measurement in the field. Frequency is determined by means of a micrometer dial. This reading is translated to frequency by accurate individual calibration charts or curves. Transducers, fittings, and cables can be supplied to meet the requirements of customers and convenient storage space for these items is provided in the lid of the instruments.



MODEL	FREQUENCY RANGE	ACCURACY
912-4	900-1200 MC	.01%
1217-4	1200-1700 MC	.02%
1723-4	1700-2300 MC	.02%
2335-4	2300-3500 MC	.02%
3545-4	3500-4500 MC	.01%
4458-4	4400-5800 MC	.01%
5882-4	5800-8200 MC	.01%

SPECIAL CAVITY DESIGNS

Frequency Standards maintains complete facilities for the design and manufacture of Reference Cavities, Preselector Cavities, and Filters to customers' specifications or blueprints. Our facilities also permit quantity production of complex waveguide assemblies.

AT THE I.R.E. SHOW! SEE US AT BOOTH 332 COMPUTER AVE.
KINGSBRIDGE ARMORY, NEW YORK CITY, MARCH 21-24, 1955

ILLUSTRATED
BULLETINS
SENT ON
REQUEST

Frequency Standards
ASBURY PARK, NEW JERSEY

Address inquiries to
BOX 504





(Continued from page 57A)

The beam then flows vertically in a second field-free region between a series of transparent deflection plates and the electrically charged phosphor screen. The tube, compact and portable, employs only electrostatic principles, which eliminate the necessity of using conventional magnetic components, which are heavy, costly and require greater electrical power, the announcement stated. Demonstrated to representatives of the American airframe industry, the new TV picture tube is a part of the program to develop an instrument panel consisting of only two basic instruments—both of which would be television picture tubes—mounted atop one another in front of the pilot. One picture would give the data on altitude, speed and attitude of the aircraft and the other would give broad physical features of the earth below and be depicted by analogy. The Navy expects that the first experimental aircraft using this instrument and control system will be flown about 1958. . . . In order to provide a direct, continuing link between the National Bureau of Standards and the organized science and technology of the nation, 12 technical area advisory committees, including several related to electronics, have been established in the bureau during the past year. The committees represent the society from which they are drawn rather than committees of the bureau in order to encourage objectivity in their functions. The committees, which will supplement the Bureau's Statutory Visiting Committee, have been set up as a result of recommendations made by the *ad hoc* Evaluation Committee appointed by the Secretary of Commerce in April 1953 to evaluate the bureau's program in relation to national needs. Under the chairmanship of Dr. Mervin J. Kelly, President of Bell Telephone Laboratories, the Evaluation Committee conducted a comprehensive survey and reported in October 1953 that the bureau's statutory functions were well conceived and its operations generally sound. At the same time, it was pointed out, the committee recognized the desirability of some means whereby the needs of the nation's scientific and engineering societies could be expressed and transmitted to the bureau for implementation in its program. The American Institute of Electrical Engineers has appointed an advisory committee, under the chairmanship of Dr. Ralph Bown of Bell Telephone Laboratories, to consider programs in electricity and electronics. Work in electricity is primarily concerned with development and improvement of standards and methods of measurement for all electrical quantities. Research in electronics at NBS is directed toward obtaining knowledge of basic electronic phenomena and the properties of materials of potential significance to electronics. Also included on this committee

(Continued on page 61A)

'AN' CONNECTORS

AMPHENOL continued to effect improvements in AN connectors during the past year. The biggest development was Potting, whereby connectors are injected with a synthetic rubber sealant that provides efficient waterproofing under the most adverse conditions. The advantages of Potting are so great (not only true moisture proofing but weight and space saving design, greater electrical reliability, less cost) that they promise to replace the conventional so-called mechanically sealed AN connector in every application.

A new and improved high-temperature AN connector design has recently been perfected by AMPHENOL. Special finish, contacts and insert material makes these connectors able to withstand a temperature of 600°F. under continuous operation.

No report on ANs would be complete without a mention of the previous AMPHENOL "firsts" that have reflected our concern with the highest quality interpretation of government specifications. AMPHENOL developed and introduced as standard on AN connectors both 1-501 blue dielectric material and gold-plated contacts—two outstanding features that help to make AMPHENOL ANs the best obtainable.



AMERICAN PHENOLIC CORPORATION

chicago 50, illinois

In Canada: AMPHENOL CANADA LIMITED. Toronto

World Radio History

On printed circuits...

MALLORY

Capacitors

cut assembly time



MALLORY

Tubular Electrolytics for Printed Circuits

In addition to the FP electrolytic capacitors, Mallory manufactures a varied line of tubular capacitors applicable to printed circuit production. Write or call for technical information.

High-speed automatic production of electronic equipment using printed circuits can be materially improved when you use Mallory FP capacitors. A special line of these famous electrolytic capacitors has been developed by Mallory for the particular requirements of printed circuits.

Mounting prongs are self-positioning, so the capacitor fits quickly and surely into its correct position. The prongs are designed to provide clearance between the capacitor can and the chassis... permitting use of both sides of the panel for printed circuitry.

Smaller terminals save chassis space, and provide good connections with a minimum amount of solder. Aluminum risers stop short of the solder area... eliminate danger of contamination.

In addition to these special features, Mallory is continuing to develop further refinements applicable to printed circuit usage. Notable among these which will soon be available are new designs for hopper feeding of capacitors on automatic assembly machines.

Long the leader in the capacitor field, Mallory FP electrolytics can be relied on to give economy in production and high standards of dependability in service. For detailed literature or for a consultation with a Mallory capacitor specialist, write or call us today.

Expect more . . . Get more from **MALLORY**

Parts distributors in all major cities stock Mallory standard components for your convenience.

Serving Industry with These Products:

Electromechanical—Resistors • Switches • Television Tuners • Vibrators
Electrochemical—Capacitors • Rectifiers • Mercury Batteries
Metallurgical—Contacts • Special Metals and Ceramics • Welding Materials





(Continued from page 59A)

are: Dr. C. G. Suits, General Electric Co.; Dean F. E. Terman, Stanford University; Dr. E. W. Engstrom, Radio Corp. of America; Robert C. Sprague, Sprague Electric Co., and Dr. J. A. Hutchison, Westinghouse Electric Corp. Also, an advisory committee appointed by the IRE has as its principal interest the NBS Central Radio Propagation Laboratory in Boulder, Colo. Chairman of this group is Dr. A. W. Straiton, Electrical Engineering Research Laboratory, University of Texas. Also serving on the committee are: Dean F. E. Terman, Stanford University; Prof. Henry G. Booker, Cornell University; Harold O. Peterson, Radio Corp. of America; Stuart L. Bailey, Jansky & Bailey, and Dean William L. Everitt, University of Illinois. . . . New efficiency in the control of servomechanisms is claimed for a new Navy-designed "half-cycle response time" magnetic amplifier which is detailed in a research report recently made available to industry through the Commerce Department's Office of Technical Services. At the same time, the OTS announced another Navy-developed unit which accurately and continuously checks the degree of impedance match between an antenna and its transmission line. The report can be ordered by number PB 111442, "A New Magnetic Servo Amplifier," from the Office of Technical Services, Commerce Department, Washington 25, D. C., for \$1 each. The second report can be ordered by number PB 111439, "Impedance-Match Indicating Devices," from the Office of Technical Services, Commerce Department, Washington 25, D. C., for \$1 each.

TELEVISION

The Federal Communications Commission has authorized a new experimental TV station to test a low-cost operation, on a non-profit basis, at Manson, Wash. The Manson Community Television Co., formed for that purpose, was authorized to experiment in converting the signals of distant VHF stations, amplifying and retransmitting them to that area on UHF Channel 16 with effective radiated power of 200 watts from various experimental types of antennas not to exceed 30 feet above the ground. The experiment, according to the FCC announcement, will be on a non-profit basis and subject to certain engineering conditions. Rules have been waived insofar as they require an operator to be on duty at the transmitter, but an operator is required for observations and adjustments. The call letters will be transmitted in International Morse Code automatically at the beginning and end of each period of operation and at least once during each operating hour. Because of its purpose, the hours of operation are not limited.

'RF' CONNECTORS

Because the majority of RF connectors are built to government drawings and specifications it is easy to overlook the contributions an imaginative company can make in improving existing designs and in developing new connectors. AMPHENOL has the imagination and the engineering skill to provide such contributions.

During the past year an entirely new line of RF connectors was developed by AMPHENOL; hundreds of special connectors were produced in cooperation with our customers; many connectors were added to the government-approved UG-/U list.

SUBMINAX is the name given to the new line. There are twenty-two subminiature connectors of 50 or 75 ohm impedance, available in push-on or screw-on coupling. So small that the entire line fits easily into the palm of your hand, SUBMINAX connectors are part of AMPHENOL's continuing miniaturization and subminiaturization programs.

Hermetically sealed, solderless, potted -- many special RF connectors incorporated new design features developed by AMPHENOL engineers and in the months ahead will become generally available to the electronics industry.



AMERICAN PHENOLIC CORPORATION
chicago 50, illinois

In Canada: AMPHENOL CANADA LIMITED, Toronto

NEW SA25

Microwave Spectrum Analyzer

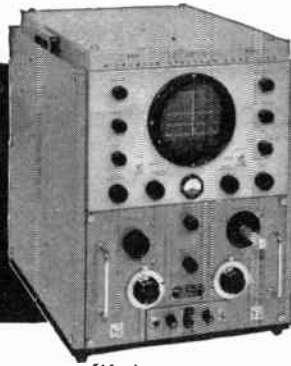

800 mc/s to 10,250 mc/s
ON FUNDAMENTALS
K-Band Coverage to 40,000 mc/s

ACCURATE — Calibrated micrometer wavemeters . . . lifetime accuracy to .05% with incremental accuracy to better than .005% independent of Klystron changes. Transmission wavemeters for maximum indication without "pulling".

RELIABLE — Double conversion for stability with maximum drift . . . standard replaceable klystrons . . . no complex harmonic interference. Highly efficient circuits with minimum power consumption, designed for cool, continuous operation.

ECONOMICAL — 99.8% of all microwave research, development, production, test, installation and maintenance requires precise work in a specific portion of the microwave spectrum, usually only a few hundred megacycles wide. Compromise coverage of large areas costs more and delivers less.

The SA25 Spectrum Analyzer includes:

- 5% medium persistence CRT display.
- Choice of I. F. Amplifier.
- Dual range sweep—2 to 20 or 6 to 60 CPS in two overlapping ranges.
- Standard CRT bezel for camera or hood.
- Improved frequency spread control.
- New wavemeter marked gain control.

THE VECTRON 25 SERIES K-BAND MICROWAVE SPECTRUM ANALYZERS are complete, including a display unit, and R.F. assembly and a K-band mixer to cover the desired portions of the "K-Band" region of the microwave spectrum.

Due to the relatively recent development of the equipment for use in K-band and the band's extremely broad range, it has been necessary to develop several assemblies to cover economically the most active portions of the spectrum.

SA25K1	15.3 kmc/s to 17.7 kmc/s
SA25K2	22.8 kmc/s to 26.4 kmc/s
SA25KQ1	34.0 kmc/s to 38.6 kmc/s

SPECIAL K-BAND MIXER — R.F. ASSEMBLY COMBINATIONS provide coverage of other ranges from 12.4 to 40.0 kmc/s.

Individual K-Band R.F. Heads may be purchased separately, or with the new Vectron SA25 Microwave Spectrum Analyzer.

Interchangeable R.F. Heads Available to 40 kilomegacycles

25L1	800-2400mc/s	25C1b	4240-4910mc/s	25X2b	5700-6600mc/s	25X1b	9500-10,250mc/s	25K1	15,300-17,700mc/s
20S1	2400-3650mc/s	25C1a	4240-5900mc/s	25X2a	5700-7425mc/s	25X1a	8500-10,250mc/s	25K2	22,800-26,400mc/s
20S1a	2400-4040mc/s	25C1	5100-5900mc/s	25X2	6250-7425mc/s	25X1	8500-9660mc/s	25KQ1	34,000-38,500mc/s

VISIT **VECTRON** at the I.R.E. SHOW
381-383 Microwave Avenue

WRITE for Bulletin SA25 and
Bulletins on R.F. Heads



"Standard Units"

"From Stock"

48 STANDARD UNITS

Now available . . . with more to come

- Standard Components . . . from stock.
- Standard Quality . . . to meet all usual precision requirements.
- Standard Prices . . . from our published price list.
- Standard Specifications

Sizes: 7/8", 1 1/16", 2" diameters Rotation: 320° and 350°
Linearity: from . . . 1/4% Bearings: Sleeve and ball
Overall Resistances: 10 to 100,000 ohms in 16 values
for each diameter
Temperature Coefficients of Resistance Wire:
0.0002 parts per °C
Starting Torque: from 1 inch-ounce



NEW VECTRON VFS 250

Variable Frequency Power Supply

FOR TESTING

Airborne Electronic Equipment
Airborne Electrical Systems
Servo Amplifiers and Equipment
Synchro and Selsyn Systems
Transformers and Inductors
Export and Foreign Equipment

FOR POWERING

Vibration Shakers
Choppers and Vibrators
Magnetic Amplifiers
FOR CONTROLLING
Synchronous Motors
Processing Equipment

- Full negative feedback networks for instantaneous voltage control.
- Built-in two range stabilized frequency generator.
- Grounded output with polarized receptacle for maximum safety.
- Compact, semi-portable package for bench use.

Output Power	_____	} 250VA continuous at 100 to 130 V	} 300VA intermittent
Output Frequency	_____		
Output Voltage	_____	0-130 Volts	
Output Regulation	_____	} ± 1% to 1,000 cycles zero to full load	} ± 2% to 2,000 cycles
Line Regulation	_____		

Send for
bulletin
and
price list
TODAY



VECTRON, inc.
Electronic and Electro-Mechanical Equipment
402 MAIN STREET WALTHAM 54 • MASSACHUSETTS



Send for
Bulletin
VFS 250
TODAY



Professional Group Meetings

AERONAUTICAL AND NAVIGATIONAL ELECTRONICS

The New York Chapter of the Professional Group on Aeronautical and Navigational Electronics met on December 16 with R. J. Bibbero presiding. David S. Little spoke on the electronic facilities of American Airlines at LaGuardia Field in New York. Afterwards, there was a tour which included the reservation input stations to Reservisor computer, the magnetic drum reservisor, automatic teletype, tower GCA, and airborne communications.

ANTENNAS AND PROPAGATION

On October 22 at the Western Society of Engineers Auditorium, the Chicago Chapter of the Professional Group on Antennas and Propagation met. James Eakins, a development engineer at Motorola, presented a paper entitled "Propagation Loss Measurements at 450 mc Applied to Mobile Systems Engineering."

The Philadelphia Chapter met on November 17 with R. P. Schwartz presiding. E. I. Hawthorne, University of Pennsylvania, was the speaker. In his paper, "Shielding with Coated Glass on Thin Conductive Surfaces," he presented a mathematical analysis of the transmission of electromagnetic fields through thin conducting planes, infinite in extent. In particular, he considered two sources: a magnetic and an electric current element assumed normal to the sheet. The field along the axis of the source on the opposite side of the sheet is determined and compared with the field which would exist if the sheet were not present.

AUDIO

The Philadelphia Chapter of the Professional Group on Audio met on October 28 at the WCAU Studio. H. E. Roys was the presiding officer. Two papers were presented. J. E. Volkmann, of RCA, spoke on "Stereo-Acoustic Principles." He discussed the basic acoustic principles involved in the recording and reproduction of stereophonic sound. Other types of multi-channel sound systems and loudspeaker placement for spatial sound effects were also described. R. C. Moyer, also of RCA in Camden, delivered a paper entitled "High-Fidelity Pre-Recorded Tapes." He reviewed the equipment and techniques which have been developed for the production of high-fidelity pre-recorded tapes. Demonstrating both types, Mr. Moyer described monoaural half-track tapes and dual-track stereophonic recordings.

At the Lovelace Clinic on November 23 the Albuquerque-Los Alamos Chapter met. Frank McIntosh, of McIntosh Corporation, was the speaker. Mr. McIntosh described and demonstrated the new McIntosh 200 watt audio amplifier.

Harold Mull presided at the meeting of the Cleveland Chapter on November 29.

(Continued on page 68A)

BLUE RIBBON CONNECTORS

One of the most striking developments at AMPHENOL since last year's IRE show has been the broadening of the popular Blue Ribbon line of connectors. The design of a unique polarization between the contact barriers of matching connector types made possible four new basic connectors and a complete line of accessory hardware to fit them.

Barrier polarized Blue Ribbons are now available in 8, 16, 24, and 32 contact inserts. With this new design the inserts are rectangular and are easily fitted in front shells and latch-lock cans. To facilitate side-by-side gang mountings the new shell and can connectors are fitted with alternate keyways that preclude mismatching when large numbers of connectors are mounted together. The latch-lock cans are available with either side or end cable outlets.

The unique spring-contact concept of Blue Ribbons can be easily adapted to many shapes, sizes and applications. Circular Blue Ribbons for use in the warheads of guided missiles have been developed by AMPHENOL. Hermetically sealed Blue Ribbons were one of the first "specials" adapted from the standard line.

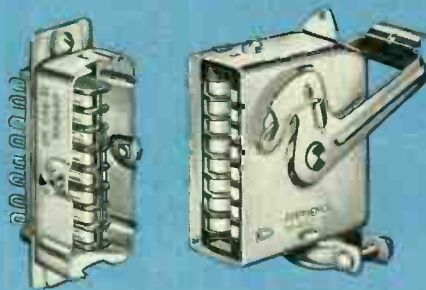

AMPHENOL

AMERICAN PHENOLIC CORPORATION
chicago 50, illinois
In Canada: AMPHENOL CANADA LIMITED, Toronto

World Radio History



From Original Engineering...

From Original Engineering... and from its half-century of specialized skills and experience, Machlett once again creates new criteria of electron tube performance for high power electronics.

Machlett is first again to offer significant, original design for high power triodes. It was six years ago that Machlett perfected a heavy duty power tube series—the first from any manufacturer. Accepted at once by equipment manufacturers, now universally used, these tubes were also *paid the compliment of imitation.*

With the New Machlett Triodes COSTS GO DOWN

Because filament power is reduced— up to 60% (enough, in many cases, to pay for the tube).

Because tube life is longer— increases of over 100%, compared to conventional types.

Because maintenance is cut— replacement minimized; cleaning simplified.

Because handling costs are low— weight down 60 to 70% for air cooled types.

With the New Machlett Triodes PERFORMANCE GOES UP

Because plate and grid ratings are higher— broader range of operation is possible.

Because safety margins are usefully increased— for thermal, mechanical and electrical ratings.

Because lead inductances are very low— circuit parasitics are reduced by as much as 10-to-1.

Because transconductance is high— plate efficiency is increased, grid drive reduced, stable performance assured over broadest loading range.

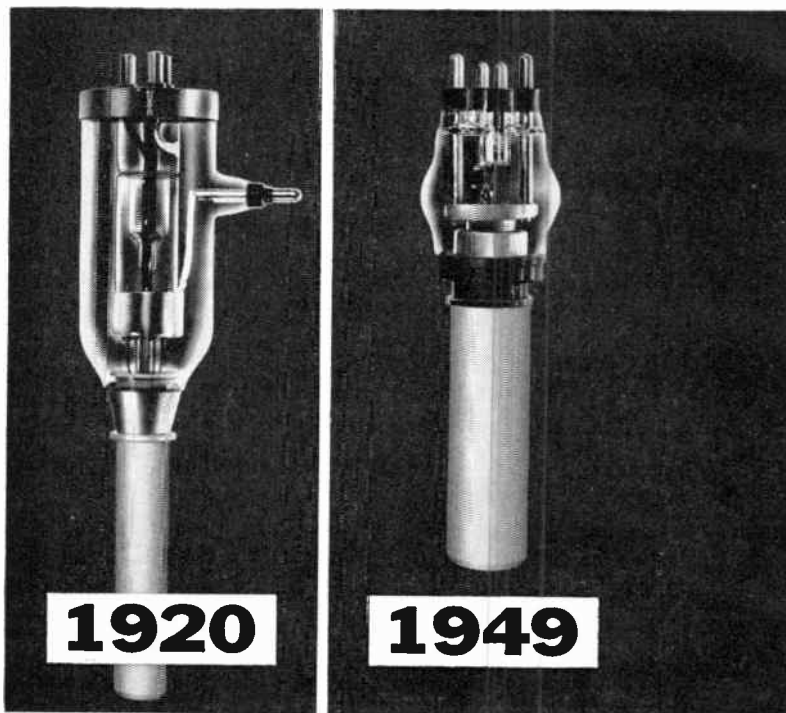

The above tubes portray progressive evolution in electron tube design. Left, Type 892, uses long, high inductance electrode leads and large glass envelope—a design now over 35 years old. Center, Machlett developed, electrical equivalent, industrial ML-5668, has stronger, less inductive internal structures, short glass envelope and sturdier seals, thicker anode with double heat dissipation capacity. Right, most modern tube, Machlett's new ML-6422, uses cylindrical electrode supports for lowest inductance, great stability; large contact area terminals for great seal strength; close-spaced, precisely-aligned electrodes for low drive and high efficiency; thick-wall anode for cool tube operation, high overload capacity; stress-free thoriated-tungsten filament for high load current, low heating power, and longer life.



And Your First Cost is Only One Postcard—that's all it takes to write Machlett Laboratories for the full story of these premium design, rugged, coaxial triodes. Learn now what to expect of a modern power triode.

MACHLETT LABORATORIES, INC.

1063 Hope Street, Springdale, Connecticut

New Performance Criteria



1955

Available only from Machlett Laboratories: Eight new rugged coaxial terminal triodes, with thoriated-tungsten filaments, and incorporating every proven design and production advance made by Machlett in its heavy duty electron tube experience.

Power Output.....	<u>5-10kW</u>	<u>10-15kW</u>	<u>15-20kW</u>	<u>25-40kW</u>	<u>25-50kW</u>
Water Cooled.....	ML-6420	ML-6422	ML-6424		ML-6426
Forced-Air Cooled.....	ML-6421	ML-6423	ML-6425	ML-6427	



A

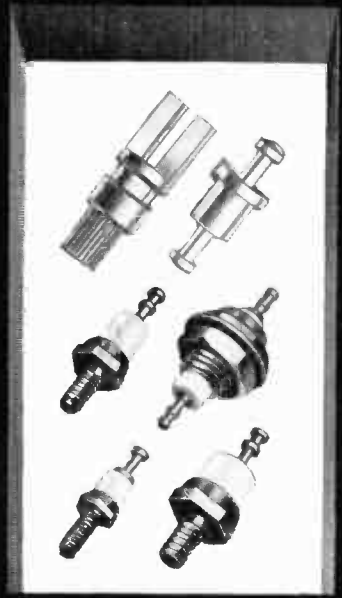

B



C

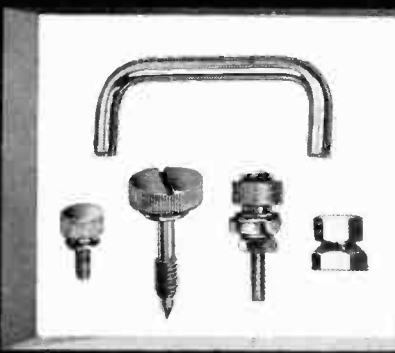

D



E



F



G

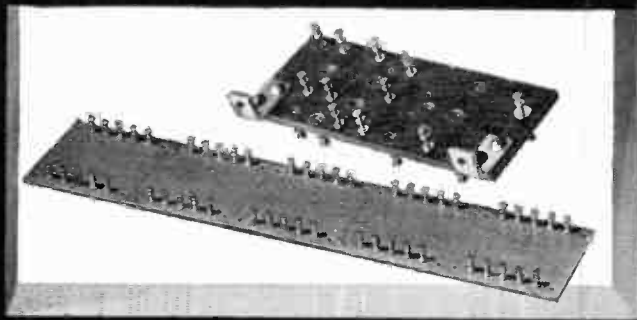

H



J

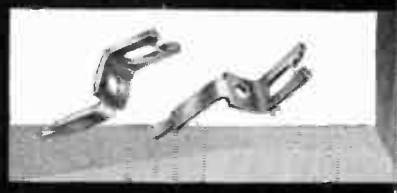

K

One big family with a single thought

Whether you need terminals, clips, coils, chokes, capacitors — or any of a number of electronic components — you can be sure they're right if they're made by CTC.

One continuing basic idea governs the manufacture of every CTC product. And that idea is: *quality control*. We could not guarantee our products as we do without a constant check of numerous details that determine reliable performance. Our quality control engineers see to it that these manufacturing standards are consistently maintained — from close scrutiny of raw materials right through to inspection of finished product.

Pictured here are a number of components available at CTC including our

three kits. These components come in standard form and are also custom engineered to meet your particular requirements. We would be glad to give you complete details, including specifications and prices, on any or all CTC units — as well as information on how CTC components can be specially designed to solve your electronic components problems.

You will find it well worthwhile to use components that are *guaranteed*. Write to Cambridge Thermionic Corporation, 456 Concord Avenue, Cambridge 38, Mass. West Coast Manufacturers contact: E. V. Roberts, 5068 West Washington Blvd., Los Angeles 16 and 988 Market Street, San Francisco, California.

CTC

CAMBRIDGE THERMIONIC CORPORATION

*makers of guaranteed electronic components,
custom or standard*



SEE THE CTC COMPONENTS ON DISPLAY AT BOOTH 502, IRE SHOW, KINGSBRIDGE ARMORY, NEW YORK, MARCH 21-24th.

◀ *CTC Components* shown include: A. capacitor; B. standard and insulated terminals; C. coil form kit; D. panel hardware; E. coil kit; F. RF choke kit; G. coil forms and coils; H. standard and custom terminal boards; I. shielded coil form; J. RF chokes; K. diode clips.

LENNARD

Serving

ELECTRONICS

Through

DUST, HUMIDITY CONTROL

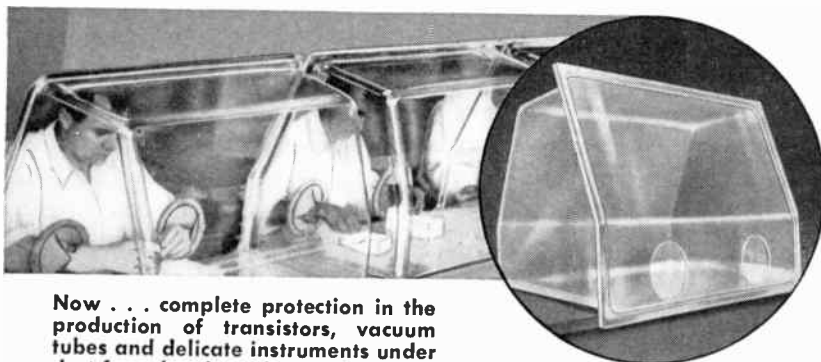

Now . . . complete protection in the production of transistors, vacuum tubes and delicate instruments under dust-free, low-humidity or inert gas conditions with LENNARD CONTROLLED ATMOSPHERE enclosures. Join Lennard Hoods together to form an adaptable, portable assembly line anywhere in your plant . . . regardless of dust or humidity conditions. And best of all, Lennard means MINIMUM INVESTMENT, especially under the new "RENTAL-PURCHASE-PLAN."

CHEM-INERT OPTICS

FOR METER WINDOWS, INSTRUMENTS and LENSES . . . LEN X-1 . . . A thermoset transparent plastic with 40 times the abrasion resistance of acrylic materials. FOR U H F INSULATION, INSPECTION WINDOWS and COIL FORMS . . . LEN X-2 . . . a transparent polystyrene.

FOR HOT FORMABILITY and IMPACT STRENGTH in INSTRUMENT WINDOWS . . . LEN X-3 . . . a thermoset transparent plastic with exceptional abrasion resistance. FOR TEMPERATURES UP TO 450°F . . . LEN X-4 . . . an exceptional material with extraordinary chemical resistance.

WRITE FOR FREE SAMPLES and PROPERTY DATA SHEETS.

SPECIAL PLASTIC MOLDINGS

• Injection • Compression • Vacuum Forming • Transfer • Fully-Automatic

To fit your specifications — A complete molding service to fill all your needs . . . from G.P. Phenolics to rubber compositions, from Styrene to Kel-F. If cost and quality are factors . . . your source is undoubtedly LENNARD.

We will immediately supply quotations upon any written request or drawings and specifications. The experienced engineering staff of the P.M. Lennard Co., the comprehensive plastics organization, is ever ready to assist you with your plastic problems.

See it all at . . .

I.R.E. SHOW, BOOTH #21, KINGSBRIDGE PALACE

P. M. LENNARD CO., INC.

312 Pine St.

Jersey City 4, N. J.



(Continued from page 63A)

"An Experiment in Stereophonics" was the title of the paper delivered by S. J. Begun of the Clevite-Brush Development Company.

On November 19 at the Western Society of Engineering Building the Chicago Chapter met. D. E. Weigand, Senior Physicist at Armour Research Foundation, spoke on "A Flux Sensitive Head for Recording and Playback."

BROADCAST AND TV RECEIVERS

With High Christian presiding, the Chicago Chapter of the Professional Group on Broadcast and TV Receivers met on November 19. Samuel Tarantur of Admiral Corporation spoke on "An Encoder for the NTSC Color Signal."

On October 1 the Chicago Chapter met again at the Western Society of Engineers Building. Jack Bridges, of Zenith Radio Corporation, delivered a paper called "The Second Detector—A Determinant of Fringe Area Performance."

BROADCAST TRANSMISSION SYSTEMS

On October 1 at WBKB Studios, the Chicago Chapter of the Professional Group on Broadcast Transmission Systems met. G. M. Ives presided. Forming twelve groups, the chapter made a tour of facilities at WBKB Studios.

CIRCUIT THEORY

The Los Angeles Chapter of the Professional Group on Circuit Theory met on January 13. J. L. Barnes, Ramo-Wooldrige Corporation, spoke on "Three Dimensional Network Duality," and L. Weinberg, of Hughes Aircraft Company, discussed "Methods of Network Synthesis."

With E. Mittman presiding, the Chicago Chapter met on October 1 at the Western Society of Engineers Building. B. S. Parmet, of Motorola, spoke on "Combined Plate and Cathode Video Compensation Using Laplace Transforms."

On October 22 the Chicago Chapter again met. Bernard S. Parmet presided. "Noise Sources in High Frequency Tubes," was the paper delivered by Robert Adler, director of Research at Zenith Radio Corporation.

The Philadelphia Chapter met at Towne School of the University of Pennsylvania on November 9. Sidney Darlington of Bell Telephone Laboratories spoke on "Network Synthesis Using Tchebycheff Polynomials." Dr. Darlington reviewed existing methods for the solution of the interpolation problem of network synthesis, assuming four-pole network realization. After discussing the relative merits of the procedures, he gave a detailed review of his work on network synthesis using Tchebycheff polynomials.

On October 12 three papers were delivered.

(Continued on page 72A)

Write for details
 ... or see America's
 Quality Line at the
IRE SHOW, BOOTH 792
 ... including our new
 Printed Circuit Varicons



ELCO

TOMORROW'S DESIGNS... PRODUCTS TODAY!

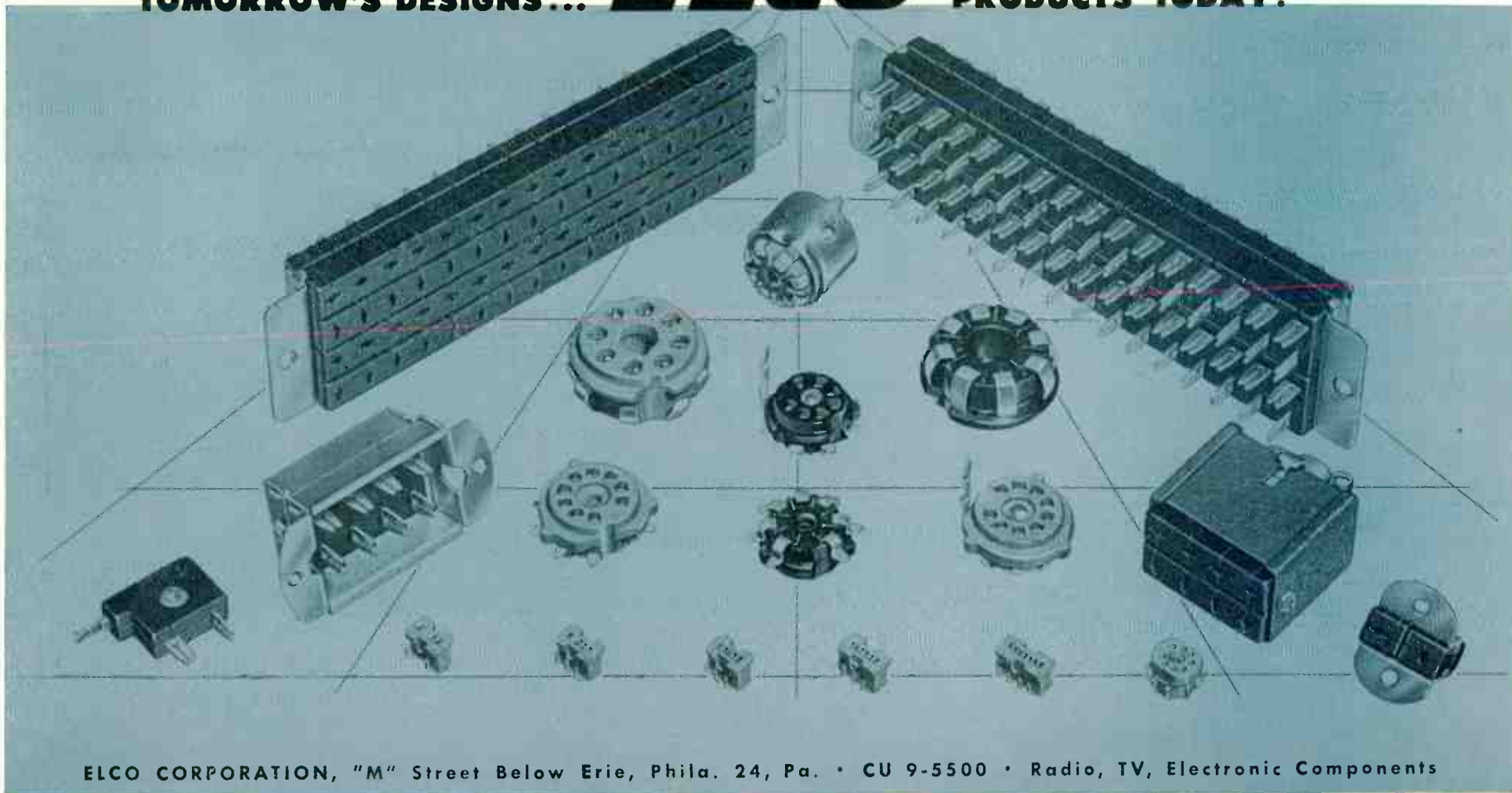

ELCO CORPORATION, "M" Street Below Erie, Phila. 24, Pa. • CU 9-5500 • Radio, TV, Electronic Components



NEW SYMBOL FOR SEMICONDUCTOR LEADERSHIP

now...from Pacific
Semiconductors

new designs

new techniques

new performance

Back of Pacific Semiconductors' new diode design is a fresh approach based on experience . . . over 145 man-years professional experience in the field of semiconductor electronics. Starting where others have left off, these pioneers in one of the decade's most promising electronic fields have developed a series of truly *new* semiconductor devices uniquely suited to the demands of today's airborne and computer circuitry.

Experienced personnel and a thorough, continuing research and development program are your assurance of the most advanced design, combined with *proven* performance at levels heretofore unobtainable. Pioneering at PSI is not mere guesswork; it is based on thorough knowledge of each product and of the conditions under which that product is used. In the months and years to come, look to PSI . . . Pacific Semiconductors, Inc. . . . for your requirements of gold bonded germanium diodes, silicon junction diodes and other important semiconductor devices. Inquiries are invited for both standard units and for the special characteristics constantly called for by advances in electronic design.

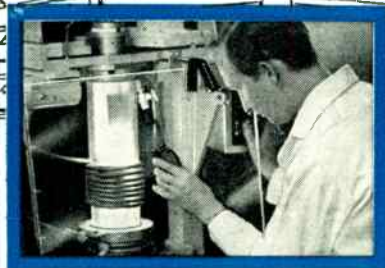

High-purity silicon crystals are drawn in PSI's high frequency induction furnaces.



X-ray diffraction orients crystals prior to slicing wafer for silicon junction diodes.

NOW AVAILABLE

- GERMANIUM GOLD BONDED DIODES
- SILICON JUNCTION DIODES

*in the new PSI diode package ...
designed around user requirements*

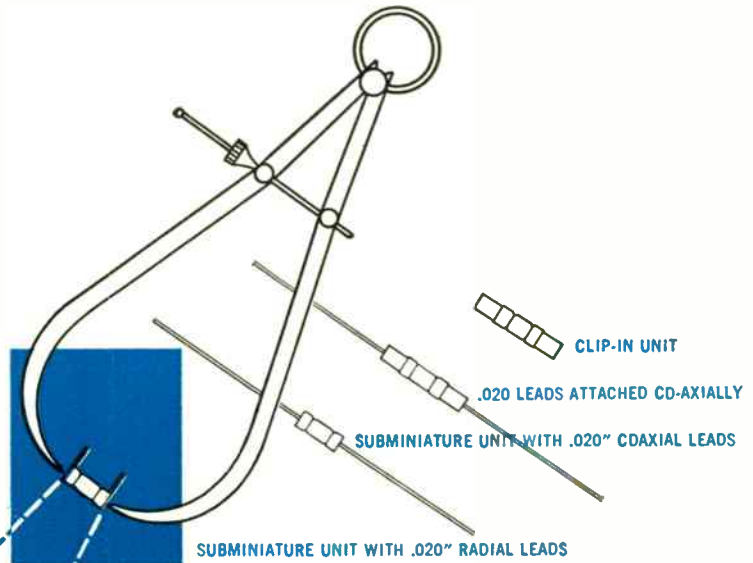

PSI's revolutionary new package, with advantages not found in any other commercially available diodes, was designed only after an exhaustive survey of user requirements. Space limitations, environmental demands, even assembly procedures became factors in the final design. The result: diodes with demonstrably superior performance, greater versatility, top all-around utility.

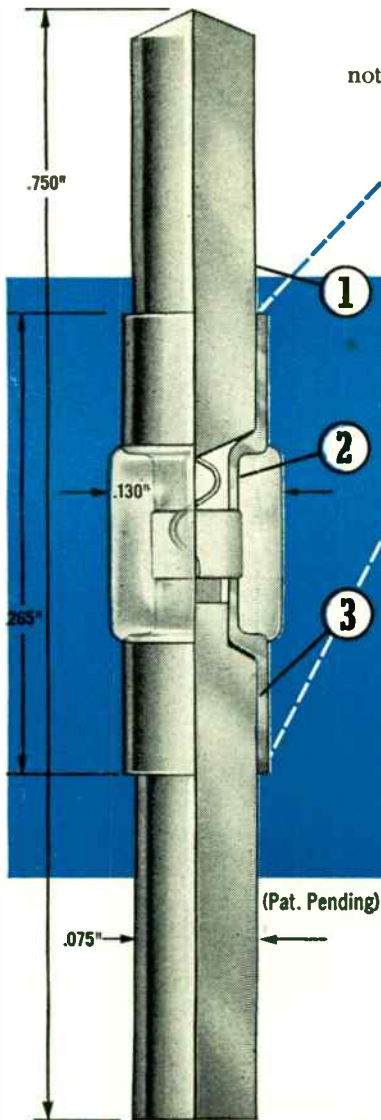

***CHECK THESE BENEFITS...**

- 1. VERSATILE LEAD ARRANGEMENT...** for maximum adaptability, diodes may be obtained in a variety of configurations.
- 2. GLASS-TO-METAL SEAL...** for positive moisture resistance, PSI uses a true fusion seal.
- 3. WELDED CONSTRUCTION...** for greater strength and freedom from contamination; no low melting point solders are used.

and your net benefit from all these features ...

NEW STANDARDS OF RELIABILITY AND STABILITY

Typical PSI Gold Bonded Diode Characteristics @ 25°C

Forward Current @ 1v (ma)	Inverse Current (µa)	Inverse Working Voltage (volts)
100	100 (-20v)	35
35	10 (-50v)	80
15	25 (-50v) 200 (-200v)	220

Typical PSI Silicon Junction Diode Characteristics

E _s /E _t (volts)	Forward Current @ 1v (ma)	Back Current	
		at 25°C	at 150°C
30/29	80	.01µa (-15v)	5µa (-15v)
55/53	40	.01µa (-30v)	5µa (-30v)
150/145	15	.01µa (-75v)	5µa (-75v)
300/290	5	.01µa (-150v)	5µa (-150v)

a: The saturation voltage (E_s) is measured at 500µa; the transition voltage (E_t) is measured at 20µa.

b: Recovery time: after switching from 5ma forward current to -40v for all these types, back resistance reaches or exceeds 50K in 1µsec.

For complete product specifications, address inquiries to Dept. S 2

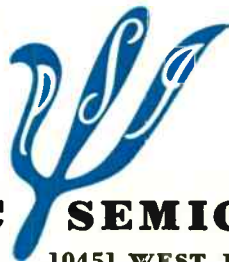

PACIFIC SEMICONDUCTORS, INC.

10451 WEST JEFFERSON BOULEVARD
CULVER CITY, CALIFORNIA

(Continued from page 68A)

ered to the Philadelphia Chapter. A. Pappoulis of BPI spoke on "The Displacement of Poles and Zeros Due to Parasitic Circuit Elements," D. Sunstein of Philco spoke on "A New Self-Oscillating Frequency Converter," and H. J. Woll of RCA discussed "An Analog Multiplier."

COMPONENT PARTS

The Philadelphia Chapter of the Professional Group on Component Parts met on December 4 at the Engineers' Club. Dr. Leopold Pessel of RCA spoke on "Solderability." He emphasized the chemical and metallurgical factors affecting the ability of metal surface to form effective joints with solders; a test method to evaluate solderability of surfaces on a numerical basis; the outlining of an industry-wide solderability standard, of particular value in improving the reliability of electronic equipment. A question period followed Dr. Pessel's paper.

ELECTRON DEVICES

At PEPCO Auditorium on December 1 the Washington Chapter of the Professional Group on Electron Devices met. J. Howard Wright presided. A. W. Holt of the U. S. National Bureau of Standards delivered a paper, "The Diode Amplifier." After discussion of the paper and refreshments, there was a short business session at which the following officers for the new chapter were elected: Chairman, J. Howard Wright; Vice-Chairman, H. D. Arnett; Secretary, Harold J. Peake.

The New York Chapter met on November 18 at the General Electric Auditorium. A. K. King was the presiding officer. James M. Early of Bell Telephone Laboratories spoke on "Junction Transistors at Very High Frequency."

The Philadelphia Chapter met, with B. T. Svihel presiding, on November 23. "Dielectric Amplifiers" was the title of the paper delivered by J. R. Horsch of General Electric Company. Dr. Horsch discussed the hysteresis characteristics of dielectric crystals and the principles of amplification by use of dielectrics. He presented the historical background of dielectric amplifiers and showed the performance curves of typical present-day amplifiers. Future development in this field, he said, is dependent largely upon the demand for capacitors with better hysteresis curves.

ELECTRONIC COMPUTERS

On November 19, the Chicago Chapter of the Professional Group on Electronic Computers met with I. S. Lerner presiding. W. Flurzeig of the Institute of Air Weapons Research spoke on the "Logic of Computers."

The Chicago Chapter also met on October 22. "Representative Problems in Operations Research" was the title of the

(Continued on page 76A)

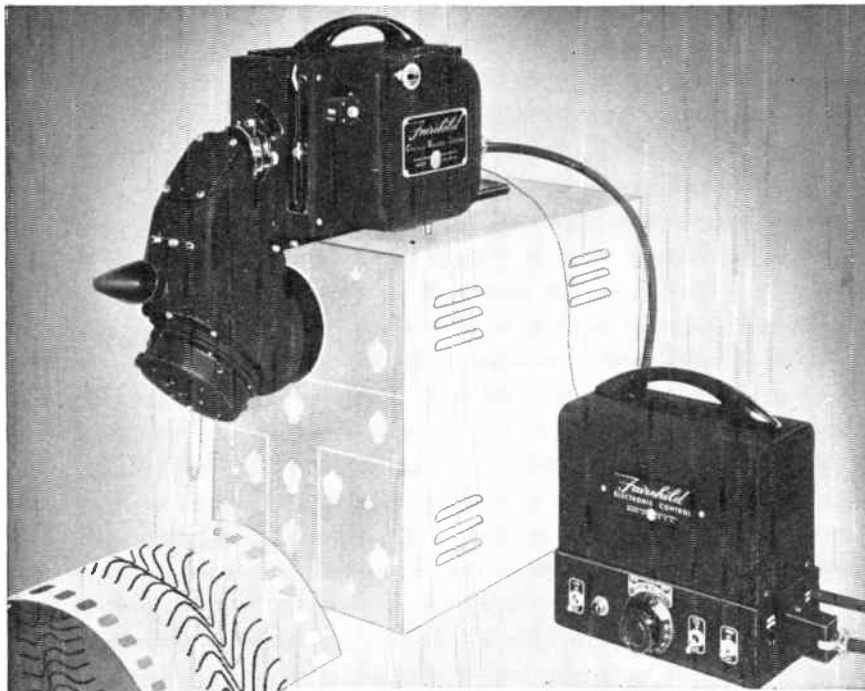

PHOTOGRAPH ANY SCOPE PATTERN

with the **FAIRCHILD** Oscillo-Record Camera

The Fairchild Oscillo-Record camera will accurately record continuously varying phenomena as well as single transients and stationary patterns. Continuously variable electronic control of the film speed from 1 to 3600 inches per minute allows you to select the optimum speed for the greatest clarity and detail, without film waste. The entire length of the 35 mm. film (100, 400 or 1,000 feet) can be run off continuously at any speed. The film is sprocket-driven so there is no slippage at any speed.

The Oscillo-Record camera mounts directly on the top of the scope. No tripod is needed and the oscilloscope controls are always accessible.

FOR IMMEDIATE EVALUATION of individual exposures the Fairchild-Polaroid® Oscilloscope Camera is economical, fast, and convenient. The trace reads from left to right, and is exactly one-half size. Each 3¼" x 4¼" Polaroid print (available in only 60 seconds) records two separate images.

For more information, write *Fairchild Camera and Instrument Corporation, 88-06 Van Wyck Expressway, Jamaica, N. Y., Department 120-2111.*

FAIRCHILD

OSCILLOSCOPE RECORDING CAMERAS

color

tv

controls



CHICAGO TELEPHONE SUPPLY
Corporation

ELKHART • INDIANA

*Specialists in Precision Mass Production
of Variable Resistors • Founded 1896*

THE ONLY COMPLETE LINE FOR ALL COLOR TV APPLICATIONS

- 1. SIZES—"dime size" to 2 1/2" diameter.
 - 2. WATTAGES—2, 10 watt to 4 watt.
 - 3. TYPES—carbon and wirewound with and without attached switch.
 - 4. MOUNTINGS—conventional bushing, twist ear and snap-in bracket for printed circuits.
 - 5. TERMINAL STYLES—for conventional soldering, printed circuits and wire wrap.
 - 6. COMBINATIONS—an endless variety of tandems, both single and dual shaft.
- A CTS control can be tailored to your specific requirement.**



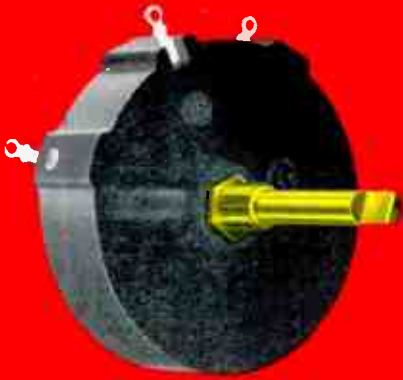

High voltage control for focus applications. Rated up to 5,000 volts DC across end terminals and 2.12 watts depending on total resistance. Will operate up to 15,000 volts DC above ground when mounted on insulated panel. CTS type 65.



Miniature 3/4" "dime size" composition control. Conserves panel space at price comparable to larger size bushing mounted controls. CTS type 70.

1 1/8" diameter composition control for applications where ratings up to 3.4 watt required. CTS type 35.



Concentric shaft tandem control with conventional bushing mounting. Designed for front panel dual knob applications, such as contrast and volume. Available in various combinations of composition or wirewound front and rear sections with or without on-off switch attached to rear section. CTS type GC-C252-45 with wirewound front section, composition rear section and on-off switch illustrated.

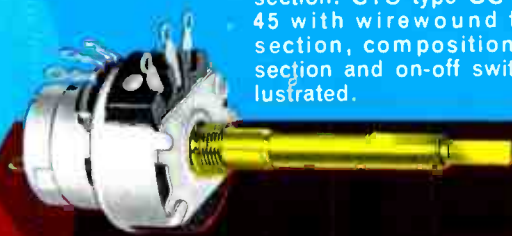

Ear mounted composition control. Simply twist two ears for rigid mounting. Eliminates bushing and mounting hardware. Available with shafts for knob operation or for preset applications with insulated or metal shaft. CTS type P45 with metal shaft illustrated.



Ear mounted two watt wirewound available with or without center tap. CTS type P-254 with tap illustrated.

Four watt wirewound control available with or without center tap. CTS type 27 with tap illustrated.



Higher Wattage Carbon Controls With Exceptional Stability Available

- **ONE WATT:** Entire 45 series 15/16" diameter line available with 90 series special one watt military resistance elements.
- **TWO WATT:** Entire 35 series 1 1/8" diameter line available with 95 series special two watt military resistance elements.

Ear mounted tandem for preset applications. Combines panel space saving features of a concentric tandem with the economy of an ear mounted unit. Available in various combinations of composition or wirewound front and rear sections. CTS type P-C2-45 with composition front and rear sections illustrated.



THE ONLY COMPLETE LINE FOR ALL COLOR TV APPLICATIONS

CTS also makes a complete line of controls for military, black and white TV, radio and other commercial applications. Consultation without obligation available for all your control applications. Write for complete catalog TODAY.



CHICAGO TELEPHONE SUPPLY
Corporation

ELKHART • INDIANA

EAST COAST OFFICE
Henry E. Sanders
130 North Broadway
Camden 2, New Jersey
Phone: Woodlawn 6-1668
TWX No. Camden NJ 380

WEST COAST OFFICE
Robert A. Stackhouse
928 S. Robertson Blvd.
Los Angeles 35, California
Phone: Crestview 4-5931
TWX No. BEV H 7666

SOUTHWESTERN U.S.A.
John A. Green Company
6815 Oriole Drive
P.O. Box 7224
Dallas 9, Texas
Phone: Dixon 9918

CANADIAN DIVISION
C. C. Meredith & Co., Ltd.
Streetsville, Ontario
Phone: 310

SOUTH AMERICA
Jose Luis Pontet
Buenos Aires, Argentina
Montevideo, Uruguay
Rio de Janeiro, Brazil
Sao Paulo, Brazil

OTHER EXPORT
Sylvan Ginsbury
8 West 40th Street
New York 18, New York
Phone: Pennsylvania 6-8239

Specialists in Precision Mass Production of Variable Resistors • Founded 1896

NOW...FROM **Transitron**

SILICON JUNCTION DIODES WITH SUPERIOR FORWARD CONDUCTANCE

- Operation up to 150°C
- Low Inverse Current
- Sharp Zener Break
- Hermetic Sealing

Transitron silicon junction diodes are specifically designed to meet exacting high temperature requirements. Combining high forward conductance with very high inverse resistance, they provide improved circuit performance in many applications. Reliability is assured through welded hermetic sealing.

SPECIFICATIONS AND RATINGS

TYPE	Forward Current at +1.0 Volt (ma)	Inverse Current at Specified Voltage (μ a)		Maximum Reverse Working Voltage (volts)
		at 25°C	at 125°C	
		1N137A	3	
1N138A	5	.01 at 10V	—	18
1N137B	20	.03 at 20V	5 at 20V	36
1N138B	40	.01 at 10V	2 at 10V	18
1N350	20	.03 at 60V	5 at 60V	70
1N351	8	.03 at 100V	5 at 100V	120
1N352	5	.05 at 150V	10 at 150V	170
1N353	3	.10 at 200V	20 at 200V	225
1N354	1	.10 at 300V	20 at 300V	325

Types 1N200 through 1N222 as well as special types, including Zener regulators, are also available. Your inquiries are invited.

VISIT BOOTH 580 AT THE I.R.E. SHOW, MARCH 21-24



SEND FOR
BULLETIN
TET322

Transitron
electronic corporation
melrose 76, massachusetts



Glass Diodes



Silicon Diodes



Germanium Diodes



Transistors



Silicon Rectifiers

NOW...
FROM

Transitron[®]



ACTUAL
SIZE

**Silicon
POWER
Rectifiers
for **125°C**
Operation**

Transitron[®]

electronic corporation
melrose 76, massachusetts

World Radio History

- ✚ Reliability at High Temperatures
- ✚ High Power Handling Ability
- ✚ Negligible Leakage Current
- ✚ No Forward Aging
- ✚ High Conductance
- ✚ Miniature Size
- ✚ Hermetic Sealing

Transitron's silicon rectifiers meet the long felt need for reliable and efficient power rectification at high temperatures.

Overcoming the basic limitations of selenium, germanium, and the vacuum tube, they provide trouble-free operation over wide ambient temperature ranges.

These rugged rectifiers offer major savings in both size and weight in any high temperature application.

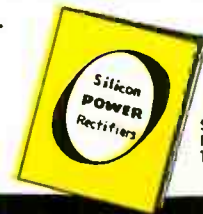

VISIT BOOTH 580 AT THE I.R.E. SHOW, MARCH 21-24

SEND FOR BULLETIN TE1321

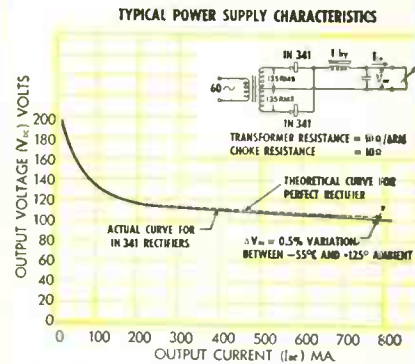
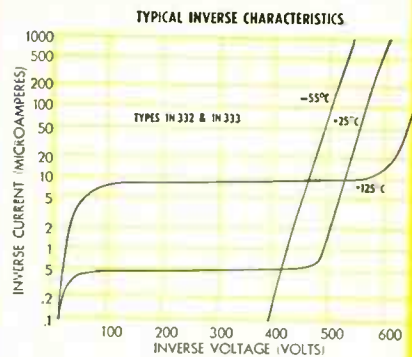
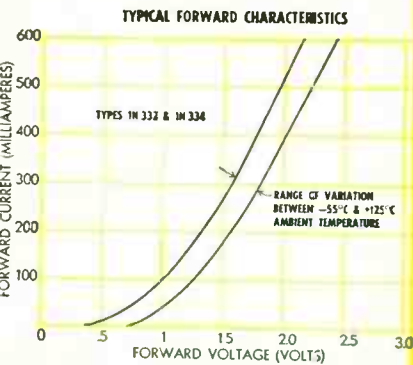

SPECIFICATIONS AND RATINGS AT 125°C

POWER SUPPLY TYPES					MAGNETIC AMPLIFIER TYPES				
TYPE	Peak Recurrent Inverse Voltage (volts)	Maximum Average Forward Current (ma)	Maximum* Average Forward Voltage (volts)	Maximum* Average Inverse Current (ma)	TYPE	Peak Recurrent Inverse Voltage (volts)	Maximum Average Forward Current (ma)	Maximum* Average Forward Voltage (volts)	Maximum* Average Inverse Current (ma)
1N341	400	400	3.0	.5	1N332	400	400	1.5	.10
1N342	400	200	3.0	.5	1N333	400	200	3.0	.10
1N343	300	400	3.0	.5	1N334	300	400	1.5	.10
1N344	300	200	3.0	.5	1N335	300	200	3.0	.10
1N345	200	400	2.5	.5	1N336	200	400	1.3	.05
1N346	200	200	2.5	.5	1N337	200	200	2.5	.05
1N347	100	1000	1.0	.5	1N338	100	1000	1.0	.10
1N348	100	400	2.5	.5	1N339	100	400	1.3	.05
1N349	100	200	1.0	.5	1N340	100	200	2.5	.05

Special silicon rectifiers, or combinations, are available to meet specific requirements. Your inquiries are invited.

*Averaged over one cycle for full wave choke input circuit with Rectifier operating at full rated forward current.



Glass Diodes



Silicon Diodes



Germanium Diodes



Transistors



Silicon Rectifiers

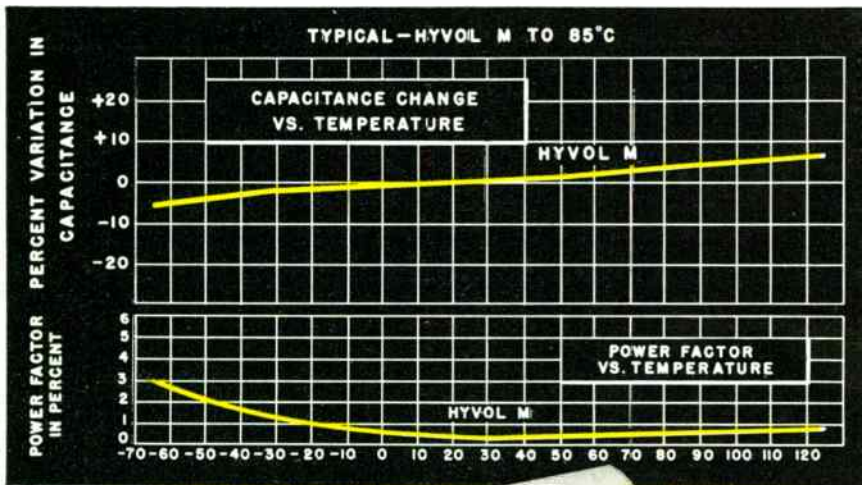

Professional Group Meetings

(Continued from page 72A)

paper delivered by Allan Butterworth, Assistant to the Director of the Institute of Air Weapons Research.

The Los Angeles Chapter met on November 18 and Willis Ware was the presiding officer. Erwin Tomash, Remington Rand West Coast Representative, spoke to the group on "DS-63, A New Business Data Processing Machine." "Patent Law In Engineering" was the name of the paper delivered by Samuel Lindenbert.

On October 27 the Detroit Chapter met at the General Motors Research Center. Roy Hock was the presiding officer. D. E. Hart, General Motors Research, spoke on the computing facilities at the center. He also demonstrated the IBM 701.

At the Franklin Institute on November 16 the Philadelphia Chapter met. Bernard M. Gordon, Vice-President of EPSCO, delivered a paper entitled, "Process Control with Operational Digital Techniques." Mr. Gordon explained how digital-analog simulators combine the advantages of digital precision, analog simplicity and flexibility.

The Philadelphia Chapter also met on October 19; T. H. Bonn was the presiding officer. There were two speakers. A. W. Vance, of the Sarnoff Research Center at RCA, spoke on "Development of a New Large-Scale Three Dimensional Analog Simulator." "Digital Computers for Real Time Simulation" was the subject discussed by Morris Rubinoff of the Moore School of Electrical Engineering.

ENGINEERING MANAGEMENT

The Chicago Chapter of the Professional Group on Engineering Management met on November 19 with Marvin Quatman presiding. "What Keeps an Engineer Out of Management" was the subject discussed by Charles W. Blahna of Motorola.

On December 3 the Philadelphia Chapter met. Irvn Travis of Burroughs Corporation spoke to the group on "New Product Planning and the Implementation of New Product Goals as They Affect Engineering Management." Dr. Travis presented the engineering management's problems in new product planning, emphasizing the need to have engineers understand the sales viewpoint and the need to express engineering viewpoints to non-engineers as lucidly as possible.

The Washington Chapter met on November 22 at the National Science Foundation. Karl Keller, Assistant Manager of Westinghouse Electric Corporation, delivered a paper on "Control of Inventory," and Robert Cheek discussed "Decentralized Project Engineering Management."

J. E. Stiles, Vice-Chairman of the PGIE, presided at the meeting of the Chicago Chapter. Joseph Gardberg, of the Teletype Corporation, spoke on "An Electronic Scale Control System."

(Continued on page 77A)

For the *Best* in
PAPER TUBULAR performance...

AEROVOX

Type P84 CM

CERAMIC-CASED CAPACITORS

Duramics (Aerovox Type P84 CM) combine quality and economy for engineers and designers seeking performance above that of conventional tubulars. Consider these features:

- Encased in dense steatite-grade ceramic tubing.
- Newly developed thermo-setting end-seals firmly adhere to ceramic tubing and wire terminals. Will not soften or flow, over unusually wide temperature range.
- Terminal lead wires will not work loose or pull out, under most severe operating conditions.
- Ceramic casing and end-seals provide exceptional protection against humidity.
- Rated temperature range of -55°C to $+85^{\circ}\text{C}$.
- Withstand a 250-hour humidity-resistance test as per REC-118.

FUNCTION
FITTED

LITERATURE ON REQUEST: Ask for Bulletin NPA 200. And let us quote on these "Best in Paper Tubular" capacitors. Also on any and all your capacitor requirements.



AEROVOX CORPORATION

NEW BEDFORD, MASS.

Hi-Q
DIVISION
OLEAN N. Y.

ACME
ELECTRONICS, INC.
MONROVIA CALIF.

CINEMA
ENGINEERING CO.
BURBANK CALIF.

HENRY L. CROWLEY & CO.
WEST ORANGE N. J.

In Canada: AEROVOX CANADA, LTD., Hamilton, Ont.

Export: Ad. Auriema., 89 Broad St., New York, N. Y. • Cable: Auriema, N. Y.

(Continued from page 76A)

INFORMATION THEORY

The Albuquerque-Los Alamos Chapter of the Professional Group on Information Theory met on December 8 with John McLay presiding. C. H. Bidwell was the speaker; he delivered a paper called "Signal To Noise Problems in L-3 Coax Development."

INSTRUMENTATION

On October 1 the Chicago Chapter met at the Western Society of Engineering Building. F. L. Moseley, President of F. L. Moseley Company, delivered a paper entitled "An X-Y Recorder, Curve Follower, and Data Plotter."

MEDICAL ELECTRONICS

The Connecticut Valley Chapter of the Professional Group on Medical Electronics met on October 21. John H. Heller, Director of the New England Institute of Medical Research, spoke to the group on "Medical Electronics."

The San Francisco Chapter met on December 2 with Lee B. Lusted presiding. "Medical Aspects of X-Ray Microscopy" was the name of the paper presented by E. M. Miller, Professor of Radiology at the University of California Medical School. H. H. Pattee and Paul Kirkpatrick, Research Associate and Professor, respectively, in the Department of Physics at Stanford University, jointly presented "Physical and Electronic Techniques in X-Ray Microscopy."

MICROWAVE THEORY AND TECHNIQUES

On November 17 the Philadelphia Chapter of the Professional Group on Microwave Theory and Techniques met at the Towne Building of the University of Pennsylvania. R. P. Schwartz was the presiding officer. D. R. Crosby of RCA spoke on "Theoretical Gain of Microwave Reflectors." He described the physical behavior of reflectors from the field point of view.

NUCLEAR SCIENCE

On October 27 at Mitchell Hall the Albuquerque Chapter of the Professional Group on Nuclear Science met. R. D. Jones delivered a paper to the group entitled "Control Applications of Proton Magnetic Resonance."

The Connecticut Valley Chapter met on November 23 at the Underwater Sound Laboratory. J. E. Basset presided and T. S. Gray was the speaker. He presented a paper called "Electronic Nuclear Instrumentation."

On October 1 the Chicago Chapter met at the Western Society Building. R. C. Goertz, of Argonne National Laboratories, spoke to the group on "Remote Manipu-

(Continued on page 100A)

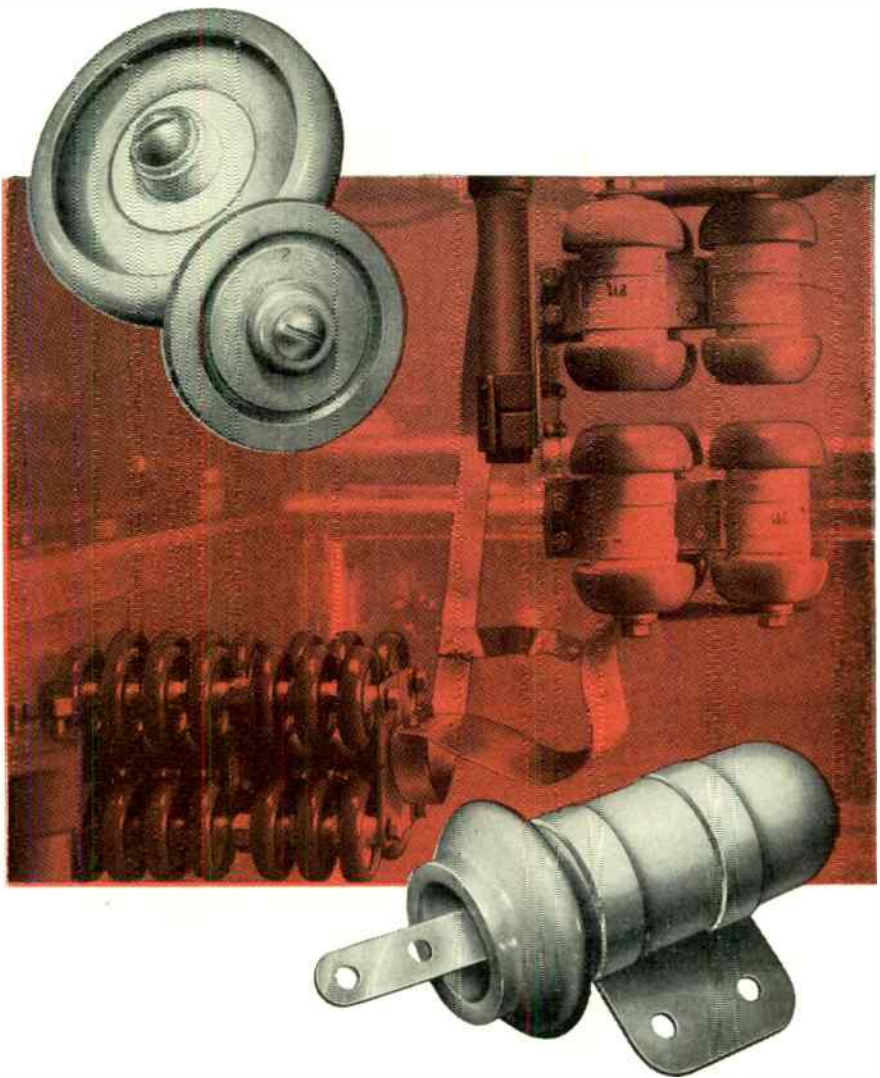

Aerovox H-P CERAMIC POWER and Transmitting Capacitors

Take advantage of that "New Look" in your electronic power assemblies! These ceramic-dielectric capacitors serve heavy-duty functions heretofore limited to mica types. H-P Ceramic Power Capacitors are particularly suited for broadcast, radio-communication, radar and similar assemblies; for industrial high-frequency equipment; for medical appliances, etc.

In both disc ("double-saucer") and cylindrical ("tubular") ceramic-dielectric bodies. Space- and weight-saving from 50% to 90% over corresponding micas. Competitively priced.

Also: Ease of mounting; ease of wiring in series or parallel; very low inductance connections; exceptional immunity to humidity, heat, cold, atmospheric pressure; wide range of designs, sizes, capacitances, voltages.

Get the FACTS!

Let our engineer-specialists collaborate in adapting these H-P capacitors to your equipment for that "New Look." Literature on request.



AEROVOX CORPORATION
CLEAN, N. Y.

AEROVOX CORPORATION
NEW BEDFORD, MASS.

ACME ELECTRONICS, INC.
MONROVIA, CALIF.

CINEMA ENGINEERING CO.
BURBANK, CALIF.

In Canada: AEROVOX CANADA LTD., Hamilton, Ont.

JOBBER ADDRESS: 740 Bellville Ave., New Bedford, Mass.

FOR HIGH RELIABILITY



THE NEWEST in G.E.'s wide germanium rectifier line is the 1N315. Specifically designed for *high* operating temperatures—up to 85°C.—and for *low* reverse current. (Note: The 1N315A *exceptionally* low-leakage design is also available.) Ideal for use in magnetic amplifiers or other circuits where low-leakage current is important. Write today for details. *General Electric Company, Section X5235, Germanium Products, Electronics Park, Syracuse, N.Y.*

Production quantities are now available!

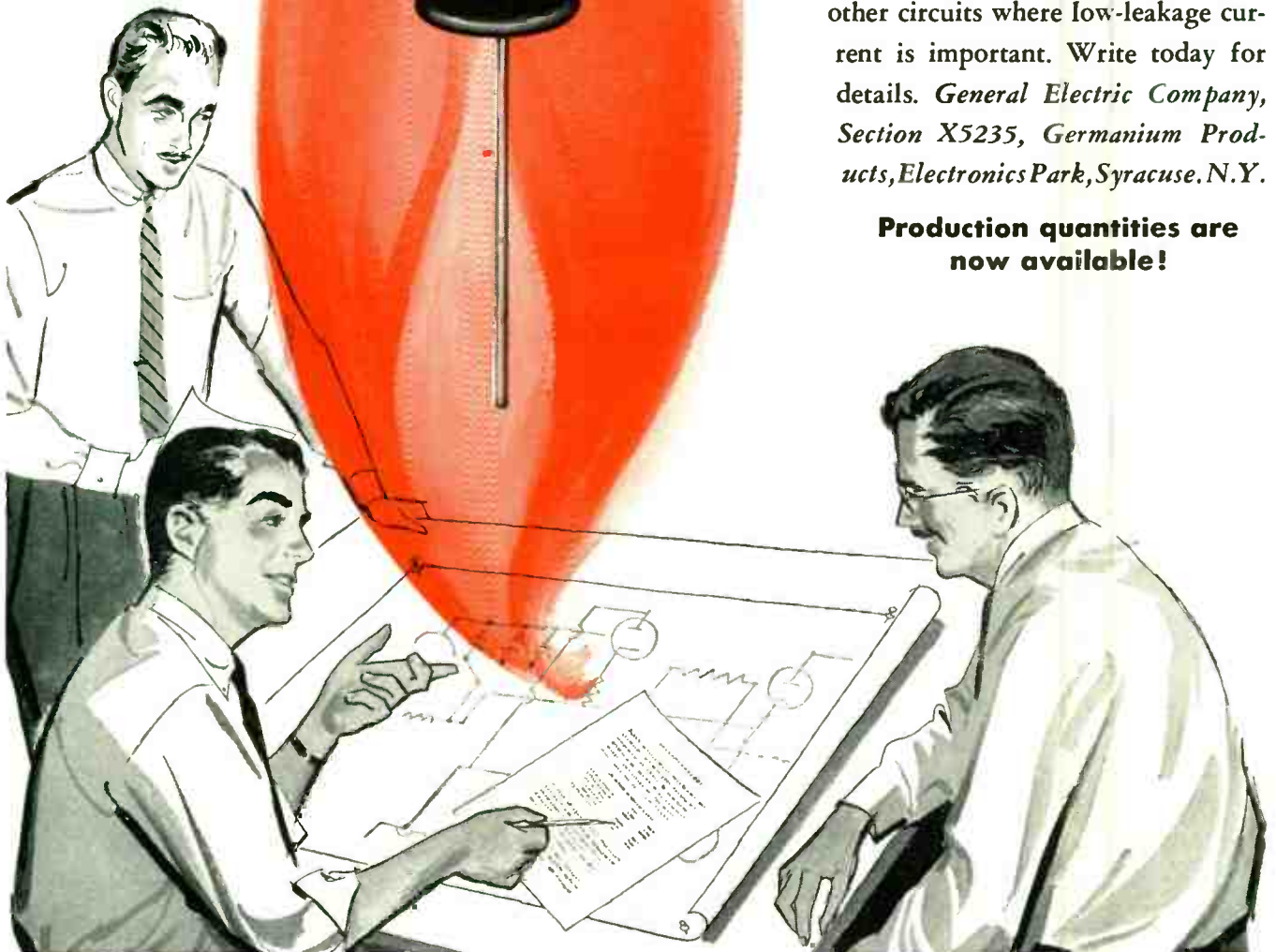

AT HIGH TEMPERATURES...

NEW G-E GERMANIUM JUNCTION RECTIFIER

SPECIFICATIONS FOR 1N315A

(Resistive or Inductive Load)

	55°C	71°C	85°C	
Maximum Allowable Peak Inverse Voltage	200	200	100	V
Maximum Allowable D-C Output Current	100	100	100	ma
Maximum Full Load Forward Voltage Drop	.48	.46	.44	V
Continuous Reverse Working Voltage	150	100	50	V
Minimum Forward to Reverse Current Ratio (Average Forward/Average Reverse at Full Load)	2000	800	500	
Maximum Operating Frequency (70% Rectification Efficiency)	50	50	50	KC
Storage Temperature	95	95	95	°C

● **Tell your secretary to mark the calendar now. See the G-E Germanium Products Exhibit at I.R.E. Convention, Booths 192 and 194 at Kingsbridge Armory, N.Y.C. March 21st to 24th.**

MARCH						
Sun	Mon	Tue	Wed	Thu	Fri	Sat
		1	2	3	4	5
6	7	8	9	10	11	12
13	14	15	16	17	18	19
20	21	22	23	24	25	26
27	28	29	30	31		



Progress Is Our Most Important Product

GENERAL  ELECTRIC

TRIAD ISOLATION TRANSFORMERS

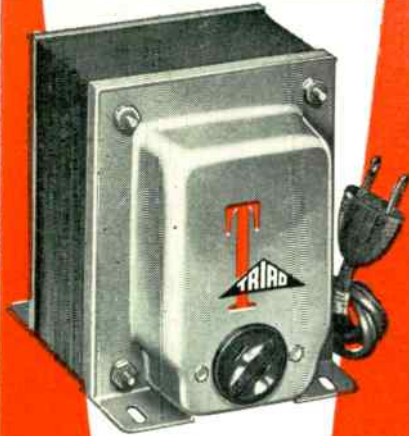

AVAILABLE FROM STOCK
AT YOUR TRIAD JOBBER

Triad Isolation Transformers are especially designed for isolation of laboratory test equipment . . . reduction of line disturbances . . . elimination of undesired grounds.

They are ideal for use in screen rooms. Such construction features as "Cemite" treatment, liberal use of high quality materials and static shielding insure optimum performance and long life.

Type No.	List Price	V. A. Output	Input Volts	Output Volts
N-51X	\$ 5.95	35	115	115
N-52M With switch and meter	32.50	350	115	95-100-105- 110-115-120- 125-130
N-53M	12.75	85	115	115
N-54M	14.30	150	115	115
N-55M	25.30	250	115	115
N-57M	40.75	500	115	115
N-59M	67.20	1000	115	115
†N-60	130.00	2000	230/115	230/115

†Special case.

Write for
Catalog TR-54H

TRIAD
TRANSFORMER CORP.
4055 Redwood Ave., Venice, Calif.

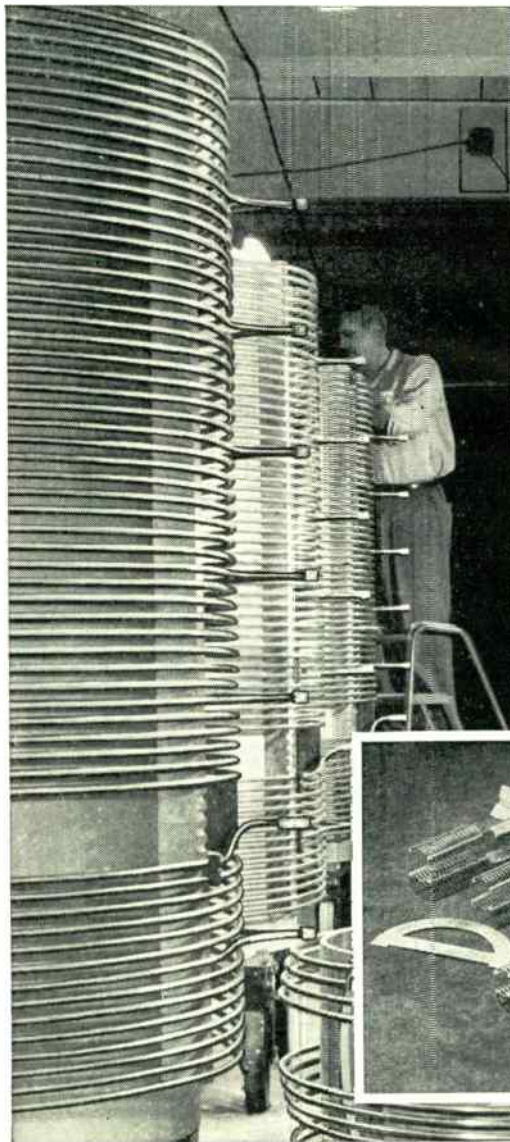

COILS

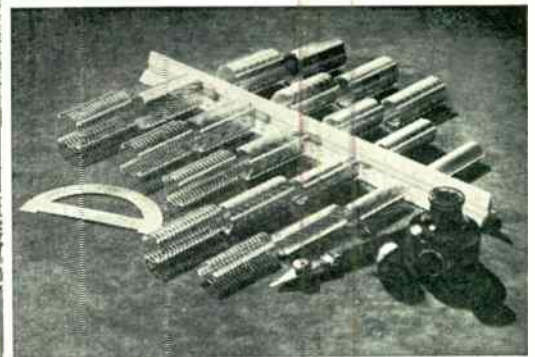

from **6' giants** to **half-inch** midgets

When you need coils . . . whether it be just a few for research and development or huge quantities for volume production . . . you'll find your needs right up B&W's alley. Regardless of size or type . . . from 6' x 48" variometer type loading coils down to half-inch miniductors, both shown above.

And you'll value the top coil performance you get, based on two decades of specialized manufacture. B&W's twenty years of experience stems from the commercial manufacture of the world's first air-inductor through *single layer solenoid coils . . . universal units with single, multiple pie, or progressive windings . . . r-f, i-f, and oscillator coils . . . traps, discriminators, toroids, filters, r-f and delay line chokes.*

Wherever your coil requirements lie, you'll find Barker & Williamson ready, willing, and able to solve them. Write now for complete information on B&W coil development and manufacturing facilities.

B&W Barker & Williamson, Inc.
237 Fairfield Ave., Upper Darby, Pa.

SEE US AT THE I.R.E. SHOW—202 Instruments Avenue

COVERAGE

where you want it



Uni-directional antenna.



High gain omni-directional antenna.

Very low VSWR point-to-point
microwave antenna.

Useless coverage is expensive to you and can be offensive to your neighboring radio systems through signal interference. For coverage where you want it, look to Andrew for performance guaranteed systems, the lower cost solution of all your transmission problems in VHF, UHF and Microwave communications. Our high technical standards are backed by a 20 year record of accepting systems responsibility.

Bring your coverage problem to Andrew—our engineers will analyze your system and make specific recommendations to achieve coverage where you want it.

Andrew
CORPORATION

*Everybody
looks up to -*

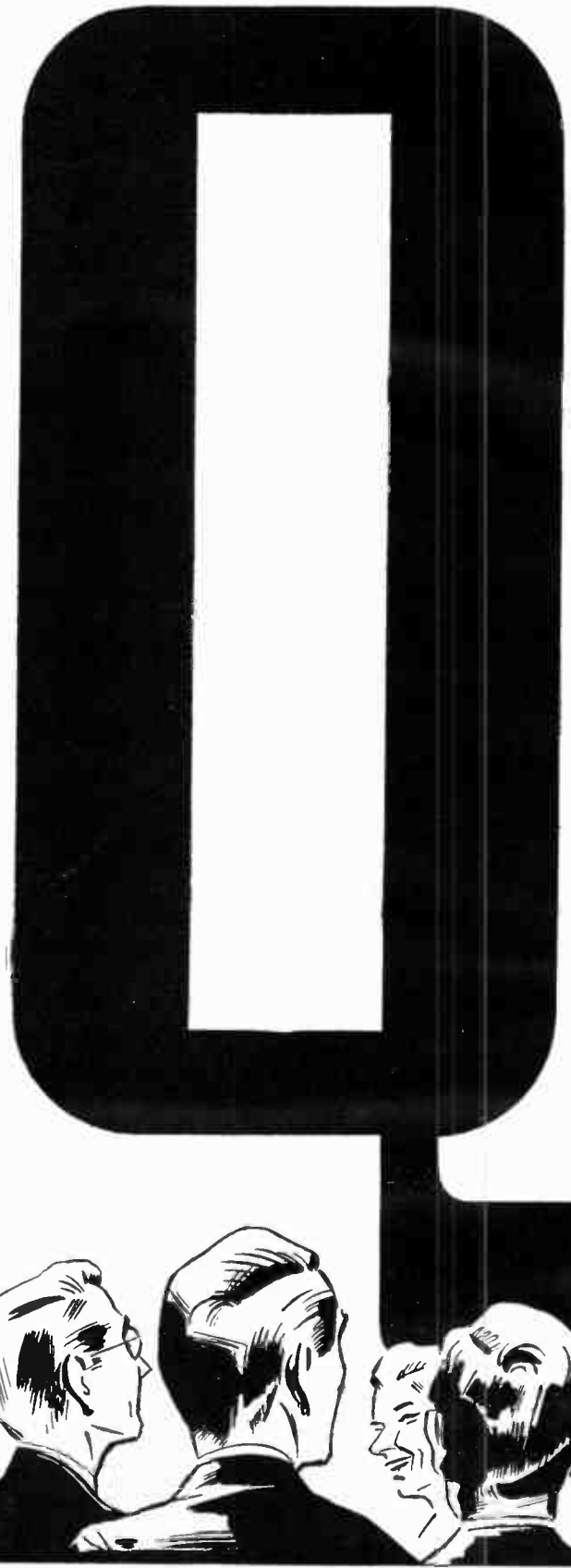

← **NEW BOOKLET AVAILABLE!**
Contains complete information on Q-max RF
Lacquer. Call or write for your copy, today.

max*

A-27 LACQUER

**America's finest coil lacquer...the accepted
standard for VHF and UHF service.**



* REGISTERED
TRADE NAME

Communication Products Company, Inc.

STATE HIGHWAY 79, MARLBORO, NEW JERSEY — TELEPHONE: FREEHOLD 8-1880

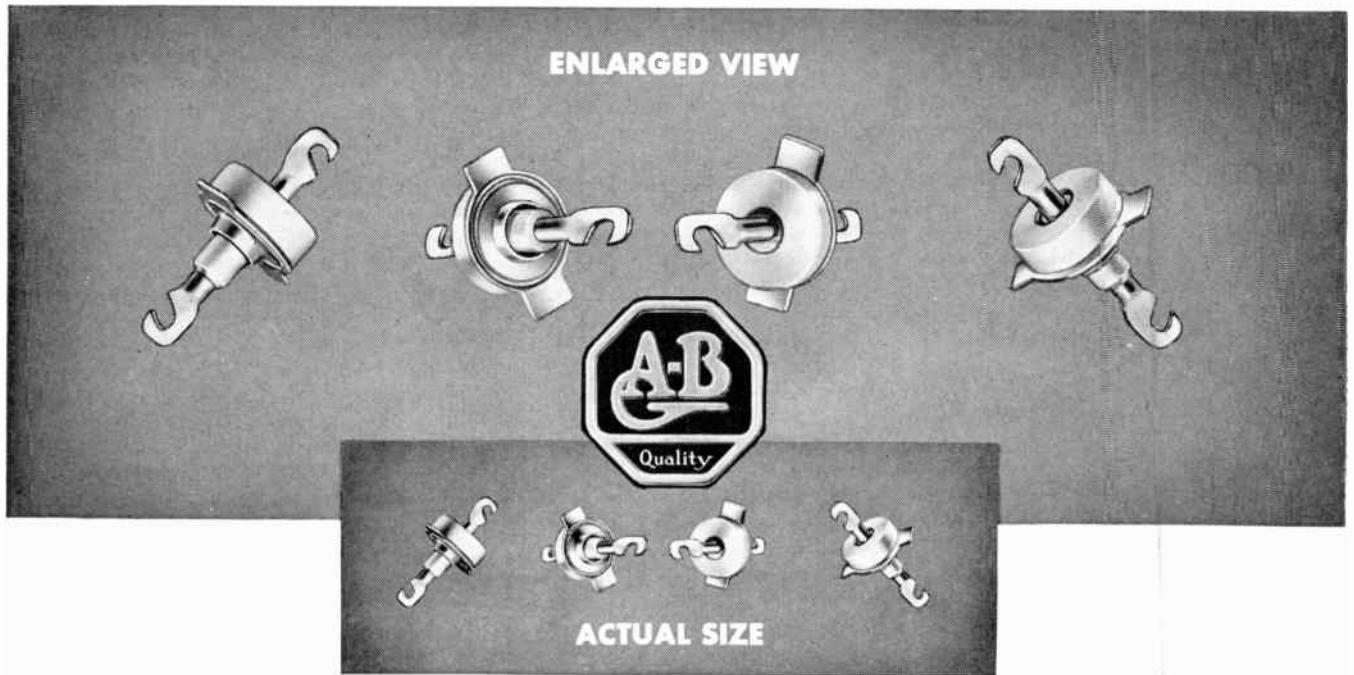

ANNOUNCING — An Improved UHF

Discoidal Feed-thru Capacitor

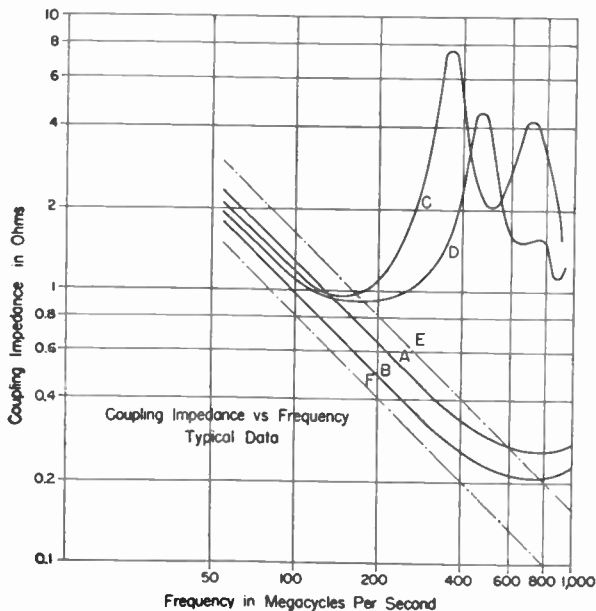

Discoidal vs. Tubular Feed-thru Ceramic Capacitors

Allen-Bradley Discoidal Type	{	Curve A—1300 MMF at 1 KC Actual
		Curve B—1600 MMF at 1 KC Actual
Representative Tubular Type	{	Curve C—1400 MMF at 1 KC Actual
		Curve D—1500 MMF at 1 KC Actual
The "Ideal" Capacitor	{	Curve E—1000 MMF at 1 KC
		Curve F—2000 MMF at 1 KC

Feed-thru filtering . . . to prevent high frequency stray currents from passing from shielded areas over the power supply circuits . . . is a "must" in television receivers, radar, and other high frequency equipment.

The new Allen-Bradley discoidal feed-thru capacitors trap such stray currents by providing a low resistance path thru the shield for power currents and a low impedance coupling to the shield for diverting undesirable, high frequency currents.

Because these tiny discoidal capacitors (over-all length—23/32 in.) are so well constructed, you need not worry about breakage which might result from assembly line handling, contact with soldering irons, and thermal shock incurred in soldering operations.

In the frequency range between 100 megacycles and 1000 megacycles (VHF and UHF television), tubular type feed-thru capacitors have been found unsatisfactory because of parallel resonance effects resulting in high "coupling impedances." Allen-Bradley discoidal feed-thru capacitors do not exhibit such resonance effects at frequencies of 1000 megacycles or less.

The absence of these parallel resonance effects and the relatively high capacitance values with resultant low coupling impedances make Allen-Bradley discoidal feed-thru capacitors ideal for ultra high frequency television receiver applications. Measurements have shown improvement in filtering of more than 20 db through their use.

You should be interested! Write for Bulletin 5420 covering feed-thru and stand-off capacitors.

Allen-Bradley Co., 114 W. Greenfield Ave., Milwaukee 4, Wis. • In Canada—Allen-Bradley Canada Limited, Galt, Ont.

See Allen-Bradley exhibit at IRE Engineering Show—Booth 794

ALLEN-BRADLEY

RADIO, ELECTRONIC AND TELEVISION COMPONENTS

Upgrade Focus Quality without Upgrading Costs

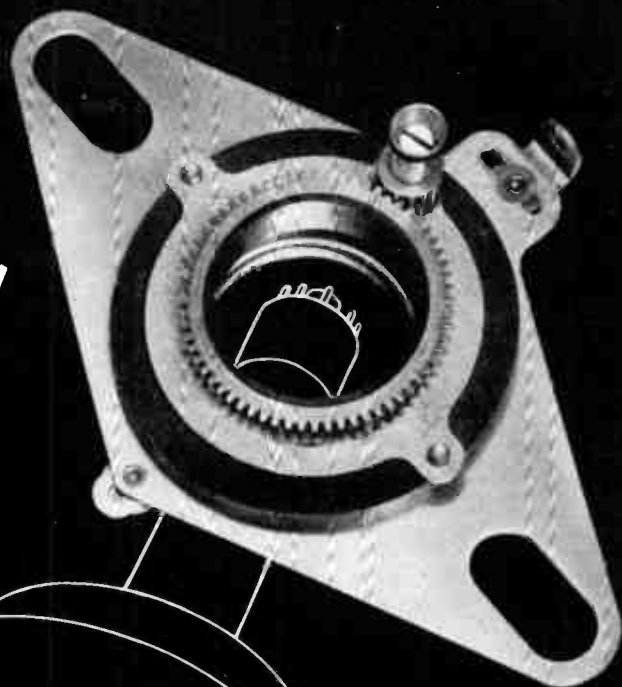

The new Glaser-Steers Economy Model Focuser makes available to the set manufacturer a means of obtaining all the advantages of magnetic focus at costs comparable with any other method.

Now in Mass Production for the Industry's Leaders

GLASER-STEERS Corporation

Manufacturers of Magnetic, Acoustic and Electronic Devices

20 Main Street, Belleville 9, New Jersey

PLymouth 9-7474

REPRESENTATIVES:

William A. Franklin
3 Holly Road
North Syracuse, New York

Henry D. Sarkis & Co.
6560 Sheridan Road
Chicago, Illinois

Perlmuth-Colman & Associates
2419 South Grand Avenue
Los Angeles, California

In Canada:

Glaser-Steers of Canada, Ltd.
99 Wragg Street
Trenton, Ontario

New TRANSISTORIZED MINIATURIZED

**TYPE
2007T**

SPECIFICATIONS

INPUT

20 to 35V DC
of approx. 5 m.a.

OUTPUT FREQUENCY

400 or 500 cycles

Type 2007T

+ .02% from -65° to + 85°C.

Type R2007T

+ .002% from + 15° to + 85°C.

Type W2007T

+ .005% from -65° to + 85°C.

OUTPUT VOLTAGE

5 volts, sine wave.

Substantially uniform
from -65° to + 85°C.

LIFE EXPECTANCY

several times that of vacuum tubes

INTERNALLY SHOCK MOUNTED
on Silostic

MAGNETICALLY SHIELDED

HERMETICALLY SEALED

OCTAL BASE

SIZE

4½" x 1½" diameter

WEIGHT

7 ounces

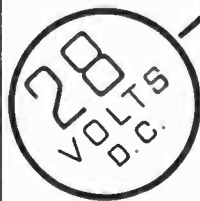

Precision

FREQUENCY STANDARDS

These units, which are the result of several years of development and testing, offer a new standard of simplicity and reliability. Particularly noteworthy is the uniformity of output signal voltage with temperature change. Small size and light weight make them ideal for airborne and portable use.

For applications where only higher B voltages are available, a simple voltage reducing circuit may be used.

COMPLETE INFORMATION ON REQUEST
PLEASE SPECIFY TYPE 2007T

American Time Products, Inc.

580 Fifth Avenue

New York 36, N. Y.

MANUFACTURING UNDER PATENTS OF WESTERN ELECTRIC COMPANY



MICROWAVE SIGNAL GENERATORS

Complete coverage of the range 950-10,800 mcs/sec.

with Polarad single dial operation

Four new Microwave Signal Generators covering the range 950-10,800 mcs/sec. All with famous Polarad single dial operation. Each provides the maximum working range possible in one compact signal generator. And, additional Polarad Signal Generators are available to cover 12.8 to 39.7 kmc.

These features on all MSG units assure fast and simple operation: direct reading, single dial frequency control that tracks reflector voltages automatically . . . direct reading attenuator dial . . . conveniently placed controls, in logical sequence . . . high visibility on the face of each instrument.

Polarad Signal Generators are built to the same high standards required for military equipment. They are practical for the factory assembly line—engineered ventilation assures continuous and stable operation of all instrument functions. Components are readily accessible for easy maintenance. And laboratory accuracy is guaranteed under the most rigorous operating conditions.

Write directly to Polarad or your nearest Polarad representative for details.

	MSG-1	MSG-2	MSG-3	MSG-4*
Frequency Range	950-2400 MCS/sec.	2150-4600 MCS/sec.	4450-8000 MCS/sec.	6950-10,800 MCS/sec.
(Frequency set by means of a single directly calibrated control)				
Frequency Accuracy	±1%	±1%	±1%	±1%
Power Output	1 MW	1 MW	.2 MW	.2 MW
Attenuator Range	120 db	120 db	120 db	120 db
Attenuator Accuracy	±2 db	±2 db	±2 db	±2 db
Output Impedance	50 ohms	50 ohms	50 ohms	50 ohms
Input Power	115V±10% 60 cps	115V±10% 60 cps	115V±10% 50-1000 cps	115V±10% 50-1000 cps
Internal Pulse Modulation:				
Pulse Width	0.5 to 10 microseconds			
Delay	3 to 300 microseconds			
Rate	40 to 4000 pulses per second			
Synchronization	Internal or external, sine wave or pulse			
Internal FM:				
Type	Linear sawtooth			
Rate	40 to 4000 cps			
Synchronization	Internal or external, sine wave or pulse			
Frequency Deviation	±2.5 MCS	±2.5 MCS	±6 MCS	±6 MCS
External Pulse Modulation:				
Polarity	Positive or Negative			
Rate	40 to 4000 pulses per second			
Pulse width	0.5 to 2500 microseconds			
Pulse separation	(For multiple pulses) 1 to 2500 microseconds			
Output Synchronizing Pulses:				
Polarity	Positive, delayed & undelayed			
Rate	40 to 4000 pps			
Voltage	Greater than 25 volts			
Rise time	Less than 1 microsecond			
Size Approx. weight	17" long x 13¼" high x 15½" deep 60 lbs.		17" long x 15" high x 19½" deep 100 lbs.	

*Also available—MSG 4A: 6,950—11,500 MCS/sec.

"THE FINEST SIGNAL GENERATORS OF THEIR KIND"

Polarad

ELECTRONICS CORPORATION

43-20 34th STREET • LONG ISLAND CITY 1, N. Y.

REPRESENTATIVES • Albuquerque • Atlanta • Baltimore • Boston • Chicago • Cleveland • Fort Worth • Kansas City • Los Angeles • New York
Philadelphia • San Francisco • Seattle • St. Paul • Syracuse • Washington, D. C. • Canada, Arnprior—Export: Rocke International Corporation

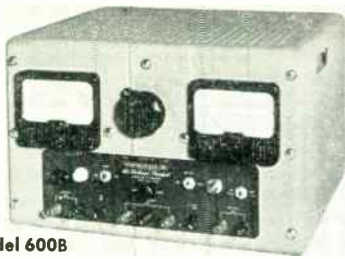

Model 600B

B-NOBATRONS

(high-voltage, low-current, regulated DC supplies).

Designed to meet the broadest technical and economical requirements. The internal impedance figures given are from measurements in accordance with IRE specifications for measurement of power supply internal impedance.

ELECTRICAL CHARACTERISTICS

Model	3258B	5608B	5008B	600B	1000B
Output voltage (VDC)	0-375	0-500	0-500	0-600	200-1000
Output current (Ma)	0-125	0-200	0-300	0-500	0-500
Reg. accuracy	±0.5%	±0.5%	±0.5%	±0.25%	±0.5%
Ripple (MV.RMS)	5 max.	5 max.	5 max.	3 max.	20 max.
Bias supply (VDC at 0-5 Ma)	0-150	0-150	0-150	0-150	none
Internal impedance (max.)	2.0 ohms	2.0 ohms	2.0 ohms	2.0 ohms	2.0 ohms
AC Input range (50-60 ~, 1ϕ)	105-125	105-125	105-125	105-125	105-125
AC voltage (C.T. unreg.)	6.3 at 10 amp.	6.3 at 10 amp.	6.3 at 10 amp.	6.3 at 15 amp.	—
Max. bias circuit impedance	25000 ohms	25000 ohms	25000 ohms	50000 ohms	—

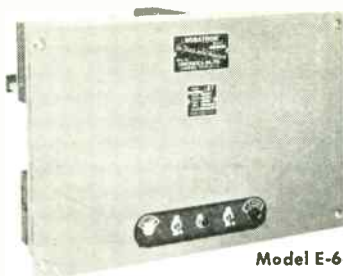

Model E-6-15A

NOBATRONS (Reg. U.S. Pat. Off.)

(low-voltage, high-current, regulated DC sources).

Provide stability comparable to batteries and eliminate recharging interruptions, fume and acid hazards, installation difficulties.

Models available (numbers indicate voltage & current) E-6-5A, E-6-15A, E-6-40A, E-6-100A, E-12-5, E-12-15, E-12-50, E-28-5, E-28-10, E-28-30, E-28-70, E-28-150, E-48-15, E-125-10, E-200-5.

ELECTRICAL CHARACTERISTICS

Input	95-130 VAC, 1ϕ, 50-60 cycles. 120/208, 3ϕ, 4-wire wye for the E-28-150. The E-28-70 requires 190/260, 1ϕ power.
Reg. accuracy	±0.2% against line, ±0.2% against load.
Ripple	Varies to 1% RMS max. under worst conditions.
Load range	1/10 to full load.
Output range	Adjustable ±10%; down to 20% at lesser accuracy.
Recovery time	0.2 seconds on all models up to 1 KW rating, increasing to 0.5 seconds at 10 KW.

Note: "A" models output either 6 or 7 volts.



Model MA65

TUBELESS REGULATED DC SOURCES

Designed for heavy-duty industrial applications, these instruments utilize magnetic amplifier principles and offer the utmost in reliability.

ELECTRICAL CHARACTERISTICS

Model	MA65	MA640	MA2850
Input (VAC, 60)	105-125, 1ϕ	105-125, 1ϕ	190-230, 3ϕ, 4-wire, wye.
Output (VDC)	6, adj. ±10%	4.5-7.7 adj.	23-32 adj.
Load range	0-5 amp.	0-40 amp.	0-50 amp.
Ripple	1% max.	1% max.	3% max.
Reg. accuracy	±1.0% for any combination of line and load.		
Recovery time	0.2 sec.	0.15 sec.	0.5 sec.

the reliable single source

The descriptions and specifications given here are necessarily brief. For further information, please send for catalogs, mentioning the instruments in which you are particularly interested.



Model 1000S

AC REGULATORS (electronic).

Utilizing the original Sorensen circuit and incorporating the Safety Diode, these regulators are noted for accuracy, economy of operation, easy maintenance. Models available with capacities from 150VA to 15KVA, single phase.

Models available (Numbers denote VA capacities) 150S, 250S, 500S, 1000S (-25 also), 2000S, 3000S (-25 also), 5000S (-25 also), 10000S (-25 also), 15000S (-25 also).

ELECTRICAL CHARACTERISTICS

Input	95-130 VAC, 1ϕ, 50-60 cycles. 190-260 VAC in "-25" models.
Output	115 VAC adj. 110-120; 230 VAC with "-25" models.
Reg. accuracy	±0.1% against line, ±0.1% against load.
P.F. range	0.95 leading to 0.7 lagging.
Distortion	Varies to 3% max. under worst conditions.
Load range	0 to full load.



Model MVR30

ISOTRANS (magnetic voltage regulators).

These magnetic voltage regulators are tubeless, give utmost reliability with good regulation. Very compact, they are ideally suited for incorporation as components. Available in capacities of 15, 30, 60, 120 VA. 250, 500, and 1000 VA models in design.

ELECTRICAL CHARACTERISTICS

Input	95-130 VAC, 1ϕ, 60 cycles.
Output	115 VAC nominal, 1ϕ.
Reg. accuracy	±0.5% against line.
Load range	0 to full load.

HERMETICALLY SEALED & MILITARIZED REGULATORS

The wound components of many Sorensen instruments can be hermetically sealed by the Fosterite process or by standard potting. Sorensen also builds equipment to meet MIL-T-27 and JAN specifications on resistance to shock, vibration, humidity, etc., as well as to the new class H type high temperature design.

REGULATED DC POWER





Model FL5015

FILTER SECTIONS FOR NOBATRONS

The ripple voltage of all Nobatrons is 1% of the nominal output voltage setting, under worst conditions. This is adequate for most applications. If, however, less ripple is required, Filter Sections are available for use with units rated up to 50 amperes, which will reduce the ripple to 0.1%.

TUBELESS DC SOURCE

Sorensen has developed a combination tubeless DC power supply and precision voltage source that is now being applied both as a laboratory bench instrument and as an incorporated component in other products.

The voltage source is line regulated and designed for specific loads, with the voltage output adjusted to specific customer requirements. Input range is 95-130 VAC, 1 ϕ , 60 cycles.



Model SR2

NOBATRON-RANGERS

(wide-range-variable regulated DC sources).

These versatile and popular instruments have electrical characteristics similar to the standard Nobatrons, except that output voltage is continuously adjustable.



Model DE-28-10

400-CYCLE INPUT NOBATRONS

These instruments are not normal production items but are available on an extended delivery schedule.

ELECTRICAL CHARACTERISTICS

Output voltage and load range	Model DE-6-40 — 6 VDC at 4 to 40 amperes. Model DE-12-10 — 12 VDC at 1 to 10 amperes. Model DE-28-10 — 28 VDC at 1 to 10 amperes.
Input voltage	105-125 VAC, 1 ϕ , 360-440 cycles.
Reg. accuracy	$\pm 0.25\%$.
Ripple	1% RMS maximum.
Recovery time	0.2 seconds.

ELECTRICAL CHARACTERISTICS

Input	95-130 VAC, 1 ϕ , 50-60 cycles for SR30 and SR100. 190-260 VAC, 1 ϕ , 50-60 cycles for the SR2.		
Reg. accuracy	$\pm 0.25\%$ at any voltage setting		
Ripple	1% RMS max.		
Output: Model	SR100	SR30	SR2
VDC	5-135	5-30	100-300
Amps	1-10	3-30	1-10

Since it pioneered the field years ago, Sorensen has been the acknowledged leader in electronic power control. Its standard line includes a wide variety of instruments in a broad range of capacities to meet practically any need. Standard items can usually be delivered quickly in reasonable quantities. Sorensen invites your inquiries concerning special instruments to meet unusual conditions.

Sorensen

for regulated power needs

See the Sorensen line at the IRE Show — Booth 646, Circuits Avenue

AC LINE REGULATION

400-CYCLE AC REGULATORS

These instruments are available in capacities of 250VA, 500VA, 1200VA, and 2500VA.

ELECTRICAL CHARACTERISTICS

Input	95-130 VAC, 1 ϕ , 400 cycles $\pm 10\%$.
Output	115 VAC, 1 ϕ , adj. 110-120.
Reg. accuracy	$\pm 0.5\%$ against line, $\pm 0.5\%$ against load.
Distortion	5% maximum.
P.F. range	0.95 leading to 0.7 lagging

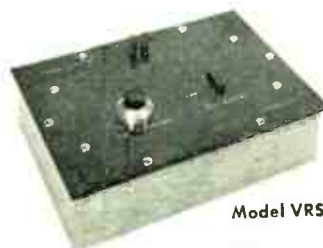

Model VRS-AC10

AC VOLTAGE SOURCES

These instruments provide highly stable AC voltage for many laboratory uses such as the direct calibration of voltmeters and oscilloscopes.

ELECTRICAL CHARACTERISTICS

Input voltage	Model VRS-AC 10 105-125 VAC, 1 ϕ	Model VRS-AC 750 60 cycles ± 5
Input frequency	50-60 cycles; also to 400 cycles with minor loss of accuracy	60 cycles ± 5
Output voltage	10 mv to 10 v in 3 ranges	1-799 v in 1 v steps
Calibration accuracy	$\pm 0.1\%$	overall accuracy $\pm 0.1\%$
Reg. accuracy	$\pm 0.25\%$ with line; $\pm 0.25\%$ with load of .5 megohm or higher	1% maximum
Distortion (generated by instrument)	negligible	1% maximum

SEE NEXT PAGE



Model 1001

PRECISION AC REGULATORS (electronic).

Giving ultra-precise, $\pm 0.01\%$ regulation, these instruments are rugged and serviceable, as proved by hundreds of applications in the field. Models available with capacities of 1000VA and 2500VA.

ELECTRICAL CHARACTERISTICS

Input	95-130 VAC, 1 ϕ , 50 and 60 cycles.
Output	115 VAC, 1 ϕ , adj. 110-120.
Reg. accuracy	$\pm 0.01\%$ against line, $\pm 0.01\%$ against load.
Distortion	3% maximum.
P.F. range	0.95 leading to 0.7 lagging.
Load range	0 to full load.

for regulated power needs

400-CYCLE FREQUENCY CHANGERS

ELECTRICAL CHARACTERISTICS

Input	95-130 VAC, 1 ϕ , 50-60 cycles for 250 VA instrument; 208 or 230 VAC \pm 10%, 1 ϕ , 50-60 cycles for 1000 VA.
Output voltage	115 VAC, adjustable \pm 10%.
Output frequency	400 cycles, adjustable \pm 10%.
Reg. accuracy	Voltage — \pm 1.0%. Frequency — \pm 1.0% in standard model, \pm 0.01% with auxiliary frequency standard.
Capacity	0-250 VA in FCD250; 0-1000 VA in FCD1000.

FREQUENCY CONTROL

Sorensen electronic frequency changers convert 50 or 60 cycle line to 400 cycles regulated or 60 cycles regulated. These instruments have found manifold uses in laboratories, production lines and inspection sections.



60-CYCLE FREQUENCY CHANGER (Model FC1000)

ELECTRICAL CHARACTERISTICS

Input	208 or 230 VAC, \pm 10%, 1 ϕ , 50-60 cycles.
Output voltage	115 VAC, adjustable \pm 10%.
Output frequency	60 cycles, adjustable 45-63 cycles.
Reg. accuracy	Voltage — \pm 1.0%. Frequency — \pm 1.0% in standard model, \pm 0.01% with auxiliary frequency standard.
Capacity	0-1000 VA.

AIRBORNE ELECTRONIC FREQUENCY CHANGERS AND INVERTERS

Sorensen has designed and built a wide variety of frequency changers and inverters for incorporation in military aircraft. These instruments meet a great many different specifications and are not considered standard instruments. Each customer requirement is quoted on individually. For the most part, the changers convert variable (320-1000~) input power to precision (\pm 0.05%) output frequency. Most models are also voltage regulated (\pm 1%) with minimum distortion (5-10%).

Sorensen airborne inverters are built to convert 28 VDC input to 400-cycle, 3-phase output, with output frequency accurate to 0.05% over wide ambients.

Sorensen's wide experience with commercial and military frequency changers may well supply the answer to your precision frequency problems. Your inquiries are earnestly solicited.

COAST-TO-COAST

The authorized Sorensen representatives listed below are at your service. Do not hesitate to call on the one nearest you for advice on regulated power requirements.

CALIFORNIA — Hollywood 28
Gerald B. Miller Co.
1550 N. Highland Ave.
Phone Hollywood 2-1195

CALIFORNIA — San Francisco
Gerald B. Miller Co.
1334 Old County Rd., Belmont
Phone Lytell 3-343B

COLORADO — Denver 3
Hytronic Measurement Associates
446 Broadway
Phone Sherman 2501

CONNECTICUT — Bridgeport
Yewell Associates (Peter Lahana)
1101 East Main Street
Phone 66-0000

D. C. — Washington 9
Horman Associates (F. L. Horman)
2017 S. Street, N.W.
Phone Decatur 2-8000

FLORIDA — Fort Myers
Arthur H. Lynch & Associates
P.O. Box 466
Phone 5-6762

GEORGIA — Atlanta
Floyd Fausett & Son
777 Pinehurst Terrace, S.W.
Phone Raymond 3104

ILLINOIS — Chicago 39
Loren F. Green & Associates
4949 W. Diversey Avenue
Phone National 2-2370

KENTUCKY —
H. A. Watson, Jr.
817 Citizens Bldg.,
Cleveland 14, O.
Phone Tower 1-1947

MASSACHUSETTS — Boston
Yewell Associates (Paul G. Yewell)
751 Main Street, Waltham
Phone Waltham 5-7420

MICHIGAN — Detroit
S. Sterling Company
15310 W. McNichols Road
Phone Broadway 3-2900

MISSOURI — Kansas City 30
Harris-Hanson Co. (R. C. Bacon)
7916 Paseo Ave.
Phone Hiland 6744

MISSOURI — St. Louis 9
Harris-Hanson Co.
(Harold H. Harris)
5506 South Kingshighway
Phone Flanders 1-5584

NEW JERSEY (Northern)
RMC Associates (Chas. Sargeant)
114 East Main Street, Bogota
Phone Diamond 2-5343

NEW JERSEY (Southern)
I. E. Robinson Co. (Leon Levy)
702 Mattison Ave., Asbury Park
Phone Allenhurst 3-2402

NEW MEXICO — Albuquerque
Gerald B. Miller Co.
327 Wyoming, S.E.
Phone 5-6466

NEW YORK — New York
RMC Associates (Robert Asen,
Milton Lichtenstein)
170 East 80th Street
Phone Trafalgar 9-2023

NEW YORK — Syracuse 2
J. D. Ryerson Associates, Inc.
412 E. Genesee Street
Phone Syracuse 76-B344

NORTH CAROLINA — Charlotte
James L. Highsmith
P.O. Box 1011
Phone 5-6436

OHIO — Cleveland 1B
S. Sterling Co.
4040 Mayfield Rd.
Phone Evergreen 2-4114

OHIO — Dayton 2
Charles D. Boehme
Talbot Building
Phone Fulton B1BB

OREGON — Portland 14
James L. Kearns Company
902 Weatherly Bldg.
Phone Empire 2444

PENNSYLVANIA — Harrisburg
I. E. Robinson Co.
37A Thomas St.
Phone Harrisburg B-9054

PENNSYLVANIA — Philadelphia
I. E. Robinson (Ivan E. Robinson)
7404 W. Chester Pike,
Upper Darby, Pa.
Phone Flanders 2-7017

PENNSYLVANIA — Stroudsburg
I. E. Robinson Co.
P.O. Box 68
Phone 1519

PENNSYLVANIA — Pittsburgh
H. E. Ransford Co. (Sam Coombs)
Grant Building
Phone Grant 1-1880

TENNESSEE — Knoxville
A. R. Haugh Co.
P.O. Box 1452
Phone Knoxville 7-6660

TEXAS — Dallas 5
Earl W. Lipscomb Associates
P.O. Box 8042
Phone Elmhurst 5345

TEXAS — Houston
Earl W. Lipscomb Co.
2422-A Rice Blvd.
Phone Linden 9303

WASHINGTON — Seattle B
223 Administration Bldg.
Boeing Field (Box 63)
Phone LA 4503

HAWAII — Honolulu 17
Gene Piety
2030 Home Rule St.

CANADA — Vancouver 5, B.C.
Frederick Goertz, Ltd.
1170 Hobson St.
Phone Tatlow 5377

CANADA — Toronto 10, Ontario
Charles W. Pinton
6 Alcina Ave.
Phone Oliver 7984

SORENSEN & CO., INC., 375 FAIRFIELD AVE., STAMFORD, CONNECTICUT

WRITE FOR LITERATURE

Sorensen's general catalog No. 254 is yours for the asking. Catalogs and engineering data sheets are also available for the AC Magnetic Voltage Regulators and the AC and DC voltage sources, all of which have been brought out since publication of the general catalog. Inquiries about special regulation problems are welcome. Address the Sales Engineering Department, Sorensen & Co., 375 Fairfield Avenue, Stamford, Conn.





Famous Kings in History

As King of Israel in the 10th Century B C., King Solomon made many foreign alliances and his reign was eminently peaceful. He erected the famous Temple at Jerusalem. Solomon's wisdom has long been proverbial throughout the world.



UG-643/U



UG-569/U



UG-571/U



UG-573A/U

FAMOUS KINGS CONNECTORS

C SERIES

It has long been considered wise to consult with Kings about connector problems. Throughout the world, in all industry, aviation and electronics, engineers specify Kings Connectors for their most particular requirements. For Kings merges competitive production ability with basic research to give you the best in "solid contact" connectors. You'll be glad you called on Kings first.



KINGS *Electronics* CO., INC.
40 MARBLEDALE ROAD, TUCKAHOE 7, N. Y.

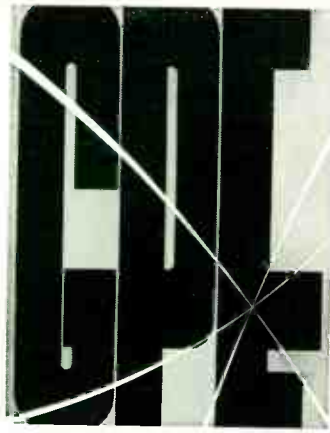

SERVES INDUSTRY

THROUGH *coordinated*

CAPACITIES									
PRECISION MECHANICS and CERAMICS									
ELECTRICAL EQUIPMENT and COMPONENTS									
HYDRAULICS and LIQUIDS HANDLING									
PROFESSIONAL and INDUSTRIAL TELEVISION EQUIPMENT									
INSTRUMENTATION									
SERVOS and CONTROLS									
AUTOMATIC COMPUTERS and COMPONENTS									
ULTRASONICS									
RADAR and MICROWAVE									
MOTION PICTURE and SOUND EQUIPMENT									
OPTICAL DEVICES									

Company	Manufacturing	Manufacturing and product development	Manufacturing, product development and research	Pilot manufacturing, product development and research
Simplex	■	■	■	■
Peerless	■	■	■	■
General Precision Laboratory	■	■	■	■
The Hertzner Electric Company	■	■	■	■
Kearfott	■	■	■	■
AMPRO	■	■	■	■
Link	■	■	■	■
Sperry	■	■	■	■
ASKANIA	■	■	■	■
DRACO	■	■	■	■
FIRRASCOPE	■	■	■	■

- Manufacturing
- Manufacturing and product development
- Manufacturing, product development and research
- Pilot manufacturing, product development and research

THE PRODUCING COMPANIES



INTERNATIONAL PROJECTOR CORPORATION — BLOOMFIELD, N. J.



J. E. McAULEY MFG CO CHICAGO



GENERAL PRECISION LABORATORY INCORPORATED — PLEASANTVILLE, N. Y.



THE HERTNER ELECTRIC COMPANY — CLEVELAND



KEARFOTT COMPANY, INC. LITTLE FALLS, N. J.

One of a series telling
how the producing companies of
General Precision Equipment Corporation
are contributing to America's progress.

precision technology

GPE Coordinated Precision Technology is the basic GPE operating policy which inter-relates the research, development and manufacturing facilities, techniques and capabilities of the producing companies of General Precision Equipment Corporation. Thus each company's specialization in its particular areas of competence is supplemented by the application of the resources of the other companies, wherever relevant. A diversified line of advanced precision equipment of superior design and performance has resulted from this application of the newest and most advanced techniques possessed among the companies in every technical capacity.

e.g. in

ELECTRONICS

Ten of the GPE Producing Companies work in this important field. These companies were "born in electronics" and pioneered in its development before the word was coined. Their work covers every phase of electronics and GPE coordination relates each new electronic problem to the specialized knowledge and experience which is most valuable. This secures the optimum solution for the customer with minimum expenditure of time and money.

GPE Producing Companies have been re-

sponsible for the research, development and manufacture of a wide range of electronic precision components, equipment and systems, including Theatre Sound Systems, Sonar Equipments, Flight Simulators, Industrial Control Systems, Analogue Computers, Digital Computers and Components, Industrial and Studio Television, Navigation Systems—both airborne and marine. GPE systems, in most instances, are advanced concepts, often employing components specifically developed for the purpose by one of the GPE companies. Of the great number, two are shown.



Kearfott X-band Test Set, frequency range 8,500 to 10,000 MC; a unique all-purpose portable radar test set, comprising a power monitor, spectrum analyzer, wave-meter and signal generator which supplies an accurately calibrated signal of known level with variable amplitude and pulse-width combinations. Also provides FM, square wave and CW output.



Librascope X-Y Plotter and Recorder; automatically displays data derived from punch cards, mechanical or electronic computers or sensing elements; features rapid graphic 2-axis display with provision for 10-fold scale expansion and zero suppression. Used in aero-dynamic and electronic research, as well as in mass data reduction systems for business and industry.

Most advanced technological products which utilize electronics also call for other advanced technological skills. Though space allows only for an outline of GPE's work in electronics, both the capacities chart on the

facing page and most of the products mentioned above serve to suggest the broad coordination of technical capacities in all fields which exists as a result of GPE Coordinated Precision Technology.

Address inquiries to:

GENERAL PRECISION EQUIPMENT CORPORATION

92 GOLD STREET, NEW YORK 38, NEW YORK



AMPRO CORPORATION
CHICAGO



LINK AVIATION, INC.
BINGHAMTON, N. Y.



THE STRONG ELECTRIC
CORPORATION—TOLEDO



ASKANIA REGULATOR
COMPANY—CHICAGO



BLUDWORTH MARINE
NEW YORK



LIBRASCOPE, INCORPORATED
GLENDALE, CALIFORNIA



All wound up
*trying to make your own
 R. F. Choke Coils?*
 Standardize on **Jeffers**
RF. Choke Coils-
*save time, labor
 and expense*

Other Jeffers Products

ceramic capacitors • disc capacitors
 high voltage condensers • capristors

**Other Speer Products
 for the Electronics Industry**

anodes • contacts • resistors • iron cores
 discs • brushes • molded notched* coil forms
 battery carbon • graphite plates and rods

* Patented



Jeffers Electronics Division
 Speer Carbon Co.
 Du Bois, Pennsylvania

Other Divisions: Speer Resistor, International Graphite & Electrode

Now you can stock a wide range of R. F. choke coils just as you do resistors, capacitors and other similar components.

Jeffers Electronics is ready to deliver to you a complete line of R. F. choke coils with the widest range of inductance values available. No longer do you have to waste time, labor and money on slow, tedious hand assembly from miscellaneous forms, wires and coatings.

Instead you receive a standardized product from Jeffers, completely assembled and ready for use. Coils that are well made, too. Insulated copper wire instead of bare wire for windings . . . husky, molded jackets instead of those fastened by glue. All windings are soldered to leads . . . shorted end-turns completely eliminated.

Why not give Jeffers R. F. choke coils a try on your next order? *Write today for our specification sheets.*

FOR

- SYNCHROS
- SERVO MOTORS
- RESOLVERS
- TACHOMETER GENERATORS
- AMPLIFIERS
- AIRBORNE INSTRUMENTS

FOR

A SINGLE PROTOTYPE
... OR 10,000 UNITS

FOR

BASIC RESEARCH
WHERE STANDARD
CONCEPTS ARE
NOT APPLICABLE

FOR A Complete Variety Of Sizes And Types

Look to

NORDEN-KETAY

AMPLIFIERS AND GEAR TRAINS



Amplifiers can be made in open, dust-proof or hermetically sealed packages. They can be individually designed and modified to meet customer's electrical, mechanical and environmental specifications. Gears and gear trains of conventional and miniaturized types are available to meet the most demanding of design requirements.

MAGNETIC AMPLIFIERS

Magnetic Amplifiers are designed for use in Servo Systems employing two phase low inertia induction motors. They require no external tubes or separate bias, and operate directly from a line supply. They employ the latest half-wave self-saturating circuitry, insuring low response time, high gain and compactness. The half wave reset mode of operation of these units supplies very desirable quadrature rejection. These Magnetic Amplifiers are noted for long life, ruggedness, and dependability.

RESOLVER AMPLIFIERS

Resolver Amplifier Systems are made for precision resolver applications where accuracy, isolation, and reliable operation under severe environmental conditions is paramount. Subminiature packaging techniques, preferred type tubes and quality components assure reliability, compactness and long life. Two basic system types are standard: a system connection employing summing resistors; the other, where the input signals are series summed with the compensating winding signal and fed to the grid of the high gain amplifier.

SERVO AMPLIFIERS

Dual Channel Servo-Amplifier, Type SEA 4-310, is made for servo-systems using miniature two-phase servo motors. Each amplifier channel is capable of accepting input error information, either in-phase or 90 degrees out of phase with the line of reference. Separate input terminals are provided for these inputs. For in-phase signals, the amplifier circuits provide the required 90 degrees phase shift for operation of the servo motor. Hence, the motor fixed field can operate without external phasing capacitors. Tuning capacitors for motor control fields are provided as integral part of each amplifier for power factor correction.

CONTROL DEVICES



Many control devices, designed and developed by Norden-Ketay engineers, are being produced in mass quantities. Custom engineered units, featuring resistance to humidity, corrosion and high temperatures, or having special configuration and other non-standard characteristics, will be made to meet the needs of your particular application.

Norden-Ketay designs and manufactures a large variety of airborne instruments for engine and flight operation, for many aircraft, missile, marine, ordnance and civilian applications. Included are many special designs insuring a high level of performance, while meeting limitations of space and operating conditions. Norden-Ketay research laboratories are staffed and equipped to co-operate with engineers that find a need for electronic control devices in their particular project.



AVAILABLE UPON REQUEST
... additional copies of this Bulletin No. 355
... more complete technical data
... consultation with our sales Engineers

NORDEN-KETAY CORPORATION

99 Park Avenue, New York 16, New York

New York, N. Y. • Milford, Conn. • Commack, L. I., N. Y. • Hawthorne, Calif. • White Plains, N. Y.

Subsidiaries: Vari-ohm Corporation, Amityville, L. I., New York. • Nuclear Science and Engineering Corporation, Pittsburgh, Pa.

ALSO SPECIALISTS IN POTENTIOMETERS • SYNCHRO OVERLOAD TRANSFORMERS
SERVO MECHANISMS • GYRO COMPONENTS • COMPUTERS • DIGITAL CONVERTERS
FIRE CONTROL SYSTEMS • NAVIGATIONAL SYSTEMS

Visit Our Booth
at the
I.R.E. SHOW
Exhibit 629-631
Kingsbridge Armory

NOT FOR SALE!

(YET)

**THIS
TRANSISTORIZED
TELEMETER
IS ONLY A
"PROGRESS REPORT"**



This 3-channel transistorized telemeter although not yet available for sale as standard equipment, is indicative of the advanced thinking of **Bendix-Pacific** engineers and represents another example of this Division's efforts to have new designs available in advance of rapidly expanding instrumentation requirements. This particular unit includes a transmitter and three subcarrier oscillators, all encapsulated as a single plug-in component. Although present development has been confined to the solution of special instrumentation problems, a possible pattern for future telemeters is indicated. The special features of transistorized components — extremely high shock resistance — low heat generation — very low power consumption — small size — light weight — provide design tools for a major advance in instrumentation techniques.

*Imagination at **Bendix-Pacific** today is building better products for tomorrow.*

PACIFIC DIVISION • Bendix Aviation Corporation

11600 Sherman Way, North Hollywood, California

East Coast Office: 475 5th Ave., N. Y. 17	Dayton, Ohio 1207 American Blvd., Dayton 2, Ohio	Washington, D. C. Suite 803, 1701 "K" St., N. W.	Canadian Distributors: Aviation Electric, Ltd., Montreal 9	Export Division: Bendix International 205 E. 42nd St., N. Y. 17
---	--	--	--	---



Good positions are available at all levels for Electronic Design Engineers. Contact W. C. Walker, Engineering Employment Manager.

CHATHAM EQUIPMENT DIVISION...

Standard and Custom Constructions

The Equipment Division of Chatham Electronics specializes in the design and manufacture of electronic equipment for government, industrial, communication and research organizations. The types of equipment produced are highly diversified. Typical examples include electronic switches, sonar equipment, test sets, speech amplifiers and modulators, high power pulse generators to 60 megawatts, ultra-stable power supplies, induction heaters, tube production, life test equipment, and many others.



Ultra Stable Power Supply System

Sonar Test Equipment

Chatham engineers are available for consultation on problems involving custom equipments. For estimates on your requirements . . . call or write.



CHATHAM RADAC DIVISION...

Pioneer Developer and Producer of Atomic Energy Instrumentation Equipment

The Chatham Radac Division is a pioneer developer of Atomic Energy Instrumentation Equipment of unusual design. For example, portable and field equipment of this type was formerly battery powered. Battery life, corrosion and logistics were a constant problem. By the application of new methods of power generation, batteries are no longer required. Further, in some cases even the tubes are replaced by a compact, trouble-free electro-mechanical amplifier. Similar advances are reflected in Chatham Radac Detector Chargers, Rate Meters, Dosimeters, Influence Generators, etc.



Operating tests of all Chatham Radac Chargers employ Dosimeters of various manufacture.

Model XA-100 Radac Detector Charger — compact, easy to use, this unit is completely self contained . . . requires no batteries.



CHATHAM RECTIFIERS



Type 1Z2
A high voltage vacuum rectifier for constant supply circuits. Filament 1.25 volts, 275 ma. Peak inverse anode voltage 15,000. Aver. anode current 1.5 ma.

Type 3B25
Half wave, Xenon Rectifier. Wide ambient range -75° to +90° C. Filament 2.5 volts 5.0 amp. Peak inverse anode voltage 4500. Aver. anode current 0.5 amp.



Type 3B28
Half-wave, Xenon rectifier. Wide ambient range -75° to +90° C. Filament 2.5 volts 5.0 amps. Peak inverse anode voltage 10,000. Aver. anode current 25 ma.

Type 4B32
Half-wave, Xenon rectifier. Wide ambient range -75° to +90° C. Filament 5 volts, 7.5 amps. Peak inverse anode voltage 10,000. Aver. anode current 1.25 amp.



Type 5R4WG1
Full wave rectifier ruggedized to stand 980 g shock Max. inverse voltage 2800 volts or inverse voltage 2400 volts at 27 milliamperes.

Type 5R4WGA
Same as 5R4WG1 but designed to operate at full inverse ratings up to 40,000 ft. altitude and at reduced rating to 60,000 ft. altitude.



Type 6H6WGT
Ruggedized twin diode with octal base. Heater 6.3 volts 300 ma. Peak inverse anode voltage 465 volts. D.C. output current 8.8 ma. per plate.



Type 6AL5W
Ruggedized miniature twin diode. Heater 6.3 volts, 0.3 amp. Peak inverse anode voltage 330. D.C. output current per plate 9 ma. max.



Type 5R4WG1
A reliable version of the 5R4WGA designed and manufactured to MIL-1B reliable tube specifications.

AT THE I. R. E. SHOW!
Visit the Chatham exhibit at
Booths 474, 476 and 478
ELECTRONIC AVENUE

Kingsbridge Armory
New York City

March 21st to 24th, 1955

Division of GERA CORPORATION



CHATHAM

World Radio History

CHATHAM THYRATRONS

Type 2D21
 Neon filled, shielded thyatron for delay-pulse and grid controlled rectifier service. Heater 6.3 volts, 6 amp. Peak inverse anode voltage 1300, average anode current 100 ma.



Type 2D21W
 Similar to 2D21 except ruggedized to conform to MIL-E-1B specifications.

Type 3C23
 Mercury Vapor Argon filled thyatron for grid controlled rectifier service. Wide ambient temperature tolerance. Medium pin phenolic base. Medium metal top. Heater 2.5 volt 7.0 amperes; peak inverse anode voltage 1250 volts; average anode current 1.5 amps.



Type 3C23B
 Same as 3C23 but has medium shell 5 pin base and small top cap.

Type 2050
 Neon filled, shielded thyatron for grid controlled rectifier service. Heater 6.3 volts, 6 amp. Peak inverse anode voltage 1300, average anode current 100 ma.



Type 2050W
 Similar to 2050 except ruggedized to conform to MIL-E-1B specifications.

Type 394-A
 Mercury vapor and Argon filled thyatron for grid controlled rectifier service. Wide ambient temperature tolerance. Heater 2.5 volts, 3.2 amps. Peak inverse anode voltage 1250, aver. anode current 640 ma.



Type 5594
 Neon filled thyatron. Operates in ambient temperatures from -55° to +90°C. Filament 2.5 volts, 5 amps. Peak inverse anode voltage 500, aver. anode current 0.5 amp.



Type 884
 Argon filled thyatron for use as sweep circuit oscillator in CRT circuits. High stability. Heater 6.3 volts, 0.6 amp. Peak forward anode voltage 300, aver. plate current 75 ma.



Type 885
 Similar to Type 884 except heater rating of 2.5 volts, 1.5 amp. Both the 884 and 885 are suitable for grid controlled rectifier applications as well as sweep circuit oscillators.



Type 395-A
 A cold cathode thyatron. Requires no filament supply. For grid controlled rectifier and relay applications. Max. D.C. anode voltage 150, Max. anode current 10 ma.



Type 359-A
 Cold cathode thyatron. No filament supply needed. Suitable for grid controlled rectifier and relay applications. Max. D.C. anode voltage 180, max. anode current 12 ma.



CHATHAM HYDROGEN THYRATRONS...

Chatham Hydrogen Thyratrons are the product of many years of concentrated experience in this specialized field. Embodying the most advanced developments in the art, many of which were pioneered by Chatham, these tubes offer uniformly high performance when employed in

the generation of pulse voltages in the order of micro-seconds.



Type VC-1257
 Hydrogen filled, zero bias thyatron with hydrogen generator for generation of pulse power up to 33 megawatts.



Type 5948/1754
 Hydrogen filled, zero bias thyatron with hydrogen reservoir for generation of peak pulse power up to 12.5 megawatts.



Type 5949/1907
 Hydrogen filled, zero bias thyatron with hydrogen reservoir for generation of peak pulse power up to 6.25 megawatts.



Type 5C22
 Hydrogen filled, zero bias thyatron with hydrogen reservoir for generation of peak pulse power up to 2.6 megawatts.



Type VC-1258
 Zero bias miniature hydrogen thyatron for the generation of peak pulse power up to 10 KW.

ELECTRICAL DATA*

Type	VC-1258	5C22	5949/1907	5948/1754	VC-1257
Maximum Peak Forward Anode Potential	1000 volts	1600 volts	25000 volts	25000 volts	33000 volts
Maximum Peak Anode Current	20 amps	325 amps	500 amps	1000 amps	2000 amps
Maximum Average Anode Current	0.05 amps	0.200 amps	0.50 amps	1.0 amps	2.0 amps
Maximum Heating Factor (epy x prr x ib)	1.0x10 ⁸	3.2x10 ⁹	6.25x10 ⁹	9.0x10 ⁹	20.0x10 ⁹
Nominal Filament Power	12.6 watts	67 watts	95 watts	190 watts	230 watts
Hydrogen Reservoir	No	Yes	Yes	Yes	Yes

*More detailed information on electrical and mechanical data will be supplied on request.

TWIN POWER TRIODES...



Type 6336
 Low mu, high perveance twin power triode for use as a series regulator tube in D.C. power supplies. Plate Dissipation 30 watts per sect.; Amplification Factor 2.7; Plate Resistance 250 ohm per sect.; Plate Current 165-200 ma per sect.; Heater 6.3 volts 4.75 amps total for both sections.

Type 6394
 Same as Type 6336 with 26.5 volt 1.25 amp. heater.



Type 6A57G
 Low mu, high perveance twin power triode for use as a regulator tube in D.C. Power Supply Units. Plate dissipation 13 watts per sect.; Amp. Factor 2.0 per sect.; Plate Res. 280 ohms per sect.; Heater 6.3 volts 2.5 amperes total for both sections.



TYPE 6520
 Characteristics same as 6A57G but intended for applications where utmost reliability is required in respect to triode balance, absence of excessive plate current drift and high grid to plate insulation.

SIE

MODEL D-1

DIRECT-COUPLED AMPLIFIER



for reliable amplification of low-level signals in:

COMPUTER DESIGN • CHEMICAL, BIOLOGICAL AND MEDICAL INVESTIGATIONS • VOLTAGE MEASUREMENT • VIBRATION ANALYSIS

The SIE Model D-1 Direct-Coupled Amplifier offers high gain, wide dynamic range, and extremely low distortion in a design which favors a wide range of laboratory investigations. Unique input "zeroing" circuit allows small voltages to be read "full-scale." Meter on front panel provides direct reading information.

- Single-ended or Differential Input
- Self-contained Power Supply (No batteries required)
- Wide frequency range
- Relay rack or bench mounting

Specifications:

GAIN: 80,000 at 50 kc. (1,000 at 120 kc.)
INPUT IMPEDANCE: 10 Megohms or open grid
INPUT NOISE: Less than 10 microvolts
MAXIMUM INPUT SIGNAL: 18 volts rms.
MAXIMUM OUTPUT SIGNAL: 80 volts (Distortion less than 1%)
DRIFT: Less than three millivolts per hour
IN-PHASE REJECTION RATIO (Differential input): More than 1500 to 1 at gain of 1000.

SIE

Price: \$515

SOUTHWESTERN INDUSTRIAL ELECTRONICS CO.
INDUSTRIAL INSTRUMENT DIVISION

P. O. Box 13058 2831 Post Oak Road Houston, Texas

REPRESENTATIVES THROUGHOUT THE WORLD

204-55



(Continued from page 77A)

lating Equipment for Handling High Level Radioactive Materials." A 16 mm film showing installations and operations was also exhibited.

The Chicago Chapter met again on October 22. Donald H. Loughridge, Dean of the Technological Institute at Northwestern University, presented a paper called "The Present Status of Nuclear Power Development."

"An Up-To-Date Survey of Elementary Particles" was the paper presented by Bernard Hamernesh, Argonne National Laboratory, at the meeting of the Chicago Chapter on November 19. Dr. Hamernesh outlined the known properties of the three additional types of elementary particles discovered in the past seven years.

QUALITY CONTROL

On October 1 the Chicago Chapter of the Professional Group on Quality Control met. C. Mydill, Director of quality control at Motorola, spoke on supplier-consumer relations. Mr. Mydill outlined the quality control organization at Motorola and its mode of operation.

VEHICULAR COMMUNICATIONS

On December 1 the Detroit Chapter of the Professional Group on Vehicular Communications met at the Engineering Society of Detroit. E. C. Denstaedt, R. Donovan, R. Karber, and J. McFatrige described the Palmer Park OCD Radio Control Center. Added information on the wire line facilities was presented by Sherman Lister of the Michigan Bell Telephone Company. Officers for this year were elected: Chairman, A. B. Buchanan; Vice-Chairman, R. J. DeHaan; Secretary-Treasurer, J. G. Nauman.



AKRON

"Contouring with Electronic Machine-Tool Controls," by N. B. Nichols, Raytheon Manufacturing Company; December 14, 1954.

"The Amplifier as a Link in the Chain of Audio Reproduction," by J. P. Overley, Radio Manufacturing Engineers, Inc.; January 18, 1955.

ALBUQUERQUE-LOS ALAMOS

"Application of Radiation Techniques," by Dr. R. S. Wilson, General Electric; December 14, 1954.

ATLANTA

Tour of Pan-Electronics Corp., conducted by J. R. Blasingame; December 8, 1954.

BALTIMORE

"Color Television Broadcasting," by J. L. Hathaway, National Broadcasting Company; January 12, 1955.

(Continued on page 112A)

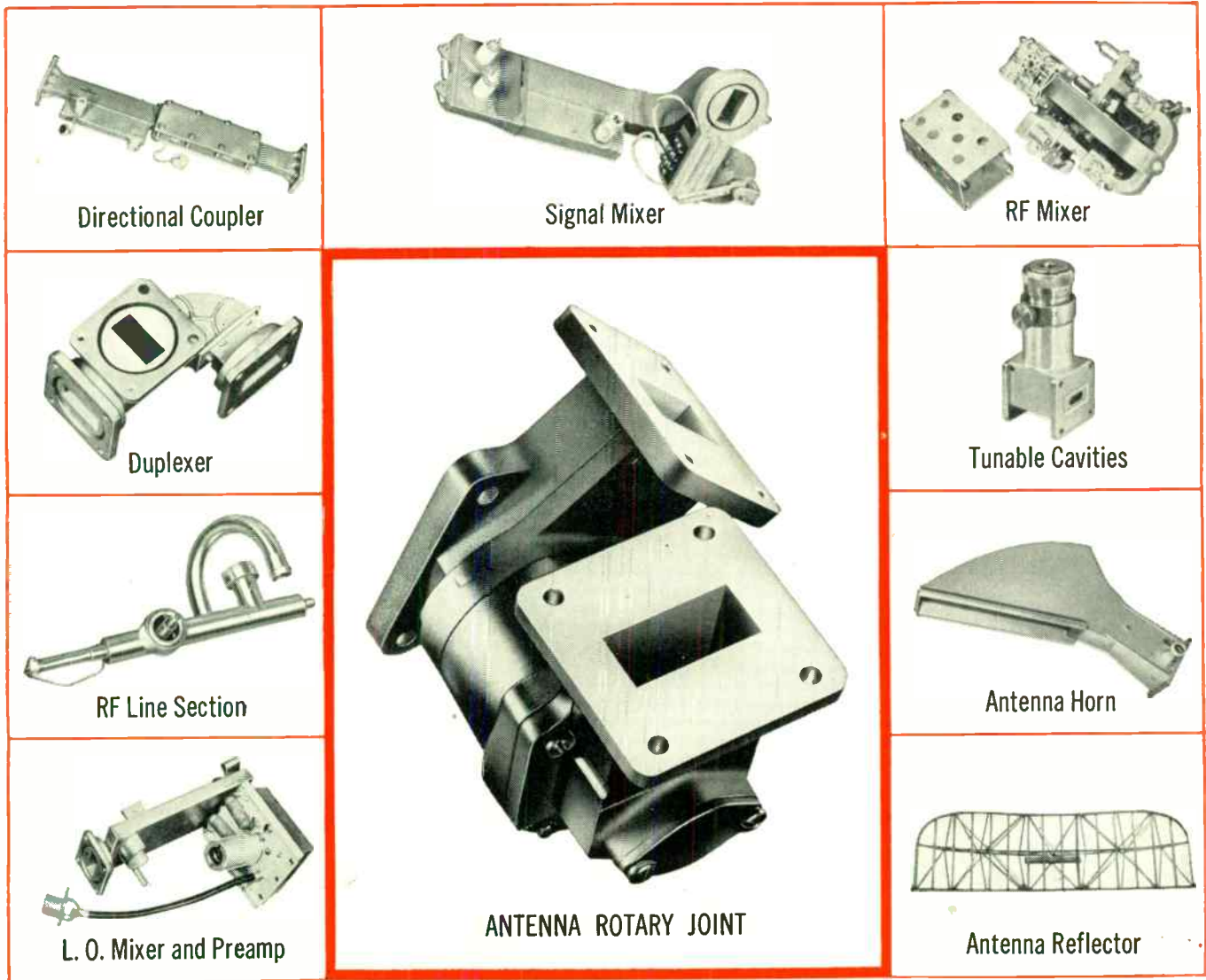

NEW—Raytheon Microwave Assemblies

**STANDARD—OR PRODUCED
TO YOUR OWN EXACT SPECIFICATIONS**

Typical of Raytheon's new line of precision microwave assemblies is the Antenna Rotary Joint which handles high power over a wide bandwidth and permits full use of the newer magnetrons' wider tuning ranges.

Raytheon—long a leader in radar and other microwave equipment—now offers to others its unexcelled design, production, and test facilities. Whether you are interested in an entire microwave system or a single component, we would appreciate hearing from you. There's no obligation.

WRITE FOR CATALOGUE NO. 5-200

Raytheon Manufacturing Company
Equipment Marketing Division
100 River Street, Waltham 54, Mass.



BROADBAND, HIGH POWER ANTENNA ROTARY JOINT

Couples rotating antenna to X-band microwave system. Power capacity: 250 KW @ .001 duty cycle.

Coaxial rotary section; standard rectangular input and output flanges.

Unique design for transition from rectangular to coaxial section provides greater power-handling capacity and superior electrical performance.

VSWR less than 1.07:1 over 11% bandwidth; VSWR of 1.10:1 maximum over greater bandwidth.

Small size, minimum weight. Can be pressurized to 30 P.S.I.

Visit Raytheon, Booth 147, I. R. E. Show, Kingsbridge Armory

FOR **KLYSTRONS AND TRAVELLING WAVE TUBES**

SPERRY CAN MEET



IN RADAR DEFENSE, Sperry's Multi-Megawatt Klystrons hold frequencies 20 to 200 times closer than conventional radar limits, permit obtaining improved information from search radars.



IN GUIDED MISSILES, Sperry's Multi-Megawatt Klystrons make possible more accurate control of missiles, permitting guidance over longer paths.



IN COMMUNICATIONS, Sperry's low powered microwave beam tubes are providing years of trouble-free service at unattended relay stations.



IN CONTINENTAL DEFENSE, Sperry's microwave beam tubes meet the needs of military radars and communications' networks which protect our shores.



IN TELEVISION, present Sperry Klystrons extend TV microwave networks. More improvements in TV transmission are possible with new Sperry microwave beam tubes.

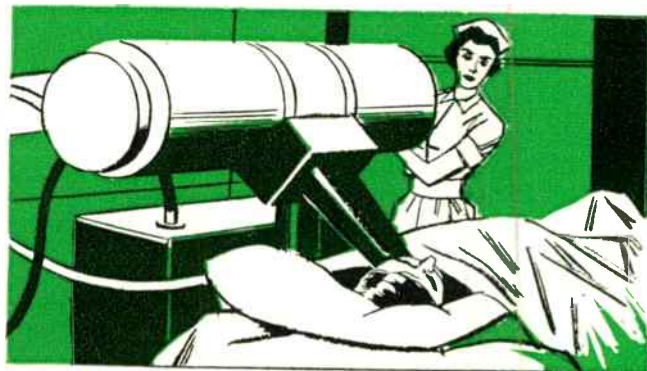

IN MEDICINE, newly developed linear accelerators give promise of improved X-ray treatment.

YOUR NEEDS



IN ATOMIC ENERGY, Sperry's Multi-Megawatt Klystrons provide stable driving power for atom smashers and high energy X-ray devices for scientific research.

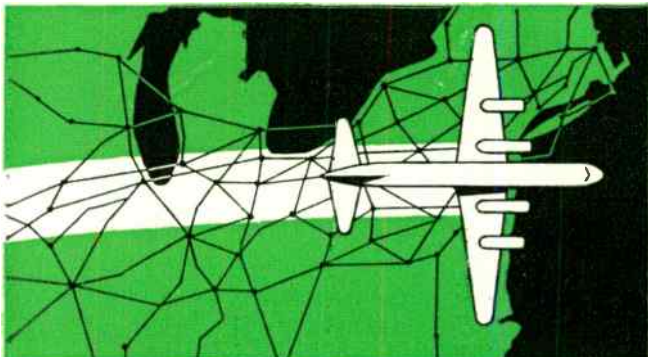

IN AIR NAVIGATION, Sperry Klystrons power a military radio system to guide air traffic precisely.

This is the 17th year of continuous development and production of microwave tubes by Sperry. Out of this experience has come a wide range of tubes for today's important microwave uses, covering frequencies from 200 mc. to 40,000 mc., and with power from a few milliwatts to many million watts. Sperry microwave beam tubes meet military and industrial requirements because of their dependability and economy.

Tomorrow's needs of the development engineer in advanced system design will be aided by the specialized knowledge of new microwave beam tube development available at Sperry.

The facilities of the Sperry laboratories, devoted to microwave beam tube and microwave test equipment development, and the new production plant of the Sperry Electronic Tube Division in Gainesville, Florida, are at your service.

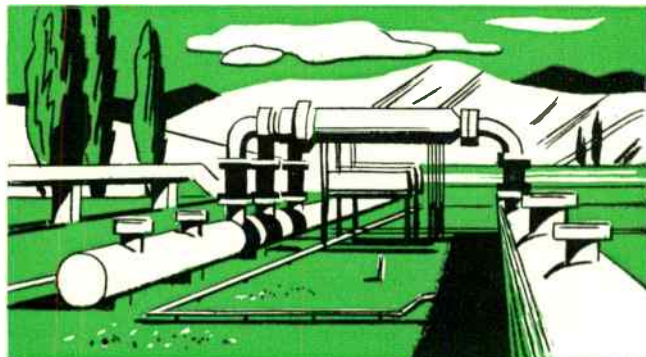

IN UTILITY AND IN INDUSTRIAL USE, Sperry microwave beam tubes permit accurate long distance controls, such as regulating pipe line flow of oil and gas throughout the country.

SPERRY **GYROSCOPE COMPANY**
DIVISION OF THE SPERRY CORPORATION
GREAT NECK, NEW YORK

CLEVELAND • NEW ORLEANS • BROOKLYN • LOS ANGELES • SAN FRANCISCO • SEATTLE
IN CANADA • SPERRY GYROSCOPE COMPANY OF CANADA, LIMITED, MONTREAL, QUEBEC

Visit our Booths 351-2-3 at the Radio Engineering Show, March 21-24



Airborne Components...

a C. A. C. Specialty

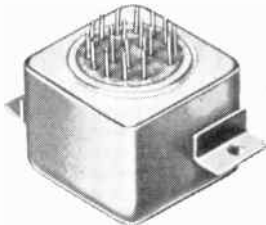
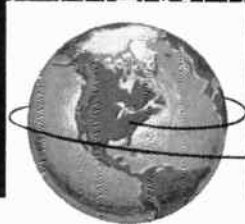

POWER TRANSFORMERS

Range—400-6000 cps
Efficiency—up to 95%
Wattage—6mw-200 watts
Temperature—-55 to +155° C.

Depicted—6KC 100 Watt Unit
Less than 1.65 cubic inches

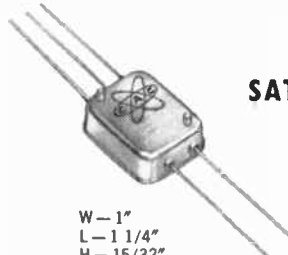

SATURABLE REACTORS

Applications

- Servo Systems
- Data Telemetry
- Remote Frequency Control

W—1"
L—1 1/4"
H—15/32"

Illustrated—High Frequency Reactor Tuned by Varying D. C. Current

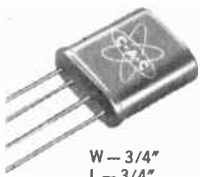

PULSE TRANSFORMERS

Pulse Width—.2-50 microseconds
Rise Time—from .03 microseconds

- Blocking oscillator
- Pulse coupling
- Toroidal construction

W—3/4"
L—3/4"
H—5/16"

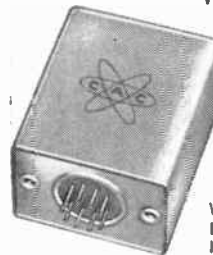

MAGNETIC AMPLIFIERS

Wattage (output) .5-200 watts
Response—1 cycle up

W—1 1/4"
L—1 3/4"
H—2 5/32"

Illustrated—Auto Pilot Application for Printed Circuit Mounting

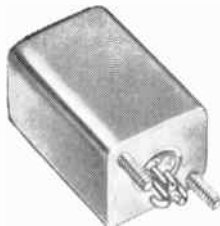

SUB-MINIATURE FILTERS

For Chassis Mount
Frequency—2.3-35Kc
Impedance in—600-10K Ohms
Impedance out—Grid

- Hermetic Sealed
- Temperature Compensated
- Internal D. C. Isolation
- Balanced or Unbalanced
- Military Specifications

W—23/32" Illustrated
L—23/32" 4KC
H—11/16" Band Pass



SUB-MINIATURE TUNED CIRCUITS

For Printed Circuit Applications

- Multiple Tuned Transformers
- Delay Lines
- Tuned Circuits

W—1"
L—4 1/4"
H—7/16"

See us at Booth 465 Electronic Avenue, I.R.E. National Convention, Kingsbridge Armory, New York City, March 21-24

FOR ADDITIONAL INFORMATION CONTACT

COMMUNICATION ACCESSORIES COMPANY

3-55/1.0

HICKMAN MILLS, MISSOURI • PHONE KANSAS CITY, SOUTH 5528



GUARDIAN

for single units or complete control assemblies

in any combination of electronic parts to your specifications, packaged (hermetically sealed), harnessed, cabled, ready to plug-in...

RELAYS

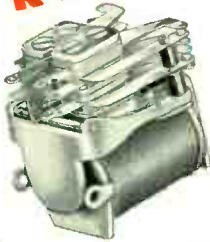

GUARDIAN Series 595-P Relay

GUARDIAN Series 210/120 Relay Interlock

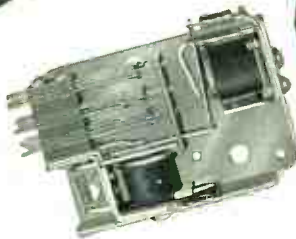

GUARDIAN Hermetically Sealed AN-3312-1 Relay



Write FOR RELAY CATALOG 11

STEPPERS

GUARDIAN M.E.R. Electrical Reset Stepper

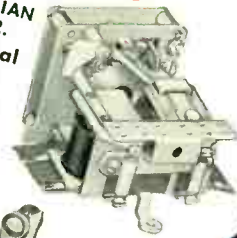

GUARDIAN Series S-120



Write FOR BULLETIN P-84

SWITCHES



GUARDIAN UNIT "A" Snap-Action Reversing Switch

Write FOR BULLETIN CS-1

SOLENOIDS



GUARDIAN Series 11 Solenoid



GUARDIAN Series 18 Solenoid

Intermittent and Continuous Duty

Write FOR BULLETIN SOL-8

CONTACTORS



GUARDIAN 100 Amp. Sealed



GUARDIAN 200 Amp. NAF-1204-3

Write FOR BULLETIN SC-9

for

starting—stopping—
timing—counting—computing—
sorting—lighting—conveying—
interval timing—cycling—selecting—
gauging—vending—reversing—
add—subtract—radio—
radar—armament—power.

VISIT
GUARDIAN BOOTHS
582-584
COMPONENTS AVENUE
1955 I. R. E. SHOW

GUARDIAN ELECTRIC

1628-C W. WALNUT STREET

CHICAGO 12, ILLINOIS

A COMPLETE LINE OF RELAYS SERVING AMERICAN INDUSTRY

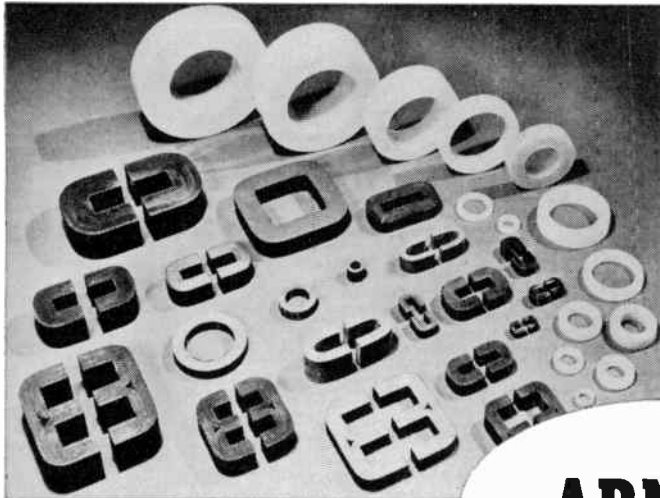

ARNOLD

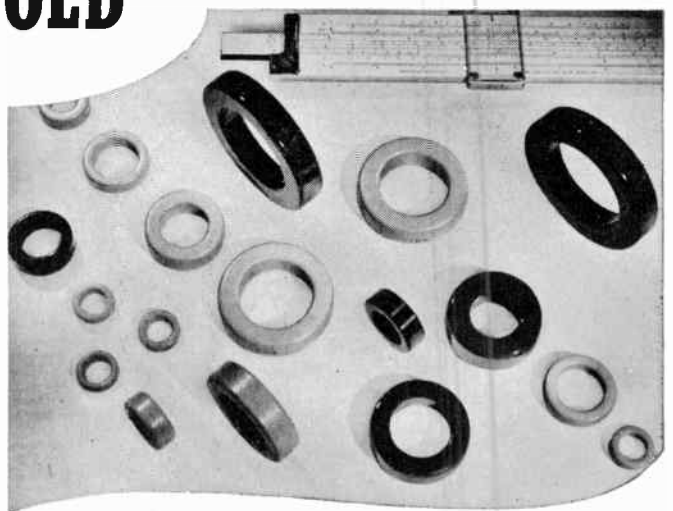
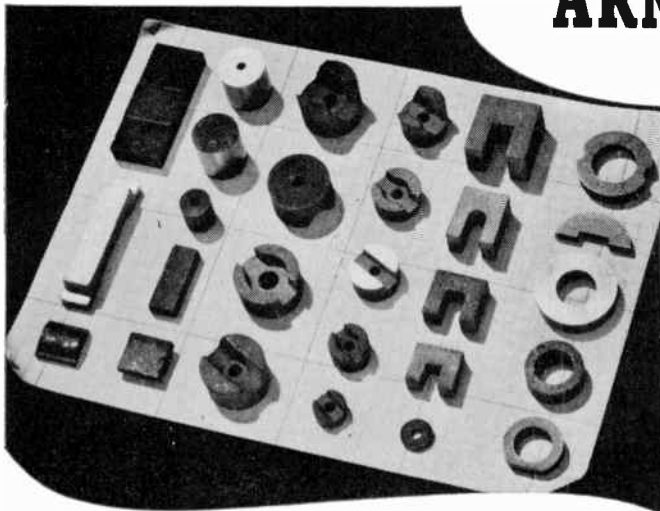

YOUR ONLY SOURCE

of a Complete Line of MAGNETIC MATERIALS

**TECHNICAL DATA ON
ARNOLD PRODUCTS... Write
for your copy.**

Bulletin GC-106 . . . General information on all Arnold magnetic materials: permanent magnets, tape-wound and powder cores, etc.

Bulletin TC-101 A . . . "Properties of Deltamax, 4-79 Mo-Permalloy and Supermalloy"—28 pages of technical data on Arnold Tape-Wound Cores.

Bulletin PC-104 . . . "Molybdenum Permalloy Powder Cores"—16 pages, complete technical data.

Bulletin SC-107 . . . "Arnold Silectron Cores"—52 pages of valuable data, covering a complete range of core shapes, sizes, tape gauges, etc.

ADDRESS DEPT. P-53

Arnold products include all grades of Alnico permanent magnets (cast and sintered) . . . tape-wound cores of high-permeability alloys, such as Deltamax, Permalloy and Supermalloy . . . types "C" and "E" cut cores of Silectron in any size or weight range from a fraction of an ounce to hundreds of pounds (50 lbs. max. on 12-mil C cores); also round, square and rectangular Silectron cores . . . powdered Mo-Permalloy cores . . . Cunife, Vicalloy, Permendur and other magnetic materials. Special magnetic components can be produced to meet your specific requirements; and such products as powder cores, tape-wound cores, and C and E cores are carried in stock in a wide range of standard sizes for immediate delivery. Many sizes of cast and sintered Alnico magnets also are stocked.

In other words, Arnold magnetic materials can answer *any* requirement you may have. It is the *only* complete line in the industry; and in addition, Arnold maintains complete control over every production step from raw materials to finished products. Such a source can bring you advantages in long experience and undivided responsibility, and in unequalled facilities for quality production and control. ● *Let us supply your needs.*

W&D 5546

THE ARNOLD ENGINEERING COMPANY



SUBSIDIARY OF ALLEGHENY LUDLUM STEEL CORPORATION

General Office & Plant: Marengo, Illinois

DISTRICT SALES OFFICES . . . New York: 350 Fifth Ave.

Los Angeles: 3450 Wilshire Blvd.

Boston: 200 Berkeley St.

Easy, Error-Free Reading!



New Dual Log-Scale VTVM By SHASTA



SHASTA Model 207A
Log Scale Vacuum Tube
Voltmeter

Dual-scale design gives 7½" effective scale length plus logarithmic meter movement, provides the most convenient, easiest-to-read volt and decibel scales yet offered. Scale increments are widely, evenly spaced; accuracy percentage stays constant at every point, from top to bottom. Simplified range switch shows only the range in use; no chance for confusion or error.

Model 207A gives accurate measurement of ac voltages from .001 to 300 and db from -60 to +50, over a frequency range of 20 cps to 2 mc. Accuracy is ± 3% to 100 kc, ± 5% to 2 mc. Price only \$275.00 f.o.b. factory.



Model 301A Audio Oscillator

A new, improved version of the Model 301, the Model 301A covers a range of 10 cps to 1.1 mc in 6 steps with an output level of ± 1 db. Has 150 milliwatt power output; minimum load impedance, 600 ohms. Distortion less than 5%. Compact, reliable general purpose laboratory oscillator. Price only \$120.00 f.o.b. factory.

New SHASTA Model 602 Impedance Bridge



SHASTA Model 602
Impedance Bridge

A versatile, wide-range instrument for measuring resistance, capacitance, inductance, dissipation factor and Q. Full-scale ranges (in decade steps) are 1 ohm to 10 meg for resistance, 100 mmf to 100 mf for capacitance, 1 mh to 100 h for inductance. Accuracy is ± 2% up to extreme high or low ranges. Interpolation by two large concentric dials gives readings as low as 1/1000 full scale.

Gives capacitor D measurements as low as .002, and inductor Q as high as 1000. Contains dc and 1000 cps ac bridge circuit power sources, sensitive dc and ac vacuum tube detectors. Many basic bridge circuits obtainable from single selector switch; external generators or detectors may also be used. Price is \$380 f.o.b. factory.



Model 702 Regulated Power Supply

Large 6" meter reduces possibility of operator error. Provides 0 to 400 volts dc at 200 ma; 0 to -150 dc at 3 ma; and 6.3 ac center tapped at 8 amps. Regulation is better than ½%, zero to full load; ripple less than 10 mv. Compact (8" W x 12" H x 10" D); weighs 16 lbs. Price \$185.00 f.o.b. factory.

SHASTA offers the first major improvement in electronic instrument mechanical construction — investigate this outstanding feature! Write now for data; please address Dept. SA 3

Shasta

division
BECKMAN INSTRUMENTS INC.
P.O. Box 296, Station A • Richmond, California
Telephone BEacon 5-7196

**SEE SHASTA'S
COMPLETE LINE
AT THE IRE SHOW**
MARCH 21-24
BOOTH 750 • AIRBORNE AVENUE
KINGSBRIDGE ARMORY
NEW YORK

New

**MARCONI
Signal
Generators**



above

TYPE TF 995A/1

2 to 216 mc
c.w., a.m. and f.m.

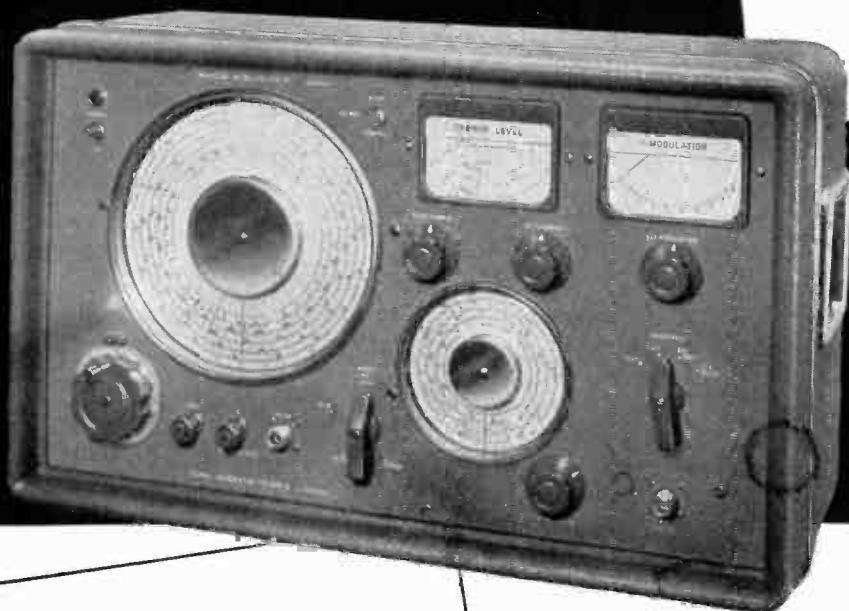

above

TYPE TF 801B

10 to 500 mc
c.w. and a.m.

These instruments, together with other new designs, may be inspected at
BOOTHS 260-262 I.R.E. SHOW.

MARCONI INSTRUMENTS

VACUUM TUBE VOLTMETERS · FREQUENCY STANDARDS · OUTPUT METERS · SIGNAL GENERATORS
WAVEMETERS · WAVE ANALYSERS · Q METERS · BEAT FREQUENCY OSCILLATORS

23-25 BEAVER STREET · NEW YORK 4 · HANOVER 2-0198

ENGLAND: HEAD OFFICE: MARCONI INSTRUMENTS LIMITED, ST. ALBANS, HERTFORDSHIRE

CANADA: CANADIAN MARCONI COMPANY, MARCONI BUILDING, 2442 TRENTON AVENUE, MONTREAL

Managing Agents in Export: MARCONI'S WIRELESS TELEGRAPH COMPANY LIMITED, MARCONI HOUSE, STRAND, LONDON, W.C.2.

TC 61

6738 ... First again in the field of tube miniaturization, Bomac developed a new type TR tube designated the 6378. Designed specifically for airborne radar equipment, the 6378 is a miniaturized version of the 1B24A (another Bomac first), 1B60 and the 1B24. Size was cut in half, and weight was reduced by one fifth with no sacrifice in performance or efficiency.



1N23D ... Bomac was the first to manufacture the 1N23D silicon diode. System designers, for the first time, could obtain a diode with greatly increased sensitivity and superior electrical characteristics in relation to existing types.



BL-25 ... The BL-25 TR tube, designed and developed by Bomac, was the first cell-type tube system — engineered to withstand high power levels and maintain recovery time over a long period of life. The BL-25, although originally designed for a specific piece of equipment, has proven its versatility in various applications within the industry.



Bomac Firsts IN MICROWAVE

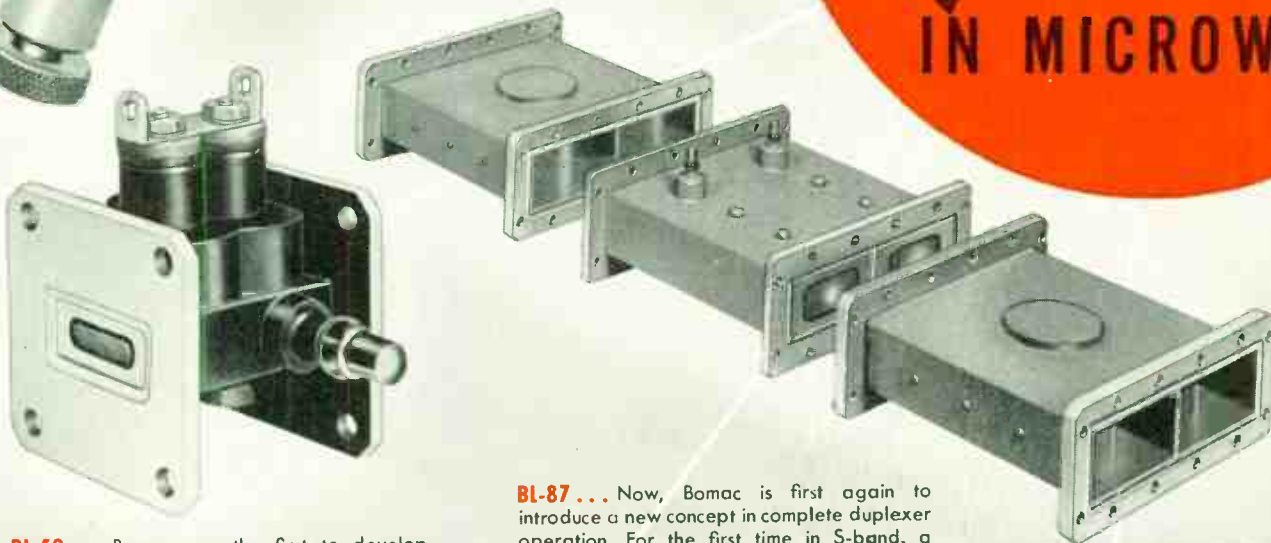

BL-58 ... Bomac was the first to develop shutter tubes and integral TR-shutter combinations for continuous crystal protection. The BL-58 was the first integral TR-shutter combination developed by Bomac. With integral TR-shutter operation, bulky waveguide shutters could be eliminated at considerable savings in size and weight. This tube has now been superseded by improved models.

BL-87 ... Now, Bomac is first again to introduce a new concept in complete duplexer operation. For the first time in S-band, a complete duplexer is offered to the industry. The BL-87 is a dual TR tube, complete with perfectly matched hybrids to assure maximum efficiency and long life. Systems designers can now be assured of reliable duplexer operation because Bomac's hybrids are designed specifically for their dual TR tubes. Bomac is first again in design and development of microwave tubes.

BOMAC DUAL TR DUPLEXERS

Tube	Frequency (MC)	Tube	Frequency (MC)
6334	8490-9578	BL71	8500-9600
(BL-27)		BL78	8490-9578
BL29	9325-9425	BL87	2700-2900
BL35	15000-17000	BL507	8490-9578
BL47	9325-9425	BL600	8490-9578
BL60	5400-5900		

BL-509 ... Bomac's BL-509 was the first complete duplexer offered in one compact unit. Combining a Bomac dual TR tube having integral shutters with two perfectly matched hybrid junctions in a single unit, the BL-509 provides duplexer operation and continuous crystal protection in one package. Light weight and compact, the BL-509 assures superior electrical performance and mechanical simplicity.

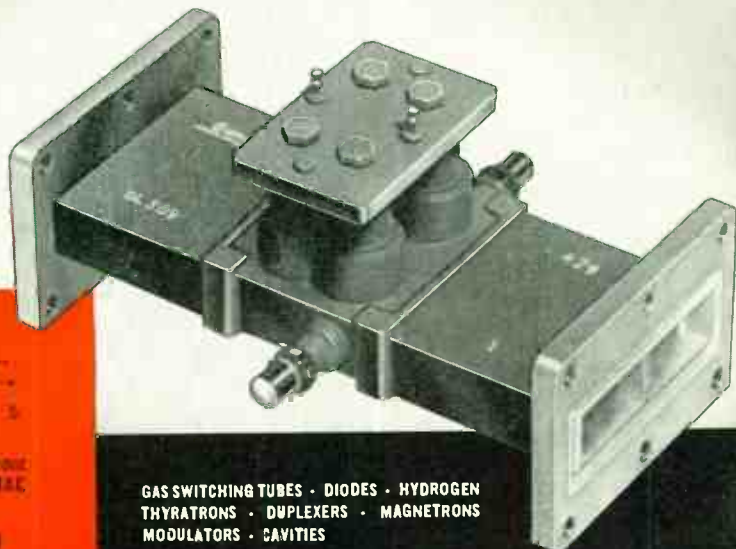

Bomac Laboratories, Inc.
BEVERLY, MASSACHUSETTS

We invite your
inquiries regarding

ENGINEERING
DEVELOPMENT
PRODUCTION

Catalog on request. Write our
company letterhead: Dept. F-3 BOMAC
Laboratories, Inc. Beverly, Mass.

VISIT OUR BOOTH — nos. 370-372 I.R.E. SHOW

World Radio History

GAS SWITCHING TUBES • DIODES • HYDROGEN
THYRATONS • DUPLEXERS • MAGNETRONS
MODULATORS • CAVITIES

Engineering

THE RECORD-SETTING G-12A*

This is the JK Glasline unit that set a stability record of one part in 100 million over a two week test period at 1000 kc — stability corresponding to a rate of change of less than one second in more than three years. Here is stability that challenges existing methods of measurement — an ultra precision time base for tomorrow's electronic wonders.

*Test by a leading U.S. Government laboratory.



Ultra-Precision frequency control requires that crystal oven, power supply and oscillator circuitry be compatible in design and construction for optimum precision and reliability. The James Knights Company will combine their precision crystals and ovens with tried and proven circuitry in packages that will meet your mechanical layout requirements, at a saving of valuable customer engineering time. Precision frequency signal sources covering the wide frequency range of 60 cycles to 150 mcs can be made available to meet your specific application.



Visit the J. K. Booth 516,
I.R.E. Show, March 21-24.

JK-G3: 10 mc to 150 mc. Miniature size, minimum aging drift, high Q for maximum performance. JK miniaturized "Glasline" crystals meet the growing need for minimum size with maximum stability.



(ACTUAL SIZE)

that unlocks tomorrow's door

CERTIFIED STABILITY

performance is the key to spectrum conservation

With the radio spectrum already congested, and channels narrowing, frequency control tolerances must narrow too. Equipment that "drifts" or "ages" has no place on this express way. Nor need it have, for today JK crystals are available that exceed your most critical stability requirements for interference-free land, sea and air radio communications. Crystals of this extreme stability are also serving as filter resonators for radar, for power line carrier communications and telemetering, and as ultra-precision time bases. And our research goes on. JK Glasline crystals, and JK Ovens, offer "packaging" that combines unprecedented environmental control with the compactness your new equipment requires. So precise, so rugged, so protected are these JK crystals that their performance can now be Certified to previously unheard of stability tolerances. So don't let frequency management problems delay your development programs. JK engineering can be the key needed to unlock tomorrow's door for you.



JK-G9: Precision "Glasline" quartz crystals, sealed in evacuated glass for cleanliness and protection, over a complete range of 800 cycles to 5 mc.

TO COMPLETE THE ENVIRONMENTAL PICTURE: THE NEW JK09 OVEN

To the protection JK Glasline design provides against moisture, contamination, vibration and barometric pressure, the JK09 oven adds control of temperature. It is production tooled for economy and uniformity, is small and light (1.28" x 1.70" ± 1.5 oz.), and is capable of maintaining a temperature constant to within ± 1°C over a range of -55° to +100°C. Here is an oven that matches the performance of many, massive multi-stage heaters — an example of JK's ultra-stable miniaturization program.



JK-G4: "Glasline" Crystal Filter Resonator. For broad filter applications, such as power line carrier communications and telemetering. Frequency range 50 to 200 kc.



PRODUCTS

THE JAMES KNIGHTS COMPANY

Crystals for the Critical - Sandwich, Illinois

JK STANDARD MILITARY AND COMMERCIAL TYPE CRYSTALS

Quality and service are James Knights traditions that apply to the simplest JK crystals as well as to the most complex, and apply to our smallest customer as well as our largest. So whatever your requirements — look to James Knights as a dependable, cooperative source for quality, price and delivery.



TEMPERATURE CONTROL OVENS: Available for a wide range of applications.



ULTRA-SONIC TRANSDUCERS: Carefully oriented and processed to your specifications, in a variety of shapes with holes, dimples, soldered-on leads, and backing plates. Can be plated with a variety of metals.



PRESSURE MOUNTED: A complete line of commercial and military types.



MILITARY TYPES: Hermetic sealed, metal cased, in frequency ranges from 16 kc to 100 mc.

marion
 advancement
 in instrument
 design

**new
 COAXIAL*
 relay**

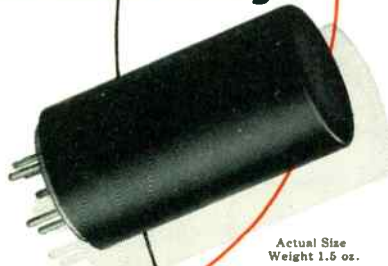

Actual Size
 Weight 1.6 oz.

Very
 sensitive,
 rugged, reliable.
 Hermetically sealed.

Engineering data for your
 application on request.



*Trademark for the basic Marion moving
 coil mechanism. Patents Pending.

marion electrical instrument co.
 407 Canal St., Manchester, N. H., U. S. A.

Manufacturers of Ruggedized and "Regular"
 Panel Instruments and Related Products.

copyright 1956 M.E.I. Co.

marion meters

**52-ohm
 LINE STRETCHERS**

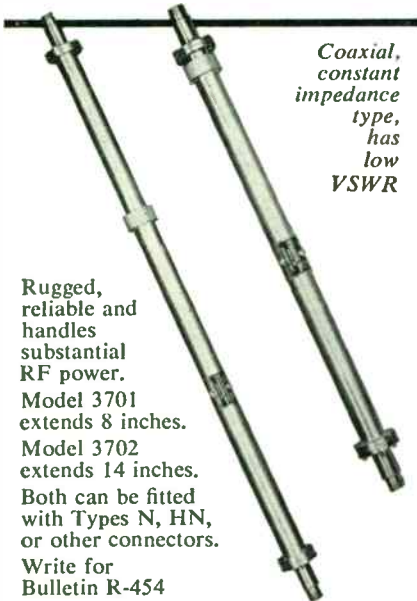

Coaxial,
 constant
 impedance
 type,
 has
 low
 VSWR

Rugged,
 reliable and
 handles
 substantial
 RF power.
 Model 3701
 extends 8 inches.
 Model 3702
 extends 14 inches.
 Both can be fitted
 with Types N, HN,
 or other connectors.
 Write for
 Bulletin R-454

ANTENNA SYSTEMS — COMPONENTS
 AIR NAVIGATION AIDS — INSTRUMENTS



Section Meetings

(Continued from page 100A)

BUFFALO-NIAGARA

"An Airborne Weather Radar," by K. F. Molz, Bendix Radio Div.; December 15, 1954.

"Modern Techniques in X-Ray," by Kevin Kilcoyne and "Distortion and Frequency Response in a Binaural Music System," by David Coddington, both students, University of Buffalo; January 19, 1955.

CEDAR RAPIDS

"Corpuscular Streams from the Sun," by Dr. W. O. Roberts, High Altitude Observatory, Boulder, Colorado; November 17, 1954.

"Dynamotor Design Considerations," by E. I. Winquist, Continental Electric Company; December 15, 1954.

CINCINNATI

"A High Powered Amplifier for High-Channel VHF TV Service," by W. F. Goetter, General Electric Company; December 21, 1954.

CONNECTICUT VALLEY

"Recent Applications of Information Theory," by Louis A. DeRosa, Federal Telecommunications Laboratory; December 16, 1954.

DALLAS-FORT WORTH

"Matching Opportunity with Need," by Dr. J. W. McRae, Sandia Corp.; November 2, 1954.

Talks on Electronics and Geophysics: "What is the Problem," by Dr. D. H. Clewell, Magnolia Petroleum Company, "Principles of Airborne Magnetometer Instrumentation," by T. W. Swafford, Geotechnical Corp., "Electronic Problems on Seismology," by Dr. J. P. Woods, Atlantic Refining Company; November 23, 1954.

"Measurement of Radio Interference," by Joseph Lorch, Empire Devices Production Corp.; November 29, 1954.

"Electronics Industry and I.R.E. in the Southwest," by Dr. A. W. Straiton, Faculty, University of Texas, and "How to Specify Transformers," by Walt Lehnert, Audio Development Company; December 7, 1954.

"Recent Developments in Long Range Communication Techniques," by A. A. Collins, Collins Radio Company (paper co-authored by M. L. Doelz); December 16, 1954.

DAYTON

"Systems Management Concepts," by E. G. Uhl, G. L. Martin Co.; December 2, 1954.

"Hi Fidelity," by Julius Knapp, United Transformer Corp.; January 6, 1955.

DETROIT

"Airborne Weather Radar System," by K. F. Molz, Bendix Radar Eng'g. Dept.; December 17, 1954.

EL PASO

"Experimental Origins of Lie Detection Equipment," by Dr. R. F. Mager; December 16, 1954.

EVANSVILLE-OWENSBORO

"Technical Aspects of an Integrated Audio System," by D. W. Pugsley, General Electric Company; October 13, 1954.

Field trip to Indiana Bell Telephone Company; January 12, 1955.

FORT WAYNE

"The Transmission of Electrical Signals in the Central Nervous System," by Dr. W. S. McCulloch, Mass. Institute of Technology; January 6, 1955.

HAMILTON

"Trends in Component Design," by A. Ainlay, Rogers Majestic Electronics Ltd.; December 13, 1954.

(Continued on page 118A)

**Now
 STYRACON "B"
 CAPACITORS**

In Wide Range
 Of Needed Values
 For Critical Applications



Now you can select Sprague Styracon "B" capacitors in the most needed voltage, capacitance, and tolerance values for those critical applications in analog and digital computers, precision timing circuits, etc.

Employing a specially processed polystyrene plastic film as the dielectric, these capacitors have extremely high insulation resistance, freedom from dielectric absorption, extremely low power factor (or high Q), close capacitance tolerance, and unusually excellent capacitance stability. Temperature coefficient of capacitance over the rated operating temperature range of -55°C to $+85^{\circ}\text{C}$ is -100 ppm/ $^{\circ}\text{C}$ and practically linear, and is independent of frequency.

Sprague Styracon "B" capacitors are also available in various mechanical configurations to meet application needs. All are hermetically sealed in metal cases.

Write for Engineering Bulletin 250A, available on letterhead request to the Technical Literature Section, Sprague Electric Company, 235 Marshall Street, North Adams, Mass.

uF	VDC	CATALOG NO.		CASE STYLE
		$\pm 5\%$ TOL.	$\pm 2\%$ TOL.	
.01	200	114P10352S2	—	TUBU- LAR
.01	600	114P10356S2	—	
0.1	200	114P10452S2	114P10422S2	BATH- TUB
0.1	600	114P10456S2	114P10326S2	
0.5	200	111P1J	111P1G	BATH- TUB
0.5	600	111P3J	111P3G	
1.0	200	111P2J	111P2G	
1.0	600	111P4J	111P4G	

World's Largest Capacitor Manufacturer

SPRAGUE

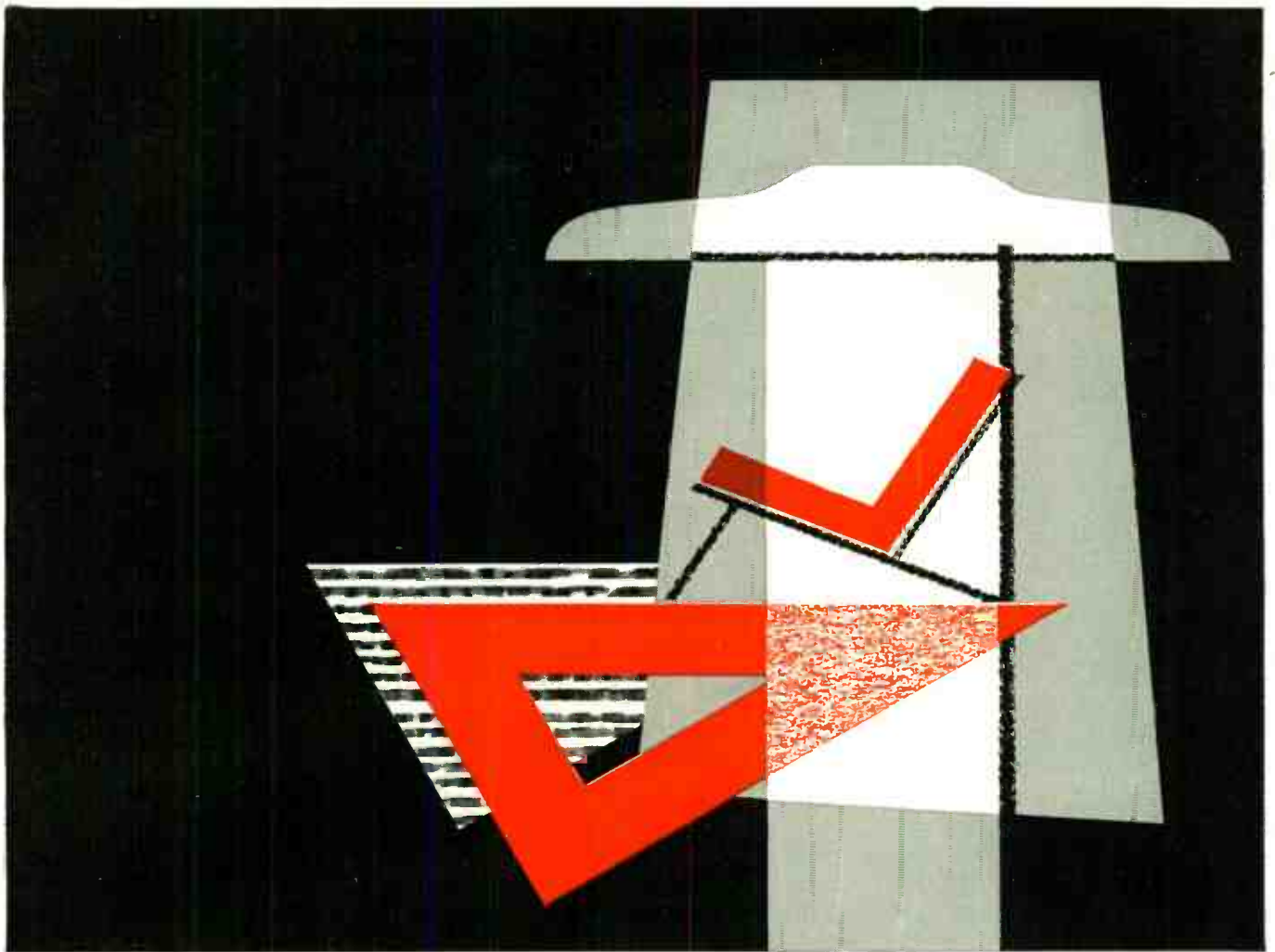

tomorrow's design and styling ...*today!*

The sleek, efficient and streamlined "New Look", which characterizes the styling of Roller-Smith's entire line of indicating instruments, symbolizes the advanced thinking and improvements incorporated in the design of every integral part contained in each and every mechanism.

Specify and install them in your equipment with the complete assurance that—they are every bit "as good as they look".

Whether the instrument you buy is "standard" or must be designed and made to order—be sure its dial bears the name of the master Instrument Makers—Roller-Smith—the epitome of instrument quality for nearly fifty years.

ROLLER-SMITH
Instrument Division
CORPORATION

1825 WEST MARKET STREET  BETHLEHEM, PENNSYLVANIA

Precision Products Since 1908



See Roller-Smith Products featuring "tomorrow's design and styling today" at Booth 702 I. R. E. Show, Kingsbridge Armory, New York City, March 21-24, 1955.

Now—an entirely new kind of signal cable!



PHELPS DODGE SPIRAFIL COAXIAL CABLE

**with exceptional
Community Antenna System
characteristics**

PHELPS DODGE SPIRAFIL CABLE 3/8 70Ω

Spirafil coaxial signal cable was developed by Phelps Dodge as a companion cable to Styroflex coaxial cable. It is designed for specific use in applications where the precise Styroflex tape helix construction is not required.

This unique signal cable is made up of a solid copper center conductor, a solid polyethylene helix and an outer, tubular aluminum conductor.

Spirafil cable is particularly adaptable to use in community antenna systems. For this purpose, it has a number of outstanding features—*no radiation, low attenuation, excellent frequency response, uniform electrical properties over wide temperature variations and unlimited operating life.*

Spirafil cable is one of that select group

of cables assigned the highest life expectancy rating.

These special Spirafil characteristics, together with the economical cost of the cable, also make it suitable for certain applications in VHF, UHF and microwave communications circuits.

Spirafil cable is manufactured in 1000-foot, continuous lengths without joints. A Habirlene (polyethylene) jacket is supplied for protection against corrosion when the cable is to be installed in underground ducts, under water, or buried directly in the ground.

★ ★ ★

For special bulletin describing new Spirafil coaxial cable, write Dept. HF.



PHELPS DODGE COPPER PRODUCTS **CORPORATION**

40 WALL STREET, NEW YORK 5, N. Y.



4 INSTRUMENTS
1 LOW PRICE

"MICROVAL" PACKAGE



Regulated Klystron
Power Supply



Tube Mount
and Pad



Standing Wave Amplifier

Slotted Section
and Probe

FXR Type ZB16A
Regulated Klystron Power Supply
Beam: 300 to 500 V up to 65 MA.
Reflector: 0 to 600 V.
Metered voltages and beam current.
Modulation: Square wave and sawtooth
(sync. and external modulation jacks)

FXR Type X763A Tube Mount
Mounts 2K25 Klystron (Tube incl.)
Built-in 15 DB variable waveguide attenuator
Frequency Range: 8,500 to 9,600 MC/S

FXR Type X105A Slotted Section
Friction Drive
CM vernier scale
Special narrow tapered slot
Precision broached waveguide (1" x 1/2")
Built-in fixed-tuned probe with
radiation suppression
Frequency Range: 8,200 to 12,400 MC/S
1N23B Crystal supplied

FXR Type B810A Standing Wave Amplifier
Standard FXR Precision Component
VSWR Ranges: 1 to 3, 3 to 10, 10 to 30,
50 to 100
Modulation Range: Wide band 300 to 4,000 CPS
Narrow band 1,000 ± 50 CPS
Metered Bolometer Bias: 3.5 to 9 MA.
Separate output jack (from cathode follower)
Calibrated Meter Scale: VSWR, DB, MA.

Other information available upon request.

COMPLETE BASIC EQUIPMENT
For measurements in the "X" band frequency range.

MICROWave VALue is packed into this FXR engineered package of companion instruments . . . made for each other, and priced right for budget minded schools and industry. The versatile Power Supply and Modulator unit drives the Klystron. The variable Buffer Attenuator controls power into the Slotted Section, where a sensitive fixed tuned Crystal Detector supplies the signal to a Standing Wave Amplifier. You get one well-integrated package for all purposes, and all these fine value-packed test instruments for one low price. Individual instruments are also available separately. Be sure to see them at the show. Delivery from stock.



See the complete line of
FXR PRECISION MICROWAVE TEST EQUIPMENT

at the I.R.E. Show
Kingsbridge Armory, March 21-24
BOOTH No. 375

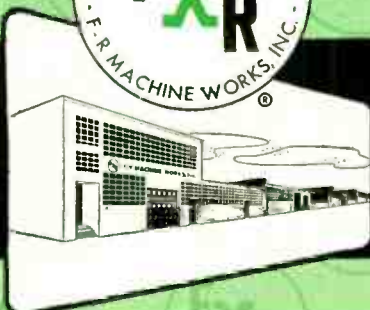

*Write today
for Complete Catalog*



Electronics & X-Ray Division

F-R MACHINE WORKS, Inc.

26-12 BOROUGH PLACE, WOODSIDE 77, N. Y. • ASTORIA 8-2800



**PORTABLE
TRANSISTOR EQUIPMENT
COSTS LESS TO MAKE,
LESS TO RUN
WHEN POWERED WITH AN**



"MINI-MAX" BATTERY

You need only *one* "Eveready" "Mini-Max" battery to power transistor equipment. Design around one of the many "Eveready" "Mini-Max" battery types ideally suited for transistor applications.

Here are the advantages:

- More power, longer life in *less space*.
 - Lowest cost-per-hour of operation.
 - Simpler cabinet design — no spring clips needed to hold battery groups in place.
- A single "Eveready" "Mini-Max" battery has only one connection, for simpler design and installation. ● Nation-wide distribution. When replacements are necessary, the user will find "Eveready" "Mini-Max" batteries available everywhere.

In addition to "Mini-Max" batteries, "Eveready" brand includes round-cells and mercury-type Energizers for transistor equipment.



Standard
Round-Cells

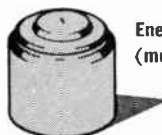

Energizers
(mercury-type)

"Eveready", "Mini-Max", and "Nine Lives" with the Cat Symbol are registered trademarks of Union Carbide and Carbon Corporation

NATIONAL CARBON COMPANY

**A Division of Union Carbide and Carbon Corporation
30 East 42nd Street, New York 17, N. Y.**

SALES OFFICES: Atlanta, Chicago, Dallas, Kansas City,
Los Angeles, New York, Pittsburgh, San Francisco

IN CANADA: Union Carbide Canada Limited, Toronto

Come see us at The Radio Engineering Show!
Discuss your transistor power supply problems
with our staff of battery engineers.

Booths No. 529 — 531

**KINGSBRIDGE ARMORY, NEW YORK
MARCH 21 — 24**

...here's new might for miniatures

Dur-Mica DM15

World's Smallest Mica Capacitor

The First Miniature Dipped Mica Capacitors with Parallel Leads.



NOW! Also available . . .

El Menco Dur-Mica DM20

1 to 3900 mmf. at 500vDCw

1 to 5100 mmf. at 300vDCw

El-Menco
Dur-Mica

IDEAL FOR PRINTED CIRCUITS. Meets all Humidity, Temperature and Electrical Requirements of MIL-C-5 Specifications. El Menco's Dur-Mica DM15 establishes a "new dimension" in capacitor performance with ranges from 1 to 390 mmf. at 500vDCw and 1 to 510 mmf. at 300vDCw. A new, tougher phenolic casing provides temperature co-efficient and stability equal to or better than characteristic F in all but the lowest capacity values . . . efficient operation at temperatures as high as 125°C. El Menco's Dur-Mica DM15 can be used in a variety of transistor circuits and other miniature electronic equipment in military and civilian applications.

Sells for Less than the famous El Menco CM-15 — Provides Economy of Size with Maximum Performance and Widest Application.

test El Menco "Dur-Micas" for yourself!

Write for free samples and catalog on your firm's letterhead.

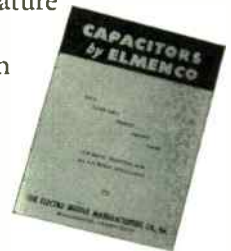

El-Menco
Capacitors

THE ELECTRO MOTIVE MFG. CO., INC.

WILLIMANTIC

CONNECTICUT

**molded mica · mica trimmer
tubular paper · ceramic**

Jobbers and distributors write to Arco Electronics, Inc., 103 Lafayette St., New York, N. Y.

in frequency meters

it's NARDA

Why? Electronically . . . and mechanically . . . Narda offers highest specifications at lowest cost. Compare Narda specs/cost ratios with *any* other. You'll agree that in frequency meters it is Narda!

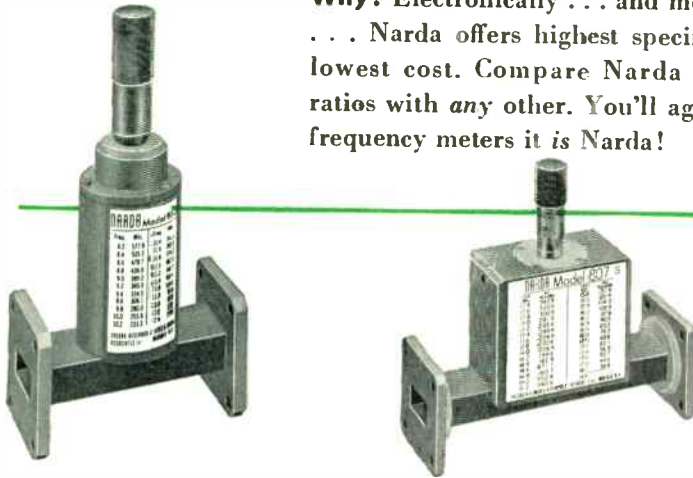

FOUR NARDA MODELS COVER 5.85 to 18.0 kmc

Model	Frequency (kmc)	Waveguide Size	Price F.O.B.
812	5.85- 8.20	1½ x ¾	\$120.00
811	7.05-10.0	1¼ x ¾	115.00
810	8.2 -12.4	1 x ½	110.00
807B	12.4 -18.0	.702 x .391	150.00

All Narda models offer 0.1% accuracy with 0.05% on special order . . . 0.05% precision . . . 10% reactive dip minimum . . . low insertion loss. *Calibration plates are clearly etched for permanent legibility.*

NARDA MODEL 802: 2,400-10,200 mc



A self-contained instrument with two coaxial resonators tuned by a single control, type N input connectors, crystal detectors, and crystal current meter for resonance indication. Features 0.2% accuracy, high loaded Q, frequency reading from a universal calibration chart in the removable cover (not illustrated). No correction charts are required. The entire frequency range is free from spurious responses or other ambiguities.

NARDA MANUFACTURES A COMPLETE LINE OF MICROWAVE TEST EQUIPMENT, THERMISTORS AND BOLOMETERS. WRITE OR CALL FOR TECHNICAL LITERATURE . . . and use the Narda advisory services without obligation.

NARDA

THE NARDA CORPORATION
66 MAIN STREET • MINEOLA, NEW YORK
Pioneer 6-4650

SEE US AT THE IRE SHOW: BOOTH 378 MICROWAVE AVE.



(Continued from page 112A)

HAWAII

Demonstration and description of circuitry, International Business Machine Electronic Calculator #604, by J. P. Erdman, IBM Co.; October 13, 1954.

"CAA Airport Surveillance Radar ASR-2," A description of design and circuitry, by Frank Kadi, CAA; November 10, 1954.

Symposium and discussion of long range navigational aids, by Capt. P. V. Colmar, Lt. Cmdr. R. L. Harris and Stanley Pickarski, U. S. Coast Guard; January 12, 1955.

INDIANAPOLIS

"Fact, Fancy and Future of Color Television," by R. B. McGregor, Arvin Industries; October 18, 1954.

INVOKERN

"Electronic Test Equipment: The Viewpoints of the Manufacturer and User," discussed by W. R. Hewlett and R. E. Rawlins, both of Hewlett-Packard Co.; December 13, 1954.

ISRAEL

"Modern Methods in Electronic Navigation," by J. Halberstein; December 12, 1954.

ITHACA

"Core Memories for High Speed Digital Computers," by W. N. Papien, Mass. Institute of Technology; January 6, 1955.

LITTLE ROCK

"Behind the Scenes in Television," by program and production staff of station KARK; December 14, 1954.

LONG ISLAND

"Ferromagnetism Applied to Microwave Circuit Techniques," by J. H. Rowen, Bell Telephone Labs.; December 14, 1954.

"Compression-Expansion of Speech," by Dr. W. L. Everitt, University of Illinois; January 11, 1955

MILWAUKEE

"Photoconductive process," by Dr. Rudolf Frerichs, Faculty, Northwestern University; November 18, 1954.

"Ferrites," by Dr. H. M. Schlicke, Allen Bradley Co.; December 9, 1954.

NEW YORK

"Modern Magnetic Ferrites and Engineering Applications," by C. D. Owens, Bell Telephone Labs.; December 1, 1954.

NORTH CAROLINA-VIRGINIA

"Television Coverage of Coronation of Queen Elizabeth II of England," by Prof. Maurice Valet, Catholic Faculty of Sciences of Lyons, France; December 10, 1954.

"Granpa," by Dr. V. S. Carson, North Carolina State College; January 14, 1955.

NORTHERN NEW JERSEY

"Design Principles in Negative Feedback Transistor Amplifiers," by F. H. Blecher and T. R. Finch (Mr. Finch delivered the paper), both of Bell Telephone Labs.; January 12, 1955.

OKLAHOMA CITY

"Computers Without Numbers," by J. B. Wiley, Oklahoma University; December 14, 1954.

"The Bell Solar Battery," by H. J. McMains, Southwestern Bell Telephone Company; January 11, 1955.

(Continued on page 122A)

Try Constantin's
NEW COMPRESSION KIT #3

**... for any glass-to-metal
 sealing problem**

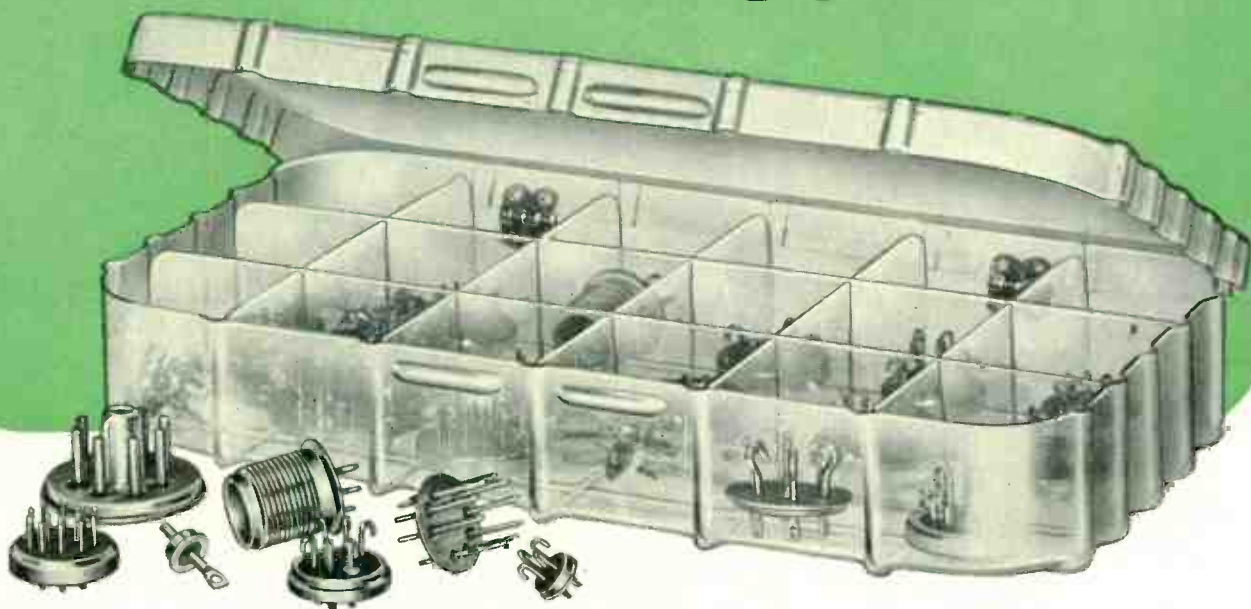

Electronic Engineers and Designers... we're convinced that you'll find Constantin's new Kit #3 will really help those of you who have not used glass-to-metal vacuum seals before. We're sure that once you try this type of seal you'll find, as thousands of others have, that their performance characteristics will solve many of your present design problems.

The kit contains over two-dozen of the more popular, high-compression glass-to-metal headers, connectors, and terminals. Packed in an attractive, sturdy plastic case, the assortment features hooked, straight, and pierced-flat pin styles. Plug-in types including octals, as well as 7

and 9 pin units to fit the standard R.M.A. miniature and noval sockets, are also contained. The range of header diameters includes the most commonly used sizes from .375" to over 1.000". Header and single terminal eyelets include straight-sided, shoulder, and flanged types to satisfy a wide variety of mounting requirements.

These are standard seals, selected from the complete line of glass-to-metal vacuum seals for which L. L. Constantin is famous. Send for your kit today. Only \$14.95.

L. L. Constantin & Co.

MANUFACTURING ENGINEERS
Route 46 Lodi, New Jersey

Also manufacturers of Glass-to-Metal

HEADERS • TERMINALS • END SEALS • TRANSISTOR MOUNTS • CRYSTAL BASES & COVERS • VACUUM COATING EQUIPMENT



L. L. Constantin & Co.,
 Lodi, N.J.

Enclosed is check/money order for _____
 #3 Compression Kits at \$14.95 each.

**VISIT US AT BOOTHS 503-505,
 COMPONENTS AVE., I.R.E. SHOW, N. Y.**



Still "On Tap" after 1,000,000 OPERATING CYCLES!

**That's why the SYSTEM ANALYZER CORP.
Chose Tech Laboratories Tap Switches
for \$200,000 Electronic "Brain"**

With more than 2100 tap switches incorporated in the design for their huge analog computer, engineers at the System Analyzer Corp., Nokomis, Illinois, made exhaustive tests to check the efficiency and operating life of many types. Of all those tested, Tech Laboratories Type 2C and 2A Tap Switches were the only ones that met every requirement. After 1,000,000 complete cycles of operation, they showed approximately the same contact resistance as at the beginning.

Designed primarily for analyzing electrical power networks — as large as the power system of an entire city — the electronic "brain" handles mathematical problems with as many as 220 unknowns, 400 times faster than the work can be done manually. It is easy to understand why dependability is a major factor in the selection of its components.

See us at booth #656, Circuits Ave.

WRITE FOR FULL INFORMATION



Manufacturers of
Precision Electrical Resistance Instruments
PALISADES PARK, NEW JERSEY

TYPE 2C TAP SWITCH SPECIFICATIONS

- Contact resistance: 3-4 milliohms
- Contact material: Silver plated brass
- Contact design: Laminated wiper arm, self-cleaning, shorting or non-shorting
- No. of contacts: 2 to 24 single pole, 2 to 11 double pole, 2 to 7 triple pole, 2 to 5 four pole; shorting or non-shorting
- Spacing: 15° or 20° shorting or non-shorting
- No. of poles per deck: 1 to 4
- No. of decks: According to requirements
- Current carrying cap.: 3 amp.
- Max. operating voltage: 120 V., a.c.
- Mounting: Single hole, 3/8"-32 bushing
- Size: 1 3/4" dia.
- Detent: Ball and spring
- Weight: Approx. 1 oz. per deck

Costs go tumbling...

when standard
Radio Receptor rectifiers
do the work of
specials in magnetic
amplifier applications

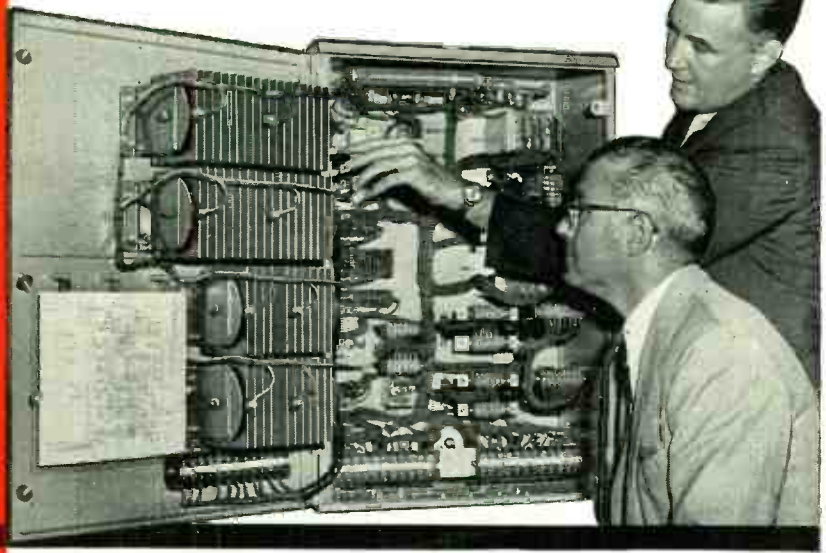

Mr. Dornhoefer (upper right) inspects current production of magnetic amplifier regulator with Mr. J. F. Hysler. Rating of the motor generator set it regulates:

Output: 5KVA, 120 V,
3 phase, 400 cycles.

Input: 175 to 345 V, DC.

Regulation accuracy:
 $\pm 0.5\%$ on both voltage
and frequency.

Ambient temperature: 50°C.

Made for and has passed
H. I. shock tests.

Here's a magnetic amplifier regulator just off the production line at Regulator Equipment Corp.'s plant in Paterson, N. J. It includes eight RADIO RECEPTOR selenium rectifier types using standard quality cells for a total of 18 units in all, and regulates the voltage and frequency of 400 cycle motor generator sets aboard many of Uncle Sam's submarines.

"The decision to use standard stacks," says Warren Dornhoefer of Regulator Equipment Corp., "is governed by such factors as desired magnetic amplifier performance, reactor core material, ambient temperatures, power supply frequency and many others. Naturally we aim for the right combination to give best overall results."

"It has been our experience," continues Mr. Dornhoefer, "that the standard RADIO RECEPTOR stacks we use perform highly satisfactorily in this mag-amp application and in others we have designed and produced. When we see such excellent results from the regular stacks we prefer to be realistic—particularly when delivery and cost are factors."

Naturally, stock rectifiers are not always the answer for every magnetic amplifier circuit. We can and do supply specials where necessary. We suggest you let us study your specs the next time you require rectifiers for this purpose. Chances are we can save you money—and time!

*We also manufacture transistors and
silicon and germanium diodes.*

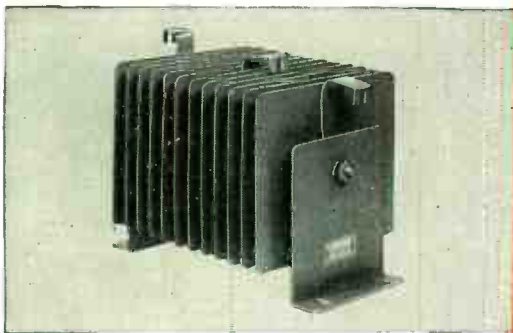

One of the Radio Receptor rectifiers incorporated into Regulator Equipment Corp.'s magnetic amplifier regulator.

Semi-Conductor Division

RADIO RECEPTOR COMPANY, INC.

In Radio and Electronics Since 1922

SALES DEPARTMENT: 251 WEST 19th STREET, NEW YORK 11 TELEPHONE: WAtkins 4-3633, FACTORIES IN BROOKLYN, N. Y.

See our exhibit at the IRE Show, March 21-24, Kingsbridge Armory, Booths 511-513 Components Avenue





Lambda-Pacific is proud to announce the premier of another new product... The KU Link! This microwave link is a worthy addition to its companion system, the 5-7 KMC, 1 watt, *Lambda Link*, which is presently being used by both the Bell System and commercial television stations.

The KU Link now makes available the 11-13 KMC frequency range previously allocated by FCC for STL, common carrier and remote service. Extreme portability added to the fact that all circuits are monitored enhances the usefulness of this unit.

SYSTEM CHARACTERISTICS OF KU LINK

Identification:	Type 1100/1200
Service:	Common carrier; STL; Remote T. V. pickup.
Power into Antenna:	100 MW
Frequency Range:	11-13 KMC
Frequency Measurement:	Wavemeters in BOTH transmitter and receiver.
Packaging:	Transmitter, receiver, and power supplies in "suitcase" housing.
Weatherproofing:	R. F. heads completely weatherproofed.

This system will be shown at Booth 386, Microwave Ave., in the I.R.E. Show, March 21 thru 24. For additional information write P.O. BOX 105, VAN NUYS, CALIF.

Inquire about our "new" Tek-Art Division which specializes in the manufacture and development of printed circuits and terminal boards. This division also specializes in silk screen processing as required by the electronic industry.

Lambda  Pacific



Section Meetings

(Continued from page 118A)

OTTAWA

"Operational Research Applied to Engineering," by Dr. G. R. Lindsey, Defence Research Board; December 9, 1954.

PHILADELPHIA

"Automation in the Automotive Industry," by J. E. Cunningham, Wilson Automation Company; October 14, 1954.

"Automatic Fabrication in the Electronics Industry," by Cleo Brunetti, General Mills; October 21, 1954.

"Etched Circuits," by Donald Mackey, R.C.A., and "Mechanization Techniques and Standards for the Use of Printed Circuitry," by Frank B. Iles and J. J. Graham, both of R.C.A.; October 28, 1954.

"Flexible Control of Electronic Assembly Automation," by G. W. Gamble, G. E. Adv. Elect. Center, and "Modular Approach to Mechanized Assembly," by R. L. Henry, A.C.F. Corp.; November 4, 1954.

"Instrumentation and the Analogue Computer in Process Control," by D. P. Eckman, Case Institute of Technology, and "Important Developments Affecting Automation in Chemical Plants," by V. F. Hanson, E. I. DuPont de Nemours & Co.; November 11, 1954.

"Management Aspects of Automation," by W. W. Beardslee, General Electric Company; November 18, 1954.

"Solar Batteries," by D. C. Reynolds, Wright-Patterson A.F.B., and Gordon Raisbeck, Bell Telephone Labs.; December 13, 1954.

PHOENIX

"Etched Circuits," by Larry Ott and George McLaughlin, both of Hughes Aircraft; December 9, 1954.

PITTSBURGH

"LORAC—Radiolocation by Phase Comparison," by W. R. Hunsicker, Seismograph Service Corp.; December 13, 1954.

"Junction Transistors Used as Switches," by Dr. R. L. Bright, Westinghouse Electric Corp.; January 10, 1955.

PORTLAND

"Electronic Aspects of Civil Defense," by James Deer, Iron Fireman Company; Films, "Main Street USA" and "Use of Radiological Instruments"; December 22, 1954.

Uses of germanium and silicon as transistors and photocells, demonstrated by Dr. W. H. Brattain, Bell Telephone Labs.; January 12, 1955.

PRINCETON

"Electronics at Brookhaven," by R. L. Chase, Instrumentation Div. of Brookhaven; December 9, 1954.

"An Outguessing Machine, A Sophisticated No-Arm Bandit," by Dr. D. W. Hagleberger, Bell Telephone Labs.; January 13, 1955.

ROCHESTER

"Federal Airways Operation and Radio Control of Aircraft," by G. R. Freitag, Rochester Airport; December 7, 1954.

ROME-UTICA

"Nuclear Reactor Design," by G. D. Roy; January 4, 1955.

SACRAMENTO

"Transistors and Their Application in Switching Circuits," by J. M. Pettit, Stanford University; January 14, 1955.

(Continued on page 130A)

GUDEMAN COAST-TO-COAST SERVICE

Manufacturers of Capacitors, Filters, Pulse Transformers,
Delay Lines and Linear Variable Differential Transformers.

■ 6 Plants

• Main Plant
340 West Huron Street
Chicago 10, Illinois
• 20401 Old U.S. 12 W.
Chelsea, Michigan

• 190 Commercial Street
Sunnyvale, California
• Dilectron Division
2661 South Myrtle
Monrovia, California

• 9200 Exposition Boulevard
Los Angeles 34, California
• Terryville, Connecticut

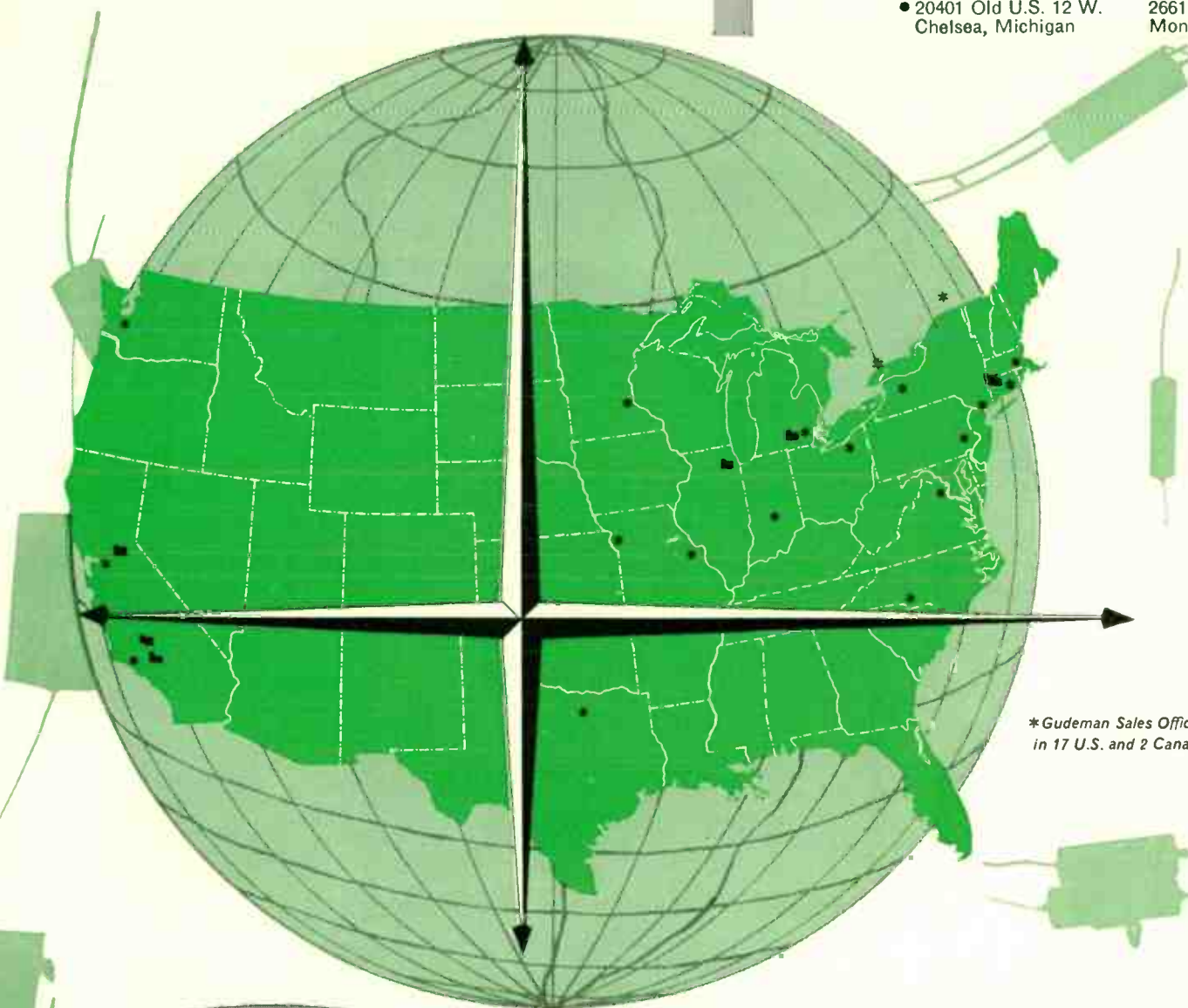

Write for latest technical data on any of the following:

- MIL-C-25A Capacitors
- High Voltage Glass Cased Capacitors (GC Type)
- Motor Starting Capacitors (Paper Dielectric-Oil Impregnated)
- Paper Tubular Capacitors
- Hi-Temperature-Plastic Dielectric Capacitors (XC Types-165°C)
- Miniature Hi-Temp Capacitors (XH Types-125°C)
- Dry Electrolytic Capacitors
- Noise Suppression Filters
- Delay Lines
- Pulse Transformers
- Ceramic Capacitors
- Plastic Dielectric Capacitors (337 & 338 Types)
- Linear Variable Differential Transformers
- Metallized Paper Capacitors

See these products at Booth 407 I.R.E. Show

*Gudeman Sales Offices and Representatives
in 17 U.S. and 2 Canadian Cities.



MAIN OFFICE: 340 WEST HURON STREET • CHICAGO 10, ILLINOIS
PHONE DELaware 7-7400

Manufacturers of Electronic Components for Military and Commercial Applications.

Flexibility in Application
Versatility in design...
 packaged
 analog-digital
 converters

Shaft Position to Digital Converters features reliability, long life, non-ambiguity and speed makes these converters ideal for computers or data handling systems where serial read-out is preferred. Librascope converters transmit information at almost any rate desired up to 1 mc and in some cases above, and may be multiple time-shared, holding extra circuitry to a minimum. All units quickly adjustable, synchro-mounted. Available in Binary, Gray code or Binary decimal code as shown in chart below. Special units may be designed to your order.

Write for catalog information.



FEATURES:

- Unique, staggered double brush pick-off system.
- Reads out serially into relays or single or multiple scan matrices.
- Analog-digital or digital-analog operation.
- May be time-shared.
- Synchro-mounted.
- Associated circuitry can be designed to fit your data-handling problems.

CODE	MODEL*	RESOLUTION PER INPUT SHAFT REV.	RESOLUTION OVER FULL RANGE	DIMENSIONS DIAMETER X LENGTH
BINARY	7 digit	128	1 part in 128	2" x 2 ⁹ / ₆₄ "
	13 digit	128	1 part in 8192	2" x 3 ¹ / ₃₂ "
	17 digit	128	1 part in 131,072	2" x 4 ¹ / ₁₆ "
	19 digit	128	1 part in 524,288	2" x 4 ¹ / ₁₆ "
BINARY CODED DECIMAL	0-2000	200	1 part in 2000	3 ¹ / ₁₆ " x 4 ²⁷ / ₄₂ "
	0-3600	200	1 part in 3600	3 ¹ / ₁₆ " x 4 ²⁷ / ₄₂ "
	0-20,000	200	1 part in 20,000	3 ¹ / ₁₆ " x 4 ²⁷ / ₄₂ "
	0-36,000	200	1 part in 36,000	3 ¹ / ₁₆ " x 6 ³ / ₈ "
GRAY	8	256	1 part in 256	3 ¹ / ₁₆ " x 1 ¹ / ₁₆ "
* SPECIAL UNITS AVAILABLE	Precision gearing Shaft Speed: 120 rpm continuous Operating temp: -55° C to +75° C Shock and Vibration: up to 15 G, 5 to 500 cps.		Life Expectancy: Function of lead current. For 13 digit unit @ 2 ma. per brush, life approx. 5x10 ⁸ breaks or makes at approx. 120 rpm.	

Engineers, physicists and mathematicians interested in challenging California careers, contact Mac McKeague, Personnel Director.



LIBRASCOPE
 COMPUTERS, COMPONENTS AND CONTROLS.

A SUBSIDIARY OF GENERAL PRECISION EQUIPMENT CORPORATION

LIBRASCOPE, INC. • 808 WESTERN AVENUE • GLENDALE, CALIFORNIA

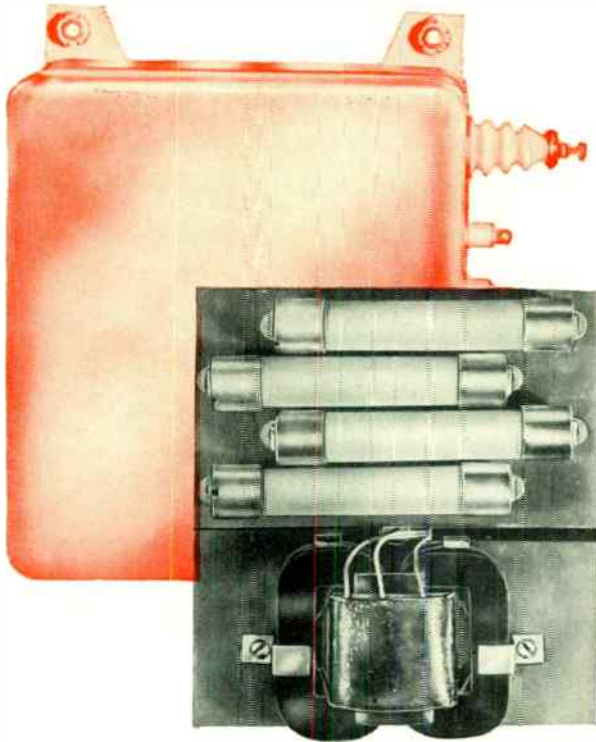

high voltage—
low current

D. C. POWER SUPPLY

ideal for aircraft, guided missiles,
other applications with limited
space and weight

This special D.C. power supply, now being produced by Keystone, has an output of 4500 volts at 1 milliamp with an operating frequency of 6000-13,000 cycles per second. Input is 150 volts. The unit is oil filled, hermetically sealed, and can be used effectively from -55°C. to $+75^{\circ}\text{C.}$, and to altitudes of 60,000 feet.

This versatile component is ideal for any application, military or commercial, where space and weight are critical factors . . . and it is typical of the unique components produced by Keystone to meet unusual standards of performance, adaptability and reliability. Each is a custom-engineered unit designed to solve specific problems which standard transformers or magnetic amplifiers cannot solve.

If you have an application for a low-input D.C. power supply like the one above—or if you have an unusual specification demanding unique performance from a transformer or magnetic amplifier—contact the Engineering Department today.

See Keystone's new transformers and "Moto Mags" at
booth # 804, I.R.E. show

write for new
illustrated brochure,
"Modern Components"

This new brochure describes and illustrates a wide variety of transformers and magnetic amplifiers produced to meet unusual and difficult specifications.



Write today for
your copy.

keystone



PRODUCTS COMPANY

904 23RD STREET UNION CITY 2, N. J.

±1% stable voltage in face of 30% line variations

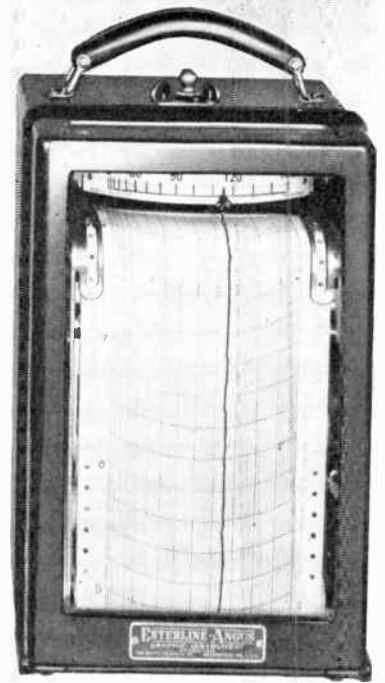
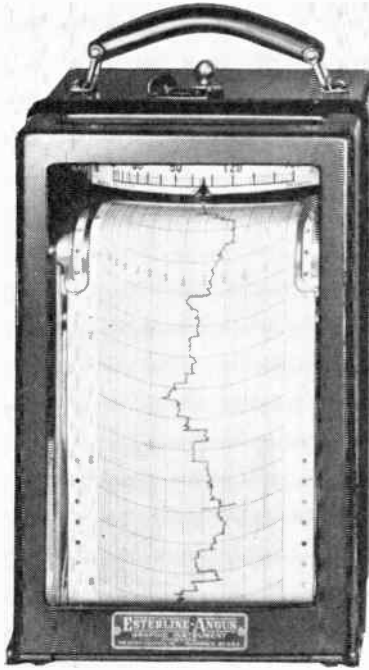

TYPICAL EXAMPLE OF SOLA VOLTAGE REGULATING ACTION. The recording on the left represents a fairly common condition of voltage fluctuation on a 115v line. The chart on the right

was made at exactly the same time from the same line. The primary of the Sola regulator was fed the voltage charted on the left, the voltage charted on the right represents its secondary output, regulated to within ±1% of 115v.

Voltage-sensitive electrical and electronic equipment can not operate to performance specifications under conditions of voltage fluctuation. A source of constant voltage can be easily supplied with a Sola Constant Voltage Transformer . . . built-in as a component, or used externally as an accessory.

Among the chief advantages of Sola regulators are: dependable, automatic operation (static-magnetic regulation) . . . substantially instantaneous response (1.5 cycles or less) . . . no maintenance (no moving or expendable parts) . . . and immediate availability (40 stock units in a wide variety of ratings).

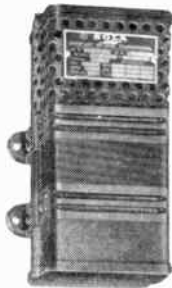

STANDARD TYPE CV

Twenty-nine units from 15va to 10kva in a common power line and filament voltage ratings . . . regulation ±1% or less with a total primary variation of 30% . . . for electronic and electrical equipment requiring close regulation.

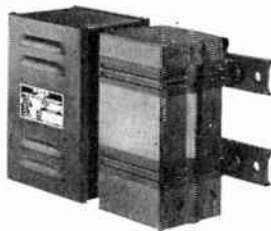

HARMONIC-NEUTRALIZED TYPE CVH

Six units from 60va to 2kva . . . input range 95-125v, output 115v . . . all the features of the Standard Type CV plus a harmonic neutralizer circuit . . . ±1% regulated voltage with less than 3% harmonic distortion.

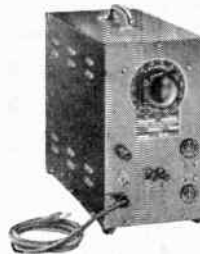

ADJUSTABLE, HARMONIC-NEUTRALIZED TYPE CVL

Two ac voltage supply units, 250va and 500va . . . input range 95-125v, output range adjustable from 0-130v . . . regulated ±1%, harmonic distortion less than 3% . . . for general lab work, testing and other applications.



PLATE AND FILAMENT TYPE CVE

Three units in popular power supply ratings . . . a single, compact source of filament and plate supply voltages . . . regulated to within ±3% or less with line voltage variations of 100-130 volts . . . supplied with separate capacitor for chassis mounting.

SOLA *Constant Voltage* TRANSFORMERS

VISIT SOLA'S I.R.E. BOOTH. See the latest in REGULATED DC POWER SUPPLY units. Booth 537, I.R.E. Show, New York, March 21.

Transformers for: Constant Voltage • Fluorescent Lighting • Cold Cathode Lighting • Mercury Vapor Lighting • Plastic Signs
 SOLA ELECTRIC CO., 4633 West 16th Street, Chicago 50, Illinois, Bishop 2-1414 • BOSTON: 272 Centre Street, Newton 58, Massachusetts
 NEW YORK 35: 103 East 125th Street • LOS ANGELES 26: 2025 Sunset Boulevard • PHILADELPHIA: Commercial Trust Building
 CLEVELAND 15: 1836 Euclid Avenue • KANSAS CITY 2, MISSOURI: 406 West 34th Street • Representatives in Other Principal Cities



This is **Greenleaf..**

you can **BOSS** this plant...

and Solve Your Precision Component Sub-Contracting Problems as These Leading Companies do:

- A. C. Spark Plug Division — General Motors Corp.
- Chance Vought Aircraft, Inc.
- Crosley Division, AVCO Mfg. Corp.
- Eastman Kodak Company
- The Emerson Electric Mfg. Co.
- Emerson Radio & Phonograph Corp.
- Farrand Optical Company, Inc.
- Hughes Aircraft Company
- The Glenn L. Martin Company
- McDonnell Aircraft Corp.
- Westinghouse Electric Corp.

Not only this plant with its precision production equipment . . . not only the laboratories with their intricate testing facilities . . . but, above all, the abilities and the brains of the men of Greenleaf are at your service. To utilize our unusual development, engineering and manufacturing experience . . . we solicit the kind of projects that make others hesitate.

A telephone call or wire will put us in touch with you immediately.

ENGINEERING • DEVELOPMENT • PRODUCTION

Where quality control works on the production line . . . producing Gyros (rate and integrating), Pressure Transmitters, Accelerometers, Synchros, Air Speed Indicators, Actuators and many other precision-built components,



THE **Greenleaf** MANUFACTURING COMPANY
7814 Maplewood Industrial Court • Saint Louis 17, Missouri

See us at the I.R.E. Show, Booth No. 40,
Kingsbridge Palace, March 21-24.

KEEP AHEAD WITH YOUR EQUIPMENT DESIGNS

RCA UHF "PENCIL" TYPES
... for superior efficiency
in UHF communications.



... Choose **RCA** **Industrial** **Receiving-** **Type** **Tubes**

RCA PREMIUM TYPES
... for added reliability
in industrial and
military environments.



RCA COMPUTER TYPES
... for dependable,
uninterrupted use in
computer applications.



RCA LOW-NOISE TYPES
... for low-noise
operation in critical
audio applications.



RCA "SPECIAL REDS"
... for exceptional uniformity,
stability, dependability, and
minimum life of 10,000 hours.



RCA VR's and THYRATRONS
... for stability and dependability
in control circuits.



To help get your share of the enormous market potential in the expanding industrial and communications fields, RCA research and manufacturing facilities bring you this important family of industrial receiving-type tubes. The line offers you a wide latitude in designing "industrial type" circuits—and, of course, offers you the famous RCA standard of performance.

See the array of RCA Tubes, Semiconductor Devices, Components, and Test Equipment ... at the IRE Show—Booths 151 to 155



RADIO CORPORATION of AMERICA
ELECTRON TUBES
HARRISON, N. J.

BOARD OF DIRECTORS, 1955

J. D. Ryder
President

Franz Tank
Vice-President

W. R. G. Baker
Treasurer

Haraden Pratt
Secretary

John R. Pierce
Editor

J. W. McRae
Senior Past President

W. R. Hewlett
Junior Past President

1955

S. L. Bailey
A. N. Goldsmith
A. V. Loughren
C. J. Marshall (R5)
L. E. Packard (R1)
J. M. Pettit (R7)
B. E. Shackelford
C. H. Vollum
H. W. Wells (R3)

1955-1956

E. M. Boone (R4)
J. N. Dyer (R2)
J. T. Henderson (R8)
A. G. Jensen
George Rappaport
D. J. Tucker (R6)

1955-1957

J. F. Byrne
Ernst Weber

George W. Bailey
Executive Secretary

John B. Buckley
Chief Accountant

Laurence G. Cumming
Technical Secretary

Evelyn Davis
Assistant to the Executive Secretary

Emily Sirjane
Office Manager



Responsibility for the contents of papers published in the PROCEEDINGS OF THE IRE rests upon the authors. Statements made in papers are not binding on the Institute or its members.



PROCEEDINGS OF THE IRE

Published Monthly by

The Institute of Radio Engineers, Inc.

VOLUME 43

March, 1955

NUMBER 3

CONTENTS

John N. Dyer, Director, 1955-1956.....	258
The Greatest Show on Earth..... <i>The Managing Editor</i>	259
5184. A Large Signal Theory of Traveling-Wave Amplifiers.....P. K. Tien, L. R. Walker, and V. M. Wolontis	260
5185. Saturation Current in Alloy Junctions..... <i>W. M. Webster</i>	277
5186. Theory of Radio Transmission by Tropospheric Scattering Using Very Narrow Beams..... <i>H. G. Booker and J. T. deBettencourt</i>	281
5187. Logical and Control Functions Performed with Magnetic Cores. <i>S. Guterman, R. D. Kodis, and S. Ruhman</i>	291
5188. Pin-Hole Camera Investigation of Electron Beams..... <i>C. C. Cutler and J. A. Saloom</i>	299
5189. Thermal Velocity Effects in Electron Guns..... <i>C. C. Cutler and M. E. Hines</i>	307
5190. Electrical Characteristics of Power Transistors... <i>Allen Nussbaum</i>	315
5191. Further Bounds Existing on the Transient Responses of Various Types of Networks..... <i>A. H. Zemanian</i>	322
5192. Magnetic Focusing of Electron Beams..... <i>J. T. Mendel</i>	327
5193. The Mitron—An Interdigital Voltage-Tunable Magnetron..... <i>J. A. Boyd</i>	332
5194. Resonant Behavior of Electron Beams in Periodically Focused Tubes for Transverse Signal Fields..... <i>R. Adler, O. M. Kromhout, and P. A. Clavier</i>	339
Correspondence:	
5195. On Reciprocal Inductance..... <i>Harry Stockman</i>	341
5196. The Mesh Counterpart of Shekel's Theorem..... <i>S. Seshu</i>	342
5197. The Compensation Theorem..... <i>David K. Cheng</i>	342
5198. Some Antics in Semantics..... <i>D. H. Sheingold</i>	343
5199. Logarithmic Amplifier Simplifications and Improvements..... <i>D. E. Sunstein</i>	343
5200. Rebuttal..... <i>T. H. Chambers</i>	343
5201. Hysteresis in Klystron Oscillators... <i>T. Moreno and R. L. Jepsen</i>	344
Contributors.....	345
IRE News and Radio Notes:	
National Convention Committees.....	347
Convention Technical Sessions Schedule.....	348
Summaries of Technical Papers.....	349
IRE News.....	378
Transactions of Professional Groups.....	380
Technical Committee Notes.....	381
5202. Abstracts of Transactions.....	382
Professional Group Chairmen.....	383
Professional Group Sections.....	384
5203. Abstracts and References.....	386
What to See..... 1A	Professional Group Meetings.. 63A
Meetings with Exhibits..... 6A	Section Meetings..... 100A
News and New Products..... 42A	Positions Open..... 286A
Industrial Engineering Notes . 52A	Positions Wanted..... 298A
IRE People.....	358A

EDITORIAL DEPARTMENT

Alfred N. Goldsmith
Editor Emeritus

John R. Pierce
Editor

E. K. Gannett
Managing Editor

Marita D. Sands
Assistant Editor

ADVERTISING DEPARTMENT

William C. Copp
Advertising Manager

Lillian Petranek
Assistant Advertising Manager

EDITORIAL BOARD

John R. Pierce, *Chairman*

D. G. Fink
E. K. Gannett
T. A. Hunter
W. R. Hewlett
J. A. Stratton
W. N. Tuttle

Changes of address (with advance notice of fifteen days) and communications regarding subscriptions and payments should be mailed to the Secretary of the Institute, at 450 Ahnaip St., Menasha, Wisconsin, or 1 East 79 Street, New York 21, N. Y.

All rights of publication, including translation into foreign languages, are reserved by the Institute. Abstracts of papers with mention of their source may be printed. Requests for republication privileges should be addressed to The Institute of Radio Engineers.



John N. Dyer

DIRECTOR, 1955–1956

John N. Dyer was born in Haverhill, Massachusetts on July 14, 1910. Attending Massachusetts Institute of Technology, Mr. Dyer in 1931 received the B.S. degree in electrical engineering.

He was in charge of radio engineering from 1933 to 1935 for the Byrd Antarctic Expedition II. Upon his return to this country, he joined the General Engineering Department of CBS, and in 1937 he became Assistant Chief Television Engineer. At the Radio Research Laboratory of Harvard University, Mr. Dyer in 1942 led the group which developed vhf transmitters. Early in 1944 he became a Director of the American British Laboratory of the National Defense Research Committee in England. It was his responsibility to assist the services in making maximum use of the countermeasure equipment developed at Harvard and other U. S. laboratories. After VE day Mr. Dyer was appointed head of the Radio Research Laboratory's field division. Following this work he joined the Airborne Instruments Laboratory where, in 1950, he became Director of the Research and Engineering Division and, in 1951, Vice-President and a member of the Board of Directors. Under Mr. Dyer's

supervision, the former Radar and Air Navigation Section conducted air traffic control studies and experiments in the use of radar at L and S bands for terminal air traffic control. In addition, he conducted general studies on all phases of air navigation and air traffic control for the Air Transport Association. These studies pioneered in the use of ground radar in civil aviation and led to equipment development at the Airborne Instruments Laboratory of rf components, high performance receivers, special antennas, and improvements in MTI techniques. The work of Mr. Dyer's section also involved video mapping, circular polarization, track-while-scan, and taxi radar.

Mr. Dyer joined the IRE in 1930 as a Junior Member. He became an Associate in 1932 and a Senior Member in 1945. In 1949 he received the Fellow Award "for administrative and technical contributions to radio, including polar-expedition communications and important wartime radio countermeasures." Mr. Dyer has served on the Navigation Aids Committee and as a representative for the Long Island Subsection. In 1950 he was elected Chairman of the subsection.

The Greatest Show on Earth

On the evening of Tuesday, March 15, the vanguard of a giant caravan of trucks will begin pouring into New York City from every part of the country. By early Wednesday morning these ten- and fourteen-wheel monsters will be backed up for eight blocks outside the Kingsbridge Armory and the nearby Kingsbridge Palace in the Bronx, waiting to disgorge hundreds of boxes. The boxes will be many sizes and shapes, but their labels will be same: "1955 IRE National Convention."

As the boxes stream into the mammoth Armory, a 1,000-man army of movers, riggers, carpenters, iron workers, painters and electricians will begin the task of unpacking and setting up the exhibits. Their movements will be controlled by a platoon of supervisors and messengers mounted, believe it or not, on bicycles so that they can speedily reach any of the 704 exhibit locations on the enormous four-acre drill floor.

By the end of the day, 100 trailer trucks will have filed to the loading platform, been unloaded and sent on their way. The following morning the line of trucks will still be eight blocks long.

In fact, the unloading process will continue at a rate of 100 trucks a day for four more days before the seemingly endless stream ceases. Finally, on Sunday night, a four-mile line of trucks will be empty, the unpacking of 20,000 boxes will be completed, the exhibits will all be assembled, two lecture halls will be equipped, registration facilities will be set up, and a 1,000,000-watt substation will be installed and connected to the vast array of booths.

Sunday night will see the midnight oil burning also at the Waldorf-Astoria Hotel in mid-town Manhattan, as the work of setting up six more lecture halls, convention headquarters, and sixty feet of registration desks nears completion. What will not be visible to the eye is the seven months of hard work which 175 volunteer committee members spent in planning and making arrangements for the technical program, banquet, cocktail party, facilities, registration, publicity, and so on ad infinitum.

The magnitude, as great as it is, of all these preparations and labors is far overshadowed by the importance of what will take place on March 21-24. On those dates 40,000 people are going to attend the greatest engineering show and convention on earth. They are coming because they cannot afford to miss it.

One of the things they cannot afford to miss is the most extensive program of technical papers in IRE history. A grand total of fifty-five sessions will be presented during four days at the Waldorf-Astoria, Kingsbridge Armory, and Belmont Plaza. This means there will be something like 275 papers and discussions by the leading authorities in the field. They will reveal a host of new technical developments in just about any subject you could mention (e.g., remote control of space stations, designing machines to simulate the behavior of the human brain, high fidelity, to name a few). The complete menu of this savory technical feast begins on page 348 of this issue.

Another reason that 40,000 people are coming is the fabulous Radio Engineering Show. You would have to see it to believe it, because it defies description. Suffice it to say that the visitor who tours the 704 exhibits will learn more about the radio-electronic industry in four hours than he otherwise could in four months, or probably four years.

There is one last and especially important thing that 40,000 people are coming to see—each other. The value which an engineer derives from meeting other engineers and exchanging ideas with them is immeasurable. In two minutes he can learn from the experience of another what it would take months to learn by himself. The convention offers unlimited opportunities of enjoying this stimulating experience of personal contact, not only at the sessions and exhibits, but also at the other features of the convention: the annual meeting of the IRE Monday morning, the cocktail party Monday evening, and annual banquet Wednesday night.

Many rich rewards await you at the IRE National Convention. And they cannot be had by staying home and reading about them.

—*The Managing Editor*

A Large Signal Theory of Traveling-Wave Amplifiers*

P. K. TIEN†, ASSOCIATE, IRE, L. R. WALKER†, AND V. M. WOLONTIS†

Summary—The large-signal or nonlinear behavior of the traveling-wave amplifier is calculated in this paper by numerically integrating a set of equations of motion, which is essentially that of Nordsieck, but includes the space-charge repulsion between the electrons. The calculations were made assuming a loss-free circuit and a small coupling between the circuit and the beam. A method of computing the space-charge field, by summing the forces between the electrons, is fully described. It is found that in the large signal theory a parameter k is required in addition to the space-charge parameter QC . $1/k$ measures the range of action of the space-charge forces and is proportional to the beam radius. The other parameters including QC are those defined in the linear theory.

Twenty cases covering useful ranges of the design and the operating parameters have been computed. The numerical integrations were done by type 701 IBM equipment. The amplitude and the phase of the circuit wave as functions of the distance are given for all the cases. It is found that the limiting efficiency increases with the electron injection speed, as found by Nordsieck, and increases with the space-charge parameter QC when QC is small, but decreases rapidly for larger QC . The efficiency also increases with the beam radius, or $1/k$, provided the assumption that the field and the current are uniformly distributed over the cross section is valid. Finally the electron motion in high level operation is analyzed. The effect of QC and of k on efficiency are explained. The study indicates several possible ways of improving the limiting efficiency.

INTRODUCTION

THE HIGH LEVEL or nonlinear behavior of the traveling-wave amplifier has been analyzed by Nordsieck.¹ Among the simplifications which were made to make the problem tractable was a neglect of the space-charge forces between the electrons. At high level, when electrons start to overtake one another, the space-charge field is generally not negligible, and in some cases may even be much greater than the circuit field. It is therefore the purpose of this paper to extend Nordsieck's model to include the space-charge interaction. For a better understanding of the problem, we shall review briefly some important features of Nordsieck's analysis and then come to the problem of space charge.

Let us consider the major assumptions which are made. In the first place, the model used is one dimensional, in the sense that we shall speak of a charge density, current and velocity which are functions only of distance along the tube (and of time). Thus, all electrons with a given co-ordinate z are supposed to be acted upon by the same rf fields, whereas, in fact, the circuit field will be stronger and the space-charge field will be weaker for the outermost electrons. The "electrons" considered in the model may be considered to represent the average behavior of all the electrons in the beam at a given z . In the same way the excitation of the

circuit by the beam is represented by the integrated effect on the circuit of all the charges at a given z . The circuit, furthermore, will be supposed to have a finite impedance for the fundamental angular frequency, ω , only, or stated more specifically, only the fundamental frequency component of the beam current excites a propagating mode on the circuit. This is generally true in actual tubes as the circuit impedance is small for harmonics. It is also assumed that the coupling of the beam to the circuit is weak, or using Pierce's² terminology, that the gain parameter, C , is small. This has the effect of insuring that the circuit voltage changes only slightly in one wavelength and that the dc beam velocity, circuit velocity, and the resultant wave velocity are all close together. The latter proviso implies that the backward wave on the circuit remains very far from synchronism with the electrons. Because of this lack of synchronism it is considered legitimate to suppose that the effect of the backward wave upon the electrons may be ignored. One calculates therefore only the excitation of the forward wave. The tube is supposed to be of infinite length, so that what is sought is a "natural" nonlinear solution, periodic in time, which shall be the generalization of the growing wave solution of linear theory.

The features of the model so far described are just those of Nordsieck's treatment. In the present analysis we wish to add to this model a representation of space-charge forces, or more precisely, the electrostatic interaction between the electrons. This may be carried out in a way which is consistent with our earlier assumptions, if we suppose that our "electrons" are uniformly charged discs concentric with the helix but not filling it (the latter for these purposes being thought of as a conducting cylinder). It is a straightforward matter to calculate the force exerted by one such disc on another at a given distance. Integrating over the z -distribution of electrons, we find the space-charge force at any point. To the extent that C is small, we are able to calculate the space-charge force at a point with sufficient accuracy although the electron paths are not yet integrated beyond the point in question. This, of course, is essential if we are to carry out a step-by-step integration.

THE EQUATIONS

For coherence it is desirable here to recapitulate some important features of the equations which will be used in calculating the rf voltage on the circuit and the electron motions inside the beam, although most of the analysis is to be found in Nordsieck. The circuit voltage

* Original manuscript received by the IRE, October 7, 1954; revised manuscript received, December 6, 1954.

† Bell Telephone Labs., Murray Hill, N. J.

¹ A. Nordsieck, "Theory of the large-signal behavior of traveling-wave amplifiers," Proc. I.R.E., vol. 41, pp. 630-637; May, 1953.

² J. R. Pierce, "Traveling-Wave Tubes," D. Van Nostrand Co., Inc., New York, N. Y.; 1950.

is written as

$$V(z, t) = \frac{Z_0 I_0}{C} A(z) \cos \Phi(z, t) \quad (1)$$

$$\Phi(z, t) = \frac{\omega}{u_0} z - \omega t = \theta(z). \quad (2)$$

Here z is measured along the axis of the helix. The helix is supposed to extend to $z = -\infty$, where the beam entered unmodulated. ω is the angular frequency of the fundamental, or $2\pi/\omega$ is the period, and u_0 , the average electron speed. $\theta(z)$ is the phase angle between the actual helix wave and a wave in synchronism with the average electron speed. Z_0 is the characteristic impedance of the circuit, I_0 , the dc beam current, and C , the gain parameter defined by Pierce.² The circuit voltage in (1) must satisfy the equation¹

$$\frac{\partial^2 V}{\partial t^2} - v_0^2 \frac{\partial^2 V}{\partial z^2} = v_0 Z_0 \frac{\partial^2 \rho_\omega}{\partial t^2}, \quad (3)$$

which describes the excitation of the circuit wave by the electrons and is generally known as the circuit equation in traveling-wave tube theory. v_0 is the velocity of propagation on a cold helix. ρ_ω is the fundamental component of the instantaneous electron linear charge density $\rho(z, t)$.

In addition to the circuit equation (3), we have, for the electron motion, the force equation and the equation of conservation of charge. They are respectively

$$m \frac{d^2 z}{dt^2} = e \frac{\partial V}{\partial z} - e E_s, \quad (4)$$

and

$$\rho(z, t) | dz | = \rho(z, 0) | dz_0 |, \quad (5)$$

where e/m is the ratio of the electron charge to the mass, a positive quantity. E_s is the space-charge field acting on the electrons, which will be discussed in detail later.

Let the z_0 's be the initial positions of the electrons at $t = 0$. We shall denote the initial phase of an electron by

$$\Phi_0 = \frac{\omega z_0}{u_0}. \quad (6)$$

So far we have acted as if $\rho(z, t)$ were a continuous function of z and t . As described in the previous section, for the present model we shall replace the continuous electron beam by a set of "electron-discs." Thus, instead of considering the electron beam as a fluid with a given velocity and density as functions of z and t , we shall follow a typical set of charged discs and calculate their velocities and positions. This is necessary in large-signal calculations when electrons overtake one another. With this in mind, using (3), (4), and (5), we obtain the following working equations after considerable algebra:

$$\frac{dA(y)}{dy} = - \frac{1}{2\pi} \int_0^{2\pi} \sin \Phi(\Phi_0, y) d\Phi_0 \quad (7)$$

$$\frac{d\theta}{dy} + b = \frac{1}{2\pi A(y)} \int_0^{2\pi} \cos \Phi(\Phi_0, y) d\Phi_0 \quad (8)$$

$$2 \frac{\partial q(\Phi_0, y)}{\partial y} = 2A(y) \sin \Phi(\Phi_0, y) - \frac{e}{u_0 m \omega C^2} E_s \quad (9)$$

$$\frac{\partial \Phi(\Phi_0, y)}{\partial y} = - \frac{d\theta(y)}{dy} + 2q(\Phi_0, y). \quad (10)$$

Here (7), (8), (9), and (10), except for the space-charge term E_s , are Nordsieck's equations¹ (13), (14), (17), and (20). z is replaced by:

$$y = C \frac{\omega}{u_0} z. \quad (11)$$

This means that distances are measured in units of $\lambda_e/2\pi C$, where λ_e is the wavelength along the beam. The velocity at y , of an electron of an initial phase Φ_0 is expressed as

$$u(\Phi_0, y) = u_0 + 2Cu_0 q(\Phi_0, y). \quad (12)$$

Here u_0 and $2Cu_0 q$ are respectively dc and ac velocities. $\Phi(\Phi_0, y)$ is the phase of the circuit voltage which an electron with an initial phase Φ_0 sees at y . In studying the electron motions, $\Phi(\Phi_0, y)$'s are the time-phases of the electrons, or more precisely, these values give a distribution of the electrons in time at the position y . In a small interval of y , a distribution in ωt at y may also be considered as the distribution in $\omega z/u_0$ at t . It is obvious that electrons whose initial phases are the same or differ by an integral multiple of 2π experience the same circuit and space-charge fields and should have the same motion. It is, therefore, only necessary for us to study the motions of the electrons whose initial phases cover an interval of 2π . b and C , as defined by Pierce, are respectively

$$b \equiv \frac{u_0 - v_0}{Cu_0}$$

$$C^3 \equiv Z_0 \frac{I_0}{4V_0}.$$

Here V_0 and I_0 are respectively the beam voltage and beam current, I_0 being considered as a positive quantity.

We can easily give a physical interpretation of these equations. Eq. (7) indicates that the rate of increase of the circuit voltage depends upon the phases of the circuit voltage at the positions of the electrons. This is equivalent to saying that the increase of the circuit voltage is mainly attributed to the density modulation of the beam. When C is small, as we have assumed previously, the rf velocity is small compared to the dc velocity. The convection current in the beam is therefore approximately equal to the product of the electron linear charge density and the dc velocity, which in our analysis is proportional to $-d\Phi_0$. On the other hand, the electric field of the circuit is $-A(y) \sin \Phi$. The negative of the product of the electric field and the convec-

tion current, which is proportional to $-A(y) \sin \Phi d\Phi_0$, integrated over all the electron-discs, is the total power contributed by the beam to the circuit. It should be proportional to $[dA^2(y)/dy]$, which is equal to $2A(y)[dA(y)/dy]$. Cancelling $A(y)$ in $\int A(y) \sin \Phi d\Phi_0$ and $2A(y)[dA(y)/dy]$, and equating them through a proper proportioning constant, we obtain exactly the equation (7). In the small-signal theory for small C , the ratio of the rf to dc velocity is a quantity much smaller than that of the rf to the dc linear charge density. It is therefore appropriate in the small-signal theory for small C to neglect the rf velocity in comparison with the dc velocity. The same simplification in the large-signal theory limits the value of C for which our theory applies. In the later calculations, the value of $2q$ near the saturation level is found to be about 3. If, for example, $C=0.02$, the error involved will be only 6 per cent. At $C=0.1$ however, the error amounts to 30 per cent.

To understand (7) and (8) better, we shall compare them with the equation derived by Pierce for the field in the circuit caused by an impressed current.³ Pierce's equation is

$$V = \frac{-\Gamma\Gamma_1 K}{(\Gamma^2 - \Gamma_1^2)} i. \quad (13)$$

In his notation, Γ and Γ_1 are the propagation constants of the actual and the cold helix waves respectively. i is the rf beam current, and K , the circuit impedance. In the small-signal theory, the circuit wave varies as $e^{(\mu_1 + j\mu_2)y}$, where μ_1 and μ_2 are respectively Pierce's x_1 and y_1 , and $j = \sqrt{-1}$. $[dA(y)/dy]$ is then proportional to $\mu_1 e^{\mu_1 y}$, and

$$I(y) \left[\frac{d\theta(y)}{dy} + b \right],$$

proportional to $(\mu_2 + b)e^{\mu_1 y}$. In a later section, we shall indicate that

$$-\frac{1}{2\pi} \int_0^{2\pi} \sin \Phi d\Phi_0,$$

in (7) and

$$-\frac{1}{2\pi} \int_0^{2\pi} \cos \Phi d\Phi_0$$

in (8), are proportional, respectively to the parts of the beam current, which are in-phase (or 180 degrees out-of-phase) and 90 degrees out-of-phase with the axially directed circuit electric field. Eqs. (7) and (8) thus express a relation between the rf beam current and the circuit electric field, and show that in the small-signal case, the current, like the circuit field, has an amplitude varying as $e^{\mu_1 y}$ but the current leads the field in time phase by $\tan^{-1}(\mu_2 + b)/-\mu_1$. This relation is identical with (13) as expected.

³ Pierce, *op. cit.*, eq. (2.10).

Eq. (9) is merely a transform of the force equation, stating that the acceleration of an electron is proportional to the sum of the circuit and the space-charge fields. Eq. (10) means that the phase shift in circuit voltage experienced by an electron in an interval of dy depends upon two factors, the phase delay of the circuit voltage in that interval, $d\theta/dy$, and the electron rf velocity, $2q$, as it should.

A study of these equations indicates that we may keep certain electrons in a favorable position to contribute power to the circuit by minimizing the quantity $d\Phi/dy$ in (10) for these electrons. This requires $(d\theta/dy) \cong 2q(\Phi_0, y)$ which can be achieved by properly adjusting the parameter b in (8) as a function of y . It is therefore possible to increase the efficiency of the device by properly varying the helix pitch or dc electron speed along the tube. The limitation comes, however, when the electrons are so much decelerated, that the amplitude of the rf velocity exceeds the dc value. In order to contribute power, electrons unfortunately must be in a retarding field.

THE SPACE CHARGE

We now want to introduce space charge or electrostatic interaction into the problem in a manner consistent with other features of the model. It is clear that in a one-dimensional hydrodynamic picture, the charge $\rho(z', t) dz'$ lying in z' to $z' + dz'$ at a time t , should produce, at a point z and at a time t , a field

$$-B(z' - z)\rho(z', t)dz', \quad (13)$$

where $B(z)$ is an appropriate function which will be discussed in detail later. The total field at z would then be

$$E_s = - \int_{-\infty}^{+\infty} B(z' - z)\rho(z', t)dz'.$$

From (5) we have

$$\rho(z', t) | dz' | = \rho(z_0, 0) | dz_0 | = \frac{-I_0}{u_0} | dz_0 |.$$

Thus,

$$E_s = \frac{I_0}{u_0} \int_{-\infty}^{+\infty} B[z(z_0', t) - z(z_0, t)] | dz_0 |. \quad (14)$$

Here z_0' and z_0 are the initial positions of the electrons which at time t and at z' and z respectively. The integral in (14) may be replaced, of course, by a sum over individual electrons.

Two questions arise immediately. The first is whether or not the fact that the space-charge field at a point depends upon the disposition of charges ahead of the point in question makes it impossible to proceed with a step-by-step integration of the equations of motion. The second question is that of a sensible choice for the function $B(z)$.

Consider the first problem. $B(z)$ is obviously a rapidly decreasing function of $|z' - z|$. As a matter of fact, we will later approximate this function by an exponential function $e^{-k(\omega/u_0)|z' - z|}$, where the value of k is generally between 1 and 5. Taking $k = 2$ for example, the function $e^{-k(\omega/u_0)|z' - z|}$ decreases to 0.00185 of its maximum value for $(\omega/u_0)|z' - z| = \pi$. It therefore seems safe for us to compute the space-charge field at z by considering only the electrons in an interval between $(\omega/u_0)z + \pi$ and $(\omega/u_0)z - \pi$. For small C , $\theta(y)$, and $A(y)$ only vary slightly in a few electronic wavelengths. We may thus substitute for $z(z_0', t) - z(z_0, t)$ the expression

$$\frac{u_0}{\omega} \{ \Phi[\Phi_0', y(\Phi_0', t)] - \Phi[\Phi_0, y(\Phi_0, t)] \}, \quad (15)$$

where $(u_0/\omega)\Phi[\Phi_0', y(\Phi_0', t)]$ means evidently a distribution of the electrons in z at a time t . A distribution of the electrons in z at constant t , in the vicinity of the point of interest, is approximately the same as the distribution in t (expressed in the unit of z) at constant z , provided that the circuit wave propagates with a constant amplitude at a constant speed and that the ac velocities of the electrons are small compared with the dc velocity. That is, to the extent that $\theta(y)$ and $A(y)$ are considered constant in an interval in which the values of $B(z' - z)$ cannot be ignored, (15) to the accuracy of order C , may be further replaced by

$$\frac{u_0}{\omega} \{ \Phi[\Phi_0', y] - \Phi[\Phi_0, y] \}, \quad (16)$$

where

$$y = y(\Phi_0, t).$$

We thus obtain the space charge field at y ,

$$E_s = \frac{I_0}{\omega} \int_{-\infty}^{+\infty} B \left\{ \frac{u_0}{\omega} [\Phi(\Phi_0 + \phi, y) - \Phi(\Phi_0, y)] \right\} d\phi. \quad (17)$$

Here Φ_0 is the initial phase of the electron which, at the time t , is situated at y , where the space-charge field E_s is evaluated. Thus, for an electron of an initial phase Φ_0 , the term E_s is calculable at y from a knowledge of Φ 's for all the other electrons when they are at y . Since $\Phi[\Phi_0 + \phi, y]$ is periodic in ϕ , this means knowing what happens to the electrons in one cycle of ϕ at y .

Turning now to the problem of how to choose $B(z)$, it is clear that the recipe most consistent with our model is to calculate the force between two infinitely thin discs of charge with a separation, z . To do this, we replace the helix by a conducting cylinder of equal radius and assume that the charges are uniformly distributed over the discs. We can calculate, by Green's function for the cylinder,⁴ the potential for one disc, and thus find the force on the second. This yields for $B(z)$

⁴ W. R. Smythe, "Static and Dynamic Electricity," McGraw-Hill Book Co., Inc., New York, N. Y.; 1939.

$$B(z) = \frac{1}{2} \frac{1}{\epsilon_0 \pi r_0^2} \sum_n e^{-(\gamma_n (r_0/a))z/r_0} \left[\frac{2 J_1 \left(\gamma_n \frac{r_0}{a} \right)}{\gamma_n J_1(\gamma_n)} \right]^2 \text{sgn } z, \quad (18)$$

where

$$\begin{aligned} \text{sgn } z &= 1 && \text{for } z' - z > 0 \\ &= -1 && \text{for } z' - z < 0 \end{aligned}$$

and

$$J_0(\gamma_n) = 0,$$

where the J 's are Bessel functions. In (18) r_0 and a are the radii of the disc and the helix respectively. $2\pi r_0^2 \epsilon_0 B(z)$ is plotted in Fig. 1 as a function of z/r_0 for

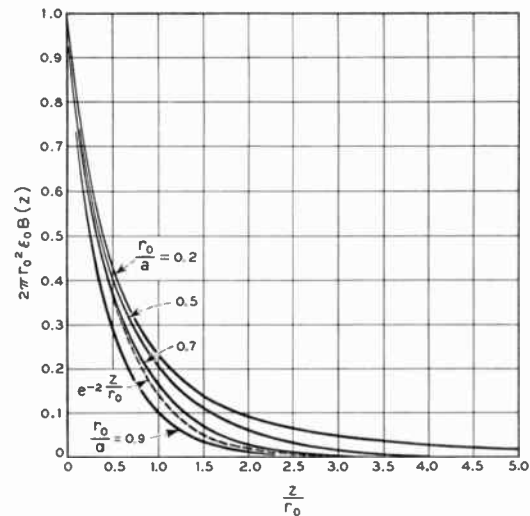

Fig. 1—The solid curves show $2\pi r_0^2 \epsilon_0 B(z)$ versus z/r_0 , calculated for the force between two electron-discs inside a conducting cylinder, and the dotted curve indicates that computed from the universal function e^{-2z/r_0} .

several values of r_0/a . When z/r_0 is small, the curves lie close together and are closely approximated by exponentials of the form $e^{-\alpha z/r_0}$. Where α is a constant in Fig. 1 the function

$$2\pi r_0^2 \epsilon_0 B(z) = e^{-2z/r_0} \text{sgn } z \quad (19)$$

is shown as a dotted line for comparison. The deviations from exponential form occur for large values of z/r_0 , where the values of $B(z)$ are small and the space-charge term in the force is relatively unimportant. Because of the convenience of an exponential function in the space-charge computations, it is desirable to use this form of approximation to $B(z)$. If z be replaced by (16), the space-charge term in (9) may be expressed as

$$\frac{e}{m\omega C^2 u_0} E_s = g \int_{-\infty}^{+\infty} e^{-k|\Phi(\Phi_0 + \phi, y) - \Phi(\Phi_0, y)|} \cdot \text{sgn} \{ \Phi(\Phi_0 + \phi, y) - \Phi(\Phi_0, y) \} d\phi, \quad (20)$$

with

$$g = \frac{eI_0}{2m\omega^2 C^2 u_0 \epsilon \pi r_0^2} = \frac{1}{2} \frac{\omega_p^2}{\omega^2 C^2} \quad (21)$$

and

$$k = \frac{\alpha}{\frac{\omega}{u_0} r_0}$$

Here ω_p is the familiar electron plasma angular frequency for a beam of infinite extent. Pierce has emphasized that Fig. 1 shows α to vary very little with r_0/a and suggests that for simplicity it may be taken equal to 2 as in (19). When this choice is made, it may be seen that if $(\omega/u_0)r_0$ runs from 0.4 to 2, as it might in practice, k varies from 5 to 1, as mentioned. $1/2\pi k$, clearly, measures range of force between disc charges in units of beam wavelength. With α fixed, range is proportional to r_0 , as might be expected, and independent of helix radius.

In the disc model, then, the space-charge force is characterized by the two parameters, g and k ; g measuring the intensity and $1/k$ the range of the force. It is essential to make a connection between these parameters and the quantity QC , which appears in the usual linear theory with space charge. This is effected by making a linearized or small signal theory of the present set of equations (carried out in Appendix I), and we find

$$QC = \frac{g}{2(k^2 + 1)} = \frac{\omega_p^2}{4\omega^2 C^2 (k^2 + 1)}, \quad (22)$$

or

$$4QC^3 = \left(\frac{\omega_p}{\omega \sqrt{k^2 + 1}} \right)^2. \quad (23)$$

The factor $[1/(1+k^2)]^{1/2}$ in (23) may be considered as a reduction factor for ω_p for a finite beam inside a helix. Denoting this reduction factor by R , and using the formula $2u_0/\omega r_0$ for k , we have

$$R = \left[1 + \left(\frac{2u_0}{\omega r_0} \right)^2 \right]^{-1/2}. \quad (24)$$

Pierce⁵ has computed values of QC by replacing the helix by a conducting cylinder as we have done and his values agree reasonably with those of Fletcher's⁶ more elaborate calculations. We may make a check on our method of evaluating space charge by comparing R calculated from the work of Fletcher and of Pierce with that found from (24). Fig. 2(a) and 2(b) shows such a comparison to be satisfactory.

THE SPACE-CHARGE PARAMETERS QC , g AND k

Let us study in more detail the quantities QC , g and k . In (23) and (21), we have respectively

⁵ Pierce, *op. cit.*, pp. 236-238.
⁶ R. C. Fletcher, "Helix parameters in traveling-wave tube theory," Proc. I.R.E., vol. 38, pp. 413-417; April, 1950.

$$QC = \left(\frac{\omega_p R}{2\omega C} \right)^2$$

$$g = \frac{1}{2} \left(\frac{\omega_p}{\omega C} \right)^2$$

It may be seen that in the QC expression, $\omega_p R$ instead of ω_p is used. ω_p^2 is proportional to the dc electron charge density of the beam. R is the reduction factor of the electron plasma frequency for a beam inside the helix, and can be calculated if the frequency and the radii of the beam and the helix are known. It has a different value for the fundamental and for the harmonic, and is also different for different harmonics. Since the parameter QC is first introduced in the small-signal theory in which the beam current is mainly of the fundamental component, the reduction factor, R , must there be specifically for the fundamental frequency.

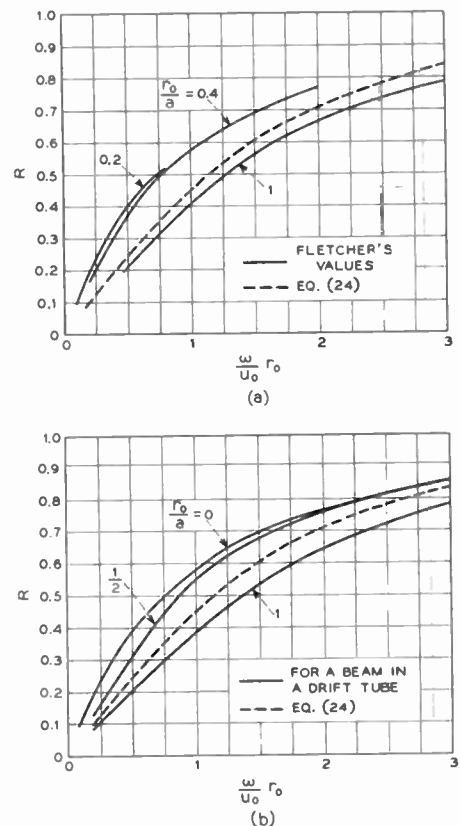

Fig. 2—The solid curves show the reduction factor, R , of the electron plasma frequency evaluated (a) from the Fletcher's values, (b) for an electron beam inside a conducting cylinder, and the dotted curves indicate that computed by the universal function e^{-22/r_0} .

In the large-signal theory, however, the beam current may contain a considerable amount of harmonic components. Although we may calculate the space charge by evaluating the reduction factors and, thus, the QC parameters for all the harmonic components of the beam, it seems simpler to set up a model consisting of a set of electron discs and compute the space-charge field by evaluating the forces between them in such a way

that only two parameters, g and k , as shown by (20), actually enter the calculations. The calculation is independent of the helix radius, because we use the approximation

$$k = \frac{2}{(\omega/u_0)r_0}.$$

In the large-signal theory, therefore, we need two parameters such as g and k , whereas in the linearized theory a single parameter QC is sufficient to specify the space charge. Instead of using g and k as the basic space-charge parameters, we often use QC and k for convenience. g , of course, is calculable from QC and k by (22). It is interesting to point out that beams having the same value of QC but different values of k must behave identically in traveling-wave tubes, when the signal is small, since QC is the only space-charge parameter involved in the small signal theory.

NUMERICAL CALCULATIONS

The equations used for numerical calculations are (7) to (10), and (20). For most of the cases computed below, the number of points used in evaluating the space-charge integral (20) by the trapezoidal rule is 24, or, stated in physical language, a model based on 24 electron discs in an electronic wavelength is used. The forward integrations, which will be discussed more fully below, are performed in steps of $\Delta y = 0.2$. To determine whether these numbers are adequately chosen, several cases were recalculated with 48 or 96 electron discs and some with $\Delta y = 0.1$. For small values of QC (See Table I, on the next page) the agreement was excellent, and well beyond what could be physically significant. For $QC = 1.0$, and to some extent for $QC = 0.5$, however, substantial variations occurred, resulting in differences of as much as 10 per cent in $A(y)$ for large y . The cause of these variations is the discontinuous nature of the space-charge force, combined with the very large magnitude of the contributions to this force from individual electrons. If the values of Φ for two electrons are nearly equal, a very small change in them may reverse the sign of their difference and, hence, the sign of the space-charge contribution. This phenomenon is also the cause of the minor irregularities appearing in the functions Φ and q past the point of overtaking even for small QC , and it is important to realize that it should not be interpreted as a truncation error in the ordinary sense resulting from inadequate numerical methods. The effect of this phenomenon decreases very slowly with an increasing number of electrons, whereas the calculation time increases steeply. The results presented in this investigation are those calculated, with 48-electron model for cases (13), (14), (18), and (19) (these cases have $QC = 0.5$ or 1.0 and saturate at relatively larger values of y because of large values of b), and with 24-electron model for the rest of the cases. The choice of $\Delta y = 0.2$ was maintained for all the cases.

The numerical calculations were carried out using the IBM Electronic Data Processing Machines Type 701 and Associated Equipment, briefly known as the "701," at IBM World Headquarters in New York City. The high-speed random-access storage of this machine consists of cathode ray tubes capable of holding 4,096 numbers consisting of 35 binary digits and sign—so-called full words, roughly equivalent to 10 digit decimal numbers—or 8,192 numbers or instructions consisting of 17 binary digits and sign, called half-words. Practically unlimited auxiliary storage is available on magnetic tapes and drums, but no use of this equipment was necessary in the present problem. The time required to add two full or half-words in the 701, one placed in the arithmetic unit and the other located anywhere in high-speed storage, is 60 microseconds, and to multiply them, 456 microseconds or less, depending on the operations that follow. Most logical operations, such as deciding between two courses of action depending on the value or sign of the quantity standing in the accumulator, take place in 48 microseconds.⁷ At these speeds, the time required for printing out all relevant variables of the problem at the end of each step in the forward integration would be substantially higher than the calculating time. In view of this, the program was designed to print normally only at intervals of 0.4 in y . Furthermore, instead of performing all calculations in so-called floating point form, i.e. with all numbers represented as $a \cdot 10^b$ with a between 1 and 10, the very short calculating time on 701 was achieved by using fixed-point form for all numbers except exponentials occurring in space-charge calculation. Running time per case, for y ranging from 0 to 10, is approximately 10 minutes. The program was prepared by Miss D. C. Leagus.

In view of the nature of the investigation at hand, simplicity rather than high accuracy was used as a guide in the choice of numerical methods. Hence, the forward integration of A , θ , Φ and $2q$ was performed by a central difference formula, e.g.

$$A(y + \Delta y) = A(y) + A'(y + \frac{1}{2}\Delta y) \cdot \Delta y.$$

The integrals in (7), (8) and (20) are evaluated by the trapezoidal rule.

The initial conditions were computed from a second-order small-signal theory, which is discussed in detail in Appendix II. The starting point for the forward integration was chosen such that the maximum value of $2q(\Phi, y)$ is approximately 5 per cent of the value of $d\theta/dy$, and is denoted by $y=0$. The lengthy space charge calculation was performed only at intervals of 0.2. Quantities, such as $d\theta/dy$, demanded by the central difference formula at intermediate points, were obtained by third-order polynomial extrapolation. Subsequently, as a check on machine performance, the value of $d\theta/dy$ thus obtained was compared to the value obtained by applying (8) to extrapolated values of Φ .

⁷ For a detailed discussion of this machine, see several articles in PROC. I.R.E., "COMPUTER ISSUE," vol. 40; October, 1953.

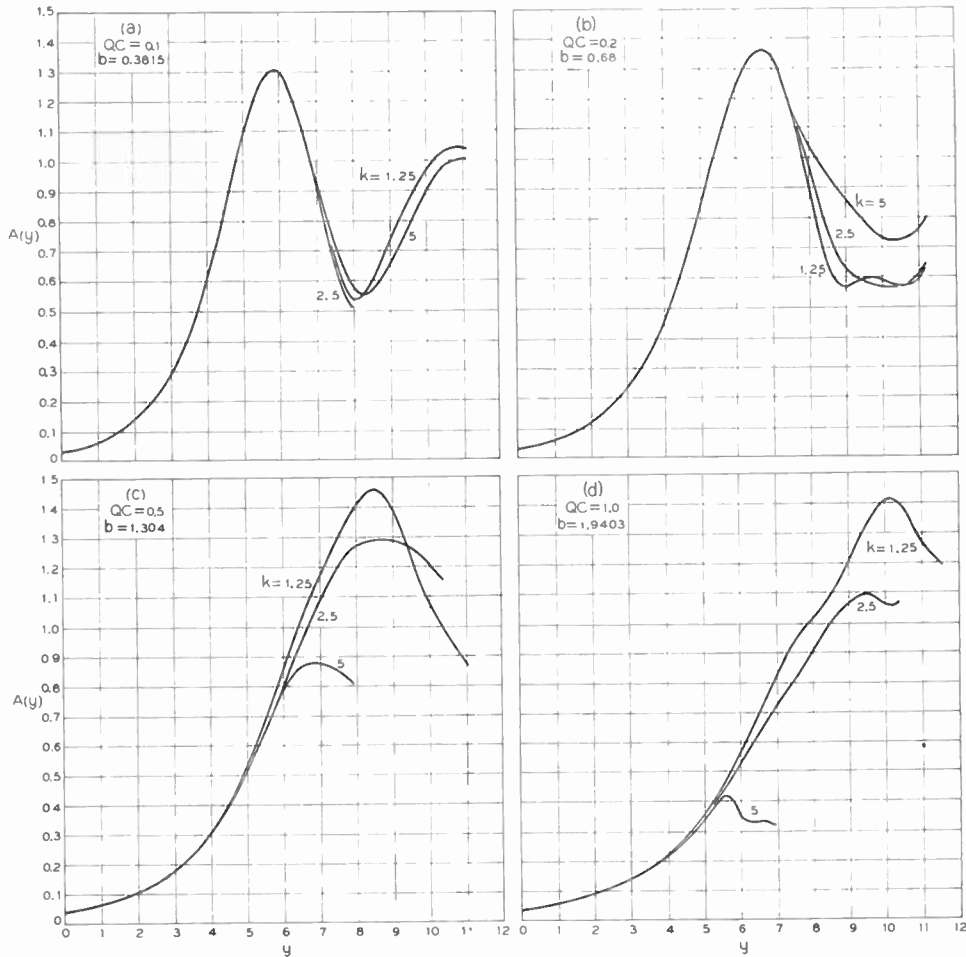

Fig. 3— $A(y)$ versus y curves for (a) cases (1), (2), and (5), (b) cases (6), (7), and (10), (c) cases (11), (12), and (15), (d) cases (16), (17), and (20).

To investigate high level operation for tubes of different signs and with different operating conditions, twenty cases with QC ranging from 0.1 to 1.0, k from 1.25 to 5.00, and b from 0.38 to 2.60, have been computed and are listed in Table I below.

TABLE I

Case Number	QC	k	b	
(1)	0.1	1.25	0.3815	$(\mu_1 = 0.7669, \mu_2 = -0.7150)$
(2)	0.1	2.50	0.3815	$(\mu_1 = 0.7669, \mu_2 = -0.7150)$
(3)	0.1	2.50	0.9595	$(\mu_1 = 0.7218, \mu_2 = -0.9596)$
(4)	0.1	2.50	1.6295	$(\mu_1 = 0.5106, \mu_2 = -1.261)$
(5)	0.1	5.00	0.3815	$(\mu_1 = 0.7669, \mu_2 = -0.7150)$
(6)	0.2	1.25	0.6800	$(\mu_1 = 0.6974, \mu_2 = -0.9196)$
(7)	0.2	2.50	0.6800	$(\mu_1 = 0.6974, \mu_2 = -0.9196)$
(8)	0.2	2.50	1.200	$(\mu_2 = 0.6564, \mu_2 = -1.1552)$
(9)	0.2	2.50	1.800	$(\mu_1 = 0.4643, \mu_2 = -1.4358)$
(10)	0.2	5.00	0.6800	$(\mu_1 = 0.6974, \mu_2 = -0.9196)$
(11)	0.5	1.25	1.3040	$(\mu_1 = 0.5824, \mu_2 = -1.4189)$
(12)	0.5	2.50	1.3040	$(\mu_1 = 0.5824, \mu_2 = -1.4189)$
(13)	0.5	2.50	1.7107	$(\mu_1 = 0.5481, \mu_2 = -1.615)$
(14)	0.5	2.50	2.1982	$(\mu_1 = 0.3877, \mu_2 = -1.852)$
(15)	0.5	5.00	1.3040	$(\mu_1 = 0.5824, \mu_2 = -1.4189)$
(16)	1.0	1.25	1.9403	$(\mu_1 = 0.4962, \mu_2 = -2.0009)$
(17)	1.0	2.50	1.9403	$(\mu_1 = 0.4962, \mu_2 = -2.0009)$
(18)	1.0	2.50	2.2800	$(\mu_1 = 0.4670, \mu_2 = -2.168)$
(19)	1.0	2.50	2.6900	$(\mu_1 = 0.3303, \mu_2 = -2.371)$
(20)	1.0	5.00	1.9403	$(\mu_1 = 0.4962, \mu_2 = -2.0009)$

In this table, μ_1 and μ_2 , which are respectively Pierce's x_1 and y_1 , are also listed for reference. In the small-signal theory, if QC is known, the values of μ_1 and μ_2 can be calculated for any b . It seems wise here to choose b to give particular values of μ_1 . Thus, in cases (3), (8), (13), and (18), and in cases (4), (9), (14), and (19), μ_1 's are respectively equal to 0.9412 and 0.6658 of their maximum values. For the rest of the cases μ_1 's are maximum, that is, at the maximum small-signal gain.

AMPLITUDE AND PHASE OF THE CIRCUIT WAVE

Among results obtained in calculations, the most valuable probably are the amplitude and phase of circuit voltage as functions of y (Figs. 3-6, on this and the following pages). $A(y)$ is plotted in Figs. 3 and 5 for all cases computed. In Fig. 3, curves are compared for cases of different values of k , in Fig. 5, for cases of different values of b . $\theta(y)$ and $\theta(y) - \mu_2 y$ are similarly plotted in Figs. 4 and 6, in which $\mu_2 y$ is also plotted for comparison.

It is found in the $A(y)$ curves that the circuit voltage first increases with y , and then decreases after reaching a saturation level. The power in the circuit at the saturation level is generally known as the "limiting power."

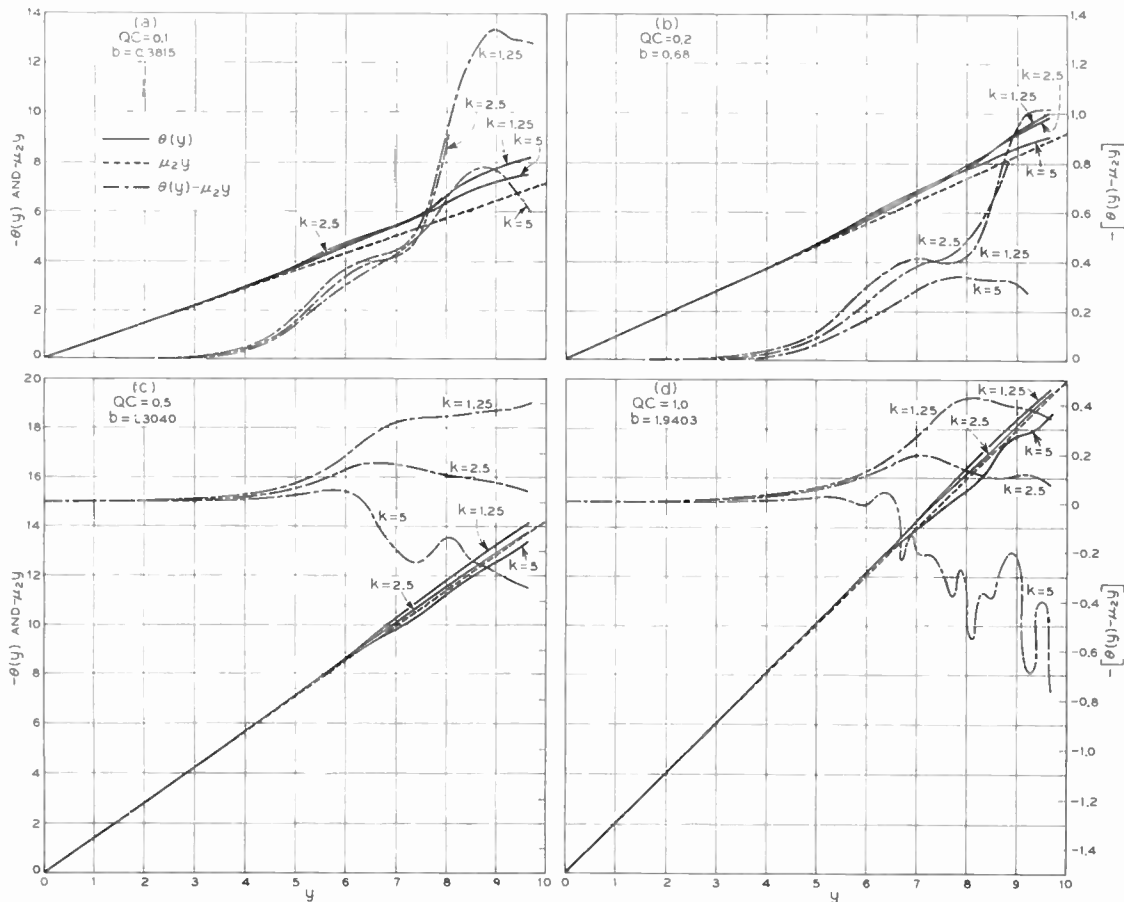

Fig. 4— $\theta(y)$, $\mu_2 y$, and $\theta(y) - \mu_2 y$ versus y curves for (a) cases (1), (2), and (5), (b) cases (6), (7), and (10), (c) cases (11), (12), and (15), (d) cases (16), (17), and (20).

$A(y)$ usually increases again after the first peak and forms another peak and so on. For example, in Fig. 5(b), the $A(y)$ curves for cases (7) and (8) contain three peaks in the range up to $y = 20$. For most of the cases, the first peak is the highest one. For $QC = 1.0$, and to some extent for $QC = 0.5$, the later peaks may have larger, but not much larger amplitudes. $\theta(y)$ does not differ widely from $\mu_2 y$ for almost all the cases.

We have mentioned heretofore that the cases having a common value of QC but different values of k must behave identically at low level. This is so found in Figs. 3 and 4; also that the effect of k is not prominent for small values of QC . This should be so, as k is introduced in the calculation only because of the space charge.

POWER AND EFFICIENCY

The circuit voltage $V(z, t)$ may be calculated from $A(y)$ by (1). The power in the circuit is obviously the time average of V^2/Z_0 that is,

$$\left(\frac{V^2}{Z_0}\right)_{\text{aver.}} = 2CA^2 I_0 V_0 \tag{25}$$

The efficiency of the traveling-wave tube is therefore

$$\text{Eff.} = \frac{2CA^2 I_0 V_0}{I_0 V_0} = 2C A^2 \tag{26a}$$

or

$$\frac{\text{Eff.}}{C} = 2A^2 \tag{26b}$$

The quantity $(\text{Eff.}/C)$, at the saturation level, or $(\text{Eff.}/C)$ at the first peak of the $A(y)$ curve [denoted as $(\text{Eff.}/C)_{\text{max.}}$], is plotted vs QC in Fig. 7(a), on page 269, using k as parameter; in 7(b) using fraction of $\mu_{1(\text{max.})}$ as parameter, to show how $(\text{Eff.}/C)_{\text{max.}}$ varies with QC , k and b . Values for $QC = 0$ are Nordsieck's. It is seen that $(\text{Eff.}/C)_{\text{max.}}$ increases with b , a result which has been found by Nordsieck in his calculations without space charge. It also increases with QC for small values of QC , but is reduced sharply at larger values of QC and k . It is also noticed that $(\text{Eff.}/C)_{\text{max.}}$ decreases as k increases, particularly when QC is large. It should be recalled that k is inversely proportional to the beam radius. In the high power tubes in which QC is generally high, a design with larger beam diameter and yet with a value of $(\omega/u_0)r_0$, such that the field is fairly uniformly distributed over the cross section, is preferred for high efficiency. This has been pointed out by C. C. Cutler as a result of his measurements of overload characteristics.

The same quantity, $(\text{Eff.}/C)_{\text{max.}}$, is plotted in Fig. 7(c) versus g for all the cases which have the values of b corresponding to the maximum small signal gain. All

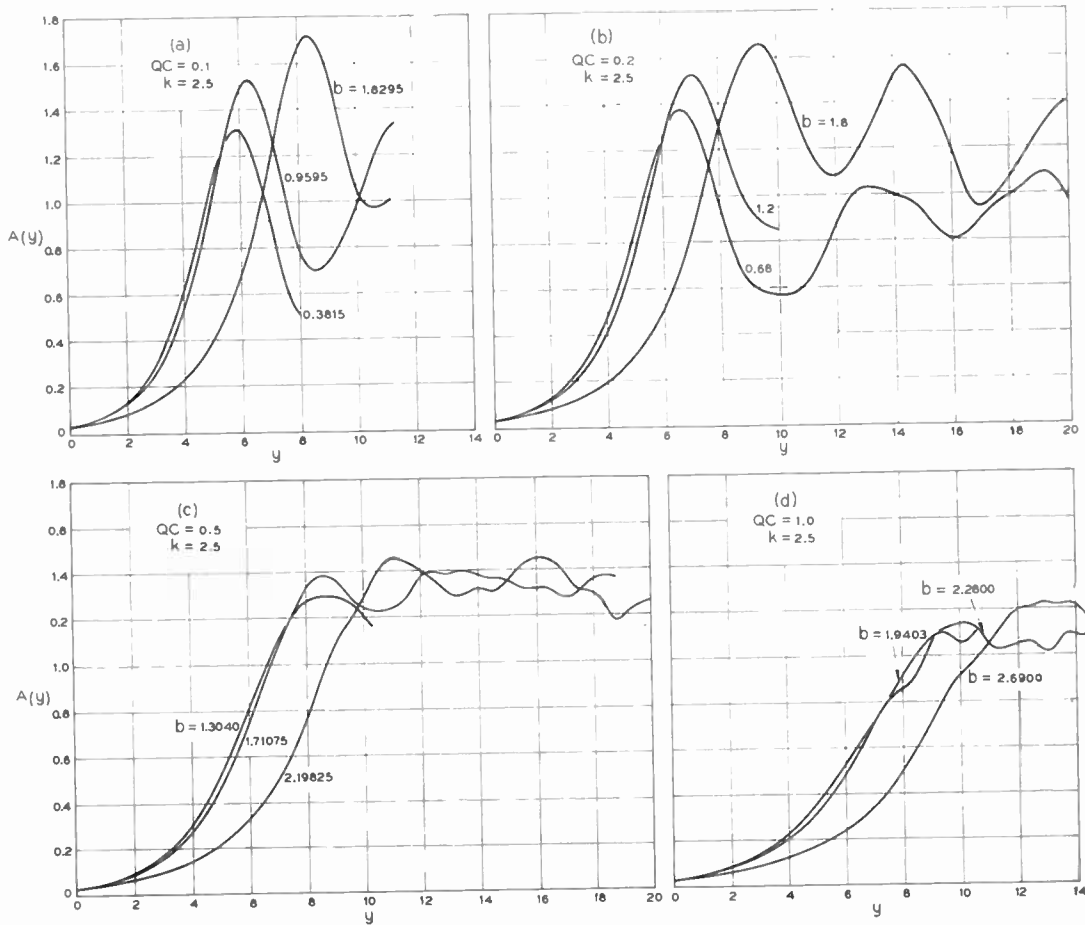

Fig. 5— $A(y)$ versus y curves for (a) cases (2), (3), and (4), (b) cases (7), (8), and (9), (c) cases (12), (13), and (15), (d) cases (17), (18), and (19).

the points are seen to be distributed inside a narrow region whereas they are widely spread in Fig. 7(a). Efficiency varies more with g , which is $\frac{1}{2}(\omega_p/\omega C)^2$, rather than with QC , which is $(\omega_p R/2\omega C)^2$; or with g , the intensity, rather than $1/k$, the range.

THE FUNDAMENTAL COMPONENT OF THE BEAM CURRENT

In this section we shall discuss (7) and (8) further. From (5) and for small C , the electron current density of a beam is

$$- I_0 \frac{|d\Phi_0|}{|d\Phi|} \tag{27}$$

The fundamental component of the beam current is then,

$$i_1(z, t) = - (\sin \Phi) \frac{1}{\pi} \int_0^{2\pi} I_0 \frac{d\Phi_0}{d\Phi'} (\sin \Phi') d\Phi' - (\cos \Phi) \frac{1}{\pi} \int_0^{2\pi} I_0 \frac{d\Phi_0}{d\Phi'} (\cos \Phi') d\Phi'$$

$$= - \frac{I_0}{\pi} \left(\sin \Phi \int_0^{2\pi} \sin \Phi d\Phi_0 + \cos \Phi \int_0^{2\pi} \cos \Phi d\Phi_0 \right) \tag{28}$$

In (28), $(1/\pi) \int \sin \Phi d\Phi_0$ is a quantity proportional to the part of $i_1(z, t)$ in-phase or 180 degrees out-of-phase with the circuit electric field, and similarly $(1/\pi) \int \cos \Phi d\Phi_0$ is proportional to the part of $i_1(z, t)$, 90 degrees out-of-phase with the circuit electric field. It should be recalled that the circuit electric field is proportional to $-A(y) \sin \Phi$. Eqs. (7) and (8) therefore mean that the in-phase (or 180 degrees out-of-phase) part and the 90 degrees out-of-phase part of the fundamental component current are proportional to

$$- \frac{dA(y)}{dy} \quad \text{and} \quad \left(\frac{d\theta(y)}{dy} + b \right) A(y)$$

respectively. Thus $i_1(z, t)$ is calculated from values of

$$A(y), \quad \frac{dA(y)}{dy}, \quad \frac{d\theta(y)}{dy} \quad \text{and} \quad b.$$

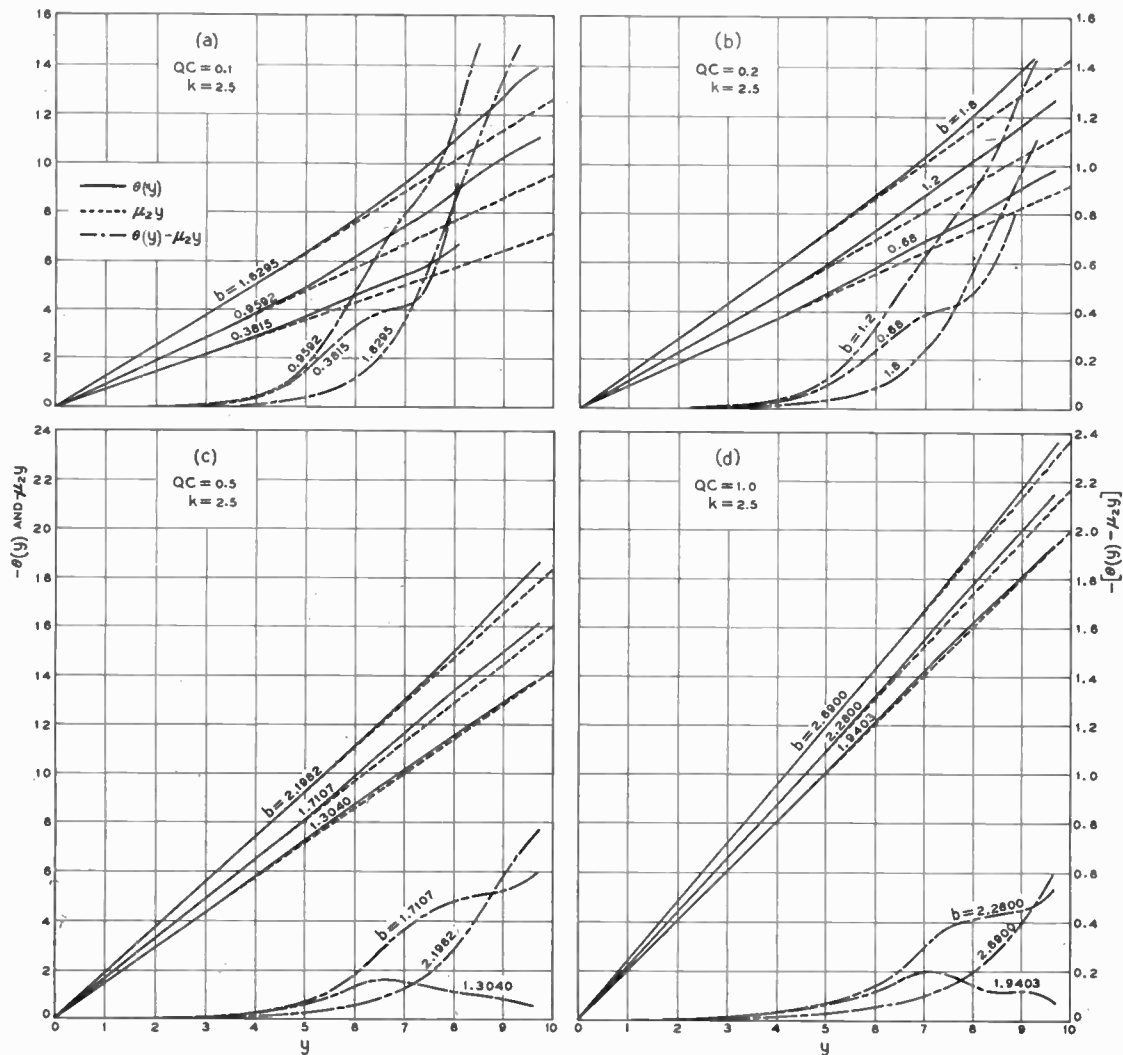

Fig. 6— $\theta(y)$, μ_2y , and $\theta(y) - \mu_2y$ versus y curves for (a) cases (2), (3), and (4), (b) cases (7), (8), and (9), (c) cases (12), (13), and (14), (d) cases (17), (18), and (19).

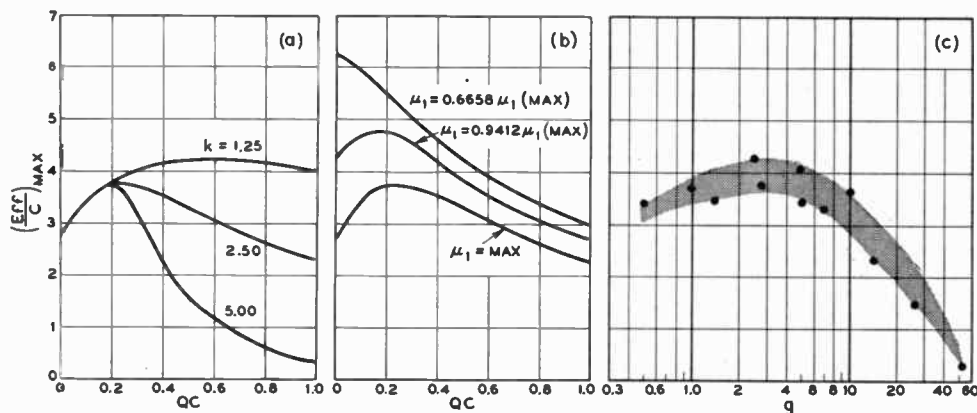

Fig. 7—(a) $(\text{Eff./}C)_{\text{MAX}}$ versus QC curves using k as the parameter, for the cases with b for maximum μ_1 . (b) $(\text{Eff./}C)_{\text{MAX}}$ versus QC curves using the fraction of $\mu_1(\text{MAX})$ as the parameter for the cases with $k=2.5$. The curves show how $(\text{Eff./}C)_{\text{MAX}}$ varies with b . (c) $(\text{Eff./}C)_{\text{MAX}}$ versus g curves for the cases with b for maximum μ_1 .

This also provides a simple method to determine $i_1(z, t)$ experimentally, as we can easily measure $A(y)$ and $\theta(y)$ along the tube by means of a measuring probe. $|i_1(z, t)|/I_0$ is plotted in Fig. 8 for case (7). It has a maximum value of 1.24 at $y=8.0$. If the beam were perfectly bunched, $|i_1|/I_0$ would be equal to 2 as pointed out by Pierce.²

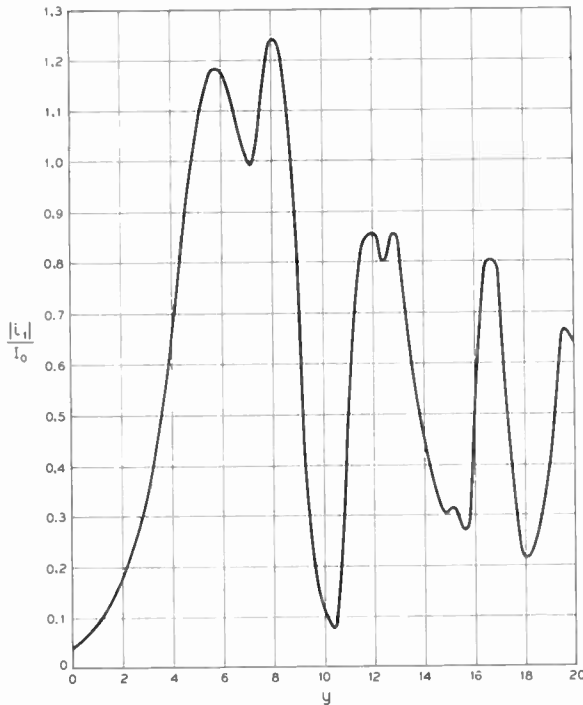

Fig. 8— $(|i_1|/I_0)$ versus y curve for case (7).

Before reaching the saturation level, $dA(y)/dy$ is always positive. $i_1(z, t)$ either leads or lags the circuit electric field by a phase somewhat between 90 and 180 degrees, depending upon the sign of the quantity

$$\left(\frac{d\theta(y)}{dy} + b\right).$$

The center of the electron bunching will be located somewhere between $\Phi = (2n+1.5)\pi$ and $(2n+2)\pi$, if

$$\left(\frac{d\theta(y)}{dy} + b\right)$$

is positive; somewhere $\Phi = (2n+1)\pi$ and $(2n+1.5)\pi$, if

$$\left(\frac{d\theta(y)}{dy} + b\right)$$

is negative, where n is an integer including zero. We shall return to this point later in the discussion related to Figs. 9(b), 9(c), and 9(d).

y Vs $(\Phi + \theta)$ CURVES—APPLEGATE DIAGRAMS

After having obtained a general picture of the circuit wave as discussed in a previous section, we shall next study the motions of the electrons and compare them for cases of different values of QC , k , and b . In the first

place, we may gain insight into the beam behavior by studying $\Phi(\Phi_0, y)$'s and $q(\Phi_0, y)$'s at some interesting points along the tube, such as, the point at the saturation, the point at which the electrons start to overtake one another, etc. Further, we can analyze the interaction between the beam and the circuit by comparing $\Phi(\Phi_0, y)$'s and $q(\Phi_0, y)$'s at different values of y . Eventually we want to establish a dynamic picture of the electron motion by following the paths of the electrons and observing their velocities, and their phases with respect to the circuit field, as y increases. For these purposes, it is desirable to plot data in a form similar to the "Applegate Diagram," a sort of "space-time" diagram used to study klystrons. Figs. 9(a) to 9(h), below and on the following pages, are for cases (2), (7), (8), (9), (11), (12), (15), and (17), respectively.

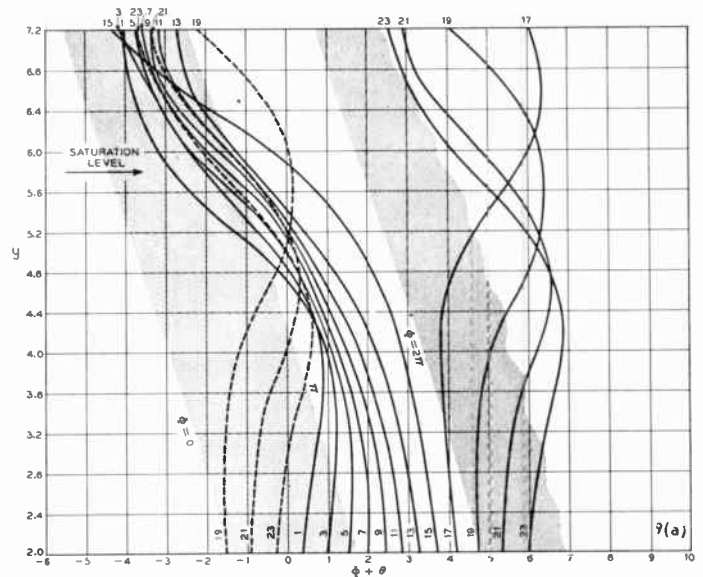

Fig. 9(a)— y versus $(\Phi + \theta)$ curves for case (2).

In these figures, y versus $(\Phi + \theta)$ curves are plotted with one curve for each electron. There should be 24 curves in an interval of 2π (in Φ or in $\Phi + \theta$), corresponding to the 24 electrons used in the calculations. Only odd numbered electrons and only electrons within an electronic wavelength (except few shown by dotted curves), however, are shown in the figures to avoid confusion by too many curves. It is understood that those curves should be repeated at every period of 2π (in Φ or in $\Phi + \theta$).

In the shaded regions (Fig. 9), the axially-directed circuit electric field is negative and accelerates the electrons in the positive z direction. Electrons are decelerated by the positive circuit field in the unshaded region. We will denote, for convenience, the shaded regions as the "accelerating regions" and the unshaded regions the "decelerating regions." The boundaries of these regions are constant Φ contours, from which we may determine the phase of the circuit wave at any position in this y versus $\Phi + \theta$ diagram.

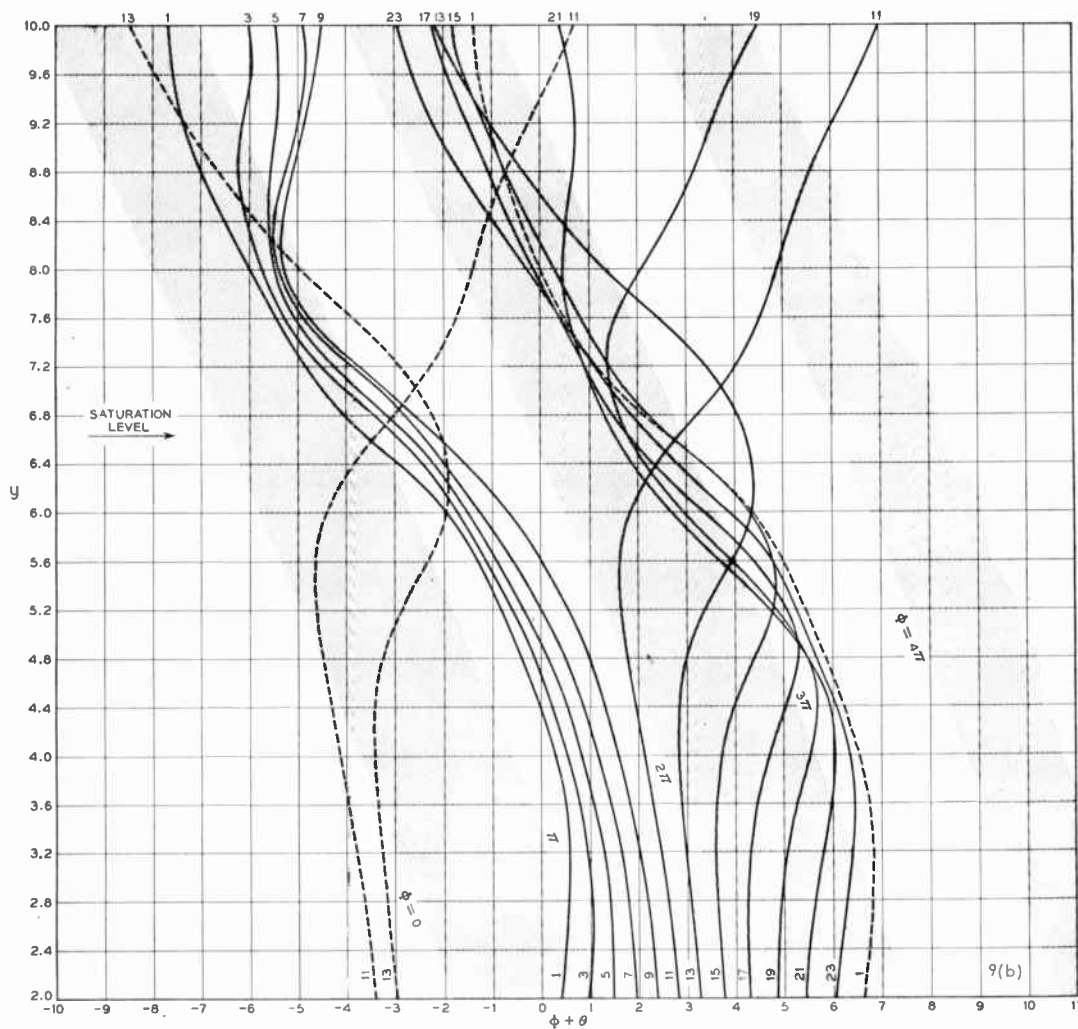

Fig. 9(b)— y versus $(\Phi + \theta)$ curves for case (7).

From (10) we have

$$\frac{\partial(\Phi + \theta)}{\partial y} = 2q(\Phi_0, y),$$

and thus the reciprocal of the slopes of the curves in Fig. 9 are proportional to the rf velocities of the electrons. As we have mentioned previously, a distribution of the electrons in Φ may be considered as the distribution in ωt or in y within a small interval of y . The distribution of the curves at any constant y line therefore represents the distribution of the electrons. More specifically, spacing between the curves should be inversely proportional to electron charge density, or electron current density when C is small. Concentration of curves indicates bunching of electrons in the beam.

Although the electron motions are drastically different for different cases, it is important to extract certain common features which we may consider as basic to the electron behavior. Let us take case (9) ($QC = 0.2, k = 2.50, b = 1.8$) [Fig. 9(d)] as an example. At low level, the rf velocities are so small that the electron paths are almost vertical. However, electrons continuously advance in phase with respect to the circuit field, because

their average speed is greater than the speed of the circuit wave. They will continue to do so up to a point at which some of the electrons are slowed down so much that they are trapped in the negative potential troughs of the field. In our case, this happens at y near 6. Up to this point, they behave much as in the small signal theory.

Suppose we are now in a co-ordinate system moving with the average electron speed u_0 , in which $2q$ is electron velocity and $d\theta/dy$ is wave speed. It is obvious that electrons must attain a negative velocity comparable to the wave speed in order to stay with the circuit wave. For convenience, we shall divide the electrons into three groups, according to the types of the orbits that they have. At y near 6, electrons 7 to 19 have negative velocities because they are decelerated by the retarding circuit field in the region between $\Phi = 3\pi$ and 4π . Among them, electrons 13 to 19 may be considered as of the first group. These have not built up enough negative velocity to follow the retrogression of the circuit wave and they will continue to advance ahead of the wave until they are trapped in the next decelerating region between $\Phi = 5\pi$ and 6π . In the second group, however, electrons 7 to 11, which have velocities comparable to

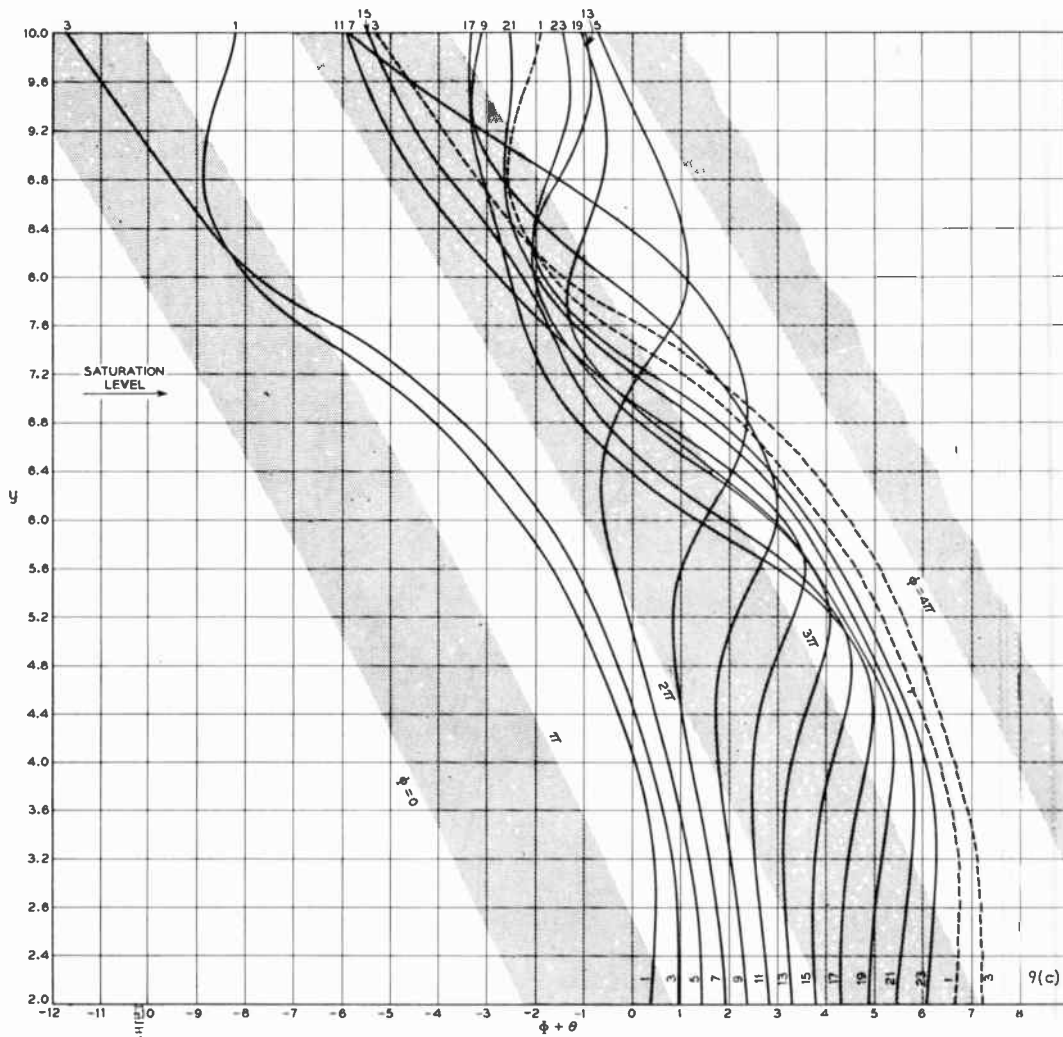

Fig. 9(c)— y versus $(\Phi + \theta)$ curves for case (8).

the wave speed, will follow paths almost parallel to the constant Φ contours. These electrons, which form the principal part of the bunch, will continuously travel inside the decelerating region and contribute power to the circuit until they cross the boundary, the $\Phi = 3\pi$ line. After that, they enter the accelerating region, where they acquire the forward velocities. For the third group, we have electrons 1 to 5 and electrons 21 to 23 (shown as the dotted curves) of the later cycle. They have forward velocities at y near 6. Sooner or later, they enter the decelerating region where they are decelerated by both the retarding circuit field and the space-charge cloud of the electron bunch. They are finally pushed back to the accelerating region where they acquire forward velocities again. Some of them might miss the bunch and would then go straight forward. This, however, does not happen in this case. By extending y far enough, one will find that most of the electrons will be trapped in the negative potential troughs of the field and oscillate back and forth around the equilibrium positions, the $\Phi = (2n + 1)\pi$ lines (n may be any integer). When they are in the decelerating region, they contribute power to the circuit, and in the accelerating

region, they gain kinetic energy at the expense of the circuit power. We thus observe a series of the peaks in the $A(y)$ curves.

Although in general the electrons will follow the same types of motion as described above, for all the cases, it is interesting to study the effects of QC , k and b on their motions. To investigate these parameters separately, we plot y versus $\Phi + \theta$ diagrams for the following cases. Figs. 9(b), 9(c), and 9(d) are plotted for the cases having the same values of QC and k , but different electron injection speeds, that is, $QC = 0.2$, $k = 2.5$, and $b = 0.68$, 1.2 and 1.8, respectively. Similarly, the cases of $QC = 0.5$, $b = 1.3040$, and $k = 1.25$, 2.50 and 5.00 are shown in Figs. 9(e), 9(f), and 9(g), and the cases of $k = 2.5$, b for maximum small-signal gain and $QC = 0.1$, 0.2, 0.5, and 1.0 are in Figs. 9(a), 9(b), 9(f), and 9(h).

Considering the first set of figures; it is observed that when b is larger the wave speed $|d\theta(y)/dy|$ also increases. Electrons thus need greater rf velocities before they can follow the types of the orbits described above. As a matter of fact, the electrons will travel a longer distance before they reach the saturation level and the limiting power is larger even though μ_1 may be smaller.

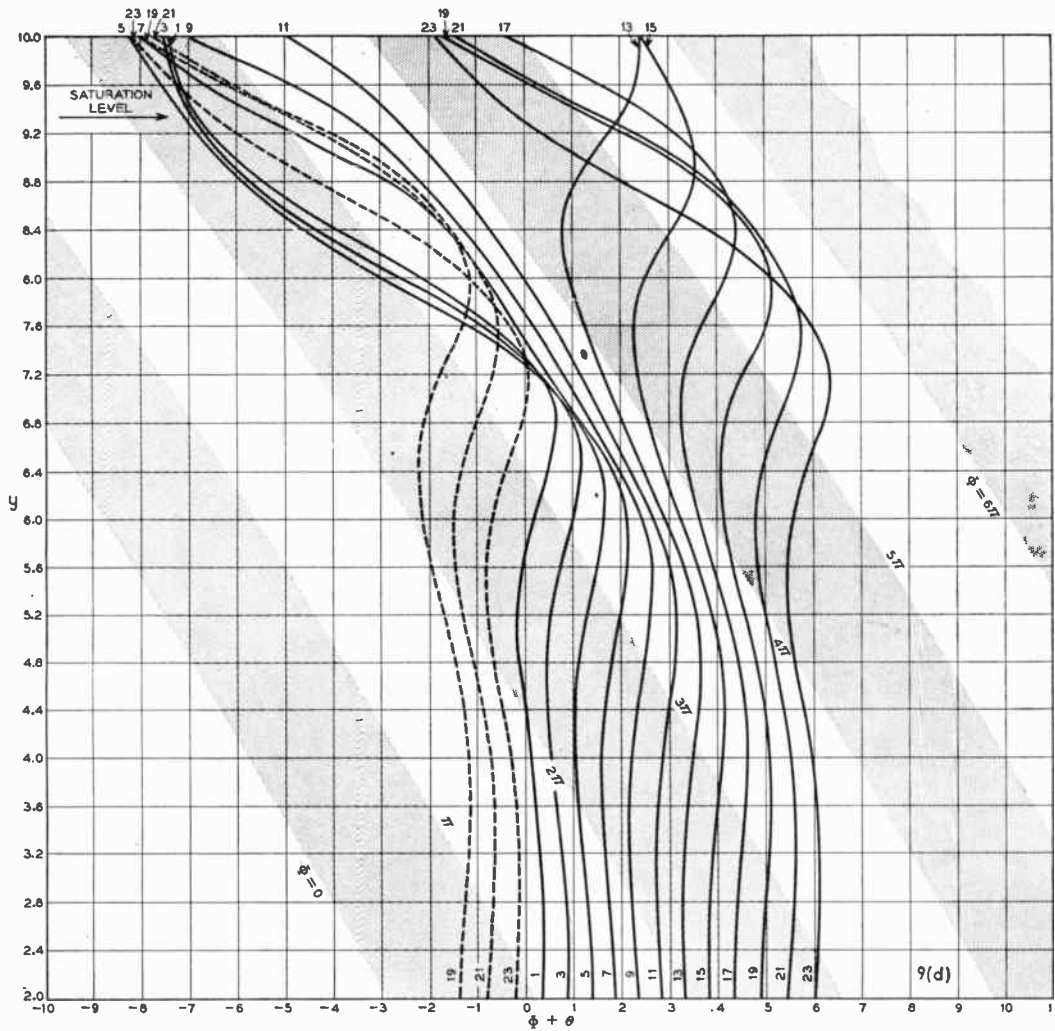

Fig. 9(d)— y versus $(\Phi + \theta)$ curves for case (9).

The effect of k can easily be seen by comparing Figs. 9(f) and 9(g). At low levels the electron orbits in both figures are identical. This should be so, as pointed out previously. At high levels, the electron bunching in Fig. 9(g) becomes loosened shortly after the electrons have started to overtake one another because of large short range space-charge forces, whereas in Fig. 9(b), the electron bunching stays tight even beyond the saturation level. The strong short-range space-charge forces generally distort the electron paths, particularly when the electrons approach one another in the bunching. This will reduce the limiting power or efficiency and the tube will saturate at a lower y . The effect of QC is interesting. When QC is large, the electron paths are spaced loosely and the rf velocities build up slowly. This, together with the fact that b is larger in the case in which QC is large, tends to raise the saturation level and to increase the limiting efficiency, as we have described, in connection with the effect of b . On the other hand, a large space-charge force, as in the case of large k , tends to distort the electron paths and to inhibit bunching, with the result of lowering the saturation level and limiting the efficiency. This explains the fact

that efficiency generally increases with QC when QC or k is small, but is reduced sharply at larger values of QC and k .

In general, when b is small as in Fig. 9(b), the electron bunching starts in the left part of the decelerating region. A larger value of b tends to place the bunching toward the right. This can be seen in Figs. 9(c) and 9(d). The location of the bunches is related to $i_1(z, t)$, as has been mentioned. As y increases, the bunching moves gradually toward the left. At the saturation level, half of the bunch is located in the accelerating region and half in the decelerating region. The net power transfer between the circuit and the beam is then zero. In general, the beam contains a strong fundamental component at the saturation level. The bunching is not effective simply because of the position of the bunch with respect to the circuit field. Thus we may increase the efficiency by introducing a sudden phase-shift to the circuit wave near the saturation level such that the bunch may be moved well inside the decelerating region. The electrons in the bunch will then continue to contribute power until they reach the accelerating region again.

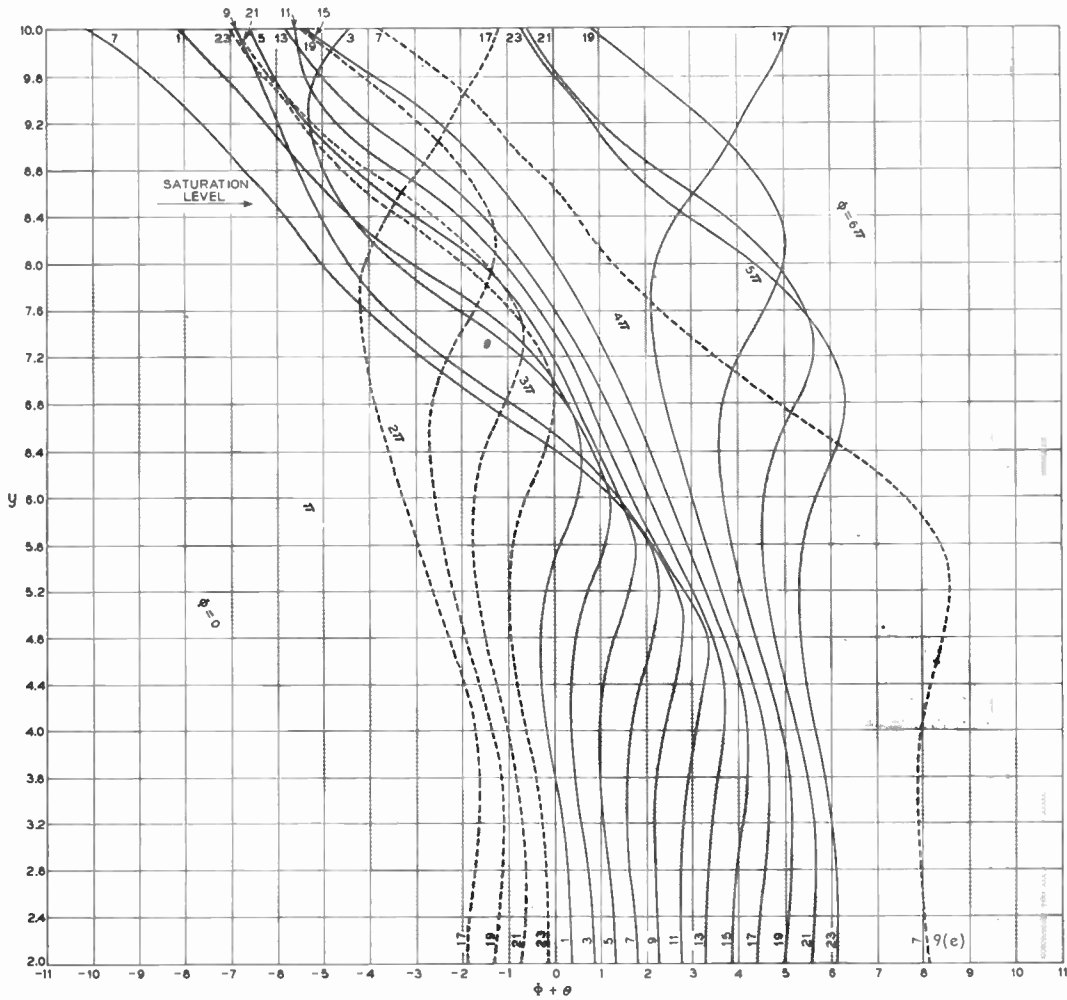

Fig. 9(c)—y versus $(\Phi + \theta)$ curves for case (11).

ACKNOWLEDGMENT

The authors wish to thank Dr. J. R. Pierce and C. C. Cutler for many valuable suggestions during the course of this investigation. The numerical computations were carried out by Miss D. C. Leagus. The accuracy, ingenuity and speed consistently applied by her to the solution of this problem have been invaluable, and the authors wish to express their sincere appreciation of her excellent contribution. The experience of P. R. Peabody, who programmed the problem for an IBM Card Programmed Calculator in 1953, was most helpful in the present calculations.

APPENDIX I

Put

$$V(z, t) = \frac{1}{2}w_1 e^{j[\omega t - (\omega/u_0)z]} + \frac{1}{2}w_1^* e^{-j[\omega t - (\omega/u_0)z]}$$

where

$$w_1 = A(z) e^{j\theta(z)} \tag{29}$$

and

$$X(\Phi_0, y) = \int_{\nu(\Phi_0, 0)}^y 2q(\Phi_0, y) dy.$$

By means of (10) this is obviously

$$X(\Phi_0, y) = \Phi(\Phi_0, y) - \Phi_c + \theta(y). \tag{30}$$

Eqs. (7), (8), (9), and (10) can be reduced to the form

$$\frac{dw_1}{dy} + jbw_1 = \frac{j}{2\pi} \int_0^{2\pi} e^{j[X+\Phi_0]} d\Phi_0 \tag{31}$$

$$\begin{aligned} \frac{\partial^2 X(\Phi_0, y)}{\partial y^2} &= jw_1 e^{-j[X+\Phi_0]} - jw_1^* e^{j[X+\Phi_0]} \\ &\quad - \frac{e}{m\omega^2 C^2} \frac{I_0}{u_0} \int_{-\infty}^{+\infty} B \left[\frac{u_0}{\omega} \left\{ \Phi(\Phi_0 + \phi, y) - \Phi(\Phi_0, y) \right\} \right] d\phi. \end{aligned} \tag{32}$$

In the linear theory, we may put

$$X = p e^{-j\Phi_0} + p^* e^{j\Phi_0}.$$

The space charge integral in (32) then becomes

$$\begin{aligned} \int_{-\infty}^{+\infty} B' \left(\frac{u_0}{\omega} \phi \right) \Delta X d\phi &= \int_{-\infty}^{+\infty} B' \left(\frac{u_0}{\omega} \phi \right) \\ &\quad \cdot [p e^{-j\Phi_0} (e^{-j\phi} - 1) + p^* e^{j\Phi_0} (e^{j\phi} - 1)] d\phi, \end{aligned} \tag{33}$$

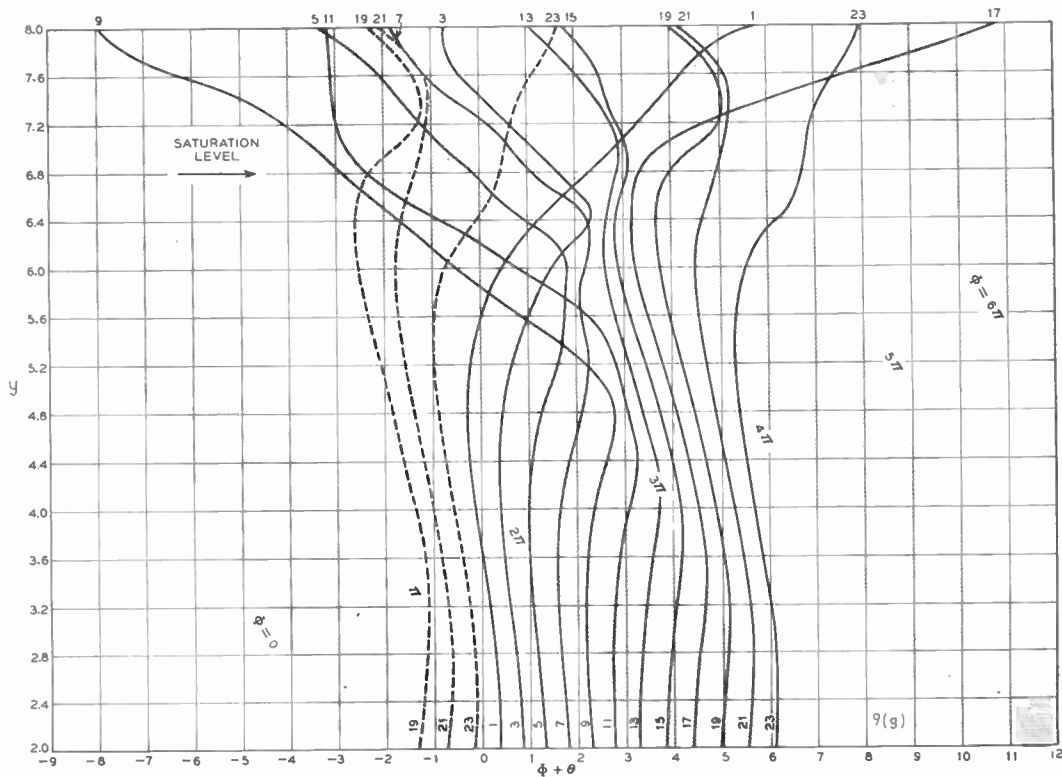
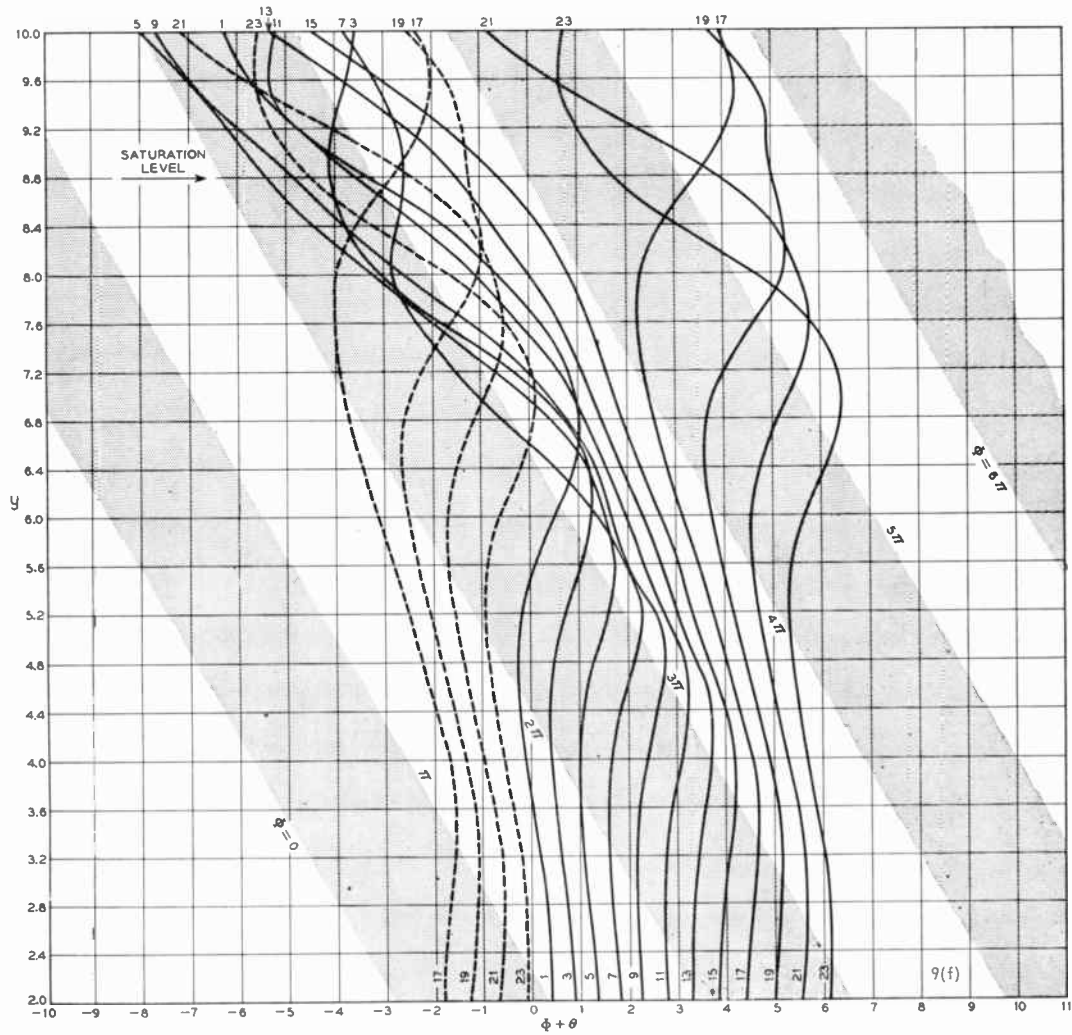

Figs. 9(f) and (g)— y versus $(\Phi + \theta)$ curves for cases (12) and (15), respectively.

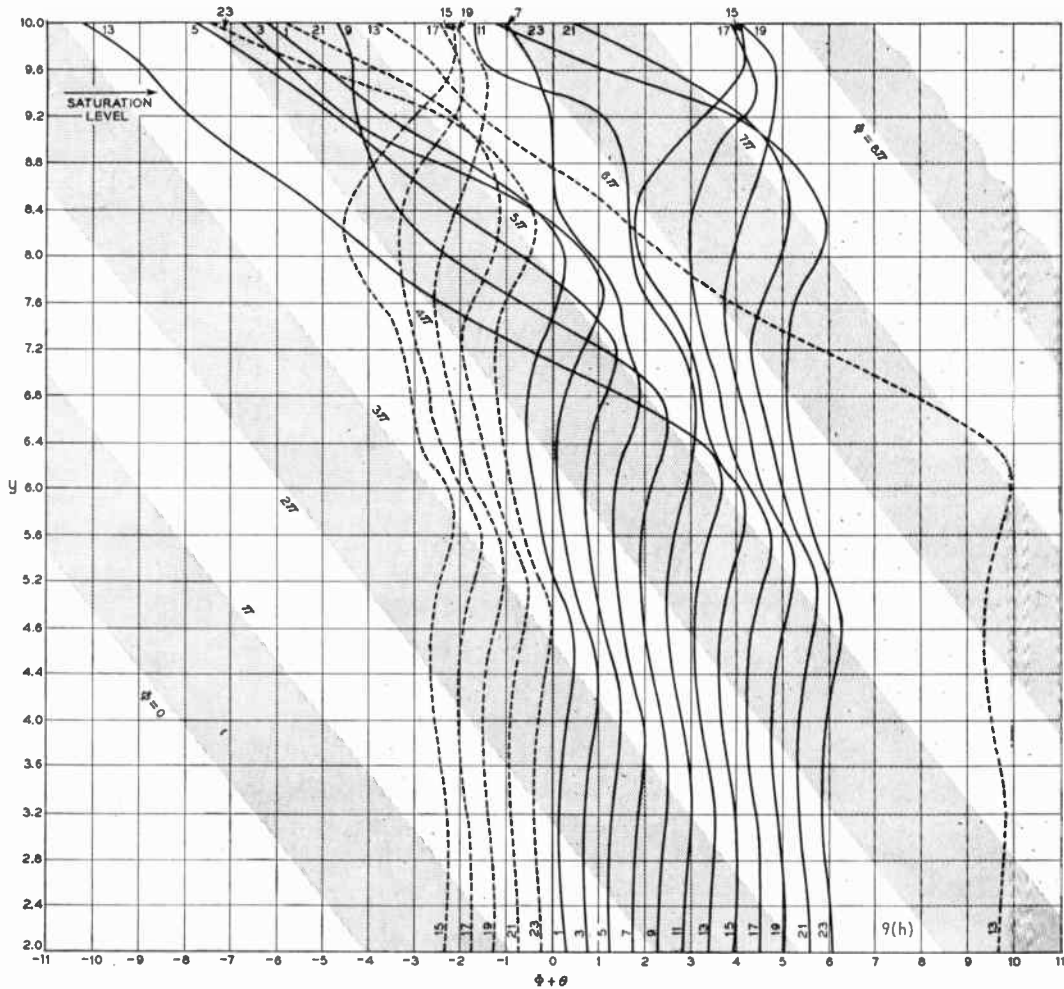

Fig. 9(h)—y versus $(\Phi + \theta)$ curves for case (17).

where $B'[(u_0/\omega)\phi]$ is the derivative of $B(z)$ with respect to ϕ . Expanding

$$e^{jX} = 1 + jX + \dots$$

we have for (31) and (32), respectively,

$$\frac{dw_1}{dy} + jbw_1 = \frac{j}{2\pi} \int_0^{2\pi} e^{j\phi_0} [1 + jX] d\phi_0 = -p \quad (34)$$

$$\frac{d^2p}{dy^2} = jw_1 - p \frac{e}{m\omega^2 C^2} \frac{I_0}{u_0} \int B' \left(\frac{u_0}{\omega} \phi \right) (e^{-j\phi} - 1) d\phi. \quad (35)$$

Substituting $-p$ in (34) into (35), we obtain

$$\left[\left[\frac{d^2}{dy^2} + \frac{c}{m\omega^2 C^2} \frac{I_0}{u_0} \int B' \left(\frac{u_0}{\omega} \phi \right) (e^{-j\phi} - 1) d\phi \right] \cdot \left[\frac{d}{dy} + jb \right] + j \right] w_1 = 0. \quad (36)$$

Comparing this with the Pierce equation,⁸

$$(\delta^2 + 4QC)(\delta + jb) + j = 0 \quad (37)$$

⁸ Pierce, *op. cit.*, eq. (7.13).

we find,

$$4QC = \frac{e}{m\omega^2 C^2} \frac{I_0}{u_0} \int B' \left(\frac{u_0}{\omega} \phi \right) (e^{-j\phi} - 1) d\phi. \quad (38)$$

According to (19), we have finally (22) or (23) of the text.

APPENDIX II

The following is the second-order small-signal theory used in this paper to calculate the initial conditions.

Put

$$V(z, t) = \frac{1}{2} v e^{j[\omega t - (\omega/v_0)z]} + \frac{1}{2} v^* e^{-j[\omega t - (\omega/v_0)z]} \quad (39)$$

$$v = \epsilon v_1 + \epsilon^2 v_2 \quad (39)$$

$$\chi = \epsilon \chi_1 + \epsilon^2 \chi_2. \quad (40)$$

Here ϵ is a small quantity and χ is X defined in (30) of Appendix I. The following quantities may be expanded into power series in ϵ .

$$e^{jX} = 1 + \epsilon j\chi_1 + \epsilon^2 \left(j\chi_2 - \frac{\chi_1^2}{2} \right) + \dots \quad (41)$$

$$e^{-j\chi} = 1 - \epsilon j\chi_1 + \epsilon^2 \left(-j\chi_2 - \frac{\chi_1^2}{2} \right) + \dots \quad (42)$$

$$B \left[\frac{u_0}{\omega} \{ \Phi(\Phi_0 + \phi, y) - \Phi(\Phi_0, y) \} \right] = B \left[\frac{u_0}{\omega} (\phi + \Delta\chi) \right]$$

$$= \left[B' \left(\frac{u_0}{\omega} \phi \right) \Delta\chi \right]$$

$$+ \epsilon^2 \left[B' \left(\frac{u_0}{\omega} \phi \right) \Delta\chi_2 + \frac{B'' \left(\frac{u_0}{\omega} \phi \right)}{2} (\Delta\chi_1^2) \right]$$

$$+ \dots, \quad (43)$$

where B' and B'' are respectively the first and the second derivatives of B with respect to ϕ . By putting

$$\chi_1 = p e^{-j\Phi_0} + p^* e^{j\Phi_0} \quad (44)$$

$$\chi_2 = q e^{-2j\Phi_0} + \gamma + q^* e^{2j\Phi_0}. \quad (45)$$

The equations of the first-order small quantities can be derived from (7) to (10) and are given by (34) and (35) in Appendix I, with $w_1 = v_1$. The equations of the second-order small quantities are

$$\frac{dv_2}{dy} + jbv_2 = \frac{j}{2\pi} \int_0^{2\pi} e^{j\Phi_0} \left(j\chi_2 - \frac{\chi_1^2}{2} \right) d\Phi_0 \quad (46)$$

$$\frac{d^2\chi_2}{dy^2} = j e^{-j\Phi_0} (-j\chi_1 v_1) - j e^{j\Phi_0} (j\chi_1 v_1^*)$$

$$- \frac{e}{m\mu_0^2 C^2} \frac{I_0}{u_0} \int_{-\infty}^{+\infty} \left[B' \left(\frac{u_0}{\omega} \phi \right) \Delta\chi_2 \right.$$

$$\left. + \frac{B'' \left(\frac{u_0}{\omega} \phi \right)}{2} (\Delta\chi_1^2) \right] d\phi. \quad (47)$$

From (46), v_2 must be zero, as χ_2 and χ_1^2 do not contain any terms involving $e^{j\Phi_0}$, or its conjugate $e^{-j\Phi_0}$. We may thus put

$$v = \epsilon v_1 = \epsilon e^{\mu y} \quad (48)$$

$$\mu = \mu_1 + j\mu_2, \quad (49)$$

where μ_1 and μ_2 are Pierce's x_1 and y_1 respectively. By means of (44) to (49), we obtain the following relations after considerable algebra,

$$\chi = -2\epsilon \left(|\mu + jb| e^{\mu_1 y} \cos [\arg (\mu + jb) + \mu_2 y - \Phi_0] \right.$$

$$\left. + \epsilon^2 \left(-2 |N| e^{2\mu_1 y} \cos [\arg N + 2\mu_2 y - 2\Phi_0] - \frac{e^{2\mu_1 y}}{2\mu_1} \right) \right) \quad (50)$$

$$2q = -2\epsilon \left(|\mu(\mu + jb)| e^{\mu_1 y} \cos [\arg \mu(\mu + jb) + \mu_2 y - \Phi_0] \right.$$

$$\left. + \epsilon^2 (-4 |\mu N| e^{2\mu_1 y} \cos [\arg \mu N + 2\mu_2 y - 2\Phi_0] - e^{2\mu_1 y}) \right) \quad (51)$$

$$\frac{e}{u_0 m \omega C^2} E_s = -\epsilon 8QC |\mu + jb| e^{\mu_1 y} \cos [\arg (\mu + jb) + \mu_2 y - \Phi_0]$$

$$+ \epsilon^2 |M| e^{2\mu_1 y} \cos [\arg M + 2\mu_2 y - 2\Phi_0], \quad (52)$$

where

$$N = (\mu + jb) \frac{1 + j12QC(\mu + jb) \frac{k^2}{k^2 + 4}}{4\mu^2 + \frac{16QC(k^2 + 1)}{k^2 + 4}} \quad (53)$$

$$M = \frac{8QC}{k^2 + 4} \left[\frac{(2k^2 - 1) - j12k^2QC(\mu + jb)}{\mu^2 + 4QC \frac{k^2 + 1}{k^2 + 4}} \right] (\mu + jb). \quad (54)$$

The initial conditions at $y=0$ are computed from (50) to (52) by setting $\epsilon=0.03$ for all the cases. For this value of ϵ , the maximum value of $|2q|$ is less than 10 per cent of $|d\theta/dy|$ for the worst case. Φ is calculated from χ by (30).

Saturation Current in Alloy Junctions*

W. M. WEBSTER†, SENIOR MEMBER, IRE

Summary—According to theory, the current which flows across a p - n junction when it is biased in the reverse direction should be nearly independent of the applied voltage. This current is called the saturation current, I_s . In actual practice, the current often increases with voltage (due to leakage paths across the junction at the surface) and eventually large currents flow as the breakdown voltage of the junction is approached. However, for "good" junctions well below their breakdown voltage, the reverse current follows theory so that the magnitude of I_s is of considerable practical interest.

A previous equation¹ for saturation current has been given which applies where the effect of free surfaces may be ignored and where there are quite thick (greater than a diffusion length) layers of mate-

rial on either side of the junction. For alloy junctions made on thin pieces of semiconductor, these conditions are violated.

In this paper a new equation is developed which applies specifically to diodes made by alloying circular junctions on thin wafers. Over its range of applicability, it gives accurate values of I_s . It is shown that most of the saturation current comes from thermal generation at the free surfaces of the base wafer. The equation for I_s consists of a geometrical term and a coefficient which depends on the physical constants of the material. The principal dependences are these: I_s increases linearly with base wafer resistivity and exponentially with temperature. It also increases, but more slowly, with wafer thickness and surface recombination velocity.

For the collector of an alloy junction transistor, the basic equation is the same as for a diode, except for a small correction involving the emitter area. For the emitter junction, reverse saturation current is often not of great interest but can also be calculated; this requires a modification of the basic equation which is also given in this paper.

* Original manuscript received by the IRE, October 25, 1954; revised manuscript received, December 7, 1954.

† RCA Laboratories, Princeton, N. J.

¹ W. Shockley, "Holes and Electrons in Semiconductors," D. Van Nostrand Co., Inc., New York, N. Y., p. 314; 1950.

GENERAL DISCUSSION

SATURATION current is due to thermal generation of hole-electron pairs on both sides of a p - n junction. The pairs diffuse toward the junction where they are separated by the applied field so that current flows. Generation occurs at surfaces and in the volume just as does recombination. This is not surprising since the two phenomena are intimately connected. Under equilibrium conditions, holes and electrons are constantly generated and recombining. These two processes must take place, on the average, at equal rates. Otherwise, the hole and electron concentrations would eventually become either zero or infinite. From measurements of the lifetime of excess hole-electron pairs (produced, for example, by illuminating a sample), the rate of recombination at equilibrium can be computed. This is also the rate of generation at equilibrium. The net generation is defined as the difference between this total generation and whatever recombination may be taking place.

Analytically, generation may be looked upon as "negative" recombination and treated with the same mathematical techniques. For example, in n -type material, the volume recombination rate per unit volume is commonly given as $(p-p_0)/\tau_v$, where p is the hole density (minority carriers), p_0 is the equilibrium value of p , and τ_v is the average hole lifetime for holes lost through volume recombination. When p is less than p_0 , the recombination rate becomes negative and, in fact, represents the net rate of thermal generation. Similarly, surface recombination and generation are both represented by $(p-p_0)s$ (per square cm second), where s is the surface recombination velocity. The saturation current, I_s , is calculated by integrating these terms over the volume and surface which contribute reverse current. In the present work, calculations are made for an n -type base wafer, such as would be used for a p - n - p alloy junction transistor. The same form applies to p -type material by appropriate exchange of symbols.

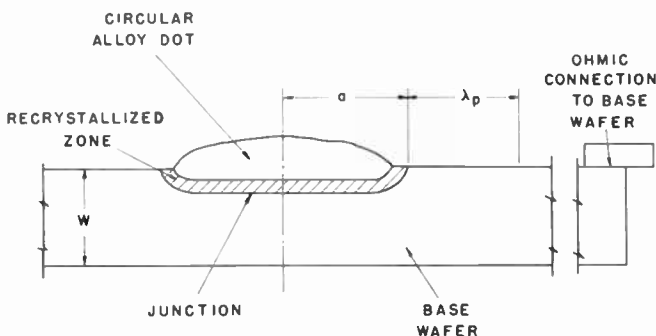

Fig. 1—Alloy junction diode geometry consisting of circular alloy dot on thin base wafer.

SATURATION CURRENT IN DIODES

Consider the diode geometry in Fig. 1 above. Four regions contribute to I_s : (1) the volume of n -type wafer within a hole diffusion length, λ_p , of the junction; (2)

the wafer surfaces within the same distance, λ_p ; (3) the volume of the recrystallized material within an electron diffusion length, L_e , in the p -type material; and (4) the surface of the p -type material within L_e .

λ_p is determined by the actual hole lifetime in the n -type wafer which, in the present case, is almost totally controlled by surface recombination. As such, it differs from the usual diffusion length (generally given the symbol L_p) which is determined only by the volume lifetime and applies where surface effects may be neglected. To avoid confusion and emphasize the difference, λ_p is used herein to designate the surface controlled diffusion length. If the actual hole lifetime is called τ_m , then λ_p is given by the expression

$$\lambda_p = \sqrt{D_p \tau_m}, \quad (1)$$

where D_p is the diffusion coefficient for holes in the n -type base material. For thin wafers such as those used for alloy junction devices,

$$1/\tau_m = 1/\tau_v + \frac{2s}{W}, \quad (2)$$

where τ_v is the mean lifetime of holes lost by volume recombination, s is the surface recombination velocity and W is the wafer thickness.² Usually, the most convenient way to compute λ_p is from direct measurement of τ_m made on the alloy junction sample itself. This may be done by measuring the transient response of the junction diode.^{3,4}

For simplicity, the analysis is limited to the case where $2s/W \gg 1/\tau_v$. This means that volume recombination and generation are neglected. Typical values of s and τ_v are 300 cm/second and 200 μ sec, respectively, in germanium. The wafer thickness, W , is usually less than 2.5×10^{-2} cm (0.010 inch). For such conditions, the contribution from the volume is less than 20 per cent of the contribution from the surface so that the approximation is not a serious limitation. Now, λ_p may be written as

$$\lambda_p = \sqrt{\frac{WD_p}{2s}}. \quad (3)$$

In addition, the two contributions to I_s from the recrystallized region are of negligible importance in practice as can be shown by the following argument: The ratio of electron current, I_n , which flows from the alloy region to the base wafer, to the hole current, I_p , which flows in the opposite direction, is given by the familiar relation

$$\frac{I_n}{I_p} = \frac{\sigma_b \lambda_p}{\sigma_e L_e}, \quad (4)$$

² Eq. (2) is derived by combining (17) and (19b) appearing on pp. 322 and 323 of Reference 1. It applies only where $sW \ll D_p$, which limits the analysis to the case of thin wafers.

³ S. Lederhandler and L. J. Giacoletto, "Measurement of Minority Carrier Lifetime and Surface Effects in Junction Devices," to be published in Proc. I.R.E.

⁴ B. R. Gossick, "Post-injection barrier electromotive force of p - n junction," *Phys. Rev.*, vol. 91, p. 1012; 1953.

where σ_b and σ_e are the conductivities of the base and p -type regions, respectively. Eq. 4 is related to the injection efficiency of the junction. From measured values of emitter efficiency of p - n - p alloy junction transistors, one may compute values of I_n/I_p which are generally much less than 0.1.

Thus, the only important contribution to I_s is from the surface of the base wafer. An approximate expression for I_s results from assuming that all holes generated at the free surfaces bounded by the radii a and $(a + \lambda_p)$ are collected and that the number of holes generated per second per square centimeter of free surface within this range is p_0s . Then,

$$I_s = qp_0s[2\pi(a + \lambda_p)^2 - \pi a^2], \quad (5)$$

where q is the electronic charge.

Eq. 5 may be put into more familiar terms by replacing s with $D_pW/2\lambda_p^2$ and p_0 with

$$p_0 = \frac{\rho}{\rho_i^2} \cdot \frac{b}{(1+b)^2} \cdot \frac{kT}{q^2D_p}$$

Here, ρ is the resistivity of the base wafer, ρ_i the resistivity of the intrinsic semiconductor, and b is the ratio of electron to hole mobilities. The result is

$$I_s = \frac{kT}{q} \frac{\rho}{\rho_i^2} \frac{b}{(1+b)^2} \pi W \left[1 + \frac{2a}{\lambda_p} + \frac{1}{2} \left(\frac{a}{\lambda_p} \right)^2 \right], \quad (6)$$

where

$$\lambda_p = \sqrt{D_p\tau_m} \approx \sqrt{\frac{D_pW}{2s}}$$

ρ_i decreases exponentially with temperature so that I_s increases rapidly. In germanium, the rate of increase of I_s is approximately 10 per cent per degree C. in the neighborhood of room temperature.

Eq. 6 may be evaluated for the case of an n -type germanium wafer where $b=2$, $\rho_i=47$ ohm-cm at 25 degrees C., and $D_p=44$ cm²/second:

$$I_s = 7.6W e^{\Delta T/10} \left[1 + \frac{2a}{\lambda_p} + \frac{1}{2} \left(\frac{a}{\lambda_p} \right)^2 \right] \text{ microamperes,}$$

and

$$\lambda_p = 4.7 \sqrt{\frac{W}{s}} \text{ cm.}$$

ΔT is the difference between operating temperature and 25 degrees C. The exponential in ΔT accounts for the dependence of ρ_i on temperature. For a typical case where $\rho=4$ ohm cm, $W=0.013$ cm, $a=0.06$ cm, and $s=300$ cm²/second, $\lambda_p=0.03$ cm, and $I_s=2.8$ μ a at 25 degrees C.

Eq. 6 may also be applied to p -type base material by substituting $\lambda_n = \sqrt{D_n\tau_m}$ for λ_p , where D_n is the electron

diffusion coefficient. Since $b/(1+b)^2$ has the same value if $1/b$ is substituted for b (i.e., when hole and electron mobilities are interchanged), no other changes need be made. In germanium λ_n will be greater than λ_p by about 40 per cent for the same value of τ_m . Thus, for the same resistivity, I_s should be a little lower in p -type base material than in n -type.

The analysis was initially limited to the case where $W \ll 2s\tau_m$ so that volume generation is neglected. For thicker wafers, (or smaller s or τ_m), the contribution from the volume must be included. This is automatically accomplished if λ_p is computed from lifetime measurements made on the sample itself, using (1) as suggested above.

In typical germanium diodes of about five mils thickness, λ_p is in the neighborhood of ten mils. For " a " less than $4\lambda_p$ (0.040 inch) the term $(1+2a/\lambda_p)$ dominates the geometrical factor. For large junctions, the term $a^2/2\lambda_p^2$ dominates. Since λ_p^2 is approximately proportional to W , this means that I_s increases with wafer thickness more rapidly for small junctions than for large ones. Also, in small junctions I_s increases approximately as \sqrt{s} while the dependence approaches the first power for large junctions.

A more rigorous calculation of the geometrical terms involves integration of the net generation, $(p_0-p)s$, over the surface. We may make the assumption that $p \approx 0$ on the surface region opposite the junction when W is small but in the circular ring where $a < r < (a + \lambda_p)$, strong radial hole density gradients exist and this assumption is certainly untrue. Rightfully, the terms $(1+2a/\lambda_p)$ should be replaced by the solution of the equations

$$J_p(r) = -qD_p \frac{dp}{dr} \quad (7)$$

and

$$2qs \int_0^r [p_0 - p(r)] r dr = -rWJ_p(r). \quad (8)$$

The first of these equations simply states that holes flow in the wafer by diffusion. The second demands continuity of hole current by equating the total hole current flowing toward the junction through a circle of radius r to the net generation from that point outward. These equations may be combined to give a Bessels' equation of zero order whose solution has an imaginary argument:

$$\frac{1}{r} \frac{d}{dr} \left(r \frac{dy}{dr} \right) = \frac{2s}{WD_p} y = \frac{y}{\lambda_p^2}, \quad (9)$$

where $y = p_0 - p$.

Without going into further detail, the term needed to replace $(1+2a/\lambda_p)$ in (6) turns out to be

$$f\left(\frac{a}{\lambda_p}\right) = \frac{2a - II_1^{(1)}(ia/\lambda_p)}{\lambda_p iII_0^{(1)}(ia/\lambda_p)}. \quad (10)$$

⁶ The origin of this expression is clear from Reference 1. Shockley's expression for saturation current and the result of the present derivation have the same coefficient; they differ in the geometrical terms.

The terms $-II_1^{(1)}$ and $iII_0^{(1)}$ are tabulated functions⁶ and $f(a/\lambda_p)$ is plotted, with $(1+2a/\lambda_p)$, against a/λ_p in Fig. 2. Only for a/λ_p less than about 0.3 do the two solutions depart appreciably. In most practical cases a/λ_p is greater than 0.3 so that the approximate expression is sufficiently good. If $a < W$, (6) will give values of I_s which are somewhat high since density gradients across the wafer thickness (which were neglected in the calculation) will become appreciable. Within the usual range of application, however, this is not a likely source of error.

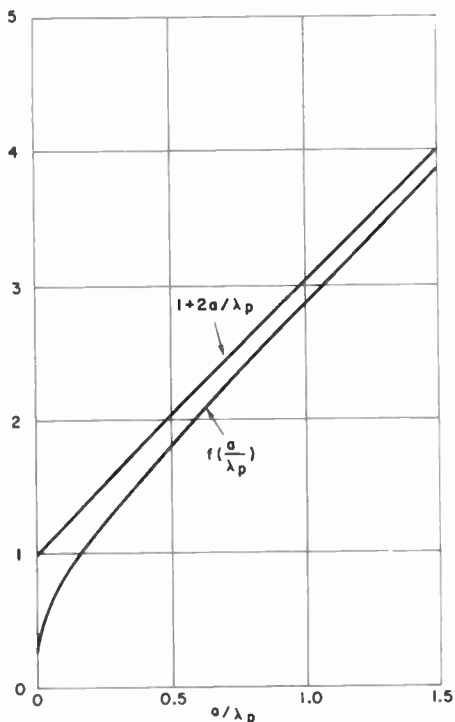

Fig. 2—Approximate solution $(1+2a/\lambda_p)$ compared to Bessel function solution $f(a/\lambda_p)$.

EXPERIMENTAL VERIFICATION

In order to verify (6), I_s was measured and computed for a series of 48 alloy junction diodes of different geometry made on n -type germanium wafers of various resistivities. λ_p was computed from τ_m measurements according to (1). The bulk resistivity was measured on the original ingots and also checked for local variations in the following manner: The capacitance of the junction when biased in the reverse direction by a voltage, V , is

⁶ E. Jahnke and F. Emde, "Tables of Functions," G. E. Stechert and Co., New York, N. Y.; 1938.

$$C \approx 4 \times 10^{-8} \frac{a^2}{\sqrt{V\rho}} \text{ farads.}$$

" a " and C were determined by direct measurement (traveling microscope and capacitance bridge respectively). From these, ρ was computed. In this experiment, I_s varied from 0.8 to 23 μ amps, ρ from 0.5 to 15 ohm cm, τ_m from 1 to 30 microseconds, and " a " from 10 to 53 mils. All samples were five mils in thickness. About 80 per cent of the measured values fell within ± 50 per cent of the calculated values and the average of the ratio of calculated to measured values is within one per cent of unity. This agreement is even better than one would expect considering the possible errors. The accuracy of measurement of resistivity alone would account for the observed spread.

SATURATION CURRENT IN TRANSISTORS

The above development applies principally to diodes since it assumes a free surface opposite the dot. For the collector of a transistor whose emitter is floating, the emitter area should be subtracted out of the geometrical term. This amounts to replacing $(a/\lambda_p)^2$ with $(a^2 - c^2)/\lambda_p^2$ in (6), where c is the radius of the emitter. This is usually a small correction since the emitter area is much less than the collector area. For the emitter, however, (6) gives much lower values of I_s than those one measures. This is because the floating collector is able to enlarge the collecting ability of the emitter by what is called the feed-in feed-out effect. By this mechanism, holes are collected by the collector near its periphery and translated to its center where they are re-emitted to contribute to the emitter saturation current. Thus, the emitter saturation current is related to the collector saturation current. An approximate expression for the emitter saturation current, I_{es} , in terms of the collector saturation current, I_{cs} , (where both currents are measured on same transistor with opposite junction floating and collector substantially larger than emitter), is:

$$I_{es} = \frac{I_{cs}}{1 + \frac{WW_b}{c^2} \left[1 + \frac{2a}{\lambda_p} + \frac{1}{2} \left(\frac{a}{\lambda_p} \right)^2 \right]}, \quad (11)$$

where W_b is the average emitter-collector spacing, " c " is the emitter radius and " a " the collector radius as before. For example, when $a=0.060$ cm, $c=0.020$ cm, $W=0.013$ cm, $W_b=0.005$ cm, and $\lambda_p=0.030$ cm, I_{es}/I_{cs} should equal 0.67. For a transistor of this geometry, the experimental value was 0.69, suggesting that (11) is valid for usual ratio of emitter to collector areas.

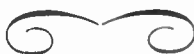

Theory of Radio Transmission by Tropospheric Scattering Using Very Narrow Beams*

H. G. BOOKER†, FELLOW, IRE AND J. T. DEBETTENCOURT‡, ASSOCIATE, IRE

Summary—Calculations have been made for communication over a 300-km path between antennas, each consisting of a paraboloid of diameter 100λ . It is assumed that, under normal atmospheric conditions, transmission over this distance is due to scattering by atmospheric irregularities and that the scattering phenomena are described by the formula used by Booker and Gordon.¹ Over this path, the effect of spread in the direction of arrival of scattered power should become noticeable for beamwidths less than about 1.5 degrees. For the 0.73 degree-beams assumed, spread in the angle of arrival should show up quite markedly for synchronized beam swinging—that is, when the beams at both transmitter and receiver are swung simultaneously so that their axes continue to intersect. When the beams are swung 1 degree to one side of the great circle path, the reduction in power received should be about 7 db, as compared with more than 40 db that would occur for propagation purely in the vertical plane containing transmitter and receiver. Narrowing the antenna beams to very small values is an important key to increasing circuit radio-frequency bandwidth capability, although at the expense of increasing antenna “aperture-medium coupling loss” (so-called “gain loss”). For the assumed circuit average bandwidth should be about 6 mcp, the loss being of the order of 10 db. For beams much larger than 1.5 degrees, the bandwidth should be limited by the medium to about 3 mcp, with negligible loss.

General formulas are given from which the important characteristics of any such communication link can be predicted.

I. INTRODUCTION

IT IS THE object of this paper to make some calculations about possible experiments that are capable of supporting the view that long-range tropospheric propagation not associated with superrefraction is due to scattering by turbulent irregularities in the atmosphere.^{1,2} Transmission by means of this scattering mechanism should involve a situation in which the energy arriving at the receiver is spread over a substantial angle, and by using sufficiently narrow beams this effect could presumably be demonstrated. Is it possible to demonstrate this effect with presently available equipment and technique?

Even at a wavelength as long as 10 cm there is now no serious difficulty in designing a paraboloidal antenna whose diameter D is 100λ . It would be feasible to arrange an experiment using such antennas for both transmission and reception between two sites about 300 km apart. This is a distance such that, in the absence of

superrefraction, the received power should be due to scattering by atmospheric irregularities and should therefore show a spread in angle of arrival. On the other hand, 300 km is a distance such that superrefraction should occasionally swamp the scattered signal, and the spread in angle of arrival should then be much less appreciable. It would be quite interesting to observe a change in the angle over which power is received as atmospheric conditions change from normal to superrefractive and back again. With such a path in mind, all calculations have been done for a distance of 300 km.

The transmitting and receiving antennas have been thought of as having identical circular apertures of diameter 100λ , and parabolic aperture distributions with maximum illumination at the center and zero at the edges. This corresponds to a beamwidth of about 0.73 degree, a sidelobe ratio of about 25 db, and a power gain of about 48 db over an isotropic antenna. In most calculations, the antennas have been assumed to produce conical beams in free space of beamwidth 0.73 degree with no sidelobes, but in certain cases a somewhat more elaborate assumption has been made.

The wavelength plays little part in these calculations except in relation to antenna size. The results would apply to transmission over a 300-km path at almost any wavelength normally used in tropospheric propagation provided that antennas of beamwidth 0.73 degree are used. However, it is only at centimeter wavelengths that such antennas are, in fact, available.

It may perhaps be stated at the outset that the assumed beamwidths should be narrow enough to exhibit the scattering nature of the mechanism of transmission provided the experiment is properly carried out. It is important to realize, however, that to carry out the experiment properly, it is not sufficient merely to swing the receiving beam. This results in radical variation of the common volume formed by the cones corresponding to the two antennas. Indeed, the common volume can easily be destroyed if only one beam is swung. It is necessary to swing the transmitting and receiving antennas simultaneously so that the axes of the two beams continue to intersect. With narrow beams, this requires a fairly high degree of pointing accuracy. The calculations presented in this paper refer to synchronized beam swinging in which the axes of the transmitting and receiving antennas always intersect. So far as the authors are aware, previous attempts to observe the effects of atmospheric scattering by beam swinging have never employed synchronized beam swinging.

Section II describes the extent to which beamwidth must be reduced in order to demonstrate easily the

* Original manuscript received by the IRE, July 23, 1954. The research in this paper was supported jointly by the Army, Navy and Air Force under contract with the Massachusetts Institute of Technology.

† School of Engineering, Cornell University, and Consultant, Lincoln Laboratory, Mass. Inst. Tech., Cambridge, Mass.

‡ Staff Member, Lincoln Laboratory, Mass. Inst. Tech., Cambridge, Mass.

¹ H. G. Booker and W. E. Gordon, “A theory of radio scattering in the troposphere,” *PROC. I.R.E.*, vol. 38, pp. 401–412; April, 1950.

² E. C. S. Megaw, “The scattering of electromagnetic waves by atmospheric turbulence,” *Nature*, vol. 166, pp. 1100–1104; December, 1950.

angular spread in the scattered power. Following a general discussion of received power in Section III, Section IV considers the effect of antenna "gain" in which the concept of "aperture-to-medium coupling loss" is introduced. Section V deals with the variation of receiver power with angle in experiments involving synchronized beam swinging. Section VI deals with pulse distortion, and this is expressed in terms of the bandwidth of the circuit for communication purposes in Section VII, which includes a discussion of the effect of antenna beam angle on the ultimate signal-to-noise ratio of the circuit.

II. THE ANGLE OVER WHICH RECEIVED POWER IS SPREAD

Following Booker and Gordon,¹ it is assumed that the power scattered by the atmosphere per unit solid angle, per unit incident power density, and per unit volume is

$$\sigma = \frac{\left(\frac{\Delta\epsilon}{\epsilon}\right)^2 (s/\lambda)^3}{\lambda \left[1 + \left(\frac{2s}{\lambda} \sin \frac{\theta}{2}\right)^2\right]^2}, \quad (1)$$

where θ is the angle between the direction of incidence and the direction of scattering, $\overline{(\Delta\epsilon/\epsilon)^2}$ is the mean-square deviation of the dielectric constant of the atmosphere from mean, $s = 2\pi$ times the scale l of the atmospheric irregularities, and λ is the wavelength. Exp. (1) is strictly appropriate to scattering in a plane perpendicular to the electric field of the incident wave, but for the small scattering angles in which we are interested the effect of polarization is negligible.

When Booker and Gordon¹ wrote their paper, no measurements had been made of $\overline{(\Delta\epsilon/\epsilon)^2}$ and l in the free atmosphere, so that they considered various possibilities, some of which are known now to be of no practical interest in tropospheric propagation. Since then, airborne refractometers^{3,4} have come into use, and an analysis of a large number of observations by Crain, Straiton and von Rosenberg⁵ has shown that values of l in free atmosphere range from about 20 to 130 meters, with a mean value of around 50 meters. There is no marked tendency for a variation with height except near the surface of the earth. Values of $\overline{(\Delta\epsilon/\epsilon)^2}$ range from 0.4×10^{-12} to 6.4×10^{-12} , with a significant tendency for a decrease with increase of height except close to the surface.

As pointed out by Gordon,⁶ therefore, values of s in (1) are to be thought of as large compared with almost any wavelength normally considered in tropospheric propagation, and very large compared with the centimeter wavelength that would be involved in the 300-km experiment. Most of the scattering takes place in a

³ G. Birnbaum, "A recording microwave refractometer," *Rev. Sci. Instr.*, vol. 21, pp. 169-178; February, 1950.

⁴ C. M. Crain, "Apparatus for recording fluctuations in the refractive index of the atmosphere at 3.2 centimeters wavelength," *Rev. Sci. Instr.*, vol. 21, pp. 456-457; May, 1950.

⁵ C. M. Crain, A. W. Straiton and C. E. von Rosenberg, "A statistical survey of atmospheric index-of-refraction variation," *Trans. I.R.E.*, vol. AP-1, pp. 43-46; October, 1953.

⁶ W. E. Gordon, "Interpretation of diversity and fading measurements in tropospheric radio scattering," presented at the URSI Meeting, Washington, April, 1953 (to be published).

beam within the angle λ/s radians of the forward direction,¹ and, at distances beyond the horizon, the receiver is not in the main scattering beam. Assuming that $\theta \ll 1$ radian, the basic scattering formula, therefore, reduces to

$$\sigma = \frac{1}{s} \frac{\overline{(\Delta\epsilon/\epsilon)^2}}{\theta^4}. \quad (2)$$

This formula applies only for scattering at angles such that

$$\lambda/s \ll \theta \ll 1, \quad (3)$$

but it is virtually certain that these conditions would be satisfied in the experiments under consideration.

It should be noticed that (2) for σ is independent of frequency and depends, not on $\overline{(\Delta\epsilon/\epsilon)^2}$ and s separately, but only upon the combination

$$\frac{1}{s} \overline{(\Delta\epsilon/\epsilon)^2} = S_P \quad (4)$$

which will be referred to as the "scattering parameter" of the atmosphere. The value of this scattering parameter is in the neighborhood of 10^{-14} to 10^{-15} meter⁻¹ at the heights at which refractometer measurements have been made (up to about 12,000 feet). At the higher heights of interest in tropospheric scattering, the value may well drop to 10^{-16} meter⁻¹.

It has been shown by Gordon⁶ that, under conditions when (2) is applicable, the horizontal angle over which scattered radiation arrives at a receiver is restricted to an angle whose magnitude is comparable with the angle of intersection of the tangent planes at transmitter and receiver. For the horizontal angle α_c in radians over which scattered radiation is spread at the receiver, Gordon gives the formula

$$\frac{2}{3} (d/R) = \frac{2}{3} \theta_0 \equiv \alpha_c, \quad (5)$$

where d is the distance between transmitter and receiver, R is the radius of the earth, modified to allow for normal atmospheric refraction, and $\theta_0 = d/R$. For the vertical angle over which scattered radiation arrives at the receiver, Gordon gives a similar formula assuming S_P varies inversely with the square of height above ground. Taking $d = 300$ km and $R = 8,000$ km, the angle of (5) evaluates to about 1.4 degrees. In these circumstances, the fact that the scattered signal is spread in direction of arrival will be quite noticeable for antenna beams appreciably less than about 1.4 degrees in width, but will not be an important feature for antenna beams appreciably wider than 1.4 degrees.

Practically all experiments made in connection with tropospheric scattering have used beam angles so wide that the effect of the spread in the direction of arrival of the scattered waves has been unimportant.^{7,8} Thus Bul-

⁷ K. Bullington, "Radio transmission beyond the horizon in the 40- to 4,000-mc band," *Proc. I.R.E.*, vol. 41, pp. 132-135; January, 1953.

⁸ G. R. Chambers, J. W. Herbstreit, and K. A. Norton, "Preliminary report on propagation measurements. From 92-1046 at Cheyenne Mountain, Colorado," Report No. 1826, National Bureau of Standards; 1952.

This formula applies for identical transmitting and receiving antennas $\alpha_T = \alpha_R = \alpha$. It further assumes that S_P is independent of height above ground. As α gets smaller, the height of the relevant scattering volume above ground decreases so that the appropriate value of S_P probably increases. Consequently, (20) gives values of loss that are probably too large.

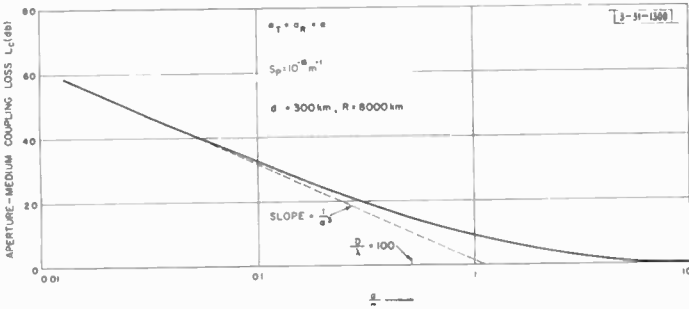

Fig. 4—Variation of aperture-medium coupling loss L_C for identical small-beam antennas with beam angle α . S_P assumed to be constant with height above the ground.

Using the solid curve for P_R and the dashed curve for P_R (large α) in Fig. 3, L_C may be determined, and is shown as the solid curve in Fig. 4. For large values of α , the “loss” is negligible and therefore independent of α ; for very small beam angles ($\alpha \ll \alpha_c$), the loss varies as $(1/\alpha^3)$. For the 100- λ paraboloids contemplated on the 300-km path, an aperture-medium coupling loss of 14 db is obtained. This value is probably several decibels too large because the variation of S_P with height was neglected and also because of the rather crude assumptions made about the antennas.

In view of what has been said, it may be seriously questioned whether use of beamwidths smaller than about d/R is worth while. Purely from the viewpoint of power received, use of beamwidths less than about d/R is probably not worthwhile. However, for transmission due to scattering by atmospheric irregularities, beam angles also have an important influence on the bandwidth of the circuit for communication purposes (see Section VII).

V. EFFECT OF SYNCHRONIZED BEAM-SWINGING ON RECEIVED POWER⁹

When propagation is due primarily to scattering by irregularities in the atmosphere, the analysis of the effect of swinging the transmitting and/or receiving beams requires careful consideration. If the beam angles are large compared with the angle over which scattered radiation is spread ($\alpha \gg \alpha_c$), the effect of beam swinging is substantially the same as for rectilinear propagation, and the variation of received power is controlled mainly by the polar diagrams of the antennas. If, however, the beam angles are small compared with the spread due to

scattering ($\alpha \ll \alpha_c$), quite a different situation arises. If one beam is swung and the other held fixed, the effect is somewhat complicated. But suppose that both beams are swung through equal angles in such a way that a common point of intersection of their axes is preserved. Then the variation of received power is controlled mainly by the scattering polar diagram of the atmosphere rather than by the polar diagrams of the antennas. Let us investigate the effect on received power of such synchronized swinging of the transmitting and receiving beams under conditions when the beam angles are small compared with the angle over which scattered radiation is important.

Let us assume that the angles of the transmitting and receiving antennas are equal, that the beams are initially directed horizontally in the vertical plane containing both antennas, and that each is then swung about a vertical axis through an angle ϕ on the same side of the great circle joining transmitter and receiver. The mean angle of scattering when $\phi = 0$ is given by (7) but, if we assume that $\alpha \ll d/R$, this becomes

$$\theta = \frac{d}{R} = \theta_0. \tag{21}$$

When the beams are swung horizontally to one side through an angle ϕ (small compared with one radian), the scattering angle becomes, by elementary geometry,

$$\theta' = 2 \left[\left(\frac{d}{2R} \right)^2 + \phi^2 \right]^{1/2}. \tag{22}$$

As a result of swinging the beams, the scattering angle is therefore changed in the ratio

$$\frac{\theta'}{\theta} = \left[1 + \left(\frac{2R}{d} \right)^2 \phi^2 \right]^{1/2}. \tag{23}$$

From (2), the power scattered per unit volume is reduced correspondingly in the ratio

$$\left(\frac{\theta}{\theta'} \right)^4 = \left[1 + \left(\frac{2R}{d} \right)^2 \phi^2 \right]^{-2}; \tag{24}$$

and, from (6), the scattering volume is reduced in the ratio

$$\frac{\theta}{\theta'} = \left[1 + \left(\frac{2R}{d} \right)^2 \phi^2 \right]^{-1/2}. \tag{25}$$

The power received is therefore reduced in the ratio

$$\begin{aligned} \left(\frac{\theta}{\theta'} \right)^5 &= \left[1 + \left(\frac{2R}{d} \right)^2 \phi^2 \right]^{-5/2} \\ &= \left[1 + \left(\frac{2\phi}{\theta_0} \right)^2 \right]^{-5/2}. \end{aligned} \tag{26}$$

Expressed in decibels, this is plotted in Fig. 5 (following page) as a function of ϕ for $d = 300$ km and for several values of the ratio of the actual to the equivalent curvature of the earth. The curve marked 0.8 may be regarded as representing normal atmospheric conditions.

⁹ The authors are indebted to J. H. Chisholm of the Lincoln Laboratory, Mass. Inst. Tech., for many helpful discussions, particularly concerning this section.

It may be seen from Fig. 5 that, for the 300-km path under normal atmospheric conditions ($\kappa/\kappa_0=0.8$), the effect of turning the two beams to one side by 1 degree is to reduce the power received by about 7 db. If on the other hand we consider highly superrefractive conditions in which the power received is due predominantly to refraction instead of scattering, the effect of turning both beams aside 1 degree would be determined by the polar diagrams of the $100\text{-}\lambda$ apertures. The received power in this case would be reduced by more than 40 db. Thus the proposed 300-km link would provide the basis for an experiment demonstrating the existence of scattering due to atmospheric irregularities. The procedure would be as follows:

- (1) Under highly superrefractive conditions, demonstrate that the effect of turning both antennas to one side about 1 degree is to reduce the power received by more than 40 db.
- (2) Repeat the experiment under normal atmospheric conditions, demonstrating that the effect of turning both antennas to one side about 1 degree is at least 30 db less than under highly superrefractive conditions.

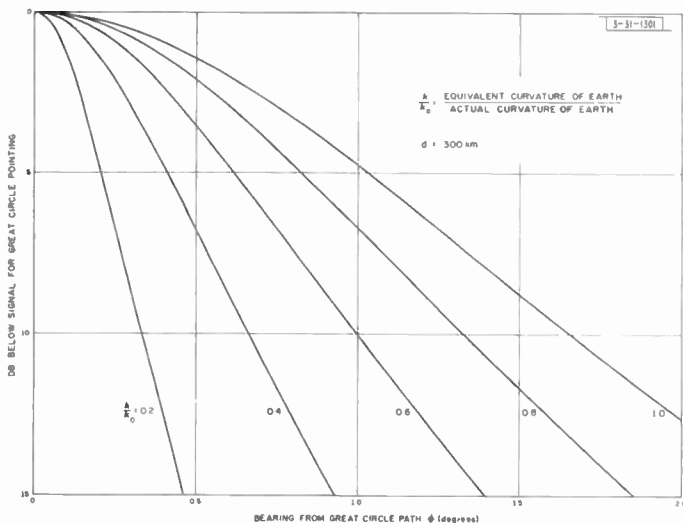

Fig. 5—Decrease in field due to turning T and R beams through equal azimuths. Indefinitely narrow beams are assumed, and a correction is required for beams of finite width (see Fig. 11).

A similar calculation to the above can be made if ϕ is kept zero but the axes of the two antenna beams are elevated by equal angles ψ . The ratio of the power received when the beams are elevated to that received when $\psi=0$ works out to be

$$\left(\frac{\theta}{\theta'}\right)^5 = \left(1 + \frac{2R}{d} \psi\right)^{-5} = \left(1 + \frac{2\psi}{\theta_0}\right)^{-5}, \quad (27)$$

assuming that the scattering parameter of the atmosphere given by (4) is independent of height. In an atmosphere of scale height H , however, we might expect the scattering parameter to decrease with height h above ground, proportional to

$$\exp(-2h/H), \quad (28)$$

and in this case the ratio of the power received for angles of elevation ψ , to that received when $\psi=0$, becomes

$$\frac{\exp[-\psi d/H]}{(1 + 2\psi/\theta_0)^5}. \quad (29)$$

Figs. 6 and 7 show this power ratio, expressed in decibels, as a function of ψ , for $d=300$ km. In Fig. 6, it is assumed that $R=8,000$ km and curves are drawn for

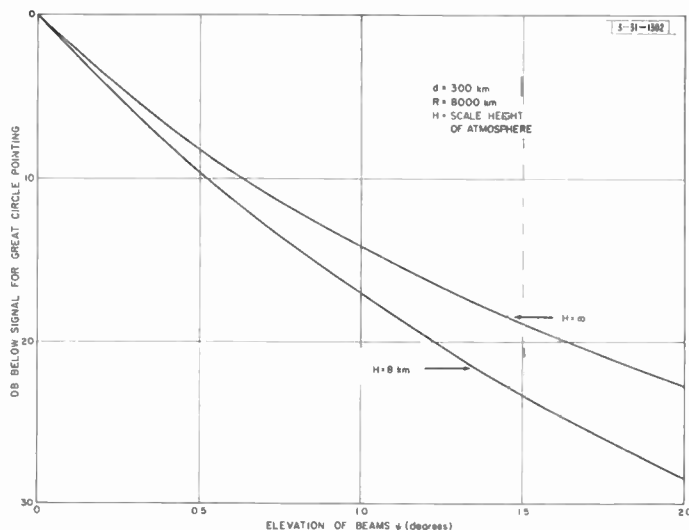

Fig. 6—Decrease in field due to elevating T and R beams equal angles, $R=8,000$ km. The calculation is done for uniform scattering with height, and for the expected exponential decrease with height. Subsequent calculations assume the latter.

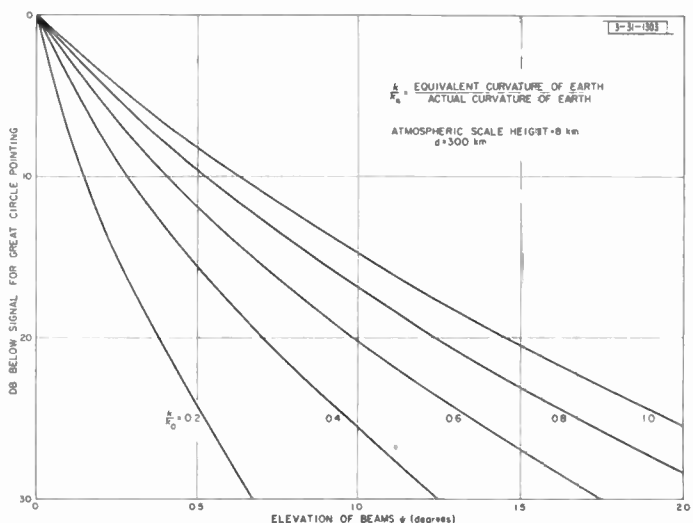

Fig. 7—Decrease in field due to elevating T and R beams equal angles, for several effective earth's curvatures. Indefinitely narrow beams are assumed, and a correction is required for beams of finite width (see Fig. 12).

$H=\infty$ and $H=8$ km. In Fig. 7, it is assumed that $H=8$ km, and various ratios of the equivalent to the actual curvature of the earth are assumed. It is clear that, in both the vertical and the horizontal directions, synchronized swinging of the beams on the 300-km circuit should produce appreciably smaller changes of re-

ceived power than would occur in free space, and this would be direct evidence that the power being received is spread over a cone larger than the antenna cones.

VI. RECEIVED PULSE SHAPE AND ITS DEPENDENCE ON BEAM SWINGING

Different scattering elements within the scattering volume involve different delay times between transmission and reception, and this leads to some difference in shape between a transmitted pulse and the received pulse. Moreover, in the synchronized beam-swinging experiments contemplated in the preceding section, the

defined by the intersection of the cones, the points corresponding to minimum and maximum transmission time may be located. These define the front and back of the pulse arriving at the receiver. From such calculations, Figs. 8 and 9, in the previous column, were constructed.

When the azimuths and elevations of the beams are both zero, the received pulse at a distance of 300 km, corresponding to sending an ideal impulse over the path, is of length $0.16 \mu\text{sec}$. Fig. 8 shows how the time of arrival of the front and back of the pulse vary as the two beams are turned to one side through equal angles. Fig. 9 gives the same information when the beams are elevated through equal angles at zero azimuth. It is clear from the figures that transmitted pulses of duration $0.1 \mu\text{sec}$ would be seriously distorted, but that there should be no marked distortion of pulses of duration $1.0 \mu\text{sec}$.

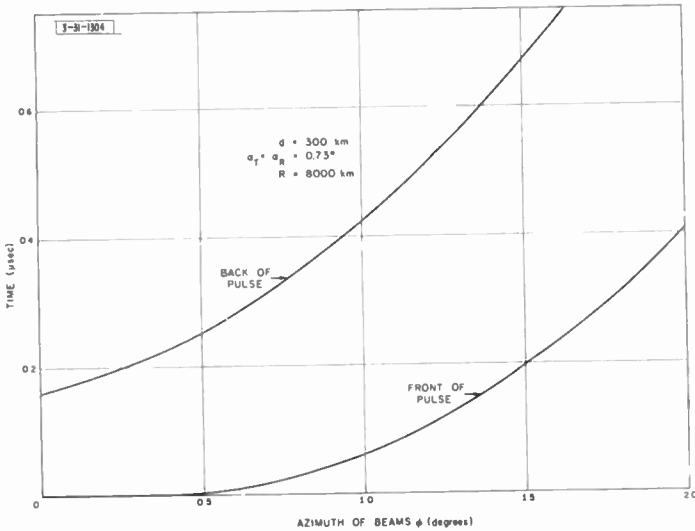

Fig. 8—Pulse delay and elongation due to turning *T* and *R* beams through equal azimuths.

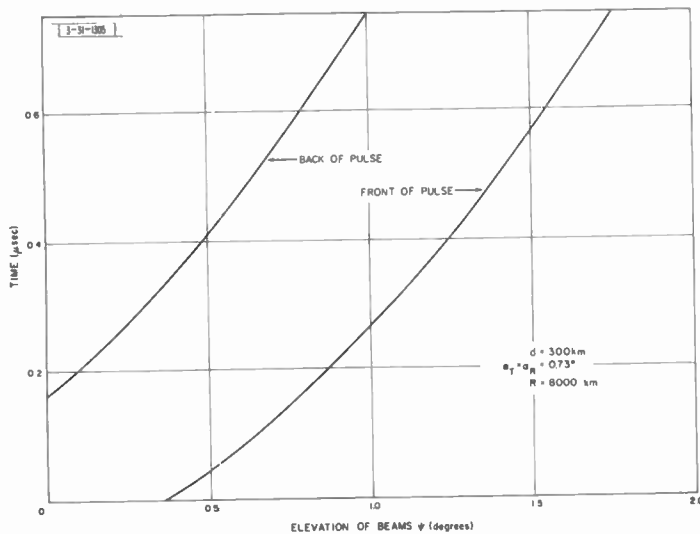

Fig. 9—Pulse delay and elongation due to turning *T* and *R* beams through equal angles of elevation.

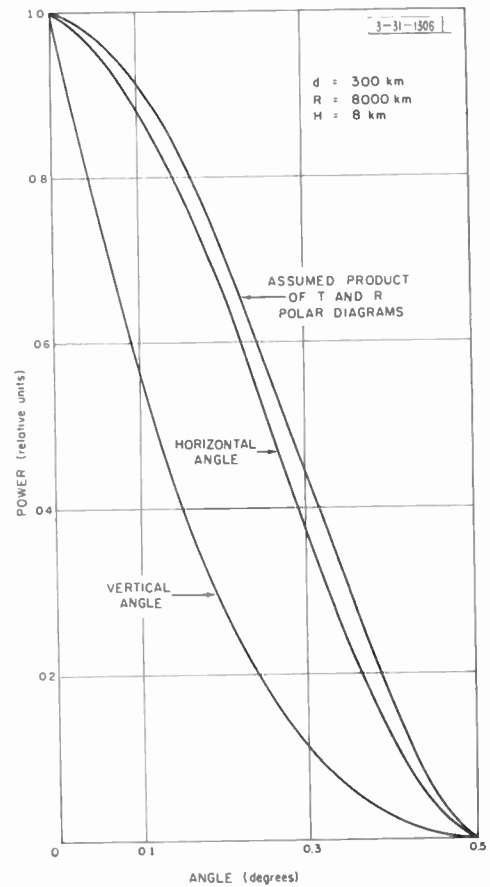

Fig. 10—Variation of response with horizontal and vertical angles of arrival, for great circle pointing. The assumed product of the *T* and *R* polar diagrams is shown. Each power polar diagram is assumed to have a parabolic main beam and no sidelobes.

mean transmission time will increase somewhat as the beams are swung away from the position of maximum signal. Let us make some calculations on these effects.

Simple calculations may be made on the assumptions that the transmitted pulse is represented by an ideal impulse function and that the beams are cones of small semivertical angle $\alpha/2$. Within the scattering volume

For accurate calculations of received pulse shape, use should be made of actual polar diagrams of antennas instead of merely approximating to them by cones. In Figs. 10–14, on this and the following pages, use has been made, not of the complete polar diagrams of the antennas, but of a better approximation than a cone. The assumption is that the power polar diagram (power

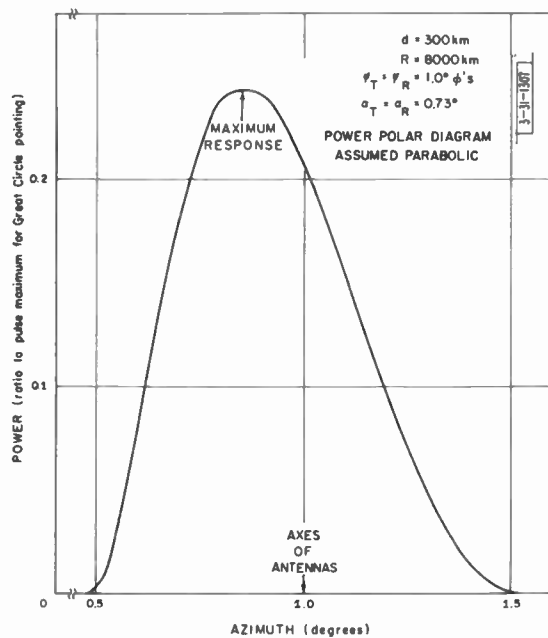

Fig. 11—Variation of response with azimuth when the axes of both antennas are at azimuth 1 degree.

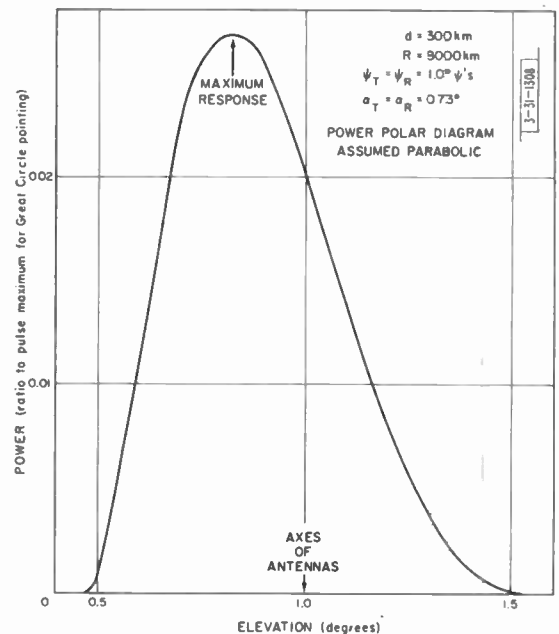

Fig. 12—Variation of response with angle of elevation when the axes of both antennas are at elevation 1 degree.

as a function of angle from axis) can be represented by a parabola and that sidelobes can be completely neglected. On this basis, the assumed product of the transmitting and receiving polar diagrams is represented by the upper curve in Fig. 10. Using this information, and the mean scattering polar diagram of the atmospheric irregularities derived from (2), we can calculate how the power received depends on direction of arrival and hence on delay time. This gives the shape of the received pulse corresponding to a transmitted pulse whose shape is an ideal impulse function, from which it is possible to deduce the corresponding information for any shape of transmitted pulse.

To simplify calculations, it has not been assumed that the antenna beams have circular symmetry about their axes. In each calculation, it has been assumed that the beam has a width (to half-power) of 0.73 degree in one plane, but is indefinitely narrow in the perpendicular plane. This assumption enables one to calculate separately the effect of horizontal and vertical multipath, but not of both simultaneously.

For the 300-km path with the axes of the beams at zero azimuth and elevation, the curve marked "horizontal angle" in Fig. 10 shows how the power received is distributed with horizontal angle of arrival. The curve marked "vertical angle" gives similar information for the distribution of received power with vertical angle of arrival. These curves are translated into received pulse shapes corresponding to a transmitted impulse function in Fig. 13 ($\phi_T = \phi_R = 0$ degree) and Fig. 14 ($\psi_T = \psi_R = 0$ degree). Fig. 11 refers to a situation in which the axes of the beams are turned to one side through 1 degree of azimuth. The curve shows the distribution of received power with horizontal angle. It shows in particular that maximum response occurs at an azimuth of 0.9 degree even though the axes of the beams are at azimuth 1.0

degree. This is because the parts of the beams nearer to the great circle path involve smaller scattering angles, and are consequently more effective. Fig. 11 is translated into a received pulse shape corresponding to a transmitted impulse function in Fig. 13 ($\phi_T = \phi_R = 1.0$ degree). Fig. 12 refers to a situation in which the axes of the beams are elevated 1 degree at zero azimuth, and this curve is translated into received pulse shape in Fig. 14 ($\psi_T = \psi_R = 1.0$ degree).

It is clear from all these calculations that a study of pulse distortion in scatter transmission over the 300-km circuit would require pulses with a rise time as short as 0.1 μ sec.

VII. RADIO-FREQUENCY BANDWIDTH FOR COMMUNICATION

The statements in the previous section concerning elongation of pulses in transmission due to atmospheric scattering may, of course, be translated into statements about the radio-frequency bandwidth of the circuit for communication purposes. In this connection, we consider only the situation in which the azimuths and elevations of the axes of the antenna beams are zero.

Consider a transmission path involving scattering at a point such that the azimuth at transmitter and receiver is ϕ , measured to the same side of the great circle path, and such that the angle of elevation at transmitter and receiver is ψ . A simple geometrical calculation shows that the corresponding path length exceeds that for $\phi = \psi = 0$ by approximately

$$\begin{aligned} \Delta P &= \frac{d}{2} \phi^2 + \frac{d}{2} \left(\frac{d}{2R} + \psi \right)^2 - \frac{d}{2} \left(\frac{d}{2R} \right)^2 \\ &= \frac{d}{2} (\phi^2 + \theta_0 \psi + \psi^2). \end{aligned} \tag{30}$$

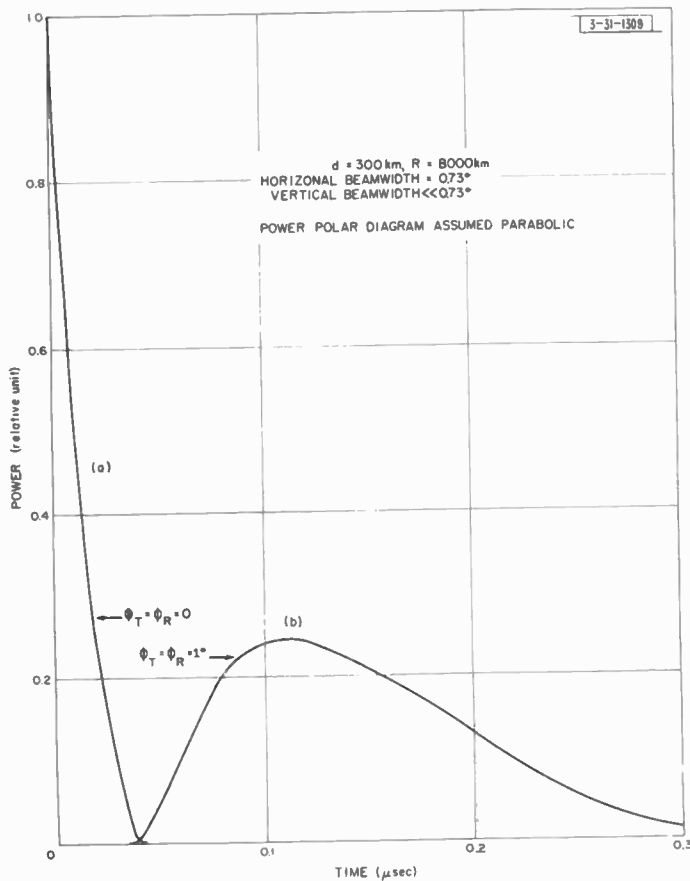

Fig. 13—Effect of horizontal multipath on the shape of the received pulses due to a transmitted impulse: (a) when azimuths are 0 degree, (b) when azimuths are 1 degree. Elevations are 0 degree.

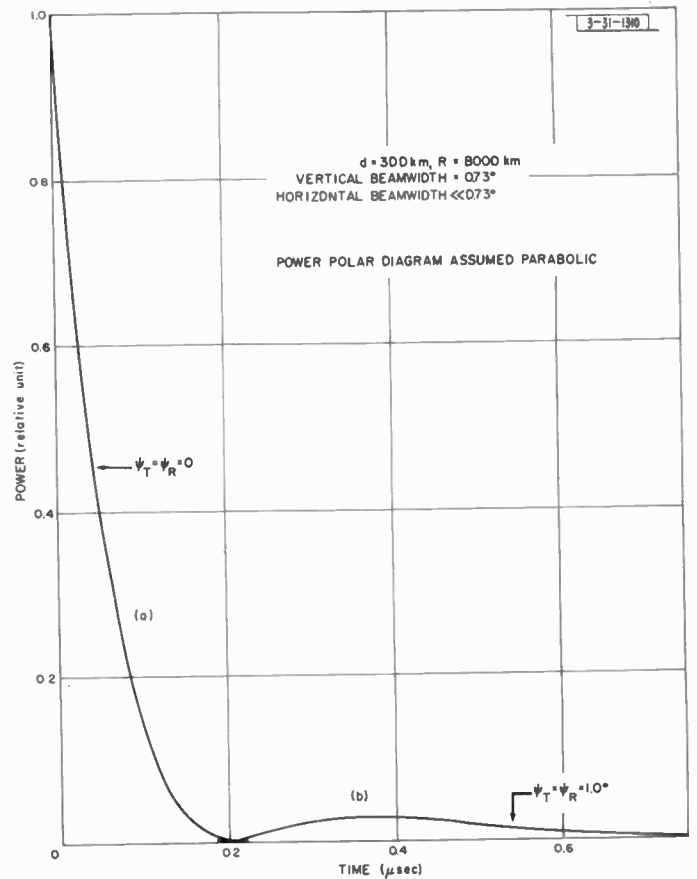

Fig. 14—Effect of vertical multipath on the shape of the received pulses due to a transmitted impulse: (a) when elevations are 0 degree, (b) when elevations are 1 degree. Azimuths are 0 degree.

The amount of pulse elongation involved in using beams of width α , less than α_c given by (5), is obtained approximately by putting

$$\phi = \alpha/2, \quad \psi = \alpha/2 \quad (31)$$

in (30), giving

$$\Delta P = \frac{\alpha d^2}{4R} (1 + \alpha/\theta_0). \quad (32)$$

Since the assumption that α is small compared with α_c implies that α is small compared with θ_0 , (32) reduces to

$$\Delta P = \frac{\alpha d^2}{4R} \quad (\alpha \ll \alpha_c), \quad (33)$$

giving a bandwidth for communication purposes of

$$B = \frac{c}{\Delta P} = \frac{4cR}{\alpha d^2} \quad (\alpha \ll \alpha_c), \quad (34)$$

where c is the velocity of light in free space. Eq. (34) shows that, for α small compared with α_c , the bandwidth of the circuit is inversely proportional to beamwidth. The narrower the beams, the less is the opportunity for multipath.

The bandwidth of a circuit for which the beam angles are greater than α_c has been considered by Gordon.⁶

Gordon obtained a value of ΔP for the conditions $\phi = 0$, $\psi = 1/2 \theta_0$. It might perhaps fit in better with (5) and (31) to put

$$\phi = \frac{1}{3}(d/R) = \theta_0/3, \quad \psi = \frac{1}{4}(d/R) = \theta_0/4 \quad (35)$$

in (30), thereby slightly modifying the numerical coefficient in Gordon's formula. (These conditions correspond to the case where S_P varies inversely with the square of height above the ground.) The bandwidth for beamwidths large compared with α_c calculates to

$$B = \frac{c}{\Delta P} = \frac{4.7cR^2}{d^3} \quad (\alpha \gg \alpha_c). \quad (36)$$

This bandwidth is independent of beam angle because, for beamwidths large compared with α_c , the degree of multipath is controlled by the properties of the atmospheric irregularities rather than by the antennas in use.

Variation of circuit bandwidth B with beam angle α is shown in Fig. 15 (next page) [$10 \log B$ (mc) vs α/α_c]. For large values of α ($\alpha \gg \alpha_c$), B , given by (36) is independent of α . For very small beam angles ($\alpha \ll \alpha_c$), B is given by (34) and varies inversely as α . For intermediate values of α , the curve is interpolated.

For $R = 8,000$ km and conditions (16) and (17), B from Fig. 15 is about 6.3 mcps which is about the reciprocal of $0.16 \mu\text{sec}$ derived from Figs. 8 and 9. For α

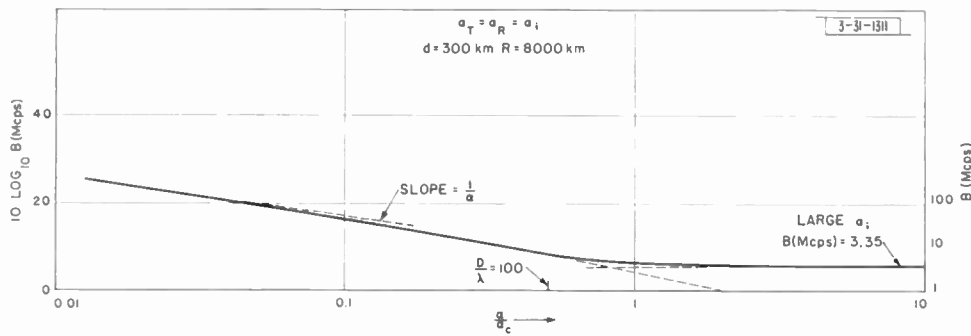

Fig. 15—Variation of transmission-circuit bandwidth B (in mc) for identical narrow-beam antennas with beam angle α .

larger than α_c , the circuit bandwidth, from (36) or Fig. 15, is about 3 mcps. Thus narrow beams, with α less than α_c , materially improve the capabilities of the transmission circuit insofar as bandwidth is concerned, even though the improvement in received power is minor.

The end result of varying beam angle on the signal-to-noise ratio S/N , is shown in Fig. 16, for conditions (16) and (17) and $R = 8,000$ km. A typical receiver noise figure NF of 10 is assumed. It is further assumed that the transmitter power P_T and wavelength λ are such as to produce a signal-to-noise ratio of 10 db with $\alpha = 10\alpha_c$. The variation of P_R is taken from Fig. 3. However, some care is necessary in discussing the variation of S/N with α . If circuit requirements are such that maximum possible bandwidth is demanded, then B is determined from Fig. 15 and the variation of S/N is determined in Fig. 16 from the curve labeled "bandwidth matched to transmission medium. . . ." In this case, narrowing the beam angle from large values results in a continued improvement in S/N until small values of α (small compared with α_c) are encountered, after which this ratio remains constant. Note that S/N does not decrease with decrease in α at values of α smaller than α_c .

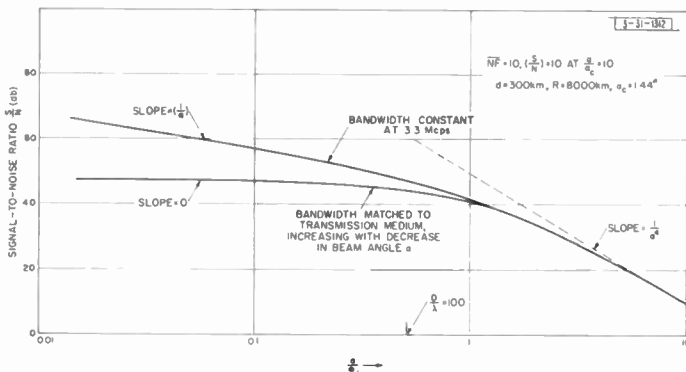

Fig. 16—Variation of signal-to-noise ratio for small-beam antennas with beam angle α .

If, however, a fixed bandwidth is to be used, equal to that given by the maximum allowed from (36)—i.e., about 3.3 mc in Fig. 16—variation of S/N with α is given by curve labeled "bandwidth constant at 3.3 mc."

Finally, if circuit requirements are such that only a

moderate bandwidth is required, constant and less than (36), the variation of S/N with α is similar to the latter curve but shifted upwards by the reduction in noise with reduced bandwidth. Thus, if a bandwidth of 330 kc is satisfactory, the variation is S/N with α for the 300-km circuit will follow that given by the 3.3-mc curve but shifted upwards by 10 db.

VIII. CONCLUSIONS

Various transmission-circuit phenomena using identical narrow-beam transmitting and receiving antennas on paths extending beyond line-of-sight can be predicted approximately from the Booker-Gordon turbulent scattering theory.¹ Computations are based upon an exponential correlation coefficient and upon the assumption of off-beam scattering with scale of atmospheric irregularities large compared with wavelength.

It is shown that the behavior of such characteristics as signal level, circuit bandwidth, and pulse deterioration is dependent upon whether the antenna beam angles α are smaller or greater than a transitional value α_c . The value of α_c is given approximately by Gordon⁶ as $2/3 \theta_0$, where $\theta_0 = d/R$, with d taken as the transmission distance and R as the equivalent earth's radius modified for refraction. For beam angles α much less than α_c , received power varies with α at a rate of $1/\alpha$ instead of $(1/\alpha^4)$ as with beams in free space, resulting in added loss interpreted as inefficient coupling between antennas and transmission medium. Again, for narrow beam angles ($\alpha \ll \alpha_c$), bandwidth capability of circuit varies as $1/\alpha$. Less multipath is involved with smaller beam angles. Simultaneous beam swinging, vertically or horizontally, should show variations differing from that for plane waves under normal tropospheric transmission conditions.

Calculations are given for a proposed 300-km path for 100λ transmitting and receiving apertures, and for a scattering parameter assumed constant or, in some cases, decreasing exponentially with height. It is considered desirable to extend approximations made herein to a more exact description of the common scattering volume and to the variations of scattering parameter with height above ground. Finally, calculations should be made for other distances and for cases where transmitting and receiving beams are dissimilar.

Logical and Control Functions Performed with Magnetic Cores*

S. GUTERMAN†, ROBERT D. KODIS‡, SENIOR MEMBER, IRE, AND S. RUHMAN‡

INTRODUCTION

IN THE RELATIVELY short period since its first application to digital computers, the magnetic core having a square hysteresis loop, has firmly established its usefulness in high-speed large-scale storage¹⁻³ and for buffer storage^{4,5} between input-output media, memory devices, and the heart or manipulative section of a computer. The magnetic core is particularly attractive because of its long life and consequent high order of reliability. A technique for performing logical functions with magnetic cores⁶⁻⁹ will be described here, which is based upon the "single-line" shift register.¹⁰ This method utilizes the inherent storage and amplification capabilities of the cores in order to make possible an all-core manipulative organ. Vacuum tubes are only used for the shift pulse sources which drive all the cores in common. Extensive tests proved the soundness of this technique.

"SINGLE-LINE" SHIFT REGISTER

The main characteristics of the "single-line" shift register (see Fig. 1) will be reviewed briefly before proceeding with a discussion of the logical techniques based on it. The shift windings of all the cores are arranged in series to form what is called a "shift line." A source of current pulses, referred to as "shift" or "read-out" pulses, is applied to the shift line. Saturation in the direction of the field applied by the shift pulse is defined as the ZERO state of a core; saturation in the opposite direction is defined as the ONE state. Application of a shift pulse clears all the cores to state ZERO, thus generating a voltage in the output winding of any core which was previously in state ONE. This voltage charges the associated condenser through a diode; after the read-out, the condenser discharges through the succeeding core, thereby writing a ONE into it. Thus the information is stored

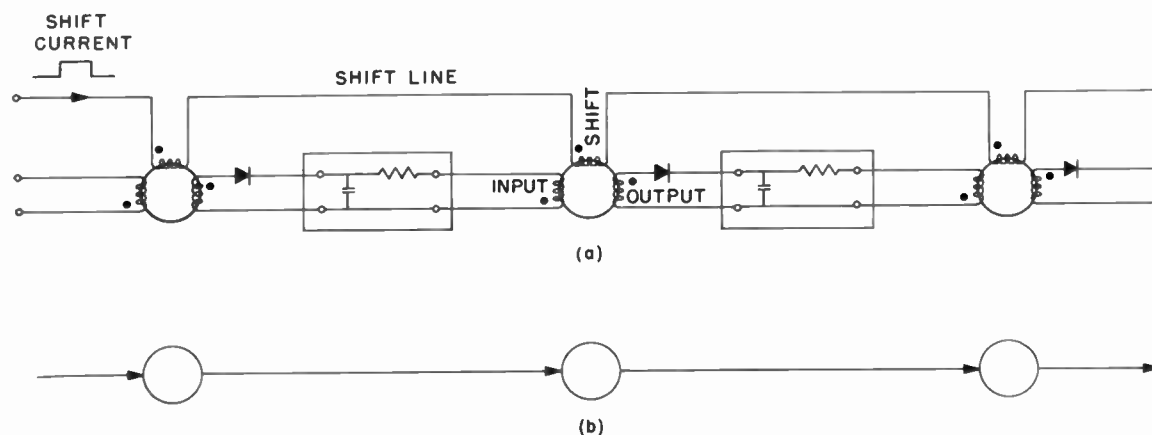

Fig. 1—Single-line shift register.

* Original manuscript received by the IRE, April 22, 1954; revised manuscript received, November 26, 1954.

† Raytheon Manufacturing Co., Waltham, Mass.

‡ W. N. Papian, "A coincident-current magnetic memory cell for the storage of digital information," *Proc. I.R.E.*, vol. 40, pp. 475-478; April, 1952.

² I. L. Auerbach, "A static magnetic memory system for the ENIAC," *Proc. ACM*, pp. 213-222; May 23, 1952.

³ J. A. Rajchman, "A myria bit magnetic-core matrix memory," *Proc. I.R.E.*, vol. 41, pp. 1407-1421; October, 1953.

⁴ A. Wang and W. D. Woo, "Static magnetic storage and delay line," *Jour. Appl. Phys.*, vol. 38, pp. 626-629; June, 1950.

⁵ E. Sands, "An analysis of magnetic shift register operation," *Proc. I.R.E.*, vol. 41, pp. 993-998; August, 1953.

⁶ M. L. Haynes, "Magnetic Cores as Elements of Digital Computing Systems," Tech. Rep., University of Illinois, Urbana, Ill., August 28, 1950.

⁷ N. B. Saunders, "Magnetic binaries in the logical design of information handling machines," *Proc. ACM*, pp. 223-229; May, 1952.

⁸ J. D. Goodell, "Testing magnetic decision elements," *Electronics*, vol. 27, pp. 200-203; January, 1954.

⁹ R. C. Minnick, "Magnetic switching circuits," *Jour. Appl. Phys.*, vol. 25, pp. 479-485; April, 1954.

¹⁰ R. D. Kodis, S. Ruhman, and W. D. Woo, "Magnetic Shift Register Using One Core Per Bit," 1953 I.R.E. Convention Record, Part 7, "Electronic Computers," pp. 38-42.

statically in the magnetic cores, and is advanced one stage with each application of the shift pulse, temporary storage being provided by the intercore link circuit. In Fig. 1(a), this link circuit is shown in its simplest form as a condenser-resistor combination.

Since many other types of temporary storage can be and have been used,¹¹ and the subject of this paper is not circuit design, the link henceforth simply will be represented by a four-terminal box. When the single-line register is applied to logical circuits, it becomes difficult to draw the circuit in detail. This has led to a shorthand notation for the register given in Fig. 1(b). It will be noted that the shift line is not shown and a common shift source for all the cores can be assumed unless otherwise indicated.

¹¹ S. Guterman and R. D. Kodis, "Magnetic core ring counter," *Proc. NEC*, Chicago, Ill., vol. 9, pp. 665-669; February, 1954.

BASIC FUNCTIONS

The three basic requirements necessary to make possible an all-core manipulative organ, such as the algebraic or control unit of a computer, are: (1) storage or delay, (2) amplification, and (3) two out of the three elementary logical operations, AND, OR, and INHIBIT (AND NOT). The storage or delay capabilities of the single-line register have already been described. The core provides indefinite static storage while, under dynamic operation, there is a delay of one pulse period per stage. Amplification is also inherent in the single-line register, as indicated by the fact that there is no attenuation in a register. In fact, each stage is a saturating magnetic amplifier, more energy being transferred to its output than is necessary to switch the core in the next stage. With proper design, it is possible to have this output switch more than one core. An amplifier stage, or branch circuit, whose output drives two other stages is shown in Fig. 2(a). The two driven cores are fed in series from the output of the amplifier stage. More than two stages can be driven from one, the upper limit being a function of the design. As a matter of fact, the authors have succeeded in driving five stages from one stage. Fig. 2(b) (above) gives the symbolic representation of the branch circuit.

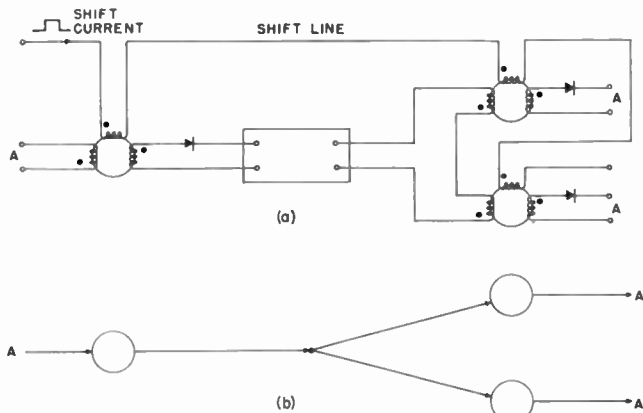

Fig. 2—Amplifier or branch circuit.

The two elementary logical operations from which the system under discussion is built up are OR and INHIBIT (AND NOT). Two ways of mixing (buffering) are used. The first, shown in Fig. 3(a), takes advantage of the diode normally associated with each core to buffer their outputs together into a common link circuit. The second, shown in Fig. 3(c), mixes the signals by feeding each into a separate input winding of the mixer core, the inputs being poled so that they tend to write a ONE in the core when they are energized. The first OR has the advantage that the buffered function is immediately available for use. On the other hand, the second OR has the advantage that the functions to be mixed as well as the buffered output are available for use, both OR circuits may handle more than two inputs, the maximum varying with the design. The symbol used for the two OR circuits, as shown in parts (b) and (d) of Fig. 3, indicates their nature and circuit arrangement.

The INHIBIT function [Fig. 4(a) (opposite)] is performed by a winding fed in opposite polarity to a normal input winding, and referred to as an INHIBIT winding. When this winding receives a ONE signal, it tends to cancel a signal appearing on the input winding. Since both windings are driven from similar stages, the two opposing signals are identical, within a small tolerance.

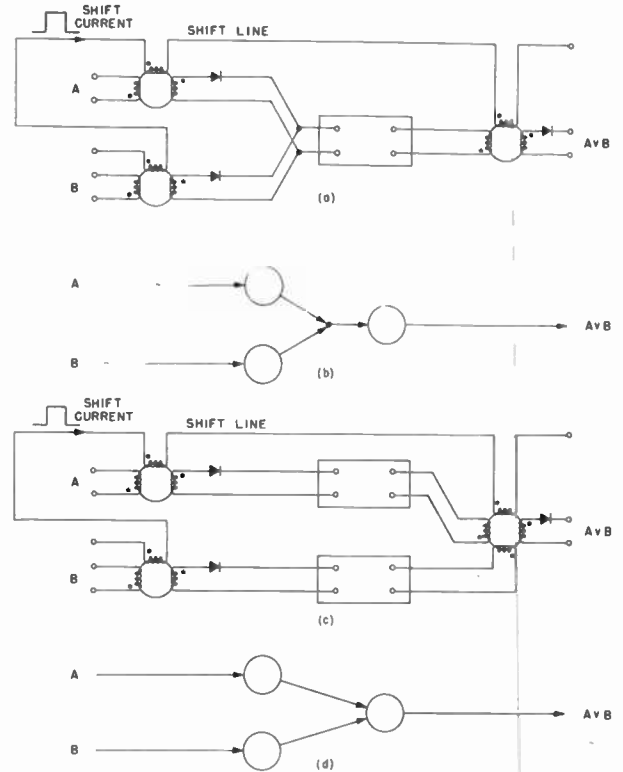

Fig. 3—Mixing or buffer circuits.

To insure that the inhibit signal will prevail, the inhibit winding may be made somewhat larger than the input winding. Where the input to be inhibited comes from a link circuit onto which the outputs of two or more cores were buffered, the inhibit winding is further increased to take care of the larger input appearing when all the buffered cores are energized simultaneously. Similarly, for a mixer core with two affirmative inputs, which is to be inhibited even when both inputs are energized together, the normal inhibit winding must be doubled. It should be pointed out that the inhibit winding places virtually no load on the driving stage, since no flux change takes place in the inhibited core. Hence, more than one INHIBIT may be driven from one stage, the upper limit again being a function of the design. Fig. 4(b) gives the symbol used for the inhibit circuit; the solid line across the path of information flow is meant to suggest the blocking or inhibit action. If it is desired to inhibit the input to a core by means of either of two signals, two inhibit windings may be used as in Fig. 4(c), or the two signals may be mixed in an OR which then drives the INHIBIT, Fig. 4(d).

These fundamental building blocks—the shift register, the BRANCH, the two ORs, and the INHIBIT—

form the whole basis for the all-core logical technique under discussion, all other logical functions being built out of them. The analysis and design of specific circuits will not be treated here; instead it will be shown how other elementary, as well as complex, circuits may be synthesized from these blocks and applied to computer systems.

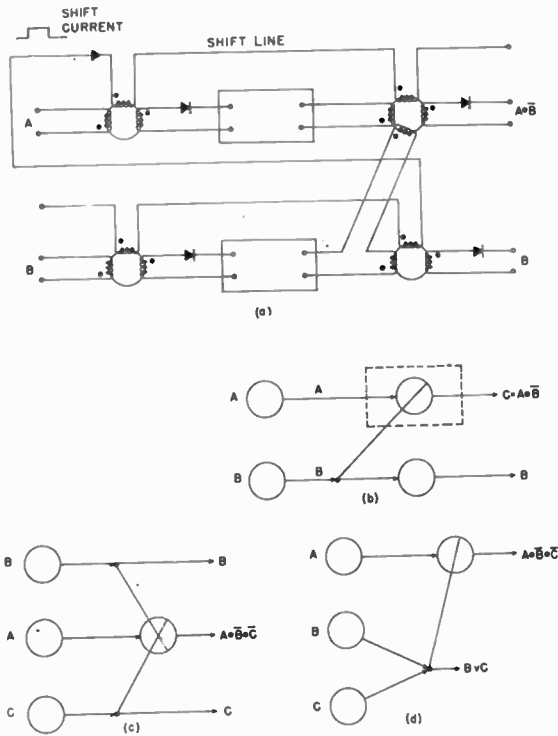

Fig. 4—Inhibit circuits.

GENERATION OF TIMING PULSES

Before proceeding with compound logical structures, it would seem desirable to discuss the generation of clock pulses, timing pulses, and other patterns or words for time-sequenced instructions and program control. A simple method, of course, is to connect a closed ring of shift register stages in which the desired information pattern is written initially and is then circulated by the shift pulses. This pattern is repeated at the output of each stage of the ring, but appears with a different timing (phase). This method has the advantage that all timing pulses are automatically available from a single ring, and any circulated pattern is available in every timing. The simplest application of this method is the generation of clock pulses (or continuous ONEs) from an initially set single register stage feeding back on itself.

A disadvantage of using a ring is that once an error occurs, the circulated pattern will remain incorrect until the shift pulse is turned off and the pattern rewritten. Another method of generating information patterns, which does not have this disadvantage, will now be discussed. The simplest example, a circuit which produces clock pulses (or continuous ONEs), will be described first. This circuit, called a ONE-Generator, is shown in

Fig. 5(a). It consists of a core whose input winding receives a small dc current, poled so as to set the core to state ONE. The current is large enough to switch the core fully in the minimum period between shift pulses. Although this current actually opposes the shift pulse, it is normally so small by comparison that it may be neglected. If necessary, however, the number of turns in the shift winding of the core may be increased to compensate for this effect. The shorthand notation for the ONE-Generator is shown in Fig. 5(b).

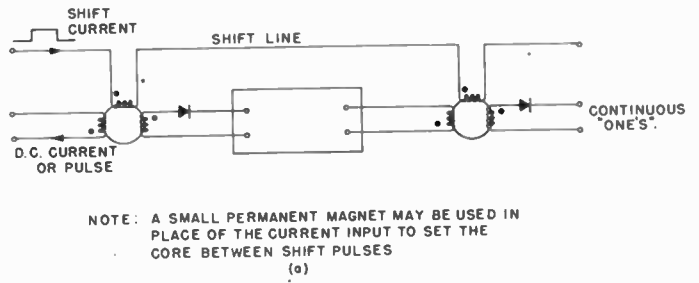

NOTE: A SMALL PERMANENT MAGNET MAY BE USED IN PLACE OF THE CURRENT INPUT TO SET THE CORE BETWEEN SHIFT PULSES

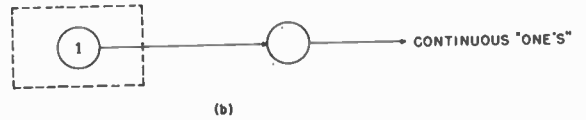

Fig. 5—ONE-Generator.

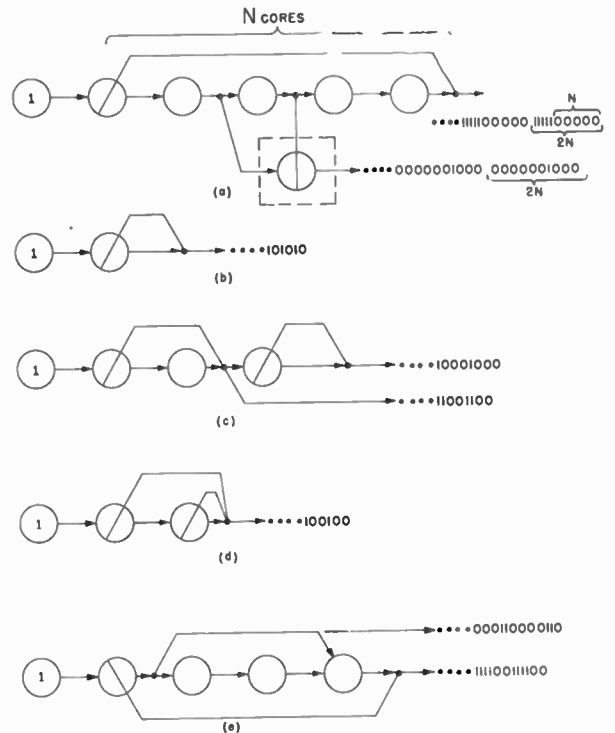

Fig. 6—Pattern generators.

More complicated patterns may be obtained by feeding a string of cores from a ONE-Generator and having feedback and advance feed between these cores that either inhibits or mixes with the main flow of information. In Fig. 6(a) such a pattern generator with an INHIBIT feedback from the last to the first core is shown.

If the number of cores in the line (aside from the ONE-Generator) is N , the resulting pattern is $2N$ digits long and consists of N ZEROS followed by N ONES. For $N=1$ a frequency division by a factor of 2 results, as shown in Fig. 6(b). A circuit with $N=2$ followed by one with $N=1$ gives a frequency division by a factor of 4 [see Fig. 6(c)]. If in Fig. 6(a) a core external to the line is fed from one stage in the line and inhibited by the following or the preceding stage, the resulting pattern is a single ONE in a sequence of $2N$ bits, the phase of the ONE depending on the cores chosen. If the two cores are not adjacent but are two places away, the pattern will be two consecutive ONES in a sequence of $2N$ bits. Two other interesting examples of pattern generation are shown in Figs. 6(d) and (e). Aside from their usefulness, the general theory of these circuits should be both interesting and challenging to the logician.

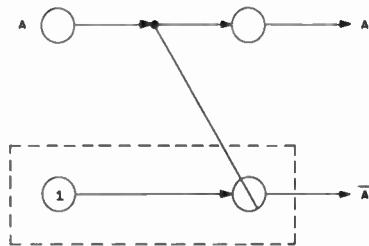

Fig. 7—Complementing circuit.

SYNTHESIS OF OTHER ELEMENTARY FUNCTIONS

Proceeding now with the description of compound functions, the first one to be taken up will be a complementing circuit. In a system where OR and INHIBIT are the two fundamental logical functions, complementing is a very frequent and important operation. Referring to Fig. 7, the output of a ONE-Generator is fed into a core which is inhibited by A , giving ZEROS where there are ONES in A , and vice versa.

$$\text{By symbolic algebra } 1 \cdot \bar{A} = \bar{A}.$$

Thus, it requires two cores to produce from a binary information train A , its complement \bar{A} . With the use of the complement circuit, it is now easy to synthesize the important elementary function, the AND gate which is otherwise difficult to do reliably in a straightforward manner. Referring to Fig. 8(b), input B is complemented and \bar{B} used to inhibit A , thus obtaining $A \cdot B$.

$$\text{By symbolic algebra } A \cdot (\overline{\bar{B}}) = A \cdot B.$$

Another AND gate, not using a ONE-Generator, is shown in Fig. 8(a). Here B inhibits A to give $A \cdot \bar{B}$, which in turn inhibits A , yielding $A \cdot B$.

$$A \cdot (\overline{A \cdot \bar{B}}) = A \cdot B.$$

It should be noted that in the gate of Fig. 8(b), A need not be available until one pulse period before the result appears, while in the circuit of Fig. 8(a), A must be available two pulse periods ahead of the result, because

of the need to form $A \cdot \bar{B}$. Obviously, applications in which $A \cdot B$ is to be fed back to form a new coincidence, $(A \cdot B)$ and B (next digit), one pulse period later, require the use of the Fig. 8(b) circuit.

A very simple function to synthesize with core logic is the exclusive OR, shown in Fig. 9. A inhibits B , and B inhibits A and the results are buffered together.

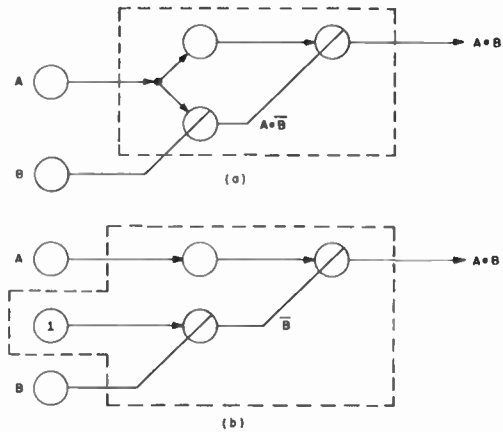

Fig. 8—Coincidence or AND circuits.

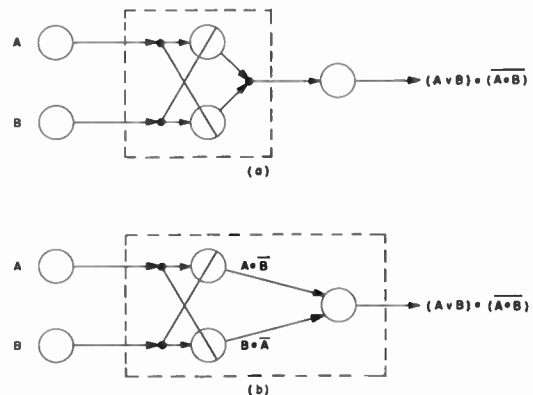

Fig. 9—Exclusive OR.

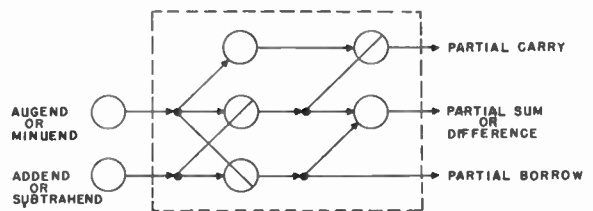

Fig. 10—Half-adder-subtractor.

$$\text{By symbolic algebra } (A \cdot \bar{B}) \vee (\bar{A} \cdot B) = (A \vee B) \cdot \overline{(A \cdot B)}.$$

Because of its simplicity, the exclusive OR is a very powerful tool in core logic. Its output is, of course, the partial sum or difference of the two incoming numbers A and B . The exclusive OR in Fig. 9(b) is in itself a partial subtractor, the partial borrow for $A - B$ appearing at the point marked $B \cdot \bar{A}$. By the addition of two cores to form a coincidence between A and B , as shown in Fig. 10, a half-adder as well as a half-subtractor is obtained, the partial carry being available at the output of the coincidence circuit.

With the single-line register, it is rather easy to build a flip-flop by the use of one stage feeding back on itself. As often as the contents of the register stage are read out, they are read back in again. To make provision for setting and resetting the flip-flop and for using its output, an OR, an INHIBIT and a BRANCH are used, all on the one-register stage. The set and feedback inputs may be mixed on the core as in Fig. 11(a), or they may be diode buffered into a common link network as in Fig. 11(b). Flip-flop (b) has the advantage that when it is set, its output is available one pulse time earlier than that of flip-flop (a). On the other hand, flip-flop (b) ties up the output of the setting core and always passes the set signal to the output, even when the reset is energized simultaneously. Two flip-flops interlocked so that the set for one is the reset for the other may be used to obtain two complementary outputs. Fig. 11(c) shows two flip-flops of type (b) arranged in this manner.

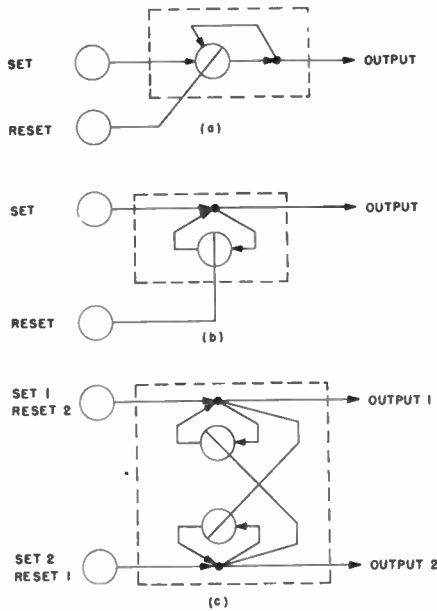

Fig. 11—Flip-flops.

GATING AND EXTRACTING

In the core logic, the magnetic core flip-flops can be used to control the flow of information throughout a computer as successfully as dynamic or static flip-flops in conventional computing technique. Here, however, anti-coincidence is mostly used for gating purposes. The output of the dynamic core flip-flop, shown in Fig. 11, when applied to an inhibiting winding of a core in a register, can stop information if a ONE is stored in it or let it pass if a ZERO is stored.

Two illustrations of the use of flip-flops to gate or control the flow of information are presented in Fig. 12. Part (a) shows a double flip-flop acting as a single-pole double-throw switch. The information to be switched branches into two cores, each inhibited by one of the two flip-flop outputs. Part (b) demonstrates how a flip-flop, used in conjunction with an exclusive OR, will gate

out a train of information when reset, and complement this information when set. If, in the latter circuit [12(b)], the output of the core (P) is used as the input to set the flip-flop (F), the information which emerges will be the so-called 10's complement ($\bar{A} + 1$). (Here one is added arithmetically to the least significant digit.) It is easy to see that the number starts to go through as a straight number until the first ONE comes along. This ONE will pass as a ONE. The remaining parts of the number will come out in complement form.

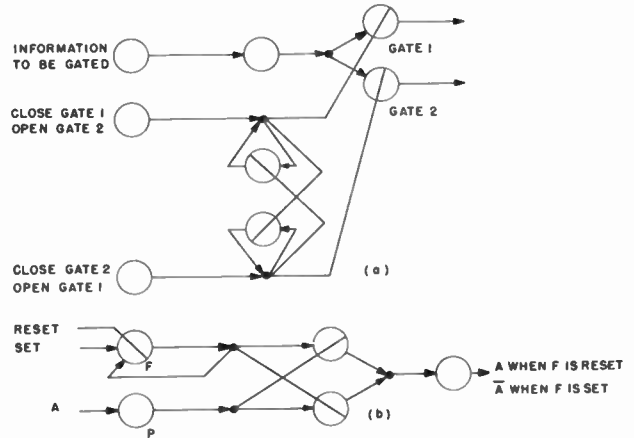

Fig. 12—Gating.

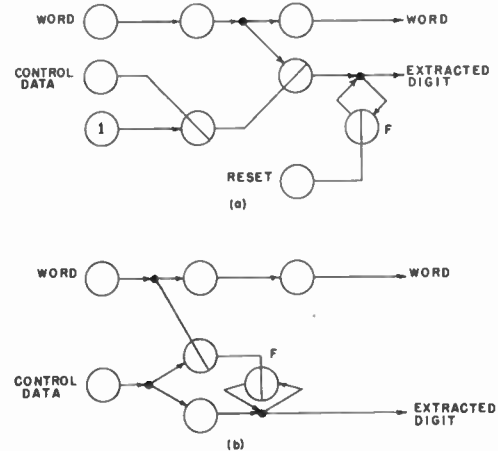
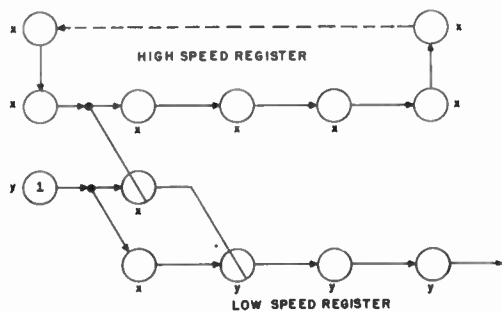

Fig. 13—Extracting and storing.

Another common computer and control function is that of extracting predetermined digits from a train of information. This may be accomplished by the conventional method of applying timing pulses as control data in coincidence with the digits to be extracted. An illustration of a circuit to extract a digit and also to store it for possible later use is shown in Fig. 13(a), along with a flip-flop, F , used to store the extracted digit. The ONE-Generator usually blocks the way in setting up flip-flop F (circuit a) except when a control data pulse appears and cuts off the ONE-Generator. F must be reset before each successive extraction. A similar circuit in which the flip-flop does not require an external reset is presented in Fig. 13(b).

COMPLEX LOGICAL STRUCTURES

A few illustrations of the use of the basic circuits, covered in the previous section, to build a complex logical structure will now be given. The extract circuit just described may be used to pass on information from a fast shift register to another slower one in arbitrary order (see Fig. 14). Two shift pulse sources, X and Y , are used such that Y is a subset of X . Every time a Y -pulse appears, a digit is transferred from the fast register to the slow register. Let N be the number of stages in the high-speed register, then a word circulating in the high-speed register will be transferred to the low-speed register in its normal order if there is one Y -pulse for every $[N+1]$ X -pulses, and it will be transferred in the reverse order if one Y -pulse occurs for every $[N-1]$ X -pulses.



NOTES: 1. THE LETTER x OR y BESIDE EACH CORE INDICATES THE SHIFT PULSE FROM WHICH IT IS DRIVEN.
2. THE PULSES FROM SOURCE "y" ARE A SUBSET OF THOSE FROM SOURCE "x"

Fig. 14—Information transfer in arbitrary order from higher-to-lower-speed register.

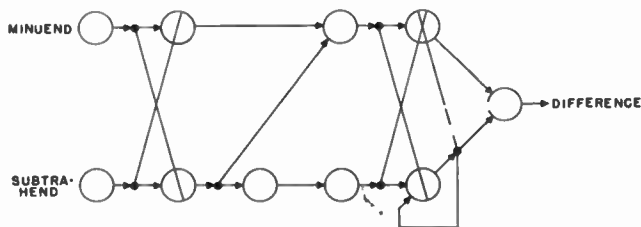

Fig. 15—Two-input subtracter.

It was explained before how a half-subtractor may be synthesized from three cores [see exclusive OR in Fig. 9(b)]. A two-input subtracter constructed from two half-subtracters is given in Fig. 15. Two additional cores are used to delay the partial borrow which appears one pulse time earlier than the partial difference, but in use should actually be one pulse time later, so as to act on the succeeding digit of the partial difference. A secondary borrow is fed back in the second half-subtractor and re-enters it one pulse time later, just as if it were a partial borrow. It can be shown that a partial and secondary borrow can never occur together. Thus, a two-input subtracter is obtained with eight cores and four pulse times of delay.

Similarly, a two-input adder may be constructed from two half-adders, as shown in Fig. 16. The first half-adder is of the type described earlier (see Fig. 10); the second is

different and uses the AND gate of Fig. 8(b). The partial carry is delayed one place by an additional core and then applied to the AND gate, which generates secondary carries. If a secondary carry does result, it is fed back and acts exactly like a partial carry, one pulse time later. It would not be possible here to use the AND gate of Fig. 8(a), because a secondary carry will act two pulse periods later, which is too late for proper operation. Again it can be shown that a partial and secondary carry can never occur together. It should be noted that a two-input adder gives the same delay (four pulse times) as a two-input subtracter, but requires more cores.

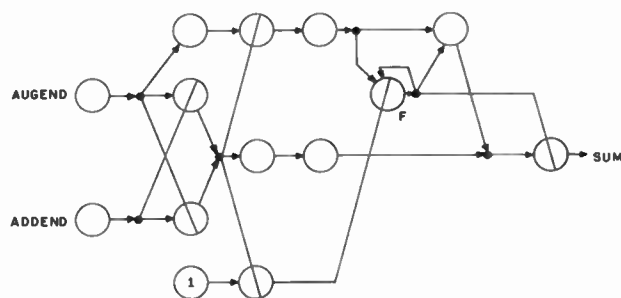
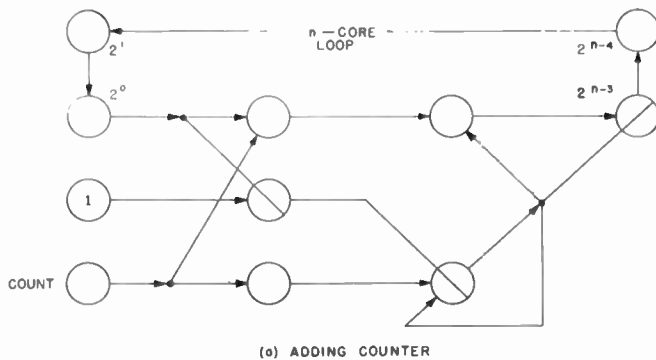
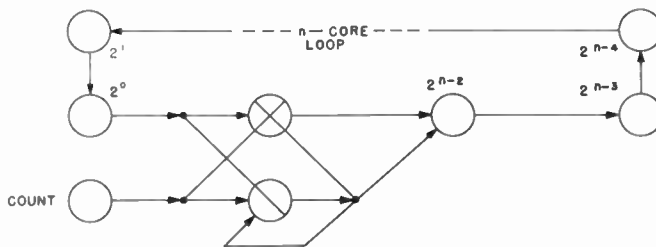

Fig. 16—Two-input adder.



(a) ADDING COUNTER



(b) SUBTRACTING COUNTERS

Fig. 17—Binary counters.

If it is desired to add or subtract just one digit from a number, the adder or subtracter discussed above may be simplified to the extent of removing the first half-adder or half-subtractor. Such an adder or subtracter may be used in conjunction with an N -core loop to form a counter of capacity 2^n , as shown in Fig. 17. The counter in part (a) uses the simplified adder. The register loop

stores the count, and is initially cleared to zero. When a count pulse appears, the loop is cycled completely and one is added to its contents. The counter in part (b) uses the simplified subtracter in a similar manner, except that all the cores in the ring are cleared to ONE, and each count pulse is subtracted from the contents of the loop, which now stores the *complement* of the true count. If necessary, the true count may be made available by the addition of a complementing circuit (two cores). In both of these counters the number in the loop must be recirculated to its initial position each time before a count can be admitted. Consequently, they are N times as slow as the core circuitry from which they are built. They are also limited in that they are unable to receive random counts. A more straightforward binary counter, which accepts random counts, has been devised using the same technique and will be described elsewhere.

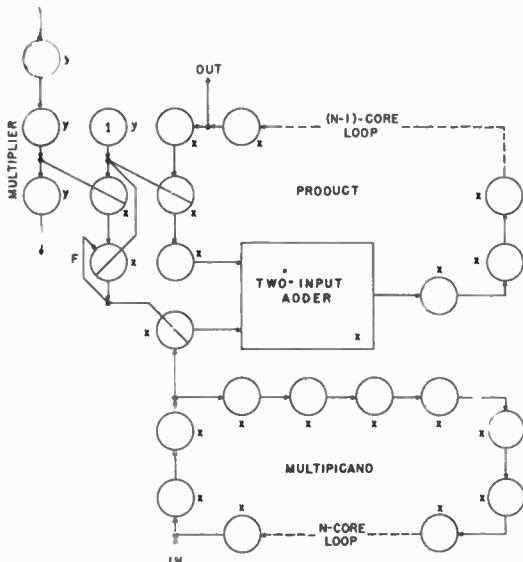

NOTES: 1. LETTERS x AND y DESIGNATE THE SHIFT PULSE SOURCE APPLIED TO EACH CORE
 2. THE " y " PULSES ARE A SUBSET OF THE " x " PULSES SUCH THAT EACH " y " PULSE IS THE FIRST OF A STRING OF N " x " PULSES
 3. MAXIMUM WORD LENGTH FOR THIS MULTIPLIER IS $(N-1)$ DIGITS

Fig. 18—Multiplier.

The full two-input adder (see Fig. 16) may be applied to build a multiplier as shown in Fig. 18. Multiplication is accomplished by the standard method of successive addition of the multiplicand to the partial product under the control of the multiplier. Two shift pulse sources are used, X and Y . The Y -pulses are a subset of the X -pulses such that every Y -pulse is the first of a group of N X -pulses. The multiplicand circulates in an N -stage loop and the partial product in an $N-1$ stage loop, including the delay in the adder. Thus, the partial product is advanced one pulse time after every addition. When the Y -pulse is applied to the ONE-Generator and the multiplier register, a digit is extracted from the multiplier and its complement is stored in flip-flop F by the next X -pulse. If the multiplier digit was a ONE, flip-flop F gates the multiplicand into the adder. If the digit was a ZERO, core F blocks the multiplicand so that it is

not added to the partial product. At the beginning of each cycle, the least significant digit of the product, which has advanced "off-register" during the previous cycle, is eliminated and flip-flop F reset by the output of the ONE-Generator. The multiplier is capable of handling numbers up to $N-1$ digits long. The multiplicand can be fed into the loop at any point and the product can be taken out of the product loop at any point. The points arbitrarily chosen in the figure are such that the Y -pulse will coincide with the entering of the least significant digit.

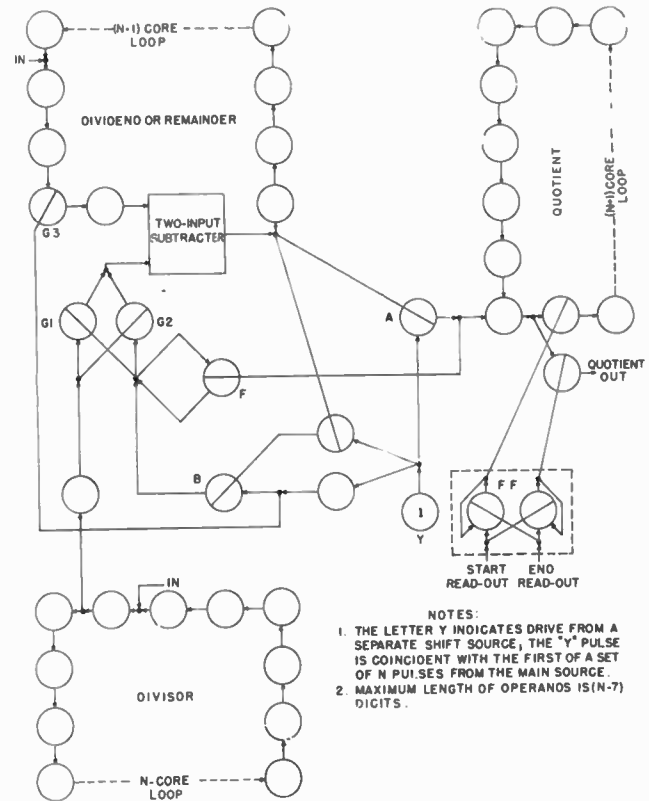

NOTES:
 1. THE LETTER Y INDICATES DRIVE FROM A SEPARATE SHIFT SOURCE, THE " Y " PULSE IS COINCIDENT WITH THE FIRST OF A SET OF N PULSES FROM THE MAIN SOURCE.
 2. MAXIMUM LENGTH OF OPERANDS IS $(N-1)$ DIGITS.

Fig. 19—Divider.

Similarly, the two-input subtracter (see Fig. 15) may be used to build a divider as depicted in Fig. 19. The division is accomplished by a process of successive subtraction of the divisor or its complement from the partial remainder, depending on the presence or absence of an over-all borrow. The complements of the over-all borrows form the quotient digits. The divisor, the dividend or partial remainder, and the quotient circulate, each in its own loop of such length that the quotient and the remainder are delayed one period with respect to the divisor after each subtraction. As in the multiplier, two shift pulse sources are used, X and Y , such that every Y -pulse is the first of a set of N X -pulses. Since the quotient digits are formed in order, starting with the most significant, the quotient is available in the proper form at the end of the division because of the one period of delay in the quotient loop.

The ONE-Generator is the only core shifted by Y -pulses. These pulses occur at the proper time for the

purpose of sensing and extracting the over-all borrows. The extracted value of the over-all borrow is stored in flip-flop F [Fig. 12(b)]. This flip-flop, together with gate cores $G1$ and $G2$, form the gating structure shown in Fig. 12(b), the function of which is to let either the divisor or its complement pass to the subtracter. The complements of the over-all borrow are fed to the quotient loop.

The output of the ONE-Generator also insures that after every subtraction the new lowest significance digit will be a zero by inhibiting it at core $G3$. Because it takes four pulse times to go through the subtracter and find out whether a final borrow will result, and it takes three more pulse times to set up gates $G1$ and $G2$, the maximum length of operands that can be handled is $N-7$ digits. However, the quotient may be obtained to any desired precision, provided the quotient loop is emptied whenever it has accumulated $N-2$ digits. The double flip-flop FF is used to gate out the contents of the quotient loop. As in multiplication, the points chosen to feed the divisor and the dividend into their loops are such that the least significant digits enter their loops coincidentally with the first Y shift pulse. Instead of using a ONE-Generator shifted by a special source, Y , it is possible to use a pattern generator similar to the one shown in Fig. 6(a). This will deliver a single ONE, followed by $(N-1)$ ZEROS.

CONCLUSIONS

All the basic circuits have been studied in some detail and many others have been built and tested at frequencies not exceeding 300 kc. This frequency is not in any sense an upper limit, but merely represents what has been done to date. Experimental results seem to indicate that the new logical technique is sound and highly practical. Work is in progress to apply the technique to a whole system in order to evaluate it more closely. The circuits presented in this paper are by no means the best, the most economical, or the only possible ones for solving these particular problems. The circuits shown serve only to illustrate the technique and show its possibilities, which are wide.

In conclusion, some of the advantages and limitations of the new all-core logical technique will be mentioned.

The advantages are:

1. The magnetic core has an exceptionally long life.
2. No tubes are required for amplification and reshaping.
3. The power level may be made quite low in an all-core system.
4. A high order of reliability is attained because only a few tubes are needed to power the system with shift pulses.
5. In some applications this type of circuitry shows greater flexibility than existing methods.
6. The core circuits operate at very low impedance level, hence they are comparatively free from pick-up and cross-talk.
7. The problem of timing stability does not exist. In fact, the rate of the clock pulses may vary at random. The only condition is that they do not exceed the maximum rate permitted for a given design.

The limitations are:

1. The maximum frequency of reliable core circuitry is, at present, limited to under one megacycle.
2. This technique, being sequential in nature, is not very suitable for parallel operation.
3. In some applications, particularly where a host of inputs are to be gated or buffered, the new logical scheme is not as flexible as some existing methods.

NOTE

The Boolean algebra and its symbolic notation also apply to core logic with one condition, however, that the coincidence in time be respected. The best way is to assign a symbol for each shift pulse (T_1, T_2, T_3 etc.) and use these symbols together with others to form a logical equation. Referring to Fig. 4(b) for example,

$$T_2 \cdot C = (T_1 \cdot A) \cdot (T_1 \cdot \bar{B}) = T_1 \cdot A \cdot \bar{B}$$

$$T_3 \cdot C = T_2 \cdot A \cdot \bar{B}.$$

In this way, mistakes are avoided in analyzing a more complex structure.

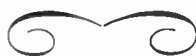

Pin-Hole Camera Investigation of Electron Beams*

C. C. CUTLER†, FELLOW, IRE AND J. A. SALOOM‡, ASSOCIATE, IRE

Summary—Electron beams produced by low- and moderate-perveance Pierce-type electron guns have been investigated by means of a pin-hole aperture. Data are presented showing the current density distribution and transverse velocity distribution of electrons at various points in the beam. The thermal velocity distribution is Maxwellian, with a width corresponding to the cathode temperature modified by the geometry of the flow. The transverse velocity distribution also reveals aberrations in the electron gun which has led to improved gun designs and a large improvement in the focusing of electron beams. The theoretical background for this work is given in a companion paper.¹

INTRODUCTION

IN SPITE OF the great progress in electron-beam type amplifiers (klystrons, traveling-wave tubes, etc.) in recent years, there is still much to be desired in the quality of high-density electron beams.

Most beam tubes now use a Pierce-type² of electron gun, which uses shaped electrodes to obtain a field distribution outside of the accelerated electron beam which matches the desired fields at the beam boundary. Several experimenters³ have made measurements on the electron beam emerging from such guns and have determined that in a broad sense the gun is performing as planned. However, the fact that the focusing of electron beams requires much more than the design value of magnetic field, and gives less than expected transmission, leads one to suspect that all is not perfect in electron guns.

The possible defects in electron focusing and flow can be roughly divided into two categories. We will call them geometric and non-geometric causes. Pierce⁴ has shown that for any given geometry- and space-charge-limited cathode emission, the electron trajectories are independent of voltage, provided the magnetic field is varied in accordance with $B \sim \sqrt{V}$. Thus we can differentiate between the two categories of defect. If the flow is controlled principally by the geometry (electrode configuration and applied fields, including space-charge effects), the beam trajectory will be independent of applied voltage (with appropriate scaling of the magnetic focusing field). Conversely, if we vary the applied potentials and magnetic fields in accordance with the above relation and get a large variation in transmission, we can be sure that there are important defects other than geometrical; such as thermal velocities, contact

potentials, parasitic magnetic fields, or electron interaction or oscillations.

Experience shows a large change of electron flow as a function of voltage,⁵ which means that there are certainly strong non-geometric defects in the focusing. The focusing at very high voltages is usually poor enough to lead one to believe that there also may be geometric defects to the flow.

Klemperer⁶ made measurements of the flow through a slit in front of a rectangular cathode which revealed a spread due to thermal velocities and some anomalous effects which he attributed to electron oscillations. His observations reveal a powerful method of approach, but are inconclusive as far as our stated problem is concerned, because of the different geometry, and the fact that he did not account for the effect of beam spreading on the thermal-velocity distribution.

BEAM ANALYSIS BY PIN-HOLE CAMERAS

In order to obtain a better picture of the initial flow conditions, several tubes were made which used a conventional electron gun followed by a pin-hole aperture and a current detector (Fig. 1, following page). In some cases the measurements were made using a sealed-off tube [Fig. 1(a)] and a fluorescent screen to indicate current density and direction.⁷ Alternatively a demountable, continuously-pumped structure as shown in Fig. 1(b) was used, and the current passing through the aperture was measured with a second movable aperture and a final collector. In either case we will refer to the plane of the current detection as the screen, and the current distribution at this plane as the image. By moving the first aperture through the beam one can measure the current density variation over the cross section. By also studying the image of the cathode in the detecting plane, one can determine a great deal about the initial transverse velocity distribution, and the flow geometry in the gun.

Ideally the flow in the gun would be laminar, and only the laminae passing through the aperture would reach the screen. This would excite a spot on the screen comparable to the size of the aperture with electrons from a similar size spot on the cathode. However, the existence of an initial thermal-velocity distribution permits electrons from a larger area to reach the aperture and create an inverted image of that area of the cathode on the fluorescent screen. The illumination of any point

* Original manuscript received by the IRE, October 25, 1954; revised manuscript received, December 2, 1954.

† Bell Telephone Laboratories, Murray Hill, N. J.

¹ C. C. Cutler and M. E. Hines, "Thermal velocity in electron guns," *Proc. I.R.E.*, p. 307; in this issue.

² J. R. Pierce, "Rectilinear flow in electron beams," *Jour. Appl. Phys.*, vol. 11, pp. 548-554; August, 1940.

³ L. M. Field, K. Spangenberg, and R. Helm, "Cathode design procedures for electron beam tubes," *Elec. Commun.*, vol. 24, pp. 101-107; March, 1947.

⁴ J. R. Pierce, "Theory and Design of Electron Beams," D. Van Nostrand Co., pp. 17, 19; 1949.

⁵ Electron flow meaning actual beam trajectory, which may or may not be indicated by beam transmission in a given tube.

⁶ O. Klemperer, "Influence of space charge on thermionic emission velocity," *Proc. Royal Soc. Lon.*, vol. 190, pp. 376-393; August, 1947.

⁷ Under the very low current densities at the screen, this light output is proportional to current.

in the image is proportional to the number of electrons leaving a corresponding point on the cathode and having the direction necessary to reach the aperture. If there is a sufficiently wide range of transverse velocities, the whole cathode may be seen and the edge clearly defined.

Since the aperture as a lens has no definite focal length, the image might be taken to represent the character of the beam at any transverse plane between the cathode and the aperture plate. We can use the gun-design parameters and space-charge equations to compute the image magnification between any beam cross section and the screen¹ and if the flow at all resembles the ideal, we can interpret the image in terms of the conditions within the gun.

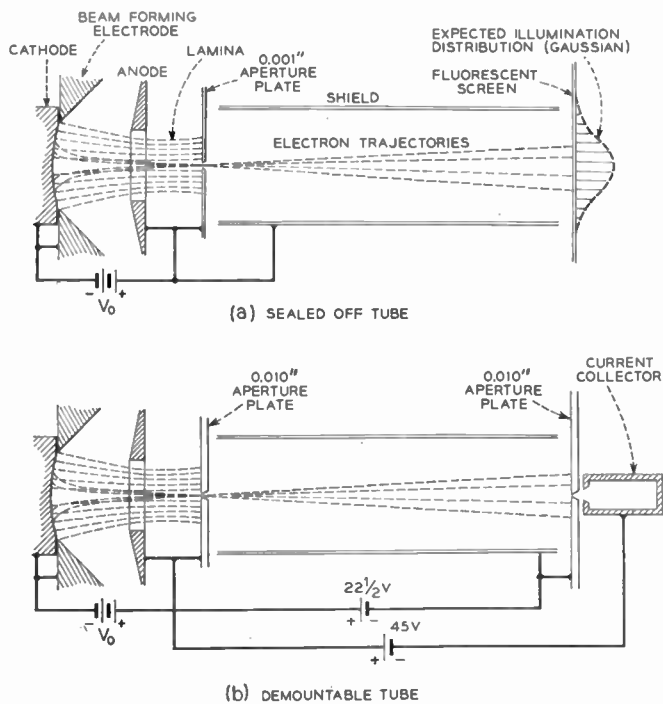

Fig. 1—Pin-hole camera tube. Case (a) uses a .001-inch diameter aperture and a fluorescent screen. Case (b) uses two .010-inch diameter aperture plates and a Faraday cage. By moving the aperture across the beam the density and lateral velocity distribution of electrons can be measured.

At the cathode the electrons might be expected to be distributed in velocity transverse to the direction of acceleration, according to the Maxwellian distribution.

$$dJ_c = \text{constant} \cdot e^{-m v_r^2 / 2kT} dv_c \tag{1}$$

It is shown in the companion paper that the velocity spread should increase in proportion to the increase in proportion to the decrease in beam radius as the beam converges. Using this and the geometry of the tube, we have at the plane of the image

$$dJ_i = \text{constant} \cdot e^{-(e/kT)V_0 M^2 (r_i/z_0)^2} dr_i \tag{2}$$

where V_0 = beam voltage (constant beyond gun anode), M = ratio of the beam radius at the aperture to the cathode radius. Other terms are defined at the end of the

paper. This relation should apply fairly well out to the edge of the image (determined by the cathode edges).

Thus we should get a Gaussian distribution of illumination out to the edge of the image, and the width of the distribution curve should correspond to the effective temperature of emission modified by the beam-convergence factor M .

The transverse velocity distribution in the beam may be modified by nonuniform emission density and aberrations in the flow. However, by moving the aperture through the beam we can sample different parts of the beam cross section and determine the current from any point on the cathode to any point in the aperture plane. From this we can deduce the transverse velocity distribution at any chosen point on the cathode. If the distribution is Gaussian, we even can dare to use it as an indication of effective temperature of the emitted electrons. From observations of this kind we can get a measure of how closely the electron flow approximates the design intentions and perhaps get a clue as to what degrades the electron flow.

Using a pin-hole camera tube, then, we would expect to see an inverted image of the cathode with a Gaussian shape of illumination or current density, perhaps deformed by nonuniformities in cathode emission or aberrations in the focussing. When the pin-hole aperture is moved across the beam, the bright region should move a proportional amount in the image and maintain the Gaussian distribution of illumination. By measuring the characteristics and position of the image, we should be able to determine the following:

1. Beam size at the aperture.
 - a. Density distribution over beam cross section.
 - b. Beam convergence factor M .
2. Beam spreading at the aperture.
 - a. Mean divergence from all causes.
 - b. Laminar divergence (of most nearly laminar components).
 - c. Divergence due to thermal velocities (effective beam temperature).
3. Transverse velocity distribution for electrons from any point in the cathode (translatable to effective emission temperature).
4. Beam density contribution of any point in the cathode to any point in the beam cross section at the aperture.

Departures from the predicted values should give a good measure of the gun's shortcomings.

EXPERIMENTAL OBSERVATIONS

Several convergent Pierce-type guns have been placed in the pin-hole camera structures described and the detailed focusing characteristics of the guns measured. In this paper two guns (Table I, page 301) will be used to illustrate the focusing characteristics observed.

Using the low perveance gun (No. 1), a series of photographs of the image on a fluorescent screen were

TABLE I

Gun No. 1 (Low perveance)	Gun No. 2 (medium perveance)
$V = 1,000$ volts	$V = 1,000$ volts
$I = 3.0$ ma	$I = 14.5$ ma
$r_c = .050$ inch	$r_c = .288$ inch
$r_{min} = .025$ inch	$r_{min} = .075$ inch
$\theta = 4$ degrees 5 minutes	$\theta = 13$ degrees

taken for different positions of the pinhole aperture, together with measurements of image deflection and total image current. As the pinhole is moved, the image itself moves, due to the diverging character of the initial beam flow at the aperture plane, and at the same time current passing through the pinhole changes due to the non-uniformity of current density in the beam. The current density and beam spreading are plotted as a function of aperture position in Fig. 2. The interpretation of the beam spreading data is a little involved.

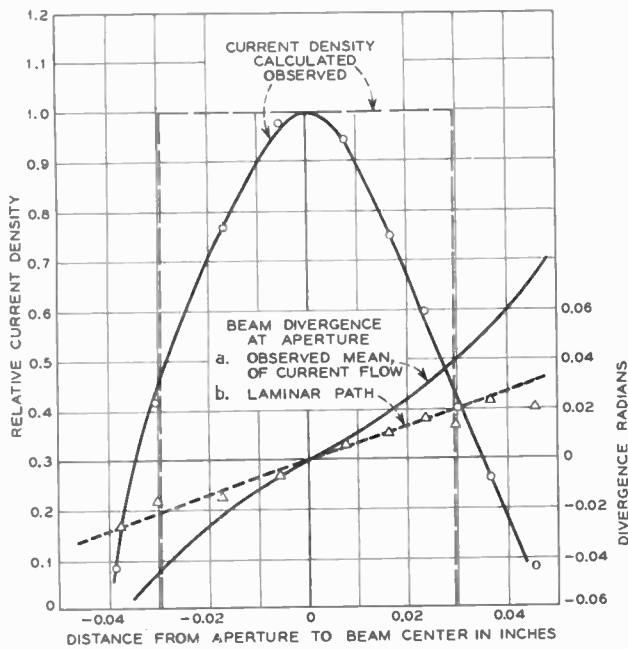

Fig. 2—Observation of current density and divergence in the beam of gun No. 1 (Table I). The points and solid lines give the measured data, the dashed lines are calculated for the design ideal.

If thermal velocities and other aberrations were negligibly small, the only point illuminated would be by laminar electrons and its position would be a good measure of the beam spreading. In presence of the other influences the laminar electrons are not so easily identified and we must trace them by other means. This can be done if the beam diameter is reasonably well defined at the aperture. A laminar electron will go from the aperture at r, ϕ to a point $(r/r_{max})R_{max}, \phi$ in the image, where r is the radial position of the aperture and R_{max} the image radius. Ideally this electron would come from a corresponding position $(r/r_{max})r_c$ in the cathode. To plot our data r_{max} was taken as the beam design radius at the aperture plane. The path so described is only known to be laminar at the plane of the

aperture and does not necessarily follow a laminar path through the electron gun. Ideally a laminar electron would arrive at the peak of a gaussian image distribution. Curve *b* gives the calculated angle of flow for the gun and beam used, taking account of gun characteristics and space charge, while the triangular points show the measured spreading of the laminar electrons at the aperture plane which checks the predicted flow very well. The other curve of beam spreading is the angle of the mean direction of current flow through the aperture as a function of aperture position and is the deflection of the “center of gravity” of the image illumination. This is a better measure of the actual flow and in this case is much greater than the predicted value. The difference between curves *a* and *b* is the excessive spreading at the measured cross section and, by measurement of the image, can be separated into the effect of thermal velocities and aberrations. In the present case both are serious, as we shall see.

A curve of current density vs r^2 was integrated to obtain the increase in density over that at the cathode, and this used as a measure of the effective beam magnification. This is very close to the design value ($M = .59$). Obviously, however, the density is far from uniform over the cross section, and the beam diameter is not sharply defined. Projecting the observed flow backwards we see that the mean convergence within the gun must be greater than the design value.

The image magnification for this tube (i.e., the ratio of the spot diameter to the cathode diameter) is almost exactly that calculated from the ideal case. The image of the cathode is strongly illuminated completely to the edge, however, and therefore is limited by the cathode size rather than by transverse velocities, as can be seen in Fig. 3(c). When the aperture is moved, the illumina-

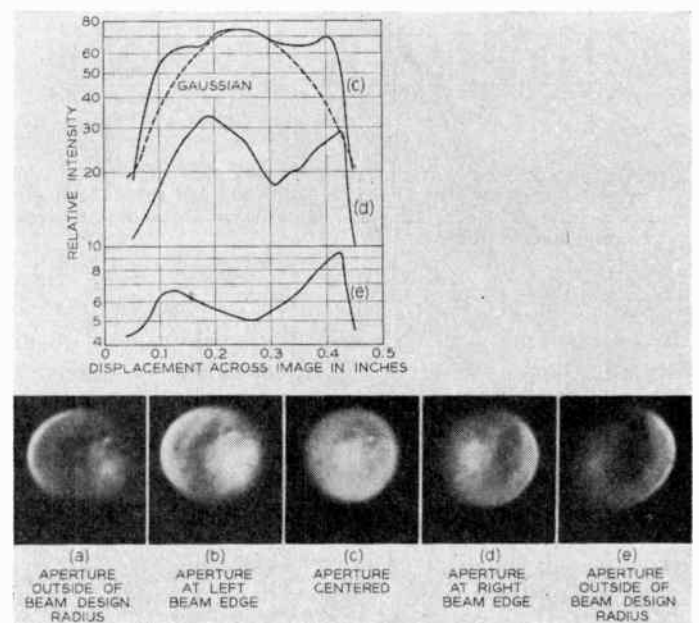

Fig. 3—Fluorescent screen images obtained from gun No. 1 in a pin-hole camera tube. The curves give the measured illumination of the corresponding image. Compare this with Fig. 7.

tion varies quite differently from that expected (see previous section). The edge of the image toward which the aperture is moved remains bright, whereas with proper flow it should become more dim. Also a bright region moves from the center toward the opposite edge of the image in roughly the proportion that the aperture is moved through the beam. When the aperture is outside of the nominal beam diameter, there is no evidence of the latter bright region, but the cathode edge (the wrong one) is still clearly defined. It is clear that the spread in transverse velocities is much greater than the Maxwellian distribution of (1).

If we assume the screen luminescence to be proportional to the current density of the impinging beam, we can get a quantitative measure of the current distribution in the images. Several photographs of the cathode image were taken with different exposures and were used to calibrate film density vs exposure. Densitometer measurements of the films give the light intensity distribution over the image as indicated in Fig. 3(c).

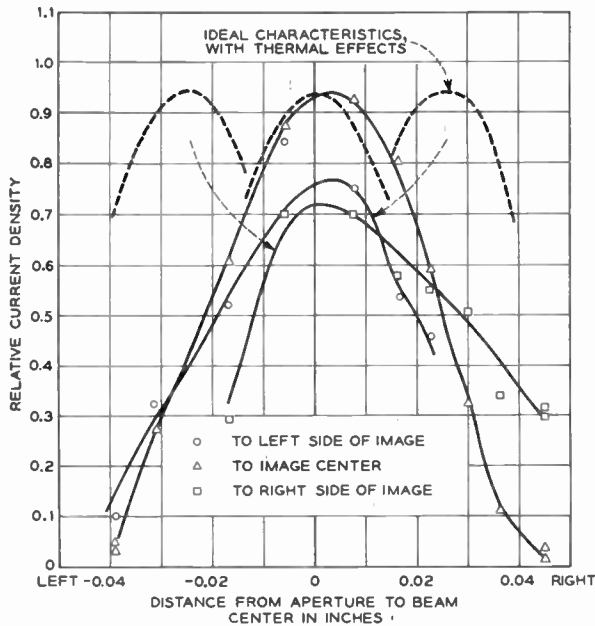

Fig. 4—Current density at given points in the image as a function of aperture position. An ideal gun, allowing for thermal effects, should give the dashed curves. The measured curves reveal excess beam convergence.

We can study the transverse velocity distribution in two ways. One is to measure the distribution of image illumination as in Fig. 3(c), and the other is to measure the illumination of a point in the image as a function of aperture position. Fig. 4 shows the current density at three points in the image as a function of aperture position. The current at one side of the image comes from the opposite side of the cathode, indicating a severe crossover in the electron flow.

It is helpful to plot current density vs transverse electron velocity at the aperture, for electrons from a fixed part of the cathode. We use as a zero velocity reference the position in the image corresponding to the

point which would be illuminated if we had the design conditions for ideal laminar flow. This point moves across the image in proportion to the motion of the aperture through the beam, while the current to the reference point in the image varies. Plotting the log of this current vs transverse velocity squared, thermal velocities would give a straight line, as in (2).

$$\text{Log } J_i = \text{const} \left(\frac{c}{kT} V_0 M^2 \frac{r_i^2}{z_i^2} \right). \quad (3)$$

shown as a dashed curve in Fig. 5. The points taken for the center of the image correspond closely to the theoretical curve, indicating that the transverse velocity distribution (or electron temperature) is near the calculated value.

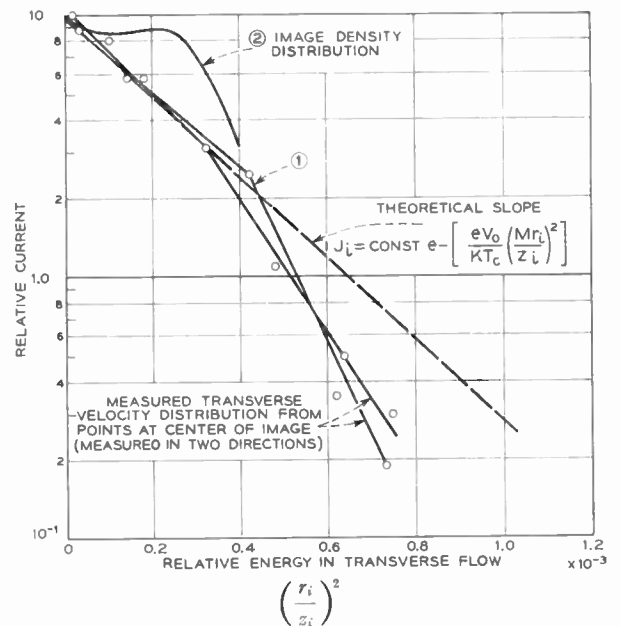

Fig. 5—Transverse velocity distribution. In Curve 1 is plotted the current arriving at the center of the image as a function of the aperture position (measured by laminar electron displacement in the image). Curve 2 is the distribution of image current density, and the dashed curve is the theoretical Maxwellian distribution which is predicted for either measurement for an ideal gun. Curve 2 reveals strong aberrations in the gun.

If we plot the curve of Fig. 3(c) on these coordinates, we get quite a different curve (curve 2 of Fig. 5) instead of the straight line velocity distribution, showing the serious effect of the gun aberrations.

The measurements described apply strictly only to the condition of the beam at the aperture. Of course the important question is: What does all this mean regarding the focusing conditions within the gun? Since the general flow conditions and image magnification are close to the calculated values, we feel reasonably safe in projecting electron paths backward through the pinhole to determine corresponding conditions at the cathode; and thus, we can be rather certain of the source of any particular nonuniformity. For instance, the bright edge (or ring) in the images of Fig. 3, if projected back to the anode aperture is still well within the

maximum beam radius. Therefore, it is not likely that it is caused by aberrations in this region. If we assume that the transverse velocity compared to any given lamina of the design ideal is constant, it projects almost exactly to the cathode edge. For this reason, we believe that the observed image does give a picture of conditions near the cathode. Thus Fig. 5, taking into account the convergence factor M , indicates a normal thermal velocity distribution at the cathode center and an excess velocity directed toward the beam axis of up to 0.6 volt near the edge of the cathode.

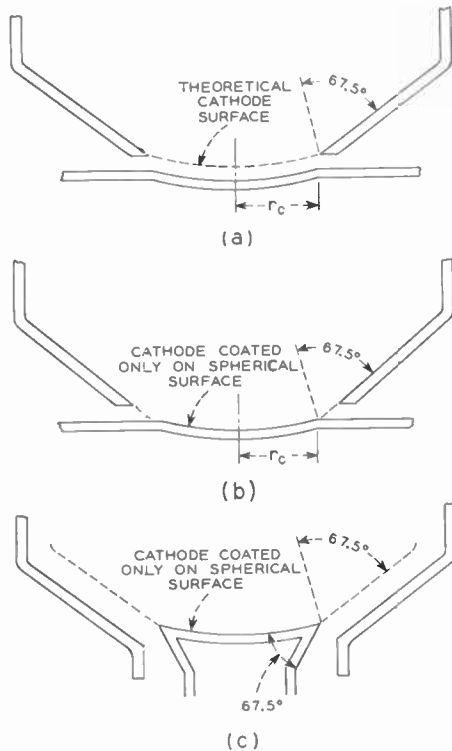

Fig. 6—Various beam-forming electrode designs providing for thermal and electrical insulation of the cathode. (a) Cathode is retracted from design position. (b) Beam-forming electrode is shaved off to clear the cathode. (c) A negative electrode is used to bring the cathode potential equipotential to the proper position.

In this gun the cathode was retracted from its design position by .002 inch to provide the necessary heat insulation from the beam-forming electrode [Fig. 6(a)]. Since voltage in the gun varies approximately as

$$V = \frac{V_0}{(z_0)^{4/3}} (z)^{4/3} = 4.8 \cdot 10^3 z^{4/3},$$

at 1,000 volts anode potential, the displacement of the beam forming electrode is equivalent to an error of about 1.2 volts. Thus it seems probable that the excess transverse velocities are caused by a mismatch of the boundary conditions at the cathode edge. This hypothesis is further verified by biasing the beam-forming electrode. A negative bias increases the edge intensity described and a positive bias reduces it, but does not correct it, for a sharp hair line remains, presumably caused by reflection of electrons from the edge of the beam-forming electrode.

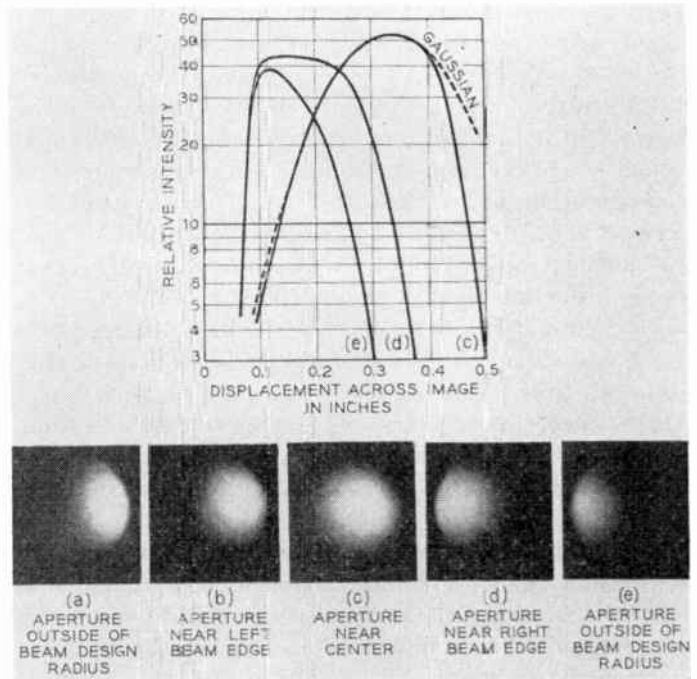

Fig. 7—Photographs of images from a gun having the same electrical design as gun No. 1, but using the negative beam-forming electrode design of Fig. 6(c). These pictures reveal no significant departure from the ideal.

IMPROVED ELECTRON GUN DESIGN

There are several ways one can approximate the cathode boundary conditions required in a Pierce-type electron gun. Ideally there should be a cathode potential surface extending away from the cathode edge making an angle of $67\frac{1}{2}$ degrees with the outside of the beam. In practice it is desirable to insulate this surface thermally and electrically from the cathode, and this is commonly done by retracting the hot cathode from a cathode potential electrode as shown in Fig. 6(a). An alternative is to remove part of the electrode as in Fig. 6(b), limiting the emitting material to a smaller diameter than the hole in the electrode. Another way is to use a specially shaped cathode and a negatively biased electrode as in Fig. 6(c).

In order to minimize the mismatch in the boundary conditions at the cathode edge, the electron gun of the previous measurements was redesigned, using a negative beam-forming electrode as indicated in Fig. 6(c). The boundary conditions at the edge of the cathode are met by using a 122.5-degree swept-back edge and an electrode shaped and biased to bring a 67.5 degree cathode equipotential to the cathode edge.

Fig. 7 shows a series of photographs of the image obtained from a pin-hole camera using this gun. It is evident that the flow is much closer to the ideal. This tube, however, gave about 20 per cent greater than the design current at the normal operating potential (1,000 volts). At first it was believed that contributions from the conical sides of the cathode might be responsible for this, but several tubes made with attempts to mini-

mize emission from this region also gave high perveance. It seems probable that the extra current is caused by the reduction of the space charge density within the gun due to thermal-velocity spreading of the beam, and that this is a natural consequence of thermal velocities. In the previous gun this effect was more than compensated for by the extra beam convergence described. This explanation is enforced by the fact that the current does not follow the $3/2$ power law of voltage but gives higher than predicted current at low voltages, approaching the design perveance at high voltages.

The arrangement indicated in Fig. 6(b) offers another solution. In this case the ideal boundary condition may not be met, but it is structurally more desirable than Fig. 6(c) and gave substantially the same performance, the thermal-velocity effects entirely masking any geometrical disturbance.

This design was used for gun No. 2 (Table I) and gave the beam cross section and transverse velocity distribution of Fig. 8. The transverse velocity distribution is Maxwellian, and increased in width over the distribution at the cathode. The magnitude of this increase corresponds to within 10 per cent of the theoretically predicted increase, provided the beam magnification is obtained from measured current density distribution.

is significantly larger than the design value. This is believed to be due to the approximate nature of the relationship used in accounting for the divergence of the exit-aperture lens. When the actual mean beam diameter is used, the thermal-velocity spreading calculated is very close to the measured value.

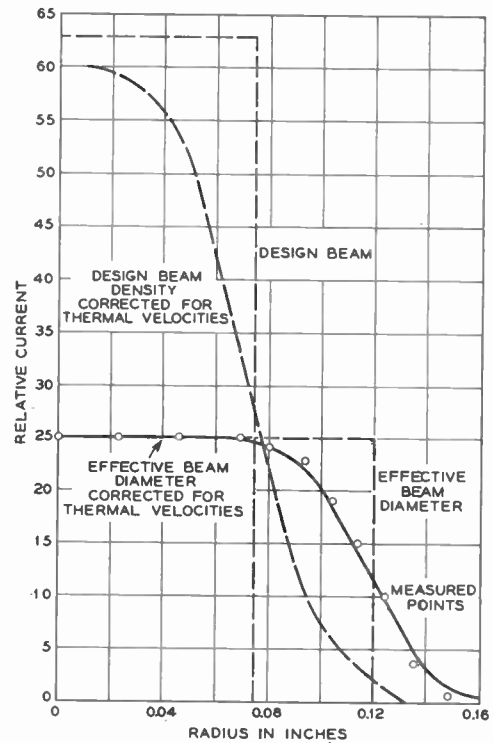

Fig. 9—Comparison of beam spread with calculated values for gun No. 2. The beam diameter is much greater than the design value, presumably due to the approximation involved in evaluating the exit lens. For the resulting beam size and density the thermal spreading is almost exactly the predicted value.

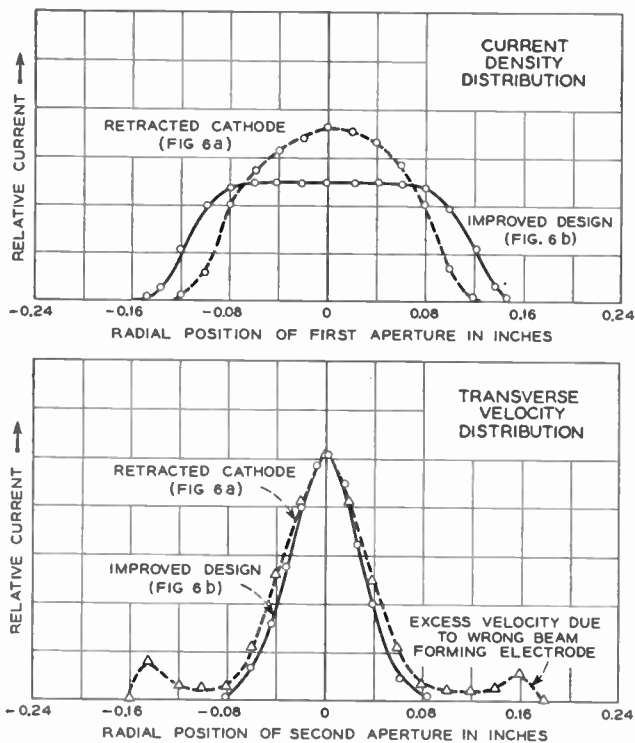

Fig. 8—Beam density and transverse-velocity distribution for gun No. 2, using the beam-forming electrode design of Fig. 6(b). The dashed curve is the result obtained with the design of Fig. 6(a).

It is to be expected that, besides determining the transverse velocity distribution, thermal effects would cause a widening of the beam and reduce the definition of the beam edge. A first order calculation of this is made in the companion paper,¹ giving for gun No. 2 the curve of Fig. 9. It is apparent that the beam diameter

OTHER GUN DEFECTS

In studying these guns several other defects were observed. The most common and obvious one is that of nonuniformity of cathode emission. This may be caused by poor cathode-coating adherence, granularity of the cathode surface, or deactivation of certain areas of the cathode by positive-ion bombardment. Tubes suffering from these troubles were photographed and the images are shown in Fig. 10 on the following page.

The non-emitting center area of Fig. 10(b) is usually seen as a tube approaches the end of its life and coincides with the development of a hole in the cathode through the coating and even into the base metal itself. The development of this spot very early in the life of the tube can be observed by cooling the cathode until the emission starts to be temperature-limited. To get a stable measurement of the effect of such a spot on focusing, the coating was deliberately removed from the center 7 per cent of the cathode area of gun No. 2, and the resulting beam measured. It is evident from Fig. 11 that an excess of inward velocity is developed, resulting in large cross over of electrons which must

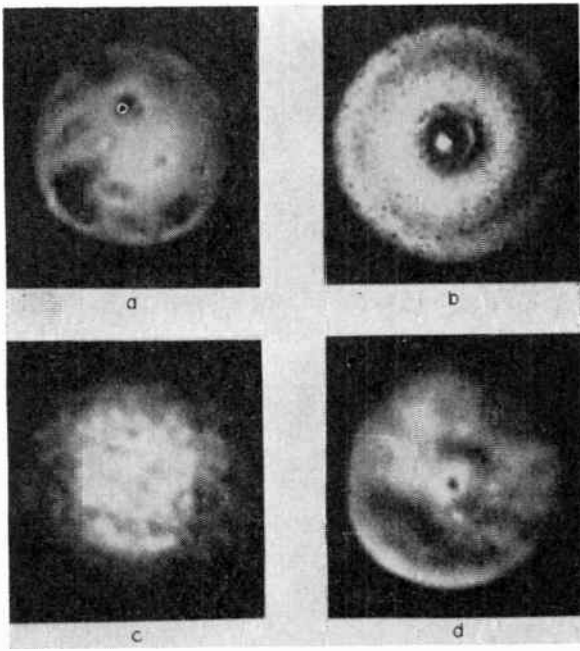

Fig. 10—Photographs of the images from several pin-hole camera tubes showing types of nonuniform emission. (a) Poor coating adherence. (b) Cathode with spot produced by back bombardment of positive ions. The ring is due to improper beam-forming electrode position. (c) Granularity of emitting surface (obtained by cooling the cathode of Fig. 7). (d) Image of cathode of Fig. 3 after 4,000 hours.

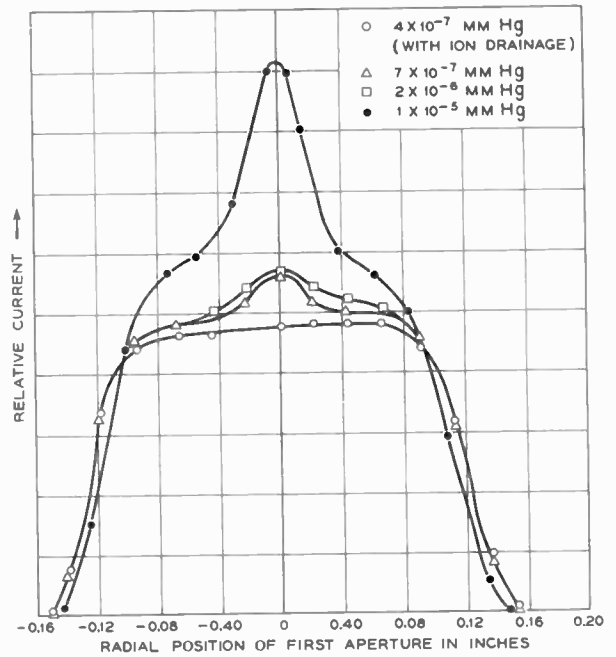

Fig. 12—Current-density distribution from gun No. 2 at various gas pressures, showing the effect of space-charge neutralization by positive ions.

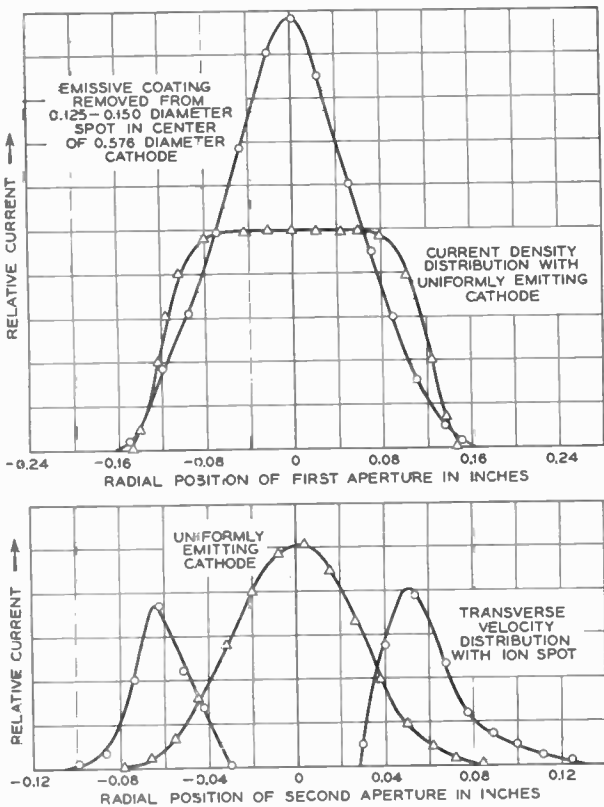

Fig. 11—Current density and velocity distribution of gun No. 2 with 7 per cent of emitting area at the cathode center removed to simulate an ion spot. Even though the beam appears to be more convergent in the gun, the anode interception was increased from 2 per cent to 14 per cent.

cause a degradation of focusing. The most obvious effect near the anode aperture is one of a peaking of the current due to the greater convergence. Note, however, that the current outside of a certain diameter actually is increased. As a result of this, the anode interception actually increased from 2 per cent to 14 per cent with the introduction of the inactive area.

EFFECT OF PRESSURE

The design of the Pierce electron gun also assumes a complete absence of positive ions in the beam. However, at pressures often considered good (10^{-7} – 10^{-8} mm Hg) sufficient ions are created to alter the space-charge conditions within the beam. To get a measure of the focusing properties of the gun in the absence of ionic effects, a special pulse technique was employed. The gun was pulsed with a 700-microsecond pulse at a 60-cycle repetition rate, and current measurements were made within the first 2–5 μ sec of the pulse. Comparing these measurements with the currents at the end of the pulse, or with the dc observations, a clear measure of the effect of positive ions is obtained. Alternatively it was found that ion effects could be removed by applying a slight longitudinal voltage gradient beyond the anode of the gun to prevent the accumulation of ions in this region.

Fig. 12 shows the current density distribution obtained at various pressures and also the current density distribution obtained in the absence of appreciable ionic effects. When the pressure is increased, it is noted that the current density distribution becomes peaked in the center and that the beam diameter is very slightly

reduced. These curves show clearly that the positive ions fall into the potential depression in the center of the beam and partially neutralize the electronic space charge of the beam, resulting in a further convergence of the electrons.

CONCLUSIONS

The pin-hole electron camera is a powerful tool with which to study gun aberrations and emission phenomena. The electron-gun studies described show some of the common defects in electron focusing. In particular they emphasize the importance of extreme care in locating the beam-forming electrode to avoid serious aberrations of the electrons emitted near the edge of the cathode. They also show that positive-ion bombardment of the cathode in higher perveance guns has serious consequences in the electron flow long before it seriously degrades the gun perveance. The presence of positive ions in the stream causes extra beam convergence and consequently, a greater transverse velocity distribution.

The transverse thermal-velocity distribution is a more fundamental limitation to the flow. The measurements show that converging the electron beam widens the transverse thermal-velocity distribution in a predictable fashion, simply due to the geometry of flow. It is also indicated that especially in low-perveance low-voltage guns, the thermal velocities widen the beam and increase the perveance. Measurements indicate that when other defects are eliminated, the diverging effect of the ungridded anode aperture is significantly greater than predicted by the approximate formula.

ACKNOWLEDGMENT

Credit is due to several of our colleagues at the Bell Telephone Laboratories for helpful advice and stimulation in this work; and especially to L. J. Heilos, F. Kras-tin, H. T. Closson, W. A. Warne, and G. J. Stiles for their assistance.

GLOSSARY OF SYMBOLS

i	Current density.
r	Radius measured in beam.
r_i	Radius measured in image.
v_c	Transverse velocity of electrons at any point at the cathode surface.
v_r	Radial velocity of electrons at r .
θ	Half-angle of convergence of electron guns.
ϕ	Angular direction.
e	Electron charge, 1.602×10^{-19} coulomb.
M	Beam convergence factor. M^2 is ratio of current density at cathode to that in beam.
m	Electron mass, 9.11×10^{-31} kilogram.
k	1.380×10^{-23} Joules/degree (Boltzman's constant).
T	Temperature, degrees Kelvin.
V_0	Voltage of anode, aperture, drift space and screen.
V_T	Voltage equivalent of transverse velocity.
I_0	Total current, amperes.
B	Magnetic field, gauss.
z	Distance measured from cathode, inches.
z_i	Separation between pinhole and image plane.
J_c	Current density in the z -direction at the cathode.
J_i	Current density in the image plane.



Thermal Velocity Effects in Electron Guns*

C. C. CUTLER†, FELLOW, IRE, AND M. E. HINES‡, MEMBER, IRE

Summary—A method is presented for determining the effect of the transverse velocities of electron emission on the flow in accelerated electron streams. Complete expressions are derived giving the degree and character of the beam spread in a Pierce-type electron gun resulting from the transverse velocity distribution, and an expression is derived for the image magnification in the pin-hole camera beam analyzer described in a companion paper.¹ The theory clearly shows the increase in effective (transverse) beam temperature caused by beam convergence.

I. INTRODUCTION

MODERN microwave tubes often require electron beams of small diameter and high current density. There are a number of factors which tend to limit the focusing in such beams, the most serious arising from the thermal-velocity distribution of the emitted electrons. It is common practice to use electron guns which converge the beam from a large cathode in order to obtain more current density than is available from practical emitters. This further accentuates the effect of the thermal velocities which ultimately limit the amount of convergence obtainable.

In this paper, a number of the effects of the thermal velocities of emission in a Pierce-type electron gun are treated theoretically. First, in Section II, a method is developed for determining the departure, caused by an initial transverse component of velocity of an electron from its ideal laminar path. This method is applied to the accelerating region, in an electron gun and in a field-free drift space under the influence of space charge. From this, in Section III, the beam spreading due to thermal velocities is determined, and the curves given make it easy to apply the results to any particular gun and beam dimensions. This concludes with the curves of Fig. 6 which show how the current density varies across the beam. The character of the variation is given in terms of the normal trajectory deviation σ which can be determined from the gun design parameters with the help of Fig. 5 in specific cases or through (32) in more general terms. Fig. 7 in turn gives the per cent current transmission within any radius, and Fig. 8 the current density contours for a specific case. A solution of uniform diameter focusing in a magnetic field for a beam dispersed by thermal velocities has been worked out by Pierce and Walker.² The solutions worked out in this paper, while similar in shape to the thermal distributions arrived at by these authors, do not constitute a solution to their boundary problem, nor is it clear that

such a solution exists. The value of their work is in predicting a limiting minimum perturbation due to thermal velocity effects in magnetically focused electron flow.

This approach was initially worked out in an effort to calculate the image magnification of the pin-hole camera, shown in Fig. 1 which is useful in experimental study of electron gun aberrations.¹ The results are readily applicable to this problem as shown in Section IV. Eq. (36) gives the image magnification in terms of the tube dimensions and gun design parameters, with the help of Figs. 2 and 3.

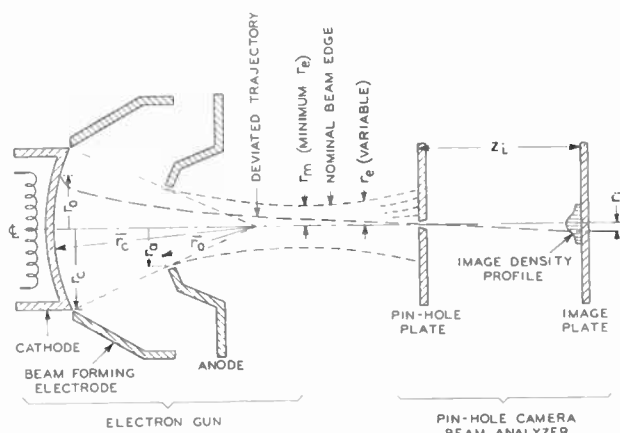

Fig. 1—Geometry of Pierce-type converging-electron gun and pin-hole camera beam analyzer.

A consequence of the convergence of an electron beam is an increase in the width of the transverse velocity distribution, the transverse velocities varying in inverse proportion with the beam diameter. A proof of this is inherent in the analysis, and it is shown in Section V that the apparent increase in velocity spread is simply a consequence of the geometry of the electron flow.

Partial verification of the conclusion is indicated by measurements presented in a companion paper.¹ The check appears to be reasonably close provided that an additional correction is made to account for the excess divergence resulting from the rather large hole in the anode apertures³ of the guns tested. Throughout the paper, MKS units will be used.

II. ELECTRON TRAJECTORIES

We shall be almost exclusively concerned with the converging type of Pierce electron gun illustrated in Fig. 1, though the development in (1) through (8) is

³ Pierce's design theory accounts for the anode aperture lens effect by use of the standard small-aperture formula for the focal length. This formula becomes somewhat inaccurate when the diameter of the aperture is an appreciable fraction of the cathode-anode spacing.

* Original manuscript received by the IRE, October 18, 1954; revised manuscript received December 2, 1954.

† Bell Telephone Laboratories, Murray Hill, N. J.

¹ C. C. Cutler and J. A. Saloom, "Pin-hole camera investigation of electron beams," *Proc. I.R.E.*, vol. 43, pp. 299-306; March, 1955.

² J. R. Pierce and L. R. Walker, "Brillouin Flow with Thermal Velocities," *Jour. Appl. Phys.*, vol. 24, pp. 1328-1330; October, 1953.

more general. The theory of this gun has been presented by Pierce⁴ for the limiting case of negligible initial electron velocities and small angles of convergence. The beam starts with space-charge limited flow from a cathode which is a concave section of a sphere. The anode electrode at high potential and the beam-forming electrode at cathode potential are so shaped that in the accelerating region the electric-field pattern within the beam matches as closely as possible the fields which would exist between complete concentric spherical electrodes with space-charge limited flow through the inter-electrode space.

In a practical gun, the anode is apertured for passage of the beam. The field pattern in the immediate vicinity of the aperture is assumed to act as an ideal thin diverging lens which causes the beam to be less convergent after passing through the aperture. Beyond the anode, it is assumed that the only fields acting are those resulting from the space charge of the beam itself. The space charge fields produce a radial repulsive force which prevents the beam from achieving a point focus. Instead, the beam converges to a minimum diameter beyond the anode and then diverges again. It is common practice in electron tubes to inject the beam into a uniform parallel magnetic field at a point near its minimum diameter in an attempt to focus the beam in the uniform-diameter "Brillouin Flow" condition.⁵

In the gun design theory of Pierce, the electron flow is assumed to be essentially laminar in character with no crossing of paths. We assume this for all electrons except the one whose trajectory across normal paths we wish to determine. The paraxial-ray assumptions made in dealing with the flow are: (1) all angles of convergence and divergence of laminar flow lines are small, (2) longitudinal electric fields are uniform over a given cross section of the beam, (3) all radial fields are proportional to the radius from the axis. As a consequence of these assumptions, radial velocities of the laminar flow electrons are proportional to the radius from the axis, and the axial velocities are uniform over a given cross section.

It is useful to employ a radial coordinate μ which varies from zero on the beam axis to unity at the beam edge. Electrons with zero initial velocity follow paths of constant μ . Let r_e be the variable radius of the edge of the beam ($\mu = 1$) and r be the actual radial position of a particular electron crossing the surfaces of constant μ , where r as a function of the axial coordinate z would describe the path of the wandering electron. We write

$$r = \mu r_e. \quad (1)$$

Differentiating twice gives

$$\frac{d^2 r}{dt^2} = r_e \frac{d^2 \mu}{dt^2} + 2 \frac{d\mu}{dt} \frac{dr_e}{dt} + \mu \frac{d^2 r_e}{dt^2}. \quad (2)$$

By the paraxial ray assumption (item 3 above),

$$\frac{d^2 r}{dt^2} = \mu \frac{d^2 r_e}{dt^2}; \quad (3)$$

therefore,

$$r_e \frac{d^2 \mu}{dt^2} = -2 \frac{dr_e}{dt} \frac{d\mu}{dt}. \quad (4)$$

Rearranging terms results in

$$\frac{d\left(\frac{d\mu}{dt}\right)}{\frac{d\mu}{dt}} = -2 \frac{dr_e}{r_e}. \quad (5)$$

A single integration gives

$$\ln \frac{d\mu}{dt} = -\ln r_e^2 + \ln r_{e1}^2 + \ln \left(\frac{d\mu}{dt}\right)_1, \quad (6)$$

where the subscript 1 indicates the value at any given cross-section plane. In general we will later refer to the cathode and anode plane s by c and a , respectively. Taking antilogarithms gives

$$\frac{d\mu}{dt} = \left(\frac{d\mu}{dt}\right)_1 \frac{r_{e1}^2}{r_e^2}. \quad (7)$$

A second integration gives

$$\mu - \mu_1 = \left(\frac{d\mu}{dt}\right)_1 \int_{t_1}^t \frac{dt}{\left(\frac{r_e}{r_{e1}}\right)^2}. \quad (8)$$

This is the fundamental equation for thermal trajectory tracing. The integral on the right involves terms which are presumably known for the ideal laminar trajectories. It is apparent that if space-charge forces are appreciable, the actual trajectories must approximate the ideal in order to justify the above derivation. It should be noted that all the above equations apply for any geometry for which the listed assumptions are valid.

Trajectories in the Accelerating Region of a Pierce Gun

The integral of (8) is to be taken from the cathode through the accelerating region of the gun and beyond to any point in the beam-spread region desired. That portion of the integral for the region of acceleration is taken up in this section. For this region the limits of the integration are t_c and t_a , respectively, c referring to values at the cathode, and a to values at the anode aperture.

Langmuir's expression for the space charge limited current in a complete spherical diode is

$$I = \frac{16\pi\epsilon\sqrt{2n} V^{3/2}}{9(-\alpha)^2}; \quad (9)$$

where $(-\alpha)^2$ is a tabulated function⁶ of the ratio of the

⁶ *Ibid.*, p. 183.

⁴ J. R. Pierce, "Theory and Design of Electron Beams," 2nd. ed., D. Van Nostrand Company, pp. 173-193; 1954.

⁵ *Ibid.*, pp. 152-157.

spherical cathode to anode radii, and $\eta = e/m$ of the electron. V is the potential difference between the cathode and anode, and ϵ is the dielectric constant of free space (see Glossary of Symbols). For a conical section of a sphere as used in a Pierce gun of half-angle θ , the beam current I_0 is given by

$$I_0 = \frac{16\pi\epsilon\sqrt{2\eta} V^{3/2} \sin^2\left(\frac{\theta}{2}\right)}{9(-\alpha)^2} \quad (10)$$

Eqs. (9) and (10) apply for any ratio of radii. If one assumes the current to be constant, these equations may be used to define the variation of potential with distance from the cathode surface in terms of the function $(-\alpha)^2$. Thus,

$$V = V_a \frac{(-\alpha)^{4/3}}{(-\alpha_a)^{4/3}} \quad (11)$$

where a indicates values at the anode. In an increment of time dt , an electron will move a distance $d\bar{r}$ at a velocity $\sqrt{2\eta V}$, or

$$dt = -\frac{d\bar{r}}{\sqrt{2\eta V}} = -\frac{\bar{r}_c(-\alpha_a)^{2/3}d\left(\frac{\bar{r}}{\bar{r}_c}\right)}{\sqrt{2\eta V_a}(-\alpha)^{2/3}}, \quad (12)$$

where \bar{r}_c is the radius of curvature of the cathode and \bar{r} is the variable distance from the same center. Substituting into the integral of (8) and referring to the cathode ($r_{e1} = r_c$), we obtain

$$\int_{t_c}^{t_a} \frac{dt}{\left(\frac{r_e}{r_c}\right)^2} = -\frac{\bar{r}_c(-\alpha_a)^{2/3}}{\sqrt{2\eta V_a}} \int_1^{\bar{r}_a/\bar{r}_c} \frac{d\left(\frac{\bar{r}}{\bar{r}_c}\right)}{\left(\frac{r_c}{r_e}\right)^2(-\alpha)^{2/3}} \quad (13)$$

Substituting \bar{r}/\bar{r}_c for r_e/r_c (which follows from radial flow) and inverting the variable of integration simplifies the expression, yielding

$$\int_{t_c}^{t_a} \frac{dt}{\left(\frac{r_e}{r_c}\right)^2} = \frac{\bar{r}_c(-\alpha_a)^{2/3}}{\sqrt{2\eta V_a}} \int_1^{\bar{r}_c/\bar{r}_a} \frac{d\left(\frac{\bar{r}_c}{\bar{r}}\right)}{(-\alpha)^{2/3}} \quad (14)$$

Fig. 2 shows a plot of the right-hand integral as a function of the upper limit. From (8) and (14) we can determine the trajectory within the accelerating region of the gun for an electron with a given initial transverse velocity. We shall apply this to the beam spread problem in Section III.

Trajectories in a Drift Region

In the drift region beyond the anode aperture, the beam diameter varies under the influence of the diverg-

ing forces of the space charge within the beam. For the case of a shielded beam of slowly varying diameter, we may approximate by using the equations applicable for cylindrical geometry,⁷

$$\frac{1}{\eta} \frac{d^2 r_e}{dt^2} = \text{Radial field strength} = \frac{\rho}{2\pi\epsilon r_e},$$

where ρ is the linear charge density in coulombs per meter of length. In terms of the beam current and voltage this becomes

$$\frac{d^2 r_e}{dt^2} = \frac{\eta I_b}{2\pi\epsilon r_e \sqrt{2\eta V_a}} \quad (15)$$

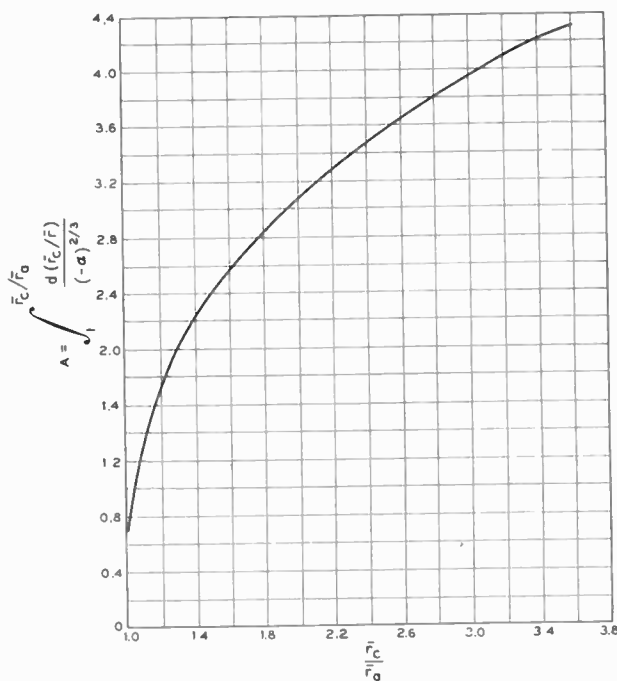

Fig. 2—A curve useful in calculating electron trajectories in the accelerating region of Pierce-type electron guns.

Substituting for I_b from (10), and assuming θ to be small so that we may approximate the sine of an angle by the angle we obtain,

$$\frac{d^2 r_e}{dt^2} = \frac{2\eta V_a \bar{r}_c^2}{9(-\alpha_a)^2 \bar{r}_c^2 r_e} \frac{1}{r_e} \quad (16)$$

This equation may be put into integrable form by substituting

$$\omega = \frac{dr_e}{dt}, \quad \omega \frac{d\omega}{dr_e} = \frac{d^2 r_e}{dt^2}$$

Integrating in this manner gives:

$$\omega = \frac{dr_e}{dt} = \pm \frac{\sqrt{2}\sqrt{2\eta V_a}}{3(-\alpha_a)} \frac{r_c}{\bar{r}_c} \left(\ln \frac{r_e}{r_m}\right)^{1/2}, \quad (17)$$

which includes the boundary condition that dr_e/dt is

⁷ *Ibid.*, p. 147.

zero at the minimum beam radius r_m . The plus sign applies for a diverging beam and the minus sign for a converging beam. The second part of the integral for (8) covering the drift region, is therefore

$$\int_{t_a}^t \frac{dt}{\left(\frac{r_c}{r_e}\right)^2} = \bar{r}_c \frac{r_c}{r_m} \left(\frac{3(-\alpha_a)}{\sqrt{2}\sqrt{2\eta V_a}} \right) \cdot \int_{r_a/r_m}^{r_e/r_m} \frac{\pm d\left(\frac{r_e}{r_m}\right)}{\left(\frac{r_c}{r_m}\right)^2 \left(\ln \frac{r_e}{r_m}\right)^{1/2}} \quad (18)$$

We may change the variable of integration to u , defined by

$$\frac{r_e}{r_m} = e^{u^2}, \quad (19)$$

which yields

$$\int_{t_a}^t \frac{dt}{\left(\frac{r_c}{r_e}\right)^2} = 3\bar{r}_c \frac{r_c}{r_m} \frac{\sqrt{\frac{\pi}{2}(-\alpha_a)^2}}{\sqrt{2\eta V_a}} \cdot \left[\frac{2}{\sqrt{\pi}} \int_0^{\sqrt{\ln r_a/r_m}} e^{-u^2} du \pm \frac{2}{\sqrt{\pi}} \int_0^{\sqrt{\ln r_e/r_m}} e^{-u^2} du \right] \\ = 3\bar{r}_c \frac{r_c}{r_m} \frac{\sqrt{\frac{\pi}{2}(-\alpha_a)^2}}{\sqrt{2\eta V_a}} \cdot \left\{ \operatorname{erf} \sqrt{\ln(r_a/r_m)} \pm \operatorname{erf} \sqrt{\ln(r_e/r_m)} \right\}. \quad (20)$$

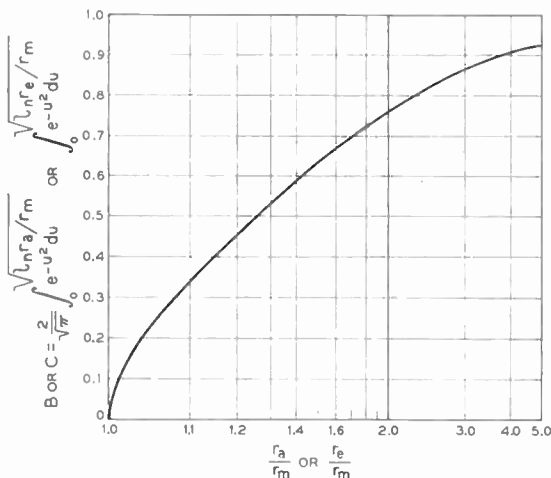

Fig. 3—A curve useful in calculating beam divergence in a drift region.

This completes the integral of (8). The plus sign applies for points beyond the beam minimum and the minus sign for points before the beam minimum is reached. Values of the error functions are given for convenience in Fig. 3. The value of r_e as a function of distance can be

obtained from the gun design data and the universal beam spread curve.⁸

Complete Trajectory, Gun Plus Drift Region

We are now in a position to write the complete expression for the trajectory deviation of an electron which has a known initial transverse velocity and which remains within the beam. From (1) and (8) it is apparent that an electron will deviate from its nominal position by an amount Δr , given by

$$\Delta r = \left(\frac{dr}{dt}\right)_c \frac{r_e}{r_c} \int_{t_c}^t \frac{dt}{\left(\frac{r_e}{r_c}\right)^2} \quad (21)$$

Assembling the integral from (14) and (20), we have

$$\frac{\Delta r}{\left(\frac{dr}{dt}\right)_c} = \frac{\bar{r}_c}{\sqrt{2\eta V_a}} \left[\frac{r_c}{r_e} (-\alpha_a)^{2/3} \int_1^{\bar{r}_c/\bar{r}_a} \frac{d\left(\frac{\bar{r}_c}{\bar{r}}\right)}{(-\alpha)^{2/3}} + 3 \frac{r_e}{r_m} \sqrt{\frac{\pi}{2}(-\alpha_a)^2} \left(\operatorname{erf} \sqrt{\ln \frac{r_a}{r_m}} \pm \operatorname{erf} \sqrt{\ln \frac{r_e}{r_m}} \right) \right]. \quad (22)$$

An electron starting with an initial transverse velocity $(dr/dt)_c$ at the cathode, will arrive at a later point, removed from the line of laminar flow by a distance Δr given by (22). The positive sign in this expression should be taken if the cross section of interest is beyond the minimum beam diameter of the space-charge beam-spread curve, and the negative sign in case the plane of interest comes before the plane of the minimum beam diameter.

This equation is complete for a single electron. The integral and the erf functions are evaluated in Figs. 2 and 3. We apply it to the case of many electrons under the influence of thermal velocities in the next section, and discuss its evaluation further at the end of that section.

III. THERMAL VELOCITY BEAM SPREADING

The theory of the preceding section applies to a single wandering electron which remains within an otherwise ideally focused beam. Though the theory was applied to the case of an initial transverse velocity in the radial direction only, it may also be shown to apply for off-axis electrons with initial velocities in any transverse direction. This is a consequence of the linear character of the variation of the radial fields with radius under the paraxial-ray assumption. For axially symmetric systems in which $E_r = ar$ it is fully equivalent to write $E_x = ax$ and $E_y = ay$ in a Cartesian co-ordinate. Thus in (1) through (8) we could replace r by x or y and μ by

⁸ *Ibid.*, p. 150.

μ_x or μ_y with full validity. This may be carried through to (21). Thus the magnitude of our deflection is independent of the direction of the initial velocity. The theory is only approximate for an electron which leaves the nominal beam boundary. To obtain the effect on the over-all beam we assume that each electron moves independently as calculated in the field of an ideal beam, and then we sum the effect of all electrons. If the beam is appreciably spread by these effects or becomes distorted by other aberrations, considerable error may result. Nevertheless, the theory does provide a first-order calculation of beam spreading due to thermal velocities which should be reasonably accurate unless the effect is very large. It should be noted that usually we are most concerned with the distribution of electrons outside of the nominal beam boundary and that the inaccuracies of our theory for these electrons are in the direction of predicting greater trajectory deviations than should actually occur in practice.

A Maxwellian distribution of the transverse velocities is assumed for the emitted electrons. The transverse components of the velocity distribution are specified by the relation

$$dJ_c = J_c \frac{m}{2\pi kT} e^{-(mv_x^2/2kT) - (mv_y^2/2kT)} dv_x dv_y; \quad (23)$$

where J_c is the current density in the z -direction at the cathode surface, T is the cathode temperature in degrees Kelvin, m is the mass of the electrons, and k is Boltzmann's constant.

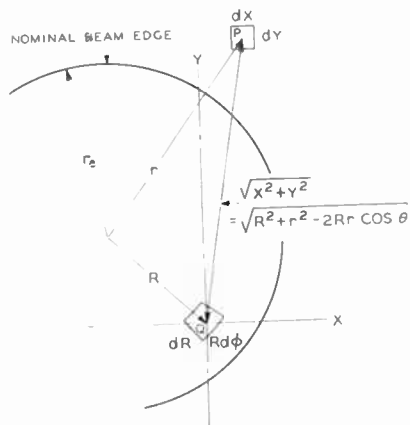

Fig. 4—Geometry for calculation of the beam spread caused by thermal velocities.

Fig. 4 shows the geometry we are considering at a cross-section of the beam an arbitrary distance from the cathode. A current element nominally expected to arrive at Q will be distributed in a symmetrical zone around Q and some of this current will arrive at the point of interest P . This point is at a radius r from the center of the beam and the beam would have a radius r_e in the absence of thermal velocities.

It is convenient at this point to define a normal deviation σ where

$$\sigma = \frac{\Delta r}{\left(\frac{dr}{dt}\right)_c} \sqrt{\frac{kT}{m}}, \quad (24)$$

in which Δr is the trajectory deviation of an electron with an initial transverse velocity $(dr/dt)_c$. It follows that

$$\sigma = \frac{\Delta r}{\left(\frac{dr}{dt}\right)_c} \sqrt{\frac{kT}{m}} = \frac{x}{v_x} \sqrt{\frac{kT}{m}} = \frac{y}{v_y} \sqrt{\frac{kT}{m}}, \quad (25)$$

where x and y are distances of deviation as shown in Fig. 4 and $\Delta r/(dr/dt)_c$ can be evaluated from (22). [See (32).]

Referring to Fig. 4, that part of the current dI_p which in the absence of thermal velocities would fall in the area $dx dy$ at P is given by substituting x, y , and σ into (23).

$$dI_p = \frac{J_0 R dR d\phi}{2\pi} e^{-(x^2+y^2)/2\sigma^2} d\left(\frac{x}{\sigma}\right) d\left(\frac{y}{\sigma}\right), \quad (26)$$

where J_0 is the current density in the beam in the absence of thermal effects. That part of the current density at P from the area at Q is given by

$$dJ_p = \frac{dI_p}{dx dy} = \frac{J_0}{2\pi\sigma^2} e^{-(x^2+y^2)/2\sigma^2} R dR d\phi. \quad (27)$$

To integrate this expression, we eliminate x and y by the law of cosines,⁹

$$x^2 + y^2 = R^2 + r^2 - 2Rr \cos \phi. \quad (28)$$

The total current density at P is determined by integrating over the area of the nominal beam circle. That is,

$$J_p = \frac{J_0}{2\pi\sigma^2} e^{-r^2/2\sigma^2} \int_0^{r_e} R e^{-R^2/2\sigma^2} dR \int_0^{2\pi} e^{+(Rr \cos \phi)/\sigma^2} d\phi. \quad (29)$$

The second integral in (29) may be identified as a representation of the modified Bessel function

$$\int_0^{2\pi} e^{(Rr \cos \phi)/\sigma^2} d\phi = 2\pi I_0 \left(\frac{rR}{\sigma^2}\right). \quad (30)$$

Thus we get, for the ratio of the expected current density J at radius r to the idealized current density J_0 ,

$$\frac{J_r}{J_0} = e^{-r^2/2\sigma^2} \int_0^{r_e/\sigma} \left(\frac{R}{\sigma}\right) e^{-R^2/2\sigma^2} I_0 \left(\frac{rR}{\sigma^2}\right) d\left(\frac{R}{\sigma}\right). \quad (31)$$

This is the relationship we have been working for. It gives the ratio of the beam-current density to the idealized value in terms of the beam radius and the position in the beam, and of parameter σ which can be obtained from the gun-design parameters. From (22) and (24)

⁹ This method of integration was suggested by W. E. Danielson of the Bell Telephone Laboratories.

$$\sigma = \sqrt{\frac{kT}{m}} \frac{\bar{r}_c}{\sqrt{2\eta V_a}} \left[\frac{r_e}{r_c} (-\alpha_a)^{2/3} A + 3 \frac{r_e}{r_m} \sqrt{\frac{\pi}{2}} (-\alpha_a)^2 (B \pm C) \right], \quad (32)$$

or

$$\frac{r_e}{\sigma} = \frac{1}{\sqrt{\frac{kT}{2eV_a}} \frac{\sin \theta}{(-\alpha_a)^{2/3} A + 3 \frac{r_c}{r_m} \sqrt{\frac{\pi}{2}} (-\alpha_a)^2 (B \pm C)}}; \quad (33)$$

where A , B , and C are defined and plotted in Figs. 2 and 3. In (32) the minus sign is to be taken for points between the anode and the point of minimum beam diameter, and the plus sign is to be taken for points beyond.

In the Pierce gun-design theory, the degree of beam compression (r_m/r_c) depends only upon the ratio of the cathode and anode radii of curvature (\bar{r}_c/\bar{r}_a).¹⁰ For the position at the nominal minimum beam diameter ($r_e=r_m$), and also at the anode aperture ($r_e=r_a$), the bracketed expression in (32) is a function of the ratio \bar{r}_c/\bar{r}_a only, and the equation can be solved to give the simple relation plotted in Fig. 5. It should be noted that for guns with fairly large angles (θ) of convergence, or wherein the anode aperture compares in size with the cathode-anode spacing, values of r_m/r_c may differ somewhat from that given by the design curve of Pierce because of second-order lens effects at the aperture. In

¹⁰ *Ibid.*, p. 188, Figs. 10 and 12.

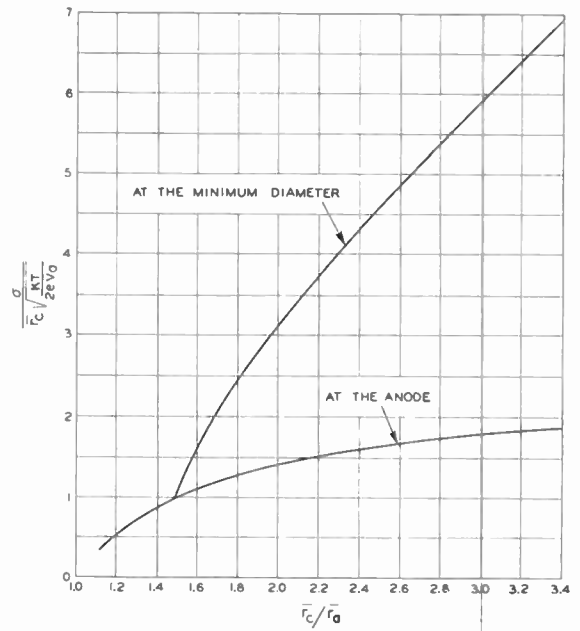

Fig. 5—Curves showing the transverse displacement of electron trajectories in Pierce-type guns. These curves may be interpreted as giving the normal displacement σ for a known value of cathode temperature.

such cases, (32) still may be calculated provided that the correct strength of the exit lens can be determined, and from this the value and position of r_m .¹¹

Eq. (31) has been evaluated by numerical integration, and gives a family of functions (Fig. 6) of normalized radius r/r_e for various values of r_e/σ . In turn,

¹¹ It is pointed out in the companion paper that this effect was large in some of the guns tested.

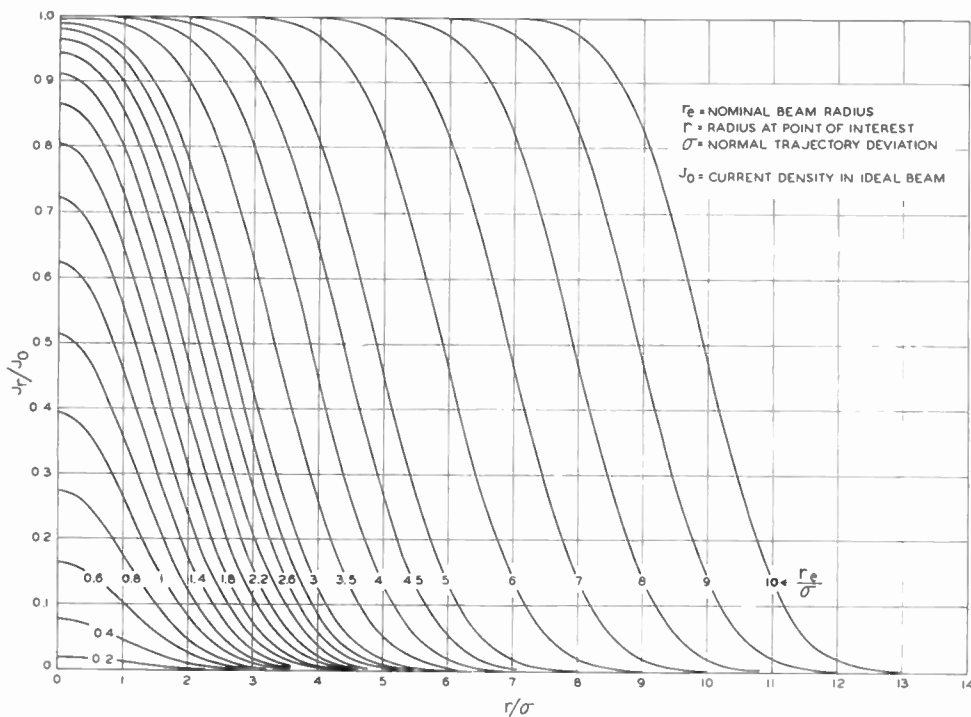

Fig. 6—Curves showing the character of the current density variation with radius in a beam which has been dispersed by thermal velocities. Here r_e is the nominal beam radius, r is the radius variable, and σ is the standard deviation defined in (38) and given in Fig. 4 for two specific positions.

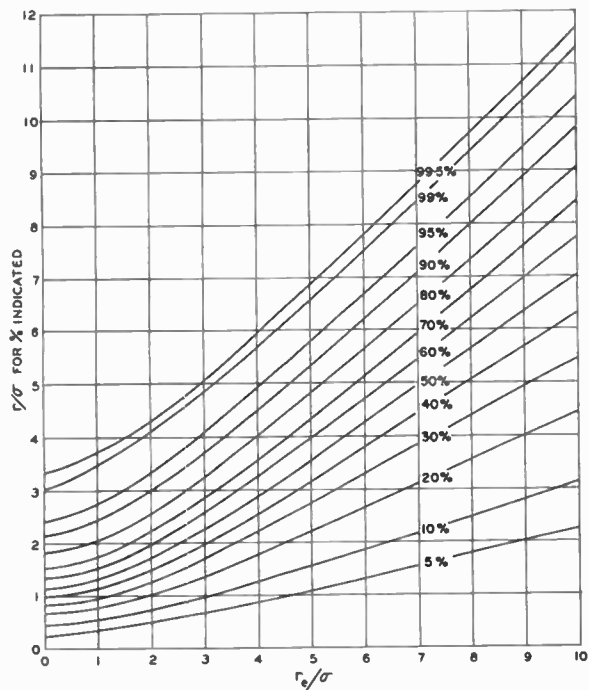

Fig. 7—Curves showing the per cent of the total beam current to be found within any given radius in a beam dispersed by thermal velocities as in Fig. 6.

Fig. 7 shows the normalized radius r/σ as a function of r_e/σ for various percentages of the total enclosed.

Fig. 8 shows how this theory predicts the variation in the current density profile of a beam with distance from the anode for a particular case. Profiles of current density vs radius are shown at a number of different points along the beam. The curve marked "Idealized Radius" is that predicted by Pierce's gun theory. The other curve shows the radius enclosing 99 per cent of

the current as predicted by this theory. An important consequence to be noted is that the diameter enclosing 99 per cent of the current reaches a minimum at a point somewhat closer to the anode than the normal beam spread curve predicts.

IV. IMAGE MAGNIFICATION OF THE PIN-HOLE CAMERA TUBE

In the "pin-hole camera" beam analyzer described by Cutler and Saloom¹ the geometry is as shown in Fig. 1. An apertured plate with a single pin hole intercepts all but a very tiny part of the beam. The electrons, which pass, spread out according to the transverse velocity distribution and produce a kind of image on the back plate. Theoretically, electrons arriving at any point in the image must have come from a particular corresponding point on the cathode, and must have started at just the right transverse velocity to bring them to the aperture. Under our idealized conditions, we would expect a complete image of the cathode but not a uniformly illuminated one. Instead, we would expect a Gaussian distribution of image intensity with a maximum corresponding to the point on the cathode from which electrons with zero initial velocity would pass the aperture. In some cases, noted experimentally by Cutler and Saloom, the Gaussian distribution falls off so rapidly that the edge of the cathode is not detectable. This is to be expected in fairly wide-angle guns of low compression. In other cases, they noted marked distortions of the expected Gaussian distribution which were caused by improper geometry or spotty cathode emission. Interpretation of such a distorted image requires a knowledge of the cathode-to-image magnification of the pin-hole camera.

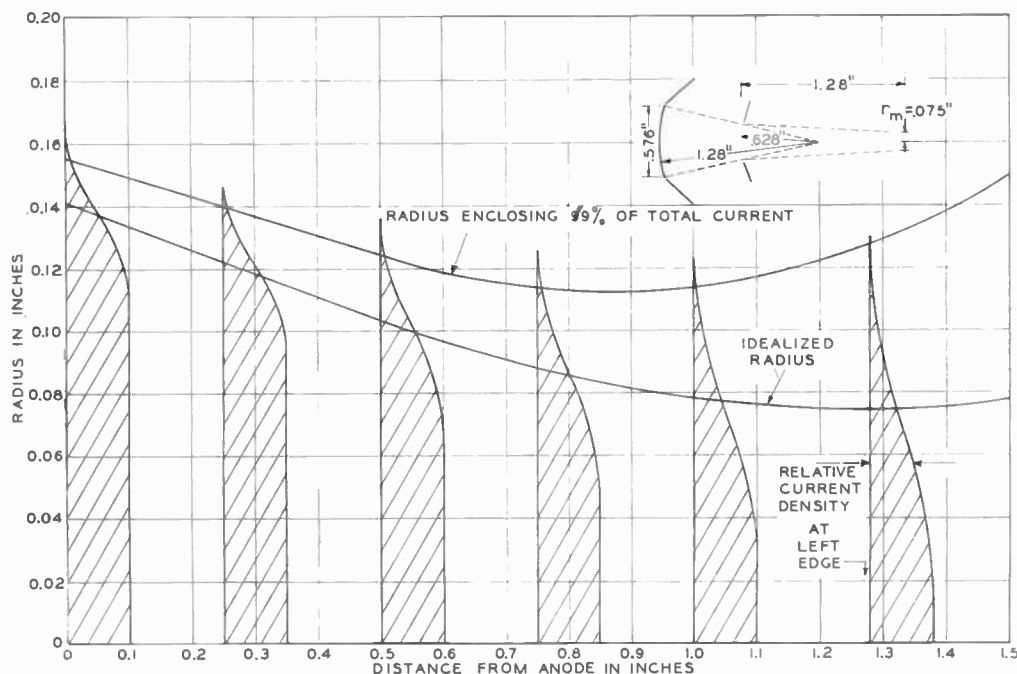

Fig. 8—Curves showing how the current density profile across the beam varies with distance from the anode for the particular gun geometry shown at an anode potential of 1,000 volts and a cathode temperature of 830 degrees C.

Referring to Fig. 1, it is apparent that the image height r_i is given by

$$r_i = Z_i \frac{\left(\frac{dr}{dt}\right)_{ph}}{\left(\frac{dz}{dt}\right)_{ph}} = Z_i \frac{\left(r_e \frac{d\mu}{dt}\right)_{ph}}{\sqrt{2\eta V_a}}, \quad (34)$$

where *ph* refers to values at the pin-hole plane. We can write for the object height r_0 ,

$$r_0 = (\mu_{ph} - \mu_c)r_c,$$

which from (8) gives

$$r_0 = r_c \left(\frac{d\mu}{dt}\right)_c \int_{t_c}^{t_{ph}} \frac{dt}{\left(\frac{r_e}{r_c}\right)^2}. \quad (35)$$

This is the integral that we evaluated in Section III. Its value from t_c to t_a is given by (14) and Fig. 2. The value in the drift space, from t_a to t_{ph} is given by (20) and Fig. 3. Combining (34) and (35), and using (7) and the above mentioned integrals, gives for the image magnification:

$$\frac{r_i}{r_0} = \frac{\frac{Z_i}{\bar{r}_c}}{\frac{r_e}{r_c} \left[(-\alpha_a)^{2/3} + 3 \sqrt{\frac{\pi}{2}} (-\alpha_a)^2 \frac{r_c}{r_m} (B \pm C) \right]}, \quad (36)$$

wherein r_e is the beam radius at the pin-hole plane. The denominator in (36) is identical to the bracketed expression in (32) or (22). If the pin-hole plane is at the anode aperture position or the nominal position of minimum beam diameter, it is the quantity plotted in Fig. 5. Otherwise using the tube and beam dimensions with (36) and Figs. 2 and 3 one can compute the image magnification.

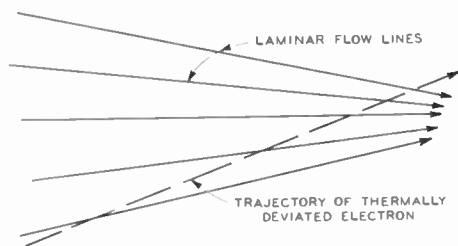

Fig. 9—Sketch illustrating how the transverse velocity of an electron across laminar flow lines is increased through beam convergence.

V. BEAM CONVERGENCE AND BEAM TEMPERATURE¹²

In Fig. 9 we picture a converging electron stream in a unipotential region where all paths are straight. One electron is shown initially crossing the lines of the simple

¹² *Ibid.*, p. 122. The effect of beam convergence on transverse velocities is indicated by J. R. Pierce from other considerations.

laminar flow at a slight angle, presumably because of an initial thermal velocity. It is apparent that this electron finds itself crossing laminar lines with an ever increasing angle as the beam converges. Hence it is evident that beam convergence causes an increase in the transverse velocity distribution. We may put this on a quantitative basis for the general case of accelerated streams through the use of (7).

$$\frac{d\mu}{dt} = \left(\frac{d\mu}{dt}\right)_c \frac{r_c^2}{r_e^2}.$$

Multiplying by r_e gives the transverse velocity of the wandering electron with respect to the coincident laminar path. From (7), then, we can write

$$\frac{r_e \left(\frac{d\mu}{dt}\right)}{r_c \left(\frac{d\mu}{dt}\right)_c} = \frac{v_{Tc}}{v_{Tc}} = \frac{r_c}{r_e} = \frac{1}{M}. \quad (37)$$

The beam compression ratio M is the same as used by Pierce.¹² We have carried the argument for radial velocities only, but it applies equally well for either component of transverse velocity. It follows that if at the cathode the current density is distributed in transverse velocity as given by (24),

$$dJ_c = (\text{const}) e^{-m/2kT(v_x^2+v_y^2)} dv_x dv_y. \quad (24)$$

At the plane z , the transverse velocities of electrons crossing any lamina are increased over those crossing any lamina at the cathode by the factor $1/M$. The new distribution of velocities is then

$$dJ_z = \text{const} e^{-(m/2kT)M_z^2(v_x^2+v_y^2)} dv_x dv_y, \quad (38)$$

and to all intents the temperature has been effectively increased by $1/M_z^2$ where M_z is the ratio of the beam radius at z to that at the cathode. In the case of laminar flow M_z^2 is inversely proportional to the current density, which sometimes can be more specifically determined.

Gun aberrations and nonuniformities of emission including the limited size of the cathode, obviously affect the velocity distribution. These effects are superimposed upon the thermal effect which remains a basic limitation to the electron flow.

VI. CONCLUSION

The theory presented here points out the basic limitations in electron gun focusing which result from the thermal velocities of electron emission. The effects are most pronounced for highly convergent guns at low voltages where significant beam spreading and a marked increase in the thermal transverse velocities in the beam are to be expected. The equations and curves shown make it possible to predict the performance of practical guns, as has been shown by the experimental work described in this issue of the PROCEEDINGS by Saloom and Cutler.¹

GLOSSARY OF SYMBOLS

A The value of

$$\int_1^{\frac{\bar{r}_c}{\bar{r}_a}} \frac{d\left(\frac{\bar{r}_c}{\bar{r}}\right)}{(-\alpha)^{2/3}}$$

a The value at the accelerating anode.

$(-\alpha^2)$ Langmuir's parameter for the solution of the spherical diode. (See reference 6.)

B The value of $\text{erf} \sqrt{\ln (r_a/r_m)}$.

C The value of $\text{erf} \sqrt{\ln (r_e/r_m)}$.

c The value at the cathode plane.

e Electronic charge = 1.602×10^{-19} coulombs.

ϵ Dielectric constant of free space = $10^{-9}/36\pi$ farads per meter.

I_0 Total average current flow, amperes.

J Current density in the *z* direction.

J_0 Current density in the beam at position *z* in the absence of thermal effects.

k Boltzman's constant = 1.380×10^{-23} Joules per degree.

m Electronic mass = 9.11×10^{-31} kilograms.

η $e/m = 1.759 \times 10^{11}$ coulombs/kilogram.

P A point to which electrons may flow under the influence of transverse velocities.

Q A point in the beam.

R Radial distance to *Q*.

r Radial position of an electron.

r_m Beam radius at the minimum of the beam-spread curve.

r_e Radius of the beam edge.

r_c Radius of cathode edge measured from axis.

\bar{r} Radial dimension in spherical co-ordinates measured from the point of convergence of flow in a spherical diode.

\bar{r}_c Radius of curvature of the cathode.

r_0 Object height in the pin-hole camera tube.

r_i Image height in the pin-hole camera tube.

Δr Trajectory deviation of an electron with an initial transverse velocity $(dr/dt)_c$.

ρ Linear charge density in coulombs per meter of length.

σ A normal deviation, defined as

$$\frac{\Delta r}{\left(\frac{dr}{dt}\right)_c} \sqrt{\frac{kT}{m}}$$

T Cathode temperature, degrees Kelvin.

t Time variable.

θ Half angle of convergence in Pierce-type gun.

u A convenient variable $e^{u^2} = r_e/r_0$.

μ Ratio of the radial position of an electron to the beam radius.

V Potential by which the electrons have been accelerated, volts.

v Velocity, meters/second.

Φ Angular dimension of beam cross section.

x, y Rectangular co-ordinates in a cross-section plane through the beam.

z Position of an electron in the axial direction.

ω A convenient variable equal to dr_e/dt .

Subscript 1 indicates the value of the variable at a particular cross-section plane.

Electrical Characteristics of Power Transistors*

ALLEN NUSSBAUM†

Summary—The following electrical characteristics of a group of power transistors whose collector dissipation is in the region of 20 watts have been measured: the small-signal current amplification as a function of emitter current, the cutoff frequency as a function of emitter current and collector voltage, and the decrease of current amplification with increasing frequency. All these measurements were made in both common-base and common-emitter configuration. The results were compared with the theory developed for low-power transistors by Shockley, Rittner, Webster, and others, and it was found that for the frequency-dependent parameters, the agreement was quite good, but that differences exist in the case of those which are a function of current. This leads to the conclusion that further work must be done on the theory of junction power transistors.

* Original manuscript received by the IRE, July 26, 1954; revised manuscript received, December 16, 1954.

† Honeywell Research Center, Hopkins, Minn.

INTRODUCTION

A GENERAL description of *p-n-p* diffused junction power transistors having a collector dissipation in the region of 20 watts has been given by Roka, Buck, and Reiland.¹ Constructional features are shown in Fig. 1 (next page). Fig. 2 (next page) gives the characteristic curves for common-emitter operation of three typical production units, representing respectively the approximate upper and lower limits of quality and an average unit. The curves shown were taken on a recording potentiometer, and some of the high current

¹ E. G. Roka, R. E. Buck, G. W. Reiland, "Developmental germanium power transistors," PROC. I.R.E., vol. 42, pp. 1247-1250; August, 1954.

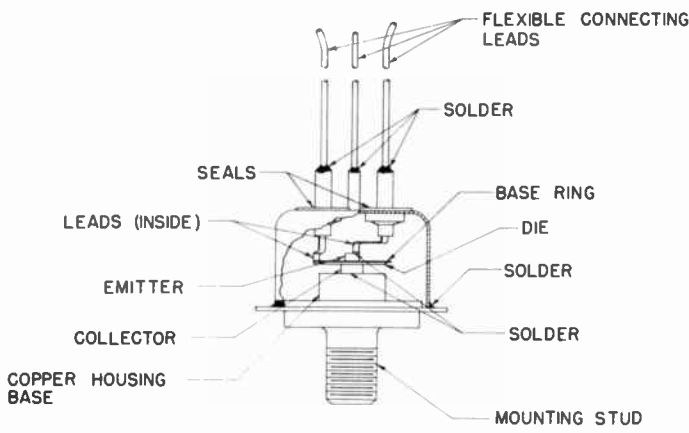

Fig. 1—Cross-sectional drawing of a power transistor.

curves show a slight negative slope due to heating effects. Oscillographic curves of the same units do not show this behavior. In the following sections, we shall give a detailed report on some of the electrical properties of these transistors, and attempt to correlate these results with theory.

CURRENT AMPLIFICATION AS A FUNCTION OF EMITTER CURRENT

Experimental Results

The current amplification α of a transistor for common base operation is defined

$$\alpha = \partial I_c / \partial I_e V_c \quad (1)$$

where I_e is the emitter current, I_c is the collector cur-

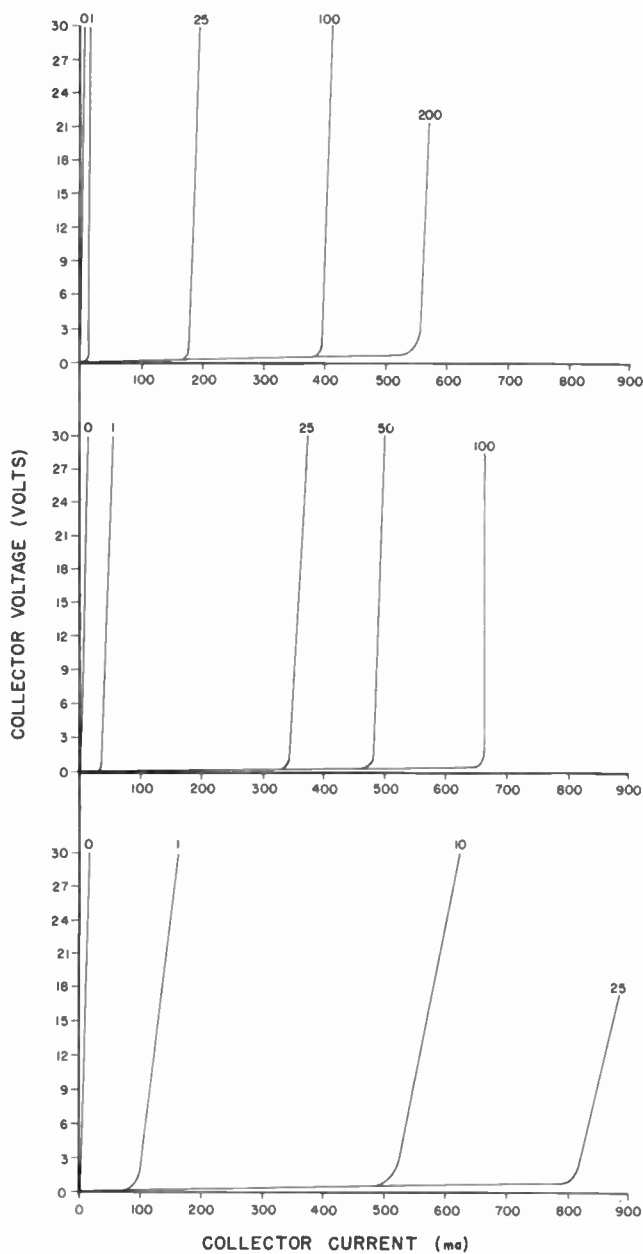

Fig. 2—Common-emitter characteristic curves of three representative power transistors.

TRANSISTOR NO. 1063			
V_b	I_b	I_c	V_c
(FLOATING)		.63 ma	30 v
.035 v	0 ma	.51	2
.085		3.8	30
.19	1	12	2
.20		19	30
1.3	25	185	2
1.3		200	30
3.0	100	400	2
3.2		415	30
4.6	200	555	2
4.8		575	21

TRANSISTOR NO. 355			
V_b	I_b	I_c	V_c
(FLOATING)		.63 ma	30 v
.04 v	0 ma	.18	2
.15		14.5	30
.25	1	38	2
.25		50	30
1.05	25	340	2
1.10		370	30
1.4	50	485	2
1.6		500	30
2.1	100	660	2
2.4		655	30

TRANSISTOR NO. 1055			
V_b	I_b	I_c	V_c
(FLOATING)		.42 ma	30 v
.036 v	0 ma	.69	2
.115	0 ma	16.0	30
.28	1	102	2
.28		160	30
1.0	10	530	2
1.05		620	30
1.8	25	815	2
1.9	25	885	17
4.2	100	1500	2

NOTE: IDENTIFYING NUMBERS ON CURVES DENOTE BASE CURRENT IN ma.

rent, and V_c is the collector voltage (see List of Symbols). For common-emitter operation the current amplification b is

$$b = \partial I_c / \partial I_b V_c, \tag{2}$$

where I_b is the base current. These parameters were measured by superposing small ac signals on the dc quantities I_e (or I_b) and I_c and measuring their ratio.

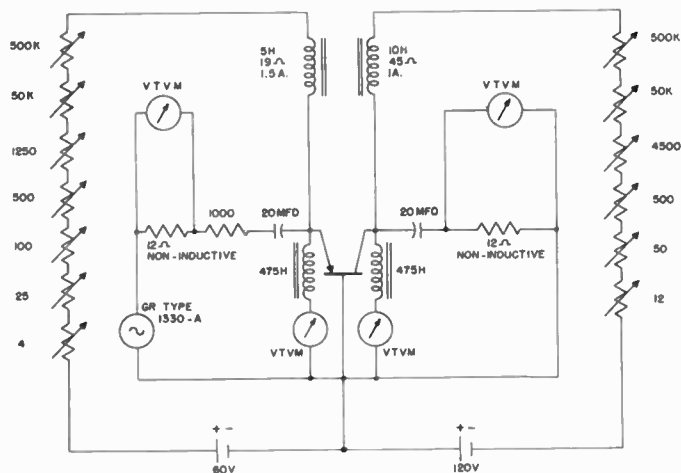

Fig. 3—Circuit diagram of current-amplification measuring apparatus.

The circuit used is shown in Fig. 3. Various direct-reading methods reported in the literature² were not usable because of the lower impedances and higher currents associated with power transistors. Chokes to handle the currents involved were specially wound and the bias sources consisted of high-current dry batteries connected in series. The frequency of measurement was 400 cycles per second. The results for common-base operation are plotted in Fig. 4, and for common-emitter operation in Fig. 5.

Theoretical Dependence of Current Amplification on Emitter Current

When the $p-n-p$ transistor is considered to be a device of rectangular shape with base region of width w , with diffusion of carriers restricted to one dimension, and with the field in the base being small enough so that carrier transport is due entirely to diffusion, then the common-base current amplification can be expressed³

$$\alpha = \beta\gamma, \tag{3}$$

where

$$\beta = \text{sech}(w/L_b), \tag{4}$$

and

$$\gamma = \frac{1}{1 + (D_n/D_p)(n_e/p_b)(L_b/L_e) \tanh(w/L_b)}. \tag{5}$$

² See, for example, R. F. Shea, "Principles of Transistor Circuits," John Wiley and Sons, Ch. 22, New York; 1953.
³ E. L. Steele, "Theory of alpha for $p-n-p$ diffused junction transistors," Proc. I.R.E., vol. 40, pp. 1424-1428; November, 1952.

In these equations β is the diminution factor due to volume recombination, γ is the injection efficiency; D_n and D_p are the diffusion constants of electrons in the emitter and holes in the base, respectively; n_e and p_b are the corresponding equilibrium concentrations; and L_e and L_b are the corresponding diffusion lengths. We also have $L_e^2 = D_p\tau_b$, where τ_b is the lifetime of holes in the base.

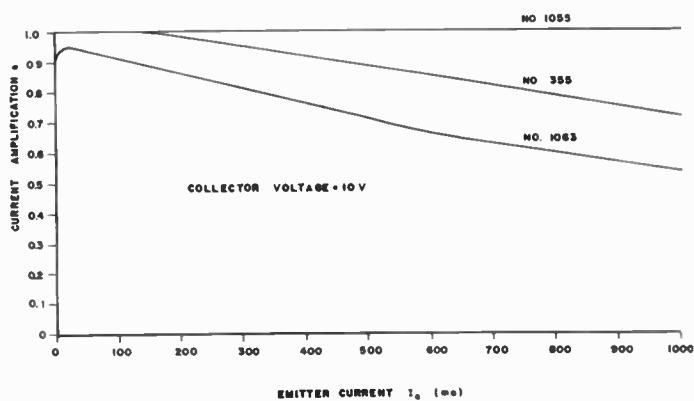

Fig. 4—Emitter current vs current amplification for common-base operation.

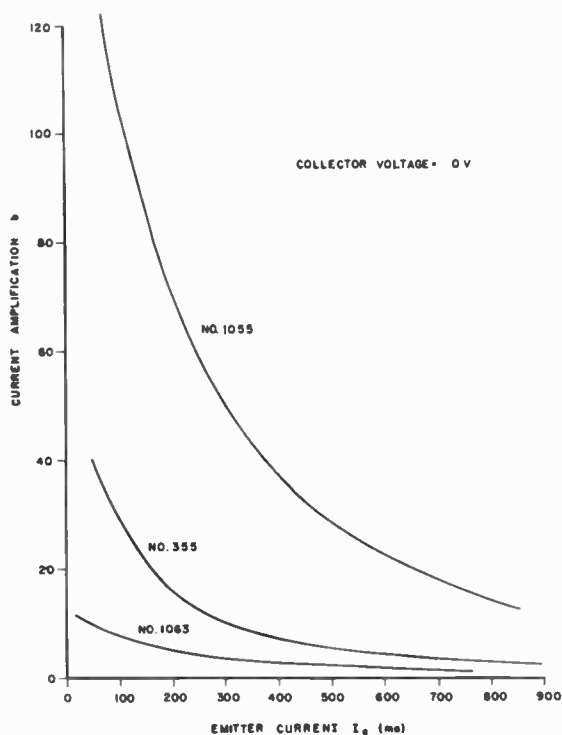

Fig. 5—Emitter current vs current amplification for common-emitter operation.

The common emitter-current amplification is

$$b = \alpha / (1 - \alpha), \tag{6}$$

and since the argument w/L_b of the hyperbolic functions is known to be small enough to permit series expansion, (6) may be converted into

$$\begin{aligned} 1/b &= 1 - \beta\gamma \\ &= 1 - (1 + w^2/2L_b^2)^{-1}(1 + D_n n_e w/D_p p_b L_e)^{-1} \quad (7) \\ &= (w^2/2D_p \tau_b) + (D_n n_e w/D_p p_b L_e), \end{aligned}$$

where only first order terms have been retained. If the effects of surface recombination are considered, Rittner⁴ and Webster⁵ have shown that an additional term must be included in (7):

$$1/b = (w^2/2D_p \tau_b) + (D_n n_e w/D_p p_b L_e) + (sA_s w/D_p A_e), \quad (8)$$

where s is the surface recombination velocity, A_s is the effective surface area for recombination, and A_e is the area of the conduction path which is approximately equal to the emitter area. All of the parameters on the right of (8) with the exception of τ_b are constants of the transistor and independent of I_e . It has been shown by Shockley and Read⁶ that τ_b should vary with injected carrier density δn in the following fashion:

$$\tau_b = \tau_0(1 + x\delta n)/(1 + y\delta n), \quad (9)$$

where τ_0 is the lifetime in the limit of no injected carriers and where we can compute $x = 9.66 \times 10^{-16}/\text{cm}^3$ and $y = 2.58 \times 10^{-15}/\text{cm}^3$ from data for lifetime vs impurity concentration given by Hall.⁷ The resistivity of the starting material used in these transistors is 4.5 ohm-cm and from this it was determined that $\tau_0 = 295 \mu\text{sec}$ with τ_b decreasing to a minimum of 110 μsec as the injected current rises. This should cause a change in the volume recombination term $w^2/2D_p \tau_b$ by a factor of 3. However, both Webster⁵ and Rittner⁴ have computed that for receiving-type transistors, both the volume-recombination and injection-efficiency terms are about 0.1 the surface-recombination term. Hence, the variation in τ_b has little effect on $1/b$ and (8) predicts that the current-amplification is independent of emitter current. Webster has shown this to be untrue for both $p-n-p$ and $n-p-n$ receiving-type transistors and Fig. 5 shows similar behavior in power transistors. To consider the reason for this dependence, it should be recalled that in the derivation of (3), it was assumed that the electric field in the base region of the transistor appears only across the junctions and can be neglected in the remainder of the n -type area. By considering the effect of this field, Webster has shown that (8) must be modified to

$$\begin{aligned} 1/b &= [(w^2/2D_p \tau_b) + (\sigma_b w/\sigma_e L_e)](1 + Z) \\ &\quad + (s w A_s/D_p A_e)g(Z), \end{aligned} \quad (10)$$

where

$$Z = (w\mu_e/D_p A_e \sigma_b)I_e \quad (11)$$

⁴ E. S. Rittner, "Extension of the theory of the junction transistor," *Phys. Rev.*, vol. 94, pp. 1161-1171; June, 1954.

⁵ W. M. Webster, "On the variation of junction-transistor current amplification factor with emitter current," *Proc. I.R.E.*, vol. 42, pp. 914-920; June, 1954.

⁶ W. Shockley and W. T. Read, "Statistics of the Recombinations of Holes and Electrons," *Phys. Rev.*, vol. 87, pp. 835-840; September, 1952.

⁷ R. N. Hall, "Electron-hole recombination in germanium," *Phys. Rev.*, vol. 87, p. 387; July, 1952.

and

$$g(Z) = \frac{1 + p_1/N_d}{1 + 2p_1/N_d}; \quad (12a)$$

$$Z = (2p_1/N_d) - \ln(1 + p_1/N_d). \quad (12b)$$

In the above equations μ_e is the electron mobility, p_1 the hole concentration in the base at the emitter junction, N_d the donor ion concentration, and the emitter and base conductivities σ_e and σ_b , respectively, enter through replacing the ratio of diffusion constants by use of the Einstein relation and the definition of conductivity in terms of mobility. Eqs. (12a) and (12b) show that the function $g(Z)$ decreases rapidly with Z , so that the surface-recombination term in (10) produces a rise in b with current, whereas the other two terms cause a decrease, and the curve of b vs I_e shows a maximum. The physical picture is that at low currents the volume-recombination rate is low, the injection-efficiency is high, but a large number of holes are being lost by diffusion to the surface. Surface recombination is presumed to occur in an annular ring surrounding the emitter and of width approximately equal to w . As the current (and the field) increases, there is less diffusion to the surface, causing b to rise, but at the same time there is a fall in b due to the other two factors. By using Lagrange's multipliers and considering (12a) and (12b) as a constraint, the maximum of b as a function of I_e is found to occur when

$$(2g-1)^2 g = [(w^2/2D_p \tau_b) + (\sigma_b w/\sigma_e L_e)]/(s w A_s/D_p A_e). \quad (13)$$

This relation will be applied subsequently.

Comparison with Experiment

The physical constants and the computed values of the various terms in (10) for the receiving-type transistors of Webster and for one of the transistors of Fig. 2 are listed in Table I. The curve for transistor No. 1055 as given in Fig. 5 was used in conjunction with

TABLE I

Parameter	RCA	MH No. 1055
Emitter diameter, d	0.015 inch	0.130 inch
Collector diameter	0.045 inch	0.150 inch
Base width, w	4.8×10^{-3} cm	6.35×10^{-3} cm
Emitter area, A_e	1.1×10^{-3} cm ²	8.55×10^{-2} cm ²
Base resistivity, $1/\sigma_b$	2.22 ohm-cm	4.5 ohm-cm
Lifetime, τ_b	500 μsec	295 μsec
$w^2/2D_p \tau_b$	0.0006	0.0016
sA_s (from best fit)	0.147 cm ² /sec	5.0 cm ² /sec
$sA_s w/D_p A_e$	0.014	0.0062
$\sigma_e L_e$ (from best fit)	1.55/ohm	1.0/ohm
$\sigma_b w/\sigma_e L_e$	0.0014	0.0014
Z	800 I_e (I_e in amp)	27.3 I_e (I_e in amp)
Current for which b is a maximum, computed from (13)	1.2 ma	0.73 ma
s (assuming $A_s = w\pi d$)	245 cm/sec	760 cm/sec

(10) for obtaining the values of $\sigma_e L_e$ and sA_s given in the table. This particular transistor was chosen since it has an α of approximately 1.0 over the entire I_e range, this being one of the assumptions involved in Webster's

theory. The principal differences between the RCA and Honeywell transistors are the size of the junctions and the magnitude of the currents carried. Because of the insensitivity of the measuring circuit at low currents it was not possible to confirm the existence of the maximum in b predicted by (13). We would expect, however, that if this maximum exists, it should occur at currents much higher than 1 ma, for when the two types of transistor are carrying the same current, the current density (and hence the field) in the power transistor should be smaller. This means that the effect of surface recombination is larger and the maximum should be shifted to the right in the I_e vs b curve. It must be concluded, therefore, that the first-order approximations which give such reasonable agreement for the smaller units do not hold for high-current transistors. The more rigorous one-dimensional theory of Rittner also predicts a curve of the same shape as Webster's. Rittner has extended his work to three dimensions in a most elegant manner, and shows that for transistors of the size he considers, the one-dimensional theory is a reasonable approximation. In view of the above discussion, it is felt at this point that in order to bring theory and experiment into line for power transistors, further work will have to be done with the three-dimensional theory with regard to converting the formidable solutions of the equations into a form suitable for numerical computation.

FREQUENCY-DEPENDENT CHARACTERISTICS

Common Base Configuration

Returning to the conditions under which (3) is valid, it has been shown by Steele³ that if the injected hole density varies sinusoidally with angular frequency ω , then this equation is still applicable provided we replace w/L_b with zw/L_b , where $z^2 = (1 + i\omega\tau_b)$. For low currents, the approximation is made that $\alpha = 1.0$, and all of the frequency variation of α is contained in β , where

$$\beta = \operatorname{sech}(zw/L_b), \tag{14}$$

or

$$\beta = [1 - (w^2/2L_b^2) - (i\omega\tau_b w^2/2L_b^2)]^{-1} = [1 - i\omega\tau_b w^2/2L_b^2]^{-1}. \tag{15}$$

(The use of the series expansion for a function with a complex argument can be justified by computing the absolute value and incorporating the condition that $w/L_b \ll 1$.) The common-base cutoff frequency f_{ca} is defined as the frequency for which the magnitude squared of β falls to one half of its low-frequency value ($f=0$), or

$$\beta(f_{ca})\beta^*(f_{ca})/\beta^2(0) = 1/2. \tag{16}$$

It can be shown that if the real part of β is independent of frequency, then f_{ca} can alternatively be defined as the frequency for which the real and imaginary parts of β are equal. Using this latter condition on (15),

$$f_{ca} = D_p/w^2\pi. \tag{17}$$

On the other hand, substituting β as given by (14) into the definition (16) yields, after taking the square root of the complex number z and expanding the hyperbolic secant of the resulting root,

$$\cosh 2x + \cos 2y = 4, \tag{18}$$

where x and y are defined by

$$x + iy = wz/L_b = (w/L_b)(1 + \omega_{ca}^2\tau_b^2)^{1/4} \cdot [\cos(\theta/2) + i \sin(\theta/2)], \tag{19}$$

and

$$\theta = \arctan \omega_{ca}\tau_b$$

$$f_{ca} = 2\pi\omega_{ca}. \tag{20}$$

The common-base cutoff frequency is plotted in Fig. 6 as a function of emitter current and collector voltage. For these frequencies we have $\omega_{ca}\tau_b \gg 1$, so that $\theta \approx \pi/2$, $x=y$, and (18) has a solution of $x=1.1$, or, by (19),

$$1.1 = (\omega_{ca}\tau_b w^2/2L_b^2)^{1/2}$$

or

$$f_{ca} = 1.22 D_p/\pi w^2. \tag{21}$$

This relation, given by Rittner⁴ and Pritchard,⁸ predicts an f_{ca} 22 per cent higher than (17). For w as given in Table I,

$$f_{ca} = 1.22 \times 44/\pi \times (6.35 \times 10^{-3})^2 = 422 \text{ kc/sec.}$$

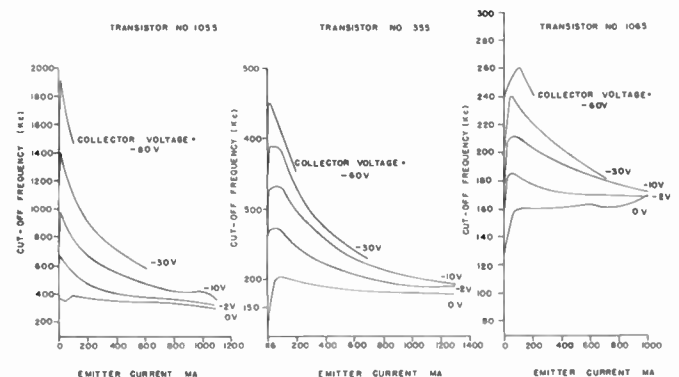

Fig. 6—Common-base cutoff frequency as a function of emitter current and collector voltage.

This is reasonable for transistor No. 355 at low currents. As I_e increases, Rittner predicts that f_{ca} should rise to twice its low-current value and then decline somewhat, due to a fall-off in injection efficiency. This general behavior is seen in Fig. 6, but here again we are faced with computational difficulties for quantitative comparisons.

The frequency dependence of α (or β) can be obtained by substituting (17) into (15),

$$\alpha = \beta = (1 - jf/f_{ca})^{-1}, \tag{22}$$

⁸ R. L. Pritchard, "Frequency variations of current-amplification factor for junction transistors," Proc. I.R.E., vol. 40, pp. 1476-1481; November, 1952.

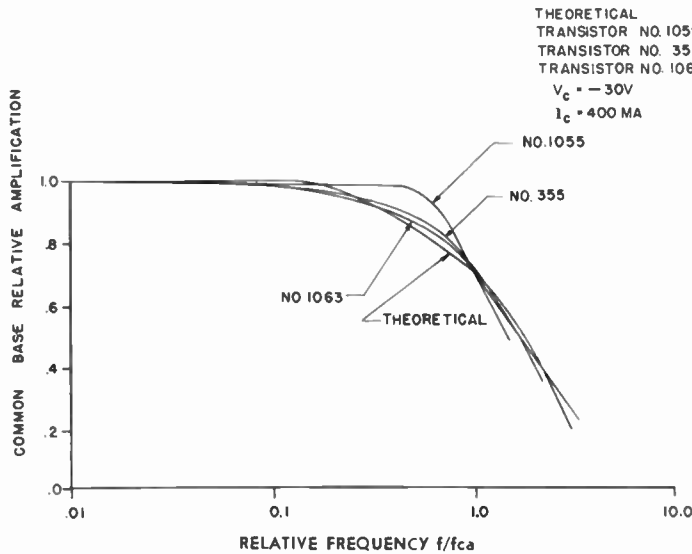

Fig. 7—Common-base relative frequency vs relative amplification.

or in polar form,

$$\alpha = A(f)e^{i\phi}, \tag{23}$$

where

$$A(f) = [1 + (f/f_{ca})^2]^{-1/2} \tag{24a}$$

$$\phi = \arctan f/f_{ca}. \tag{24b}$$

By (24a)

$$A(f)/A(0) = [1 + (f/f_{ca})^2]^{-1/2} \tag{25}$$

As shown by Pritchard,⁸ (25) and (24a) mean that the relative amplitude $A(f)/A(0)$ and the phase ϕ of α are universal functions of the relative frequency f/f_{ca} . A comparison of the plot of (24a) with measured values is given in Fig. 7. The collector current and voltage used were selected for convenience. Little dependence on these quantities was observed. The agreement for transistors No. 355 and 1063 is quite good. The deviation for No. 1055 might be due to a frequency variation in γ suggested by Pritchard.⁹ The measurement of phase angle was found to be difficult using standard Lissajous¹⁰ methods, so that it was necessary to compute ϕ in the following manner:

$$b = Be^{i\Delta} = Ae^{i\phi}/(1 - Ae^{i\phi}),$$

where B is the amplitude of b and Δ the phase angle. Then

$$B^2 = bb^* = A^2(1 + A^2 - 2A \cos \phi),$$

or

$$\cos \phi = (1 + A^2/B^2)/2A \tag{26}$$

Fig. 8 shows experimental values of ϕ as computed from (26) and the theoretical values computed from (25).

⁹ R. L. Pritchard, "Frequency variations of junction-transistor parameters," Proc. I.R.E., vol. 42, pp. 786-799; May, 1954.

¹⁰ F. E. Terman and J. M. Pettit, "Electronic Measurements," McGraw-Hill Book Co., pp. 267-268, New York; 1952.

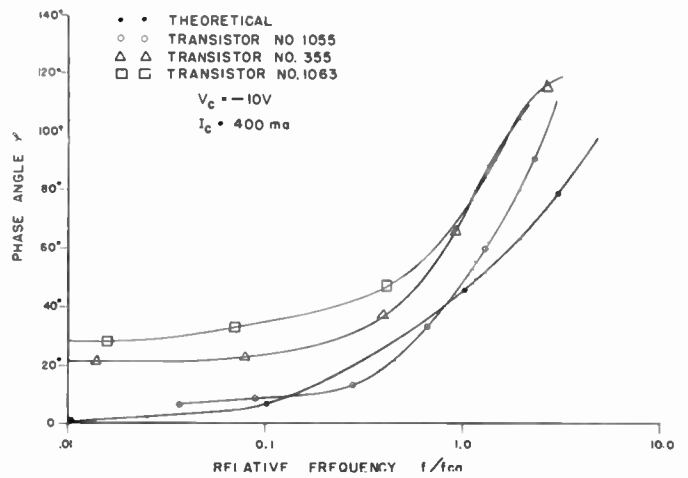

Fig. 8—Phase angle vs relative frequency for common-base operation.

Common Emitter Configuration

For convenience in derivation of equations, we will interchange the order of treatment in this section. First we will get an approximate expression for f_{cb} , the cutoff frequency for this configuration. From (6) and (15), assuming as usual that α is not a function of frequency and $w/L_b \ll 1$,

$$b = [\cosh(zw/L_b) - 1]^{-1} = [(z^2w^2/2L_b^2) + z^4w^4/4!L_b^4]^{-1}. \tag{27}$$

Equating real and imaginary parts

$$f_{cb} = 1/2\pi\tau_b \tag{28}$$

so that under the assumption that volume recombination is of major importance at high injection levels, f_{cb} should rise with an increase in I_c . A linear rise is seen in Fig. 9 (opposite). The change in lifetime from 295 to 110 μ sec should give corresponding values of f_{cb} from 0.55 to 1.5 kc/sec, so that (28) is not a very good approximation formula.

To find the dependence of b on f_{cb} , put (28) into (27) to get

$$b = [(w^2/2D_p\tau_b)(1 + if/f_{cb})]^{-1} \tag{29}$$

or

$$B(f)/B(0) = [1 + (f/f_{cb})^2]^{-1/2}, \tag{30}$$

which is of the same form as (25). This curve and the experimental results are shown in Fig. 10 (opposite page).

The cutoff frequency definition as exemplified by (16), when applied to the combination of (7) and (14), yields, using the same symbols as (19),

$$b^2(0)/2 = [\cosh(zw/L_b) - 1]^{-1}[\cosh(z^*w/L_b) - 1]^{-1}$$

or

$$\cosh 2x + \cos 2x - 4 \cosh x \cos x + 2 = 0, \tag{31}$$

where we have dropped a term $4/b^2(0)$. The solution is $x = 0.743$, or

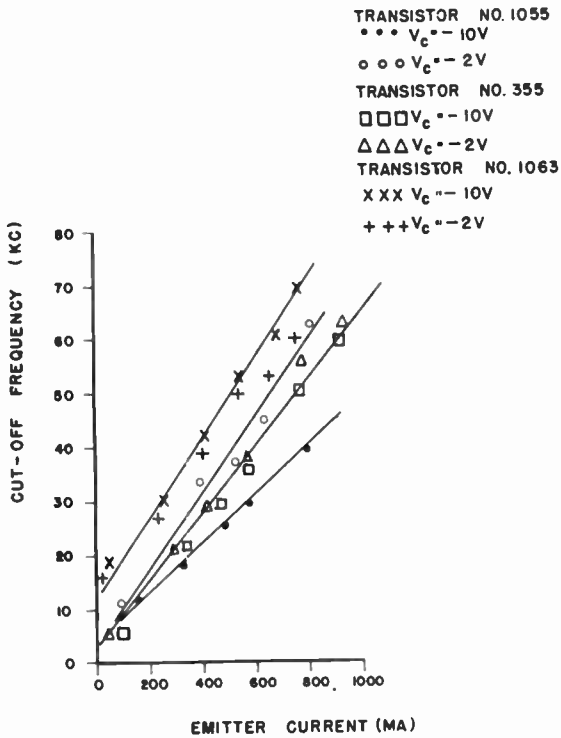

Fig. 9—Common-emitter cutoff frequency as a function of emitter current and collector voltage.

$$f_{cb} = 0.549 D_p / \pi w^2 \quad (32)$$

and

$$f_{cb} = 190 \text{ kc/sec.}$$

This is not a good approximation, either, but is in the opposite direction to (28).

A third method of estimating f_{cb} has been given by Thomas.¹¹ By (22),

$$\alpha(f) = \alpha(0) / (1 - if/f_{ca}),$$

so that

$$b(f) = \alpha(f) \{ 1 - \alpha(f) \} = \frac{\alpha(0)}{\{ 1 - \alpha(0) \} \left[1 - \frac{if}{f_{ca} \{ 1 - \alpha(0) \}} \right]} \quad (33)$$

By (29),

$$b(f) = b(0) / (1 + if/f_{cb}), \quad (34)$$

hence

$$f_{cb} = \{ 1 - \alpha(0) \} f_{ca}. \quad (35)$$

Estimating an error of about 1 per cent in the measurement of α , this means that f_{cb} should be of the order of $0.01 f_{ca}$ for Nos. 1055 and 355 at low currents. This prediction is quite reasonable. The agreement for No. 1063 is similar. However, (35) does not predict the rise in f_{cb} as f_{ca} falls.

¹¹ D. E. Thomas, "Transistor amplifier—cutoff frequency, PROC. I.R.E., vol. 40, pp. 1481-1483; November, 1952.

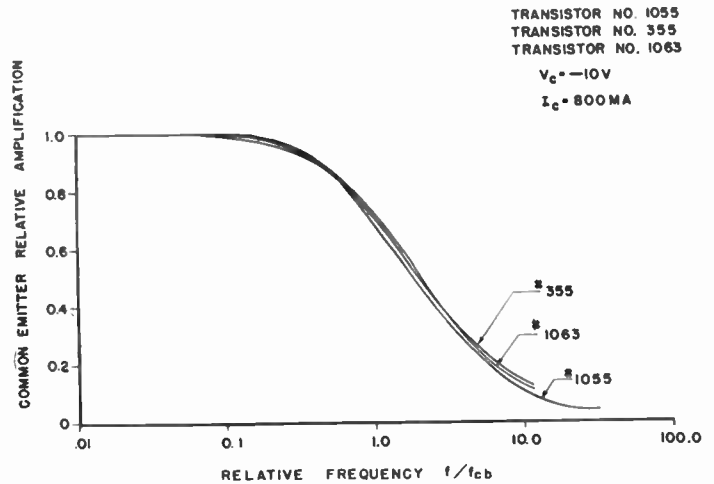

Fig. 10—Common-emitter relative frequency vs relative amplification.

CONCLUSIONS

It is apparent from the data presented that, in the case of power transistors, successful devices were manufactured before their theory of operation was too well understood. It is felt that numerical calculations based on Rittner's work hold out the most hope for deriving expressions connecting current-amplification and cutoff frequency with current density in transistors carrying large currents and having large junctions. It is also planned to test these results by making similar studies on units of about 60 watts dissipation, now in the process of development.

ACKNOWLEDGMENT

The writer would like to express his appreciation to Finn J. Larsen and Van W. Beringer, who provided continuous encouragement and support of this project. A special note of thanks is due John R. Crane, who constructed all the measuring circuits and performed the tedious task of taking the data.

LIST OF SYMBOLS

- A = amplitude of α
- A_e = emitter area
- A_s = surface recombination area
- B = amplitude of b
- b = current amplification for common-emitter operation
- D_n = diffusion constant of electrons
- D_p = diffusion constant of holes
- d = emitter diameter
- f_{ca} = common-base cutoff frequency
- f_{cb} = common-emitter cutoff frequency
- $g(Z) = (1 + p_1/N_d) / (1 + 2p_1/N_d)$
- I_b = base current (dc)
- I_c = collector current (dc)
- I_e = emitter current (dc)
- L_e = diffusion length in emitter
- L_b = diffusion length in base
- N_d = donor ion concentration

n_e = equilibrium electron concentration in emitter
 p_1 = hole concentration in base at emitter junction
 p_b = equilibrium hole concentration in base
 s = surface recombination velocity
 V_c = collector voltage
 w = base width (distance from emitter to collector junctions)
 $x + iy = wz/L_b$
 $z = (1 + i\omega\tau_b)^{1/2}$
 $Z = w\mu_e/D_p A \sigma_b = (2p_1/N_d) - \ln(1 + p_1/N_d)$
 α = current amplification for common base operation
 β = diminuation factor

γ = injection efficiency
 Δ = phase angle of b
 δn = injected-carrier density
 $\theta = \arctan \omega_{ca}\tau_b$
 μ_e = electron mobility
 σ_b = base conductivity
 σ_e = emitter conductivity
 τ_0 = minority carrier lifetime with no injected carrier density
 τ_b = lifetime of holes in base
 ϕ = phase angle of α
 ω = angular frequency of injected hole current
 $\omega_{ca} = 2\pi f_{ca}$

Further Bounds Existing on the Transient Responses of Various Types of Networks*

A. H. ZEMANIAN†, ASSOCIATE, IRE

Summary—Five new theorems stating bounds on the transient response of certain types of networks are derived and illustrated. The first one states that any system function, whose real part on the positive real-frequency axis decreases monotonically as frequency increases, cannot have an overshoot in its step response greater than eighteen per cent, nor can its rise time, from the time that the input step is applied to the time that the response first crosses the final value line, be less than $1.22(r-K)C$ where r is the final value of the step response and K and $1/C$ are the constant term and the coefficient of the $1/s$ term in the inverse power-series expansion of the system function. Similarly, the other four theorems show that when the system function is appropriately restricted, the transient response is bounded. These restrictions include never-negative or never-positive conditions on the real or imaginary parts of the system function along the real-frequency axis, while the resulting bounds are determined by certain coefficients occurring in the power-series expansions of the system function.

INTRODUCTION

MANY EMPIRICAL rules exist which relate characteristics of the frequency response of systems to characteristics of their transient response.¹⁻⁴ Furthermore, the frequency responses of many types of networks, such as passive driving point impedances or minimum phase networks, are restrained in various ways.⁵

In a previous paper,⁶ analogous bounds have been shown to exist on the transient response when the frequency response of the system is appropriately restricted. Moreover, these relations are exact ones and not approximate rules of thumb. In this paper theorems stating new exact relations of this type are proven and illustrated.

THEOREMS

Only fixed, lumped, linear, and stable networks will be considered in the forthcoming discussion where the system function, $Z(s)$, has no poles on the real-frequency axis or in the right-half s -plane. Since this system function is analytic at $s=0$ and $s=\infty$, it may be expanded around these two points into the following two infinite series, respectively:

$$Z(s) = r + k_1s + k_2s^2 + k_3s^3 + \dots; |s| \leq q,$$

$$Z(s) = K + \frac{1}{Cs} + \frac{K_2}{s^2} + \frac{K_3}{s^3} + \dots; |s| \geq p.$$

As these expansions will be used only in the vicinity of $s=0$ and $s=\infty$, let p be a number greater than the distance from the origin to the pole of $Z(s)$ furthest from the origin, and let q be a number less than the distance from the origin to the pole nearest the origin. In this paper, the first expression will be called the power-series expansion of $Z(s)$ and the second, the inverse power-series expansion of $Z(s)$. As usual all input functions are assumed applied at time, $t=0$, so that all responses are zero for negative values of time.

The first theorem states that any network, whose system function has a real part along the real-frequency

* Original manuscript received by the IRE, October 12, 1954; revised manuscript received, December 9, 1954.

† Elec. Engrg. Dept., College of Engrg., New York Univ., New York, N. Y.

¹ G. E. Valley, Jr., and H. Wallman, "Vacuum Tube Amplifiers," McGraw-Hill Book Co., 1st ed., pp. 71-84; 1948.

² A. V. Bedford and G. L. Fredendall, "Transient response of multistage video amplifiers," PROC. I.R.E., vol. 27, pp. 277-284; April, 1939.

³ H. E. Kallman, R. E. Spencer and C. P. Singer, "Transient response," PROC. I.R.E., vol. 33, pp. 169-195; March, 1945.

⁴ G. S. Brown and D. P. Campbell, "Principles of Servomechanisms," John Wiley & Co., 1st ed., pp. 105-109; 1948.

⁵ H. W. Bode, "Network Analysis and Feedback Amplifier Design," D. Van Nostrand Co., 1st ed., ch. 9 and 13; 1945.

⁶ A. H. Zemanian, "Bounds existing on the time and frequency responses of various types of networks," PROC. I.R.E., vol. 42, pp. 835-839; May, 1954.

axis $R(\omega)$, which decreases monotonically as ω increases from zero toward infinity, will have a unit step response, $A(t)$, whose percentage overshoot will be less than 18 per cent and whose rise time from the time the step input is applied to the time the response crosses the final value line will be greater than $1.22(r - K)C$. This situation is illustrated in Fig. 1 for the case where $K=0$. When the derivative of $R(\omega)$ is excluded from the positive region shown shaded in Fig. 1(a), the unit step response is excluded from those regions which are shaded in Fig. 1(b). An example also is indicated wherein the real part of the system function and the corresponding unit step response are realizable by a shunt-peaked filter whose poles are at $s = -1 \pm j1$ and whose zero is at $s = -2$. The statement of this theorem and its proof follow.

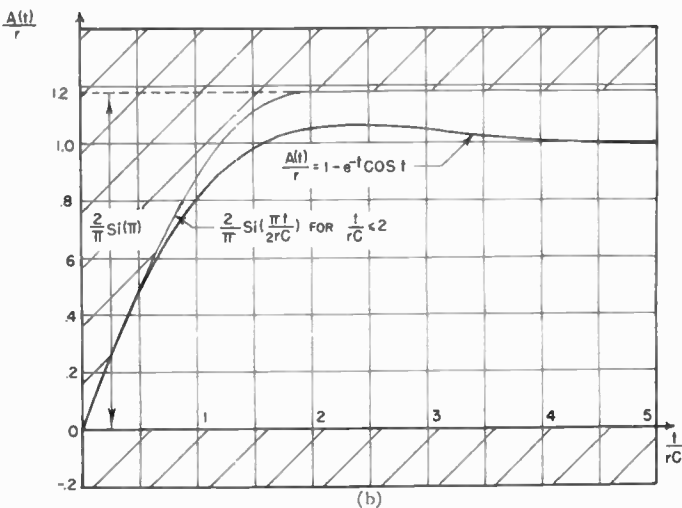
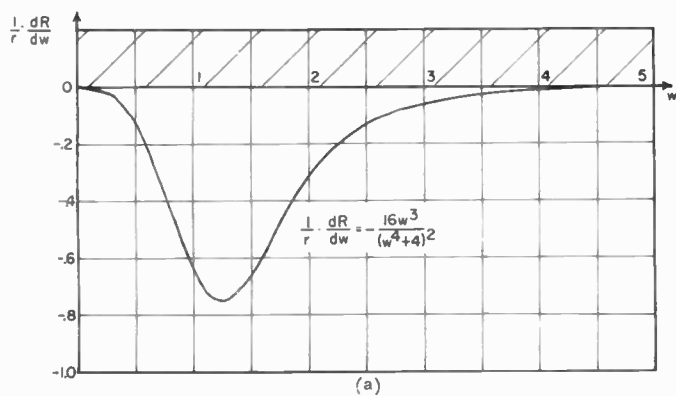

Fig. 1—Prohibited regions of Theorem 1 for the case $K=0$. (a) The region from which $dR/d\omega$ is excluded by the hypothesis of Theorem 1. (b) The regions into which the corresponding $A(t)$ cannot enter.

Theorem 1

If $Z(s)$ is such that $(dR/d\omega) \leq 0$ for $0 \leq \omega$, then for $0 \leq t \leq 2(r - K)C$:

$$K \leq A(t) \leq K + \frac{2}{\pi} (r - K) Si \left[\pi \frac{t}{2(r - K)C} \right]$$

and for $2(r - K)C \leq t$:

$$K \leq A(t) \leq K + \frac{2}{\pi} (r - K) Si(\pi) < K + 1.18(r - K).$$

Proof: Consider the Fourier transform which expresses the unit step response in terms of the real part of the system function.

$$A(t) = \frac{2}{\pi} \int_0^\infty R(\omega) \frac{\sin \omega t}{\omega} d\omega \tag{1}$$

$$= \frac{2}{\pi} t \int_0^{\pi/t} R(\omega) \frac{\sin \omega t}{\omega t} d\omega + \frac{2}{\pi} t \int_{\pi/t}^\infty R(\omega) \frac{\sin \omega t}{\omega t} d\omega \tag{2}$$

$$= G(t) + H(t).$$

Denoting the second term in expression (2) by $H(t)$ and integrating it by parts, the following may be obtained:

$$H(t) = K - \frac{2}{\pi} Si(\pi) R \left(\frac{\pi}{t} \right) + \frac{2}{\pi} \int_{\pi/t}^\infty \left(-\frac{dR}{d\omega} \right) Si(\omega t) d\omega.$$

Since $(dR/d\omega) \leq 0$ and $Si(\omega t) \leq Si(\pi)$,

$$H(t) \leq K - \frac{2}{\pi} Si(\pi) R \left(\frac{\pi}{t} \right) + \frac{2}{\pi} Si(\pi) \int_{\pi/t}^\infty \left(-\frac{dR}{d\omega} \right) d\omega$$

$$H(t) \leq K \left[1 - \frac{2}{\pi} Si(\pi) \right]. \tag{3}$$

Now a bound will be obtained on the first term of expression (2) which will be denoted by the symbol, $G(t)$. Within the interval $0 \leq \omega \leq (\pi/t)$, the function $(\sin \omega t / \omega t)$ is positive and monotonically decreasing. Therefore, of all the positive functions, $R(\omega)$, such that $(dR/d\omega) \leq 0$, the rectangular pulse function, $R_m(\omega)$, is the one which will yield the greatest value of $G(t)$.

$$R_m(\omega) = r \text{ for } |\omega| \leq \omega_c \\ = K \text{ for } \omega_c \leq |\omega| \tag{4}$$

where $K < r$. Integrating $[Z(s) - K]$ around the right half s -plane and making use of the fact that there are no poles in the right half s -plane nor on the $j\omega$ axis, the following expression may be obtained:⁵

$$\frac{2}{\pi} \int_0^\infty [R(\omega) - K] d\omega = \frac{1}{C}$$

Applying this to $R_m(\omega)$ and solving for ω_c ,

$$\omega_c = \frac{\pi}{2(r - K)C}$$

Thus, when $(\pi/t) \geq \omega_c$ so that $t \leq 2(r - K)C$,

$$G(t) \leq \frac{2}{\pi} t \int_0^{\omega_c} r \frac{\sin \omega t}{\omega t} d\omega + \frac{2}{\pi} t \int_{\omega_c}^{\pi/t} K \frac{\sin \omega t}{\omega t} d\omega \\ \leq \frac{2}{\pi} [r - K] Si(\omega_c t) + \frac{2}{\pi} K Si(\pi). \tag{5}$$

Adding (3) and (5),

$$A(t) \leq K + \frac{2}{\pi} [r - K] Si \left[\pi \frac{t}{2(r - K)C} \right]. \quad (6)$$

Similarly, when $(\pi/t) \leq \omega_c$, so that $t \geq 2(r - K)C$:

$$G(t) \leq \frac{2}{\pi} Si(\pi)r.$$

Therefore

$$A(t) \leq K + \frac{2}{\pi} Si(\pi)[r - K]. \quad (7)$$

Expressions (6) and (7) constitute the upper bounds of this theorem. The fact that the unit step response corresponding to $R_m(\omega)$ equals this bound for $0 \leq t \leq 2(r - K)C$ demonstrates that these are the lowest possible bounds of this form.

To obtain the lower bound, integrate (1) by parts:

$$A(t) = K + \frac{2}{\pi} \int_0^\infty \left(-\frac{dR}{d\omega} \right) Si(\omega t) d\omega.$$

The fact that both terms in the integrand of this expression are never negative establishes this lower bound. It is the greatest possible constant one, since $A(0) = K$. This completes the proof.

When $(dR/d\omega) \geq 0$ for $0 \leq \omega$, so that $K > r$, it may be shown in exactly the same way that for $0 \leq t \leq 2(r - K)C$:

$$K - \frac{2}{\pi} [K - r] Si \left[\pi \frac{t}{2(r - K)C} \right] \leq A(t) \leq K,$$

and for $2(r - K)C \leq t$:

$$K - \frac{2}{\pi} [K - r] Si(\pi) \leq A(t) \leq K.$$

In these expressions, C is a negative quantity.

The second theorem improves the result of Theorem 2 of reference 6. It shows that any network, whose system function has a real part along the positive real-frequency axis $R(\omega)$ which decreases monotonically to zero as ω increases from zero toward infinity, will have a unit impulse response, $W(t)$, which is bounded by the functions shown in Fig. 2. The example is obtained from the same system function used in illustrating Theorem 1.

Theorem 2

If $Z(s)$ is such that $K = 0$ and $(dR/d\omega) \leq 0$ for $0 \leq \omega$, then for $0 \leq t \leq rC$:

$$|W(t)| \leq \frac{1}{C} \frac{\sin \frac{\pi t}{2rC}}{\frac{\pi t}{2rC}}$$

and for $rC \leq t$:

$$|W(t)| \leq \frac{2r}{\pi t}.$$

Proof: The impulse response may be written in terms of the real part of the system function as follows:

$$W(t) = \frac{2}{\pi} \int_0^{\pi/2t} R(\omega) \cos \omega t d\omega + \frac{2}{\pi} \int_{\pi/2t}^\infty R(\omega) \cos \omega t d\omega \quad (8)$$

$$= J(t) + L(t).$$

Denoting the second term in (8) by $L(t)$, integrating it by parts and using the fact that $\sin \omega t$ is always less than one, it can be shown that $L(t)$ is a negative quantity. Therefore, $W(t) \leq J(t)$.

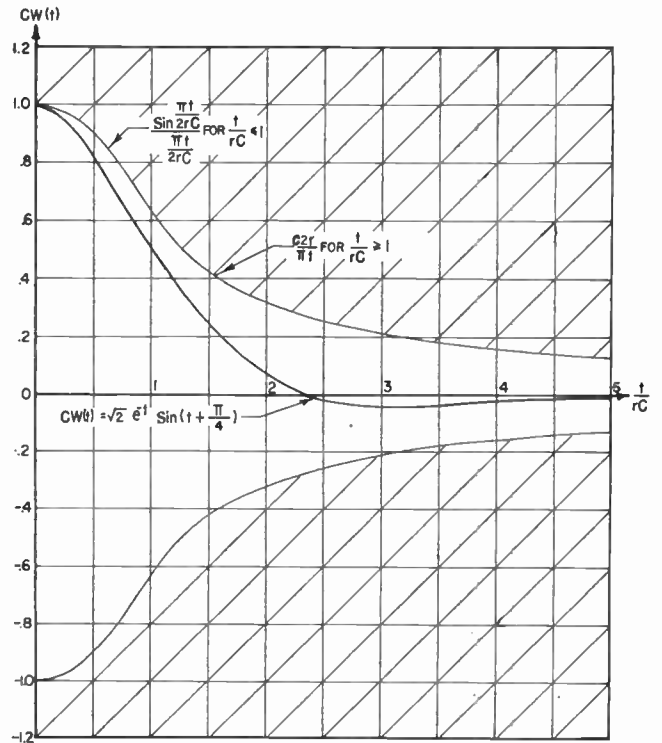

Fig. 2—Prohibited regions of the conclusion of Theorem 2.

Of all the positive functions, $R(\omega)$, such that $(dR/d\omega) \leq 0$, the rectangular pulse function given by (4) is the one which will yield the greatest value of $J(t)$ and thereby the upper bounds. Thus, for $(\pi/2t) \leq \omega_c$ so that $t \geq rC$:

$$W(t) \leq \frac{2}{\pi} \int_0^{\pi/2t} r \cos \omega t d\omega = \frac{2r}{\pi t};$$

and for $(\pi/2t) \geq \omega_c$ so that $t \leq rC$

$$W(t) \leq \frac{2}{\pi} \int_0^{\omega_c} r \cos \omega t d\omega = \frac{1}{C} \frac{\sin \frac{\pi t}{2rC}}{\frac{\pi t}{2rC}}.$$

The lower bounds are obtained in the same way except that use is made of the fact that $\sin \omega t \geq -1$. Consideration of the impulse response corresponding to $R_m(\omega)$ demonstrates that the upper bounds are the lowest possible ones of this form.

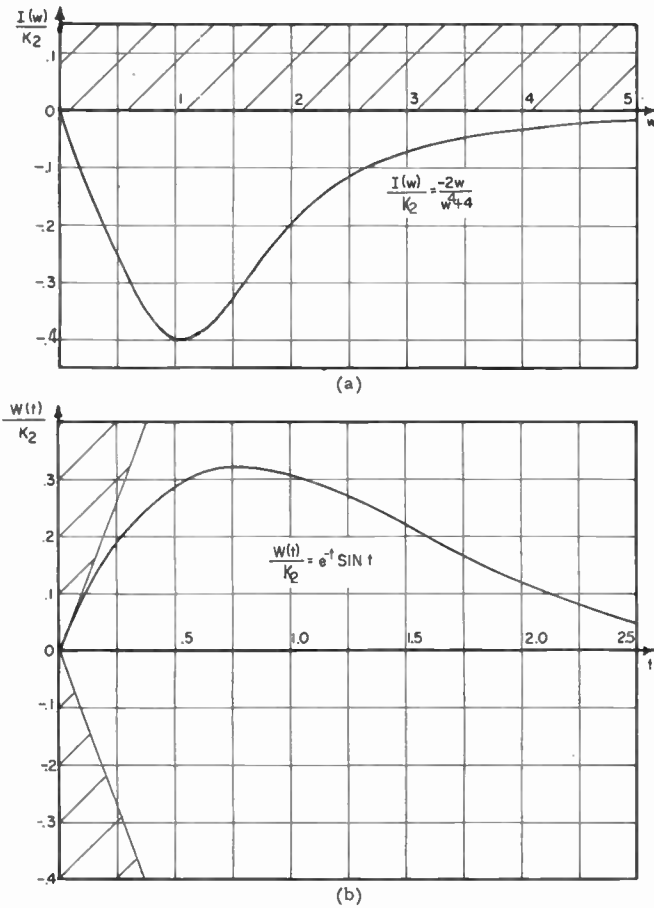

Fig. 3—Prohibited regions of Theorem 3. (a) The region from which $I(\omega)$ is excluded by the hypothesis of Theorem 3. (b) The regions into which the corresponding $W(t)$ cannot enter.

The third theorem states that any network, whose system function has two more poles than zeros and has a never-positive imaginary part along the positive real-frequency axis, $I(\omega)$, will have a unit impulse response, $W(t)$, whose magnitude is bounded by $K_2 t$. This, of course, means that the magnitude of the unit step response is bounded by $(K_2/2)t^2$. The shaded portions of Fig. 3 indicate the regions from which the imaginary part and the corresponding impulse response are excluded by the hypothesis and conclusion of this theorem, respectively. Again an example is given. The functions shown are obtained from a system function having only two poles at $s = -1 \pm j1$.

Theorem 3

If $Z(s)$ is such that $K = 1/C = 0$ and $I(\omega) \leq 0$ for $0 \leq \omega$, then $|W(t)| \leq K_2 t$.

Proof: The usual argument is applied to the Fourier sine transform which relates the unit impulse response to the imaginary part of the system function.

$$W(t) = -\frac{2}{\pi} \int_0^\infty I(\omega) \sin \omega t \, d\omega \quad (9)$$

Since $I(\omega)$ is never-positive and $|\sin \omega t| \leq \omega t$,

$$|W(t)| \leq -\frac{2}{\pi} t \int_0^\infty \omega I(\omega) \, d\omega \quad (10)$$

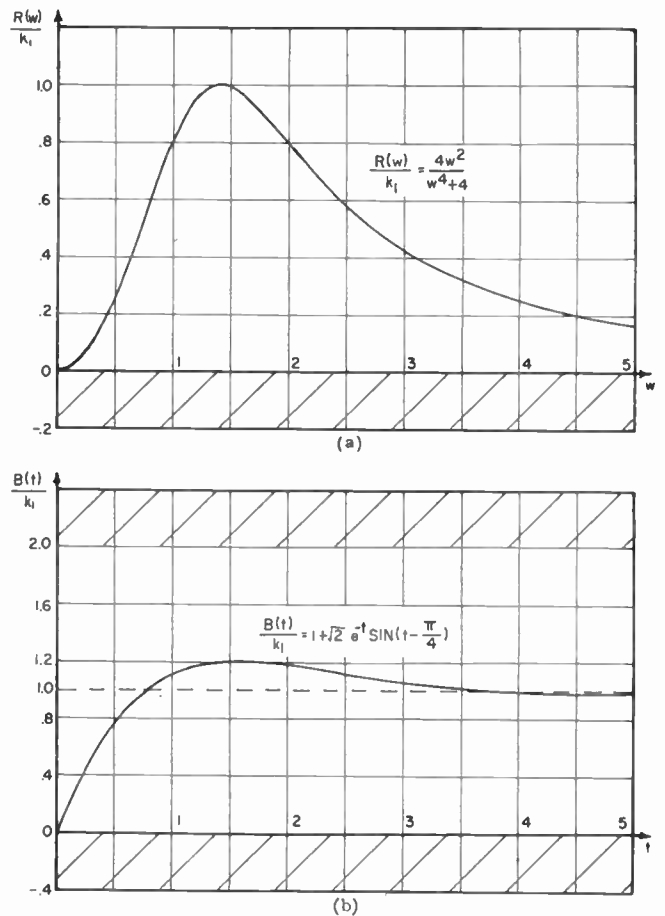

Fig. 4—Prohibited regions of Theorem 4. (a) The region from which $R(\omega)$ is excluded by the hypothesis of Theorem 4. (b) The regions into which the corresponding $B(t)$ cannot enter.

Integrating $sZ(s)$ around the right-half s -plane and using the fact that there are no poles on or within this contour (if the path of integration is indented to the right at the origin to avoid the simple pole occurring there), a value for the integral in (10) may be found.⁵

$$\frac{2}{\pi} \int_0^\infty \omega I(\omega) \, d\omega = -K_2$$

Thus:

$$|W(t)| \leq K_2 t$$

That this bound is the best possible linear one which passes through the origin can be shown by applying the initial value theorem to the derivative of $W(t)$.

$$\lim_{t \rightarrow 0} \frac{dW}{dt} = \lim_{s \rightarrow \infty} s^2 Z(s) = K_2;$$

therefore $W(t)$ is tangent to $K_2 t$ at the origin. This completes the proof.

The fourth theorem states that when the system function has a simple zero at the origin and has a never-negative real part on the real-frequency axis, the corresponding unit ramp response, $B(t)$, will never be less than zero nor greater than $2k_1$. This unit ramp function is defined as being zero for negative values of time, t , and equal to t for positive values of time. Fig. 4 il-

illustrates the restricted regions of the hypothesis and conclusion while the example is obtained from a system function having two poles at $s = -1 \pm j1$ and a zero at the origin.

Theorem 4

If $Z(s)$ is such that $r=0$ and $R(\omega) \geq 0$ for all ω , then $0 \leq B(t) \leq 2k_1$.

Similarly, the last theorem states that, when the system function has a double zero at the origin and its imaginary part is never-negative along the positive real-frequency axis, the corresponding unit parabolic response, $C(t)$, will never be less than zero nor greater than $4k_2$. The unit parabolic function is defined as being zero for negative values of time, t , and equal to t^2 for positive values of time. Again these restricted regions on $I(\omega)$ and $C(t)$ are shown in Fig. 5. The example is obtained from a system function having two poles at $s = 1 \pm j1$ and a double zero at the origin.

considering $2(Z(s)/s^2)$ as the system function and letting $-2(I(\omega)/\omega^2)$ replace $I(\omega)$, $2k_2$ replace r , and $C(t)$ replace $A(t)$. This process of finding bounds on responses to inputs of the form t^n for system functions with multiple zeros of n th order at the origin cannot be continued, for neither $R(\omega)$ nor $I(\omega)$ can be never-negative or never-positive for these higher order cases where $r = k_1 = k_2 = 0$. On the other hand, the examples given for each theorem demonstrate that the conditions of these theorems are realizable. To show that the bounds of these last two theorems are the best possible constant ones, one need only consider an $R(\omega)$ or $I(\omega)$ which is a very narrow pulse at some positive and negative value of ω and zero elsewhere. Corresponding responses will approach their bounds at overshoots and undershoots.

CONCLUSION

The results of this paper demonstrate the possibility of reflecting bounds which might occur on the responses of systems in the frequency domain into bounds which hold on their responses in the time domain. These effects may be interpreted as practical limitations on the rise times or overshoots of the responses of general types of networks.

APPENDIX

- $A(t)$ The response to a unit step function applied at time, $t=0$.
- $B(t)$ The response to the input function, t , applied at time, $t=0$.
- C The reciprocal of the coefficient of $1/s$ in the power-series expansion of $Z(s)$.
- $C(t)$ The response to the input function, t^2 , applied at time, $t=0$.
- $G(t)$ The first term in (2).
- $H(t)$ The second term in expression (2).
- $I(\omega)$ The imaginary part of a system function for real frequencies.
- $J(t)$ The first term in (8).
- K The constant term in the inverse power-series expansion of $Z(s)$.
- K_2 The coefficient of $1/s^2$ in the inverse power series expansion of $Z(s)$.
- k_1 The coefficient of s in the power-series expansion of $Z(s)$.
- k_2 The coefficient of s^2 in the power-series expansion of $Z(s)$.
- $L(t)$ The second term in (8).
- $R(\omega)$ The real part of a system function for real frequencies.
- $R_m(\omega)$ Rectangular pulse function defined by (4).
- r The constant term in the power-series expansion of $Z(s)$.
- $Si(\omega t)$ $\int_0^{\omega t} (\sin x/x) dx$.
- s A complex variable.
- $W(t)$ The response to a unit impulse function applied at time, $t=0$.
- ω (2π) (frequency) = angular frequency.
- $Z(s)$ A system function.

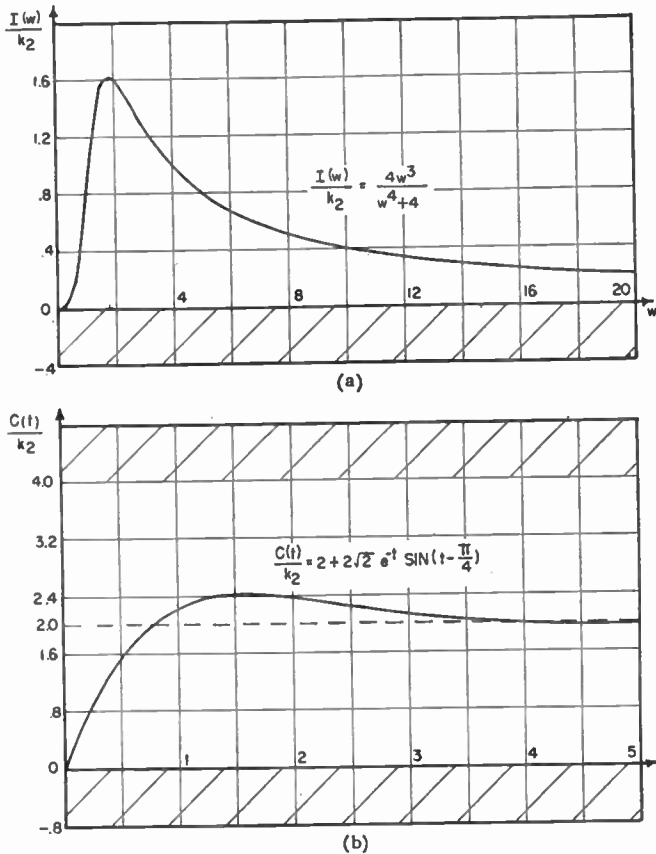

Fig. 5—Prohibited regions of Theorem 5. (a) The region from which $I(\omega)$ is excluded by the hypothesis of Theorem 5. (b) The regions into which the corresponding $C(t)$ cannot enter.

Theorem 5

If $Z(s)$ is such that $r = k_1 = 0$ and $I(\omega) \geq 0$ for $0 \leq \omega$, then $0 \leq C(t) \leq 4K_2$.

Theorem 4 can be obtained from Theorem 3 of reference 6 by considering $Z(s)/s$ as the system function. In this case, $-(R(\omega)/\omega)$ replaces $I(\omega)$; k_1 replaces r ; and $B(t)$ replaces $A(t)$. Similarly, Theorem 5 can be obtained from the same theorem of reference 6 by

Magnetic Focusing of Electron Beams*

J. T. MENDEL†, ASSOCIATE, IRE

Summary—Electron trajectories for a pencil beam are studied for both uniform and periodic magnetic fields. General equations are given which apply to shielded and unshielded cathodes and all intermediate cases. The balance conditions which yield minimum ripple solutions are presented as a function of magnetic field. It is shown that these conditions require that considerable magnetic flux thread the cathode for magnetic fields in excess of the Brillouin value

INTRODUCTION

THE DYNAMICS of an electron beam guided by an axial field is well known, and in particular several special cases have been studied in great detail. Probably the most familiar amongst these special cases is "Brillouin" focusing for which the cathode is completely shielded from the magnetic field.¹ A pseudo-type of Brillouin focusing in which a periodic magnetic field was employed has recently been described in the literature.^{2,3} Some work has also been done on "confined" systems in which the cathode is immersed in a long uniform magnetic field.

It is the purpose of this paper to show the simple relationship which exists between these various systems, and several new systems which have not been discussed heretofore in the literature. Considered here for the first time are cases intermediate between a completely shielded and an unshielded cathode both for uniform and periodic magnetic fields. The optimum conditions of operation are derived and simple expressions for the electron trajectories are given. A semi-shielded cathode possesses the advantage of inhibiting the spread of the beam in the gun region due to thermal velocities while still retaining some of the magnetic efficiency of complete shielding. For a periodic system the weight-saving feature of alternately poled permanent magnets can be realized while the low noise properties of a "confined" system are presumably retained.

DYNAMICS

In the general case of an unshielded cathode, where an arbitrary amount of magnetic flux is allowed to thread the electron beam, Bush's theorem becomes

$$\dot{\theta} = \frac{\eta}{2\pi r^2} (N_2 - N_1); \tag{1}$$

* Original manuscript received by the IRE, October 20, 1954; revised manuscript received December 31, 1954.

† Bell Telephone Labs, Inc., Murray Hill, N. J.

¹ C. C. Wang, "Electron beams in symmetric fields," *Proc. I.R.E.*, vol. 38, pp. 135-147; February, 1950.

² J. T. Mendel, C. F. Quate, and W. H. Yocum, "Electron beam focusing with periodic permanent magnets," *Proc. I.R.E.*, vol. 42, pp. 800-810; May, 1954.

³ A. M. Clogston and H. Heffner, "Focusing of an electron beam by periodic fields," *Jour. Appl. Phys.*, vol. 25, pp. 436-447; April, 1954.

where $N_2 = B\pi r^2$, $N_1 = B_c\pi r_c^2$, B is the longitudinal magnetic field at r , B_c is the longitudinal magnetic field at the cathode, and r_c is the radius of the electron beam as it leaves the cathode. It is assumed that the initial θ is zero (at the cathode) and that there is no radial variation of the magnetic field.

Combining the three forces (magnetic, centrifugal, and space-charge repulsion) acting on an edge electron of a round beam in an axially symmetrical magnetic field, one obtains

$$\frac{d^2r}{dt^2} + r \left(\frac{\eta^2 B^2}{4} \right) - r \left(\frac{\eta^2 B_c^2}{4} \right) \left(\frac{r_c}{r} \right)^4 - \frac{r_0^2 \omega_p^2}{2r} = 0; \tag{2}$$

where

$$\omega_p^2 = \frac{\eta \rho}{\epsilon}$$

$$\rho = \frac{I}{\sqrt{2\eta v_0 \pi r_0^2}}$$

and r_0 is the reference radius from which ρ is calculated (see Fig. 1).

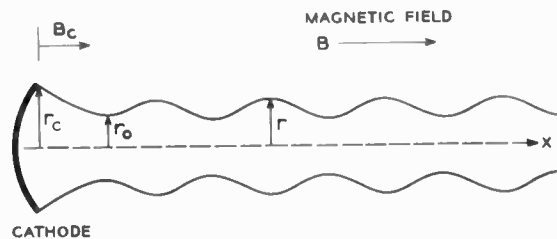

Fig. 1—Schematic diagram of the beam (r_0 generally, but not necessarily, equals r_{min} from the gun).

Note that (2) is quite general and makes no assumptions as to variation of the longitudinal magnetic field.

As a practical matter most electron guns (for traveling-wave tubes) are convergent, which leads to r_c (cathode radius) being larger than r_0 , the reference radius of the beam. However, there is no loss of generality if r_c is set equal to r_0 , since B_c can still be adjusted at will. It is only the product $B_c r_c^2$ which is significant, so either may be fixed. Letting $r_c = r_0$, (2) becomes

$$\ddot{r} + r \left(\frac{\eta^2 B^2}{4} \right) - \frac{r_0^4}{r^3} \left(\frac{\eta^2 B_c^2}{4} \right) - \frac{r_0^2}{r} \left(\frac{\omega_p^2}{2} \right) = 0$$

Further simplification results from letting $y = r/r_0$:

$$\ddot{y} + y \left(\frac{\eta^2 B^2}{4} \right) - \frac{1}{y^3} \left(\frac{\eta^2 B_c^2}{4} \right) - \frac{1}{y} \left(\frac{\omega_p^2}{2} \right) = 0. \tag{3}$$

This is a non-linear differential equation about which little is known unless certain restrictions are imposed on

the variable. Since we are interested primarily in stable electron beams the important solutions occur when y is close to unity. Therefore, let $y = 1 + \delta$. For $\delta \ll 1$,

$$\frac{1}{(1 + \delta)^3} \cong 1 - 3\delta,$$

and

$$\frac{1}{(1 + \delta)} \cong 1 - \delta.$$

Eq. (3) becomes

$$\ddot{\delta} + \left(\frac{\eta^2 B^2}{4} + \frac{3\eta^2 B_c^2}{4} + \frac{\omega_p^2}{2} \right) \delta + \left[\frac{\eta^2 B^2}{4} - \frac{\omega_p^2}{2} - \frac{\eta^2 B_c^2}{4} \right] = 0. \tag{4}$$

For magnetic fields which have a uniform region B_0 , the following notation can be used:

$$\omega_L = \frac{1}{2} \eta B_0$$

$$K = \left(\frac{B_c}{B_0} \right)^2 = \left(\frac{N_1}{N_2} \right)^2.$$

Substituting the above,

$$\ddot{\delta} + \left[\omega_L^2(1 + 3K) + \frac{\omega_p^2}{2} \right] \delta + \left[\omega_L^2(1 - K) - \frac{\omega_p^2}{2} \right] = 0. \tag{5}$$

Here K is just the square of the fractional percentage of the flux threading the cathode. For complete shielding of cathode (Brillouin focusing) $K=0$. For no shielding at all (confined flow) $K=1$. The solution of (5) is

$$\delta = C_1 \sin \left[\omega_L^2(1 + 3K) + \frac{\omega_p^2}{2} \right]^{1/2} t + C_2 \cos \left[\omega_L^2(1 + 3K) + \frac{\omega_p^2}{2} \right]^{1/2} t - \frac{\left[\omega_L^2(1 - K) - \frac{\omega_p^2}{2} \right]}{\left[\omega_L^2(1 + 3K) + \frac{\omega_p^2}{2} \right]}, \tag{6}$$

where

$$C_1 = \frac{\frac{d\delta}{dt}(0)}{\left[\omega_L^2(1 + 3K) + \frac{\omega_p^2}{2} \right]^{1/2}} \tag{7}$$

and

$$C_2 = \delta(0) + \frac{\left[\omega_L^2(1 - K) - \frac{\omega_p^2}{2} \right]}{\left[\omega_L^2(1 + 3K) + \frac{\omega_p^2}{2} \right]}. \tag{8}$$

Arbitrarily we can say that the beginning of the uniform magnetic field occurs when $t=0$.

In most practical cases it is desirable to keep the perturbations of the beam edge to a minimum. To accomplish this several alternatives avail themselves. If we let $d\delta/dt=0$ at $t=0$ (start the beam parallel in the uniform field) then $C_1=0$. If we further stipulate that at $t=0$, $\delta=0$; that is, at the beginning of the uniform field $r=r_0$, then the minimum ripple solution is obtained when

$$\frac{\left[\omega_L^2(1 - K) - \frac{\omega_p^2}{2} \right]}{\left[\omega_L^2(1 + 3K) + \frac{\omega_p^2}{2} \right]} = 0,$$

or

$$\omega_L^2(1 - K) - \frac{\omega_p^2}{2} = 0,$$

and

$$K = 1 - \frac{\left(\frac{\omega_p^2}{2} \right)}{\omega_L^2}.$$

For Brillouin-type focusing,

$$(\omega_L^2) = \left(\frac{\omega_p^2}{2} \right)$$

and $K=0$. In practice it is generally necessary to increase the magnetic field above the Brillouin value by at least a factor of 1.5 to take care of transverse thermal velocities and lens aberrations. For $\omega_L = 1.5 \omega_{L\text{Brillouin}}$,

$$K = 0.55 = \left(\frac{B_c}{B_0} \right)^2$$

$$B_c = 0.75 B_0,$$

or 75 per cent of the flux should thread the cathode for a minimum ripple solution if the magnetic field is increased 50 per cent above the Brillouin value. For higher magnetic fields this percentage goes up. For the case of larger magnetic fields it should be noted that the ripple due to a finite input derivative is less [see (7)].

If we remove the requirement that $\delta=0$ at $t=0$, then referring to (8) we can make the constant $C_2=0$ if

$$\delta(0) = - \frac{\left[\omega_L^2(1 - K) - \frac{\omega_p^2}{2} \right]}{\left[\omega_L^2(1 + 3K) + \frac{\omega_p^2}{2} \right]}.$$

That is, we start the beam in the uniform field at a radius smaller than r_0 (assuming a field greater than Brillouin) and completely shield the cathode. This brings us right back to Brillouin flow with a smaller beam radius. It is argued (by some people) that this is a

better approach since it yields a smaller diameter beam which presumably will go through a smaller diameter tube. In a highly convergent system this cannot always be done since here there are limits beyond which it is impossible to reduce the size of the beam. Also, controlling the beam in this way (reducing the diameter to compensate for the increased magnetic field) leads to a nonuniform current distribution over the cross section and larger space-charge forces.

By the simple adjustment of the parameter K the previous equations can be made to describe all uniform systems lying between complete shielding and complete immersion of the cathode in the magnetic field. Thus the comparison of particular cases is greatly simplified.

The periodic counterpart of uniform Brillouin focusing has already been shown in the literature,^{2,3} but as yet periodic focusing with flux threading the cathode has not been treated. It would seem desirable to develop this in the above manner using the parameter K .

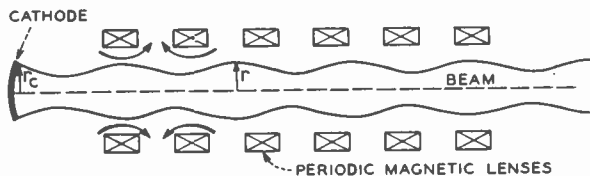

Fig. 2—Schematic diagram of the beam in a periodic magnetic field. Here L equals twice the distance between lens centers.

PERIODIC FIELDS

For sinusoidally varying fields let $B = B_0 \cos x$ (longitudinal field) where $x = \omega t$ and $\omega = 2\pi u_0/L$, $\omega_L = 1/2\eta B_0$, as in Fig. 2. Rewriting (4) with a periodic field, we have

$$\ddot{\delta} + \left(\frac{\omega_L^2}{2} (1 + \cos 2x) + 3K\omega_L^2 + \frac{\omega_p^2}{2} \right) \delta + \left[\frac{\omega_L^2}{2} (1 + \cos 2x) - \frac{\omega_p^2}{2} - K\omega_L^2 \right] = 0. \quad (9)$$

Substituting

$$\frac{d^2\delta}{dt^2} = \omega^2 \frac{d^2\delta}{dx^2}$$

and

$$\alpha = \frac{1}{2} \left(\frac{\omega_L}{\omega} \right)^2 \text{ magnetic field parameter}$$

$$\beta = \frac{1}{2} \left(\frac{\omega_p}{\omega} \right)^2 \text{ space charge parameter,}$$

$$\delta'' + [\alpha(1 + \cos 2x) + 6\alpha K + \beta] \delta + [\alpha(1 + \cos 2x) - \beta - 2K\alpha] = 0, \quad (10)$$

where the primes indicate differentiation with respect to x . Eq. (10) is readily solved if the term $(\alpha \cos 2x)\delta$ is dropped. Such an approximation can be justified by comparison to an exact solution obtained from the analog computer, and by physical arguments. Since we

are restricting ourselves to cases where the flux threads, the cathode, K will be of the order of 1/2 in most practical cases. Consequently we are ignoring only about 20 per cent of the second term of (10). With this approximation we can write

$$\delta = C_1 \cos (\alpha + 6\alpha K + \beta)^{1/2} x + C_2 \sin (\alpha + 6\alpha K + \beta)^{1/2} x + \frac{\beta + 2K\alpha - \alpha}{(\alpha + 6\alpha K + \beta)} + \frac{\alpha \cos 2x}{4 - (\alpha + 6\alpha K + \beta)}. \quad (11)$$

To minimize beam ripple let

$$\beta + 2K\alpha - \alpha = 0$$

$$K = \frac{\alpha - \beta}{2\alpha}. \quad (12)$$

For $\alpha = \beta$ (periodic Brillouin flow), K will be zero and the cathode completely shielded. For α (magnetic field) far in excess of the Brillouin value K approaches 1/2, or 70 per cent of the peak, magnetic field should thread the cathode for minimum ripple. If the balance conditions of (12) are maintained, (11) becomes

$$\delta = C_1 \cos (4\alpha - 2\beta)^{1/2} x + C_2 \sin (4\alpha - 2\beta)^{1/2} x + \frac{\alpha \cos 2x}{4 - (4\alpha - 2\beta)}. \quad (13)$$

If

$$\delta(0) = \frac{\alpha}{4 - (4\alpha - 2\beta)^{1/2}},$$

then $C_1 = 0$ and

$$C_2 = \frac{\delta'(0)}{(4\alpha - 2\beta)}.$$

For the above conditions,

$$\delta = \frac{\delta'(0)}{(4\alpha - 2\beta)^{1/2}} \sin (4\alpha - 2\beta)^{1/2} x + \frac{\alpha \cos 2x}{4 - (4\alpha - 2\beta)}; \quad (14)$$

$\delta'(0)$ is the initial derivative of the beam profile as it enters the peak of the periodic field. In more familiar terms

$$\delta'(0) = \frac{L}{2\pi r_0} \frac{dr}{dz}(0).$$

In practice the first term of (14) generally predominates, so to obtain a smooth beam it behooves one to pay close attention to the problem of starting the beam out parallel.

BEAM STABILITY

The approximate forms of (3) are intended to serve only as a guide to the magnitude and period of the small ripple solutions and are not intended as criteria of stability. The power series expansion of $1/y^3$ and $1/y$ assumed values of y close to unity, and therefore the equations in δ are suspect even before regions of instability are approached. It is necessary to locate the

unstable regions (divergent flow) from (3) (with $B = B_0 \cos x$) since this equation contains no assumptions concerning the value of y . Thus we have

$$y'' + \alpha(1 + \cos 2x)y - \frac{2\alpha K}{y^3} - \frac{\beta}{y} = 0. \quad (15)$$

The first two terms of (15) comprise a form of Mathieu's equation which has received extensive treatment in the literature.^{2,3} It was found experimentally² and with the analog computer that the term $-\beta/y$ does not seem to alter the location of the first stop band (unstable region) which seems to be wholly dependent upon α . One could further argue that in view of the above, the term $-(2\alpha K/y^3)$ would contribute negligibly to the stability of the solution. Judging from the computer solutions for a variety of conditions this indeed seems to be the case. To predict behavior in the higher order pass and stop bands one must be more circumspect since both $-(B/y)$ and $-(2\alpha K/y^3)$ contribute singularities at $y=0$ which are absent in Mathieu's equation. It could be argued that the $-(\beta/y)$ term is not actually a singularity in a physical situation because one can never obtain a point focus of an electron beam. However, the $-(2\alpha K/y^3)$ term is a real singularity regardless of the aberrations in the system. As long as some flux threads the cathode no electrons can cross the axis (this can be seen from simple energy considerations). Just how this effects the higher order pass bands is not known. The experimental results of the shielded gun case ($K=0$) indicate that the higher order pass and stop bands are not significantly different from those of Mathieu's equation alone.

There seems to be no simple way of including the $1/y$ and $1/y^3$ terms in a stability criterion, which gives further inducement for the above assumptions.

COMPARISON OF THE SHIELDED AND UNSHIELDED CASES

It is difficult to classify categorically one system as superior to another unless a specific application was the basis for comparison. One can, however, enumerate several advantages of both systems.

Shielded Cathode

1. A shielded cathode will focus the greatest amount of space charge with a given magnetic field.
2. Only electrostatic forces exist in the cathode-anode region since the gun is shielded from the magnetic field.
3. With a fixed period of magnetic field a greater amount of space charge can be focused in the first pass band.

Unshielded Cathode

1. A balance condition with respect to the various forces acting on the beam can be maintained re-

gardless of how much the magnetic field is varied merely by altering the flux threading the cathode. This means that magnetic fields far in excess of the Brillouin value can be employed while still maintaining a minimum ripple solution. This may be advantageous in a low-noise device.

2. In some instances it may be easier to construct an unshielded gun since the proximity of the cathode to the magnetic circuit is not so critical. (In the shielded case the magnets must begin at the beam minimum which is generally close to the cathode). Also no magnetic materials such as a shield cans need be used near the gun.
3. Thermal spread is inhibited in the gun region.

SQUARE-WAVE MAGNETIC FIELDS

The necessity of getting the rf energy on and off a traveling-wave tube focused with periodic magnetic fields creates serious electrical problems, especially when the period is quite small. Any disturbance of the magnetic field strength or period is likely to initiate a large ripple on the beam. Therefore, it is desirable to incorporate the waveguide or other matching system within the periodic structure. If the individual lenses are shorter than the waveguide width then something must be done to either the matching section or the magnetic structure. To obviate the necessity of making these changes (which are difficult) it has been suggested that a long period be used where the magnetic field is made to approximate a square wave rather than a sinusoid.

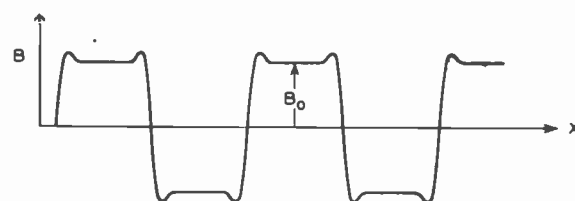

Fig. 3—The variation of magnetic field with distance along the axis for a peaked square-wave system.

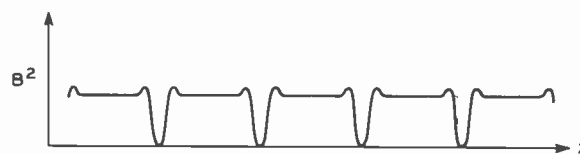

Fig. 4—The variation of magnetic focusing force with distance (since force is proportional to B^2).

In order to circumvent the disturbance experienced by an electron in going between two lenses, J. R. Pierce has proposed peaking the field in the manner shown in Figs. 3 and 4. As can be seen from (3), it is the square of the magnetic field which determines the inward focusing force on the electrons. If the peaking of the magnetic

field is properly adjusted the average impulse that an electron receives in crossing a transition between two lenses can be made zero. That is,

$$B^2 < \text{average} > = B_0^2$$

For this condition one might expect an electron to traverse the transition with a minimum disturbance.

If in addition to the above requirement the peaks and troughs of Fig. 4 are adjusted so that the fundamental Fourier component is absent, then the lowest order stop band will have been eliminated. In principle this argument can be extended to the second, third, and higher harmonics. As demonstrated by Pipes⁴ for any periodic waveform of the form in Fig. 4, the first unstable region of Hill's equation occurs when the natural period of the wave solution is twice the period of the lowest order harmonic of the square of the magnetic field as shown in Fig. 5. We are again assuming that the terms in $1/y$ and $1/y^3$ do not materially alter the stability criterion.

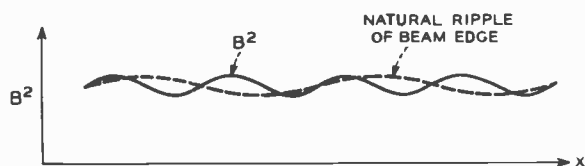

Fig. 5—The conditions for the first unstable region, where the ripple period equals twice the period of B^2 .

The process of limiting the harmonic content of the magnetic field and thereby removing stop bands has certain physical limitations in that the resulting wave shape must be producible with a physical structure. Cut-and-try procedures based on the above indicate that the best structure seems to be one in which the transition is made as short as possible and the impulse made to be zero. Any further refinement seems to complicate the system disproportionately.

Traveling-wave tubes are relatively short in terms of the number of magnetic lenses necessary to focus the beam. If the operation is such that the beam radius is diverging exponentially, it may not appreciably effect the current transmission if the divergence is slow enough. Thus a stop band does not always imply no transmission. Many uniform solenoids have small periodic perturbations of field strength which in theory produce stop bands although these are not detected by observing percentage transmission of beam current.

In order to obtain quantitative measurements, (3) with a B of the form shown in Fig. 3 was solved on the analog computer for various magnitudes of B and B_c (field strength at the cathode). The particular form of B was chosen because it resembled a physical structure under investigation.

⁴ L. A. Pipes, "Matrix solution of equations of the Mathieu-Hill type," *Jour. Appl. Phys.*, vol. 24, pp. 902-910; July, 1953.

J. W. Sullivan of these Laboratories, during the course of his investigations of focusing a low noise traveling-wave tube, analyzed the above wave in terms of its Fourier expansion. The results are given in Fig. 6. Although the first and third harmonics are present to some extent the instability was associated with the fourth harmonic (that is, the period of the beam profile just prior to the unstable point was approximately twice that of the fourth harmonic). This is not unusual since the amplitude of the fourth harmonic is quite large compared to the rest. There are two explanations for the apparent absence of instability for the first and third harmonics. First, the width of a stop band is proportional to the amplitude of the corresponding sinusoidal component in the magnetic field. The width may have been so small we inadvertently missed it. Second, the degree of divergence (the rate of growth of the beam profile) is also proportional to the magnitude of the sinusoidal component, and because this was small for the first and third harmonics, they might have gone undetected since only about 10 periods were followed on the computer (for the case studied this represents a length of travel for the beam greater than any practical traveling-wave tube).

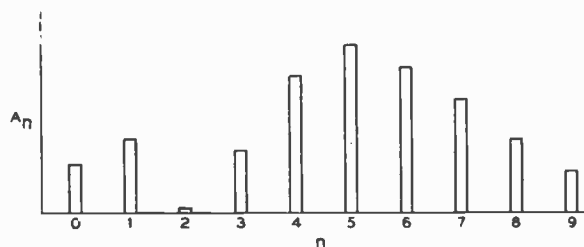

Fig. 6—Fourier components of the peaked magnetic field $B = B_0 + \sum A_n \cos nx$.

CONCLUSION

To summarize it can be said that some of the foregoing relationships appeared as somewhat of a surprise to the author. The fact that the balance conditions require a high percentage of flux threading the cathode for a relatively small increase in magnetic field above the Brillouin value is not generally known. For these conditions it is possible in principle to obtain a beam with a more uniform current density and smaller perturbations of the beam edge than is the case for Brillouin focusing. The presence of some magnetic field at the cathode tends to inhibit the motion due to thermal velocities and therefore can be very useful especially with high-density beams. It is interesting that these principles hold equally well for uniform or periodic fields.

ACKNOWLEDGMENT

The author owes a great deal to C. C. Cutler of these Laboratories for suggesting the approach to the problem used in this paper.

The Mitron—An Interdigital Voltage-Tunable Magnetron*

J. A. BOYD†, MEMBER, IRE

Summary—This paper describes a voltage-tunable magnetron which can be electronically tuned in the frequency range 1,500 to 3,500 mc. This tube delivers a useful power output of approximately 200 mw and, when used as a local oscillator in a microwave receiver, gives a noise figure 3 db greater than is obtained when a reflex klystron is used with the same receiver. It is shown that temperature-limited operation of the cathode is necessary for coherent operation of the tube and that the operating voltage is greater than that predicted by the Hartree relation. The relation of tube operation and circuit parameters is discussed.

INTRODUCTION

THIS PAPER describes the design, construction and operation of a microwave generator that can be used in many of the applications where electronically-tunable power is needed. This generator consists of an external-cavity interdigital magnetron, which has been called a mitron, and its associated cavity structure. The mitron can be electronically tuned in the frequency range of 1,500 to 3,500 mc and delivers a useful power output in the order of 200 mw.

The frequency of operation of the mitron can be made dependent on the anode potential for certain operating conditions. This mode of operation has been called "voltage tuning," and is defined here as the variation in the frequency of the output signal from a magnetron as the anode potential is varied (when the dc anode current, magnetic field, and load impedance are maintained constant).¹ Voltage-tuning was first observed by P. H. Peters and D. A. Wilbur.² Using conventional power magnetrons with special low- Q or nonresonant circuits, they obtained voltage-tuning in the frequency range 500 to 1,000 mc. Dr. J. S. Needle³ obtained voltage-tuning in the frequency range of 2,000 to 3,000 mc, using a bar-and-vane type magnetron structure. The power output from this tube was in the order of 10 to 30 microwatts of coherent signal power.

Significant results which are discussed in this paper are: (1) the operation of voltage-tunable magnetrons, with useful power output, has been obtained in the frequency range 1,500 to 3,500 mc, as compared to the 500 to 1,000 mc range at the General Electric Company;

(2) much higher power has been obtained than was obtained by Needle; (3) much data have been obtained which contribute to knowledge of the operation of voltage-tunable magnetrons.

DESIGN OF MITRON AND CAVITY

Design of Cavity

In the design of this magnetron and its cavity, two factors were considered essential if a satisfactory voltage-tunable magnetron was to be developed. These factors were: (1) low anode-to-anode capacitance; and (2) A high-impedance external cavity, the impedance being a slowly varying function of frequency (by high impedance, we mean in the order of 100 ohms).

The interdigital anode structure is adaptable to mounting in a waveguide structure and was selected for this reason. It also has wide-range tuning possibilities and is mechanically simple.

The ridge waveguide offers a possibility for increasing the circuit impedance over that of a rectangular waveguide for a given spacing between anode supports. The ridge waveguide is characterized by its lowered cut-off frequency and lowered impedance (compared with a rectangular guide of equal dimensions), and by a wide bandwidth free from higher-mode interference.

A section of standard S-band rectangular waveguide was used with a ridge 0.84 inch high and 1.0 inch wide. This structure has a characteristic impedance at infinite frequency of 160 ohms and a cut-off frequency of 1,250 mc. Since it is desirable to have a coaxial output from the mitron, a tapered-ridge waveguide-to-coaxial-line junction was used to terminate each end of the ridge waveguide. This arrangement is shown in Fig. 1, facing page. Junctions used are based on a design given by Cohn.⁴ They have an upper cutoff frequency of approximately 4,800 mc; therefore, when used with a ridge waveguide give a very wide-band structure.

Design of Mitron

The Interaction Space: In the design of the interaction space for the mitron, there were two factors, the anode-to-anode capacitance and the shape of the anode bars, which were considered to be critical to voltage-tunable operation. Thus, in addition to the usual consideration of current, voltage, frequency, magnetic field and in-

* Original manuscript received by the IRE, September 22, 1954; revised manuscript received, December 9, 1954. This work was supported in part by the U. S. Army Signal Corps.

† Dept. Elec. Engrg., Univ. of Michigan, Ann Arbor, Mich.

¹ H. W. Welch, Jr., "Prediction of traveling-wave magnetron frequency characteristics: frequency pushing and voltage tuning," Proc. I.R.E., vol. 41, pp. 1631-1653; November, 1953.

² D. A. Wilbur, R. B. Nelson, P. H. Peters, A. J. King, and L. R. Koller, "C. W. Magnetron Research," Final Rept., Contract No. 2-36-039 sc32279, Res. Lab., Gen. Elec. Co.; April, 1950.

³ J. S. Needle, "The Insertion Magnetron," Univ. of Michigan Electron Tube Lab. Tech. Rep. No. 11; August, 1951.

⁴ Radio Research Laboratory Staff, Harvard University, "Very High Frequency Techniques," vol. II, McGraw-Hill Book Co., Inc., New York, N. Y.; 1947.

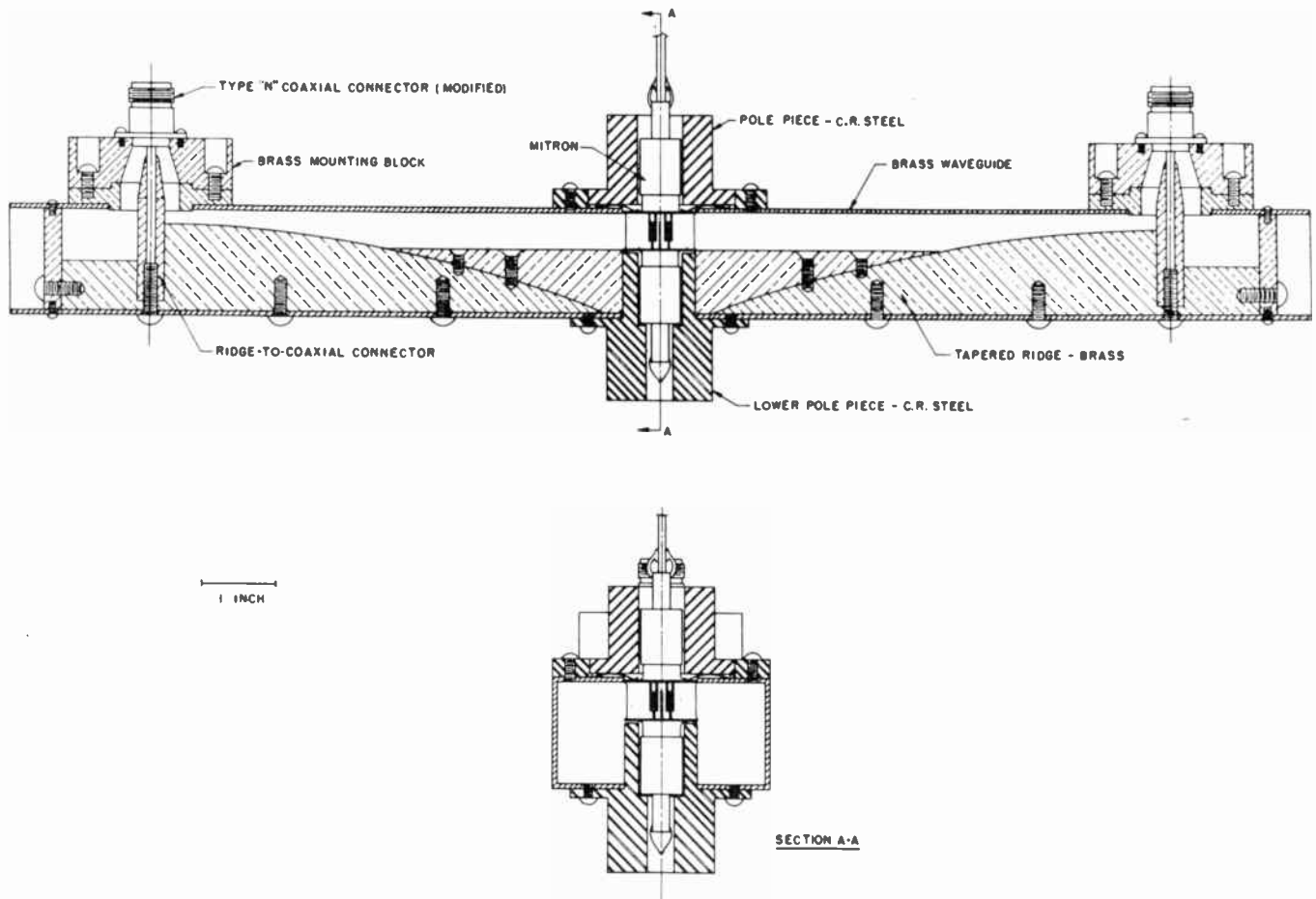

Fig. 1—Dual output cavity for mitron.

interaction space dimensions, special attention was given to these two parameters.

Hull⁵ has suggested that the operation of a typical magnetron can be improved by redesigning the interaction space to reduce the higher order space (or Hartree) harmonics of the rf field. On the basis of these considerations, and the fact that round anode bars give less anode-to-anode capacitance, it was decided to use round anode bars in the design of the mitron.

Listed below are the values of the parameters which resulted from the design of the interaction space.

$f = 3,000$ mc (chosen to suit available test equipment)

$P_i = 50$ watts

$I_p = 0.050$ ampere (required to satisfy the maximum power demand at an anode voltage of 1,000 volts)

$N = 12$ (number of anode bars, based on existing magnetrons)

$r_c/r_a = 0.75$

$d_a = 0.030$ inch (diameter of anode bars)

$r_a = 0.205$ inch (determined by size of molybdenum

rod available, and anode radius of existing magnetrons)

$L_c = 0.150$ inch (length of emitting surface on cathode required to satisfy maximum power requirements with a safety factor of two)

$l_a = 0.290$ inch (overlap length of anode bars; chosen to allow for length of emitting portion of cathode and end hats)

$E_0 = 250$ volts

$B_0 = 550$ gauss

$C_p = 0.9 \mu\mu\text{f}$ (anode-to-anode capacitance, no cathode present).

The Magnetic Circuit: In the design of the magnetic circuit there were two factors which were considered to be important to the successful operation of the tube: (1) that the magnetic field be as nearly uniform as possible throughout the interaction space, and (2) that relatively high fields, in the order of 3,000 gauss, be obtained without unreasonable requirements for an electromagnet. Fig. 2 (next page) shows the mitron with an oxide-coated cathode in place. As indicated, the iron pole pieces (part 1) serve as anode supports. The molybdenum anode rods are brazed onto the pole pieces. Parts 2 and 3 are made of Kovar to facilitate making the glass seals as indicated.

⁵ J. F. Hull, "Analysis of a Magnetron Interaction Space for Elimination of Hartree Harmonics," Memo. Rep., SCCSCL-RTB2, Proj. 322A, Evans Signal Lab.; January, 1951.

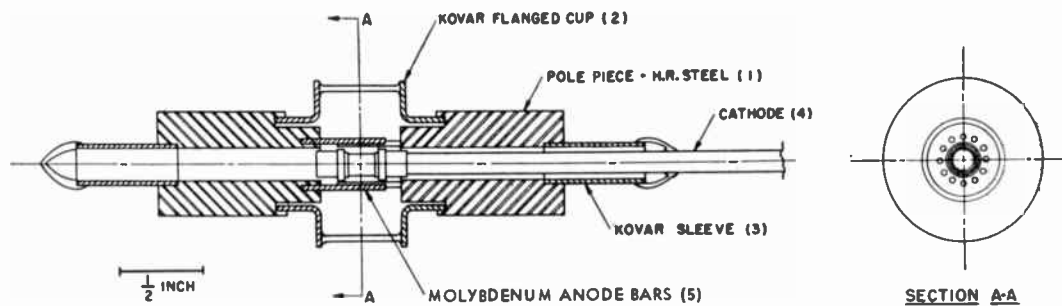

Fig. 2—Mitron.

PERFORMANCE OF THE MITRON

Several types of cathodes have been used in the mitron; namely, oxide-coated, thoriated tungsten, tungsten, and a button cathode. Results of this investigation indicate, as expected, that the pure tungsten cathode is most satisfactory for use in the mitron. The first tube constructed used an oxide-coated cathode. This tube could not be operated cw because backheating prevented control of the cathode temperature required for coherent operation of the tube. The thoriated tungsten cathode made possible the cw operation of the tubes but was more sensitive to backheating than the pure tungsten cathode. The tube using a button cathode could only be operated under pulsed conditions because of the backheating of the cathode. For coherent operation of the tube, it was necessary to operate the cathode under temperature-limited conditions.

Typical data from a mitron which used a tungsten cathode are presented. This tube was tested under dynamic operating conditions. Results are shown in Figs. 3 and 4 (opposite). The conditions of operation are indicated on the figures. A 60-cycle voltage was superimposed upon the dc anode potential, giving an anode-voltage swing of 900 volts. Filament power was supplied from a battery to eliminate the frequency modulation caused by the variation of the magnetic field which is produced by an ac heater current. Fig. 3 shows the variation of the frequency with the anode voltage.

In addition to the voltage-tunable mode indicated in Fig. 3, there were two other modes which were very weak, but still detectable over portions of the voltage range. One of these modes tuned from 2,845 mc at 2,100 v to 3,170 mc at 2,300 v; the second tuned from 4,080 mc at 2,050 v to 4,370 mc at 2,200 v. In the voltage range 2,350 to 2,850 only the main mode was present. Under certain conditions of operation, there are discontinuities in the operation of the main mode. These discontinuities in the operation are detectable in either the power output or anode current curves. Frequency deviations of 400 to 600 mc can be obtained with no difficulty in maintaining continuous operation; for frequency deviations of the order of 800 to 1,000 mc, the adjustment of the cathode temperature becomes more critical.

With the modulation voltage reduced to 450 v peak-to-peak, the frequency of operation could be shifted as much as 50 mc by varying the filament heater current

and still maintain coherent operation over the voltage range. An increase in cathode temperature decreases the frequency of oscillation. The tube seemed to operate best at, or near, the lowest cathode temperature.

For cw operating conditions, it was possible to vary the filament current from 8.9 to 9.3 amperes and still maintain a coherent signal output. The power output varied from 52 mw at an anode current of 5 ma to 350 mw at an anode current of 18.75 ma. The corresponding frequency variation was from 2,450 mc to 2,320 mc.

Fig. 4 shows the variation in power output and anode current with the anode voltage. The frequency range in Fig. 4 is approximately 900 mc (as shown in Fig. 3) and the peak power is of the order of 550 mw. Fig. 4 shows the variation of anode current with anode voltage, the average current being approximately 12 ma. It should be noted that there are no discontinuities in the operation and it was determined that the tube was oscillating coherently throughout the range. The decrease in the power output in the right (high frequency) side of Fig. 4(a) is due to the loading resulting from the cathode circuit at that frequency.

This tube was operated with battery supplies for the filament and anode, and a regulated power supply for the electromagnet. Under these conditions, the output signal (as observed on a spectrum analyzer) was stable; no jitter was present in cw operation. The output could be tuned over several hundred mc without readjusting the cathode temperature.

Satisfactory operation was obtained with anode voltages as low as 800 v and frequencies in the order of 2,000 mc. Under these conditions the output power was reduced, but the signal was stable and relatively free of noise.

A modification was made in the cathode helix so that the resonance between the helix and the coaxial filament lead was outside the frequency range of tube operation. Typical data from tubes using this cathode are shown in Fig. 5 (facing page). There, the frequency was varied from 2,190 mc to 3,330 mc, by applying a sine wave modulating voltage with an amplitude of 530 v peak-to-peak. The power output at the center of the range was 185 mw. It was determined that the tube was oscillating coherently throughout the range; there were no discontinuities in operation, and only one mode of operation was detectable.

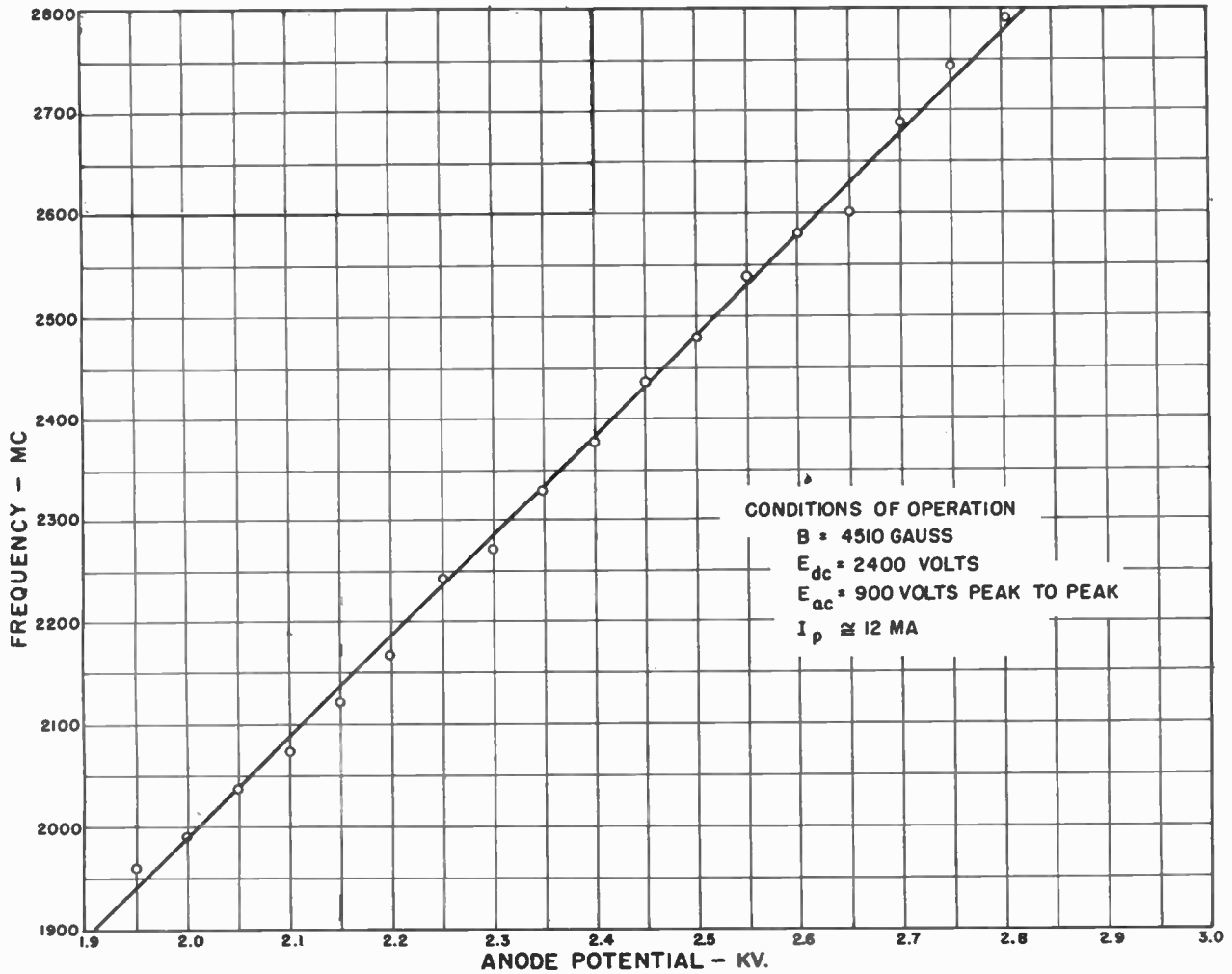

Fig. 3—Frequency vs anode potential.

An electronic controller has been used to maintain the dc anode current constant by controlling the filament power. This arrangement makes it possible to operate the mitron cw in the frequency range indicated in Fig. 5 without requiring manual readjustment of parameters other than anode potential. The tubes have been operated with permanent magnets, dc filament supply, and voltage regulated anode supply; under

these conditions the output signal is stable. The output is sensitive to mismatches in the rf circuit, in some cases causing spurious oscillations and discontinuities in operation to occur. With a well-matched circuit, a single mode of operation is obtained with no discontinuities.

The mitron has been used as the local oscillator of a microwave receiver. The noise figure of the receiver (which consisted of a wide-band crystal mixer, a 30 mc IF amplifier with a 3 db bandwidth of 2 mc, and a de-

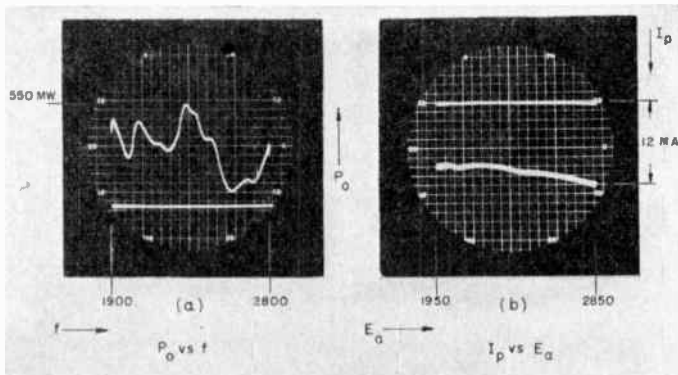

Fig. 4—Power and current characteristics.
 $B = 4,510$ gauss
 $E_{dc} = 2,400$ volts
 $E_{ac} = 900$ volts peak-to-peak
 $I_p \approx 12$ ma.

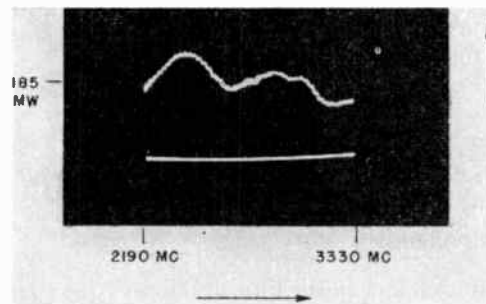

Fig. 5—Power vs frequency characteristics.
 $B = 2,200$ gauss
 $E_{dc} = 1,425$ volts
 $E_{ac} = 530$ volts peak to peak
 $I_p \approx 13.6$ ma.

tor) was measured, using first the mitron and then a reflex klystron as the local oscillator. When a klystron was used as the local oscillator a noise figure of 8.5 db was obtained. When the mitron was used as the local oscillator, noise figures of 10.5 to 12.5 db were obtained. These variations in the noise figure have been attributed to variations in the anode current. The noise figure obtained with the mitron was sensitive to the anode current; a change in the anode current of 0.3 ma from the optimum caused an increase of 6 db in the noise figure. Measurements have been made in the frequency range 2,600 to 3,000 mc. The noise figure obtained with the mitron does not change much with frequency.

EFFECTS OF CIRCUIT DESIGN ON PERFORMANCE

The power output of the mitron has been shown to be very closely related to the total shunt impedance of the rf circuit, the power being a minimum when the shunt impedance is a minimum. With a wide-band nonresonant circuit, the peak power output was in the order of 500 mw; however, when the shunt impedance of the rf circuit was increased by shorting one end of the cavity, power output of 4 w was obtained. Under these conditions the frequency of the output signal could be varied by as much as 200 mc by varying the anode voltage.

Fig. 6 shows an approximate equivalent circuit for the mitron and its associated cavity. Fig. 6(a) is a first approximation in which the various elements are defined as follows: I_θ is a current generator representing the rf current induced in the circuit by the space charge. θ is the phase angle between the rf voltage and rf current, the relation being

$$|Y_T| |\theta| = \frac{I_\theta}{E_{rf}}$$

where I_θ and E_{rf} are rms values, θ being defined so that it is negative for a lagging current.

C_p is the total capacitance between anode sets, equal to approximately $1 \mu\mu f$.

L_p is the equivalent inductance of the anode bars between the interaction space and the anode supports, equal to approximately $130 \mu\mu h$.

X_c is the impedance of the coaxial line formed by the cathode support and the pole piece looking out from the cathode; its value given approximately by

$$X_c = -jZ_{01} \cot \frac{2\pi l}{\lambda}, \tag{1}$$

where

- $Z_{01} = 28.5$ ohms (characteristic impedance of the line)
- l = length of the line.
- λ = wavelength.

This assumes losses in the line, and losses due to radiation from extension of the center conductor, to be negligible.

C_1 and C_2 are the capacitances between end hats and respective anode sets.

G_t is the equivalent conductance representing the losses in the waveguide portion of the structure.

Z_1 is the rf impedance of cathode surface between end hats.

Z_2 is the rf impedance of the coaxial line formed by the filament leads.

T_1 and T_2 represent the waveguide-to-coaxial junctions, assumed to be ideal transformers.

Z_{L1} and Z_{L2} are the external loads connected to the coaxial output terminals.

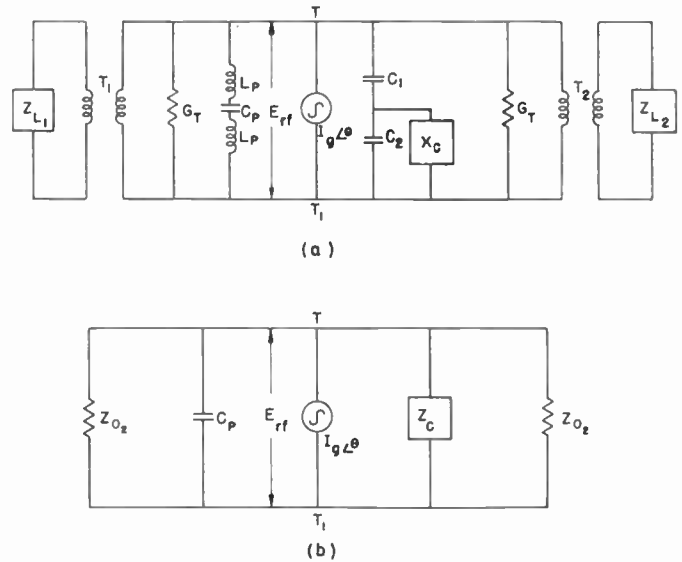

Fig. 6—Equivalent circuit of mitron.

In Fig. 6(a) (above) it has been assumed that $Z_1 = 0$; in Fig. 6(b), a helical cathode is assumed which gives a finite value to Z_1 . Fig. 6(b) represents a second approximation in which it has been assumed that the coaxial output terminals are terminated in their characteristic impedances and that the losses in the waveguide are negligible compared to the load. Since the reactance due to $2L_p$ is never more than 10 per cent of the reactance due to C_p , X_{Lp} is neglected. Z_{02} is the characteristic impedance of the ridge waveguide, assumed to be a pure resistance given by

$$Z_{02} = Z_\infty \frac{1}{\sqrt{1 + \left(\frac{f_c}{f}\right)^2}} \tag{2}$$

Let

$$Z_c = X_1 + X_2 + Z_3,$$

where

$$X_1 = \frac{1}{j\omega C_1}$$

$$X_2 = \frac{1}{Z_c + \frac{1}{j\omega C_2}}$$

$$Z_2 = -jZ_{03} \cot \frac{2\pi l}{\lambda}$$

$$Z_3 = \frac{Z_1 Z_2}{Z_1 + Z_2}$$

$Z_{03} = 39.2$ ohms (characteristic impedance of coaxial filament line).

The admittance of the circuit shown in Fig. 6 may therefore be expressed as

$$Y_T' = \frac{2}{Z_{03}} + j\omega C_p + \frac{1}{Z_c} \quad (3)$$

Since Z_c is a complex impedance, it is this term in (3) which causes the greatest variation in total impedance with frequency.

Effect of Cathode on Performance

Experience has shown that an oxide-coated cathode is unsatisfactory for coherent voltage-tunable operation of the mitron. It has been possible to obtain coherent voltage-tunable operation using oxide cathodes. However, the mode of operation was very sensitive to the cathode temperature, and the operation of the tube was unstable due to the backheating of the cathode.

A pure tungsten cathode which operates at approximately 2,200 degrees Centigrade was found to be most suitable for voltage-tunable operation for obtaining a coherent signal. The operation of the mitron is sensitive to the temperature of the cathode, but the filament input power can be adjusted to give stable, coherent operation.

The improvement in voltage-tunable operation of the mitron with the use of a pure tungsten cathode is attributed primarily to the fact that more filament power is required for the pure tungsten cathode than for either the thoriated tungsten or oxide cathode. The emission from both oxide and thoriated tungsten cathodes is unstable and tends to cause the anode current to "run away." It is impossible to determine from presently available data the exact operating conditions at the cathode for voltage-tunable operation. It has been determined experimentally that the mode of operation is sensitive to the cathode temperature and that the mitron anode current varies with the temperature of the cathode.

Requirement for Temperature-Limited Operation of the Cathode

In the mitron there is a range of anode current for which a coherent signal is produced; for values of anode current above and below this range noncoherent signals are produced. The sensitivity of the mitron operation to cathode temperature may be attributed primarily to the low impedance which the anode and cavity structure presents to the electron stream.

Experimental data, obtained from Model 9 (bar-and-vane structure³) and mitrons, indicate that one of the most important parameters in obtaining voltage-tunable operation is the impedance presented to the electron stream by the anode and cavity structure. Coherent operation was obtained in the Model 9 magnetron with anode currents in the order of 100 μ a. The operation was very sensitive to cathode temperature and coherent operation was obtained over a very narrow range of anode current. Coherent operation of a mitron has been obtained with anode currents in the order of 5 to 20 ma. The interaction space in the two tubes is quite similar. The most significant differences are in the anode-to-anode capacitance and in cavity impedance. The anode-to-anode capacitance in the Model 9 is approximately 2 μ mf and in the mitron approximately 1 μ mf; the cavity impedance in the Model 9 is 25 ohms and in the mitron it is 80 ohms.

It is believed that voltage-tunable operation of a magnetron can be obtained under space-charge limited operation of the cathode if the impedance of the cavity and anode structure can be made sufficiently large.

FREQUENCY VS ANODE VOLTAGE CHARACTERISTICS FOR VOLTAGE-TUNABLE MAGNETRONS

In order to compare the voltage-tuning characteristics of all tubes, an equation describing the frequency-anode voltage characteristic for a voltage-tunable magnetron has been derived. This equation is arranged in nondimensional form so that all experimental data can be compared with the theoretical expression by using a graphical presentation. This derivation is based on the equations for the high- Q magnetron; however, the results obtained should approximately describe the behavior of the low- Q voltage-tunable magnetron.

By combining the following well-known expressions:

$$E_H = B \frac{\omega_n}{2} r_a^2 \left(1 - \frac{r_c^2}{r_a^2}\right) - 1/2 \left(\frac{m}{e}\right) r_a^2 \omega_n^2 \quad (4)$$

(Hartree equation)

$$E_n = \frac{B^2 e}{8m} r^2 \left(1 - \frac{r_c^2}{r_a^2}\right)^2 \quad \text{(Hull cut-off potential)} \quad (5)$$

$$B_0 = \frac{2 \frac{m}{e} \omega_n}{\left(1 - \frac{r_c^2}{r_a^2}\right)} \quad (6)$$

$$E_0 = \frac{m}{2e} r_a^2 \omega_n^2 \quad \text{(synchronous energy equation)} \quad (7)$$

$$\frac{E_H}{E_0} = \frac{2B}{B_0} - 1 \quad \text{(normalized Hartree equation)}, \quad (8)$$

we obtain⁶

⁶ J. A. Boyd, "A Voltage-Tunable Magnetron for Operation in the Frequency Range 1500 to 3000 Megacycles," Univ. of Michigan, Electron Tube Lab. Tech. Rep. No. 15; November, 1953.

$$\frac{f}{f_0} = \left[1 - \sqrt{1 - \frac{E_H}{E_u}} \right], \quad (9)$$

where

E_H = threshold potential

E_u = Hull cut-off potential

f_0 = is the frequency of the current induced in the anodes by an electron at the anode with a tangential energy of E_u .

$$f_0 = \left[\frac{E_u e}{m 2 \pi^2} \right]^{1/2} \frac{n}{r_a} \quad (10)$$

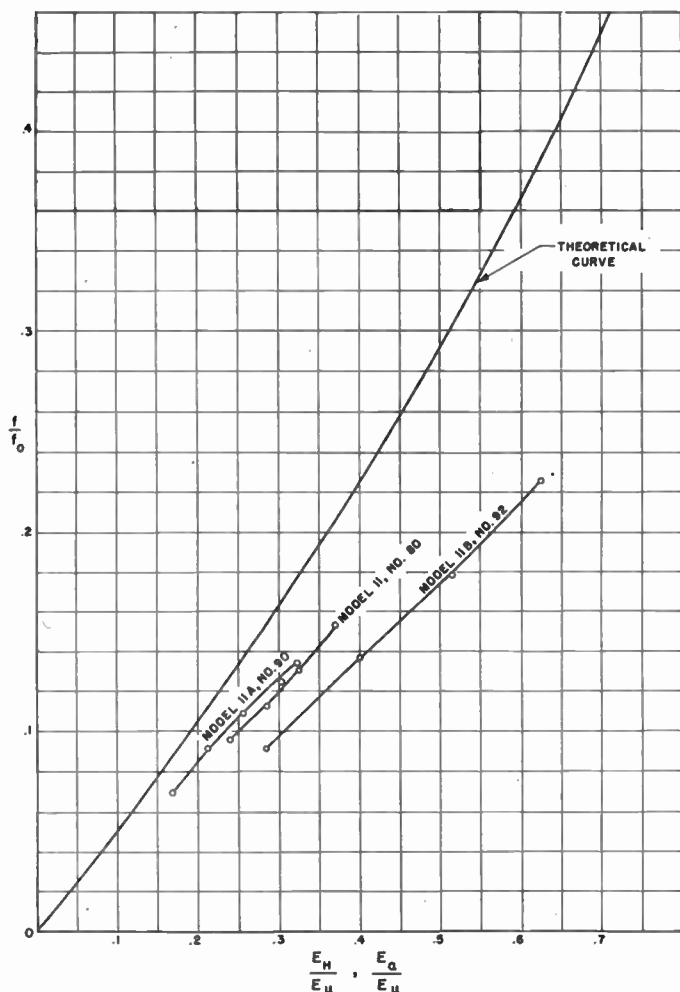

Fig. 7—Typical voltage tuning characteristics for Models 11, 11A, and 22B. π -Mode of operation assumed $n = N/2 = 6$.

Fig. 7 shows the theoretical tuning curve plotted for comparison with the experimental curves for three forms of the tube. In plotting the experimental data, f is the operating frequency and E_a is the anode potential; E_u and f_0 were determined from the operating conditions assuming π -mode of operation. It should be noted that all forms of the tube had essentially linear-tuning characteristics and all tubes operated at higher anode potentials than indicated by the Hartree equation, when

π -mode of operation is assumed. It was assumed that the mitron would operate in the π -mode. Rotating-probe measurements on this tube and its associated cavity structure show that with an rf voltage applied to one of the output terminals of the cavity, a π -mode voltage distribution does exist on the anode bars.

It can be shown that if one assumes the presence of radial energy of the electrons that threshold potentials above the Hartree potential will be obtained.⁶ There is experimental evidence that electrons in the mitron do possess considerable radial energy; therefore, it is concluded that the high operating potentials are at least in part due to the fact that the electrons arrive at the anode with considerable radial energy.

CONCLUSIONS

A voltage-tunable magnetron has been developed with operating characteristics that make the tube useful as a source of microwave power. It has been shown that the tube is satisfactory as the local oscillator of a spectrum analyzer and as an rf power source for most rf measurement applications. Noise figure measurements indicate that by using a balanced mixer it may be feasible to use the mitron as the local oscillator in microwave receivers.

A pure tungsten cathode was found to give better voltage-tunable operation than either an oxide-coated or a thoriated-tungsten cathode. The cathode support and the filament leads were found to cause variations in the power output of the tube.

With the present circuit arrangement, the anode-to-anode capacitance appears to be the limiting factor in obtaining higher power from the tubes. A reduction in the value of this capacitance is necessary if significantly higher power is to be obtained. Some improvement in efficiency and power output may be obtained by increasing the external circuit impedance although the improvement to be obtained in this way is limited.

The operating anode voltage was found to be higher than predicted by the Hartree equation, assuming π -mode of operation. This increase in operating voltage is attributed in part to the electrons reaching the anode with considerable radially-directed velocity. It is proposed that the sensitivity of voltage-tunable operation to cathode temperature is due primarily to the low impedance which is presented to the electrons by the anode and cavity structure.

ACKNOWLEDGMENT

The author wishes to acknowledge the contribution to this work made by other members of the Department of Electrical Engineering staff. Profs. W. G. Dow, G. Hok, H. W. Welch, Jr., J. S. Needle, and Mr. J. R. Black have contributed much by their helpful criticisms and discussions. The tubes and test equipment were constructed in the Electron Tube Laboratory, under the supervision of J. R. Black.

Resonant Behavior of Electron Beams in Periodically Focused Tubes for Transverse Signal Fields*

R. ADLER†, FELLOW, IRE, O. M. KROMHOUT†, ASSOCIATE, IRE, AND
P. A. CLAVIER†, MEMBER, IRE

Summary—A ribbon beam which is focused by a series of bi-dimensional electrostatic lenses exhibits a well-defined transverse resonance within a certain range of focusing conditions. The frequency of the resonance is derived for the case of a simple space-periodic focusing field; it is also shown that the focusing field determines the current density in the beam (and thus, in practice, the maximum usable beam current). An experiment is described which demonstrates by means of a transverse signal field the existence of the transverse electron resonance.

SPACE-PERIODIC fields symmetrical with respect to a center plane x, z are of interest in tubes which use ribbon or sheet beams. A simple solution exists for the motion of an electron, traveling initially with the velocity $u_0 = dz/dt$ at the distance y_0 from the center plane, through a stationary field of the form

$$V = V_0(1 + \epsilon \sin \nu z \cosh \nu y), \quad (1)$$

under these two restrictions: (weak field)

$$\epsilon \ll 1 \quad (2)$$

and (electron close to axis)

$$y \ll \frac{1}{\nu}. \quad (3)$$

The derivation proceeds as follows: If ϵ were zero, the electron would continue along a straight line $y = y_0$. If ϵ is finite but very small, two first-order effects appear: a periodic variation of the velocity component $\partial z/\partial t$ about the average u_0 , and a periodic variation of y (ripple) about the average y_0 . Each of these perturbations cooperates with the periodic field to produce a second-order effect—a force component which, when averaged over one spatial period, is different from zero. These two average force components can be determined separately and added.

The following equations are needed in the derivation: From (3) follows

$$\cosh \nu y \sim 1 + \frac{1}{2}(\nu y)^2. \quad (4)$$

The dc potential V_0 is related to the average velocity u_0 as follows:

$$2 \frac{e}{m} V_0 = u_0^2. \quad (5)$$

Contribution from variation of the velocity component $u = \partial z/\partial t$ is considered first. The instantaneous

velocity is

$$u = u_0 \left(1 + \frac{\epsilon}{2} \sin \nu z \right). \quad (6)$$

Hence

$$\frac{dt}{dz} = \frac{1}{u} = \frac{1}{u_0} \left(1 - \frac{\epsilon}{2} \sin \nu z \right). \quad (7)$$

Transverse field at distance y_0 from axis:

$$\frac{\partial V}{\partial y} = V_0 \epsilon \sin \nu z \cdot \nu^2 y_0. \quad (8)$$

Instantaneous transverse force:

$$f = e \frac{\partial V}{\partial y} = e V_0 \epsilon \sin \nu z \cdot \nu^2 y_0. \quad (9)$$

Transverse impulse per unit length of travel:

$$f \frac{dt}{dz} = e V_0 \epsilon \sin \nu z \cdot \nu^2 y_0 \cdot \frac{1}{u_0} \left(1 - \frac{\epsilon}{2} \sin \nu z \right). \quad (10)$$

Time average of force over one full period of $\sin \nu z$

$$\begin{aligned} &= \text{time average of } e V_0 \epsilon \sin \nu z \cdot \nu^2 y_0 \left(1 - \frac{\epsilon}{2} \sin \nu z \right) \\ &= -\frac{1}{4} e V_0 \epsilon^2 \nu^2 y_0. \end{aligned} \quad (11)$$

Contribution from periodic variation of y (ripple) is considered next. The transverse force from (9),

$$f = e V_0 \epsilon \sin \nu z \cdot \nu^2 y_0,$$

can be expressed as a function of time:

$$f = e V_0 \epsilon \sin u_0 \nu t \cdot \nu^2 y_0. \quad (12)$$

The expression y_0 now designates the distance from the axis averaged over one ripple in the trajectory caused by the periodic force. The ripple Δy is obtained by dividing (12) by the electron mass m and integrating twice with respect to time:

$$\Delta y = -\frac{1}{u_0^2 \nu^2} \frac{e}{m} V_0 \epsilon \sin u_0 \nu t \cdot \nu^2 y_0, \quad (13)$$

or, substituting from (5),

$$\frac{e}{m u_0^2} = \frac{1}{2 V_0};$$

$$\Delta y = -\frac{1}{2} \epsilon \cdot \sin u_0 \nu t \cdot y_0; \quad (14)$$

or in terms of z :

* Original manuscript received by the IRE, June 23, 1954; revised manuscript received October 29, 1954.

† Zenith Radio Corp., Chicago, Ill.

$$\Delta y = -\frac{\epsilon}{2} \sin \nu z \cdot y_0. \tag{15}$$

Thus the trajectory perturbed by ripple will be

$$y = y_0 + \Delta y = y_0 \left(1 - \frac{\epsilon}{2} \sin \nu z \right). \tag{16}$$

Transverse force (9) is proportional to y . Taking this into account to get the second-order term, one finds

$$e \frac{\partial V}{\partial y} = e V_0 \epsilon \sin \nu z \cdot \nu^2 y = e V_0 \epsilon \sin \nu z \cdot \nu^2 y_0 \cdot \left(1 - \frac{\epsilon}{2} \sin \nu z \right). \tag{17}$$

This has the time average (taken over one period of νz)

$$-\frac{1}{4} e V_0 \epsilon^2 \nu^2 y_0. \tag{18}$$

The two contributions are equal and add up to $-\frac{1}{2} e V_0 \epsilon^2 \nu^2 y_0$. This has the form of an elastic restoring force; it could be ascribed to a fictitious electric field E_e (in the following called the elastic field) of the form

$$E_e = -K y_0 = -\frac{1}{2} V_0 \epsilon^2 \nu^2 y_0. \tag{19}$$

The gross behavior of the electron, disregarding the small ripples and velocity variations which correspond to $\sin \nu z$, is determined by this elastic field. In such a field an electron performs transverse oscillations of the form $y = y_0 \cdot \cos \omega_e t$ where ω_e , the angular frequency of transverse electron resonance, is

$$\omega_e = \sqrt{K \frac{e}{m}} = \sqrt{\frac{1}{2} \frac{e}{m} V_0 \cdot \epsilon \nu}, \tag{20}$$

and by substituting (5),

$$\omega_e = \frac{\epsilon}{2} u_0 \nu. \tag{21}$$

Dividing by u_0 , we find $\omega_e/u_0 = (\epsilon/2)\nu$. The length of one wave of the trajectory caused by the transverse oscillations is $\lambda_e = 2\pi u_0/\omega_e$; the spatial period of the field is $s = 2\pi/\nu$; thus we obtain

$$\lambda_e = s \cdot \frac{2}{\epsilon}. \tag{22}$$

Since $\epsilon \ll 1$, the concept of many spatial periods per wavelength is justified.

So far, this derivation has been concerned with a single electron. Let us now assume a sheet beam of charge density ρ , centered about $y=0$ and thin enough to meet (3). The space charge produces a field

$$\frac{\partial V}{\partial y} = \rho y. \tag{23}$$

If the beam is stable, the elastic field must balance the space charge field:

$$\frac{1}{2} V_0 \epsilon^2 \nu^2 = \rho. \tag{24}$$

Also, since $\omega_e^2 = \frac{1}{2} (e/m) V_0 \epsilon^2 \nu^2$ [from (20)], we can write

$$\omega_e^2 = \frac{e}{m} \rho. \tag{25}$$

Thus the transverse resonance frequency ω_e equals the plasma frequency (as was pointed out by D. A. Dunn of Stanford University). The elastic field acts somewhat like a stationary positive plasma, in the center of which a beam of equal negative density is stable.

If the beam is displaced from the center plane by y_B , the space charge field becomes

$$\frac{\partial V}{\partial y} = \rho(y - y_B). \tag{26}$$

The elastic field E_e is still

$$E_e = -\frac{1}{2} V_0 \epsilon^2 \nu^2 y.$$

Then if (24) holds, there remains only a residual field

$$\frac{\partial V}{\partial y} = -\rho y_B = -\frac{1}{2} V_0 \epsilon^2 \nu^2 y_B. \tag{27}$$

This acts upon the entire beam as if all electrons were at y_B . Thus, the entire beam as a unit is capable of resonant transverse motion according to (20) and (22), just like a single electron.

It should be remembered that these conclusions apply only under the restrictions $\epsilon \ll 1$ (weak field) and $y \ll (1/\nu)$ (narrow strip along center plane). The first restriction excludes the stop bands observed in stronger fields; the second rules out some tubes, because of their construction. One might thus think that the derivations had no practical application.

We have found, however, that the transverse resonance at ω_e dominates that class of tubes designed to work with transverse signal fields. In such tubes it is vital that all parts of the beam move together under the influence of a signal field. To insure this, the displacement of the beam caused by a signal should produce equal increments of force in all parts of the beam; this calls for $\partial E_e/\partial y = \text{const}$ or $E_e = y \cdot \text{const}$ at any given cross section z . This condition is met whenever restriction (3) holds, i.e. all parts of the beam are close to the center plane.

In addition, it is required that each trajectory wave include enough spatial periods so that the specific location of these periods on any particular wave has negligible influence on its length; if a trajectory wave included only one or two spatial periods, the relative phase of wave and spatial period at the starting point would strongly influence the shape of each trajectory, so that the wavelength would vary irregularly in space and in some cases also in time. The required relationship is insured by restriction (2) in view of (22).

If either of the two restrictions is violated, the effect of a transverse signal field at one point is soon converted into turbulence instead of concerted motion of the entire beam. Thus the two restrictions are charac-

teristic of tubes which use transverse signal fields such as the one illustrated in Fig. 1.

We have built a number of such tubes based on the structure illustrated. A thin flat ribbon beam travels in a space bounded by closely spaced electrode pairs which are held alternately at high and low potentials.

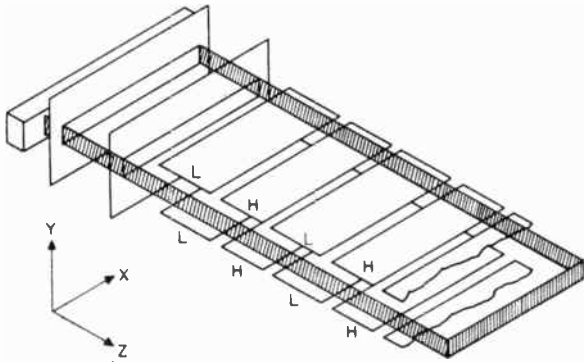

Fig. 1—Electrostatically focused ribbon-beam tube: beam from elongated cathode passes through collimating slots into space bounded by electrode pairs which are held at alternately high and low potentials.

Some of these tubes serve to study focusing; others are transverse-field traveling-wave tubes or related devices. We find consistently that the properties of these tubes are well described by the concept of a beam tied to the center plane by an elastic field and capable of resonant transverse oscillation.

One particularly convincing experiment is the following: In the structure illustrated, all plates on each side of the beam are interconnected by means of condensers so that it becomes possible to apply a homogeneous transverse signal field across the beam and deflect it from its normal path. After the beam has passed through this structure it is intercepted by a target assembly which, by means of an aperture of known width or by a fluorescent coating, provides information on how much the beam has been deflected. As the signal frequency is varied, a pronounced resonance is observed; its frequency is found to depend on the two dc voltages applied to the electrode pairs, but not on the beam current. In a typical case, the resonance occurs at 160 mc. A computation, using $V = V_0(1 + \epsilon \sin \nu z)$ where $V_0(1 \pm \epsilon)$ are the two applied dc voltages (admittedly a crude approximation of the potential along the center plane of the structure shown), gives 142 mc. In this case, $\epsilon = .38$.

The maximum current which a tube can pass ranges from 30 per cent to over 50 per cent of that obtained by multiplying the density from (25) with the available cross section. (One would hardly expect 100 per cent, since thermal velocities are neglected in the derivation). We find the equations quite helpful in predicting the properties of such tubes.

The transverse electron resonance appears to permit some interesting practical applications on which we hope to report in the near future.

Correspondence

On Reciprocal Inductance*

Reference is made to the suggested term "inertiance" for reciprocal inductance, L^{-1} or Γ .¹ There are many models, making possible analogous mechanical and electrical systems. Electric networks have duals, and the possibility of more than one electric analog of a given mechanical system exists. One relationship has been chosen by Baghdady, and if this turns out to be the approved one, "inertiance" is an excellent term for L^{-1} . Using a different relationship this author arrived at the rather contradictory term "recimass."

It is important to note that the second formula given in the text referred to above

$$\frac{di}{dt} = \Gamma \frac{d\psi}{dt}$$

is a *fundamental* relation, not restricted to any particular model. When the table for transfer to a mechanical network is decided

upon for one of the three quantities i , Γ , and ψ , the other two will adjust themselves accordingly. The formula cannot be used to prove that "inertiance" fits Γ better than it fits L . In an initial approach, would not most engineers associate "inertiance" with inductance rather than reciprocal inductance?

While "inertiance" supposedly solves half the nomenclature problem, it leaves the other half unsolved; the *unit* for L^{-1} . Capacitance has the unit "farad" and elastance the unit "daraf," both excellent. Inductance has the unit henry, but "inertiance" has no unit. This author suggested and used the unit "yrneh" at Cruft Laboratory in 1942, and now proposes this term for practical use.

There are many other symbols, terms, and abbreviations, which should be given proper identifications. A few of the ones the author has coined, more or less successfully, are as follows:

For immittance: \mathfrak{Z} , \mathfrak{Y} (Z and Y combined)
For reciprocal immittance: \mathfrak{z} , \mathfrak{y}

For radius vector (which is not a conventional vector): radius spinner

For "a" in $H = a + jb$: prime direction part $Pr(H)$ or $P(H)$. (The part "b" is widely referred to as the quadrature part, $Qu(H)$ or $Q(H)$.)

For amplification: amion, or ampion

For distributed amplifier: D —amplifier
For distributed power amplifier: DP —amplifier, or DPA

Other readers may independently have thought of these, or better ones, at an earlier date. While "amion" or "ampion" scarcely can be defended as abbreviations, one of them may survive, if considered as a new word. The reader's attention is called to the excellent suggestion by Professor R. Rüdberg, Harvard University, of replacing the term "negative resistance" by "stimulance."²

HARRY STOCKMAN
Scientific Specialties Corp.
Boston 35, Mass.

* Received by the IRE, December 27, 1954.
¹ E. J. Baghdady, "On reciprocal inductance," Proc. I.R.E., vol. 42, p. 1807; December, 1954.

² R. Rüdberg, "Transient Performance of Electric Power Systems," McGraw-Hill Book Co., pp. 200, 467, New York; 1950.

The Mesh Counterpart of Shekel's Theorem*

In a recent paper Shekel¹ showed that the determinant of the admittance matrix of a network is independent of the choice of the reference node. The same statement is also made very often about the mesh determinant. The following example shows that the latter statement is not true.

Example: Choice 1 (see Fig. 1):

$$\Delta_1 = \begin{vmatrix} 3 & 1 & -1 \\ 1 & 3 & 1 \\ -1 & 1 & 3 \end{vmatrix} = 16.$$

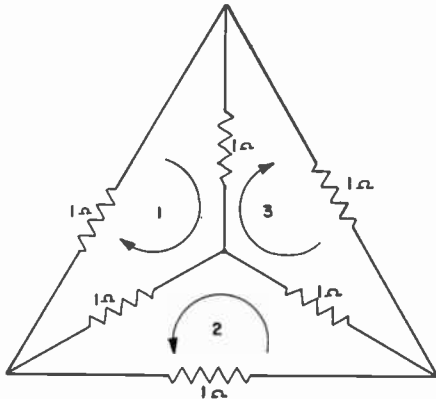

Fig. 1—Choice 1.

Choice 2 (see Fig. 2):

$$\Delta_2 = \begin{vmatrix} 4 & 0 & 0 \\ 0 & 4 & 0 \\ 0 & 0 & 4 \end{vmatrix} = 64.$$

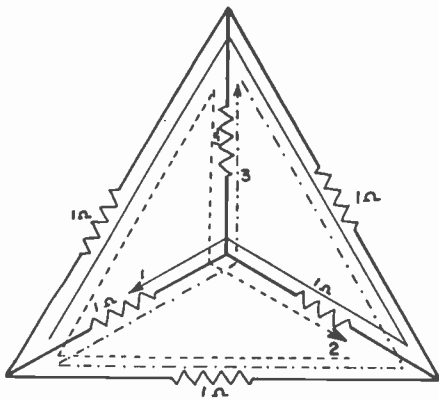

Fig. 2—Choice 2.

The following theorem gives the correct statement.

Theorem: If Δ_1 and Δ_2 are any two mesh determinants of the same network then $\Delta_2 = k\Delta_1$ where k is a real constant depending only on the two choices of circuits (and not on the impedances in the network).

Proof: The mesh impedance matrix Z_m is given by

$$Z_m = BZB',$$

where B is the circuit matrix of the network with circuits for rows and branches for

* Received by the IRE, July 19, 1954; revised manuscript received, September 13, 1954.
¹ J. Shekel, "Two theorems concerning change of voltage reference terminal," *Proc. I.R.E.*, vol. 42, p. 1125; July, 1954.

columns (B is the transpose of the matrix Γ as defined by Cauer²), B' is the transpose of B , Z the branch impedance matrix. Let

$$Z_m = B_1 Z B_1'$$

and

$$Z_{m_2} = B_2 Z B_2'.$$

(Z is the branch impedance matrix and is thus independent of the choice of circuits.)

Since B_1 and B_2 form two bases for the same system of circuits there exists a non-singular matrix D such that³

$$B_2 = D B_1$$

B_1 has a rank equal to the number of rows ($b-n+1$ for a connected network). Hence B_1 contains a non-singular submatrix of maximum rank. Let the columns of B_1 be arranged such that this non-singular submatrix appears in the leading position. Let the columns of B_2 be arranged in the same order as the columns of B_1 . Letting B_{111} be the non-singular submatrix of B_1 we have

$$[B_{211} \ B_{212}] = D[B_{111} \ B_{112}]$$

from which

$$B_{211} = D B_{111}.$$

Since the product of nonsingular matrixes is nonsingular, B_{211} is nonsingular. Also, since B_1 and B_2 contain only elements 1, -1, or 0, the determinants of B_{111} and B_{211} are both real constants. Hence using the notation $\det A$ for the determinant of matrix A ,

$$\det D = \det B_{211} / \det B_{111}$$

is also a real constant. Let this be r . Then

$$\Delta_2 = \det B_2 Z B_2' = \det D B_1 Z B_1' D'$$

or

$$\Delta_2 = \det D \times \det B_1 Z B_1' \times \det D'$$

or

$$\Delta_2 = r \times \Delta_1 \times r$$

or

$$\Delta_2 = r^2 \Delta_1 = k \Delta_1$$

where $k=r^2$ is a real constant. This completes the proof.

Since the mesh determinant is a rational function and the poles and zeros of a rational function are unaltered by a constant multiplier we also have this obvious corollary.

Corollary: The poles and zeros of the mesh determinant are independent of the choice of meshes.

S. SESHU
 Dept. of Elec. Engrg.
 Univ. of Ill.
 Urbana, Ill.

² W.F. Cauer, "Theorie der linearen Wechselstromschaltungen," Akademische Verlagsgesellschaft, Leipzig, p. 33; 1941.

³ G. Birkhoff and S. MacLane, "A Survey of Modern Algebra," The MacMillan Co., Theorem 1, p. 245, New York; 1953.

The Compensation Theorem*

The compensation theorem in network theory is generally very lightly treated in books as one of those theorems which have to be mentioned for the sake of completeness but which are obvious statements without much value. The cause for this deplorable fate can probably be attributed to the

* Original manuscript received by the IRE, October 25, 1954; revised manuscript received, December 13, 1954.

reasoning that, in order to apply the compensation theorem, a solution of the circuit under consideration should first be available and the theorem therefore, is merely of academic interest rather than usefulness.

This note aims to point out the usefulness of the compensation theorem and also supplies two proofs for the theorem.

One form of the compensation theorem can be stated as follows: The effect of a change ΔZ in the impedance of a network branch is equivalent to that of inserting a compensating potential source ($-I\Delta Z$) in series with the changed branch, where I is the current which flowed in the branch before the change; the relative polarities of the voltage ($-I\Delta Z$) are such that it represents a potential rise in the direction of I . The theorem expressed in this form is extremely useful in predicting the effect of changes in the value of an element on the performance of the whole circuit. Where only the effects of changes in different circuit elements are of importance, re-computation and subtraction by the original values are not the best approach. Computations in connection with dc amplifier stability are a good example, where, for small changes, the application of the compensation theorem makes possible the use of equivalent circuits for vacuum tubes. It is to be noted, however, that restriction of small changes is not required for validity of compensation theorem.

Proof 1: Consider the network in Fig. 1(a) where an impedance Z is connected between two network terminals A and B .

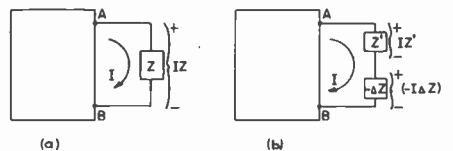

Fig. 1

The current I establishes a potential difference $I Z$ between $A-B$ as shown. That Fig. 1(b) is equivalent to Fig. 1(a) is readily seen ($\Delta Z = Z' - Z$); what constitutes the network to the left of terminals $A-B$ is immaterial. The effect of the change of Z to Z' is then equivalent to that of cancelling the potential difference ($-I\Delta Z$) by an equal and opposite potential source as shown in Fig. 2. This proves the theorem.

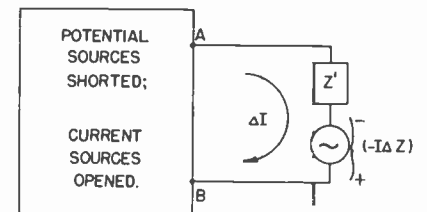

Fig. 2

Proof 2: Consider the general loop equation for the s -th loop of an n -loop network.

$$Z_{s1}I_1 + Z_{s2}I_2 + \dots + Z_{ss}I_s + \dots + Z_{sm}I_m = E_s, \quad (1)$$

where E_s is the algebraic sum of all applied potential rises in the direction of I_s in loop s . It is important to note that, if all loop currents are chosen in the same reference direction, e.g., clockwise, then Z_{ss} is a positive

quantity and all other impedance coefficients or a flat network can be made negative by an appropriate choice of loops. Suppose the impedance in an outside branch (a branch in which only one loop current flows) in the s -th loop is increased by an amount ΔZ , then (1) will be changed to

$$Z_{s1}I_1' + Z_{s2}I_2' + \dots + (Z_{ss} + \Delta Z)I_s' + Z_{sn}I_n' = E_s \quad (2)$$

Subtracting (1) from (2), one has

$$Z_{s1}(I_1' - I_1) + Z_{s2}(I_2' - I_2) + \dots + (Z_{ss} + \Delta Z)(I_s' - I_s) + \Delta Z I_s + \dots + \dots + Z_{sn}(I_n' - I_n) = 0 \quad (3)$$

Eq. (3) can be re-written as

$$Z_{s1}\Delta I_1 + Z_{s2}\Delta I_2 + \dots + Z_{ss}'\Delta I_s + \dots + Z_{sn}\Delta I_n = -\Delta Z I_s \quad (4)$$

where $Z_{ss}' = Z_{ss} + \Delta Z$ is the new loop impedance for the s -th loop. It is readily seen that (4) leads directly to the compensation theorem as stated above. There is no difficulty in arriving at the same conclusion if the impedance change occurs in a common branch. Besides, a given branch in a network can always be made an outside branch by choosing the loops suitably.

It is also easy to prove (a) that the network determinant of impedance coefficients is changed from D_s to $(D_s + \Delta Z D_{ss})$ if the impedance change, where D_{ss} is the cofactor of D_s with the s -th row and s -th column omitted; and (b) that the change in the loop current in a k -th loop, ΔI_k , is

$$\Delta I_k = \frac{-\Delta Z I_s D_{sk}}{D_s + \Delta Z D_{ss}} \quad (5)$$

In (5), all quantities except ΔZ on the right-hand side are in terms of known quantities before the change.

A parallel statement of the compensation theorem, which will be useful where the network is more conveniently analyzed on a junction basis, is: The effect of a change ΔY in the admittance of a network branch is equivalent to that of applying a compensating current source ($-E\Delta Y$) in parallel with the changed branch, where E is the potential difference which appeared across the branch before the change; the direction of the current ($-E\Delta Y$) is such that it flows toward the junction which has positive reference polarity. Eq. (5) would apply equally well to this case, if loop currents and impedances are changed to junction-pair voltages and admittances respectively.

DAVID K. CHENG
Elec. Eng. Dept.
Syracuse University
Syracuse 10, N. Y.

Some Antics in Semantics*

The only appropriate reply to M. S. Corrigton¹ for his interesting exploration into mathematical semantics is

$$\frac{q}{\sqrt{\pi}} \int_0^{\infty} \frac{1}{\sqrt{x}} e^{-x/100} dx = 10q.$$

D. H. SHEINGOLD
George A. Philbrick Res., Inc.
Boston, Mass.

* Received by the IRE, November 18, 1954.
¹ M. S. Corrigton, "Adventures in Calculus," Proc. I.R.E., vol. 42, pp. 1703; November, 1954.

Logarithmic Amplifier Simplifications and Improvements*

The article by Chambers and Page¹ admirably describes one method of obtaining a logarithmic response. We, at Philco, have been over the same ground and find that simplifications are possible with no degradation of performance. For this reason, the following general discussion of the matter is offered. Much of this may be found in Patent #2,662,978, Logarithmic Transducer, D. E. Sunstein, and Patent #2,663,015, Object Location System Employing Logarithmic Transducer, D. E. Sunstein, both applied for June 11, 1946.

First, we have found that certain precautions are necessary if one is to obtain from each stage a video output vs IF input which saturates in the manner described in Fig. 3 of the article referred to.¹ That is, there is, in general, a tendency for the video detected output obtained from an IF amplifier to increase with increase of input signal level up to some particular maximum output value. Further increase in IF input signal may cause a reduction in video output. This effect has been particularly observed when plate detection alone is used to develop the video output signal from a given IF stage. When the sum of plate and screen current is used, however, to form the video output, this back-down characteristic does not occur. Such a back-down characteristic, however, has also been found to occur when grid current is used for detection and when the grid load impedance is moderately high. In this instance, the back-down characteristic usually occurs as a result of overload in the preceding stage rather than of overload in the stage producing the video output being measured, but can be prevented by the use of small grid video load resistors.

Thus, we have found it practical to produce useful video detected signals either from the cathode current of the stage, the grid current of the stage, or the sum of the plate and screen current.

We have not found it necessary to cause the IF gain per stage to be reduced below that which would be obtained for a conventional IF amplifier. This is in contrast to the work of Chambers and Page who indicate about 4 to 5 db less gain per stage than obtainable with conventional practice. In the case of cathode detection, we have found it is not necessary to suffer a loss in gain simply by using a normal value of cathode resistance on the order of 100 ohms, rather than the relatively high value of 3,600 ohms used by Chambers and Page. In this instance, we can provide an adequate IF bypass across the cathode resistor without suffering video smearing. A further benefit as a result of the low cathode impedance which we have found practical will be realized later in that it plays a part in permitting the removal of the separate video isolation amplifier utilized by Chambers and Page.

Of the three useful methods of producing a video output from the overloaded IF stage, we have found that the use of plate plus

screen current has not been plagued by any inability to compensate for end effects or difficulties with regard to IF feedback as experienced by Chambers and Page. However, plate plus screen detection has been found undesirable in some installations because of the presence of hum and assorted other interferences on the $B+$ line.

The use of cathode or grid detection removes the requirement for an extremely well filtered $B+$ line. It has been found, in practice, that grid detection usually cannot provide as high video frequency capability as cathode detection, without suffering some loss in IF gain. For this reason, the amplifiers we have made in the past several years have all used cathode detection, but with the grid returned directly to ground through a low impedance, and with a cathode resistance on the order of 100 ohms.

By providing a video output from each IF stage with an impedance of only 100 ohms or less, we have been able to linearly add the detector outputs in a delay line of impedance of perhaps 1,000 ohms simply by use of an isolating resistor of about 15,000 ohms between each video detected output and the corresponding tap on the delay line. This causes the signal on the delay line to be substantially lower than in the Chambers and Page receiver. Reduced gain can be made up at end of delay line by a single video amplifier rather than 5 or more video amplifiers feeding the several taps on the delay line.

Moreover, we have found that it has not been necessary to limit the choice of interstage coupling networks to synchronous single or multiple tuned systems. In fact, we have successfully used staggered tuning to achieve the usual advantages with regard to effective gain-bandwidth product. In order to use staggered tuning, the staggering should be so chosen that all the poles lie on a circle whose center is at the IF carrier frequency. In this way, the gain of each stage at carrier is identical, and this has been found sufficient to insure a clean transient response to radar pulse signals having any rate of rise to which the IF can respond. Moreover, it has been found that the use of such staggered tuning still provides a selectivity curve which is adequately symmetrical about carrier when measured at any given input signal strength, or even when measured with input signal varying an amount necessary to hold output constant.

By the use of these techniques, we have been able to obtain a 60 db logarithmic range utilizing four 6AK5's followed by a crystal video detector. In other applications, more than 90 db of dynamic range has been obtained utilizing a correspondingly increased number of detecting IF stages. These IF stages so constructed have, in fact, been in production for several years, and have utilized no more tubes than a standard IF having the same signal gain and bandwidth.

D. E. SUNSTEIN
Philco Corporation
Philadelphia 34, Pa.

Rebuttal²

Mr. Sunstein's letter seems to indicate that he has missed the objective of the work leading to the development of the log-

* Received by the IRE, November 26, 1954.
¹ T. H. Chambers and I. H. Page, "The high-accuracy logarithmic receiver," Proc. I.R.E., vol. 42, pp. 1307-1314; August, 1954.

Received by the IRE, December 9, 1954.

rhythmic receivers described in our article. The parent problem required a logarithmic receiver having a characteristic accurate to within about $\pm 1/2$ db throughout its range, and having the extreme stability and reliability so essential in equipment for computer-type applications.

The authors are familiar with the work not only of the Philco Corporation but also with the work done by other American concerns and by the British.

As Mr. Sunstein points out, the use of the successive detection principle (which incidentally was in use at the Naval Research Laboratory as early as 1942) allows the use of almost any type of detector in the logarithmic receiver, provided that it is accompanied by satisfactory limiting or overload characteristics in the IF stages. However, extensive study of and experimentation with the various systems has indicated that only the nonamplified back-biased stage with its outputs summed through unilateral elements will yield the desired $\pm 1/2$ db accuracy without critical adjustments and despite tube changes, supply voltage variations and the other exigencies of service use.

Mr. Sunstein's use of low cathode resistances and (bilateral) resistances for performing the summing function is certainly entirely satisfactory for a lower accuracy receiver. It will, however, yield a characteristic which is sensitive to tube aging and changes and to other variations.

T. H. CHAMBERS
Naval Research Laboratory
Washington 25, D. C.

Hysteresis in Klystron Oscillators*

Hysteresis in klystron oscillators falls into two categories. One is circuit hysteresis, the other is electronic hysteresis. Circuit hysteresis is due to such things as high-Q loads and long lines between klystron and load, and is well understood and adequately discussed in the literature.^{1,2} The causes of electronic hysteresis are less unambiguous.

Perhaps the best known electronic cause of hysteresis is that of multiple transit electrons in reflex klystrons. This is partially treated both by Pierce and Shepherd³ and by Hamilton.² A reasonable qualitative picture exists, but quantitative calculations are formidable.

It is stated by Pierce and Shepherd¹ and by Hamilton² that another important cause of hysteresis is that due to phase shift of electronic admittance with rf voltage. This can be calculated from second-order bunching theory. A simple way of visualizing the way in which phase shift can produce hysteresis is by reference to the admittance diagram of a klystron oscillator (Figs. 1 and 2). It is seen that if the locus of the electronic admittance vector is a curved line as indicated, hysteresis with two breaks will occur on one side of the mode only. It is further observed that increasing the load conductance should move the hysteresis points toward the edge of the mode, and that for

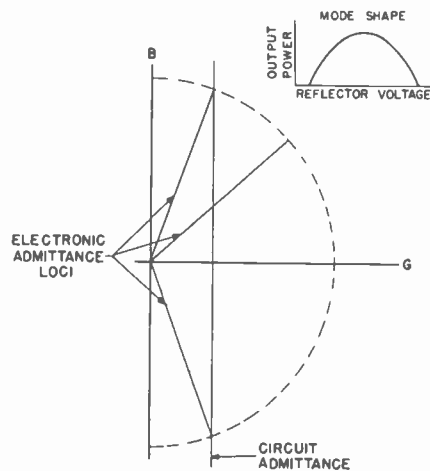

Fig. 1—Admittance diagram of klystron oscillator without phase shift.

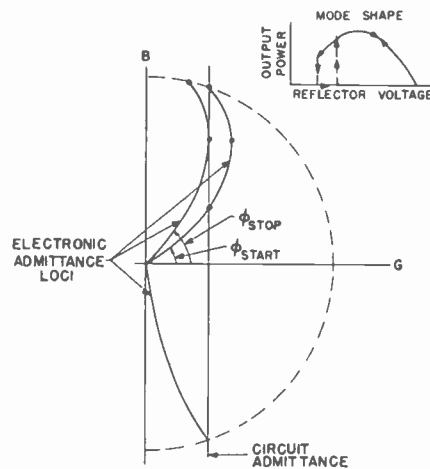

Fig. 2—Admittance diagram of klystron oscillator with phase shift.

returned beam. While the observed hysteresis may be modified by phase shift, it is clear that phase shift alone is not adequate to produce the observed hysteresis. For one thing, the hysteresis occurs on both sides of the mode. In addition, the hysteresis points move toward mode center rather than away from it as the load conductance is increased.

The following explanation, supported additionally by other experiments, is proposed: It is usually supposed that, in the absence of multiple transit electrons, the electronic admittance decreases in magnitude monotonically with increasing rf voltage. Suppose, instead, that the electronic admittance first increases with rf voltage and then decreases, as indicated in Fig. 4. This is clearly a situation that will produce hysteresis on both sides of the mode, and will allow the break points to move toward mode center as the load conductance is increased.

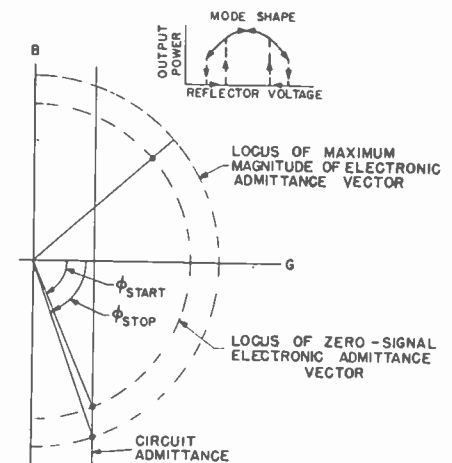

Fig. 4—Admittance diagram of klystron oscillator, with admittance first increasing with rf voltage and then decreasing.

large enough loads the hysteresis should disappear entirely.

It is found experimentally with certain reflex klystron oscillators, and with some two-cavity klystron oscillators, that a type of hysteresis occurs which cannot be explained in terms of either multiple transit electrons or simple phase shift. Examples of this kind of hysteresis are shown for a two-cavity oscillator in Fig. 3.

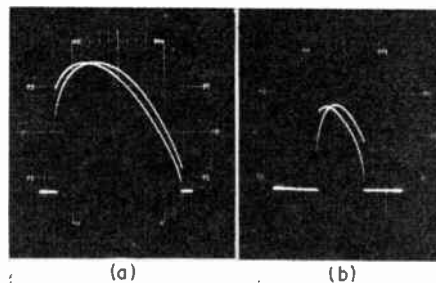

Fig. 3—Oscilloscope photographs of power vs beam voltage (sinusoidal sweep) for two-cavity klystron oscillator. (The two traces are displaced slightly in phase to show the hysteresis breaks.) (a) Moderate load. (b) Heavy load (large load conductance).

There are several reasons why electronic admittance might increase with rf voltage before decreasing. One possibility is that rf causes a spreading of the beam, which may improve its coupling to the rf output gap (or increase the beam-coupling coefficient). Another possibility is that rf spreading decreases space-charge density and thus reduces certain deleterious space-charge effects in the beam, such as longitudinal debunching. In the case of the reflex klystron, reduction in space-charge density in the neighborhood of the turn-around plane in the reflector region may favorably affect the optics, thus increasing the electronic admittance. It might be expected that such space-charge effects would be more pronounced in klystrons having high density electron beams.

In two-cavity klystron oscillators, it is likely that both phase shift and growth of the electronic admittance vector occur simultaneously, thus causing a mixed type of hysteresis. In reflex klystrons, multiple transit electron effects often exist in addition, so that the resultant hysteresis is some combination of the three types. This obscures their separation and identification.

T. MORENO and R. L. JEPSEN
Varian Associates
611 Hansen Way
Palo Alto, California

* Received by the IRE, November 19, 1954.

¹ J. R. Pierce and W. G. Shepherd, "Reflex oscillations," *Bell Sys. Tech. Jour.*, vol. 26, pp. 460-681; July, 1947.

² D. R. Hamilton, J. K. Knipp, and J. B. H. Kuper, "Klystrons and Microwave Triodes," McGraw-Hill Book Co., New York, N. Y., pp. 384-440; 1948.

Dependence on load or circuit admittance is indicated. Multiple transit electron hysteresis cannot occur because there is no

Contributors

R. Adler (A'42-SM'47-F'51) was born in Vienna, Austria, in 1913. He received the Ph.D. degree in physics from the University of Vienna in 1937. He



R. ADLER

was assistant to a patent attorney in that city and later worked in the laboratories of Scientific Acoustics, Ltd., in London and Associated Research, Inc., in Chicago. In 1941 he joined the research group of Zenith Radio Corp. in Chicago, where he became associate director of research in 1952.

He is a member of the American Association for the Advancement of Science.



H. G. Booker (SM'45-F'53) was born at Barking, Essex, England, in 1910. He was educated at Cambridge University, where he received the B.A. degree in 1933 and the Ph.D. degree in 1936. He was awarded the Smith's Prize in 1935 and became a Research Fellow of Christ's College in the same year.



H. G. BOOKER

During the war he was in charge of theoretical research at the Telecommunications Research Establishment in England. After the war he returned to Cambridge University as a lecturer, and in 1948 became a professor of electrical engineering at Cornell University. He is now on leave of absence from Cornell and is at Cambridge University.

Dr. Booker is an associate member of the Institution of Electrical Engineers, London.



J. A. Boyd (M'52) was born in Oscar, Kentucky, on March 25, 1921. He received the B.S.E.E. and M.S.E.E. degrees from the University of Kentucky in 1946 and 1949 respectively, and the Ph.D. degree from the University of Michigan in 1954. He was an instructor in electrical engineering in 1947-48 and an assistant professor in 1949 at the University of Kentucky.



J. A. BOYD

From 1949 to 1954 he has been employed as a member of the research staff and lecturer in the Department of Electrical Engineering at the University of Michigan.

He is now an assistant professor in electrical engineering at the University of Michigan.

He is a member of Eta Kappa Nu, Tau Beta Pi and Sigma Xi.



P. A. Clavier (M'48) was born in Paris, France, in 1922. He graduated from the Ecole Centrale des Arts et Manufactures de Paris in 1947. From 1947 to 1948 he was a research engineer at Laboratoire Central de Telecommunications in Paris where he worked on traveling-wave tubes.



P. A. CLAVIER

From 1948 to 1953 he was employed at the Physics Laboratory of Sylvania Electric, working on microwaves and applied mathematics. In 1952 he was appointed engineer in charge of the newly formed theoretical section. Since 1953 he has been with Zenith Radio Corp. in Chicago.

He is a member of the American Physical Society and the American Association for the Advancement of Science.



For a photograph and biography of C. C. Cutler, see page 231 of the February, 1955 issue of the PROCEEDINGS OF THE I.R.E.



J. T. deBettencourt (A'50) was born in Washington, D. C., on June 9, 1912. He received the B.E. E. degree in 1932 and the M.S. degree in physics in 1934 both from the Catholic University of America. He received the M.S. degree in 1937 and the Sc.D. degree in 1949 both in communication engineering at Harvard University.



DEBETTENCOURT

From October, 1941 to June, 1946, Dr. deBettencourt served with the Bureau of Ships, during the latter period as head of the Airborne Radar Design Section. After the war, he joined the Raytheon Manufacturing Co. as part-time engineer while finishing his Doctorate as research associate at Harvard. Until 1951 he was section head and section manager in the Engineering Division. In January, 1951, he joined the Research Laboratory of Electronics at M.I.T. as a staff member and is now with the Lincoln Laboratory.

S. S. Guterman was born in Warsaw, Poland, in May, 1913. He received the equivalent of the American B.S. degree in electrical engineering from Polytechnic Institute of Grenoble, France. Later, he attended the Ecole Supérieure of "Electricite" in Paris, where in 1935 he received a degree corresponding to the M.S. in telecommunication engineering.



S. S. GUTERMAN

In 1951 he came to the United States, where, since May, 1952, he has been with the Raytheon Manufacturing Company as a group leader in the research and development section of the Computer Department.



M. E. Hines (S'46-A'47-M'50) was born on November 30, 1918, in Bellingham, Wash. He attended the California Institute of Technology, where he received the B.S. degree in applied physics in 1940 and where, as a member of the Air Force Weather Service, he received the B.S. degree in meteorology in 1941. After World War II he returned to the Institute and received the M.S. degree in electrical engineering in 1946.



M. E. HINES

Mr. Hines has been employed since 1946, at the Bell Telephone Laboratories at Murray Hill, N. J., where he has been engaged in the development of traveling-wave tubes, microwave triodes and storage tubes.



R. D. Kodis (S'46-A'51) was born on July 8, 1921, in Boston, Mass. He received the B.S. degree from Northeastern University in 1946.



R. D. KODIS

Mr. Kodis has been associated with the Harvard Computation Laboratory (1946-1947), Watertown Arsenal Laboratory (1948-1951), and Transducer Corp. (1951-1952). In 1952 he joined the Raytheon Manufacturing Company, where he is head of the research and development section of the Computer Department.

Contributors

O. M. Kromhout (A'54) was born in New Orleans, Louisiana, in 1925. She received a B.A. degree from Tulane University in 1945.



O. M. KROMHOUT

After five years with the Department of Agriculture, she obtained an M.S. degree at the University of Illinois in 1951.

Mrs. Kromhout has been a research physicist with the Zenith Radio Corp. since 1952, where she is working on high frequency electron devices.

She is a member of Pi Mu Epsilon.



For a photograph and biography of J. T. Mendel, see page 863 of the May, 1954 issue of the PROCEEDINGS OF THE I.R.E.



Allen Nussbaum was born in Philadelphia, Pa., on August 22, 1919. He received the B.A. degree in chemistry in 1939 and the M.A. degree in physics in 1940, from the University of Pennsylvania. He entered service in 1941, serving as a radio engineer with the Signal Corps in Italy and with the Air Force in Germany from 1947 to 1949.



A. NUSSBAUM

Dr. Nussbaum reentered the University of Pennsylvania in 1950, where he received the Ph.D. degree in semiconductor physics in 1953. Since November, 1953, he has been a member of the semiconductor group at the Honeywell Research Center.

He is a member of the American Physical Society.



Snihl Ruhman was born on September 2, 1925, in Bessarabia, Roumania. He received the B.S. degree in electrical engineering from the Worcester Polytechnic Institute in 1949.



S. RUHMAN

From 1949 to 1952, he served as research assistant at the Digital Computer Laboratory of the Moore School of Electrical Engineering, University of Pennsylvania, where he took part in the development of the MSAC, a large scale electronic digital computer. While at the University of Pennsylvania, he continued his studies in electrical

engineering, completing the course requirements for the M.S. degree. In July, 1952, he joined Raytheon Manufacturing Company, Computer Department, where he has been engaged in research and development work in magnetics.

Mr. Ruhman is a member of Tau Beta Pi and Sigma Xi.



J. A. Saloom (S'48-A'52) was born in Herrin, Illinois, in 1921. He attended the University of Illinois from 1942 to 1943, served in the U. S. Air Force from 1943 to 1946, and returned to the University in 1946 to continue his studies. He received the B.S., M.S. and Ph.D. degrees from the University of Illinois in 1948, 1949 and 1951 respectively. From 1949 to 1951 Dr. Saloom was a research associate



J. A. SALOOM

at the University of Illinois, engaged in the study of gaseous discharges. In 1951 he joined the Bell Telephone Laboratories and has since been engaged in microwave tube development, with emphasis on electron beam studies.

Dr. Saloom is a member of Pi Mu Epsilon, Eta Kappa Nu and Sigma Xi.



For a photograph and biography of P. K. Tien, see page 82A of the September, 1954 issue of the PROCEEDINGS OF THE I.R.E.



L. R. Walker was born in England, on August 6, 1914. He received the B.Sc. degree in 1935 and the Ph.D. degree in 1939 from McGill University. From 1939 to 1941 he was with the Radiation Laboratory at the University of California, and from 1941 to 1946 with the Radiation Laboratory at the Massachusetts Institute of Technology, where he worked on magnetrons. Since 1946 he has been a member of



L. R. WALKER

the technical staff of the Bell Telephone Laboratories, Murray Hill, N. J., engaged in work on microwave tubes and gyromagnetron propagation.

W. M. Webster (A'48-SM'54) was born in Warsaw, N. Y., in 1925. He studied physics at Rensselaer Polytechnic Institute, and at Union College. He received the B.S. degree in physics from Union College, and the Ph.D. degree from Princeton University.



W. M. WEBSTER

In 1946 he joined the RCA Laboratories Division, Princeton, N. J., where he has worked primarily on solid state devices and vacuum and gas-

eous electronics.

Dr. Webster is a member of Sigma Xi.



V. M. Wolontis was born in Helsinki, Finland, in 1926. He received the M.A. degree in mathematics from the University of Helsinki in 1947 and the Ph.D. degree in mathematics from Harvard University in 1949. He was a teaching fellow at Harvard in 1948-49 and an assistant professor of mathematics at the University of Kansas from 1949 to 1953. In 1953 he joined the Mathematical Research Department of



V. M. WOLONTIS

the Bell Telephone Laboratories.

Dr. Wolontis is a member of the American Mathematical Society and the Association for Computing Machinery.



A. H. Zemanian (A'51) was born on April 16, 1925, in Bridgewater, Mass. He received the B.E.E. degree from the College of the City of New York in 1947 and the M.E.E. and Eng.Sc.D. degrees from New York University in 1949 and 1953, respectively. He taught in the electrical engineering department of C.C. N.Y. for the academic year 1947-48, and then joined the Maintenance Company, New York, N. Y. Since 1952 he has been teaching electrical engineering at New York University, where he is an assistant professor.



A. H. ZEMANIAN

Dr. Zemanian is a member of the National Society of Professional Engineers, the American Institute of Electrical Engineers, Tau Beta Pi, Eta Kappa Nu, and Sigma Phi Omega.

1955 IRE NATIONAL CONVENTION PROGRAM

Waldorf-Astoria Hotel, Kingsbridge Armory, March 21-24, New York, N.Y.

GENERAL COMMITTEE

G. W. Bailey, *Chairman*
 S. L. Bailey, *Vice-Chairman*
 J. D. Ryder, *Ex-Officio*
 Emily Sirjane, *Secretary*

Horace Atwood R. P. Burr
 W. M. Baston W. C. Copp
 E. W. Bemis L. G. Cumming
 J. F. Bisby E. K. Gannett
 J. B. Buckley J. Z. Millar
 J. S. Saby

BANQUET COMMITTEE

E. W. Bemis, *Chairman*

Robert Bright, Jr. Alden Opie
 A. F. Childs O. J. Sather
 A. C. Norwine C. H. Singer

COCKTAIL PARTY COMMITTEE

R. P. Burr, *Chairman*

B. F. Tyson R. J. Keogh
 N. A. Spencer

CONVENTION RECORD COMMITTEE

John S. Saby, *Chairman*
 E. K. Gannett, *Secretary*

G. S. Axelby R. W. Greenwood
 C. P. Bastuscheck C. M. Heiden
 Ralph Batcher Keith Henney
 A. C. Beck W. C. Jakes
 Julius Bernstein V. J. Kublin
 T. H. Bonn W. C. Moore
 M. Copel Charles E. Page
 Milton Dishal G. T. Royden
 Charles Doersam W. R. Thurston
 L. G. Fischer Lewis Winner
 Wilson Greatbatch Victor Wouk

EXHIBIT MANAGER

W. C. Copp

FACILITIES COMMITTEE

W. M. Baston, *Chairman*
 R. J. Kircher, *Vice-Chairman*

R. I. Brown R. E. Olson
 L. J. Climent F. R. Pike
 P. J. Clinton L. A. Pulley
 R. L. Cohoon H. J. Reed, Jr.
 H. L. Cushing E. R. Saul
 Joseph Emerson John Schaller
 A. A. Gallonio Gerard Schneider
 O. B. Gibson A. F. Schoenfuss
 Samuel Grodzinsky A. A. Schwartz
 R. M. Hammer R. E. Simonds
 E. J. Hoffman C. M. Singleton
 G. H. Houseworth S. T. Spangler
 R. P. T. Jutson W. R. Spittal
 Robert Kelleher F. H. Stansfield
 R. J. Keogh C. E. Taggart
 R. M. Kurzrok Charles Tillstrand
 Roderic Lowman E. R. Trelewicz
 Nicholas Medici E. P. Vehslage
 H. M. Miller D. G. Williams

FINANCE COMMITTEE

J. B. Buckley, *Chairman*

HOSPITALITY COMMITTEE

Horace Atwood, Jr., *Chairman*
 G. D. Hulst, *Vice-Chairman*

Bernard Amos R. S. Mason
 Albert Baracket O. J. Morelock
 L. A. Bondon C. M. Puckette, Jr.
 P. F. Brown R. L. Ringer, Jr.
 T. J. Coursey G. D. Robinson
 R. W. Deichert J. E. Schlener
 A. E. Hylas W. V. Tyminski
 R. J. Iversen C. E. Webb
 S. S. Krinsky E. G. Whitley
 H. C. McBriar M. R. Yeiter

INSTITUTE ACTIVITIES COMMITTEE

L. G. Cumming, *Chairman*

E. I. Anderson R. A. Heising
 J. L. Callahan J. T. Henderson
 A. G. Clavier Leon Podolsky
 R. I. Cole L. C. Van Atta
 J. J. Gershon Ernst Weber

PUBLICITY COMMITTEE

E. K. Gannett, *Chairman*
 Lewis Winner, *Vice-Chairman*

W. C. Copp Jack Hobby
 Rufus Crater T. R. Kennedy
 Fred Donat W. W. MacDonald
 E. E. Grazda B. F. Osbahr
 J. D. Whitmore

REGISTRATION COMMITTEE

J. F. Bisby, *Chairman*

J. F. Craib H. C. Nelson
 W. P. Frantz R. C. Palmer
 L. W. Garrand D. S. Rau
 R. E. Lafferty Norman Salz
 Joseph Mazzacki W. H. Yocom

TECHNICAL PROGRAM COMMITTEE

J. Z. Millar, *Chairman*

I. L. Auerbach J. G. Marble
 R. R. Batcher J. L. McLucas
 J. F. Byrne C. H. Page
 Michel Copel D. C. Ports
 L. A. FeRosa A. W. Rogers
 C. H. Doersam J. R. Steen
 J. F. Herrick W. R. Thurston
 A. L. Lane J. E. Ward
 R. R. Law Ben Warriner
 D. H. Loughridge E. S. White
 A. A. Macdonald Lewis Winner

Registration

Members and visitors may register at either the Waldorf-Astoria Hotel (49th Street and Lexington Avenue) or Kingsbridge Armory (Kingsbridge Road and Jerome Avenue, Bronx) during the following hours:

Waldorf-Astoria Hotel

Monday 9 A.M.-5:30 P.M.
 Tuesday 9 A.M.-8:00 P.M.
 Wednesday 9 A.M.-6:00 P.M.
 Thursday 9 A.M.-2:30 P.M.

Kingsbridge Armory

Monday 10 A.M.-10 P.M.
 Tuesday 10 A.M.-10 P.M.
 Wednesday 10 A.M.-5 P.M.
 Thursday 10 A.M.-10 P.M.

Technical Sessions

Over 250 technical papers will be presented in 55 sessions. A schedule of sessions and locations is given on page 348. Complete program of papers, authors, and 100-word summaries appears on pages 349-377.

Exhibits

The Radio Engineering Show, featuring 704 exhibits, will be held at the Kingsbridge Armory and at the Kingsbridge Palace, located one and a half blocks south of the Armory on Jerome Ave. Exhibit hours are from 10 A.M. to 10 P.M. every day but Wednesday, when they close at 5 P.M.

Transportation

Free bus service will be provided between the Waldorf-Astoria Hotel and Kingsbridge Armory. In addition, both locations are convenient to the Jerome Avenue line of the Lexington Avenue IRT subway.

Annual Meeting

Of particular interest to members will be the Annual Meeting of the IRE at the Waldorf, which opens the convention at 10:30 A.M. Monday, March 21. A. V. Loughren, Director of Research, Hazeltine Corporation, will be the principal speaker. The program will include reports from officers regarding IRE activities.

Convention Record

All available papers will be published in the 1955 IRE Convention Record. The Convention Record will be published in ten parts and will be available in June, 1955.

All persons who become paid members of a professional group by April 30, 1955 will automatically receive a free copy of that part of the Convention Record containing the papers sponsored by their professional group.

Convention Record parts may be ordered at the Convention Record Desk, Waldorf-Astoria, or from IRE headquarters.

Social Events

A Cocktail party will be held on Monday at the Waldorf-Astoria, the annual IRE Banquet will take place Wednesday evening at the same hotel, and a full program of women's activities is scheduled throughout the four days of the IRE Convention. For full details see News and Radio Notes section, page 379, of this issue.

1955 IRE CONVENTION PROGRAM

SCHEDULE OF TECHNICAL SESSIONS

	BELMONT-PLAZA	WALDORF-ASTORIA					KINGSBRIDGE ARMORY	
	Moderne Room	Starlight Roof	Astor Gallery	Jade Room	Sert Room	Grand Ballroom	Marconi Hall	Faraday Hall
Monday March 21 2:30 P.M.- 5:00 P.M.	<i>Session 1</i> INSTRUMENTATION I	<i>Session 2</i> ANTENNAS AND PROPAGATION I—Antennas	<i>Session 3</i> MOBILE COMMUNICATIONS	<i>Session 4</i> COMMUNICATIONS SYSTEMS	<i>Session 5</i> INDUSTRIAL ELECTRONICS	<i>Session 6</i> TELEMETRY AND REMOTE CONTROL I— <i>Symposium</i> : Some Problems Associated With Telemetry and Remote Control of a Space Station	<i>Session 7</i> CIRCUIT THEORY I— <i>Symposium</i> : Network Design	<i>Session 8</i> AUTOMATIC CONTROL I
Tuesday March 22 10:00 A.M.- 12:30 P.M.	<i>Session 9</i> TELEMETRY AND REMOTE CONTROL II—Remote Control	<i>Session 10</i> ANTENNAS AND PROPAGATION II—Antennas	<i>Session 11</i> AERONAUTICAL AND NAVIGATIONAL ELECTRONICS I—Airborne Devices and Environment	<i>Session 12</i> BROADCAST TRANSMISSION SYSTEMS I—TV Broadcasting	<i>Session 13</i> AUDIO I—General	<i>Session 14</i> INFORMATION THEORY I (Ends at noon)	<i>Session 15</i> (Joint) INSTRUMENTATION AND TELEMETRY AND REMOTE CONTROL	<i>Session 16</i> ELECTRON DEVICES I—Tubes
Tuesday March 22 2:30 P.M.- 5:00 P.M.	<i>Session 17</i> INSTRUMENTATION II	<i>Session 18</i> ENGINEERING MANAGEMENT I— <i>Panel Discussion</i> : Operations Research—A Tool of Engineering Management	<i>Session 19</i> AERONAUTICAL AND NAVIGATIONAL ELECTRONICS II—Radar and Aircraft Landing Aids	<i>Session 20</i> BROADCAST TRANSMISSION SYSTEMS II—Color Television	<i>Session 21</i> AUDIO II— <i>Symposium</i> : Music, High Fidelity, and the Listener		<i>Session 22</i> TELEMETRY AND REMOTE CONTROL III—Recent Telemetry Developments	<i>Session 23</i> ELECTRON DEVICES II—Microwave Tubes
Tuesday March 22 8:00 P.M.- 10:30 P.M.		<i>Session 24</i> AUTOMATIC CONTROL II—Trends in Automatization of Procedures and Processes in Business and Industry					<i>Session 25</i> AUDIO III— <i>Seminar</i> : Magnetic Recording for the Engineer	
Wednesday March 23 10:00 A.M.- 12:30 P.M.	<i>Session 26</i> ULTRASONICS I	<i>Session 27</i> ELECTRONIC COMPUTERS I	<i>Session 28</i> MICROWAVE THEORY AND TECHNIQUES I—Microwave Components	<i>Session 29</i> PRODUCTION TECHNIQUES—Electronic Equipment Assembly Methods	<i>Session 30</i> (Joint) INSTRUMENTATION AND NUCLEAR SCIENCE	<i>Session 31</i> (Joint) SYMPOSIUM ON SPURIOUS RADIATION (Ends at noon)	<i>Session 32</i> CIRCUIT THEORY II—General Theory	<i>Session 33</i> ANTENNAS AND PROPAGATION III— <i>Panel Discussion</i> : Extended Range VHF and UHF Propagation
Wednesday March 23 2:30 P.M.- 5:00 P.M.	<i>Session 34</i> ULTRASONICS II	<i>Session 35</i> ELECTRONIC COMPUTERS II— <i>Symposium</i> : The Design of Machines to Simulate the Behavior of the Human Brain	<i>Session 36</i> MICROWAVE THEORY AND TECHNIQUES II—Microwave Techniques	<i>Session 37</i> QUALITY CONTROL AND RELIABILITY STUDIES OF ELECTRONIC TUBES AND SYSTEMS	<i>Session 38</i> BROADCAST AND TV RECEIVERS		<i>Session 39</i> CIRCUIT THEORY III—Filters and Lines	<i>Session 40</i> ANTENNAS AND PROPAGATION IV—Propagation
Thursday March 24 10:00 A.M.- 12:30 P.M.	<i>Session 41</i> MEDICAL ELECTRONICS I— <i>Panel Discussion</i>	<i>Session 42</i> INFORMATION THEORY II	<i>Session 43</i> ELECTRON DEVICES III—Cathode-Ray Type Tubes	<i>Session 44</i> COMPONENT PARTS I—Electro-Magnetic Devices	<i>Session 45</i> NUCLEAR SCIENCE I	<i>Session 46</i> ENGINEERING MANAGEMENT II—General (Ends at noon)	<i>Session 47</i> MICROWAVE THEORY AND TECHNIQUES III—Ferrites	<i>Session 48</i> ELECTRONIC COMPUTERS III
Thursday March 24 2:30 P.M.- 5:00 P.M.	<i>Session 49</i> MEDICAL ELECTRONICS II—General	<i>Session 50</i> ENGINEERING MANAGEMENT III— <i>Symposium</i> : Management Selection as Viewed by Psychologists and Engineering Executives	<i>Session 51</i> ELECTRON DEVICES IV—Transistors	<i>Session 52</i> COMPONENT PARTS II—General	<i>Session 53</i> INFORMATION THEORY III		<i>Session 54</i> (Joint) MICROWAVE COMMUNICATIONS AND SYSTEMS	<i>Session 55</i> AERONAUTICAL AND NAVIGATIONAL ELECTRONICS III—Navigation

SUMMARIES OF TECHNICAL PAPERS

SESSION I

MON. 2:30-5:00 P.M.

BELMONT-PLAZA
MODERNE ROOM

Instrumentation I

Chairman: P. S. CHRISTALDI, *Allen B. Dumont Labs., Inc., Clifton, N. J.*

1.1 "Direct-Reading Instrument for the Measurement of RMS Pulse Jitter," by *Jesse J. Taub and Charles I. Smith, Material Laboratory, New York Naval Shipyard, Brooklyn 1, N. Y.*

An instrument for the measurement of rms time jitter in the leading edges and trailing edges of video pulses is described. In conjunction with a detector, this device will also measure jitter in rf pulse trains. The instrument operates on the principle that a portion of the electrical energy of the jitter may be isolated from the energy of the pulse train by means of a low-pass filter. It can be shown mathematically that the portion of the jitter energy thus isolated can be converted to a voltage which is directly proportional to the rms time jitter in microseconds. This equipment is easily calibrated and is direct-reading. The jitter may have sinusoidal, random, or other waveforms.

1.2 "An Automatic Sonic Spectrum Analyzer and Curve Tracer," by *Edward F. Feldman, Panoramic Radio Products, Inc., Mt. Vernon, N. Y.*

The instrument described is an all-electronic panoramic spectrum analyzer which provides a means for rapid sonic Fourier analysis. A wide-band 40-20,000 cps logarithmic and three variable center-frequency linear-sweep modes are selectable by means of a switch. Both linear and two decade logarithmic vertical deflection amplitude axes are provided. The instrument's residual distortion is at least -60 db.

The crux of the log sweep design lies in the relationship between df/dt , the rate of scan, and the maximum achievable adjacent frequency component resolution. An expression is derived which relates the IF bandwidth to the instantaneous df/dt . By means of a dual swept crystal filter, the bandwidth is varied in synchronism with the log frequency scan to maintain optimum resolution at all frequencies.

A simple adjunct equipment converts the analyzer into an audio sweep generator and frequency response curve tracer which has unique properties. "Stopbands" more than 60 db down are measured accurately because of the synchronous detection action.

1.3 "A Simplified Method for the Measurement of Highly Linear Sawtooth Waveforms," by *Sherwood King, University of Tennessee, Knoxville, Tenn.*

A resistance-capacitance differentiating circuit is described which develops a constant amplitude signal during the useful portion of the sawtooth, with the departure from linearity appearing as deviations from the constant level. Following removal of the constant level,

the deviations are amplified and displayed on a standard cathode-ray oscilloscope. In this way the effect of altering various circuit parameters in the sweep generator is immediately observed.

The equation necessary to determine the error arising from the use of an imperfect differentiator is derived, and an example of the successful use of this technique is given as well as the conditions necessary for applying this method to sawtooth waveforms of other amplitudes and periodicity.

1.4 "The Diagraph—A Direct-Reading Instrument for Graphic Presentation of Complex Impedances and Admittances," by *Richard C. Hess, Federal Telephone & Radio Co., Clifton, N. J.*

The necessity for measuring complex impedances at rf rapidly and accurately is becoming an increasingly important problem. An instrument is described which measures complex impedances and presents the results graphically in the most useful form (i.e., either on a Smith chart, Carter chart, or a Polar chart in terms of a complex reflection coefficient.) Use is made of directional couplers to measure the amplitude of the reflection factor directly and to project its magnitude on the chart by means of a light-spot galvanometer. The phase angle is determined semi-automatically and is indicated by a rotation of the chart. In addition to measuring impedances, the unusual flexibility of the device allows it to measure attenuation and phase shift in a four-terminal network and also the phase difference between two signals. This paper describes work done by the firm of Rohde and Schwarz, Germany.

1.5 "Measurement of Parameters that Determine Front Edge Response of Pulse Transformers," by *Isidore Bady, Signal Corps Engineering Labs., Ft. Monmouth, N. J.*

The equivalent circuit that is commonly used in the analysis of the front edge response of pulse transformers consists of the leakage inductance and distributed capacitance of the pulse transformer. Several methods that have been used to measure these parameters are analyzed and sources of errors discussed. A novel method for the measurement of the parameters is described. Results obtained with this method agree very well with theoretically calculated values. A large amount of test data on many different type transformers is presented to support the theoretical analysis.

SESSION II

MON. 2:30-5:00 P.M.

WALDORF-ASTORIA
STARLIGHT ROOFAntennas and Propagation I
AntennasChairman: JOHN V. N. GRANGER, *Stanford Research Institute, Stanford, Calif.*

World Radio History

2.1 "Efficiency of Surface Wave Excitation," by *Alan F. Kay, Technical Research Group, New York, N. Y., and Francis J. Zucker, Air Force Cambridge Research Center, Cambridge, Mass.*

The excitation efficiency of surface waves is the ratio between the power in an open-waveguide mode and the total power available at the feed. It should be maximized if the open waveguide is used as a transmission line; and it should be a predictable quantity if the guide is used as an antenna whose pattern is to be modified in some specified manner by the feed radiation.

A method based on Fourier transforms is used to calculate the excitation of dipoles, slots, and extended sources of arbitrary orientation. Some of the predictions have been verified experimentally. The question of optimum efficiency obtainable for diverse surface wave applications is also discussed.

2.2 "Serrated Waveguide: Theory and Experiment," by *R. S. Elliott and K. C. Kelly, Hughes Research and Development Lab., Culver City, Calif.*

An experimental study of linear arrays of closely spaced nonresonant transverse slots in X-band waveguide is described and analytical expressions for the complex propagation constant in the guide proper are given. These closely slotted (or serrated) waveguides have the advantage of broadband operation and may be used as flush-mounted antennas in many applications. Normally the beam maximum occurs at a tilt angle from endfire equal to $\cos^{-1} c/v_g$. The guide velocity, v_g , may be altered by the use of a ridge in the guide, or a dielectric, or by varying the thickness of the slotted wall. The last mentioned method has the ability to speed or slow the wave in the guide depending on the wall thickness and the slot length. Aperture illumination can be controlled by varying slot length and spacing. Characteristics obtained and applications attempted are given in some detail, and the wide range of possible beam shapes is discussed.

2.3 "Properties of a Radiating Discontinuity on a Corrugated Surface Transmission Line," by *M. J. Ehrlich and I. K. Williams, Microwave Radiation Co., Inc., Venice, Calif.*

Although much work has been done, both theoretically and experimentally, on surface wave transmission lines and surface wave radiators, no data have been available regarding the radiation properties and equivalent network representation of radiating discontinuity on the surface wave transmission line.

An experiment was designed to obtain the free-space radiation patterns and equivalent network representation of a discontinuity on a corrugated surface-wave transmission line as a function of the parameters of the discontinuity and line.

Data obtained were then used to formulate an empirical theory which furnishes the four-terminal network representation and free-space radiation characteristics.

These data and the empirical theory allow the design of shaped beam antennas, physically realized by surface-wave transmission lines utilizing corrugation discontinuities as the radiating elements, to be carried out by current linear array design theories.

2.4 "Symmetrical Microwave Lenses," by C. Goatley and C. F. Parker, Melpar, Inc., Alexandria, Va.

Three new microwave lenses are described which have the common property that they focus energy arriving from two diametrically opposite directions in space. One of these lenses with constant index of refraction is related to the double convex lens of optics while the other two are formed of variable index of refraction media. The derivations of the equations for each lens are briefly discussed and methods of construction are indicated. Experimental models of each lens are described together with results of radiation pattern measurements.

2.5 "Lens and Feed System for Volumetric Scanning GCA Antenna," by George D. M. Peeler and William F. Gabriel, Naval Research Lab., Washington, D. C.

An X-Band, bifocal, constrained, metal plate lens, 10×15 feet, has been designed to produce a beam $\frac{1}{2} \times \frac{3}{4}$ degrees, and to permit scanning this beam over a volume $6\frac{1}{2}$ degrees in elevation by 20 degrees in azimuth (± 6.7 beamwidths in elevation by ± 13.3 beamwidths in azimuth). The correction points are at ± 10 degrees azimuth, 0 degrees elevation. A plane focal surface is obtained by stepping the lens in approximately hyperbolic contours to correct phase errors on-axis while maintaining perfect focus at the correction points. Wavefront calculations show deviations less than one-tenth wavelength from a plane wave for all feed positions within the volume of interest.

The subject antenna was proposed by Naval Research Laboratory for obtaining a rapid, two-dimensional scan directly applicable to the GCA (Ground Control Approach) aircraft landing problem. It is to consist of a lens, a stacked organ pipe, and a ring scanner. An X-Band prototype sponsored by the Air Force, is now under development which will scan a sector of $6\frac{1}{2}$ degrees in elevation by 20 degrees in azimuth with four pencil beams of beamwidths $\frac{1}{2}$ degree in elevation by $\frac{3}{4}$ degree in azimuth. A "television" type scan action is to be employed in which there are 20 horizontal scan lines spaced $\frac{1}{2}$ degree apart and the frame repetition rate is 4 per second. To accommodate the four pencil beams, the $6\frac{1}{2}$ degrees elevation scan is to be divided into four sectors of $1\frac{3}{4}$ degrees, all four sectors to be scanned simultaneously. An experimental working model of the feed system (organ pipe plus ring scanner) has been built and tested, with satisfactory results obtained therefrom.

SESSION III

MON. 2:30-5:00 P.M.

WALDORF-ASTORIA
ASTOR GALLERY

Mobile Communications

Chairman: DANIEL E. NOBLE, Motorola, Inc., Chicago, Ill.

3.1 "An Experimental Mobile Dispatching System," by R. W. Collins

and V. A. Douglas, Bell Telephone Labs., New York, N. Y.

This mobile telephone system provides dispatch service for a number of small vehicular groups and their respective dispatchers on one radio channel. Wire lines connect the dispatchers' standard manual telephone sets directly to common terminal and signaling equipment arranged to control the radio transmitter and receiver and to comply with FCC rules. The fleets use commercially available radio equipments modified to add suitable tone generating and receiving equipment. It is anticipated that the system will be used for large numbers of brief calls and will increase considerably the amount of dispatch type traffic that can be handled over telephone company mobile telephone facilities.

3.2 "450 MC Mobile Equipment Employing Direct Frequency Modulation," by W. Ornstein, Canadian Marconi Co., Montreal, P.Q., Canada.

A 450 mc mobile radiotelephone having several unique features is described. The transmitter oscillator stage has an output frequency of 150 mc and employs a 50 mc overtone crystal. Direct frequency modulation of the crystal is accomplished using only passive elements and retaining a high order of frequency stability in the oscillator circuit.

The transmitter employs only four rf stages including the oscillator and has an output power level of 7.5 w.

The receiver is a double conversion super-heterodyne employing a disc seal triode in a coaxial cavity as the input rf amplifier. Receiver noise figure is 10 db and sensitivity (on a 12 db signal to noise basis) is 0.5 microvolts.

3.3 "Design Problems of VHF Repeater Stations," by J. R. Neubauer, Radio Corp. of America, Camden, N. J.

This is a discussion of the physical and electrical design considerations which determine the functional effectiveness and operating reliability of stations employing simultaneous operation of transmitter and receiver as a control or reradiating system. Consideration will be given to requirements for station location, primary and emergency power control and regulation, antennae supports and radio equipment control and supervision. In addition, the effects of simultaneous operation on the system performance will be evaluated. Methods of overcoming the effects of desensitization, intermodulation, spurious emission and response, distortion and noise are discussed. The importance of adequate study of propagation and frequency allocations are emphasized. Slides will be used to illustrate pertinent circuit considerations and interesting applications.

3.4 "Evaluation of Sideband Noise and Modulation Splatter of VHF Transmitters," by W. L. Firestone, Motorola, Inc., Chicago, Ill.

The ever-increasing demand for additional spectra in the vhf and uhf bands emphasizes the problems of transmitter sideband noise and modulation sideband splatter.

This paper is concerned with the determination and the reduction of the various factors which contribute to sideband splatter and noise. Splatter created as the byproduct of the

modulation processes in typical AM, PM, and FM transmitters is analyzed, measured, and compared. Measurements of AM spectra show that this splatter exceeds the expectations based on simple theory and nonlinear theory is shown to predict the additional measured side bands. Noise sources in typical FM sets are determined and methods of reducing noise are discussed. The addition of a low-pass filter as the last element in the audio system is shown to be a must in both FM and AM if noise and sideband splatter are to be controlled.

3.5 "A Miniature Reflectometer for Portable and Mobile Transmitters," by Edwin M. Stryker, Jr., Collins Radio Co., Cedar Rapids, Ia.

It is desirable to incorporate into transmitters, especially those of the portable and mobile types, a reflectometer or standing-wave indicator to provide a means of determining transmitter output and proper termination and functioning of the antenna and its transmission line. The reflectometer has the advantages of small size and low cost as well as being useful over a wide frequency range. Employing printed circuitry and requiring no adjustment to permit directional coupling, this device lends itself well to mass production techniques. Principles applicable to this type of directional coupler are discussed and test data are given.

SESSION IV

MON. 2:30-5:00 P.M.

WALDORF-ASTORIA
JADE ROOM

Communications Systems I

Chairman: F. M. RYAN, American Telephone and Telegraph Co., New York, N. Y.

4.1 "A New Horizon in Communication Theory—The Polyphase Concept," by Allan A. Kunze and John G. Schermerhorn, Rome Air Devel. Center, Griffiss Air Force Base, Rome, N. Y.

Communication engineering has been treated, hitherto, generally from single-phase concepts only. For instance, the recognition of push-pull circuitry as a two-phase polyphase circuit has not been emphasized in communication theory. Since it is believed that the significance of the polyphase concept and its application is not known clearly, as yet, this paper attempts to fill such a need. It is demonstrated that the polyphase concept is of sufficient scope and power to penetrate into every domain constituting communication theory and provide new approaches to old problems—information theory, modulation, propagation, antennas, detection, tubes, circuitry and even acoustics. The Fortescue symmetrical component theory is borrowed from the power engineer and its extension is shown to be a powerful analytic tool in communications analysis.

Further outlined are the possibilities of new antennas, transformers, circuitry, instruments and generally new techniques for application in

communications resulting from preliminary considerations of polyphase applications. In particular, such applications as interference suppression, multiplex, high-power generation, and wide aperture D/F's are discussed.

4.2 "A Theorem Concerning Noise Figures," by *A. G. Bose and S. D. Pezaris, Massachusetts Institute of Technology, Cambridge, Mass.*

This theorem concerns the greatest lower bound of the noise figure of a system consisting of n identical tubes whose plate signals are directly added and whose inputs are obtained through a linear passive coupling network from a source having a finite impedance. It is proved that the optimum attainable noise figure of this system is equal to the optimum noise figure of a circuit consisting of one such tube and an appropriate coupling network. The theorem is extended to the lower bound of the noise figure of a similar circuit in which arbitrary phase shifts are introduced before the plate signals are added. This extension includes the use of distributed-line amplifiers.

4.3 "Automatic Operation of a High-Power Amplifier," by *V. R. DeLong, Collins Radio Co., Cedar Rapids, Iowa.*

Automatic operation of a high-powered radio frequency amplifier operating in the 1.5 to 30 mc frequency range will be described. Details of a unique switchless coarse-fine information system will be explained. Emphasis will also be placed upon the problems involved in automatically adjusting the tank circuit and load control of the amplifier when operating in single sideband service.

4.4 "The Use of Reflex Techniques in a VHF-UHF Communication System," by *Paul G. Wulfsberg, Collins Radio Co., Cedar Rapids, Iowa.*

The use of novel reflex techniques in the design of a new 1800 channel vhf-uhf communication set are described. Reduction of nearly 50 per cent in tube count and 25 per cent in tuned circuits is achieved in a transmitter-receiver unit employing direct frequency synthesizing techniques. A new transmitter circuit is described which eliminates the conventional side-step oscillator and mixer. Methods permitting the transmit and receiver spurious responses to be suppressed nearly 80 db are outlined.

The use of the foregoing techniques permits design of a radio set of unusually small size and very high reliability achieved by a 40 per cent reduction in total electrical components.

4.5 "A New Teletypewriter Using the Integration Method of Detection," by *Henning F. Harmuth, Signal Corps Engineering Labs., Ft. Monmouth, N. J.*

In standard teletypewriters detection of the signals is performed by sampling pulses and pulse spaces. Instead of this, one may integrate in several ways over the signals and use the integrals obtained for the distinction of the different signals. This integration method is less susceptible to noise than the sampling method since the positive and negative noise amplitudes partly cancel each other. Some basic aspects of this integration method are discussed and its application to the construction of a teletype receiver is shown.

SESSION V

MON. 2:30-5:00 P.M.

WALDORF-ASTORIA SERT ROOM

Industrial Electronics

Chairmen: CONAN A. PRIEST, Onondaga Pottery Co., Syracuse, N. Y., and WILFRID L. ATWOOD, Warren, Ohio

5.1 "An Instrument to Count and Size Particles Suspended in a Gas," by *Ernest S. Gordon, Illinois Institute of Technology, Chicago, Ill.*

An instrument embodying optical and electronic principles has been developed to count and size aerosol particles automatically. This device, known as an aerosoloscope, eliminates the tedious and time-consuming method employed by chemists in microscopic counting of particles collected on a slide. Among the applications of the aerosoloscope are the study of air pollution problems, milling operations, and precipitation monitoring at weather stations.

Particles from 1 to 64 microns in diameter and counting rates up to 150 particles per second are handled by the instrument described. The particles are diluted and drawn across a high intensity beam of light; a multiplier phototube receives the light scattered by each particle at 90 degrees. The resulting impulses are amplified and separated into 12 size groups by a unique pulse height discriminator. Glow transfer decade counters are used to count the pulses in the various size groups.

5.2 "Design Considerations of Microwave Ovens," by *Robert A. Rapuano and Robert V. Smith, Raytheon Manufacturing Co., Newton, Mass.*

Practical electronic ovens offering the desirable characteristics of food cooked with microwaves have been developed using a reliable high power cw magnetron at 2,450 mc.

Food has the properties of a lossy dielectric, and therefore can be cooked by the heat resulting from the absorption of microwaves in a multi-resonant cavity with a microwave efficiency greater than 90 per cent.

Practical designs require that the microwave energy distribution be uniform and that the resonant cavity be the proper rf load for the magnetron over a wide range of food loading.

Methods are developed for determination of proper magnetron operation into various cavity designs. Criteria for an isotropic pattern oven are given.

5.3 "High-Speed Electronic Fault Protection for Power Tubes and Their Circuitry," by *W. N. Parker and M. V. Hoover, Radio Corp. of America, Lancaster, Pa.*

High-speed electronic circuits have been developed to minimize the possibility of damage to power tubes as a consequence of the "flash-arc" or "Rocky Point Effect." The circuit detects the development of fault conditions in a power tube (and/or its circuitry) and triggers a gaseous conduction device connected in shunt with the dc power supply. Fault currents are rapidly bypassed from the faulting power tube by means of the gaseous conduction

device; consequently, the "flash-arc" in the protected power tube is extinguished before serious damage results. The gaseous conduction device bypasses the rectifier-output and filter-circuit energy until such time as the rectifier can be de-energized.

5.4 "A Magnetic Thyatron Grid Control Circuit," by *James H. Burnett, Electrons, Inc., Newark, N. J.*

A new compact magnetic method for driving thyatron grids has recently simplified high-power fast response servos and regulated power supplies.

Since large power gain is available in the thyatron, power amplification can be sacrificed in the magnetic circuit to gain speed of response comparable to the thyatron inverse cycle. The new grid circuit provides a rapid rate of rise of thyatron firing voltage, wide-control range and high-voltage amplification. Dc or ac input signals to the magnetic circuit work equally well, and the signal voltage source can be isolated from the power circuit.

5.5 "A Static Frequency Detector, Magnetic Type," by *Henry W. Patton, Collins Radio Co., Cedar Rapids, Iowa.*

A static frequency detector operable at audio frequencies will be described. This detector circuit delivers a dc output signal accurately and linearly proportional to input frequency. Large variations in input signal amplitude, signal distortion, and environmental conditions do not change the output signal amplitude. It is easy to construct, inexpensive, and when once calibrated has an almost indefinite life. The circuit is simple, compact, and does not require a power supply. Input signal energy requirements are less than a watt. The circuit has application to audio frequency measurements, quartz crystal manufacture, FM telemetering, and tachometers.

5.6 "A New Machine for Automatic Production of Electronic Assemblies," by *Cledo Brunetti, T. R. James, C. H. Bergsland, and D. F. Melton, General Mills, Inc., Minneapolis, Minn.*

SESSION VI

MON. 2:30-5:00 P.M.

WALDORF-ASTORIA GRAND BALLROOM

Telemetry and Remote Control I Symposium: Some Problems Associated with Telemetering and Remote Control of a Space Station

Chairman: J. GORDON VAETH, Office of Naval Research, Port Washington, N. Y.

This is a symposium which will discuss some of the problems associated with telemetering and remote control of a space station. *Problems*

to be discussed include: *problems* associated with acquisition of data on the nature of space; *problems* associated with an ionic rocket engine; *problems* associated with construction of a space platform; *problems* associated with the tracking of a space station; *problems* associated with training of men to operate in space; *problems* associated with telemetering and communication.

It is the purpose of this symposium to acquaint the audience of Radio Engineers with some of the basic problems with which he may some day be faced.

6.1 "The Use of Piloted Balloons as Space Laboratories," by *M. D. Ross, Office of Naval Research, Washington, D. C.*

6.2 "Ionic and Nuclear Problems of Rocket Propulsion," by *F. J. Murray, Columbia University, New York, N. Y.*

6.3 "Instrumentation of a Minimum Satellite for Astro-Physical Research," by *S. F. Singer, University of Maryland, Baltimore, Md.*

6.4 "Telemetering and Control of a Space Station," by *Werner Von Braun, Redstone Arsenal, Huntsville, Ala.*

6.5 "Telemetering in the Development of Space Flight," by *C. B. Ruckstuhl, Jr., Bendix Aviation Corp., N. Hollywood, Calif.*

6.6 "Synthetic Training for Space Flight," by *G. V. Amico, Office of Naval Research, Port Washington, N. Y.*

SESSION VII

MON. 2:30-5:00 P.M.

KINGSBRIDGE ARMORY
MARCONI HALL

Circuit Theory I
Symposium: Network Design

Chairman: CHESTER H. PAGE, National Bureau of Standards, Washington, D. C.

7.1 "Influence of Computing Machines on Network Design Methods," by *John T. Bangert, Bell Telephone Labs., Murray Hill, N. J.*

For years network design has relied on a combination of theory and experience, supplemented by calculation. With this procedure calculation has played an important though

subordinate part. The spectacular development of electronic computers has provided cogent reasons for revising certain design techniques to give computation a major role. This has stimulated the evolution of a new design philosophy which will be illustrated by a group of selected examples. These involve such topics as iteration, conformal mapping, and the potential analog.

In this new philosophy the computer serves two major functions. The first is to uncover any promising solutions by rapid exploration of many areas. The second is to perform extensive mathematical operations on large quantities of numerical data with great speed and with complete freedom from error. The use of modern computers has made the design of networks of extreme precision and complexity economically possible. In addition certain intractable problems formerly treated empirically are gradually being reduced analytically.

7.2 "The Use of Potential Analogs in Network Synthesis," by *Ronald E. Scott, Massachusetts Institute of Technology, Cambridge, Mass.*

A summary is given of the use of potential analogs for synthesis in the time domain, the frequency domain, and the real-part domain. Most of the analogs discussed are based on current flow in a resistive sheet. In addition a new device is described which combines the three types and yields essentially instantaneous curves of the gain function, the phase function, the real part, the imaginary part, and the transient response. This device can be used for network synthesis by any of the three methods and also for checking the relations between them. Throughout the discussion particular attention is devoted to the use of symmetry and conformal mapping to reduce the size of physical devices and decrease the inherent errors.

7.3 "Iterative Network Synthesis," by *Howard B. Demuth, Stanford Research Institute, Stanford, Calif., and George A. Caryotakis, A. Donald Moore, and David F. Tuttle, Stanford University, Stanford, Calif.*

An iterative method of network synthesis, believed to be new, was developed at Stanford by A. D. Moore in 1952. The method was originally applied to distributed amplifier design, but recently it has been used to synthesize low-pass stagger-tuned amplifiers having special amplitude or phase characteristics.

The iterative method consists of alternately satisfying two relationships between the poles and zeros of the system function. The first relationship R_1 is obtained by specifying the network configuration. Given the network configuration, a set of zeros may be obtained from a set of poles. A realizable amplitude or phase restriction on the system function yields a second relationship R_2 , which may be used to determine a set of poles from the zeros. Maximally-flat or equal-ripple amplitude restrictions, or a linear phase restriction, have been used to produce R_2 . In each step of the iteration process one obtains a set of zeros from a set of poles using R_1 , and then one obtains a new set of poles from these zeros using R_2 . The object is to find poles and zeros which satisfy both R_1 and R_2 , and thereby determine a network with the required configuration which does have the desired phase or amplitude characteristic. This iterative process has been found to converge rapidly enough to be useful. As factorization of high-order polynomials, or evaluation of large determinants, is required in each cycle of iteration, use of a digital computer is necessary.

The designs produced by this method make best use of the available degrees of freedom. An optimum amplitude or phase characteristic can be attained without resorting to cancellation of the system function zeros by use of extraneous poles. Pole-zero cancellation has been used in the past to produce an all-pole function. In the absence of zeros the location of the poles to produce a certain characteristic is generally known. However, pole-zero cancellation wastes degrees of freedom and one fails to attain optimum gain-bandwidth or phase linearity, as the case may be.

An example of iterative amplifier synthesis will be described and other designs will be presented and compared with conventional amplifiers.

7.4 "The Use of Least Squares in Network Design," by *M. R. Aaron, Bell Telephone Labs., Murray Hill, N. J.*

Least squares is an effective tool in performing the various steps in network design from approximation to network alignment. The common denominator in each of these procedures is the approximation of a desired network performance or change in performance by a linear sum of functions. After this preconditioning, the mathematical steps that remain involve matrix multiplication and the solution of a set of linear simultaneous equations (matrix inversion). Both of these processes have been programmed for solution by a digital computer. The marriage of digital computers to this means of network design has been highly compatible. Several "offspring" are displayed to attest to this high degree of marital bliss. These examples include: (1) Alignment of a one-port to match a prescribed magnitude characteristic; (2) Solution of the approximation problem in the design of a two-port; (3) Synthesis of all-pass networks into a composite delay equalizer.

7.5 "Summation and Outlook," by *Ernest A. Guillemin, Massachusetts Institute of Technology, Cambridge, Mass.*

SESSION VIII

MON. 2:30-5:00 P.M.

KINGSBRIDGE ARMORY
FARADAY HALL

Automatic Control I

Chairman: JOHN E. WARD, Massachusetts Institute of Technology, Cambridge, Mass.

8.1 "Analysis of Combined Sampled- and Continuous-Data Systems on an Electronic Analog Computer," by *Louis B. Wadel, Chance Vought Aircraft, Inc., Dallas, Texas.*

Combination sampled- and continuous-data dynamic systems can be studied on a conventional electronic analog computer. The only auxiliary equipment needed is a timing device

to control relays already contained in the computer. Each combination of sampling-switch and zero-order hold device is simulated by one integrator connected as a store and controlled in state separately from the integrators in the continuous-data portion of the circuit. Simulation of higher-order hold devices require additional storage integrators. Real time solution is not obtained because computer time halts during sampling.

8.2 "An Adaptive Servo System," by A. H. Benner and R. F. Drenick, Radio Corp. of America, Camden, N. J.

An adaptive servo system is here defined as a servo which can adjust its parameters in accordance with the character of its input. It is intended to follow chiefly inputs which vary linearly with time. It is therefore designed for this purpose as a linear device. However, on occasion the signal is expected to vary quadratically with time. This suggests that an adaptive feature of the servo be added which allows it to change its parameters for tight and fast follow-up. A linear system is first described and an equation for signal prediction is derived. The limits of stability of this system are shown graphically and analyzed. It is then shown that the conditions for optimum performance for following a quadratic signal are strictly incompatible with those for a linear one.

The nature of the adaptive system is discussed and the necessary limiting conditions for its use are stated. It is shown that the decision as to when to shift to the tight mode of operation and back, can be based on the instantaneous follow-up error. Optimum decision rules are drawn up and discussed. Finally the performance of an adaptive servo is compared to a linear servo for typical statistical and non-statistical inputs. Considerable improvement in performance is indicated.

8.3 "Application of a Magnetic Amplifier to a High-Performance Instrument Servo," by Paul R. Johannessen, Massachusetts Institute of Technology, Cambridge, Mass.

The design of a high-performance two-phase motor servomechanism utilizing a magnetic amplifier as the power stage will be described. For compensation, the servomechanism employs tachometer feedback, passed through a high-pass filter to obtain a high velocity constant. The magnetic amplifier not only provides a convenient, compact power output stage, but also has the advantages of being insensitive to quadrature and of being able to accept as its input the sum of an ac error signal and a dc tachometer signal. The high-pass tachometer filter blocks the transmission of dc bias voltages to the magnetic amplifier, so that the servomechanism has extremely low drift.

8.4 "A Nonlinear Compensating Configuration for Saturating Servomechanisms," by W. H. Surber, Jr., Princeton University, Princeton, N. J.

A nonlinear compensating circuit configuration for a feedback control system which can appreciably improve its performance relative to that obtainable using conventional types of control networks is analyzed and the system operating characteristics studied. Experimental results are given for an actual positional servomechanism and for several somewhat idealized systems simulated with an analog computer.

Two general classes of nonlinearities are important in the operation of high performance servomechanisms. The ultimate obtainable dynamic performance is limited by saturation in the power amplifying elements and in the output energy conversion device. For optimum utilization of equipment, the output device should be operated at its maximum or saturation level for relatively small errors or error derivatives. In the neighborhood of the error null, however, a group of "small signal" nonlinearities such as potentiometer resolution, backlash, coulomb friction and others impose limitations on the system performance and affect the control network design in order to prevent small amplitude hunting.

A nonlinear auxiliary feedback loop consisting of a regenerative connection of the output rate signal through a nonlinear network and a stabilizing high-pass filter is shown to provide a close approach to the optimum recovery of the system from saturation without affecting the error null stability as is the case for certain other types of nonlinear control configurations for saturating servomechanisms. This can be accomplished with relatively simple and reliable networks.

8.5 "Delay-Line Methods for Compensating Closed-Loop Systems in the Time Domain," by R. E. Scott and Y. C. Ho, Massachusetts Institute of Technology, Cambridge, Mass.

Theoretical, analog, and experimental results are given for a new method of compensating feedback networks in the time domain. The method is based upon the open-loop impulse response of the system, and it yields the desired closed-loop transient response and the required compensation network. The compensation network is obtained in the form of a distributed element transfer function which can be realized approximately by lumped parameter elements. If the design criteria are given in the time domain, a simple iterative procedure will lead to the desired result. If the design criteria are given in the frequency domain, the required network is obtained by the inversion of a specified matrix.

SESSION IX

TUES. 10:00 A.M.-12:30 P.M.

BELMONT-PLAZA MODERNE ROOM

Telemetry and Remote Control II Remote Control

Chairman: CHARLES H. DOERSAM, JR., Sperry Gyroscope Co., Great Neck, N. Y.

9.1 "New Apparatus and Techniques of Air Traffic Control Data Handling and Display," by David J. Anthony, Convair, San Diego, Calif.

General limitations of conventional radar identification techniques are defined insofar as they place limits upon the information capacity of compatible codes. A complete system is described wherein a new type of display tube is utilized. This tube produces joint displays of radar data and identification symbols wherein

symbol displays are directly formed without the necessity for area scanning. An associated computer and control system is described, which serves to convert time sequential codes into analog data for control of the tube display. Details of the display tube, the manner in which registration difficulties are minimized, code- and timing-sequences are discussed.

9.2 "The Role of the Digital Computer Processing in Guided Missile Data," by H. N. Morris, RCA Missile Test Proj., Patrick AF Base, Fla.

The high-speed automatic digital computer has become an indispensable tool in the processing of guided missile data. Major utilization has been in the field of optical position and attitude data reduction. One example is the computing of position of a vehicle in space, given azimuth, elevation, and timing information from two or more instruments, along with accurate position location of the data-gathering cameras. Electronic position and trajectory information provide an ever-increasing workload for the computer as new type radar and other electronic measuring devices are placed into operation. Last, but certainly not destined to be least, is the field of telemetering. The highly versatile digital computer offers tremendous possibilities in the processing of this "internal" data so as to increase by large factors both the speed and accuracy of the reduction.

9.3 "A New Method for Designing the Compensation of Feedback Control Systems," by Gilbert S. Stubbs, The Franklin Institute, Philadelphia, Pa.

It is often convenient to separate the synthesis of the open-loop transfer function of a feedback control system from the details of compensation circuitry. A method for accomplishing this end is outlined in this paper. A significant feature of the method is the representation of the control compensation by a single-series transfer function equal to the system open-loop function, divided by the product of the transfer functions of the fixed components in the open loop. A few general restrictions on this series-equivalent compensation function usually suffice to insure realizable compensation circuits. Graphical and analytical methods for synthesizing the compensation circuit functions to obtain the series-equivalent function are described.

9.4 "Analysis of Sampled Data Systems and Digital Computers in the Frequency Domain," by Rubin Boxer, Rome Air Devel. Center, Griffiss AF Base, Rome, N. Y.

Functions defined at discrete intervals, i.e., sampling or impulse functions are analyzed. These are shown to be Laplace transformable utilizing either jump or impulse functions. The relation between jump function transforms and z-transforms is derived.

Methods for solving linear difference equations utilizing z-transforms are introduced. The particular difference equations utilized as examples are derived from digital positional and velocity-aided track with scan-feedback loops.

The concept of transfer function for sampled data systems is utilized. Equivalent Nyquist diagrams are derived for a frequency analysis of the systems previously solved by the difference equation method.

The utility of the techniques for analyzing digital computer programs is illustrated by a frequency analysis of numerical analysis methods of differentiation and integration.

Limitations of the methods are included.

SESSION X

TUES. 10:00 A.M.—12:30 P.M.

WALDORF-ASTORIA STARLIGHT ROOF

Antennas and Propagation II Antennas

Chairman: GEORGE SINCLAIR, *Sinclair Radio Labs., Ltd., Ontario, Can.*

10.1 "Omnidirectional Circularly Polarized Antennas," by *K. S. Kelleher and C. W. Morrow, Melpar, Inc., Alexandria, Va.*

This paper considers several circularly polarized antennas with radiation patterns which are omnidirectional in azimuth and which, in the vertical plane have, respectively, a broad beam, a narrow beam and a shaped beam. The broad-beam pattern is obtained from a biconical horn structure in which circular polarization has been introduced by means of depolarizing elements. The other two antennas consist of toroidal lenses fed by the biconical horn radiator. Because of the symmetry of these lenses, their design can be obtained from a two-dimensional analysis. For the narrow beam lens, the analysis is straightforward. The shaped-beam system required a novel design.

10.2 "The N.R.L. Precision 'Big Dish' Antenna," by *D. L. Holzschuh, Collins Radio Co., Cedar Rapids, Iowa.*

The highest gain antenna in the world today is the 50-foot parabolic reflector built for the Naval Research Laboratory for operation at wave-lengths as short as 8 mm. A description of this precision antenna, which is used for research in radio astronomy, is presented. The mechanical aspects of the dish are given primary consideration. Fabrication procedures, design considerations, and a description of the unique surface machining apparatus are treated—these techniques yielding a reflector with an over-all surface accuracy of ± 0.020 inches. A mention is made of a few of the recent advances in radio astronomy made at N.R.L. through the use of the Big Dish—testifying to the successful completion of the project.

10.3 "The Omnidirectional Antenna; an Omnidirectional Waveguide Array for UHF-TV Broadcasting," by *O. M. Woodward, Jr., RCA Laboratories, Princeton, N. J., and James Gibson, Vattersnas, Sweden.*

The Omnidirectional antenna is a new type of high-gain antenna developed for UHF-TV broadcasting. Waveguide components are employed in the design instead of coaxial line elements in order to increase the power-handling capacity. Separate picture and sound inputs are provided which are decoupled independent

of frequency, thus eliminating the need for a frequency-selective combining filter. A reflection-absorbing circuit increases the picture input bandwidth with very small sacrifice of power.

Experimental measurements taken on an antenna of this type constructed for UHF Channel No. 72 are described. Considerations are given to several alternative variations of the system to cover the entire UHF range.

10.4 "The Circular Traveling-Wave Antenna," by *W. J. Bergman and F. V. Schultz, The University of Tennessee, Knoxville, Tenn.*

This antenna consists of a wire formed into a circle, fed at one point and so terminated at the diametrically opposite point that only a traveling wave exists on the antenna. The azimuthal radiation patterns have been calculated over a frequency range of three-to-one, and measured over a frequency range of eight-to-one. The patterns have a single main lobe with rather high-level sidelobes. An initial investigation has been made of the possibility of reducing the sidelobe level by using two concentric circular antennas having different radii.

10.5 "Stripline Radiators," *James A. McDonough, Airborne Instruments Lab., Inc., Mineola, N. Y.*

The application of etching and printing techniques to electronic circuits makes feasible the construction of microwave strip antenna arrays both from practical and economical viewpoints. Many conventional broadside curtains used at lower frequencies were impractical to fabricate in the region above 1,000 mc. Progress in the design of strip conductors as microwave antennas indicates that many of these arrays can now be adapted for operation at microwaves and fabricated with sufficient accuracy to be truly useful. Some of the components involved in the design of strip antennas, such as balanced lines, twists, baluns, and power dividers have been investigated. Complete strip arrays consisting of up to 80 elements have been tested. The gain, bandwidth, and radiation patterns appear comparable to the results obtained from the corresponding arrays used at the lower frequencies for which the same theory of operation applies.

SESSION XI

TUES. 10:00 A.M.—12:30 P.M.

WALDORF-ASTORIA ASTOR GALLERY

Aeronautical and Navigational Electronics I Airborne Devices and Environment

Chairman: G. L. HALLER, *General Electric Co., Syracuse, N. Y.*

11.1 "Aircraft Electronics—Environment, Specifications and Survival," by *F. Mintz and M. B. Levine, Armour Research Foundation, Chicago, Ill.*

The widespread use of electronics in military aircraft requires constant evaluation of the design criteria as related to reliability. Of con-

siderable importance are the environmental factors: mechanical shock, vibration, and noise. This paper examines the existing environments as measured aboard both reciprocating and jet engine aircraft, and draws a comparison with current military specifications governing shock and vibration testing of electronic components. In addition, the results of shock and vibration testing on representative airborne electronic components are presented. Also included are the effects of high-intensity sound on certain components. Some recent work shows that high-intensity acoustic excitation can produce malfunctions of electronic components, although no government specifications cover acoustic effects. Much of the work discussed was sponsored by the Wright Air Development Center.

11.2 "Dynamic Environmental Testing of Airborne Electronic Components," by *R. H. Jacobson and M. B. Levine, Armour Research Foundation, Chicago, Ill.*

The effects of vibration, shock, and high intensity acoustic excitation on airborne electronic components and equipments were investigated. The investigation was conducted under Air Force sponsorship with the ultimate objective of enhancing the reliability of electronic equipment utilized in conventional aircraft as well as missiles.

Tubes, relays, potentiometers, transformers, fixed capacitors, and pressure switches were included among the components which were studied. The paper describes the techniques and procedures followed and summarizes the test results obtained.

11.3 "A Communication Theory Approach toward the Design of Aircraft Instrument Displays," by *Lawrence J. Fogel, Stavid Engineering, Inc., Plainfield, N. J.*

The effectiveness of a military aircraft depends upon the transmission of information from the instrument display to the pilot. In the past, this communication link has received much empirical study. Now, however, an analytical approach is possible which will not only indicate which display design is better, but will also provide criteria to insure future displays that will meet the specified requirements of the aircraft system wherein they must operate. An approach-strategy for such a research program is presented in this paper, together with its limitations and an indication of those aspects which must yet be studied before the final solutions will be achieved. Although much remains to be done, sufficient data are currently obtainable to allow displays to be designed with the knowledge that they will fulfill their mission.

11.4 "The C19K Charactron," by *J. T. McNaney, Convair, San Diego, Calif.*

An engineering paper on the C19K Charactron will include detailed discussions of its operating characteristics and applications to which this cathode-ray tube is being put as a large screen-target identification-display instrument in air surveillance systems. Its utility as a computer read-out device will also be discussed.

An analysis of the tube and its associated components has been made, which includes a discussion of the electron optical system, the beam-forming principle, and beam-deflection system. The discussion will be supplemented by diagrams, illustrations, and photographs which

explain the optical properties and behavior of the beam, and which also show actual displays of characters on the viewing screen of the tube.

11.5 "Versatility of Floated-Type Rate Integrating Gyroscopes in Systems Applications," by *J. W. Lower, Minneapolis-Honeywell Regulator Co., Minneapolis, Minn.*

Floated Rate Integrating Gyroscopes (HIG Units) have been gaining ever increasing acceptance in high-performance systems over the last five years. The reasons for this include the combination of extreme ruggedness with high sensitivity, a wide dynamic range of operation, fast response characteristics, and considerable versatility in servo-loop closures. These gyros can be used as displacement gyros, as platform-stabilization gyros, or as rate-measurement gyros. The combination of a precision torque motor with the gyro permits highly accurate precession characteristics to command inputs. Several gyro applications and the attendant systems' concepts are explored in this paper.

SESSION XII

TUES. 10:00 A.M.—12:30 P.M.

WALDORF-ASTORIA JADE ROOM

Broadcast Transmission Systems I TV Broadcasting

Chairman: RONALD J. ROCKWELL, *Crosley Broadcasting Corp., Cincinnati, Ohio*

12.1 "Synchronization of Multiplex Systems for Recording Video Signals on Magnetic Tape," by *Donald E. Maxwell and William P. Bartley, G. E. Co., Syracuse, N. Y.*

The over-all and inter-channel timing-accuracy requirements for multiplex, magnetic-tape recording systems are discussed, with particular emphasis on the synchronization of time-division multiplex systems designed for use in the megacycle frequency range. The effects of tape flutter and skew on timing accuracy are considered, and methods for achieving good synchronization despite flutter and skew are described. The effects of inadequate synchronization on the signal output of the system are shown.

12.2 "Channel Response Requirements of Multiplex Systems for Recording Video Signals on Magnetic Tape," by *Benjamin G. Walker, General Electric Co., Syracuse, N. Y.*

Recently the time-division multiplex process has been employed as a means of recording a wide-band video signal on multiple-track magnetic tape. The desired frequency response in the individual channels is discussed, and a simple method for relating the sampling errors

to the deviations from ideal response is developed. The effects of sampling errors on the output video signal are shown.

12.3 "Ferrite Heads for Magnetic Recording in the Megacycle Range," by *William R. Chynoweth, General Electric Co., Syracuse, N. Y.*

The performance, in a linear magnetic recording system, of ferrite heads having $\frac{1}{2}$ mil resolution, has been evaluated. The use of ferrite heads in a system recording in the megacycle range has been shown to be feasible, and a determination of the advantages and disadvantages of these heads for this use has been made.

12.4 "Attenuation Measurements on Short Line Samples," by *Louis E. Raburn, Crosley Division, AVCO Manufacturing Corp., Cincinnati, Ohio.*

A simple technique has been developed to measure the attenuation of relatively short samples of rigid coax lines. The general technique employed is to short both ends of the line, couple into one end through an impedance meter, and then measure the input impedance of the line as a resonant coaxial (TEM) cavity. In an example measurement the line sample is terminated at both ends with shorting plates having RMA flanges and center bullets.

The same technique could be used to calculate the attenuation of other transmission lines including the open-wire and waveguide types.

12.5 "A New Television Transmitting Antenna," by *R. W. Masters and C. J. Rauch, The Ohio State University, Columbus, Ohio.*

The structural simplicity, broadband impedance, and beam-pattern properties of traveling-wave antennas lead one to consider them for use in TV broadcasting. By locating the proper type of element more or less uniformly in a prescribed spiral along a transmission line, it is possible to obtain high-gain, null-less, pancake beams which are stabilized in direction over suitable vhf or uhf frequency ranges.

A practical embodiment utilizing probe-coupled, axial-slot radiators in the outer shell of a large diameter coaxial-transmission line is described, as well as measured characteristics of a representative (channel 7), high-frequency scale model, simple analysis and design equations.

12.6 "Spurious Emission Filters for High-Power TV Transmitters," by *William J. Judge, Jr., East Paterston, N. J.*

The basic theory and design of the transmission line constant- K low-pass section is evolved from a survey of papers on the subject. In addition, theory and design of transmission line low-pass M -derived sections (series and shunt) is discussed.

The composite filter is constructed, with specific application to television transmission service. Correlation of theory with practical design of high-power vhf and uhf filters is demonstrated. Associated mechanical problems are related. Charts showing the pass band and stop-band characteristics of (a) channel 2-6 25 kw, (b) channel 7-13 50 kw, and (c) channel 14-83

12 kw low-pass filters are supplied. Effect of insertion of the filter in the transmission system is outlined.

SESSION XIII

TUES. 10:00 A.M.—12:30 P.M.

WALDORF-ASTORIA SERT ROOM

Audio I General

Chairman: HARRY F. OLSON, *RCA Laboratories, Princeton, N. J.*

13.1 "Electronically Controlled Audio Filters," by *L. O. Dolansky, Northeastern University, Boston, Mass.*

The use of filters whose cut-off characteristics are controllable by electronic means is often desirable in problems dealing with audio signals. Based on the recent work on fixed rc active filters by J. G. Linvill, variable active low-pass and high-pass filters have been developed using transistor negative impedance converters.

The design theory of such filters will be summarized and measured characteristics compared with those predicted theoretically. An application, in which the cut-off characteristics are controlled by the incoming audio signal for use in formant tracking, will be described and experimental results given.

13.2 "Distortion in Class B Transistor Amplifiers," by *Maurice V. Joyce, Polytechnic Institute of Brooklyn, Brooklyn, N. Y.*

An experimental investigation has been made of distortion in Class B grounded-base and grounded-emitter amplifiers using junction transistors. While it is now known that a small amount of forward-emitter bias allows low distortion operation of such circuits, no detailed investigation of distortion as a function of bias has previously been published. This information, however, may be of great interest in very low-power drain circuits, where transistors would normally be used.

Data are also given on the dependence of distortion on source impedance, load impedance, and frequency. It is shown that distortion is practically independent of power output, depending rather on output current. Gain and input impedance are also discussed.

13.3 "Detection of Audio Power Spectrum Dispersion," by *H. S. Littleboy and J. Wiren, Northeastern University, Boston, Mass.*

This paper deals with the design and description of a "V" filter which is to be used to distinguish between power spectra having the same central frequency and average power but different dispersions. The power spectra that are discussed have a Gaussian distribution curve when plotted on a logarithmic frequency scale. The filter is adaptable for use in the analysis of speech and its use in this analysis will be described. The design of the filter including graphical means of establishing the filter characteristics from the dispersion of the given power spectra is included.

13.4 "Calibration of Test Records by B-Line Patterns," by *B. B. Bauer, Shure Brothers, Inc., Chicago, Ill.*

Test records are often calibrated by measuring the width of the optical pattern formed when a sharp beam of light is reflected from the modulated grooves. An error has been found in this measurement owing to diffraction of light at the edges of the pattern, which results in a fuzzy ending and a general enlargement of the pattern width, especially at high frequency. A new optical method has been devised for calibration of test records by the use of interference-line patterns. Two sets of interference lines have been identified: (a) Uniformly-spaced lines which are related to the recorded frequency, the angular velocity of the record, and the wavelength of light—these have been called the *A*-lines; (b) lines with variable spacing which are related to the amplitude of modulation and to the wavelength of light—these have been called the *B*-lines. *B*-line patterns may be readily related to the theoretical width of the optical pattern free of diffraction error, with the resultant improvement in the accuracy of test-record calibration.

13.5 "Design and Performance of a High-Frequency Electrostatic Speaker," by *Lloyd Bobb, R. B. Goldman, and R. W. Roop, Philco Corporation, Philadelphia, Pa.*

An electrostatic speaker has been developed which provides a quality of high-frequency reproduction not available with electro-magnetic tweeters. The diaphragm consists of a thin plastic film bearing an evaporated metallic layer. The membrane is stretched around a semi-cylindrical perforated electrode on which ridges are embossed to provide clearance. The response varies less than ± 2 db in the frequency range between 8 and 16 kc. The azimuthal distribution pattern is excellent, owing to the cylindrical geometry, and is essentially independent of frequency in the same range. The second harmonic distortion inherent in this type of speaker is maintained at a low level. An indication of the quality of high-frequency reproduction is provided by oscillograms of the response to tone burst signals. The speaker is in quantity production and has been incorporated in several models of home reproduction instruments.

13.6 "Electronic Music Synthesizer," by *Harry F. Olson and Herbert Belar, RCA Laboratories, Princeton, N. J.*

The electronic music synthesizer is a machine that produces music from a coded record. The coded record is produced by a musician, musical engineer or composer with a fundamental understanding of the composition of sound. The electronic music synthesizer provides means for the production of a tone with any frequency, intensity, growth, duration, decay, portamento, timbre, vibrato, and variation. If these properties of a tone are specified, the tone can be completely described. The advantage of the electronic music synthesizer is that it can produce new and radical tone complexes for musical satisfaction and gratification. The new system does not displace the artist and musician of today. It does not take the place of talent combined with work. The electronic music synthesizer provides the musician, musical engineer and composer with a new musical tool with no inherent physical limitations.

SESSION XIV

TUES. 10:00 A.M.—12:00 Noon

WALDORF-ASTORIA GRAND BALLROOM

Information Theory I

Chairman: LOUIS A. DE ROSA, *Federal Telecommunication Labs., Nutley, N. J.*

14.1 "Coding For Noisy Channels," by *Peter Elias, Massachusetts Institute of Technology, Cambridge, Mass.*

A remarkable result of Shannon's "Mathematical Theory of Communication" is the fact that information can be transmitted at a definite rate over a noisy channel, with as low an error probability as is desired, by properly matching the message to the noisy channel. The matching process is called "coding." The problem of designing codes for particular noisy channels is central for many applications of the theory. This paper reviews the progress which has been made in coding, especially for the noisy binary channel. Some new results will be presented on the dependence of error probability and efficiency on coding delay and equipment complexity.

14.2 "The Rate of Approach to Ideal Coding," by *C. E. Shannon, Bell Telephone Labs., Murray Hill, N. J.*

Let C be the capacity of a noisy discrete channel without memory. Consider codes for the channel consisting of 2^{Hn} sequences each sequence being n symbols long. The basic coding theorem for a noisy channel states that by taking n sufficiently large it is possible to find codes such that both $\Delta = C - H$ and the probability of error after reception, P_E , are arbitrarily small. This paper is concerned with the problem of estimating the value of n necessary as a function of P_E and Δ . Both upper and lower bounds are found in fairly general cases. The upper and lower bounds for n approach each other percentage-wise as Δ and P_E approach zero, giving an asymptotic formula for n . Various special cases are investigated in detail, such as the symmetric binary channel and the flat gaussian channel.

14.3 "The Mathematics of Information Theory," by *Brockway McMillan, Bell Telephone Labs., Murray Hill, N. J.*

14.4 "Session Commentary," by *Robert M. Fano, Mass. Inst. of Tech., Cambridge, Mass.*

SESSION XV

TUES. 10:00 A.M.—12:30 P.M.

KINGSBRIDGE ARMORY MARCONI HALL

Instrumentation, Telemetry and Remote Control

Chairman: ROBERT L. SINK, *Consolidated Engineering Corp., Pasadena, Calif.*

15.1 "Compound Modulation—Method of Recording Data on Magnetic Tape," by *George B. Newhouse, Consolidated Engineering Corp., Pasadena, Calif.*

This paper describes a new method of recording instrumentation data on magnetic tape. A combination of suppressed-carrier amplitude modulation and frequency modulation (compound modulation) minimizes the errors associated with direct recording and FM carrier recording. The theory and principles of operation of a typical CM channel are presented. It is shown that the system is compatible with FM and direct recording. Thus, all types of input transducers may be used. The errors for each system are compared and it is shown that CM has the following advantages: (1) small zero drift, (2) FM modulator center frequency not critical, (3) system nonlinearities have reduced effect, (4) less flutter error, and (5) good amplitude stability.

15.2 "Development of a Portable Magnetic Tape Recorder for Precision Data Recording," by *Glenn D. Maxwell, Consolidated Engineering Corp., Pasadena, Calif.*

Development of a portable, three-speed, 28-channel magnetic-tape recorder, primarily intended for application in an aircraft flight test instrumentation system having a system accuracy of 1 or 2 per cent, is described. The principal design requirements are compactness, reliability, low flutter, ruggedness, and versatility. About half of the contents relate to flutter. Definitions and methods of measurement are given. Results of a six-month flutter research program are presented. Equations show the effect of capstan torque variation and eccentricity on flutter. A rigid capstan drive is compared to a filtered drive. Results of environmental tests and design features are presented.

15.3 "A System for Precise Time-Storage and Expansion of Electrical Data," by *Clarence B. Stanley, Ampex Corp., Redwood City, Calif.*

A six-speed, four-channel magnetic-tape data recording and reproducing system for fixed installation is described. Solutions of design problems posed by rigid specifications on flutter, timing accuracy, operational and maintenance ease are discussed. The solution to the problem of precise timing accuracy in reproduction is of particular interest. A time displacement error of ± 25 milliseconds throughout the length of a 4,800-foot reel is achieved at the high-tape speeds, thus permitting precise recording and reproduction of time-based data.

15.4 "Automatic Oscillograph Readers," by *Louis L. Fisher and George L. Hatchett, J. B. Rea Co., Inc., Santa Monica, Calif.*

At the present time, considerable amounts of data are recorded on oscillographs. The analysis of these data is limited by the task of con-

verting the information into a form which can be handled by computing or tabulating devices.

This paper describes techniques which are useful to automatically read oscillograph records and provide a suitable output for subsequent processing. Originally developed for teledeltos-type paper, the principles evolved may be applied to other types of records with nonintersecting traces.

15.5 "Analysis of Data Recording Systems," by *Thomas L. Greenwood, Huntsville, Ala.*

Data recording is analyzed as to goals, methods, and techniques. System components are classified as functional elements. Definitions of system elements are suggested with a view to facilitate comparison between systems.

Ambiguities in current nomenclature of data handling systems are discussed, with a view toward standardization of terms.

Recording systems are treated as communication channels and their information-handling properties evaluated with the aid of current information theory.

The transducer is classified as an element but not discussed except in cases where the recording techniques are affected by the transducer type.

Proposals are made for a high-speed automatic digital-recording system using electronic counting and magnetic-tape recording techniques.

SESSION XVI

TUES. 10:00 A.M.-12:30 P.M.

KINGSBRIDGE ARMORY
FARADAY HALL

Electron Devices I
Tubes

Chairman: G. D. O'NEILI, *Sylvania Electric Products, Inc., Bayside, N. Y.*

16.1 "A Gas Discharge Noise Source," by *W. Honig and P. Parzen, Johns Hopkins University, Baltimore, Md.*

Previous studies have indicated the presence of large fluctuations in a gas discharge maintained by a magnetic field. An experimental study was made of the noise powers available from gas discharge tubes of Philips gauge geometry. Measurements indicate that noise powers as much as 70-80 db above KT per megacycle are available in certain frequency bands. Curves describing the operating conditions and frequency spectrum of noise power are given. It is believed that the large magnitudes of noise power are due to the presence of growing plasma waves which exist because of the magnetic field.

16.2 "Corrections to the Theory of the Grounded-Grid Triode," by *W. A. Harris, Radio Corp. of America, Harrison, N. J.*

In available literature on the theory of the grounded-grid triode, it has been assumed that the input conductance includes "the square-of-

the-frequency" term caused by transit time in a grounded-cathode circuit and that feedback can be neglected. Even at moderate frequencies, the use of these assumptions leads to inconsistencies between calculated and realized performance.

This paper describes an exact method of treatment based on four-pole circuit equations. Expressions derived for the short-circuit admittances, using the Llewellyn-Peterson equations, are compared with measured data. Theoretical and measured values and curves are also given for power gain and for input admittance with tuned output loads.

16.3 "Development of a Large-Diameter Dumet Lead for Sealing to Soft Glass," by *D. L. Swartz and J. C. Turnbull, Radio Corp. of America, Lancaster, Pa.*

Dumet leads having diameters greater than 0.030 inch have long been desired in the power-tube industry for increased rf-current-carrying capacity. This paper describes a 0.060-inch, high-conductivity dumet lead which was developed by careful matching of radial and axial thermal-expansion coefficients. In this lead, relative copper volume is about $\frac{1}{2}$ to $\frac{1}{3}$ that found in conventional dumet leads. The core material is a nickel-iron alloy having an expansion coefficient of 90×10^{-7} in/in/°C. The use of this alloy provides a considerably better match to G0120 glass than that provided by conventional dumet leads. Relative merits of three possible techniques for producing the high-conductivity dumet leads are discussed.

16.4 "Novel Design Approach for Microwave Tubes," by *J. E. McLinden and D. Lichtman, Airborne Instruments Lab., Inc., Mineola, N. Y.*

An approach to electron tube construction is presented which is highly suited to tubes and components requiring establishment and maintenance of critical geometries in vacuum-sealed, heated assemblies. In this method, spacings are established by optical measurements and maintained by coherence with the assembly envelope. This approach should not only improve reliability of the component but reduce cost. The method is discussed as applied to the development of a planar microwave triode having spacing tolerances of ± 0.0001 inch.

16.5 "Magnetron Operation at Very-Long Pulses," by *Markus Nowogrodzki, Amperex Electronic Corp., Hicksville, N. Y.*

The paper describes a phenomenological study of long-pulse performance in a 4J52-type magnetron employing a new type of emitter, the Philips' impregnated cathode. The basic cathode structure is described, a comparison of electrical performance with a standard tube at normal operating conditions is made, and the new tube's (6507) operation at 14-microsecond pulse conditions is analyzed. Design problems in the specialized test equipment are related, and pertinent tube data at long-pulse operation are described, such as cathode temperatures, power output, stability, life-test performance, et cetera. A tentative specification for long-pulse operation of the 6507 is included.

SESSION XVII

TUES. 2:30-5:00 P.M.

BELMONT-PLAZA
MODERNE ROOM

Instrumentation II

Chairman: EDWIN P. FELCH, *Bell Telephone Labs., Inc., Whippany, N. J.*

17.1 "A New Instrument for the Automatic Measurement of Transistor Noise Figure," by *D. D. Grieg and S. Moskowitz, Electronic Research Associates, Caldwell, N. J.*

The noise generated in a transistor is one of its basic characteristics, and the accurate measurement of this quantity is of considerable importance in the development, manufacture, and application of transistor devices.

This paper describes a new instrument which eliminates the drawbacks of the present manual procedure of transistor noise figure measurement. The instrument operates on the basic principle of synchronously connecting and disconnecting a calibrated noise generator to the input of the transistor or transistor-amplifier under test. By automatically comparing the internal transistor noise with that of the external noise source, a continuous direct reading of noise figure is obtained.

The paper describes the basic operating principles, gives details of a practical operating model, and presents comparative results with respect to standard manual methods.

17.2 "A Radio-Frequency Parameter Bridge for Junction Transistors," by *Anthony Illavacek and Ge Yao Chu, Sylvania Electric Products, Inc., Ipswich, Mass.*

A radio-frequency bridge to measure the ohmic base resistance and the collector capacitance of junction transistors is described. The four arms of the bridge are essentially formed by a three-terminal rc network, and the collector-base circuit of the transistor under test. A sinusoidal radio-frequency signal is applied to the collector-base terminals while a null detector is placed between the emitter and a terminal of the rc network. The principle of operation and a brief description of the bridge are presented.

17.3 "A Versatile Transistor Tester for Measuring Open Circuit 'T' Parameters," by *R. P. Crow, Motorola, Inc., Chicago, Ill.*

Although "T" equivalent circuit parameters are conveniently used, and can be readily measured on point contact transistors, it has not been practical to make direct open-circuit measurements of these parameters on junction transistors because of the high-collector impedances. This paper describes a technique for using a "Q" multiplier for raising the effective collector-circuit impedance of a tester to values of over 200 megohms, permitting accurate

measurements of the open-circuit parameters. A description, with circuit diagrams, is given of a complete tester that measures 1,000 cps small-signal "T" equivalent circuit parameters and grounded-base and grounded-emitter current gains, input impedances with various loads, and power gains with various loads.

17.4 "A Transistorized Oscillograph," by *W. G. Reichert, Jr., Allen B. DuMont Labs., Inc., Clifton, N. J.*

The attractiveness of small size and low-power consumption of transistors led to the development of a transistorized, battery-operated, portable oscillograph. Utilizing only commercially available transistors, this unit has a frequency response of from 20 to 200,000 cps, a deflection factor of 0.2 volts per inch, and a sweep range of from 20,000 to 5 μ sec. A description of the feedback amplifier, the multivibrator, and the turn-off and lock-out circuitry will be supplemented by a discussion of design problems peculiar to this application. High input impedance and output voltage swing requirements of the amplifier, and linearity restrictions on the sweep circuit will be covered.

17.5 "A 200 CPS to 5 MC Recording Equipment," by *Charles C. Comstock, Sig. Corps Engrg. Labs., Ft. Monmouth, N. J.*

The task of designing and constructing a magnetic-type recorder-reproducer to operate in the band 200 cps to 5 mc is divided into two portions. The mechanical system for achieving high relative head-to-tape motion with its attendant problems of obtaining proper head-to-tape contact and registration of reproduce heads on the recorded tracks, is one portion. The second portion is the electrical system to rearrange the signals which are to be recorded into such a form that the broad band may be recorded, and eventually rearranged at playback into the original frequencies.

SESSION XVIII

TUES. 2:30-5:00 P.M.

WALDORF-ASTORIA STARLIGHT ROOF

Engineering Management I

Panel Discussion: Operations Research—A Tool of Engineering Management

Chairman: C. M. JANSKY, JR., *Jansky & Bailey, Inc., Washington, D. C.*

Panel Members: *Sir Robert Watson-Watt, Airtrol, Ltd., Toronto, Canada; Sherman Kingsbury, Arthur D. Little Company, Cambridge, Massachusetts; Dr. Ellis Johnson, Operations Research Office (Army), Johns Hopkins University, Baltimore, Md.; Leroy Brothers, Operations Analysis Group Hqts., U. S. Air Force; Martin Ernst, Operations Evaluation Group (Navy), MIT, Cambridge, Mass*

SESSION XIX

TUES. 2:30-5:00 P.M.

WALDORF-ASTORIA ASTOR GALLERY

Aeronautical and Navigational Electronics II Radar and Aircraft Landing Aids

Chairman: BERNAL M. MEADOR, *Trans World Airlines, Kansas City, Kans.*

19.1 "Airport Surface Detection Equipment," by *J. E. Woodward, Airborne Instruments Lab., Inc., Mineola, N. Y.*

Airport surface detection equipment (ASDE) is a radar set used to observe surface traffic on an airport. Tests of an experimental model have demonstrated its usefulness but also demonstrated the desirability of making certain improvements in performance. These improvements have been achieved in a design program preceding the fabrication of an engineering model which will have the following:

Frequency	24,000 mc
Pulse Width	0.02 μ sec
PRF	14,400 pps
Azimuthal Beamwidth	0.25 degree
Antenna Vertical Coverage	Horizon to -25 degrees
Antenna Polarization	Vertical or Circular
Scan Rate	60 rpm.

The technical aspects of this equipment and the special design problems will be discussed.

19.2 "A Marine Radar Identification System," by *Charles M. Tiffin, Federal Telecommunication Labs., Nutley, N. J.*

A marine radar identification system is described which operates on the principle of a transponder. The system enables a radar operator to distinguish the azimuth of a ship carrying the identification equipment from other ships in the vicinity.

The equipment is portable, self-powered, inexpensive, and simple to operate.

It is thought that this system, or variations thereof, will be useful in solving the radar identification problem as applied to marine or aeronautical navigation.

19.3 "Statistical Techniques for Analysis of ILS Flight-Test Data," by *Abe Tatz, Airborne Instruments Lab., Inc., Mineola, N. Y.*

Large amounts of flight-test data were obtained in an Instrument Landing System (ILS) evaluation program. These data were reduced by machine computation to provide quantitative measures of ILS performance. The measures of ILS performance are explained, the computing procedures are described, and typical results are presented to demonstrate the application of statistical techniques to a multitude of flight-test data.

19.4 "An Analysis of Angular Accuracy in Search Radar," by *Robert Bernstein, Columbia University, New York, N. Y.*

The problem of determining the theoretical limit of angular accuracy in search radar and the manner in which the controllable system parameters affect accuracy is of current interest in the design and operation of automatic track-while-scan systems, height-finding radars, and early warning detection and tracking systems.

The ultimate limitation to angular accuracy resides in the existence of receiver noise and target scintillation. Both these phenomena are random processes. The problem is formulated in a manner which brings the effect of these random processes into evidence, and it is concluded that the methods of parametric estimation as developed in the field of mathematical statistics are most appropriate for its solution. Possession of a sufficient estimator of target azimuth would be most satisfactory because such an estimator would extract from the echoes all the information they contain concerning azimuth. It is proved, however, that a sufficient estimator of azimuth cannot exist for the case of search radar.

The maximum likelihood estimator is chosen as the best alternative and its distribution is found. A set of weighting functions are obtained for the purpose of maximum likelihood azimuth estimation; these functions are interpreted in terms of the information content of echoes from various parts of the antenna beam. Quantitative results are presented which give the standard deviation of the estimator as a function of beam axis rms signal-to-noise ratio and the number of pulses per beamwidth. This result is employed as a standard of performance against which the efficiency of more easily implemented azimuth estimators is judged.

19.5 "Radio Direction-Finding from the Standpoint of Sampling and Interpolation," by *Martin Masonson, Federal Telecommunication Labs., Nutley, N. J.*

This paper discusses systems ranging from the rudimentary in radio guidance such as the Bellini-Tosi, to continuous scan systems, e.g. a VOR beacon, to versatile high-accuracy systems such as those presented by Earp and Godfrey. Concepts underlying and unifying an apparent variety of such systems, innovations on them, simple criteria and formulas for intrinsic repetitive errors are given and illustrated. From the standpoint of this paper these systems appear as interpolation computers which in practice are manifested in a diversity of instrumentations suiting given operational or production demands.

SESSION XX

TUES. 2:30-5:00 P.M.

WALDORF-ASTORIA JADE ROOM

Broadcast Transmission Systems II Color Television

Chairman: ROBERT E. SHELBY, *National Broadcasting Co., Inc., New York, N. Y.*

20.1 "Proposed Controls for Electronic Masking in Color Television," by *W. L. Brewer, J. H. Ladd, and J. E. Pinney, Eastman Kodak Co., Rochester, N. Y.*

Electronic masking in the color television studio is accomplished by the use of cross-coupling networks. These networks yield three output signals, each of which is a linear function of the three input signals. The colors of the final reproduction depend upon the values of the coefficients in the linear equations relating output voltages to input voltages. A change in the value of *any* individual coefficient in these equations affects the hue, saturation, and brightness of *most* nonneutral colors. The effect of an incremental change in each coefficient is described for a given set of masking equations. Coefficient controls may be ganged to simplify the relationship between manual adjustments and visual effects. A block diagram is shown for a particularly suitable circuit. A means for ganging the controls is also described.

20.2 "Experimental Equipment for Recording and Reproducing Color Television Images on Black-and-White Film," by *William L. Hughes, Iowa State College, Ames, Iowa.*

This paper is concerned with the design and construction of certain pieces of experimental electronic and mechanical equipment which can be used for recording and reproducing color television images on black-and-white film. The design of this equipment is based on the black-and-white film system for color television proposed at the 1954 National I.R.E. convention. Certain changes from the original proposals are described.

Theoretical and economic advantages and disadvantages of such a system are discussed briefly, but the major portion of the paper is concerned with descriptions and operating characteristics of existing equipment.

20.3 "Cathode-Ray Vectorgraph," by *Frank Uzel, Jr., Allen B. DuMont Labs., Inc., Clifton, N. J.*

This paper will describe a new cathode-ray vectorgraph developed primarily to display NTSC color television chrominance information as processed by a vector decoder unit.

The specifications and performance characteristics of this unit will be presented. Of special interest are the stability and small relative phase shift of the identical X and Y amplifiers.

Although primarily intended for color television instrumentation, it is felt that this unit will have considerable general application where relative phase-shift measurements are necessary.

20.4 "Automatic Balance Control of Colorplexers in Color TV," by *J. R. Popkin-Churman, Telechrome, Inc., Amityville, N. Y.*

A new colorplexer is described which has been designed to eliminate long and short time drifts of balance for chroma components, thus eliminating the necessity for the frequent man-

ual adjustment of balance controls as in standard colorplexers.

An auxiliary correction servo unit is also described for application to any type of colorplexer.

An automatic balancing system takes advantage of the error components present in the color signal during the synchronizing interval. The encoder is then servoed to null the unbalance components. A memory system is incorporated so that interruptions in signals or switching transients will not interfere with the operation of the correction circuits.

The application of the principles described in the paper eliminates one of the main defects in present-day color broadcasting equipment.

20.5 "Television in Europe," by *Hubert A. S. Gibas, Uster, Switzerland.*

Three different television standards exist in Europe. These cause problems in the frequency allocation of television transmitters, in the construction of receivers for places where two or three television systems can be received, and in the international exchange of television programs. A European television network is in the state of development. There are, with a few exceptions, uhf links in use. The greatest progress of television we find in Great Britain, where, as early as the year 1937, a regular television service was inaugurated. In Europe, also, industrial television has found practical application.

SESSION XXI

TUES. 2:30-5:00 P.M.

WALDORF-ASTORIA
SERT ROOM

Audio II

Symposium: Music, High Fidelity,
and the Listener

Chairman: LEO L. BERANEK, *Bolt, Beranek & Newman, Inc., Cambridge, Mass.*

21.1 "Electronic Organ-Tone Radiation," by *Daniel W. Martin, The Baldwin Piano Co., Cincinnati, Ohio*

The acoustical effects achieved and the techniques used in the radiation of electronic organ tone are quite different from the conventional effects and practices of both public-address sound systems for auditoria, and "high-fidelity" music reproduction systems for the home. In this paper the fundamental acoustical design principles of organ tone chambers are reviewed. Specific examples of tone cabinet design are described, and organ installation principles are illustrated by examples of actual installation.

21.2 "The Role of Room Acoustics in Music Listening," by *John A. Kessler, Massachusetts Institute of Technology, Cambridge, Mass.*

As sound travels from a source to a listener or to a microphone, its spectral and temporal characteristics are altered by the room through which the sound travels. In the case of recorded music, at least two rooms usually contribute to the quality of the sounds which the listener hears. The effects of the room on the music may be beneficial or detrimental to listening enjoyment. The evaluation of these physical effects in terms of listener preference is a subject of continuing interest to musicians, architects, and engineers concerned with design of concert halls and with the recording and broadcasting of music.

21.3 "Environment-Fitness Considerations of High-Fidelity Audio Systems," by *R. D. Darrell, Stone Ridge, N. Y.*

Performance evaluations become progressively more difficult as the field of interest expands from isolated audio components to integrated systems and as rigorously objective measurements either become impractical or are superseded by wholly subjective aural judgments. Yet if the final evaluation of over-all sound qualities must be determined by aesthetic rather than engineering criteria, the latter still are significantly applicable to system-operation techniques and to the fitness of a specific system to a specific environment. The present paper calls for extended and intensified study of present-day operator-listeners' practical audio needs and psychological attitudes, and, anticipating the results of such study, suggests some possible engineering approaches to the better "matching" of home high-fidelity systems to their actual "habitats."

21.4 "Acoustic Requirements of a Sound System Determined by the Listener," by *Cyril M. Harris, Columbia University, New York, N. Y.*

The listener to a high-fidelity system requires a certain acoustical performance from his system. This paper discusses the acoustical factors which set the requirements the system loudspeaker output must be capable of meeting to be acceptable to the critical listener. Areas of research will be indicated which must be pursued in order to provide additional knowledge required to specify completely this problem.

21.5 "Man, a Somewhat Neglected Component of Hi-Fi Systems," by *Walter A. Rosenblith, Massachusetts Institute of Technology, Cambridge, Mass.*

In recent years much progress has been made in assessing the transmission efficiency of communication systems. In most situations that are of interest to the "hi-fi" enthusiast, it is however not possible to specify the message that is to be transmitted. Under these circumstances, one might suggest that the most realistic yardstick for the performance of hi-fi systems is man's discriminative ability. This talk will, in the main, deal with man's hearing. It will also be concerned with the question: "To what extent do laboratory experiments on pure tones predict human reactions in more general listening situations?"

SESSION XXII

TUES. 2:30-5:00 P.M.

KINGSBRIDGE ARMORY
MARCONI HALLTelemetry and Remote Control III
Recent Telemetry Developments*Chairman: MARTIN V. KIEBERT, JR.,
Convair, Pomona, Calif.*22.1 "A Multiple-Frequency Antenna-Coupling System," by *H. R. Sigler, Bendix Aviation Corp., North Hollywood, Calif.*

The most satisfactory solution to the problem of radiating several telemetry carriers from a vehicle is to radiate them from a single antenna, provided they can be coupled to it without excessive loss.

Two antenna couplers are suggested and described that will make up a system to couple as many as four transmitters to a single-phased antenna.

The first coupler is of the notch-filter variety and applies two signals to one antenna with a minimum insertion loss. The second coupler is based on the hybrid ring principle and will couple two signals to a phased-antenna array. When two of the former units are used with one of the latter, a system results which will combine four signals at one antenna.

The paper describes a new transmission line configuration which is used successfully in these two couplers and contributes to their compactness and resistance to environmental effects. The electrical characteristics and environmental reactions are also discussed.

22.2 "Germanium Photoconductor as Missile Spin-Counter in an All-Transistor FM/FM Telemeter Transmitter," by *C. M. Kortman, Bendix Aviation Corp., North Hollywood, Calif.*

A germanium photoconductor is used to frequency modulate a telemetry-subcarrier oscillator according to the intensity of the light falling upon the sensitive area. Intensities between complete darkness and bright sunshine can be measured and the difference between the light source and the shadow cast by the device, when it is between the source and the sensor, causes an appreciable frequency shift. In the missile application it is only necessary to count the cycles between bright light and shadow to determine the spin frequency. The germanium photoconductor is ideal for use with the all-transistor system since it requires no high-operating voltages or other special treatment. The frequency response is adequate for spin rates as high as several hundred revolutions per second.

22.3 "Linear Voltage Controlled Frequency Modulation of the Hartley Oscillator," by *W. F. Link, Ben-**dix Aviation Corp., North Hollywood, Calif.*

A brief historical background of the evolution and use of the Hartley oscillator in FM/FM missile-telemetry systems is given.

The theoretical problems involved in obtaining large, linear-frequency deviations of an oscillator by voltage stimulus are discussed, particularly as affected by limitations imposed for use in missile telemeters. Practical solutions to this problem are given, especially as they have been achieved with the Hartley oscillator. Advantages accruing from use of the Hartley circuit over other possible oscillators are discussed. Finally a description is given of a commercially available voltage-controlled FM oscillator developed by the Pacific Division of Bendix Aviation Corporation.

22.4 "Application of Process Circuitry to Telemetry Components," by *L. A. G. Ter Veen, Bendix Aviation Corp., North Hollywood, Calif.*

The new arts of printed and etched circuitry have been applied to many items where high-quantity production and economy have been the most important factors. In telemetry components, neither of these two factors is of primary importance, reliability and compactness being worthy of greater consideration. This paper shows how process circuitry may be employed to enhance these factors.

The specialized design techniques which must be employed to adapt process circuitry to meet the needs of telemetry components is discussed in detail. Specific examples are given. A telemetry subcarrier oscillator employing an etched circuit, which is currently being produced in a quantity of 3,000 units, will be illustrated and described. Telemetry packages utilizing etched circuitry to achieve rugged, compact construction will also be discussed.

22.5 "Wide-Band AC Rate Networks," by *L. F. Lyons, Bendix Aviation Corp., North Hollywood, Calif.*

In servo system design, there frequently arises a need for lead or lag rate networks in the signal or feedback loop in order to achieve stability or modify the servo system frequency response for special applications. In systems where dc control and feedback voltages are employed, rate network design is comparatively simple. Many systems employ ac control and feedback because of its compatibility with synchro-position indicators and two-phase drive motors; however, ac differentiating or integrating networks present a more difficult design problem. Networks normally employed for this purpose are of the bridge *T* and parallel *T* null network, or lc resonant circuit variety. Both are frequency-drift sensitive, limited to high intelligence-frequency applications, and may have relatively high insertion loss.

This paper discusses ac lead and lag networks for applications at all intelligence frequencies. The networks presented are insensitive to variations in signal frequency. They also permit mixing of control and feedback signals in a common impedance which includes the rate network even in cases where one signal is ac and the other dc.

SESSION XXIII

TUES. 2:30-5:00 P.M.

KINGSBRIDGE ARMORY
FARADAY HALLElectron Devices II
Microwave Tubes*Chairman: WELLESLEY J. DODDS, RCA Tube Div., Harrison, N. J.*23.1 "Klystron Power Amplifiers for Long-Hop Microwave Relay," by *N. P. Hiestand, Varian Associates, Palo Alto, Calif.*

Recent interest in long-hop microwave relay communications has again emphasized the importance of the klystron as a means of obtaining very high power in the microwave region. This paper will review the use of klystrons as a communications instrument and discuss the latest developments in the field.

Particular emphasis will be placed on those features of the klystron amplifier that are important to the communications engineer, such as efficiency, gain, tunability, linearity, bandwidth, and operating parameters.

A family of tubes will be described which provide appreciable energy (several kilowatts) at most important communication frequencies from 350 mc to 8,000 mc.

23.2 "Wide-Band, High-Power Traveling-Wave Tubes at S-Band," by *S. F. Kaisel and W. L. Rorden, Stanford University, Stanford, Calif.*

This paper will describe three experimental traveling-wave tube power amplifiers in the 100 w to 1-kw power range at S-band. The T-230 and the T-231 are pulsed traveling-wave tubes which will give the order of 1-kw output at 30 db gain from 2.5-3.5 kmc. The T-231 employs a control grid in the convergent flow electron gun, to allow beam-keying with low-voltage pulses. The T-351 is a cw power amplifier which will give greater than 100 w of cw output at 20 db gain from 2-4 kmc. The electrical design considerations for such tubes and the mechanical design details will be described.

23.3 "A 1-KW Pulsed Traveling-Wave Tube Amplifier at X-Band," by *J. E. Nevins, S. F. Kaisel, and M. Chodorow, Stanford University, Stanford, Calif.*

This paper will describe the application of the contra-wound helix structure to a high-power, narrow-band pulsed traveling-wave tube amplifier for operation in the frequency range 8.5-9.6 kmc. Power output greater than 1 kw at 30 db gain has been obtained. The impedance of the contra-wound helix as predicted by Chodorow and Chu has been verified by cold perturbation methods and by beam measurements. Some comparisons are made with performance and dimensions that would be predicted for the single-wound helix. A novel method of construction for the cross-wound helix will be described.

23.4 "Noise Analysis of Traveling-Wave Tube Video Detector," *Glen Wade, Stanford University, Stanford, Calif.*

An analysis is made of the rectification characteristics and the noise characteristics of a traveling-wave tube modified for use as a video detector. The purpose of the analysis is to determine the "minimum detectable signal" as limited solely by noise.

The high velocity electrons in the velocity modulated beam at the output of a traveling-wave tube can be separated from the slower electrons by means of a velocity-sensitive deflecting field or by biasing the collector near cathode potential. The current thus separated can be developed into a rectified signal.

Using reasonable values for the tube parameters the calculated "minimum detectable signal" from such a device is approximately minus 80 dbm.

SESSION XXIV

TUES. 8:00-10:30 P.M.

WALDORF-ASTORIA STARLIGHT ROOF

Automatic Control II

Trends in Automatization of Procedures and Processes in Business and Industry

Chairman: GORDON S. BROWN, Massachusetts Institute of Technology, Cambridge, Mass.

Panel Members: Gordon S. Brown, Massachusetts Institute of Technology, Cambridge, Mass.; Richard L. Meier, University of Chicago, Chicago, Illinois; W. R. G. Baker, General Electric Co., Syracuse, N. Y.; Low K. Lee, Stanford Research Institute, Stanford, Calif.; Roger W. Bolz, Penton Publishing Co., Cleveland, Ohio.

The growing use of the inter-connected techniques of feedback control, automatic assembly (automation), and electronic digital computation in industrial operations has led to an intense interest in the technical, managerial, economic, and social implications of automatic control. In this panel session, a chairman and speakers with a variety of backgrounds have been selected in order to obtain a comparison of viewpoints, as well as an over-all look at current trends toward automatization of procedures and processes in business and industry.

SESSION XXV

TUES. 8:00-10:30 P.M.

KINGSBRIDGE ARMORY MARCONI HALL

Audio III

Seminar: Magnetic Recording for the Engineer

Chairman: SEMI J. BEGUN, Clevite-Brush Dev. Co., Cleveland, Ohio

25.1 "Magnetic Tape as a Recording Medium," by *Frank Radocy, Audio Devices, Inc., New York, N. Y.*

Magnetic tape effects on recorder characteristics are discussed. Value of new polyester base in overcoming temperature and humidity effects is studied. Oxide improvements and use of coating orientation have improved output and signal/noise ratio. New binder formulations have improved anti-friction characteristics even in high humidity, without impairing high-frequency response by cupping. Defect-free tape for computer, instrumentation, and video recording has developed from improved coating, slitting, winding, and quality control techniques, manufacturing not over one defect in 24,000 feet. Special dust-free packing protects in transportation and storage, but user must protect against dust-pickup on recorder.

25.2 "Recorder-Reproducer Design," by *Walter T. Selsted, Ampex Corp., Redwood City, Calif.*

This paper presents the various design parameters which must be considered in the design of a magnetic recorder intended particularly for radio industry use. Those design characteristics which must be weighed when designing a machine of high performance and reliability are studied in relationship to one another and in some considerable detail.

25.3 "Tape-Recording Applications," by *Marvin Camras, Armour Research Foundation, Chicago, Ill.*

Standard designs are flexible enough for most uses of tape recorders. Special machines have been devised for unusual applications, such as pronouncing dictionaries, length-measuring machines, time compressors, dc and square-wave recorders, artificial reverberation generators, musical instruments, memory devices, and video recorders. The construction and operation of typical devices are reviewed.

25.4 "Tape Life," by *W. S. Latham, Groton, Conn.*

This paper will be concerned with certain physical properties of magnetic tape and environmental factors which create tape-storage problems. Comparisons will be made of the effects of storage on instantaneous-lacquer disk recordings, with effects on magnetic-tape recordings stored for the same period of time under the same conditions of temperature and humidity. Actual measurements of coefficients of expansion and contraction of various types of magnetic tape due to temperature and humidity changes in storage vaults will be discussed.

Information will also be presented concerning the effects of continuous replay of recorded tapes upon the physical structure of current oxides and backing, and upon the information recorded thereon.

Essential requirements for the construction of a special tape and disk storage vault, at present under construction at the U. S. Navy Underwater Sound Laboratory, will also be presented.

25.5 "The Future of Magnetic Recording," by *John S. Boyers, National Company, Inc., Malden 48, Mass.*

Magnetic recording was invented somewhat over 50 years ago and has seen its greatest development in the past 10 or 15 years. Both systems and components are still in a terrific state of flux. Future developments in both areas are certain to be startling. In the area of components, possibilities for greater packing density, both linear and cubic are discussed along with transducers and other components. In the area of systems, application to automation controls and other non-audio as well as pure audio application are considered.

SESSION XXVI

WED. 10:00 A.M.-12:30 P.M.

BELMONT-PLAZA MODERNE ROOM Ultrasonics I

Chairman: FRANK MASSA, Massa Labs., Inc., Hingham, Mass.

26.1 "Antenna-Type Transducers for Ultrasonic Flowmetering," by *R. C. Swengel, York, Pa.*

In the first application of the Bidirectional Ultrasonic Flowmeter, the measurement of hydraulic turbine discharge, it was necessary to design transducers that would distribute energy uniformly over a flow passage whose rectangular area was 390 square feet.

Difficulties in space limitations as well as obstruction to the flowing water led to the development of simple, antenna-type transducers. They consist of slender metal rods driven in compression by crystal or magnetostrictive drivers. Several methods for evaluating performance, both optical and electronic, are discussed, as well as specific data and the results of trials in a 42,500 horsepower hydroelectric turbine.

26.2 "Electrokinetic Hydrophones," by *Ernest Yeager, Western Reserve University, Cleveland, Ohio.*

At the interface between a solid and an ionic solution, a layer of ions of predominately one charge is absorbed on the surface of the solid with a diffuse layer of ions of predominately opposite charge adjacent in the solution. The periodic disturbance of this diffuse layer of ions by acoustical waves can produce several types of alternating potential effects which are significant in hydrophone applications. Such electrokinetic hydrophones offer special advantages at both infrasonic and ultrasonic frequencies in terms of their resistive impedance and their extremely small dimensions.

26.3 "Characteristics of Torsional Transducers," by *R. N. Thurston and Peter Andreatch, Bell Telephone Labs., Inc., Murray Hill, N. J.*

This paper is a collection of significant information about transducers for generating or detecting torsional oscillations.

The existing methods of making torsional transducers from barium titanate ceramic, quartz, and ADP are reviewed. Typical values are given for the electromechanical coupling coefficient, the "Q," and the voltage-torque

sensitivity when used as a torque-meter. Barium titanate ceramic transducers having coupling coefficients as high as 0.37 have been realized. Some practical methods of attaching these transducers to other materials such as glass and steel are described.

26.4 "Parameters Affecting the Q of Quartz Crystal Units," by *A. W. Warner, Bell Telephone Labs., Whippany, N. J.*

One of the principal electrical characteristics of a quartz crystal unit used as a high-frequency standard is its Q . Other factors being equal, the ability of a crystal unit to reduce the effects of circuit instabilities on the frequency of a crystal oscillator is directly proportional to its Q .

Studies have been made to find the relationship of Q to frequency, temperature, size, shape, surface preparation, and mode of vibration of AT-cut quartz plates, varying in size from 12 mm to 100 mm in diameter and 0.1 to 20 mc in frequency.

This has resulted in (1) crystal unit designs having a wide choice of crystal unit impedance in the frequency range of 1 to 10 mc, all units having a Q greater than 1×10^6 , (2) a very practical primary frequency standard crystal unit design at 5 mc having a Q greater than 2×10^6 , and (3) a particular design having a Q of 10×10^6 at room temperature. It is believed that Q 's limited principally by the internal losses of the quartz itself have been achieved, and some data are given showing the relationship of these losses to frequency and temperature.

26.5 "The Frequency-Temperature Behavior of Piezoelectric Resonators Made of Natural and Synthetic Quartz," by *Rudolf Bechmann, The Brush Laboratories Co., Cleveland, Ohio.*

Resonators made of synthetic quartz show some differences in the frequency-temperature behavior compared with natural quartz. To evaluate the frequency-temperature behavior of resonators, the determination of the temperature coefficients of the measured frequency dependence up to the third order is necessary. These coefficients are functions of several variables, such as the orientation of the resonators and to some extent the ratio of dimensions as well as other factors. The representation of the frequency-temperature behavior of a resonator by the first-, second- and third-order temperature coefficients forms the basis for investigation into the fundamental constants, as the frequency-temperature behavior of a resonator depends on the temperature coefficients of the elastic constants and the coefficients of expansion. In synthetic quartz the constants are modified to some extent. These investigations also have practical application to problems of crystal manufacture. The synthetic quartz studied was grown under the U. S. Signal Corps sponsorship.

26.6 "Ultrasonics in the Decortication of Natural Fibers," by *Ethel R. Fleming, B. M. Harrison Labs., Newton Highlands, Mass.*

Experiments intended to evaluate the potential use of ultrasonic energy in the decortication of natural fibers are described. Practical limitations are discussed and possibilities for future developments along these lines are sug-

gested. Particular emphasis is placed upon economic factors, especially insofar as these concern electronic generators. Essential requirements of high-frequency power supplies are examined.

SESSION XXVII

WED. 10:00 A.M.-12:30 P.M.

WALDORF-ASTORIA STARLIGHT ROOF

Electronic Computers I

Chairman: HARRY LARSON, *Ramo-Wooldridge Corp., Los Angeles, Calif.*

27.1 "Experiments on a Three-Core Cell for High-Speed Memories," by *J. Raffel and S. Bradspies, MIT, Cambridge, Mass.*

A core memory ten times faster than the coincident-current memory (the fastest available arbitrary-access storage) now seems possible by the use of three cores per bit of information. None of these cores need be of the true square-loop type, since two are exclusively for switching, one exclusively for memory; it is merely necessary that the switch cores be saturable and that the memory core have remanence. Since selection is completely external to the memory cores, noise is extremely low. The speed of such a memory is limited only by the amount of current supplied to the cores. Single three-core cells have yielded cycle times below 0.5 microsecond, with access times between 0.1 and 0.2 microsecond.

27.2 "Bimag Circuits for Digital Data-Processing Systems," by *David Loev, William Miehle, John O. Pavinin, and Joseph Wylene, Burroughs Corp., Paoli, Pa.*

Some new techniques for using bimag in data-processing systems are disclosed. A brief summary of bimag characteristics is given, and three fundamental transfer loops are qualitatively described. Two of these transfer loops permit conditional transfer between bimag and thus permit logical operations upon isolated cores. A logical symbolism, useful both in drawings and system design, is offered.

Bimag circuits that are described include OR circuits and some novel techniques for realizing the AND, EXCLUSIVE-OR, and MATERIAL-EQUIVALENCE functions.

Some special-purpose magnetic shift registers are described, and techniques for synthesizing logical networks are indicated.

Comments on the experience gained in designing and operating a large bimag system are offered.

27.3 "A Transistor-Magnetic Core Circuit: A New Device Applied to Digital Computing Techniques," by

S. S. Guterman and W. M. Carey, Jr., Raytheon Manufacturing Co., Waltham, Mass.

A circuit composed of a magnetic core with square-hysteresis-loop and of a single transistor, preferably of a junction type, forms a two-state memory cell.

In this circuit only the magnetic core remembers the state of the cell. The transistor serves as a driving or shifting element, as a buffer, and also supplies output power. Stand-by power is negligible. Diodes are not used in general.

From such cells are built all kinds of computing circuits, such as dynamic flip-flops, shift registers, counters—binary and decade, as well as logical structures.

These circuits are characterized by very low-power consumption, wide tolerances in component values, as well as in transistor parameters, and they have long life expectancy, especially if junction transistors are used.

Because the collector dissipation increases directly with frequency, the frequency of operation, as of this date, is limited by the transistor. With low-frequency low-power transistors, operation at 100 kc and even higher had proved to be satisfactory and quite reliable.

27.4 "A 'One-Turn' Magnetic Reading and Recording Head for Computer Use," by *D. F. Brower, Hughes Res. and Dev. Labs., Culver City, Calif.*

The design and characteristics of a "one-turn" magnetic reading and recording head are discussed. Among its desirable characteristics are high efficiency and ease of construction. An uncomplicated, compact, mechanical configuration simplifies shielding and the accurate positioning of gaps. Heads may be closely spaced while maintaining a low cross-talk ratio.

27.5 "Magnetic Selection Systems Using a Single Pyramid for Both Selective Writing and Reading in Large-Scale Electronic Computers," by *Amir H. Sepahban, Monroe Calculating Machine Co., Morris Plains, N. J.*

Selective writing of information on a chosen memory channel (magnetic drum channel) as well as selective reading from such a chosen channel in electronic computers is commonly performed by means of relay pyramids or diode or vacuum tube pyramids. This paper suggests the use of magnetic-core elements for this application in order to obtain a higher degree of reliability and longer life essential in large-scale electronic computers.

Description is given of the principle of operation of a 2-way all-magnetic 50-channel selection system developed as a prototype for a 3,500-channel magnetic drum storage unit.

Use of high permeability, nonrectangular hysteresis-loop-type cores allows noise-free gating of high-level writing currents as well as low-level reading voltages with a single magnetic pyramid. This departure from the conventional principle of switching cores with rectangular hysteresis-loop characteristics is essential for two-way operation of large-scale selection system.

Signal-to-noise ratios better than fifteen-to-one at a 100 kc signal repetition rate with channel selection speeds in the order of 100 microseconds are obtainable.

SESSION XXVIII

WED. 10:00 A.M.—12:30 P.M.

WALDORF-ASTORIA
ASTOR GALLERYMicrowave Theory and Techniques
I Microwave ComponentsChairman: H. F. ENGLEMAN, *Fed.
Tel. Labs., Inc., Nutley, N. J.*28.1 "Wideband Waveguide Rotary
Joint," by *Henry Schwiebert, Wheel-
er Labs., Great Neck, N. Y.*

A waveguide rotary joint has been developed for operation over a 20 per cent frequency bandwidth, matched within 1.2 db SWR (1.15 VSWR). It is based on a coaxial-line midsection, and handles the maximum pulse power consistent with single-mode propagation in such a line. At each end, it utilizes the ring type of junction with rectangular waveguide, previously developed for half this bandwidth. The improvements include a special compensation for the frequency variation of waveguide impedance and a special damping against incidental ring resonance in an uncoupled mode. Designs and models have been made for various bands in the range of 4 to 12 kmc.

28.2 "The Use of Modified Coaxial
Structures for the Instrumentation
of Components in Coaxial Line," by
*Bernard Dwork, Harvard University,
Cambridge, Mass., and Arthur A.
Oliner, Polytechnic Institute of Brook-
lyn, Brooklyn, N. Y.*

A number of components of novel construction employing modified coaxial structures have been designed for use in coaxial lines. These components are intended to supplement existing equipment so that a bench setup in coaxial line need no longer resort to transitions to rectangular waveguide for the necessary components. Among the components to be discussed are a variable attenuator, a hybrid tee, a directional coupler, and a novel type of double stub tuner. The modified coaxial structures employed are two- and three-plate parallel strip lines, and bifurcated coaxial lines. Emphasis in the design is placed on wide-band characteristics, small size, and simplicity of construction.

28.3 "High-Power Breakdown of
Microwave Components," by *G. K.
Hart and M. S. Tanenbaum, Sperry
Gyroscope Co., Great Neck, N. Y.*

The main problems involved in the experimental determination of the peak-power capacity of waveguide components are discussed. An experimental approach based upon a statistical concept of breakdown is presented and the equipment required for this approach is described. Experimental evidence is given which supports both the statistical concept and the experimental approach. Data is presented on the power-carrying capacity of directional couplers, E- and H-plane tee junctions, E- and H-plane bends, and flange junctions.

28.4 "A Low Noise-Figure Micro-
wave Crystal Diode," by *G. Mes-
senger and C. T. McCoy, Philco
Corp., Philadelphia, Pa.*

Microwave mixer noise figure can be uniquely calculated from the rectifier's equivalent circuit, which in turn can be uniquely determined from fundamental physics parameters.

The theoretical and practical relation of these parameters will be discussed in their application to the development of a germanium diode, with x -band noise figure as low as 4.5 db.

Though based on quantitative analyses, the presentation will confine itself to qualitative reasoning and graphical illustration.

Factors included in the discussion are the effects of spreading resistance, barrier capacity, power dissipation, noise temperature, surface treatment, etc.

28.5 "Tapered Velocity Couplers"
—Part I, by *J. S. Cook.*

It is known that if two transmission lines with equal phase velocities are mutually coupled over some length, a signal introduced into one line will be completely transferred periodically back and forth between the lines.

This principle is employed in power-"splitting" devices where power is, for instance, equally divided between two lines. Half of the signal power is permitted to transfer from one line to the other and at this point the coupling is discontinued. Other devices utilizing this coupling principle provide complete transfer of a signal from one line to another. These devices, however, do not work so well when operation over a very large bandwidth is desired.

Certain considerations lead to the conclusion that if the relative phase velocities of two coupled transmission lines are caused to vary over their length, being equal at one end and widely divergent at the other, a signal introduced into one line will become equally divided between the lines. This scheme has only a second order frequency dependence and its useful bandwidth is a function of its physical length. A demonstration of a mechanical analog in the form of two coupled pendulums will be given to verify these conclusions.

Due to the relatively great physical length of this kind of coupler it will probably find most practical application at frequencies above 10,000 mc/s and/or in devices such as traveling-wave tubes with slow-wave structures.

28.5 "Tapered Velocity Couplers"
—Part II, by *A. G. Fox.*

While a linear variation of the phase constant difference between a pair of coupled waveguides can produce a first order broad-band transfer of power from one waveguide to another, the transfer characteristic will contain small ripples unless the waveguides are infinitely long. However, by simultaneously varying the coupling coefficient throughout the coupling region, the power transfer can be made substantially complete. The simultaneous variation of coupling coefficient and phase constant difference is based on a new principle of coupling between traveling waves here referred to as "normal mode tapering." The normal modes in such a tapered system are characterized by transverse field and energy distributions which change from point to point along the coupling region. Provided energy is introduced into only one of the normal modes, it can travel through the coupler with a desired change in the power distribution between two waveguides, and the distribution will not be sensitive to frequency changes. In contrast, the usual

couplers employing matched phase constants achieve power transfer by means of the interference between two normal modes, and bandwidth will be limited by changes in this interference. A demonstration using the pendulum model will be given of the improvement in power transfer which can be achieved by simultaneous variation of coupling and phase constant difference.

SESSION XXIX

WED. 10:00 A.M.—12:30 P.M.

WALDORF-ASTORIA
JADE ROOMProduction Techniques—Elec-
tronic Equipment Assembly
MethodsChairman: RALPH R. BATCHER, *Radio Elec-
tronic TV Mfrs.' Assoc., New York, N. Y.*29.1 "Electronic Design for a Digi-
tal Computer," by *R. J. O'Neill,
Hughes Res. and Dev. Labs., Culver
City, Calif.*

The cabinet is constructed of a top pan, bottom pan, and pillars separating these pans. The pillars are hollow, acting as supports and air ducts. Tiers are stacked between pillars and air vented through the tiers. Small chassis-holding electronic components plug into the tiers. Chassis are designed for preformed or post-formed etched boards but presently are being used with flat boards until others are production tested. Machine wiring is all by taper pin connections. Cabinet doors open such that all wiring is accessible for service.

29.2 "A Flexible Automatic Com-
ponent Assembly System," by *Ben
Warriner and George W. Gamble,
General Elec. Co., Ithaca, N. Y.*

This paper describes an automatic system for assembling lead-mounted components on printed circuit boards. It is being constructed under contract with the United States Army Signal Corps as an industrial preparedness measure. The component preparation, feed, placement, and testing functions are automatically controlled by a punch card programming system. Flexibility for job lot production has been stressed. This paper includes a discussion of the characteristics of the system, a description of the major units, and its overall operation.

29.3 "Principles of Circuit Packag-
ing for Auto-Semby," by *Sherman
G. Bassler, Sig. Corps Engrg. Labs.,
 Ft. Monmouth, N. J., and Myron
Hinebaugh, P. R. Mallory and Co.,
 Inc., Indianapolis, Ind.*

The printed-wiring technique of electronic circuit fabrication known as Auto-Semby was introduced by the Signal Corps in 1949 and presented at the IRE Convention in New York in 1950. Acceptance and effective application by industry has confirmed the soundness of the principles involved.

The application of the system to more complex equipments, miniature as well as the larger size equipments, has shown the need for improvement in integration and circuit packaging methods.

To provide design information to meet this need has been the objective of a Signal Corps research and development contract with P. R. Mallory and Co., entitled "Development of Principles and Techniques of Integration and Packaging of Printed Circuit Assemblies," Contract DA-36-039 SC-42468.

This paper will present pertinent data developed from this contract and will show some of the aids evolved to assist the designer in selecting the proper circuit package and integration method to meet his design requirements. Four types of circuit packaging are presented with analyses of their efficiencies. Weight, volume, maintenance, and thermal efficiencies are considered. The methods devised for integrating the packaged sub-assemblies together with their integration efficiencies are shown.

The increasing demand for smaller, lighter, more rugged and efficient electronic gear, makes this new design information particularly useful for designers of new equipments.

29.4 "Standards for Automation," by J. J. Graham, *Radio Corp. of Amer., Camden, N. J.*

This is a paper discussing the need for and development of guide lines for the mechanization and eventual automatization of the assembly and construction of electronic equipment.

Development of standards for hole sizes, board sizes, component mounting and arrangement, equipment assembly, and manufacturing processes will be presented.

Comparison of problems and costs of automation processes with and without standards with special emphasis on machine design problems will also be treated.

The paper will close with a summation of the benefits derived from using standards, both from a manufacturing and a cost standpoint.

29.5 "Mechanization of Electronic Equipment," by Frank B. Iles, *Radio Corp. of Amer., Camden, N. J.*

This paper will present a discussion of the machine development program being followed by RCA's Production Department, with explanation of the over-all program and detailed description of machinery developed to date. A detailed description and production history of the following five pieces of equipment will also be furnished:

24-inch Shearing Machine with Automatic Control

Programmed Punching Machine

12-inch Shearing Machine

Two-Station Component Installing Machine

Automatic Soldering Machine

Equipment usage will then be treated, with discussion of conveyerization and general plant arrangement for eventual automatization of the process.

29.6 "An Engineering Approach to Printed Circuitry and Automation," by Rinaldo DeCola and George Harrigan, *Admiral Corp., Chicago, Ill.*

This paper concerns the distribution of responsibility during the development of a printed circuit and automation program for the design and production of radio and television receivers using these techniques.

Also work over a period of time covering two and a half years is considered, certain spe-

cific problems and their solutions are discussed, equipment for use in the design and sample production of printed chassis, coils and other components is described.

Test and evaluation of field and environment conditions as well as field reaction and service problems are discussed.

A program of new component design, adaptation, quality control, and the need for further controls to insure more reliable flow of products through a high speed production system is considered.

As four groups, electrical engineering, mechanical engineering, production engineering and engineering quality control are involved in such a program. The co-ordination of these into an effective staff is covered.

While the sync, sound IF, video stage, and audio output tubes were first printed and mechanized, the adaptation of a universal IF system is described in detail.

SESSION XXX

WED. 10:00 A.M.-12:30 P.M.

WALDORF-ASTORIA SERT ROOM

Instrumentation and Nuclear Science

Chairman: URNER LIDDEL, *Bendix Aviation Corp., Detroit, Mich.*

30.1 "An Atomic Frequency Standard," by Jerrold R. Zacharias, James G. Yates, and R. D. Haun, Jr., *Massachusetts Institute of Technology, Cambridge, Mass.*

This research was supported by the Signal Corps; the Office of Scientific Research, Air Research and Development Command; and the Office of Naval Research.

The hyperfine structure resonance line of atomic Cesium at approximately 9192.632 mc/sec has been used to stabilize the frequency of a microwave signal generator. This resonance frequency, describable as the Larmor precession frequency of the valence electron of atomic Cesium in the magnetic field of the atomic nucleus, is observed by the atomic beam magnetic resonance method as a resonance curve with a half-width of approximately 200 cycles/sec. The techniques necessary to make it into a practical device have become available only in the last few years in connection with researches on rare isotopes of the alkali atoms. These techniques will be described.

Preliminary results show that the short-time stability thus obtained (for times less than one second) is better than 1 part in 10^9 and that the average stability for long times will be considerably better than this. The beam tube has run satisfactorily for periods as long as 50 days indicating that a sealed-off tube with a life of several years should be quite possible.

30.2 "A Molecular Microwave Amplifier, Oscillator, and Frequency Standard," by Charles H. Townes, *Columbia University, New York, N. Y.*

A device has been developed which produces microwave amplification or oscillation as

a result of interactions between electromagnetic fields and a beam of molecules in radiative states. The oscillation is extremely monochromatic and very stable in frequency because the frequency is primarily determined by the resonant frequency of isolated molecules. Experimental tests and theoretical analysis indicate that the device should provide a very constant and rugged frequency standard.

30.3 "Collision Reduced Doppler Effect. A Sodium Clock?," by R. H. Dicke, *Harvard University, Cambridge, Mass.*

It seems to be very important if not essential that an "atomic clock" employ an atomic or molecular resonance with an intrinsic frequency width which is very small. The one factor affecting this line width most difficult to modify is the Doppler effect resulting from atomic thermal velocities. The hyperfine transitions in the monatomic vapor of the alkali metals is characterized by the fact that the Doppler effect can be essentially eliminated in a very simple fashion. If the alkali metal vapor at a pressure of perhaps 10^{-4} mm of Hg is carried in a helium atmosphere at a pressure of perhaps .1 mm, the Doppler effect contribution to the line width is given by the time required by the alkali metal atom to diffuse a wavelength, rather than the time to move a wavelength as in the normal Doppler effect, an improvement of about a factor of 100. It is essential that the electronic spin orientation in the metal atom be unaffected by a collision with a helium atom. The technique of "optical pumping" for improving signal-to-noise will be discussed, also techniques for coherent pulse-induced radiation.

30.4 "Eddy-Current Bridge for Measurement of Skin Losses," by Quentin A. Kerns, *University of California, Berkeley, Calif.*

Search for a suitable measurement technique for skin losses led to the development of the present instrument, which seems to be one member of a family of similar devices.

The eddy-current bridge has been used to measure the conductivity of materials from silver to graphite at frequencies ranging from 1 kc to 40 mc. To obtain a reading, the sample is placed against the instrument head and two adjustments are made, corresponding to resistive and reactive balancing of a bridge, which may be calibrated to read resistivity in ohm-cm or ohms square at a given frequency.

A wide frequency range is desirable in the instrument. In particular, a plot of loss vs frequency for a sample can be used to measure plating thickness, or to detect the presence of a lossy layer on a base metal of higher conductivity. Such a lossy layer, found in copper-clad steel, was easily removed by pickling.

30.5 "Modifications to the Hutchinson-Scarrott Pulse Height Analyzer to Obtain a Coded Decimal Presentation and a Decimal Print-out," by J. L. McKibben, J. D. Gallagher, and H. J. Lang, *Los Alamos Scientific Lab., Los Alamos, N. M.*

The modifications to be described improved the memory stability to the point where the analyzer would give dependable operation for a period of at least one month with no adjust-

ments of the memory or adder during that time. The modifications to the memory section were made to improve the reliability and to permit an easy conversion to storage in a coded decimal system. The storage in a coded decimal system resulted in two advantages, an easily read display and the availability of data in a form suitable for use with an automatic print-out machine. The code was made such that the very simple binary adder could be retained. To further improve reliability, a very stable fused quartz delay line was chosen instead of a mercury delay line or a magnetostriction line.

SESSION XXXI

WED. 10:00 A.M.-12:00 Noon

WALDORF-ASTORIA GRAND BALLROOM

Symposium on Spurious Radiation

Chairman: RALPH BOWN, Bell Telephone Laboratories, Murray Hill, N. J.

Panel: W. R. G. Baker, General Electric Co., Syracuse, N. Y.; A. V. Loughren, Hazeltine Corp., Great Neck, N. Y.; G. E. Sterling, formerly FCC Commissioner; Ernst Weber, Polytechnic Inst. of Brooklyn, Brooklyn, N. Y.; E. M. Webster, FCC Commissioner.

SESSION XXXII

WED. 10:00 A.M.-12:30 P.M.

KINGSBRIDGE ARMORY MARCONI HALL

Circuit Theory II General Theory

Chairman: SAMUEL J. MASON, Massachusetts Institute of Technology, Cambridge, Mass.

32.1 "A Generalization of Foster's and Cauer's Theorems," by F. M. Reza, MIT, Cambridge, Mass.

The following lemma is proved by the potential analog method.

If $P(s)$ is a Hurwitz polynomial, then $d^n P(s)/ds^n$ is also a Hurwitz polynomial. Using this lemma as a starting point, the well-known Foster and Cauer's theorems are then generalized. The generalization in the latter case requires a more elaborate proof than in the first case. It is shown that if $Z(s) = P(s)/Q(s)$ represents the driving-point impedance of an RL or RC passive network, then

$$[d^n P(s)/ds^n] \div [d^n Q(s)/ds^n]$$

also will represent an RL or RC driving-point impedance.

A general discussion on the generation of positive real functions presenting the driving-point impedances of two-element kind networks is undertaken. In this direction the following general theorem is proved: If

$$Z(s) = \frac{a_0 + a_1s + \dots + a_n s^n}{b_0 + b_1s + \dots + b_n s^n}$$

represents the driving-point impedance of a two-element kind one-terminal pair dissipative

network, and $P(s)$ is a Hurwitz polynomial with negative real distinct roots, then:

$$Zk(s) = \frac{a_0 + a_1P' + \dots + a_n P^{(n)}}{b_0 + b_1P' + \dots + b_n P^{(n)}}$$

will also represent the driving-point impedance of a two-element kind one-terminal pair dissipative network.

32.2 "On the Separability of Laplace Transform Variable and its Applications in Carrier Systems," by Sheldon S. L. Chang, New York University, New York, N. Y.

Carrier systems are analyzed by separating the Laplace transform variable into a data component and a carrier component. Independent phasors are introduced giving rise to independent complex planes for the data transform variable and carrier transform variable. Data transfer function linking directly the demodulated signal to the modulating signal is derived for arbitrary carrier network and is applicable to both sinusoidal and transient inputs.

The method is applied to carrier servomechanisms. The equivalent time constants for a carrier network is derived under condition with phase and frequency errors.

For dual channel carrier servos, doubly complex input and response functions are introduced. Together with the complex transfer function, "cross-talk" can be treated as a single servo problem instead of as that of two interlinked servo-systems, with much simplification in the analysis.

32.3 "A New Approach to the Approximation Problem," by Walter L. Baker, Ordnance Research Laboratory, Pennsylvania State University, State College, Pa.

The signals encountered in industrial control processes and other control systems is often some arbitrary function which is known only in the form of graphical or tabulated data. It is desirable for design purposes to obtain a mathematical expression for the signal function. A method is presented for obtaining by a function of the form $e^{-t}(a_n t^n + a_{n-1} t^{n-1} + \dots + a_0)$, a desired fit to a large group of signal functions. It is assumed that the signal is a real function of time which:

1. is bounded and single valued for $0 \leq t < \infty$
2. must approach zero as $t \rightarrow \infty$
3. is zero for all values of $t < 0$
4. has only points of ordinary discontinuity.

The method of approximation which is presented, provides greater flexibility and rapidity in obtaining a fit where the difference between the given function and the approximating function is to be minimized at any desired points. One can also estimate initially how much work is justified in obtaining a desired fit and arrange the detailed procedure accordingly.

32.4 "A New Series Representation for Correlation Functions," by W. M. Kaufman and J. B. Woodford, Carnegie Institute of Technology, Pittsburgh, Pa.

A special series representation of the autocorrelation function of a statistically described signal is presented which can adequately describe in a few terms most functions likely to be encountered. Use of this approximation will allow many synthesis problems to be solved analytically instead of numerically or graphi-

cally. A generalization of this method is suggested for the fourth and higher moment correlation functions. Examples are given of the use of this method in the design of optimum linear servomechanisms and filters involving a statistically described input signal.

32.5 "Theory of Low-Frequency Oscillators Employing Point-Contact Transistors," by B. J. Dasher, D. L. Finn, and T. N. Lowry, Georgia Institute of Technology, Atlanta, Ga.

This paper describes a theory for low-frequency oscillators, employing point-contact transistors, novel features of which include the use of precalculated design curves for determining the amplitude of oscillations, and the direct calculation of frequency stability. The analysis is based on a Fourier-series representation in which the nonlinear negative resistance characteristic is approximated by straight-line segments. Instead of assuming the characteristic to be nearly linear, the oscillation is assumed to be nearly sinusoidal. With the help of design curves computed for idealized typical characteristics it is possible to predict with reasonably good accuracy both the amplitude stability and the frequency stability of an oscillator with respect to known variations of transistor parameters.

The application of the theory to design problems is illustrated by example, and experimental confirmation of the results is presented.

SESSION XXXIII

WED. 10:00 A.M.-12:30 P.M.

KINGSBRIDGE ARMORY FARADAY HALL

Antennas and Propagation III Panel Discussion: Extended Range VHF and UHF Propagation

Chairman: JEROME B. WIESNER, Massachusetts Institute of Technology, Cambridge, Mass.

Panel Members: Kenneth Bullington, Bell Tel. Labs., New York, N. Y.; William E. Gordon, Cornell University, Ithaca, N. Y.; Oswald Villard, Stanford University, Stanford, Calif.; Dana Bailey, Nat. Bureau of Standards, Washington, D. C.; Walter Morrow, Massachusetts Institute of Technology, Cambridge, Mass.

Discussion of new techniques, experimental data and current research in long-range vhf and uhf propagation.

SESSION XXXIV

WED. 2:30-5:00 P.M.

BELMONT PLAZA MODERNE ROOM

Ulstrasonics II

Chairman: OSKAR E. MATTIAT, Clevite-Brush Dev. Co., Cleveland, Ohio

34.1 "Nondestructive Testers by Means of Ultrasonics," by *Bertram M. Harrison, B. M. Harrison Labs., Newton Highlands, Mass.*

A general examination is made of the techniques currently being employed in non-destructive testing by the use of ultrasonic and sonic vibrations. Limitations economic and practical are discussed. Suggestions of possibilities involving new and different techniques are advanced and practical limitations of strictly theoretical approaches discussed.

34.2 "Ultrasonic Echo-Ranging for Tissue Diagnostic Studies," by *John M. Reid and John J. Wild, Medico-Technological Research Dept., St. Barnabas Hospital, Minneapolis, Minn.*

An ultrasonic beam is used to scan tissues at a carrier frequency of 15 megacycles, a pulse length of 1 microsecond, and a repetition rate of 1 kilocycle. A thickness-resonant, air-backed, X-cut quartz crystal is used as a transducer. Echoes returned by tissue are displayed, using radar techniques, to form a picture of the irregularities. Several transducer transport mechanisms are described. Empirical studies using biological techniques have been made of reflection patterns from different parts of the body. The equipment has been in clinical use for the diagnosis of human breast lesions, including cancer. Pictures characteristic of various types of breast lesions are shown.

34.3 "Techniques Used in the Ultrasonic Visualization of Soft Tissue Structures of the Body," by *Douglas H. Howry, University of Colorado Medical Center, Denver, Col.*

Sound echo-ranging techniques used in materials testing do not lend themselves to the study of the interior construction of the body, since the high acoustic absorption plus the anatomic complexity require a low-frequency signal while maintaining an azimuth and range-resolving power of 32 objects to the inch over a 40 db scale.

The range problem has been satisfactorily solved by three separate methods: (1) Either by coupling the crystal driver to water by making it into an asymmetric compound oscillator, or by a special acoustic impedance transformer, which produces an efficient wide-band transfer of power with a resultant short pulse. (2) By double reverse pulsing which causes the echo to phase-cancel itself after a predetermined number of oscillations. (3) By a new system of phase-modulation echo-ranging which makes possible a resolution of structures separated by $\frac{1}{2}$ wave length.

The azimuth problem has been partially solved by beam focusing, and by a system of multiple position scanning which accurately interchanges range information for azimuth resolution. A computer circuit is being developed which will further improve azimuth resolution. Examples of two and three dimensional pictures will be shown, and technical and physical limitations of the system described.

34.4 "Technical Aspects of the Cavitron Ultrasonic Process in Dentistry," by *Lewis Balamuth, Cavitron Equipment Corp., Long Island City, N. Y.*

The Cavitron ultrasonic dental machine will be described with reference to its ultrasonic engineering features. Recent successes in clinical applications on patients have pointed to ultrasonic dentistry as one of the more significant advances in the growing field of ultrasonic technology.

The ultrasonic machining process will be discussed in the light of its meaning for operating on living tooth structure. The differences between the action of conventional rotary dental instruments and the Cavitron dental tool will be described in detail. Evidence will be presented to show that the Cavitron method of cutting tooth structure takes place at very low speeds and consequently with only the slightest pressure during the excavation. This is in direct contrast with the trend of rotary instrument research where recent work has been at high and higher rotary speeds.

34.5 "Application of Ultrasonics to Clinical Dentistry," by *Alvin E. Strock, Peter Bent Brigham Hospital, Boston, Mass.*

The use of ultrasonic vibrations to activate tools for carrying out dental procedures is being evaluated. It is proving of practical value in many branches of dentistry.

Using the Cavitron process, many intricate excavations in tooth structure can be made. The sensation of the ultrasonic drill to the patient is quite different and distinctly less disagreeable than conventional tools.

It can also be used for filling nerve canals in nonvital teeth. Conventional techniques have often resulted in freezing and fracturing of rotating files inside the tooth root. Files threaded into the end of the transducer are very effective and eliminate these difficulties.

Tools can also be made for condensing various types of filling materials. The possibilities for cutting bone and disintegrating tartar have great promise and will be reported.

34.6 "Ultrasonic Destruction of Erythrocytes," by *Eugene Ackerman and David B. Lombard, Pennsylvania State University, State College, Pa.*

Equipment has been constructed to observe the breakdown of mammalian erythrocytes in cavitating acoustic fields from 50 kc to 1 mc. These fields are produced in three ceramic bowls which can easily be used at frequencies either side of their resonances. The sound pressures are measured with calibrated ceramic probe hydrophones, and the particle velocities with electrokinetic hydrophones. The erythrocyte concentration is measured directly in the exposure tube in the sound field by means of an optical densitometer built into the equipment. The output is recorded on an Esterline Angus milliammeter.

Preliminary measurements on the frequency dependence of the breakdown rate of the erythrocytes will be presented.

Electronic Computers II Symposium: Design of Machines to Simulate the Behavior of the Human Brain

Chairman: HOWARD E. TOMPKINS, Burroughs Res. Center, Paoli, Pa.

Panel Members: Anthony G. Oettinger, Harvard Computation Lab., Cambridge, Mass.; Warren S. McCulloch, Massachusetts Institute of Technology, Cambridge, Mass.; Nathaniel Rochester, International Business Machines Corp., Poughkeepsie, N. Y.; Otto H. Schmitt, U. of Minnesota, Minneapolis, Minn.

The most versatile machines—electronic digital computers—can perform only a fraction of the tasks commonplace to the human brain.

How can we go about designing machines of greater versatility and adaptability, whose performance resembles more closely the higher behavior patterns of the human brain?

The possibility of such an approach is important both in engineering and in medicine, and the points of view of both of these disciplines will be discussed by the panel.

SESSION XXXVI

WED. 2:30-5:00 P.M.

**WALDORF-ASTORIA
ASTOR GALLERY**

**Microwave Theory and
Techniques II
Microwave Techniques**

Chairman: W. L. PRITCHARD, Raytheon Mfg. Co., Newton, Mass.

36.1 "A Broadband Electronic Doppler Simulator," by *Gershon J. Wheeler and John Reed, Raytheon Mfg. Co., Newton, Mass.*

Instead of using a wheel or other mechanical device in this Doppler simulator, a single side-band signal is obtained electronically with no moving parts.

The incoming signal is split in a hybrid tee. Both halves are amplitude modulated by audio signals in quadrature and then recombined in quadrature. As a result one side-band is completely suppressed while the other is transmitted with little attenuation. Carrier suppression may be accomplished by using balanced modulators.

Extreme bandwidth is obtained by making the side arms of the hybrid of waveguides of different dimensions, so chosen that the difference in electrical length remains constant over a broad band.

36.2 "A Contribution to Microwave Measurements," by *F. J. Tischer, Huntsville, Ala.*

This paper is concerned with the subject of field distribution in the vicinity of a special helix line structure with regard to the existence of waves traveling with reduced velocity along the line element. The existence of such waves

SESSION XXXV

WED. 2:30-5:00 P.M.

**WALDORF-ASTORIA
STARLIGHT ROOF**

makes practical the application of the line element to a standing wave detector at frequencies less than 500 mc.

Problems discussed include instruments which show the standing wave pattern of the field strength in a transmission line on the screen of a cathode ray tube. Prototypes are shown in photographs.

The investigation of the field distribution in waveguides, with both progressing and reflected waves, shows the applicability of a probe rotating around its axis for the standing wave detection.

36.3 "Measurement of Electromagnetic Parameters by the Use of Spheres Placed Near a Wall in a Resonant Cavity," by *W. K. Saunders, Diamond Ordnance Fuze Labs., Washington, D. C.*

A standard method for the measurement of electromagnetic parameters at microwave frequencies is through the study of the frequency shifts caused by the introduction of a sample into a resonant cavity. This method requires a knowledge of the field within the sample in terms of the unperturbed field. For rods and plates, this is easily obtained, but for the more mechanically convenient spheres, a problem arises as the sample is allowed to approach a wall of the cavity. Now the free-space dielectric sphere solution is no longer valid, and one requires a solution of Laplace's equation for a sphere in the presence of a plate. The author has not been able to find this solution in the literature. A method is given which indicates the structure of the solution and the variation of the cavity frequency perturbation as the sample approaches the wall.

36.4 "Impedance Measurement Through a Discontinuity in a Transmission Line," by *R. Mitra, University of Toronto, Toronto, Canada.*

The paper describes a method for calibrating a slotted line when measuring impedance through a discontinuity, e.g. an adapter, a coupling element between two guides, or a four-terminal network in series with the transmission line.

The method consists of performing standing wave measurements through the discontinuity with three specified reactance terminations. For the lossless junctions, three calibration constants are obtained directly from the measurement data. The evaluation of constants for a lossy structure involves certain simple graphical constructions on a Smith chart.

Typical application of the method in the fields of impedance measurements and matching, with examples illustrating the procedure, and certain advantages of the method over those already existing in the field are presented.

36.5 "Measurement of Small Complex Reflection Coefficient," by *Howard Scharfman, Raytheon Mfg. Co., Bedford, Mass.*

An accurate method of measuring reflection coefficients of magnitudes in the range .003 to .1 with good phase information is presented. The length of time required for a measurement is negligibly longer than for conventional slotted line techniques, and the measurement accuracy is considerably better. The system employs a ferrite circulator to separate incident and reflected powers at the unknown load. A microwave bridge is used to

measure the relative phase and amplitude of the reflected power from the unknown load as compared to a reference short circuit.

The limitations of the method, means for extending the range of accurate measurement, and examples of successful application in matching problems are discussed.

SESSION XXXVII

WED. 2:30-5:00 P.M.

WALDORF-ASTORIA
JADE ROOM

Quality Control and Reliability
Studies of Electronic Tubes
and Systems

Chairman: MARCUS A. ACHESON,
*Sylvania Elec. Prod., Inc., Kew
Gardens, N. Y.*

37.1 "Prediction of Missile Reliability," by *M. J. Kirby and H. R. Powell, Sperry Gyroscope Co., Great Neck, N. Y.*

This paper describes a method of testing missile elements to failure and analysis of the results. The "ultimate strength" of an element is plotted as the probability of failure vs the duration of exposure to the test environment. This is a convenient numerical indication of the inherent reliability of a design or a production lot, if the simulation of the use-environment in the tests is realistic. Comparison of the curves of "probability of first failure" with the "probability of second failure" indicates what limits the reliability and the degree of improvement to be expected from a remedy. Also, classification of failures according to cause as "design," "workmanship," "tubes," etc. shows where corrective emphasis should lie and whether the proportion of manufacturing errors is decreasing or increasing. This makes the method useful for monitoring the quality of production. A sufficient number of missile components has been tested to failure to demonstrate the feasibility of the method, and its effectiveness in providing a basis for recommending remedial changes.

37.2 "Detection of Intermittent Circuit Faults," by *Sidney Wald, Glenn L. Martin Co., Baltimore, Md.*

The detection of intermittent faults in electronic equipment is an art in which the chief tools have been experience, ingenuity, intuition, and patience.

A new test method is described herein which is designed to ferret out potential trouble areas in electronic apparatus before the faults therein cause malfunction of the equipment (present operational checks and voltage and resistance analyses show only present faults, not potential ones), and without resorting to damaging extremes such as excessive heat, cold, moisture, shock, or overvoltage.

In its present state of development, this new technique applies to RF and IF circuits which normally handle continuous modulated signals.

The method consists of the following steps: (1) A large amplitude unmodulated carrier of frequency suitable to the circuit under test is

applied to the circuit input; (2) the output is brought to a detector; (3) the detector output is amplified and monitored with a loudspeaker, test oscilloscope, and voltmeter. Refer to the block diagram (Figure 2); (4) the circuit under test is explored by gently tapping each component; (5) any perturbation of circuit constants causes a modulation of the carrier and results in an output. The circuit under test becomes extremely microphonic; that is, detachable electrical outputs are produced by extremely small mechanical vibrations or shocks. Such outputs are not produced in the absence of the carrier signal in most circuits.

37.3 "Statistics of Electronic System Failures," by *J. H. Parsons, K. L. Wong, and A. S. Yeiser, Hughes Aircraft Co., Culver City, Calif.*

Electronic systems are studied with respect to the probability of an operation of specified length being failure free. How this probability depends upon the maintenance policy is described. Under many types of maintenance, failures tend toward a pseudo-random distribution quite irrespective of the components' failure characteristics. Thus, the effectiveness of a proposed program of scheduled component replacement is difficult to predict from system failure statistics, but can be deduced if the coefficients of variation of the mean lives of the components are known. A simplified mathematical model of the failure behavior of a large scale electronic system is presented. Failure and error data from a moderately large digital computer are found in agreement with this model.

37.4 "New Reliable Voltage Reference Tubes for Severe Environmental Conditions," by *Earl J. Handly, Raytheon Mfg. Co., Newton, Mass.*

The variation in characteristics of some new glow-discharge voltage reference tubes are discussed. The paper includes material on the ionization and operating voltages for both short- and long-term operation. The effect of several factors such as vibration, shock, and high ambient temperatures are discussed. Values of initial voltage drift and voltage repeatability are given. The results are particularly applicable where the VR tubes are used as a source of reference voltage.

37.5 "Guided Missile Reliability and Electronic Production Techniques," by *Alfred R. Gray, Glenn L. Martin Co., Baltimore, Md.*

Reliability and maintenance problems peculiar to airborne electronic equipment are discussed. Emphasized are the fantastic demands made upon electronic component-part reliability by the vibration and temperature of guided missiles. Comment is made regarding the influence of component-part changes upon production techniques, as parts manufacturers strive to meet the missile reliability challenge. A general description is given (with slides) of various contemporary manual production methods, and of several concepts for electronic automation. An attempt is made to view these techniques and concepts objectively, and to evaluate them in terms of their ability to cope with present component-part changes, and in terms of trends for the future. A note of caution is sounded concerning blind acceptance of any one of these schemes as the complete solution

for present automatic production. But, at the same time, a note of confidence is voiced that out of these concepts of automation and semi-automatic production, will soon come a philosophy which will successfully marry automation techniques to the reliability requirements of even the intercontinental guided missile.

SESSION XXXVIII

WED. 2:30-5:00 P.M.

WALDORF-ASTORIA SERT ROOM

Broadcast and Television Receivers

Chairman: EDWIN B. HASSLER, *Warwick Mfg. Corp., Chicago, Ill.*

38.1 "A Developmental Pocket-Size Broadcast Receiver Employing Transistors," by *D. D. Holmes, T. O. Stanley, and L. A. Freedman, RCA Labs., Princeton, N. J.*

This paper describes a pocket-size developmental AM broadcast receiver which utilizes eight junction transistors. Its performance is comparable to that of conventional personal receivers. Emphasis has been given to developments which contribute to stability with respect to temperature, battery voltage, and variations among transistors. The superheterodyne circuit employed uses a single-transistor frequency converter to perform the functions of both mixer and oscillator. Refined detector and automatic-gain-control circuits and an audio amplifier embodying further development of the principle of complementary symmetry are incorporated. Reduction in physical size and battery requirement, as compared to conventional receivers, is substantial.

The circuits are described in detail and certain aspects of components and of physical arrangement, which contribute to the small size, are discussed. Detailed performance data are also included.

38.2 "Progress in Ferrite Components for Television and Radio Receivers," by *H. M. Schlicke, Allen-Bradley Co., Milwaukee, Wis.*

The reported improvements in ferrite components for television and radio receivers are based on better material, or on novel circuits, or on the utilization of normally unwanted properties. An example for each kind is given.

A new high efficiency ferrite (W-02) perceptibly out-performs all others for color television flyback transformers. The half-cycle criterion is used to determine the optimum parameters of ferrites for this application.

A simple small sized omnidirectional ferrite antenna circuit provides a possibility for inside automobile antennas and miniaturized aircraft antennas.

Ferrite beads acting essentially as resistors for UHF only are incorporated in discoidal feed-through capacitors as integrated filter units.

38.3 "What Price Horizontal Linearity?," by *Monte Burgett and John*

Tossberg, Philco Corp., Philadelphia, Pa.

This paper will be a study of the factors affecting the linearity of horizontal deflection. The types of nonlinearity are classified according to what part of the raster is affected and according to what circuit elements cause the nonlinearity. Statements are made of what changes in component parts and what additional parts are required to improve linearity. Estimates are made of the increased power drain and cost involved in these changes. The experimental techniques which were used in the study are explained.

38.4 "A Compatible High Definition Monochrome Television System," by *Pierre M. G. Toulon, and Francis T. Thompson, Westinghouse Research Labs., East Pittsburgh, Pa.*

A system for doubling the maximum number of horizontal and vertical picture elements of a televised scene is described. This system operates with conventional sweeps and is compatible with monochrome receivers.

The additional picture definition is obtained by making more efficient use of the available bandwidth. Redundancies between a given picture element in successive fields and between adjacent elements in a given field are measured at the transmitter, and this information is transmitted to the receiver in a compatible manner. This information is used to determine whether the receiver will display conventional large-size picture elements on a short-persistence phosphor or small-size picture elements on a long-persistence phosphor.

38.5 "Determination of the Optimum Demodulation Angles in Color Receivers," by *Stephen K. Altes, General Elec. Co., Syracuse, N. Y.*

A pair of demodulators can extract all the information from the color subcarrier signal. The only restriction on the output signal of a demodulator is that it should be zero for $R=G=B$, which represents reference white.

With the aid of a graph, the expression for the output signal for a certain demodulation angle can be obtained the most conveniently. The graphical method for accomplishing the inverse operation is also possible.

Detection circuits using angles other than the conventional $R-Y$ and $B-Y$ angles have advantages sometimes.

Several circuits incorporating these principles are analyzed.

38.6 "A Color Projection Receiver," by *W. F. Bailey and R. P. Burr, Hazeltine Corp., Little Neck, N. Y.*

This paper describes the results of an investigation of the use of projection displays for color television receivers. The display described consists of three small picture tubes producing red, green, and blue images and the Schmidt optical systems which project the three images onto a viewing screen. A general discussion is given of the technical problems encountered in the investigation and the means by which these problems were solved. One of the major problems—maintenance of registry—is considered in some detail. Some comparisons are made of the performance of the projection display with respect to other color display devices. Circuit description is limited to those circuits which differ from normal practice in color television receivers.

SESSION XXXIX

WED. 2:30-5:00 P.M.

KINGSBRIDGE ARMORY MARCONI HALL

Circuit Theory III Filters and Lines

Chairman: WILLIAM H. HUGGINS, *Johns Hopkins University, Baltimore, Md.*

39.1 "A Method of Rational Function Approximation for Network Synthesis," by *N. De Claris, Massachusetts Institute of Technology, Cambridge, Mass.*

A general method is developed for finding functions of a single complex variable s , which approximates an assigned network characteristic, within the special class of functions realizable as networks of linear lumped parameter circuits. The method is based upon an interpolation technique with a series of general rational functions on the unit circle of the z -plane. A number of transformations that map the interval of interest of the s -plane into the unit circle of the z -plane are discussed.

A great advantage of the method presented in this paper is that it allows preassigning, if so desired, the pole location of the desired rational function anywhere in the left half of the s -plane. In addition to this freedom, it also makes it possible to approximate on some contour of the complex plane the function itself rather than its modulus. Indeed in some applications of electric circuits, one is interested in both magnitude and phase characteristics of a network in specified frequency interval.

Following a former mathematical treatment, procedures are outlined for three cases of approximation in frequency and time domain.

39.2 "Input Capacitance of Maximally-Flat Filters," by *John L. Stewart, University of Michigan, Ann Arbor, Mich.*

Low-pass lossless ladder filters, operating between different source and load resistances and adjusted to have an n -pole maximally-flat transfer function where n is the total number of inductors and capacitors in the filter, usually are built with a shunt capacitor as the element nearest the source and, if n is odd, also have a shunt capacitor adjacent to the load. These capacitances are evaluated for arbitrary n and source-to-load-resistance ratio using a method obtained from the Darlington synthesis procedure. Several formulas and useful curves are given. The relationship between the leading capacitance of the filter and the Bode limit is also demonstrated. Finally, it is shown that no mismatch is permitted if the maximum bandwidth-times-transmission-coefficient product is desired.

39.3 "Application of Time Series to the Calculation of the Transient Response of Bandpass Systems," by *C. J. Peters, Gulf Res. and Dev. Co., Pittsburgh, Pa., and J. B. Woodford, Carnegie Institute of Technology, Pittsburgh, Pa.*

A method is developed for determining numerically the response of a bandpass system to an arbitrary input, by use of a time series. The method is well suited to machine computation, and is an extension of low-pass time-series methods of others. Extreme complexity of the input, which can be either a time function or a time function modulating a carrier, is no disadvantage in using this method. As an example, the response of a spectrum analyzer is calculated for an input consisting of two sinusoidal signals of three different frequency separations for three different IF amplifier selectivities.

39.4 "Maximizing the Bandpass Ratio in Impedance Transforming Filters," by D. H. Geipel, North

American Aviation, Inc., Downey, Calif., and R. L. Bright, Westinghouse Elec. Corp., Pittsburgh, Pa.

A lumped-element, four-terminal, impedance-transforming network is synthesized by applying a necessary condition to the impedance determinant of a system of mesh equations. The requirement for single band-pass operation is applied, and the relationships between bandwidth ratio and impedance transformation ratio are determined. Formulas for the element values of different types of three mesh networks as functions of the impedance transformation ratio are developed. Also, experimental results are compared to theoretical response curves.

39.5 "Miniaturized High-Impedance Magnetic-Core Delay Line," by H. W. Katz and R. E. Schultz, General Elec. Co., Syracuse, N. Y.

The high permeability and high resistivity of the ferrites have long attracted their use to the miniaturization of high-frequency magnetic components. One among many such components is the distributed constant delay line. Since the time delay per unit length equals \sqrt{LC} , large increases in the per unit length inductance by means of high permeability cores would decrease the total length of line required for a given time delay. But the simple introduction of ferrites into standard lines does not seem to lead to satisfactory results.

This paper will present an analysis of magnetic-core delay lines which will lead to the source of the poor high-frequency response which is normally obtained. The analysis also indicated what changes in the line configuration must be made to extend the frequencies over which the time delay remains constant.

Ferrite delay lines designed according to the procedures outlined in the analysis have been constructed and tested. Successful lines having a time delay of 0.2 μ s/in. and a characteristic impedance of 6,000 ohms have been made. The useful frequency range has been extended to over 4 mc. In addition it has been found possible to vary the time delay electrically without serious pulse distortion. The paper will conclude with a discussion of the experimental results to date and an indication of future development.

SESSION XL

WED. 2:30-5:00 P.M.

KINGSBRIDGE ARMORY
FARADAY HALL

Antennas and Propagation IV Propagation

Chairman: KENNETH A. NORTON, National Bureau of Standards, Boulder, Colo.

40.1 "Airborne Measurement of Effective Ground Conductivity at Low Frequency in Alaska," by Glenn M. Stanley and T. Neil, University of Alaska, College, Alaska.

Airborne field strength measurements have been made over large sections of the Territory of Alaska in the frequency range of 203 to 407 kc. Theoretical field strengths are computed after the methods presented by K. A. Norton for both a plane and spherical single-layered earth and the theoretical values are compared with experimental data to obtain the effective ground conductivity. A discussion of the method of analysis is presented, and a map of the effective conductivity of wide regions of the Territory is included. The effective conductivity is shown to be between 0.5 and 5 mmho/m over most sections of Alaska.

40.2 "Atmospheric Attenuation of Microwave Radiation," by Gene R. Marner, Collins Radio Co., Cedar Rapids, Ia.

Solar radiation at wavelengths of 8.7 mm and 1.9 cm has been monitored for several months at the Collins Feather Ridge Observatory with two radio telescopes. The Collins Radio Sextant is utilized to position the two radio telescopes so that they continuously receive maximum solar power independent of atmospheric refraction. The decrease in received power as the atmospheric path length increases at sunset is used to calculate the atmospheric attenuation constant. A statistical study of the daily values of attenuation constants is presented, and the effect of several weather factors upon attenuation is discussed.

40.3 "Back-Scattering from the Sea Surface," by Martin Katzin, Naval Research Lab., Washington, D. C.

The available experimental data on back-scattering from the sea surface ("sea clutter") are described, and discussed with reference to the physical processes involved. It is shown that the scattering elements of the surface are illuminated by a combination of direct and indirect fields, the latter being "reflected" (forward-scattered) by surface elements closer to the radar. At low angles, these interfere destructively, giving rise to the so-called "critical angle," polarization dependence, "spikyness," and steeper frequency dependence. A theory is developed in which elemental scatterers are taken to be small patches or "facets" of sea surface. It is shown to give characteristics in general agreement with available experimental data.

40.4 "Measurements of Correlation, Height Gain, and Path Antenna Gain at 1,046 Megacycles on Spaced Antennas Far Beyond the Radio Horizon," by A. F. Barghausen, M. T. Decker, and L. J. Maloney, National Bureau of Standards, Boulder, Colo.

Studies made and reported by the National Bureau of Standards in 1953 on the correlation of 1,046 mc radio fields on spaced antennas at distances far beyond the radio horizon are supplemented by more recent measurements. Data taken from three vertically spaced dipole antennas for longer periods of time allow correlations of instantaneous fields to be determined for various fading rate conditions. Measurements were made on the National Bureau of Standards Cheyenne Mountain transmission path in Colorado and Kansas at a frequency of 1,046 mc, the receiving location being at an angular distance of 27 milliradians (for standard atmosphere), i.e. approximately 150 miles beyond the transmitter radio horizon. In addition to the correlation of instantaneous fields, the correlation of hourly median fields and the diurnal variation of the received signal are shown. Simultaneous measurements from a parabolic reflector antenna are used to indicate loss in gain relative to expected free-space gain of a large aperture array.

40.5 "An Airborne Radar and Wave Propagation Laboratory," by David L. Ringwalt, Naval Research Lab., Washington, D. C.

The Naval Research Laboratory has instrumented an R5D aircraft (Douglas DC-4) as an airborne radar and wave propagation laboratory. The installation includes four radar systems (with frequencies ranging roughly from 1 to 10 kmc), associated radar recording and calibration apparatus, and an extensive meteorological instrumentation for measurement of related atmospheric conditions. All radars operate synchronously from a centralized control. The antennas, along with transmitter-receiver systems, allow transmission of vertical, horizontal, or circular polarization, with simultaneous reception of transmitted polarization and its orthogonal component.

This aircraft is intended for investigations in two general fields, back-scattering (radar) and wave propagation. In the radar field, it may be used for the determination of the back-scattering properties of individual targets or of area-extensive targets such as ground, sea, or precipitation. In the propagation field, it may be used as one terminal of a one-way transmission link, such as in investigations of radio ducts and atmospheric scattering.

SESSION XLI

THUR. 10:00 A.M.-12:30 P.M.

BELMONT-PLAZA
MODERNE ROOM

Medical Electronics I
Panel Discussion

Chairman: OTTO H. SCHMITT, University of Minnesota, Minneapolis, Minn.

Panel Members: Stanley Briller, Bellevue Medical Center, New York, N. Y.; Coleman C. Johnston, Lexington, Ky.; Joseph Moldaver, Institute of Physical Medicine and Rehabilitation, New York, N. Y.; J. W. Buchta, University of Minnesota, Minneapolis, Minn.; Britton Chance, University of Pennsylvania, Philadelphia, Pa.; Hector F. Skifter, Airborne Instruments Lab., Inc., Mineola, N. Y.; Saul R. Gilford, Colson Corp., Elyria, Ohio.

A panel discussion on medical electronics has been planned with the hope of being able to answer several questions which have been raised concerning this rapidly developing field of science.

The term, medical electronics, will be defined and its scope will be described. Doctors of medicine and electronic engineers will be brought together for a lively and extemporaneous discussion which will demonstrate good teamwork and a breakdown of the supposed language barrier. A timely and interesting problem will be presented to the members of the panel. An analysis of this problem will be made and likely solutions will be suggested. The value of the assumed results will be emphasized.

SESSION XLII

THUR. 10:00 A.M.-12:30 P.M.

WALDORF-ASTORIA
STARLIGHT ROOF
Information Theory II

Chairman: THOMAS P. CHEATHAM,
Melpar, Inc., Watertown, Mass.

42.1 "Time-Varying Filters for Nonstationary Signals on a Finite Interval," by *Arnold H. Koschmann, Univ. of Minn., Minneapolis, Minn.*

The concepts of signal space are applied to the problem of determining the optimum linear filter for a nonstationary signal which is known on the time interval $(0, T)$. The output of the filter at time T can be expressed as the weighted sum of the Fourier coefficients of the input defined with respect to a suitable set of orthogonal functions. For a fixed value of T this sum can be interpreted as the convolution of the input with the impulse response of a fixed network. As T is varied, a set of impulse responses is obtained. Relationship between this set of impulse responses and impulse response of a time-varying linear system is shown.

42.2 "Analysis of Linear Systems with Randomly Varying Inputs and Parameters," by *A. Rosenbloom and J. Heilfron, The Ramo-Wooldridge Corp., Los Angeles, Calif., and D. L. Trautman, Hughes Aircraft Co., Culver City, Calif.*

This paper begins with a brief discussion of the historical progression of analyses of linear system behavior from fixed parameters and deterministic (completely known) signals to randomly varying parameters and signals. Major attention is then focussed on some of the newer techniques and latest results, due to the authors and others, applicable to (a) random inputs (not necessarily Gaussian) to fixed systems, and (b) deterministic inputs to randomly varying systems. In both of these cases the outputs are random processes which can be described by moments or more completely by probability distributions. Both modes of description are discussed.

42.3 "Detection of Coherent and Noncoherent Pulsed Signals," by *R. F. Drenick, S. Gartenhaus, and P. Nesbeda, RCA-Victor Division, Camden, N. J.*

The use of statistical methods in the theory of detection of pulse signals in noise has been very fruitful. Certain rules for optimum detection have been derived by various authors for the video as well as the IF portion of the receiver. This paper discusses the optimum detection procedure in the IF portion of the receiver. It extends previous work in that the cases of coherent and noncoherent detection of a signal of unknown frequency are considered. The problems are formulated statistically as a composite hypothesis problem and solved by Wald's decision function theory. The optimum (minimax) decision rules for the above cases are derived and illustrative mechanizations which suggest themselves in each case are described.

42.4 "The Linear Filtering of Sampled Data," by *Gene Franklin, Columbia University, New York, N. Y.*

The following is an application of least-squares filtering theory to situations where a time-stationary random message and additive noise are sampled before being filtered. Such a situation might possibly occur with a pulsed radar or data link or in a system where an instrument measures only samples. The transfer function of the filter obtained from this application of the theory is usually a product of two terms, one of them rational in s and the other rational in e^{sT} , where s is the complex frequency and T is the sampling period. The first term is obviously a network of lumped $R, L,$ and C elements while the second term has the form of a linear program on a digital computer.

SESSION XLIII

THUR. 10:00 A.M.-12:30 P.M.

WALDORF-ASTORIA
ASTOR GALLERY

Electron Devices III Cathode-Ray Type Tubes

Chairman: RUSSELL R. LAW, CBS-Hytron,
Danvers, Mass.

43.1 "A Time-Sampling and Amplitude-Quantizing Tube," by *R. P. Stone, C. W. Mueller, and W. M. Webster, RCA Labs., Princeton, N. J.*

The possibility of a saving of bandwidth—or of transmitting additional information in a given bandwidth—by means of amplitude quantizing and time sampling has recently been realized.

Beam-deflection type tubes were successfully built and tested, which perform these functions. They will change a continuous signal into a quantized signal having six discrete amplitude levels, and simultaneously sample as often as ten million times per second. A residue signal is also generated.

Two types of output structure have been used, both of which permit the external adjustment of the output amplitude levels. The tube operates with an anode voltage of 300 volts. The stability of operation is such that after initial setup no critical operating conditions or adjustments are involved.

43.2 "Cathode-Ray Tube with Single Step Intensifier," by *Jenny E. Rosenthal, A. B. Du Mont Labs., Passaic, N. J.*

A study is presented of a single-step intensifier for cathode-ray tubes. Various designs are investigated to test the premise that the electron lens constituted by the second anode and the intensifier should be a thin lens type to minimize distortions of the barrel or pin-cushion type. Field plots are given showing the fields corresponding to various electrode shapes, such as the truncated cone, suggested by standard electron lenses. Data are given on experimental tubes and compared with results obtained from field plots.

43.3 "An Electrostatic Shutter Image Converter Tube," by *B. R. Linden and P. A. Snell, A. B. Du Mont Labs., Inc., Passaic, N. J.*

The simple electrostatic image converter proposed by Schagen, *et al.* has been modified by the insertion of a mesh between cathode and anode to allow pulsing the tube. Design equations have been derived which will allow construction of the tube for any desired set of geometrical and electrical parameters. Tubes have been constructed which may be pulsed on and off with a 165 volt pulse for 10,000 volts between cathode and anode. With modifications in the geometrical parameters it is possible to construct a tube which may be pulsed on and off with as low as a 10 volt pulse for 10,000 volts between cathode and anode. The resolution of the displays obtained so far on this type of image converter is about 700 television lines over a 4-inch diameter circle. The photocathode sensitivity lies in the range of 30 to 60 $\mu A/lumen$ to a light source at a color temperature of 2,870 degrees K.

43.4 "A New High Efficiency Parallax Mask Color Tube," by *M. E. Amdursky, R. G. Pohl, and C. S. Szegho, Rauland Corp., Chicago, Ill.*

Electron transmission through parallax masks of current tri-color tubes is no more than 12 per cent with a consequent low picture brightness. A new tube is described employing a parallax mask at a potential intermediate to that of the screen and a collector mesh maintained at anode potential. Not only is the brightness of such a tube increased 3-4 fold by virtue of enlarged mesh holes and the ensuing post-deflection focusing, but secondary emission from the mask, which would dilute color, is minimized. In contrast to other post-accelerating tubes, mask holes and fluorescent screen dots are uniformly spaced over the entire area. Nineteen-inch round and twenty-four-inch rectangular tubes incorporating the new principle have been built.

43.5 "The Tricolor Vidicon—an Experimental Camera Tube for Color Television," by *P. K. Weimer, S. Gray, H. Borkan, S. A. Ochs, and*

H. C. Thompson, RCA Labs., Princeton, N. J.

A television camera tube capable of generating three simultaneous color signals is now being developed. The experimental Tricolor Vidicon to be described is comparable in size to a standard monochrome Image Orthicon and has separate output terminals for each color channel. Color filter strips with associated conducting signal strips are built into a photoconductive target. All signal strips corresponding to the same primary color are connected to a common output terminal. Special preamplifiers have been developed to obtain independent color signals in the presence of the high interstrip capacity of the target. Color fidelity independent of the scanning process is obtained with a single electron beam.

SESSION XLIV

THUR. 10:00 A.M.-12:30 P.M.

WALDORF-ASTORIA
JADE ROOM

Component Part I Electro-
Magnetic Devices

Chairman: REUBEN LEE, Westinghouse Elec. Corp., Baltimore, Md.

44.1 "Blocking Oscillator Transformer Design," by *P. R. Gillette, K. W. Henderson and K. Oshima, Stanford Research Institute, Stanford, Calif.*

An important step in the design of a blocking oscillator circuit is the determination of the coupling capacitance and transformer characteristics necessary to produce the desired output pulse. The nonlinear behavior of the tube characteristics cannot be taken into account by most methods that have been suggested for use in analyzing blocking oscillator circuits, but a step-by-step method has been developed which gives reasonably accurate predictions of output pulse shape. This method has been used in the calculation of the coupling capacitance and transformer turns ratio, open-circuit inductance, leakage inductance, and distributed capacitance required to produce an output pulse of optimum shape, maximum amplitude, and specified rise time and duration.

44.2 "Improvements in Pulse-Switching Reactor Design," by *R. A. Mathias and E. M. Williams, Carnegie Institute of Technology, Pittsburgh, Pa.*

Design equations are derived for quantity of core material and distribution of core material, copper in windings, and capacitors in Melville-line pulse-generating systems for microsecond and fractional microsecond service. Experimental tests described yield excellent agreement with predicted results. Examples of

designs for particular high-power pulsing applications are also described.

44.3 "Magnetostriction Resonators as Circuit Elements," by *R. T. Adams, Federal Telecommunication Labs., Nutley, N. J.*

A compact magnetostriction rod resonator is described, applicable to a number of tone generator and filter circuits for carrier telephone and telemetering systems. The unit has properties of a single resonant circuit with independent input and output coupling. Frequency stability is ± 2 ppm per degree C, with typical Q 's of 3,000 to 4,000 at 24 kc.

In addition to conventional applications as a "single-frequency" filter or as a frequency determining element, analogous to a quartz crystal, by suitable adjustment of magnetic bias, the resonator can be made to respond to sum and difference frequencies in the input and/or output circuit. A single rod can thus be used as a filter-modulator, as a modulator-filter, or as a complete heterodyne-tuned filter (modulator-filter-demodulator) tunable by means of an external local oscillator signal supplied to input and output. Efficient frequency doubling can also be performed by the element.

44.4 "Wide-Range Electrically Tunable Oscillators," by *John L. Stewart and Kermit S. Watkins, University of Michigan, Ann Arbor, Mich.*

This paper describes several recently explored low-level electronically tunable oscillators which illustrate techniques using conventional components and tubes for achieving rapid electrical tuning over relatively wide frequency ranges. The mechanism by which voltage (or current) control of frequency is achieved for each of the oscillators is described with particular attention being given to a most promising technique defined as parallel-network tuning. Typical circuitry as well as experimental curves relating output voltage and frequency as functions of the control voltage for the tunable oscillators are presented and practical limitations regarding gain, bandwidth, and component requirements are discussed.

44.5 "Fluorochemical Liquid and Gases as Transformer Design Parameters," by *L. F. Kilham, Jr. and R. R. Ursch, Raytheon Mfg. Co., Waltham, Mass.*

Liquid and gaseous fluorochemicals were applied with considerable success to the design of high temperature (Class H) transformers. We found these materials approximately equal in dielectric strength and power factor to 100 cstks, silicone oil, and "self-healing." Being chemically inert two or more of these liquids may be mixed to give a "tailor-made" dielectric-coolant. It is shown that such a liquid may be designed for maximum heat transfer for a specified condition of temperature and pressure.

Techniques using these dielectric-coolants are detailed and were used to redesign three specific Class "A" R.M. Co. transformers. Savings in size and weight by the redesigns are considerable. A magnetron filament transformer was reduced greater than 4 to 1 by volume.

SESSION XLV

THUR. 10:00 A.M.-12:30 P.M.

WALDORF-ASTORIA
SERT ROOM

Nuclear Science I

Chairman: JEROME D. LUNTZ, McGraw-Hill Publishing Co., New York, N. Y.

45.1 "A Study of a Variable Frequency Cyclotron Resonant System," by *M. R. Donaldson, R. E. Worsham, and N. F. Ziegler, Oak Ridge National Lab., Oak Ridge, Tenn.*

To accelerate several different particles in a cyclotron, the ratio of the frequency of the electric field to the magnitude of the magnetic field must be adjustable to the value required for each particle. In this paper a cyclotron design is considered which would allow operation at a number of discrete frequencies in the 5.5 to 8.6 megacycle range.

Data are presented showing the effect of the physically large variable capacitor upon voltage standing wave, Q , and tuning range. The data have been obtained by making measurements before and after the installation of the parallel plate capacitors. The results indicate that the variable frequency feature is obtained at the expense of Q and voltage gain of the dee stems.

45.2 "Bevatron Operation," by *Dick A. Mack, University of California, Berkeley, Calif.*

Particle accelerators in the billion electron-volt field have substantially extended the range of nuclear research in providing a better understanding of the interactions between high-energy particles. The Bevatron, a proton synchrotron at the University of California Radiation Laboratory, was placed in operation in February 1954. Since that time numerous tests and engineering changes have improved the continuity of operation and the uniformity of accelerated beam pulses. Recently a beam of 3×10^8 protons per pulse has been accelerated to the design energy of 6.3 billion electron-volts (Bev). Refinements in preventive maintenance are in progress to improve the usefulness of the Bevatron as a physics research tool.

45.3 "A 100-Channel Pulse-Height Analyzer Using Magnetic Core Storage," by *Preston W. Byington and C. Wilkin Johnstone, Los Alamos Scientific Lab., Los Alamos, N. M.*

The growing complexity of nuclear experiments often makes the use of a 100-channel pulse-height analyzer highly desirable in order to speed up the taking of data without sacrificing accuracy or resolution. The analyzer to be described uses a linear pulse height to time conversion to achieve equal channel widths. The complete equipment may be subdivided into three groups by function: the pulse-amplitude analyzer, the memory or storage, and the readout.

This paper will be concerned chiefly with storage and readout techniques, but will include a brief discussion of analyzer circuits and performance.

45.4 "One Hundred-Channel Serial Memory Pulse-Height Analyzer," by *T. L. Emmer, Oak Ridge National Lab., Oak Ridge, Tenn.*

When a pulse-height analyzer having in the order of 100 channels is under consideration, the problems of interchannel drift and an economical, trouble-free memory unit for storing pulse-height information are immediately apparent. In the conventional voltage-discriminator type of analyzer, the pulse-height spectrum is divided into channels by a series of biased trigger circuits. Thus any drift in the grid-to-cathode potential of the triggers will cause interchannel drift. Also, each trigger is followed by a series of scalars and a mechanical register to store the pulse-height information. For 100 channels then, this type of storage system is both troublesome and expensive.

In an effort to eliminate these problems, a 100-channel analyzer was designed by G. W. Hutchinson and G. G. Scarrott of Cavendish Laboratories, Cambridge University. Their analyzer employs a mercury delay-line memory unit and a voltage-to-time discriminator.

Information will be given on a second model of this type. This model will incorporate many new features such as a quartz delay line, 120 channels with six times the storage capacity, shorter dead time, better provisions for coincidence counting, brightening of every tenth channel in the display, and provisions for an automatic print-out.

45.5 "Nuclear Reactor Control Systems Utilizing Solid-State Devices," by *Stephen F. Malaker and Edward Rathje, Daystrom Instrument Co., Archbald, Pa.*

The current trend toward industrial participation in the nuclear reactor program with its ultimate goal being economical and competitive production of power has given impetus to the science of control of nuclear power plants. As a consequence, considerable emphasis must be placed upon the design of control instrumentation, since, among other factors, proximity to population centers dictates that, divorced from proper functioning, complete reliability must be an inherent characteristic of any system.

Reliability and rugged long-life features are attributes peculiar to solid-state devices. Recent developments in components and their application in control systems have become widespread. Among the solid-state devices used are thermocouples, rectifiers, transistors, magnetic amplifiers, nonlinear dielectric elements and various combinations of these elements.

The criteria for selecting optimum operating points, dynamic ranges, and specific characteristics will be discussed with emphasis on applications of the diverse solid-state devices to nuclear circuitry, and more specifically to reactor control systems.

45.6 "A New Frequency-Modulation System for the UCRL 184-Inch Cyclotron," by *Quentin A. Kerns, University of California, Berkeley, Calif.*

A modification is planned for the Berkeley 184-inch cyclotron to achieve particle energies commensurate with magnet size. Added magnet coils will raise the flux density to 23 kilogauss and permit the acceleration of protons and deuterons, for example, to energies of 705 and 435 Mev respectively. The higher particle energies however, necessitate greater frequency range (35 to 19 mc for protons, and 17.5 to 13.5 mc for deuterons), while the shorter magnet gap effectively increases the rf energy storage to about one joule. It appeared that these rf specifications precluded the use of the usual rotating capacitor.

SESSION XLVI

THUR. 10:00 A.M.—12:00 Noon

WALDORF-ASTORIA
GRAND BALLROOM

Engineering Management II
General

Chairman: JOHN F. BYRNE, *Motorola, Inc., Riverside, Calif.*

46.1 "Cost Considerations in Automatic Production," by *E. Finley Carter, Stanford Research Institute, Stanford, Calif.*

New types of automatic production equipment for the electronics manufacturing industry are being developed and installed. Management must decide if the disadvantages of investing capital in new equipment will be offset by such advantages as lower operating cost and higher-value product. The important cost factors which management must consider are discussed. The results of a typical cost analysis are reported. Conclusions drawn from this analysis in regard to production volume, operating costs, and capital investment requirements are discussed.

46.2 "Personal Responsibilities of the Professional Engineer," by *D. J. Simmons, Convair, Ft. Worth, Texas.*

Available engineering manpower can be more effective and each engineer's opportunities for advancement can be increased by recognition and observance of the professional responsibilities of the individual engineer.

Each engineer has responsibilities which he owes to himself, his associates, his supervisor, and his company. If he is a supervisor, he also owes certain responsibilities to those working under his direction. This paper describes these responsibilities.

Each engineer must realize that the primary responsibility for his development and advancement rests entirely upon himself. He must be competent, know how to organize and carry out assignments, and continually develop his abilities.

To his associates, the engineer owes harmonious relations, loyalty, team work, and co-operation.

Observance by the individual engineer of

his personal responsibilities will increase his value, effectiveness, and professional stature.

46.3 "The Management of Basic Research," by *T. M. Linville, General Elec. Co., Schenectady, N. Y.*

This paper will describe the objectives and plans of the research that seeks to extend the understanding of materials and forces in nature. It will describe what can be accomplished with people, facilities, money, and other resources.

It will tell how the work and resources can be organized to carry out the objectives and plans; how the resources are to be utilized.

Most importantly, it will tell how the work is done, how it is directed, what stimulates it, what relationships give it strength, and what some of the key human factors are.

It will describe how the work can be evaluated, how it is brought to practical use, and how continual evaluation controls the direction of it.

In addition, it will show how a research laboratory that is focused on finding basic discoveries that widen business horizons and lead to higher living standards can, at the same time, provide staff services to industrial operations and can also provide an extraordinarily valuable "doctor in the house."

46.4 "The Organization and Management of Engineering in a Small Company," by *Roderick M. Scott, Perkin and Elmer, Norwalk, Conn.*

The Perkin-Elmer Corporation is a small corporation by definition for it employs at this moment less than 500 people. It does not intend to remain at its present size, however, for it is a growth organization in every sense. This concept of growth has had a profound influence on the organization of its engineering function.

The group designated as the Engineering Department consists of forty-five trained scientists and engineers; design, drafting and Model Shop personnel to a total of about 115. The Quality Control and Plant Engineering sections, about thirty more, are also a part of our engineering function. Of the many separate problems of management in a group of this description I would like to discuss three in some detail: first, the relative emphasis and control of research and development under direct contract and that for the support and growth of the corporate manufactured product; second, the role of the project engineer and his place in our organization; and third, the mechanism of establishing compensation for engineering personnel.

SESSION XLVII

THUR. 10:00 A.M.—12:30 P.M.

KINGSBRIDGE ARMORY
MARCONI HALL

Microwave Theory and Techniques III Ferrites

Chairman: TORE N. ANDERSON, *Airtrol, Inc., Linden, N. J.*

47.1 "Behavior of Ferroxdure at Microwave Frequencies," by *Max T. Weiss, Bell Tel. Labs., Holmdel, N. J.*

Ferroxdure is a ceramic permanent magnetic material with high anisotropy and has a hexagonal crystal structure. Ferromagnetic resonance experiments have been performed on both oriented and unoriented Ferroxdure at various microwave frequencies from 9,000 mc to 72,000 mc. With no externally applied magnetic field a natural resonance occurs near 50,000 mc. With magnetic field applied perpendicular to the hexagonal axis a double resonance occurs for frequencies below 50,000 mc, while with a field applied along the hexagonal axis a single resonance occurs above 50,000 mc. A theory is developed to explain the above results. Significance of these results to the application of Ferroxdure to nonreciprocal microwave circuits will be discussed.

47.2 "Some Applications and Characteristics of Ferrite at Wavelengths of 0.87 CMS and 1.9 CMS," by *Clyde Stewart, Collins Radio Co., Cedar Rapids, Iowa.*

This paper describes the use of ferrites in waveguide to produce Faraday rotations at 0.87 cm and 1.9 cm wavelengths. The Dicke radiometric receiver is briefly reviewed and its improvement by the use of ferrite waveguide components is discussed. Experimental equipment to measure the Faraday rotations consists of a cylindrical section of waveguide, containing ferrite, placed between two transitions from rectangular to circular waveguide. Power from a klystron is applied to the rectangular waveguide and passes through into the circular waveguide. The circular waveguide containing the ferrite is provided with a controllable axial magnetic field which produces a Faraday rotation. The angle of rotation can be measured by rotating the output transition while monitoring the power output. Details are given for the construction of a waveguide unidirectional transmission line for 0.87 cm wavelength.

47.3 "Microwave Devices Using Ferrite and Transverse Magnetic Field," by *Jorgen P. Vinding, Los Gatos, Calif.*

This paper gives a survey of a new class of ferrite devices which have a magnetic field applied transverse to the direction of propagation. Within this class three groups of devices are distinguished: phaseshifters, unidirectional transmission lines, and attenuators.

For each of these the basic principles are briefly discussed and certain design problems are mentioned together with the solutions adopted in particular designs. It is mentioned that other solutions and better results will be possible when better ferrite materials become available.

Among the phaseshifters special attention is given to the single-sideband-modulator and among the unidirectional transmission lines a broadband type is discussed in some detail.

47.4 "Broadband Ferrite Characteristics," by *Murray B. Loss, Sperry Gyroscope Co., Great Neck, N. Y.*

By using two suitably chosen ferrite rods in series in circular waveguide with the magnetic field on one ferrite applied in the opposite

direction to that on the other, the frequency sensitivity of Faraday rotation of the combination can be made flat over a large frequency range by the automatic cancellation of the frequency sensitivities of the individual ferrites.

47.5 "Measurement of Microwave Electric and Magnetic Susceptibilities of Ferrite Spheres," by *E. G. Spencer, R. C. LeCraw, and F. Reggia, Diamond Ordnance Fuze Labs., Washington, D. C.*

Resonant cavity methods are described for measuring electric and magnetic susceptibilities of spheres of experimental ferrites of about one millimeter diameter. The Bethe-Schwinger perturbation techniques are used to derive the equations for the susceptibilities in terms of the real and imaginary parts of the frequency shift which are measurable quantities. For a sample placed in the cavity in the position of maximum electric and zero magnetic field, the electric susceptibility is obtained while the converse holds for the magnetic susceptibility. The individual components of the tensor permeability are obtained by measurements using alternately positive and negative circularly polarized waves in the cavity. Data are presented on a magnesium-manganese ferrite to illustrate the techniques described.

SESSION XLVIII

THUR. 10:00 A.M.-12:30 P.M.

KINGSBRIDGE ARMORY FARADAY HALL

Electronic Computers III

Chairman: RALPH E. MEAGHER, *University of Illinois, Urbana, Ill.*

48.1 "The Typotron—A Novel Character-Display Storage Tube," by *H. M. Smith, Hughes Aircraft Corp., Culver City, Calif.*

This report describes the Typotron tube, a novel character writing storage tube, developed by the Electron Tube Laboratory of the Hughes Aircraft Company for the Lincoln Laboratory at M.I.T. This tube will display any one or any combination of the 63 characters available on the character matrix incorporated in the writing gun. The characters can be written in less than 50 microseconds, displayed indefinitely until erased at brightness up to a few hundred foot-lamberts. The methods used for character formation, selection, deflection, and display are outlined. Included are schematic diagrams of the Typotron tube and photographs of its essential components and of completed tubes.

48.2 "Electrographic Recording," by *Herman Epstein and Frank T. Innes, Burroughs Corp., Paoli, Pa.*

Some of the properties and possible applications of a new recording technique known as Electrographic Recording include the fact that

it is a high-speed technique by which a mark may be put on paper in a duration as small as one microsecond and printed characters, formed from a 5X7 matrix, may be recorded at rates exceeding 5,000 characters per second; for instance, recording rates at hundreds of inches per second of paper strip are potentially possible.

The only motion involved in the technique is the continuously moving paper under the printing head; there are no moving styli or the like. Further, the system is basically low in cost and consumes very little power; the power necessary to print 5,000 characters per second, serially, requires about 5 watts in addition to that necessary to move the paper.

The system is quiet—essentially the only noise is caused by the moving paper. The printing technique does not involve any messy, wet, or damp processes.

Permanent recording, with no fading, is achieved. No wear of electrodes, or the like, is involved.

In short, this technique offers dry, high-speed, low-cost, low-power, and quiet recording capabilities.

48.3 "Surface-Barrier Transistor Computer Circuits," by *Ralph H. Beter, William E. Bradley, and Ralph B. Brown, Philco Corp., Philadelphia, Pa., and Morris Rubinoff, University of Pennsylvania, Pa.*

The proper use of transistors in computers involves a realization of their special inherent characteristics. Basic computer circuits will be described; that is, flip-flops, multivibrators, and OR and AND gates which result in a minimum number of total components.

48.4 "Semi-Conductor Diode Amplifier Considerations," by *Henry W. Kaufmann, Remington-Rand Inc., Philadelphia, Pa.*

The delay in recovery of back resistance after forward conduction, a phenomenon widely observed in semi-conductor diodes, affords a means of controlling charge at low potential and then using it through a large potential difference. This has been proposed as a means of amplification. Some observations of the relation between forward charge and reverse charge, as functions of time, are reported for samples of commercially available diodes; the significance of these to diode amplification is discussed.

48.5 "An Electronic Circuit for the Generation of Functions of Several Variables," by *Hans F. Meisinger, Reeves Instrument Corp., New York, N. Y.*

Arbitrary functions of two independent variables may be generated electronically by means of diode networks by extending a method commonly used for approximating functions of a single variable. Two variable voltages, x and y , are inserted into the diode network rather than one variable, x , and a fixed bias. This has the effect of making the output of the circuit depend on y as well as on x . The method can be further extended to functions of more than two independent variables.

This article contains a discussion of a systematic design procedure for the function generator and indicates the classes of functions to

which the method is applicable. Illustrative examples of such functions are given. Certain other functions not in this category may be reduced to a suitable form by a preliminary transformation.

The new method eliminates many of the difficulties encountered in representing functions of several variables on electronic analog computers. It offers the advantages of high speed operation, flexibility, and low cost, compared with the methods heretofore in use. The accuracy depends to a large extent on the number of diodes used in the network, and is comparable to that obtained from other function generators employing a bilinear interpolation scheme.

SESSION XLIX

THURS. 2:30-5:00 P.M.

BELMONT-PLAZA MODERNE ROOM

Medical Electronics II General

Chairman: L. H. MONTGOMERY, Vanderbilt University, Nashville, Tenn.

49.1 "New Linear Electron Accelerators for Radiotherapy," by John C. Nygard and M. G. Kelliher, High Voltage Engrg. Corp., Cambridge, Mass.

The microwave linear accelerator for the production of intense high-energy electron beams is for the first time now available for general use. Two accelerators with electron energies of 6 and 50 mev will be discussed. The 50-mev electron beam will be utilized directly for cancer therapy, whereas the 6-mev electron beam may be utilized either for the direct sterilization of biological materials or for the production of X-rays for cancer therapy. The general problem of beam and/or patient maneuverability for use in a therapy program, and some aspects of simplified control system requirements will be discussed.

49.2 "Cineradiography," by Earl R. Miller, Eldon Nickel, and Lee B. Lusted, University of California Medical School, San Francisco, Calif.

The need for cineradiographic equipment is discussed.

The cineradiographic equipment in the Department of Radiology, University of California School of Medicine, San Francisco, is presented.

The equipment consists of two separate camera units connected to a single X-ray generator.

(a) A 35-mm camera with F0.75 lens and associated control circuits, a Westinghouse Super Dynamax X-ray tube capable of 120KV operation.

(b) A 16-mm camera with F0.85 lens, Philips Image Amplifier and Westinghouse Dynamax 41 X-ray tube.

Each camera unit is connected to the X-ray high voltage by selsyn motors. Film speeds of $1\frac{1}{2}$, $3\frac{1}{2}$, $7\frac{1}{2}$, 15, 30, and 60 frames a second are available.

49.3 "The Use of U-V Microspectrophotographic and Phase and U-V Television Densitometry Techniques in Medical Research," by Philip O'B. Montgomery, Southwestern Medical School, Dallas, Texas

The use of microspectrophotographic densitometry techniques in living and nonliving biologic systems with the principal emphasis upon medical research will be illustrated by means of lantern slides of the necessary equipment and the results obtained by the study of arteriolar disease in hypertension and collagen in cancer of the skin.

The use of ultraviolet and phase television, and microspectroscopy and densitometry will be considered from the point of view of research in biologic fields related to normal and abnormal growth. The equipment necessary will be illustrated by means of lantern slides, and preliminary data and projects will be outlined with a consideration of projected general applications in medical research.

49.4 "Application of the Television Ultraviolet Microscope to the Direct Visualization of Cytological Absorption Characteristics," by George Z. Williams, National Institutes of Health, Bethesda, Md.

The ultraviolet absorption characteristics of intact living cells are directly visualized on the television screen by the application of industrial television components to the ultraviolet microscope and the use of a specially developed RCA ultraviolet sensitive camera tube. A single line of the cathode-ray picture tube is analyzed by inserting a suitable oscilloscope into the cathode-ray circuit, thus depicting the relative degrees of absorption of the ultraviolet wavelength by the cellular material. Rapid photographic records of selected cells may be simply made.

49.5 "Some Applications of Scanning Techniques in Instrumentation," by C. Berkley and H. P. Mansberg, Allen B. DuMont Labs., Inc., Clifton, N. J.

The human may be considered as a data-processing machine supplied with information from transducers of pressure, smell, taste, light, etc., and it is shown that the visual transducer has certain advantages in information handling capabilities. Any information in a visual field can be converted to electronic form by scanning. The resultant waveshape then contains all the information observable visually. Computers can be designed to extract and use this information at a much faster rate than the human. Considerable ingenuity is often required in the information extraction. Some specific applications illustrating typical problems encountered in this process are considered and described, including field scanning and plotting, and optical scanning.

SESSION L

THURS. 2:30-5:00 P.M.

WALDORF-ASTORIA STARLIGHT ROOF

Engineering Management III Symposium Management Selection as Viewed by Psychologists and Engineering Executives

Chairman: ROBERT D. LOKEN, Life Magazine, New York, N. Y.

The selection of management personnel in engineering presents a combination of problems which are unique in the management field. Individually, these problems are approached in several ways.

Psychologists have shown increasing skill in identifying basic traits and abilities. This has led to testing procedures for personnel evaluation.

As various patterns have emerged, extension to managerial areas has followed, and been highly relied upon by some executives. Conversely, countless people in management have reached their positions without psychological evaluation, and they do not rely on these methods for purposes of promotion.

This symposium will explore various approaches to the above problems by psychologists and engineering executives.

50.1 "Selection of Technical Managers as Viewed by a Personnel Psychologist," by A. P. Johnson, Educational Testing Services, Princeton, N. J.

The topic of the selection of technical managers can be approached in many ways.

This talk will describe the broad framework and some details of an approach which repeatedly, in other selection situations, has proved effective and which gives promise of being effective in the selection of technical managers.

Basically the approach is simple. For any technical management position find out: (1) the key duties to be performed; (2) the management climate surrounding it; (3) what man under consideration has best demonstrated his ability to do well key duties like these and would be happy in the management climate involved.

50.2 "Psychological Means for the Selection of Managers," by John C. Flannigan, University of Pittsburgh, Pa.

50.3 "Selection of Engineering Executives," by Leron N. Vernon, Personnel Lab., Chicago, Ill.

Selection of managers for engineering organizations is like selection of other executives with some additional problems. Executive potential in general should be judged in terms of (1) emotional and social maturity, (2) intellectual capacity, and (3) management skills.

Additional problems in selecting engineering executives include the following. (1) An outstanding technologist may earn promotion, but is likely to be a poor manager. The necessary skills, standards, and personal qualities are different. (2) The need for management skills is

greater among engineers because technical men are more difficult to manage than other groups. (3) There is need for a research approach to this problem. Progress will come from better use of available techniques in man evaluation and from scientific study of existing situations. Engineers need to accept and use a science different from their own; in this problem, that science is psychology.

50.4 "Balance in Management Selection," by *Ronald L. McFarlan, Raytheon Mfg. Co., Newton, Mass.*

50.5 "Selection of Technical Management Personnel," by *Dean E. Wooldridge, Ramo-Wooldridge Corp., Los Angeles, Calif.*

The problem of selecting suitable personnel for management of scientific or engineering development work has many elements in common with the problem of selecting personnel for management of other types of activities, but there are also some important differences. One such difference will be particularly emphasized—the importance of selecting successful scientists or engineers, rather than nontechnical people, to manage the activities of other scientists and engineers. The point will be made that, if properly done, the conversion of technically trained men to administrators is by no means the waste of scarce manpower that it is frequently considered to be.

SESSION LI

THURS. 2:30–5:00 P.M.

WALDORF-ASTORIA ASTOR GALLERY

Electron Devices IV Transistors

Chairman: HARPER Q. NORTH,
*Pacific Semiconductors, Inc.,
Los Angeles, Calif.*

51.1 "Thermal Properties of Semiconductor Diodes," by *J. N. Carman and W. R. Sittner, Pacific Semiconductors, Inc., Culver City, Calif.*

Experimental and analytical methods for determining steady state and transient thermal properties of semiconductor diodes will be presented. Comparisons of power dissipation constants and thermal time constants of various diode envelope designs will be given.

Curves of measured junction-temperature rise as a function of power dissipation will be shown together with effects of dissipated power on electrical characteristics of typical germanium and silicon diodes.

Operation of silicon and germanium diodes at elevated temperatures and required power derating will be discussed. The relationship between dissipation constants, thermal time constants and high-temperature derating factors will be outlined.

51.2 "Grain Boundaries and Transistor Action," by *Herbert F. Ma-*

ture, Signal Corps Engrg. Labs., Ft. Monmouth, N. J.

The advanced knowledge and study of imperfections in crystals has opened a new field of fruitful work. While the "perfect" crystal and its use for electronic devices in the semiconductor field allows *p-n* technique with all its variations as to impurity distribution, the use of defined crystal imperfections, especially in the form of grown grain-boundaries, opens a new variety of possible electronic behavior.

Measurements of grain-boundary orientation in correlation with probe measurements show interesting properties as to current amplification, i.e., release of trapped carriers, and gate-action. The use of grain-boundary-stress fields in transistor electronics should prove also effective in the higher frequency range since these fields which define the characteristics of grain-boundary transistors may be limited to thickness of 1 micron and less.

51.3 "Developments in Silicon Junction Diodes and Power Rectifiers," by *H. Gunther Rudenberg, Transitron Electronic Corp., Melrose, Mass.*

New silicon junction rectifiers are presented. Different alloying techniques provide *p-n* junctions of smaller as well as much larger areas than formerly available. Types developed handle kilowatts of alternating current, others milliwatts of high-frequency signals. They have low forward-voltage drops, excellent rectification efficiencies at rated power, inverse currents of microamperes or fractions thereof, and inverse voltages from 10 to 1,000 volts even at high ambient temperatures. The low-power diodes have minute junctions of 0.1 μm^2 capacitance, excellent pulse recovery within 0.1 microsecond, cut-off frequencies above 500 mc, and inverse voltages from 10 to 100 volts. High-power rectifiers can operate at currents up to 100 amperes, others at inverse voltages of 1,000 volts. A representative unit measures 5 volts forward drop at 30 amps, and an inverse voltage above 100 volts up to 150 degrees C. Characteristics of types in quantity production will be presented with application data. Thermal design encountered in mounting hermetically-sealed power units will be discussed.

51.4 "Comparative High-Frequency Operation of Junction Transistors Made of Different Semiconductor Materials," by *L. J. Giacomello, RCA Labs., Princeton, N. J.*

The high-frequency performance of junction transistors is determined in part by the time required for the injected minority carriers to traverse the base region. Large minority carrier mobility contributes to reducing this transit time. However, the hf performance is also affected by factors such as base-lead resistance and collector-to-base junction capacitance, and large majority carrier mobility will reduce the detrimental effects of these factors.

One can determine the design requirements for the optimum hf power amplification. Since both minority and majority carrier mobilities are of about equal importance, it follows that the high-frequency performance of an *n-p-n* transistor should be about the same as that of a geometrically similar *p-n-p* transistor. Furthermore, for evaluation of new semiconductors, a knowledge of the values of both mobilities is

required, and a figure of merit is proposed which is formed by the product of the two drift mobilities divided by the square root of the dielectric constant.

51.5 "Characteristics and Some Applications of Fused Junction *P-N-P* Germanium Transistors for High-Frequency Use," by *R. D. Greene, Raytheon Mfg. Co., Newton, Mass.*

The basic characteristics of fused junction *p-n-p* germanium transistors are discussed with particular emphasis on the viewpoint of the circuit designer.

Those parameters of importance in the design of high-frequency transistors are pointed out and optimized. Circuitry for such devices as portable radios, video amplifiers, and gating circuits are discussed.

SESSION LII

THURS. 2:30–5:00 P.M.

WALDORF-ASTORIA JADE ROOM

Component Parts II General

Chairman: LLOYD T. DEVORE, *General Electric Co., Syracuse, N. Y.*

52.1 "A Miniature Precision Delay Line," by *James B. Hickey, Rome Air Dev. Center, Griffiss AF Base, Rome, N. Y.*

This paper describes the development, unique construction details, and characteristics of a miniature precision delay line of the *l-c* lumped constant type, having an equivalent "*m*"-derived low-pass filter configuration. This delay line was designed to replace a wire-wound distributed-constant type employed in a complex aircraft identification system. The new lumped constant delay line is superior to the replaced wire-wound distributed constant delay line on the following counts: (1) reproducibility; (2) temperature stability; (3) space factor; (4) availability of delay taps at extremely small delay increments; and (5) versatility of design for a wide range of characteristic impedance and bandwidth.

52.2 "Criteria and Test Procedures for Electromagnetic Delay Lines," by *Norman Gaw and David Silverman, Helipot Corp., Mountainside, N. J.*

The general types of fixed and variable electromagnetic delay lines are reviewed and conventional terminology is defined. Distortions common to delay lines are illustrated and methods for correction are analyzed. Test procedures, both pulse and sinusoidal, and methods for measuring linearity and phase shift are described. The general areas of usefulness of electromagnetic delay lines in today's technologies and some applications are discussed.

52.3 "Evolution of Selenium Rectifier Voltage Ratings," by *N. Bechtold, Signal Corps Engrg. Labs., Ft. Monmouth, N. J.*

The prewar 14-volt plate evolved through accelerated emergency development to the postwar 26-volt plate. Through Signal Corps sponsorship (Contract DA-36-039 SC-107) the 40-volt plate was developed and produced on a large quantity basis. The 1.5 miniaturization factor achieved has been proven reliable in a number of high-voltage power supplies and by virtue of over 15,000 hours of life data. Additional investigations have made use of its advantageous high reverse-resistance for magnetic amplifier applications. Recently, a 60-volt selenium plate was developed under Contract DA-36-039 SC-15454, an extension of the original work. Further advancement of this voltage rating will be contingent upon resolution of the barrier layer stability problem.

52.4 "A Precision Deflection Yoke," by *Harold J. Benzuly, Radio Corp. of Amer., Camden, N. J.*

A method for constructing a deflection yoke assembly suitable for camera pickup tubes using entirely new techniques is described. In particular, a deflection coil assembly for an image orthicon camera is discussed. Although some problems remain to be solved, the electrical and physical characteristics of a standard wound yoke can be realized, making direct substitution with only minor circuit modifications possible.

52.5 "Ceramic-to-Metal Seals for Magnetrons," by *Leo J. Cronin, Raytheon Mfg. Co., Waltham, Mass.*

The advantages of ceramic-to-metal seals are enumerated. Applications of these seals in the construction and operation of magnetrons are discussed and illustrated. The new Mo-Ti sealing technique is described following its historical sequence. Processing techniques such as application of metalizing, firing, and soldering are covered. Mention is made of physical design correlated with stress and strain. Properties of ceramics which were considered when choosing an alumina body are given. The fabrication of ceramics is also mentioned. Results of research utilizing X-ray diffraction and petrographic methods are listed. A selection of slides is presented which shows magnetrons, seals, properties of ceramics and metals, cross sections, equipment, and other salient points.

SESSION LIH

THURS. 2:30-5:00 P.M.

WALDORF-ASTORIA SERT ROOM

Information Theory III

Chairman: JOHN W. MAUCHLY, *Remington Rand, Inc., Philadelphia, Pa.*

53.1 "Communication Theory Model and Economics," by *Samuel Bagno, Altertronic Corp., Long Island City, N. Y.*

The mathematical theory of communication is shown to provide a good model for the description of economic activity. Physical production corresponds to transmitting entropy into a communication channel. The economy corresponds to the channel. In the noiseless case, money in circulation corresponds to the capacity of a communication channel. In the presence of noise, maintaining a constant channel capacity requires introducing sufficient redundancy to nullify the equivocation due to noise. The corresponding economic duplication is shown to be the need for an ever-increasing total money supply. The law of diminishing returns and other economic laws have striking analogies in certain theorems of Shannon.

53.2 "Removal of the Redundancy Due to Intersymbol Interference," by *H. Davis, University of California, Los Angeles, Calif., and D. L. Trautman, Hughes Aircraft Co., Culver City, Calif.*

Since the appearance of Shannon's classic paper on communication theory, much attention has been directed to making use of redundancy which might occur in signals in order to reduce the probability of misinterpretations when received in the presence of noise. This has led also to various schemes for using intentionally introduced redundancy to reduce error in reception (error-correcting codes). There are, however, cases where it may be desirable to remove the redundancy present rather than add to it. In this paper we consider discrete parameter, real valued time series which may have members which are statistically dependent (intersymbol redundancy). We transform such series so that the members of the resultant series are mutually independent and such that the resultant series is in one-to-one correspondence with the original signal. This may be useful, for example, if it is desired to transform an arbitrary signal to a Gaussian time series.

53.3 "Noise through Nonlinear Devices," by *Ralph Deutsch, Hughes Aircraft Co., Culver City, Calif.*

A method proposed by Wiener for studying nonlinear transformations of noise voltages is discussed. The technique is extended to a system consisting of a passive linear four-terminal network followed by a member of a general class of nonlinear devices and a linear output filter. The elements are all allowed to interact mutually. For the particular case of bandwidth-limited normal noise, the system equations can be expressed in convenient form. The analysis technique is illustrated by application to a typical physical problem.

53.4 "Linear Filter Optimization with Game Theory Considerations," by *M. C. Yovits and J. L. Jackson, Johns Hopkins University, Silver Spring, Md.*

The optimum reproduction of a signal in noise by a linear filter is considered when the signal spectrum is unknown. The problem is likened to a game; the signal producer by his spectrum choice attempts to *maximize* the filter error while the filter designer attempts to *minimize* it.

The optimum transfer function for any fixed signal spectrum is found; the optimum signal spectrum for any allowable transfer function is

found. Their functional intersection gives the game theory solution.

A new variational principle is developed which conveniently gives the *amplitude* of the optimum transfer function for any fixed signal spectrum. Results are listed for some simple cases.

53.5 "The Effect of AGC on Radar Tracking Noise," by *R. H. DeLano and I. Pfeffer, Hughes Aircraft Co., Culver City, Calif.*

The response of the AGC in a radar receiver to the low-frequency fluctuations of the radar echo can produce an increase in the low-frequency spectral density of the angle tracking noise. An increase in noise spectral density by a factor of two to three is representative of what can happen when the envelope of the radar echo is approximately Rayleigh distributed. By simulation, using an electronic analogue computer, the increase in spectral density has been obtained as a function of the product of the envelope bandwidth and the AGC time constant. This consideration must be balanced against other factors requiring a short AGC time constant and one of these is discussed.

SESSION LIV

THURS. 2:30-5:00 P.M.

KINGSBRIDGE ARMORY MARCONI HALL

Microwave Communications and Systems

Chairman: S. M. KAPLAN, *General Electric Co., Cornell University, Ithaca, N. Y.*

54.1 "Evaluation of Survey Methods for Use in Microwave Path Analysis," by *W. C. Eddy, Television Associates of Indiana, Inc., Michigan City, Ind.*

There have been many approaches to the problem of evaluating a proposed microwave path. The aerial survey substantiated by a ground survey described in this paper appears best to satisfy the several equations of economy, accuracy and expedition in obtaining data.

This paper describes in detail the techniques that have been developed over the past ten years in aerial survey, as well as outlining in a broad evaluation the other systems that have been used.

The aerial system described in this paper has been used in the original evaluation of many of the presently operating microwave systems. Using data developed by this system, these operating microwave systems have encountered no paths that were marginal or obstructed.

54.2 "A Monopulse Radar Technique," by *R. M. Page, Naval Research Lab., Washington, D. C.*

A technique is described whereby a single radar pulse may provide angle as well as range information for tracking. As a consequence,

angle as well as range information may be presented in the video channel, thus providing simultaneously angle and range information on all echoes independently, so long as they are resolved in range. Since resolution in range is resolution in time, the possibility is suggested that the technique may be applied in radio astronomy to resolve in angle two independent point sources simultaneously in the radio beam, but resolved in time by suitable wide-band circuitry before integration. This is known to work for signals large relative to receiver noise.

54.3 "A Frequency Selective Directional Coupler for Multiplexing," by *Herbert J. Carlin, Polytechnic Institute of Brooklyn, Brooklyn, N. Y.*

This paper describes the design principles, construction, and operation of a UHF antenna coupler designed to multiplex transmitters and receivers on a single antenna in the frequency band 225-400 mc/sec. The coupler design in first approximation is the realization of a bridged-T circuit in coaxial line employing two tunable precalibrated cavities plus a special balancing network to compensate for antenna mismatch. A more general point of view is to regard the device as a directional coupler with high directivity and with coupling coefficients whose frequency response is similar to that of bandpass and band elimination filters. The resultant multiplexer achieves high isolation and low insertion loss at unusually close frequency spacings between transmitters and receivers. When the multicouplers are used with a frequency separation of 3 mc/sec. (approximately 1 per cent) between equipments, the average insertion loss in a four-coupler system is 1 db per coupler, and the average isolation between equipments located at adjacent couplers is approximately 60 db.

54.4 "Application of Ferrites for Audio Modulation of Microwaves," by *Philip Zirkind, Rome Air Dev. Center, Griffiss AF Base, Rome, N. Y.*

A novel method of transmission of audio frequencies by means of microwaves is described. The plan of polarization of a microwave carrier of 9,375 mc is rotated in varying amounts when propagated through a ferrite inserted in a circular waveguide and subjected to a longitudinal magnetic field varying in strength at audio frequencies. Rectangular waveguides which are perpendicular to each other are coupled to both sides of the ferrite section. It is then observed that in the waveguide beyond the ferrite section in the direction of propagation, the microwave carrier is modulated in proportion to the variations in the magnetic field strength applied to the ferrites. Further observations are described of the propagation of this modulated microwave carrier through space, and detection at a receiver. The means of demodulation and the characteristics of the demodulated signal are described.

54.5 "A Narrow-Band Radar Relay System," by *C. W. Doerr and J. L. McClucas, Haller, Raymond and Brown, Inc., State College, Pa.*

The HRB Narrow-Band Radar Relay System provides for presenting at a remote point the PPI display from any standard surveillance or airport radar which uses a continuously rotating antenna.

Basic units are the encoder, the decoder, and the indicator. The encoder first reduces the bandwidth of the radar video to the audio range through a process of integration. The encoder also generates a rate signal, whose frequency is related to antenna rotation speed, and a North mark. These three signals are superimposed on subcarriers and mixed before being fed to a standard communications link. The decoder separates the three signals and uses them to create PPI display on Indicator.

SESSION IV

THURS. 2:30-5:00 P.M.

KINGSBRIDGE ARMORY FARADAY HALL

Aeronautical and Navigational Electronics III Navigation

*Chairman: GEORGE RAPPAPORT,
Aircraft Radiation Lab., Wright
Field, Dayton, Ohio*

55.1 "An All-Weather Radio Sextant," by *D. O. McCoy, Collins Radio Co., Cedar Rapids, Iowa*

The techniques used in radio astronomy have been applied to produce an all-weather solar tracking instrument for navigational purposes. The principle of operation of this device is described. An illustrated description of a typical radio sextant is given together with a discussion of the accuracies obtained from several versions of the equipment.

55.2 "A UHF Ground-Based Automatic Direction Finder," by *Robert L. Cattoi, Collins Radio Co., Cedar Rapids, Iowa*

This paper presents a general description of the Collins DF-101 ground-based automatic direction finder. The described system gives a continuous bearing indication of the relative direction of arrival of amplitude modulated or unmodulated signals in the 225-400 megacycle frequency range. Design goals included over-all simplicity, relatively small size, portability and good operational accuracy. The paper outlines design requirements, brief operational theory, development problems, physical and electrical description, as well as equipment application and performance.

55.3 "Wullenweber-Type Ultra High-Frequency Radio Direction Finder," by *Richard C. Benoit, Jr., Rome Air Dev. Center, Griffiss AF Base, Rome, N. Y., and W. M. Fur-*

low, Jr., Melpar, Inc., Alexandria, Va.

This paper deals with the development and fabrication of an ultra high-frequency Wullenweber type of radio direction finder capable of a 10 to 1 frequency coverage at a high order of azimuth bearing resolution permitting the display of simultaneous bearings on a single frequency.

It is primarily designed to cover the 225-400 mc band but also offers coverage from 100-1,000 mc at a possible sacrifice of performance. The antenna system consists of 100 vertically polarized dipoles having an array diameter of 10 meters which are utilized to produce a beamwidth in the order of 6 degrees sweeping in azimuth at 600 rpm.

Of the several components comprising the system, detailed discussion is given of the radio frequency switch, couplers, and phasing elements. The switch was designed to connect simultaneously each of 36 adjacent dipoles to 36 phasing lines, using transformers made of flat strip transmission lines to eliminate mechanical contacts. Cross-talk between channels and insertion loss are negligible. The coupler matches 36 inputs of 50 ohms each to a 50-ohm output cable and is made up of five cascaded coaxial transformers, telescoped together and loaded with dielectric material to minimize over-all size.

Aperture Wullenweber systems are also presented.

55.4 "High-Precision Computer for Automatic Solution of the Celestial Triangle," by *Gene R. Marner, Collins Radio Co., Cedar Rapids, Iowa*

A precise electromechanical analog computer which automatically solves the celestial triangle will be described. The inputs are shaft positions representing the latitude of the instrument and the declination and local hour angle of a point on the celestial sphere. The computer then continuously presents shaft positions representing the altitude and azimuth of the point in question. No restrictions are placed on the range of any of the angles involved. The results of an extensive experimental error analysis will be presented, and applications to navigation systems and to the direction of altitude-azimuth mounted radio telescopes will be pointed out.

55.5 "JAINCO: a High-Precision Lightweight Aircraft Navigational System," by *Donald H. Jacobs, Jacobs Instrument Co., Bethesda, Md.*

JAINCO is a high-precision phase comparison type of navigational system involving three ground stations: a master and two slaves. Each ground station transmits five sinusoidal modulation frequencies on its carrier. Phase comparisons are made in the airplane automatically and simultaneously on all these modulations. These comparisons give two unambiguous hyperbolic coordinates of position with six-figure accuracy. One set of ground stations can control an unlimited number of aircraft. Other important characteristics are the small size and lightness of ground and airborne equipments, the fact that no airborne operator is required, and the fact that the system gives unambiguous position readings (no cycle counting). The aircraft, being guided, emits no signals.

IRE News and Radio Notes

A. N. GOLDSMITH MADE EMINENT MEMBER OF ETA KAPPA NU HONOR SOCIETY

The fifty-six college chapters of Eta Kappa Nu, the electrical engineering honor society, have elected Alfred N. Goldsmith to the rank of Eminent Member. Induction ceremonies were held on January 31 at the Henry Hudson Hotel. Following the ceremonies, new Eminent Members were presented at Eta Kappa Nu's Award Dinner.

Over the years only twenty men have achieved Eminent Membership, which is offered "to those individuals who by their technical attainments and contributions to society have shown themselves to be outstanding leaders in the field of electrical engineering and great benefactors of their fellow men."

BUENOS AIRES SECTION HOLDS EIGHTH CONVENTION

The Buenos Aires Section held its eighth annual convention in November. The program presented technical papers, tours, an exhibition of communications and electronic equipment, and a banquet.

Technical sessions included the following papers: G. Von Trentini, "Radar Antennae"; P. J. Noizeux, "The History of Communications in Argentina"; S. Castro, "The Future of Electronics in Our Laboratories"; J. C. Coriat, "Manufacture of Television Receivers in Argentina."

An exhibition held in the Argentine Automobile Club featured the latest electronic equipment designed and manufactured in Argentina. P. N. Guzzi, Chairman of the Buenos Aires Section, presided at inauguration ceremonies. In his speech to the group, Mr. Guzzi described the part taken by the Buenos Aires Section in the development of electronics in Argentina.

Tours were conducted at the Transradio International, largest transmission station in the country, at Compañía Standard Electric Argentina, and at Capehart Argentina.



P. N. Guzzi, Chairman of the Buenos Aires Section, speaks to the Convention group on recent developments made in the field of electronics in Argentina and on the contribution of the Buenos Aires Section to this area.

ASEE Will Meet in June

The annual meeting of the American Society for Engineering Education will be held June 20-24, 1955, at Pennsylvania State University, State College, Pennsylvania. The meeting will be attended by over 2,000 educators and educational administrators from colleges throughout the country. The society, this year especially welcoming foreign visitors, will present a program featuring international aspects of engineering education.

The program will offer the reports of two committees. The Committee on Evaluation of Engineering Education will report on the curricular goals of engineering education, emphasizing changes needed to keep engineering education abreast of scientific and technological advances. A second committee will discuss the teaching of humanities, social sciences, and business studies in the engineering curriculum.

The Engineering College Research Council will have a session dealing with education for research, while the Engineering College Administrative Council will feature a session on methods of interesting secondary school students in engineering as a career. Over 75 other conferences, concerning all areas of engineering education as well as related areas, will be offered.

The printed program for the meeting will be available in May, and further information may be obtained from the Secretary of the ASEE, Northwestern University, Evanston, Illinois.

NEW APPOINTMENTS MADE TO THE BOARD OF DIRECTORS

At the meeting of the IRE Board of Directors on January 6 in New York, a number of appointments to the Board of Directors were made for this year. W. R. G. Baker was appointed Treasurer; Haraden Pratt, Secretary; J. R. Pierce, Editor; A. N. Goldsmith, Director; A. V. Loughren, Director; and Howard Vollum, Director.

Calendar of Coming Events

IRE Philadelphia Section Color TV Symposium, Physics Building, University of Pennsylvania, March 8, 15, 22, 29, and April 5

Symposium on Electromagnetic Relays, Oklahoma A and M College, Stillwater, Oklahoma, March 9-11

IRE National Convention, Waldorf-Astoria Hotel and Kingsbridge Armory, New York, N. Y., March 21-24

IRE-PIB Symposium on Modern Network Synthesis, Engineering Societies Building, New York, N. Y., April 13-15

Instrumentation Symposium, Proving Ground Instrumentation Committee of the American Ordnance Association, Patrick Air Force Base, Cocoa, Florida, April 14 and 15

SMPTE 77th Semiannual Convention, Hotel Drake, Chicago, Ill., April 17-22

International Symposium on Electrical Discharges in Gases, Technical University, Delft, Netherlands, April 25-30

IRE Seventh Region Technical Conference and Trade Show, Hotel Westward Ho, Phoenix, Ariz., April 27-29

Semiconductor Symposium, Electrochemical Society, Cincinnati, Ohio, May 2-5

National Aeronautical Electronics Conference, Biltmore Hotel, Dayton, Ohio, May 9-11

IRE-AIEE-IAS-ISA National Telemetering Conference, Hotel Morrison, Chicago, Ill., May 18-20

IRE-AIEE-RETMA-WCEMA Electronic Components Conference, Hotel Ambassador, Los Angeles, Calif., May 26-27

American Society for Engineering Education Annual Meeting, Pennsylvania State University, State College, Pennsylvania, June 20-24

URSI-U. of Michigan International Symposium on Electromagnetic Wave Theory, University of Michigan, Ann Arbor, Mich., June 20-25

International Analogy Computation Meeting, Societe Belge des Ingenieurs des Telecommunications et D'Electronique, Brussels, Belgium, September 27-October 1

IRE-AIEE Conference on Industrial Electronics, Rackham Memorial Building, Detroit, Michigan, September 28-29

Second International Automation Exposition, Chicago Navy Pier, Chicago, Illinois, November 14-17

CONVENTION SOCIAL PROGRAM TO FEATURE GEN. RIDGWAY

The National Convention activities (p. 347) will include an outstanding program of social events and women's activities.

Social Events

A get-together cocktail party will be held from 5:30 P.M. to 7:30 P.M. on March 21 in the Grand Ballroom of the Waldorf. Tickets may be purchased at the door.

The Annual IRE Banquet on March 23 will also be held in the Waldorf's Grand Ballroom. The featured speaker will be General Matthew B. Ridgway, Chief of Staff, U. S. Army. The winners of the awards for 1955 will be honored during the banquet in ceremonies conducted by President John D. Ryder. Reservations (while they last) may be purchased in advance from IRE at \$14.00 apiece.

Women's Program

Registration and headquarters for women's activities will be held in the Regency Suite on the fourth floor of the Waldorf. In addition to the program outlined below, tickets to radio and TV broadcasts will be available gratis.

Monday, March 21

9:30 A.M.—5:00 P.M.—Registration—Waldorf-Astoria, Regency Suite, Fourth Floor. Get-Together Coffee Hour, 9:30 A.M.—10:30 A.M.

1:45 P.M.—4:30 P.M.—Behind the Scenes at R.H. Macy Department Store (a view of merchandising from manufacturer to customer).

Tuesday, March 22

9:15 A.M.—11:00 A.M.—Conducted tour of European Masterpieces, Metropolitan Museum of Art. (One-way transportation included.) @ \$1.75

11:30 A.M.—1:00 P.M.—Luncheon (Optional) Metropolitan Museum Cafeteria Restaurant. (Price of luncheon extra, as ordered)

3:00 P.M.—5:00 P.M.—Tea at new IRE Headquarters Building, 5 East 79 Street.

Wednesday, March 23

8:15 A.M.—11:30 A.M.—Tour of United Nations, including a meeting of the "Commission on the Status of Women." @ \$1.50

12:00 NOON—2:00 P.M.—Luncheon and Fashion Show, Empire Room, Waldorf-Astoria Hotel. @ \$4.50.

2:30 P.M. Matinee. "Kismet" or "Teahouse of the August Moon." @ \$4.55

Thursday, March 24

8:50 A.M.—11:00 A.M.—N.B.C. Tour of Radio City, 30 Rockefeller Plaza, including "Break the Bank" radio broadcast. @ \$.70

URSI INVITES PAPERS FOR SPRING MEETING

The URSI Spring Meeting will be held at the National Bureau of Standards in



Ralph Hackbusch (right), former IRE Vice-President, receiving radio citation from G. C. W. Browne.

Washington, May 3 to 5. The meeting will be sponsored by the USA National Committee of the International Scientific Radio Union and co-sponsored by the PG on Antennas and Propagation and the PG on Microwave Theory and Techniques. The meeting will include a combined technical session followed by separate sessions in various fields.

Authors who wish to present papers are asked to submit titles and one or two hundred word abstracts by March 1. Papers should be submitted to the representative in each field as follows: Radio Measurements and Standards, *Dr. R. G. Fellers, Bldg. 3, PH, Radio 1, Naval Research Laboratory, Washington 20, D. C.*; Radio and Troposphere, *Dr. J. B. Smyth, U. S. Navy Electronics Laboratory, San Diego 52, Calif.*; Ionospheric Radio, *Dr. Millett Morgan, Thayer School of Engineering, Dartmouth College, Hanover, New Hampshire*; Radio Noise of Terrestrial Origin, *F. H. Dickson, Communications Liaison Branch, Room 2D276, National Defense Building, Washington 25, D. C.*; Radio Astronomy, *Dr. J. P. Hagan, Naval Research Laboratory, Washington 20, D. C.*; Radio Wave and Circuits, *Dr. E. C. Jordan, Dept. of E.E., U. of Ill., Urbana, Ill.*; Radio Electronics, *Dr. W. G. Shepherd, Inst. of Tech., U. of Minn., Minneapolis 14, Minnesota*; PG on Antennas and Propagation, *H. F. Englemann, Federal Telecommunication Labs., Nutley, N. J.*; Microwave Theory and Technique, *J. T. Booljahn, Stanford Research Institute, Stanford, California.*

PROCEEDINGS OF ELECTRONIC COMPONENTS SYMPOSIUM NOW AVAILABLE

The 1954 *Electronic Components Symposium Proceedings* are available at \$4.50 per copy. Those interested in obtaining *The Proceedings* may write to A. E. Zdobysz, Associated Engineering Services, Incorporated, 1 Thomas Circle, N.W., Washington 5, D. C.

RALPH HACKBUSCH RECEIVES CITATION UPON RETIREMENT

Ralph A. Hackbusch, Vice-President of the IRE in 1944, has recently retired as President of the Canadian Radio Technical Planning Board. G. C. W. Browne, Controller of Telecommunications of the Department of Transport, presented Mr. Hackbusch, upon his retirement, with a citation. The award was made in "recognition of his enterprise and leadership in formulating sound engineering principles and organizing technical facts to assist in the development of the Canadian radio industry and radio service of the Nation."

In addition to his position on the planning board, Mr. Hackbusch has been a member of the Canadian Electrical Code Committee, the Canadian Standards Association, and the Radio Manufacturers Association.

BRIG. GEN. B. S. KELSEY TO MAKE CHIEF SPEECH AT PGANE LUNCHEON IN NEW YORK

Brigadier General Benjamin S. Kelsey, USAF, will be the principal speaker at the annual luncheon of the Professional Group on Aeronautical and Navigational Electronics to be held March 22 during the National Convention in New York. General Kelsey, who formerly headed the USAF's All-Weather Flying division, will speak on "The First and Last Thousand Feet." Gen. Kelsey's present post is Deputy Director of Research and Development, Office of the Deputy Chief of Staff for Development.

The PGANE luncheon will be held in the Empire Room of the Waldorf-Astoria, site of two PGANE-sponsored technical sessions to be held the same day. Tickets, priced at \$3.50, may be obtained by writing to William P. McNally, W. L. Maxson Corporation, 460 West 34 Street, New York 1, New York.

TELEMETERING GROUP TO MEET

The National Telemetering Conference, under the sponsorship of the IRE (Radio Telemetering and Remote Control Professional Groups participating), American Institute of Electrical Engineers, Instrument Society of America, and the Institute of Aeronautical Sciences, will be held at the Morrison Hotel in Chicago, May 18-20. Kipling Adams of the General Radio Company is National Chairman. Thirty-six papers will be presented at the conference, and the following schedule of papers has been planned:

Wednesday, May 18

Morning

Flight Control

Afternoon

System I—Industrial Telemetering
Components I—Pickups and Transducers

Thursday, May 19

Morning

Systems II—Flight Testing

Afternoon

Systems III—Data Processing
Components II—Transmitting Link

Friday, May 20

Morning

Systems IV—New Developments in Telemetering and Remote Control

Afternoon

Components III—Data Processing

EXECUTIVE COMMITTEE APPROVES TWO NEW CHAPTERS

At its meeting of January fifth, the Executive Committee approved two P. G. Chapters. They are: Microwave Theory and Techniques, Northern New Jersey Chapter; Production Techniques, Washington Chapter. The Pasadena Subsection of the Los Angeles Section was also approved.



This is Beanie, a character who will appear frequently in the new IRE Student Quarterly, which goes to student members without extra charge, and to which other IRE members can subscribe for \$2.00 a year. Here Beanie is shown traveling with the speed of light at the IRE Convention, trying to see it all on his lunch hour. (But he didn't make it.)

TRANSACTIONS OF IRE PROFESSIONAL GROUPS

The following issues of TRANSACTIONS are available from the Institute of Radio Engineers, Inc., 1 East 79 Street, New York 21, N. Y., at the prices listed below.

Sponsoring Group	Publications	Group Mem- bers	IRE Mem- bers	Non Mem- bers*	
Aeronautical & Navigational Electronics	PGAE-5: A dynamic Aircraft Simulator for Study of Human Response Characteristics (6 pages)	\$.30	\$.45	\$.90	
	PGAE-6: Ground-to-Air Co-channel Interference at 2900 MC (10 pages)	.30	.45	.90	
	PGAE-8: June 1953 (23 pages)	.65	.95	1.95	
	PGAE-9: September 1953 (27 pages)	.70	1.05	2.10	
	Vol. ANE-1, No. 1: March 1954 (51 pages)	1.00	1.50	3.00	
	Vol. ANE-1, No. 2: June 1954 (22 pages)	.95	1.40	2.85	
Antennas and Propagation	PGAP-4: IRE Western Convention, August 1952 (136 pages)	2.20	3.30	6.60	
	Vol. AP-1, No. 1: July 1953 (30 pages)	1.20	1.80	3.60	
	Vol. AP-1, No. 2: October 1953 (31 pages)	1.20	1.80	3.60	
	Vol. AP-2, No. 1: January 1954 (39 pages)	1.35	2.00	4.05	
	Vol. AP-2, No. 2: April 1954 (41 pages)	2.00	3.00	6.00	
	Vol. AP-2, No. 3: July 1954 (36 pages)	1.50	2.25	4.50	
	Vol. AP-3, No. 4: October 1954 (36 pages)	1.50	2.25	4.50	
Audio	PGA-5: Design Interrelations of Records and Re-producers (8 pages)	.30	.45	.90	
	PGA-7: Editorials, Technical Papers, and News, May 1952 (47 pages)	.90	1.35	2.70	
	PGA-10: November-December 1952 (27 pages)	.70	1.05	2.10	
	Vol. AU-1, No. 1: January-February 1953 (24 pages)	.60	.90	1.80	
	Vol. AU-1, No. 2: March-April 1953 (34 pages)	.80	1.20	2.40	
	Vol. AU-1, No. 3: May-June 1953 (34 pages)	.80	1.20	2.40	
	Vol. AU-1, No. 4: July-August (19 pages)	.70	1.05	2.10	
	Vol. AU-1, No. 5: September-October 1953 (11 pages)	.50	.75	1.50	
	Vol. AU-1, No. 6: November-December 1953 (27 pages)	.90	1.35	2.70	
	Vol. AU-2, No. 1: January-February 1954 (38 pages)	1.20	1.80	3.60	
	Vol. AU-2, No. 2: March-April 1954 (31 pages)	.95	1.40	2.85	
	Vol. AU-2, No. 3: May-June 1954 (27 pages)	.95	1.40	2.85	
	Vol. AU-2, No. 4: July-August 1954 (27 pages)	.95	1.40	2.85	
	Vol. AU-2, No. 5: September-October 1954 (22 pages)	.95	1.40	2.85	
Broadcast and Television Receivers	PGBTR-1: Round-Table Discussion on UHF TV Receiver Considerations, 1952 IRE National Convention (12 pages)	.50	.75	1.50	
	PGBTR-3: June 1953 (67 pages)	1.40	2.10	4.20	
	PGBTR-5: January 1954 (96 pages)	1.80	2.70	5.40	
	PGBTR-6: April 1954 (119 pages)	2.35	3.50	7.00	
	PGBTR-7: July 1954 (58 pages)	1.15	1.70	3.45	
	PGBTR-8: October 1954 (20 pages)	.90	1.35	2.70	
	Circuit Theory	PGCT-1: IRE Western Convention, August 1952 (100 pages)	1.60	2.40	4.80
		PGCT-2: Papers presented at the Circuit Theory Sessions of the Western Electronic Show and Convention, San Francisco, California, August, 19-21, 1953, (106 pages)	1.95	2.90	5.85
Vol. CT-1, No. 1: March 1954 (80 pages)		1.30	1.95	3.90	
Vol. CT-1, No. 2: June 1954 (39 pages)		1.00	1.50	3.00	
Vol. CT-1, No. 3: September 1954 (73 pages)		1.00	1.50	3.00	
Vol. CT-1, No. 4: December 1954 (42 pages)		1.00	1.50	3.00	
Communications Systems		Vol. CS-2, No. 1: January 1954 (83 pages)	1.65	2.50	4.95
Component Parts		PGCP-1: March 1954 (46 pages)	1.20	1.80	3.60
	PGCP-2: September 1954: Papers presented at the Component Parts Sessions at the 1954 Western Electronic Show and Convention, Los Angeles, California (118 pages)	2.25	3.35	6.75	
Electronic Computers	Vol. EC-2, No. 2: June 1953 (27 pages)	.90	1.35	2.70	
	Vol. EC-2, No. 3: September 1953 (27 pages)	.75	1.10	2.25	
	Vol. EC-2, No. 4: December 1953 (47 pages)	1.25	1.85	3.75	
	Vol. EC-3, No. 1: March 1954 (39 pages)	1.10	1.65	3.30	
	Vol. EC-3, No. 2: June 1954 (65 pages)	1.65	2.45	4.95	
	Vol. EC-3, No. 3: September 1954 (54 pages)	1.80	2.70	5.40	
	Vol. EC-3, No. 4: December 1954 (46 pages)	1.10	1.65	3.30	

* Public libraries, colleges, and subscription agencies may purchase at IRE member rate.

(Continued on the following page)

TRANSACTIONS OF IRE PROFESSIONAL GROUPS

(Continued)

Sponsoring Group	Publications	Group Mem- bers	IRE Mem- bers	Non- Mem- bers*
Electron Devices	PGED-2: Papers on Electron Devices presented at the IRE National Conference on Electron Tube Research, Ottawa, Canada, June 16-17, 1952, and IRE Western Convention, Long Beach (84 pages)	\$1.60	\$2.40	\$4.80
	PGED-4: December 1953 (62 pages)	1.30	1.95	3.90
	Vol. ED-1, No. 1: February 1954 (72 pages)	1.40	2.10	4.20
	Vol. ED-1, No. 2: April 1954 (75 pages)	1.40	2.10	4.20
	Vol. ED-1, No. 3: August 1954 (77 pages)	1.40	2.10	4.20
Engineering Management	PGEM-1: February 1954 (55 pages)	1.15	1.70	3.45
	PGEM-2: November 1954 (67 pages)	1.30	1.95	3.90
Industrial Electronics	PGIE-1: August 1953 (40 pages)	1.00	1.50	3.00
Information Theory	PGIT-2: A Bibliography of Information Theory (Communication Theory-Cybernetics) (60 pages)	1.25	1.85	3.75
	PGIT-3: March 1954 (159 pages)	2.60	3.90	7.80
	PGIT-4: September 1954 (234 pages)	3.35	5.00	10.00
Instrumentation	PGI-2: Data handling Systems Symposium: IRE Western Electronic Show & Convention, Long Beach, California, August 27-29, 1952 (111 pages)	1.65	2.45	4.95
	PGI-3: April 1954 (55 pages)	1.05	1.55	3.15
Medical Electronics	PGME-1: November 1953 (40 pages)	1.05	1.55	3.15
Microwave Theory and Techniques	Vol. MTT-1, No. 2: November 1953 (44 pages)	.90	1.35	2.70
	Vol. MTT-2, No. 1: Papers presented at the Microwave Radio Relay Systems Symposium, New York N. Y., April 1954 (107 pages)	2.20	3.30	6.60
	Vol. MTT-2, No. 2: July 1954 (67 pages)	1.25	1.85	3.75
	Vol. MTT-2, No. 3: September 1954: Papers presented at the joint IRE Professional Group-URSI meeting held in Washington, D. C., May 5, 1954 (54 pages)	1.10	1.65	3.30
Nuclear Science	Vol. NS-1, No. 1: September 1954 (42 pages)	.70	1.00	2.00
Reliability and Quality Control	PGQC-1: Papers presented at the 1951 Radio Fall Meeting, and 1952 IRE National Convention (58 pages)	1.20	1.80	3.60
	PGQC-2: March 1953 (51 pages)	1.30	1.95	3.90
	PGQC-3: February 1954 (39 pages)	1.15	1.70	3.45
Telemetry and Remote Control	PGRTRC-1: August 1954 (16 pages)	.85	1.25	2.55
Ultrasonics Engineering	PGUE-1: June 1954 (62 pages)	1.55	2.30	4.65
	PGUE-2: November 1954 (43 pages)	1.05	1.55	3.15
Vehicular Communications	PGVC-2: Symposium on What's New in Mobile Radio (32 pages)	1.20	1.80	3.60
	PGVC-3: Theme: Spectrum Conservation Washington, D. C., December 3-5, 1952 (140 pages)	3.00	4.50	9.00
	PGVC-4: Design, Planning and Operation of Mobile Communications Systems, June, 1954 (98 pages)	2.40	3.60	7.20

* Public libraries, colleges, and subscription agencies may purchase at IRE member rate.

Technical Committee Notes

The Facsimile Committee met at the Times Annex on December 10 with Vice Chairman A. G. Cooley presiding. The test chart and definitions being prepared by the committee were discussed.

The Audio Techniques Committee met at IRE Headquarters on December 15 with Chairman D. E. Maxwell presiding. The work of three new subcommittees was discussed and further revisions were made in the proposed *Measurements Standard* (on amplification, bridging loss, and insertion loss; power loss and transducer loss; attenu-

ation; transformer loss and transition loss).

The Standards Committee met at IRE Headquarters on January 13 with Vice-Chairman Baldwin presiding in the morning and Chairman Weber presiding during the afternoon session. The committee discussed procedure for IRE delegates in voting on ASA Standards, and considered two groups of definitions of ASA Sectional Committee C42. The committee voted to request that the IRE Executive Committee set up a Technical Committee on Radio Frequency Interference. The proposed *Standards on Antennas and Waveguides: Definitions for Wave-*

guide Components were reviewed and conflicts with ASA C42 definitions were discussed at length.

The Ad Hoc Committee on Terminology in Spurious Radiation Work met January 12 with Chairman Wayne Mason presiding. Problems in terminology were discussed and definition for "extraneous emission" was tentatively selected.

The Ad Hoc Committee on Spurious Radiation met on January 12 with R. F. Shea, Chairman, presiding. Mr. Shea described the tri-service sponsored conference on interference held in December in Chicago by the Armour Research Foundation. Mr. Glenn told of the work being done on open field measurements and screen room measurements by IRE Subcommittee 17.4. Mr. Cumming announced that an Interference Symposium has been planned for the 1955 IRE Convention.

The committee voted to request the formation of a new technical committee on radio frequency interference. Work on interference done by Roy Abbett was not assigned to a technical committee at this time, so that developments on the new committee could be considered.

The Radio Transmitters Committee met at IRE Headquarters on January 12 with Chairman P. J. Herbst presiding. The committee discussed definitions for terms in the field of spurious output. The committee considered the following proposed standards now being prepared by the various subcommittees: proposed standards on pulses; methods of measurement of pulse quantities; proposed standards on monochrome television transmitters; and proposed methods of testing radio-telegraph transmitters (below 50 mc). The committee also discussed IRE published standards on radio transmitters which were in need of review and revision.

The Navigation Aids Committee met on November 19 and on December 8 at IRE Headquarters, and H. R. Mimno presided. The committee continued work on the proposed *Standards on Direction Finder Measurements*.

The Video Techniques Committee met at IRE Headquarters on November 29 with Chairman W. J. Poch presiding. The committee discussed the IRE-RETMA spurious radiation program. Vice-chairman J. L. Jones reported on the recent progress made on the measurement of "differential gain" and "differential phase."

P. H. Smith presided when the Antennas and Waveguides Committee met on November 17 at IRE Headquarters. The Committee discussed the proposed *Definitions of Waveguide Components* and the proposed *Navigation Aids Definitions*. It was noted that the Measurements of *Waveguide Components* (in preparation) should be restricted to linear and reciprocal elements, and that the advice of the Circuits Committee should be requested on the use of "port" nomenclature.

On December 1, the Industrial Electronics Committee met at IRE Headquarters, with Chairman J. E. Eiselein presiding. The committee decided that the Professional Group on Production Techniques should be notified of their desire to originate and sponsor IRE standard definitions, standard methods of test and measurements, and good engineering practices relating to automation, including automatic machinery for production of electronic equipment.

Abstracts of Transactions of the I.R.E.

The following issues of "Transactions" have recently been published, and are now available from the Institute of Radio Engineers, Inc., 1 East 79th Street, New York 21, N. Y. at the following prices. The contents of each issue and, where available, abstracts of technical papers are given below.

Sponsoring Group	Publication	Group Members	IRE Members	Non-Members*
Antenna and Propagation	Vol. AP-3, No. 1	\$1.60	\$2.40	\$4.80
Broadcast and Television Receivers	Vol. BTR-1, No. 1	\$1.25	\$1.85	\$3.75
Electron Devices	Vol. ED-1, No. 4	\$3.20	\$4.80	\$9.60

* Public libraries and colleges may purchase copies at IRE Member rates.

ANTENNAS AND PROPAGATION

Vol. AP-3, No. 1, January, 1955

News and Views

Double Parabolic Cylinder Pencil-Beam Antenna—R. C. Spencer, F. S. Holt, H. M. Johanson, and J. Sampson

Radiation from a point source placed on the focal line of a parabolic cylinder is reflected in succession from this cylinder and from a second parabolic cylinder crossed so that its focal line coincides with the directrix of the first cylinder. The two reflections result in a parallel beam. The theory is applicable to both microwaves and light. The advantages of shipping the cylinders in the form of flat sheets and the possibilities of independent control of horizontal and vertical beamwidths and shapes are pointed out. Experimental models have been built and tested.

An Atmospheric Analyzer—P. F. Smith

The enormously powerful radiation from lightning discharges has been used as a tool for the study of the ionosphere at very low frequencies. Previous workers have calculated the height of the ionosphere and the distance to the radiation source by application of the ray theory of multiple ionospheric reflections. Time measurements for use in the height and distance formulas were obtained by direct measurement of recorded oscillograms. Time resolution was limited and the calculations were extremely tedious.

This paper describes a complete system which records the received atmospheric wave form and simultaneously derives a plot of the time intervals between peaks of the wave form vs time. The time-interval plot greatly facilitates data reduction by means of a simple curve-fitting technique. Accuracy of measurement of height and distance is limited chiefly by the validity of the multiple reflection theory and the assumption of a simple layer structure in the ionosphere. The time differences are measured more accurately than is ordinarily possible with direct measurement on the waveform. The system automatically derives frequency-time plots for whistling atmospherics and relates the whistler to preceding impulsive atmospherics. Consumption of photographic film is low. The system can be used to visually monitor tape-recorded atmospherics.

A Single-Control Tuning Circuit for Electrically Small Antennas—R. E. Webster

It is often desirable to tune electrically small antennas at their feed terminals. An "L" matching circuit for this purpose is considered.

It is shown that one fixed element and one variable tuning element are adequate for certain small antennas. The manner in which losses affect the circuit efficiency and the single-control tuning feature is discussed. Application of the technique to a tunable cavity antenna is noted.

Design of Line-Source Antennas for Narrow Beamwidth and Low Side Lobes—T. T. Taylor

It is well known that the phenomenon of radiation from line-source antennas is very similar to that of the diffraction of light from narrow apertures. Unlike the optical situation, however, antenna design technique permits the use of other-than-uniform distributions of field across the antenna aperture. Line source synthesis is the science of choosing this distribution function to give a radiation pattern with prescribed properties such as, for example, narrow angular width of the main lobe and low side lobes. In the present article the mathematical relationships involved in the radiation calculation are studied from the point of view of function theory. Some conclusions are drawn which outline the major aspects of synthesis technique very clearly. In particular, the problem of constructing a line source with an optimum compromise between beamwidth and side-lobe level (analogous to the Dolph-Tchebycheff problem in linear array theory) is considered. The ideal pattern is $\cos \pi \sqrt{A^2 - u^2}$, where $u = (2a/\lambda) \cos \theta$, a is the half-length of the source, and $\cosh \pi A$ is the side-lobe ratio. Because of theoretical limitations, this pattern cannot be obtained from a physically realizable antenna; nevertheless its ideal characteristics can be approached arbitrarily closely. The procedure for doing this is given in detail.

On the Input Conductance of Thin Antennas—G. Barzilai

Input conductances of thin antennas are computed by evaluating separately input voltage and radiated power for a prescribed value of the current near the maximum. The current distribution required to evaluate the radiated power and the input voltage is obtained by solving Hallen's equation for the prescribed value of the current. First and second order computations were carried out for full wave antennas, and the results compared with those obtained by others.

Theory of Radio Reflections from Electron-Ion Clouds—Von R. Eshleman

Approximations to the reflection coefficients of electron-ion clouds of various sizes, shapes, and densities are determined. A simplified approach to the problem is employed, wherein the total reflection from the low-density clouds is computed by summing the scattered wavelets from the individual electrons, while the

high-density clouds are treated as total reflectors at the critical density radius. Some of the limitations of this method are discussed. While more elaborate determinations should be used in certain regions of cloud size and density, the method used here provides an overall, first order approximation of the effects of size, shape, and density on the reflecting properties of electron-ion clouds. Several possible applications of the theoretical results are outlined.

Discussion on Optimum Patterns for Endfire Arrays—R. L. Pritchard

The method of synthesizing an equal-minor-lobe directivity pattern suggested by Riblet for the broadside array was applied recently by DyHamel to the case of the endfire array. In the present paper, an alternative synthesis procedure is described, based directly on Dolph's method of synthesis for the broadside array. Advantages of this alternative procedure include (a) applicability to arrays having even as well as odd numbers of elements, and (b) somewhat simpler equations for calculating relative currents for the elements of the array. This alternative procedure is described here in detail together with numerical examples for the seven-element array used by DuHamel and for a four-element array. A tabulation of equations for relative current amplitudes for arrays of 5, 7, 9, 11, and 13 elements is given in an Appendix. In conclusion, an alternative method of overdesigning a supergain antenna is described.

AUDIO

Vol. AU-3, No. 1, Jan.-Feb., 1955

D. W. Martin (Editorial)
PGA News

List of Chapter Chairmen, IRE Professional Group on Audio

Correction to "Equivalent Circuit Analysis of Mechano-acoustic Structures," B. B. Bauer
Equalization of Tone Controls on Phonograph Amplifiers—F. H. Slaymaker

The necessity for equalization in phonograph amplifiers is explained, and numerous examples are given. The difference between the action of equalization controls and tone controls is explained. Examples are shown in terms of response curves for a particular amplifier.

The Manufacture of High-Fidelity Magnetic Tape Records—R. C. Moyer

The equipment used in the manufacture of magnetic tape records by RCA is described. The choice of tape speed, track width, and pre-emphasis used is explained, and the desirability of standardization on these possible variables is emphasized.

Loudspeakers and Microphones—Leo L. Beranek

This paper covers the development of loudspeakers and microphones and gives many illustrations of commercially available units dating from 1915 to the present time.

BROADCAST AND TELEVISION RECEIVERS

Vol. BTR-1, No. 1, January, 1955

A Simple Method of Phase Compensation of Video Delay Lines—D. A. Gillen

A new method of phase compensation of delay lines of the distributed constant type is described in detail. This method produces a simple, compact line having superior phase and response characteristics. The phase compensation is effected by using inductive coupling within the line in the proper amount and phase

to achieve the desired correction. Such coupling does not introduce additional losses into the line and therefore the frequency response of the line, is not impaired by the introduction of the compensating means. Steady state and transient response measurements on various types of lines made using the above principle are shown and a practical method of designing a line to meet a given set of conditions is described.

Optimum Crystal Mixer Operation—The 1N82 Crystal—S. Deutsch

The dc voltage-current characteristic and the 10 mc/sec. noise temperature ratio of a group of 1N82 crystals were measured. The data thus obtained make it possible to calculate the condition for optimum mixer operation of the 1N82 crystal.

The most unpredictable element in the design of a television UHF tuner employing a crystal mixer is the image-frequency impedance, Z_i . Various quantities are accordingly plotted, as a function of Z_i , as the latter goes from zero to infinity in the resistance domain. For example, for an average 1N82 crystal, the optimum rf source resistance ranges from 397 to 801 ohms, the minimum conversion loss ranges from 3.32 db to 4.71 db, the optimum mismatch ranges from 2.02 to 2.74, and the IF output resistance ranges from 397 to 2031 ohms. The latter factor has proven to be extremely troublesome in television uhf tuners.

The average 1N82 noise temperature ratio, at 10 mc/sec, was found to be 4.9. This leads to a mixer noise temperature ratio, as a function of Z_i , of from 1.39 to 1.84 at 30 mc/sec. Finally, a set of curves is shown giving the optimum intermediate frequency and minimum mixer—IF amplifier noise figure for various 30 mc/sec. IF noise figures.

The method of analysis used here is applicable to any diode mixer. The minimum mixer—IF amplifier noise figure values will indicate the degree of success of any given 1N82 tuner design. In addition, the curves

show that certain mixer circuit configurations are superior to others.

A New Self Oscillating Frequency Converter—D. E. Sunstein

A frequency converter utilizing the autodyne principle has been developed which has a feature not normally expected of the autodyne, namely, the ability to accommodate an automatic gain control signal. This ability is achieved by causing the amplitude of the oscillations to be controlled by an element external to the non-linear device doing the frequency converting. Conversion gain, noise performance, image rejection, as well as oscillator radiation, are generally equivalent to or better than that of the standard pentagrid circuits at broadcast band frequency.

Color Purity in Ungated Sequential Displays—G. S. Ley

(Paper given at Radio Fall Meeting, Syracuse, New York, October 18, 1954)

Color purity of ungated sequential displays involving the modification of the NTSC signal and the addition of harmonics is discussed. It is shown that in an idealized case of a continuous color sequence display very good color accuracy can be obtained by the addition of only the second harmonic of the color writing frequency. It is compared with an idealized reversing color sequence display using second harmonic only and another including fourth harmonic.

A block diagram of a receiver to give the continuous color sequence is given.

The Practical Aspects of the Color Subcarrier Synchronization Problem—Wolf J. Gruen

This paper deals with the behavior of different color subcarrier synchronizing circuits. These circuits include the simple AFC circuit, the hunting AFC circuit, the narrow-band—wide-band AFC circuit, and the crystal filter followed by balanced diode synchronous detectors. An evaluation of these circuits with respect to reliability of performance and simplicity of operation is presented.

The Second Detector—A Determinant of Fringe-Area Performance—J. E. Bridges

The linear diode detection process is shown to have an important influence on the performance of AM and television receivers in the fringe area. The diode detection process can seemingly increase selectivity; can, apparently, overload; and can, in effect, generate noise. Principal factors are the carrier-to-noise ratio, IF amplifier response, location of the carrier within the IF response, frequency of the modulating signal, and the degree of modulation. Special detection circuits which minimize undesired by-products of the detection process are capable of small improvements in the performance of television receivers in the fringe area.

A UHF-VHF Tuner Using Pencil Tubes—W. A. Harris and J. J. Thompson

The use of pencil tubes in a television tuner covering all channels in the uhf and vhf bands is discussed. The input and output resonant frequencies of the pencil tubes are high enough to allow the use of shunt-tuned circuits in a uhf-vhf tuner, and the feedback inductance is low enough to insure stability in the required frequency ranges. The shunt-tuning method has the advantages of providing small over-all dimensions and a moderate number of switching components.

The paper includes discussion of the measurements of the tube characteristics at high frequencies and the use of such data in the design of the tuner circuits.

ELECTRON DEVICES

Vol. ED-1, No. 4, December, 1954

Symposium on Fluctuation Phenomena in Microwave Sources, November 14–18, 1954, New York, N. Y.

For contents and abstracts of papers, see Proc. I.R.E., pp. 1577–1580, October, 1954.

Professional Groups

	Chairman
AERONAUTICAL & NAVIGATIONAL ELECTRONICS	Edgar A. Post United Air Lines Operations Base Stapleton Field Denver 7, Colo.
ANTENNAS AND PROPAGATION	D. C. Ports Jansky & Bailey 1339 Wisconsin Ave. N.W. Washington 7, D. C.
AUDIO	Vincent Salmon Stanford Research Institute Stanford, Calif.
AUTOMATIC CONTROL	R. B. Wilcox Raytheon Mfg. Co. 148 California St. Newton, Mass.
BROADCAST & TELEVISION RECEIVERS	Wilson P. Boothroyd Philco Corporation Tioga & C Streets Philadelphia 32, Pa.
BROADCAST TRANSMISSION SYSTEMS	Lewis Winner 52 Vanderbilt Ave., New York, N. Y.
CIRCUIT THEORY	C. H. Page National Bureau of Standards Washington, D. C.
COMMUNICATIONS SYSTEMS	Col. J. Z. Millar Western Union Telegraph Co. 60 Hudson St., New York 13, N. Y.
COMPONENT PARTS	Floyd A. Paul Bendix Development Lab. 116 W. Olive Ave. Burbank, Calif.
ELECTRON DEVICES	George A. Espersen Phillips Laboratories, Inc. Irvington-on-Hudson, N. Y.
ELECTRONIC COMPUTERS	Harry T. Larson Ramo-Wooldridge Corp. 8820 Bellanca Ave. Los Angeles 45, Calif.

	Chairman
ENGINEERING MANAGEMENT	Charles J. Breitwieser Lear, Inc. 3171 S. Bundy Drive Los Angeles 34, Calif.
INDUSTRIAL ELECTRONICS	George P. Bosomworth Firestone Tire & Rubber Co. Akron 17, Ohio
INFORMATION THEORY	Louis A. De Rosa 500 Washington Ave. Nutley, N. J.
INSTRUMENTATION	R. L. Sink Consolidated Engineering Corp. 300 Sierra Madre Villa Pasadena, Calif.
MEDICAL ELECTRONICS	J. F. Herrick Mayo Clinic Rochester, Minn.
MICROWAVE THEORY AND TECHNIQUES	W. W. Mumford Bell Telephone Laboratories Whippany, N. J.
NUCLEAR SCIENCE	D. H. Loughridge Northwestern Technical Institute Evanston, Ill.
PRODUCTION TECHNIQUES	R. R. Batcher 240-02 42 Ave. Douglaston, L. I. N. Y.
RELIABILITY AND QUALITY CONTROL	Leon Bass Quality Engineering General Electric Co. Cincinnati 15, Ohio
TELEMETRY AND REMOTE CONTROL	M. V. Kiebert, Jr. Convair P. O. Box 1011 Pomona, California
ULTRASONICS ENGINEERING	A. L. Lane 706 Chillum Road Hyattsville, Md.
VEHICULAR COMMUNICATIONS	W. A. Shipman Columbia Gas. Sys. Ser. Corp. 120 E. 41 St., N. Y. 17, N. Y.

Sections*

Chairman

K. F. Sibila
1745-13 St.
Cuyahoga Falls, Ohio

T. F. Marker
3133-40 St.
Sandia Base
Albuquerque, N. M.

G. M. Howard
413 Ridgecrest Rd., N.E.
Atlanta, Ga.

C. D. Pierson, Jr.
Broadview Apts. 1126
116 West University
Pkwy.
Baltimore 10, Md.

L. C. Stockard
1390 Lucas Dr.
Beaumont, Texas

N. S. Lawrence
Johnson's Corners, R.D. 1
Harpurville, N. Y.

A. J. Pote
M.I.T., Lincoln Lab.
Box 73
Lexington 73, Mass.

P. N. Guzzi
Uruguay 1035
Buenos Aires, Argentina

J. H. Doolittle
Goodrich Road
Clarence, N. Y.

E. W. Pappenfus
1101-30 St. Dr., S.E.
Cedar Rapids, Iowa

Hans Scharla-Nielsen
Radiation Inc.
P. O. Drawer 'Q'
Melbourne, Florida

J. J. Gershon
De Vry Tech. Inst.
4141 Belmont Ave.
Chicago 41, Ill.

R. A. Maher
6133 Sunridge Dr.
Cincinnati 24, Ohio

H. R. Mull
4558 Silverdale Ave.
North Olmsted, Ohio

R. W. Masters
1633 Essex Road
Columbus 21, Ohio

H. E. Rohloff
Southern New England
Telephone Co.
227 Church St.
New Haven, Conn.

J. A. Green
6815 Oriole Dr.
Dallas 9, Texas

A. B. Henderson
801 Hathaway Road
Dayton 9, Ohio

R. E. Swanson
1777 Kipling St.
Denver 15, Colo.

A. A. Read
511 Northwestern Avenue
Ames, Iowa

N. D. Saigeon
1544 Grant
Lincoln Park 25, Mich.

J. L. Sheldon
179 Dodge Ave.
Corning, N. Y.

Secretary

AKRON (4) C. O. Lambert
1144 Roslyn Ave.
Akron 20, Ohio

ALBUQUERQUE-
LOS ALAMOS (7) T. G. Banks, Jr.
1124 Monroe St., S.E.
Albuquerque, N. M.

ATLANTA SEC-
TION (6) K. W. Bugg
Board of Education
14 Floor, City Hall
Atlanta, Ga.

BALTIMORE (3) M. I. Jacob
1505 Tredegar Ave.
Catonsville 28, Md.

BEAUMONT-
PORT ARTHUR (6) John Petkovsek, Jr.
4390 El Paso Ave.
Beaumont, Texas

BINGHAMTON (4) O. T. Ling
100 Henry St.
Binghamton, N. Y.

BOSTON (1) T. P. Cheatham, Jr.
Hosmer St.
Marlborough, Mass.

BUENOS AIRES C. E. Sussenguth
Gral. Urquiza 1914
Florida F.C.N.G.B.M.
Argentina

BUFFALO-
NIAGARA (4) W. L. Kinsell
207 Ridgewood Dr.
Snyder
Buffalo 21, N. Y.

CEDAR RAPIDS
(5) Emil Martin
Collins Radio Company
Cedar Rapids, Iowa

CENTRAL
FLORIDA (6) G. F. Anderson
Radiation Inc.
P. O. Box 'Q'
Melbourne, Florida

CHICAGO (5) J. S. Brown
9829 S. Hoyne Ave.
Chicago 43, Ill.

CINCINNATI (5) W. S. Alberts
6533 Elwynne Dr.
Silverton
Cincinnati 36, Ohio

CLEVELAND (4) W. G. Piwonka
3121 Huntington Road
Cleveland 20, Ohio

COLUMBUS (4) T. E. Tice
2214 Jervis Road
Columbus 21, Ohio

CONNECTICUT
VALLEY (1) B. R. Kamens
45 Brooklawn Circle
New Haven 15, Conn.

DALLAS-FORT
WORTH (6) G. K. Teal
Texas Instruments, Inc.
6000 Lemmon Ave.
Dallas, Texas

DAYTON (5) N. L. Laschever
849 N. Upland Ave.
Dayton, Ohio

DENVER (5) S. Bedford, Jr.
Mountain States Tel. &
Tel.
Room 802
Denver, Colo.

DES MOINES-
AMES (5) W. L. Hughes
Dept. of Elec. Engr'g.
Iowa State College
Ames, Iowa

DETROIT (4) A. L. Coates
1022 E. Sixth Street
Royal Oak, Michigan

ELMIRA-COR-
NING (4) J. P. Hocker
Pilot Plant No. 2
Corning Glass Works
Corning, N. Y.

Chairman

J. F. Stuart
Box 991
El Paso, Texas

E. H. Boden
R. D. 1
Emporium, Pa.

A. P. Haase
2230 St. James Ct.
Owensboro, Ky.

J. J. Iffland
2603 Merivale St.
Kirkwood Park
Ft. Wayne 8, Ind.

G. M. Cox
154 Victoria St., S.
Kitchener, Ont., Canada

G. W. Clark
Box 193
Lanikai, Oahu, T. H.

W. J. Greer
Halliburton Oil Well &
Cementing Co.
1628 Old Spanish Trail
Houston 25, Texas

D. E. French
1403 E. Clinton St.
Huntsville, Ala.

J. T. Watson
1515 Central Ave.
Indianapolis 2, Ind.

G. D. Warr
213-A Wasp Rd.
China Lake, California

Franz Ollendorf
Box 910
Hebrew Inst. of Tech.
Haifa, Israel

Ben Warriner
General Electric Co.
Advanced Electronics
Center
Ithaca, N. Y.

K. V. Newton
Bendix Aviation Corp.
Box 1159
Kansas City 41, Mo.

Raymond Beem
Route 3
Malvern, Ark.

J. H. Blackwell
863 Colborne St.
London, Ont., Canada

W. F. Bailey
Hazeltime Corp.
58-25 Little Neck Pkwy.
Little Neck, N. Y.

B. S. Angwin
3300 Colby Ave.
Los Angeles, Calif.

R. W. Mills
1017 Eastern Pkwy.
Louisville 4, Ky.

C. S. Clemans
Station WSWN
Belle Glade, Florida

W. E. Watts
2224 N. 70 St.
Wauwatosa 13, Wis.

R. W. Cooke
18 Muir Road
Senneville, P.Q., Canada

L. J. N. Du Treil
202 Homedal Ave.
New Orleans 24, La.

A. B. Giordano
85-99 Livingston St.
Brooklyn 2, N. Y.

G. B. Hoadley
North Carolina State Coll.
Raleigh, N. C.

F. A. Polkinghorn
63 Monroe Pl.
Bloomfield, N. J.

EL PASO (7) W. T. McGill
7509 Mazatlan Road
El Paso, Texas

EMPORIUM (4) H. S. Hench, Jr.
R. D. 2
Emporium, Pa.

EVANSVILLE-
OWENSBORO (5) D. D. Mickey, Jr.
Engineering Department
General Electric Co.
Owensboro, Ky.

FORT WAYNE (5) T. L. Slater
1916 Eileen Dr.
Waynedale, Ind.

HAMILTON (8) A. L. Fromanger
Box 507
Ancaster, Ont., Canada

HAWAII (7) J. R. Sanders
c/o Matson Navigation
Co.
Box 899
Honolulu, T. H.

HOUSTON (6) R. S. Bush
3818 Alberta Ave.
Houston 21, Texas

HUNTSVILLE (6) T. L. Greenwood
1709 LaGrande St.
Huntsville, Ala.

INDIANAPOLIS (5) M. J. Arvin
4329 Fletcher Ave.
Indianapolis 1, Ind.

INYOKERN (7) B. B. Jackson
54-B Rowe St.
China Lake, California

Israel J. H. Halberstein
P.O. B. 1
Kiriath Mozkin, Israel

ITHACA (4) R. L. Wooley
110 Cascadilla St.
Ithaca, N. Y.

KANSAS CITY (5) Mrs. G. L. Curtis
Radio Industries, Inc.
1307 Central Ave.
Kansas City 2, Kan.

LITTLE ROCK (5) D. L. Winn
10 & Spring Sts.
Little Rock, Ark.

LONDON (8) J. D. B. Moore
27 McClary Ave.
London, Ont., Canada

LONG ISLAND (2) P. G. Hansel
Addison Lane
Greenvale, L. I., N. Y.

LOS ANGELES (7) C. E. Rutherford
209 S. Oakhurst Dr.
Beverly Hills, Calif.

LOUISVILLE (5) L. A. Miller
314 Republic Bldg.
Louisville 2, Ky.

MIAMI (6) H. F. Bernard
3670 S. W. Ninth Terrace
Miami 34, Florida

MILWAUKEE (5) W. A. Van Zeeland
4510 N. 45 St.
Milwaukee 16, Wis.

MONTREAL (8) F. H. Margolick
Canadian Marconi Co.
2442 Trenton Ave.
Montreal, Que., Canada

NEW ORLEANS
(6) J. A. Cronvich
Dept. Elec. Engineering
Tulane University
New Orleans 18, La.

NEW YORK (2) H. S. Renne
366 Madison Ave.
New York 17, N. Y.

NORTH
CAROLINA-
VIRGINIA (3) M. J. Minor
Route 3, York Rd.
Charlotte, N. C.

NORTHERN
NEW JERSEY (2) B. G. Griffith
127 Park Ave.
Verona, N. J.

* Numerals in parentheses following Section designate Region number.

Sections

Chairman

G. W. Holt
4420 N.W. 19 Blvd.
Oklahoma City 7, Okla.

M. L. McGowan
5544 Mason St.
Omaha 6, Neb.

W. A. Cumming
Radio & Elec. Eng. Div.
National Research Council
Ottawa, Ont., Canada

S. C. Spielman
Philco Corp.
4700 Wissahickon Ave.
Philadelphia, Pa.

P. W. Sokoloff
1113 E. Oregon Ave.
Phoenix, Ariz.

F. C. Alexander, Jr.
2824 Mt. Royal Blvd. &
Sutter Road
Glenshaw, Pa.

Howard Vollum
1000 N.W. Skyline Blvd.
Portland, Ore.

Jerome Kurshan
RCA Labs.
Princeton, N. J.

Allan Holstrom
551 Spencer Rd.
Rochester 9, N. Y.

Harry Davis
716 Cherry St.
Rome, N. Y.

I. L. Dutton
5980 N. Haven Dr.
North Highlands, Calif.

M. E. Van Valkenburg
Dept. of Elec. Eng.
University of Utah
Salt Lake City 1, Utah

Secretary

W. E. Lucey
1348 Kinkaid Ave.
Oklahoma City, Okla.

C. W. Rook
Dept. Elec. Engineering
University of Nebraska
Lincoln 8, Neb.

C. F. Pattenson
3 Braemar
Ottawa 2, Ont., Canada

M. S. Corrington
12 E. Cottage Ave.
Haddonfield, N. J.

Everett Eberhard
30 E. Colter St.
Phoenix 43, Ariz.

K. A. Taylor
Bell Tel. Co. of Pa.
416 Seventh Ave.
Pittsburgh 19, Pa.

R. R. Pooley
Radio Station KPOJ
Box 31
Portland 7, Ore.

J. L. Potter
Rutgers University
New Brunswick, N. J.

W. F. Bellor
186 Dorsey Road
Rochester 16, N. Y.

M. V. Ratynski
205 W. Cedar St.
Rome, New York

Ewald Berger
3421-58 St.
Sacramento 20, Calif.

A. E. Lennert
5507 Waterman Ave.
St. Louis 12, Mo.

A. L. Gunderson
3906 Parkview Dr.
Salt Lake City, Utah

Chairman

C. M. Crain
Engineering Bldg. 149
University of Texas
Austin, Texas

F. X. Byrnes
1759 Beryl Street
San Diego 9, California

A. J. Morris
1827 Cordilleras Road
Redwood City, Calif.

R. E. Anderson
638 Brandywine Ave.
Schenectady, N. Y.

A. E. Harrison
Elect. Engr'g. Dept.
University of Washington
Seattle 5, Wash.

W. H. Hall
General Electric Co.
Syracuse, N. Y.

L. S. Rynder
140 Rockingham St.
Toledo 10, Ohio

E. L. Palin
2137 Bayview Ave.
Willowdale
Toronto, Ont., Canada

C. F. Hadley
1356 E. 45 Pl.
Tulsa 15, Okla.

F. S. Hird
Northwestern Bell Tel.
Co.
224 S. Fifth St.
Minneapolis, Minn.

M. Green
North-West Tel. Co.
2226 W. Tenth Ave.
Vancouver, B.C., Canada

T. B. Jacocks
General Electric Co.
777-14 St., N.W.
Washington, D. C.

J. E. Snook
1629 Warren Ave.
Williamsport, Pa.

Haakon Haakonsen
University of Manitoba
Dept. of E.E.
Fort Garry, Man., Canada

Secretary

SAN ANTONIO (6) W. H. Hartwig
Dept. of Elec. Engr.
University of Texas
Austin 12, Texas

SAN DIEGO (7) R. T. Silberman
4635 Edgeware Road
San Diego, California

SAN FRANCISCO (7) J. S. McCullough
1791 Willow St.
San Jose 25, Calif.

SCHENECTADY (2) J. S. Hickey, Jr.
General Electric Co.
Research Lab.
Schenectady, N. Y.

SEATTLE (7) R. H. Hoglund
1825 E. Lynn St.
Seattle 2, Wash.

SYRACUSE (4) M. A. Johnson
R.D. 1, Totman Road
East Syracuse, N. Y.

TOLEDO (4) L. R. Klopfenstein
Portage,
Ohio

TORONTO (8) F. J. Heath
830 Lansdowne Ave.
Toronto 4, Ont., Canada

TULSA (6) L. H. Hooker
4064 E. 22 Pl.
Tulsa 5, Okla.

TWIN CITIES (5) J. L. Hill
25-17 Avenue, N.E.
North St. Paul 9, Minn.

VANCOUVER (8) J. S. Gray
4069 W. 13 Ave.
Vancouver, B.C., Canada

WASHINGTON (3) R. I. Cole
2208 Valley Circle
Alexandria, Va.

WILLIAMSPORT (4) F. T. Henry
1345 Pennsylvania Ave.
Williamsport, Pa.

WINNIPEG (8) G. R. Wallace
400 Smithfield Ave.
Winnipeg, Man., Canada

Subsections

Chairman

R. B. Spear
510 E. Hill St.
Brownfield, Texas

S. C. Leonard
Cheshire
Mass.

E. C. Sternke
Route 2, Box 122
Camarillo, Calif.

R. V. Higdon
1030 S. Atherton St.
State College, Pa.

W. L. Schachte
152 Grove St.
Charleston 22, S. C.

J. L. Corl
622 Rincon Road
Richmond 11, Calif.

A. R. Davidson
3422 Argyle Ave.
Erie, Pa.

G. W. Scott, Jr.
Research Labs.
Armstrong Cork Co.
Lancaster, Pa.

E. J. Breiding
54 S. Grand Ave.
Poughkeepsie, N. Y.

Secretary

J. B. Joiner
2621-30 St.
Lubbock, Texas

W. E. Neubert
21 Highlawn Dr.
Pittsfield, Mass.

O. LaPlant
325 North 'J' St.
Oxnard, Calif.

W. L. Baker
1184 Oneida St.
State College, Pa.

Arthur Jonas
21 Madden Dr.
Dorchester Terr.
Charleston Heights, S. C.

R. D. Ogg
48 Arlington Ave.
Berkeley 8, Calif.

K. L. Hestor
2909 Tuttle Ave.
Erie, Pa.

G. E. Mandell
522 East King St.
Lancaster, Pa.

E. S. Wilson
I.B.M. Corp.
Engineering Lab.
Poughkeepsie, N. Y.

Chairman

W. M. Goodall
Bell Telephone Labs.
Box 107
Red Bank, N. J.

K. L. Huntley
Mary Esther
Fla.

B. F. Husten
Naval Ord. Lab.
Corona, Calif.

J. V. Granger
320 Encinal Ave.
Menlo Park, Calif.

I. M. Jacobs
1322 Birch
Richland, Washington

W. V. Record
4511 E. Ninth St.
Tucson, Ariz.

L. A. Yarbrough
Box 3001, USAFIT
Wright-Patterson AFB
Ohio

H. G. Swift
1642 South Main
Wichita, Kan.

Secretary

MONMOUTH (2) A. H. Ross
(New York) 923 Broad St.
Shrewsbury, N. J.

NORTHWEST G. C. Jones
FLORIDA (6) 12 N. Okaloosa Road
(Atlanta) Fort Walton Beach, Fla.

ORANGE BELT T. A. Mayeda
(7) 3658 Monroe St.
(Los Angeles) Riverside, Calif.

PALO ALTO (7) W. B. Wholey
(San Francisco) 342 Verano Dr.
Los Altos, Calif.

Pasadena (7)
(Los Angeles)
(To be elected)

RICHLAND (7) W. G. Spear
(Seattle) 1519 McPherson
Richland, Washington

TUCSON (7) A. J. Bersbach
(Phoenix) 5326 E. Seventh St.
Tucson, Ariz.

USAFIT (5) J. J. Gallagher
(Dayton) Box 3482 USAFIT
Wright-Patterson AFB
Ohio

WICHITA (5) V. N. Johnson
(Kansas City) 1652 S. Edgemoor
Wichita 17, Kan.

Abstracts and References

Compiled by the Radio Research Organization of the Department of Scientific and Industrial Research, London, England, and Published by Arrangement with that Department and the *Wireless Engineer*, London, England

NOTE: The Institute of Radio Engineers does not have available copies of the publications mentioned in these pages, nor does it have reprints of the articles abstracted. Correspondence regarding these articles and requests for their procurement should be addressed to the individual publications, not to the IRE.

Acoustics and Audio Frequencies	386
Antennas and Transmission Lines	386
Automatic Computers	388
Circuits and Circuit Elements	388
General Physics	390
Geophysical and Extraterrestrial Phenomena	391
Location and Aids to Navigation	392
Materials and Subsidiary Techniques	392
Mathematics	395
Measurements and Test Gear	395
Other Applications of Radio and Electronics	396
Propagation of Waves	397
Reception	397
Stations and Communication Systems	398
Subsidiary Apparatus	398
Television and Phototelegraphy	398
Transmission	399
Tubes and Thermionics	399

The number in heavy type at the upper left of each Abstract is its Universal Decimal Classification number and is not to be confused with the Decimal Classification used by the United States National Bureau of Standards. The number in heavy type at the top right is the serial number of the Abstract. DC numbers marked with a dagger (†) must be regarded as provisional.

U.D.C. CHANGES

In anticipation of a new edition of the Universal Decimal Classification Abridged English Edition (BS 1000 A), certain changes in U.D.C. numbers will be made in this and subsequent issues. The new numbers used will be:

Radio astronomy: 523.16

Ultrasonics: 534 subdivisions with the special analytical subdivision -8 attached.

Sound recording and reproducing: 534.85
Electroacoustic problems, transduction, etc.: 534.86.

ACOUSTICS AND AUDIO FREQUENCIES

- 534.121.1 **311**
Excitation of Flexural Vibrations in Metallic Plates using Polycrystalline Barium Titanate—I. S. Zheludev. (*Zh. tekh. Fiz.*, vol. 24, pp. 1467-1473; August, 1954.) Production of Chladni's figures with square Fe, Al and duralumin plates is described. The BaTiO₃ powder is fixed in a given pattern in an adhesive between the plate and appropriately shaped foil electrodes, and is then polarized. The observed frequencies of vibration are in good agreement with values calculated from the Ritz formula; frequencies between 450 cps and 20.3 kc were produced.
- 534.213.4 **312**
A New Method of Computing Acoustical Filters—W. K. R. Lippert. (*Acustica*, vol. 4, no. 4, pp. 411-420; 1954.) Filters consisting of n equal sections, with nonreflecting output duct, are considered. Each section consists of an input and output duct of uniform cross section with a discontinuity between them. For loss-free filters, the characteristic transmission and reflection factors may be expressed in terms of B and β , where the transmission factor for a single section is $T = Be^{i\beta}$. Graphs are drawn for the corresponding quantities for 2,

The Index to the Abstracts and References published in the PROC. I.R.E. from February 1954 through January 1955 is published by PROC. I.R.E. as Part 2 of the April, 1955 issue. It is also published by *Wireless Engineer* and included in the March 1955 issue of that journal, which may be purchased for \$1 (including postage) from the Institute of Radio Engineers, 1 East 79th Street, New York 21, N. Y. Included with the Index is a selected list of journals scanned for abstracting with publishers' addresses.

3 and 4 sections. Measured and computed values for a filter with two rectangular bends, i.e. with two sections, are in satisfactory agreement. The characteristic factors for a filter with a reflecting output duct or with dissimilar sections may be derived from the fundamental case.

534.232:538.652 **313**
Some Remarks on the Analysis of Magnetostrictive Transducers—H. Nødtvedt. (*Acustica*, vol. 4, no. 4, pp. 432-438; 1954.) From the energy conditions in the system, an expression for the coupling coefficient is derived and used in plotting a curve of coupling-coefficient/polarizing-field for a Ni rod. Equivalent circuits of the rod are considered, and the analysis of either the admittance or impedance diagrams is shown to give the transducer operational parameters.

534.24-14 **314**
Radiation Pressure in Fluids—J. Mercier. (*Acustica*, vol. 4, no. 4, pp. 441-446; 1954. In French.) Radiation pressure is treated as a vector quantity equal to the product of the excess pressure and the velocity of displacement of a section of a plane wave. In the case of reflection from an obstacle, it must be calculated separately for incident and reflected waves. The cases of plane waves in an absorbent medium and spherical waves are also considered.

534.833.4 **315**
Sound Transmission through Spherical Bosses—A. Bergassoli, F. Canac and T. Vogel. (*Acustica*, vol. 4, no. 4, pp. 403-405; 1954. In French.) The frequency response curves for sound transmitted through (a) a hollow spherical boss, and (b) a disk having the same base dimensions were obtained. One plexiglass and three Al bosses were used, with different radii of curvature and/or heights. Sound insulation is considerably improved at frequencies below 1,000 cps by using a boss. Simple theory can account fairly well for these results.

534.844 **316**
The Acceptability of Artificial Echoes with Reverberant Speech and Music—A. F. B. Nickson, R. W. Muncey and P. Dubout. (*Acustica*, vol. 4, no. 4, pp. 447-450; 1954.) An artificial echo of adjustable intensity level and delay was added to speech and music signals. The subjectively determined acceptable-echo-level/delay relation is dependent on (a) the Haas effect (*Acustica*, vol. 1, pp. 49-58; 1951) for delay times up to 50 ms, (b) natural echoes in the recording room for the next few hundred milliseconds, and (c) the dynamic range of the program material for longer delay times.

534.86 **317**
Facilities for the Sound Recording and Observation of Interviews—G. F. Mahl, J. Dollard and F. C. Redlich. (*Science*, vol. 120, pp. 235-239; August 13, 1954.) The special conditions to be considered in relation to the recording of psychotherapeutic interviews are discussed. An installation at Yale University comprises a suite of two interviewing rooms with individual control rooms, and a waiting room forming a sound lock. Details are given of the low-noise air-conditioning system. A diaphragm-blanket acoustic treatment renders the sound natural although the rooms are quiet.

621.395.623.7 **318**
Loudspeakers and Enclosures—(*Audio*, vol. 38, pp. 27-28, 55; August, 1954.) A comprehensive survey, in simple terms, of the construction and operation of modern loudspeakers, including baffles and combination systems.

621.395.623.743 **319**
Electrostatic Speaker accents High Frequencies—M. Hobbs. (*Electronics*, vol. 27, pp. 143-145; November, 1954.) A loudspeaker for the range 7-15 kc comprises a stiff curved perforated copper-backed plate mounted rigidly with a gold-sprayed styroflex or polyethylene foil stretched over it, the capacitor thus constituted has a capacitance of about 4 μ mf. A polarizing voltage of the order of 250 v is required. The arrangement provides an economical design for radio receivers, used in conjunction with a cone loudspeaker for the lower frequencies.

621.395.625.3 **320**
New Portable Magnetic Recorder Type R85 for Commentaries—K. E. Gondesep. (*Tech. Hausmitt. Nordw.Dtsch. Rdfunks*, vol. 6, nos. 5/6, pp. 127-132; 1954.) The electrically driven recorder, amplifier unit and batteries are combined in a suitcase model weighing about 10 kg. The tape runs at 19 cm and reverses mechanically. One amplifier deals with recording and erasing, a separate one with reproduction and modulation control. A spool runs for 30 minutes and the accumulator which drives the motor permits continuous operation for four hours.

ANTENNAS AND TRANSMISSION LINES

621.315.212:621.372.51:621.396.67 **321**
New Antenna Coupler for U.H.F. Circuits—R. I. Stainbrook. (*Tele-Tech*, vol. 13, pp. 86-88, 181; August, 1954.) Coupling units for the 230-390-mc frequency band comprising cut-away coaxial-line sections are described. These couplers, when arranged in groups of 2-6 units, provide a system in which 2-6 transmitters, re-

ceivers and/or transmitter-receivers can operate simultaneously on a single antenna. The insertion loss for each one of a 6-unit group is 0.66 db.

621.372.2+621.372.8 322

The Transformation Properties of Lossless Six-Terminal Networks between Homogeneous Transmission Lines, their Representation by a Six-Terminal-Network Surface and their Significance in Measurement Technique—H. Lueg. (*Arch. elekt. Übertragung*, vol. 8, pp. 331-340; August, 1954.) The transfer characteristics of a six-terminal network representing a waveguide junction are derived by a matrix treatment and a three-dimensional surface is constructed, projection of which on to an appropriate plane gives the position of a voltage node on the input line as a function of the location of short circuits on the other two lines. Using the double-short-circuit technique [2850 of 1954 (Weissfloch)] input impedance can be determined directly by plotting a single curve. Power distribution between the outputs is dealt with and a method of determining parameter values for the equivalent circuits is illustrated.

621.372.2 323

The "Unit" Treatment of Impedance Irregularities and its Application to Long Lines—A. Rosen. (*Proc. IEE*, part IV, vol. 101, pp. 271-289; August, 1954. Digest, *ibid.*, part III, vol. 101, pp. 349-356; September, 1954.) Line irregularities are studied by a statistical method alternative to that based on correlation theory. It is assumed that the irregularities are built up of units each of which has a characteristic form; this may be produced by one independent physical factor operating over its own characteristic distance, but the amplitudes of the resulting unit irregularities occurring at different places along the line may be different, each being independent of any other. The length of the unit irregularity is assumed to be small compared with the length of the line, so that the attenuation over this length can be neglected. The procedure is to assemble a family of lines in which the amplitudes of the units are distributed at random and in which the units can occupy all positions with equal probability; the mean and mean-square values of the reflection and transmitted-echo coefficients for this family are calculated. The method is used to examine the effects of line irregularities on wide-band telephony and television transmissions. Results indicate that while the smoothness of the input-impedance/frequency characteristic is a suitable criterion for the regularity of coaxial-cable sections for telephony, this should be supplemented by pulse-reflection observations if the cable is intended for television. See also 1295 and 1668 of 1954.

621.372.2 324

Lower Modes of a Concentric Line having a Helical Inner Conductor—L. Stark. (*Jour. Appl. Phys.*, vol. 25, pp. 1155-1162; September, 1954.) Analysis is presented using cylindrical coordinates, the helix being assumed for convenience to have the form of an infinitely thin tape. Closed expressions are derived for the propagation factors of some of the lower modes. Numerical results are presented for a system with typical geometry.

621.372.2 325

Directional Electromagnetic Couplers—B. M. Oliver. (*Proc. I.R.E.*, vol. 42, pp. 1686-1692; November, 1954.) General theory is given for the directional coupling action of ordinary transmission lines. Simple transmission-line couplers for the 1-mc-1-kmc band are discussed; the transmission characteristic is controlled by varying the coupling along the lines. An arrangement of four wires, or two wires and ground, is described which can serve simultaneously as directional coupler, filter and transformer.

621.372.2+538.566]:621.3.012 326

New Chart for the Solution of Transmission-Line and Polarization Problems—G. A. Deschamps. (*Elec. Commun.*, vol. 31, p. 188; September, 1954.) Addendum to 965 of 1954, acknowledging earlier work by Steiner (1361 of 1947).

621.372.2.029.6 327

Contribution on the Physics of the Multi-layer Transmission Line—W. Wild, H. Larsen and W. Ebel. (*Arch. elekt. Übertragung*, vol. 8, pp. 346-352; August, 1954.) A laminated coaxial line with five conducting layers is treated as four elementary pairs each of which is coupled to its neighbors by the impedance of the common conducting lamina. Taking account of this coupling, and assuming a uniform propagation coefficient, analysis shows that (a) resistive losses are low, since each conductor carries only the difference of the transmission currents of two adjacent pairs; (b) towards the center of the stack of laminae these transmission currents increase steadily while the conductor currents tend to zero. This result is generalized to apply to any number of layers; the coupling impedance greatly affects the magnitude and frequency characteristic of the line attenuation. Methods of coupling a laminated line to a two-wire system are briefly considered.

621.372.2.029.6 328

Input and Output Couplings for Coaxial Laminated Transmission Lines—H. Kaden and H. E. Martin. (*Arch. elekt. Übertragung*, vol. 8, pp. 387-403; September, 1954.) An examination is made of the energy loss due to mode conversion when a laminated line is excited by coupling it to a coaxial line. For a laminated line without metal core this loss is reduced to a minimum value of 0.064 N by making the radius of the inner conductor of the coaxial line 26.8 per cent and the inner radius of the outer conductor of the coaxial line 91.7 per cent of the radius of the laminated line. For a laminated line with metal core and radius ratio 3.65 the corresponding values are 0.0503 N, 39.8 per cent and 92.7 per cent. If in addition losses due to reflections at the junctions are eliminated by inserting transforming sections, total coupling loss at sending and receiving ends can be reduced to 0.128 N and 0.106 N respectively. The mode conversion losses can be further reduced by applying different potentials to the laminations; the design of networks for supplying these potentials is discussed.

621.372.8 329

Reciprocity Theorem applied to Waveguide Junctions with Elliptical Polarization—G. Pircher. [*Compt. Rend. Acad. Sci. (Paris)*, vol. 239, pp. 694-696; September 20, 1954.] Matrix analysis is presented based on consideration of the combined effects, at a reference plane in each waveguide arm, of the waves traveling towards and reflected from the junction, each of which can be represented either by a pair of orthogonal linearly polarized components, or by a pair of components with opposite directions of rotation.

621.372.8 330

An Estimation of the Discontinuities introduced by Flange Couplings in Rectangular Waveguides—R. B. Nicholls. (*Elliott Jour.*, vol. 2, pp. 140-143; August, 1954.) From measurements made with couplings displaced abnormally sideways and with relatively large gaps left between flanges, theoretical predictions can be checked and the effects of smaller discontinuities estimated. Transverse displacements and twists occurring in flanged guides made to present dimensional tolerances are found to be of minor significance, but even small gaps (e.g. 0.001 inch at 3 cm λ) may give rise to serious reflections.

621.372.8 331
Propagation of Electromagnetic Waves

over Plane Surface with Anisotropic Homogeneous Boundary Conditions—M. A. Miller [*Compt. Rend. Acad. Sci. (URSS)*, vol. 87, pp. 571-574; December 1, 1952. In Russian.] The surfaces considered are corrugated waveguides consisting of an assembly of thin parallel metal strips mounted on a metal base with or without guiding walls, as described by Rotman (33 of 1952). The dependence of the propagation modes on the ratio of surface reactance components is discussed.

621.372.8:621.318.134 332

Propagation of Transverse Electric (TE) Waves in a Waveguide containing Ferrites—A. Chevalier and E. Polacco. [*Compt. Rend. Acad. Sci. (Paris)*, vol. 239, pp. 692-693, September 20, 1954.] Analysis is presented for the TE_{m0} mode propagated in a rectangular waveguide with an applied magnetic field perpendicular to the direction of propagation and parallel to the guide thickness.

621.396.67:621.372.8 333

Application of Homogeneous Boundary Conditions in the Theory of Thin Aerials—M. A. Miller. (*Zh. Tekh. Fiz.*, vol. 24, pp. 1483-1495; August, 1954.) Theory of thin antennas and of slot radiators is applied to the case of antennas with given homogeneous anisotropic boundary conditions of the type $E_z + Z_1 H_z | \Sigma$, $E_z = -Z_2 H_z | \Sigma$ where Z_1 and Z_2 are different complex impedances which can be considered as components of the tensor of surface impedance Z ; z and \bar{z} are orthogonal coordinates on the surface of the antenna Σ . Such boundary conditions can be formulated for the interface of two media if the structure of the field in one medium is known and is independent of the structure of the field in the other medium (331 above). The formulas derived are applied to the case of a disk-loaded cylindrical waveguide-section, the dimensions of the disks being small compared with λ , and to a rectangular corrugated waveguide element in the form of a short trench.

621.396.673 334

The Characteristics of a Vertical Antenna with a Radial Conductor Ground System—J. R. Wait and W. A. Pope. (*Appl. Sci. Res.*, vol. B4, no. 3, pp. 177-195; 1954.) An approximate method is presented for calculating the input impedance; graphical methods are used in evaluating integrals involved in the solution. Results are plotted to show the dependence of the impedance on the number and length of the radial conductors for given frequency, antenna height and ground conductivity. The presence of the ground system modifies the radiated fields by only a few parts in a hundred under usual conditions. Calculated values for a 250-foot mast are in good agreement with experimental results for operation at 100 kc.

621.396.676:621.396.93 335

Ultra-High-Frequency Omnidirectional Antenna Systems for Large Aircraft—W. Sichak and J. J. Nail. (*Elec. Commun.*, vol. 31, pp. 202-213; September, 1954.) Reprint. See 2568 of 1954.

621.396.677 336

On the Optimum Illumination Taper for the Objective of a Microwave Aerial—J. W. Crompton. (*Proc. IEE*, part III, vol. 101, pp. 371-382; November, 1954.) "The Fourier-transform description of the radiation pattern from an aperture is used to obtain curves relating to over-all gain of an idealized antenna system, comprising an objective and waveguide flare, with the size and illumination of the aperture of the latter. For rectangular objectives the dimensions of the aperture of the flare may be varied independently in the two planes of symmetry and the over-all gain obtained by multiplying together the gain factors for the distributions across the objective in these two planes. In the case of the circular

objective this no longer applies, but curves are drawn showing the variation of the gain of the system as the size of a symmetrical feed is varied by equal amounts in the two planes of symmetry. It is shown that maximum over-all gain is obtained with a rectangular objective when the size of the feed is adjusted to give a primary pattern such that the illumination intensity at the edges of the objective is $8\frac{1}{2}$ db below that at the center. The corresponding optimum taper for circular objectives is $11\frac{1}{2}$ db. Primary radiation-patterns are drawn for 'constant,' 'cosine' and 'double-cosine' illuminations of the feed aperture. The variations of secondary beam-widths and first side-lobe levels with feed size for rectangular and circular objectives are discussed."

621.396.677.32 337
Resonance in a System of Coupled Vibrators and Tuning of "Wave-Channel" Aerials—D. M. Vysokovski. [*Compt. Rend. Acad. Sci. (URSS)*, vol. 97, pp. 659-662; August 1, 1954. In Russian.] The calculation of the mean length of the director elements of this Yagi-type antenna to give maximum directivity is considered for the case of weak coupling between the elements, which are spaced at $\lambda/3$. The useful range of element lengths is from about 0.46λ , which is optimum for one director, to about 0.41λ , which is optimum for 20.

621.396.677.71.012.12 338
Polar Diagrams of Plane Slot Aerials—G. N. Kotschershevski. (*NachrTech.*, vol. 4, pp. 272-274; June, 1954.) A vertical $\lambda/2$ slot in a plane screen with dimensions of the order of one wavelength is considered as a magnetic dipole and an approximate expression is derived for the current density distribution in the horizontal plane. Polar diagrams are constructed for the equatorial horizontal plane for radiation (a) on one side only and (b) on both sides of the slot; these agree closely with experimental results.

621.396.677.833.2:535.42:538.566 339
On the Radiation Pattern of a Paraboloid of Revolution—J. P. Schouten and B. J. Beukelman. (*Appl. Sci. Res.*, vol. B4, no. 3, pp. 137-150; 1954.) The pattern is determined using the form of Huyghens' principle in which the field intensities in a given domain are expressed in terms of their tangential components on the boundary. Expressions involving infinite series of Bessel functions are obtained for the intensities of the distant field when an electric dipole is placed at the focus.

AUTOMATIC COMPUTERS

681.142 340
A New German Differential Analyser for Differential Equations—A. Walther. (*Z. Ver. Dtsch. Ing.*, vol. 96, pp. 755-758; August 1, 1954.) A mechanical instrument built for the Institute of Applied Mathematics, University of Bonn, and comprising 8 integrators.

681.142 341
A Curve Analyzer and General-Purpose Graphical Computer—C. S. French, G. H. Towner, D. R. Bellis, R. M. Cook, W. R. Fair and W. W. Holt. (*Rev. Sci. Instr.*, vol. 25, pp. 765-775; August, 1954.) The analog computer described comprises five photoelectric curve followers, two integrators, nine adding amplifiers and a pen recorder. The independent variable is represented by a low alternating voltage increasing linearly with time; the form of the equation is determined by the connections between the units, and the values of constants are set by potentiometers.

681.142 342
Harmonic Cancellation from Computing Voltage Source in Servo Analogue Computers—J. Alman. [*Elec. Eng. (N.Y.)*, vol. 73, pp. 711-713; August, 1954.] Analysis showing how harmonics of the carrier can be canceled out in the summing network of the servo amplifier

by injecting appropriate harmonic signals into the quadrature rejection circuit. The analysis is valid for very small phase shift. The system is advantageous when harmonics cannot be sufficiently attenuated by filters.

681.142 343
Some Comparisons between Analogue and Digital Computers—W. E. Scott and A. C. D. Haley. (*Jour. Brit. IRE*, vol. 14, pp. 476-486; October, 1954.) The uses of analog and digital computers in industry are discussed and a large-scale machine of each class is described briefly.

681.142 344
Electronic Computers and Industrial Mathematics—B. D. Dagnall and R. L. Michaelson. (*Jour. Brit. IRE*, vol. 14, pp. 487-496; October, 1954.) The mode of operation of a high-speed digital computer is described in functional terms; programming procedure is illustrated in relation to typical applications.

681.142 345
The Application of Electronic Digital Calculating Methods to Punched Card Machines—J. H. Lucas. (*Jour. Brit. IRE*, vol. 14, pp. 497-503; October, 1954.) Principles of operation and design of the "Electronic Multiplying Punch" are discussed. An outline is given of the calculating process used for sterling and for decimal systems.

681.142:621.314.63 346
Welded Joints on Diodes reduce Computer Bulk—S. G. Lutz. (*Electronics*, vol. 27, pp. 154-158; November, 1954.) Diode-mounting methods are discussed taking up the least possible space while affording adequate accessibility. By using spot welding, the diode leads can be shortened to $<1/4$ inch. An elongated matrix and a honeycomb arrangement accommodating up to 128 diodes/in² are among the alternatives described.

681.142:621.385.012 347
Making Use of Curved Characteristics for the Higher Types of Calculation in Electronic Computers—H. Harmuth. (*Acta Phys. austriaca*, vol. 8, pp. 332-337; July, 1954.) Where errors up to a few per cent are permissible, deliberate use can be made of the curvature of tube characteristics in analog computers. Circuits for multiplying, dividing, squaring and obtaining square roots are discussed.

681.142:621.385.832 348
The Design of an Electrodynamical Multiplier—E. M. Deeley. (*Proc. IEE*, part IV, vol. 101, pp. 187-191; August, 1954. Digest, *ibid.*, part II, vol. 101, pp. 344-345; June, 1954.) Development of a design described earlier [1977 of 1949 (Deeley and Mackay)] for use in a differential analyzer.

CIRCUITS AND CIRCUIT ELEMENTS

621.3.015.3:621.316.5 349
The Suppression of Switching Transients by a Shunt RC Circuit—E. A. Finlay. (*Proc. IEE*, part IV, vol. 101, pp. 266-270; August, 1954. Digest, *ibid.*, part II, vol. 101, pp. 575-576; October, 1954.) A detailed analysis is presented of the phenomena occurring when apparatus including shunt capacitance is suddenly switched across a low-impedance source of power through a short transmission line; conditions for the transient voltage in the shunt RC damping circuit to be nonoscillatory are deduced. It is proved that the current through the switch can be made unidirectional. Numerical illustrations are given.

621.3.018.75:621.387.4 350
Fast Single-Channel Pulse Amplitude Analyser—W. L. Buys. (*Jour. Phys. Radium*, vol. 15, p. 582; July/September, 1954.) Designed for use with proportional or scintillation counters, the equipment has a channel-edge

position stable to within $\pm 0.02v$ under operation for periods up to 10 hours.

621.3.018.75:621.387.4 351
Description of a Recording Instrument—P. Desneiges and A. Pages. (*Onde élect.*, vol. 34, pp. 700-704; August/September, 1954.) The recorder was designed for operation with the pulse analyzer described by Guillon (39 of February). It has 25 channels each comprising a decade counter and em register; one unit is recorded in the n th channel for every train of n pulses. Details are given of circuits and operation.

621.3.066.6 352
Migration of Material in Silver and Platinum Contacts—E. Holm and R. Holm. (*Z. angew. Phys.*, vol. 6, pp. 352-361; August, 1954.) An experimental investigation of deformation caused exclusively by the passage of current.

621.314.2 353
Component Design Trends—Iron-Core Transformers run Smaller and Hotter—F. Rockett. (*Electronics*, vol. 27, pp. 136-142; November, 1954.) A survey of the developments in core materials, coatings and insulating materials and of new construction methods which have in combination made possible a 50 per cent reduction of size of iron-core components over a period of about ten years while permitting operation at much higher temperatures.

621.314.7:[621.373.5+621.375.4] 354
Surface-Barrier-Transistor Measurements and Applications—R. J. Turner. (*Tele-Tech.*, vol. 13, pp. 78-80, 165; August, 1954.) Circuits for determining the transistor characteristics are described and examples of applications taking advantage of the high frequency cut-off of the surface-barrier transistor are given. These include a two-stage video amplifier of bandwidth 3.2 mc and gain 28 db, a bandpass amplifier for 5-55 mc with measured power gain of 12.2 db at 55 mc, a crystal-controlled oscillator delivering 400 μw at 50 mc with an efficiency of 25 per cent, a mixer with a conversion gain, from 55 mc to 5 mc, of 8.6 db, and a nonsaturating flip-flop circuit with rise time 0.07 μs and fall time 0.15 μs .

621.316.8:[621.317.353+621.396.822] 355
New Resistor Voltage-Coefficient Tester—L. A. Rosenthal and A. S. Louis. (*Tele-Tech.*, vol. 13, pp. 62-64, 114; September, 1954.) The variation of resistance with applied voltage is determined from measurements of the third harmonic generated by the resistor on application of a sinusoidal voltage. The basic circuit is described and some experimental results are given. The measurements of resistor noise at af is also briefly described.

621.316.8.029.5 356
The Design of a Radio-Frequency Coaxial Resistor—C. T. Kohn. (*Proc. IEE*, part IV, vol. 101, p. 299; August, 1954.) Discussion on 2019 of 1954.

621.316.84:621.372.221 357
On the Use of Commercial Wire-Wound Resistors in High-Level Video Amplifiers—A. J. Seyler. [*Proc. IRE (Australia)*, vol. 15, pp. 219-227; September, 1954.] By compensating the inherent inductance by means of a parallel RC network, commercial wire-wound resistors can be adapted for use in high-power video amplifiers. Practical arrangements are illustrated and results of measurements are compared with calculated values.

621.316.86+621.316.89]:621.396.822 358
Measurements on Current Noise in Carbon Resistors and in Thermistors—K. M. van Vliet, C. J. van Leeuwen, J. Blok and C. Ris. (*Physica*, vol. 20, pp. 481-496; August, 1954.) Measurements are reported on carbon and similar resistors in the frequency range from 2 cps to

- 1.2 mc, and on negative-temperature-coefficient thermistors between 2 cps and 50 kc. In carbon resistors the current noise is proportional to the square of the current (i) and inversely proportional to approximately the first power of frequency (ν). In thermistors the noise level is lower and the spectrum shows deviations from the $1/\nu$ relation. The spectral density in the part of the spectrum where the $1/\nu$ relation holds is proportional to $i^{1.2}$. This is in agreement with measurements by Brophy (*Jour. Appl. Phys.*, vol. 25, pp. 222-224; February, 1954.)
- 621.318.42** 359
Calculation of Iron-Cored Inductances for Direct Current—P. Ross. (*Rev. gén. élect.*, vol. 63, pp. 551-559; September, 1954.) A method described by Kammerloher (29 of 1949) is used. The position of the maximum is determined corresponding to the optimum gap length for laminations of given shape and size; variation of the maximum with number of ampere-turns is investigated. Examples are worked out.
- 621.319.46** 360
A Fixed Gas-Dielectric Capacitor of High Stability—W. K. Clothier. (*Proc. IEE*, part II, vol. 101, pp. 453-459; August, 1954.) Factors contributing to instability of capacitors are reviewed and design principles are proposed for parallel-plate types suitable for use under laboratory conditions. A 1,000- μf capacitor embodying these principles is described; the performance figures indicate that a considerable gain in stability can be achieved without serious complication in design.
- 621.37/.39.029.4:004.1** 361
Better Audio Specs Needed—N. Grossman. (*Audio*, vol. 38, pp. 36, 38; September, 1954.) The significance is explained of technical terms commonly used in catalogue descriptions of af amplifiers, loudspeakers and af output transformers and a list is given of additional information required for a full technical description of components and apparatus.
- 621.37/.39].029.63/.64** 362
Microstrip Kit—(*Elec Commun.*, vol. 31, p. 214; September 1954.) Note of a commercially available set of microstrip components permitting rapid construction of circuits for operation in the frequency range 1-8 kmc.
- 621.372** 363
A Mathematical Technique for the Analysis of Linear Systems—J. R. Ragazzini and A. R. Bergen. (*Proc. I.R.E.*, vol. 42, pp. 1645-1651; November, 1954.) The technique of the z transformation developed for investigating sampled-data systems [1801 of 1953 (Ragazzini and Zadeh)] is applied to the numerical solution of continuous linear systems. A model of the linear system is devised in which sampling is introduced at some convenient point. A polygonal approximation to the sampled function is reconstructed by means of a holding operator, and the output of the system is computed as a train of pulses.
- 621.372** 364
Properties of some Wide-Band Phase-Splitting Networks—M. Dishal. (*Proc. I.R.E.*, vol. 42, p. 1698; November, 1954.) Errors in the design equations presented by Luck (1614 of 1949) are indicated and alternative methods of deriving the design parameters are mentioned.
- 621.372** 365
The Return-Difference Matrix in Linear Networks—L. Tasny-Tschiasny. (*Proc. IEE*, part IV, vol. 101, pp. 299-300; August, 1954.) Discussion on 662 of 1954.
- 621.372** 366
The Solution of a Certain Differential Equation—E. B. Moullin. (*Proc. IEE*, part IV, vol. 101, pp. 290-299; August, 1954. Digest, *ibid.*, part I, vol. 101, pp. 204-206; July, 1954.) A method of obtaining approximate solutions to a class of nonlinear network problems is discussed. The method was developed in relation to the problem of a capacitor in series with a nonlinear resistor of the SiC type, and its application is illustrated by reference to this problem, the resistor characteristic being assumed cubic and the applied voltage simple harmonic. An exact steady-state solution for this network is unobtainable, but an approximate solution is obtained by choosing the constants in the formula for the voltage across the resistor such that the applied voltage has no third-harmonic component.
- 621.372:512.831** 367
Matrix Analysis of Linear Time-Varying Circuits—L. A. Pipes. (*Jour. Appl. Phys.*, vol. 25, pp. 1179-1185; September, 1954.)
- 621.372.413** 368
On Cavity Resonators with Nonhomogeneous Media—A. Cunliffe, R. N. Gould and K. D. Hall. (*Proc. IEE*, part IV, vol. 101, pp. 215-218; August, 1954. Digest, *ibid.*, part III, vol. 101, pp. 192-193; May, 1954.) "Perturbation theory is used to find the frequencies of oscillation and Q -factors of a cavity containing a medium for which the permittivity and the permeability are arbitrary functions of position. The theory is applied to an H_{011} cylindrical cavity containing a disc of dielectric which does not extend over the complete cross section of the cavity."
- 621.372.413:530.145** 369
Quantum Effects in the Interaction between Electrons and High-Frequency Fields: Part 1.—I. R. Senitzky. (*Phys. Rev.*, vol. 95, pp. 904-911; August 15, 1954.) The problem of determining at what frequency quantum-mechanical effects become apparent is approached by analyzing the velocities of electrons after passage through a cavity resonator. From the formulas derived a calculation is made of the ratio of (minimum possible mean-square deviation of velocity) to (velocity increment due to the field). Assuming the volume of the cavity to be of the same order as λ^3 and the initial electron velocity to be one-tenth that of light, this ratio becomes unity for a frequency of the order of 3×10^{12} cps.
- 621.372.5** 370
Synthesis of Ladder Networks to give Butterworth or Chebyshev Response in the Pass Band—E. Green. (*Proc. IEE*, part IV, vol. 101, pp. 192-203; August, 1954. Digest, *ibid.*, part III, vol. 101, pp. 115-118; March, 1954.) General formulas are derived for the design of low-pass ladder networks. See also 1267 of 1953.
- 621.372.5** 371
Synthesis of Constant-Time-Delay Ladder Networks using Bessel Polynomials—L. Storch. (*Proc. I.R.E.*, vol. 42, pp. 1666-1675; November, 1954.) A low-pass minimum-phase transfer function is constructed which produces a maximally flat time-delay/frequency characteristic and a nearly Gaussian impulse response. Evaluation of delay and loss characteristics is simplified since the transfer function can be expressed in terms of tabulated functions. Synthesis of the corresponding ladder network using low- Q elements is described. Characteristics of a class of related nonminimum-phase transfer functions are also discussed.
- 621.372.5** 372
Gain-Bandwidth Limitations on Equalizers and Matching Networks—H. J. Carlin. (*Proc. I.R.E.*, vol. 42, pp. 1676-1685; November, 1954.) Comprehensive theory is presented and new results are given for the optimum voltage transfer to an arbitrary load.
- 621.372.5** 373
Synthesis of Transfer Functions by Active RC Networks—D. B. Armstrong and F. M. Reza. (*Trans. I.R.E.*, vol. CT-1, pp. 8-17; June, 1954.) A criterion is presented for determining whether a prescribed transfer function can be synthesized by means of an active RC network with a single feedback loop. It is shown that any quadratic function can be synthesized by this means; the arbitrary function can be treated by breaking it down into quadratic elements. Alternative methods involving (a) inversion of the transfer function or (b) a ladder-network realization are also discussed.
- 621.372.5** 374
Power Gain in Feedback Amplifier—S. J. Mason. (*Trans. I.R.E.*, vol. CT-1, pp. 20-25; June, 1954.) A search is made for a network figure of merit which remains invariant for different connection conditions, a quantity U is found satisfying this requirement and identified as the available power gain when the coupling is chosen to make the device unilateral. The quantity U may be useful for classifying active networks; its value is unity for a gyrator. The method directs interest to power gain and signal-flow considerations rather than to voltage gain and the network interpretation of an impedance matrix.
- 621.372.54** 375
Determination of Energy and Phase Characteristics of Electrical Filters—G. N. Rapoport. (*Zh. Tekh. Fiz.*, vol. 24, pp. 1496-1498; August, 1954.) The Leontovich theorem, which states that in nondissipative media the velocity of propagation of em energy is equal to the group velocity, is applied to the case of a filter, considered as an equivalent waveguide system. The velocity of propagation of energy can be calculated when the dispersion is known.
- 621.372.54.029.4:534.113** 376
Tunable Audio Filters—G. Zelinger. (*Electronics*, vol. 27, pp. 173-175; November, 1954.) Electromechanical filters of clamped-resonant type are described. The Q factor can be varied from 100 to 400 over the frequency range 60-700 cps.
- 621.372.543.029.3** 377
L. F. Vibration Filters—F. M. Gol'tsman. (*Zh. Tekh. Fiz.*, vol. 24, pp. 1350-1353; July, 1954.) The application of vibration galvanometers as lf narrow-band electrical filters is considered theoretically; experimental results for frequencies of 27-420 cps are tabulated and presented graphically. The corresponding bandwidths varied between 0.6 and 3.8 cps.
- 621.372.543.3:621.372.22** 378
Inhomogeneous Transmission Lines as Filters—A. L. Feldstein. (*Nachr. Tech.*, vol. 4, pp. 264-266; June, 1954.) Mathematical treatment of the filtering action of a transmission line with periodic structure. Design is based on an approximate integral formula expressing reflection coefficient as a function of characteristic impedance ρ . Its application in a simple case shows that the center frequency is determined by the length of a section, and the width of the stop band is dependent only on the total length, i.e. the number of sections. The formula gives results in good agreement with experiment for a single-section filter with ratio $\rho_{\text{max}}/\rho_{\text{min}} = 8$.
- 621.372.6** 379
Improved Matrix and Determinant Methods for Solving Networks—W. S. Percival. (*Proc. IEE*, part IV, vol. 101, pp. 258-265; August, 1954. Digest, *ibid.*, part III, vol. 101, pp. 278-279; July, 1954.) "It is shown that a linear electrical network, which may include tubes and transformers, can be represented topologically by a network composed entirely of elements of a single type. In its most general form an element of this type comprises four nodes and two directed branches. It is also

shown that a linear electrical network can be represented algebraically by a matrix, termed an H-matrix. If the elements of the network are shown in the network diagram in the form of elements of the above type, the H-matrix can be written down directly from the network diagram."

- 621.373.4** 380
Effect of Electrical Fluctuations on Valve Oscillator—P. I. Kuznetsov, R. L. Stratovnich and V. I. Tikhonov. [*Compt. Rend. Acad. Sci. (URSS)*, vol. 97, pp. 639-642; August 1, 1954. In Russian.] The effect of fluctuations which are slow compared with the oscillation frequency is considered theoretically and a method of calculating the effect is developed based on the Einstein-Fokker equation.
- 621.373.4:621.376.3** 381
Frequency Control of Short-Wave Oscillators by means of an Electrodeless Gas Discharge—E. Häusler and B. Koch. (*Z. Naturf.*, vol. 9a, pp. 182-183; February, 1954.) Continuation of investigations reported previously [362 of 1954 (Koch)]. With lower oscillator power, higher gas pressure and looser feedback coupling a characteristic of quite different type is obtained, giving a rapid decrease of frequency with increase of anode voltage over a narrow range.
- 621.373.4:621.385.029.65** 382
Possibility of obtaining Very Short Continuous Waves, using a Reflex Klystron supplying Energy at High-Order Harmonics of the Fundamental Oscillation—J. Bernier and H. Leboutet. [*Compt. Rend. Acad. Sci. (Paris)*, vol. 239, pp. 796-798; October 4, 1954.] A formula is given for determining the wavelengths of the natural resonances of the klystron cavity. The dependence of these wavelengths on the grid separation is shown graphically, together with curves giving the values corresponding to exact harmonics of the fundamental. The two families of curves intersect at an infinite number of points, at each of which the cavity is capable of oscillating at both fundamental and harmonic frequency. Using a klystron with a beam voltage of about 2 kv and current 65 ma, and reflector voltage 1-1.5 kv, wavelengths down to 1.7 mm (24th harmonic of 4.08 cm) have been generated with a power of some tens of microwatts.
- 621.373.431.1** 383
Method for Elimination of Effect of Stray Capacitances in the Production and Amplification of Step Voltages—W. Kroebel. (*Z. angew. Phys.*, vol. 6, pp. 293-297; July, 1954.) Discussion is presented of the charge and discharge mechanism of a multivibrator circuit; to obtain a steep leading pulse flank, a rapid discharge of the negative charge accumulated at one of the anodes is necessary. This is achieved by using the anode-dynode path of an auxiliary secondary-emission tube. Pulses of amplitude up to 400 v, with flanks of slope about 10^{10} v/second were obtained. Application of the principle in frequency dividers is also described.
- 621.375.1** 384
General Properties of Electromagnetic Amplifiers—D. A. Bell. (*Wireless Eng.*, vol. 31, pp. 310-319; December, 1954.) The relations between gain, bandwidth or time constant, and power rating are discussed; results to be expected from use of feedback are examined. The amplifiers considered include thermionic-tube, magnetic and rotating-machine types. Devices for improving the shape of the pass-band normally involve delay; distributed amplifiers permit improvement of the gain-bandwidth parameter but not of the gain/time-constant ratio.
- 621.375.2.024:621.385.5** 385
"Starved Amplifiers"—G. E. Kaufer. (*Electronic Eng.*, vol. 26, pp. 498-503; November, 1954.) Advantages of the starved amplifier (i.e. tube operated with very low anode and

screen voltages) for high-gain amplification of dc are indicated. Relevant tube data must be determined by the designer; typical curves for Type-6SG7 and 6AG5 miniature pentodes are presented and discussed.

- 621.375.221** 386
Design of Video Couplings—D. G. Sarma. (*Wireless Eng.*, vol. 31, pp. 327-334; December, 1954.) A method is presented for designing low rise-time video-amplifier coupling networks with three or four independent elements by the proper location of complex zeros and poles of the network function. The relations between rise-time, overshoot and delay are determined. Graphs are presented for determining the type of response of a circuit with given constants, or the circuit constants for a given type of response.
- 621.375.222** 387
Zero Stabilization of Directly-Coupled Amplifiers—E. H. Frost-Smith and A. R. B. Churcher. (*Elliott Jour.*, vol. 2, pp. 136-139; August, 1954.) Details are given of circuits in which stability of a direct-coupled amplifier is achieved by use of a second amplifier in a feedback arrangement. The auxiliary amplifier is highly stable but has a low cut-off frequency; hence low-frequency signals are pre-amplified, giving enhanced signal/noise ratio at these frequencies. For high-frequency signals the auxiliary amplifier is by-passed.
- 621.375.3** 388
An Even-Harmonic Magnetic Amplifier—P. D. Atkinson and A. V. Hemingway. (*Electronic Eng.*, vol. 26, pp. 482-485; November, 1954.) The circuit is an adaptation of the inverter described by Frost-Smith (73 of 1954); a typical figure for the power gain is 1,000, and for the output 1 mw. The zero drift is less than the shift produced by an input power of 10^{-11} w. The input impedance ranges up to about 3 k Ω , making it suitable for use with many types of transducer, but the poor response time restricts application to cases where the input varies slowly. Multistage amplifiers of this type are useful for control and measurement purposes.
- 621.375.3** 389
Fast-Response Magnetic Amplifiers—G. E. Hughes and H. A. Miller. (*Trans. AIEE, Part I, Communication & Electronics*, vol. 73, pp. 69-75; March, 1954. Digest, *Elec. Eng. (N.Y.)*, vol. 73, p. 723; August, 1954.) Expressions are given for the number of control turns and the gain of magnetic amplifiers of the type described by Ramey (3503 of 1953), in which load and control circuits operate on the magnetic state of the core on a time-sharing basis.
- 621.375.3:538.244** 390
Effect of Circular Field on Form of Longitudinal Magnetization Curve—R. E. Ershov. (*Zh. Tekh. Fiz.*, vol. 24, pp. 1508-1512; August, 1954.) The variation was investigated experimentally of the magnetization of an iron tube placed in a coaxial magnetic field combined with a circular field produced by a current flowing in a conductor placed along the axis of the tube. The results, which are presented graphically, are of interest in the construction of transformers for amplification of weak currents.
- 621.375.4** 391
Feedback Simplifies Transistor Amplifiers—S. Schenkerman. (*Electronics*, vol. 27, pp. 129-131; November, 1954.) "Voltage amplification in transistor stages is obtained using a degenerative feedback path shunting the output and in series with the input. Use of interstage transformers or grounded-collector stages is avoided."
- 621.375.4.029.4** 392
A Transistor Remote Amplifier—P. Pen-

field, Jr. (*Audio*, vol. 38, pp. 26-27; September, 1954.) A portable af pre-amplifier using Type-CK-721 point-contact transistors is described; precautions necessary to avoid damage to the transistors during construction of the equipment and during use are indicated.

- 621.375.5:537.227** 393
Ferroelectrics and the Dielectric Amplifier—Mason and Wick. (See 447.)
- 621.375.9:537.312.8** 394
Galvanomagnetic Low-Frequency Amplifier—E. Just and H. J. Tüvy. (*Z. Naturf.*, vol. 9a, pp. 183-184; February, 1954.) A simple arrangement is described based on the high magneto-resistance of Bi at low temperature. The device is much less noisy than an ordinary tube or transistor. See also 3179 of 1954 (Thuy).
- 621.376.239** 395
Magnetic Demodulation with Sinusoidal Variation of the H. F. Induction Flux—G. Meinshausen. (*Arch. elekt. Übertragung*, vol. 8, pp. 373-386; September, 1954.) With magnetic demodulation using sinusoidal rf current in the demodulating reactor [3400 of 1953 (Pungs and Meinshausen)], the rf flux is distorted. By arranging instead for the rf flux to be sinusoidal, the power can be increased. Analysis is given based on analogy with diode theory, the flux being treated as the equivalent of the voltage across the diode. Essential differences between magnetic and diode demodulators are discussed.
- GENERAL PHYSICS**
- 53:519.2** 396
Statistical Concepts in Theoretical Physics—R. Fürth. (*Brit. Jour. Appl. Phys.*, vol. 5, pp. 273-276; August, 1954.) A plea for the teaching of classical physics on an empirical basis on statistical lines, to make easier the transition to quantum physics.
- 530.112** 397
Proposal for a New Aether Drift Experiment—H. L. Furth. [*Nature (London)* vol. 174, pp. 505-506; September 11, 1954.] Further elucidation of the proposal made previously (1726 of 1954).
- 535.23** 398
The Maximum of the Planck Energy Spectrum—R. N. Bracewell. [*Nature (London)* vol. 174, pp. 563-564; September 18, 1954.] In the formula generally used for locating the maximum in the energy spectrum of a black body, the spectral distribution is based on the amount of energy lying between two closely spaced wavelengths. If the distribution is considered on a frequency basis instead of a wavelength basis, a very different value is obtained for the position of the maximum; for a body at 6,000 degrees (roughly the temperature of the sun) the maximum then falls at 8,497 Å, which is outside the visible region. Re-examination of Planck's formula leads to a Wien-type law yielding a natural maximum at 6,115 Å for the 6,000 degree spectrum; the location of this maximum does not alter on changing from a wavelength to a frequency basis.
- 535.33:538.56.029.6** 399
Apparatus for Microwave Spectroscopy—M. W. P. Strandberg, H. R. Johnson and J. R. Eshbach. (*Rev. Sci. Instr.*, vol. 25, pp. 776-792; August, 1954.) The design of a spectrograph using Stark modulation and a crystal or bolometer detector is discussed, and a detailed description is given of a particular equipment.
- 535.42** 400
Diffraction of Waves by a Wedge—F. Oberhettinger. (*Commun. pure Appl. Math.*, vol. 7, pp. 551-563; August, 1954.) Green's functions of the wave equation for a wedge are given in the form of an integral representation for the two-dimensional case, and are evaluated by the residue theorem. The half-plane is considered as the limiting case of a wedge with

- angle 2π . The analysis is extended to the three-dimensional case.
- 535.42** **401**
A Uniqueness Theorem and a New Solution for Sommerfeld's and Other Diffraction Problems—A. S. Peters and J. J. Stoker. (*Commun. pure Appl. Math.*, vol. 7, pp. 565-585; August, 1954.)
- 535.42:538.566** **402**
On the Scalar Diffraction by a Circular Aperture in an Infinite Plane Screen—A. T. de Hoop. (*Appl. Sci. Res.*, vol. B4, pp. 151-160; 1954.) Application of variational principles reduces the problem of finding the aperture distribution to the solution of an infinite system of linear equations. An investigation is made of a particular system of equations based on a convenient expansion of the aperture distribution given by Bouwkamp.
- 535.42:538.566** **403**
General Approximation Method for solving Diffraction Problems—M. Jessel. [*Compt. Rend. Acad. Sci. (Paris)*, vol. 239, pp. 753-756; September 27, 1954.] A system of integrodifferential equations is established for the boundary values. A known variational principle is used for calculating certain functionals involved.
- 537.291+538.691** **404**
Motion of Charged Particles in a Homogeneous Magnetic Field, with Superposed Magnetic Field of Linear Current and Electric Field of Cylindrical Capacitor—V. M. Kel'man and S. Ya. Yavor. (*Zh. Tekh. Fiz.*, vol. 24, pp. 1329-1332; July, 1954.) The problem considered theoretically by Kel'man and Rodnikova (75 of 1953) is extended to include the effect of a magnetic field parallel to the axis of the cylinder. Calculated results for several particular cases are presented graphically.
- 537.311.31:621.317.332.029.65** **405**
R. F. Conductivity in Copper at 8 mm Wavelengths—J. S. Thorpe. (*Proc. IEE*, part III, vol. 101, pp. 357-359; November, 1954.) Measurements at 8 mm λ indicate that reduction of conductivity below the dc value is caused not only by surface roughness but also by the presence of surface layers having dc conductivity lower than that of the bulk material, and by stress in the bulk material. These effects can be overcome by etching and annealing, or by covering the surface layers by a process involving oxidation and reduction.
- 537.311.33:537.323** **406**
Limits of Practical Application of Pisarenko's Formula—T. A. Kontorova. (*Zh. Tekh. Fiz.*, vol. 24, pp. 1291-1297; July, 1954.) Pisarenko's formula expresses thermoelectric power in terms of charge-carrier concentration and effective mass and of absolute temperature. A constant factor is included to take account of scattering of the charge carriers in the crystal; its value depends on the type of scattering and crystal lattice. Calculations show that the errors are small (<5 per cent) up to carrier concentrations of about 2×10^{19} in atomic lattice and 7.2×10^{19} in ionic-lattice crystals at 300 degrees K. The errors are discussed, and compared with those of other formulas. Results are tabulated.
- 537.36** **407**
The Motion of Electricity—J. J. Gruetzmacher. (*Naturwiss.*, vol. 41, p. 368; August, 1954.) Preliminary experiments are described on the mechanical transportation of electric charge, e.g. by blowing streams of ionized air, or by causing such streams to flow in tubes under a pressure difference. G-M tubes are used as detectors, with loudspeaker indicators. Currents up to 10^{-14} a have been produced.
- 537.525:546.291** **408**
Energy Distribution Function of Electrons in Pure Helium—F. H. Reder and S. C. Brown. (*Phys. Rev.*, vol. 95, pp. 885-889; August 15, 1954.)
- 537.525:546.291** **409**
Microwave Determination of the Probability of Collision of Electrons in Helium—L. Gould and S. C. Brown. (*Phys. Rev.*, vol. 95, pp. 897-903; August 15, 1954.)
- 537.525.72:538.63** **410**
Some Effects in Inductively Coupled Electroless High-Frequency Gas Discharges with Superposed Magnetic Field—N. Neuert, H. J. Stuckenberg and H. P. Weidner. (*Z. angew. Phys.*, vol. 6, pp. 303-310; July, 1954.) The effects noted by Lindberg et al. (85 of 1953) were further investigated. The resonance effect appears to be due to electrons moving initially in circular orbits coaxial with the tube wall rapidly acquiring energy in the alternating field. An application of the effect in a hf ion source is briefly described. For another application see 90 of February (Koch and Neuert).
- 538.221** **411**
Extension of the Spin-Wave Theory of Ferromagnetism to Higher Temperatures—G. Heber. (*Z. Naturf.*, vol. 9a, pp. 91-97; February, 1954.)
- 538.3** **412**
Possibility of considering Potentials and Fields as Quantities having Density: New Type of Quadrivector—É. Durand. [*Compt. Rend. Acad. Sci. (Paris)*, vol. 239, pp. 751-753; September 27, 1954.]
- 538.312** **413**
On Multipole Expansions in the Theory of Electromagnetic Radiation—C. J. Bouwkamp and H. B. G. Casimir. (*Physica*, vol. 20, pp. 539-554; August, 1954.) "A new method is developed for expanding the electromagnetic field of radiating charges and currents in multipole components. Outside a sphere enclosing all sources, the field is represented in terms of Debye potentials which are shown to be closely related to the radial components of the electric and magnetic vectors. Attention is drawn to remarkably simple source representations of these radial components. A discussion of vector-potential versus Debye-potential representation of multipole fields is included. Only familiarity with ordinary vector calculus is required."
- 538.56** **414**
The Radiation Green's Functions—J. G. Linhart. (*Jour. Frank. Inst.*, vol. 258, pp. 99-112; August, 1954.) Analysis for the radiation field of a group of charges is derived using functions similar to Green's function of potential theory but applied to the time-variables problems of radiation theory. The method presents a model of interaction between a quantum of movement of a unit point charge and the corresponding excitation of a set of eigen-fields; it is illustrated by treating the case of a point charge rotating in a cylindrical cavity.
- 538.566:538.614** **415**
Propagation of Electromagnetic Waves in a Gyrotropic Medium—M. A. Gintsburg. [*Compt. Rend. Acad. Sci. (URSS)*, vol. 97, p. 572; August 1, 1954, in Russian.] Correction to paper abstracted in 2927 of 1954.
- 538.632/.633** **416**
Direct Comparison of Hall Effect and Corbino Effect—W. J. Poppelbaum. (*Helv. Phys. Acta*, vol. 27, pp. 355-394; August 31, 1954, in French.) By using a cylindrical sample immersed in radial magnetic field, a transverse current is produced when an alternating voltage is applied between the ends of the cylinder; this transverse current gives rise to an induced voltage in a coaxial coil. Both the Corbino and the Hall effects can be measured with this arrangement, thus providing two independent means of determining the Hall constant; the
- discrepancy between the two results is <5 per cent.
- 621.3.032.44** **417**
The Distribution of Temperature along a Thin Rod Electrically Heated in Vacuo: Parts 2-4—S. C. Jain and K. S. Krishnan. (*Proc. Roy. Soc. A.*, vol. 225, pp. 1-32; August 6, 1954.) The theoretical solution presented in part 1 (2375 of 1954) is considered in the light of formulas discussed by Stead (*Jour. IEE*, vol. 58, p. 10; 1920) relating the temperature distribution in a finite rod to that in an infinitely long rod heated by the same current. A useful expression is found for the temperature at the center of a finite long rod as a function of its length. Detailed experimental verification of the main theoretical results is reported. Empirical formulas proposed by Worthing are shown to follow from the theory developed.
- 53.05** **418**
The Physics of Experimental Method [Book Review]—H. J. J. Braddick. Publishers: Chapman & Hall, London, Eng., 404 pp., 35s (*Phil. Mag.*, vol. 45, p. 884; August, 1954.) Sections are included on relevant mathematics, mechanical construction and materials, vacuum technique, electrical measurements and electronics, optics and photography, natural limits of measurements, and techniques of nuclear physics.
- GEOPHYSICAL AND EXTRATERRESTRIAL PHENOMENA**
- 523.16** **419**
A Comparison of the Intensity Distribution of Radio-Frequency Radiation with a Model of the Galactic System—G. Westerhout and J. H. Oort. (*Bull. astr. Insts Netherlands*, vol. 11, pp. 323-333; August 26, 1951, in English.) A comparison is made between the radiation to be expected from objects distributed like the common stars and the observed rf radiation. Satisfactory agreement with Bolton and Westfold's observations on 100 mc (348 of 1951) is obtained for the regions where the radiation is considerable. Near the galactic poles and in the hemisphere opposite the center the observed temperatures are about 600 degrees in excess of the calculated values; this excess is possibly due to a background of distant extragalactic nebulae.
- 523.16** **420**
Methods and Results of Radio Astronomy—H. Sidentopf. (*Z. angew. Phys.*, vol. 6, pp. 376-384 and 422-430; August and September, 1954.) A survey with over 100 references.
- 523.5:621.396.96** **421**
Radio Observations of Meteors—P. M. Millman. (*Science*, vol. 120, pp. 325-328; August 27, 1954.) A summarized general account, with literature references, of the most significant results obtained during the seven years up to the end of 1953.
- 523.746.5** **422**
Present Phase of Solar Cycle—D. E. Trotter and C. Pecker. [*Compt. Rend. Acad. Sci. (Paris)*, vol. 239, pp. 633-635; September 6, 1954.] Observations of the intensity of the coronal 5303-Å green line suggest that the 1954 minimum of solar activity is flatter and lower than that of 1944; a first indication of the rise of the new cycle was observed at the beginning of August, 1954. The next maximum is expected to occur between summer, 1959 and the end of 1960 and to be rather low.
- 550.385** **423**
The Prediction of Geomagnetic Disturbances—J. C. Pecker and W. O. Roberts. [*Compt. Rend. Acad. Sci. (Paris)*, vol. 239, pp. 635-637; September 6, 1954.] Shapley's method for predicting geomagnetic indexes (*Trans. Amer. Geophys. Union*, vol. 28, p. 715; 1947) is modified to take account of (a) the variation

of the periodicity of the disturbance about the 27-day average, and (b) the maxima observed in the values of the indexes in March and September.

551.510.53+621.396.11 424

Rocket Exploration of the Upper Atmosphere—R. L. F. Boyd, M. J. Seaton and H. S. W. Massey, Eds. (*Jour. Atmos. Terr. Phys.*, special supplement, vol. 1, p. 376; 1954.) The text is given of 49 papers read at a conference at Oxford in August, 1953. Sections 1-3 cover rocket techniques, atmospheric phenomena and composition of the high atmosphere. Section 4 deals with the ionosphere in particular and includes papers on wave-propagation measurements made using rockets (reported earlier), a specially designed antenna used on dry rocky soil for short-range sky-wave measurements at 1f, an analysis of a method of determining charge densities from rocket-tracking data, and a suggested program of rocket-borne-magnetometer measurements. Section 6 covers laboratory studies, including an experiment on cross-modulation.

551.510.535 425

Study of Layer Splitting in the Ionosphere—O. Burkard. (*Arch. Met. A, Wien*, vol. 7, pp. 283-291; June 30, 1954.) An equation is derived expressing the conditions for one or more maxima to occur in the height distribution of electron concentration, for arbitrary height distributions of temperature and recombination coefficient. A numerical treatment is given for splitting into F_1 and F_2 layers. The occurrence of splitting with uniform temperature distribution would imply a highly improbable value for the recombination coefficient. On the other hand, the presence of a warm layer within the F layer would lead to results consistent with the observations.

551.510.535 426

Absorption of Short Waves in the Ionosphere—É. Argence and K. Rawer. [*Compt. Rend. Acad. Sci. (Paris)*, vol. 239, pp. 773-775; September 27, 1954.] Expressions are derived analytically for the value of the decrement δ_2 for values of the frequency above and below critical, assuming that collisions of electrons with ions are much more numerous than with neutral molecules.

551.510.535:523.16 427

High Latitude Ionospheric Observations using Extraterrestrial Radio Waves—C. G. Little. (*Proc. I.R.E.*, vol. 42, pp. 1700-1701; November, 1954.) A preliminary account is given of observations made at College, Alaska, over a two-month period in the spring of 1954, of the effect of the ionosphere on the reception of cosmic radiation at 65 mc. Strong absorption of the diffuse rf background is most common at midday and least common during late evening; it is correlated with no-echo conditions and with variations of the geomagnetic field. Observations on localized radio sources indicate that scintillations are commoner in Alaska than in England. Scintillations were observed whenever marked 65-mc absorption occurred during transit of the localized source through the antenna beam; this indicates that the lateral distribution of ionization during periods of absorption is nonuniform. Study of the scintillations should provide information about irregularities in the ionosphere.

551.510.535:538.566 428

The Propagation of Long Electric Waves round the Earth in relation to Transmission Interference and Lightning Atmospherics—Schumann. (*See* 528.)

551.594.21 429

An Analysis of Electric Field after Lightning Discharges—Y. Tamura. (*Jour. Geomag. Geoelect.*, vol. 6, pp. 34-46; March, 1954.) The thundercloud is represented by a vertical

dipole, and the emf in it is represented by a constant current generator. The electric field comprises components due to (a) the charge on each pole, which depends on the conductivity of the air, (b) space charge related to the charge on the poles, and (c) free decaying space charge released after a lightning discharge. Dissimilarity between the field recovery curves for near discharges and distant discharges are explained by this theory.

551.594.6:621.396.11.029.45 430

Theoretical Calculations of Field of Low-Frequency Electromagnetic Waves above Earth's Surface—Al'pert. (*See* 535.)

LOCATION AND AIDS TO NAVIGATION

621.396.93:551.594.6 431

The Accuracy of the Location of Sources of Atmospherics by Radio Direction-Finding—F. Horner. (*Proc. IEE*, part III, vol. 101, pp. 383-390; November, 1954.) An investigation of the accuracy of the United Kingdom network of twin-channel cathode-ray direction finders operating at frequencies near 10 kc is reported. Hilly terrain and buried cables have caused errors of several degrees at some stations. Instrumental errors are small, apart from polarization errors, which may be as high as 2 degrees or 3 degrees in summer daytime and rather higher in winter. An estimate has been made of the accuracy of storm location; the potential accuracy depends not only on bearing errors, station spacing, and storm distance, but also on the number and interpretation of the observations. With the existing network and technique, the probable error in position of a storm center distant 1,000 km is about 20 km on a summer day, 50 km on a winter day, and 100 km by night.

621.396.933 432

Navaglobe-Navarho Long-Range Radio Navigational System—C. T. Clark, R. I. Colin, M. Dishal, I. Gordy and M. Rogoff. (*Elec. Commun.*, vol. 31, pp. 155-166; September, 1954, *Convention Record I.R.E.*, vol. 2, part 5, pp. 88-97; 1954.) The Navaglobe system developed for the U.S.A.F. is described; reliability is achieved by operating at a frequency of about 100 kc, and tolerable signal/noise ratio at long range by using a bandwidth of 20-100 cps. The service is omnidirectional and the airborne bearing indications are automatic. Arrangements for reducing the effects of atmospheric noise are described. Performance on transcontinental and transatlantic tests is reported. Plans to complete the system by incorporating phase-comparison distance-measurement equipment are discussed.

621.396.933 433

Fixed-Beam Aircraft Approach System—R. A. Hampshire. (*Elec. Commun.*, vol. 31, pp. 189-197; September, 1954, *Convention Record I.R.E.*, vol. 2, part 5, pp. 77-83; 1954.) A system designed for the U.S.A.F. and compatible with existing instrument-approach installations consists of a localizer operating at a frequency between 108 and 112 mc and glide-slope equipment operating at a frequency between 329 and 335 mc, both using modulation at 90 and 150 cps. The localizer is of dual-beam type.

621.396.96 434

Influence of the Polarization of the Radiated Waves on Radar Detection—G. Pircher. [*Compt. Rend. Acad. Sci. (Paris)*, vol. 239, pp. 756-757; September 27, 1954.] Analysis for elliptically polarized radiation is based on a polarization factor which is given by the scalar product of unit vectors representing respectively the transmitter and receiver polarizations. It is shown that for one particular polarization of the radiated waves the echo is annulled, and that for any obstacle there is one particular polarization which gives maximum echo power.

621.396.962.23 435

Radar offers Solution to Midair Plane Collisions—J. Q. Brantley. (*Electronics*, vol. 27, pp. 146-150; November, 1954.) Early indication of collision danger is obtained by use of cw Doppler technique to measure closure rate, deviation of closure rate and deviation of closure angle. Suitable circuits are described.

MATERIALS AND SUBSIDIARY TECHNIQUES

531.788.7 436

Ultimate Vacuum in a Vacuum-Enclosed Ionization Gauge—L. J. Varnerin, Jr., and D. White. (*Jour. Appl. Phys.*, vol. 25, pp. 1207-1208; September, 1954.) Brief report of measurements made with a Bayard-Alpert gauge.

533.583:[546.821+546.831] 437

Investigation of Absorption Capacity of Nondispersal [contact] Getters—E. Lyubovskaya and A. Ravdel'. (*Zh. Tekh. Fiz.*, vol. 24, pp. 1392-1400; August, 1954.) The sorption of hydrogen and oxygen by Zr getters and by Ti getters containing some Th was investigated in the range between room temperature and ~700 degrees C. Results, which are presented graphically, indicate that both getters are suitable for use in tubes in the range investigated. The sorption capacity of Zr is highest at ~500 degrees C. for H_2 and increases monotonically for O_2 above ~400 degrees C.; for TiTh getters the corresponding temperatures are 400 degrees-600 degrees C. and >500 degrees C., respectively. At optimum temperatures Zr absorbs more O_2 than does the TiTh getter; the reverse is true for the H_2 sorption. The rate of sorption was also investigated.

535.215 438

Photoconductivity—A. Rose. (*Onde élect.*, vol. 34, pp. 645-651; August/September, 1954.) Discussion of photoconduction mechanism in normally poor conductors such as CdS single crystals, pointing out discrepancies between experimental results and simple theory, and illustrating how energy-level distributions in the forbidden bands can be determined by development of suitable theoretical models. See also 1005 of 1952.

535.215.1:546.482.31 439

Photoconductivity in Cadmium selenide—H. J. Dirksen and O. W. Memelink. (*Appl. Sci. Res.*, vol. B4, pp. 205-215; 1954.) Published theories are discussed and a new theory is proposed. Values of the material constants calculated from the theory are in good agreement with results of measurements on CdSe in its basic form and in the form of thin films.

535.37:546.561-31 440

Nature of Luminescence of Copper Oxide—Yu. I. Karkhanin and V. E. Lashkarev. [*Compt. Rend. Acad. Sci. (URSS)*, vol. 97, pp. 1007-1010; August 26, 1954. In Russian.] A brief report is presented summarizing recent experimental results. It is concluded that Cu vacancies do not luminesce by themselves, but that luminescence is produced at those centers which force the exciton to radiate on annihilation. The wavelength of the infrared luminescence of Cu_2O is about 0.96μ at 20 degrees C. and 0.93μ at -180 degrees C.

535.376 441

Experiments on Electroluminescence—J. F. Waymouth and F. Bitter. (*Phys. Rev.*, vol. 95, pp. 941-949; August 15, 1954.) Observations on green-luminescent ZnS:Cu:Pb and yellow-luminescent ZnS:Cu:PB:Mn phosphors are reported. The optical and electrical response of the materials to applied electric fields was studied for dispersions in lucite and for individual particles. Luminescence in alternating fields is restricted to spots very much smaller than the individual particles, and occurs only once per cycle. The results indicate that the most important excitation process involves removal of electrons from lumines-

cent centers, luminescence occurring when the state of the field allows the electrons to return and recombine.

537.227:546.431.811.824-31 442

Ferroelectric Properties of Solid Solutions of Barium Stannate in Barium Titanate—G. A. Smolenski and V. A. Isupov. (*Zh. Tekh. Fiz.*, vol. 24, pp. 1375-1386; August, 1954.) Solid solutions containing up to 30 per cent molar of BaSnO_3 were investigated. Measurements were made of the dielectric constant in weak fields, the resonance and antiresonance frequencies and the fractional elongation $\Delta l/l$ over the temperature range -150 degrees to $+150$ degrees C. In several cases, the dependence of the dielectric constant on the field strength (up to ~ 8 kv/cm) was also determined. Phase transitions were also investigated. The preparation of the specimens and experimental details are described and results are presented graphically and in some cases also in tabulated form.

537.227:546.431.817.824-31 443

X-Ray Study of Structure of (Ba, Pb) TiO_3 Solid Solutions—E. G. Fesenko and A. G. Slabchenko. (*Zh. Tekh. Fiz.*, vol. 24, pp. 1288-1290; July, 1954.)

537.227:546.431.824-31 444

Pressed Barium Titanate Piezoelectric Materials—A. I. Kogan and M. M. Kitaigorodski. (*Zh. Tekh. Fiz.*, vol. 24, pp. 1371-1374; August, 1954.) The dielectric constant and the piezoelectric modulus d_{11} were determined experimentally for polarized (Ba, Pb) TiO_3 specimens containing up to 18 per cent Pb. The dielectric constant lies between 40 and 95 and is practically constant at frequencies between 50 kc and 12 mc; d_{11} varies between 0.6×10^{-7} and 10×10^{-7} cgse. The effect of temperature and length of the thermal pre-treatment was investigated. Results are tabulated.

537.227:546.431.824-31 445

Domain Formation and Domain Wall Motions in Ferroelectric BaTiO_3 Single Crystals—W. J. Merz. (*Phys. Rev.*, vol. 95, pp. 690-698; August 1, 1954.) Continuation of work reported previously (759 of 1953). Nucleation and growth of the domains were studied as a function of applied electric field and temperature. The manner of growth of new domains on reversing the polarity of the applied field is discussed in relation to processes observed in ferromagnetic materials and to switching processes when the crystals are used as storage units. Compared with Fe, the walls in BaTiO_3 are much thinner and the energy density in the walls is somewhat greater. Since there is practically no sideways motion of the side walls, there is no crosstalk between different sets of electrodes on the same crystal even when they are spaced as closely as 0.01 cm.

537.227:546.431.824-31 446

Dielectric Constant and Loss Measurements on Barium Titanate Single Crystals while Traversing the Hysteresis Loop—M. E. Drougard, H. L. Funk and D. R. Young. (*Jour. Appl. Phys.*, vol. 25, pp. 1166-1169; September, 1954.) Permittivity measurements were made with small-amplitude sinusoidal voltages of frequency 100-600 kc superposed on a bias voltage switched at 10-200 cps. Results indicate that the frequency dependence of the permittivity and loss is consistent with a relaxation mechanism with a relaxation time of 5.5 μ s. See also 3245 of 1954 (Drougard and Young).

537.227:621.375.5 447

Ferroelectrics and the Dielectric Amplifier—W. P. Mason and R. F. Wick. (*Proc. I.R.E.*, vol. 42, pp. 1606-1620; November, 1954.) Properties of BaTiO_3 single crystals and ceramics are reviewed in relation to their use for capacitors, transducers, dielectric amplifiers, etc. By adding PbTiO_3 and CaTiO_3 the ceramics can be stabilized so as to be satisfactory for

electromechanical filters and delay lines. For use in dielectric amplifiers and signal-storage units, single crystals are more suitable than ceramics by virtue of their narrower hysteresis loop. Experiments are briefly reported on dielectric amplifiers with crystals of thickness 0.002 inch operated below the Curie temperature; these crystals are saturated by a voltage of 10v, and their hysteresis loops do not vary with frequency up to 200 kc or higher. The amplifier has a gain of about 12 db for modulation frequencies up to 7 kc.

537.311.33:535.215 448

Photovoltaic Effect in InAs—R. M. Talley and D. P. Enright. (*Phys. Rev.*, vol. 95, pp. 1092-1094; August 15, 1954.) Report of measurements of the spectral variation of the photovoltaic effect in InAs p - n junctions.

537.311.33:536.21.022 449

Some Regularities in the Magnitudes of Thermal Conductivities of Semiconductors—A. V. Ioffe and A. F. Ioffe. [*Compt. Rend. Acad. Sci. (URSS)*, vol. 97, pp. 821-822; August 11, 1954. In Russian.] The decrease in thermal conductivity with increase in atomic or molecular weight, and, in the case of ionic-lattice compounds, also with increase in the ratio of the atomic weight of the positive to that of the negative constituent element, is shown graphically. The semiconductors considered include alkali halides, AgCl, AgBr, TlCl and TlBr, diamond, Si, Ge, GaSb, and InSb.

537.311.33:537.312.8 450

Transverse Galvanomagnetic Effects in Semiconductors—J. Appel. (*Z. Naturf.*, vol. 9a, pp. 167-174; February, 1954.) The investigation reported by Johnson and Whitesell (2329 of 1953) is extended to magnetic fields of any strength. The value found for the magnetoresistance with strong fields and high carrier mobilities is much greater than that given by Harding's theory (*Proc. Roy. Soc. A.*, vol. 140, p. 205; 1933), and is in agreement with experimental results reported by Estermann and Foner (661 of 1951) and by Pearson and Suhl (166 of 1952). The two-band model is considered; the influence of intrinsic conduction on the magnetoresistance of Ge at room temperature and the change of sign of the Hall constant in some circumstances are discussed.

537.311.33:539.234 451

Evaporated Multiple Layers with Semiconductor Properties—J. C. M. Brentano and J. D. Richards. (*Phys. Rev.*, vol. 95, pp. 841-843; August 1, 1954.) Thin multiple-layer films were deposited on pyrex in vacuum by alternate evaporation of two metals not likely to form intermetallic compounds or alloys. The experimentally observed variation of resistivity with temperature is plotted for a film comprising 210 layers each of Fe and Pb; the temperature coefficient of resistivity is negative. For films of either Fe or Pb alone, produced under similar conditions, the temperature coefficients are negligible or positive. The significance of this difference is discussed in relation to the lattice structure.

537.311.33:546.28 452

Formation of Single-Crystal Silicon Fibers—E. R. Johnson and J. A. Amick. (*Jour. Appl. Phys.*, vol. 25, pp. 1204-1205; September, 1954.) Details are given of fibers formed when SiCl_4 diluted with a carrier gas is caused to react with Zn vapor at a temperature of 800 degrees-1,000 degrees C. The average diameter of the fibers is about 1 μ and the lengths are up to 1 cm.

537.311.33:546.28 453

Hyperfine Splitting in Spin Resonance of Group V Donors in Silicon—R. C. Fletcher, W. A. Yager, G. L. Pearson and F. R. Merritt. (*Phys. Rev.*, vol. 95, pp. 844-845; August 1, 1954.) Continuation of investigations reported previously [3254 of 1954 (Fletcher et al.)]. Sam-

ples with various concentrations of P, Ar and Sb have been studied; with all three donors, the multiplicity of resonance lines is replaced by a single narrow line when the concentration exceeds a certain value.

537.311.33:546.28 454

Precipitation of Impurities at Dislocations in Heat-Treated Silicon—S. Mayburg. (*Phys. Rev.*, vol. 95, pp. 838-839; August 1, 1954.) Results of experiments indicate that impurities are precipitated at dislocations when Si single crystals are heated at temperatures below 900 C. The heating was performed in vacuum by passing current through the specimens, and the effects were studied by measurements of the room-temperature conductivity after quenching. The critical temperature of 900 degrees C. is that at which plastic deformation is first observed in Si; a similar critical point is observed in Ge at about 500 degrees C. [2430 of September (Fuller et al.)].

537.311.33:[546.289+546.28+546.24] 455

Effect of Surface Levels on Electrical Properties of Fine-Grain Films of Ge, Si, and Te—Ya. E. Pokrovski. (*Zh. Tekh. Fiz.*, vol. 24, pp. 1229-1243; July, 1954.) The Hall coefficient and resistivity of films prepared by condensation in vacuum were determined over the temperature range from about -180 degrees C. up to several hundred degrees C. The grain dimensions, which were in the region of 10^{-6} - 10^{-6} cm, were controlled by using thin quartz base plates at various temperatures. Results, which are presented graphically, indicate that the surface levels of Ge are acceptor levels filled, at room temperature, with electrons at a density of about 3.5×10^{11} cm^{-2} ; the activation energies of the surface levels are about 0.004, 0.02 and 0.055 ev. The properties of Si films can be explained if it is assumed that an empty band lies just above a filled surface band, both near the middle of the forbidden band. Te has acceptor surface levels lying above the filled band.

537.311.33:546.289 456

Ionization Energies of Groups III and V Elements in Germanium—T. H. Geballe and F. J. Morin. (*Phys. Rev.*, vol. 95, pp. 1085-1086; August 15, 1954.) Experiments indicate that differences between the ionization energies of Group-III acceptors and Group-V donors in Ge are similar to, but less pronounced than, those previously reported for Si [*Bull. Amer. Phys. Soc.*, vol. 29, p. 22; 1954. (Morin et al.)].

537.311.33:546.289 457

Theory of Dislocations in Germanium—W. T. Read, Jr. (*Phil. Mag.*, vol. 45, pp. 775-796; August, 1954.) Theory is discussed quantitatively on the basis of a model due to Shockley (*Phys. Rev.*, vol. 91, p. 228; 1953). In n -type Ge a dislocation gives rise to a row of acceptors; the space charge which develops as these accept electrons has a controlling influence in determining the occupation of the remaining centers. Formulas are derived for the temperature variation of the average electron concentration in slightly deformed specimens. Experimental methods for testing the theory are suggested.

537.311.33:546.289:541.135 458

Self-Powered Semiconductor Amplifier—C. G. B. Garrett and W. H. Brattain. (*Phys. Rev.*, vol. 95, pp. 1091-1092; August 15, 1954.) A slice of n -type Ge with an In-alloyed emitter on one surface has its other surface exposed to a suitable electrolyte. Another electrode having a half-cell potential higher than that of Ge is also placed in the electrolyte. Connections are made to the In, to a gold-bonded contact on the Ge, and to the other electrode. Such a unit constitutes an amplifier incorporating its own power supply, multiplication of holes taking place at the Ge/electrolyte surface. Measured values between 1.4 and 2.0 have been obtained for the current gain. The cut-off fre-

quency is comparable to that of a transistor of similar dimensions.

537.311.33:546.3-1-28-289 459
Energy Gap of Germanium-Silicon Alloys—A. Levitas, C. C. Wang and B. H. Alexander. (*Phys. Rev.*, vol. 95, p. 846; August 1, 1954.) Measured values of energy gap are shown graphically against alloy composition.

537.311.33:546.3-1-28-289 460
Speculations on the Energy-Band Structure of Ge-Si Alloys—F. Herman. (*Phys. Rev.*, vol. 95, pp. 847-848; August 1, 1954.)

537.311.33:546.46-31 461
Electrical Conductivity of Magnesium Oxide Single Crystals—E. Yamaka and K. Sawamoto. (*Phys. Rev.*, vol. 95, pp. 848-850; August 1, 1954.) Results of experiments indicate that the 2.3-ev energy level available to the charged carriers originates from excess Mg and not from excess O atoms.

537.311.33:546.682.18 462
Optical Properties of Indium Phosphide in the Infrared—F. Oswald. (*Z. Naturf.*, vol. 9a, p. 181; February, 1954.) Report of measurements over the wavelength range 0.8-15.2 μ on an *n*-type specimen of resistivity 0.1 Ω cm. A sharp absorption edge is found corresponding to an energy gap of 1.25 ev. Absorption observed at wavelengths $>14.5 \mu$ may be due either to an impurity or to the lattice vibrations.

537.311.33:[546.682.86+546.289 463
Analysis of Magnetoresistance and Hall Coefficient in *p*-Type Indium-Antimonide and *p*-Type Germanium—T. C. Harman, R. K. Willardson and A. C. Beer. (*Phys. Rev.*, vol. 95, pp. 699-702; August 1, 1954.) Existing theory is re-cast in a form convenient for the analysis of experimental results. For *p*-type InSb good agreement is obtained between experimental and theoretical results; in the case of *p*-type Ge the theory is not capable of explaining the experimentally observed variations of Hall coefficient with magnetic field or of magnetoresistance with temperature.

537.311.33:546.722-31 464
Application of R.F. Absorption in Iron Oxides to the Determination of the Activation Energy of their Lattice Defects—B. Hagène. (*Jour. Phys. Radium*, vol. 15, pp. 583-584; July/September, 1954.) Continuation of work reported previously [2328 of 1953 (Freyman et al.)]. Examination of experimental curves in the light of the formula relating frequency of maximum Debye absorption to absolute temperature indicates that for iron oxide mixtures in group the activation energy is ~ 0.1 ev, probably related to defects due to the presence of Fe₃O₄. For another group the activation energy is 0.5-0.9 ev, possibly corresponding to an electronic phenomenon. The activation energy of α -Fe₂O₃ is 0.4 ev and of γ -Fe₂O₃ 0.07 ev.

537.311.33:548.53 465
Solute Redistribution by Recrystallization—R. G. Pohl. (*Jour. Appl. Phys.*, vol. 25, pp. 1170-1178; September, 1954.) Theoretical investigation of the modification of the distribution of impurities in a melt of metal or alloy during solidification. Results are presented graphically and tabulated, and are compared with previously published findings.

537.311.33:621.314.7 466
Transistor Electronics: Imperfections, Unipolar and Analog Transistors: Parts 2 and 3—W. Shockley. [*Proc. IRE (Australia)*, vol. 15, pp. 194-201 and 228-234, August and September, 1954.] Reprint, see 746 of 1953. Part 1: 3600 of 1954.

537.582 467
Thermionic Constants of Metals and Semiconductors: Part 4—Monovalent Metals (continued)—S. C. Jain and K. S. Krishnan.

(*Proc. Roy. Soc. A*, vol. 225, pp. 159-172; August 31, 1954.) Regarding the electrons in the metal and in the vapor phase as a single-component thermodynamic system, the temperature coefficient of the work function ϕ corresponds to an apparent lowering of Richardson's constant *A* by about 8-10 per cent. This agrees with experimental results. The effects of thermal expansion of the lattice and thermal agitation of the atoms on ϕ practically cancel each other, so that the observed variation of ϕ with temperature may be regarded as due to electronic specific heat alone. Part 3: 2700 of 1953.

538.221 468
The Spontaneous Magnetization of Alloys: Part 1—Copper Nickel Alloys—D. J. Oliver and W. Sucksmith. (*Proc. Roy. Soc. A*, vol. 219, pp. 1-17; August 11, 1953.) Report and discussion of measurements made to determine the variation of spontaneous magnetization with temperature. A magnetothermal method gives a curve below that obtained from purely magnetic measurements. The relation of the magnetocaloric temperature rise to the square of the magnetization is nonlinear above the Curie point.

538.221 469
Temperature of Heating in Thermomagnetic Treatment of Magnico Alloy—G. F. Golovin and A. A. Shekalov. (*Zh. Tekh. Fiz.*, vol. 24, pp. 1503-1507; August, 1954.) The effect was investigated experimentally of various heat treatments of the alloy (50.5 per cent Fe-23.6 per cent Co-13.6 per cent Ni-8.6 per cent Al-3.0 per cent Cu-0.05 per cent C) on the structure and magnetic properties. Results are presented graphically and microphotographs of surface structure are shown.

538.221 470
A Theory of Domain Creation and Coercive Force in Polycrystalline Ferromagnetics—J. B. Goodenough. (*Phys. Rev.*, vol. 95, pp. 917-932; August 15, 1954.) "Granular inclusions, grain boundaries, lamellar precipitates, and the crystalline surface have been examined as possible nucleation centers for domains of reverse magnetization in ferromagnetic materials. It is concluded that the surface density of magnetic poles at the grain boundaries is the most common source of nucleation energy in polycrystalline materials. The concept of nucleation of domains of reverse magnetization has led to a calculation of three more terms which may contribute to the coercive force in polycrystalline materials, viz., a grain-boundary, a lamellar-precipitate, and a domain-wall-surface-tension contribution. The theoretical predictions are compared with several old experiments. New insight is gained on the problem of stress sensitivity of polycrystalline ferromagnetics and *B-H* loop shape."

538.221:538.114 471
Theory of Ferromagnetic Resonance and Results of Experimental Investigation—K. H. Reich. (*Z. angew. Phys.*, vol. 6, pp. 326-338; July, 1954.) A survey of experimental and some theoretical work, with particular reference to Kittel's theory. 83 references include work up to October 15, 1953; several more recent references are given in the addendum.

538.221:538.652 472
Investigation of Magnetostriction of Iron-Nickel Alloy in Strong Magnetic Fields—G. P. D'yakov and R. A. Reznikova. [*Compt. Rend. Acad. Sci. (URSS)*, vol. 97, pp. 633-634; August 1, 1954. In Russian.] An experimental investigation of wires of composition 41 per cent Fe and 59 per cent Ni is reported. Plotting $\lambda_s - \lambda$ against H^{-2} , where λ_s is the saturation magnetostriction and H the magnetizing field, results in a straight line the slope of which is $32 K^2 \lambda_s / 35 J_s^2$, where K is a magnetic anisotropy constant and J_s the saturation magnetization. The result is briefly discussed.

538.221:538.652 473
Magnetostriction of Ferromagnetic Alloys based on Manganese—D. I. Volkov. [*Compt. Rend. Acad. Sci. (URSS)*, vol. 97, pp. 809-811; August 11, 1954. In Russian.] The materials investigated comprised the binary Mn alloys with Sb, Bi and Sn, and alloys of the type Cu-Mn-X, where X is Al, Sn, or Bi. Several of these are highly magnetostrictive both at room temperature and at -195 degrees C. The magnetostriction of 31.2 per cent Mn-68.8 per cent Sb rises to a value more than twice that of Ni at saturation; the longitudinal magnetostriction of 30.9 per cent Cu-14 per cent Mn-55.1 per cent Bi is about -140×10^{-6} at saturation, a value nearly equal to that for the best Pt-Fe alloy investigated by Kussmann and Rittberg (2788 of 1950). Experimental curves are given for several alloys.

538.221:538.652 474
A Peculiarity of Magnetostrictive Properties of Mn-Sn Ferromagnetic Alloys—D. I. Volkov and V. I. Leont'ev. [*Compt. Rend. Acad. Sci. (URSS)*, vol. 97, pp. 995-997; August 21, 1954.] Results are reported of an experimental determination of the longitudinal, transverse and volume magnetostriction in Mn-Sn alloys containing between 42 and 48 per cent Mn, at temperatures of -78 degrees and -195 degrees C. All three magnetostriction coefficients were found to be negative at saturation.

538.221:621.318.134 475
The Spontaneous Magnetization of Alloys and Compounds: Part 2—Ferrites—C. A. Clark and W. Sucksmith. (*Proc. Roy. Soc. A*, vol. 225, pp. 147-159; August 31, 1954.) Magnetic and magnetocaloric measurements have been made on Mn ferrite and Mg-Zn ferrite. Values of spontaneous magnetization obtained by three extrapolation techniques are similar; this agreement is maintained at temperatures about the Curie point, in contrast to the results for ferromagnetic materials [part 1: 468 above (Oliver and Sucksmith)]. The saturation magnetization of both ferrites and the reduced-magnetization/reduced-temperature curve for Mn ferrite are in satisfactory agreement with Néel's theory.

538.221:621.318.134 476
Magnetic Ferrites: New Materials for Modern Applications—V. E. Legg and C. D. Owens. (*Elec. Eng. (N.Y.)*, vol. 73, pp. 726-729; August, 1954.) Review of properties and applications of different ferrites, with a note on manufacturing processes. Typical characteristics of NiZn, MnZn and Ni ferrites are tabulated. *Q* values and applications in different frequency ranges are listed.

538.247 477
Investigation of Hysteresis of Ballistic Demagnetization Factor—A. P. Lyustrova and V. A. Lipatova. (*Zh. Tekh. Fiz.*, vol. 24, pp. 1513-1519; August, 1954.) An experimental investigation is reported. Soft and hard ferromagnetic specimens in prismatic form were used.

621.315.61:537.533.8 478
A Method of Investigating the Secondary Emissive Properties of Insulators—C. N. W. Litting. (*Brit. Jour. Appl. Phys.*, vol. 5, pp. 289-293; August, 1954.) The method is limited to surfaces with $\delta > 1$. The insulator under investigation is in contact with a backing plate to which is applied a square wave whose mark/space ratio is varied to obtain zero net loss of charge from the surface over a complete cycle. The mark/space ratio of this waveform is then used to compute the value of δ . Results obtained from simultaneous measurements using this method and a dc one show very good agreement. Difficulties are discussed. The method may also be used to determine the energy distribution of the secondary electrons.

- 621.315.612:537.226.31 479
Dielectric Losses in High-Frequency Ceramics—N. P. Bogoroditski and I. D. Fridberg. (*Zh. Tekh. Fiz.*, vol. 24, pp. 1194-1204; July, 1954.) A discussion of previously published experimental results is used as a basis for classifying dielectric loss mechanisms; seven main types are tabulated and the conditions for these losses to be low or high are stated.
- 621.315.612:621.385.032 480
Advances in Ceramics related to Electronic Tube Developments—L. Navias. (*Jour. Amer. Ceram. Soc.*, vol. 37, pp. 329-350; August 1, 1954.) A detailed study is made of the physical properties of alumina, forsterite, zircon-talc and steatite in relation to the requirements of tubes for operation in the 3-cm waveband. The development of sealing techniques is described, and details are given of methods of making ceramic/metal seals using (a) Mn-Mo, (b) MoO₃ or (c) TiH₂ as the metallizing agent.
- 621.315.613.1 481
Three Forms of Synthetic Micas—T. B. Merrill, Jr. (*Materials and Methods*, vol. 40, pp. 80-83; August, 1954.) Discussion of the preparation, properties and uses of material obtained by (a) glass-bonding finely powdered mica, (b) reconstituting small flakes into sheets by calendaring, or (c) hot-pressing finely powdered mica into homogeneous blocks.
- 621.791.3:546.621 482
Soldering Aluminum—J. C. Bailey and J. A. Hirschfeld. [*Research (London)*, vol. 7, pp. 320-326; August, 1954.] A review is presented of methods, materials, techniques and applications. Tables are given of the composition of various solders and their melting points, and of results of breaking and tensile strength tests on soldered joints. Solder embrittlement and corrosion are also discussed.
- MATHEMATICS**
- 517 483
On the Behavior of the Solutions of the Differential Equation $\Delta U = F(x, U)$ in the Neighborhood of a Point—C. Müller. (*Commun. pure Appl. Math.*, vol. 7, pp. 505-515; August, 1954.) An equation involved in the theory of em oscillations is investigated.
- 517.9 484
An Extended Use of Perturbation Theory—R. N. Gould and A. Cunliffe. (*Phil. Mag.*, vol. 45, pp. 818-822; August, 1954.) A method of solving partial differential equations arising in boundary-layer problems is given.
- 517.7 485
Handbook of Elliptic Integrals for Engineers and Physicists [Book Review]—P. F. Byrd and M. Friedman. Publishers: Springer, Berlin, Germany, 1954, 355 pp., 36 DM. (*Arch. elekt. Übertragung*, vol. 8, p. 403; September, 1954.)
- 518.3 486
Leitfaden der Nomographie [Book Review]—W. Meyer zur Capellen. Publishers: Springer, Berlin, Germany, 1953, 178 pp., 17.40 DM. (*Z. angew. Phys.*, vol. 6, p. 334; August, 1954.) The theoretical bases of nomography are presented and numerous examples and applications are given.
- MEASUREMENTS AND TEST GEAR**
- 621.3.018.41(083.74)+529.786]:538.569.4 487
Atomic Clocks and Frequency Standards on an Ammonia Line: Parts 2 and 3.—K. Shimoda. [*Jour. Phys. Soc. (Japan)* vol. 9, pp. 558-575; July/August, 1954.] Use of the Zeeman and Faraday effects for eliminating causes of error in atomic clocks is examined. The nonreciprocal transmission characteristics of a waveguide absorption cell in an axial magnetic field are investigated theoretically in relation to the design of a highly accurate clock. An arrangement is described which makes use of Stark, source and Zeeman modulation and is free from errors due to reflections in the microwave line. Preliminary results using a cell of length 1 m indicate that accuracy within 10⁻⁹ is obtainable.
- 621.3.018.41(083.74):621.373.421.13 488
Audio and R.F. Secondary Frequency Standard—R. C. Moses. (*Radio-Electronic Eng.*, vol. 23, pp. 16-18, 30-31; August, 1954.) The frequency standard supplies sine-wave and square-wave outputs at five frequencies between 1 kc and 100 kc, and harmonics of a basic 100-kc oscillator up to 150 mc. The 100-kc master oscillator is maintained at constant temperature and operated at very low power level. Supplementary crystal-stabilized 1-mc and 10-mc oscillators are used. The frequency divider comprises cascaded decade-scaling circuits with stability dependent primarily on tuned LC circuits.
- 621.316.84(083.74) 489
Enclosed Standard Resistors—A. Schulze and H. Zacherl. (*Z. angew. Phys.*, vol. 6, pp. 324-326; July, 1954.) The construction of the Au-Cr resistor [772 of 1953 (Schulze and Ericke)] and of the manganin resistor is modified to make it watertight. Helium is found to provide the best atmosphere for the Au-Cr type, argon or nitrogen for the manganin type.
- 621.317.3 490
Measurement Methods—(*Fernmeldetechn. Z.* vol. 7, pp. 379-436; August, 1954.) A special number including the following papers:
 "Measurements on Coaxial Cables,"—A. Knacke (pp. 387-393.) The pulse reflection method is discussed.
 "High-Accuracy Direct-Indicating Frequency Meter,"—J. Hacks (pp. 394-398.) Equipment using counter circuits is described.
 "Development Trends in Impedance Meters for Very High Frequencies,"—R. Eichaker (p. 399).
 "Ratio Meter for Determination of Admittance particularly in the U.S.W. Range,"—H. Fricke (p. 400).
 "Direct Indication of Envelope Delay in the Frequency Range 100 kc/s-5 Mc/s,"—W. Kaiser and H. Wilde (pp. 401-405.) Variations of envelope transmission time down to 10⁻⁹ seconds are determined from very accurate phase measurements.
 "Investigations with a Direct-Indicating Envelope-Delay Meter in the Range 60-90 Mc/s,"—H. Reiner (pp. 406-409.) Oscillograms are shown of phase-delay characteristics of various quadripoles, if amplifiers and imperfectly terminated cables.
 "Methods of Measurement of Impedance at Frequencies up to 10 kMc/s,"—A. Jauermann (pp. 410-418.) Methods using bridges and directional couplers for measurement of impedance or reflection coefficient are described.
 "Noncontacting Plungers for Microwave Instruments,"—J. Deutsch and O. Zinke (pp. 419-424.) New designs give increased bandwidth and reduced losses.
 "Time-Expanding Methods for Cathode-Ray Oscillographs,"—J. Czech (pp. 425-430).
- 621.317.3:621.314.7 491
Stability Considerations in the Parameter Measurements of V.H.F. Point-Contact Transistors—D. E. Thomas. (*Proc. I.R.E.*, vol. 42, pp. 1636-1644; November, 1954.) In early forms of measurement equipment for transistors the α cut-off frequencies involved were low enough for lead impedances and parasitic shunt capacitances to be neglected. Modified forms of equipment are discussed suitable for dealing with later types of transistor having α cut-off frequencies in the vhf range. Negative-resistance collector regions may give rise to discontinuities in the static characteristics. Simple circuits are shown for characteristic-curve tracers with either oscilloscope or X-Y recorder presentation.
- 621.317.3:621.396.674.1 492
Generation of Standard Fields in Shielded Enclosures—F. Haber. (*Proc. I.R.E.*, vol. 42, pp. 1693-1698; November, 1954.) With the known method of calibrating loop antennas by arranging the loop in the vicinity of a radiating wire inside an enclosure, the boundary conditions in the formulas involved are satisfied for an infinite set of images. Errors are introduced if consideration is limited to one or two images; errors are also caused by frequency limitations. New formulas are derived which give the field strength accurate to within 1 per cent for low and medium frequencies. A method of estimating the error for high frequencies is discussed.
- 621.317.331 493
An Absolute Measurement of Resistance by Albert Campbell's Bridge Method—G. H. Rayner. (*Proc. IEE*, part IV, vol. 101, pp. 250-257; August, 1954. Digest, *ibid.*, part II, vol. 101, pp. 574-575; October, 1954.) Two determinations of the unit of resistance in terms of mutual inductance and frequency were made during 1951 using Campbell's bridge method. They gave the same value within 1 part per million, and the mean value agreed with that found in 1936 to the same accuracy. The value obtained for the ohm as maintained by the group of coils forming the reference standard at the National Physical Laboratory is: 1 N.P.L. ohm = 1.000 002 ± 0.000 015 absolute ohm.
- 621.317.331:621.385.032.216 494
Sensitive Apparatus for the Measurement of Cathode Parasitic Resistance—Sevin. (*See* 598.)
- 621.317.333.6.029.62 495
A Breakdown Cell for Measuring the Dielectric Strength of Solids at 100 Megacycles—L. J. Frisco and J. J. Chapman. (*Rev. Sci. Instr.*, vol. 25, pp. 733-737; August, 1954.) The cell is liquid-filled and contains the specimen under test, a high-voltage resonant circuit, and a built-in probe for measuring voltage. The calibration of the voltage-measurement network is discussed.
- 621.317.335:621.317.336.029.6 496
The Computation of the Complex Dielectric Constant from Microwave Impedance Measurements—J. P. Poley. (*Appl. Sci. Res.*, vol. B4, pp. 173-176; 1954.) Diagrams supplementing that developed by Benoit (935 of 1950) are presented for facilitating determination of the complex dielectric constant.
- 621.317.335:621.372.413 497
Dielectric Measurements with H_{01n} Resonant Cavities having Appreciable Loading—J. L. Farrands. (*Proc. IEE*, part III, vol. 101, pp. 404-406; November, 1954.) "Modifications to the usual formulas for dielectric measurements in H-mode cavities are suggested to allow for damping due to coupling irises. The correction permits the use of low-level sources."
- 621.317.335.2.029.4 498
The Measurement of Capacitance at Low Frequencies—P. Phillips. [*Proc. IRE (Australia)*, vol. 15, pp. 191-193; August, 1954.] "The fundamental formulas relating the series and parallel equivalent circuits of a lossy capacitor are given and some methods of measuring capacitor properties at low frequencies are discussed."
- 621.317.335.3(083.74) 499
Capacitor with Definite Loss Angles for Checking Bridge Measurements at Power Frequency—A. W. Stannett. (*Jour. Sci. Instr.*, vol. 31, p. 304; August, 1954.) Description of improvements to the synthetic "lossy" capacitor constructed to represent a filled oil cell and

required in connection with the international comparison of power-factor measurements.

621.317.353+621.396.822]:621.316.8 500
New Resistor Voltage-Coefficient Tester—Rosenthal and Louis. (See 355.)

621.317.42:621.385.832 501
The Use of an Electron Beam for the Accurate Measurement of Alternating Magnetic Field Strengths—S. E. Barden and K. Phillips. (*Proc. IEE*, part II, vol. 101, pp. 441-449; August, 1954. Digest, *ibid.*, part III vol. 101, p. 406; November, 1954.) A method of making measurements relative to a standard field uses a lv electron-optical system which produces a beam if the magnetic field in which it is placed is less than or of the order of 0.01G. The measurement is based on the voltage pulse produced at field zero. The operation of the instrument in time-varying fields such as those in particle accelerators is discussed.

621.317.44 502
An Automatic Plotter for Magnetic Hysteresis Loops—H. McG. Ross. (*Proc. IEE*, part II, vol. 101, pp. 417-427; August, 1954. Discussion, pp. 427-430.) An instrument is described with which measurements are made under substantially zero-frequency conditions, the period of the cycle being nearly one minute. The magnetic flux is detected by a search coil on the sample, the emf being amplified and integrated by a variable-speed motor on the plotting table, whereby the displacement of the pen is a measure of the magnetic induction. Calibration is in terms of voltage and time.

621.317.7:621.373.421.1 503
Small-Amplitude Oscillator for Capacitive Measurement of the Deflection of Sensitive Rotating Systems—J. W. Hiby and K. G. Müller. (*Z. angew. Phys.*, vol. 6, pp. 361-363; August, 1954.) In a modified form of the capacitance micrometer using a quartz resonator, described e.g. by Dye (*Proc. Phys. Soc.*, vol. 38, pp. 399-457; 1926.), the oscillation amplitude is made very small so that the mechanical force on the oscillator plate is practically zero. Variation from the nominal frequency of 3.17 mc is not more than 5 parts in 10^6 . Spontaneous amplitude fluctuations occur when the amplitude falls below 15 mveff.

621.317.723 504
A General-Purpose Electrometer—R. M. Fry. (*Jour. Sci. Instr.*, vol. 31, pp. 269-271; August, 1954.) An instrument based on the Townsend null method, but incorporating automatic adjustment of the compensating voltage, is described. It is suitable for free-air-chamber work and for extrapolation-chamber work over the current range 10^{-12} - 10^{-9} a, and can be adapted for use in a bridge circuit for capacitance measurement.

621.317.729 505
Some Applications of the Electrolytic Tank to Engineering Design Problems—H. Diggle and E. R. Hartill. (*Proc. IEE*, part II, vol. 101, pp. 349-364; August, 1954. Discussion, pp. 364-368.) The solution of problems relating mainly to electric and magnetic fields is discussed.

621.317.733:621.317.4 506
A New Method for Measurement of Complex Susceptibility by Magnetic Resonance Absorption in the U.S.W. Range—W. Müller-Warmuth. (*Naturwiss.*, vol. 41, p. 368; August, 1954.) A bridge method is used in which the balance is highly sensitive to the absorption. A special heterodyne receiver is used as a null indicator instrument.

621.317.743:621.372.56 507
A Radio-Frequency Transformer Attenuator for use with a Level Recorder—C. G. Mayo and R. E. Jones. (*Proc. IEE*, part III, vol. 101, pp. 401-403; November, 1954.) An

attenuator for operation at 10.7 mc is described which can be substituted for the potentiometer of a commercial high-speed level recorder without requiring modification of the latter. A method of recording field strength is indicated using the attenuator and level recorder with a receiver having an IF of 10.7 mc.

621.317.784.029.63 508
U.H.F. Meter measures Low Power Levels—R. L. Bailey and J. B. Quirk. (*Electronics*, vol. 27, pp. 159-161; November, 1954.) A coaxial-line device is described for measuring power in the range 10-100 μ w at frequencies up to 900 mc with an insertion loss <0.8 db.

621.37/39.001.4 509
Pan-climatic Testing—G. W. A. Dummer, S. C. Schuler and J. E. Green. (*Wireless World*, vol. 60, pp. 598-600; December, 1954.) Information compiled for the Ministry of Supply K. 114 series of test schedules for Service equipment is summarized. The tests cover combinations of extreme climatic conditions and mechanical stresses. A list is given of common faults in electronic equipment as indicated by this series of tests.

621.373.4.029.64 510
New 7-11-kMc/s Signal Generator yields Valuable Design Hints—A. Fong. (*Tele-Tech*, vol. 13, pp. 92-93, 184; August, 1954.) An account is given of some of the problems encountered in the design of a signal generator suitable for pulse work, slotted-line work and applications requiring a sawtooth FM signal. The oscillator uses a Type-5721 reflex klystron with a $\frac{3}{2}\lambda$ coaxial-line resonator. The frequency range is covered by means of two repeller modes: the $3\frac{3}{2}$ mode for the 7-9 kmc range, the $4\frac{3}{2}$ mode above 9 kmc. A special plunger is used to suppress the $\lambda/4$ resonator mode. A waveguide operated beyond cut-off is used as output attenuator. The power-output monitor is also briefly discussed.

621.397.61.001.4 511
Color Test Technique for TV Broadcasters—J. W. Wentworth. (*Electronics*, vol. 27, pp. 120-123; November, 1954.) Methods of testing the amplitude/frequency, phase/frequency, differential-gain and differential-phase characteristics of transmitters are outlined. Color-bar and dot-pattern generators are described.

621.397.62.001.4 512
Measurements on Television Receivers: Part 5—Measurements on the Deflection System—O. Macek. (*Arch. tech. Messen*, no. 224, pp. 205-208; September, 1954.) Part 4: 3634 of 1954.

OTHER APPLICATIONS OF RADIO AND ELECTRONICS

526.2:535.22.082.5/7 513
The Geodimeter—an Electronic "Eye" for Measuring Distance—C. E. Granqvist. (*Tele-Tech*, vol. 13, pp. 68-69, 148; September, 1954.) Bergstrand's Kerr-cell method of measuring the velocity of light (3396 of 1952) is applied to the converse problem of distance measurement.

535.24:778 514
A Simple Integrating Light Meter—W. Hartnagel. (*Z. angew. Phys.*, vol. 6, pp. 310-313; July, 1954.) The measurement is affected by means of a photocell, the current from which periodically discharges a capacitor; the latter is automatically recharged by a relaxation oscillator which simultaneously actuates a counter.

621.316.718:534.85:621.94 515
Recorder-Controlled Automatic Machine Tools—E. W. Leaver and G. R. Mounce. (*Electronics*, vol. 27, pp. 124-128; November, 1954.) Description of the operation of an engine lathe in which the carriage feed and cross feed are actuated by motors controlled by signals

magnetically recorded on wire or tape. A sinusoidal reference oscillation is used.

621.317.39:61 516
Electrical Techniques in Medicine—C. N. Smyth. (*Trans. Soc. Instr. Tech.*, vol. 6, pp. 84-95; June, 1954. Discussion, pp. 95-96.) A survey is presented of electrical instruments with particular reference to the measurement of pressure and strain. About 100 applications are classified in nine main groups and the principles of operation of several instruments, such as the ultrasonic microscope, are briefly described. 63 references.

621.383.2:778.37 517
Application of the Electron-Optical Converter for Photography of High-Speed Processes—M. P. Vanyukov and E. V. Nilov. (*Zh. Tekh. Fiz.*, vol. 24, pp. 1209-1218; July, 1954.) Application of the A.E.G. electrostatically focused three-electrode image-converter to the photography of spark discharges of duration 0.4-2 μ s is discussed. Image distortion observed with photocathode illumination $>10^6$ lux is related to the field distribution in front of the photocathode and the build-up of the space charge.

621.384.611 518
Alternating Gradient Focusing of Cyclotron External Beam—E. L. Hubbard and E. L. Kelly. (*Rev. Sci. Instr.*, vol. 25, pp. 737-739; August, 1954.) Description of an arrangement comprising three alternately converging and diverging electrostatic lens elements of hyperbolic cross section for focusing the $\frac{3}{2}$ -MeV external proton beam for the 20-inch Berkeley cyclotron.

621.385.833 519
Requirements contributing to the Design of Devices used in correcting Electron Lenses—G. D. Archard. (*Brit. Jour. Appl. Phys.*, vol. 5, pp. 294-299; August, 1954.) Voltage requirements and positioning tolerances are discussed.

621.385.833 520
Experimental Investigation of Cylindrical Magnetic Electron Lenses—V. M. Kol'man, D. L. Kaminski and S. Ya. Yavor. (*Zh. Tekh. Fiz.*, vol. 24, pp. 1410-1427; August, 1954.) Formulas derived, assuming the lens field to be practically equal to that produced by equal currents flowing in opposite directions along two parallel infinitely long wires, were tested experimentally. The calculated and measured values were in good agreement. Results for one lens and for a system of two cylindrical lenses are presented graphically and the apparatus used is briefly described.

621.385.833 521
The Theoretical Resolving Power of an E.S. Immersion Objective—A. Septier. (*Jour. Phys. Radium*, vol. 15, pp. 573-581; July/September, 1954.) Calculations based on geometrical optics give a limiting value of the order of 30 $m\mu$ for the resolving power. This might be reduced to about 10 $m\mu$ by special grid design, but spherical aberration is then of the same order of magnitude. Calculations based on the distribution of electron density in planes adjacent to that of the Gaussian image give a theoretical limiting value of the order of 1 $m\mu$.

621.385.833:537.533 522
Field-Emission Current Densities and Surface Field Strengths in Field-Emission Microscopes, and Methods for the Determination of the Radius and Shape of the Point, the Magnification and the Resolving Power—M. Drechsler and E. Henkel. (*Z. angew. Phys.*, vol. 6, pp. 341-346; August, 1954.)

621.387.424 523
The Efficiency of Halogen-Quenched Geiger-Counters for X Rays—D. van Zoonen.

(*Appl. Sci. Res.*, vol. B4, no. 3, pp. 196-204; 1954.)

621.387.424 524
Small-Diameter Geiger-Müller Counters with External Cathode—D. Blanc. (*Jour. Phys. Radium*, vol. 15, p. 590-591; July/September, 1954.) Counters 6 mm in diameter, with methylal/argon filling, and having a Geiger threshold of 820 v are described.

621.398:621.396.65 525
Radiation Monitor for Atomic Explosions—(*Tech. News Bull. Nat. Bur. Stand.*, vol. 38, pp. 116-118; August, 1954.) Data on the radiation intensity and other variables in the neighborhood of the explosion are automatically measured and transmitted by radio to a control station, where the operator is able to select one of several data stations and is also able to select the particular property on which to be informed. The vhf FM radio link and station interrogation system are based on standard equipment including a 0.25-w portable transmitter-receiver. Repeater stations capable of handling information from ten data stations are located at positions of high elevation.

681.81:621.3 526
Electronic Musical Instruments—W. Kwasnik. (*Elektrotech. Z., Edn. B*, vol. 6, pp. 305-312; August 21, 1954.) A historical survey from 1761 up to date includes brief descriptions of instruments, their principles of operation and circuits used. 31 references.

PROPAGATION OF WAVES

538.566:537.562:621.37 527
Analogues of an Ionized Medium—R. N. Bracewell. (*Wireless Eng.*, vol. 31, pp. 320-326; December, 1954.) The propagation of plane waves in ionized media can be represented by equations of the same form as those representing wave propagation in transmission lines. Equivalent circuits are presented for propagation in (a) free space, (b) an ionized medium, (c) an ionized medium, taking account of collisions, (d) the ionosphere, taking account of inhomogeneities. The analogy provides an explanation of the ability of a highly reflecting layer to transmit radiation if the medium beyond the reflecting layer satisfies certain conditions of resonance. Mechanical and waveguide analogs of the ionized medium are also mentioned.

538.566:551.510.535 528
The Propagation of Long Electric Waves round the Earth in relation to Transmission Interference and Lightning Atmospherics—W. O. Schumann. (*Z. angew. Phys.*, vol. 6, pp. 346-352; August, 1954.) Literature on long-wave propagation is surveyed. In order to explain the "slow-tail" phenomena of atmospherics, very low values of ionosphere conductivity must be assumed. On the other hand, in order to explain numerous observations of signals comprising multiply reflected pulses high conductivity must be assumed, and in some cases different reflection heights. Further observations and analysis are required.

621.396.11+551.510.53 529
Rocket Exploration of the Upper Atmosphere—Boyd, Seaton and Massey. (*See* 424.)

621.396.11 530
Velocity of Radio Waves—R. L. Smith-Rose. (*Wireless World*, vol. 60, pp. 590-591; December, 1954.) At the 11th General Assembly of the International Scientific Radio Union in 1954 the value of 299792 ± 2 km was adopted for the velocity of em waves in vacuum. The circumstances leading to this decision are outlined.

621.396.11 531
The Extension of Sommerfeld's Formula for the Propagation of Radio Waves over a Flat Earth, to Different Conductivities of the

Soil—H. Bremmer. (*Physica*, vol. 20, pp. 441-460; August, 1954.) Propagation over a mixed terrain is discussed, starting from an integral equation of the type used by Hufford (2311 of 1952). Such an integral equation can take account of different distributions of the dielectric constant and conductivity in the region between the point source and the receiving point. The solution for the special case of two adjacent homogeneous media is identical with Clemmow's solution (3688 of 1953). Expressions derived are suitable for numerical computations. The case of three adjacent media is also investigated.

621.396.11 532
Ray-Path Characteristics in the Ionosphere—G. Millington. (*Proc. IEE*, part IV, vol. 101, pp. 235-249; August, 1954. *Digest, ibid.*, part III, vol. 101, pp. 193-196; May, 1954.) A quicker and more accurate method of making magneto-ionic calculations is presented than that previously given (778 of 1952), based on the introduction of a new parameter. Propagation in the magnetic meridian plane is studied in detail, including the phenomenon described by Poeverlein of a cusp at the ray-path apex within a certain critical angle of incidence. The theory indicates that the effect of lateral deviation on direction finding is too small to be observable except under special conditions unlikely to occur in practice.

621.396.11:531.510.535 533
Some Notes on the Absorption of Radio Waves reflected from the Ionosphere at Oblique Incidence—W. J. G. Beynon. (*Proc. IEE*, part III, vol. 101, pp. 367-370; November, 1954.) Discussion on 1550 of 1954.

621.396.11:551.510.535 534
The Reflection and Absorption of Radio Waves in the Ionosphere—W. R. Piggott. (*Proc. IEE*, part III, vol. 101, pp. 367-370; November, 1954.) Discussion on 1679 of 1953.

621.396.11.029.45:551.594.6 535
Theoretical Calculations of Field of Low-Frequency Electromagnetic Waves above Earth's Surface—Ya. L. Al'pert. [*Compt. Rend. Acad. Sci. (URSS)*, vol. 97, pp. 629-632; August, 1954. In Russian.] The propagation of lightning atmospherics at frequencies between about 0.5 and 15 kc is considered. Numerical results of field-strength calculations are presented graphically using a formula relating the field strength (in mv/m) at distances greater than about 50-100 km to the frequency, the antenna current (in a), the effective antenna and ionosphere heights and the distance (all in km), and functions of the reflection coefficient and complex permittivity of the ionosphere. Infinite conductivity of the earth's surface is assumed. The variation of the amplitude and of the phase velocity with distance is also shown graphically. Results are compared with experimental results of Chapman and Matthews (419 of 1954) showing the relation between relative amplitude and frequency at distances of 500, 1000 and 2000 km, and those of Weekes (1491 of 1950) showing the relation between signal strength \times distance and distance; the frequency used in the calculation was near 15 kc, that in the latter experiments 16 kc. Good agreement was obtained with both sets of observations, indicating that the irregular properties of the field are principally due to complex interference effects rather than to irregularities of the transmission medium.

621.396.11.029.55:551.510.535 536
Ionospheric Absorption at Vertical and Oblique Incidence—G. McK. Allcock. (*Proc. IEE*, part III, vol. 101, pp. 360-367; November, 1954. Discussion, pp. 367-370.) Research on ionospheric absorption is briefly reviewed and an account is given of an experimental investigation made in New Zealand during 1949-1950. The relation between absorption at verti-

cal incidence and absorption over an 800-km oblique-incidence path was studied by measurements on frequencies of 5.455 and 9.16 mc respectively. The observed results differ from those predicted by Martyn's absorption theorem by an amount which is subject to a diurnal variation. Empirical formulas are derived for diurnal and seasonal variation of absorption.

621.396.11.029.64:535.4 537
The Reflection of Electromagnetic Waves From a Rough Surface—H. Davies. (*Proc. IEE*, part IV, vol. 101, pp. 209-214; August, 1954. *Digest, ibid.*, part III, vol. 101, p. 118; March, 1954.) A statistical method is used to investigate scattering and reflection from perfectly conducting surfaces having random irregularities which are assumed to be not so large as to shield any part of the surface from the incident radiation. The method is used to study scattering of light by a disturbed water surface and to calculate the sea clutter in radar at centimeter wavelengths; the calculated results in the latter case are compared with observations reported previously (3257 of 1947 (Davies and Macfarlane)) and the limitations of the approximation are discussed.

621.396.812.029.62 538
Long-Distance U.S.W. Reception—E. A. Lauter and L. Klinker. (*NachrTech.*, vol. 4, pp. 242-247, 271; June, 1954.) Records of field-strength measurements made at Kühlungsborn since 1951 are analyzed in respect of diurnal variations of mean level, sudden changes in level, and rapid fluctuations. Data cover transmissions in the 87.5-100-mc band over two 200-km land paths and one 180-km sea path, and hourly records of some 30 transmissions over distances 50-500 km. Refraction theory accounts satisfactorily for propagation over distances up to three times the optical range; partial reflections can give field strengths below the horizon only 20-30 db below the level for free-space propagation; relatively high mean field strength at great distances during unstable atmospheric conditions is ascribed to scattering processes.

621.396.812.3 539
Spaced-Receiver Experiments on Radio Waves of 19-km Wavelength—J. Harwood. (*Proc. IEE*, part IV, vol. 101, pp. 183-186; August, 1954. *Digest, ibid.*, part III, vol. 101, pp. 113-115; March, 1954.) Signals from GBR were received at a distance of about 100 km at two spaced sites. Fading records of the wave reflected from the ionosphere indicated the presence of a randomly varying component superposed on the steady amplitude. The correlation between the records at the two receiving points was about 0.8 for a spacing of 15 km and 0.35 for a spacing of 40 km. The time variations of the random component were consistent with reflection from scattering centers in the ionosphere moving with random velocities having an rms value of about 8 m/s in the line of sight, or drifting steadily with a velocity of about 100 m/s in a direction predominantly east-west.

RECEPTION

621.376.332:621.396.822 540
The Statistical Properties of the Output of a Frequency Sensitive Device—G. R. Arthur. (*Jour. Appl. Phys.*, vol. 25, pp. 1185-1195; September, 1954.) Analysis is presented for a frequency discriminator with an input consisting of a narrow-band spectrum with random characteristics. For the case when the output is not filtered, a solution is found in which the output is given as the difference between two independent random quantities; the characteristic function method is used. For the case when the discriminator is followed by a filter, a solution is found by determining the predominant moments of the output probability density from a series expansion. This method shows that the Gaussian density is approached

when the output filter has a very narrow pass band.

621.396.62 541
Ratio Squarer—L. R. Kahn. (*Proc. I.R.E.*, vol. 42, p. 1704; November, 1954.) Analysis indicates that in order to optimize the combined output signal/noise ratio in a diversity system in which the signals are added linearly and the noise according to root mean squares, the ratio of the signal levels should be squared before combination. A block diagram of a circuit used in the U. S. Army AN/FGC-29 equipment for obtaining the ratio squarer selection curve in a two-receiver system is shown.

621.396.621:621.314.7 542
Transistor Circuit—W. G. Walter and K. Walter. (*Wireless World*, vol. 60, p. 595; December, 1954.) The circuit is given of a highly selective receiver using a single junction transistor and a Ge diode. The signal drive is on the emitter and the rectified signal is derived from a coil in the base circuit.

STATIONS AND COMMUNICATION SYSTEMS

621.376:621.396.822 543
Theoretical Limits for Transmission in the case of High Noise Level for Different Continuous and Coded Modulation Systems—F. de Jager. (*Onde élect.*, vol. 34, pp. 675-682; August/September, 1954.) Using optimum bandwidth, the minimum power necessary for transmitting a sinusoidal signal to give a signal/noise ratio of 30-40 db at the receiver output is roughly the same for FM, PPM, binary-code PM and delta modulation systems, the noise level in the transmission channel being such that the signal/noise ratio obtainable with ssb modulation using the same power is 17-20 db. The required minimum power is a few db higher if pulses are modulated at hf. When the transmission chain comprises many sections the necessary power per section is much higher for continuous modulation systems such as FM and AM, but only a few db higher for coded systems.

621.376.5:621.39 544
Mean [energy] Spectrum of a Train of Pulses of Generally Periodic and Identical Character but Displaced and Deformed in a Random Manner—R. Fortet. (*Onde élect.*, vol. 34, pp. 683-687; August/September, 1954.) General formulas are derived, particular cases having been dealt with by Macfarlane (217 of 1950). The spectrum comprises: (a) lines at harmonics of the theoretical pulse repetition frequency, the amplitudes being dependent on the deformation and displacement of the pulses; (b) a continuous spectrum dependent on both deformation and displacement; this disappears if the pulse train is undisturbed. Thus the ratio of the total energies of (a) and (b) is effectively a signal/noise ratio.

621.396.41 545
A New Frequency-Division Multiplex Radiotelegraphy System (MADFAS)—A. Niutta. (*Poste e Telecomun.*, vol. 22, pp. 171-178; April, 1954.) Description of a frequency-shift system designed for high frequency stability and low frequency-band occupancy. The signal is generated in the af band and raised to radio frequency by successive modulations. A pilot frequency is transmitted for automatic control of the receiver oscillator. Tests made between Rome and Amsterdam gave satisfactory results.

621.396.712.3 546
New Unit-Construction Studio Equipment—G. Schadwinkel. (*Tech. Hausmitt. Nordw-Dtsch. Rdfunks*, vol. 6, nos. 5/6, pp. 137-140; 1954.) Details are given of the microphone supply unit Type N52a and the adjustable bandpass filter Type W75k.

621.396.933 547
A Single-Sideband Controlled-Carrier System for Aircraft Communication—G. W. Barnes. (*Proc. IEE*, part III, vol. 101, pp. 399-400; November, 1954.) Discussion on 2512 of 1954.

621.376.:621.39 548
Modulation Theory [Book Review]—H. S. Black. Publishers: Van Nostrand, New York and London, 1953, 363 pp., \$8.75. (*Science*, vol. 120, p. 342; August 27, 1954.) The subject is considered in the light of information theory, with primary emphasis on the systems aspect of modulation. The material presented has been used in the communications development training program of the Bell Telephone Laboratories.

SUBSIDIARY APPARATUS

621-526 549
Analysis of Systems Involving Difference-Differential Equations—T. M. Burford. (*Jour. Appl. Phys.*, vol. 25, pp. 1145-1148; September, 1954.) A method alternative to that presented by Chu (1185 of 1954) for analysis of control systems.

621-526:621.372.55 550
Compensation Networks for Carrier-Frequency Servomechanisms—P. Bonnet. (*Onde élect.*, vol. 34, pp. 688-699 and 812-818; August-October, 1954.) Methods are described for determining the transfer function and for the synthesis of gain- and phase-correction networks, particularly symmetrical bridged-T and parallel-T networks.

621.311.6:621.396.712 551
Power Supply for Automatically Controlled Transmitters—H. Kreuzträger. (*Tech. Hausmitt. Nordw-Dtsch. Rdfunks*, vol. 6, pp. 133-136; 1954.) Descriptions are given of the normal arrangements for taking power from the public supply and of emergency arrangements using batteries or Diesel generators.

621.314.634.3.012 552
Selenium Rectifier Instantaneous Characteristics—G. F. Pittman, Jr. (*Trans. AIEE*, Part I, *Communication and Electronics*, vol. 73, pp. 45-49; March, 1954. *Digest, Elec. Eng. (N.Y.)*, vol. 73, p. 719; August, 1954.) Current/voltage characteristics obtained by applying a rectified sinusoidal voltage to a Se cell in the reverse direction have been recorded. A current in the forward direction flows during a large part of the cycle. A convenient equivalent circuit to explain this result comprises nonlinear capacitance and nonlinear resistance in parallel. Both resistance and capacitance decrease with increasing reverse voltage and are relatively independent of the frequency of the supply voltage over a wide range.

621.396.63 553
Signal-Operated Switching—R. Selby. (*Wireless World*, vol. 60, pp. 613-615; December, 1954.) Description of a fault-warning system operated by cessation of an audio signal and used as a program-failure alarm. The circuit is based on a thyratron tube.

TELEVISION AND PHOTOTELEGRAPHY

621.397.26:621.396.65 554
The U.H.F. Radio-Link Equipment Type-RVG 904 for relaying Television Signals—C. Boden. (*NachrTech.*, vol. 4, pp. 267-271; June, 1954.) Review of the transmitter and receiver circuits and the antenna system of the equipment [3693 of 1954 (Mansfeld)], illustrating problems of design. A coaxial coupling system is used; the frequency-conversion stage at the input has a parallel-fed oscillator and push-pull IF output; the transmitter amplifier comprises four stages in cascade. Matching arrangements are outlined and operating characteristics are shown. Details are given of an uhf discriminator connected to the antenna feeder for monitoring purposes.

621.397.26:621.397.62:535.88 555
Large-Screen Projection Television: Demonstration at the Palais de Chaillot of News Item televised from Tours—R. Aubert and M. Sollima. (*Rev. gén. élect.*, vol. 63, pp. 533-535; September, 1954.) The demonstration was presented in May, 1954, to mark the occasion of the sixtieth anniversary of the École supérieure d'Électricité and of the Tours Week; it constituted the first radio relay of a televised news item by the French broadcasting organization. The existing Paris-Tours link was used in reverse. The relay stages and equipment used are indicated briefly; the pickup tube was a supericonoscope of French manufacture, and the projection system was of Schmidt type.

621.397.5 556
Reflections on the Future Development of Television—F. Schröter. (*Ricerca sci.*, vol. 24, pp. 1613-1640; August, 1954. In French.) A survey of problems involved, including program distribution, simplification of synchronizing-pulse scheme, collective reception, transmission of picture and sound on common carrier, and reduction of receiver costs. The imminence of color television in Europe enhances the need for unifying standards. Advantages of image storage at the receiver are discussed and various methods of compressing signal bandwidth are compared.

621.397.5:535.623 557
The Electronic Colour-Television System developed by the Société nouvelle de l'Outillage R.B.V. and the Société La Radio-Industrie—L. Kohn. (*Rev. gén. élect.*, vol. 63, pp. 527-532; September, 1954.) Report of developments in France, where efforts have been directed to devising a system simpler than that of the N.T.S.C. Using the whole 10.4 mc of the 810-line video channel, the first 8 mc is shared by the red and green signals in sequence, while the blue signal is transmitted continuously in a single sideband of width 1 mc on the outer side of a subcarrier at 9.4 mc. For convenience, 810 lines are used instead of 819, and the red and green signals alternate in line sequence, so that the red lines of one frame are superposed exactly on the green lines of the preceding one, i.e. there is no interlacing. Pickup arrangements for color film and for direct viewing are outlined, using three photocells and three image orthicons respectively, with optical splitting devices. Possible reception arrangements include (a) a three-tube projection system retaining the alternating red and green and continuous blue signals, (b) a single tube of chromatron type, involving sequential red, green and blue operation, and (c) use of an R.C.A. type three-gun color-dot tube, which again permits operation with a continuous blue signal.

621.397.5:535.623 558
Compatible Colour-Television Systems—É. Labin. (*Rev. gén. élect.*, vol. 63, pp. 516-526; September, 1954.) Conditions for compatibility between monochrome and color signals are considered and two particular systems are discussed in detail, that of the N.T.S.C. developed in the U.S.A., and that of Valensi, investigated in France. Valensi's system uses at the transmitter a special coding tube, having a screen with areas of different opacity corresponding to the 30 divisions of the color triangle recognized by the C.I.E., to produce a single-component chrominance signal from the three signals delivered by the trichromatic camera. A bandwidth of 1.2-1.5 mc is sufficient for this signal, which is placed on a subcarrier located near the edge of the video channel at a frequency which is an odd multiple of half the line frequency. At the receiver the three color signals are recovered by a decoding system in which the received chrominance signal is applied to three formatron tubes generating appropriate output functions determined from consideration of the nature of the C.I.E. coordinates. A construc-

tion in which the three formatron tubes are combined into one is described. Reception would require a variant of the synchronized-detection system combined with use of comb-characteristic filters. It would alternatively be possible to transmit Valensi-type signals by using the first 7 mc of the video channel for the luminance signal and the remaining 3 mc for the chrominance signal modulated on a sub-carrier, in which case synchronous detection would not be required. See also 557 above.

621.397.5:535.623 559
Colour Television—History, Present State and Future Development—E. Schwartz. (*Tech. Hausmitt. Nordw.Dtsch. Rdfunks*, vol. 6, pp. 105–126; 1954.) The developments culminating in the N.T.S.C. frequency-interlace system are described and the possibility of adapting this system for use in Europe is discussed.

621.397.6:535.623:621.385.832 560
Electronic Tubes for Colour Television—R. Juillerat. (*Rev. gén. élect.*, vol. 63, pp. 507–515; September, 1954.) A review of the different types of tube that have been developed both for the pickup and for the display of color-television pictures. Difficulties encountered in the design of suitable tubes, especially for reception, are having an important effect on the whole development of color television.

621.397.61:535.623 561
Problems of Television Cameras and Camera Tubes—L. H. Bedford. (*Jour. Brit. IRE*, vol. 14, pp. 464–474; October, 1954.) "Questions of sensitivity and signal-to-noise ratio are discussed. While the results are of general application, the subject is developed with particular reference to the image orthicon type of camera tube. The latter, in its standard form (the 3 inch image), has a considerable sensitivity advantage compared with other types of tube. For some purposes, particularly studio use, it is desirable to exchange some of this sensitivity for other properties, such as signal/noise ratio. In this case the balance of properties can be improved by increase in target area which leads to the large (4½-inch) image orthicon. A description is given of a new camera designed around the large image orthicon with maximum exploitation of the properties of the latter. Three approaches to the color television camera problem are described, and the repercussions of color on sensitivity and signal/noise ratio is discussed."

621.397.61.001.4 562
Color Text Technique for TV Broadcasters—Wentworth. (See 511.)

621.397.62 563
Flywheel Synchronizing—W. T. Cocking. (*Wireless World*, vol. 60, pp. 519–522, 557–560 and 621–624; October–December, 1954.) The effect of noise and interference on the line synchronization of television receivers is explained, and the use of balanced and unbalanced afc circuits for synchronization is described.

621.397.62 564
Television Safety Precautions—E. G. Goodhew. (*Wireless World*, vol. 60, pp. 591–592; December, 1954.) Brief discussion of considerations involved in drafting British and international standards covering precautions against the usual electrical hazards as well as tube implosion and incidental X radiation.

621.397.62 565
Television Intermediate Frequencies—(*Wireless World*, vol. 60, pp. 582–583; December, 1954.) A note on the considerations leading to the British Radio Equipment Manufacturers' adoption of 34.65 mc as vision IF for television receivers. A chart is presented showing the main possible forms of interference, for local-oscillator frequency above signal frequency.

621.397.62:621.386.842 566
Solid-State Image Intensifier—R. K. Orthuber and L. R. Ullery. (*Elec. Commun.*, vol. 31, pp. 198–201; September, 1954.) Reprint. See 3061 of 1954.

621.397.62.001.4 567
Measurements on Television Receivers: Part 5—Measurements on the Deflection System—O. Macek. (*Arch. tech. Messen*, No. 224, pp. 205–208; September, 1954.) Part 4: 3634 of 1954.

621.397.621:621.375.232 568
Feedback I.F. Amplifiers for Television—H. S. Jewitt. (*Wireless World*, vol. 60, pp. 609–611; December, 1954.) Application of design principles described previously (1009 of 1954) to a vision IF amplifier with bandwidth about 3 mc; stray capacitance is an important feature. Performance figures are given for an experimental amplifier for a vision IF of 16 mc, the sound IF being 19.5 mc, the feedback is used in this case unaccompanied by transformer coupling or stagger tuning, though it can alternatively be used to give improvement in conjunction with these other features.

621.397.621.2:621.373.43 569
Differential Width Control for Television Line Scanning Circuits—K. G. Beauchamp. (*Electronic Eng.*, vol. 26, pp. 476–481; November, 1954.) A typical receiver line-scan circuit is studied to determine ways of varying the amplitude of the sawtooth current waveform without unduly affecting the extra-high voltage. An investigation is made of the design and performance of systems using a combination of series and parallel inductance connected to the output transformer, arranged so that the total inductance across the transformer windings remains constant.

621.397.82:621.396.61 570
Sine Wave all the Way—Blackie. (See 574.)

621.397.82.029.62 571
Band-III Television Interference—R. Davidson. (*Wireless World*, vol. 60, p. 594; December, 1954.) A note suggesting that the problem is less serious than indicated by Strafford (3708 of 1954).

621.397.828.029.62 572
Suppression of Interference from Motor Vehicles—W. Scholz. (*Elektrotech. Z., Edn A*, vol. 75, pp. 504–506; August 1, 1954.) Results of measurements, presented graphically, show that 95 per cent of cars (excluding diesel-driven vehicles) and 99 per cent of motorcycles produce an interference field-strength $> 500 \mu\text{v/m}$ at 10 m distance at a frequency of 200 mc. This was measured using a receiver with a ± 100 -kc passband in conjunction with a tuned dipole mounted 3 m above ground. The field-strength indication corresponding to $500 \mu\text{v/m}$ would be $50 \mu\text{v/m}$ on British or U.S.A. equipment. The use of built-in suppressors is recommended, e.g. resistors in spark plugs, as these have the advantage of being close to the source of interference and also of being inseparable from the engine component. Other suppressors are mentioned.

TRANSMISSION

621.396.61:621.376.4 573
The Circuit Development of the Ampliphase Broadcasting Transmitter—T. H. Price. (*Proc. IEE*, part III, vol. 101, pp. 391–398; November, 1954.) Two circuit arrangements are described for obtaining an amplitude-modulated output by differentially controlling the phase of two rf generators of substantially constant voltage operating with a common load; these are (a) the quarter-wave or constant-current ampliphase system, and (b) the push-pull or constant-voltage ampliphase system. Typical performance figures are quoted; these are equal to those for the usual types of transmitter circuit. Such designs are claimed to

be highly economical as regards equipment and tubes.

621.396.61:621.397.82 574
Sine-Wave all the Way—L. Blackie. (*Short Wave Mag.*, vol. 12, pp. 312–315; August, 1954.) A discussion of the operation and efficiency of the final rf amplifier in amateur transmitters indicates that little reduction of available power is caused by changing from Class-C to Class-B, Class-AB2, or even Class-AB1 operation, while the corresponding reduction of harmonic output, and hence of interference with television, is considerable.

621.396.61:621.398 575
Pulse Transmitter for Rocket Research—D. G. Mazur. (*Electronics*, vol. 27, pp. 164–167; November, 1954.) The 15-channel AN/DKT transmitter installed in Aerobee rockets is described. The normal sampling rate in each channel is 312.5 per second, the input range is 0–5 v, the rf pulse width is $3 \mu\text{s}$, the frequency 227 mc, the peak power output 10 w and the channel deflection range $150 \mu\text{s}$. Provision can be made for a higher sampling rate in one channel by disabling three others.

TUBES AND THERMIONICS

621.314.63+621.314.7:537.311.33 576
Semiconductors—[*Elec. Rev. (London)*, vol. 155, pp. 307–311; August 27, 1954.] An account of work in progress at the new G.E.C. Wembley laboratories on the development of crystal tubes.

621.314.63:621.318.57 577
Transient Response of a p-n Junction—B. Lax and S. F. Neustradter. (*Jour. Appl. Phys.*, vol. 25, pp. 1148–1154; September, 1954.) Calculations are made of the diode current and the voltage across the junction over a period after reversing the applied voltage; typical values are assumed for the diode parameters. Results are shown graphically for various values of included series resistance, and are compared with those obtained by Kingston (2539 of 1954).

621.314.632:537.312.9 578
Influence of Mechanical Pressure on Barrier Height in Galena Rectifiers—J. N. Das and V. G. Bhide. (*Current Sci.*, vol. 23, pp. 185–186; June, 1954.) Measurements show that the barrier height of the galena/Pt-whisker contact rises from 1.275 to 1.830 and then falls to 0.320 v while the spread resistance falls from 82.10 to 15.61Ω and then rises to 67.55Ω for pressures of 30, 110, and 150 g weight, using a whisker of radius 0.008 cm at the point of contact. Similar results were obtained with Al and C whiskers.

621.314.7 579
Theory of Diffusion-Type and Drift-Type Transistors: Part 2—Frequency Characteristics—H. Krömer. (*Arch. elektr. Übertragung*, vol. 8, pp. 363–369; August, 1954.) The quadrupole admittances of a junction transistor (part 1: 3389 of 1954) taking account of the boundary-layer capacitances are dependent on frequency; a limiting frequency is thus introduced which is dependent on the matching conditions. The inherent frequency limit set by alpha cut-off is higher for the drift type than the diffusion type, in the case of Ge by a factor of 8. A detailed analysis is given for the case of purely ohmic matching. Performances are compared under different operating conditions. In practice better use can be made of the inherent cut-off frequency in the drift type.

621.314.7:001.4 580
Nomenclature of Transistor Parameters—H. Mette. (*Funk u. Ton*, vol. 8, pp. 420–421; August, 1954.) A list is given of recommended German equivalents of English transistor terms.

621.314.7:537.311.33 581
Transistor Electronics: Imperfections,

Unipolar and Analog Transistors: Parts 2 and 3—W. Shockley. [*Proc. IRE (Australia)*, vol. 15, pp. 194–201 and 228–234; August and September, 1954.] Reprint, see 746 of 1953. Part 1: 3600 of 1954.

621.314.7:621.317.3 582
Stability Considerations in the Parameter Measurements of V.H.F. Point-Contact Transistors—Thomas. (See 491.)

621.314.7:621.372.5 583
Design Considerations of Junction Transistors at Higher Frequencies—H. Statz, E. A. Guillemain and R. A. Pucel. (PROC. I.R.E., vol. 42, pp. 1620–1628; November, 1954.) An accurate equivalent network for the junction transistor is developed based on a solution of the diffusion equation. The relation between gain and frequency is calculated and the upper limiting frequency for obtaining power gain is determined; from these results it is possible to determine the proper values of collector capacitance and base resistance in order to make full use of obtainable base width. Use of the formulas in the design of transistors to have a prescribed upper limiting frequency is illustrated by numerical examples.

621.383.2 584
Increased Light Sensitivity from Standard Gas Phototubes—E. O. Johnson. (*Rev. Sci. Instr.*, vol. 25, pp. 839–840; August, 1954.) A circuit is described by means of which current amplification as high as 10^8 can be obtained with a commercial photocell without producing instability. The mechanism involves secondary emission at the photocathode due to bombardment by ions produced by the photoelectrons. The current build-up is terminated periodically by firing a thyatron.

621.383.2 585
The Behaviour of Gas-Filled Photocells operating in the Region of Self-Maintained Discharge—W. Kluge and A. Schulz. (*Z. angew. Phys.*, vol. 6, pp. 364–370; August, 1954.) It was shown previously [3264 of 1953 (Kluge)] that self-maintained discharge currents in gas-filled photocells can be controlled by illumination of the cathode. An investigation is made of the upper limit which the discharge current can attain without causing structural modifications of the composite cathode. Reversible fatigue effects due to bombardment by positive ions are observed; these effects are very small with potassium hydride cathodes, hence reproducible values of photocurrent can be obtained.

621.385.004.15 586
Developments in Trustworthy-Valve Techniques—E. G. Rowe and P. Welch. (*Elec. Commun.*, vol. 31, pp. 172–188; September, 1954.) Special tests for reliability are discussed and a complete testing procedure is indicated. Designing for reliability is considered as a problem distinct from that of making ordinary commercial valves more robust. See also 1776 of 1952 (Rowe).

621.385.029.6 587
Measurement of the Most Important Parameters of Helix-Type Travelling-Wave Valves for Amplification and Efficiency Calculations—W. Klein. (*Arch. elekt. Übertragung*, vol. 8, pp. 404–410; September, 1954.) Methods are described for determining the required parameters from measurements on completed prototype tubes. The results are useful for assessing the accuracy of calculated characteristics. Cases of special interest are (a) power tubes with relatively large difference between beam velocity and phase velocity on the helix, and (b) tubes in which the helix characteristics are appreciably modified by the dielectric supports.

621.385.029.62/.63:621.396.822 588
Minimum Noise Figure of Traveling-Wave Tubes with Uniform Helices—J. R. Pierce and W. E. Danielson. (*Jour. Appl. Phys.*, vol. 25, pp. 1163–1165; September, 1954.) An expression for the minimum noise figure is derived using a theorem presented by Pierce (304 of February) in conjunction with analysis developed by Watkins (1470 of 1952). Assuming reasonable values for the tube parameters, the value of 6 db is obtained for the minimum noise figure.

621.385.029.63/.64 589
Helix-Coupled Traveling-Wave Tubes—P. D. Lacy. (*Electronics*, vol. 27, pp. 132–135; November, 1954.) Two amplifier tubes with coupling helices outside the vacuum envelope are described. Both operate over the range 2–4 mc. One has a gain of 35 db, output 20 mw and noise figure of the order of 20 db; the other has a gain of 30 db, output 1 w and noise figure < 30 db. The coupling mechanism is that of spatial beating [30 of 1950 (Krasnushkin and Khokhlov)].

621.385.029.63/.64 590
A Wide-Band Voltage-Tunable Oscillator—J. W. Sullivan. (PROC. I.R.E., vol. 42, pp. 1658–1665; November, 1954.) An experimental backward-wave tube has a bifilar helix in which matching is facilitated by forming one winding as a thread on a rod and the other as a wire insulated from the rod; the structure is essentially a coaxial line wound into a helix. Oscillations were obtained with frequency ranging from 2.6 to 13.3 mc as the beam voltage was increased from 40 v to 3 kv, using appropriate magnetic focusing. Power outputs of 5–50 mw were obtained.

621.385.029.63/.64 591
Traveling-Wave Amplifiers and Backward-Wave Oscillators—M. Muller. (PROC. I.R.E., vol. 42, pp. 1651–1658; November, 1954.) Analysis is presented in a unified form for the travelling-wave tube, the magnetron amplifier and the corresponding backward-wave oscillators. Formulas are derived for amplifier gain, oscillator starting current and tuning parameters.

621.385.029.63/.64 592
Rippled Wall and Rippled Stream Amplifiers—C. K. Birdsall. (PROC. I.R.E., vol. 42, pp. 1628–1636; November, 1954.) Velocity-modulation tubes are discussed having space-periodic variations of diameter of drift tube or beam or both. The periodic length is a quarter of the plasma wavelength. Gain is produced by reinforcing the simple harmonic motion of the electrons in the beam; formulas are derived giving its value for various cases, including the use of velocity jumps. Design curves are presented. An experimental rippled-wall tube for the frequency range 1–4 knics described. See also 2498 of 1953 (Birdsall and Whinnery).

621.385.029.63/.64 593
Power Flow and Equivalent Circuits of Travelling-Wave Tubes—C. C. Wang, J. R. Pierce and P. K. Tien. (PROC. I.R.E., vol. 42, pp. 1701–1703; November, 1954.)

621.385.029.63/.64 594
A Computational Contribution to the Linear Theory of the Travelling-Wave Valve with Low Gain—D. Weber. (*Arch. elekt. Übertragung*, vol. 8, pp. 341–345; August, 1954.) For predicting low-gain operation the initial amplitude and phase of all three rf components must be known. These are calculated neglecting attenuation of the delay line and space-charge forces. A table of numerical values of characteristic parameters is given including a correction to those published earlier [3754 of 1953 (Schnitger and Weber)]. By means of a graphi-

cal method outlined initial conditions can be determined with sufficient accuracy in many cases without an exact construction. The results also apply to the carcinotron.

621.385.032.216 595
Cathode Parasitic Impedance—M. Berthaud. (*Onde élect.*, vol. 34, pp. 663–673; August/September, 1954.) Detailed discussion giving results of measurements made on commercial tubes at different cathode temperatures and of investigations of the formation of interface layers. The indications are that the whole of the cathode contributes to the increased impedance. Summarized version abstracted in 1620 of 1954.

621.385.032.216 596
Studies of the Interface Layer in Oxide Cathodes—L. S. Nergaard and R. M. Matheson. (*RCA Rev.*, vol. 15, pp. 335–361; September, 1954.) The complex nature of the interface layer is discussed and an experimental investigation is reported of the interface behavior of $2\text{BaO}\cdot\text{SiO}_2$ which is formed by reaction between the BaO of the coating and Si diffusing out of the Ni base. No definite conclusions are drawn. Measurements of interface resistance should be made at normal-operation cathode current, otherwise the effect of the tube's previous history may be obscured.

621.385.032.216 597
Thermionic Emission and Electron Diffraction from Thin Films of Barium Oxide—P. N. Russell and A. S. Eisenstein. (*Jour. Appl. Phys.*, vol. 25, pp. 954–961; August, 1954.) The structure of and thermionic emission from evaporated BaO films on a Ni base were examined simultaneously, using a specially developed sealed-off electron-diffraction tube with fluorescent screen. The thermionic activity increased with film thickness up to about 20 monolayers and then remained constant up to 50 monolayers. The effect of heat treatment was examined. The emission density is comparable to that for sprayed oxide coatings, which are much thicker; the significance of this in relation to the emission mechanism is discussed.

621.385.032.216:621.317.331 598
Sensitive Apparatus for the Measurement of Cathode Parasitic Resistance—P. Sevin. (*Onde élect.*, vol. 34, pp. 673–674; August/September, 1954.) Voltages at 6 mc and 10 kc are modulated in phase quadrature by a 200-cps signal and applied simultaneously to the tube grid. A resistance across a 6-mc retractor circuit in the cathode lead is adjusted until modulation in the anode circuit is suppressed. Using an amplifier with a voltage gain of 10^6 , internal resistance below $5\ \Omega$ in the cathode can be detected.

621.385.032.216:621.396.822 599
Noise Mechanisms in Oxide-Coated Cathodes—A. van der Ziel. (*Physica*, vol. 20, pp. 327–336; June, 1954.) Various explanations of flicker noise in tubes are reviewed. Schottky's emission-center theory gives best agreement with observations in the case of W, Th-W and L-type cathodes. For oxide-coated cathodes, calculations based on Nergaard's concept of a depletion layer (1528 of 1953) give values of noise of the same order of magnitude as the observed values.

621.385.5:621.375.2.024 600
"Starved Amplifiers"—Kaufer. (See 385.)

621.385.832 601
Operation of C.R.T. Storage Devices—S. Winkler and S. Nozick. (*Electronics*, vol. 27, pp. 184–187; October, 1954.) Types suitable for different applications are listed, with notes useful for design purposes. Limitations are indicated.

MATERIALS RESEARCH • ELECTRONIC COMPONENTS • PRECISION INSTRUMENTS • SYSTEMS ENGINEERING

New ultrasonic drill gives maximum driving energy with minimum power



Model U-600 Ultrasonic Drill and Generator

Employing the superior characteristics of a Glennite ceramic transducer, the new Model U-600 ultrasonic drill requires power of only 35 watts. It is an efficient, economic tool for cutting, machining, shaping, grinding and polishing.

Miniature packaged circuit reduces space requirements

This Glennite Ten Terminal "OR" Circuit Block underscores the advantages of potting subsidiary circuits to achieve miniaturization and high reliability. In this instance space is reduced by a factor of 10. Maintenance is facilitated by replacement of plug-in circuits. Packaged circuit techniques can be applied to numerous circuits, including "OR" and "AND" which appear hundreds of times in computers.

Glenco's production of these units begins with the raw materials on through final assembly. Capacitors of various sizes, shapes, capacitances and materials of diverse temperature coefficients are designed and developed. Components can be packaged in any combination to meet special de-

This ultrasonic drill is especially useful for drilling such materials as glass, tungsten carbide, sapphire, ceramics, and hardened steel to within a tolerance of .0005 inch depending upon size of abrasive in the slurry.

The working table is moved vertically by a rack and pinion arrangement; work can be fed automatically by adjusting the weight of a counterbalance arm. A dial gauge indicates cutting rate.

The generator supplied with the drill has an input of 117 volts at 1 ampere, 60 cycles. It is housed in a cabinet 9 x 9 x 6 inches. Completely portable, the entire ultrasonic unit including drill and generator weighs only 15 pounds.

Vibro-Ceramics Corporation

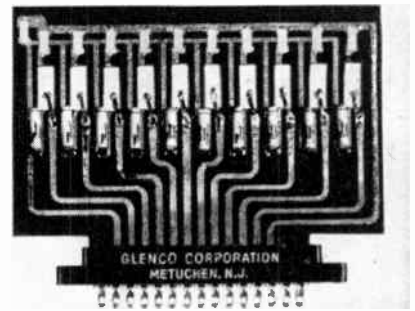

mands. The thinness of Glennite, high reliability resistors and capacitors permits stacking, providing unlimited flexibility in circuit layout while maintaining close tolerances.

All components are pre-tested and precured. Performance of final assembly can be precisely determined in advance.

Glenco will assist in developing packaged circuits for any requirement.

Glenco Corporation

New low frequency accelerometers of high resolution and accuracy, provide full scale measurements of ± 1 g

These small size, light weight, low frequency accelerometers, utilizing transducers of the differential transformer type, are high resolution and high accuracy devices for measuring accelerations with frequencies ranging from 0-40 cps and magnitudes up to ± 10 g.

A novel seismic suspension system gives true alignment of the seismic element over the full acceleration range, minimizes lateral sensitivity and provides better than $\pm 1\%$ resolution and linearity. Phase distortions of the carrier and effects of stray magnetic fields are minimized by use of magnetic shielding.

Units can be powered by frequencies of 60 cps to 10,000 cps, permitting use with standard aircraft and missile AC power sources. Other applications in-



Glennite Model ADT-701 Accelerometer
Specifications: Range, ± 1 g; Sensitivity with 400 cps carrier, 125 mv per g/volt input; Maximum input voltage, 10 v r.m.s.; Size, $1\frac{1}{2}$ " d x 2" h; Weight, 3 oz.

clude analysis of vibrations in rotating machinery, plant equipment, ships, trucks and automobiles.

Gulton Mfg. Corp.

Gulton Industries, Inc.

201 Durham Ave., Metuchen, New Jersey

- Put me on Gulton Abstracts mailing list
Please send me additional information on:
- Model U-600 Ultrasonic Drill
 - Glennite Packaged Circuits
 - Glennite Model ADT-701 Accelerometer
 - Glennite Electromechanical and Electronic Instruments
 - Glennite Electronic Components

NAME _____

TITLE _____

COMPANY _____

ADDRESS _____

Published by
GULTON INDUSTRIES, INC.

Comprising: Gulton Mfg. Corp. • Glenco Corporation • Vibro-Ceramics Corporation
Greibach Instruments Corporation • Thermistor Corporation of America

(Continued from page 122A)

SALT LAKE CITY

"Air Ionization and Medical Physics," by S. B. Hammond, University of Utah; December 9, 1954

SAN DIEGO

"Television in Color," by R. D. Kell, R.C.A. Labs.; October 19, 1954.

"Stereophonic Reproduction," by W. B. Snow, consulting engineer; November 2, 1954.

"Motorless Flight," by W. S. Ivans, Jr., Convaire; December 7, 1954.

"Stabilization of Feedback Amplifiers," by Dr. D. C. Kalbfell, San Diego State College; January 4, 1955.

SCHENECTADY

"Particle Accelerators," by Dr. R. L. Kyhl, General Electric Research Lab.; December 13, 1954

SYRACUSE

"Automatic Language Translation," by Dr. L. E. Dostert, Georgetown University; December 2, 1954.

"Aims of the Professional Group," by Dr. W. R. G. Baker. "What is an Engineering Manager," by H. B. Fancher. "Low Frequency Filters in Hi-Fi," by N. S. Cromwell, all of General Electric Company. and "Modern Network Theory," by Dr. Norman Balabanian, Syracuse University; January 6, 1955.

TOLEDO

Round-table discussion on radio broadcasting in northwestern Ohio, by Chief Engineers of broadcast stations in that area; November 11, 1954.

"Educational Programming and Its Development," by M. W. Stahl, University of Toledo; December 9, 1954.

TORONTO

"Color Television," by P. A. Wigley; September 27, 1954.

"Recent Developments in High-Quality Sound Reproduction," by F. H. Slaymaker; October 25, 1954.

"Tube Application in TV Deflection Circuits," by S. F. Love; November 15, 1954.

"Wavestack Antenna," by G. M. MacKimmie; December 13, 1954.

TWIN CITIES

"Application of Electronic Computer Techniques to Heart Analysis," by Dr. O. H. Schmitt, University of Minnesota; December 7, 1954.

VANCOUVER

"Commercial TV Systems," by G. C. Chandler, Tru Vu Television Ltd.; November 15, 1954.

Field Trip to CBUT Television Studios; December 16, 1954.

WASHINGTON

"Time or Frequency Compression Expression of Speech," by Dr. W. L. Everitt, University of Illinois; January 10, 1955.

WINNIPEG

"Transistors in Audio," by C. Chaykowsky and "A Discussion on Accelerometers," by R. Wall, both students, University of Manitoba; December 1, 1954.

Guided tour of RCAF Telecom centre conducted by F/L D. Kyle, RCAF; December 15, 1954.

(Continued on page 136A)

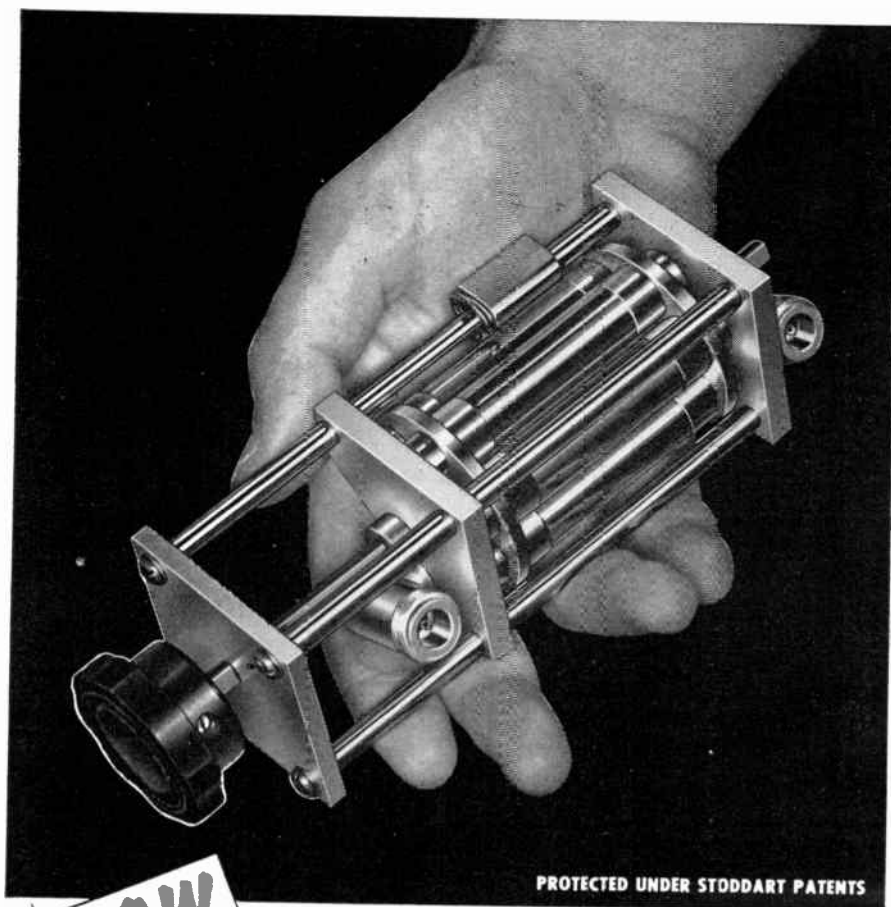

PROTECTED UNDER STODDART PATENTS

NOW

Precision Attenuation to 3000 mc!

TURRET ATTENUATOR featuring "PULL-TURN-PUSH" action



SINGLE "IN-THE-LINE" ATTENUATOR PADS and 50 ohm COAXIAL TERMINATION

FREQUENCY RANGE:
dc to 3000 mc.

CHARACTERISTIC IMPEDANCE:
50 ohms

CONNECTORS:
Type "N" Coaxial female fittings each end

AVAILABLE ATTENUATION:
Any value from .1 db to 60 db

VSWR:
<1.2, dc to 3000 mc., for all values from 10 to 60 db
<1.5, dc to 3000 mc., for values from .1 to 9 db

ACCURACY:
±0.5 db

POWER RATING:
One watt sine wave power dissipation

Send for free bulletin entitled "Measurement of RF Attenuation"

Inquiries invited concerning pads or turrets with different connector styles

STODDART AIRCRAFT RADIO Co., Inc.
6644-C Santa Monica Blvd., Hollywood 38, California • Hollywood 4-9294

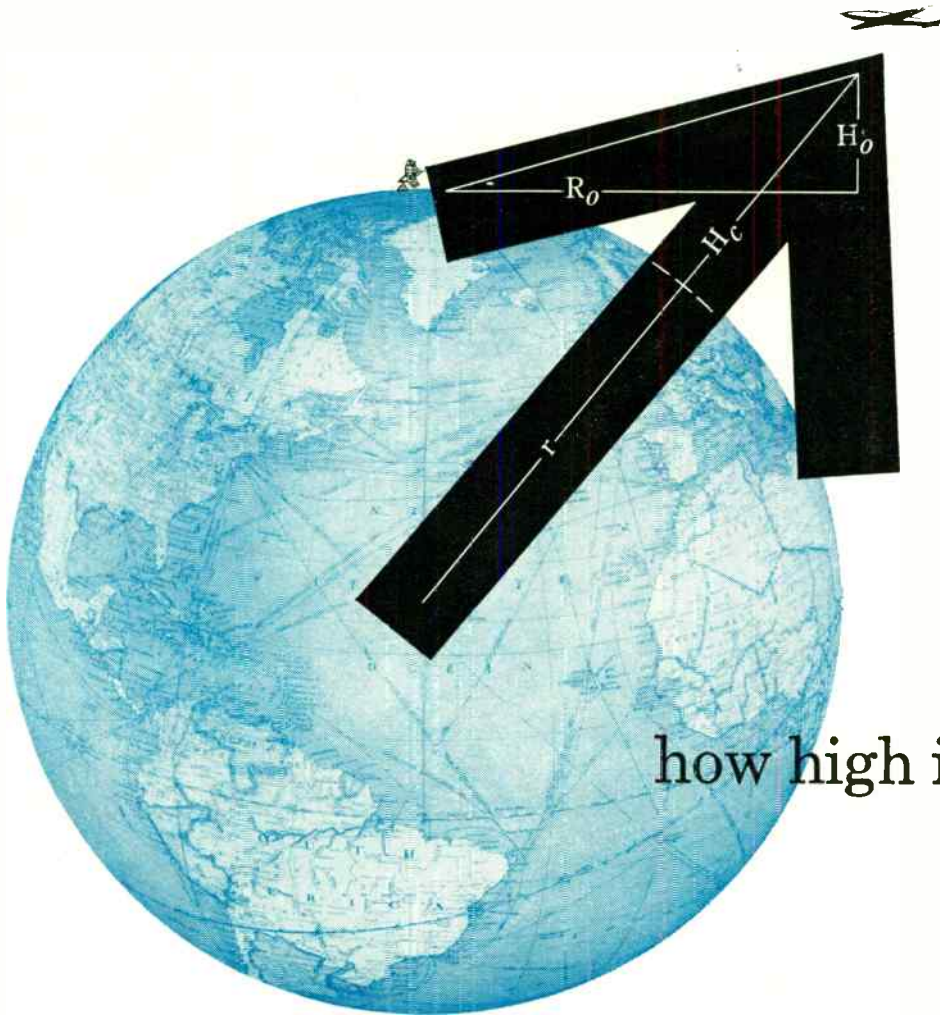

how high is up?

A child's conundrum becomes a matter of life and death... when radar tells a lie. When our radar tracks attacking aircraft... or an incoming missile... the lives of all of us on target balance on the pinpoint of a mathematical riddle.

How high is up? It depends on the point-of-viewing.

Because of earth's curvature, radar sees an interloper... 100 miles away... 6600 feet lower than it really is. Readings must be corrected instantaneously before being fed to our interceptors... otherwise, attacker and defender play true or false at twice the speed of sound.

Electronic Engineering Company of California has designed an analog computer that makes this vital correction... converting radar observation into true altitude above sea level. The computer continuously solves the equation

$$H_c = H_0 + (R_0^2 / 2r)$$

The mathematics are complex. The mechanism, with a two-gang HELIPOT* series A precision potentiometer at its heart, is beautifully simple. Both are fully described in a new application data sheet... write for Data File 302.

Helipot makes precision potentiometers... linear and non-linear... in the widest choice of sizes, mounting styles and resistances. Many models are stocked for immediate shipment... our engineers will gladly adapt standard models to your requirements... or design entirely new HELIPOT precision potentiometers for you.

 **Helipot** *first in precision potentiometers*

Helipot Corporation/South Pasadena, California
Engineering representatives in principal cities
a division of BECKMAN INSTRUMENTS, INC.



405 *REG. U.S. PAT. OFF.

Waterman

POCKETSCOPE

The Pocket-Size Oscilloscope

S-14-A



HIGH

6 INCHES

S-14-B



WIDE

6 INCHES

S-15-A



TWIN

6 INCHES

...light... compact... accurate... portable

Featuring small size, light weight and outstanding performance the HIGH, WIDE and TWIN POCKETSCOPES have become the "triple threat" of the oscilloscope field. Their incomparable versatility, reliability and accuracy have skyrocketed this team of truly portable instruments into unparalleled demand. Each oscilloscope features DC coupled amplifiers in both vertical and horizontal channels.

HIGH

The S-14-A HI-GAIN POCKETSCOPE provides the optimum in oscilloscope flexibility for analysis of low-level electrical impulses. Extremely light weight (12 $\frac{3}{4}$ lbs.), compact in size (12 x 5 $\frac{3}{4}$ x 7 in.), dependable and accurate in performance. Vertical and horizontal channels: 10mv rms/inch with response within 2DB from DC to 200 KC and pulse rise of 1.8 μ s . . . non-frequency discriminating attenuators and gain controls with internal calibration of trace amplitude . . . repetitive or trigger time base with linearization from $\frac{1}{2}$ cycle to 50 KC with \pm sync or trigger.

WIDE

The S-14-B WIDE BAND POCKETSCOPE is ideal for investigations of transient signals, DC signals, aperiodic pulses or recurrent waveforms. Vertical channel: 50 mv rms/in. within -2DB from DC to 700 KC . . . pulse rise time of 0.35 μ s. Horizontal channel: 0.15v rms/in. within -2DB from DC to 200 KC . . . pulse rise of 1.8 μ s. Attenuators and gain controls are non-frequency discriminating . . . trace amplitude calibration . . . repetitive or triggered time base from $\frac{1}{2}$ cycle to 50 KC . . . \pm sync or trigger . . . trace expansion, filter graph screen and many other features . . . 14 lbs. . . 12 x 6 x 7 inches.

TWIN

The S-15-A POCKETSCOPE is a portable, twin tube, high sensitivity oscilloscope with two independent vertical as well as horizontal channels. It is indispensable for investigation of electronic circuits in industry, school and laboratory. Vertical channels 10

mv rms/in. with response within -2DB from DC to 200 KC and pulse rise time of 1.8 μ s . . . horizontal channels 1v rms/in. within -2DB from DC to 150 KC . . . non-frequency discriminating controls . . . internal signal amplitude calibration . . . linear time base from $\frac{1}{2}$ cycle to 50 KC, triggered or repetitive, for both horizontal channels.

S-11-A

The S-11-A INDUSTRIAL POCKETSCOPE is a small, compact (5x7x11 inches), and lightweight (8 $\frac{3}{4}$ lbs.) instrument for observing electrical circuit phenomena. The flexibility of the POCKETSCOPE permits its use for AC measurements as well as for DC. The vertical and horizontal amplifiers are capable of reproducing within -2DB from DC to 200 KC with a sensitivity of 0.1v rms/in. . . repetitive time base from 3 cycles to 50 KC continuously variable throughout its range . . . variations of input impedance, line voltage or controls do not "bounce" the signal—the scope stabilizes immediately.



RAYONIC CATHODE RAY TUBES BY WATERMAN

TUBE	PHYSICAL DATA		STATIC VOLTAGE		DEFLECTION*		LIGHT OUTPUT**
	FACE	LENGTH	A3	A2	VERT	HOR	
3JP1	3"	10"	3000	1500	111	150	352
3MP1	3"	8"		750	99	104	33
3RP1	3"	9.12"		1000	61	86	44
3SP1	1.5x3"	9.12"		1000	61	86	44
3XP1	1.5x3"	8.875"		2000	33	80	218

*Deflection in volts per inch.

The basic properties of the cathode ray tube that concern the designer or the user are: deflection sensitivity, unit line brightness, line width, static voltage requirements and physical size. A comparison between cathode ray tubes manufactured by Waterman Products Company is shown in the table adjoining. These tubes are available in P1, P2, P7 and P11 phosphors. 3JP1, 3JP7, 3SP1 and 3XP1 are available as JAN tubes.

Write for your complimentary copy of "POCKETSCOOP" • Official Waterman publication.

PULSESCOPE

by

Waterman

The Oscilloscope that Portrays the Pulse

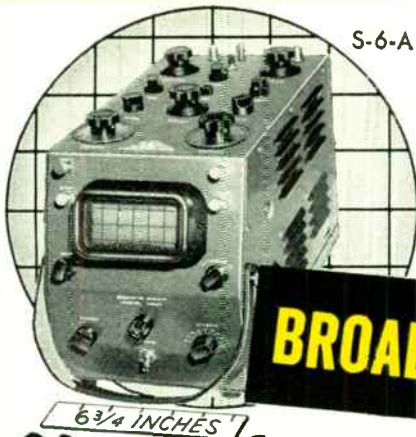

Classic Examples of Precision Engineering...

The PULSESCOPES are cathode ray tube oscilloscopes that portray the attributes of the pulse: shape, amplitude, duration and time displacement. All PULSESCOPES have internally generated markers with the basic difference that in the SAR PULSESCOPE the markers initiate the sweep while in the others the sweep starts the markers.

BROAD

The S-6-A BROAD BAND Scope is a PULSESCOPE

in performance, POKETSCOPE in size. The instrument measures DC as well as AC signals. Unique DC calibration methods permit rapid measurements of either positive or negative, AC or DC signals. Vertical amplifier sensitivity of 0.2v rms/inch, and response to 5 mc within 3DB . . . pulse rise time of 0.1 μ s . . . internal markers from 1 to 1000 μ s . . . repetitive or trigger sweep from 5 cycles to 500 KC with 5X sweep expansion . . . sweep, marker and DC calibrating voltage available externally. Size 8 1/2 x 6 3/4 x 13 3/4 in. Weight 22 lbs. Operates from 50 to 400 cycles at 115 volts AC.

LAB

The S-5-A LAB PULSESCOPE is a JANized (Gov't Model No. OS-26)

portable, AC, wide band-pass, laboratory oscilloscope ideal for pulse as well as general purpose measurements. Internal delay of 0.55 μ s permits observation of pulse leading edge. Includes precision amplitude calibration, 10X sweep expansion, internal trace intensity time markers, internal trigger generators and many other features. Video amplifier 0.1v p to p/inch . . . pulse rise time of .035 μ s or response to 11 mc. 1.25 to 125,000 μ s triggered or repetitive sweep . . . internally generated markers from 0.2 to 500 μ s . . . trigger generator from 50 to 5000 pps. for internal and external triggering. Operates from 50 to 400 cycles at 115 volts AC.

SAR

The S-4-C SAR PULSESCOPE is a JANized (Gov't Model No. OS-4)

portable instrument (31.5 lbs.) for precision pulse measurements for radar, TV and all electronic measurements. Portrays all attributes of the pulse . . . internal crystal controlled markers of 10 and 50 μ s available for self-calibration . . . in R operation a small segment of the A sweep is expandable for detailed observation with a direct-reading calibrated dial accurate to 0.1%. Video amplifier band-pass up to 11 mc . . . optional video delay 0.55 μ s . . . pulse rise and fall time better than 0.07 μ s . . . R pedestal (sweep) 2.4 to 24 μ s . . . video sensitivity of 0.5v. p to p/inch. Easily convertible from μ s to yards. Operates from 50 to 400 cycles at 115 volts AC.

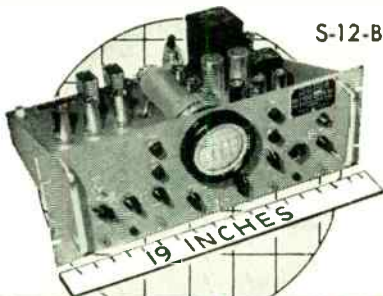

RAKSCOPE

Because the panel is only 7" high and fits any standard rack, the S-12-B RAKSCOPE admirably fills the need for a small oscilloscope of wide versatility. With all the features of the S-11-A POKETSCOPE, the RAKSCOPE is JANized (Gov't Model No. OS-11), and has many additional advantages; the sweep, from 5 cycles to 50 KC, is either repetitive or triggered . . . vertical and horizontal amplifiers are 50 mv rms/inch with band-pass from 0 to 200 KC . . . special phasing circuitry for frequency comparison.

WATERMAN PRODUCTS CO., INC.

PHILADELPHIA 25, PENNA., U.S.A.

CABLE ADDRESS, POKETSCOPE, PHILA.

Manufacturers of POKETSOPES® • RAKSCOPES® • PULSESCOPES® and RAYONIC® TUBES

IT'S HERE! A fast, accurate wide-range microwave

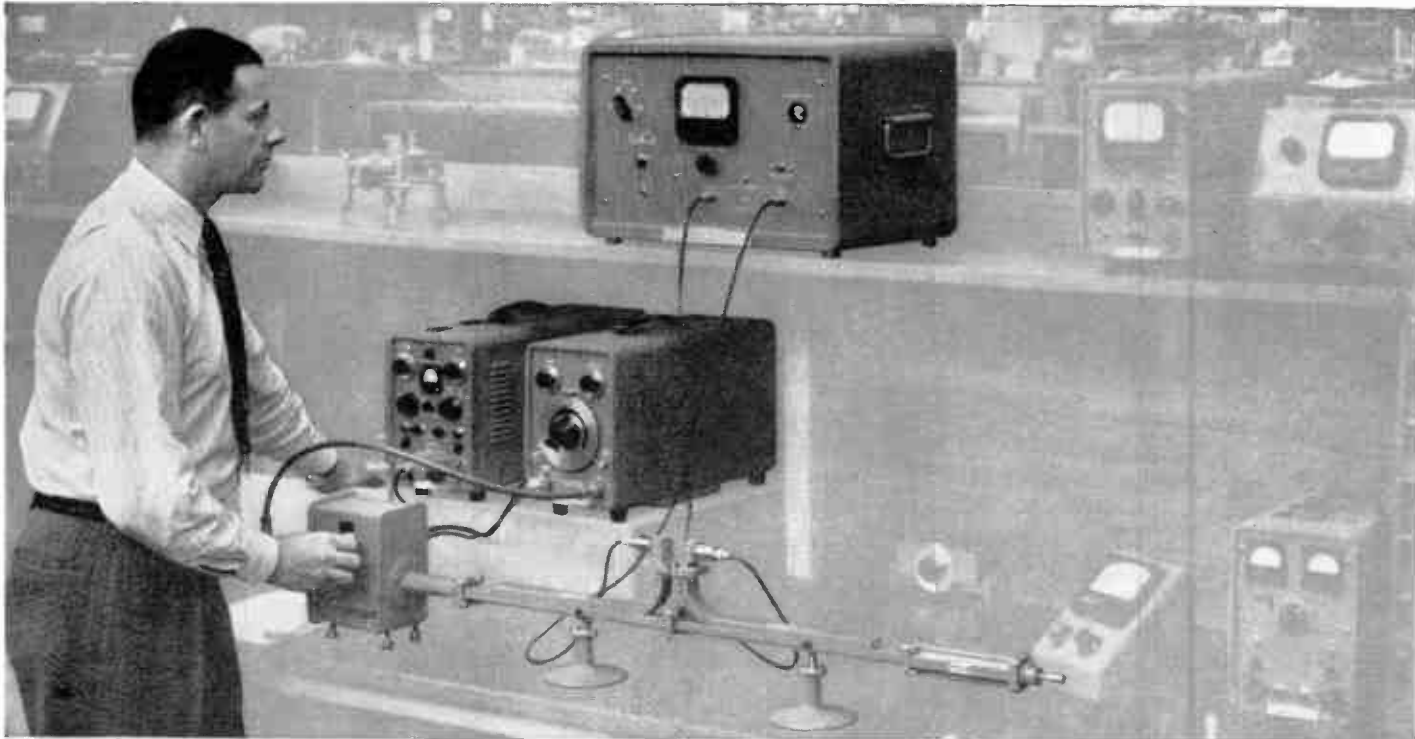

New *-hp-* reflectometer system comprises Klystron Power Supply, Swept Frequency Oscillator and Ratio Meter (rear) plus Variable Attenuator, Directional Couplers, Waveguide Crystal Detectors and Load (simulated by Shart).

SPECIFICATIONS

-hp- 416A RATIO METER

METER PRESENTATION: (a) As a Reflectometer: Percent reflection (magnitude of reflection coefficient). Four ranges, full scale values of 100%, 30%, 10%, 3% reflection. (1.00, 0.30, 0.10, 0.03 reflection coefficient.) (b) As a VSWR Indicator Voltage Standing Wave Ratio. Four ranges, 1 to 3, 3 to 10, 10 to 30, 30 to 100 VSWR. (c) Decibel scale for either application: 0 to 10 db, 40 db total, ranges spaced exactly 10 db.

ACCURACY: $\pm 3\%$ of full-scale value for 20 to 1 range of incident or reference r-f power.

CALIBRATION: Square-law, for use with Crystal Detectors or barretters.

FREQUENCY: 1,000 cps. ± 40 cps.

INPUT VOLTAGE: Incident or Reference Channels 3 mv to 100 mv rms. Reflected or Probe Channel: 0.3 mv to 100 mv rms. (Square-wave or sine-wave).

INPUT IMPEDANCE: Approximately 75 K ohms.

EXCESS COUPLER LOSS: Provision made for increasing sensitivity of the Incident Channel by 10 db for reflectometer setups employing couplers with different coefficients. Under certain circumstances, accuracy can be improved by this procedure.

OUTPUT: Connectors for oscilloscope and recorder.

ADJUSTMENTS: "Set to Full Scale" control for initial calibration with 100% reflection, or at VSWR peak.

INTERNAL CHECK: "Eye" tube continuously monitors input amplitude (and frequency indirectly) to assure proper operating range for instrument and for crystal detectors.

PRICE: \$365.00.

-hp- 670HM shf OSCILLATOR

FREQUENCY RANGE: 7.0 kmc to 10.0 kmc.

OUTPUT POWER: Approximately 10 mw entire frequency range.

ATTENUATOR RANGE: 100 db.

MODULATION: (a) Grid Modulation for optimum swept-frequency performance. (b) Reflector Modulation for optimum single-frequency performance. Modulating signals must be provided from external source (normally the *-hp-* 717A Power Supply). Pulses as short as 3 microseconds can be produced.

MECHANICAL SWEEP: Fully adjustable to cover any 10% or larger portion of the 7.0 kmc to 10.0 kmc spectrum. Sweep rate approximately 12 to 60 complete cycles per minute depending on swept frequency range. (Special sweep rates available of additional charge.)

SWEEP VOLTAGE PROVIDED: Linear voltage proportional to mechanical sweep. (Approximately 50 volts change provided for 7 to 10 kmc swept frequency range.)

PRICE: \$850.00.

-hp- 717A KLYSTRON POWER SUPPLY

BEAM SUPPLY:

VOLTAGE RANGE: 800 to 1,000 volts.

CURRENT: 25 ma, maximum.

REGULATION: (a) For constant load, less than $\pm 0.1\%$ output voltage change for $\pm 10\%$ variations from 115-volt line. (b) Less than $\pm 1\%$ output voltage change for output currents from 0 to 25 ma.

HUM: Less than 10 millivolts.

REFLECTOR SUPPLY:

VOLTAGE RANGE: 0 to 600 volts in 3 ranges.

CURRENT: 1 ma maximum; source resistance approximately 300 K ohms.

REGULATION: For constant load, less than $\pm 0.05\%$ change for $\pm 10\%$ variations from 115-volt line.

HUM: Less than 10 millivolts.

SQUARE WAVE MODULATION: (a) Amplitude adjustable 0 to 60 volts peak-to-peak. (b) Rise and decay times less than 10 microseconds. (c) Frequency adjustable from 400 to 1,000 cps.

SINE WAVE MODULATION FOR FM'ing: (a) Amplitude adjustable from 0 to 300 volts peak-to-peak. (b) Frequency: line voltage frequency. (c) Oscilloscope horizontal sweep voltage: 15 volts peak-to-peak, phase adjustable $\pm 45^\circ$ with respect to modulating voltage.

EXTERNAL: Terminals available for applying external modulating voltage. System will pass 3 microsecond pulses.

GRID SUPPLY:

VOLTAGE RANGE: 0 to +30 volts, open circuit, referred to cathode potential.

SQUARE WAVE MODULATION: (a) Amplitude adjustable 0 to 60 volts peak-to-peak. (b) Rise and decay times less than 10 microseconds. (c) Frequency adjustable from 400 to 1,000 cps.

EXTERNAL: Terminals available for applying external modulating voltage. System will pass 3 microsecond pulses.

FILAMENT SUPPLY: 6.3 volts cc., 2 amps.

PRICE: \$375.00.

-hp- X421A CRYSTAL DETECTOR

FREQUENCY RANGE: 8.2 kmc to 12.4 kmc.

SENSITIVITY: Approximately 1 mv/0.01 mw (average value).

VSWR: Less than 1.5 entire frequency range.

FREQUENCY RESPONSE: Flat within ± 2 db entire frequency range.

PRICE: \$75.00. (Includes 1N26 Silicon Diode and matched video-load resistor.)

-hp- 752 DIRECTIONAL COUPLERS

COUPLING: X752C = 10 db coupling
X752D = 20 db coupling

WAVEGUIDE SIZE (in.):

1 x 1/2

FREQUENCY RANGE (kmc):

8.2 - 12.4

DIRECTIVITY: Better than 40 db full range.

PRICE: \$100.00

All prices f.o.b., Palo Alto, California

Data subject to change without notice

See reflectometer
and other new



INSTRUMENTS

reflectometer system for impedance measurement

Reflection coefficient or SWR measured instantly over wide frequency range

Direct, continuous swept-frequency oscilloscope presentation

Higher accuracy than slotted lines for single frequency measurement

Ends tedious point-by-point checking; system unaffected by amplitude variation

Ideal for fast production checks, system alignment, laboratory work checking waveguide components, antenna and rotary joint performance, etc.

Now *-hp-* offers a fast, accurate and *practical* reflectometer system that eliminates long hours of engineering previously required for microwave impedance measurements. The system provides direct meter readings of reflection coefficient, and is so simple to operate it can be used by non-technical personnel. An output is also available for oscilloscope or recorder presentation. The system eliminates the need for measuring forward and reverse power separately, and does away with tedious adjustments to correct for source amplitude variations. At present the equipment is available for X band operation only but components for other frequency ranges will be offered soon. The system includes several completely new *-hp-* instruments:

-hp- 416A Ratio Meter automatically combines forward and reverse signals and displays their ratio directly, irrespective of amplitude variations. Reflection coefficient may be read directly on the front panel meter. A signal at a rear terminal is provided to operate an oscilloscope or recorder. Model 416A contains an rf power monitor indicating proper power level. Obtainable accuracy for single frequency measurement is ± 0.005 reflection coefficient; for swept frequency measurement, ± 0.015 reflection coefficient.

Model 416A may also be used to measure SWR in connection with slotted lines. A reference voltage from the system power source applied to the ratio meter eliminates error due to amplitude variation.

-hp- 670HM Swept Frequency Oscillator operates over a frequency range of 7 to 10 KMC. It may be manually tuned or motor driven to sweep any portion of this frequency band automatically. Sweep is at a velocity which is constant and sufficient to insure a clear trace on a long-persistence cathode ray oscilloscope. *-hp-* 670HM has a direct-reading frequency dial, and a waveguide-beyond-cutoff attenuator. It is normally grid modulated for sweeping, but also has reflector modulation for both fm and pulsed output. The oscillator requires an external power supply.

-hp- 717A Klystron Power Supply provides 800 to 1,000 volts beam voltage with regulation better than 0.1%, and 0 to 600 volts reflector voltage with regulation better than 0.05%. Model 717A also includes square wave modulation for both grid and repeller, as well as sine wave modulation for fm'ing. It is specifically designed as a companion instrument to *-hp-* 670HM.

-hp- 752 Series Directional Couplers are high directivity units consisting of two waveguides joined on their broad faces. Coupling is obtained through a series of precisely matched, graduated holes. In the system pictured, two couplers (with 10 db and 20 db directivity respectively) are joined back to back. Power flow is then as indicated in Fig. 1.

-hp- 421A Waveguide Detectors have square-law characteristics and demodulate the rf signal for use by *-hp-* 416A Ratio Meter.

Brief specifications of major instruments in the *-hp-* reflectometer system are given here. Complete specifications on all instruments in the system will be sent on request. For a comprehensive discussion of reflectometer measurements with these instruments, see *-hp-* Journal, Volume 6, Number 1-2, or write direct.

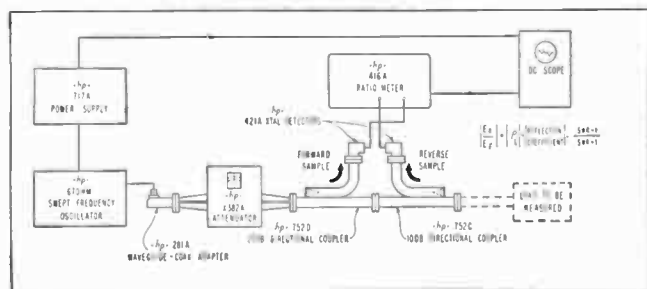

Figure 1. Reflectometer system. Swept rf power is provided by Oscillator. Directional Couplers sample forward and reverse power. Waveguide Detector Maunts terminating both Couplers demodulate power and present a 1,000 cps signal to Ratio Meter. Oscilloscope presents continuous visual study of reflection coefficient over the swept frequency range.

HEWLETT-PACKARD COMPANY

3150D Page Mill Road • Palo Alto, California, U.S.A.

Cable: "HEWPACK"

Field Representatives in all principal areas

at Booths 248-250
(Radio Road at Instrument Ave.)



I.R.E. SHOW



DB319 Tunable Crystal Mount (above)



DB915 Phase Shifters



DB715 Frequency Meters



DB820 Stdg Wave Detectors



DB410 Precision Attenuator



DB310 Crystal Mounts



DB919 Variable Stub Tuners



DB350 Crystal Multipliers

A COMPLETE LINE OF RESEARCH INSTRUMENTS COVERING FREQUENCIES UP TO 90,000 MC!

What new miracles are waiting to be found in the virtually unexplored microwave region above 40,000 MC? Scientists have begun to seek the answer to this question — and hints of some important discoveries are in the wind.

Here, for the first time, is a complete line of accurate, dependable microwave equipment, which features specially engineered instruments for these UPPER FREQUENCY RANGES, as well as lower ranges!

Standing wave detectors, precision attenuators, phase shifters, tuners, crystal mounts, wavemeters, horns, terminations, couplers — every type of instrument generally used for more conventional frequencies from 2.6 to 18 KMC — are now available in continuous coverage up to 90 KMC. D-B Crystal Multipliers produce required frequencies when above the range of currently available tubes.

WRITE FOR FURTHER INFORMATION

DeMornay-Bonardi, leaders in microwave instrumentation for 14 years, will aid research organizations in planning systems, setting up test equipment, or developing special units. RESERVE YOUR NEW 1955 DEMORNAY-BONARDI CATALOG NOW. Write on company letterhead to the address below.

Also Available — Microwave Spectroscopy Equipment up to 90 KMC, including absorption cells, Stark and Zeeman cells, and associated equipment.

See it at the IRE Show—669 Circuits Ave.

Dept. IR-1

DE MORNAY  **BONARDI**
Pasadena, California  780 S. Arroyo Parkway



(Continued from page 130A)

SUBSECTIONS

AMARILLO-LUBBOCK

"Recent Developments in Transistor Materials and Devices," by Dr. G. K. Teal, Texas Instruments, Inc.; November 15, 1954.

"An Electronic Servo System for Guiding Telescopes," by Dr. J. H. Rush, Texas Technological College; December 9, 1954.

BERKSHIRE COUNTY

"UHF Television Trials and Tribulations," by Leon Podolsky, Greylock Broadcasting Company; November 12 and 13, 1954.

BUENAVENTURA

"Research Resources and Resourcefulness," by Dr. A. M. Zarem, Stanford Research Institute; December 9, 1954.

CENTRE COUNTY

"The A-C Network Calculator," by A. H. Forbes and P. E. Shields, Pennsylvania State Univ.; December 7, 1954.

MONMOUTH COUNTY

"Aircraft Flight Control and Navigation Systems Used by Man and Machine," by Edgar H. Fritze, Collins Radio Company; January 19, 1955.

PALO ALTO

"Some Aspects of Human Communication," by Dr. Alexis Bavelas, Mass. Institute of Technology; January 13, 1955.

What to See at the Radio Engineering Show

(Continued from page 1A)

AIRBORNE INSTRUMENTS LABORATORY
MINEOLA, L. I., N. Y.

BOOTHS
63 and 65

KINGSBRIDGE PALACE

AMP BOOTHS 770-2
AIRBORNE AVE.

SOLDERLESS TERMINALS & CONNECTORS FEATURING
MINIATURE TAPER PIN CONNECTOR BLOCKS*
TAPER PIN & TAPER TAB RECEPTACLES*
PATCHCORD PROGRAMING SYSTEMS
PULSE-FORMING NETWORKS & HIGH-VOLTAGE CAPACITORS

AIRCRAFT-MARINE PRODUCTS, INC.
HARRISBURG, PENNA.

(Continued on page 140A)

NEW HIGH VOLTAGE SILICON JUNCTION DIODES

NEWLY EXPANDED TI LINE NOW INCLUDES 15 SINGLE CRYSTAL JUNCTION TYPES IN 20% VOLTAGE RANGES FROM 4.7 TO 470 VOLTS!

high temperature conditions call for silicon diodes from Texas Instruments — your most experienced source of supply for silicon semiconductor devices. The first commercial producer of silicon transistors, TI has produced for commercial and military use many thousands of silicon junction diodes and triodes. TI now introduces a completely new line of silicon diodes including many high voltage types, greatly increasing the application for these reliable devices. This new line features types with characteristics stable to 150°C.

2009

TI

low back current, another important characteristic of TI silicon junction diodes, opens up still more space and weight saving circuit design possibilities. With back current as low as 0.001 microamp at rated voltage for many types, these silicon junction diodes can be used in applications where high operating temperatures and low back current requirements make germanium diodes unsuitable.

100 per cent inspection and aging of every TI diode assures maximum reliability. Thoroughly tested at high temperatures, these uniformly high quality silicon diodes will increase electronic equipment dependability where heat, shock and vibration are problems. Every unit is hermetically sealed, providing maximum protection against ambient moisture.

TI Type	Max. Rev. Working Voltage	Min. Junct. Break-down Voltage	Minimum Forward Current 25°C		Maximum Ratings at 25°C			Maximum Ratings at Elevated Temperatures				Typical Capacity μA-Id f = 500 kc Temp. = 25°C Rev. Volts -12V†
			Ma.	Volts	Reverse Current Amperes*	Dissipation mw	Average Rectified Forward Current ma	Ambient Temp. °C	Reverse Current Amperes*	Dissipation mw	Average Rectified Forward Current ma	
600C	—	30.0	3	1	$1 \cdot 10^{-6}$ @ -1V	100	25	100	$0.4 \cdot 10^{-4}$	40	15	2.5
601C	—	50.0	3	1	$1 \cdot 10^{-8}$ @ -1V	100	25	150	$0.5 \cdot 10^{-4}$	20	10	2.5
604C	4.7	5.5	60	1	$1 \cdot 10^{-7}$	150	100	150	$0.5 \cdot 10^{-4}$	40	40	20
606C	6.8	7.5	35	1	$1 \cdot 10^{-7}$	150	90	150	$0.5 \cdot 10^{-4}$	40	35	16
608C	10.0	11.0	25	1	$1 \cdot 10^{-7}$	125	75	150	$0.5 \cdot 10^{-4}$	20	25	12
610C	15.0	17.0	12	1	$1 \cdot 10^{-7}$	125	60	150	$0.5 \cdot 10^{-4}$	20	20	7
612C	22.0	25.0	7	1	$1 \cdot 10^{-7}$	125	50	150	$0.5 \cdot 10^{-4}$	20	20	5
614C	33.0	37.0	5	1	$1 \cdot 10^{-7}$	125	35	150	$0.5 \cdot 10^{-4}$	20	15	3.5
616C	47.0	52.0	3	1	$2 \cdot 10^{-7}$	100	30	125	$0.4 \cdot 10^{-4}$	20	15	2.5
618C	68.0	75.0	1.5	1	$2 \cdot 10^{-7}$	100	25	125	$0.4 \cdot 10^{-4}$	20	10	2.0
620C	100.0	110.0	0.9	1	$2 \cdot 10^{-7}$	100	20	125	$0.4 \cdot 10^{-4}$	20	8	1.4
622C	150.0	170.0	6.5	4	$2 \cdot 10^{-7}$	90	15	100	$0.3 \cdot 10^{-4}$	30	5	1.2
624C	220.0	250.0	3	4	$0.4 \cdot 10^{-6}$	80	10	71	$0.2 \cdot 10^{-4}$	40	5	1.0
626C	330.0	370.0	2	4	$1 \cdot 10^{-6}$	75	7	71	$0.2 \cdot 10^{-4}$	30	4	0.9
628C	470.0	520.0	1	4	$1 \cdot 10^{-6}$	70	5	71	$0.2 \cdot 10^{-4}$	20	3	0.7

* At maximum working voltage.

† On types 604C, 606C, and 608C reverse voltage was reduced below breakdown voltage.

628C

For detailed information about TI's complete line of silicon junction diodes, write for Bulletin No. DL-S 431.

TEXAS INSTRUMENTS
INCORPORATED
6000 LEMMON AVENUE DALLAS 9, TEXAS

SEE the industry's widest semiconductor products line --- booth 796 at Radio Engineering Show!



New Simpson Core Meter Movement



Shown
TWICE
Actual
Size

Rugged... yet built like a fine watch!

Here's the new Simpson **Core-Type Meter Movement**. It's a more compact, more sensitive, **self-shielding** movement that gives electrical measurements with laboratory accuracy, yet has the ruggedness to withstand severe shocks. Its accuracy specifications are so rigid that Simpson engineers had to devise unusual production techniques.

Let Simpson engineers design panel meters using the new core movement to your special instrument requirements. Simpson continues to maintain its large stock of standard panel meters in over 700 sizes and ranges, available through distributors.

RUGGEDIZED METERS

Simpson's 2 1/2" and 3 1/2" Panel Meters are available in **sealed, ruggedized** models to meet specifications MIL-M-10304-(Sig. C). Movements are sealed against moisture and other adverse atmospheres, and are spring-mounted to absorb excessive vibration.

SEND FOR NEW CATALOG 17



INSTRUMENTS THAT STAY ACCURATE

Simpson

ELECTRIC COMPANY

INVITATION! Drop in and see us at the **I.R.E. National Convention**, March 21-24, in New York City. . . . Booth No. 448 on Electronic Avenue and Radio Road.

5201 W. Kinzie St., Chicago 44, Illinois, Phone: EStebrook 9-1121
In Canada: Bach-Simpson, Ltd., London, Ontario

Simpson

MODEL

260

MULTI-TESTER

outsells all others combined!

More technicians are using the Model 260 than any other high-sensitivity VOM. Over half a million Model 260's have been sold to date! 20,000 Ohms per volt. You'll find it wherever quick, accurate, electrical checks are needed. It's so handy, so dependable, so sensibly priced. Ask your jobber to show you the Simpson Model 260. Only **\$38.95**, including Adjust-A-Vue Handle. Carrying cases from **\$6.75**.



world's most popular!

MODEL

262

the new vom with a 7" meter

20,000 Ohms per volt DC. 5,000 Ohms per volt AC. 33 RANGES
DC VOLTAGE: 0-1.6, 0-8, 0-40, 0-160, 0-400, 0-1600, 0-4000 volts (20,000 ohms per volt sensitivity)
AC VOLTAGE: 0-3, 0-8, 0-40, 0-160, 0-800 volts (5,000 ohms per volt sensitivity)
AF OUTPUT VOLTAGE: 0-3, 0-8, 0-40, 0-160 volts (0.1 microfarad internal series capacitor)
VOLUME LEVEL IN DECIBELS: -12 to +45.5 DB in 4 ranges. Zero DB Power Level, .001 watt in 600 ohms.
DC RESISTANCE: 0-500 ohms (4.5 ohms center); 0-5,000 ohms (45 ohms center); 0-50,000 ohms (450 ohms center); 0-500,000 ohms (4,500 ohms center); 0-5 megohms (45,000 ohms center); 0-50 megohms (450,000 ohms center)
DC CURRENT: 0-80, 0-160 microamperes, 0-1.6, 0-16, 0-160 milliamperes, 0-1.6, 0-16 amperes (267 millivolts maximum drop)
MODEL 262 complete with 2 test leads with removable alligator clips, 4,000 v. DC multiplier
Dealer's Net Price, including Adjust-A-Vue Handle. **..\$59.50** Carrying Case. **..\$9.95**
Accessory High Voltage Probe for 16,000 volts DC. **..\$11.50**, 40,000 volts DC. **..\$12.50**



Deluxe!

SEE THEM AT YOUR JOBBER, OR WRITE . . .

Simpson ELECTRIC COMPANY

WORLD'S LARGEST MANUFACTURER OF ELECTRONIC TEST EQUIPMENT

5201 W. Kinzie St., Chicago 44, Illinois, Phone: EStebrook 9-1121
In Canada: Bach-Simpson, Ltd., London, Ontario

INVITATION! Drop in and see us at the I.R.E. National Convention, March 21-24, in New York City. . . . Booth No. 448 on Electronic Avenue and Radio Road.

your "special" transformers are

stock units at *Chicago Standard*

Most CHICAGO-STANCOR transformers are available in at least three different mountings and terminal types . . . some in as many as six! You can get the one that is best for your job . . . and get it fast, from stock, through your CHICAGO-STANCOR distributor.

CHICAGO-STANCOR transformers are the logical choice for

- Industrial and military research and instrumentation
- Prototype production
- Amateur and commercial broadcasting
- Communications
- High fidelity
- Public address



FREE: CHICAGO STANDARD catalogs listing over 1000 transformers for original equipment and replacement applications.



<p>H Type</p>	<p>C and TD Types</p>
<p>B Type</p>	<p>S Type</p>
<p>V and C Types</p>	<p>M Type</p>
<p>A, J, L, and U Types</p>	<p>FS Type</p>

CHICAGO STANDARD TRANSFORMER CORPORATION

ADDISON AND ELSTON
CHICAGO 18, ILLINOIS

Export Sales: Roburn Agencies, Inc.
431 Greenwich Street, New York 13, N. Y.

What to See at the Radio Engineering Show

(Continued from page 136A)

Aircraft Transformer Corp.

507 Components Ave.

Transformers for electronic application in military and high quality commercial equipment. Featuring "FormFlex," the new and revolutionary coatings for high and low temperature environments.

Air-Marine Motors, Inc.

717 Airborne Ave.

Sub-fractional motors, Fans, Blowers, Gear motors.

See the new "TORSYNATOR"

Aironic Accessory Co., Inc., 308 Computer Ave.

Tape resistors, miniature connectors and relays, printed circuit connectors, precision gear trains, precision potentiometers, subfractional IIP motors and blowers, semi-automatic wire cutter and stripper, clips and clamps, transformers, toroids, filters.

Airpax Products Co.

744 Airborne Ave.

Choppers (mechanical modulators), Power Inverters and Vibrators, Power, Audio & Pulse Transformers, Power and Audio Chokes, Magnetic Amplifiers. Developed and Built to Customer Specifications.

Microwave Ferrite Components • Antenna Feeds • Rotary Joints • Flexible Waveguide Assemblies • Precision Cast Mixers, Duplexers, and Hybrids • Directional Couplers • Double Ridge Waveguide • Lightweight, High Power Terminations. Equipment available in Airtrotron, Inc. designs or to your specifications.

Alcar Instruments, Inc., 412 Electronics Ave.

*More Powerful Ultra Sonic "Solder Gun" for rapid fluxless soldering to aluminum & other fast oxidizing materials. Improved, versatile coil winder for laboratory & production.

*Indicates new product

(Continued on page 142A)



... automatically made, therefore made with precision metal and insulation components. CINCH automatically assembled parts assure the uniformity and quality mandatory for use in AUTOMATION in the end users equipment. Adequate and unequaled facilities have advanced CINCH to the foremost producer of low loss Mica components in production quantity.

FOR OVER A QUARTER OF A CENTURY ... PRODUCER OF THE STANDARD ELECTRONIC COMPONENT

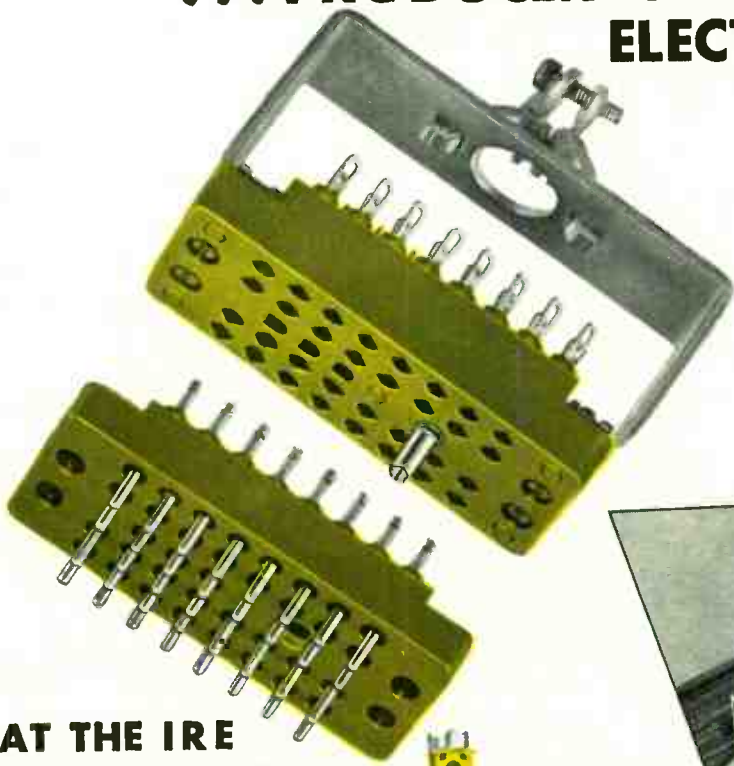

CINCH molded general purpose connectors, from three to fifty contacts or more, are designed and made of materials as desired and necessary to meet application requirements. They are available in low loss mica for chassis mounting or assembled with cap for cable applications. Terminals gold or silver plated.

Cinch components available at leading electronic jobbers—everywhere.



AT THE IRE
SHOW BOOTHS
NOS. 394 & 396



Centrally located plants
at Chicago, Shelbyville, Indiana
and St. Louis.

CINCH MANUFACTURING CORPORATION

1026 South Homan Ave., Chicago 24, Illinois

Subsidiary of United-Carr Fastener Corporation, Cambridge, Mass.

For a component in the list that follows, or for a component to be designed to fit a specific need,

CONSULT CINCH

- ANTENNA JACKS
- BANANA PINS AND JACKS
- BARRIER TERMINAL STRIPS
- FANNING STRIPS
- BATTERY PLUGS & SOCKETS
- BINDING POSTS
- DIODE SOCKET
- CONNECTORS, MULTI CONTACT
- FUSE STRIPS, BLOCKS & BOARDS
- GRID CAPS
- GRID CAP SHIELDS
- HERMETICALLY SEALED TUBE SOCKETS

- METAL STAMPINGS
- MICRO-CONNECTORS
- MOUNTING DEVICES
- PHONO TIP JACKS
- PRINTED CIRCUIT, CONNECTORS
- SHIELDS, TUBE-MINIATURE & NOVAL & BASES SOLDERING LUGS—200 VARIATIONS
- STRAP NUTS
- TRANSISTOR SOCKET
- TUBE HOLDERS—SPRING TYPE
- VIBRATOR PLUGS AND SOCKETS

SOCKETS:

- Tube (Receiver, Transmitter and Special): Battery, all types
- C-R Tube
- Crystal
- Electrolytic
- Glass Type: 4 to 7 prong laminated
- Infra-red Ray Tube
- High Altitude Airborne Types
- Kinescope; Magnal, Duodecal, Diheptal

- Laktal-Miniature-Multiplug
- Noval-Octal (Molded bakelite, steatite, teflon, Kel-F and laminated)
- Plexicon
- Printed Circuit
- Special Sockets to Specs
- Sub-Miniature; Hearing Aid Types
- TV; 110V Circuit Breakaway
- Vibrator
- Pencil Tube Transistor
- Diode

LIECO THE MOST COMPLETE LINE OF MILLIMETER WAVEGUIDE COMPONENTS and TEST EQUIPMENT

WAVEGUIDE RG-()/U FLANGES UG-()/U FREQUENCY BAND in kmc/s	53	96	97	98	99
	595 or 425	599 or 381	383	385	387
	18.0-26.5	26.5-40.0	33.0-50.0	50.0-75.0	60.0-90.0
VARIABLE ATTENUATOR	9LBI	9MSI	9NSI	9PSI	9QSI
PRECISION ATTENUATOR	10LBI	10MSI	10NSI	10PSI	10QSI
ADJUSTABLE SHORT	13LBI	13MSI	13NSI	13PSI	13QSI
CRYSTAL MIXERS	14LBI	14MSI			
TERMINATION	16LBI	16MSI	16NSI	16PSI	16QSI
CRYSTAL DETECTOR MOUNT	21LBI	21MSI	21NSI	21PSI	21QSI
E-H TUNER	26LBI	26MSI	26NSI	26PSI	26QSI
90° TWIST	4LBI	4MSI	4NSI	4PSI	4QSI
90° E-BEND	5LBI	5MSI	5NSI	5PSI	5QSI
90° H-BEND	6LBI	6MSI	6NSI	6PSI	6QSI
E-PLANE TEE	7LBI	7MSI	7NSI	7PSI	7QSI
H-PLANE TEE	8LBI	8MSI	8NSI	8PSI	8QSI
E-H TEE	15LBI	15MSI	15NSI	15PSI	15QSI

FINISH: SILVER PLATING
WITH RHODIUM FLASH.

LIECO INC.

ADDITIONAL ITEMS
UPON REQUEST.

147 OCEAN AVE., LYNBROOK, N.Y. • LY. 9-6920

SEE US AT
IRE SHOW
BOOTH 380
MICROWAVE
AVENUE

SUBMINIATURE TOGGLE SWITCHES

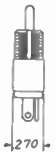

Model TSA
Single Pole Double Throw

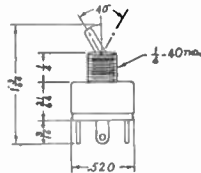

Model TSB
Double Pole Double Throw

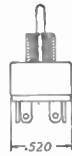

ELECTRICAL CHARACTERISTICS

CURRENT RATINGS (RESISTIVE):

2.0 amp. at 115 volts AC
2.0 amp. at 24 volts DC
1.0 amp. at 50 volts DC

CONTACT RESISTANCE:

Less than 0.005 ohm

INSULATION RESISTANCE:

Greater than 500 megohms

DIELECTRIC STRESS:

No breakdown or flashover between mutually insulated parts or between mutually insulated parts and ground at a potential of 330 volts rms, 60 cycles

Miniature  *Switch Corporation*

Telephone:
LYnbrook 9-9607

AN AFFILIATE OF LIECO, INC.

147 OCEAN AVENUE • LYNBROOK • NEW YORK

What to See at the Radio Engineering Show

(Continued from page 140A)

ALDEN PRODUCTS CO. 185, 187 Television Ave.

Mechanical components that simplify design, construction, and servicing of your electronic circuitry.

COMPONENTS mount your circuitry in compact, vertical planes. House your circuitry in accessible plug-in chassis and packages. Inter-connect your units with "point-of-check" connectors. Monitor your circuitry operation with tiny "tell-tale" indicators.

Helix recorders and components for High or Slow Speed Graphic Recording without Inks or Photography

New "build it yourself" helix recorders and components incorporating all techniques necessary for adjusterless, helix recording using Alfax Paper.

Permit wide variety of set ups

Alden Electronic and Impulse Recording Equipment Company

189 Television Ave.

Alfax Paper & Engineering Co. 191 Television Ave.

Alfax Paper—"electricity is the ink" for instantaneous graphic recording without photography or secondary processing—For the first time extremely high speed recording, or equally important, slow speed recording, is now possible without inks, pens, precision parts, styli or any delicate parts using new Alden techniques and Alfax Paper.

Alford, Andrew, Consulting Engineers,
393 Microwave Ave.
RF Equipment

Alford Manufacturing Co., Inc.

393 Microwave Ave.

TV Broadcast Transmitting Antennas, Air Navigation Aids and Test Equipment.

All-Tronics, Inc., 57 Palace
Radio interference filters, screen room filters,
*line stabilization networks.

Allegheny Ludlum Steel Corp., 146, 148,
150 Television Ave.

"Steelmakers to the Electric Industry" . . .
Producers of a complete line of silicon steels,
special electrical alloys & laminations, for
every electrical & electronic application.



ALLEN-BRADLEY
QUALITY
Radio & Television
Components

See them at IRE Booth 794

Fixed resistors—Copper clad resistors—
Ceramic enclosed resistors—Miniature
resistors—Adjustable resistors & po-
tentiometers—Ceramic capacitors—Feed
thru capacitors—Ferrite cores & filters.

* Indicates new product

(Continued on page 144A)

Spotlighting Standardization!



hermetically-sealed terminations and miniature closures*

- **MULTIPLE HEADERS** — Strain-free, vacuum tight headers featuring cushioned glass construction. Silicone treated for maximum dielectric strength and tin dipped for easy soldering.
- **SEALED TERMINALS** — These E-I terminals offer high thermal shock resistance and feature cushioned glass construction. Available in many economical preferred types and special designs.
- **OCTAL HEADERS** — Both plug-in and multiple types feature a new principle of hermetic sealing. Solid metal blanks afford maximum rigidity and mechanical strength.
- **E-I END SEALS** — Completely strain-free. Provide a permanent hermetic seal. For condensers, resistors and other tubular-type components. Available in many standard types.
- **COMPRESSION TYPE HEADERS** — Super rugged, practically indestructible and absolutely rigid. Exclusive E-I process affords increased resistance to shock and vibration.
- **LUG-TYPE, LEAD-THRU INSULATORS** — Compression sealed, super rugged. For applications requiring voltage ratings from 2000 to 4000 (rms.) — transformers, "bath-tub" condensers, etc.
- **MINIATURE CLOSURES** — For transistors and other components requiring hermetic sealing. Square, rectangular and round cases. Supplied in E-I standard types or custom designs to specifications.
- **COLOR-CODED TERMINALS** — Featuring glass inserts with permanent coloring in the glass. All types offered in standard, easily-identified RMA color codes.

*PATENT PENDING
ALL RIGHTS RESERVED

AVAILABLE IN A
WIDE RANGE OF
STANDARD TYPES TO
ECONOMICALLY MEET
SPECIAL REQUIREMENTS!

Economical E-I standardized hermetically-sealed terminals and miniature closures are available to meet almost any electronic application. Samples and recommendations on your particular needs will be supplied promptly on receipt of your data. Call or write for complete E-I catalogs, today!

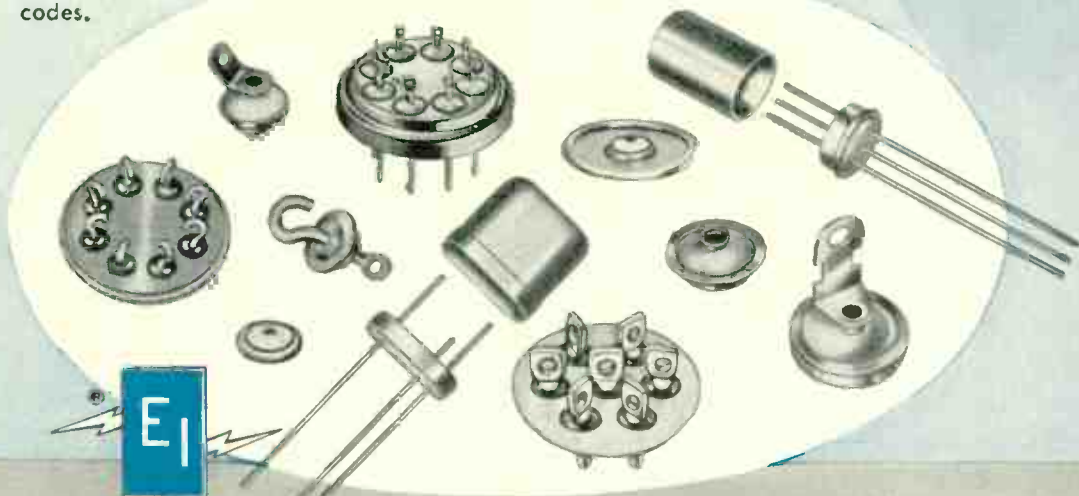

ELECTRICAL INDUSTRIES

44 SUMMER AVENUE, NEWARK 4, NEW JERSEY

DIVISION OF AMPEREX ELECTRONIC CORP.

AT THE I.R.E. SHOW!

BOOTHS 650, 652
CIRCUITS AVENUE

Kingsbridge Armory
New York City
March 21-24, 1955



RESINITE

Corporation

invites you

TO VISIT

BOOTH No. 791*

**AT THE
RADIO
ENGINEERING SHOW**

**1955
IRE**

National Convention

New York City ••• March 21-24

*KINGSBRIDGE ARMOY,
AIRBORNE AVE.



RESINITE: THE COIL FORM WITH THE HIGHEST RESISTIVITY OF ANY RESINATED PRODUCT.

Custom fabrication to your exact specification assures correct dimensions to within the most critical tolerances, plus uniformity throughout.

Threads are positioned in accordance with your requirement —full thread, each end, one end, center only.

We will furnish—without charge—a pilot production run of custom-made embossed forms to fit your particular application. We will also send a winding mandrel made to the specifications you supply.

Resinite representatives will be on hand to explain full details on Use of Threaded Tubes, Threaded Iron Cores VS. Torque Control.

RESINITE CORPORATION

Sales Representatives in:

New England:
Framingham, Massachusetts, Framingham 7091
Metropolitan New York, New Jersey:
Jersey City, New Jersey, Journal Square 4-3574
Upstate New York:
Syracuse, New York, Syracuse 76-8056
Northern Ohio, Western Pennsylvania:
Cleveland, Ohio, Atlantic 1-1060
Indiana, Southern Ohio:
Logansport, Indiana, Logansport 2555

Missouri, Southern Illinois, Iowa:
St. Louis, Missouri, Sterling 2318
Maryland:
Baltimore, Maryland, Plaza 2-3211
Philadelphia, Camden:
Philadelphia, Pa., Chestnut Hill 8-0282
California:
Pasadena, California, Sycamore 8-3919
Canada:
Montreal, Quebec, Canada, Walnut 2715

Division
of..

PRECISION PAPER TUBE COMPANY

2035G W. CHARLESTON ST. • CHICAGO 47, ILLINOIS

What to See at the Radio Engineering Show

(Continued from page 142A)

Allied Chemical & Dye Corp., Booth 558
Components Ave.

See Barrett Division of Allied Chemical & Dye Corp.

Allied Control Co., Inc., 492 Electronics Ave.

*Sub-subminiature relay, D.P.D.T., with 0.5 amp. rating. Subminiature sensitive relay, D.P.D.T., 40 mw., 2 am. rating. Contacts for low-level applications. Counterbalanced armature in subminiature relay for 100G. Subminiature relay 6-4 pole, 20G, to 2000 cycles. 4 pole & 2 pole subminiature relays 10 amp. rating.

Allied Engineering Div., Allied International Inc., 71 Palace

**"Jetrol" Plotomat, an electronic strain calculator. "Trichrometer" color control and recording equipment. General Products of power supplies and test equipment.

Alpha Metals, Inc., 701 Production Rd.

Printed circuit solder, fluxes, cen-tri-core energized rosin-cored solder, special low melting alloys for diodes and transistors, preforms and fluxes for all automatic operations.

Alpha Wire Corp.

454 Electronics Ave.

Complete line of Electronic Wire & Cable, and *introducing the new Alphex line of tubing & sleeving. Government specification and commercial types.

Altec Lansing Corp.

882, 884 Audio Ave.

Complete line of microphones, dynamic, velocity and condenser, control consoles and loudspeakers, featuring the new 440A remote and 340A power amplifiers.

American Aluminum, 25 Palace

Precision drawn, non-ferrous components for radio, radar and electronic devices; including riveted, heliarc welded and spot welded assemblies. Precision spinnings will also be exhibited.

American Electronics, Inc., 726, 728 Airborne Ave.

American Electric Motors, manufacturers of small blower motors, alternators, ground power equipment, plane cooling equipment, load banks, test equipment, resolvers, servo motors, tachometers, induction potentiometers, computers, synchros.

* Indicates new product

(Continued on page 146A)

FIRST AID ROOM

A nurse is in charge at all times. First Aid Room is the sixth room to right of Lobby directly off registration area in Kingsbridge Armory.

A BILLION OPERATIONS

... with no maintenance whatsoever

... from NEW CLARE

Mercury-Wetted Contact Relays



• Cutaway view showing sealed-in-glass, mercury-wetted contact switch, surrounded by the operating coil and encased in a metal housing mounted on an octal base.

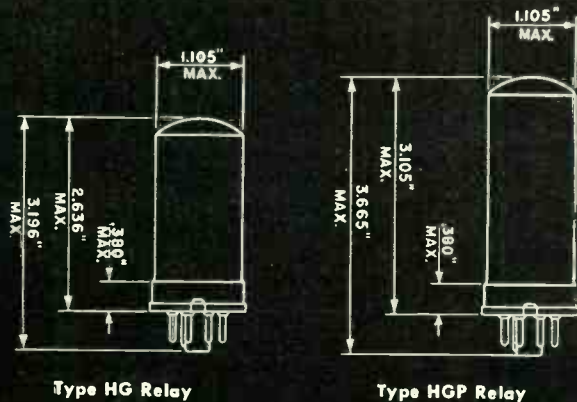

CLARE Type HG and HGP Relays are built to meet the exacting requirements for—

Computing machines	Servo-mechanisms
Sorting machines	Relay amplifiers
Tabulating machines	High-speed keying relays
Totalizers	Signaling devices

All kinds of high-speed switching devices

Outstanding features of CLARE Type HG and HGP Relays

ELECTRICAL FEATURES

LONG LIFE: Conservative life expectancy of over a billion operations when operated within ratings.

HIGH SPEED: Give consistent performance at speeds up to 60 operations per second.

HIGH CURRENT—and voltage-handling capacity (up to 5 amperes, and up to 500 volts).

UNIFORMITY: Operating time varies by only about 0.1 millisecond under constant drive conditions.

CHATTER-FREE: Mercury dampens armature vibration and bridges mechanical chatter between metal contact surfaces.

MECHANICAL FEATURES

- Small chassis space required
- Convenient plug-in mounting
- Environment-free
- Tamperproof
- High sensitivity
- Maintenance-free
- No contact wear
- Adjustment cannot change

This first announcement of the new CLARE Mercury-Wetted Contact Relays is of especial importance to designers of high-speed switching machines and devices which demand accuracy and dependability of a high order.

In these relays, with their unique electrical and mechanical stability, you will find exactly the qualities this kind of apparatus requires—

- Long life (over a billion operations)
- High speed (up to 60 operations a second)
- High current- and voltage-handling capacity (up to 5 amperes, and up to 500 volts)
- Bounce- and chatter-free contacts
- Extraordinary uniformity of operation

These distinctive characteristics are achieved by the use of platinum contact surfaces, continuously wetted with mercury by capillary action, and the hermetic sealing of a magnetic switch in a protected glass capsule, filled with pressurized hydrogen.

CLARE Type HG Relays comprise a switch element and an operating coil. CLARE Type HGP Relays are similar but can be factory-adjusted to provide either biased or polarized operating characteristics.

For complete information on the new CLARE Type HG and HGP Mercury-Wetted Contact Relays, contact your nearest CLARE representative or address C. P. Clare & Co., 3101 Pratt Blvd., Chicago 45, Illinois.

Send for CLARE Sales Engineering Bulletin No.120

CLARE RELAYS

FIRST IN THE INDUSTRIAL FIELD

Visit CLARE Booth 434

Radio Engineering Show • March 21-24

Kingsbridge Armory • New York, N.Y.

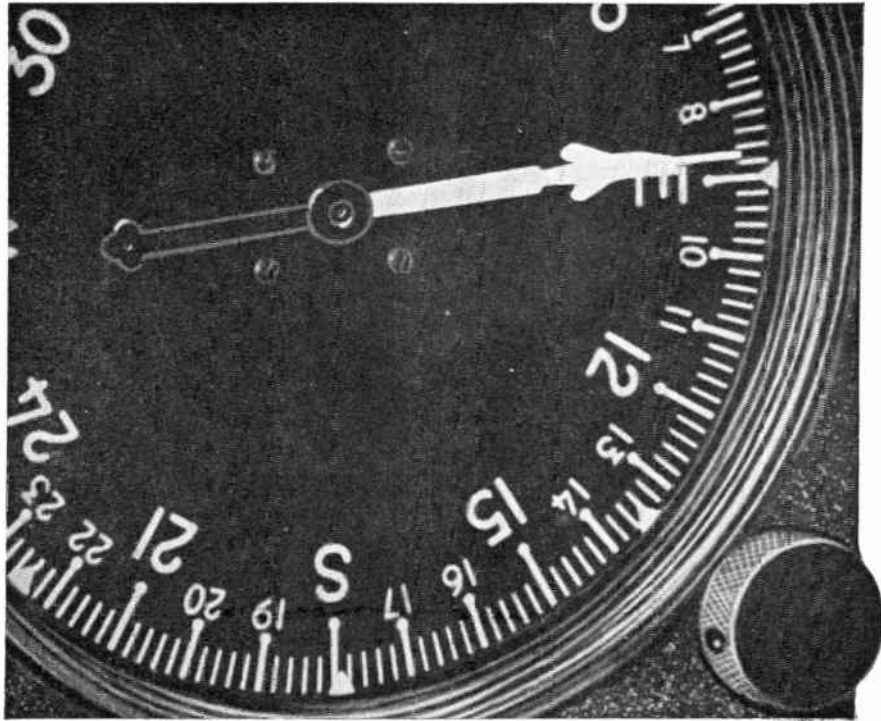

Both the Counter and the Dial Indicator are shown full size.

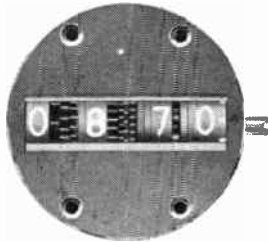

WHICH IS READ WITH GREATER ACCURACY?

The Kearfott Counter shown can be read with the same ease and accuracy as a dial indicator 14 3/4 inches in diameter.

Ball Bearings and precision hardened steel parts used in Kearfott Counters permit their high speed rotation for long periods of time. Kearfott Counters are capable of being driven at 1800 RPM. Precision parts also contribute to precise positioning and precise reading.

STANDARD KEARFOTT TYPES

ANGLE COUNTERS: Odometer indication of shaft position, fully reversible operation returning to 0° at end of count. Either 0°-359.9° in 1/10 or 0°-359° in 1/2° increments as desired. Maximum speed 1800 RPM.

KEARFOTT COMPONENTS INCLUDE:

Gyros, Servo Motors, Synchros, Servo and Magnetic Amplifiers, Tachometer Generators, Hermetic Rotary Seals, Aircraft Navigational Systems, and other high accuracy mechanical, electrical and electronic components.

Send for bulletin giving data of Counters and other components of interest to you.

DECIMAL COUNTERS: High speed decimal count from 0-9999 and return to 0 in 1/2 increments. Maximum speed 1800 RPM. One revolution of shaft equals 10 units.

LONGITUDE COUNTERS: For east-west longitude indication in degrees and minutes in 1/2 minute increments. Mask transfers hemispheric indication at 0° and 179°59'. Maximum speed 1800 RPM.

LATITUDE COUNTERS: Indicates N 89°59' to S 89°59'. For same direction of input the mask transfers hemispheric indication and reverses reading at 00 degrees 00 minutes. Maximum speed 1800 RPM.

Variations of these Standard Types are available for special purposes.

KEARFOTT DISPLAY AT THE NATIONAL I.R.E. SHOW, KINGSBRIDGE ARMOY, NEW YORK, BOOTH 152.



A SUBSIDIARY OF GENERAL PRECISION EQUIPMENT CORPORATION

KEARFOTT COMPANY, INC., LITTLE FALLS, N. J.

Sales and Engineering Offices: 1378 Main Avenue, Clifton, N. J.
Midwest Office: 188 W. Randolph Street, Chicago, Ill. South Central Office: 6115 Denton Drive, Dallas, Texas
West Coast Office: 253 N. Vineland Avenue, Pasadena, Calif.

What to See at the Radio Engineering Show

(Continued from page 144A)

American Elite, Inc. 81 Palace

TELEFUNKEN microphones; Magnetophon professional portable tape recorder; Telefunken receiving tubes and cutting head. Premiere showing in United States of the tubes and cutting head.

ALSiMAG®

Custom Made
Technical Ceramics

BOOTH 124
Television
Avenue

Engineers in attendance to advise on special electronic applications.

AMERICAN LAVA CORPORATION

A Subsidiary of
Minnesota Mining and Manufacturing Company

American Machine & Foundry Co.

106, 108, 110 Television Ave.

Newly developed Flame Detector (for jet aircraft engines), demonstration of precision electronic controls for high speed industrial production and ordnance. Special purpose batteries, relays, fastening devices. Radar, Teflon film, Dynamic Tube comparator demonstrations.

443
AMPHENOL
445
447

New components, new catalogs,
new product literature — all on
display at the AMPHENOL exhibit

See us at RADIO ROAD
and ELECTRONIC AVENUE

American Silver Co., 350 Microwave
Ave.

*Temperature-actuated (thermostat) metals, electronic grade nickel-clad steel, oxide-free beryllium-copper strip, high-precision tolerance titanium foil, silver-clad beryllium-copper strip, high-permeability alloys. Also: wide variety of ultra-thin, high-precision tolerance metal strip, clad metals.

ATR American Television & Radio Co. 695 Circuits Ave.

Auto Radio VIBRATORS, ATR
DC-AC INVERTERS, ATR Vibrator
Power Supplies, ATR Rectifier
POWER SUPPLIES, ATR "A" Battery
ELIMINATORS, ATR SHAV-
PAKS, ATR BATTERY CHARG-
ERS, and ATR CHARA-VERTERS.

*Indicates new product

(Continued on page 149A)

★ **THIS IS IT!** ★



NEW 3-WATT Blue Jacket[®]
miniaturized axial-lead wire wound resistor

This power-type wire wound axial-lead Blue Jacket is hardly larger than a match head *but it performs like a giant!* It's a rugged vitreous-enamel coated job—and like the entire Blue Jacket family, it is built to withstand severest humidity performance requirements.

Blue Jackets are ideal for dip-soldered sub-assemblies . . . for point-to-point wiring . . . for terminal board mounting and processed wiring boards. They're low in

cost, eliminate extra hardware, save time and labor in mounting!

Axial-lead Blue Jackets in 3, 5 and 10 watt ratings are available without delay in any quantity you require. ★ ★ ★

SPRAGUE TYPE NO.	WATTAGE RATING	DIMENSIONS L (inches) D	MAXIMUM RESISTANCE
151E	3	1 1/2 1 3/4	10,000 Ω
27E	5	1 1/4 3/4	30,000 Ω
28E	10	1 1/4 3/4	50,000 Ω

Standard Resistance Tolerance: ±5%

SPRAGUE

WRITE FOR ENGINEERING BULLETIN NO. 111B

SPRAGUE ELECTRIC COMPANY • 235 MARSHALL ST. • NORTH ADAMS, MASS.

Surco

WIRE · CABLES · TUBING

OPERATING TEMPERATURES FROM -90°C TO 210°C

SIZES FROM 32 TO 4/0

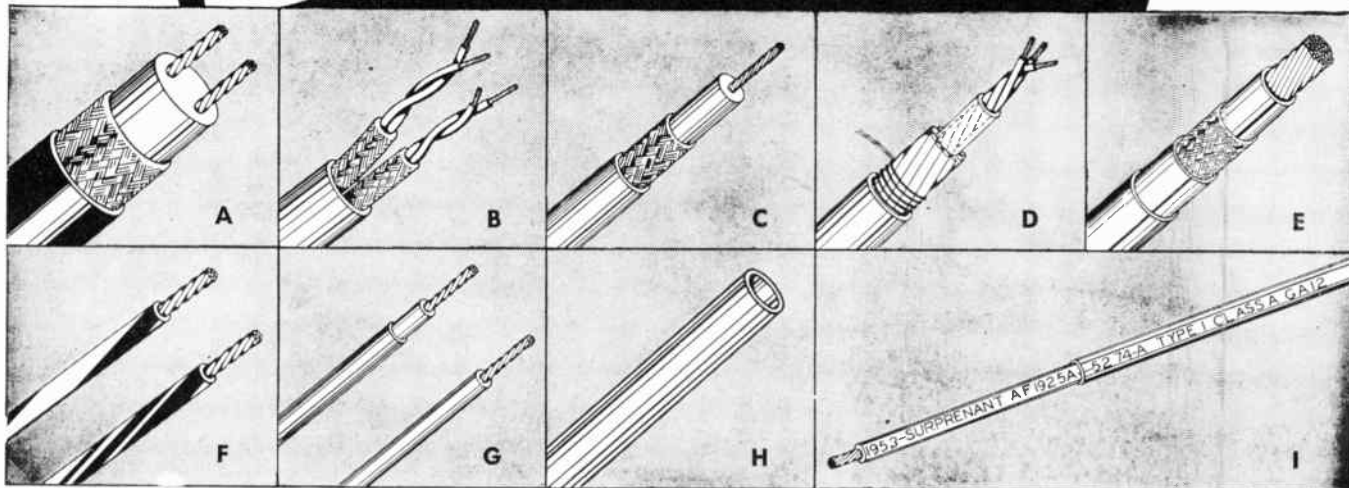

A Coaxial Cables—“Surco” coaxial cables include a wide variety of types, such as low capacity, extra flexibility, small diameter, microphone, 2 conductor, and high temperature “Teflon”. Conform to Military Spec. Jan-C-17A. Many special designs. If you have a coaxial cable problem consult us.

B Miniature Wire & Cable—“Surco” miniature wire and cables are made in conductor sizes down to No. 32 AWG in stranded and solid. Close control in manufacturing permits small finished diameters on both single and multi-conductor cable. Available in standard colors with and without nylon jacket or shielding in the various vinyl or polyethylene compounds.

C “Surflene” Insulated Hook-up Wire—“Surflene”, extruded monochlorotrifluoro ethylene, has excellent resistance to heat, abrasion, and most chemicals, including nitric acid. Having high dielectric strength and insulation resistance, it is especially useful in totally enclosed applications with continuous temperatures up to 135°C. “Surflene” is available in 15 solid colors and wall thicknesses down to 0.008”. “Spiralon” colors presently under development.

D Multi-Conductor Cables—“Surprenant” multi-conductor cables are available with conductor sizes from No. 32 AWG and larger, with or without nylon jacket or shielding and can be made to specification for special design and applications. Close tolerances permit unusually small overall diameters and “Spiralon” color coding permits easy identification even when hundreds of conductors are involved.

E New Improved Aircraft Wire—Surprenant new lightweight, smaller diameter MD wire-(vinyl-glass braid-nylon) and the standard Surprenant sandwich construction (vinyl-glass braid-vinyl-nylon) give excellent overload safety, high and low temperature performance, good electrical properties and have a nylon jacket giving greater resistance to abrasion, fungus, moisture, hydraulic and other oils (nylon braided jacket on sizes 10 AWG and larger for greater flexibility) and are made to conform to MIL-

W-5086. “Surprenant” also offers nylon jacketed-poly-vinyl-chloride construction made to conform to Military Spec. AN-J-C-48A.

F “Spiralon”—“Surco-Spiralon” color coding is available on all vinyl, polyethylene, and nylon insulated wires, with or without nylon jackets. One, two, or three color stripes are available in the standard Nema colors providing almost unlimited color identifications.

Solid color insulation is also available in the 10 standard Nema colors.

G “Surco” A-10 For (105°C) Hook-up Wire—A-10 is an unusually high grade vinyl insulating compound developed in our own laboratories for a better hook-up wire. It has excellent resistance to deformation, soldering, high temperature, low temperature and aging; high electrical properties; Underwriters Lab. approved for continuous operation to 105°C without fibrous covering. A-10 insulated wire made to conform to MIL-W-16878.

JAN-C-76 Hook-up Wire—Made to conform to Military Spec. (WL-SRIR-SRHV-SRRF) in all sizes. WL available with nylon jacket or glass braid. The nylon jacket has greater abrasion resistance and high surface resistivity under adverse conditions. SRIR-SRHV-SRRF available with primary insulation only or with the addition of a glass braided covering. All standard colors including “Spiralon” spiral striping.

H “Surco” Tubing—“Surco” vinyl tubing is available in special formulations to provide low temperature (-65°C), high temperature (U.L. approved for 105°C), high dielectric strength, flexibility and colors. Standard compounds are carried in stock in regular sizes. Polyethylene and nylon tubing are also available and are carried in stock in natural color, limited sizes.

I MIL-W-5274A Radar & Electronic Hook-up Wire—Made to conform to Air Forces Spec., this wire offers excellent low temperature performance. Nylon jacketed, it has high abrasion resistance and superior surface resistivity even under adverse humidity conditions, making it very adaptable for high impedance circuits.

**Extruded
THIN-WALL Teflon
INSULATED (210°C)
HOOK-UP WIRE**

Extruded Thin-Wall Teflon Insulated (210°C) Hook-Up Wire—Continuously operable over the range from -90°C to 210°C without appreciable deterioration, extruded “Teflon” (polytetrafluoroethylene) is now available in walls as thin as 0.010” (type WTE) and 0.015” (type RTE). Teflon combines non-flammability, chemical and solvent resistance, high volume and surface resistivity with extremely low electrical losses. This wire is available in all flexible strandings from AWG 30 to AWG 10 and conforms to performance requirements of MIL-W-16878. Colors conform to MIL-STD-104.

Surprenant MFG. CO.
199 WASHINGTON ST. BOSTON 8, MASS. Plant CLINTON, MASS.

See you at the IRE Show
Kingsbridge Army, N. Y. City
Booths 729-731, March 21-24

**What to See at the
Radio Engineering Show**

(Continued on page 146A)



Amperex
ELECTRONIC CORP.
Hicksville, Long Island, N. Y.
273-275 INSTRUMENTS AVE.
(Corner of Transistor Way)
Transmitting and Power Tubes, Rectifiers,
Magnetrons, Thyratrons, Geiger Tubes, X-Ray
Tubes, Fixed Vacuum Condensers, Germanium
Diodes, Transistors, Special Purpose Tubes.

AMPEX
CORPORATION

INSTRUMENTATION DIVISION
206-208 Instruments Avenue
Introducing a new line of shock-resist-
ant magnetic tape data recorders
for mobile and airborne applications.

ANTENNAS, ANTENNA SYSTEMS,
COAXIAL TRANSMISSION LINES

Andrew
CORPORATION

VISIT WITH US AT:
352 MICROWAVE AVENUE

Antlab, 36 Palace.

Antenna pattern range components. Special emphasis on new polar pattern plotter and model support tower. Wide range square root recorder and precision rotator on display.

Apex Machine Company
62 Palace

Marking Machines for printing with colored inks & hot foil stamping on wire, plastics, metal, glass, etc. Electric components in any shape with sharp color imprints for decorating, trade marking, color coding, piece marking, etc.



ARCO
ELECTRONICS INC.
NEW YORK 13, N. Y.
Booth 361 - Microwave Ave.
ELMENCO CAPACITORS
ELECTRO-MOTIVE MFG. CO.

(Continued on page 150A)



**What's
Your Use for...**

**vernistat...The Revolutionary
New Precision Variable-Ratio Transformer**

Analog Computers? Servos? Control Systems? Vernistat is a completely different type of voltage divider combining low output impedance with an inherently high resolution and linearity not ordinarily attainable by precision potentiometers.

The Vernistat consists of a tapped auto-transformer which provides the basic division of voltage into several discrete levels. These levels are selected and further sub-divided by a continuous interpolating potentiometer that moves between 30 transformer taps.

Because of its unique operating principles, electrical rotation is held to close tolerances eliminating the need for trim resistors. In many applications there is also no need for impedance matching amplifiers.

Specifications of the standard model Vernistat are shown below. Other versions are under development to meet specific end uses.

What are your requirements for this unique precision voltage divider? Fill in the coupon now.

vernistat division PERKIN-ELMER CORPORATION
NORWALK, CONNECTICUT

See It At Booth #20 (Palace)

SPECIFICATIONS

- Linearity Tolerance
better than $\pm 0.05\%$
- Resolution better than $.01\%$
- Output Impedance
130 ohms (max.)
- Max. Output Current 50 ma
- Frequency 50-3000 cps
- Other models including a miniaturized 400 cps version will be available in the near future.

vernistat division  **PERKIN-ELMER CORPORATION**
814 Main Avenue, Norwalk, Connecticut

Send me more information on the Vernistat.
The application I have in mind is as follows:.....

NAME

TITLE

COMPANY

ADDRESS

Those who know

know *Hycon*

LEADER

in guided missile test instrumentation

Hycon is one of the nation's most important factors in the production of "GO NO-GO" test and ground support equipment for missile programs. A pioneer in test and check-out, Hycon builds instruments which "flight test" missiles automatically in a matter of minutes.

IF YOU ARE QUALIFIED IN THE ELECTRONICS OR PHOTOGRAPHIC FIELDS, HYCON OFFERS PROGRESSIVE OPPORTUNITIES. CONTACT THE EMPLOYMENT MANAGER, HYCON MFG. COMPANY, BOX N, PASADENA 15, CALIFORNIA.

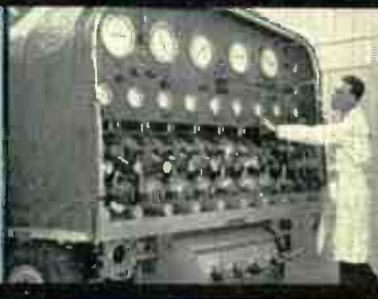

Hycon Mfg. Company
2951 EAST COLORADO STREET • PASADENA 8, CALIFORNIA

"Where Accuracy Counts"

ORDNANCE • ELECTRONICS • AERIAL SURVEYS • AERIAL CAMERAS

What to See at the Radio Engineering Show

(Continued from page 149A)

Arga Div., 760 Airborne Ave.
See Beckman Instruments, Inc.

Arnold Engineering Co. 146, 148, 150 Television Ave.

Alnico permanent magnets (cast and sintered); tape wound cores of high permeability; alloys including Delta-max, Permalloy and Superalloy; "C" and "E" Cores of Silectron; Powdered Molybdenum Permalloy; Vibralloy and other magnetic materials.

Asquith Co., S. A., 680 Circuits Ave.
See Pacent Engineering

Assembly Products, Inc.

311 Computer Ave.

Meter-Relays. Pyrometers. API Panel Meters. Simplytrol Temperature Control. *Versatrol Controls. *Ruggedized Indicating Meter-Relays. *4-1/2-inch Ruggedized Panel Meter. *Very High Sensitivity Relay.

Associated American Trading Div., Syrkus & Guttman, Inc., 713 Airborne Ave.

*Coil Winding Machines & Tensioning Equipment. No gears, no cams, no calculations... No set-up man! Toroid, Layer, Precision Layer, Random, and Transformer winding.

FIRST MOLDED PLASTIC
METALIZED
PAPER TUBULAR
—plus other new subminiature capacitors

by **ASTRON** 368
Microwave Avenue

MANUFACTURERS OF HIGH QUALITY CAPACITORS
AND R.F. INTERFERENCE FILTERS FOR EVERY
COMMERCIAL AND MILITARY USE

Atlas E E Corporation, 745 Airborne Ave.

*.015" Micro Pin Socket, *Vertical Subminiature Tube Holder, *Floating Socket Miniature Tube Mount, *Printed Circuit Jack, Component Holder, *Diode Clips, Locking Clips, Lucite Cap Nuts.

Atlas Tool & Machine Co., 723 Airborne Ave.
See Electro Devices Co., Inc.

Atomic Instrument Co., 323, 325 Computer Ave.

*Industrial counters and control instruments including high speed units, bench-type fast combination registers, Nuclear instrumentation including glow scalers, scintillation spectrometry apparatus, H.V. Supplies.

Audio, 852 Audio Ave.
See Radio Magazines, Inc.

*Indicates new product

What to See at the Radio Engineering Show

Audio & Video Prods. Corporation, 74,
76, 78 Palace

*Newly developed line of Magnetic Tape Recording Equipment for instrumentation features "Building Block" assembly, "W" Type Tape Drive and A-V "Super Performance" Heads. Equipment utilizes direct recording, FM carrier, and other recording techniques.

Audio Devices, Inc., Theatre 1, 829 Audio Ave.

Audiotape - Audiocassettes - Audiopoints - Audiofilm. *Type EP AUDIOTAPE—Extra precision for data recording. *Type LR AUDIOTAPE—50% longer recording—See display all makes tape and disc recorders in our theatre.

Aurora Equipment Company, 874, 876 Audio Ave.
See Equipto Division.

"Automatic Control," 46 Palace
See Reinhold Publishing Corp.

Automatic Electric Sales Corp.

463 Electronic Ave.

Telephone-Type Relays and Switches, Open and Hermetically Sealed: Featured are "Series OCS" Cam Switching Relay. "Types 44 & 45" Rotary Stepping Switches, and others.

Avery Adhesive Label Corp., 389, 391 Microwave Ave.

*Combination oil and heat-resistant pressure-sensitive labels; *Two new label dispensers (electric and manual) that dispense labels either singly or in multiples.

Baker & Company, Inc., 810 Audio Ave. Rhodium plating for the electronic field. Contacts of all metals in a wide range of shapes and sizes. Fine wires for vacuum tubes.

Balco Research Laboratories, 818 Audio Ave.

High-reliability capacitor stable from -55° to $+200^{\circ}\text{C}$ guarantees insulation resistance of 10^{14} ohms. Compact 400-MC Low-pass filter provides 60 db attenuation of harmonics, less than 1 decibel insertion loss.

Ballantine Laboratories, Inc.

245 Instruments Ave.

Sensitive electronic voltmeters; true RMS electronic voltmeters; ultra low frequency voltmeters; DC-AC precision calibrator; sensitive electronic inverter; decade amplifier; a new capacitance meter; DC output adapter; voltage multipliers; shunt resistors.

BARBER
COLMAN

783 Airborne Ave.

See our exhibit of versatile, ultra-sensitive polarized d-c relays . . . and a high quality line of a-c and d-c sub-fractional hp motors.

Barber-Colman Company
Rockford, Illinois

(Continued on page 152A)

Hycon

QUALITY TEST INSTRUMENTS

FOR TOMORROW'S REQUIREMENTS

When you visit the I.R.E. National Convention in New York, be sure to stop at the HYCON booth. You'll see instruments actually ahead of today's test needs . . . ready for tomorrow's circuitry. All are applicable to and meet the exacting requirements of radio engineering's newest field . . . color TV.

MODEL 615 DIGITAL VTVM

This is the widely heralded new Hycon VTVM which gives direct readings, without interpolation. Features 1% accuracy (DC and ohms); 1 millivolt sensitivity; illuminated digital scale with decimal point and polarity sign. Has 12 ranges (AC, DC, ohms) and frequency response (with auxiliary probes) to 250 MC.



MODEL 617 3" OSCILLOSCOPE

Designed specifically for color TV and research laboratory requirements . . . provides undistorted trace from edge to edge on a special flat 3" CRT. Features high deflection sensitivity (.01 v/in. rms); 4.5 MC vertical bandpass, flat within ± 1 db; internal 5% calibrating voltage. Small, lightweight . . . but accurate enough for the most exacting work.



... and a new instrument to be shown for the very first time ...

MODEL 622 5" OSCILLOSCOPE

Rugged enough for field and plant use but an instrument of true laboratory caliber . . . automatic triggered sweep . . . calibrating voltage accurate to $\pm 3\%$. . . electronically regulated power supplies.

IF YOU ARE QUALIFIED IN THE ELECTRONICS OR PHOTOGRAPHIC FIELDS, HYCON OFFERS PROGRESSIVE OPPORTUNITIES. CONTACT EMPLOYMENT MANAGER.
HYCON MFG. COMPANY,
BOX N, PASADENA 15, CALIFORNIA

Don't Forget

See us at Booth #735, Airborne Avenue, Kingsbridge Armory, in March . . . and for detailed information about HYCON test instruments any time, write to the factory or see your local electronic parts jobber.

Hycon Mfg. Company

2961 EAST COLORADO STREET
PASADENA 8, CALIFORNIA

"Where Accuracy Counts"

ORDNANCE • AERIAL CAMERAS • AERIAL SURVEYS
ELECTRONIC TEST INSTRUMENTS • ELECTRONIC SYSTEMS
GO NO-GO MISSILE TEST SYSTEMS • BASIC ELECTRONIC RESEARCH

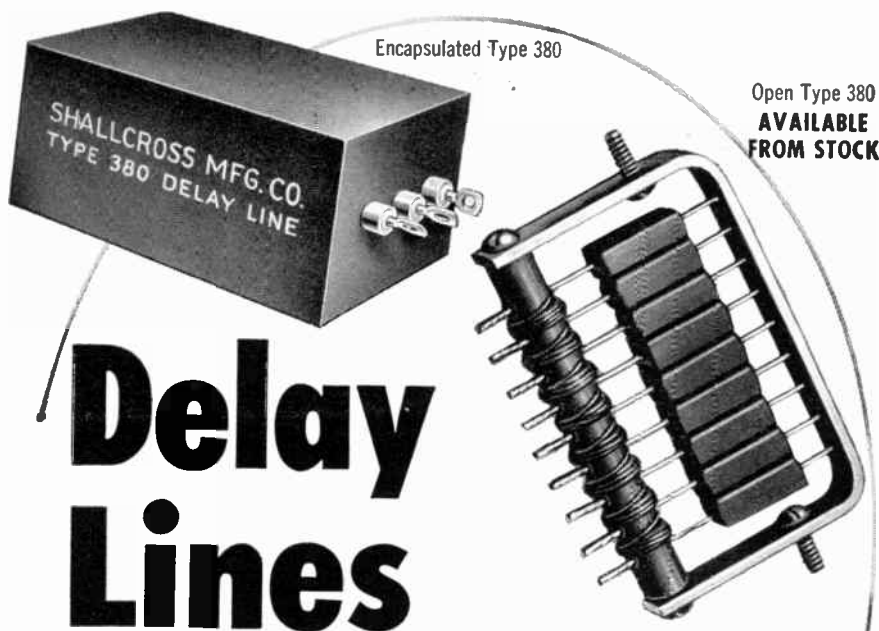

Delay Lines

... STOCK TYPES FOR QUICK DELIVERIES
 ... SAMPLES AND "SPECIALS" TO EXACT SPECIFICATIONS

As engineering specialists in both wire winding and electronic equipment assemblies, Shallcross offers complete facilities for the design and large-scale production of delay lines in a variety of open and encapsulated styles for both highly critical as well as commercial uses.

Typical applications include use as compensating delays for color television, in signal delays for TV synchronizing signal generators, and in wideband distributed-type amplifiers.

Now available for prompt delivery is the Shallcross open-type 380 described below. This is a typical lumped parameter delay line using silvered mica capacitors conforming to JAN Style CM-15, Characteristic E. Many other types can be readily designed for specific applications. Quick delivery of prototypes! Send your specifications for prompt consideration by Shallcross engineers. SHALLCROSS MFG. CO., 524 Pusey Avenue, Collingdale, Pa.

SHALLCROSS TYPE 380 DELAY LINE

SIZE: Open Type: $2\frac{1}{4}'' \times 1\frac{1}{2}'' \times \frac{5}{16}''$
 Encapsulated Type: $2\frac{1}{4}'' \times 1'' \times 1''$

ELECTRICAL CHARACTERISTICS:
 Maximum pulse voltage: ± 100 volts
 Rise time: 0.04 microseconds
 Total delay: 0.3 ± 0.03 microseconds
 Impedance: 500 ohms
 Cut-off frequency: 8.5 megacycles

Shallcross

See us at the I.R.E. Show, Booths 559 & 561 Components Ave.

WHEN WRITING TO ADVERTISERS PLEASE MENTION — PROCEEDINGS OF THE I.R.E.

What to See at the Radio Engineering Show

(Continued from page 151A)

Barker & Williamson, Inc. 202 Instruments Ave.

Chokes, Coils, Discriminators, Filters, Measuring Instruments, Receivers, Transmitters, and Test Equipment. Complete communications systems of: V-H-F Radio Relay. Frequency-shift, Radio Teletype & Telephone, microwave, and direction finding.

Barrett Div., Allied Chemical & Dye Corp., 558 Components Ave.

PLASKON Alkyed molding compounds offers high arc resistance, high dielectric strength, excellent dimensional stability, great heat resistance, low water absorption and possible production economies for critical electronic applications.

Barry Corporation, 696, 697 Broadcast Way

Vibration & shock isolators & special mounting bases for all applications; Shock machines; Research & development engineering; *All angle aircraft mount for jets & guided missiles.

Bart Laboratories Co., Inc.

514 Components Ave.

Precision electronic components manufactured by electroforming, to achieve unusual shapes, close tolerance and high interior surface finish. Gold plating with Sel-Rex "Bright" processes, including silver and rhodium.

Beckman Instruments, Inc. Arga Division

760 Airborne Ave.

Arga will exhibit the following components: resolver, synchro, miniature generator, PM inverter and new expanded scale panel voltmeter. New instruments include autospenser and magnetic mill.

Belock Instruments Corp., 7 Palace

See Instrument Components, Inc.

Bendix Aviation Corp. Eclipse-Pioneer Div. 128-140 Television Ave.

Synchros, servo motors and systems, power supplies, vacuum tubes, receiving vacuum tubes, rectifiers and special purpose vacuum tubes, transmitting, voltage regulators, klystrons.

(Continued on page 154A)

Busses every eight minutes
 Kingsbridge to Waldorf Astoria
FREE

Microwave and Radar Engineers!

Obtain Your Complete Frequency Coverage at High Accuracy with

ONLY ONE · FREQUENCY METER · **THE TELERAD MODEL TFM-186**

Complete frequency coverage from 100 megacycles to 10,000 megacycles with overall accuracy of .01% or better.

Crystal calibrator includes thermostatically controlled temperature chamber which gives an accuracy of .002% at the check points.

Input circuit accommodates both waveguide and coaxial fittings.

Video output jack permits visual observation of beats by the use of an external oscilloscope.

No bandswitching, continuous coverage of the entire frequency range by the use of a counter type dial with fiducial index.

Phone jack for aural detection of the presence of a beat with visual presence of a beat being indicated on the panel meter.

Used in the leading research and development laboratories of the electronic industry and government agencies and wherever its very high accuracy, stability and wide frequency coverage are of the greatest importance.

Specifications

SPECTRUM—100mc/s TO 10,000mc/s.

OVERALL ACCURACY 0.01% or better.

CRYSTAL CALIBRATOR — ACCURACY
0.002%.

VIDEO OUTPUT RECEPTACLE.

THERMOSTATICALLY CONTROLLED
CRYSTALS.

BEAT INDICATING METER.

CONTINUOUS COVERAGE, NO
SWITCHING.

WAVEGUIDE AND COAXIAL INPUTS.

PHONE JACK FOR AURAL RECEPTION.

COUNTER TYPE DIAL WITH FIDUCIAL.

AC OPERATED—COMPACT-PORTABLE.

TIME PROVEN—JAN COMPONENTS.

Write today for complete information on the Telerad TFM-186 Frequency Meter. Telerad sales engineers at our New York office will be glad to discuss the application of this instrument to your frequency measurement problems.

Current manufacturers of "S" and "L" Band Guided Missile Radar Beacons

TELERAD

Designers and Manufacturers of Microwave • Radar Transmission Lines and Test Equipment

1440 BROADWAY · NEW YORK 18, N.Y.

Telephone BRyant 9-0893

PRICE IS RIGHT! DELIVERY IS RIGHT!

ECLIPSE-PIONEER AUTOSYN* SYNCHROS

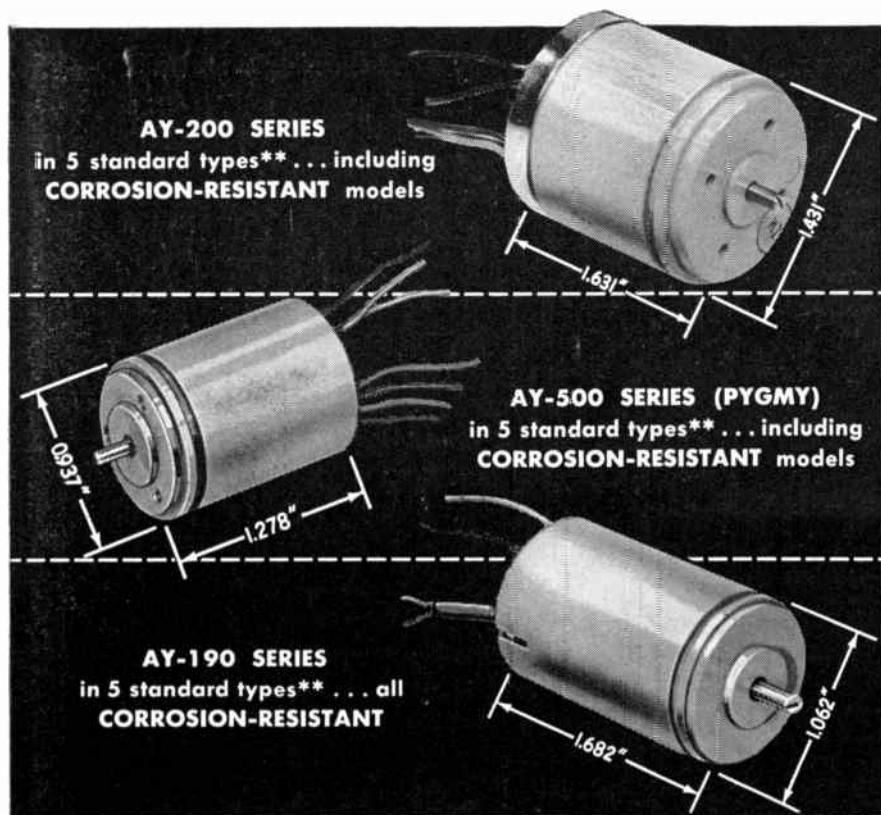

**TRANSMITTERS, RECEIVERS, CONTROL TRANSFORMERS, DIFFERENTIALS AND RESOLVERS

And there's a type to meet every need!

Our Autosyns provide the perfect answer to synchro requirements for three good reasons. First, they're priced attractively to keep down your initial cost. Second, they can be delivered in prototype quantities at once. Third, they're available in all standard types in production quantities . . . as well as practically any special type you could ever need. And, of course, military specifications are used as design objectives in all cases. Only at Eclipse-Pioneer can you find the combination of

experience, facilities, and production techniques that make possible all these important advantages. So, whatever your synchro requirements, it will pay you to see Eclipse-Pioneer.

OTHER STANDARD AND SPECIAL ECLIPSE-PIONEER AUTOSYN SYNCHROS INCLUDE models 1, 11, 15, 18, 23 and 2R as well as high temperature, high frequency, linear, and other types for special needs.

*REGISTERED TRADE-MARK BENDIX AVIATION CORPORATION.

WRITE DEPARTMENT B

ECLIPSE-PIONEER

TETERBORO, NEW JERSEY

West Coast Office: 117 E. Providencia Ave., Burbank, Calif.
Export Sales: Bendix International Division, 205 E. 42nd St., New York 17, N. Y.



**What to See at the
Radio Engineering Show**

(Continued from page 152A)

**Bendix Aviation Corp.
Pacific Division**

128-140 Television Ave.

Sonar, Underwater Sound Detection; Telemetering, Airborne & Industrial Data Transmission Systems & Components; Ultra-Sonics, High Frequency Sound for Cleaning Inspection Quality Control, etc.; Radar, Airborne Radar, including Beacons and Transponders.

**Bendix Aviation Corp.
Bendix Radio Div.**

128-140 Television Ave.

AVIATION—DME Interrogator; DME Antenna; DME Indicator; VHF Transmitter; Frequency Selectors; VHF Receiver; VOR Receiver; OMNI-Mag; Glide Slope Receiver; Glide Slope Antenna; Loop Antenna (ADF). MOBILE AND RAILROAD—Remote Control; HF Communications; Packset.

**Bendix Aviation Corp., Red Bank Div.,
128-140 Television Ave.**

Vibrators, dynamotors, inverters, motor generators, motors, power supplies. Cold cathode types, counter tubes, klystrons, thyratrons, voltage regulators.

**Bendix Aviation Corp.
Scintilla Div.**

128-140 Television Ave.

Electrical Connectors—standard & special types, AN, Ordnance, Radio Shielded, Firewall, Waterproof, Miniature, High Voltage, & Special Application Types. Ceramics for Exacting Requirements.

**BENNETT
MANUFACTURING COMPANY**
779 Airborne Ave.

Custom-made Metal Enclosures and Components for Radio-Electronic Industries.



A prime and dependable source of metal fabrication since 1900.

CABINETS • CONSOLES
ENCLOSURES • PANELS
CHASSIS • FRAMES

**Berkeley, Division of
Beckman Instruments, Inc.**

752, 754 Airborne Ave.

*0-42 ma freq. meter; *decade inductor; *push button analog computer; *decimatic scaler; *digital printer; *EASE components.

(Continued on page 156A)

*Indicates new product

new...precision Continental Connectors



miniature AN-type

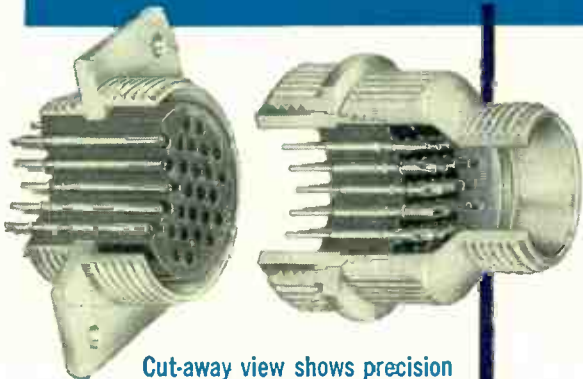

Cut-away view shows precision construction of Continental Series 1300

CONTACTS FOR #20 AWG WIRE

NO. OF CONTACTS	SHELL SIZE
4 and 5	$\frac{1}{16}$ -24
15, 19, 27 and 31	$\frac{13}{64}$ -18

If you have been looking for a dependable, miniaturized version of the popular A N-type connector, then consider this new Continental Connector Series 1300.

Two small shell sizes accommodate several contact arrangements. The shells are precision machined aluminum, threaded for use with conventional cable clamps. Brass pin contacts and spring temper phosphor bronze female contacts are gold plated for easier soldering — pre-tinning of solder cups is unnecessary. Each contact is individually floating, to assure self-alignment and reduced engagement forces.

One-piece molded inserts prevent moisture traps and possible electrical breakdown. They can be interchanged between the plug and receptacle shells for greater versatility. Our standard molding compound is Mineral filled Melamine (MIL-P-14D, Type MME). However, other compounds are available on order.

Write to our sales engineering department for technical data on the Series 1300, PLUS other special designs and circuit applications requiring the use of sub-miniature, printed circuit, hermetic seal, pressurized, high voltage or power connectors.



JUST OFF THE PRESS!

98-page technical catalog for engineers, purchasing executives and engineering libraries. Gives detailed specifications on Continental precision connectors. Request a free copy on your company letterhead, indicating your name and title.

Electronic Sales Division **DeJUR**

DeJUR-Amsco Corporation, 45-01 Northern Boulevard, Long Island City, L. I., N. Y.

See us at Booth 200, Production Road, IRE Show

Lapp

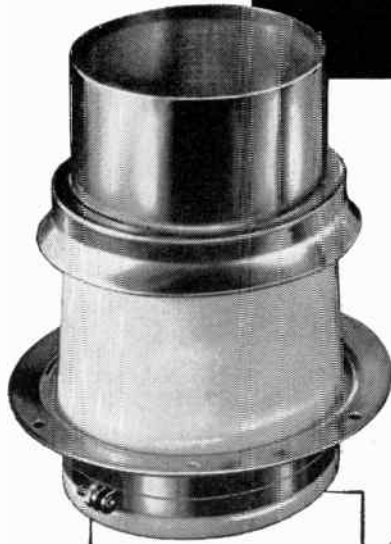

TUBE SUPPORTS

for forced-air-cooled

power tubes

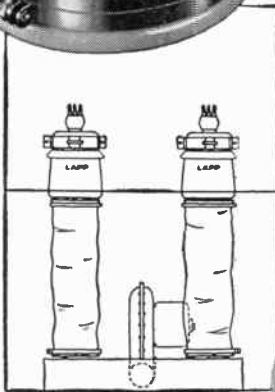

● No longer is it necessary for equipment manufacturers to design supports for forced-air-cooled tubes. After producing many such special designs, Lapp has engineered and built a complete series of insulating supports for air-cooled tubes. Use of these supports facilitates design of transmitter and other high-power circuits. Simple, compact, efficient and attractive in appearance, they make for economical production, easy interchangeability, and availability of replacement units. Write for Bulletin 301, with complete description and specification data. Lapp Insulator Co., Inc., Radio Specialties Division, 223 Sumner St., Le Roy, N. Y.

Lapp

What to See at the Radio Engineering Show

(Continued from page 154A)

Beta Electric Corp., 320 Computer Ave.
High voltage dc power supplies for color television; ac/dc, ac & dc "Hipot" equipment; dc vs ac testing vividly demonstrated.

Biddle Co., James G., 714 Airborne Ave.
Megger Electrical Resistance Measuring Equipment, Frahm Resonant Reed Frequency Meters, Relays and Oscillators, Biddle Corona Test Equipment, for non-destructive evaluation of electrical insulation.

Bingham Mfg. Co., J. F., 789 Airborne Ave.

Ferrous & non-ferrous precision sheet metal fabricators specializing in magnesium & aluminum cabinets, chassis, & components for the military service & civilian electronic industries.

Bird Electronic Corp., 254 Instruments Ave.

Thurline RF Wattmeters; Termaline RF Wattmeters; Termaline Coaxial Load Resistors; Coax Switches; Coaxial RF Filters.

Bliley Electric Co.

585 Components Ave.

Quartz crystals, crystal ovens, frequency standards, ultrasonic delay lines, custom assemblies. Miniature bantam crystal units, Standard Delay Lines for 1000 and 2000 yard markers, color TV crystals.

TV Distribution Systems

**B-T
LABS**

for **INDUSTRIAL
and BROADCAST
TELEVISION**

**614 Circuits Ave., (nr. Radar Rd.)
BLONDER-TONGUE LABS., INC., Westfield, N. J.**

Bodnar Industries, Inc.

797 Broadcast Way

Mil-P-7788 (ANP89) plastic lighting panels and dials—illumination, gloss, contrast and abrasion testing equipment approved by BuAir and Bu Standards—consulting aid to project engineers.

Boeing Airplane Co.

590 Components Ave.

"Guided Missiles are Rough on Electronic Components." See Boeing display for the effect on electronic components from extreme vibratory environments.

(Continued on page 158A)

LOOK TO

Amperex®

FOR CONTINUAL DEVELOPMENTS IN JAN TYPE TUBES for Military and Commercial Applications



The AMPEREX history in both design and production of tubes is one that points up the strength of the AMPEREX organization in pioneering engineering advancements and improving production techniques. Year after year, AMPEREX has been in the forefront . . . introducing new types and new methods.

Many of these AMPEREX "firsts" are now standards throughout the world. This constant awareness of the fact that new designs and new applications are of the utmost importance spurs our engineering staff, which is second to none in the world, into producing the tubes of the future . . . today.

On this page we illustrate only a few of the AMPEREX JAN-TYPE MAGNETRONS and a couple of the HYDROGEN THYRATRONS. It by no means reflects the extent of these operations which encompass a complete range of frequency and power outputs for magnetrons in both packaged and non-packaged types, nor does it give any indication of the number of tubes which we make.

Naturally, all AMPEREX tubes receive strenuous life expectancy tests in field performance before any information is released. Most AMPEREX Magnetrons use new hobbled anodes, the one-piece construction technique which affords a cleaner, higher-Q resonator structure for improved performance plus longer life.

▶ THE NEW AMPEREX MAGNETRON Type 6507 features an improved cathode providing extreme stability with **3-times normal pulse width**. It also enables operation at extremely high repetition rates. When operated under standard 4J52 conditions, its life expectancy is **better than 4-times normal**.

▶ AMPEREX JAN-TYPE HYDROGEN THYRATRONS give **more than double** the normal life-expectancy . . . due to an advanced design featuring a built-in, self-regulating hydrogen generator, which requires **no outside power source** . . . providing operation with **less jitter** than any other available tubes. They are **completely interchangeable** with standard military types.

▶ AMPEREX Types 5C22 and 6268 are the only hydrogen thyratrons with this completely automatic, built-in, self-regulating generator. The 6268 is a 4C35 type tube with this added feature.

Write for list of other JAN-type AMPEREX Tubes . . .
Data Sheets are Available Upon Request.

AMPEREX ELECTRONIC CORP.

230 Duffy Avenue, Hicksville, Long Island, N. Y.

In Canada: Rogers Majestic Electronics Ltd.
11-19 Brentcliffe Road, Leaside (Toronto 17)



4J47



6507



5657



2J48

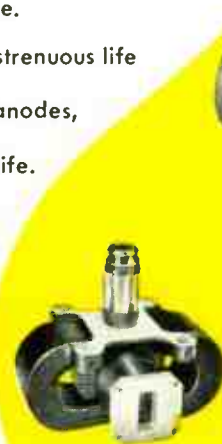

4J52



5586



4J57
4J58
4J59

The New **SHURE** "TWIN-LEVER"
CERAMIC PICKUP CARTRIDGE
for High Fidelity phonographs



PC Series for 33 $\frac{1}{3}$, 45, 78 r.p.m.

AN "AB" LISTENING TEST WILL PROVE THAT THIS CARTRIDGE SURPASSES ANY OTHER HIGH QUALITY COMMERCIAL CARTRIDGE FOR EQUIPMENT MANUFACTURERS!

Here is a "Balanced-Fidelity" cartridge designed for the equipment manufacturer to give you the maximum quality possible within your cost objectives.

A new frontier for the Ceramic principle has been crossed by the development of this cartridge. Designers of high fidelity phonographs and hi-fi radio or tv phono combinations, who have been "test piloting" this new "Twin-Lever" ceramic development, report an amazing superiority in tone quality that can be easily heard before the cartridge is even measured!

This "Twin-Lever" ceramic cartridge represents the ultimate in commercial high fidelity reproduction—**without compensating preamplifiers!** Smooth, wide range response from 30 to 13,500 c.p.s. Other features which help to make this new cartridge so outstanding in performance are: high compliance that virtually eliminates tracking distortion . . . extremely low effective mass provided by new specially-designed needles and new coupling . . . tailored needles on separate needle shafts, functioning independently for best 78 rpm response, too—as well as the superior micro-groove performance.

The new unique design eliminates "turnover" of either the cartridge or the needles. Both needles are in the same plane, and an ingenious, lever-operated shift mechanism gently moves each needle in and out of position.

RADICAL NEW DESIGN FOR NEEDLE REPLACEMENT!

Needle replacement is now so simple it can be done blindfolded!! This is a feature that will be of special interest to the ultimate users of your original equipment. Anybody can replace the needle, without tools, in a few seconds—while the cartridge remains in the pickup arm!

MODELS PC4 and PC5

Output Level at 1,000 c.p.s.	.40 volts (33 $\frac{1}{3}$, 45 rpm)
Output Level at 1,000 c.p.s.	.60 volts (78 rpm)
Frequency Response	30 to 13,500 c.p.s.
Compliance	1.30 x 10 ⁻⁶ cm/dyne
Tracking Force	5 gr. min.
Net Weight	7 grams
Dimensions	1 $\frac{3}{4}$ " overall length; $\frac{3}{8}$ " wide $\frac{3}{8}$ " high

ALSO . . .

New High Output Ceramic Cartridges NO LESS OUTSTANDING IN THEIR CONTRIBUTION TO LOW COST, FINE QUALITY REPRODUCTION ARE THE HIGH-OUTPUT CARTRIDGES, MODELS PC2 and PC3.

SHURE *The Mark of Quality*

For further information on these remarkable new cartridges, write
SALES DIVISION—SHURE BROTHERS, INC., 225 W. HURON STREET, CHICAGO 10, ILL.

**What to See at the
 Radio Engineering Show**

(Continued from page 156A)

**Boesch Mfg. Co., Inc.
 705-802 Production Rd.**

Toroidal Coil Winding Machines featuring new 1/16" shuttle for miniature size coils. Also, featuring our *Bobbin Winding Machines and *Transformer Coil Winding Machine.

**Bogart Mfg. Corp.
 379 Microwave Ave.**

Designers and producers of Electronic and Microwave components and assemblies. Items include *waveguide switches, *broadband rotating joints, *bifurcated balanced mixers, *dummy loads, *hybrid junctions, *short slot hybrids.

PRECISION ELECTRICAL EQUIPMENT
Boque SINCE 1892
Announcement
NEW SILICON POWER RECTIFIERS
 See them at BOOTHS 109-111 AVAILABLE FOR THE FIRST TIME IN PRODUCTION QUANTITIES
BOGUE ELECTRIC MANUFACTURING COMPANY
 PATERSON 3, NEW JERSEY

BOMAC
370-372
MICROWAVE AVENUE

Bond Electronics Corp., 363 Microwave Ave.

Precision Wire-wound Resistors, Coils, Coil Assemblies.

Boonton Electronics Corp., 776 Airborne Ave.

Featuring 2 new instruments, "Direct Capacity Bridge," measuring extremely small capacitance and "RF Distortion Meter," covering 1-100 mc. Also UHF Grid Dip Meter on demonstration.

*Indicates new product

(Continued on page 160A)

Show Hours: Monday 10 AM-10 PM

Tuesday 10 AM-10 PM

Wednesday 10 AM-5 PM

Thursday 10 AM-10 PM

SLOGAN for SERVICE
custom-made by **ESC***

**DELAY LINES • FILTER NETWORKS
PULSE TRANSFORMERS
DECADE DELAY LINES**

*Custom-Made by ESC signifies your specifications have been met with the precision and skill born of years of experience in the production of all types of video delay lines! ESC Delay Lines, custom-made or from our large selection of stock models, all meet MIL specifications and assure you maximum efficiency in a minimum of space.

Our Representatives Are At Your Service

EDWARD F. AYMOND COMPANY
Dallas 19, Texas Logan 5233
Tulsa, Oklahoma Oklahoma 7-9617

WALTER J. BRAUER & ASSOC.
Cleveland 7, Ohio

COMPONENT SALES CORP.
Hartsdale, New York Scarsdale 5-1050

A. I. LIVERA & ASSOC.
Madison, N. J. Madison 6-3220
St. Albans, N. Y. St 6-9686
Lansdowne, Pa.

MAGNUSON & ASSOC.
Chicago 41, Ill. Kildare 5-4426

WM. M. MEILY CO.
Fort Wayne, Ind.

WEIGHTMAN & ASSOC.
Burbank, Calif.

Write for Our Delay Line Brochure

See Us In Booth 684
I.R.E. Show
Kingsbridge
Armory
Bronx, N. Y.



ESC

C O R P O R A T I O N

534 BERGEN BLVD., PALISADES PARK, NEW JERSEY

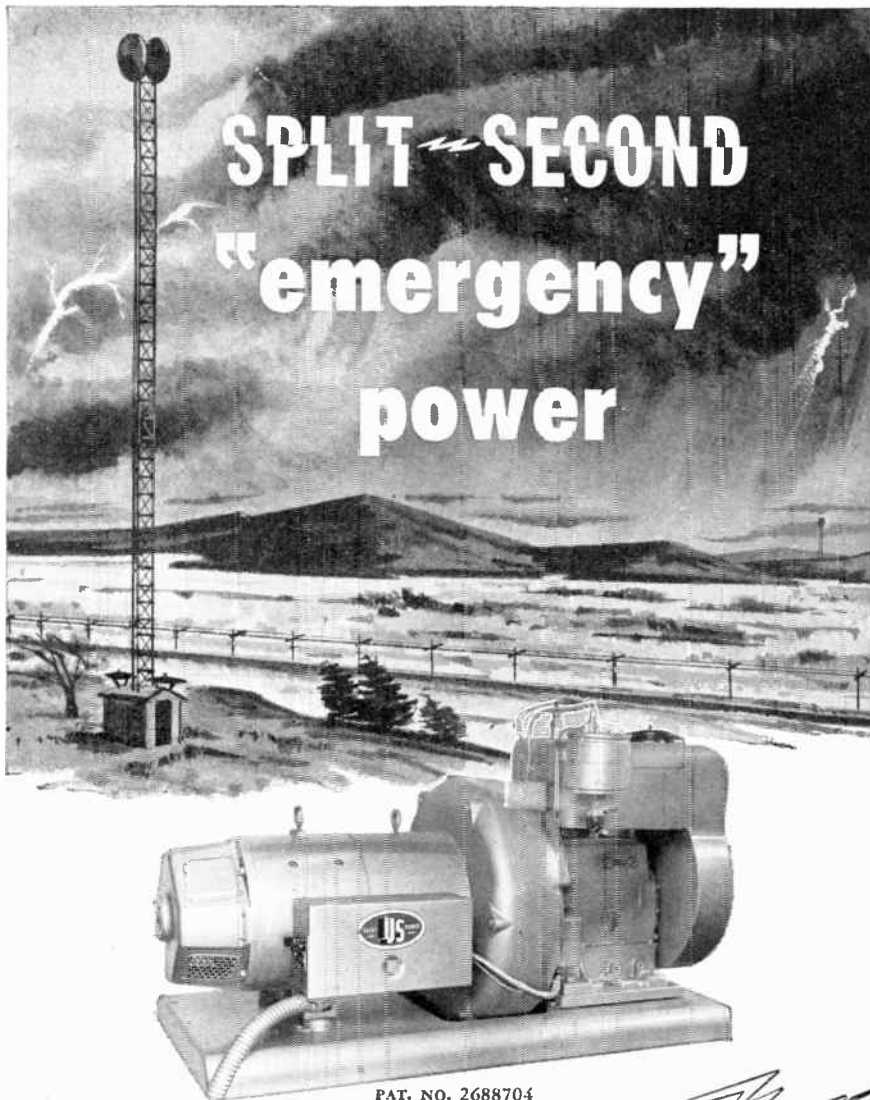

SPLIT-SECOND "emergency" power

PAT. NO. 2688704

... With U.S. MICRO-POWER

BEFORE . . . voltage drops below a usable level . . . **before** there is any loss of power to essential equipment . . . **MICRO-POWER IS IN ACTION.** Completely automatic, Micro-Power operates with the main source of power. No time-consuming "load transfers", no power "outages" . . . **EVEN FOR PRECIOUS SECONDS!**

Micro-Power is a complete stand-by service that replaces several units of costly, more complicated equipment. Electric plant, rectifier, battery banks and motor—
Write U. S. Motors for complete information, specifications and power curve charts.

generator **CAN ALL BE ELIMINATED** . . . with the installation of a single **MICRO-POWER UNIT.** **NEW INSTALLATIONS — SAVE UP TO \$300 PER MILE!**



**UNITED STATES
MOTORS CORPORATION**
554 Nebraska Street
OSHKOSH, WISCONSIN

What to See at the Radio Engineering Show

(Continued from page 158A)

See the **NEW**
SWEEP SIGNAL GENERATOR

 Q Meters, RF Bridges, Univerters, FM-AM Signal Generators, G Meter, ILS Signal Generators, RF Voltage Standard, Sweep Signal Generator.

225-227 Instruments Ave.
BOONTON RADIO CORPORATION
Boonton, New Jersey

Borg Equipment Div., George W. Borg Corp., 536 Components Ave.
Complete series of linear multi-turn potentiometers; instrument motors, synchronous and induction; and servo control motors.

Boston Engineering Division of American Machine & Foundry Co., 106, 108, 110 Television Ave.
Demonstrations of Dynamic Tube Comparator, newly developed Flame Detector (for jet aircraft engines), and Teflon film.

Bourns Laboratories 788 Airborne Ave.

*New high temperature trimpot with 0.6 watt power rating. *New wobble shaft linear motion potentiometer with high natural frequency.

Bradley Laboratories, Inc., 722 Airborne Ave.
Selenium and copper oxide rectifiers and self-generating photoelectric cells.

Brady Co., W. H., 289 Instruments Ave.
Self-sticking industrial products including: All-temperature wire markers; special markers for coils, leads, assemblies, etc.; conduit markers for identifying conduits, cables, switch boxes, control panels, etc.; positive placement insulation for use in electrical components of all types; pre-cut masks for protection during spray painting, tumbling and buffing.

Branson Corp., 17 Palace
Miniature Magnetic Relays—Thermal Time Delay Relays. For those applications where dependable performance is essential under all combinations of electrical and environmental variations.

 140 FIFTH AVENUE
HAWTHORNE, NEW JERSEY

**MANUFACTURERS
and HEAT TREATERS of
BERYLLIUM COPPER**
Components for the Electronic Industry
BOOTH 417—Electronic Avenue

British Industries Corp., 453 Electronic Ave.
Ersin multicore solder with *5-core construction. Widney-Dorlec cabinet component system.

(Continued on page 162A)

*Indicates new product

**INSTRUMENT CORPORATION
OF AMERICA**

slip ring & commutator assemblies

One-piece construction*
assures high accuracy and
super-dependability to the
most rigid specifications.

*Proven for
performance in
precision instruments
and equipment including
SYNCHROS, GYROS, RADAR,
FIRE CONTROL, TEST TABLES
and other CRITICAL APPLICATIONS*

Specify Instrument Corporation of America Slip Ring and Commutator Assemblies for closer tolerances, absolute uniformity and the ultimate in miniaturization. Wherever extreme dimensional precision, accurate concentricity and high dielectric qualities, are required, Instrument Corporation of America assemblies are specified with confidence. One-piece, unitized construction eliminates dimensional variation due to accumulated errors, provides jewel-like finish, uniform ring hardness and reduced weight. Engineering "know-how" resulting from years of specialization and continuous collaboration with leading manufacturers all over the world is at your immediate service.

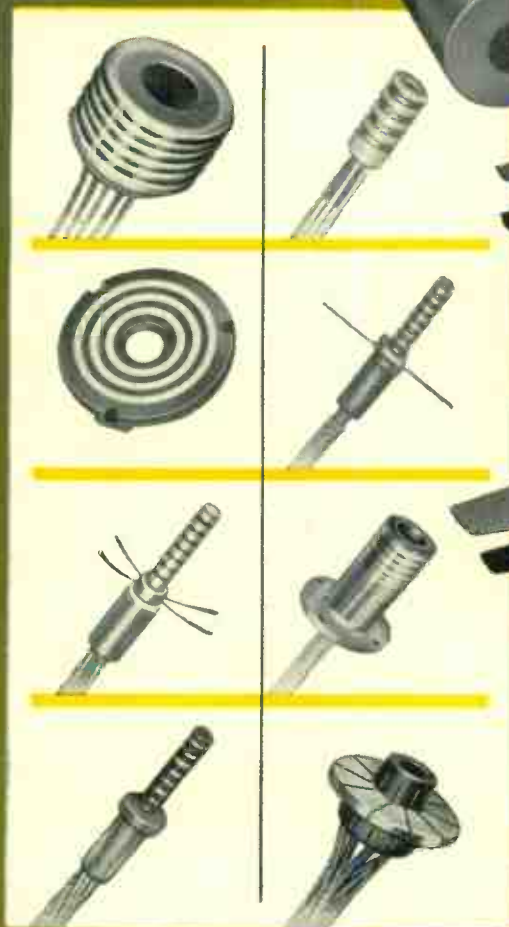

**TYPICAL
SPECIFICATIONS**

- SIZES: .035" to 36" Diameter, Cylindrical or Flat
- CROSS-SECTIONS: Ring Thickness .005" to .060" or More
- FINISH: 4 Micro-Inches or Better
- BREAKDOWN: 1000 V or More Hi-Pot Inter-Circuit
- RING HARDNESS: 70 to 95 Brinell
- SURFACE PROTECTION: Palladium and Rhodium, or Gold Prevent Tarnish, Minimize Wear & Noise

INSTRUMENT CORPORATION OF AMERICA
BLACKSBURG · VIRGINIA

*ELECTRO DEPOSITION PROCESS AVAILABLE UNDER EXCLUSIVE LICENSE AGREEMENT WITH ELECTRO TEC CORP.

new!

OTHER POPULAR ILLINOIS TYPES

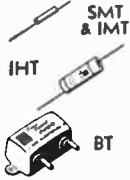

ILLINOIS CERAMIC CASED CAPACITORS

- hermetically sealed
- high temperature operation
- excellent power factor
- accurate capacity
- high insulation resistance
- overload tested

"ILLINI STE-TITE" TYPE ITC



CAPACITY RANGES FROM .0005 TO 1.0 MFD. 200-400-600 & 1600 WVDC

New ILLINOIS ITC Capacitors are made especially for the "tough" applications. Their non-inductively wound foil assemblies are oil impregnated and hermetically sealed in steatite cases. Thermostat end seals will not soften or flow with soldering, or at any conceivable operating temperature.

TYPE ITC Capacitors have unusually high insulation resistance, exceptionally low power factor and long life performance at high temperatures. Normal rating 85° Centigrade. Accurate capacity when required or commercial tolerances $\pm 20\%$. Tinned copper leads, 2" minimum length are easy to solder.

When the application calls for stable operation at higher temperatures and higher voltages, be sure to specify "ILLINI STE-TITE" ITC Capacitors, the newest in the famous ILLINOIS line of "Time Tested Quality" capacitors.

Write for catalog and literature on the complete ILLINOIS line.

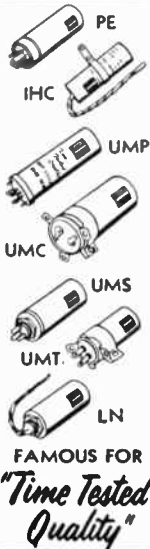

ILLINOIS CONDENSER CO.
1616 N. THROOP ST. CHICAGO 22, ILLINOIS

Get a fresh viewpoint on TV, radio, audio!



RADIO-ELECTRONICS gives engineers a fresh perspective on electronics. It's a great thought starter for applications off the beaten track. If you're not familiar with it, buy the current issue at your newsstand or parts distributor—or write for a free sample. If you are familiar with it, why not subscribe now and save up to \$5.05 over the newsstand price.

Do you have any bright ideas?

It will be profitable for you to tell our readers about them. Write to I. Fenster for a copy of our author's guide.

Visit us at Booth 452 at the IRE Show.

3 YEARS \$8.00 2 YEARS \$6.00 1 YEAR \$3.50
RADIO-ELECTRONICS Dept. P. 25 West Broadway New York 7, N.Y.

What to See at the Radio Engineering Show

(Continued from page 160A)

Browning Laboratories, Inc., 238, 240 Instruments Ave.

New instrument Model 701D medium priced wide band oscilloscope. Models 801 & 802 VSWR Meters, Models 501 & 502 Modulation Monitor, and Hi-Fi Tuners.

Brubaker Mfg. Co., Inc., 640 Circuits Ave.

Photographs and exhibits of three Brubaker facilities and products manufactured including delay lines, relays, switches, capacitor assemblies, filter assemblies, time measuring and other test equipment.

Brush Electronics Company, 869, 871, 873, 875 Audio Ave.

Industrial & research instruments; magnetic recording components; acoustic products & piezoelectric crystals & ceramics. *Portable ac & dc amplifiers & multichannel oscillographs.

Buchanan Electrical Products Corp., 608 Circuits Ave.

Live demonstration in latest splicing and terminating wire work plus complete line of electrical fittings. *Self-covered, self-joined Sectional Terminal Blocks.

Buckbee Mears Company
721 Airborne Ave.

Pioneers in TV shadow masks, electronic & instrument parts, fine mesh grids & precision miniature parts produced by etching & electroforming processes.

IMPORTANT NEWS OF INTEREST TO YOU BOOTH 681

BUDD • STANLEY Co., Inc.
Microwave Transmission Equipment



Buggie, Inc., H. H., 418, 420 Electronic Ave.

Connectors: Printed Circuit; subminiature Coax for printed circuit; miniature waterproof and pressurized; compression type glass sealed; and tube clamps. 18KV Coax Cable Assemblies.

Burgess Battery Co., 762 Airborne Ave. Complete line of dry batteries for industrial applications, power supplies for transistors, ignition, flashlights, flashlight batteries, portable radios and farm radios.

BURLINGAME ASSOCIATES

ELECTRO INSTRUMENTS

Digital Voltmeters

LÁBSCOPE, INC.

Precision Equal-Amplifier Oscilloscopes

NEW JERSEY ELECTRONICS CORP.

Regulated D.C. Power Supplies

234-236 Instruments Ave.

(Continued on page 164A)

* Indicates new product

IMPROVED
FOR OUTSTANDING PERFORMANCE
AND APPLICATION

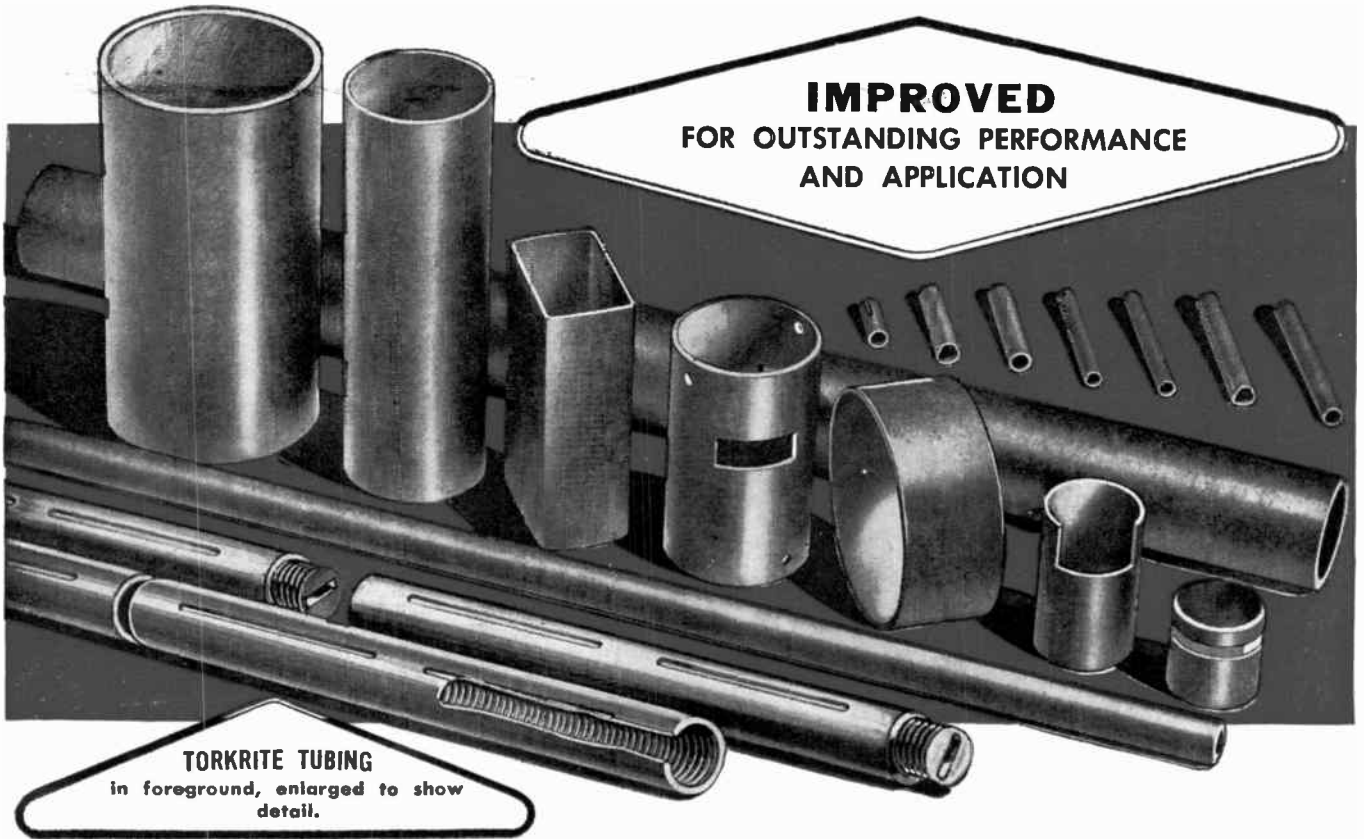

TORKRITE TUBING
in foreground, enlarged to show
detail.

★ ★ ★

**TORKRITE
POSSESSES MANY
ADVANTAGES**

Torkrite affords unmatched recycling ability. After a maximum diameter core has been recycled in a given form a reasonable number of times, a minimum diameter core can be inserted and measured at 1" oz. approximately.

Torkrite has no hole or perforation through the tube wall. This eliminates the possibility of cement leakage locking the core or cores.

Torkrite permits use of lower torque as it is completely free of stripping pressure.

With Torkrite, torque does not increase after winding, as the heavier wall acts to prevent collapse and core bind.

Improved new Torkrite is now available in various diameter tubes. Lengths from 3/4" to 3 1/8" are made to fit 8-32, 10-32, 1/4-28 and 5/16-24 cores.

★ ★ ★

Visit
our Exhibit #519
at the
Radio Engineering Show
in New York City
March 21-24.

CLEVELITE ✱
LAMINATED PAPER BASE PHENOLIC TUBING

In seven specific grades, Clevelite is one of the finest and most complete lines of tubing available to the electronic and electrical industries.

Grade	Application
Grade E	Improved post-cure fabrication and stapling
Grade EX	Special grade for TV yoke sleeves
Grade EE	Improved general purpose
Grade EEX	Superior electrical and moisture absorption properties
Grade EEE	Critical electrical and high voltage application
Grade XAX	Special grade for government phenolic specifications
Grade SLF	Special for very thin wall tubing having less than .010 wall

High performance factors, uniformity and inherent ability to hold to close tolerances, make Clevelite outstanding for Coil Forms, Collars, Bushings, Spacers and Cores. Competent Research and Engineering facilities are always available to aid in solving those tough and stubborn design and fabrication problems. May we help you?

Fast, Dependable Delivery at all times.

WHY PAY MORE? For Good Quality . . . call CLEVELAND!

*Reg. U. S. Pat. Off.

The **CLEVELAND CONTAINER Co.**
6201 BARBERTON AVE. CLEVELAND 2, OHIO

PLANTS AND SALES OFFICES at Chicago, Detroit, Memphis, Plymouth, Wisc., Ogdensburg, N. Y., Jamesburg, N. J.
ABRASIVE DIVISION at Cleveland, Ohio
CANADIAN PLANT: The Cleveland Container, Canada, Ltd., Prescott, Ontario



REPRESENTATIVES

- NEW YORK AREA R. T. MURRAY, 604 CENTRAL AVE. EAST ORANGE, N. J.
- NEW ENGLAND R. S. PETTIGREW & CO., 62 LA SALLE RD., WEST HARTFORD, CONN.
- CHICAGO AREA PLASTIC TUBING SALES, 5215 N. RAVENSWOOD AVE., CHICAGO
- WEST COAST IRV. M. COCHRANE CO., 408 S. ALVARADO ST., LOS ANGELES

**What to See at the
Radio Engineering Show**

(Continued from page 162A)

**BURLINGTON
INSTRUMENT COMPANY
673 Circuits Ave.**

AC and DC electrical indicating instruments including hermetically sealed ruggedized types. Also generator voltage regulators. Instruments built to your specifications.

Burnell & Co., Inc., 678 Circuits Ave.

*New adjusteroid, subminiature companion to rotoroid, toroidal coils of every description. All types of telemetering filters.

**Burroughs Corporation
Electronic Instruments Div.**

337, 339 Computer Ave.

See unitized pulse control equipment with new pulse counter, *Flip-flop, *Coincidence detector and *power supply. See Also *ultra-thin tape wound magnetic cores and core testing equipment. Industrial computing facility available on regular basis.

(Continued on page 166A)

**FOIL
NAME PLATES**

ADHESIVE-BACKED

park "thinplates"

are .003-inch aluminum foil **ANODIZED**, and backed by pressure sensitive adhesive. These plates conform to JAN specifications.

PARK NAMEPLATE CO., INC.

61-07 32 Ave.

Woodside 77, N.Y.

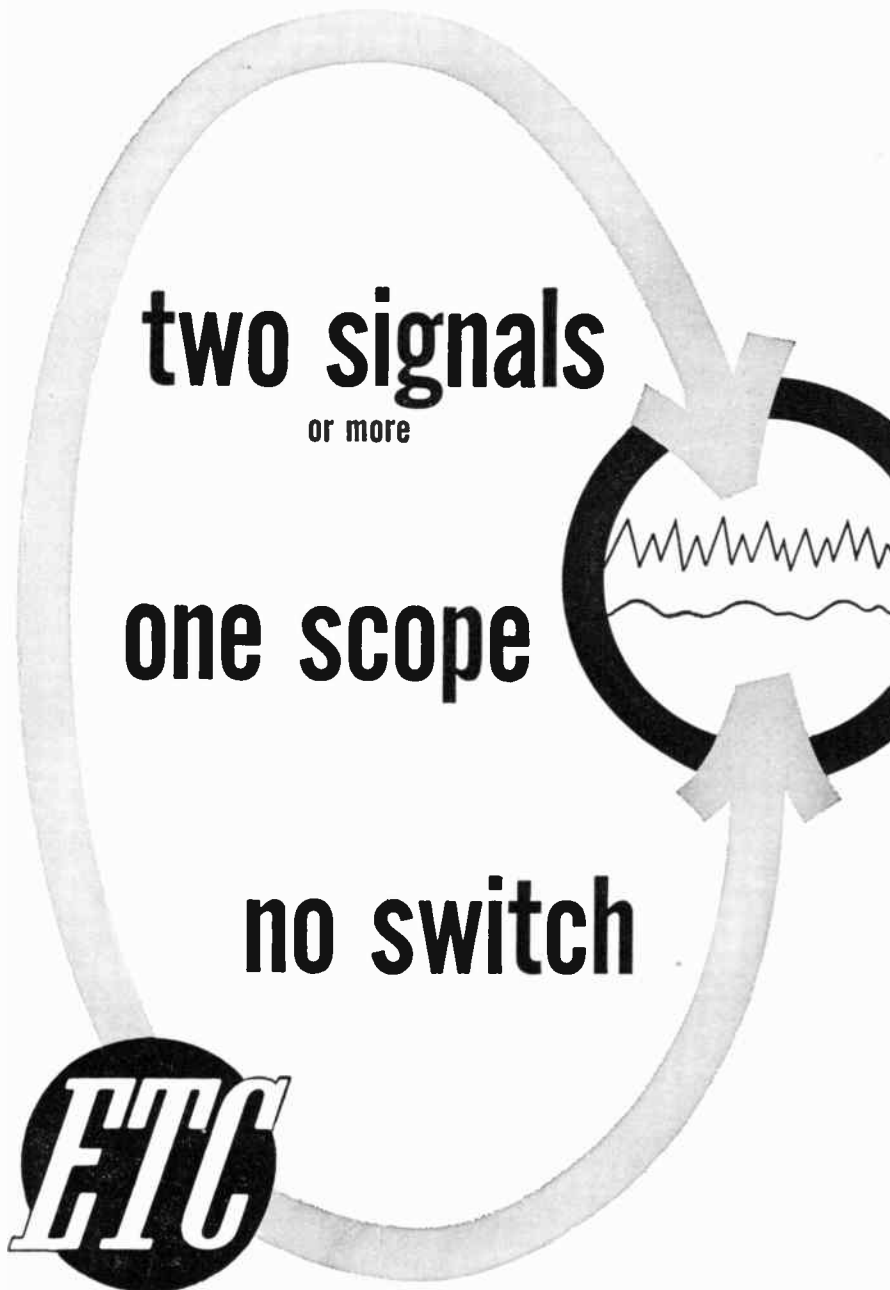

**two signals
or more**

one scope

no switch

ETC

ETC multi-channel oscilloscopes and multi-gun tubes display up to 8 independent phenomena *simultaneously* on the face of a *single* cathode ray tube . . . without switching.

Write for complete catalog.

electronic tube

C O R P O R A T I O N

1200 E. Mermaid Lane

Philadelphia 18, Penna.

See Us at the IRE Show—Booth 241 Instruments Ave.

WHICH "150"

**fits your
oscillographic
recording need?**

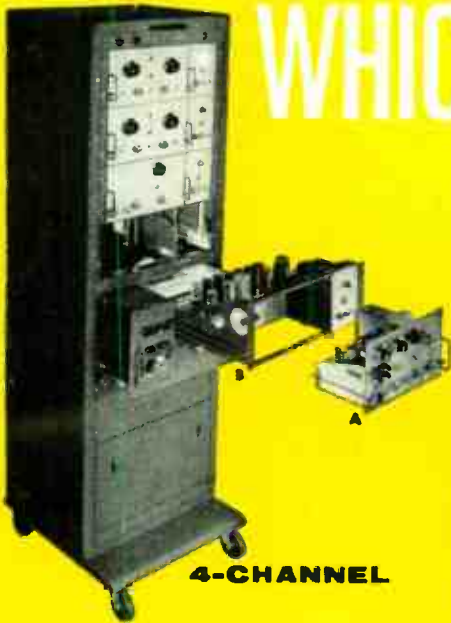

4-CHANNEL

As a graphic example of the design idea that has brought new versatility to industrial recording, a Carrier Preamplifier (A) is shown above in position to plug into a Driver Amplifier in framework with Power Supply (B) which are normally already in place in the Basic Cabinet Assembly.

The identical design principles of the four-channel system are provided in the two-channel, the only difference being the number of channels.



2-CHANNEL

Sanborn "150" Recording Systems that put to use the original design concept of amplifier interchangeability (illustrated at the left) start with either a four-channel or two-channel standard Basic Assembly, to which the user adds whatever selection or combination of pre-amplifiers (A) are needed for his recording problem. The standard Basic Assemblies comprise a metal Cabinet, Recorder, and a built-in Driver Amplifier and Power Supply (B) for EACH channel. Presently available Preamplifiers are: AC-DC, Carrier, DC Coupling, Servo Monitor, Log-Audio, and Low Level Chopper.

Advantages common to ALL Sanborn Recorders are: inkless recording (by heated stylus) on plastic coated strip chart paper, and in true rectangular coordinates . . . high torque galvanometer movement . . . time and code markers . . . numerous paper travel speeds.

"150"

COMPLETE FOUR-CHANNEL SYSTEM FOR USE WITH ANALOG COMPUTERS

This "150" system consists of a Cabinet Assembly, a four-channel Recorder, and two dual channel DC Amplifiers. Each amplifier is complete with a common power supply. Each measures and records two separate single-ended signals, at sensitivities between one and one hundred volts per centimeter. The two-channel version of this system will comprise Cabinet, two-channel Recorder, and one dual channel amplifier.



Ask, also, for a copy of the *Right Angle* — a Sanborn publication devoted to oscillographic recording in industry.

"150"

SINGLE-CHANNEL RECORDER

A compact, lightweight unit for use when only one channel is required — provides permanent, inkless recording in true rectangular co-ordinates; five paper speeds (5, 10, 25, 50, 100 mm/sec.); extra stylus for either manual or remote timing and coding marks. Designed for simple, patch cord connection to any of the several "150" preamplifiers (plus driver amplifier and power supply), available soon in portable metal cases.



Catalog and technical data on all "150" equipment available on request.

SANBORN COMPANY
Industrial Division
CAMBRIDGE 39, MASS.

Be sure to see the 150 Series at Booths 455-457, IRE Convention, Kingsbridge Armory, Bronx, New York, March 21-24, 1955.

point-to-point COMMUNICATIONS

A
COMPLETE
LINE

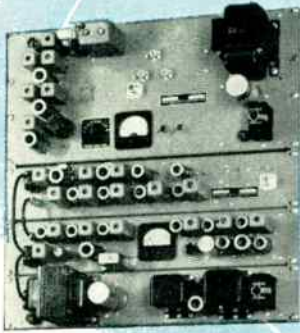

From telephone carrier to microwave, Budelman manufactures a complete line of equipment, outstanding in performance, efficiency, and low cost. Typical is the 14BW FM transmitter-receiver for multi-channel use in the 890 to 960 mc band. Compact design and low operating costs make these the ideal units for public safety, common carrier, and similar services, where reliable, trouble-free operation is so important. The 14BW, as well as other Budelman equipment, meets all applicable FCC requirements. It will meet your requirements, too, in design, quality, and performance at an economical price.

Write to Budelman today for full information on your best buy in point-to-point communication equipment.

BUDELMAN RADIO CORPORATION
376 FAIRFIELD AVENUE, STAMFORD, CONNECTICUT



★
ULTRA LOW

capacitance
& attenuation

WE ARE SPECIALLY ORGANIZED
TO HANDLE DIRECT ORDERS OR
ENQUIRIES FROM OVERSEAS
SPOT DELIVERIES FOR U.S.
BILLED IN DOLLARS—
SETTLEMENT BY YOUR CHECK
CABLE OR AIRMAIL TODAY



NEW 'MX and SM' SUBMINIATURE CONNECTORS
Constant 50Ω-63Ω-70Ω impedances

TYPE	μμF/ft	IMPED.Ω	O.D.
C1	7.3	150	.36
C11	6.3	173	.36
C2	6.3	171	.44
C22	5.5	184	.44
C3	5.4	197	.64
C33	4.8	220	.64
C4	4.6	229	1.03
C44	4.1	252	1.03

TRANSRADIO LTD. 138_A Cromwell Rd. London SW7 ENGLAND CABLES: TRANSRAD, LONDON

What to See at the Radio Engineering Show

(Continued from page 161A)

Burton Mfg. Co., 861 Audio Ave.
Miniature DC motors, precision potentiometers,
aircraft instruments.

Bussmann Mfg. Co. 488 Electronic Ave.

Small dimension fuses of various types. Fuse-tron dual-element (slow blowing) fuses, fast acting fuses for instrument protection—and fuses of all types for the protection of television, radio, controls, avionics, and automobiles. Plus many kinds of fuse blocks, fuse clips and fuse holders.

CEC Instruments, Inc., 237, 239 Instruments Ave.

*37-103 Precision Pressure Balance System; *1-127 20k-c Carrier Amplifier, latest in recording oscillographs, 3-132 dc power supply, SADIC (analog to digital converter,) pressure and velocity transducers, vibration equipment 23-109 oscillogram processor.

CGS Laboratories, Inc., 666, 668 Circuits Ave.

*Computer accepts Morse code and operates standard page teleprinter. *TRAK tuning lock automatically re-tunes receiver. *Noise rejecting signal gate separates intelligence from intense noise. *LP series INCREDUCTOR controllable inductors.

Caldwell-Clements, 642 Circuits Ave. See Tele-Tech & Electronic Industries

Calidyne Co., 462, 464 Electronic Ave.
Manufacturers of Vibration Test Equipment.
Featuring *100 pound force Shaker System and the Calivolt, a precision voltage standard.

Cambridge Thermionic Corp.

502 Components Ave.

Coils, coil forms, ceramic capacitors, terminal boards, terminals, insulated terminals, chassis & panel hardware, *Shielded coil forms. *Single contact connectors.

Camloc Fastener Corporation, 880 Audio Ave.

Offering a new Electronic Chassis Latch, particularly suited for engaging and disengaging multiple contact plugs. The latch can also be used as a carrying handle for the chassis when it is removed.

Campbell Industries, Inc., 725, 727 Airborne Ave.

See Clarostat Mfg. Co., Inc.

Canadian Radium & Uranium Corp. 414 Electronic Ave.

"DUPLICAN"

Photo-Contact Process
High Precision Markings on
Flat and Irregular Shaped Materials
Luminous Applications to all
Government Specifications

(Continued on page 168A)

* Indicates new product

Designed for one...

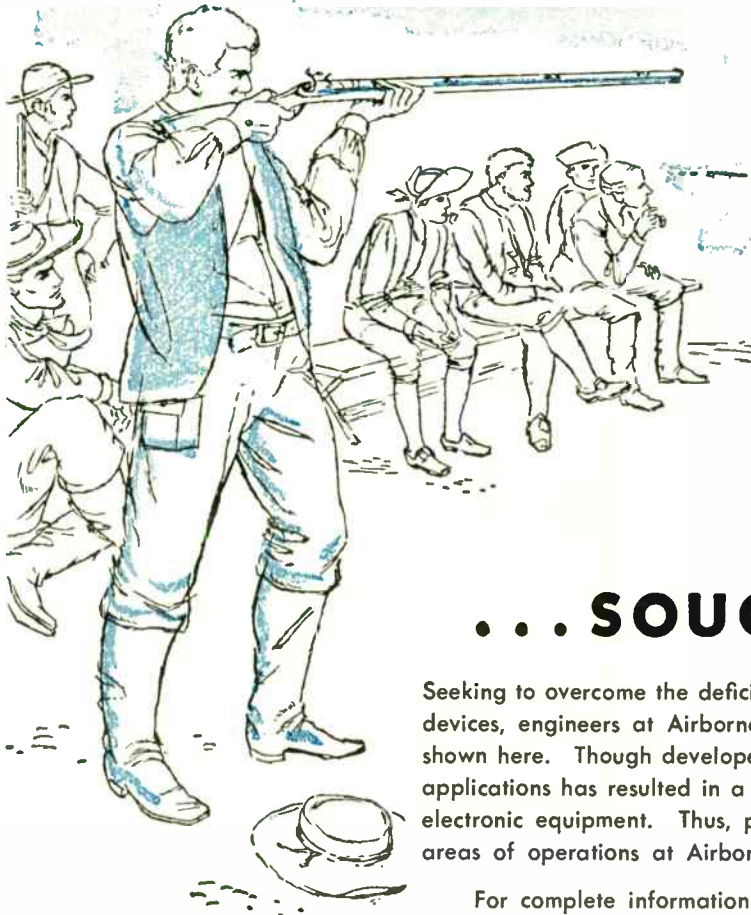

In 1816, Eliphalet Remington was dissatisfied with the old inaccurate squirrel gun, which consistently spoiled his attempts to win a shooting match. He determined to build a gun which would meet the specific needs of precision marksmanship. The weapon he produced achieved such remarkable results that the ensuing demand for similar models created a great industry.

... SOUGHT BY MANY

Seeking to overcome the deficiencies in many of today's standard electronic devices, engineers at Airborne Instruments Laboratory created the devices shown here. Though developed for use at ALL, their adaptability for many applications has resulted in a wide demand by manufacturers and users of electronic equipment. Thus, production and sales have become important areas of operations at Airborne.

For complete information on these and other advanced devices, now in production or available soon, be sure to visit Booths 63 and 65, at the IRE Show, Kingsbridge Palace, New York. Literature on request.



**AIRBORNE
INSTRUMENTS
LABORATORY**
INCORPORATED
160 OLD COUNTRY ROAD, MINEOLA, L. I., N. Y.





R5-E VACUUM RELAYS

for pulse forming networks, antenna transfer switching, guided missiles applications

are small, high voltage relays with a 12 or 24 volt DC actuating solenoid located in the base of the unit. Designed for minimum space requirements, the relays are 3 inches long and 2 inches in diameter. All types have flanges for easy mounting and none of them depend on flexible leads to carry current.

Their vacuum dielectric has over 30 times the dielectric strength of air making possible a fast acting 10 KV relay of compact design. Current ratings of 10 amperes RMS are obtained by the use of tungsten contacts. Series-break contacts include normally open, normally closed, and single pole double throw types.

A transmit-receive relay is also available with SPDT contacts and another NO contact which grounds the receiver when the relay is in the transmit position. This type R5-F is enclosed in a copper housing with three coaxial fittings. The housing shields the switch and provides a good ground connection for the receiver. It will handle antenna power up to 5 KW at frequencies up to 30 mc. when operating into a flat 51.5 ohm line.

Send for catalog literature describing these and larger relays manufactured by Jennings for DC, 60 cycle, and RF applications up to 85 KV and several hundred amperes.

Visit Our Booth #436 at the I.R.E. Show.

JENNINGS RADIO MANUFACTURING CORP. - 970 McLAUGHLIN AVE. P. O. BOX 1278 - SAN JOSE 8, CALIF.

What to See at the Radio Engineering Show

(Continued from page 166A)

Cannon Electric Co. 546 Components Ave.

CANNON PLUGS

The most complete line of multi-contact electric connectors: MIL specifications, audio, power, sub-miniature, hermetically sealed; de solenoids. Many new designs featured.

Capitol Radio Engineering Institute 692 Circuits Ave.

CREI residence and/or home study courses in Practical Radio Engineering, Broadcast Radio Engineering, Television Engineering, Aeronautical Radio Engineering, Television, FM and Advanced Servicing, Television Studio Operations.

Carboloy Dept., General Electric Co., 526, 528, 530 Components Ave.

Permanent magnets—sintered—cast—aluminum cast. Thermistors—most thermally sensitive resistor material. Hevimet—heavy and dense material. Technical engineering data and application information on display.

Carborundum Company, 866, 868 Audio Ave.

See Stupakoff Ceramic & Mfg. Co.

Cardwell Electronics Production Corp., Allen D., 710 Airborne Ave.

Variable & fixed air capacitors, rigid & flexible couplings, printed circuit 40mc. I.F. strips, printed circuitry, photo blanking, *facsimile recorders & transmitters.

Cargo Packers, Inc., 141 Television Ave.

Special packaging for electronic equipment, electron tubes & instruments.

NEW 6/12 v. DUOVOLT GENEMOTORS NEW CHANGE-A-VOLT DYNAMOTORS NEW DC to AC CUSTOM CONVERTERS INDUCTOR ALTERNATORS

Booth 409 Electronics Ave.

Carter Motor Co.

2644 N. MAPLEWOOD AVE. CHICAGO 47

Carter Parts Company, 69 Palace

Jacks, plugs, potentiometers, switches, plus two *new jack designs, three new potentiometers, new push button switch, new lever switches, new toggle switches.

Cascade Research Corp., 376 Microwave Ave.

Uniline, the ferrite microwave load isolator, and the Gyriline, the ferrite microwave amplitude modulator or switch now available in new frequency ranges and power levels.

Century Geophysical Corp., 274, 276 Instruments Ave.

Recording oscillographs, galvanometers, carrier and Linear-Integrate Amplifiers for recording and measurement of vibration, stress, strain, pressure, temperature, etc.

*Indicates new product

(Continued on page 170A)

A combination to make

ELECTRONICS HISTORY...

MACK TRUCKS'
extensive research, manufacturing and
quality production facilities

plus **WHITE INDUSTRIES'**
electronic engineering skill, experience
and know-how

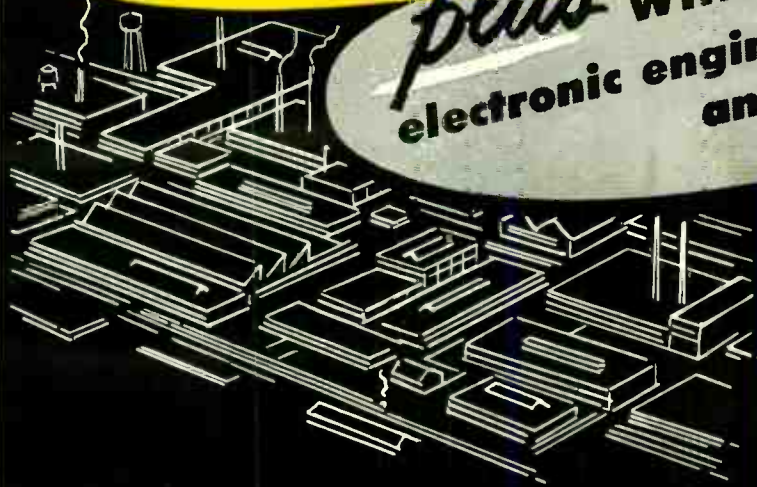

Mack Trucks, for over 54 years a great name in the field of quality manufacture of automotive products, combines its manufacturing, production, engineering and metallurgical research facilities with the electronic engineering techniques of White Industries, Inc.

This brings to the electronics field a combination which provides unmatched production and technical resources serving avionics, marine and industrial markets and the military.

- Complete fire control systems
- Missile control systems
- Weapon procurement systems
- Radar antennae
- Industrial applications of ultrasonics
- Environmental engineering
- Nuclear and electronic test equipment
- Metallurgical specialists



WHITE INDUSTRIES INC.

421 WEST 54TH STREET, NEW YORK 19, NEW YORK

A Wholly-owned Subsidiary of MACK TRUCKS, Inc.

HIGH Reliability

PLUS

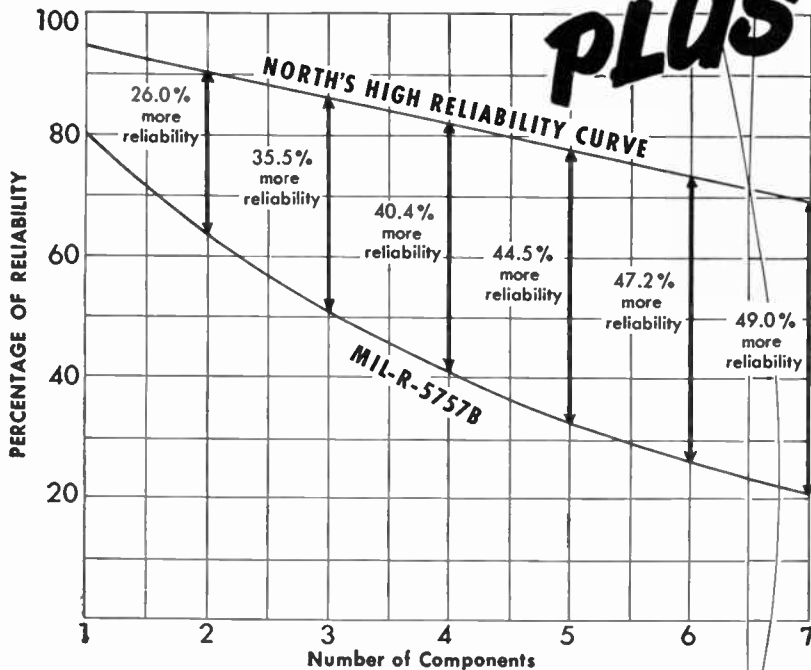

The feedback of results from a new series of tests has enabled North engineers to produce a new high in relay reliability. These relays are especially suited for a wide range of airborne applications where a high degree of shock and vibration immunity is required, and where reliability must exceed the standards set up under MIL-R-5757B.

North's high reliability program subjects each relay to these tests. Comparison of Curves above shows the ratio by which system reliability is reduced in proportion to the number of components employed. Tests prove that the uniformly tight control of the high reliability program developed by North* greatly improves the value of this ratio as applied to North Relays.

Conformity with the pattern which these tests define is your best assurance of reliable system performance.

*Detailed explanation of these tests is available on request.

ACTUAL SIZE

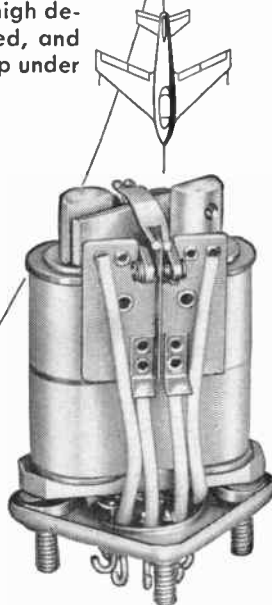

IR 226 RELAY (with cover removed)
 Hermetically Sealed—Sensitive Type—Temperature Range -65° to +125°C—Zero Bounce or Chatter at 50 Gs Shock and 500 Cycle Vibration Tests—2C (two make-break) Contacts—100,000 Operations at Rated Load of 2.0 amps at 30v DC resistive—specifications not applicable to your requirements may be deleted.

See North's Display at the IRE Show Mar. 21 thru Mar. 24



THE NORTH ELECTRIC MANUFACTURING COMPANY

Originators of ALL RELAY Systems of Automatic Switching
 543 South Market Street, Galion, Ohio, U.S.A.

What to See at the Radio Engineering Show

(Continued from page 168A)

Ceramaseal Company, 630 Circuits Ave. High temperature terminals, operating temperatures to 600°C. Terminals consist of high alumina ceramic to which are brazed metal parts. Have extremely high thermal shock resistance, may be brazed to covers, 100% leak tested.

Chatham Electronics 474, 476, 478 Electronic Ave.

Special purpose tubes, hydrogen thyratrons, gas & vacuum rectifiers, cold cathode discharge tubes, custom built electronic equipment, power supplies, modulators. Radiac devices.

Chester Cable Corp. 664 Circuits Ave.

PLASTICORD and PLASTICOTE
 Wires & Cables
 —for every electronic and electrical application

CHICAGO STANDARD TRANSFORMER CORP. BOOTH #415



See the CHICAGO stock line of MILITARY STANDARD 400 CYCLE TRANSISTOR and other transformers for military and industrial applications.



Chicago Telephone Supply Corp.

450 Electronic Ave.

Complete line composition & wire-wound variable resistors for military and commercial applications. Variable resistors for printed circuit and wirewrap applications. Also twist ear mounted types.

Cinch Mfg. Corp.

394, 396 Broadcast Way

Tube sockets and shields—micro-connectors—terminal strips—battery plugs & sockets—transistor sockets—strapnuts—tube holders—metal stampings.

(Continued on page 172A)

AVAILABLE
SOON!

NEW
STANDARD
SIZES OF
HUDSON
PRECISION
DRAWN
CLOSURES

WATCH
HUDSON
MESSAGES
IN COMING
ISSUES!

Offering designers and production engineers the economy of HUDSON standardized production of cases and covers made to precision requirements. Solve your closure problems at lower cost with the most complete standard line in the industry!

VISIT
BOOTH
472
ELECTRONIC
AVENUE
I. R. E.
SHOW
KINGSBRIDGE
ARMORY
NEW YORK
CITY
March 21st
to 24th

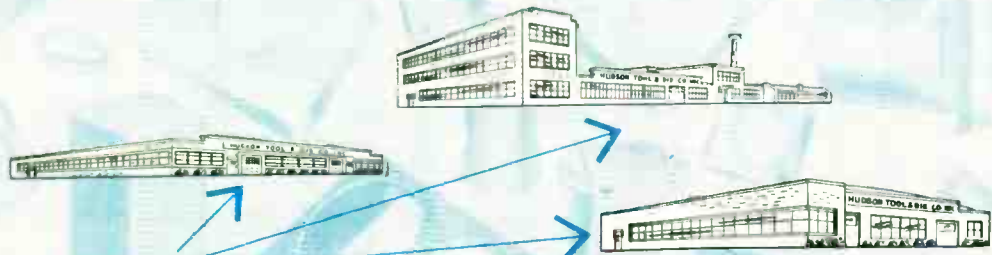

3* FULLY-EQUIPPED PLANTS

Offering the Most
Complete Line of
Precision Drawn
Cases and Covers
in the Industry!

...THREE COMPLETE SERVICES!*

Hudson Standard Metal Closures

Over 1000 economical standard types mean HUDSON can supply precision components at commercial prices. A wide variety of optional features make it possible to solve all but the most unusual closure requirements with standard types selected from HUDSON stocks.

Hudson Quality Metal Stampings

Metal parts produced to your exact specifications at prices that reflect the economies of mass production methods. Hudson can work to close tolerances and maintain uniformity throughout production runs. Quotations supplied promptly on receipt of drawings.

Hudson Sheet Metal Facilities

Depend on HUDSON for expert fabrication of simple or complex sub-assemblies. Facilities include certified welding of alloys, silver soldering, brazing and chrome plating.

NEW
CATALOG
READY,
NOW!

The Hudson story is contained in one handy catalog. Full descriptions of all standard items and complete information on Hudson metal working facilities. Call or write for your copy, now!

Precision Components of
Steel, Aluminum, Copper,
Brass, Mu Metal



HUDSON
TOOL & DIE COMPANY • INC
118-122 SOUTH 14th ST., NEWARK 7, N. J.

For **HIGHEST ELECTRICAL & MECHANICAL Efficiency!**

New
JONES 2400 SERIES PLUGS & SOCKETS

Improved Socket Contacts. Four individual flexing surfaces. Positive contact over practically their entire length.
Both Plug and Socket Contacts mounted in recessed pockets greatly increasing leakage distance, **INCREASING VOLTAGE RATING.**
Plug and Socket Contacts cadmium plated. Add to appearance of your equipment. Interchangeable with Jones 400 Series.
Ask for Catalog 20, Complete line Jones Plugs, Sockets, Terminal Strips.

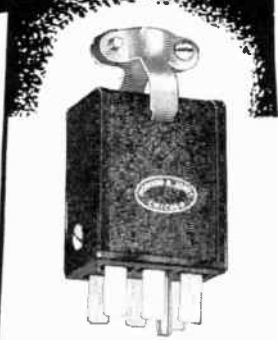

P-2406 CCF Plug—with cable clamp in top.



S-2406-SB Socket with shallow bracket for flush mounting.

SEE NEW DEVELOPMENTS AT I.R.E. Show • Booth 394-396

Jones
HOWARD B. JONES DIVISION
CINCH MANUFACTURING CORPORATION
CHICAGO 24, ILLINOIS
SUBSIDIARY OF UNITED-CARR FASTENER CORP.

What to See at the Radio Engineering Show

(Continued from page 170.1)

Cinema Engineering Division, 548, 550, 552 Components Ave.
See Aerovox Corp.

C. P. Clare & Co.
434 Electronic Ave.

The Clare booth will display Relays & Switches for Aircraft, Computers and industrial application. New item will be a *high speed, long life mercury wetted contact relay made under license from Western Electric Company.

Clarostat Mfg. Co., Inc., 725, 727 Airborne Ave.
"Precision Carbon Deposited Fixed Resistors."

Cleveland Container Co.
519 Components Ave.

CLEVELITE phenolic tubing—various grades and fabrications—also "Forkrite" the answer to torque and stripping problems encountered in coil forms requiring the use of iron cores.

Clough Brengle Co., 290 Instruments Ave.
Audio oscillators, beat frequency, RC, and audiomatic types; RF signal generators; IF sweep generators; capacitance-inductance; resistance bridge; transmission measuring sets.

Coastal Publications Corp., 616 Circuits Ave.
The "New Leader" in the field of technical publications . . . specializing in the preparation of handbooks for industry and government. "You can rely on Coastal."

Sigmund Cohn Corp.
571, 670 Transistor Way

Base metals; Precious metals, Fine wire and ribbon, bare drawn, etched, electroplated, enamel insulated.

Coil Winding Equipment Co.
305, 102 Production Rd.

Newest winding developments in: Motor coils, Delay lines, Transformers, Resistors; Bank patterns. *High Production Equipment. Special Laboratory Winders. Tensions for wires #10-#56. Engineering help on special problems.

TRAVELING-WAVE TUBES

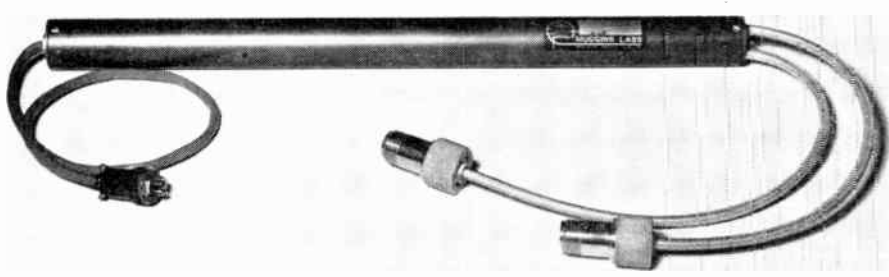

An X-Band amplifier, the Type HA-1B Huggins Traveling-Wave Tube operates over the 7 to 11 kilomegacycle band with no mechanical or electrical adjustments required. A high-gain, low-powered device suitable for broadband microwave applications, it includes

provisions for grid modulation. Important tentative specifications include:

- small signal gain 30 db min (7-12 kmc)
- small signal gain 20 db min (12-14 kmc)
- power output 7.5 dbm min (7-12.4 kmc)
- magnetic field 400 gauss
- capsule length 13.8 inches
- capsule diameter 1.0 inch
- net weight 1 lb

At the IRE Show, visit us and see these tubes at Booth 5, Kingsbridge Palace.



HUGGINS LABORATORIES
MENLO PARK 2 CALIFORNIA

(Continued on page 171A)

*Indicates new product

SERVO MOTORS

from FORD INSTRUMENT for
EXTREMELY LOW INERTIA AND
HIGH FREQUENCY RESPONSE

See in Booth 748
Airborne Ave.
at Radio Eng.
Show



- STANDARD SERVO MOTORS in nominal ratings of 10w, 5w, 2½w, 1½w and ½w
- SPECIALS to customer requirements.

Ford Instrument's high precision servos are available in high and low voltage models, in 60cy and 400cy designs, for a multitude of applications. With Ford's smooth iron, low-inertia rotors, they offer these advantages:

- Linear torque-voltage characteristics
- Linear torque-speed characteristics
- Withstand continuous stalling
- High torque efficiency

FREE—Fully illustrated data bulletin gives specifications and performance information. Address Dept. IRE.



48



FORD INSTRUMENT COMPANY

Division of The Sperry Corporation
31-10 Thomson Ave.
Long Island City 1, N. Y.

Ford Instrument's standard components



Rate Generators



Differentials



Servo Motors



Telesyn Resolvers



Integrators



Telesyn Synchros



Goodness!
Such growth!

During the past five years, the radio-electronic industry's spectacular growth has been paced by the increase of advertising pages in the annual IRE DIRECTORY.

In the 1949 edition, 158 advertisers took 133 pages. In the 1954 IRE DIRECTORY, the number of advertisers mushroomed to 501 and advertising pages numbered 358—an increase of 168% over the '49 edition.

The IRE DIRECTORY sells year 'round by serving over 35,000 IRE members who daily are developing and perfecting remarkable new devices. To sell ahead, put your product story before radio-electronic engineers who are planning ahead ... in the 1955 IRE DIRECTORY.

Engineers are educated
to specify and buy.

IRE DIRECTORY



Published by

The Institute of Radio Engineers
Adv. Dept., 1475 Broadway,
New York 36, N. Y. BRyant 9-7550

SUBMINIATURE RELAY-Plus!

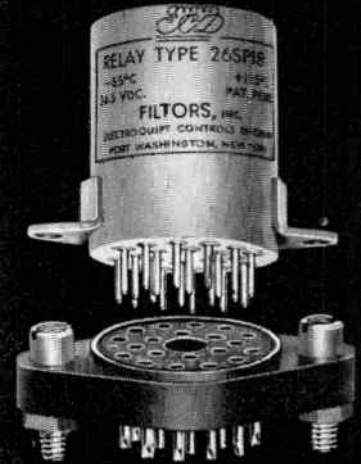

ACTUAL SIZE

Compact . . . Rugged . . .
Lightweight . . .

6 PDT Arrangement

ALL these features are achieved by the use of an extremely efficient rotary motor, precision built, with hydrogen annealed parts.

COMPACT — One inch diameter, with 1-5/16" long enclosure

RUGGED — Withstands operational shock of 50 G's and operational vibration of 5-500 C.P.S. at 10 G's. Altitude to 70,000 feet. Ambient temperature range of -65°C to +125°C.

LIGHTWEIGHT — Only 3.3 ounces (including socket and hardware).

Tests of production relays, under USAF supervision, have proven that this relay meets or exceeds the requirements of MIL-R-5757B.

Contacts are rated at 3 amperes at 26.5 V.D.C. or 115 V.A.C., 60 to 400 CPS.

Coil resistance values range from 6 ohms to 14,000 ohms.

Other standard contact arrangements are 2 PDT, 3 PDT and 4 PDT. All are available with solder-type terminals.

See us at the Booth 840,
Radio Engineering Show,

Kingsbridge Armory, March 21-24.

Fill in coupon for catalog.

FILTORS, Inc.

30 Sagamore Hill Drive
Port Washington, L.I., N.Y.

Please send data sheets on your subminiature relays.

NAME

TITLE

COMPANY

CITY STATE

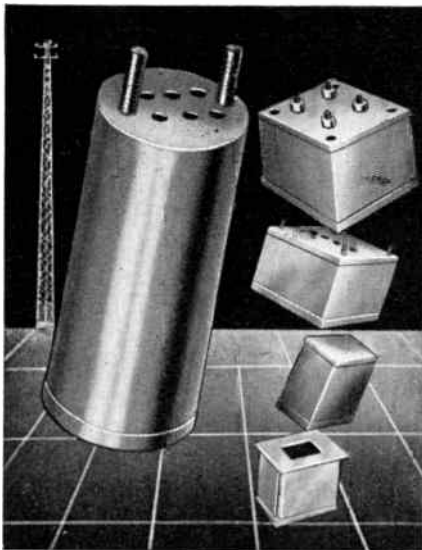

OVER 12 YEARS EXPERIENCE in Specialization and Standardization

Ask "OLYMPIC" to apply its Accumulated Knowledge, Skills and Techniques to YOUR Design Problems.

Use OLYMPIC'S "complete coordination" from design to delivery. It's to your advantage now to consolidate your speculations or your specifications with OLYMPIC.

- **ENGINEERING and DESIGNING** . . . of housings and hardware.
- **PRODUCTION** . . . with prompt, scheduled deliveries.
- **FINISHING** . . . centrifugal hot-tin dipping, cadmium plating, and black oxide finish.
- **SAMPLE SHOP FACILITIES** . . . in addition to production facilities.
- **TOOL and DIE SHOP** . . . fully equipped.

OLYMPIC Plans Today for Your Products of Tomorrow



OLYMPIC

METAL PRODUCTS COMPANY, INC.
ALPHA, NEW JERSEY

What to See at the Radio Engineering Show

(Continued from page 172A)

See Collins

Aviation
Broadcasting
Communications



and Amateur Equipment
496-694 Broadcast Way

COLOR TELEVISION INCORPORATED

Specialized Test Equipment. VSWR Measuring Systems. The Supertester—an automatic quality-control instrument. Log-Linear Amplifiers.

137 Television Ave.

Colortone Electronics, Inc., Div. International Television Corp., 623 Circuits Ave.

Model TS 175A/U Frequency Meter, a frequency setting and determining instrument for general purpose use, 85 to 1000 mc. Also new test instruments.

Comar Electric Co. 314 Computer Ave.

A complete line of miniature, light, medium and heavy duty relays for commercial & military requirements. Solenoids, coils, switches, transformers, hermetic sealing.

BOOTH 465
ELECTRONIC AVENUE



- Electrical Wave Filters
- Hi-Cycle Power Transformers
- Toroidal Inductors
- Magnetic Amplifiers
- Pulse and Transistor Transformers
- Saturable Reactors
- Delay Lines

**COMMUNICATION ACCESSORIES
COMPANY**
HICKMAN MILLS, MISSOURI

Compagnie Générale de Métrologie

321 Computer Ave.

Complete series of precision electronic measuring instruments: overload protected multimeters, TV and standard signal generators, tube analyzers, impedance bridges.

(Continued on page 176A)

MULTIMETER Type 430 "INTERNATIONAL"

**CANNOT BE DAMAGED
BY ANY KIND OF
OVERLOAD**

An automatic overload cutoff immediately isolates all component parts if an overload is applied. Push button reset.

Rugged 50 μ A meter movement largely dimensioned. New inclined moulded case, long easy reading scale. Single range switch.

Sensitivity: 20,000 Ohms per volt A.C. and D.C. 29 ranges. A.C. and D.C. volts: 3 - 10 - 30 - 100 - 300 - 1000 - 5000. D.C. current: 50 μ A - 1 - 10 - 100 mA - 1 - 10 Amp. Resistances: 0 to 20 Megohms. Output meter: 3 - 10 - 30 - 100 - 300 - 1000 volts. Accuracy: D.C. 1.5%; A.C. 2.5%. Dimensions: 8 1/4 x 5 7/8 x 3 1/8 ins. Weight: 3 lbs. 8 ozs.



MANUFACTURERS OF:

A.F.-H.F.-V.H.F. Signal
Generators Multimeters

Impedance Bridges
T.V.-Sweep Generators

**COMPAGNIE GÉNÉRALE DE
MÉTROLOGIE**

Chemin de la Croix-Rouge

ANNECY

FRANCE

U.S. REPRESENTATIVE: M. E. GERRY & CO., INC. 230 Bayard Road
UPPER DARBY, PA.

PHILADELPHIA: Granite 6-2540

I.R.E. SHOW: Booth 321

METRIX

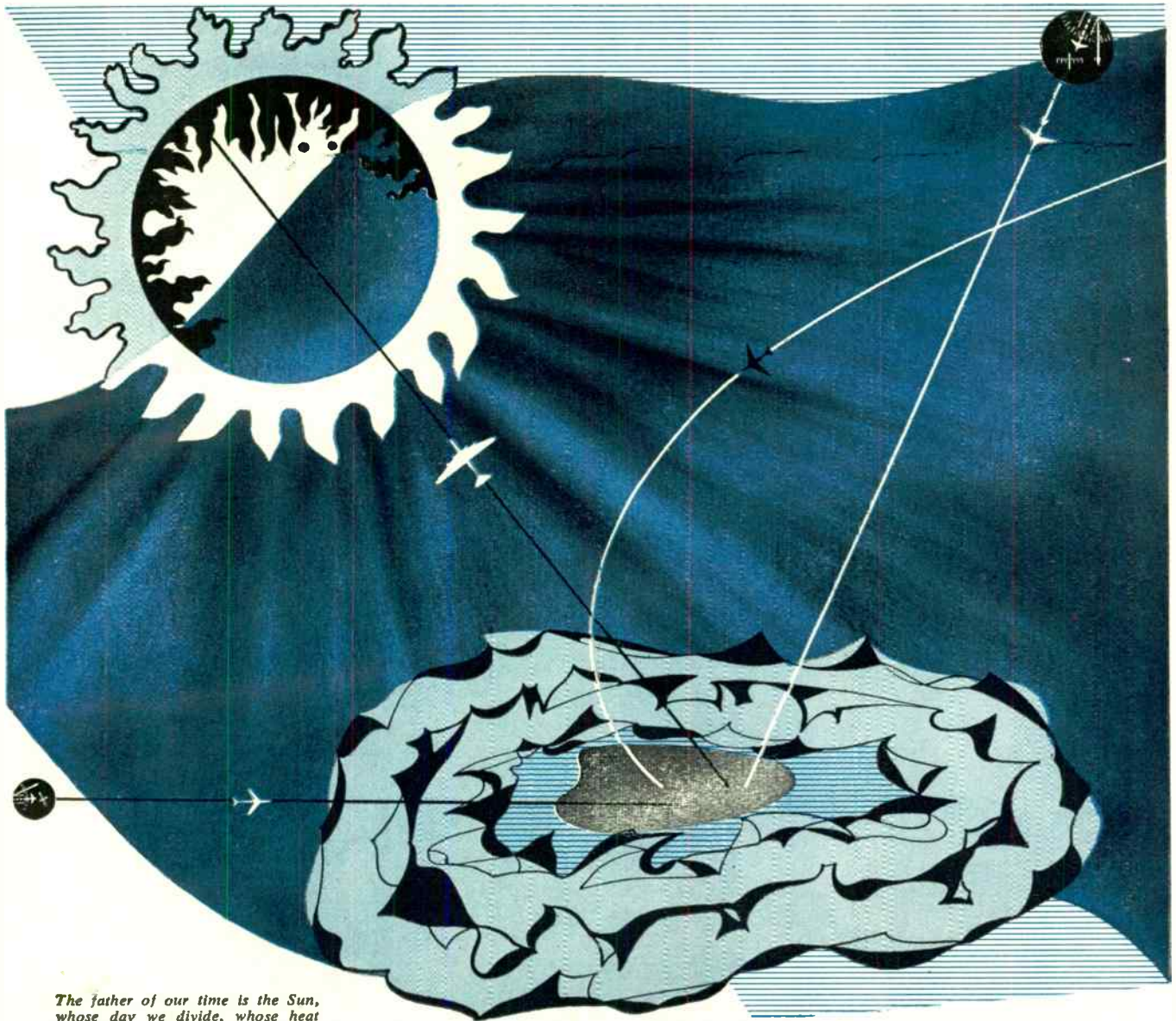

The father of our time is the Sun, whose day we divide, whose heat gives life. To the Oriental, time is as a silent pool, and man comes and goes as do the ripples on its surface—enduring within the great continuum of creation. To the Westerner, time is an arrow, swift in flight—sure in destination, passing, ever passing on.

enduring accuracy

Flights come and flights go. The sun boils and pools freeze. Time comes and time goes, but the accuracy of Kollsman products endures.

You can depend upon Kollsman . . . in these seven fields:

- AIRCRAFT INSTRUMENTS**
- PRECISION CONTROLS**
- PRECISION COMPUTERS AND COMPONENTS**
- OPTICAL COMPONENTS AND SYSTEMS**
- RADIO COMMUNICATIONS AND NAVIGATION EQUIPMENT**
- MOTORS AND SYNCHROS**
- INSTRUMENTS FOR SIMULATED FLIGHT TRAINERS**

Our manufacturing and research facilities . . . our skills and talents, are available to those seeking solutions to instrumentation and control problems.



kollsman INSTRUMENT CORPORATION

80-16 45th AVE., ELMHURST, NEW YORK • GLENDALE, CALIFORNIA • SUBSIDIARY OF *Standard* COIL PRODUCTS CO. INC.

precision instruments by DeJUR

SERIES BC-200-E
(Extended Terminal Board)

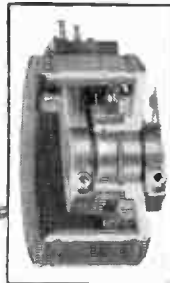
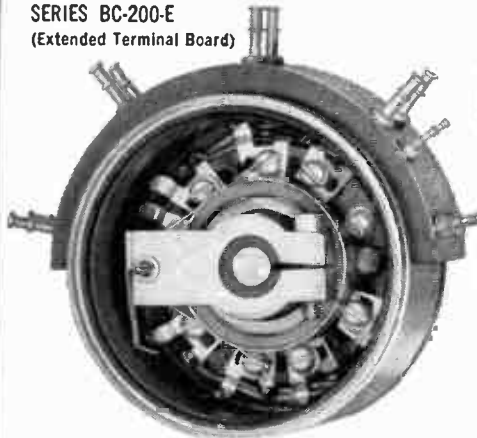

BC-200
(Typical Cross-Section)

Linear and non-linear function Ball Bearing Potentiometers

- External phasing
- Starting torque: 0.5 oz. in. max.
- Backlash: 0.05° max.
- Logarithmic, sine-cosine and other functions
- Multiple, adjustable taps
- Multiple, adjustable taps
- Precision design for universal coupling
- Precision machined aluminum housing
- Servo or single hole mounting

Our engineering department can supply prototypes quickly to meet unusual design specifications for tests and approval. Write for complete technical literature. No obligation.

DeJUR

Electronic Sales Division

DeJUR-Amsco Corporation

45-01 Northern Blvd., Long Island City 1, N. Y.

- Fully enclosed precision ganging types
- Standard and power types
- High resolution precision types

"You're always sure with DeJUR potentiometers"

See us at Booth 200, Production Road, Radio Engineering Show

What to See at the Radio Engineering Show

(Continued from page 174A)

Computer Control Company, Inc. 1 Palace

3C-PACS and 3C-BLOC, *new 1-megacycle universal logical packages for performing any 3-variable digital operation. Display of computing equipment and services for advanced digital system design, programming, and operation.

Condenser Products Co. 423 Electronic Ave.

Manufacturers of glassmike capacitors, plasticon capacitors, 60 and 400 cycle high voltage power supplies, pulse forming networks, and introducing *a new molded nylon capacitor.

Consolidated Vacuum Corp., 233, 235 Instruments Ave.

High speed rotary sealing and exhaust machine, valveless TV aluminizer, thermocouple gauge with printed circuit, KS-200 diffusion pump, and other high vacuum equipment.

L.L. Constantin & Co.

LODI, NEW JERSEY

503, 505 Components Ave.

Vacuum-tight, Glass-Metal Seals

HIGH COMPRESSION AND KOVAR

For Transistor, Relay, Transformer, Crystal, and Electronic Manufacturers. Composite Headers and Special Designs.

Inquire about new compression Kit #3

Continental Carbon, Inc.

456 Electronic Ave.

Nobleloy Metal Film High Stability Resistors Both Radial and Axial Lead Construction. Wire Wound Low Power Resistors. New Carbon Film Resistors in three wattage ratings.

Continental-Diamond Fibre Co., 665, 667 Circuits Ave.

Diamond Vulcanized Fibre & Vulcoid, Dilecto laminated plastics, Celoron molded products. Spiral tubing, Micabond, Teflon & Silicone tapes. Copper-clad laminate & fabricated parts from all materials.

Continental Connectors

Long Island 1,
New York

BOOTH 200 Production Road

World's most complete line of miniature precision connectors and terminal boards. Distributed and displayed at the IRE Show by DeJUR-Amsco Corporation.

(Continued on page 178A)



Control...

The rockets and guided missiles which carry man's quest for knowledge into space . . . and protect America against enemy air attack, rely on AMP capacitors, dielectrics and pulse forming networks to withstand the environmental conditions imposed by modern flight. The use of Ampli-film, AMP's synthetic dielectric material, provides the workhorse reliability in small size which is required by the weapons of the Rocket Age.

Because AMP's integrated plant in Elizabethtown manufactures its own dielectric and controls all the processes through to the finished product, you are assured of consistently high quality products to meet your most exacting requirements.

at the IRE Show . . . Booths 770 and 772

Another example of AMP's Creative Approach to Better Wiring

AIRCRAFT-MARINE PRODUCTS INC., Chemicals and Dielectrics Division
155 Park Street • Elizabethtown, Pennsylvania • Phone 7-1105

PROCEEDINGS OF THE I.R.E. March, 1955



AMP

Manufacturers of Specialty Rotating Equipment

FANS • MOTORS • BLOWERS



A15BD-8—115 Volt 60 cycle Double Blower. 46 CFM at .28" static pressure.

Variable frequency blower for operation on 115 Volt single phase. Available with axial fan or centrifugal blower. A15BF-15—50 to 800 cycles—single winding available with axial fan or centrifugal blower. A15AB-2 — 50-60 cycle and 400 cycle operation single winding. A15CF10 — 50-60 and 320-1000 cycle operation dual winding.

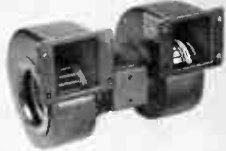

A15AD3—Axial blower unit for operation on 115 Volt 60 cycle single phase supply at 3300 RPM delivering 35 CFM at 0.2 S.P. This unit has special mounting bracket.



E Frame—Totally enclosed induction motor. 400 cycle 2, 4, 6 or 8 poles. 60 cycle 2 or 4 poles. 2-5/16" dia. H.P. up to 1/25 (up to 1/10 H.P. for axial vane blower application.)



Synchronous Motors—Hysteresis or Reluctance type. 60 or 400 cycle. Available single or dual speeds.



B20B-7 — 115 Volt 60 cycle. 50 CFM at 1.5" static pressure. Metal housing, L type bracket. Also available in 400 cycle.



631 x 1—115 Volt, 60 cycle, 3450 RPM 100 CFM @ 2 1/2" water gauge. Fits in space 9 1/2" long, 8 3/4" wide, 7 3/4" high.



631 x 35—115 Volt, 60 cycle or 220 Volt, 60 cycle, 1 or 3 phase. 3450 RPM continuous duty. 250 CFM at 2 1/2" water gauge. Used in microwave generators, unattended repeater stations. Fits in space 13 1/2" long, 8 3/4" wide, 7 3/4" high.



The features of all AIR MARINE motors include Stainless steel thru-bolts, Rigid die-cast aluminum housings, and Riveted stator to insure Extra-Rigid Construction.

Positive bearing alignment and uniform air gap. Motors are protected against humidity and fungus growth — can be mounted in any position— are equipped with ball bearings using lubricants for high and low temperatures—meet all AN specifications.

The motors and blowers on this page are representative of the many varied models available. Detailed information specifications and performance data on all units available on request.



Showing comparison between our large and small blowers

Booth 717

Send for our new Catalog AM-60

What to See at the Radio Engineering Show

(Continued from page 176A)

CORNELL-DUBILIER ELECTRIC CORPORATION

294-296 BROADCAST WAY



SOUTH PLAINFIELD, NEW JERSEY

CAPACITORS • VIBRATORS • CONVERTERS
ANTENNAS • ROTORS

Corning Glass Works, 397, 494, 495 Broadcast Way

22 inch rectangular color television bulb; metallized glass components for hundreds of electronic applications; fused silica delay lines; capacitors; resistors; inductances; photosensitive glasses.

Cox & Co., Inc., 819 Audio Ave.

Heaters: THERMOWIRE* THEMOPATCH*. Over 400 different approved military applications: aerial cameras, instruments, batteries, hydraulic equipment, T/R Tubes, crystal ovens, etc. More than 75,000 in use.

Craig Machine, Inc., 610 Circuits Ave.

Exhibiting various types of aluminum transit cases and reusable containers for shipping, carrying, and protecting delicate instruments and equipment. Also illustrative material on transportation and mobile shelters, vans, trailers, etc., for electronic equipment.

Cramer Company, Inc., R. W., 587, 589 Components Ave.

Precision electrical timing devices & synchronous timing motors—interval, cycling, pulse, percentage, program and reset timers; time delay relays, hermetically sealed timers, appliance timers.

Crest Labs., 634 Circuits Ave.
See Microtran Co.

Crosby Laboratories, Inc.

481 Electronic Ave.

*Single side-band with displays of transmitter, receivers, signal generators & receiving adapters for ham use. *Also featuring a wideband identical amplifier oscilloscope.

Crowley & Co., Inc., Henry L., 548, 550, 552 Components Ave.
See Aerovox Corp

Crucible Steel Company of America

Henry W. Oliver Building
Pittsburgh, Pa.

105, 107 Television Ave.

Crucible Permanent Alnico Magnets
Highest gap flux per unit of weight

* Indicates new product

(Continued on page 180A)

Constantly developing
to meet your exacting needs . . .

air-marine motors Inc.

369 Bayview Avenue
Amityville, L. I., N. Y.
AMITYVILLE 4-6122

West Coast Factory
2055 Pontius Avenue
Los Angeles 25, Calif.

VISIT US AT THE SHOW!
 A warm welcome awaits you at
 BOOTHS 691, 693 CIRCUITS AVENUE
 I. R. E. SHOW
 Kingsbridge Armory
 New York City
 March 21-24, 1955

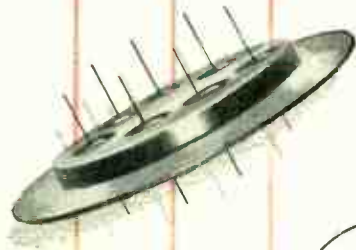

Use this handy  guide to -

dependable
**RESISTANCE
 ALLOYS**
for electronics



EVANOHM® (NICKEL CHROME) — For high specific resistance (800 ohms c.m.f.) — low temperature coefficient and low thermal e.m.f. vs. copper.

TOPHET A® (NICKEL CHROME) — For resistors, potentiometers and high temperature applications.

TOPHET C® (NICKEL CHROME IRON) — Offers great strength in fine sizes. For rheostats and resistors.

RODAR® (NICKEL, COBALT, IRON) — An alloy for hard glass to metal seals.

CUPRON® (COPPER NICKEL) — Non-magnetic with low temperature coefficient. For rheostats and resistors.

BALCO® (NICKEL IRON) — Offers high temperature coefficient of resistance. Applications include sensing bulbs and ballasts.

FILAMENT WIRE — MODIFIED HILO®, COBANK®, SYLVALOY®

GRID WIRE — MANGRID®, SILVER PLATED MANGRID®

CARBONIZED NICKEL — RADIOCARB A®, POLICARB®, DUOCARB®



All wires available with insulations of Enamel, Cotton, Silk, Nylon and Glass. Call or write for engineering assistance — the Wilbur B. Driver engineering staff welcomes an opportunity to work with you on special alloys for electronic applications.

WILBUR B. DRIVER CO.

150 RIVERSIDE AVENUE, NEWARK 4, NEW JERSEY



How are you fixed for CABINETS?

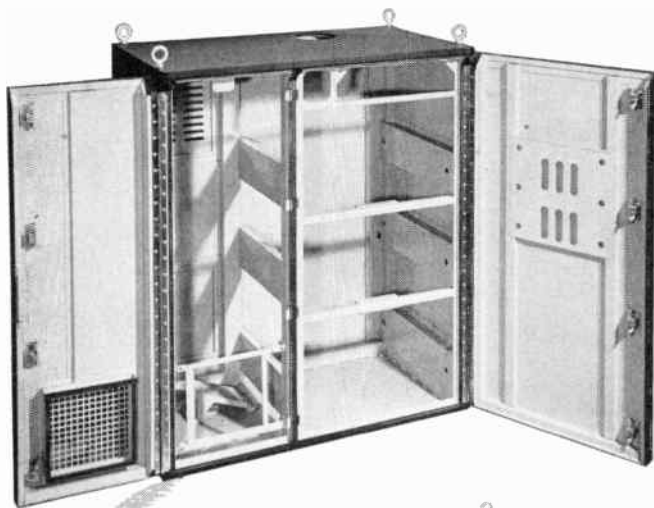

SEE US AT
I.R.E. SHOW
354 Microwave Ave.



Are your sheet metal housings of this quality—Are they being delivered according to schedule—and competitively priced?

We're producing many electronic cabinets . . . some much smaller, a few larger but all are quality through and through!

Whether yours is an individualized "custom job" or a long production run, R & T's complete, modern facilities and vast cumulation of equipment and skill can *save you money*. Investigate, today!

- Aluminum Spot Welding
- Heliarc Aluminum Welding

REPRESENTED BY

Frank W. Taylor Co.
P.O. Box 316
DeWitt, N.Y.

Paul R. Sturgeon
25 Huntington Ave.
Boston 16, Mass.

William E. McFadden
150 Broad St.
Columbus 15, Ohio

Samuel K. Macdonald, Inc.
1531 Spruce St.
Philadelphia 2, Pa.

Ralph T. Sullivan
1551 North Austin Blvd., Chicago 51, Ill.



MANUFACTURERS
Special Steel Equipment
Metal Cases - Cabinets
CONTRACTORS
Sheet Metal
Building Products
**VENTILATION,
AIR CONDITIONING**

**THE
RIESTER & THESMACHER
COMPANY**
1526 W. 25TH ST. CHERRY 1-0154
CLEVELAND, OHIO

What to See at the Radio Engineering Show

(Continued from page 178A)

Cubic Corp. 8 Palace

New microwave peak power test set.
New automatic VSWR indicator.
New Calorimetric wattmeter, new
microwave Components, also klystron
power supplies, standing wave am-
plifiers, phasemeter.

Cunningham, Son & Co., Inc., James, 313 Computer Ave.

High frequency Crossbar Switches featuring
high speed, compact design. Especially low
crosstalk level and low capacitance. Type P
Switch especially designed for TV and Radar
switching.

CURTIS Terminal Blocks

Better Connections
Economically—Quickly
A type for every purpose
644 Circuits Ave.

Dage Electric Company, Inc. 719 Airborne Ave.

New Dage DM series coaxial cable
connectors featuring 1/2 size of BNC
and many other new and unusual
connector types. Engineering consul-
tation available at booth.

Dale Products, Inc., 769, 771 Airborne Ave.

*Pressurized Potentiometers. *Precision collet
type instrumentation knobs. *Cork screw an-
chors for TV antenna masts & ham antennas.
Plus features of Dalohm resistors in types for
all precision applications.

Danbury-Knudsen, Inc., 703 800 Produc- tion Rd.

RF Components—Connectors

The Daven Co. 543, 545 Components Ave.

Encapsulated precision wire wound resistors;
audio, video, and rf attenuators; solenoid-
operated rotary switches; transmission measur-
ing sets for microwave relays systems; her-
metically sealed metal film resistors, single-
turn linear and non-linear potentiometers.

* Indicates new product

(Continued on page 182A)

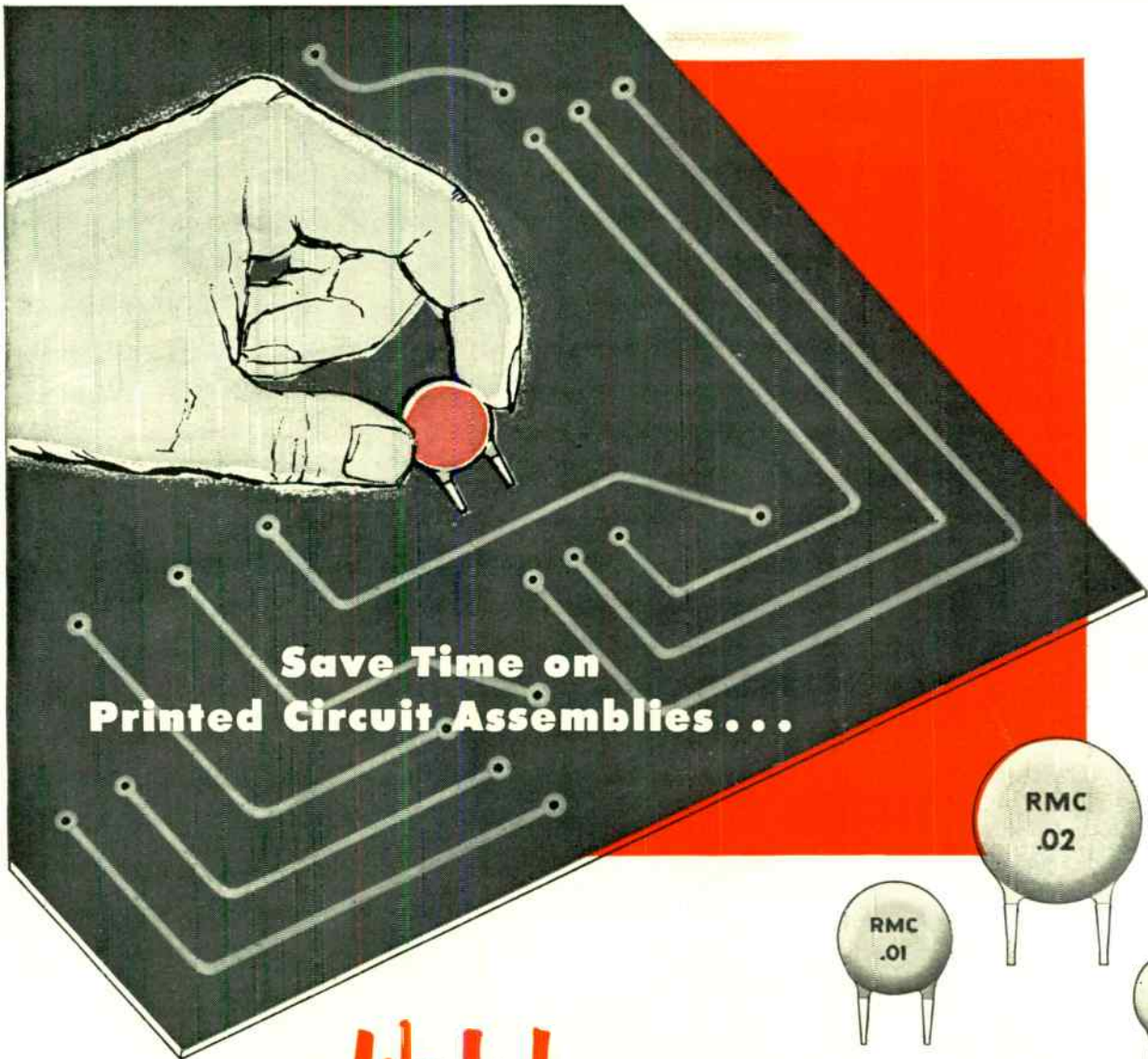

**Save Time on
Printed Circuit Assemblies . . .**

RMC *Wedg-Loc* DISCAPS

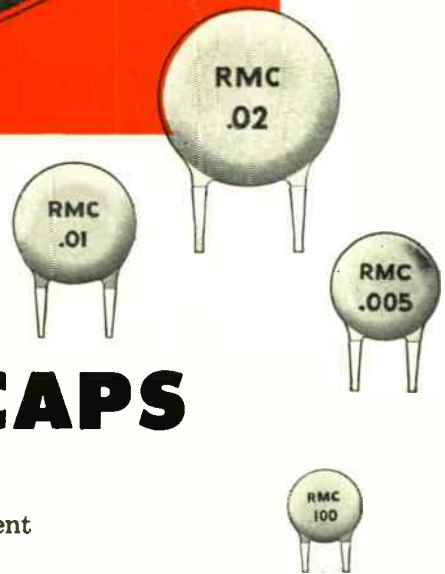

RMC "Wedg-Loc" DISCAPS are designed specifically to cut assembly time on all types of electronic equipment using printed circuits.

The exclusive wedge design of the leads on these new type DISCAPS locks them firmly in place on printed circuits . . . eliminates their falling out during production line operations . . . insures a uniform connection with a minimum amount of solder.

Available in capacities between 2 MMF and 20,000 MMF in temperature compensating, by-pass and stable capacity types, "Wedg-Loc" DISCAPS will provide worthwhile economies on printed circuit assembly. Suggested hole size for "Wedg-Loc" DISCAPS is a .062 square hole.

BOOTH 518, Components Ave., I.R.E. Show

DISCAP
CERAMIC
CAPACITORS



RADIO MATERIALS CORPORATION

GENERAL OFFICE: 3325 N. California Ave., Chicago 18, Ill.

FACTORIES AT CHICAGO, ILL. AND ATTICA, IND.

Two RMC Plants Devoted Exclusively to Ceramic Capacitors

world's largest Ion Trap maker
offers lowest priced Ion Trap
on the market

NEW SIMPLIFIED CONSTRUCTION

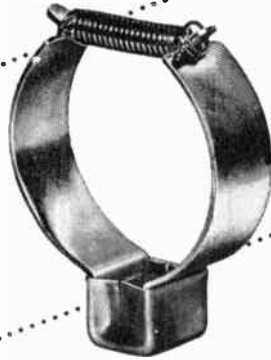

MODEL T-312. The new simplified steel construction lowers manufacturing costs by fully utilizing, for the first time, the Alnico permanent magnet's maximum efficiency. This makes Model T-312 the lowest priced ion trap on the market. Installs in only 2-3 seconds—just slip on.

FEATURES OF BOTH MODELS

STAYS PUT—No wobble; no shift during shipment; no realignment necessary when your TV set is installed in the home.

EASILY ADJUSTED—Slides more uniformly over tube's neck due to metal-to-glass contact.

STABILIZED AND TESTED on special equipment designed and used only by Heppner, each individual Heppner Ion Trap is guaranteed to meet your working requirements.

UNUSUALLY FAST DELIVERY.

LIGHTWEIGHT—Snap-On Model weighs only 1/2 ounce; Slip-On Model only 3/8 ounce. Will not harm tube's neck.

ALNICO P.M. USED—Retains magnetism indefinitely.

SNAP-ON ION TRAP

installs instantly—just snap on—stays put

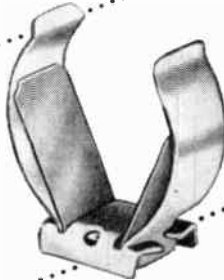

MODEL E-437. Saves you expensive production manhours with EXCLUSIVE instant snap-on feature. Reduces your parts costs because priced below competition. Clamp-type construction of Hardened Spring Steel.

Heppner has built over 15,000,000 ion traps to date

Write today for further information on better ion traps at lower prices.

HEPPNER
MANUFACTURING COMPANY

Round Lake, Illinois (50 Miles Northwest of Chicago)
Phone: 6-2161

SPECIALISTS IN ELECTRO-MAGNETIC DEVICES

Representatives: William I. Duncan, Jr., 3451 N. 10th St., Philadelphia 40, Penna.
Ralph Hatley, R.R. 1, U. S. 27, Coldwater Rd., Ft. Wayne 8, Indiana
Irv. M. Cochrane Co., 408 S. Alvarado St., Los Angeles, Calif.
John J. Kopple, 60 E. 42nd St., New York 17, N.Y.
Ben H. Tollefson, 144 Collingsworth Drive, Rochester 10, N.Y.

**What to See at the
Radio Engineering Show**

(Continued from page 180A)

Davies Laboratories, Inc., 222 Instruments Ave.

*Miniature Airborne Magnetic Tape Data Recorder. *Automatic Wave Analyzer. Laboratory and Portable Magnetic Tape Data Recording & Playback Equipment. *Multi-Track Record/Reproduce Heads for Tape Recording.

Davis Publishing Co., Inc., Bryan, 892 Audio Ave.

Annual IRE Radio Engineering Show number of SERVICE Magazine, highlighting industry trends, and featuring Service Engineering reports.

Featuring instrumentation and research, development and manufacturing services

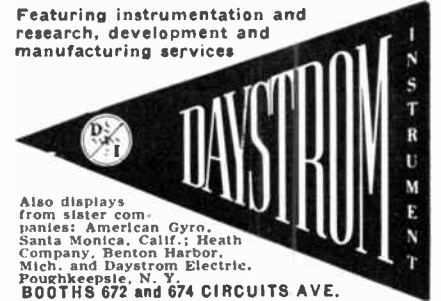

Also displays from sister companies: American Gyro, Santa Monica, Calif.; Heath Company, Benton Harbor, Mich. and Daystrom Electric, Poughkeepsie, N. Y.
BOOTHS 672 and 674 CIRCUITS AVE.

**Decade Instrument Co.
207 Instruments Ave.**

Booth will show operation Decaviders, Decalators, Deca-Sweeps, and two new instruments—the *Sweepalator, a 10 kc to 15 mc sweep signal generator and the *Decalator 100, a crystal controlled signal generator from 10 kc to 15 mc.

De JUA-AMSCO CORPORATION
LONG ISLAND CITY 1, NEW YORK

BOOTH 200
Production Road

Featuring a complete line of precision potentiometers, rheostats, watertight and "Ruggedized" panel instruments, and Continental connectors and terminal boards.

Spotlight on the NEW

D-B Precision Microwave Equipment
2.8 KMC-90.0 KMC

ULTRA-MICROWAVE equipment

DE MORNAY BONARDI
669 CIRCUITS AVE.

* Indicates new product

(Continued on page 184A)

Show Hours: Monday 10 AM-10 PM
Tuesday 10 AM-10 PM
Wednesday 10 AM- 5 PM
Thursday 10 AM-10 PM

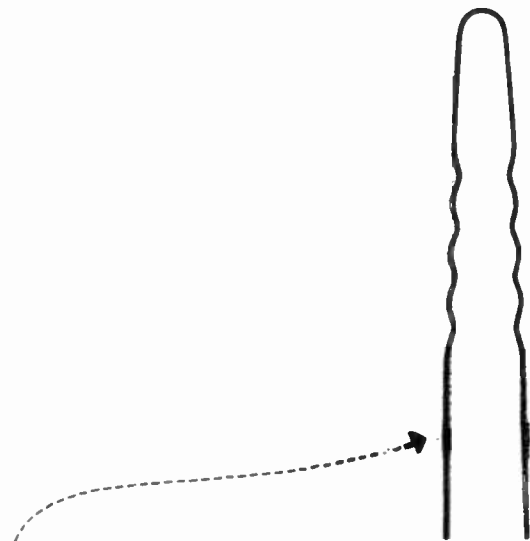

Something in Common



*No single tool...
not even
a hairpin...
works best
for all applications.
This is
true of
diodes, too.*

The Hughes line of semiconductor devices is multiplying swiftly. It comprises several different categories and numbers more than two hundred separate RETMA, JAN, and special diode types. This means that you can now spell out requirements for a diode in terms of your particular circuit application. And it means that one or more types in the extensive Hughes line will most probably match those requirements with *just the right* characteristics.

Greater selectivity is one of the results of the vigorous and continuing Hughes program of research and devel-

opment—a program aimed directly at satisfying anticipated industrial and military requirements. At the same time, your assurance of better quality and thorough dependability in *all* Hughes semiconductors is maintained. So, when you need diodes with High Temperature . . . High Forward Conductance . . . Computer Type . . . High Back Resistance . . . JAN-Approved . . . General Purpose, or other special characteristics, be sure to ask about Hughes Diodes. The chances are that you will find just the one you want.

At the IRE Show

We will be displaying samples of our famous GERMANIUM POINT-CONTACT DIODES, as well as the new GOLD JUNCTION and SILICON JUNCTION series. You will want to inspect the operating demonstration of light beam voice transmission system, with circuitry featuring our latest types of NPN fused junction transistors and photocells. So come in to Booths 753-5-7 and pay us a visit. You will be most cordially welcome.

Hughes

SEMICONDUCTOR SALES DEPARTMENT

Aircraft Company, Culver City, Calif.



New York Syracuse
Philadelphia Chicago

ALL SUBMINIATURE DIODES MADE BY HUGHES ARE FUSION-SEALED IN A ONE-PIECE MOISTURE-PROOF GLASS BODY. ACTUAL DIMENSIONS, DIODE GLASS BODY: 0.265-INCH LONG, BY 0.105-INCH DIAMETER, MAXIMUM.

Stupakoff

Kovar **HARD GLASS** Seals

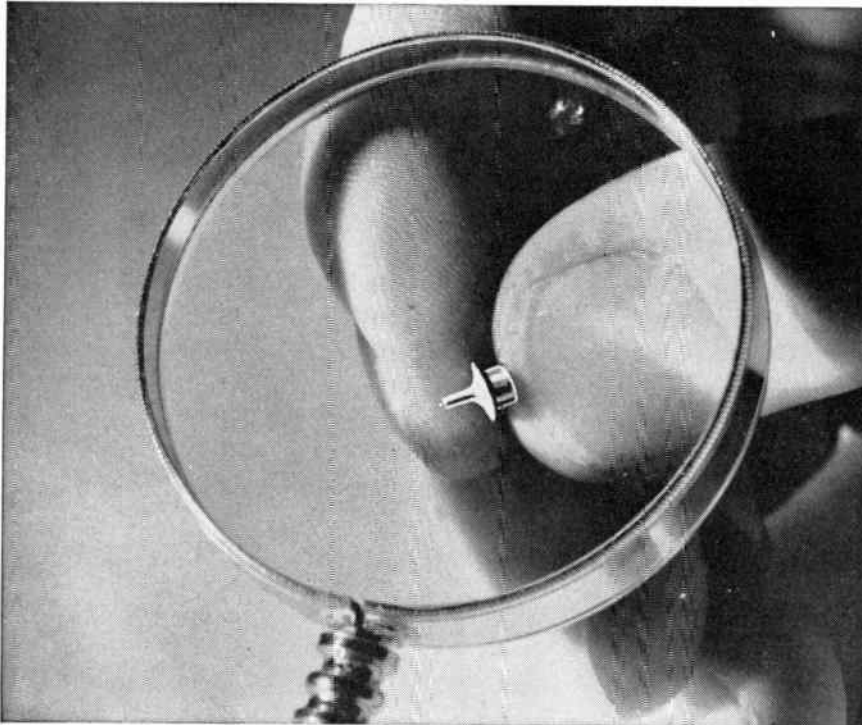

No "Leakers" in 52 million!

Over 52 million of the seals illustrated above are in use; and not a single "leaker" has been discovered!

In their manufacture, Kovar metal and *hard borosilicate glass* (Pyrex) are permanently bonded together, forming a fused-oxide seal that is vacuum- and pressure-tight, and corrosion-proof at the interfaces.

Borosilicate glass, matching perfectly the thermal expansion of Kovar, gives to Stupakoff seals thermal endurance, weather resistance, and high electrical insulating properties over the full temperature range of the glass.

Complete data of hundreds of sizes, styles and ratings of standard Stupakoff Kovar **HARD GLASS** hermetic seals is given in this catalog. Send for a free copy of Bulletin 453A.



Stupakoff

CERAMIC & MANUFACTURING COMPANY • LATROBE, PA.

DIVISION OF *The CARBORUNDUM Company*

We will be glad to see you at the Radio Engineering Show, Kingsbridge Army, New York, booths 866 and 868.

What to See at the Radio Engineering Show

(Continued from page 182A)

BOOTH 39

KINGSBRIDGE PALACE

SEE THE NEW DS-6100-T FREQUENCY COUNTER

Electronic Counters • RPM Indicators
Time Interval Meters • Frequency Counters
Decimal Decade Totalizers • Predetermined Counters
Computer-Measurements Div.

THE *Detection* CORPORATION
5528 Vineland
No. Hollywood, Calif.

Deutschmann Corporation, Tobe, 574
Components Ave.

Fixed capacitors and Interference Filters.

DIALCO 177-179

TELEVISION AVE.

Sub-Miniature Indicator Lights, grounded and insulated. Edge-Lighting Assemblies... Pilot Light Assemblies for neon and incandescent lamps... NEW OIL-TIGHT, RUGGED INDUSTRIAL STYLES and many other innovations.

Foremost Manufacturer of Pilot Lights
DIALIGHT
CORPORATION

Diamond Manufacturing Corp.

485, 487 Electronics Ave.

Diamond production samples of popular R.F. Connectors and Microwave Components. Sales Engineers on hand to discuss your problems.

Diamond Microwave Corp., 485, 487
Electronics Ave.

See: Diamond Mfg. Corp.

Diehl Mfg. Co., 3 Palace

Two-phase ac low inertia servo motors (1 to 750 watts output, 60 & 400 cycles). *1 & 5 watt instrument servo motors with gear trains, integral tachometers.

Doelcam Division, Minneapolis-Honeywell Regulator Co., 366 Microwave Ave.

Military components: Synchros, servo motors, microsyns, gyroscopes, magnetic servo amplifiers, flight test equipment. Precision laboratory and industrial instruments: featuring Doelcam's second harmonic magnetic converter.

Donner Scientific Company, 733 Airborne Ave.

*"Poor Man's" Analog Computer and accessories, *"Super" Oscillator, *L. F. Oscillator, *Harmonic Wave Analyzer, *Comparator Bridge, *Video Probe Amplifier, *WOW Meter, *sensitive Servo Accelerometers.

* Indicates new product

(Continued on page 186A)

Busses every eight minutes
Kingsbridge to Waldorf Astoria
FREE

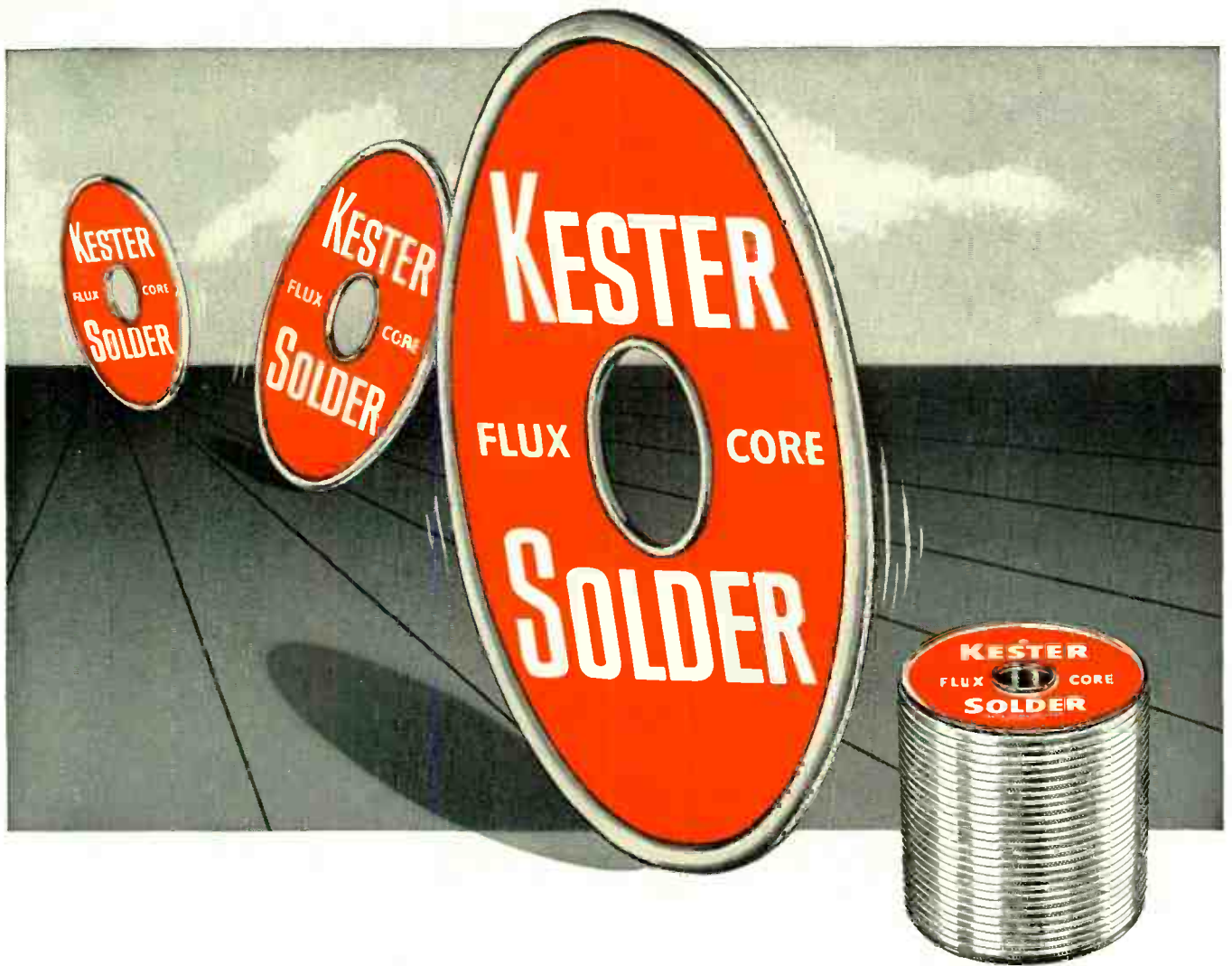

KEEPS 'EM ROLLING!



KESTER "44" Resin, Plastic Rosin and "Resin-Five" Flux-Core Solders keep the production lines moving by providing the exactly right solder for every application. Only virgin metals are

used in Kester . . . further assurance of the constant solder alloy control combined with consistent flux formulae . . . all part of Kester Flux-Core Solder quality that'll "keep 'em rolling" for you!

. . .

BE SURE YOU GET KESTER'S new 78-page informative textbook "SOLDER . . . Its Fundamentals and Usage."

KESTER SOLDER

COMPANY 2419 Wrightwood Avenue, Chicago 39, Illinois; Newark 5, N. J.; Brantford, Canada

for service and lab. work

Heathkit PRINTED CIRCUIT OSCILLOSCOPE KIT FOR COLOR TV!

① Check the outstanding engineering design of this modern *printed circuit* Scope. Designed for color TV work, ideal for critical Laboratory applications. Frequency response essentially flat from 5 cycles to 5 Mc down only 1½ db at 3.58 Mc (TV color burst sync frequency). Down only 5 db at 5 Mc. New sweep generator 20-500,000 cycles, 5 times the range usually offered. Will sync wave form display up to 5 Mc and better. Printed circuit boards stabilize performance specifications and cut assembly time in half. Formerly available only in costly Lab type Scope. Features horizontal trace expansion for observation of pulse detail — retrace blanking amplifier — voltage regulated power supply — 3 step frequency compensated vertical input — low capacity nylon bushings on panel terminals — plus a host of other fine features. Combines peak performance and fine engineering features with low kit cost!



MODEL
O-10
\$695.00
Shpg. Wt.
27 lbs.



MODEL
TS-4
\$495.00
Shpg. Wt.
16 lbs.

Heathkit TV

SWEEP GENERATOR KIT ELECTRONIC SWEEP SYSTEM

② A new Heathkit sweep generator covering all frequencies encountered in TV service work (color or monochrome). FM frequencies too! 4 Mc — 220 Mc on fundamentals, harmonics up to 880 Mc. Smoothly controllable all-electronic sweep system. Nothing mechanical to vibrate or wear out. Crystal controlled 4.5 Mc fixed marker and separate variable marker 19-60 Mc on fundamentals and 57-180 Mc on calibrated harmonics. Plug-in crystal included. Blanking and phasing controls — automatic constant amplitude output circuit — efficient attenuation — maximum RF output well over .1 volt — vastly improved linearity. Easily your best buy in sweep generators.

Heath
COMPANY
A SUBSIDIARY OF DAYSTROM, INC.
BENTON HARBOR 4, MICH.
WRITE FOR FREE CATALOG
...COMPLETE INFORMATION

What to See at the Radio Engineering Show

(Continued from page 184A)

**Microwave Components
and Test Equipment**
366 Microwave Ave.
**DOUGLAS MICROWAVE CO.
INC.**

Dow Chemical Company, 12 Palace
Fabricated magnesium items for use in electronic equipment of all kinds. *Demonstrates excellent workability characteristics of magnesium. Illustrates light weight, rigidity and versatility.

DRAKE
SOCKET &
JEWEL LIGHT
ASSEMBLIES
**Booth
812**
DRAKE MANUFACTURING CO.
1711 W. Hubbard St. . . . Chicago 22, Illinois

**Driver-Harris
Company**
607 Circuits Ave.

NICHROME®V and
NICHROME® KAR-
MA® and other high
resistance alloys.
THERLO® and other
glass-to-metal sealing
alloys.

Wilbur B. Driver Co.
691, 693 Circuits Ave.

Melters and manufacturers of alloys for the following electronic applications: (1) Filament (2) Grid Wire (3) Carbonized Nickel for anodes, wire and ribbon (4) resistors (5) glass to metal seals.

Alloy Names: EVANOHM, TOPHEST, CUPRON, SYL-ALOY, MODIFIED HILO, COBANIC, RODAR.

Dubrow Development Co., 37 Palace
*Precision vacuum-tube ac milliammeter-voltmeter, *transistor amplifier, *meter test set, *vibration meter, *omni-phase oscillator, *limiting amplifier.

*Indicates new product

(Continued on page 138A)

FIRST AID ROOM

A nurse is in charge at all times. First Aid Room is the sixth room to right of Lobby directly off registration area in Kingsbridge Armory.

1440 pgs.
Fully catalogs
Radio-TV-
Electronic
parts &
equipment:
Tubes,
Trans-
mitters,
Test Equip-
ment, Comm.
Receivers,
Transformers,
Capacitors,
Antennas,
Resistors,
Coils & Relays,
Recording &
PA Systems,
Hardware,
Tools, etc., etc.
**OFFICIAL BUYING
GUIDE OF THE
INDUSTRY**

1440 page MASTER for everything in Electronics

Make rapid selections from one industry-wide MASTER CATALOG complete with SPECIFICATIONS, ILLUSTRATIONS, DESCRIPTIONS, DIAGRAMS, PRICES on thousands of Radio-TV-Electronic parts and equipment.

NEW! 1955 BUYING GUIDE

List \$6.50
As low as **\$1.95**
as

- Over 85,000 • Fully indexed items
- Over 8,500 illus. • 8½" x 11"
- Weighs 6 lbs.

From leading parts distributors or write to:
UNITED CATALOG PUBLISHERS, INC.
110 Lafayette Street, New York 13, N. Y.

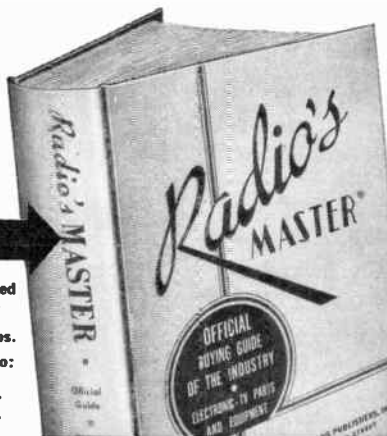

There is Always One Leader in Every Field BODNAR INDUSTRIES, Inc.

leads in the field of
PLASTIC LIGHTING PANELS AND DIALS
BECAUSE OF Quality • Uniformity • Performance
Design & Layout "Know-How Service"
Quantity Production Promptly

NEW YORK —19 Railroad Ave., New Rochelle (Home Office)
CALIFORNIA—4440 Lankershim Blvd., P.O. Box 264, North Hollywood
CANADA —44 Wellington St. E., Toronto
SPECIMEN PANEL MIL-P-7788 (AN-P-89) SENT ON LETTERHEAD REQUEST

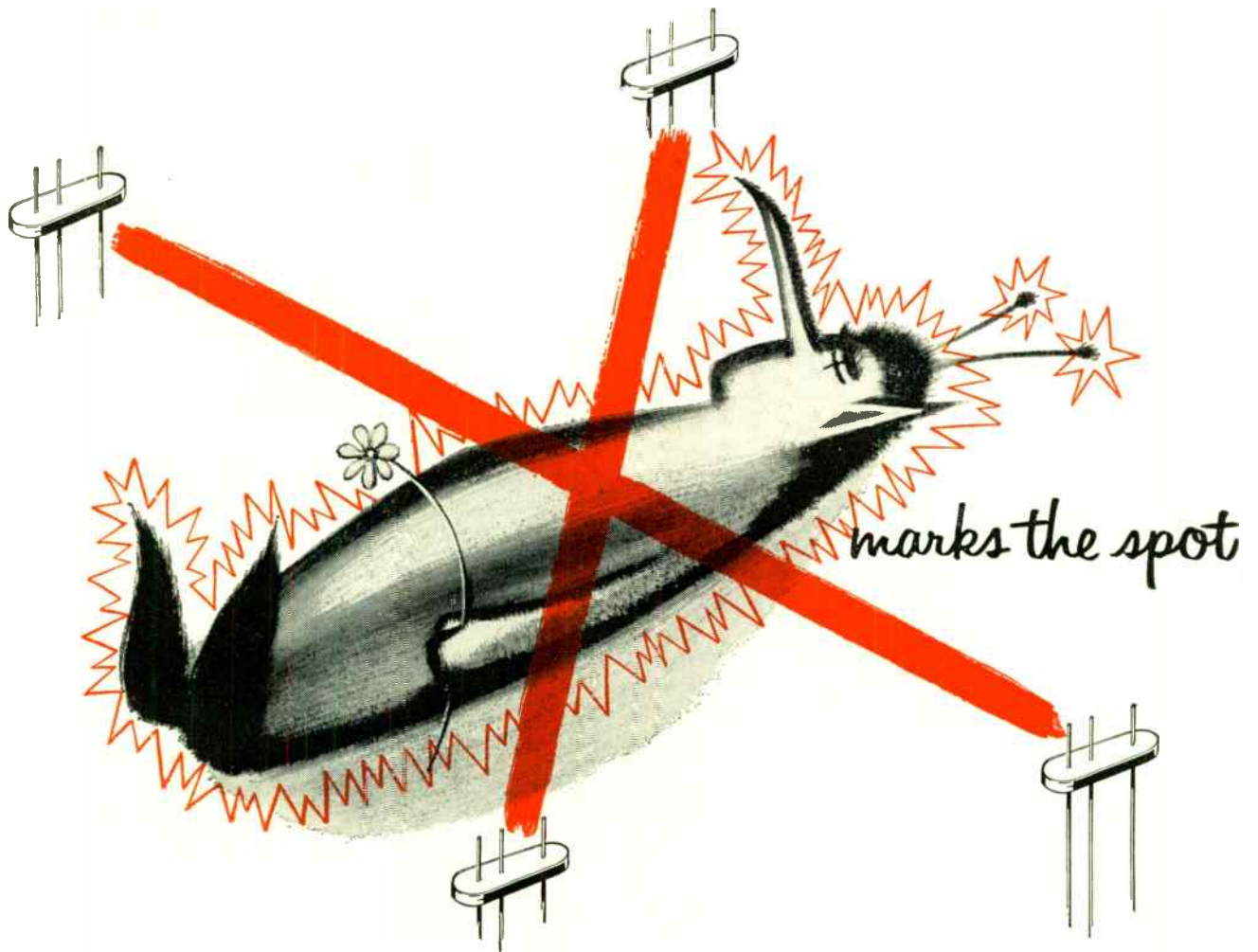

... That's Where Hermetic Kills Sputter "Bugs" in Transistor Housing Bases—

We have used *all glass* in the internally exposed area of our No. 1619 Transistor Base. This all-glass construction prevents contamination of a transistor wafer when closure is made after mounting. Had we left this area as *metal* . . . your "buttoning-up" operation would float solder and flux right in under the wafer. When this occurs, the possibility of contamination or degradation of the wafer is raised, and with results that are difficult to predict.

Hermetic's specialist-engineers can help you avoid trouble in all your hermetic sealing problems. Why not draw upon their knowledge and skill? . . . it covers the full range of matched glass or VAC-TITE* hermetic sealing for the most advanced components.

Write us about your problem, and for your copy of our latest addition to the "Encyclopedia Hermetica." You'll find it most complete and up-to-date.

*Vac-Tite is Hermetic's new vacuum-proof, compression construction glass-to-metal seal.



Hermetic Seal Products Company

29 South 6th Street,
Newark 7, New Jersey

Visit us at the IRE Show—
199 Broadcast Way

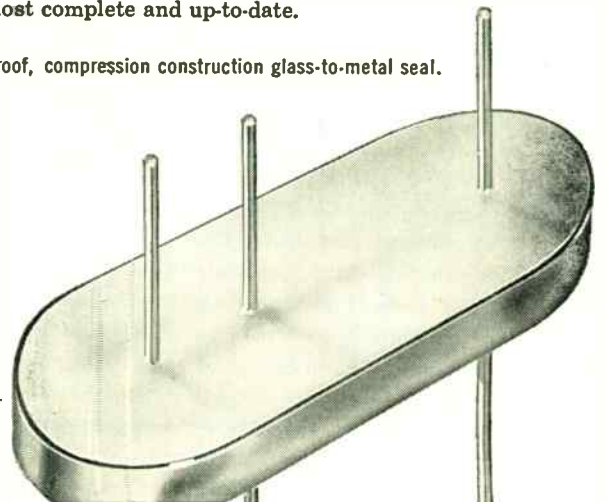

FIRST AND FOREMOST IN MINIATURIZATION

Now...



Supramica

**Supramica
555**

**Superior
grades of
glass-bonded
mica**

From Mycalex Corporation of America come two new grades of glass-bonded mica that increase temperature endurance nearly 300 degrees!

Supramica 500 For fired silver paste printed circuits and thermal endurance applications . . . **Supramica 500** in sheet or rod form with minimum distortion under no load at 1000°F.

Supramica 555 For electronic applications . . . precision-molded **Supramica 555** with minimum distortion under no load at 950°F.

The characteristics that have made Mycalex® glass-bonded mica world-famous are found, too, in the new Supramica formulations.

- * **Total and permanent dimensional stability**
- * **Low electrical loss**
- * **High dielectric strength**
- * **Resistance to radiation**
- * **Impervious to water, oil and organic solvents**
- * **Unequaled arc resistance**

**MYCALEX
CORPORATION
OF AMERICA**

World's largest manufacturer
of glass-bonded mica

EXECUTIVE OFFICES:
30 ROCKEFELLER PLAZA
NEW YORK 20, N. Y.

For complete data on this remarkable basic material write:
Mycalex Corporation of America
General offices and plant, Dept. 111
Clifton Boulevard, Clifton, New Jersey
Booths 651 and 653 at the IRE Show



What to See at the Radio Engineering Show

(Continued from page 186A)

**Allen B. Du Mont
Laboratories, Inc.**
**Communication Products
Div.**

167-171 Television Ave.

VHF-UHF Studio-Transmitter equipment;
Flying Spot Scanner Systems for 16 mm.
Film and Opaque Slide Pickup for Mono-
chrome and Color; *Video Switcher; Mobile
Communications Equipment.

**Allen B. DuMont
Laboratories, Inc.**
(Instrument Division)

264-268 Instruments Ave.

A complete new line of cathode-ray
oscillographs covering frequency
spectrum from dc to over 20 mc;
complete line of cathode-ray tubes
and radar tubes; complete line of
multiplier phototubes.

**Dumont Airplane & Marine Instruments,
Inc., 432 Electronic Ave.**

Capacitors (oil, paper, plastic, sub-miniature,
Mil-C-25A, electrolytics, precision, computer,
noise suppression). *A revolutionary design in
disc type capacitors.

**du Pont de Nemours & Co., Inc., E. I.,
846 Audio Ave.**

"Mylar" polyester film's unusual combination
of properties is demonstrated by subjecting it
to electrical stress, boiling water and dry ice.
Commercially available "Mylar" insulated ca-
pacitors, transformers, coils, wire and mag-
netic recording tape will be displayed.

Dyna-Labs., Inc.
480 Electronic Ave.

Gaussmeter; miniature earphones
and microphones; ultrasonic and un-
derwater-sound transducers; sonar
equipment; noise generators; sound
pressure standards; transducer cali-
brating equipment.

Dynamic Gear Co., Inc., 98 Palace
Introducing *medium & fine pitch precision
gears available for immediate delivery from
stock. Tooth range from 20 thru 300 in in-
crements of one tooth!

**Dynamic Sales Enterprises, 592 Compo-
nents Ave.**
See Fairchild Guided Missiles.

E.I.C.O., 209, 211 Instruments Ave.
See: Electronic Instruments Co., Inc.

**delay-lines
are
custom-made
at**

See Us in Booth 684

*Indicates new product

(Continued on page 192A)

IS YOUR PROBLEM TO SAVE SPACE?

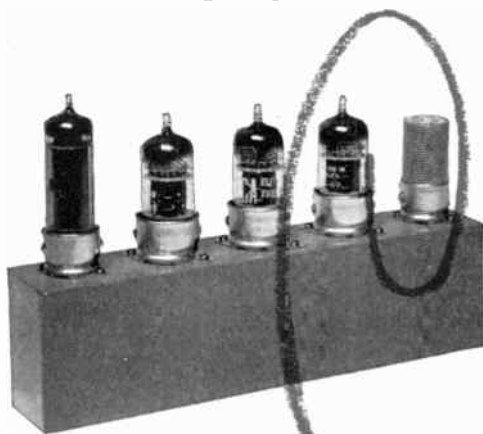

**400-CPS AIRPAX CHOPPER PLUGS
INTO 7-PIN MINIATURE SOCKET
IN THIS COMPACT D-C AMPLIFIER**

This miniature 400-cps chopper stands about $1\frac{3}{8}$ inches above the chassis, is about $\frac{3}{4}$ inch in diameter, and can be locked in place in a standard 7-pin tube socket with a tube shield.

Coil excitation of 20 milliamperes is readily obtained from 6.3-volt heater transformer.

Contacts of this single-pole double-throw continuously operating switch are rated for 1 milliampere at 100 volts maximum. On tests at no current—most severe operating condition for life test—units have operated within design limits for well over the rated 2,000-hours life.

Contact noise across 1 megohm has a peak amplitude of about 1.5 millivolts, an average value of 200 microvolts.

Designated as Airpax Type 300, this chopper provides reliable operation in unusually small space. Consider saving space by using this Airpax Type 300 chopper in your miniature equipment.

For complete specifications write to



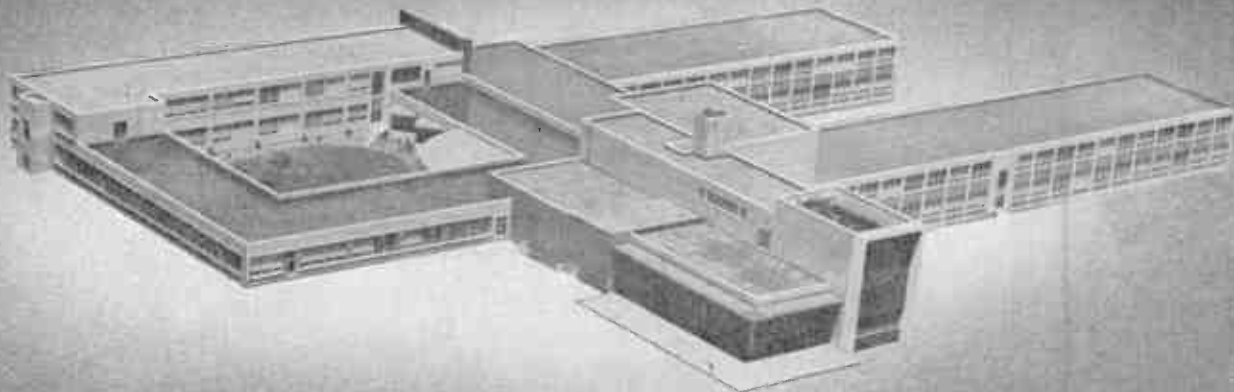

Newest electronic concept by Burroughs Corporation

BEAM SWITCHING TUBE

AVAILABLE NOW IN PRODUCTION QUANTITIES

The beam switching tube offers a new basic device to the engineer of electronic equipment. Versatility of the basic ten-position tube is such that any desired type of sequential, simultaneous or random switching of any number of positions may be obtained. The simplicity of the tube design and associated required circuitry result in a new standard of reliability. It reduces the total number of tubes required in a circuit, space, weight, and heat in control and switching systems.

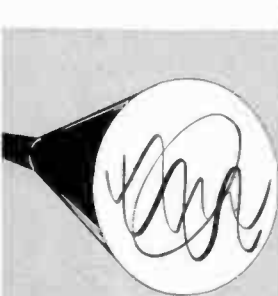

multi-channel cathode ray recording

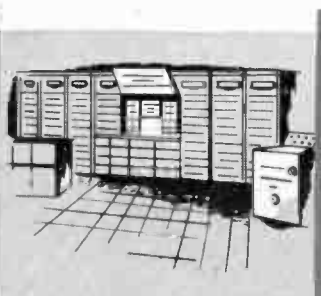

computers

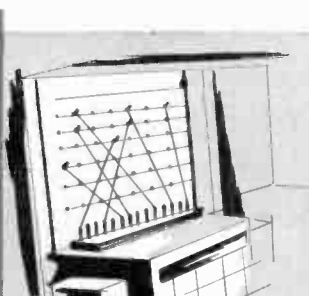

telephone exchange switching

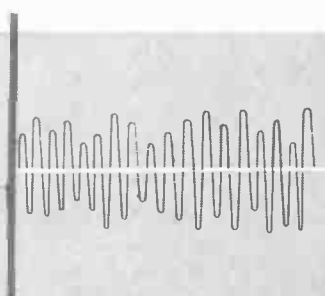

pulse sequences

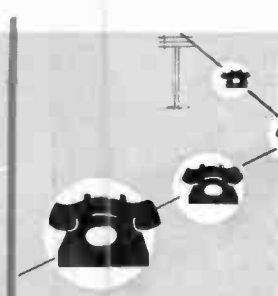

multiplex telephony

See us at Booth 335 I.R.E. Show

Research Center



Perfected by the Burroughs Research Center . . . rigidly tested and accepted by key electronic plants and communications labs throughout the world . . . this revolutionary new tube is now precision-manufactured in production quantities with complete accuracy and dependability by the Haydu tube division, specialists in the electronic industry.

For complete specifications, performance data and design-engineering consultation on applications of this device, write *today* to the Applications Section.

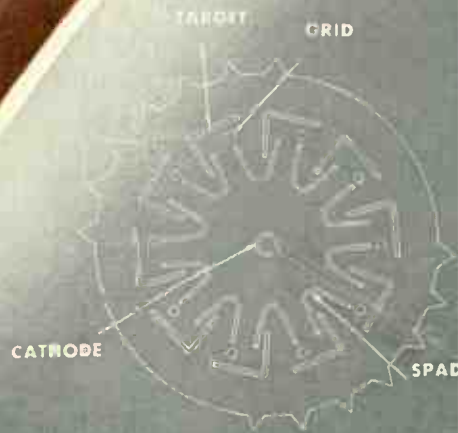

Cross Section showing Cathode, Grids, Spades and Targets for 10- position switching.

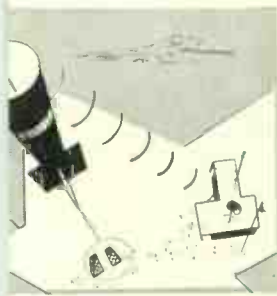

rocket telemetering

HAYDU

BROTHERS OF NEW JERSEY

Subsidiary of Burroughs Corporation



PIPELINE TO PRECISION



MODEL WWVR

A receiver of the instrument class which is setting a new standard for the reception and presentation of the world's finest standards of time and frequency as broadcast by the National Bureau of Standards from WWV and WWVH.

The fundamental use of this receiver is in the calibration of local equipment to the accuracy of these primary time and frequency standards.

This time saving instrument incorporates all the latest techniques for clear reception. A glance at the front panel will at once show the ease of operation and instant availability of the desired Radio and Audio frequencies.

Model WWVR allows the operator full use of the world's finest primary standards of frequency and time. All frequencies broadcast from WWV (or WWVH) are accurate to one part in fifty million. This instrument in your laboratory will truly give you a . . .

PRIVATE PIPELINE TO PRECISION

—Specifications—

SENSITIVITY—Better than 1 microvolt on all frequencies.

SELECTIVITY—Less than 18 KC for -60db, 2.5 KC for -3db.

FREQUENCIES—Choice of three RF front ends delivered with receiver, 2.5, 5, 10, 15, 20 or 25 mc.

SMALL IN SIZE—Standard 5/4" relay rack panel.

DOUBLE CONVERSION—First IF amplifier at 2 MC, crystal converter to 60 KC second IF amplifier.

FRONT END—Four tuned circuits at the signal frequency for maximum sensitivity and image rejection.

AGC and AVC—AGC system provides constant RF input to second detector. AVC system independently controls audio resulting in constant output on tones.

INDIVIDUAL INPUTS—Three individual inputs for tuned antennas plus one common input for broad-band antenna. Balanced 300 ohm or unbalanced 72 ohm input.

Send for complete specifications, prices and delivery schedule.



What to See at the Radio Engineering Show

(Continued from page 188A)

Eastern Air Devices, Inc., 655 Circuits Ave.

Miniature and Sub-Fractional H.P. Motors, Blowers, Fans, Tachometers, Generators, Alternators, Gear Motor Servos, for use in Automatic Control, Instruments, Electronic Devices, Aircraft Components.

Eastern Industries, Inc., 633 Circuits Ave.

We will exhibit electronic tube cooling equipment, refrigeration units, pressurization units, hydraulic pumps, fuel pumps and fluid motors for both airborne and ground service.

Eastern Precision Resistor Corp., 686 Circuits Ave.

First showing of *encapsulated miniature trimming potentiometer "COMP-U-TRIM," featuring higher resolution. Precision, stability and a wide choice of temperature coefficients. Also a complete line of encapsulated precision wire wound resistors.

Hugh H. Eby, Inc.

577 Components Ave.

Color TV Components. New *Fuse Holder. Switch Sockets. Custom Moldings. Printed Circuits. Custom Built Sub Assemblies.

Edin Company, Inc., 482 Electronic Ave.
Edin Company will feature their Model 8 082 recorder which is a six speed two channel portable recorder.

Thomas A. Edison, Inc.

Instrument Division

677 Circuits Ave.

Sensitive dc Relays (operate in microampere range). Thermal Time Delay Relays, Thermal Current Limiters (Antenna cutout). Thermostats for crystal oven temperature control. Ratio Indicator. Indicates ratio of two direct currents.



The Mark of Excellence in Electron-Power Tubes

The world's largest manufacturer of transmitting tubes will feature new ceramic tube, klystron and negative grid tube developments, as well as Eimac's complete line of UHF klystrons and klystron circuit components, triodes, tetrodes, pentodes and rectifiers. Members of Eimac engineering and management groups will be present for consultation.

EITEL-McCULLOUGH, INC.
Booths 549-551, Components Ave.

ELCO CORPORATION
2nd & GLENWOOD, PHILA. 40, PA.

America's Quality Line of Miniature & Subminiature Sockets, Shields and World-Famous "Varicon" Connectors

792 AIRBORNE AVE.

(Continued on page 194A)

WHERE PERFORMANCE COUNTS

specify these 3 ϕ , 400 ~ isolation transformers

Hermetically sealed meet MIL-T-27 grade 1, class A requirements

Primaries 115V, 3 ϕ Δ
380-1000 cycles

T-806-H Sec. 26V, 3 ϕ Y
0.65 amp A.C. per ϕ

T-810-H Sec. 26V, 3 ϕ Y
1.3 amp A.C. per ϕ

	Dimensions	Weight
T-806-H	2½"x4"x1½"	1.95 lbs.
T-810-H	3½"x4"x1½"	2.4 lbs.



Write today for quotation on your special requirements.

PEERLESS
Electrical Products

A DIVISION OF **ALTEC**
MANUFACTURING CORPORATION

9356 Santa Monica Blvd., Beverly Hills, Calif.
161 Sixth Avenue, New York 13, New York

Introducing **FERRAMIC "Q"**

by **GENERAL CERAMICS**

A NEW HIGH Q, LOW LOSS, HIGH FREQUENCY CORE MATERIAL WITH STABLE CHARACTERISTICS



An ideal Core Material for Antenna Rods, Filter Inductances, Loading Coils, RF Coils and all other Applications Requiring High Performance up to 30 Megacycles.

Ferramic "Q" is an exclusive development of General Ceramics Corp. It was created to overcome the instabilities that characterized previous high performance ferrites. Exhaustive tests prove that Ferramic "Q" is completely stable in respect to age, shock, vibration, temperature. In addition this new material features higher Q and lower losses than former materials at all frequencies up to 30 Megacycles. Cost-wise, Ferramic "Q" offers extremely favorable comparison with competitive materials. For complete details, call, write or wire today.

OUTSTANDING ADVANTAGES OF FERRAMIC "Q" ARE SHOWN IN COMPARATIVE CHARACTERISTICS OF IDENTICAL COILS WITH CORES OF FERRAMICS J AND N, AND THE NEW FERRAMIC "Q" MATERIAL



CUP CORE F-261



RING CORE F-108



ANTENNA ROD F-214 - 8" LONG

	L	C	Q
Ferramic J	154	165	50
Ferramic N	120	210	65
Ferramic Q	73	350	175

Coil consists of 20 turns #28 AWG S.F. wire random wound. Cup cores mating surfaces ground (no air gap). Inductance measured in micro-henries, capacitance measured in micro-micro-farads on Beantone Model 260-A Q-Meter. Frequency 1000 Kcs.

	L	C	Q
Ferramic J	90	280	60
Ferramic N	60	425	100
Ferramic Q	35	725	400

Coil consists of 25 turns #20 AWG S.F. wire wound uniformly on toroid. Inductance measured in micro-henries, capacitance measured in micro-micro-farads on Beantone Model 260-A Q Meter. Frequency 1000 Kcs.

	L	C	Q
Ferramic J	340	75	120
Ferramic N	270	95	160
Ferramic Q	210	120	350

Coil consists of solenoid of 85 turns #26 AWG S.F. wire. Space wound along approx. 80% of rod length and centered on rod. Inductance measured in micro-henries, capacitance measured in micro-micro-farads on Beantone 260-A Q meter. Frequency 1000 Kcs.

TABLE OF MAGNETIC PROPERTIES OF OTHER FERRAMIC® BODIES

PROPERTIES	UNIT	C	E	G	H	I	Q
Initial Perm. at 1 mc/sec.	—	250	750	410	850	900	125
*Max. Perm.	—	1100	1710	3300	4300	3000	400
*Sat. Flux Density	Gauss	4200	3800	3200	3400	2000	3300
*Residual Mag.	Gauss	2700	1950	1050	1470	700	1800
*Coercive Force	Oersted	2.1	.65	.25	.18	.30	2.1
Temp. Coef. of Initial Perm.	%/°C	.40	.25	1.3	.66	.30	.10 max.
Curie Point	+°C	330	160	160	150	70	350
Vol. Resistivity	ohm-cm.	Med.	Med.	High	Med.	Med.	High
Loss Factor:	$\frac{1}{\mu_0 Q}$						
At 1 mcs/sec.	—	.00007	.00008	.00008	.00030	.0003	.000020
At 5 mcs/sec.	—	.0008	.0020	.00075	.00155	.005	.000050

*Measurements made on D.C. Ballistic Galvanometer with Hmax = 25 oersteds. Above data is based on nominal values.

TYPICAL ANTENNA ROD MEASUREMENTS

FREQUENCY	Q	C = mmf.
0.6	334	344
0.8	350	189
1.0	350	120
1.2	338	83
1.4	318	60

TEMPERATURE COEFFICIENTS

Antenna Rod No. F-214 (.330 x 8"). Standard Test Coil - Space wound solenoid 85 turns #26 AWG. Formex copper, occupying approx. 80% of length of rod and centered on rod. (Resonates at 1 Mc. with 120 mmf.)

$$TC = \frac{\% \Delta \mu_0}{\mu_0} (25^\circ \text{ to } 75^\circ \text{C})$$

Temp. Coef. of Rod +1.0 to +2.0
Temp. Coef. of Coil only = 0



General CERAMICS CORPORATION
TELEPHONE: VALLEY 6-5100
General Offices and Plant: KEASBEY, NEW JERSEY.

VISIT OUR "OPEN HOUSE" AND EXHIBIT AT THE HOTEL BELMONT PLAZA CRYSTAL ROOM A, 10:00 A.M. TO 10:00 P.M. LEXINGTON AVENUE AT 50TH STREET, NEW YORK CITY, MONDAY MARCH 21 THROUGH THURSDAY MARCH 24



See these new books—and dozens of others—in Booth 588 at the IRE Show.

TRANSISTOR AUDIO AMPLIFIERS

By RICHARD F. SHEA, General Electric Co., Syracuse, N.Y.

How transistor fundamentals can be applied in the construction and use of audio amplifiers. Using these principles you can: (1) apply transistor principles in a multitude of designs, (2) avoid pitfalls in planning, and (3) achieve the ultimate in performance from transistor devices. Here are all the tools you need to design an amplifier of maximum reproducibility, long life, maximum freedom from the effects of temperature and humidity, and *lowest cost*.

1955. 219 pages. 199 illus. \$6.50.



Also . . .

PRINCIPLES of TRANSISTOR CIRCUITS

Edited by Richard F. Shea. 1953. 535 pages. 502 illus. \$12.75



SERVO MECHANISMS and REGULATING SYSTEMS DESIGN Volume II

By HAROLD CHESTNUT and ROBERT W. MAYER, both of the General Electric Co.

Packed with the information needed by the servo design engineer to cope with analytical and practical aspects of design. The authors state the problems met in design, then develop methods for their solution. Emphasis is on the practical aspects, but analytical proofs are provided where they are needed.

Vol. II: 1955. 384 pages. 297 illus. \$8.50
Vol. I: 1951. 505 pages. 250 illus. \$9.25

MAGNETIC AMPLIFIERS

By Dr. H. F. STORM and a staff of 10 General Electric specialists

Provides a broadly useful understanding of the theory of magnetic amplifiers, together with theoretical and practical data on core materials, core-making techniques, and metallic rectifiers.

1955. 545 pages. 381 illus. \$13.50.

MATHEMATICS of ENGINEERING SYSTEMS (Linear and Non-Linear)

By DEREK F. LAW DEN, College of Technology, Manchester, England. 1955. 380 pages. 127 diagrams. \$5.75.

SONICS

Techniques for the Use of Sound and Ultrasound in Engineering and Science

By THEODOR F. HUETER and RICHARD H. BOLT, both of the Massachusetts Institute of Technology

Offers a thorough presentation of the principles and practices of the rapidly expanding field of *sonics*. Techniques and devices ranging from a few cycles to hundreds of megacycles per second are covered. Material is drawn from the fields of physics, engineering and electronics.

1955. 456 pages. 231 illus. \$10.00

THE PHYSICS OF EXPERIMENTAL METHOD

By H. J. J. BRADDICK, Manchester University, England. 1954. 404 pages. Illus. \$7.00.

—Mail for your ON-APPROVAL copies today—

JOHN WILEY & SONS, Inc. 440 Fourth Ave., New York 16, N.Y.

(IRE-35)

Please send me book(s) checked below to read and examine ON APPROVAL. Within ten days I will either return same and owe you nothing or will remit the price(s) indicated, plus postage.

- Transistor Audio Amplifiers, \$6.50
- Principles of Transistor Circuits, \$12.75
- Servomechanisms and Regulating Systems Design, Vol. II, \$8.50
- Servomechanisms and Regulating Systems Design, Vol. I, \$9.25
- Magnetic Amplifiers, \$13.50
- Sonics, \$10.00
- Mathematics of Engineering Systems, \$5.75
- The Physics of Experimental Method, \$7.00

Name
State
City Zone State

SAVE POSTAGE! Check here if you ENCLOSE payment, in which case we pay postage. Same return privilege applies, of course.

What to See at the Radio Engineering Show

(Continued from page 192A)

Electra Manufacturing Company, 477 Electronic Ave.

Precision Resistor Manufacturers. Deposited Carbon Resistors To Your Most Exacting Requirements. Can be had with Regular Coating, *Hermetically Sealed Ceramic, or *Molded in Plastic.

Electric Regulator Corporation, 627 Circuits Ave.

Booth showing giant model Regohm with moving fingers lighting up. A multiplex 12 page display will have schematics and application photos. Also a dynamic demonstrator of line-load regulation. *Size 4 extra large Regohm.

ELECTRICAL & PHYSICAL INSTRUMENT CORP.

42-19 27th Street, Long Island City 1, New York



FAST PULSE AND COUNTING EQUIPMENT

including one millimicrosecond rise time square pulse generators, 10 mc decade and binary scalars, pulse amplifiers, and custom designed equipment.

Electrical Equipment, 864 Audio Ave. See Sutton Pub. Co., Inc.

Electrical Industries Div. Amperex Electronics Corp.

650, 652 Circuits Ave.

Hermetically Sealed Leads and Multiple Headers Including Compression Types Cans and Bases For Transistors and Diodes.

Electrical Reactance Co., 548, 550, 552 Components Ave.

See Aerovox Corp.

Electro Devices Co., Inc., 723 Airborne Ave.

A coil winder specifically for winding miniature toroids. Will wind wire sizes from #30 to #42AWG, and down to .093 inside diameter.

Electro Impulse Laboratory, Inc.

384 Microwave Ave.

Dummy loads
Power meters



Digital Voltmeters

Burlingame Associates
234-236 Instruments Ave.

*Indicates new product

(Continued on page 196A)

problem: Electronic Assemblies



Long experience in this highly specialized field enables Makepeace to supply efficiently and promptly electronic assemblies which meet the most unusual and exacting specifications.

Even Tighter Tolerances Than MIL-T-85-B Are Readily Met

When Makepeace supplies such components as rotary joints, antenna feeds, crystal mixers or highly specialized assemblies, manufacturers can be confident that each one will not only exactly meet but often surpass the most rigid specifications. Our engineering staff is always available for consultation on the design and manufacture of prototypes and for projection of production runs . . . and our unusually complete testing facilities are at your disposal. We invite your inquiries.

Makepeace Can Meet Your Requirements In Collector Rings and Brushes

Complete self-contained assemblies are available either MAKEPEACE standard 2 to 24 circuit stock ring and brush assembly or units made to meet special requirements for miniature large electro-mechanical rotating devices and systems. New materials and techniques developed in our laboratory and tried in the field provide hitherto unobtainable performance at very high speeds and extremely low noise levels as well as economy of space and weight. Slip rings from .050" O.D. to 48" O.D. in solid or laminated precious metals are available in a great variety of alloys. Our unique facilities for designing, testing and engineering are at your disposal.



D. E. MAKEPEACE COMPANY

Division of Union Plate and Wire Co.

ATTLEBORO, MASS.

Sales Offices: New York • Chicago • Los Angeles • Columbus
Precision Rectangular Waveguide Tubing • Microwave Components • Microwave Transmission Assemblies • Electrical Contact Material • Formed Electrical Contacts • Crossbar Welded Contacts • Slip Ring and Slip Ring Assemblies • Brush Assemblies • Precious Metals Clad To Base Metals • Sheet - Tubing - Wire and Assemblies • Sendzmir Precision Rolling

See us at Booth 403-405 IRE Show

for modern, profitable
automatic production...

...call on **KAHLE**

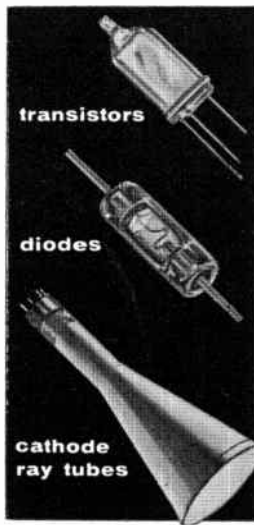

Write for information
on special experimental
and research services
offered by Kahle.

...world's leading
exclusive
manufacturer
of production
machinery for the
electronics field

If you're making (or plan to make) diodes, transistors, sub-miniature, miniature, cathode ray tubes, or other electronic tubes or component parts, take full advantage of Kahle's invaluable experience. With Kahle methods and "know-how" you're sure of getting exactly the right machinery to produce exactly what you want ...accurately, dependably, profitably. For more than a quarter of a century the leaders in the electronics field have relied on Kahle for production machinery. Typical production steps automatically performed by Kahle equipment include sealing, bulb making, stem making, exhausting, grid winding, filament coil winding, lead wire welding.

Write today for additional details, equipment specifications, production data, and quotations.

Kahle ENGINEERING
COMPANY
1310 SEVENTH STREET • NORTH BERGEN, N. J.

GLAS-GUIDE

R. F. COMPONENTS
MADE OF
LAMINATED
GLASS CLOTH

Microwave Transmission Lines
Fabricated in This Manner
Offer the Following Superior
Properties:

NON CORROSIVE
NON HEAT CONDUCT-
ING
HIGH STRENGTH TO
WEIGHT RATIO
CLOSE MECHANICAL
TOLERANCES
FINE SILVERED
CONDUCTING
SURFACE

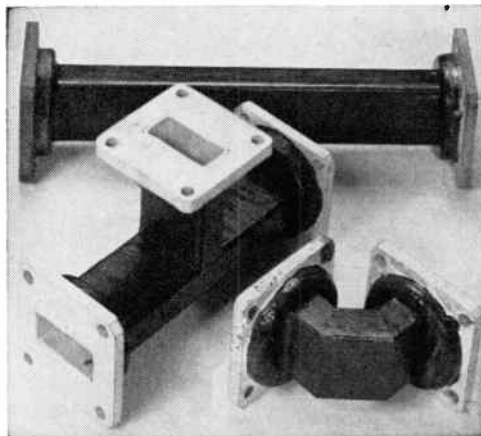

Straight sections, tees and mitered elbows are among the many components available as standard items. GLAS-GUIDE can also be made to your print.

"Don't say waveguide, say Glas-Guide"

Write today for complete data.

LEE LABORATORIES, Inc.
Genesee, Pennsylvania

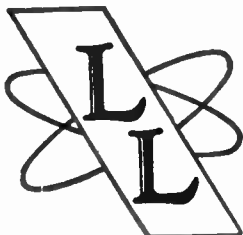

See us in Booth 815 Audio Avenue, Radio Engineering Show

What to See at the Radio Engineering Show

(Continued from page 194A)

Electro-Measurements, Inc., 212 Instru-
ments Ave.

*Fault Locating Bridge, *Limits Bridge, *DEKAPACITOR (decade capacitor), *ESI-POT (multiturn high resolution potentiometer), Impedance Bridges, Null Amplifiers, DEKABOXES (decade resistance boxes), DEKASTATS (precision rheostats), DEKA-POTS (precision potentiometers), DEKAVIDERS (precision laboratory voltage dividers).

Electromec, Inc., 35 Palace

*New large screen oscilloscopes featuring rack mounting models using 17" rectangular tubes and laboratory models using 21" rectangular tubes. *New swept frequency generators and auxiliary equipment.

Electro-Mec Laboratory Inc.

862 Audio Ave.

Potentiometers, ultra-low torque, extreme precision, 7/8" up to 3" diameter, servo mounting, ball bearing. Also new product, DIGITOMETER* —a precision coded commutator.

Electro-Motive Mfg. Co., 361 Microwave
Ave.

See Arco Electronics.

Electro-Pulse, Inc.

221 Instruments Ave.

Block unitized wide range pulse instrumentation. Pulse oscillators, analog and digital time delay generators, single multiple pulse generators. *First showing of four new instruments.

Electro-Snap Switch & Mfg. Co., 82
Palace

Precision snap-action switches for the electronics industry. Featuring subminiature high capacity switches with a variety of auxiliary actuators for special purposes applications.



Electro Tec Corp.
133, 135
TELEVISION AVE.

Ultra-precise slip ring and commutator assemblies for instrumentation and electronics. Electro Tec's revolutionary patented process for manufacture of slip ring components in prototype and production quantities. Diameters range from 0.035" to 36". Patent No. 2,696,570. Foreign patents pending.

Electronic Associates, Inc.

329, 331, 333 Computer
Ave.

Analog computer, associated components, Variplotter plotting boards, precision functional potentiometers, Variplotter, Model 1100 plotting boards (a new achievement in desk top X-Y recorder versatility and performance).

*Indicates new product

(Continued on page 198A)

FREED MINIATURE PULSE TRANSFORMERS

USED IN UNIQUE BLOCKING OSCILLATOR CIRCUIT CAN PASS UP TO 200,000 PULSES PER SECOND.

Freed Miniature Pulse Transformers are being used in a novel blocking oscillator circuit which produces sharp pulses at repetition rates up to 200,000 pulses per second. With the circuit constants shown, an output pulse of two microseconds duration, 65 volts amplitude can be obtained with a p.r.f. of 20,000. The rise time obtained with the FREED MPT-8 is less than 0.05 microsecond. This fast repetition rate circuit can be triggered with either a sine or a square wave, and requires a driving voltage of anywhere from one to fifty volts. The bias voltages need not be obtained from a low impedance supply. If a negative pulse output is required, the FREED MPT-7 transformer provides a tertiary winding for this purpose.

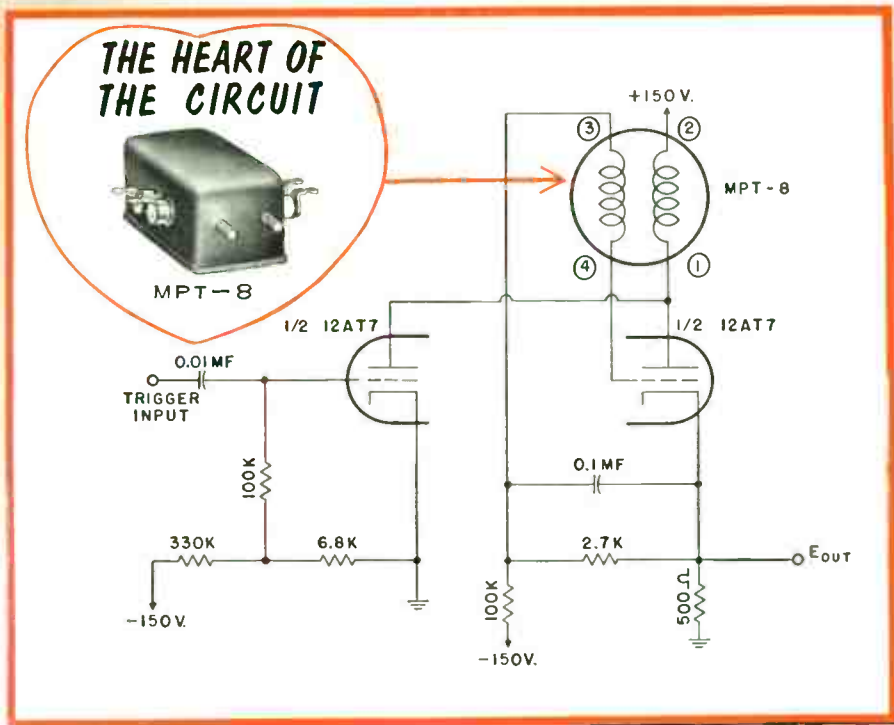

HERMETICALLY SEALED PULSE TRANSFORMERS for use in blocking oscillators, low level interstage coupling, and modulator outputs. Made in accordance with MIL-T-27 specifications. These pulse transformers are designed for maximum power, efficiency and optimum pulse performance. Balanced coil structures permit series or parallel connection of windings for turn ratios other than unity. Pulse characteristics, voltages and impedance levels will depend upon interconnections made.

OTHER FREED PRODUCTS TRANSFORMERS

- High Fidelity
- High Level Pulse
- High Q Toroids
- Power
- Slug-Tuned
- Hermetically Sealed
- Step-down
- Magnetic Amplifiers
- Miniature Transistor
- High Q Reactors
- High Temperature
- Miniature Audio
- Charging Reactors
- Sub-Miniature
- Precision Reactors
- Precision Filters

INSTRUMENTS

- Comparison and Limit Bridges
- Low Frequency "Q" Indicators
- Incremental Inductance Bridges
- Universal Bridges
- Null Detectors and V.T. Voltmeters
- Power Supplies
- A.C. Bridges and Accessories
- Differential Voltmeters
- Harmonic Distortion Meters
- Wide Band Amplifiers
- Decade Amplifiers
- Decade Inductors
- Decade Capacitors
- Megohmmeters
- Filters
- Magnetic Voltage Regulators

Catalog Number	Application	Pulse Voltage Kilovolts	Pulse Duration Microseconds	Duty Ratio	Test Voltage KV., RMS	Characteristic Impedance Ohms	Case Size
MPT- 1	Blocking oscillator or interstage coupling.	0.25/0.25/0.25	0.2-1.0	.001	0.7	250	DM-12
MPT- 2	Blocking oscillator or interstage coupling.	.025/0.25	0.2-1.0	.001	0.7	250	DM-12
MPT- 3	Blocking oscillator or interstage coupling.	0.5/0.5/0.5	0.2-1.5	.002	1.0	250	DM-18
MPT- 4	Blocking oscillator or interstage coupling.	0.5/0.5	0.2-1.5	.002	1.0	250	DM-18
MPT- 5	Blocking oscillator or interstage coupling.	0.5/0.5/0.5	0.5-2.0	.002	1.0	500	DM-12
MPT- 6	Blocking oscillator or interstage coupling.	0.5/0.5	0.5-2.0	.002	1.0	500	DM-12
MPT- 7	Blocking oscillator, interstage coupling or low power output.	0.7/0.7/0.7	0.5-1.5	.002	1.5	200	DM-18
MPT- 8	Blocking oscillator interstage coupling or low power output.	0.7/0.7	0.5-1.5	.002	1.5	200	DM-18
MPT- 9	Blocking oscillator, interstage coupling or low power output.	1.0/1.0/1.0	0.7-3.5	.002	2.0	200	DM-18
MPT-10	Blocking oscillator, interstage coupling or low power output.	1.0/1.0	0.7-3.5	.002	2.0	200	DM-18
MPT-11	Blocking oscillator, interstage coupling or low power output.	1.0/1.0/1.0	1.0-5.0	.002	2.0	500	DM-01
MPT-12	Blocking oscillator, interstage coupling or low power output.	0.15/0.15 0.3/0.3	0.2-1.0	.004	0.7	700	DM-8

Send for further information and catalog

FREED TRANSFORMER CO., INC.

1720 Weirfield St., Brooklyn (Ridgewood) 27, N. Y.

World Radio History

ATR INTRODUCES

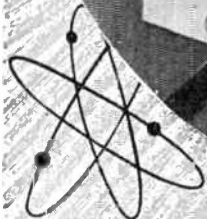
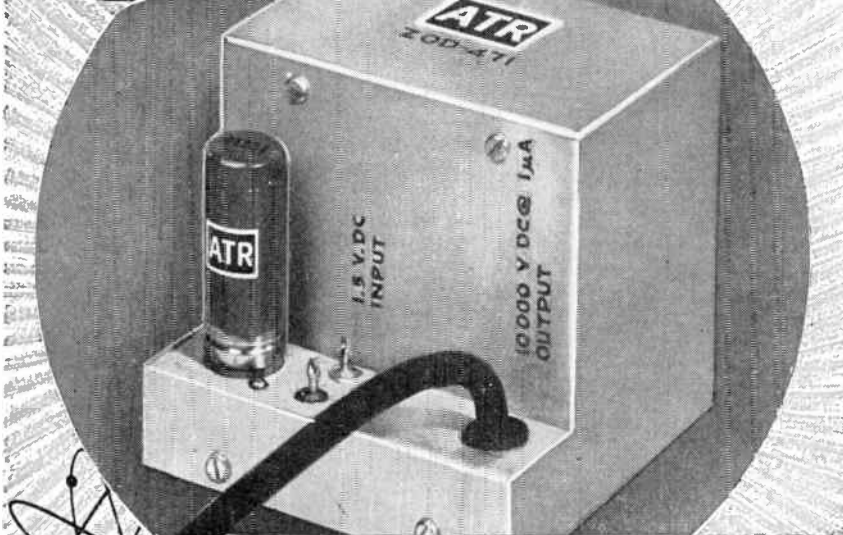

Developed by ATR in cooperation with Squier Signal Laboratory, Signal Corps Engineering Laboratories, Fort Monmouth, New Jersey.

Miniature HIGH Voltage - LOW Current POWER SUPPLIES

The ATR HIGH Voltage - LOW Current Power Supplies utilize ATR miniature vibrators and are ideally suited for flash-light cell operation in conjunction with:

- RADIATION MEASURING DEVICES.
- PHOTO-MULTIPLIER CELLS.
- INFRA-RED DETECTION EQUIPMENT.

SPECIFICATIONS

Five (5) basic ATR HIGH Voltage - LOW Current flash-light cell operated Power Supplies are available as follows:

ATR TYPE NO.	DC INPUT VOLTAGE	DC OUTPUT VOLTAGE	DC OUTPUT CURRENT
ZOD-451	1.5 VDC	800 VDC	50 μ o.
ZOD-455	1.5 VDC	900 VDC	100 μ o.
ZOD-471*	1.5 VDC	10,000 VDC	1 μ o.
ZOD-463	6 VDC	1,000 VDC	3 mo.
ZOD-443	6 VDC	16,000 VDC	1 μ o.

*AS FEATURED ABOVE

QUOTATIONS ON REQUEST ONLY TO ACCREDITED ORGANIZATIONS.

ATR manufactures a complete line of Auto Radio Type Vibrators, Heavy Duty Inverter Type Vibrators, DC-AC Inverters, and Rectifier Power Supplies.
Literature Available On Request.



AMERICAN TELEVISION & RADIO Co.

Quality Products Since 1931

SAINT PAUL 1, MINNESOTA - U.S.A.

What to See at the Radio Engineering Show

(Continued from page 196A)

**Electronic Computer Div.
Underwood Corporation**
801 Production Rd. &
Audio Ave.

A new small, low cost Electronic Digital Computer for Accounting, Engineering and Scientific Applications. Also wide range of Computer Components.

Electronic Design, 872 Audio Ave.
See Hayden Publishing Co.

**Electronic Instrument Co., Inc., 209, 211
Instruments Ave.**

Electronic Test Instruments—Kitsor factory wired, VTVMs, Oscilloscopes, Tube Testers, Generators, VOMs, Signal Tracers, Decade Boxes, Battery Eliminators, Probes.

**Electronic Measurements Co., Inc., 838
Audio Ave.**

The new "REGATRONs" using the new electronic super-regulating system. Models for bench use, computers, etc. Into the ampere range. Also, electronically controlled airborne power.

**Electronic Research
Associates, Inc.**

216 Instruments Ave.

Exhibiting transistor test equipment, transamp transistor amplifiers, transpac miniaturized power packs, tubeless power supplies, *Transistor Tester, Transistor Magnetic Amplifiers, Power Transistor Supplies, Automatic RF Noise Figure Meter.

Electronic Tube Corp.

241 Instruments Ave.

Presenting a new *Dual-Beam Oscilloscope designed for industry, laboratory and research, supplementing multi-channel line. New *Strip Film Camera added to line. Headquarters for special multi-gun CRT.

Electronics, 126 Television Ave.
See McGraw-Hill Pub. Co.

Electronics Digest, 72 Palace
The only magazine of its kind . . . 100 pages, pocket-size—condensing the best of the world's electronic literature each month.

**Elgin Metaformers Corporation, 297
Broadcast Way**

Avoid high costs, long delivery time, with the EMCOR ENCLOSURE SYSTEM, the complete, flexible line of MODULAR enclosures for housing electronic equipment and fine instrumentation.

**BOOTH
520
Components
Avenue**

**sub-
miniature
relays**

ELGIN-NEOMATIC, INC.

A Subsidiary of Elgin National Watch Co.
9010 Bellanca Avenue • Los Angeles 45

Manufacturers of High Precision Sub-Miniature
Electro-Mechanical Devices

*Indicates new product

(Continued on page 200A)

IRE

BRINGS A NEW CONCEPT INTO THE FIELD OF
SIMULTANEOUS MULTIPLE MEASUREMENT

direct writing

TYPE 550-A

OSCILLOGRAPHIC RECORDER

DC TO 900 CYCLES

A New High in Frequency
Response For Direct Writing
Oscillographs!

**MULTI-CHANNEL:
EIGHT
SIMULTANEOUS
TRACES**

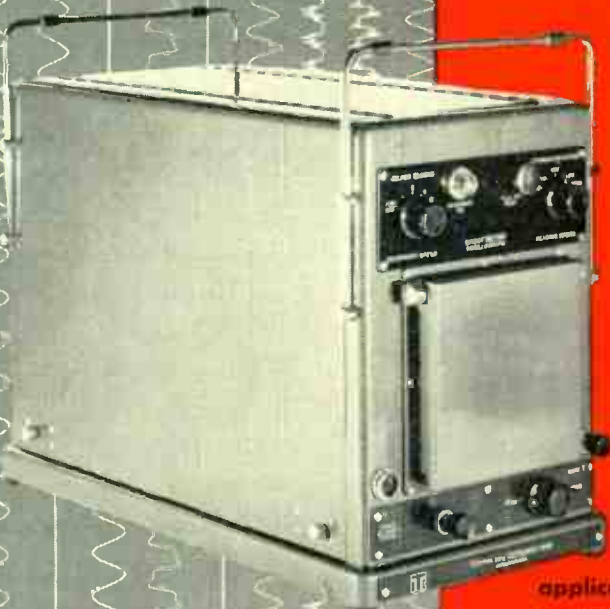

applicable to inquiry into:

- GEOPHYSICAL EXPLORATION
- MEDICAL AND BIOLOGICAL RESEARCH
- VIBRATION STUDIES
- ACCELERATION TESTING
- STRAIN EVALUATION
- SHOCK TUBE INVESTIGATIONS
- EVENTS SEQUENCE RECORDING
- DETONATION MEASUREMENTS
- PERCENT FACILITY UTILIZATION
- WELDING ANALYSIS
- BOW-DOWN TUNNEL WORK
- HYDRODYNAMIC TESTING

A brochure will gladly be supplied if you wish.

TECHNOLOGY INSTRUMENT CORP.

535 MAIN STREET • ACTON, MASS. COLonial 3-7711
West Coast Mail Address: P.O. Box 3941, North Hollywood, Calif. POplar 5-8620

See us at Booths 226-228 Instruments Avenue at the IRE Show

McCoy

MINI-DUAL

Variable Capacitor

SELECTED
FOR USE IN . . .

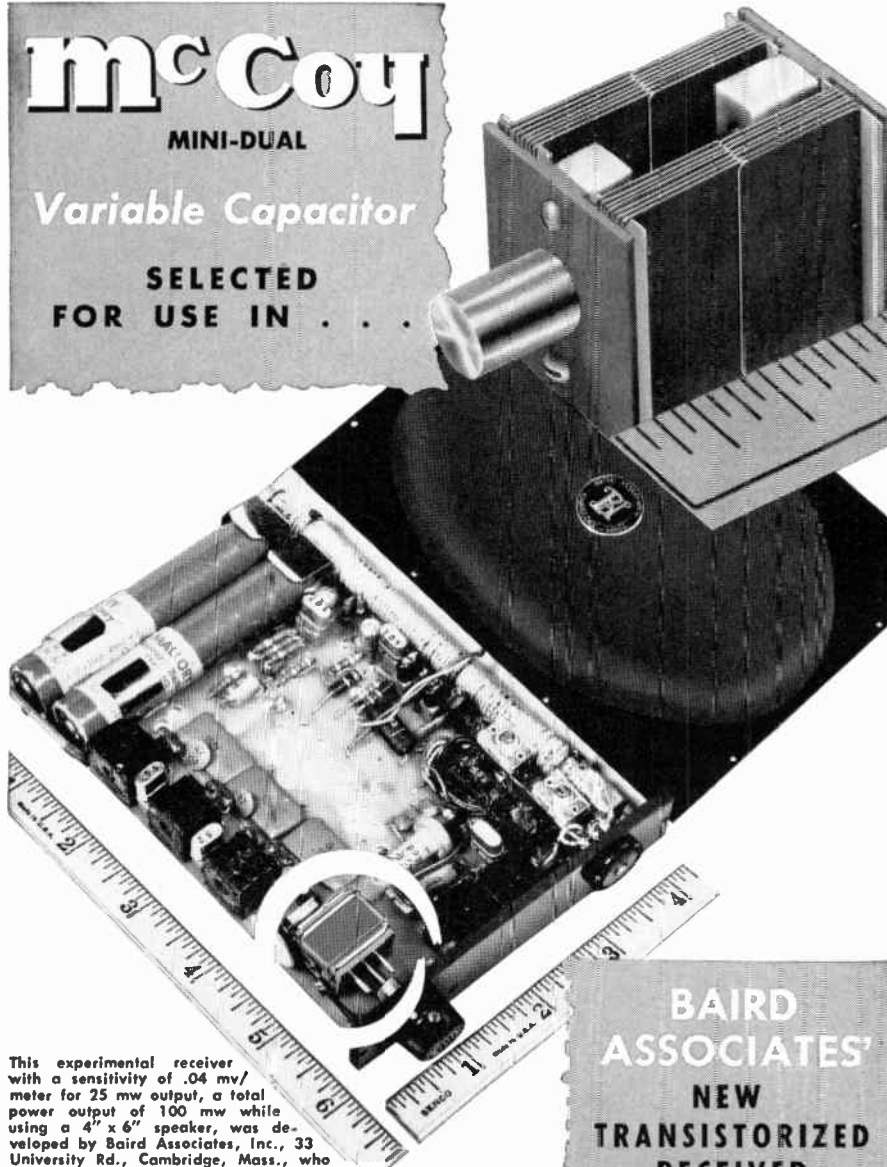

This experimental receiver with a sensitivity of .04 mv/meter for 25 mw output, a total power output of 100 mw while using a 4" x 6" speaker, was developed by Baird Associates, Inc., 33 University Rd., Cambridge, Mass., who will be happy to answer inquiries regarding the circuitry design of their new receiver.

BAIRD ASSOCIATES' NEW TRANSISTORIZED RECEIVER

Baird Associates, Inc. needed a very small dual variable capacitor . . . tiny enough to make possible the design of a miniature transistorized receiver, only 4-1/4" x 6-1/16" x 1-1/16" in overall size. One that would tune the complete broadcast band and offer the same performance as conventional tube models.

McCoy's Mini-Dual Variable Capacitor met Baird's requirements in every respect. Just *one-sixth* the volume of the smallest presently available capacitor needed to do a comparable job, the Mini-Dual's dimensions are only 11/16" x 13/16" x 1-1/16". Capacitance range: Up to 430 mmfd per section, with at least 10:1 ratio from maximum to minimum. Both "rotors" and "stators" are isolated for flexibility of circuitry. Can be furnished in Straight line capacitance or Straight line Wavelength and if desired one section can have a 455 KC I.F. cut into its plates. Shaft diameter: 3/16" or 1/4". Standard shaft length 3/8". Weight 1/2 oz.

McCoy ELECTRONICS
COMPANY
MT. HOLLY SPRINGS, PENNSYLVANIA

See both the McCoy Mini-Dual Variable Capacitor and the Baird Associates transistorized receiver at Booth 764, IRE Show, Kingsbridge Armory, New York City, March 21-24, 1955.

What to See at the Radio Engineering Show

(Continued from page 198A)

Elly Electronics Corp., 890 Audio Ave. Spotlighting the "Snapper" thermal time-delay relays with double throw, snap-action, small size and rugged Mil Spec construction—the "series TA snap-action thermostats with new design, construction and unexcelled performance.

Emerson & Cuming, Inc., 676 Circuits Ave.

Plastics for Electronics—radomes, fibre-glass structures; casting resins, electronic embedments; microwave absorbers; adjusted dielectric constant materials; plastic foams; featuring an 18" Dialneberg Lens.

MANUFACTURERS OF
FIELD INTENSITY METERS
DISTORTION ANALYZERS
IMPULSE GENERATORS
COAXIAL ATTENUATORS
CRYSTAL MIXERS

Visit our Booth 252,
on Instrument Ave.

edp EMPIRE DEVICES
PRODUCTS CORPORATION

38-15 BELL BOULEVARD
BAYSIDE 61, NEW YORK

Endevco Corporation, 67 Palace
DYNAMIC INSTRUMENTATION: Wide range Piezo electric, self-generating accelerometers, force gages and pressure pickups. Sub-miniature electronic amplifiers and associated equipment packaged for airborne or laboratory applications.

EpcO Products, Inc., 371 Microwave Ave. Transformers: Power, Audio, Chokes—commercial or military—Class A, B, & H. Also encapsulated, made to specifications.

Equipto Division, Aurora Equipment Company, 874, 876 Audio Ave.

Display of latest parts storage equipment for the jobber and serviceman. Modern design and construction in steel shelving, counters, benches, drawer units and chassis stands.

Erie Resistor Corp.
Erie, Pa.

538 Components Ave.

A Complete Line of
High Quality
Electronic Components

Essex Wire Corporation, 617, 619 Circuits Ave.

New and improved types of relays, controls, cord sets, wire assemblies and magnet wire for communication and electronic equipment.

CERTIFIED FABRICATORS
OF
MAGNESIUM—ALUMINUM—STAINLESS STEEL
CHASSIS, PANELS—CASES, CONSOLES
FRAMES, BRACKETS & ALL COMPONENTS
NEW ENGLAND'S MOST COMPLETE &
MODERN FABRICATING PLANT

Eugene ENGINEERING CO., Inc.
1217 HYDE PARK AVE.
BOSTON 36, MASSACHUSETTS

23 Palace

*Indicates new product

(Continued on page 202A)

Let's stop expensive double-talk about Regulated Power Supplies!



WRITE FOR OUR CATALOG...
"A Sensible Approach to Regulated Power Supply Design". It Contains Engineering Data, Prices, And Good News About Our Fast Delivery In-Stock Plan.

**MOST REQUIREMENTS ARE
 BEST SATISFIED BY A
 CLEAN-CUT, STRAIGHTFORWARD,
 LOW-COST, STANDARD DESIGN...**



NJE Standard-Grade Model S-300-R

Typical of our 32 Standard Grade models is the S-300-R (200-500 volts, 0-300 ma, 0.3% load regulation). Has no electrolytics, generous transformer design, clean layout, solid construction, all first quality commercial-grade components, fine workmanship . . . (Less Meters) \$149.50

Our mass-produced, standardized designs guarantee you more for your power-supply dollar than ever before. From \$52.50 to \$299.50, from 200-325V at 100 ma to 0-600V at 0-300 ma, you can't buy better, watt-for-watt and dollar-for-dollar, than NJE!

**... BUT, IF YOUR APPLICATION
 REQUIRES THE MAXIMUM
 IN LIFE EXPECTANCY:**



NJE Laboratory-Grade Model L-800-CM

The 32 models in our Laboratory Grade are the ultimate in dependability . . . at a sensible price. Illustrated is Model L-800-RM (0-600 volts, 0-600 ma, 0.3% load regulation) . . . (Less Meters) \$440.00

Our Laboratory Grade line incorporates every possible safeguard against any failure in the first five years of service: selenium power rectifiers, blower cooled 10,000 hour tubes, oil-filled capacitors, no carbon resistors or carbon pots, magnetic circuit-breakers, sealed transformers. Every component derated at least 30% . . . From 0-300V, 0-300 ma to 0-600V, 0-1200 ma. Priced—\$315.00 to \$935.00

NEW JERSEY ELECTRONICS CORP.

349 Carnegie Avenue, Kenilworth, New Jersey
 Competent Engineering Representation Everywhere



Our custom quotes are rapid, complete, competitive. We custom-build from 500 amperes (low voltage) to 100 KV (low current).

Will be at the IRE Show at 234-236 Instrument Avenue



you can depend on
SECON for
PRECISION WIRE & RIBBON
 if your product-need is here

Secon specializes in the development and production of base, rare and precious metals and alloys which are supplied bare, electroplated or enamelled and in all shapes and forms—to close tolerances and for highly engineered applications. Extremely close tolerances can be held on such important characteristics as resistance, tensile strength, elongation, surface appearance, special spooling, purity, torque, linearity, composition, cross section, weight per unit length.

Secon—a complete metallurgical unit at your service.

Tell us your wire and ribbon problems and we'll gladly submit prompt recommendations. Small quantity inquiries and orders specially invited. WRITE FOR PAMPHLET P-3.

- Fine Wire drawn to 0.0003" diameter.
- Ribbon rolled to 0.0001" in thickness
- Electro-Plated Wire and Ribbon
- Special Solder
- Enamelled and Insulated Wire
- Pirani Gauge Wire
- Electric Primer, Ignition Wire
- Galvanometer Suspension Strip
- Etched Wire
- Precision Potentiometer Wire
- Transistor Components
- Experimental Melts



for wherever the element calls for **PRECISION**

SECON METALS CORPORATION
 7 Intervale Street, White Plains, New York
 White Plains 9-4757

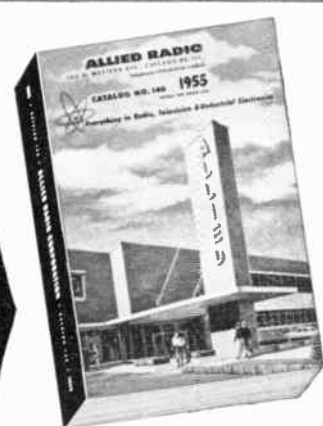

free
 send for the most widely used
Electronic Supply Guide

ALLIED'S COMPLETE 308-PAGE 1955 CATALOG

your guide to the world's largest stocks of ELECTRONIC SUPPLIES FOR INDUSTRY

We specialize in Electronic Equipment for Research, Development, Maintenance and Production Operations

Simplify and speed *all* your electronic supply purchases. Order from the world's largest stocks of electron tubes (all types), test instruments, audio equipment, electronic parts (transformers, capacitors, controls, etc.) and accessories—*everything* for industrial and communications application. Let our expert Industrial supply service save you time, effort and money. Send today for your **FREE** copy of the 1955 **ALLIED** Catalog—the *complete* up-to-date guide to the world's largest stocks of Electronic Supplies for Industrial and Broadcast use.

ALLIED RADIO
 100 N. Western Ave., Dept. 35-C-5, Chicago 80, Ill.

Send for **FREE CATALOG**

One complete dependable source for everything in electronics

What to See at the Radio Engineering Show

(Continued from page 200A)

**HIGH POWER PULSE MODULATORS
 CUSTOM BUILT MICROWAVE PLUMBING**

PRECISION MICROWAVE TEST EQUIPMENT
 Impedance & Power Measuring Equipment
 Frequency Meters • Klystron Power Supplies
 Spectrum Analyzers • Attenuators
 Accessories

#375 MICROWAVE AVENUE
 Kingsbridge Armory
Electronics & X-Ray Division
F-R MACHINE WORKS, INC.

26-12 BOROUGH PLACE • WOODSIDE 77, N.Y.

Fairchild Camera and Instrument Corp.
Potentiometer Div.
648 Circuits Ave.

Complete line of precision potentiometers—linear and non-linear. Two new multi-turn designs (1" ten-turn and 2" three-turn). New Rectilinear. The FilmPot, metallic film potentiometer.

Fairchild Guided Missiles Div.

- ***Transistor Dynamic Analyzer** — Provides complete performance measurements for all types of point contact and junction transistors.
- ***Flexible Decade Amplifier** — A versatile, lightweight amplifier, having four independent sections, each with flat response through to the megacycle region.

592 Components Ave.
Fairchild Engine & Airplane Corp.

Fairchild Recording Equipment Co., 831, 833 Audio Ave.

Professional disk playback equipment—3 speed synchronous. Transcription turntable, Arms, new Moving Coil Cartridges. High fidelity components—preamplifiers, new power amplifiers. Disk recorders, accessories, specialized equipment.

FALSTROM COMPANY
 Falstrom Court, Passaic, N.J.
766 & 768 AIRBORNE AVE.
 Aluminum cabinets, frames, & weldments, instrument & control panels & consoles, transmitter & power supply housings, custom-built fabrication.

Federal Shock Mount Corp., 778 Airborne Ave.

Unit vibration isolators, shock mounts and mounting bases for mobile and airborne equipment.

Federal Telecommunication Labs, 877-893 Audio Ave.

Development of Electronic Equipment, partially in the fields of Communications, Television Broadcasting, Air Navigation, Guided Missiles, Semiconductors, Dielectrics, Traveling Wave Tubes and Computers.

* Indicates new product

(Continued on page 204A)

Sylvania "600 ma" Tubes

99.7 proof*

FOR SERIES-STRING TV



* In a 15-tube series string, analysis proved that 99.7% of all probable combinations of Sylvania types operated within 2% of the heater-current design center. Sylvania's tight heater-current limit is one of the most important contributions to tube performance for series string operation.

Best for Set Designers In 4 big ways

Sylvania pioneered the development of "600 ma" series string tubes to make possible the cost, space and weight saving features of series-string TV design. And Sylvania gives you these important advantages to insure dependable set performance.

1. Less heater voltage variations—as a result of Sylvania's 99.7 proof tolerances on heater current, fluctuations in line voltage have less harmful effect on heater voltage. Steady-state heater voltage distribution is improved.

2. Less heater burn-outs—Rated heater warm-up time of approximately 11 seconds provides control of thermal characteristics. Voltage surges are alleviated.

3. Less time for normal set operation—Thermal control permits the use of a series resistor instead of a

thermistor. Receiver reaches normal operation in less than half the time.

4. More uniformity—Because Sylvania makes everything but the bulb, quality is controlled from raw materials straight through to finished product.

Get the full story on the use of series-string tubes in TV sets by writing for this handy wall-chart brochure on the complete line of Sylvania "600 ma" tubes.

All Sylvania TV PICTURE TUBES now have heaters specially controlled for series string operation!



SYLVANIA

Dept. C32P
Sylvania Electric Products Inc.
1740 Broadway, New York 19, N. Y.
In Canada: Sylvania Electric (Canada) Ltd.
University Tower Bldg., St. Catherine St.
Montreal, P. Q.

LIGHTING • RADIO • ELECTRONICS • TELEVISION • ATOMIC ENERGY

See Sylvania in Booths 168-170-172 at the 1955 IRE Show

PROCEEDINGS OF THE I.R.E.

March, 1955

203A

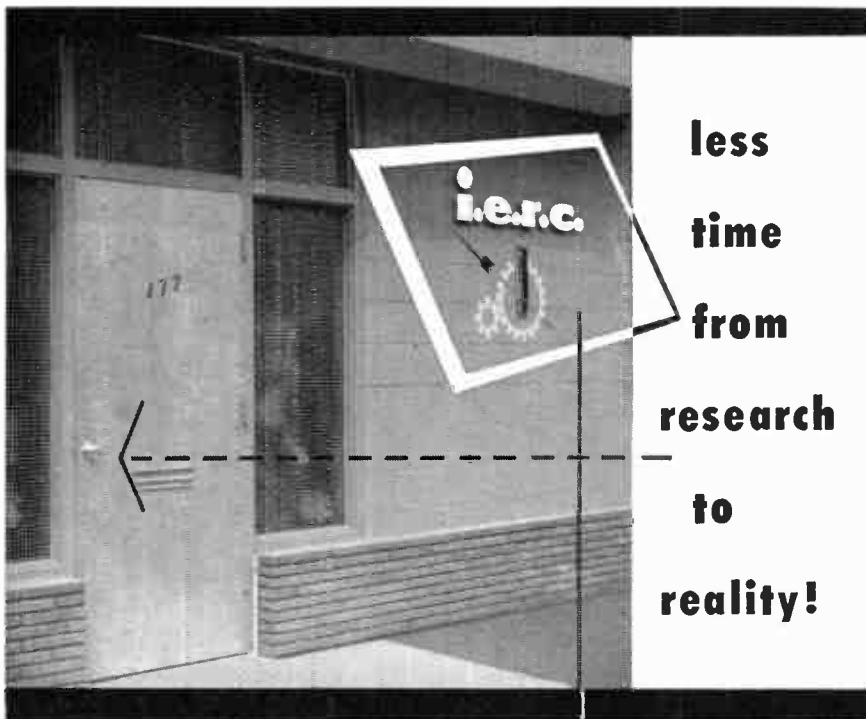

less
time
from
research
to
reality!

RIGHT PLACE...

*I.E.R.C. has the best answers
to your equipment failures
due to tube heat and vibration!*



I.E.R.C.'s research, design, development and manufacturing facilities are saving time and money — speeding "top level" projects into production for many leading electronic equipment firms.

For these achievements, I.E.R.C. is recognized as the finest source for effectively solving electron tube heat and vibration problems — the major cause of short tube life and other heat-vibration affected failures in electronic and electro-mechanical equipment.

Prevent future failures TODAY by calling I.E.R.C. or a convenient I.E.R.C. engineering representative nearest you!

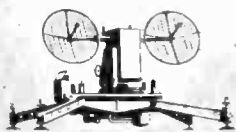

International

ELECTRONIC RESEARCH CORPORATION

CONTACT THESE I.E.R.C.
ENGINEERING REPRESENTATIVES:
HOLIDAY-RATHAWAY, INC.
Cambridge, Mass.
WILLIAM JONES
Baltimore, Maryland

MAGNUSON ASSOCIATES
Chicago, Illinois
G. S. MARSHALL CO.
Pasadena, California
G. S. MARSHALL CO.
Redwood City, Calif.

WRITE FOR LITERATURE
177 W. Magnolia Boulevard
Burbank, California

THE MORT REED CO.
Rochester, New York
B. B. TAYLOR CO.
Rockville Centre, N.Y.
THOMSON ENG. SERVICE
Fort Worth, Texas

research • design • development • prototypes • manufacturing

What to See at the Radio Engineering Show

(Continued from page 202A)

Federal Telephone and Radio Company

Division of IT&T

877-893 Audio Ave.

Microwave, Carrier Systems, Mobile Radio, Measuring-Testing Equipment, Vacuum Tubes, Coaxial Cable, Hook-up Wire, Transformers, DC Power Supplies, Dial Intercom, and Selenium, Silicon and Germanium Rectifiers.

Feedback Controls, Inc., 43 Palace

Industrial and military analog systems. Packaged servos and servo components including magnetic, electronic amplifiers, precision gear trains and output gearing and assemblies—digitizers, digital voltmeters.

Felsenthal & Sons Inc., G., 22 Palace

Edge-lighted panels, MIL-P-7788 approved source, authorized Bureau of Standards light testing laboratory. Fabricated and injection molded plastics. Dials, knobs, nameplates, cases and components in plastic.

Felts Corp., 679 Circuits Ave.

See Microdot Division.

Ferranti Electric, Inc., 24 Palace

Introducing miniature rapid access Magnetic Memory Drum and Integrated Microwave Test Set. Also showing High Speed Photoelectric Tape Reader, Electrostatic Voltmeters, and Hermetically Sealed Transformers.

Ferris Instrument Co., 265-271 Instru- ments Ave.

*Hinge Type Ultra High Frequency Tuner. Battery Powered Field Strength Generator for Checking Loop Receivers and Field Strength Meters.

Ferroxcube Corp of America, 340 Com- puter Ave.

Manufacturers of magnetic core materials, memory rings, yoke rings, shielding beads, tuning slugs, recording heads, toroids, and *Magnadur—the new permanent magnet material.

FILTORS RELAYS
SUBMINIATURE • RUGGED
LIGHTWEIGHT
840 AUDIO AVE.

SEE THE *New*
Models!

FILTORS, INC.
PORT WASHINGTON, L. I., N. Y.

filtered by
FILTRON
FLUSHING, L. I., N. Y.

BOOTH 649
CIRCUITS AVE.

RF INTERFERENCE FILTERS

*Indicates new product

(Continued on page 206A)

LIKE THE **GREAT** **ELECTRONICS** **INDUSTRY**



LORAL

too has **GROWN!**

Imprint of Integrity

In the past decade, our organization has developed extensive know-how and experience in the service of the ARMED FORCES, and others, in the DESIGN—DEVELOPMENT—and MANUFACTURE of specialized ELECTRONIC and ELECTRO-MECHANICAL EQUIPMENT in the fields of:

- AIRBORNE NAVIGATIONAL EQUIPMENT
- COMMUNICATIONS SYSTEMS
- RADAR EQUIPMENT
- TEST EQUIPMENT

Our coordinate engineering and manufacturing facilities are at your disposal.

LORAL has delivered annually many millions of dollars of **ELECTRONIC EQUIPMENT**

.... on time!

● Write for Facilities Brochure Dept. 1-3

See Us at the
I.R.E. SHOW
Booth 821
Audio Avenue

LORAL ELECTRONICS CORPORATION
794 EAST 140th STREET • NEW YORK 54, N. Y.

See us
at

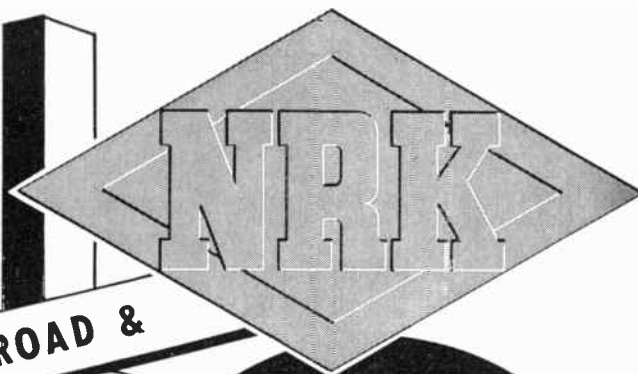

RADAR ROAD &
ELECTRONICS AVE.

Microwave
Assemblies,
Radar Components,
and Precision
Instruments . . .
manufactured to
your Blueprints
and Specifications.

BOOTH No. 426
Radio Engineering Show
MARCH 21-24, 1955
Kingsbridge Armory
New York City

N.R.K. MFG. & ENGINEERING CO.

4601 WEST ADDISON STREET • CHICAGO 41, ILL. • SPing 7-2970

West Coast Representatives TUBERGEN ASSOCIATES 2232 W. 11th St., Los Angeles 6, Calif.



**Leading Manufacturer
of MASTER TV SYSTEMS**

*Is expanding its
Research and Production
to include Industrial
TV Systems and other
New Developments
in VHF and UHF*

AMPLIFIERS
DISTRIBUTION UNITS
CONVERTERS
BOOSTERS
IMPEDANCE MATCHING
DEVICES AND OTHER
TV ACCESSORIES

BLONDER-TONGUE LABORATORIES, INC.
WESTFIELD, NEW JERSEY

Visit the B-T Exhibit
at the IRE Show
BOOTH 614
CIRCUITS AVENUE
near Radar Road

**What to See at the
Radio Engineering Show**

(Continued from page 204A)

Finn & Co., Inc., T. R., 421 Electronic Ave.

Vibration and shock control equipment—mounting bases for airborne electronic equipment—shipboard, mobile & industrial shock & vibration mounts—packaging of electronic equipment.

FORD INSTRUMENT COMPANY
Division of The Sperry Corp.
LONG ISLAND CITY 1, N. Y.
748 Airborne Avenue at Radio Road

Control systems and computers for the military and industry—plus servos, synchros, computing cams, integrators, resolvers, and other precision components.

Formica Company, 835, 837 Audio Ave.

Special laminated plastic sheets, tubes, rods, and molded, postformed and fabricated parts for electronics industries . . . including the *FORMICA Q-125 flame and arc quenching grade.

Freed Transformer Co., Inc.

Booths 522, 524 Components Ave.

Power and Communications Components for Military and Commercial Applications. Precision Laboratory and Production Test Equipment. Pulse Transformers. Magnetic Amplifiers. High "Q" Toroidal Inductors. Filters and Discriminators.

Frequency Standards

332 Computer Ave.

Frequency meters — precision machined components.

Furst Electronics
Chicago 25, Ill.
416 Electronic Ave.

Power Supplies, DC Amplifiers, Wow Meter and Laboratory Instruments.

Fusite Corp., 824 Audio Ave.

Introducing "T.P." terminals with V-24 Glass for glass to steel hermetic terminal applications. Available in multiples, singles, stand-offs and threaded bushing type terminals.

*Indicates new product

(Continued on page 210A)

How Lewyt engineering licked a 10,000 rpm stumbling block to mass-produce radar test equipment!

Before the TS-452 Signal Generator existed, technicians had to check the frequency response of radar system networks with a point-by-point plot of frequency amplitude curves.

Each plot took as much as 30 minutes. Checking and readjustment were long, tedious jobs.

To overcome these problems, specifications were drawn up for a Sweep Signal Generator that would permit an instantaneous check of frequency response. However, two major problems presented themselves:

1. A motor-driven variable capacitor had to be designed that would rotate up to 10,000 rpm. The best obtainable could operate at only 500 rpm. Some flew apart in minutes, some in a few hours.
2. A highly accurate push-button RF attenuator was also required. It had to be of such range and accuracy that the specification requirements could not be met by existing measurement techniques.

At this point, Lewyt engineering went to work. The resulting TS-452 C/U has since become a "must" for maintenance of all Armed Forces radar installations. With it, technicians can make and observe corrections in split seconds!



Visit us at
116
Television Ave.
Radio Engineering
Show

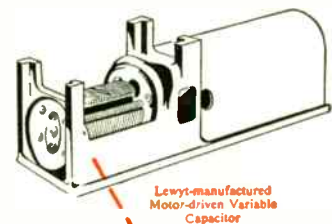

Lewyt-manufactured
Motor-driven Variable
Capacitor



Lewyt-manufactured
TS-452 C/U Sweep Signal Generator
Radar Testing Equipment

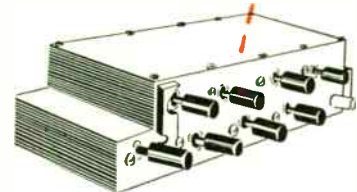

Lewyt-manufactured
Push-button RF
Attenuator

LEWYTT

To make this possible, Lewyt designed a motor-driven variable capacitor that rotated at 10,000 rpm for several hundred hours without a quiver—maintaining its electrical calibration at all speeds. *It is probably the world's fastest rotating variable capacitor!*

Lewyt also developed a high precision attenuator with an accuracy over the frequency range not attained before. *New techniques and standards for testing it had to be devised by the Bureau of Standards!*

In addition, Lewyt engineering designed the unit with functional sub-assemblies, simplified circuitry and controls, a minimum of components—all making for easier maintenance and trouble-free performance.

Another challenging job successfully completed—one of many in Lewyt's 66 years of engineering and manufacturing for Government and Industry.

LEWYTT . . . Manufacturer of Electronic and Electro-Mechanical Equipment Since 1888

LEWYTT MANUFACTURING CORPORATION, BROOKLYN 11, NEW YORK

PROCEEDINGS OF THE I.R.E. March, 1955

207A



HITEMP **SPECIALISTS IN HIGH** **TEMPERATURE INSULATION**

Manufacturers of:

TEMPRITE Teflon Magnet Wire, sizes 14 to 50 AWG, single heavy, triple, or quad. thickness.

TEMPRITE X Special Teflon magnet wire for severe applications.

NON RIGID FLEXIBLE TEFLON TUBING Sizes 10 to 26, solid colors and spiral striped combinations. Both tape wrapped and extruded.

TEMPRENE Teflon hook-up wire, sizes 14 to 30 AWG. Two and three-color striped combinations plus ten solid colors. Made to meet MIL-W-16878A(E).

TEMPREX Teflon extruded hook-up wire, sizes 10 to 26 AWG, in both striped and solid colors—conforms to MIL-W-16878A(E and EE).

TEMPCLAD Teflon insulated lead wire with teflon impregnated outer glass fibre covering. Sizes 8-30 AWG.

RETEP Teflon saturated glass braid lead wire. Low cost, low voltage, push back type. Sizes 14 to 30 AWG.

NEBROCTM Teflon glass fibre card, tape and thread. Developed especially for coil and harness tying.

TEMP TUBE Teflon glass fibre sleeving, sizes up to 1 1/4" I.D., colors available.

All Teflon products are rated for continuous operation from -90°C to +260°C, have excellent dielectric strength, and are impervious to all commercial solvents.

All colors conform to MIL Std. 104.

HITEMP WIRES, INC. • 26 WINDSOR AVENUE, MINEOLA, NEW YORK

Visit our Booth 609 Circuits Avenue at the IRE Show

STACKPOLE

"GA" FIXED COMPOSITION CAPACITORS

...for all low capacity requirements

Stackpole "GA" fixed composition capacitors represent the simplest, most inexpensive capacitor design ever produced—and their operating stability is more than ample for the great majority of applications.

Pioneered by Stackpole, these sturdy little units are now available in an expanded range of values from 0.10 to 10.0 μf —all with standard RETMA 3 or 4 band color code. Insulated bodies, dielectrics and electrodes are integrally molded for maximum stability and durability. Leads are securely anchored and treated for easy soldering.

Electronic Components Division

STACKPOLE CARBON COMPANY, St. Marys, Pa.

CHOOSE FROM THESE

46

RETMA VALUES...

Capacity in μf Standard Values in			Color Bands			Max. Dim. "A"	Capacity in μf Standard Values in			Color Bands			Max. Dim. "A"
20%	10%	5%	1st	2nd	3rd		20%	10%	5%	1st	2nd	3rd	
.10	.10	*	Brown	Black	Gray	.330	1.2	1.2	Brown	Red	White	.330	
	.12	*	Brown	Red	Gray	.330		1.3	Brown	Orange	White	.330	
.15	.15	*	Brown	Green	Gray	.330	1.5	1.5	Brown	Green	White	.330	
	.18	*	Brown	Gray	Gray	.330		1.6	Brown	Blue	White	.330	
		.20	Red	Black	Gray	.330		1.8	Brown	Gray	White	.290	
.22	.22	.22	Red	Red	Gray	.330		2.0	Red	Black	White	.290	
		.24	Red	Yellow	Gray	.330	2.2	2.2	Red	Red	White	.230	
		.27	Red	Violet	Gray	.330		2.4	Red	Yellow	White	.230	
		.30	Orange	Black	Gray	.330		2.7	Red	Violet	White	.230	
.33	.33	.33	Orange	Orange	Gray	.330		3.0	Orange	Black	White	.230	
		.36	Orange	Blue	Gray	.330	3.3	3.3	Orange	Orange	White	.210	
		.39	Orange	White	Gray	.330		3.6	Orange	Blue	White	.210	
		.43	Yellow	Orange	Gray	.330		3.9	Orange	White	White	.210	
.47	.47	.47	Yellow	Violet	Gray	.330		4.3	Yellow	Orange	White	.210	
		.51	Green	Brown	Gray	.330	4.7	4.7	Yellow	Violet	White	.180	
		.56	Green	Blue	Gray	.330		5.1	Green	Brown	White	.180	
		.62	Blue	Red	Gray	.330		5.6	Green	Blue	White	.250	
.68	.68	.68	Blue	Gray	Gray	.330		6.2	Blue	Red	White	.250	
		.75	Violet	Green	Gray	.330	6.8	6.8	Blue	Gray	White	.250	
		.82	Gray	Red	Gray	.330		7.5	Violet	Green	White	.220	
		.91	White	Brown	Gray	.330		8.2	Gray	Red	White	.220	
1.0	1.0	1.0	Brown	Black	White	.330		9.1	White	Brown	White	.220	
		1.1	Brown	Brown	White	.330	10.0	10.0	Brown	Black	Black	.180	

TOLERANCE Color Code

CAPACITIES
0.1 to 10.0 μf

20% —none
10% —Silver
5% —Gold

CAPACITIES
10.0 μf & over

20% —Black
10% —White
5% —Green

COLOR CODE AND DIMENSIONS

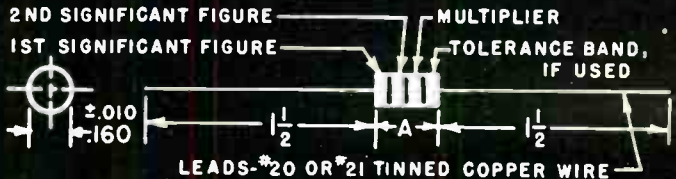

YOKE SPECIALISTS



- Military or special yokes and focus coils designed to your specifications.
- Production yokes for TV sets.

For your answer to yoke problems write Dr. Henry Marcy today.

syntronic

INSTRUMENTS, INC.

100 Industrial Road • Addison, Ill. • Phone: Terrace 4-6103

What to See at the Radio Engineering Show

(Continued from page 206A)

G-M Laboratories, Inc., 61 Palace
Fast, flexible service on servo motors and motor generators for 400 and 60 cycle applications, including geared motors, hysteresis-synchronous motors, and permanent magnet generators.

Gabriel Electronics Division, The Gabriel Laboratories, 193, 195 Television Ave.

*2000 mc and 4000 mc microwave antennas; *Corner reflectors; *Mobile communications antennas; *offset microwave antenna for 2000 mc; *radar antennas (scale models).

The Gamewell Company, 716 Airborne Ave.

Precision potentiometers. Linear and sinusoidal complete series of plastic and metal housed potentiometers from 3/8" diameter to 5". New miniature sinusoidal unit on display.

Garfield Wire Division Overlakes Corporation 45 Palace

Enamel Magnet Wire to close tolerances. Single and bare and Tinned Wires. Bunched and Concentric bare and tinned wires. Specifications held closer than NEMA.

Gates Radio Company, 157-165 Television Ave.

*Power saver 5 kw high fidelity transmitter—self contained, 100 watt VHF TV Transmitter and Antenna. *Modern design audio control console. *Streamlined high fidelity 1 kw Transmitter. Assemblies and group displays for TV, Broadcast and Communications.

General Communication Co., 724 Airborne Ave.

Coaxial Switches, Radar Test Equipment, Radar Beacons.

General Dry Batteries, Inc. 388 Microwave Ave.

Mercury Batteries for electronic and transistor applications requiring constant voltage, low impedance source. Also a complete line of carbon-zinc radio and industrial batteries.

G-E APPARATUS DEPARTMENT 174-180 TELEVISION AVENUE

- Capacitors
- Rectifiers
- Soldering Irons
- Aircraft Relays
- Molecular Vacuum Gage
- Thermocouple Vacuum Gage
- Spectrophotometer
- Leak Detector

Progress Is Our Most Important Product

GENERAL ELECTRIC

*Indicates new product

(Continued on page 212A)

**Show Hours: Monday 10 AM-10 PM
Tuesday 10 AM-10 PM
Wednesday 10 AM- 5 PM
Thursday 10 AM-10 PM**

Specialists in the Unusual

DIRECT TEMPERATURE MEASUREMENT UP TO 3700°F.

IRIDIUM vs. RHODIUM IRIDIUM THERMOCOUPLE WIRE

The only thermocouple material which may be used at these very high temperatures in an oxidizing atmosphere.

Ductile wire made possible by high purity and our advanced melting and drawing techniques.

Output: Over 10 millivolts at 3700° F
Uniform • Reproducible

Write for List of Products

SIGMUND COHN CORP. Metallurgists and Producers of Small Wire
121 South Columbus Avenue • Mount Vernon, N. Y.

SINCE 1901

ELECTRO TEC SLIP RING ASSEMBLIES

At the I.R.E. SHOW!
BOOTHS #133, 135 TELEVISION AVENUE
Kingsbridge Armory, New York City
March 21-24, 1955

HIGH TEMP PLASTIC!

NEW ETC-7 (POLYESTER RESIN)
USED ON ILLUSTRATED PART FOR
HIGH TEMPERATURE OPERATION

— for high temp applications!

HARD GOLD RINGS!

24 KT. SOLID GOLD RINGS —
ENTIRE RING THICKNESS ELEC-
TRODEPOSITED* UNIFORM
HARDNESS, 90 to 100 BRINELL.

COURTESY LEAR, INC.

— these two features were incorporated in the assembly illustrated above, having 45 rings, dia. .180", ring width .020", barrier width .010". Overall length, less leads 1.763".

Electro Tec Corp., in its constant endeavor to keep pace with the most exacting requirements, has developed these new processes and products. They provide flawless performance under conditions far exceeding the capabilities of other types of construction. Where high temperature is involved, the superiority of these assemblies is so marked, that acceptance has been industry-wide. At the same time, an increasing number of users are specifying these assemblies for the ultimate in dependability under normal operating conditions. Inquiries will receive prompt attention; no obligation.

72 rings on integral support — no accumulated tolerances — fulfills electrical, minimum weight and space requirements.



Dual purpose assembly combining "V" grooved signal circuits and wide power rings



Miniature high speed sampling switch — 24 channels



Combining low friction torque slip rings (.060 dia.) with reference switch segments.

NEW ETC-7 (POLYESTER RESIN) WITHSTANDS TEMPERATURE RANGE FROM -60° to +500°F

PRODUCTS OF PRECISION CRAFTSMANSHIP
BY A NEW AND REVOLUTIONARY PROCESS



ELECTRO TEC CORP.

SOUTH HACKENSACK, NEW JERSEY

*PAT. NO
2,696,570

NEW STANDARD OF PROFESSIONAL TAPE RECORDING



the magnificent
Dynacord[®]
 by Pentron

Now
 for the
 first time

... a professional tape recorder that offers both
MAXIMUM OPERATING CONVENIENCE
plus **UNMATCHED DEPENDABILITY**

Dynacord is engineered to exceed the rigid requirements of broadcast stations, sound studios, industry and government. Its wide dynamic range and many convenient operating features amaze engineers and audiophiles alike. Compare it in every way with any other professional tape recorder and see why Dynacord sets the new standard of professional recording.

Model DTM Tape Transport Mechanism, \$395.

Model DP-100 Broadcast Amplifier, \$150.

Model DS-10 Audiophile Amplifier, \$90.

Write for
 details and
 bulletin

Exclusive 2-speed, inside-out Hysteresis synchronous motor. Direct capstan drive.

Exclusive dynamic braking, fast, positive, fool-proof.
 Frequency Response: 30-15,000 CPS at 15 in./sec. \pm 2DB
 Signal to Noise Ratio: better than 55 DB

THE PENTRON CORPORATION

783 South Tripp Avenue, Chicago 24, Illinois, Dept. 1RE-3

Canada: Atlas Radio Corp., Ltd., Toronto

Hear the ALL-ELECTRONIC ORCHESTRA
 Kingsbridge Army • Booth 856 Audio Avenue

PENTRON

**What to See at the
 Radio Engineering Show**

(Continued from page 210A)

**General Electric Company
 Commercial Equip. Dept.
 174-196 Television Ave.**

Print Wire circuit boards, ferrites, resistor capacitor networks, distributed constant delay lines and delay sticks, Kor-Lea power resistors and precision formed and stamped metal parts. Transistors, rectifiers, diodes, oscilloscopes, sweep and marker generators, color bar generators, power supplies.

**General Electric Co.
 Germanium Products Dept.
 174-196 Television Ave.**

Transistors, rectifiers, diodes. Transistor tester, oscilloscopes, sweep generator, marker generator, diode tester.

General Electric Co., Laminated & Insulating Prods. Dept., Chemical & Metallurgical Div., 174-196 Television Ave.

Don't miss the G-E Textolite Laminates Exhibit featuring five new Punching Grade Phenolic Laminates at a new low cost and with extreme ease of fabrication.

General Electric Co., Lamp Div., 174-196 Television Ave.

Pure Tungsten & Molybdenum Products. Phosphorus, Fluxes, Rubber Tubing & Parts. Lead Wires, Dumet Wire, Fabricated Parts. Fused Quartz Products. Miniature Lamps.

**General Electric Co.
 Tube Department
 174-196 Television Ave.**

INDUSTRIAL & TRANSMITTING TYPES—
 *4000 MC. metal-ceramic medium- μ triode, plus wide range other high-power metal-ceramic tubes. Magnetrons and Klystrons.
 RECEIVING TYPES—*Computer tubes, series-string receiving tubes and high-reliability types. CATHODE-RAY TYPES—
 *Single-layer, single component phosphors, *techniques for depositing phosphors in any configurations on face-plates.

**General Electric Co., Ltd. of England,
 97 Palace**

Two products that are unique in the U.S.A.: G.E.C. Bothway Uniselectors, and G.E.C. Tension Gauges. Also the G.E.C. Relays and the Wharf Engineering Laboratories' Magnetic Storage Drums.

**General Hermetic Sealing
 Corp., 803 Audio Ave.**

Your assemblies inert-gas filled. — Mass Spectrometer Leak Testing — Manufacturers of non-destructive, high-potential test sets and hermetic K-W panel-sealed toggle switches.

*Indicates new product

(Continued on page 214A)

**Highest Microwave Power
Absorption.. Smallest Size
.. Lowest Weight..**



Model X4062

**BOGART
VHP*
DUMMY
LOADS**

No Cooling Fins Required

In laboratory, in field testing, in production — wherever extremely high microwave power is used—Bogart VHP* Dummy Loads do the job of much larger and heavier units. Even at the full peak power rating of rigid waveguides, no cooling fins are required.

Negligible Moisture Absorption

The lossy material is uniquely designed to present a minimum reflection coefficient, while permitting only negligible absorption of moisture.

Lightweight, Heat Resistant

All-Aluminum construction and black enamel finish help reduce weight and resist heat. All models are available with either choke or cover flanges.

Special Applications

We invite your engineers to consult with our own staff. We will be pleased to discuss your particular problems with you, without any obligation on your part. Write today.

**Very High Power!*

VISIT US at the I.R.E. Show,
Booth 379, Microwave Ave.,
Kingsbridge Armory

MODEL NO.	FREQUENCY RANGE (KMC/S)	MAX. PEAK POWER (MEGA-WATTS)	MAX. AVERAGE POWER (WATTS)	MAXIMUM VSWR	LENGTH (INCHES)	WIDTH (INCHES)	HEIGHT (INCHES)	APPROX. WEIGHT (LBS.)	WAVEGUIDE AN TYPE
X4062	8.20-12.4	0.29	750	1.10	4¾	1¼	1½	¾	RG-52/U
B4062	7.05-10.0	0.46	850	1.10	5¾	1¼	1¾	1	RG-51/U
C4062	5.85-8.20	0.71	1000	1.10	6¾	1½	2¼	1¾	RG-50/U
H4062	3.95-5.85	2.0	2000	1.10	9½	1¾	2¾	3	RG-49/U
S4062	2.60-3.95	3.2	2500	1.10	13¾	2¼	3¾	6½	RG-48/U
L4062	1.12-1.70	17.2	4000	1.10	30	4¾	8	48	RG-69/U

Above data subject to change without notice.

BOGART MANUFACTURING CORPORATION
315 Selgel Street
Brooklyn 6, New York
design • development • production



NEW "PARAFORMED" PAPER TUBES

MAKE YOUR COIL WINDING
EASIER! FASTER! BETTER!

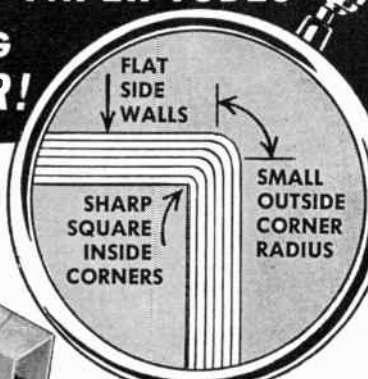

SPIRAL WOUND
NOT DIE FORMED

ANY SIZE—SQUARE OR RECTANGULAR

Entirely new technique in tube making developed and perfected by PARAMOUNT now for the first time solves many coil winding problems, *yet costs you no more!* Hi-Dielectric. Hi-Strength. Kraft, Fish Paper, Acetate, Red Rope or any combination wound on automatic machines. Produced from stock arbors or special sizes engineered for you.

Write on Company letterhead for Stock Arbor List of over 2000 sizes

- No sharp outside edges to cut wire
- Has full rigidity and physical strength
- Permits winding coils to closer tolerances
- No need for wedges to tighten wire
- Allows faster stacking of wound coils

PARAMOUNT PAPER TUBE CORP.

618 LAFAYETTE STREET, FORT WAYNE 2, INDIANA

Manufacturers of Paper Tubing for the Electrical Industry Since 1931

VISIT BOOTH NO. 806

(AUDIO AVENUE)

AT THE I.R.E. SHOW



f e a t u r e s

- EDGE-LIGHTED PANELS
- METAL DIALS, PANELS and NAMEPLATES
- ISOTOPE ACTIVATED LIGHT SOURCES
- RADIATION SOURCES including Isotopes, Radium, Ra D, and Polonium
- LUMINESCENT MATERIALS
- TV PHOSPHORS

Literature on above items available at booth,
or on request by mail—address Dept. PR-3

UNITED STATES RADIUM CORPORATION

Eastern Sales Office—535 Pearl St., New York 7, N.Y.

Western Sales Office—5420 Vineland Ave., N. Hollywood, Cal.

Plants and Laboratories at—

Bloomsburg, Pa., Whippany, N.J. Bernardsville, N. J., North Hollywood, Cal.

What to See at the Radio Engineering Show

(Continued from page 212A)

General Instrument Corp., 355 Micro-wave Ave.

*VHF Tuners, *UHF Tuners and Combination Tuners. *Color Deflection Components. *Black and White Deflection Components. Delay Lines —I.F. Transformers—All types of Inductance Coils.

General Precision Lab., Inc. 152, 154 Television Ave.

Precision TV Cameras for Industrial Systems application featuring high resolution at low light levels—Professional Projection TV Systems for Closed Circuit and "Off-the-air" use in hotels, hospitals, clubs, etc.

GENERAL RADIO CO.



40 YEARS OF PRECISION
INSTRUMENT MANUFACTURE

See our new 970-series potentiometers and many new laboratory instruments, including three sweep drives for oscillators, signal generators, and slotted lines—an r-f bridge—a Universal ZY bridge that measures any impedance from zero to infinity—new 900-2000 Mc oscillator—6 kva voltage regulator—pulse generator—u-h-f detector.

Booths 251-253-255

INSTRUMENTS AVENUE
Corner Radio Road

General Transformer Company, 359 Microwave Ave.

Transformers satisfy power, audio, specialty requirements for commercial, industrial, military applications. *Introducing new catalog incorporating unique method of ordering custom transformers.

Gera Corporation, 474, 476, 478 Electronic Ave.

See Chatham Electronics

SEE THE NEW
HIGH TEMPERATURE
N-P-N GROWN JUNCTION
TRANSISTORS
at Booth 419

Germanium PRODUCTS CORPORATION
SUBSIDIARY OF
RADIO DEVELOPMENT & RESEARCH CORP.
26 CORNELISON AVENUE - JERSEY CITY 4, NEW JERSEY

Gernsback Publications, 452 Electronic Ave.
See Radio-Electronics

Gertsch Products, Inc., 204 Instruments Ave.

Frequency Meters, *LF, HF, VHF, UHF and Microwave. AC Ratio Transformers (Precision AC Voltage Dividers). Frequency Standards. Peak Reading Wide Band Voltmeters. Half Octave Filters.

Giannini & Co., Inc., G. M., 117, 119 Television Ave.

Airborne Instruments & Controls—accelerometers, aeroheads, gyros, pressure transmitters. Digital Instruments—digital data handling systems, shaft position digitizers, Electro-mechanical products—potentiometers, stepping motors, magseal relays, pressure switches, switching commutator.

*Indicates new product

(Continued on page 216A)

radio
began
here...

Here is the original miracle upon which all wireless telephony is founded... Lee de Forest's Audion tube.

Today of course it has been improved a thousand-fold... in sensitivity, in power, in range. But this one still stands as the granddaddy of them all.

And what has this to do with Driver-Harris? Simply this:

The improvements on the Audion have come about through the combined efforts of thousands of devoted physicists, metallurgists, and engineers, whose increasing skills have in turn been made possible by the production of ever more effective radio alloys. Since the very beginnings of radio, the Driver-Harris metallurgists have led the way in developing these special-purpose alloys conforming to rigid specifications, upon which the performance of electron tubes so largely depends.

With the result that today Driver-Harris sells annually more tons of radio alloys to the makers of electron tubes than does any other supplier.

Driver-Harris makes alloys for every electronic tube requirement: for grids, plates, side rods, glass seals, cathode sleeves and tabs, socket prongs, mica straps. We offer over 80 electrical heat- and corrosion-resistant alloys for various electrical and electronic applications.

If the alloy you need hasn't already been developed, send us your specifications. Our engineers with 48 years of experience are at your service.



The Audion electron tube, invented by Lee de Forest in 1906

SOME PROMINENT DRIVER-HARRIS RADIO ALLOYS: Nichrome* • Gridnic* • Nickel "A", "D", "E", "Z", 330, 499, 599 • Thermo* • 152 Alloy • 142 Alloy • 146 Alloy

*T. M. Reg. U. S. Pat. Off.



Sole producers of world-famous Nichrome

Driver-Harris Company HARRISON, NEW JERSEY

BRANCHES: Chicago, Detroit, Cleveland, Louisville, Los Angeles, San Francisco

In Canada: The B. GREENING WIRE COMPANY, Ltd., Hamilton, Ontario.

MAKERS OF THE MOST COMPLETE LINE OF ELECTRIC HEATINGS, RESISTANCE, AND ELECTRONIC ALLOYS IN THE WORLD
See us at Booth 607, Radio Engineering Show

for direct measurement
of electrical, mechanical
or optical events



new SMALL
SIZE!

new!
DS-6100-T
FREQUENCY COUNTER
New Low Cost!
New Light Weight!

A compact precision frequency counter designed for direct measurement of any electrical, mechanical or optical phenomena which can be converted into a varying voltage. Reads out in direct digital form requiring no interpolation or reference to curves or tables. The all new DS-6100-T is ideal for use by skilled or unskilled personnel. Price \$700.00

EXCLUSIVE FEATURES
at no extra cost...
TEN CYCLE GATE
increases accuracy of period measurement
MULTI-SAMPLING
manually scans the unknown frequency for any multiple of the time base for greater accuracy
BATCH COUNTING
NEW, IMPROVED SENSITIVITY

THE **Detectron** CORP.

*Trade Mark

TECHNICAL REPRESENTATIVES:

NEW ENGLAND
Electronics Associates, Inc.,
Stamford, Conn.—ST. 4-7380
**ILLINOIS, INDIANA,
SO. WISCONSIN**
Warren B. Cozzens
Evanston, Ill.—DA. 8-4800
**NEW YORK &
NO. NEW JERSEY**
Gerard G. Leeds Company
Great Neck, N.Y.—HU. 2-7784

**SO. NEW JERSEY &
EAST PENNSYLVANIA**
Louis A. Garten & Associates
Montclair, N.J.—MO. 3-0257
**MARYLAND, D.C., VIRGINIA,
NO. CAR., TENN.**
S. S. LeV. Associates
Washington, D.C.—EM. 2-8626
Branch:
Baltimore 29, Md.—AR. 3742
**OHIO, SO. MICH.,
W. VIR., W. PA.**
Michael J. Cudahy
Chicago 40, Ill.—SU. 4-5858

**WASH., ORE., W. IDAHO
& MONTANA**
Testro
Seattle 8, Wash.—MO. 4895
**CALIFORNIA, ARIZONA,
NEVADA**
Koesler Sales Co.
Los Angeles 38, Calif.—YO. 6271
Branch: San Francisco 18, Calif.
JO. 7-0622
**MINN., NO. WIS. NO. MICH...
NO. & SO. DAK.**
Industrial Representatives Co.
Minneapolis 16, Minn.—
WE 9-8019

**COLORADO, WYO.,
E. IDAHO, UTAH, NEBR.**
Allen I. Williams Co.
Denver 4, Colo.—MA. 3-0343
**NEW MEXICO &
EL PASO COUNTY, TEXAS**
Allen I. Williams Co.
Albuquerque, N. Mex.—AL. 5-9632
CANADA
Electromechanical Products
St. Thomas, Ontario—
St. Thomas 5094-W
EXPORT
Frazar and Hansen, Ltd.
San Francisco, Calif.—EX. 2-5112

EXCELLENT LOW FREQUENCY ACCURACY

The new DS-6100-T has an accuracy of ± 10 microseconds over the frequency range of 1 to 10,000 events per second. In addition, frequencies of 10,000 to 100,000 events per second can be measured with an accuracy of \pm one count \pm one part in 100,000 (one part in 1,000,000 with crystal oven).

SPECIFICATIONS

FREQUENCY MEASUREMENT

- Frequency Range—10-100,000 cycles per second
- Input Sensitivity—
0.1 volt RMS: 20-100,000 cps
0.25 volt RMS: 10-20 cps
- Accuracy— ± 1 count \pm stability
- Time Base—1 second (0.1 and 10 seconds optional)
- Read-Out—Cycles per second:
Five digits

PERIOD MEASUREMENT

- Frequency Range—1-10,000 cycles per second
- Input Sensitivity—0.1 volt RMS
- Accuracy— ± 10 microseconds
- Gate Time—1 and 10 cycles of unknown frequency. May be increased by multi-sampling (only below 5 cycles per second).
- Read-Out—Tens of microseconds

GENERAL

- Stability—1 part in 100,000 (1 part in 1,000,000 with crystal oven)
- Display Time—Automatic: continuously variable from 1 to 10 seconds. Manual: until reset
- Input Impedance—0.5 meg., 0.05 mf
- Power Requirements—117 volts \pm 10%, 50-60 cycles (50-400 cycles optional); 150 watts
- Dimensions—14 $\frac{1}{4}$ " wide x 7 $\frac{1}{2}$ " high x 13 $\frac{1}{2}$ " deep
- Weight—28 lbs. net (approximately)

VISIT US IN
BOOTH 39 - IRE Show
Kingsbridge Palace, N.Y.C.

COMPUTER-MEASUREMENTS DIVISION

5528 Vineland, North Hollywood, Calif. Dept. 86-E

**What to See at the
Radio Engineering Show**

(Continued from page 214A)

Glenco Corporation, 850 Audio Ave.
*High reliability electronic components. Sub-miniature capacitors and resistors, close tolerance temperature compensating capacitors; non-linear dielectrics for modulation amplification, and memory devices. Packaged RC circuits.

Globe Industries, Inc., 612 Circuits Ave.
Manufacturers of precision miniature and sub-miniature permanent magnet dc, 400 and 60 cycle ac motors and motorized devices.

Gombos Co., Inc., John, 573, 575 Components Ave.

Custom built microwave units, custom built electronic units, custom built electro-mechanical units, complete test facilities. Custom built converters, jacks, connectors, precision parts. Finest quality control.

Good-All Electric Mfg. Co., 75 Palace
Capacitors, paper, "MYLAR," and polystyrene dielectrics for civilian and military use. All type mountings including printed circuits, MIL C-25A, Film-X, seramelite, marbelite, and metal-lined types.

Goodrich Sponge Products Div., B. F., B. F. Goodrich Company, 382 Microwave Ave.

Microwave absorbents for indoor and outdoor installations; 100mc through 60,000mc; broad-band materials for 300 cm, 60 cm, 30 cm, 12 cm and 6 cm.

Goodyear Aircraft Corp.
316, 318 Computer Ave.

GEDA Analog Computing Equipment. GA215-L3 Linear Analyzer—24 amplifier, GN215-N3 non linear analyzer, GA215-R5 Six-channel recorder, GN215-N3A Electronic Multiplier, GN215-N3E function generator.

Gorham Mfg. Company, 32 Palace
Fabricated and Cast Microwave Components and Assemblies—Mixers—Duplexers—Bands—Tees—Couplers—Feed Horns—Cavities—Dummy Loads—Slip Ring Assemblies—Electro-Mechanical Assemblies.

Gorn ELECTRONICS
STAMFORD, CONN.
Booth 49
PALACE BUILDING

<p>ELECTRONIC CONNECTORS: Specialists in Printed Circuit and Miniature Multiple Precision Electrical Connectors.</p>	<p>AIRCRAFT SWITCHES: Pneumo and Fluo Switches designed and tested to meet military specifications.</p>
---	--

Grant Pulley & Hardware Corp., 301, 303 Production Rd.

Spectacular demonstration of Industrial Slides shown in dramatic settings. Two and three section slide for servicing, repair, maintenance. Inexpensive tilt slides. Variety of installations.

*Indicates new product

(Continued on page 218A)

FIRST AID ROOM

A nurse is in charge at all times. First Aid Room is the sixth room to right of Lobby directly off registration area in Kingsbridge Armory.

New
These
GEAR HEADS
 are our Answer to
HIGH TORQUE
 at **LOW SPEEDS**

We are producing a complete line of gears for our 1600 frame motors to meet any precision, low speed high torque requirements. Gear reduction units built to withstand impact, vibration and high acceleration are available. If your requirements are such that control problems are the important factor we incorporate the correct actuating device in the design.

Our 1600 frame motors are available in highly efficient induction, non-synchronous types or in hysteresis or reluctance synchronous types. They may be for 60 cycle, 400 cycle or variable frequency operation (50-1600 cps), single or polyphase. Supplied in ratings from 1/1000 to 1/10 horsepower for continuous duty. Housing is anodized aluminum. Ball or sleeve bearing construction. Will withstand ambient temperatures from -55° up to 150°C .

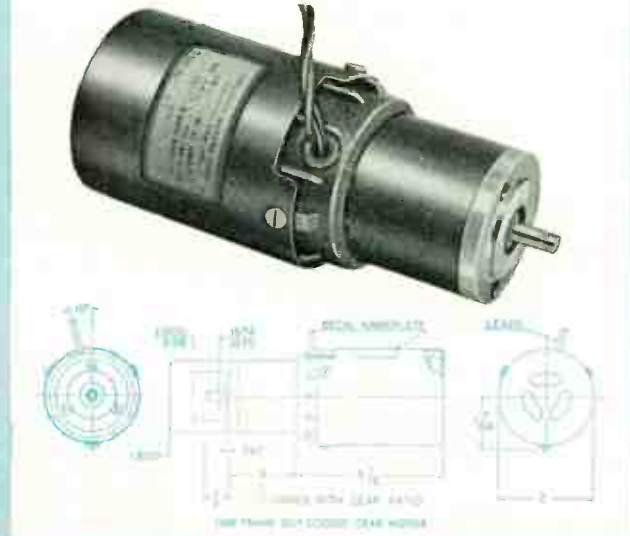
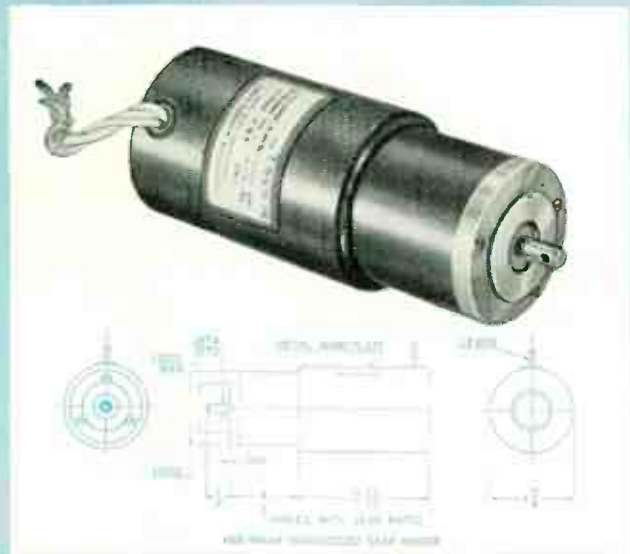

TYPICAL APPLICATIONS

- Servo Mechanisms
- Automatic Flight Controls
- Fire Control Systems
- Sine Wave Alternators
- Aircraft Cameras

If you have any problem involving sub-fractional horsepower motors, Induction Motor Corporation is your logical source of supply. We manufacture induction, synchronous and servo motors for gearhead, blower, fan and torque motor applications. We can either build them to your specifications or design them to meet your requirements.

For the answer to your problems, write or phone:



Induction Motors Corp.

570 Main St., Westbury, L. I., N.Y. • Phone WEStbury 7-7070

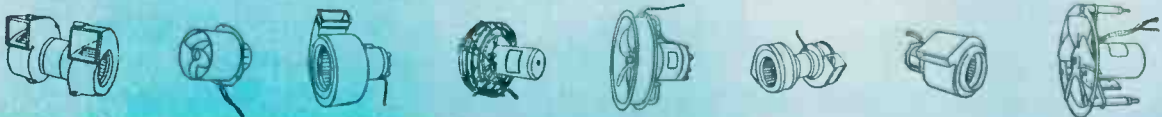

Improved Performance!

A versatile instrument... newly revised... for research and applications involving high repetition rates

**MODEL B-2A
PULSE GENERATOR**

PULSE WIDTH: variable in 4 ranges from .1 μ s to 1,000 μ s

PULSE RISE TIME: .025 μ s

PULSE AMPLITUDE: 40 volts into 93 ohms

INTERNAL DELAYS: variable in 5 ranges from 0 to 10,000 μ s with respect to synchronizing pulse

INTERNAL REPETITION RATES: variable in 4 ranges from 10 cycles to 100 KC

SYNCHRONIZING PULSES: 5— independently available at separate output jacks

See our Complete Display at the IRE show—Booth 424



- High duty factors
- Can be triggered externally through Schmidt trigger input circuit
- Calibrating potentiometers are provided for each range

Write for complete data: our Bulletin I-B-2A

Rutherford ELECTRONICS CO. 3707 S. ROBERTSON BLVD. CULVER CITY, CALIFORNIA

What to See at the Radio Engineering Show

(Continued from page 216A)



Switches Test Clips
Binding Posts
Molded Parts
743 Airborne Ave.

Green Instrument Co., Inc., 243 Instruments Ave.

Green (Pantograph) Engravers for all metals and plastics. Featuring the new, heavy-duty Model D-2 Green Engraver.

**First Public Appearance of the
HIG-3 GYRO**

Booth 40—Kingsbridge Palace also Integrating and Rate Gyros, Servo Motors, Accelerometers, Pressure Transmitters

BY **Greenleaf** ST. LOUIS, MISSOURI

Greibach Instrument Company, 850 Audio Ave.

* $\frac{1}{2}$ % accuracy megohm meter 100,000 ohms to 5000 megohms. Microameters and millivoltmeters utilizing revolutionary friction-free movements; high sensitivity and accuracy; high resistance to overload as well as shock and vibration. Light pointer movements available.

Gremer Mfg. Co., Inc., 50 Palace
Designer and manufacturer of radio frequency coaxial cable connectors, radio frequency fittings and associated components.

Guardian Electric Manufacturing Co.

582 • 584
COMPONENTS AVENUE

The Latest in Relays, Solenoids, Hermetically Sealed Controls, Electromagnetic Developments.

Gudebrod Bros. Silk Co., Inc.

737 Airborne Ave.

Lacing Tapes & Cords

*Indicates new product

(Continued on page 220A)

SHOPPING FOR

LOW COST

CLASS B

Insulation?

Nothing on the market today excels the low priced Class B protection of Varflo Tubing and Sleeving

Flexible Varflo is solvent-, oil-, moisture-, flame-, and fungus-resistant. Passes the NEMA heat endurance test of 15 minutes at 225°C. Will not lose dielectric strength when subjected to severe handling, bending and twisting. Has good shelf life.



Available in Grades A-1 and B-1 tubing and Grades C-1 and C-2 sleeving. Let us help you with your problem. Describe it in a letter—no cost, no obligation.

Send for free folder containing description and samples of VARFLO Tubing and Sleeving.



Varflex Corporation • 518 W. Court St. • Rome, N. Y.

**"Built-in" stability
here . . .**

**means consistent
performance here**

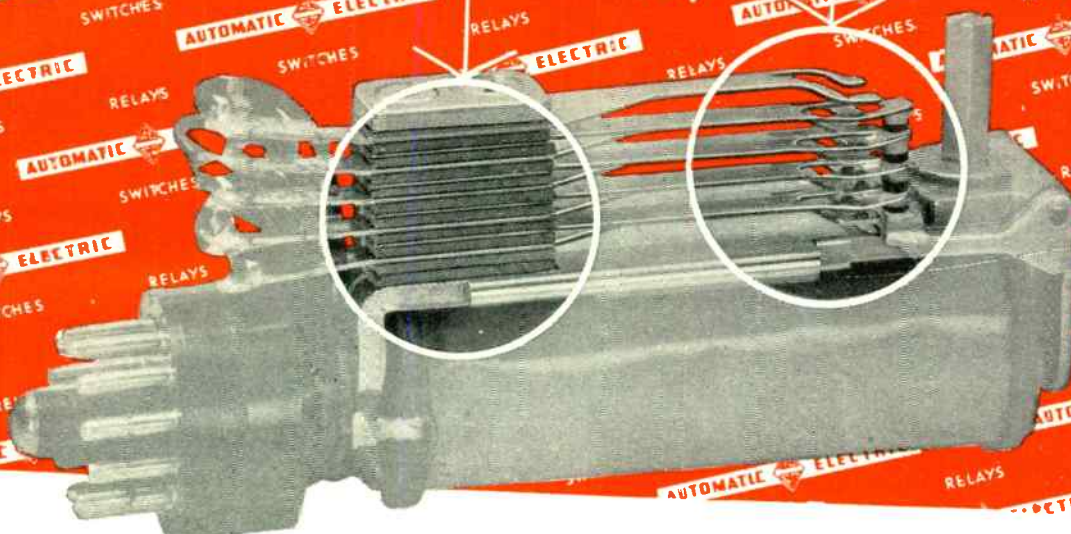

Relay contact springs still drum-tight after 200,000,000 operations!

After hundreds of millions of operations, throughout years of service, there's not the slightest sign of shifting or loosening of contact springs on this typical Automatic Electric relay! Such exceptional performance is common for relays like this and other types used in many aircraft and industrial applications.

Spring pile-ups on Automatic Electric relays are *permanently tight!* They're made that way by exacting assembly techniques which guarantee uniform and consistent "make and break"—even when extreme temperature, humidity and vibration conditions are present! That's the kind of performance that increases relay dependability and pleases the most exacting relay users . . . the kind they know they'll get when they order genuine Automatic Electric relays!

Write: Automatic Electric Sales Corporation, 1033 W. Van Buren St., Chicago 7, Ill. In Canada: Automatic Electric Sales (Canada) Ltd., Toronto. *Offices in principal cities.*



See Automatic Electric's complete line of relays and stepping switches at the IRE SHOW
463 Electronic Avenue

RELAYS

SWITCHES

PRODUCTS OF THE INDUSTRIAL DEPARTMENT OF

AUTOMATIC ELECTRIC

CHICAGO

Dur-Mica

the NEW MICA CAPACITOR

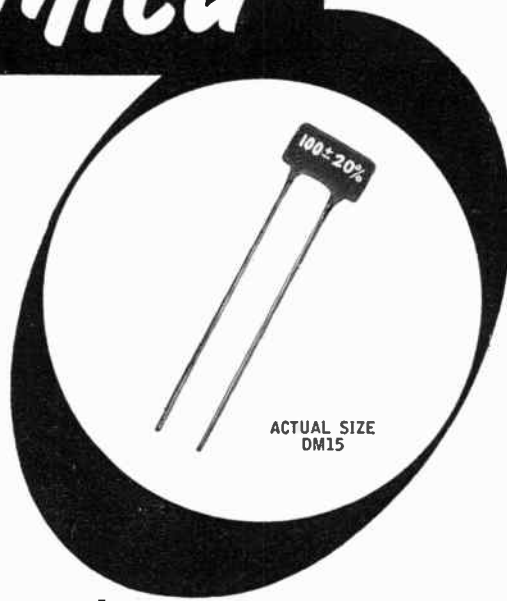

does more jobs — in less space
at lower cost — better!

1. The new "Dur-Mica" is a silvered mica capacitor coated with a specially developed plastic coating for extra durability.
2. Operating temperature range — 55° C. to 125° C.
3. Improved moisture resistance particularly in the higher temperature range.
4. New reduced size makes "Dur-Mica" the smallest mica capacitors.
5. Temperature coefficient approaching the "NPO" range.
6. New radial lead construction for reduced inductance, plug-in circuitry, and automatic assembly techniques.
7. A versatile capacitor that gives precision performance with substantial savings in cost.
8. The "Dur-Mica" meets or exceeds all applicable MIL and RETMA standards for mica capacitors.

now available

DM15 — 7/16 x 9/32 x 5/32 to 7/32 thick
DM19 — 5/8 x 13/32 x 5/32 to 7/32 thick
DM20 — 23/32 x 13/32 x 5/32 to 7/32 thick

See us at the
I.R.E. Show
Booth #361

Write for
further
information
and Free
Catalog



ARCO ELECTRONICS INC.

103 LAFAYETTE STREET, NEW YORK 13, N. Y.

West Coast Branch

ARCO Capacitors Inc. 5281 West Pico Blvd., Los Angeles, Calif.

What to See at the Radio Engineering Show

(Continued from page 218A)

The Gudeman Company

407 Electronic Ave.

Coast to coast service, 6 manufacturing plants, sales offices and representatives in 17 U.S. and 2 Canadian cities. Manufacturers of capacitors, filters, pulse transformers, delay lines, and linear variable differential transformers.

Gulton Industries, Inc.

850 Audio Ave.

*Variable reluctance pressure gauges. *Differential transformer accelerometers for missile, aircraft and industrial control. *Pressure transducers and subminiature electronic devices for shock and vibration. *Subminiature connectors. *Low noise cable. *FLEXDUCER devices, Piezoelectric transducers and accelerometers.

H. & B. American Machine Co., 349 Computer Ave.

See Karp Metal Products

Hammarlund Mfg. Co., Inc., 411, 413 Electronic Ave.

*Fixed Frequency Super Pro-600 communications receiver, *the Long Wave Super Pro-600 Communications Receiver, *the Pro-310 Receiver and *the modern modular designed remote control and telemetering equipment.

Hastings Instrument Co., Inc., Engineering and Research Div., 410 Electronic Ave.

Raydist—Navigation & Tracking Systems. *Vacuum Gauges, vacuum controllers, flowmeters, air velocity instruments & recorders, *one millimeter to atmosphere.

Hayden Publishing Co., 872 Audio Ave.

The latest IBM data processing equipment will be employed to demonstrate the typical monthly processing of 27,000 inquiries from the subscribers of Electronics Design.

Haydon Co., A. W., 570, 572 Components Ave.

Standard, miniature, governed dc timing motors. 60 and 400 cycles reversible timing motors. Repeat cycle timers; Time delay relays; Elapsed time indicators; Special timers.

BOOTH 335 COMPUTER AVE.

1. Beam switching tubes
2. Cathode Ray Tubes
3. Power and receiving tubes
4. Electron guns
5. Burner equipment and accessories
6. Precision metal parts

HAYDU Plainfield, N. J.
BROTHERS
DIVISION OF BURROUGHS CORPORATION

*Indicates new product

(Continued on page 222A)

Show Hours: Monday 10 AM-10 PM

Tuesday 10 AM-10 PM

Wednesday 10 AM- 5 PM

Thursday 10 AM-10 PM

COMPRESSING TIME

In any security program *time* is the one irreplaceable element. Making the most of time is particularly vital in guided missiles projects. Fairchild's Guided Missiles Division has demonstrated its ability to "spend" time effectively. Its completely integrated engineering and production organization can, in effect, *compress time*.

With a balanced engineering team and an experienced production staff housed together in a facility built specifically for the development and manufacture of missiles, Fairchild can cut down lags in moving a missile project from the design and development phase into the production phase.

It *has* done so.

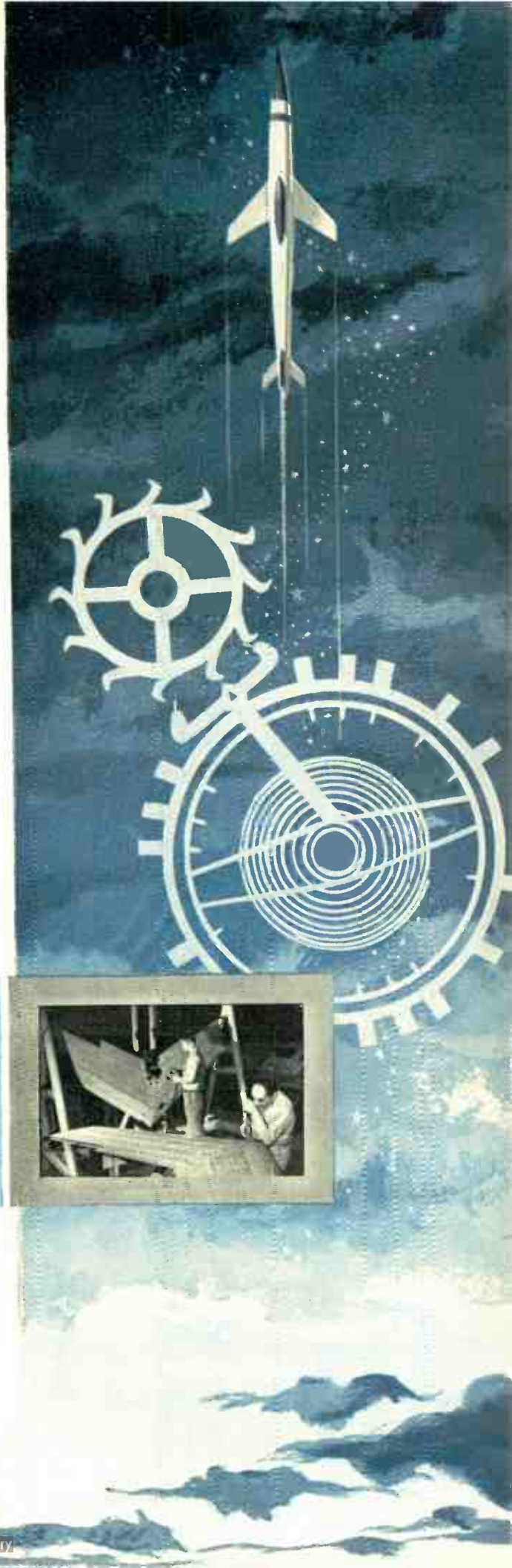

ENGINE AND AIRPLANE CORPORATION

FAIRCHILD

Guided Missiles Division

WYANDANCH, N. Y.

American Helicopter Division, Manhattan Beach, Calif.

Aircraft Division, Hagerstown, Maryland · Engine Division, Farmingdale, N.Y.
Speed Control Division, St. Augustine, Fla. · Stratos Division, Bay Shore, N.Y.

PORTABLE PHONOGRAPHS · TV BOOSTERS · INDUSTRIAL and MEDICAL EQUIPMENT

SERVICING KITS · TAPE RECORDERS · ANTENNA ROTATOR · CONTROL CABLES

PORTABLE RADIOS · SERVICE MEN'S CARRYING CASES · PORTABLE PA SYSTEMS

When You Need



Coated fabrics...



Fabric-covering problems vary with the size and shape and function of the carrying case. Here's the cue for APEX specialists! For fast-colored, durable fabrics to make your units SELL faster and LAST longer... ask men who KNOW.



It will cost you nothing to let APEX specialists consider your problems.

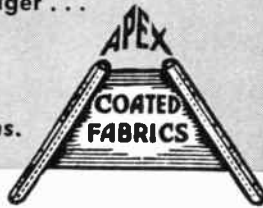

For 29 years "THE HOUSE of SERVICE"

APEX COATED FABRICS, Inc.

12-16 East 22nd St., N. Y. City 10

Spring 7-3140

SOUND and PROJECTION EQUIPMENT · PORTABLE TV SETS · TEST INSTRUMENTS

"Wow-Meter"

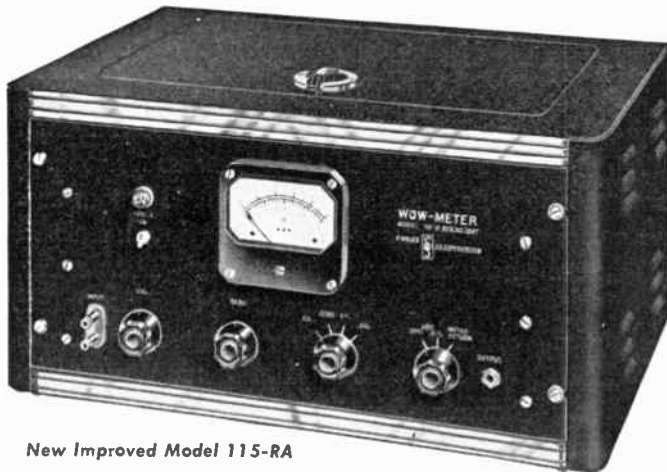

New Improved Model 115-RA

Improved direct-reading instrument simplifies measurements of wow and flutter in speed of phonograph turntables, wire and tape recorders, motion picture projectors and similar recording or reproducing mechanisms. It is the only meter in existence providing direct, steady indication of meter pointer on scale.

The Furst Model 115-RA with improved stability is suitable for both laboratory and production application and eliminates complex test set-ups.

A switch on the front panel permits selection of low frequency cut-off and corresponding meter damping for use on slow speed turntables.

Frequency Response: 1/2 to 120 cycles or 10 to 120 cycles
Sensitivity: 0.2, 0.5, and 2.0% Wow Full Scale
Inquiries invited on our line of Regulated Power Supplies



FURST

ELECTRONICS, INC.

3326 W. Lawrence Ave., Chicago 25, Illinois

See Us At Booth 416 Electronic Ave. I. R. E. Show

What to See at the Radio Engineering Show

(Continued from page 220A)

HEATH company

A SUBSIDIARY OF DAYSTROM, INC.

BENTON HARBOR, MICHIGAN

MANUFACTURERS OF ELECTRONIC EQUIPMENT IN KIT FORM

BOOTH 732

Heiland Div., Minneapolis-Honeywell Reg. Co., 364 Microwave Ave.

*Series 700C eight and twelve inch recording oscillographs; Sub-miniature galvanometers; amplifiers; bridge balance units.

Heinemann Electric Company, 365 Microwave Ave.

Complete line of hydraulic-magnetic circuit breakers for 400 cycle use and various other electronic protection and control applications; Silic-O-Netic time delay relays.

Heldor Mfg. Corp., 863 Audio Ave.

*Heldor rivet-type non-turning Hermetic Seal bushings to meet MIL-T-27 Specifications. New drawn cans and covers. New sheet metal cabinets. Regular standard transformer cans and bushings.

first in precision potentiometers

Helipot

Helipot Corporation: South Pasadena, California
Engineering representatives in principal cities a division of BECKMAN INSTRUMENTS, INC.

756-758 AIRBORNE AVENUE

Heminway & Bartlett Mfg. Co., 888 Audio Ave.

*Fungus-proof nylon lacing cords and flat braided tape, special synthetic resin coating resists growth of mold and micro-organisms—factors most often responsible for deterioration of linen and cotton lacing cords and tapes. High abrasion resistance—low moisture absorption—non-toxic to humans.

Henry and Miller Industries, Inc.

307 Computer Ave.

Modulator Pressurized Cases in all sizes and shapes and gauges. Featuring color anodizing on assembly and sub-assembly for identification purposes. Also processors of Mu Metal in cones, shields, housing and baffles, as well as other components.

Heppner Mfg. Co.

854 Audio Ave.

Focus devices; rod antennas; ion traps; centering devices, speakers, horizontal outputs.

*Indicates new product

(Continued on page 224A)

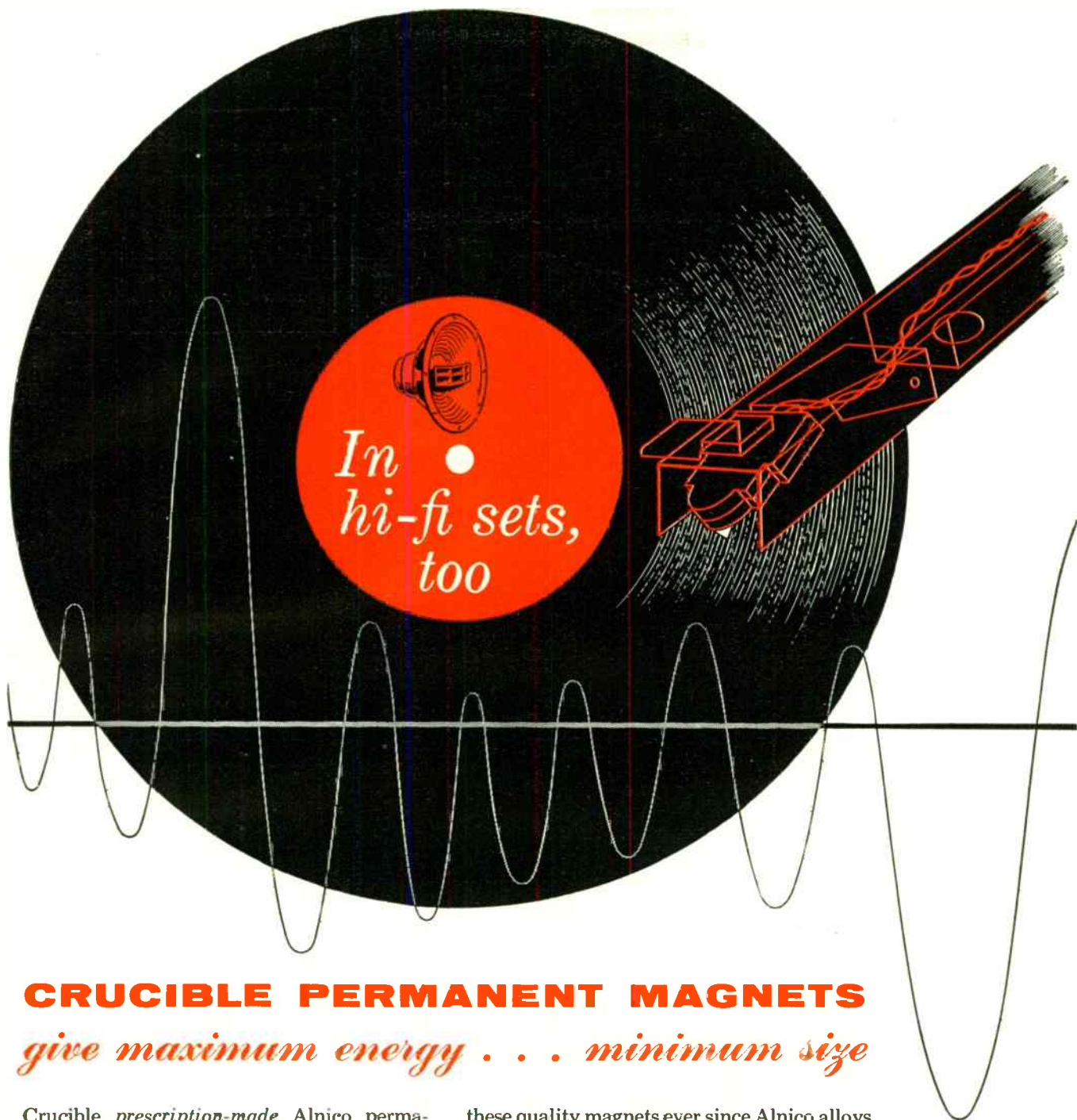

CRUCIBLE PERMANENT MAGNETS
give maximum energy . . . minimum size

Crucible *prescription-made* Alnico permanent magnets provide *consistently higher* energy products.

This means greater design freedom . . . more compact products for manufacturers of high-fidelity sound equipment, instruments, controls, motors, and other magnet equipped devices.

Crucible has been a leading producer of

these quality magnets ever since Alnico alloys were first developed. You can get them sand cast, shell molded, or investment cast to meet every size, tolerance, shape and finish need.

Next time you need top quality magnets, or help with magnet applications, call Crucible. *Crucible Steel Company of America, Henry W. Oliver Building, Pittsburgh 30, Pa.*

Visit us at Booths 105-107 IRE Show — New York City, March 21-24

CRUCIBLE

first name in special purpose steels

Crucible Steel Company of America

No. 2
in a
series

design progress through
inter-company co-operation

... coordinated by *Airtron inc.*



NEW...
DOUBLE-RIDGE WAVEGUIDE
for both X-band and C-band operation!

Recently, Airtron was confronted with a difficult problem—how to develop a waveguide that would perform satisfactorily for both “X” and “C”-Band operation.

Due to differences of opinion concerning the optimum frequency for airborne weather radar systems, equipment manufacturers have selected two different operating frequencies for their designs . . . 5.6 cm (“C”-band) and 3.2 cm (“X”-band). As a result, two different waveguide sizes were required. This meant that should it become advisable to switch from one frequency band to the other it would necessitate the installation of an entirely new waveguide system . . . as well as the replacement of the radar equipment.

This was highly impractical and, accordingly, a coordinated effort was set up among the airlines technical advisory organization (ARINC), leading manufacturers of radar equipment, and the engineering staff of Airtron.

Working as a team the theoretical and practical difficulties were overcome and the solution evolved in a new double ridge waveguide. The new design not only permits handling of both bands, but also results in a considerable reduction in size and weight for “C”-band and improved electrical properties for “X”-band.

This is just another concrete example of how Airtron’s creative engineering . . . and their close association with leading manufacturers in all phases of electronics . . . can be of assistance to you . . . whether the components you need are new in design or so-called “standard” plumbing.

FREE CATALOG on Ridge Waveguide for Airborne Weather Radar . . . contains a complete description of the new ridge waveguide series. Write on your letterhead c/o Dept. C for your copy today!

Airtron inc. Linden, New Jersey
Designers & Manufacturers of Rigid and Flexible Waveguide Components and Aircraft Accessories
Branch Offices: Albuquerque • Boston • Chicago • Dallas • Dayton • Kansas City
Los Angeles • San Francisco • Seattle • London

Visit our Booth 373 at the IRE Show

What to See at the
Radio Engineering Show

(Continued from page 222A)

Hermetic Seal Products Co.
199 Broadcast Way

Hermetic Seals, glass-metal hermetically sealed terminals; bushings; headers; AN connectors; plugs and bases in single terminals or multi-headers for the electronic industry.

Hetherington, Inc., 330 Computer Ave.
Snap-action switches, push-button and toggle, indicator lights and relays. *Miniature toggle switch and low-cost push buttons.

hp
BOOTHS
248-250
CORNER
RADIO ROAD
AND
INSTRUMENTS AVE.

Hickok Elec. Instrument Co.
458, 460 Electronic Ave.

*Color Bar, *Microvolt, TV Video, *Time square wave, and noise generators; *Wide band color oscilloscopes; *Laboratory tube testers; VTVM's; *Wattmeters; Ruggedized, 250 degree panel meters; switchboard and portable meters.

Hi-G Inc., 14 Palace
Hi-G Spotlights—advances in relay design to gain highest resistance to shock and vibration in miniature construction. Offering *2 PDT, 6 PDT, and 12 PDT units to trade.

High Vacuum Equipment Corp., 310 Computer Ave.
See versatile laboratory vacuum coater perform all kinds of metallizing operations—also ionization—Philips—thermocouple gauge controls—all types high vacuum equipment and components available.

Hi-Q Division, 548, 550, 552 Components Ave.
See Aerovox Corp.

HITEMP WIRES, INC.
26 WINDSOR AVE., MINEOLA, L. I.
Specialists in
CLASS H TEFLON
INSULATION
BOOTH 609 CIRCUITS AVE.

*Indicates new product

(Continued on page 226A)

A Significant Engineering
Achievement In
Industrial Power Supplies

maintenance free precision regulated dc power supplies



- NO TUBES
- DUAL MAGNETIC REGULATED
- 0.2% REGULATION
- ULTRA-FAST
- SHORT CIRCUIT PROOF
- FLUX OSCILLATOR CONTROLLED
- MAGNETIC AMPLIFIER REGULATED
- HERMETICALLY SEALED MAGNETIC COMPONENTS
- PROVEN IN CONTINUED SERVICE
- GUARANTEED



STABLVOLT TYPE A

APPLICATIONS

INDUSTRIAL ... as production test equipment, where quality control is desired and where production stoppages must be eliminated or minimized.

LABORATORY ... as stable voltage references or bias supplies, as regulated filament supplies, as strain gauge or instrumentation supplies, etc.

ORIGINAL EQUIPMENT ... as precision regulated and maintenance-free power source in automation, computer, communication and instrumentation equipment.

DESCRIPTION

STABLVOLT D.C. power supplies are dual magnetic, precision regulated units providing reliable, maintenance-free operation for industrial, laboratory and original equipment applications.

STABLVOLT, precision regulation with ultra high speed response is attained by utilizing new high performance Flux Oscillators in connection with high gain magnetic amplifiers... thereby eliminating vacuum tubes, mechanical references and other delicate elements.

STABLVOLT'S short circuit proof characteristics are achieved by using **only** static magnetic circuitry. When short circuited, line current is automatically limited and power supply protected from internal damage. Normal operation is resumed automatically, without resetting switches or replacing fuses... thus eliminating down time and insuring maintenance free operation.

SPECIFICATIONS

TYPE A: 200 WATTS OUTPUT

MODEL	DC OUTPUT RANGE	
	VOLTS	AMPERES
MR-6-20	4-8	0-20
MR-12-10	6-15	0-10
MR-28-5	16-32	0-5
MR-150-1	130-175	0-1
MR-300-0.5	270-330	0-0.5

TYPE A: 1000 WATTS OUTPUT

MODEL	DC OUTPUT RANGE	
	VOLTS	AMPERES
MR-6-100	4-8	0-100
MR-12-50	6-15	0-50
MR-28-20	16-32	0-20
MR-150-5	135-175	0-5
MR-300-3	270-330	0-3

STATIC REGULATION:

- ± 0.2% for ± 10% line voltage change
- ± 0.2% for ± 10% line frequency change
- ± 0.2% from zero to full load current

RIPPLE: 0.2% RMS at full load

1 Volt models have 1% ripple

AC INPUT: 95-125V, 1 phase, 55 to 66 cps

OVERLOAD: Power Supplies are conservatively rated and can be operated continuously at 150% overload current

SHORT CIRCUIT CURRENT: 200% of rated load current

DYNAMIC REGULATION AND RESPONSE TIME:

- ± 2% for ± 10% line voltage transient

Response Time: 50 milliseconds

- ± 3% for ± 10% load current transient

Response Time: Max. 100 milliseconds under most steady conditions of loading.

IMMEDIATE DELIVERY FROM STOCK ON MOST MODELS

For complete technical data and performance curves... request Engineering Bulletin EB-203.

REPRESENTATIVES

BIRMINGHAM ASSOCIATES
NEW YORK 12, N.Y.

H. P. ODELL CO.
CLEVELAND 18, OHIO

HUGH MARSLAND & CO.
CHICAGO 35, ILLINOIS

MAGNETIC RESEARCH CORP.

200 CENTER STREET • EL SEGUNDO, CALIFORNIA

Mfrs. of Magnetic Amplifiers and Converters, Magnetically Regulated DC Power Supplies, Magnetic Pulse Generators.



SAVE THOUSANDS OF DOLLARS in testing Aircraft Generators

United's **NEW** FEEDBACK TEST STAND

- Eliminates Load Bank
- Simplifies Operation
- Cuts Initial Cost

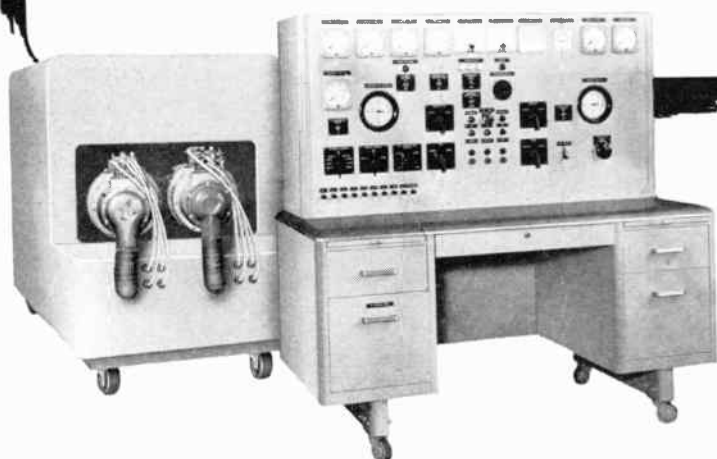

The wraps are off! United's new feedback test stand, a compact unit $\frac{1}{3}$ to $\frac{1}{2}$ the size and weight of conventional equipment, provides complete testing with up to 200% loading. No load bank is required, a saving in both initial cost and test space. The feedback drive uses less than $\frac{1}{3}$ of the horsepower of an old-type test stand. A direct economy! Only two simple controls are used for all load and power factor changes. Automatic protection is provided for temperature, voltage, air pressure, faults, current and synchronization. Full details are ready for you.

Write us today for Bulletin FTS



UNITED MANUFACTURING COMPANY

DIVISION THE W. L. MAXSON CORPORATION
41 HAIG STREET, HAMDEN, CONNECTICUT

See Feedback in Operation at I.R.E. Show, New York, March 21-24, W. L. Maxson Corp.
Booths # 620-622-624.



AN/APR-4 LABORATORY RECEIVERS

Complete with all five Tuning Units, covering the range 30 to 4,000 Mc.; wideband discone and other antennas, wavetraps, mobile accessories, 100 page technical manual, etc. Versatile, accurate, compact—the aristocrat of lab receivers in this range. Write for data sheet and quotations.

We have a large variety of other hard-to-get equipment, including microwave, aircraft, communications, radar; and laboratory electronics of all kinds. Quality standards maintained. Get our quotations!

NEW TS-13/AP X-BAND SIGNAL GENERATORS, with manual, \$575.00 . . . T-47A/ART-13 Transmitters, \$450.00 . . . H-P, Boonton, G-R, Measurements, and other standard items in stock; also nucleonic equipment.

ENGINEERING ASSOCIATES

434 PATTERSON ROAD

DAYTON 9, OHIO

What to See at the Radio Engineering Show

(Continued from page 224A)

Honeycomb Co. of America, Inc., 604 Circuits Ave.

Aluminum, Cotton, Paper and Fiberglass Honeycomb Panels, Dielectric (Micro-wave) Windows, Radomes, GLASMOLD (glass pipe), and Honeycomb Transit Cases.

Hubbell, Inc., Harvey, 406 Electronic Ave.

*Type "B" Interlock "Automatic Locking" insulated plug possessing all the unique features of Interlock line—quick disconnect, low resistance contact, double compensating contact and vibration plug. Also full line of Automatic Locking Connectors.

Hudson Tool & Die Co., Inc.

472 Electronic Ave.

- THE MOST COMPLETE LINE OF PRECISION DRAWN CASES AND COVERS IN THE INDUSTRY
- COMPLETE METAL FABRICATING AND SUB-ASSEMBLY FACILITIES
- QUALITY METAL STAMPINGS

Huggins Laboratories, Inc.

5 Palace

S-Band, C-Band, and X-Band traveling wave tubes will feature low power tubes, medium power tubes, and backward wave oscillators and their associated solenoids.

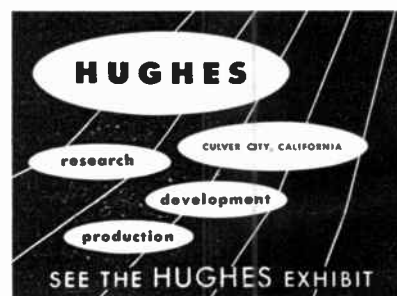

Hyeon Mfg. Co.

735 Airborne Ave.

On Display—Electronic Test Equipment Featuring the *Digital Voltmeter and the *5" oscilloscope—Kerr Cell Shutter—A Picture in 1/10,000 second.

Hycor Company, Inc.

369 Microwave Ave.

*Toroid Inductors and Low Power Magnetic Amplifiers. Precision wire-wound resistors for printed circuits, wave filters, toroid transformers, hermetically sealed attenuators.

(Continued on page 229A)

Federal





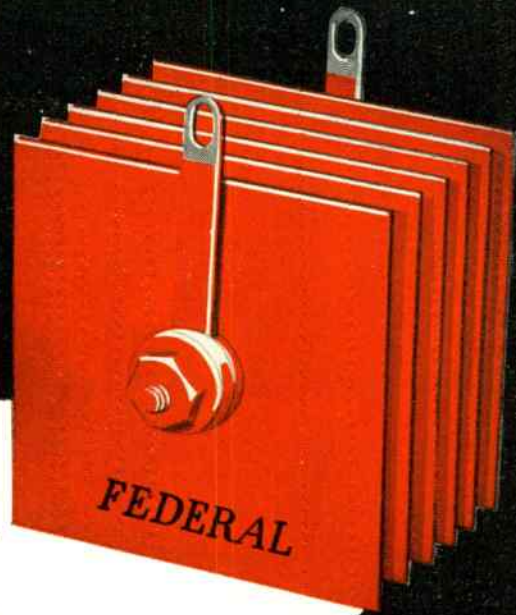

**THE SELENIUM RECTIFIER
WITH THE GREATEST**

Manufacturer
Aceptance







More design and component engineers in the radio-TV industry have put their approval on Federal Selenium Rectifiers than any other make

And HERE'S why— point by point:

-  **LONGER LIFE** . . . 5,000 hours life expectancy in most approved applications.
-  **HIGHER OUTPUT VOLTAGE** . . . 3 to 6½ higher B+ output volts than competitive selenium rectifiers in conventional doubler circuits.
-  **LOWER TEMPERATURE RISE** . . . 2° C to 10° C lower average operating temperature than competitive selenium rectifiers.
-  **SUPERIOR HUMIDITY RESISTANCE** . . . passes 1,000-hour life test in 95% relative humidity at 40° C.
-  **PROVEN MECHANICAL CONSTRUCTION** . . . brass eyelet or aluminum stud construction used exclusively. Patented "dead-center" construction allows stack to be tightened until rigid, without affecting the pressure-sensitive selenium characteristic.
-  **UNDERWRITERS LABORATORY ACCEPTANCE FOR 85° C OPERATION** . . . Federal's popular radio-TV types have been tested and accepted by UL for operation at cell temperatures of 85° C.

- 1 Longer life**
- 2 Higher output voltage**
- 3 Lower temperature rise**
- 4 Superior humidity resistance**
- 5 Proven mechanical construction**
- 6 85° C. UL acceptance**
- 7 Conservative ratings**
- 8 More uniform quality**
- 9 Largest plant capacity**
- 10 More engineering know-how**

-  **CONSERVATIVE RATINGS** . . . rectifiers offered to the industry are rated only after exhaustive temperature rise and ageing tests on minimal grade units to insure full value and satisfaction.
-  **MORE UNIFORM QUALITY** . . . Federal rectifiers are automatically 100% tested and inspected to meet standard forward and reverse current specifications, as well as for dielectric strength.
-  **LARGEST PLANT CAPACITY** . . . production facilities to satisfy any quantity requirement.
-  **MORE ENGINEERING KNOW-HOW** . . . the research and design facilities of the world-wide, American-owned International Telephone and Telegraph Corporation assure continued product leadership.



Federal Telephone and Radio Company

A Division of INTERNATIONAL TELEPHONE AND TELEGRAPH CORPORATION
COMPONENTS DIVISION • 100 KINGSLAND ROAD, CLIFTON, N. J.
In Canada: Standard Telephones and Cables Mfg. Co. (Canada) Ltd., Montreal, P. Q.
Export Distributors: International Standard Electric Corp., 67 Broad St., N. Y.

DESIGNERS:
For information
about Federal
Selenium Rectifiers
—write Dept. F-537

FIRST METALLIZED

Exclusive New Design

paper molded plastic miniature tubular... EVER!

THE COMET

CREATED BY the thinking of tomorrow, Astron's newest capacitor gives you features never before possible. All the important operating characteristics of a metallized paper capacitor are combined with the absolute protection of a molded plastic shell and bonded seal... an Astron exclusive.

THE NEW Comet has the unique properties that add extra protection against overloads and momentary surges... small size and light weight due to metallized paper construction... low R.F. impedance... improved insulation resistance and dependable operation up to 125° C.

THE ATTRACTIVE bonded shell and patented seal are impervious to all extremes of heat, cold and moisture. Leads are locked in... can't pull or melt out. Clearly marked units completely immersion-proof... individually tested and guaranteed.

THE NEW Astron Comet can reduce your costs while saving space and weight... write for Bulletin AS-21 TODAY!

BE SURE TO SEE THE COMET AND OTHER

NEW SUBMINIATURE CAPACITORS AT

BOOTH #388 MARCH I.R.E. SHOW

ASTRON CORPORATION

255 GRANT AVENUE, E. NEWARK, NEW JERSEY

Export Division: Radio International Corp. (R. E. 49 St.) (N. Y. City, N. Y.)
In Canada: Central W. Electric & Airline Ave., Toronto 10, Ontario



are you ready for

COLOR TELEVISION ?

Optical can supply all types of high vacuum equipment in laboratory or industrial sizes.

- Automatic TV tube aluminizer
- Complete high vacuum units
- Oil diffusion pumps
- Package pumping systems
- Aluminizing equipment
- Specialized exhaust systems
- Optical coatings
- High efficiency mirrors
- Electrically conductive transparent coatings
- Dichroic beam splitter and low reflection films



Write for literature giving detailed information.

Visit Our Display, 865 Audio Ave., IRE Show



OPTICAL FILM ENGINEERING CO.

2731-37 North Sixth St. • Philadelphia 33, Pa.

pressurized cases
for sealing
electronic systems

BOOTH #307
COMPUTER AVE.
I.R.E. SHOW

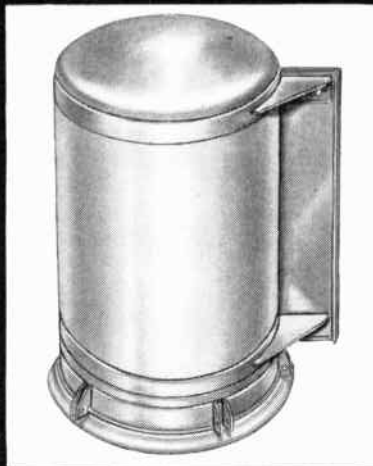

Specialists in producing pressurized cases in any sizes or shapes to meet your most minute specifications. Also processors of MU-Metal in cones, shields, housings and baffles, as well as other components.

Henry and Miller Industries, Inc. have been producing components for major companies for over 10 years. We'll be glad to consult with you without obligation.

ARMY-NAVY CERTIFIED

HENRY AND MILLER INDUSTRIES, Inc.

675 Garfield Avenue

Jersey City, N. J.

ELECTRONIC AND METAL FABRICATORS, MACHINISTS, WELDERS, PRECISION ANODIZERS, PLATERS AND PAINTERS

World Radio History

What to See at the Radio Engineering Show

(Continued from page 226A)

INCO, 173-272 Transistor Way
See International Nickel Co., Inc.

I-T-E Circuit Breaker Co., 576 Components Ave.

Sub-miniature precision wire-wound potted resistor networks; precision wire-wound resistors; power wire-wound resistors; both fixed and adjustable; receiver type deflection yokes; vidicon camera deflection yokes; 21" metal television picture bulbs for color TV.

Illinois Condenser Co.
422 Electronic Ave.

*"Illini Ste-Tite" type ITC, ceramic cased tubular paper capacitors. *Miniature and sub-miniature electrolytic capacitors for new miniaturized circuitry. *Electronic Flash Kit featuring new low-voltage design.

Illinois Tool Works, 739 Airborne Ave.
See Shakeproof, Div. of Illinois Tool Works

Imtra Corporation, 97 Palace
See General Electric Co., Ltd. of England

Indiana Steel Products Co., 523 Components Ave.

Hyflux Alnico V Permanent Magnets for loudspeakers, radar, electronic equipment, on display with Cunife and Indox ceramic magnets. Also featured: Free "On-the-Spot" Design Assistance with magnet problems.

Induction Motors Corp.
WESTBURY
LONG ISLAND
734 AIRBORNE AVENUE
Servo, Gear, Blower, Actuator and Torque Motors: synchronous and non-synchronous in ratings from 1/1000 to 1/10 horsepower.

Industrial Accessories, Inc., 91 Palace
*Hermetic Seals using synthetic rubber in their construction. *Catalog of approved seals in sizes for components, used by the military, effecting amazing economy.

Industrial Hardware Mfg. Co., Inc.
579 Components Ave.

Laminated sockets, terminal strips, wired assemblies, bakelite stampings, anode connectors, molded high voltage sockets, laminated printed circuit sockets.

Industrial Instruments, Inc., 637 Circuits Ave.

Automatic Helixing Film Type Resistors, Portable Cable Harness Tester, Unique Portable Low Resistance Ohmmeter, General Line of Electrical Test Equipment.

Industrial Laboratories Pub. Co., 322 Computer Ave.

We will have on exhibit our three magazines, INDUSTRIAL LABORATORIES, INDUSTRIAL SCIENCE & ENGINEERING, and WESTERN ELECTRONIC NEWS.

*Indicates new product

(Continued on page 230A)

At the I.R.E. SHOW!
BOOTHS #293, 295
INSTRUMENTS AVE.
Kingsbridge Armory
New York City
March 21-24, 1955

EXPANDED SCALE, THREE BANDWIDTHS ENABLE FASTER, MORE ACCURATE VSWR MEASUREMENTS



Speed up production of microwave components through faster, more accurate reading of low VSWR. An expanded meter scale is provided on the PRD Type 277 Standing Wave Indicator for readings up to 1.3. Choice of not one, nor two, but three bandwidths allows greater flexibility in the choice of modulation. The narrow and broad band positions are useful when the modulator is less stable or accurate and for convenience in making preliminary adjustments in the test setup. The very narrow bandwidth, on the other hand, permits operation with minimum noise and interference. These features, coupled with high gain and wide range of input levels, make this instrument extremely versatile. Only \$235.00 f.o.b. New York. Write for complete new catalog of precision microwave and VHF-UHF test instruments and components.

SPECIFICATIONS

	Very Narrow Band	Narrow Band	Broadband
Center Frequency (cps)	1000 ±2%	1000 ±2%	350-2500
Bandwidth (cps)	15	50	
Sensitivity for Full Scale Deflection (μv)	0.3	1	4
Noise Level (μv)	0.03	0.06	0.4
Range of Input Level (db)	70	70	70
	Db	0 to 10	
Meter Scales	Expanded	VSWR 1.0 to 1.3	
	Normal No. 1	VSWR 1.0 to 4.0, 10 to 40, etc.	
	Normal No. 2	VSWR 3.2 to 10.0, 32 to 100, etc.	
Input Selection	(1) Crystal; (2) Bolometer, 4.5 ma bias;		
	(3) Bolometer, 8.75 ma bias; (4) 75,000 ohm impedance.		

Polytechnic

RESEARCH

& DEVELOPMENT CO. INC

202 TILLARY ST.
BROOKLYN 1, N.Y.
Telephone
ULster 2-6800



Midwest Sales Office:
1 SO. NORTHWEST HWY., PARK RIDGE, ILL. — TAICot 3-3174
Western Sales Office:
741½ NO. SEWARD ST., HOLLYWOOD 38, CAL. — HO 5-5287

See this and other
Edison Developments
at the
IRE Show, Booth 677



The Edison Control Relay Amplifies Power 500,000 Times

The Edison Control Relay Amplifies Power 500,000 Times

New Edison Control Relay Amplifies Power 500,000 Times

New Edison Control Relay Amplifies Power 500,000 Times

New Edison Control Relay Amplifies Power 500,000 Times

New Edison Control Relay Amplifies Power 500,000 Times

New Edison Control Relay Amplifies Power 500,000 Times

New Edison Control Relay Amplifies Power 500,000 Times

Edison Control Relay Amplifies Power 500,000 Times

Control Relay Amplifies Power 500,000 Times

Relay Amplifies Power 500,000 Times

Amplifies Power 500,000 Times

Because there is an amplification factor of approximately 500,000 between the input power to the operating coils and the load capacity of its own contacts, Edison's Magnetic Control Relay actually eliminates the need for electronic boosting—operates *directly* from a thermocouple, photocell, or from vacuum tube currents. Yet this precision instrument stands up even under the shock and vibration of aircraft service.

Designed and developed in the world-famous Edison Laboratory, this small relay has features of particular interest to designers of electronic equipment.

Low power operation—Standard types operate at as low as 30 microamperes—do not drain

power from other circuit components, such as gyro motors.

Versatility—Coils can be supplied with resistances from 0.5 to 20,000 ohms. Differential operation is made possible by separate connections from each coil with polarized operation as an inherent characteristic.

Stability—Test relays have exceeded 8,000,000 cycles without calibration change.

Rugged Movement—Dissipates overloads up to 10,000 times normal operating input—withstands 50 g shock in all planes (unenergized).

Contacts—Platinum-iridium wire, either SPST or SPDT, with capacity of ½ ampere at 28 volts d.c. non-inductive.

Write us—especially if you are now using a single-stage electronic amplifier—for more complete information.

Thomas A Edison

A GREAT NAME CONTINUES GREAT NEW ACHIEVEMENTS

Thomas A. Edison, Inc.

INSTRUMENT DIVISION • 62 LAKESIDE AVENUE • WEST ORANGE, NEW JERSEY

What to See at the Radio Engineering Show

(Continued from page 229A)

Industrial Products Co., 703, 800 Production Rd.
See Danbury-Knudsen, Inc.

PHAZOR

**BOOTH NO.
309
COMPUTER AVE.**

Features the new in Phase Meters, Null Meters, Impedance Comparators, Power Oscillators and other Electronic Test Equipment.

**Industrial Test Equipment Co.
NEW YORK, N. Y.**

Industrial Timer Corporation, 100 Palace Synchronous motor-driven timers; interval timers, time delay timers, single-cycle and recycling multi-cam timers. Running time meters. *Motor driven, multi-circuit sequence switches.

Industrial Transformer Corp.

31 Palace

Custom transformers to military and commercial specifications. Audio, power, and pulse. Open type, encapsulated, and hermetically sealed. Subminiature, class A, class B and class H.

Infra Electronic Corp., 9 Palace Precision Synchros, Servos, Gearhead Motors, High Temperature Servos. Turns Measuring Set, Phase Angle Measuring Set, and Electro-mechanical Test Equipment and Instrumentation.

INSTRUMENT COMPONENTS INC.

14-34 112th St., College Point, N.Y.
Division of BELOCK INSTRUMENT CORP.

7 Palace

- manufacturers of a complete line of precision electro-mechanical servo components including:
- precision differentials
- precision gears
- high speed magnetic clutches
- gear reduction heads for servo motors

Instrument Specialties Co., Inc.

867 Audio Ave.

Complete assortment of beryllium copper contact finger strips, split rings, compression coil springs, and custom made flat springs.

(Continued on page 233A)

FIRST AID ROOM

A nurse is in charge at all times. First Aid Room is the sixth room to right of Lobby directly off registration area in Kingsbridge Armory.

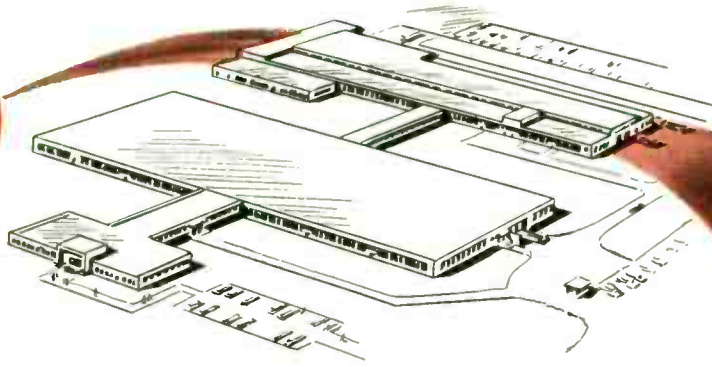

Servo Amplifiers
 Electronic Chassis
 Gear Assemblies
 Instrumentation
 Sheet Metal Cabinets
 Gyros Radar
 Computers

Precision Parts To Products Weighing Tons

... A Range Of Unusual Versatility!

From Drawing Board To Finished Product

... All Under One Roof!

In Daystrom's 350,000 sq. ft. plant the very finest modern machinery and equipment has been acquired for the manufacture, assembly and test of these products. Daystrom's research, development, engineering and manufacturing specialists have a collective experience that embraces electronics, nuclear instrumentation, computing and electro-mechanical devices. To supplement these creative skills Daystrom also has specialists in metallurgy and welding, as well as organic and plated finishes. Daystrom Instrument has earned its place in the expanding Daystrom Incorporated family.

**VISIT OUR
 BOOTHS**
**672-674
 CIRCUITS AVE.
 AT THE
 I.R.E. SHOW**

*DIVISION OF DAYSTROM
 INCORPORATED*

Radio Servo Controls
 Gun Fire Control Systems
 Ordnance Telescope Mounts
 Nuclear Instrumentation
 Precision Potentiometers
 Electrical Test Equipment

DAYSTROM INSTRUMENT

ARCHBALD, PENNA.

Affiliates: American Type Founders, Inc., Elizabeth, N. J.; Daystrom Furniture Div., Olean, N. Y.; Daystrom Electric Corp., Poughkeepsie, N. Y.; American Gyro, Santa Monica, Calif.; Heath Company, Benton Harbor, Mich.

the pioneer is the leader

DEMONSTRATING LEADERSHIP

in solving spectrum analysis problems for research, development and production



Pioneering in the field of spectrum analysis, PANORAMIC has risen to a position of leadership in producing instruments for laboratory, research and production applications that transform spectrum content into easily interpreted visual spectrographic displays.

Again, at the I.R.E. Show, PANORAMIC introduces *new* Panoramic Instruments of interest and importance to the electronic field. Be sure to see them.

SEE PANORAMIC at the I.R.E. show BOOTHS 230, 232

NEW

Panoramic Sub-Sonic Waveform Analyzer with exceptional frequency resolution capabilities offers the many advantages of the famous Models AP-1 and LP-1 Panoramic Sonic Analyzers.

NEW

Panoramic Indicator Model SC-8b Type T10,000 designed especially for applications demanding high sensitivity and flat frequency response. Maximum scanning width 10 MC, sensitivity 75 microvolts for full scale deflection.

NEW

An improved line of Model SA-8b Panadaptors and Model SB-8b Panalyzers significantly increased operational versatility. Special new features are continuously variable scan rate of 1 cps to 60 cps . . . linear, log and square law amplitude scales . . . internal or external synchronized sweep rates.

NEW

Marker Generator designed for use with the Models AP-1 and LP-1 Panoramic Sonic Analyzers. Output: 60 cps, 500 cps with harmonics up to 3000 cps and 5 KC with harmonics up to 20 KC.

NEW

Panoramic Simultaneous 11 Point Calibrator, Model TMC-211, designed for high speed automatic checkout of FM/FM Telemetering subcarrier Discriminators. A single space saving rack mount chassis provides two channels. Combine two or more chassis to assemble a system to suit your specific needs.

AT WORK ON YOUR PROBLEMS . . .

PANORAMIC THE PIONEER provides instruments of unsurpassed excellence. Panoramic's specialized models covering sub-sonic to microwave frequencies speed and simplify analysis of waveform distortions, sounds, vibrations, spurious oscillations or modulation, response characteristics of filters or transmission lines characteristics of AM, FM or pulsed signals, or monitoring many frequency channels simultaneously.

A Panoramic Analyzer can provide the answer to your problems.

Inquiries invited on Panoramic Spectrum Analyzers for Special Problems.

If you cannot attend the show, write for information on Panoramic's *new* and important instruments.
12 South Second Ave., Mount Vernon, N.Y.
MOUNT VERNON 4-3970



Veco Thermistors also are sensitive to temperature!

These versatile sensing elements are resistors with a high negative temperature coefficient of resistance — temperature goes up — resistance goes down. This characteristic makes thermistors useful components in electronic circuits as temperature compensators, surge suppressors, voltage regulators, automatic gain controls, etc.

They are used also as sensing elements in high speed thermometry and temperature control for which they are available in a multiplicity of forms such as small beads, rods, discs, washers, glass, plastic or metal probes, or even embedded in the tips of hypodermic needles! Because of their extremely small size, they assist in miniaturization.

To find out how "VECO" thermistors can improve your products, write for free information. New M-168 kit of 6 thermistors and 1 varistor with suggested circuitry. \$5.00 postpaid, or available at electronics parts wholesalers.

See us at the IRE Show
Booths 657, 659 Circuits Ave.

Victory Engineering Corporation

Springfield Road, Union, New Jersey
Tel. UNIONVILLE 2-7150



THERMISTORS • VARIATORS
TEMPERATURE SENSING DEVICES
ELECTRONIC AND THERMAL
CONTROL INSTRUMENTS

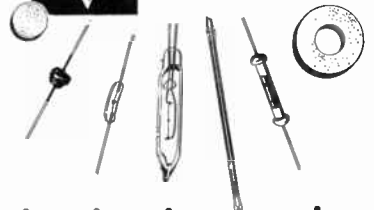

What to See at the Radio Engineering Show

(Continued from page 230A)

Instruments for Industries Inc.

741 Airborne Ave.

Series M 200 Miniature I-F Amplifiers, Model 400 High Power Distributed Amplifier having 100 watts CW Output 50 to 300 mcs. *Unique Modular Plug-in Electronic Chassis. *Broad-Band All Channel Television Amplifier.

Instruments Publishing Co., Inc., 218 Instruments Ave.

"Instruments & Automation." Magazine and books on instrumentation, automation, research.

Instruments Sales Corp., 788 Airborne Ave.

See Bourns Labs.

Insulated Circuits, Inc.

18 Palace

Printed wired boards. Printed circuit commutators and switches (raised and flush). Micro strip (microwave components). Printed circuit assembly. We feature carry-thru holes for continuity top to bottom.

Insulating Fabricators, Inc., 47 Palace

Fabricates and distributes all families of Plastics, which are used for electronic insulation, from the oldest vulcanized fibre to the newest Kel-F, Teflon and epoxies.

Insuline Corp. of America, 430 Electronic Ave.

Electronic Housings and Components; standard and custom made metal enclosures; special electronic assemblies.

INTERNATIONAL BUSINESS MACHINES CORPORATION

77, 79 Palace

World's Leading Producer of
Electronic Accounting Machines

*Indicates new product

(Continued on page 235A)

Radio Engineering Show

For a preview of products to be exhibited at the Radio Engineering Show, consult the advertisements in this issue. Advertising exhibitors are listed in boxed display "adlets".

233A

DEPEND ON

CLIFTON SIZE 10 SYNCHROS

for *Consistent*
HIGH ACCURACY

Error Spread
Curve for a
typical month's
production of
transmitters.

- Average Error Spread 7
- Average Max. Error from EE about 5
- Average RMS Error under 3
- GUARANTEED Maximum Error Spread 12*

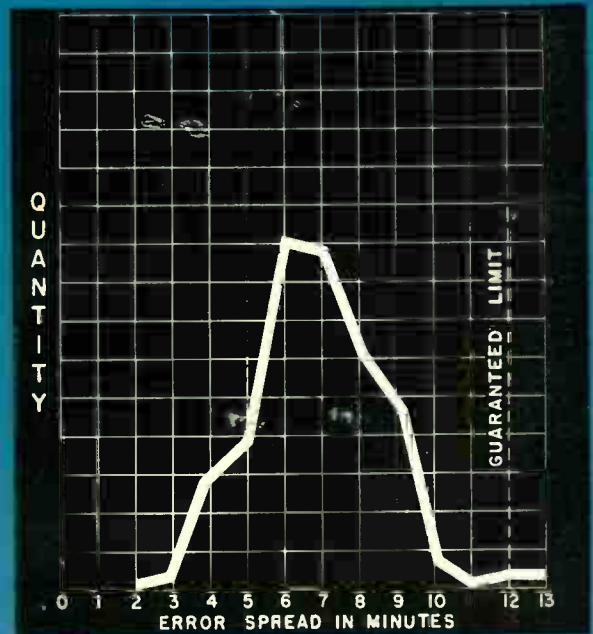

ACTUAL SIZE



Visit the exhibit at our Belmont Plaza Hotel suite
NAT'L I.R.E. CONVENTION
New York City, Mar. 21-24

IMMEDIATELY AVAILABLE

For full engineering information on transmitters, receivers, resolvers, differentials and control transformers, and complete lines of Size 11 and 15 synchros also immediately available, write or telephone T. W. Shoop, Sales Mgr. (Telephone Phila.) MAdison 6-2101.

West Coast Rep. Wm. J. Enright, 988 W. Kensington Rd., Los Angeles. MUtual 6573.

LOOK TO CPPE FOR

cppe

SYNCHRO PROGRESS

CLIFTON PRECISION PRODUCTS CO. INC.
CLIFTON HEIGHTS PENNSYLVANIA

* **SEE** the ADVANCED features of this 2100 Series **MULTIPOLE RELAY**

* at Booth 793 - Airborne Ave. I.R.E. SHOW **KINGSBRIDGE ARMORY, NEW YORK CITY**
KINGSBRIDGE PALACE MARCH 21-24, 1955

SPECIAL CONSTRUCTION AND ADVANCED DESIGN FEATURES PROVIDE LONG LIFE AND HIGHLY EFFICIENT OPERATION

Designed to meet requirements of military specifications and Underwriters Laboratory standards

PIN-TYPE HINGE FOR LONG LIFE

See the latest in subminiature relay development.

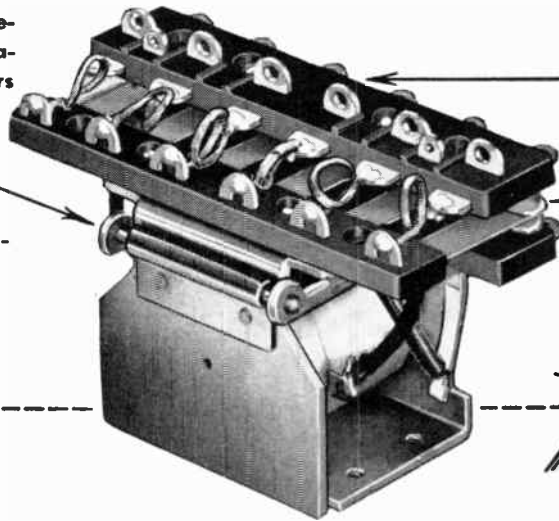

CONTACTS PERMANENTLY MOLDED IN THERMOSETTING PLASTIC... Always perfect adjustment

LARGE-SIZE CONTACTS IDEALLY SUITED FOR MOTOR STARTING AND LAMP LOADS



Price Electric
CORPORATION
FREDERICK, MARYLAND

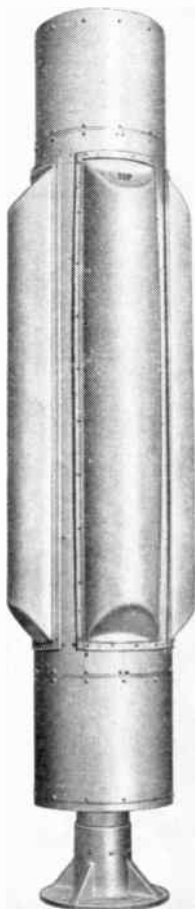

The Type 2602-E **VOR antenna*** *has these important advantages*

- ▶ no moving parts
- ▶ can be installed in a few hours
- ▶ no field adjustments
- ▶ used successfully both in the U.S.A. and in other countries
- ▶ frequency range — 108 mc to 118 mc
- ▶ shipped completely assembled, and tuned when frequency is specified
- ▶ can be readily retuned to any frequency within its range
- ▶ net weight — approximately 140 lbs.

Write for Bulletin R-255

*Original model was developed for the Air Navigation Development Board.

AMCI ANTENNA SYSTEMS — COMPONENTS — AIR NAVIGATION AIDS — INSTRUMENTS
ALFORD Manufacturing Co. Inc.
299 ATLANTIC AVE., BOSTON, MASS.

SHEET METAL

CABINETS • FRAMES • CONSOLES
WELDMENTS • CHASSIS • PANELS
BRACKETS • CLAMPS • STAMPINGS
ETC.

MACHINE PARTS

TOOLS • DIES • FIXTURES • JIGS •
GAGES • SCREW MACH. PROD. • GEN.
MACH. WORK • ETC.

Experimental and Production

Government certified source for spot-welding,
arc and heli-arc welding

Aluminum Magnesium Steel

Foremost in the field for:—
Close tolerance metal fabrication

Widely recognized for:—
Fine quality control methods & standards

More than ten years experience with
components for aircraft
and electronics controls

**WHEN YOU BUY EUGENE
YOU BUY ALL THREE**

QUALITY PRICE DELIVERY

Eugene Engineering Co., Inc.
1217 Hyde Park Avenue
Hyde Park 36, Mass.

What to See at the Radio Engineering Show

(Continued from page 233A)

International Electronic Research Corp.

813 Audio Ave.

Features I.E.R.C. standard heat dissipating vibration resistant shields for electron tubes—*specialized shields for special purpose power tubes—transistor clips—vibration testing equipment.

International Electronics Corp.

841 Audio Ave., Theatre II

Receiving, audio and special purpose electron tubes for industry and communications, including cold cathode tubes, trigger, voltage reference, stabilizing, flash tubes, photocells, diodes, transistors, etc. Equipment for research and industry, ultrasonic equipment, electro-chemical equipment.

International Instruments, Inc., 763 Air- borne Ave.

Complete line miniature electrical panel instruments, including *modernly styled Side Indicators, giving maximum readability with minimum panel space. Ruggedized, military and commercial models.

International Nickel Co., Inc., 173, 175, 270, 272 Transistor Way

Uses of nickel and high nickel alloys in automation, ultrasonics, and lighting with emphasis on new developments made possible through "Nickel . . . The First Metal in Practical Electronics."

International Pump & Machine Works, 784 Airborne Ave.

Vacuum Pumps and Vacuum Equipment.

International Radiant Corp.

826 Audio Ave.

Member E.E.I. (Environmental Equipment Institute). Manufacturers of Environmental test equipment. Be sure to stop at Booth 826 to see one of our machines in operation and to obtain one of our new 1955 Catalogs.

International Rectifier Corp.

730 Airborne Ave.

Latest developments in industrial selenium and germanium power rectifiers, miniature rectifiers, color TV rectifiers, high voltage cartridges, selenium and germanium diodes and selenium sun batteries.

* Indicates new product

(Continued on page 237A)

A PARTIAL LIST FROM CURRENT RECORDS...

ELECTRONIC MANUFACTURERS . . . *Admiral Corporation *Air Associates Bell Sound System *Bendix Aviation Corporation Allen D. Cardwell Co. Eclipse-Pioneer *General Electric Co., Holyoke Mass.; Utica, N.Y.; Johnson City, N.Y.; Cincinnati, Ohio Hoffman Radio Corporation Melpar, Inc. *Motorola, Inc. Northern Electric Co., Ontario, Canada *Radio Condenser Co. *Radio Engineering Labs., Inc. Raytheon Mfg. Co. *R.C.A., Bloomington, Ind.; Browns Mills, N.J.; Camden, N.J.; Harrison, N.J.; Lancaster, Pa.; Moorestown, N.J.; Los Angeles, Calif. *Sperry-Gyroscope Co. *Stewart-Warner Electric Co. Sylvania Electric Products Co. Western Electric Co. *Westinghouse Electric Corporation, Buffalo, N.Y. Air Arm Div. Westinghouse, E. Pittsburgh, Pa. *Westinghouse Electronics Div. Baltimore Philco Corporation Avionex Electronics Corporation General Precision Laboratory Radio Engineering Laboratories, Inc.

AVIATION COMPANIES . . . *Boeing Aircraft Co. *Chance-Vought Aircraft Consolidated Vultee Aircraft Grumman Aircraft Engineering Corporation Hughes Aircraft Co. Republic Aviation Corporation Temco Aircraft Corporation Douglas Aircraft Co. Air Research Aviation Co. Airborne Instrument Laboratories Glenn L. Martin Co. Lockheed Aircraft Corp.

U. S. GOVERNMENT AGENCIES INCLUDING: *Buair Bureau of Yards and Docks *USAF U. S. Coast Guard U. S. Radiological Laboratories *Civil Aeronautics Administration *Signal Corps National Bureau of Standards Corps of Engineers.

UNIVERSITIES . . . *Massachusetts Institute of Technology University of California New York University

MISCELLANEOUS . . . Bell Laboratories Bell Sound Laboratories Bertke Electric Co. Carbide & Carbon Chemical Div. City of Rochester, N. Y. Eastman Kodak Co. E. I. duPont de Nemours & Co. International Electronic Engineering, Inc. Manning-Maxwell-Moore Allison Division of General Motors Corp. California Research Corporation General Electric Co., Utica, N. Y. Fluor Corp. Ltd. Drake-Merritt J. A. Construction Plus rooms sold to electrical contractors, State and Municipal agencies

*designates organizations that have made repeated purchases

**MULTI-CELL
Shielding
Rooms**

SHIELDING, Inc. *

customers are a

"Who's Who"

of American Industry,

Science and Government Agencies

*Complete list on request.

Screen or solid enclosures with attenuation characteristics—

**MIN 100DB from .10
to 10,000 MC and HIGHER**

Critically tested and rated by the most authoritative methods. Easily moved, enlarged, decreased, modified by the use of exclusive, own design, interchangeable panels and doors. Wide choice of filter panel locations, filters, ventilating entries, laboratory benches, illumination, etc. (To fit your specific problem!). Erected anywhere by our trained crews—or do-it-yourself from clear instructions supplied. Catalog with valuable data mailed on request.

FOR MILITARY USE
SPECIFY

**MIL-E-4957A
(ASG) NOV. 1954**

(Joint USAF &
US NAVY BUAER
Specifications for
shielded enclosures)



"The talent to create—
The skill to produce."

SHIELDING, INC.

RIVERSIDE, N. J.

Phone: HObart 4-1202

CULVER CITY, CALIF.

3895 MAIN ST.

Phone: TEXAS 0-3213

How to Measure Vacuum from 1000 to .0001 mm. Hg.

Quickly, Easily, Accurately with ONE Trouble-free Gauge

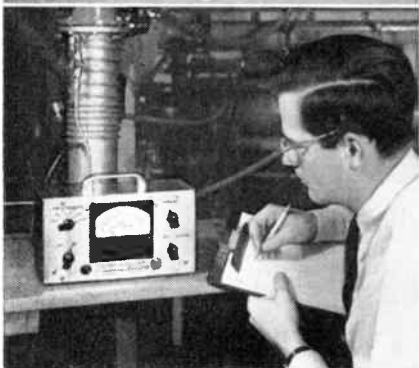

The AC-operated Model 517, newest of the Alphanon® Vacuum Gauges, with 6 ranges covering pressures from 1000 to .0001 mm. Hg. Price: \$425.

The Model 517 Alphanon® Vacuum Gauge provides continuous accuracy, instantaneous response, and linear measurement over the widest range of any AC-operated vacuum gauge. It has a connection for recorder or controller. This gauge is also an efficient, low cost leak detector.

Another new addition to the Alphanon line is the AC-operated Model 515 with a four-decade logarithmic scale covering ranges from 10 to .001 mm. Hg. Price: \$225.

Send for Data Sheets on our complete line of vacuum gauges and accessories.



NARESCO EQUIPMENT CORPORATION

Equipment Sales Subsidiary of National Research Corporation

103 Charlemont St., Newton Highlands 61, Mass.

Please send me Data Sheets:

- Model 517 Alphanon® Vacuum Gauges
- Model 515 Alphanon® Vacuum Gauges
- All other NRC Vacuum Gauges

Name _____ Title _____

Company _____

Address _____

City _____ State _____

SALES OFFICES: Boston, Chicago, Cleveland, Los Angeles, New York, Palo Alto, Philadelphia; in Canada: Toronto, Amrpor

FOR TRANSISTOR APPLICATIONS

TUBELESS HIGH CURRENT SUPPLY

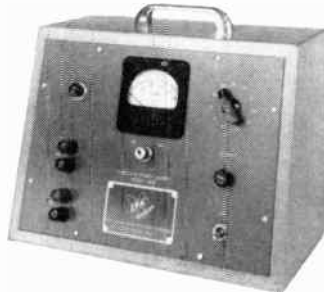

The Model 30 Tubeless Supply is a portable, variable low voltage, high current DC/AC power supply designed especially for high amperage applications. Ideally suited for high power transistor amplifiers, regulated AC or DC filament supply, solenoid and magnetic clutch operation, AC motor control, and all types of high current AC or DC laboratory and factory applications.

Specifications

Input 100-125v, 60 cps
 Output Voltage 0-30 volts DC or 0-130 volts AC
 Output Current 1.5 amperes max., 30 va capacity
 Line Regulation
 Less than $\pm 1\%$ change in output for 100-125v input
 Load Regulation Internal DC imp. less than 2 ohms
 Ripple Less than 1% for DC output
 Hardwood Case, 8" x 11" sloping panel

For Additional Information Write for Bulletin PS

See our line of transistor instruments and miniaturized components at Booth 216, Instruments Ave., I.R.E. Show.

Model 30M, illustrated ... \$117.50
 Model 30 \$ 97.50
 All prices F.O.B. Nutley, N.J.

Sales Engineers in all Areas



ELECTRONIC RESEARCH ASSOCIATES, INC.

MAILING ADDRESS: BOX 29, CALDWELL, NEW JERSEY

67 EAST CENTRE STREET, NUTLEY, N.J.

Nutley 2-5410

Need special transformers fast?

You can get them from us, engineered to your specifications and produced faster than you may think possible.

Our staff of design engineers have long experience in communications. They know how to design around special problems of size, weight, high voltage or temperature; and they understand over-all circuit requirements. They can design what you need.

And our manufacturing and inspection facilities can put the engineers' design into quality-controlled production in a remarkably short time.

When you have a transformer problem, call on



Dept. PI-3, Caledonia, N. Y.

What to See at the Radio Engineering Show

(Continued from page 235A)



INTERNATIONAL RESISTANCE CO.
Phila., Pa.
553 and 555 Components Ave.

IRC will display Automation Machinery in addition to its standard line of Resistors and Controls, including new smaller sizes of Molded Deposited and Boron Carbon Resistors • Power Types • Chokes • Encapsulated Precisions • Precision Potentiometers • Hermetic Seal Terminals • Varistors • Selenium Rectifiers and Printed Circuits.

International Television Corp., 623 Circuits Ave.
See Colortone Electronics, Inc.

J-B-T Instruments, Inc., 205 Instruments Ave.

Vibrating rod frequency meters including sealed types, rotary selector switches, JAN-S-23 toggle switches, lever action switches, temperature measuring instruments, elapsed time meters, including 400 cycle sealed type, reasonably priced. 2" ac abd dc electrical panel meters made by subsidiary Shurite Meters.



JFD MFG. Co. Inc.

Brooklyn 4, New York

Booth 123, TELEVISION AVENUE

Piston Capacitors, Military Communication Equipment, TV Antennas and Accessories.

Jackson Company, Byron, 92 Palace
*Rollin microwave signal generator employing automatic frequency stabilization. *Vibratron pressure-frequency transducer. *Rollin differential slotted line.

James Vibrapowr Company, 658 Circuits Ave.

Will exhibit full line of power vibrator, military vibrator power supplies, instrument choppers, coaxial switches and will introduce *line of tone generators and resonant relays.

Jan Hardware Mfg. Co., Inc., 83 Palace

*Controlled Torque-Safety Knobs with built-in slip clutches. *Shock Testing Machine to test the shock stress resistance of delicate electronic components, a totally new concept in Bezel Assemblies along with a wide variety of magnetic shields.



436 Electronic Ave.

Vacuum Capacitors, Fixed and Variable Types. Vacuum Relays for DC, 60 Cycle and rf Circuits. High Voltage Vacuum Tube Voltmeter.

*Indicates new product

(Continued on page 239A)

Show Hours: Monday 10 AM-10 PM
Tuesday 10 AM-10 PM
Wednesday 10 AM- 5 PM
Thursday 10 AM-10 PM



"CLIP-TYPE"
closed entry socket contact
now standard in

BENDIX SCINFLEX ELECTRICAL CONNECTORS



Cannot be overstressed—eliminates intermittent circuit problems resulting from socket contact malfunction.

The heart of any electrical connector is the socket contact. This is why the Bendix-Scinflex* socket contacts have always been machined from bar stock. Stampings, with their required thin sections, can be easily overstressed.

Even with the machined sockets, industry has been plagued with overstressed spring leaves due principally to the misuse of test probes and lax tolerances on pin contacts. Bendix engineers have now provided the only socket contact on the market today which completely eliminates all these problems.

The "Clip-Type" socket will not accept any oversize probe or pin nor can one be forced into it. Also, no amount of wrenching or twisting of an acceptable pin or probe can possibly distort the spring clip. This new socket is now standard in all Scinflex connectors including those using solderless, high-temperature and thermocouple contacts.

Our sales department will be glad to furnish complete information on request.

*TRADE-MARK

SCINTILLA DIVISION of



SIDNEY, NEW YORK

Export Sales: Bendix International Division, 205 E. 42nd St., New York 17, N. Y.

FACTORY BRANCH OFFICES: 117 E. Providencia Ave., Burbank, Calif. • Stephenson Bldg., 6560 Coss Ave., Detroit 2, Michigan • 512 West Ave., Jenkintown, Pa. • Brouwer Bldg., 176 W. Wisconsin Avenue, Milwaukee, Wisconsin • 8401 Cedar Springs Rd., Dallas 19, Texas • American Bldg., 4 S. Main Street, Dayton 2, Ohio • 1701 "K" Street, N. W., Washington 6, D. C. • Boeing Field, Seattle 8, Washington.

COLOR TV - UHF VHF

**TESTING
EQUIPMENT**



VHF - UHF BALUNS
Complete line of baluns matching 50 or 75 ohms to 300 ohms over VHF and UHF TV Bands with negligible insertion loss and SWR less than 1.2.

Designers

and

Manufacturers of

- UHF TRANSFORMERS
- UHF BALUNS
- UHF WAVEMETERS
- UHF GRID-DIP OSC.
- UHF REFLECTION BOX
- VHF BALUNS
- VHF REFLECTION BOX
- TERMINATIONS
- LO-C OSCILLOSCOPE
- SQUAREWAVE GENERATOR
- NOISE FIGURE TEST SET
- VIDEO LINE AMPLIFIER



UHF WAVEMETER
Unique coupling loop permits coupling to normally inaccessible circuitry. Cavity tuned. No sliding contacts. Microometer indication.



LO-C OSCILLOSCOPE
Probe Head and Wide Band Amplifier (12 mc) Provides negligible circuit loading (less than 2mmf) Greatly extends usefulness at any as cilloscope.



LA-2 VIDEO LINE AMPLIFIER
Specifically designed to handle color signals without compression. Choice of output polarity. Ideal for production line use.

HF-10 SQUARE WAVE GENERATOR
Wide range (5 cy to 5 mc) Fast rise time. Adjustable symmetry.



UHF GRID-DIP-METER
Small coupling loop permits ready exploration of tuning elements. Invaluable aid in design of UHF tank circuits.

ON DISPLAY

#786 BOOTH

or write Dept. R-5

LINEAR EQUIPMENT LABORATORIES INCORPORATED

380 OAK STREET, COPIAGUE, N.Y.

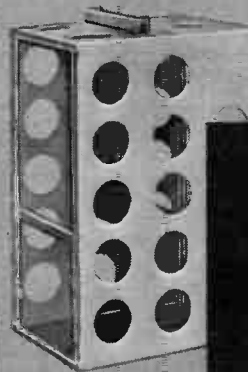
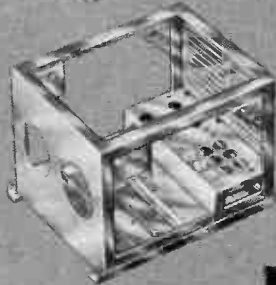
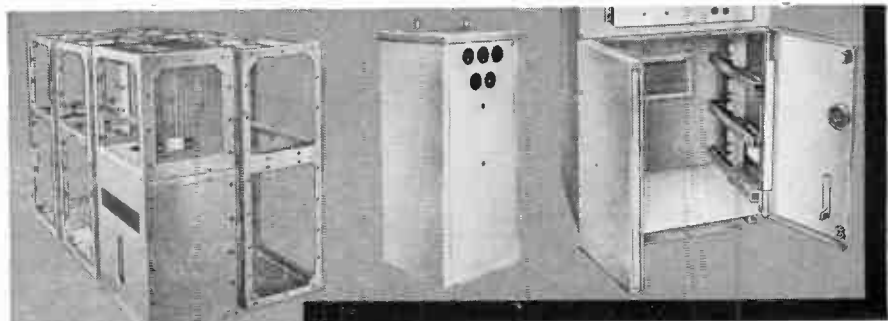

FALSTROM SHEET METAL FABRICATORS
chassis, cabinets housings, enclosures, etc.

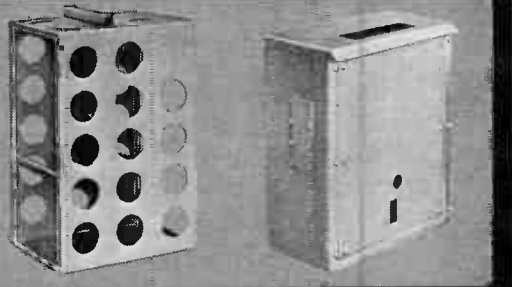

Falstrom has the quick, accurate, low cost answer to your instrument mounting needs, regardless of shape, size, metal (aluminum, steel, stainless steel, etc.) or finish . . . regardless of whether you need one unit or thousands!

Design to assembly—Falstrom handles the complete job under one roof. Falstrom engineers are highly experienced; Falstrom facilities are modern. And—wherever possible—Falstrom makes use of standard production techniques, stock tools and dies—to eliminate unnecessary costs!

Ask for quotes on your blueprints, samples or sketches—no obligation. Contact Falstrom now—write, wire or phone for your illustrated Falstrom catalog #142-B.

FALSTROM MEANS IT'S THAT MUCH BETTER!

FALSTROM

FALSTROM COMPANY, 93 Falstrom Court, Passaic, N. J. PRescott 7-0013 Since 1870

**What to See at the
Radio Engineering Show**

(Continued from page 237A)

**Howard B. Jones Div.
Cinch Mfg. Corp.**

394-396 Broadcast Way

Multi-contact plugs and sockets—
barrier terminal strips—fanning
strips—terminal panels—fuse mounts.

**M. C. Jones Electronics Co.,
Inc.**

685 Circuits Ave.

Standing Wave Ratio and RF Power
Measuring Equipment—RF Absorp-
tion Type Wattmeters—Dummy Load
Resistor and new *Primary Standard
of RF Power.

**Kaiser Metal Products, Inc.
16 Palace**

Precision Digital Delay Generator to
measure and generate time intervals
at variable repetition rates. Accurate
to one part per million.

KARP METAL PRODUCTS CO.

Div. of H & B American Machine Co., Inc.

349 Computer Ave.

Specialists in engineered
sheet metal enclosures for
electronics. Cabinets, racks,
chassis at low cost. Complex
units produced entirely with
stock tooling. Advanced
welding, finishing tech-
niques.



C. B. Kaupp & Sons

720 Airborne Ave.

Precision formed metal components
for prototype including economical
"Hydroformed" parts for develop-
ment.

(Continued on page 241A)

**Busses every eight minutes
Kingsbridge to Waldorf Astoria**

FREE

**ANOTHER
Carter
FIRST** **EXCLUSIVE!**

Carter DUOVOULT GENEMOTORS



**DC to AC
CONVERTERS**

Operate recording and
audio equipment from 6
to 115 volts DC.

**NEW 6/12 DYNAMOTOR POWER FOR 60 WATT
144-176 MC MOBILE RADIO TRANSMITTERS**

Now, Carter engineering solves the 6/12 volt change-
over problem in mobile radio installations. For, with
Carter 6/12 v. DUOVOULT power, standard communica-
tions equipment can be used in ANY automobile . . .
in NEW CARS with 12 volt batteries or older models
with 6 volt circuits.

To everyone who buys, sells, uses or services mobile
radio, it's good sense to specify DUOVOULT power. Then,
you're sure of 6/12 versatility combined with the proven
dependability of rotary dynamotor power.



**CHANGE-A-VOLT
DYNAMOTORS**

Adapt 6 volt mobile ra-
dio to 12 volt cars.

Carter 6/12 v. DUOVOULT genemotors draw minimum
current, operate at high efficiency. Low r.p.m. speed
makes for longer life, cuts maintenance cost. Five models
provide adequate capacity for
even the most powerful 60
watt sets. Backed by 23 years
experience in mobile radio
power.

Mail Coupon

for bulletin 954A, perform-
ance charts, specifications and
prices.

Carter
2645 N. Maplewood Ave.
Chicago 47, Illinois

**ROTARY POWER
IS BEST**



In modern screw-driven
tow-boats, smooth RO-
TARY power has long
since displaced the vi-
brating pulsations of
the paddle wheel, just
like dependable RO-
TARY power has proven
best for mobile radio.



CARTER MOTOR CO.
2645 N. Maplewood Ave.
Chicago 47, Illinois

Please send Bulletin 954A, with performance charts,
specifications and prices of Carter Duovolt gene-
motors.

Name

Address

City..... State.....



**INDUCTOR
ALTERNATORS**

Provide 400 to 800 cycle
AC from DC input.

Stevens Wire starts with
the **finest . . . GARFIELD WIRE**

to end with the
the **best . . . SERVED WIRE**

Starting with GARFIELD Enameled Magnet Wire, the Stevens Wire Insulating Co., Chicago 30, Ill., produces only the finest in served wire

You start with the finest when you start with Garfield enameled wire, because our modern drawing and enameling equipment, our rigid production control and our stringent inspection system are geared to produce only top-quality wire with tolerances closer than NEMA specifications.

. . . and that goes for all Garfield wire: bare solid copper—concentric strand conductors—bunched copper conductors—tinned solid copper wire—bunched tinned copper conductors

Write for complete price lists and specification charts on all the Garfield Wires.

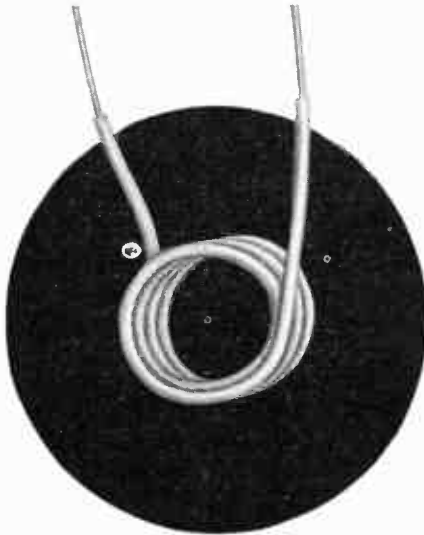

GARFIELD WIRE DIVISION

of The Overlakes Corporation

142 Monroe St., Garfield, N.J.

GRegory 2-3661—2

Bourns

sub-miniature

TRIMPOTS

TRADE MARK



PROVIDE
THE ULTIMATE
IN CIRCUIT
TRIMMING

Simple screwdriver adjustment . . .

The **TRIMPOT** is a 25 turn, fully adjustable wire-wound potentiometer, designed and manufactured exclusively by BOURNS Laboratories. Electrical settings in increments of 1/4 to 1/2% are securely maintained during vibration of 20 G's up to 2,000 cps or sustained acceleration of 100 G's. BOURNS' unique self-locking design eliminates cumbersome locknuts. Power rating is 1/4 watt at 100° F. Standard resistance values from 250 ohms to 25,000 ohms are available for immediate delivery. Information on higher and lower resistances on request.

BOURNS **TRIMPOTS** are accepted as standard components by aircraft and missile manufacturers and major industrial corporations.

9 **TRIMPOTS**
TAKE LESS
SPACE THAN
A 2¢ STAMP

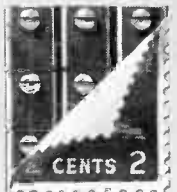

Tiny cross-sectional size—only 1/4" x 5/16"—and rectangular shape save valuable panel space. Instruments are easy to mount individually or in stacked assemblies with two standard screws through the body eyelets.

Bourns also manufactures precision potentiometers to measure Linear Motion; Gage, Absolute, and Differential Pressure and Acceleration.



Bourns
LABORATORIES

6135 MAGNOLIA AVENUE
RIVERSIDE, CALIFORNIA
Technical Bulletin On Request, Dept.

© B L PATENTS PENDING

SPECIFY

Lackon

Trade Mark

Dials • Panels • Scales

Made to the Highest Degree of Accuracy

Edgelit • Translighted • Backlit

Equip your instruments with sharp, easy to read Lackon dials, panels, etc. . . . made to any size . . . any shape . . . any quantity . . . accurate to your most critical tolerances . . . uniform and highly durable. Printed on metal, plastic, glass, etc., in black and white or multi-color. Passes all government tests. Send for illustrated brochure or contact:

SUN DIAL CORPORATION • Caldwell, N. J.

What to See at the Radio Engineering Show

(Continued from page 239A)

Kay Electric Co. 242-246 Instruments Ave.

Sweeping Oscillators • Marker Generators for Video, UHF & VHF Frequencies • Noise Figure Measurement & Gain Sets • Noise Generators, calibrated 5mc-26,500mc • Pulse Carrier Generators • VHF-UHF Low Power Color Transmitters • Color Bar & Dot Generators.

KAY LAB

San Diego
California

Electronics for Communication, Measurement, and Control

- Absolute DC Power Supplies
- DC Decade Amplifiers
- DC Microvoltmeters
- Industrial Television Systems
- Broadcast Television Systems

261, 263 Instruments Ave.

Kearfott Company, Inc. Little Falls, N. J.

156 Television Avenue

AIRCRAFT NAVIGATION SYSTEMS
AIRCRAFT INSTRUMENTS • SYNCHROS
SERVO MOTORS • TACHOMETER
GENERATORS • GYROS (FREE, RATE,
VERTICAL) • MAGNETIC AND SERVO
AMPLIFIERS • HERMEFLEX • ANGLE
COUNTERS • INDUSTRIAL SERVO SYSTEMS

Keithley Instruments, 66 Palace

Vacuum Tube Electrometers for use as dc voltmeters, kilovoltmeters, microammeters, micro-microammeters, megohmmeters, dc amplifiers, and static detectors.

Kemtron Electron Products, Inc., 479 Electronic Ave.

Diodes—microwave, television, computer, industrial instrumentation types. Special silicon and germanium semiconductor products. New and improved *computer type diodes: square law, linear-logarithmic, transient perfect.

Kennedy & Co., D. S., 64 Palace

Exhibiting scale models of 28 ft. and 60 ft. Parabolic Antenna Systems. Fiberglass Radomes and Reflectors. Radar Antenna Reflectors.



The latest in transformers
Miniature, Molded,
Cased, Oil Filled, T-Line,
Toroids, at Booth 541

KENYON TRANSFORMER CO., Inc.

840 Barry St., New York 59

*Indicates new product

(Continued on page 242A)

Good products
deserve
good
components

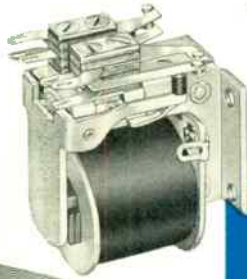
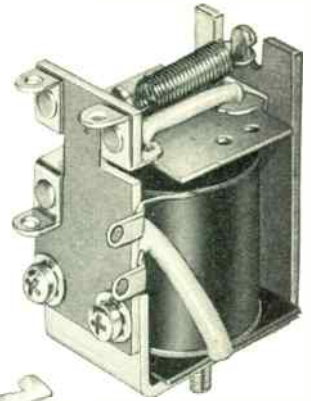

Comar
components
help
good products
perform better

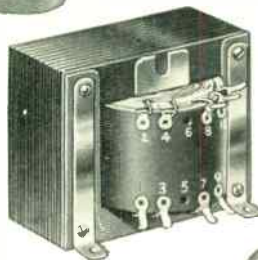

Visit Booth 314
The I. R. E. Show



RELAYS • SOLENOIDS • COILS • TRANSFORMERS • SWITCHES • HERMETIC SEALING

THIS BOOK DOESN'T

tell all

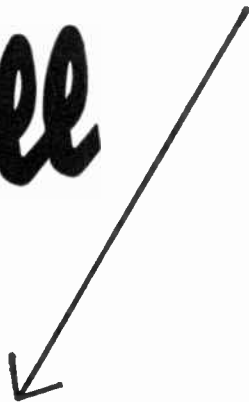

... but it's full of ideas you can use

SUCCESSFUL developments in the electronics field depend mainly on three things: ideas . . . experience . . . facilities. *This book is full of all three.*

Just a short request on your letterhead . . . or the coupon below . . . will bring this valuable book in the mail to you at once.

Thompson Products, Inc.

ELECTRONICS DIVISION • 2196 CLARKWOOD ROAD, CLEVELAND 3, OHIO

Thompson Products, Inc.
Dept. 51, Electronics Division
2196 Clarkwood Road, Cleveland 3, Ohio

Please send me a copy of Electronic Advancement.

Name _____ Title _____

Company _____

Address _____

City _____ Zone _____ State _____



What to See at the Radio Engineering Show

(Continued from page 241A)

Kepeco Laboratories

342, 344 Computer Ave.

Power Supplies

Frank Kessler Company

29 Palace

See World's Smallest
Sub-miniature Transformer

Kester Solder Company

521 Components Ave.

*Very latest development in Kester "Solderforms" (Preformed Solder) Nothing like it before! Washers, Discs, and Special Stampings of Solder that are FLUX-FILLED! No Other Flux Needed.

A Division of Norden-Ketay Corporation

Ketay LABORATORIES

Booths 629-631 Circuits Avenue

Synchros

Servo Amplifiers

Servo Motors

Airborne Instruments

Resolvers

Electronic Equipment

Keystone Electronics Company

736 Airborne Ave.

Quartz crystals of every type for frequency control applications in military and commercial equipment.

*Indicates new product

(Continued on page 245A)

Show Hours: Monday 10 AM-10 PM
Tuesday 10 AM-10 PM
Wednesday 10 AM- 5 PM
Thursday 10 AM-10 PM



INTERNATIONAL

Selenium Rectifiers

the **WIDEST RANGE** in the **INDUSTRY**

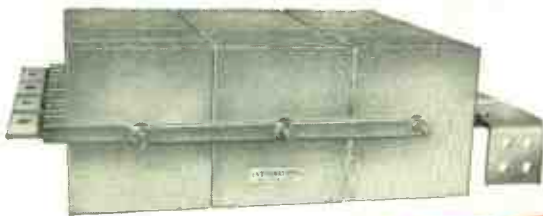

INTERNATIONAL
industrial power rectifiers

Ratings to 250 KW, 50 ma to 2,300 amperes and up. From 0 volts to 30,000 volts and up. Efficiency to 97%. Power factor to 95%. Cell sizes from 1 sq. in. to 42 sq. in. Ambient temperature range to 125 C without derating. **Write for Bulletin C-349.**



INTERNATIONAL
tv and radio miniature rectifiers

Input ratings from 25 to 195 volts AC and up. DC output current from 10 to 1,000 ma. Available in half wave and voltage multiplier units. Bridge units available to 1200 ma. **Write for Bulletin ER-178A**



INTERNATIONAL
high voltage cartridge rectifiers

DC output voltages from 20 volts to 20,000 volts and up. DC output current, half wave, from .2 to 195 ma. Cell diameters: 1/16" to 1". Overall length: 1/2" to 12". Available with pigtail, stud, or ferrule terminals. Hermetically sealed types also available. **Write for Bulletin H-2**



INTERNATIONAL
RECTIFIER CORPORATION

EL SEGUNDO, CALIFORNIA • OREGON 8-6281
NEW YORK: 501 MADISON AVENUE • PLAZA 3-4942
CHICAGO: 205 W. WACKER DR. • FRANKLIN 2-3889

World's Largest Supplier of Quality Industrial Rectifiers

For PILOT LIGHTS

CONSULT



Your product benefits 3 ways from the use of a DIALCO Pilot Light:

Enhanced appearance: The glow of light and sparkle of a lens add colorful visual attraction.

Greater safety: A timely warning flashed by a pilot light can prevent damage to equipment.

Added service: Discs inserted behind lenses can be used to deliver specific messages, such as "FUEL LOW", "ON", "OFF", etc.

Let the Dialco engineering department assist you in selecting the right lamp and the most suitable pilot light for your needs.

Dialco offers the complete line of pilot lights, from sub-miniature types to giant units with 1½" lenses.

Every assembly is available complete with lamp.

SAMPLES ON REQUEST AT ONCE — NO CHARGE

Illustrations are approx. 70% actual size... (A) No. 8-1930-111 sub-miniature pilot light... (B) No. 521308-991, with multivue cap... (C) No. 922210-111, dimmer type... (D) No. 47901 with light shield cap.

Write for Catalogues L-151, L-153, and L-154

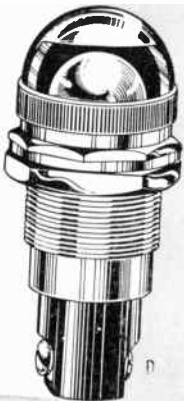
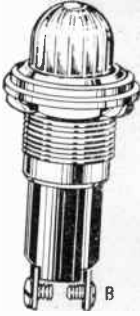

Foremost Manufacturer of Pilot Lights

DIALIGHT CORPORATION

60 STEWART AVE. • BROOKLYN 37, N. Y.

HYACINTH 7-7600

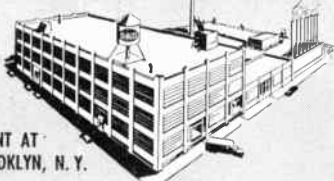

PLANT AT BROOKLYN, N. Y.

Booths 177, 179 at the IRE Show.

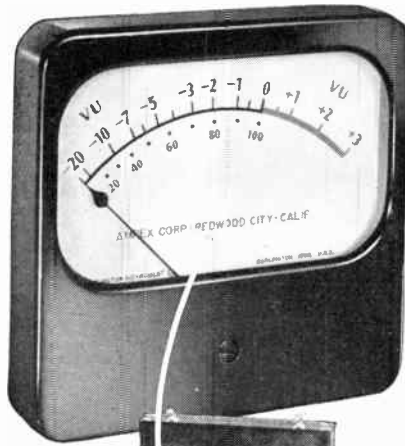

Try this on your recorder!

Model 745
4½" Semi-Flash



WRITE FOR CATALOGUE N1
Shows cases, ranges, prices

Visit our Booth 673, Circuits Ave., IRE Show.

BURLINGTON INSTRUMENT COMPANY
129 N. Third St., Burlington, Iowa



New! Mark I OSCILLOSCOPE

The only oscilloscope COMPOSITELY-DESIGNED to embody ALL the features wanted by engineers for general purpose work! At the industry's lowest cost!

- From DC to beyond 10 mc.
- Sweep speeds .25 microseconds to 10,000 microseconds per INCH!
- Crystal-controlled sweep calibration.
- Precise vertical amplifier calibration.
- Vertical sensitivity 100 millivolts per inch.
- New flat-face CRT (5AMP1).
- Signal delay .15 microseconds, switchable in or out (latest distributed parameter delay line).
- Rise time less than .04 microseconds (10 to 90%).
- Functional layout of all controls.



\$7500

f.o.b. New York City

Ask for a free demonstration. Write for Catalog P-3.

See our IRE Booth #58, Palace.

TLG ELECTRIC CORPORATION
31 WEST 27TH STREET • NEW YORK 1, N. Y.

**What to See at the
Radio Engineering Show**

(Continued from page 242A)



BOOTH 804

AUDIO AVENUE

custom transformers
magnetic amplifiers

keystone PRODUCTS CO.

23RD STREET • UNION CITY 2, N. J.

Kimble Glass Company, 142, 144 Tele-
vision Ave.

Kimble Glass Company will exhibit television
bulbs, electronic glassware and other glassware
items related to the electronic field.

Kinetix Instrument Div., 629-631 Cir-
cuits Ave.

See Ketay Mfg. Corp.

Kings Electronics Co., Inc.
506, 508 Components Ave.

Coaxial connectors, radar-aircraft
antennas, microwave assemblies com-
ponents, cable assemblies, waveguide
components, telephone jacks and
plugs.

**The James Knights
Company**
516 Components Ave.

Crystals for the Critical. High stability
quartz crystals for filter oscillator and ultra-
sonic use. Wide range of frequencies. Famous
"Glasline" quartz crystals. Precision crystal
ovens, variety of sizes, precision low frequency
standards.

Kollsman Instrument Corp.
790 Airborne Ave.

Aircraft Instruments. Precision Con-
trols. Precision Computers and Com-
ponents. Optics. Radio Communi-
cations and Navigation Equipment.
Motors and Synchros. Instruments for
Simulated Flight Trainers.

Krengel Mfg. Co., Inc., 95 Palace
Marking devices—engraved schematic vinylite
and blacktex stamps and dies—steel stamps—
special inks—bakelite plates—conveyor mark-
ing machines—interchangeable rubber type—
rubber stamps.

Krohn-Hite Instrument Company, 201
Production Rd.

Ultra-low distortion amplifier —0.005% IM at
50 watts. Ultra-high regulation power supplies
—0.001%, 0 to 500 V., 1/2 amp. Variable electronic
filters and ultra wide range oscillators 0.001 to
100,000 cps.

(Continued on page 246A)

**RECORDS 3-TO-16 TRACES
PER PRINT...
AUTOMATICALLY**

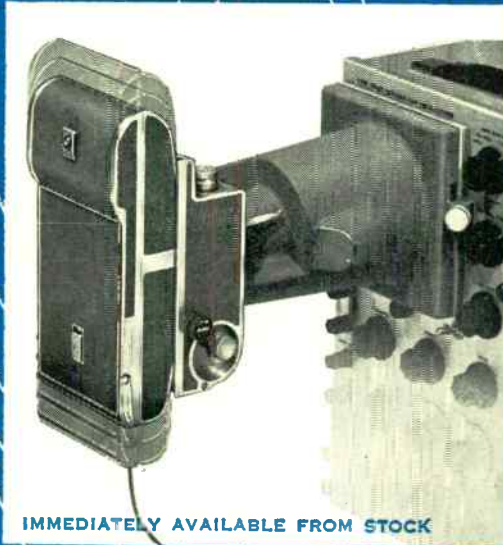

IMMEDIATELY AVAILABLE FROM STOCK

AUTOMATIC AND MANUAL OSCILLOSCOPE CAMERA

RECORDSCOPE 1185

*delivers developed black-field print
in 60 SECONDS*

Technical advantages of the RECORD-
SCOPE'S automatic magazine-shifting
operation permits the camera to be
pre-set for from 3-to-16 traces on each
3" x 4" POLAROID® print. Thus,
through progressive recordings on a
single print, the technician can immedi-
ately compare and evaluate changes
occurring in an electronic parameter
over a wide variation, thereby simpli-
fying optimization of a circuit.

SIMPLE TO-OPERATE. Uses POLAROID®
magazine and standard Polaroid film.
Delivers finished print in 60 seconds.
Provides full size image on 3" scope,
half-size image on 5" scope... with
no image reversal. **STURDY CAMERA
MOUNT** with swing-away adapter
hood. Camera easily swung aside when
not in use. **VERSATILE**... one camera
can service several scopes. Can be
interchanged in seconds.

AREMAC MANUAL RECORDSCOPE

Where technical limitations or applications do
not justify use of the automatic magazine-shifting
feature, the manually operated version of the
RECORDSCOPE 1185 fulfills expanding technical
engineering needs for an oscilloscope camera of
greater capacity, accuracy, efficiency and adaptability.
This camera, when requirements demand, is designed
for easy factory conversion to automatic operation.



*Write for complete technical data and new
lower price schedules on Aremac Oscilloscope Cameras.*

*POLAROID is the registered name of the Polaroid Corporation

Aremac

ASSOCIATES
Manufacturers of Precision Mechanical
and Optical Instruments

319 WEST WASHINGTON STREET PASADENA 3, CALIFORNIA

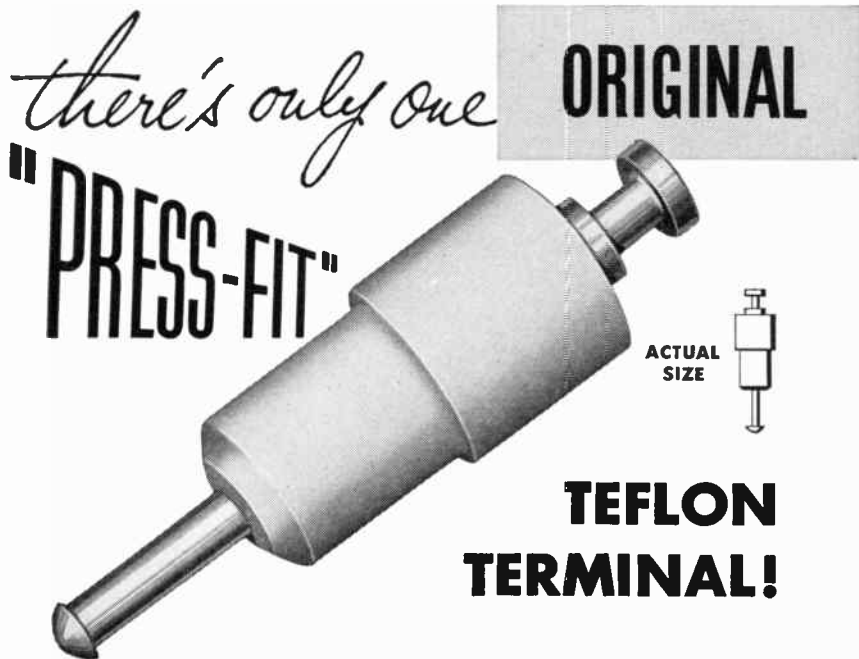

Sealectro has pioneered the use of Teflon** in its "Press-Fit" stand-off and feed-thru terminals. And the "Press-Fit" technic of simplified mounting reflects years of specialized engineering in closest collaboration with designers and assemblers who want the very best. Such "know-how" is available to you, through Sealectro.

Here, briefly, is why Sealectro "Press-Fit" Teflon terminals are so popular in so many fine assemblies:

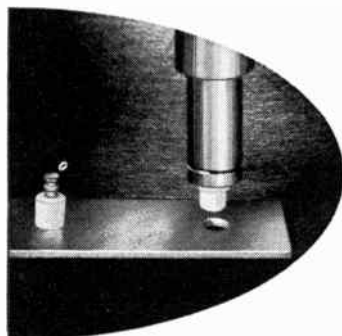

"Press-Fit" Teflon terminals press-fit into chassis holes by means of inexpensive insertion tool. Teflon seals terminal firmly and permanently in place.



Stand-offs, feed-thrus, connectors and other "Press-Fit" Teflon pieces available in wide variety of standard and special types. Also sub-miniature types used in most compact assemblies.

INSULATION

Typical electrical characteristics: Dielectric Strength, 400 to 500 V/mil. Volume Resistivity, ohm-cm., less than 10^{15} . Surface Resistivity, 100% R.H., 3.6×10^6 . Dielectric Constant, 60 cycles, greater than 0.0005; 10^4 cycles, greater than 0.0005. Excellent Temperature Stability of dielectric properties. Non-adhesive Surface. No Shelf Deterioration. Etc.

IMMUNITY

Unaffected by widest range of climatic conditions. Immune to chemicals and salts. Unaffected by corrosive atmospheres or fungus. Zero water absorption. Will not melt, burn, char. No breakage or damage from vibration, mechanical shock, rough handling. No acute strain point as with fused glass and metal seals with different thermal expansion rates. Resists collection of dust and dirt to non-adhesive surface, prolonging use of maximum terminal ratings.

MINIATURIZATION

Teflon's superior insulating properties enable quick and easy miniaturization. Minimum material for maximum insulation. Replaces glass and ceramics.

ASSEMBLY

"Press-Fit" means pressing insulator into chassis hole, with inexpensive Sealectro insertion tool. No hardware needed such as nuts, washers, screw-threads, glands, gaskets. Precision-machined insulator press-fits into chassis hole for immediate yet permanent mounting. Withstands 10 lbs. pull test.

- AND ECONOMICAL!

"Press-Fit" eliminates usual mounting hardware. Big saving in materials. Likewise in labor. Overall cost compares favorably with ordinary terminals.

SEE THEM . . . GET THE DETAILS . . .

During the IRE CONVENTION, at Booth 48, Kingsbridge Palace. Or write for sample and literature.

*Pat. Pending.

**Reg. Trade-mark of E. I. Du Pont de Nemours & Co.

What to See at the Radio Engineering Show

(Continued from page 245A)

Kulka Electric Mfg. Co., Inc.
425 Electronic Ave.
Molded barrier type terminal blocks, convenience outlets, lampholders, harnesses, JAN -5-23 electronic switches, terminals, solder lugs, laminated terminal strips. "Kliptite" quick disconnect terminal blocks, fanning strips.

Kupfrian Mfg. Co., 470 Electronic Ave.
Flexible shaft couplings, and flexible shaft assemblies for remote control of potentiometers, tuners, switches, counters, and other instruments and components; electrostatic wire shielding; push-pull controls; universal joints; portable motor generators; electric harnesses.

Laboratory for Electronics
229-328 Radar Rd.
*dc-10 mc oscilloscope, plug-in adapters, delayed trigger generators, microwave oscillators; *time-rate indicator with top speed of ten million impulses per second.

LABSCOPE inc.

Precision Equal-amplifier Oscilloscopes

BURLINGAME ASSOCIATES
234-236 Instruments Ave.

LAMBDA
INDUSTRIAL AND LABORATORY POWER SUPPLIES
FIRST CHOICE OF MEN WHO BUY POWER SUPPLIES
467, 469 Electronic Ave.
Lambda Electronic Corp.
103-02 Northern Boulevard
Corona 68, N. Y. • TWining 8-9400

BOOTH 386; MICROWAVE AVE.
Lambda-Pacific
ENGINEERING, INC.
MANUFACTURERS OF
• Microwave Link Systems
• T-V Boosters
• Printed Circuits
• Terminal Boards
• Silk Screen Processing

(Continued on page 249A)

SUB-MINIATURE S-BAND CAVITIES

2750-3000 mc

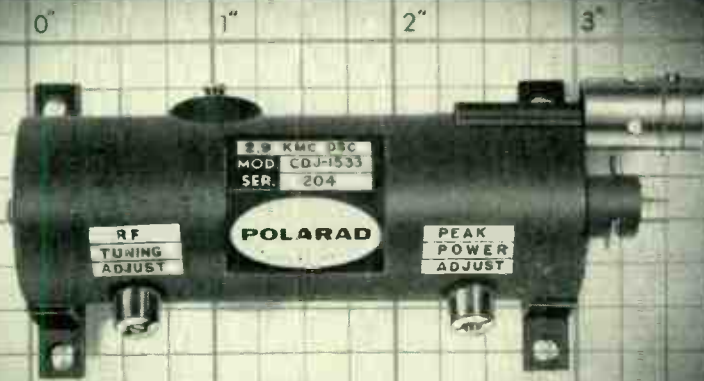

Sub-miniature is the word. The new Polarad S-Band cavities are only 3" long and 1" in diameter, yet outperform many larger cavities. They are particularly suited for beacon transmitters, missiles, radar, etc., where miniaturization is a key factor in the choice of components. These cavities withstand vibration, 500 g shock test, 100 g longitudinal acceleration, and are temperature compensated over the range of 0°C to 70°C. They are available for grid-pulsed, plate-pulsed, or CW operation. They may be code modulated by conventional drive circuits using hard tube or gaseous tube types.

All S-Band cavities are factory-tuned to the desired frequencies, and can be varied by means of a simple special tool which permits simultaneous frequency and locking adjustment.

FEATURES:

- Extremely small size, 1" x 3"
- Reggeized pencil triode
- 300 V DC supply is required for grid pulsing
- Temperature compensated
- Meets all MIL specifications
- Fixed low impedance output coupling into 50 OHM BNC connector

CONSULT US ON YOUR APPLICATIONS

FIELD MAINTENANCE SERVICE THROUGHOUT THE COUNTRY

SPECIFICATIONS:

MODEL	Modulation	Power Output	PRF
CGP-1	Grid Pulsed	2 watts peak	0-4,000 PPS
CPP-1	Plate Pulsed	100 watts peak	0-1500 PPS
CCW-1	CW	50 MW	— —

Tuning Range.....	2750 — 3000 mc
Pulse Width.....	0.75 + 0.1 μSec.
Rise Time.....	0.1 μSec.
Frequency Stability.....	0.02 mc/°C.



ELECTRONICS CORPORATION

43-20 34th STREET • LONG ISLAND CITY 1, N. Y.

• REPRESENTATIVES • Albuquerque • Atlanta • Baltimore • Boston • Chicago • Cleveland • Fort Worth • Kansas City • Los Angeles • New York
Philadelphia • San Francisco • Seattle • St. Paul • Syracuse • Washington, D. C. • Canada, Arnprior—Export: Rocke International Corporation

Getting to the bottom of things

Tradition of the true engineer and scientist . . . no thought of personal glory . . . only satisfaction in the development of those things which contribute most to a better civilization . . . tireless in his never-ending search for something finer . . . such is the heritage of the engineering profession . . . to these we owe much.

FAST engineers, true to their profession . . . forward looking; searching beyond the horizon and planning ahead; ever seeking those refinements that make their product better to fit the needs of TOMORROW'S equipment . . . are eager to help you plan for the new day just ahead.

How well they are prepared to cope with tomorrow's problem can be demonstrated by their use of X-Ray as an instrument in the development of finer capacitors . . . 1935* found them applying this scientific device as part of research and manufacturing procedure . . . another proof of FAST years-ahead investigation and getting to the bottom of things.

SPECIALISTS IN: Fixed Paper-Dielectric Capacitors, Oil or Wax Impregnated and Filled; Mylar[†] or Polystyrene Film Units. In Cardboard, Ceramic, Phenolic Molded or Metallic, Rectangular or Tubular Containers. For use in Electrical, Electronic, Radio-TV or Scientific Equipment. Power-Factor Correction Capacitors. Heavy-Wire (No. 10 to No. 20) Choke Coils—Air or Iron Core—For RF or Radio Noise-Suppression.

AVAILABLE LITERATURE:

Tubular Capacitors in Cardboard Tubes
Tubular Capacitors in Molded Phenolic Cases
Tubular Capacitors in Ceramic Tubes
Polystyrene Film Capacitors
Mylar[†] Film Capacitors
Hermetically-Sealed Tubular Capacitors
Subminiature Hermetically-Sealed Capacitors
High-Reliability Hermetically-Sealed Capacitors
MIL-C-25A Approved Capacitors: Refer to "MIL-C-25A Specifications"

*See HERMAN E. SEEMANN, PHYSICIST, KODAK RESEARCH LABORATORIES, "Miscellaneous Applications of Radiography and Fluoroscopy," Symposium on Radiography and X-Ray Diffraction Methods, American Society for Testing Materials, Philadelphia, Pa. (1937).

†DuPont Trade-Mark for Polyester Film

JOHN E. FAST & CO.

Capacitor Specialists for Over A Third of A Century
3177 North Pulaski Road, Chicago 41, Ill.

"WHEN YOU THINK OF CAPACITORS . . . THINK FAST"

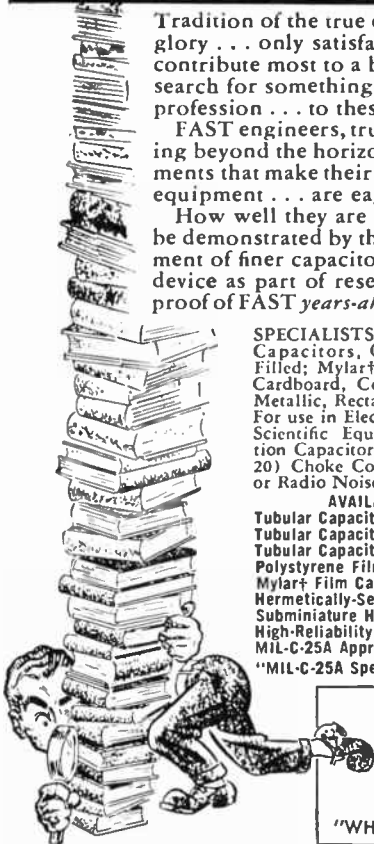

770

HICKOK

WIDE RANGE
HIGH SENSITIVITY

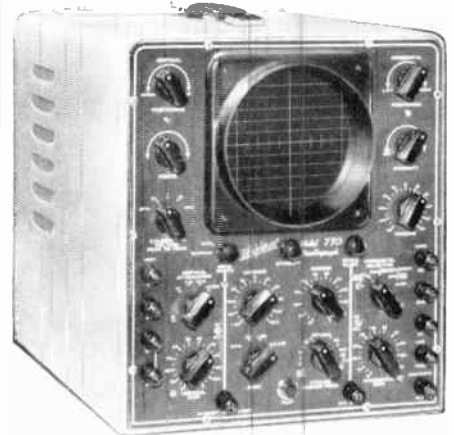

MODEL 770

Engineers' Scope

FREQUENCY RANGE:

- a. Vertical Amplifier:
 1. DC to 2.5 MC, 3db Down, with Band Width Switch in Narrow position.
 2. DC to 5 MC, 3 db Down, with Band Width Switch in Wide position.
- b. Horizontal Amplifier: DC to 500 KC, 3 db down.
- c. Sweep Circuit Oscillator: 2 cycles to 30 KC.
- d. Fixed Sweep Frequencies: 30 cycles and 7875 cycles.

INPUT IMPEDANCE:

- a. Vertical Amplifier: 2.2. Megohms—50 MMF.
- b. Horizontal Amplifier: 2.2 Megohms—50 MMF.

DEFLECTION SENSITIVITY:

- a. Vertical Amplifier:
 1. .010 RMS Volts Inch with Band Width Switch in Narrow position.
 2. .035 RMS Volts/Inch with Band Width Switch in Wide position.
- b. Horizontal Amplifier: .075 RMS Volts /Inch.

SPECIAL FEATURES:

- a. Illuminated, Calibrated Screen backed with a green filter for reducing incidental illumination in the room—for accurate measurements and comparisons.
- b. Built-In Calibrated Voltages: Peak-To-Peak—100, 10, 1, .1 Volts. Ideal for Observation of Color Burst at 3.58 MC.

THE HICKOK ELECTRICAL INSTRUMENT CO.
10551 Dupont Avenue • Cleveland 8, Ohio

Make
INSTANT CONNECTIONS
without
Screws

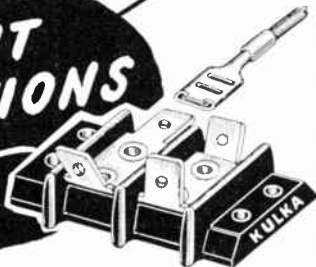

Use "KLIPTITE" TERMINAL BLOCKS (Molded, Barrier-type) with ANGLED TABS Made for AMP, Self-locking Wire Terminals.



SINGLE & DOUBLE POLE ELECTRONIC SWITCHES

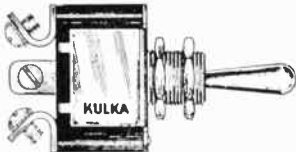

Tabs are plated brass and come eyeletted to block, or separately. Tab combinations in various angles, or flat, for single or multiple connections. Several sizes and number terminals.

Other terminal blocks available in approved materials range from subminiature (shown) to jumbo (90 amps).

Toggle handle, aircraft type. Bakelite housing. With screw terminals, or solder lugs. DC, or AC up to 1600 cycles. One-hole mounting.

KULKA ELECTRIC MFG. CO., Inc.

Manufacturers of Electrical Wiring Devices
MOUNT VERNON, N. Y.

For Over
a Quarter
Century
Specialists
in the
Manufacture
of
Electrical
Wiring
Devices

SEE OUR
EXHIBIT
IRE SHOW
425
ELECTRONIC
AVE.

What to See at the Radio Engineering Show

(Continued from page 246A)

LaPointe Electronics, Inc., Circuitron
Division, 285 Instruments Ave.
Printed Circuits & Applications of Printed
Circuitry.

Langevin Manufacturing Corp., 620, 622,
624 Circuits Ave.
See W. L. Maxson Corp.

Lavoie Laboratories, Inc. 400, 401, 500 Production Rd.

*Automatic synthesizer for communications
equipment; radar systems, airborne and ma-
rine; *miniature crystal oven; packaging tech-
nique; spectrum analyzer demonstrating pre-
cision UHF measurements.

Lee Laboratories, Inc. 815 Audio Ave.

Glas-Guide microwave components;
duplexers, mixers, and antennas. Lee-
Pac transistorized plug-in circuits;
amplifiers and computer circuits.

Leland, Inc., G. H., 118 Television Ave.
Ledex rotary solenoids, Ledex circuit selectors
and stepping relays, *#4 circuit selector fea-
turing positive indexing escapement. *#5 sol-
enoid with adjustable return spring.

P. M. Lennard Co., Inc. 21 Palace

Controlled atmosphere enclosures: low cost,
completely transparent, individual units.
Available continuous engineered systems per-
mit dust-free assembly of instruments and
tubes under low humidity or inert gas; in-
creased quality control and greater produc-
tion economy.

Lepel High Frequency Labs., Inc., 832 Audio Ave.

Induction heating units for bombarding cath-
odes and anodes and flashing getters. Induction
heating units for brazing, soldering and general
heat treating. Units for heating pretinned
wires prior to cutting and stripping saving
dipping and twisting operations.

LEWYT
MANUFACTURING CORP.
116 TELEVISION AVE.
Electronic, electro-mechanical and
mechanical products for Government and
Industry.

*Indicates new product

(Continued on page 250A)

OVER 10,000 HOURS

OF CONTINUOUS TROUBLE-FREE OPERATION . . .

Reliable CURRENT OR VOLTAGE STABILIZED POWER SUPPLIES



MODEL 323M
200-325 VDC.
0-300 MA.
6.3 VAC. 6A

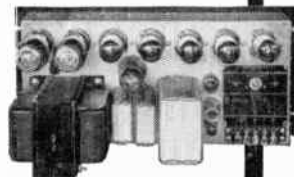

with Weston 3 1/2"
Meters
\$19950
available less meters
\$16950

An installation of ten standard models in a data processing system at a large Municipal airport has been in continuous operation for a full year without breakdown or tube replacement. Yet this high order of performance has been achieved without affecting the moderate cost of these equipments.

Typical of the instruments in this line is the Model 323M as shown. Occupying only 8 3/4" of rack space, and 9" deep, it provides a regulation of 0.1%, a maximum ripple of 1 millivolt and a response time of 150 microseconds.

WRITE FOR COMPLETE CATALOG

Power Designs inc.

119-22 ATLANTIC AVENUE
RICHMOND HILL 19, NEW YORK

Intricate parts and precision components can be **LECTROFORMED!***

If the radio frequency component you need cannot be made by conventional methods or is difficult and costly to manufacture, the possibilities are it can be **LECTROFORMED**.

Write Dept. IRE-3
for "LECTROFORMING
Applications
and
Procedure"



*Trademark

LECTROFORMING can produce parts of intricate design, accurate interior dimensions and with high interior surface finish up to 5 micro-inch. Various metals may be used (such as silver, gold, copper, nickel and/or iron) to meet specific requirements for conductivity, strength and corrosion resistance.

LECTROFORMING achieves dimensional stability impossible by any other method.

LECTROFORMING is the manufacturing of an article by the electrodeposition of metal on a form of predetermined size, shape and finish. We welcome the opportunity to discuss your problem, no matter how difficult it may seem.



BART LABORATORIES CO., INC.
227 Main Street, Belleville 9, New Jersey

NOW

adjustable

POLYSTYRENE CAPACITORS

with Accuracy

in the order



of 0.1% or better

and Long Time

Stability in

the order

of 0.03%



Check these outstanding features:

- I. R. @ 25° C - 10¹² OHMS
- Dielectric Absorption - .015%
- Dissipation Factor - .0002
- Temp. Coeff. (-20° to 140° F.)

100 P.P.M. per °C

Excellent for Computer Integration, Test Equipment

or Secondary Standards.

Join these other leading firms in specifying Southern Electronics' precision polystyrene capacitors for your most exacting requirements: Reeves Instrument Corp., Electronic Associates, Inc., Convair, Berkeley Scientific, M.I.T., Calif. Inst. of Tech., and many others.

Write for complete catalog -

Available from 0.1 M.F.D. to 8 M.F.D.

SOUTHERN ELECTRONICS



Corporation

239 West Orange Grove Ave., Burbank, Calif.

What to See at the Radio Engineering Show

(Continued from page 249A)

Librascope, Inc.

154, 156 Television Ave.

X-Y plotter and recorder operating from punch tape, keyboard and analog inputs. Analog digital converters. Magnetic Decision elements. Computer components.

LIECO INC.

**380 MICROWAVE AVE.
MILLIMETER WAVEGUIDE
COMPONENTS &
TEST EQUIPMENT**

Linde Air Products Co., 527 Components Ave.

Xenon, Krypton, Argon, Helium, Neon, and Rare Gas Mixtures, Synthetic Sapphire Disks for Optical Transmission, Molecular Sieves for Selective Adsorption, L-45 Silicone Oil, Dielectric Fluid.

Linear Equipment Laboratories, Inc.

786 Airborne Ave.

Oscilloscopes, Square Wave Generators, Noise Figure Test Sets, Broad Band I. F. Amplifiers, Video Line Amplifiers, UHF and VHF Baluns, Wavemeters, Grid Dip Oscillators, Reflection Boxes. Unusual requirements solicited.

Link Aviation, 152-156 Television Ave.

Gear Boxes—for use in servo mechanisms and instruments with adapters for various servo motors. Resomax Potentiometers—.02% linearity, infinite resolution. Phase Comparator—measures phase angle to 0.1 milliradian. Cable Checker—for high-speed continuity testing.

Littelfuse, Inc., 525 Components Ave.

Exhibiting all types of circuit protection equipment including small glass enclosed cartridge fuses, low voltage circuit breakers, also standard and custom manufactured fuse holders.

Little Falls Alloys, Inc.

682 Circuits Ave.

Non-ferrous Speciality Wires (not insulated) of *Titanium, Beryllium copper, Bronzes, Silver Plated Wires and Aluminum, used for Springs, Transistors, Grid Construction and other Electronic uses. Shaped wires: square, round, half-round, and flat.

*Indicates new product

(Continued on page 252A)

We'll be there—Booth 509—I.R.E. Show, Kingsbridge Armory, New York, March 21-24



TRANSFORMERS for...

RADIO • TELEVISION • MILITARY • SPECIAL APPLICATIONS

RADIO & TV



PLATE TRANSFORMERS
 MODULATION TRANSFORMERS
 REACTORS
 FILAMENT TRANSFORMERS
 UNITIZED RECTIFIERS
 PULSE TRANSFORMERS
 CHARGING REACTORS
 OIL, ASKAREL
 DRY TYPE, (CLASS A, B & H)
 PER { MIL-T-27 } SPEC.
 { RETMA }

RADIO & TV



MEMO

Visit our booth
 No. 680
 at the IRE
 Show



HIPERCORE CORES

for smaller, lighter, low loss transformers. Write for Bulletin SR 205 listing standard cores, weights, dimensions, performance and prices.

MILITARY



MILITARY



Moloney quality, backed by 58 years of transformer experience, is designed and built into each unit.

This engineering background and experience enables Moloney to produce transformers that offer the maximum in reliability, endurance and efficiency at a minimum of size and weight.

Write for Specialty Transformer Bulletin ST 3505.

ME88-5

SPECIAL APPLICATIONS

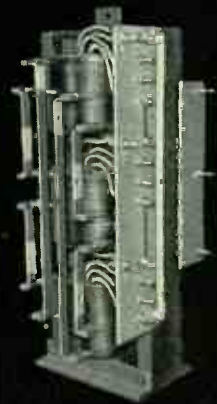

MOLONEY ELECTRIC COMPANY

SALES OFFICES IN ALL PRINCIPAL CITIES FACTORIES, ST. LOUIS, MO., TORONTO, ONT., CANADA



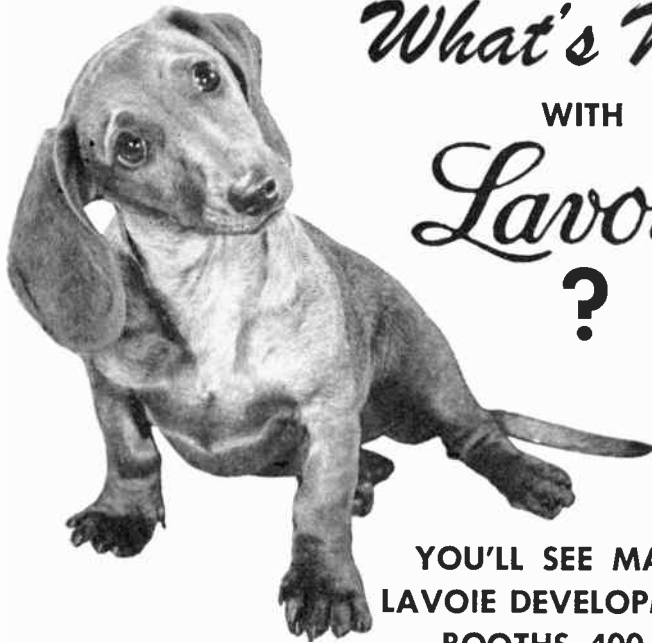

What's New WITH Lavoie ?

YOU'LL SEE MANY NEW
LAVOIE DEVELOPMENTS AT
BOOTHS 400, 401, 500
PRODUCTION ROAD, I. R. E. SHOW, Mar. 21-24

... Like the LA17

Spectrum Analyzer

A bench and field instrument in which impressive reductions in size, weight and power have been made. The entire instrument is contained in two sliding drawers, mounted in a case that is but 25" high, 19" wide and 18" deep NO CHANGING OF TUNING HEADS OR DRAWERS IS REQUIRED, SINCE ALL RF HEADS ARE CONTAINED IN A SINGLE DRAWER. Frequencies are read in ONE direct-reading illuminated dial, with an accuracy of $\pm 1\%$.

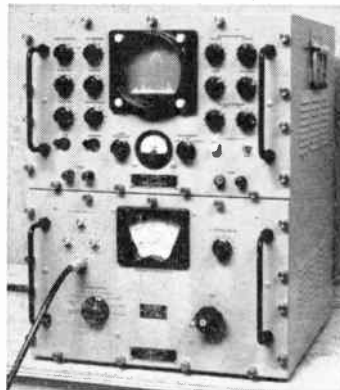

Like the

NEW CRYSTAL OVEN embodying advanced technical improvements with notable economies of size and weight. And the

NEW MOISTURE PROOF CONTAINER providing pressurized protection for delicate electronic instruments, as well as a

NEW AUTOMATIC SYNTHESIZED TUNER

THE BAT New lightweight, low-priced **MARINE RADAR**

and a complete showing of time-tested Lavoie engineered

ELECTRONIC INSTRUMENTS

Lavoie Laboratories, Inc.

MORGANVILLE, NEW JERSEY

What to See at the Radio Engineering Show

(Continued from page 250A)

Litton Industries 708 Airborne Ave.

Design and manufacture of precision components and integrated systems. Magnetrons, precision potentiometers, film resistors, delay lines, rotary joints, ferrite load isolators, digital computers, instrumentation, guidance and control, radar.

LORAL

LORAL ELECTRONICS CORP.
794 E. 140th STREET · N. Y. 54, N. Y.
BOOTH 821-Audio Ave.
DEVELOPMENT, DESIGN AND PRODUCTION
OF ELECTRONIC AND ELECTRO-MECHANICAL
EQUIPMENT AND COMPONENTS

Lord Manufacturing Company, 504 Components Ave.

Bonded-rubber mountings for vibration and shock control, tempproof (metal) mountings, idler wheels, flexible couplings, shipping container mountings, bonded-rubber mechanical parts.

"*Heard Everywhere*"

LOWELL
Manufacturing Company
858 Audio Ave.

"Ear Level" sound speaker baffles, grilles, protective enclosures and intercom equipment.

New LOWELL CONSOLES
5 models, for schools, airports, broadcast studios

MB Manufacturing Co., Inc., 120, 122 Television Ave.

*Dual Model S6 Exciters designed for structural testing. *TS7 Electronic Amplifier, *Probe pickup, vibration meters. Standard products for vibration control, measurement, and reproduction.

Machlett Laboratories, Inc.
567, 569 Components Ave.

New Coaxial Terminal Triodes for 5kw to 50kw equipments—New Light Weight Coaxial Triodes with aluminum radiator—Complete coaxial heavy duty triode line, 2kw to 150kw, for broadcast and industrial equipment.

MacIen Corporation, 859, 861 Audio Ave. Regulated low voltage rectifier power supplies; servo components and aircraft instruments.

MacLeod & Hanopol, Inc., 287 Instruments Ave.

Will show vacuum tube testing equipment, low capacitance and high resistance measuring sets, data on ADRAD analog to digital conversion.

*Indicates new product

(Continued on page 254A)

New!

LAMBDA MODEL 71 PORTABLE POWER SUPPLY

WIDE RANGE! 0-500 VDC @ 0-200 MA

LIGHT! Weighs only 49 lbs.

COMPACT! 13" high, 8¾" wide, 14½" deep

A de luxe unit that combines every good engineering feature with maximum compactness and portability.

\$289⁵⁰

F.O.B. Factory, Corona, N. Y.



A VERSATILE, HEAVY-DUTY PORTABLE WITH BROAD FIELD AND LABORATORY APPLICATIONS

Cannot be damaged by external overloads! No down time! Circuit breakers provide complete protection!

SPECIAL FEATURES

- Overload Circuit Breakers. AC and DC Circuit Protection
- Hermetically-Sealed, Oil Filled Condensers
- No "Down Time" due to External Overloads
- Time Delay Tube Protection
- Stable 5651 Reference Tube
- All-Aluminum Construction
- Vernier High Voltage Control
- Made by America's Leading Power Supply Specialists

SPECIFICATIONS FOR LAMBDA MODEL 71 PORTABLE

INPUT.....105-125 VAC, 50-60 CPS, 475 W (max)

DC OUTPUT NO. 1 (regulated for line and load)

Voltage.....0-500 VDC (continuously variable)

Current.....0-200 MA (over entire voltage range)

Regulation (line).....0.15% or 0.3 volt (whichever is greater)

Regulation (load).....0.15% or 0.3 volt (whichever is greater)

Internal Impedance.....Less than 4 ohms

Ripple and Noise.....Less than 5 millivolts rms

Polarity.....Either positive or negative may be grounded

DC OUTPUT NO. 2 (regulated for line only)

Voltage ranges: (a) 0-50 VDC (no load) (b) 0-200 VDC (no load)

Internal Impedances: 5,500 ohms 25,000 ohms

Current range:

Any value of external load impedance may be used including continuous low impedance or short-circuit. Insignificant inter-action on Output No. 1 Short Circuit Current: 9 MA (Max.)

Regulation (line).....Better than 0.1%

Ripple and Noise.....Less than 5 millivolts rms

Polarity.....Positive terminal connected internally to negative terminal of DC Output No. 1.

AC OUTPUTS (unregulated)

Two outputs, isolated and ungrounded. Each is 6.5 VAC at 5A (at 115 VAC input). Allows for drop in connecting leads.

May be connected in series for 12.6V (nominal) at 5A, or in parallel for 6.3V (nominal) at 10A.

AMBIENT TEMPERATURE AND DUTY CYCLE:

Continuous duty at full load up to 40°C (104°F) ambient.

OVERLOAD PROTECTION:

External overload protection.....AC and DC magnetic circuit breakers. Trip-Free. Instant manual reset. Front panel.

Internal failure protection.....Fuses, access through rear of cabinet.

INPUT AND OUTPUT CONNECTIONS:

Input.....8 foot heavy duty rubber covered line cord with integral molded plug, rear of cabinet.

Output.....Sturdy insulated "5-way" binding posts, front panel.

METERS:

Output voltage.....Multi-range 3½" rectangular voltmeter calibrated 0-50 VDC, 0-200 VDC, 0-500 VDC.

Output current.....3½" rectangular milliammeter calibrated 0-200 MA.

VOLTAGE REFERENCE TUBE:

A stable 5651 reference tube is used to obtain superior long-time voltage stability.

TIME-DELAY RELAY CIRCUIT:

A 30 second time delay circuit is provided to allow tube heaters to come to proper operating temperature before high voltage can be applied.

SIZE AND WEIGHT AND FINISH:

Size.....13" H x 8¾" W x 14½" D

Weight.....49 lbs.

Finish.....Two-tone gray



LAMBDA Electronics Corp.

THE FIRST NAME IN POWER SUPPLIES

103-02 NORTHERN BLVD. • CORONA 68, NEW YORK • TWINING 8-9400

**ARE YOU ASKED TO RECOMMEND
HIGH FIDELITY LOUD-
SPEAKER SYSTEMS?**



Then you will be interested in the corner horn types developed and licensed by Paul W. Klipsch and the units manufactured by Klipsch and Associates. Their performance is the closest approach to fidelity now available and the horns are adaptable to new advances in the art, if and when they are achieved.

Write for new literature on the Klipschorn and Shorthorn corner horn loudspeaker systems.

KLIPSCH & ASSOCIATES
Hope, Arkansas

Paul W. Klipsch, Owner-Manager; member
Acoustical Society of America, S.M., IRE.

UNITED STATES WIRE & CABLE CORP.

of UNION, NEW JERSEY



Extends a Cordial Invitation to the Industry to partake of our hospitality.

**During the Week of the IRE show
in New York City**

March 21 thru March 24, 1955

We will be at the **BELMONT PLAZA Hotel**

Lexington Avenue, between 49-50 Streets

(Opposite the Waldorf-Astoria)



**MICROWAVE
COMPONENTS**

DICO designs and manufactures custom and standard Co-axial Line and Waveguide components. These are produced under highest quality control standards, a typical example being . . .

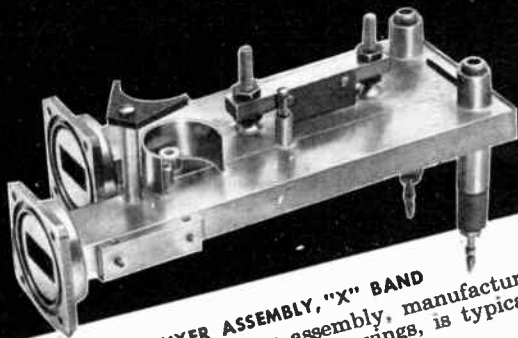

WAVEGUIDE MIXER ASSEMBLY, "X" BAND
This particular mixer assembly, manufactured to exacting customer's drawings, is typical of DICO'S custom products.

**DIAMOND
MICROWAVE CORPORATION**

Send for catalog 953

7 North Avenue, Wakefield, Mass.

485-487 ELECTRONIC AVENUE • IRE SHOW

**What to See at the
Radio Engineering Show**

(Continued from page 252A)

Magnatran, Inc., 34 Palace
Unitized Rectifiers up to 500 KW, 250 KV-DC askarel immersed, oil immersed and dry type. Plate transformers, Filament transformers, Reactors and Modulation transformers.

Magnecord, Inc., 809 Audio Ave.
Complete line of tape recording equipment and accessories for home and professional use. New M81 and M90 series, portable and console models and others for every requirement.

Magnecraft Electric Co., 286 Instruments Ave.
General Purpose AC & DC Relays, Instrument Relays, Sensitive Relays, Time Delay Relays, Telephone Type Relays, Hermetically Sealed Relays & Military Type Relays.

Magnetic Amplifiers, Inc.
Affil. of General Ceramics Corp.
568 Components Ave.

The company's new line of Miniaturized Magnetic and Transistor Magnetic Servo Amplifiers for high performance tubeless servo systems will be exhibited in an operative servo mechanism. Voltage Regulators and Transistor Curve Tracers will also be exhibited.

**BOOTH 89
KINGSBRIDGE PALACE**
PRECISION REGULATED D.C. POWER SUPPLIES
MAGNETIC AMPLIFIERS AND CONVERTERS
MAGNETIC PULSE GENERATORS AND COMPONENTS



MAGNETIC RESEARCH CORP.
200 Center Street • El Segundo, California

Magnetics, Inc.

795 Airborne Ave.

Tape wound cores of all high permeability magnetic materials, tape thickness from .014" to .000125" including ultra-thin cores for computer and high frequency applications; Magnetic Shields; Reactors and specialized magnetic amplifier components and assemblies.

Magnetics Research Co., 312 Computer Ave.

*Subminiature Magnetic Shift Registers, Magnetic Selection Switches, Subminiature Magnetic Amplifiers; Also Logical Building Blocks, Pulse Transformers, Magnetic Amplifier Power Supplies.

O. J. Maigne Co.

59 Palace

Teflon tape and stock production samples of molded, machined, and preformed parts.

*Indicates new product

(Continued on page 257A)

DESIGN AND DEVELOPMENT ENGINEERS!
HERE'S A SURE CURE FOR YOUR

Deep Drawn Instrument Case Problems!

KAUPP

— facilities for

SPINNING, STAMPING, PUNCHING, DEEP
DRAWING, **HYDROFORMING**, ANNEALING,
SPOT WELDING, ASSEMBLING, TOOL MAKING

Kaupp can supply your instrument cases to exact specification quickly and economically. Special shapes and odd sizes are a specialty at Kaupp and, in most cases, can be turned out on reasonably short notice. Kaupp has the experience and the metal working facilities for precision forming of intricate shapes to close tolerances. Gauges .002 to $\frac{3}{8}$ stock in stainless steel, Inconel, aluminum, cold rolled steel, brass and other alloys. Check with Kaupp on your metal parts needs, now!

C. B. KAUPP & SONS
NEWARK WAY • MAPLEWOOD • NEW JERSEY

R The new 16 page Kaupp Brochure with complete information on metal forming and sub-assembly facilities. Call or write for your copy, today!

**PRODUCTION AND DEVELOPMENT METAL FORMING FOR ELECTRONICS,
NUCLEONICS, AVIATION, MARINE AND GENERAL INDUSTRY**



See us at the
I.R.E. Show
BOOTH #720
AIRBORNE
AVENUE
Kingsbridge Armory
New York City
March 21-24, 1955

News in Analog Computing

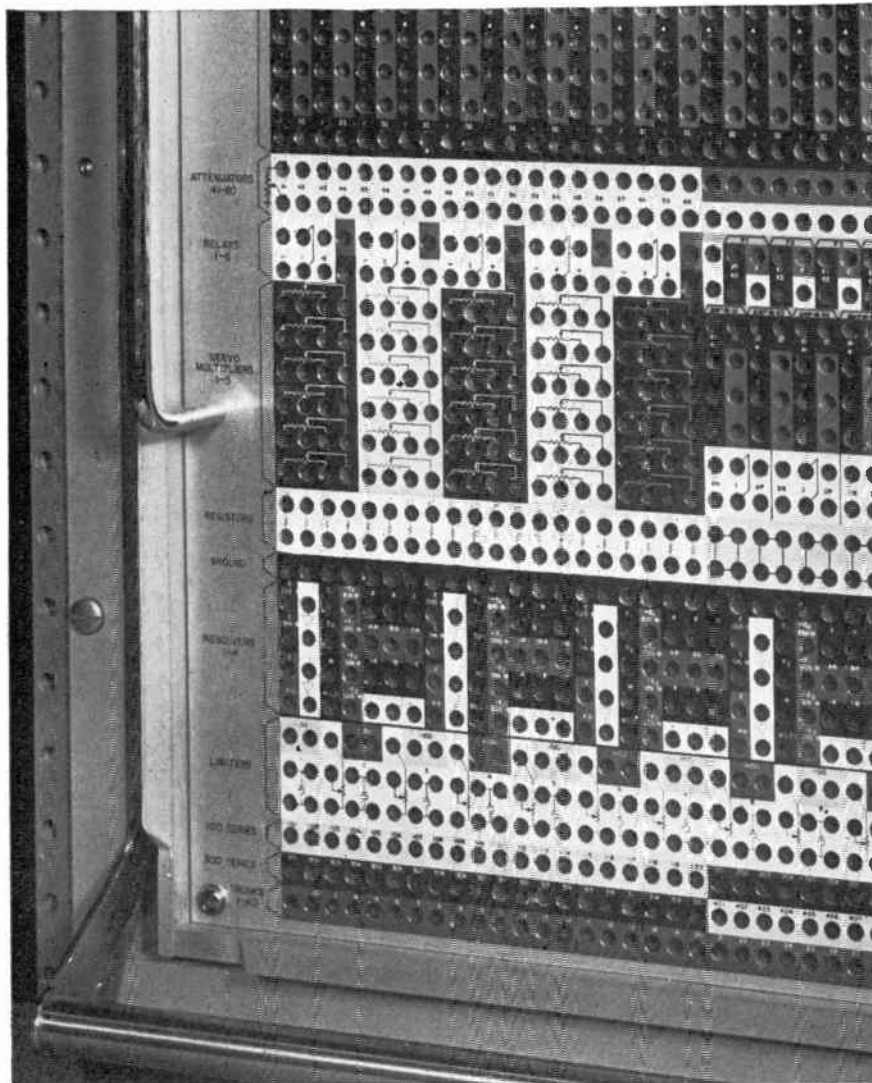

Shielded cords are used with this metal pre-patch panel

Only Electronic Associates' Analog Computing Equipment includes an all metal pre-patch panel with coaxial shielded patch cords. This unique shielding avoids errors caused by inter-terminal leakage. This is just one of the reasons why EAI sets the pace for accuracy and reliability in analog computing equipment. Electronic Associates' PACE Equipment (Precision Analog Computing Equipment) can be purchased at a reasonable price for single purpose use, such as the control of a process—or as a basic general purpose simulator which may be expanded into a large, versatile system—or computing time may be rented at our Princeton Computation Center, completely staffed and equipped to provide fast answers. May we forward you complete details.

WRITE DEPT. IR-5 AND/OR VISIT BOOTH 331 AT IRE SHOW.



EAI SETS THE **P A C E**
PRECISION ANALOG COMPUTING EQUIPMENT
LONG BRANCH, NEW JERSEY

ENGINEERS

Save your firm thousands of dollars in searching for data on ELECTRONIC TEST EQUIPMENT of interest to USAF.

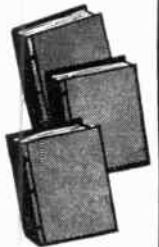

By special permission data sheets on Research supported and monitored under our WADC, ARDC contract now available to manufacturers at low cost.

- Order your copy of a three volume set containing illustrated descriptive data sheets on 870 items procured for use by the U. S. Air Force.
- Contains 2400 (8½ x 11") pages, recently brought up-to-date, mounted in 3 post expandable hard back binders.
- Price \$100 per set plus postage while supply lasts. Orders accompanied by check filled as received with postage paid.

CARL L. FREDERICK
AND ASSOCIATES
Bethesda 14, Maryland

NOW! over 15 million Microdot[®] coax combinations

Microdot cuts design time by multiplying possibilities . . . with the world's smallest, lightest microminiature coax connectors and cables. See the unique Microdot line at the IRE Show, Booth 679, Kingsbridge Armory, N. Y., March 21-24, or write today for applications data.

1/3 BNC diameter
1/10 BNC weight!



MICRODOT
1826 FREMONT AVENUE
SO. PASADENA • CALIF.

What to See at the Radio Engineering Show

(Continued from page 254A)

D. E. Makepeace Co., Div. of Union Plate & Wire Co. 403, 405 Electronic Ave.

*Miniature and Multi-Circuit slip ring and brush assemblies. Precision wave guide and wave guide assemblies. Laminated precious metals. "Off the shelf" slip ring and brush assemblies.

P. R. Mallory & Co., Inc. 348 Microwave Ave.

- * Mercury battery
- * "Vibrapak"
- * Capacitors
- * Switch pulse resistor tuners and rectifiers

MARCONI INSTRUMENTS BOOTHS 260-262 INSTRUMENTS AVENUE

*Signal Generator 10-500 Mc/s. *Signal Generator. *Spectrum Analyser 35 kMc/s. *Dual Frequency Universal Bridge. *Vibrating Reed Electrometer. *Wide Range FM Generator. World's finest MF Generator.

Marion Electrical Inst. Co. 556 Components Ave.

Marion new glass-to-metal, hermetically sealed aircraft navigational instruments; sensitive relays; ruggedized, hermetically sealed, panel meters, and commercial type panel meters. Adaptations of new coaxial meter movements.

Markem Machine Co., 306 Computer Ave.

*Model 69A color bander for condensers, capacitors, diodes, also will show continuous films on standard and special marking machines for electrical industry.

Maryland Acrylic Etching Co., 774 Airborne Ave.

"Catsight" edge lighted panels and dials made to MIL-P-7788. Metal name plates. Dials and panels etched or aluminated. Custom made to your specifications or to meet any government specifications.

The W. L. Maxson Corp. 620, 622, 624 Circuits Ave.

Featuring Electronic Systems, Airborne Armaments, Ordnance Equipment, and Industrial Instruments. Also products of—Unimax Division (Switches, counters and accelerometers); United Manufacturing Co. (Aircraft electrical test equipment); Langevin Manufacturing Corp. (Transformers, amplifiers, and power supplies).

*Indicates new product

(Continued on page 258A)

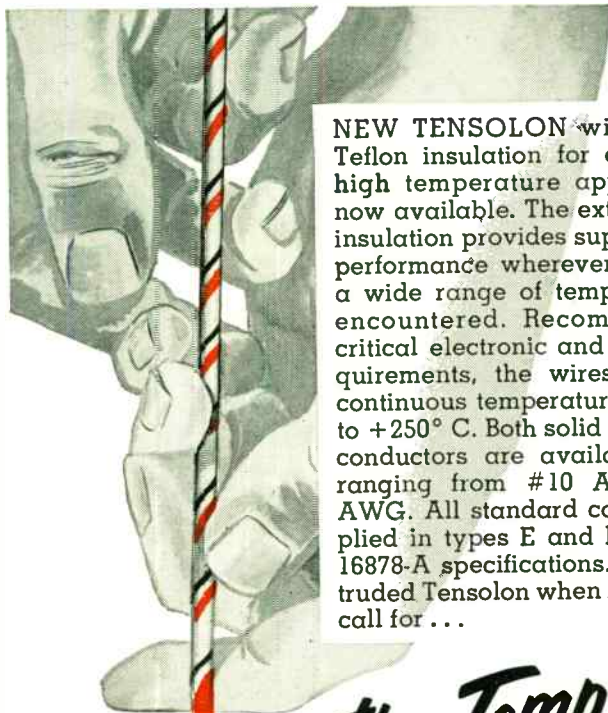

NEW TENSOLON with extruded Teflon insulation for extra rugged high temperature applications is now available. The extruded Teflon insulation provides superior service performance wherever abrasion or a wide range of temperatures are encountered. Recommended for critical electronic and electrical requirements, the wires function at continuous temperatures of -90°C to $+250^{\circ}\text{C}$. Both solid and stranded conductors are available in sizes ranging from #10 AWG to #30 AWG. All standard colors are supplied in types E and EE to MIL-W-16878-A specifications. Insist on extruded Tensolon when specifications call for . . .

Breaking the Temp Barrier!

TENSOLON TEFLON[®] INSULATED WIRE & CABLE



Tensolite has complete fabricating facilities for solving your high temperature wire problems —

- PARALLEL WRAPPED TEFLON
- SPIRAL WRAPPED TEFLON
- EXTRUDED TEFLON
- SPIRAL STRIPING WITH
TEFLON INKS

Watch Tensolite for progress in electronic wiring — inquiries are invited.

At the I.R.E. Show
BOOTH #647
CIRCUITS AVE.
Kingsbridge Armory,
N.Y.C.
March 21-24, 1955

NEW! 16 pages of specifications and data covering the complete Tensolite line; a note on your letterhead will bring your copy promptly.



© Du Pont

Tensolite

INSULATED WIRE CO. INC

TARRYTOWN, NEW YORK — TARRYTOWN 4-2300

Tensolite products include: TENSOLON — Teflon Hook-up Wire to MIL-W-16878A and Miniature Teflon Jacketed Cables; TENSOLEX—Vinyl Insulated Wires to JAN-C-76, MIL-W-76A, MIL-W-16878A; TENSOLITE — Super-flexible Constructions including Phonograph Pick-up Cables and Hearing Aid Cordage.

WIND AT 6500 RPM

**MORE OUTPUT . . .
LOWER COSTS . . .
EASIEST TO OPERATE**

MODEL 212-AM SCREW FEED BOBBIN-RESISTOR WINDER

- 6500 RPM top winding speed.
- NEW instant fingertip re-settable wire guide.
- Winds random wound, space wound, repeater and relay coils, solenoids, resistors, distributed constant delay lines, etc.
- Maximum traverse for any single winding - 6". (Specify Model 212-AML for 12").
- Maximum OD of coil wound - 4".
- Maximum distance between winding centers - 9". (15" for Model 212-AML).
- Winding range from 22 to 1520 turns per inch.
- Infinitely adjustable winding width from 1/8" to 6" (12" for Model 212-AML).
- Wire guide carriage for single winding. Easily modified for multiple winding.
- High-speed gears are oil bath lubricated.
- New magnetic self-adjusting reversing mechanism.
- Instant re-setting automatic counter.
- Exclusive economy positive stopping magnetic brake.

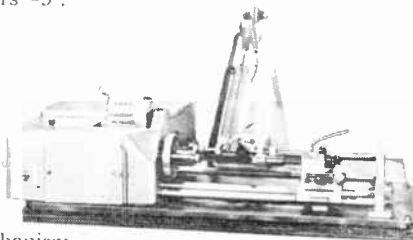

MODEL 319-AM ADJUSTABLE LENGTH BOBBIN WINDER

- 7000 RPM top winding speed.
- Winds random wound bobbins, solenoids, resistors and repeater coils from 1/8" to 2 1/2" wide and up to 5 1/2" OD.
- Infinitely adjustable winding width from 1/8" to 2 1/2".
- Instant re-setting automatic counter.
- Exclusive economy positive stopping magnetic brake.

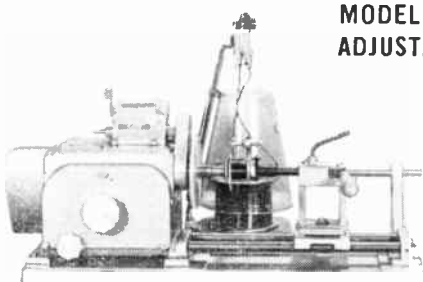

NEW GEO. STEVENS CATALOG

—describes machines that wind practically every kind of coil for production line or laboratory. Write for your copy today.



REPRESENTATIVES

FRANK B. TATRO, 6022 N. Rogers Ave., Chicago 30, Ill.
INSULATION & WIRES, Inc.

2040 E. Washington Blvd., Los Angeles 21, Calif.
1077 Howard St., San Francisco, Calif.

R. A. STAFF & CO., 1213 W. 3rd St., Cleveland 13, Ohio

RICHARD H. WHITEHEAD, 150 Church St., Guilford, Connecticut

HARRISON BLIND, 1508 Winton Ave., Indianapolis, Ind.

ALLIED INTERNATIONAL, INC., 230 Park Avenue, New York 17, N.Y.

SAMUEL JEFFRIES, 105 Forrest Ave., Narberth, Penna.

Geo Stevens
MANUFACTURING COMPANY, INC.
Pulaski Road at Peterson, Chicago 30, Illinois
**THE MOST COMPLETE LINE OF
COIL WINDING EQUIPMENT MADE**

What to See at the Radio Engineering Show

(Continued from page 257-A)

McColpin-Christie Corp., 859 Audio Ave.
STAVOLT Power rectifiers for closely regulated DC voltage. STAVOLT automatic battery chargers for Ni-Cad and lead acid types.

McCoy Electronics Co. 764 Airborne Ave.

Quartz crystals and miniature "McMite" crystals that are rugged, precise and dependable. Crystal ovens for both military and commercial use. *miniature "Mini Dual" variable capacitors and crystal filters.

McGraw-Hill Publishing Co.

126 Television Ave.

ELECTRONICS, the magazine of design, production and use of the electronic industry.
NUCLEONICS, the authoritative journal of the nuclear energy industry.

McMillan Industrial Corp., 387 Microwave Ave.

Radomes (Reinforced Plastic, Glass & Ceramics); Microwave Windows, Lenses & Reflectors; Loaded Solid & Foam Dielectrics; Microwave Absorbers (Plastic Foam, Hairflex, Thin Flexible Materials); Pre-fabricated Free Space Rooms.

Laboratory Standards



MEASUREMENTS CORPORATION
749 Airborne Ave.
Boonton, New Jersey

MEPCO

439-441 ELECTRONICS AVE.

- DEPOSITED CARBON RESISTORS
- PRECISION WIRE WOUND RESISTORS
- RESISTOR SWITCH ASSEMBLIES
- EXTERNAL METER MULTIPLIERS
- PRECISION POWER RESISTORS
- CUSTOM FINE WIRE WINDINGS

MEPCO, INC. Morristown, New Jersey

*Indicates new product

(Continued on page 260-A)

FIRST AID ROOM

A nurse is in charge at all times. First aid Room is the sixth room to right of Lobby directly off registration area in Kingsbridge Armory.

MICAMOLD

MOVES FORWARD ...AGAIN

*Two
New
Products*

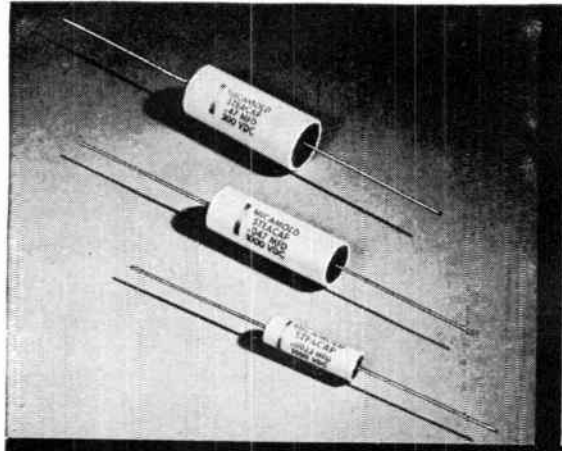

31 years ago when electronics was a new industry called "radio," Micamold designed the first molded mica capacitor. From those small beginnings the company's line grew quickly with variety . . . including paper, electrolytic and oil capacitors . . . keeping pace with the tremendous growth of electronics . . . and developing many other significant "firsts" over the years. Now Micamold moves forward again with . . .

MICAMOLD STEACAPS

Steatite encased tubular paper capacitors. The construction of these capacitors makes them capable of withstanding the most severe tests and operating conditions. Steacaps are conservatively rated for continuous operation at temperatures from -40° to $+85^{\circ}$ C. For further information write for Bulletin 111.

MICAMOLD MICAPS

Encapsulated mica capacitors . . . hermetically sealed by a dip coating method . . . with radial leads. This terminal arrangement results in a shorter RF current path, and in many cases greater convenience in assembly. They are smaller than comparable molded types . . . useful in miniature equipment. For further information write for Bulletin 110.

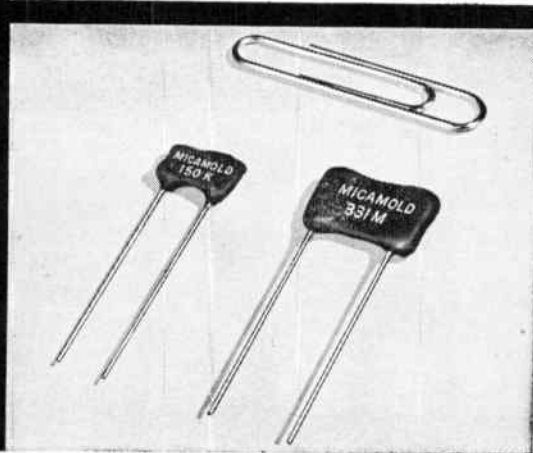

MODERN IDEAS Micamold is 31 years young . . . but our thinking keeps in step with the times. Aggressive engineering and management personnel are added to our staff at regular intervals. This policy of seeking-out new ideas gives our customers the benefit of alert, modern thinking tempered by experience . . . enables Micamold to maintain its position as a pioneer in the industry.

MODERN PRODUCTS Micamold products are used in tanks and refrigerators . . . planes and hearing aids . . . radar and your TV set . . . from high altitudes in the arctic to the steamy tropics. They range from subminiature capacitors to RF filters, pulse networks and delay lines . . . for military and commercial applications.

NEW MODERN PLANT Built in Tazewell, Va., in addition to expanded manufacturing facilities in Brooklyn, N. Y. At both locations modern production machinery is combined with fully-equipped labs, complete test equipment and competent research personnel.

Visit our Booth 466 Electronics Ave., at the IRE Show





MICAMOLD RADIO CORPORATION

1087 Flushing Avenue, Brooklyn 37, N. Y.

MANUFACTURERS OF ALL TYPES OF PAPER, ELECTROLYTIC AND MICA CAPACITORS, RF INTERFERENCE FILTERS, PULSE NETWORKS AND DELAY LINES

BE Sure with **CORNISH**
Electronic **WIRES and CABLES**

MICROPHONE CABLES 
 Designed for low capacitance, high insulation resistance, low attenuation—in plastic or rubber insulation to stand severe service

T-V LEAD-IN CABLES 
 Furnished only in pure virgin polyethylene to insure best electrical properties and long life under severe operating conditions

T-V LEAD-IN CABLES 
 Made hollow, of pure virgin polyethylene, for maximum efficiency in receiving Ultra High Frequency signals

INTERCOMMUNICATION CABLES 
 These quality cables are made in various constructions, utilizing plastic insulation for both conductors and jacket

SHIELDED INTERCOMMUNICATION 
 When installation conditions dictate, shielded cables are recommended. Made with internal or external shield—2 and 3 conductors

"MADE BY ENGINEERS FOR ENGINEERS"

CORNISH WIRE COMPANY, INC.
 50 Church Street New York 7, N. Y.

**What to See at the
 Radio Engineering Show**
 (Continued from page 258A)

Metal Textile Corp.
 Roselle, N.J.
433 Electronic Avenue
METEX RF SHIELDING PRODUCTS

- See demonstration
- Get new *Design booklet*

Mica Fabricators Association, 324 Computer Ave.
 All types of Fabricated, Natural Mica Parts including capacitor films, radio and TV tube spacer and bridges plus other parts for electronics and appliance industries.

Micamold
MICAMOLD RADIO CORP.
BROOKLYN 37, N. Y.
 Paper • Electrolytic • Mica Capacitors
 RF Interference Filters
 Pulse Networks • Delay Lines
BOOTH 466 ELECTRONICS AVE.

**Microdot Division—
 Felts Corporation**
679 Circuits Ave.

Microminiature Coaxial Cables and Connectors—Teflon Dielectric. Microminiature Assemblies and Development. New Products: Solder Type Plugs. "Quick Connect" Series. Introductory Kits—For 50, 70, or 93 ohm.

Micro Switch Div., Minneapolis-Honeywell Regulator Co., 356, 358 Microwave Ave.
 *Illuminated push button snap-action switches for applications on computers and other electronic equipment. See the expanding line of subminiature selectors, toggles and memory switches in multi-circuit variations.

Microtran Co., 634 Circuits Ave.
 Latest types, quality miniaturized transformers; encapsulated, molded, sealed. Hundreds of types, sizes, ratings available as stock catalog items. For guided missiles, radio paging, military, transistor, and airborne applications.

Microwave Associates, Inc.
392 Microwave Ave.

Microwave components ranging from 3 to 75 kilomegacycles including magnetrons, duplexer tubes, new *video diodes, and *wave-guide components and test equipment.

*Indicates new product
 (Continued on page 262A)

VSWR and RF POWER MEASURING EQUIPMENT



Micro Match models are available as components for incorporating directly into transmitters or as complete independent test equipments for measuring RF power and VSWR from 500 KCS. to over 4,000 MCS., and power levels from 10 milliwatts to 120 kilowatts. These instruments are being used as test and monitoring equipment by Government Agencies, transmitter manufacturers, FM & TV Stations, Laboratories, Mobile Communication Agencies, etc.

Write for complete literature on: THE MICROMATCH • RF ABSORPTION TYPE WATTMETERS • DUMMY LOAD RESISTORS • STATION GUARDIAN FOR TRANSMITTER PROTECTION • DIRECTIONAL COUPLERS.

See Us At
BOOTH #685

M.C. Jones Electronics Co.
 INCORPORATED
 BRISTOL, CONN.

Wrinlay
PROCESS

FOR
PERMANENT MARKINGS
ON

- DIALS
- PANELS
- CHASSIS
- SCHEMATICS
- INSTRUCTION PLATES
- PRINTED CIRCUITS

FLUORESCENT AND
RADIUM APPLICATION

- **LOW COST**
- **PERMANENT**
- **CLOSE TOLERANCE**

COMPLETE ART DEPT. AND
TYPE SETTING FACILITIES
DESIGN ASSISTANCE
METAL PREPARATION
SPRAY FINISHING
FULL COMPLIANCE
TO GOVT. SPECS.

ASK FOR
LITERATURE AND
FREE SAMPLES

PHOTO CHEMICAL PRODUCTS

479 WALTON AVE.
LUDLOW 5-0200

1715 BERKELEY ST.
EXBROOK 5-0919

NEW YORK 31, N.Y.

SANTA MONICA, CALIF.

LARGEST VARIETY

of
SIZES

and
TYPES

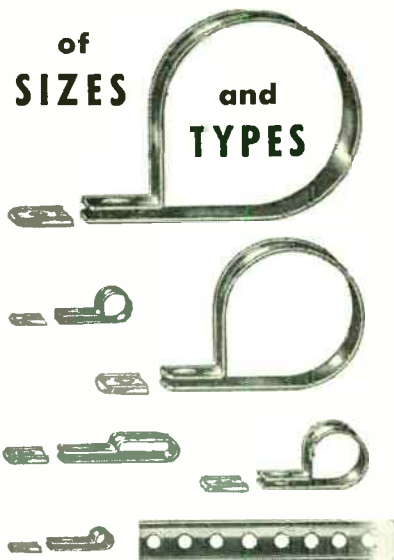

PLASTIC CABLE CLIPS and PERFORATED STRAPPING

Hold open wiring, fragile components, tubing, etc. with these safe, light weight supports.

Free samples and complete information.

WECKESSER CO.

5269 N. Avondale Ave., Chicago 30, Ill.

See our exhibit at Booth 33,
IRE Show, New York, March 21-24



new

RAYTHEON

2KVA

VOLTAGE STABILIZER

with Magnetic Amplifier Control

This latest advance in voltage stabilizer design by Raytheon gives you these outstanding advantages of Magnetic Amplifier Control: (1) lower harmonic content (2) better no load to full load regulation (3) less cubic space required and (4) ability to take heavy overload without damage.

Write for complete information.

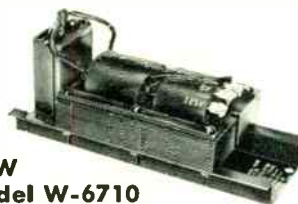

NEW Model W-6710 Voltage Stabilizer

OPEN TYPE CONSTRUCTION FOR CHASSIS MOUNTING

Insures constant 6 volts output at 25 watts, stabilized to $\pm 1/2\%$ from an input of 95 to 130 volts. Designed for 6-volt incandescent reference lamps; for colorimetric or spectrophotometric instruments and for stabilized filament voltages to tubes used in electronic apparatus within its rating.

SPECIFICATIONS

- Input: 115 volts, $\pm 10\%$, 58-62 cycles, single phase.
- Output: 115 volts, 2000 va.
- Output voltage stabilizations:
Fixed load, $\pm 1/2\%$ for line change.
 $\pm 1\%$ for frequency change.
No load to full load (85% P.F.), 1% maximum.
- Temperature rise of components; 50°C maximum.
- Harmonics (at 60 cycles input); less than 5% total.
- Efficiency at full load (100% power factor); 90% minimum.
- Mounting: Bench, floor, wall or relay rack.

RAYTHEON



NEW CATALOG

Gives performance data for the complete line of Raytheon Voltage Stabilizers. Write for it.

Excellence in Electronics

RAYTHEON

MANUFACTURING COMPANY
EQUIPMENT SALES DIVISION

Dept. 6120P

WALTHAM 54, MASS.

What to See at the Radio Engineering Show

(Continued from page 260A)

★ SEE ★
the NEW DEVELOPMENTS
in ★
coil winding
equipment ★

AT THE
**IRE National Convention and
Radio Engineering Show**

BOOTH 305, 420 PRODUCTION ROAD

Coil Winding Equipment Co.

109 AUDREY AVE., OYSTER BAY, NEW YORK

Microwave Development Labs., Inc.

377 Microwave Ave.

Wave Guide Circuit Component, Hybrid Junctions, Balanced Mixers, Balanced Duplexes, Compensated Invar Reference Cavities, Rotary Joints, Precision Cast Bends, Precision Directional Couplers, and Custom Wave Guide Assemblies.

Midland Manufacturing Co., Inc.

143 Television Ave.

Quartz Crystal Oscillator
Plates

Midwestern Instruments, Room A, Reg- istration Row

*590 oscillograph, *581 oscillograph, *Bridge Balance Unit, as well as our other oscillographs, galvanometers, servo-valves, servo-amplifiers, etc.

James Millen Mfg. Co., Inc.

557 Components Ave.

GridDip Meters; Radar, Radio & Electronic equipment and components, Magnetic Metal Shields; *Delay lines, Delay line Kits; *Complete line, subminiature parts; *1" instrumentation oscilloscope.

Miller Dial & Name Plate Co., 357 Mi- crowave Ave.

The revolutionary Miller Foilcal plus printed circuits, edge-lite panels, instrument panels, dials, scales, silk screening, etching, lithographing, engraving, radium & fluorescent applications and general graphic arts.

William Miller Instruments, Inc., 288 Instruments Ave.

Demonstration: 16 channel *Type CR-1A Cathode Ray Recording Oscillograph; 27 channel *Type M Miniature Recording Oscillograph. Custom Instrumentation Systems, Galvanometers, Tuning Forks, Accelerometers, Amplifiers, Power Supplies, and Transformers.

Millivac Instrument Corp., 281, 283 In- struments Ave.

This year's exhibit mainly devoted to amplifier noise problems. *Accurate signal-to-noise Ratio Voltmeter and Volkers & Schaffer ultra-sensitive oscilloscopes having less than one microvolt noise.

Milwaukee Gas Specialty Co., 738 Air- borne Ave.

Hermetically Sealed Sensitive Relay.

*Indicates new product

Show Hours: Monday 10 AM-10 PM
Tuesday 10 AM-10 PM
Wednesday 10 AM- 5 PM
Thursday 10 AM-10 PM

THIS Midget is KING SIZE

in **PRECISION**
and **DEPENDABILITY!**

MINIATURE OVERTONE QUARTZ CRYSTALS

In Hermetically Sealed Metal Holder

Freq. Range: 15 to 100 Mc.

Operating Temp. Range:
-55° to + 105°C

Same performance, same tolerances as larger units such as MIL CR-23, CR-32, etc. Has 1½" wire leads for mounting in selector switch or soldering to printed circuit terminal board.

We're always ready to help on your miniaturization or other design problems — at your plant or ours. Write or phone.



New Crystal Brochure
on Request to Dept. P3

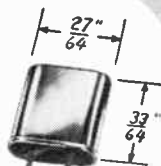

NOW IN
PRODUCTION

SEE US AT I.R.E. SHOW
BOOTH 736

KEYSTONE ELECTRONICS COMPANY

114 Manhattan Street Stamford, Connecticut

Phone: STamford 4-9504

QUARTZ CRYSTALS
OF EVERY TYPE

What to See at the
Radio Engineering Show

SEE SUBMINIATURE
TOGGLE SWITCHES

380 MICROWAVE AVE.

MINIATURE SWITCH CORP.
LYNBROOK, NEW YORK

**Minneapolis-Honeywell
Regulator Co.**

**Aeronautical Division
360, 362 Microwave Ave.**

Power Type Transistors, Thermistor Level
Switch demonstrated, Transistorized Aircraft
Fuel Gauge, Pressure-Ration Indicating Sys-
tem for Jet Engines, Gyros for every applica-
tion, New Null Balance Indicators, Magnetic
Servo Amplifiers, Recording Oscillographs,
Six Divisions will display in a combined
booth.

Minnesota Mining and Manufacturing
Co., 124 Television Ave.
See American Lava Corp.

Model Engineering & Mfg. Inc., Booth
444 Electronic Ave.
See Tru-Ohm Products Div.

Model Rectifier Corp., 29 Palace

Selenium and germanium rectifier power sup-
plies for testing and operation of DC apparatus
allowing continuous variation of current and
voltage. Transistor range power supplies.

**Molon Motors and Coil
Company**

314 Computer Ave.

Complete line of fractional horse-
power motors. Skeleton and clutch-
gear types. Custom-manufactured to
specifications.

MOLONEY ELECTRIC CO.
ST. LOUIS, MISSOURI



**HIPERCORE CORES
TRANSFORMERS**

680 CIRCUITS AVE.
IRE, U. S. A.

Moseley Co., F. L., 315 Computer Ave.

Autograf X-Y Recorder, Curve follower, input-
output table for computer use, digital to analog
Converter, Servo Voltmeter giving analog and
digital output.

Motson Co., J. Frank, 606 Circuits Ave.

Printing on electronic and industrial parts;
plastics, glass, metals, ceramics, dials, termi-
nal boards, chassis, panels, shields, schematics,
etc.; direct printing of conductive and resistive
materials in specialized applications.

(Continued on page 261A)

NOW AVAILABLE
With **ADJUSTABLE CAM TRAVERSE**

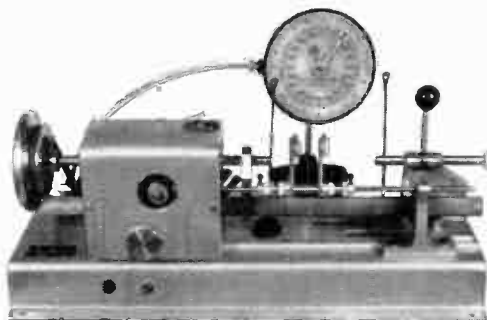

MODEL W COIL WINDER

- ★ Bank winding now possible with a commercial machine.
- ★ Improved progressive universal winding achieved with compensating cam form.
- ★ Will also wind bobbins, single layer close and space windings, transformers, universal (pi) and conventional progressive universal coils.
- ★ Set up for universal windings greatly simplified.

Send for complete technical literature.

Coil Winding Equipment Co.

OYSTER BAY, NEW YORK—OYster Bay 6-1285

Visit The IRE National Convention and Radio Engineering Show Booth 305 420 Production Road

**epoxide
or
ceramic-**

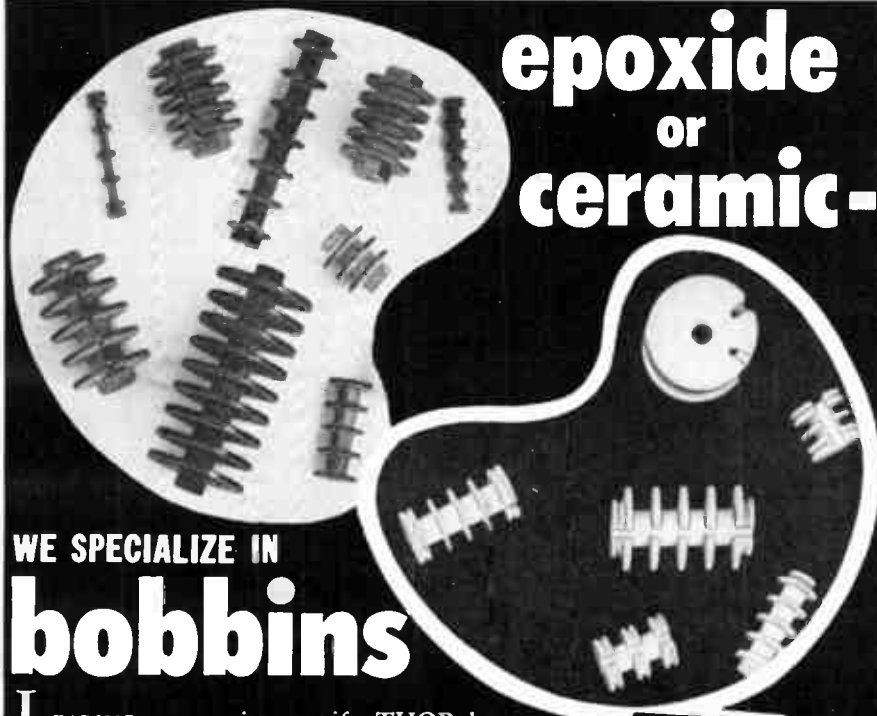

**WE SPECIALIZE IN
bobbins**

LEADING companies specify THOR, because
Thor is a specialist in custom-producing
epoxide and steatite bobbins, pressed
and machined steatite
parts to commercial or
Jan-1-10 specifications.*

You, too, should
specify Thor.

Thor

Thor Ceramics, Inc.

225 Belleville Avenue, Bloomfield, New Jersey

Visit Booth #334 Computer Ave., IRE Show, March 21-24, 1955

The Sign of precision engineered
TRANSFORMERS
 for greater **DEPENDABILITY**
QUALITY
CONSTRUCTION

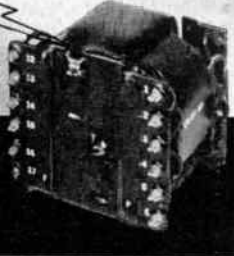
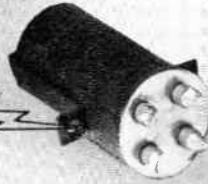

**AUDIO - POWER
 PULSE
 TRANSFORMERS AND INDUCTORS**
 High Temperature—Miniaturized
 Encapsulated Units.

SEE US AT
 THE IRE SHOW
 Kingsbridge Palace
 Booth #31

INDUSTRIAL ITC TRANSFORMER
Corporation
 GOULDSBORO PENNSYLVANIA

What to See at the Radio Engineering Show

(Continued from page 263A)

Mucon Corporation, 442 Electronic Ave.
 Sub-Miniature ceramic capacitors, for coupling, by-pass, temperature compensation where space and weight are factors. New voltage-sensitive capacitors. New UHF standoff and ribbon lead capacitors.

Muirhead Instruments, Inc., 490 Electronic Ave.

Wave Analysers and associated equipment for vibration, sound and electrical wave-form analysis. High-Accuracy Decade Oscillator. Resolvers and other computation elements. *Miniature Standard Cell.

Mullard Ltd. of England, Booth 841 & Th. II Audio Ave.

See International Electronics Corp.

Mycalex Corp. of America

651, 653 Circuits Ave.

Mycalex glass-bonded mica-high temperature, dimensionally stable low loss insulating materials and synthetic mica. Telemetering Switches, Coil Forms, Printed Circuit Tube Sockets, molded and fabricated components.



**RADAR RD. &
 ELECTRONICS
 AVE.**

BOOTH No. 426

Microwave components such as Antenna Feeds, Rotary Joints, Duplexer-Mixer Assemblies, Crystal Mixers, Directional Couplers, Waveguide Switches, designed and manufactured to your specifications.
N.R.K. MFG. & ENGINEERING CO., Chicago 41, Ill.



**BOOTH 378
 MICROWAVE AVENUE**

A complete line of Microwave Test Equipment, Thermistors and Bolometers.

**THE NARDA CORPORATION
 MINEOLA • NEW YORK**

BERYLLIUM COPPER
 Silvercote ®

titanium

phosphor bronze

ALUMINUM

OTHER NON-FERROUS

Send for descriptive folder.



LITTLE FALLS ALLOYS Inc.
 191 Caldwell Ave., Paterson 1, N. J.

Special Purpose **WIRE**

Consider WIRE and the importance of its function in your product. Whether a highly engineered application or a simple stapling purpose, your choice of the proper alloy or composition, temper and type of wire could mean success or failure during crucial test.

round • flat — square ■ half-round ▲

Precision gauges from 1/8 to .002.

SPRING WIRE — WIRE FOR INSTRUMENTS —
 ELECTRONICS. STRAND FOR WIRE ROPE AND
 BRAIDED APPLICATIONS — MANDREL WIRE
 — WIRE FOR FORMS — RIVETS — STAPLING

**AMPLITUDE
 LINEARITY
 MODEL ALT-2 TESTER**



A new linear staircase generator for quick and accurate differential gain checks of color or monochrome television systems or individual units. Supplies composite video signal with adjustable sync pulse, blanking level, and staircase amplitude. Number of steps variable from 3 to 14. Step exponent adjustable from 1.0 to 2.75. Internal r-f generator modulates steps at frequencies from 1.0 mc to 4.2 mc. Provisions for external modulation.

See our color television studio equipment and laboratory test instruments in operation—

Television Avenue • Booth 139

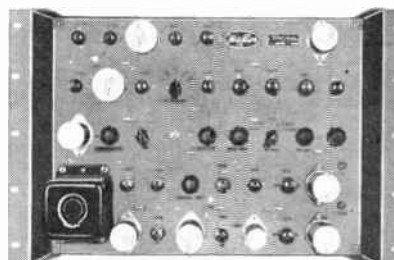

Wickes ENGINEERING AND CONSTRUCTION COMPANY
 12TH STREET AND FERRY AVENUE ESTABLISHED 1920 CAMDEN 4, NEW JERSEY

**Naresco Equipment Corp.
 National Research Corp.**

224 Instruments Ave.

*Impregnation equipment, *logarithmic & wide range vacuum gauge, *quick cool booster pumps. Also, rotary gas ballast pumps & other high vacuum equipment.

*Indicates new product

(Continued on page 266A)



Visit
IRE
Booth 639
Circuits
Ave.

INTERMEDIATE FREQUENCY AMPLIFIER

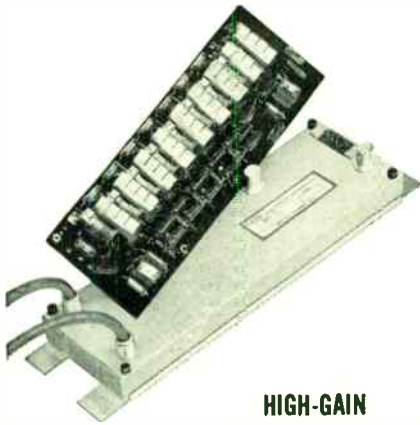

HIGH-GAIN
LOW-NOISE
SUBMINIATURE
8 1/2" LONG

RS new high-gain, low-noise intermediate frequency radar amplifiers smallest in size, lightest in weight, offer rugged compactness, versatile circuitry including up to 100 Db automatic and manual gain control, low impedance output, video detection, fast time constant, and low-noise input. Unparalleled simplicity and efficiency are evidenced in the exclusive RS printed circuit. Currently in use, this miniature instrument is vibration and shock resistant, lends itself to innumerable applications. Modifications and special designs are available as required. Available to military specifications and with military source inspection on government contracts and subcontracts. Write for detailed information.

SPECIFICATIONS

Center Frequency.....20 to 100 Mc.
Bandwidth.....2 to 12 Mc.
Noise Figure.....Better than 2 Db.
Gain.....Up to 120 Db.
Automatic and/or Manual Gain Control..100 Db, or greater.
Operative Temperature -65°C to +100°C, ambient.
Size.....As an example, a nine tube amplifier is available completely enclosed in on 8 1/2" by 3" by 3/4" case. Smaller amplifiers available for special installations.
Shock.....Will withstand at least 30 G shock.
Vibration.....Will withstand at least 10 G vibration for extended periods while operating.
Weight.....Approximately 1 lb.

RS Products include Noise Generators, Post Amplifiers and Conventional IF Amplifiers

RS
ELECTRONICS CORPORATION

434 PORTAGE AVENUE
PALO ALTO, CALIFORNIA

PROCEEDINGS OF THE I.R.E. March, 1955

SLIP RING SPECIALIST



PARDNER . . . IF YOU'RE LOOKING FOR SLIP RINGS, LET P M I SHOW YOU A FEW TRICKS!

When it comes to designing and manufacturing slip ring (collector ring) assemblies, pardner, you've come to the right corral. We can make them small as a Rhode Island gnat or big as a Texas moon. When you're at the IRE Show this month be sure to stop in and pay us a visit at Booth #602.



PROJECT 240E191

Commutator and Slip Ring Assembly designed and produced to meet Gov't specs., MIL-E-5400, MIL-E-5272B. Electrical tolerance (phasing) $\pm 1^\circ$ RPM 140 — Life 1000 hours min. Brush noise 3 MV max. at 0.5A. 3/4" dia. rotor.

P M I **P M INDUSTRIES, INC.**
268 FAIRFIELD AVE.
STAMFORD, CONN.

AMBIENT
+600°

HOT

COLD

+200° TO
-100° F

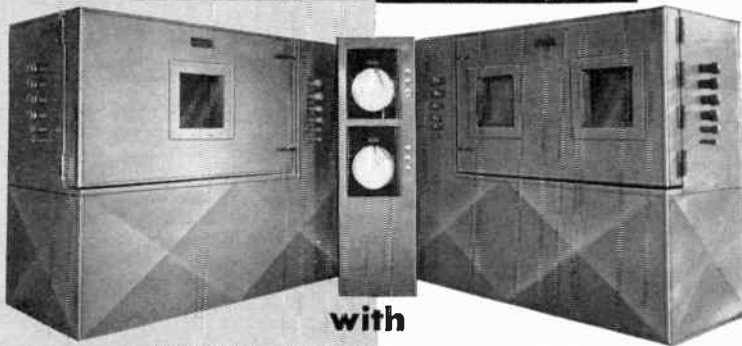

with
SINGLE CENTRAL CONTROL

Another environmental test cabinet to solve the testing problems of industry. This is a combination unit comprising a hot and cold cabinet and connected into one by utilizing a central control system.

Manufacturers of temperature, altitude, humidity, sand and dust, etc. For a complete listing of equipment manufactured by us, please send for our new 1955 catalog.

Our job is to solve your problem. Compare these features—

- Complete hot and cold test set-up for hydraulic or other components with central control.
- Temperature Range in Hot chamber from ambient to +600° F.
- Temperature Range in cold chamber from +200° F to -100° F. (lower temperatures if desired.)
- Cooling provided by dry ice. (Mechanical if required)
- Heating provided by electric heaters.
- Control to $\pm 3^\circ$ F at any temperature. (Closer tolerances if desired). WRITE DEPT. R3.

INTERNATIONAL RADIANT CORP.

MEMBERS: ENVIRONMENTAL EQUIPMENT INSTITUTE
4 MANHASSET AVENUE, PORT WASHINGTON, NEW YORK

**What to See at the
Radio Engineering Show**

(Continued from page 264A)

**National Carbon Co.
Div. of Union Carbide
& Carbon Corp.**

527, 529, 531 Components Ave.

12 new "Eveready" "Mini-Max" Battery types for Transistor Equipment will be featured. Also complete "Eveready" Radio Battery line. Various "Eveready" Battery Engineering Bulletins available free of charge.

**National Co., Inc.
848 Audio Ave.**

Engineers and manufacturers of precision electronic equipment and components for government and commercial use. Exhibit to include Receivers, Components and Engineered Products.

**National Vulcanized Fibre Co., 777 Air-
borne Ave.**

Copper-clad Phenolite, laminated plastic, for printed or etched circuits. Laminated plastics of glass, cloth and paper combined with phenolics, melamines, polyesters, and silicone resins. Copper-clad fibre and components.

Nems-Clarke, Inc., 127 Television Ave. Exhibiting latest development in special purpose receivers for telemetering and television rebroadcasting. A highly stable crystal controlled telemetry receiver will be featured.

Neomatic Inc., 520 Components Ave.
See Elkin-Neomatic, Inc.

Network Mfg. Corp., 782 Airborne Ave. Toggle Switches, MIL and IAN Military Styles per JAN-S-23 and MIL-S-6745. *1680 Series of Appliance Switches in 36 Various Combinations.

**New Hermes Engraving Machine Corp.,
468 Electronic Ave.**

*First Showing of only chip-proof, laminated plastic, called GRAVOFLEX, for label plates, panels, etc. See demonstration on New Hermes portable engraving machine.

New Jersey Electronics Corp.



345 Carnegie Ave.
Kenilworth, N. J.

Exhibiting in

BURLINGAME ASSOCIATES BOOTH
234-236 INSTRUMENT AVE.

Manufacturers of the most complete line of
Regulated Plate Power Supplies in the industry

**New London Instrument Co., 166 Tele-
vision Ave.**

Test Equipment, Signal Generators, RF Noise Generators, Frequency Standards, Square Wave Generators. *Vacuum Tube Transconductance analyzer.

New York Air Brake Co., 90 Palace New features of Kinney compound vacuum pumps for electronic tube industry: (1) adequately vibration-free for mounting on carts, (2) controlled gas ballast, (3) single mechanical shaft seals.

Ney Co., J. M., 291 Instruments Ave. Precious metal alloys in electrical contacts, contact assemblies, slip rings, sub-ring assemblies, precious metal fine resistance wire.

*Indicates new product

(Continued on page 268A)

precision stampings

Specialists
in
**BERYLLIUM
COPPER**

Manufacturers of complex design parts (to customers' specification) for Electronic, Radar, Television, Radio, Aircraft and Communication units.

Producer of parts made from Beryllium Copper, Coin Silver, Phosphor Bronze, Brass, Aluminum and steel in thicknesses from .002 to .090 for experimental and production requirements.

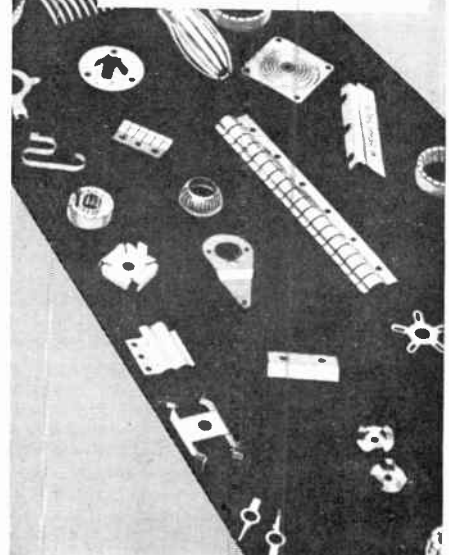

COMPLEX METAL PARTS

- Grounding Strips
- Diaphragms
- Crystal Contacts
- Grid Contacts
- Cavity Contacts
- Gaskets
- Contact Springs
- Spring Selectors
- Screen Plates
- Contact Rings, etc.

Quotations submitted upon request



140 Fifth Avenue
Hawthorne, New Jersey

CONT

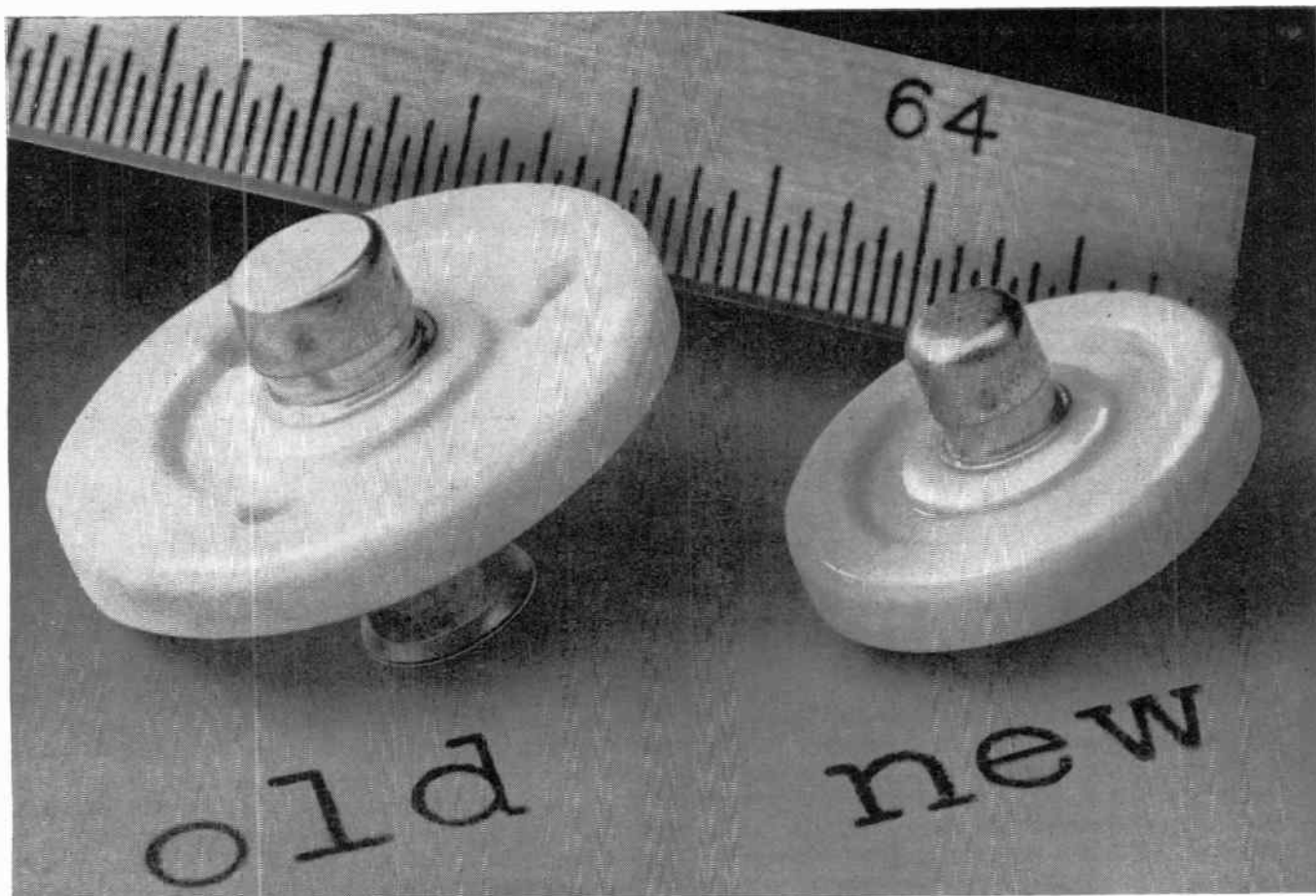

New miniature disc cathode shank diameter and length are reduced by approximately 25% from the previous model. Ceramic

also is about 25% smaller. Concentric groove in ceramic inhibits leakage from sublimation deposits. Magnification 8x.

NEW SUPERIOR TUBE MINIATURE DISC CATHODE SAVES 25% SPACE, UP TO 50% HEATER POWER

Up to now, practically all cathode ray tubes were equipped with disc cathodes as large as the one shown on the left in the above picture. But since the aperture in the first grid of most cathode ray tubes is normally so much smaller than the cap of the cathode, Superior Tube engineers reasoned that the cathode could be smaller and still give as good emission. They were right. The new cathode is shown above.

Think what this means: Tri-gun color TV tubes can have more slender necks. So also can multi-gun special purpose cathode ray tubes. Cost can be saved in the glass, the base, and the socket. Even single gun tubes can benefit. Less metal and ceramic means a lower heater power requirement.

These miniature disc cathodes are available in all regular Superior Tube cathode alloys. Ceramics can be either 0.365" or 0.490" dia., with or without breather holes. Cap to ceramic dimensional tolerance (the "E" dimension) guaranteed within $\pm .0005$ ".

Ask for a sample quantity of these new cathodes and try them for performance. Write for engineering information, Superior Tube Company, 2506 Germantown Ave., Norristown, Pa.

All analyses
.010" to $\frac{3}{8}$ " O.D.
Certain analyses in
light walls up to
 $2\frac{1}{2}$ " O.D.

Superior Tube
The big name in small tubing



Radius of Curvature of edge of cap lessens the danger of high temperature "dishing" frequently experienced with large area, sharp edge cathodes. "Dishing" would affect cut-off voltage of tube, require use of more expensive variable resistor in grid circuit. A small flat surface is retained to provide a satisfactory source of emission current.

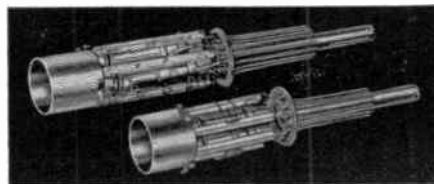

Size Comparison of Color TV Guns. Note how much more compact gun can be with miniature disc cathodes. Permits more slender tube neck.

precision
instruments
by DeJUR



ACTUAL SIZE

There's
"big meter"
precision in
this Series 100
SEALED

SUBMINIATURE METER

Now you can specify this tiny, light weight instrument and still get $\pm 3\%$ accuracy over full scale.

Imagine, 9 precision meters take only $3\frac{3}{8}$ square inches of space! Yet you do not sacrifice the accuracy of larger meters. The subminiature series 100 uses an extremely accurate external pivot D'Arsonval movement and special "O" ring and locknut for watertight, single hole mounting. (Square model available on special order)

Our Engineering Department can supply prototypes quickly to meet unusual design specifications for tests and approval. Write for complete technical literature. No obligation.

DeJUR

DeJUR sealed and ruggedized panel instruments are also available in $1\frac{1}{2}$ ", $2\frac{1}{2}$ ", $3\frac{1}{2}$ ", and $4\frac{1}{2}$ " sizes. Send us your requirements and we will submit our quotations.

ELECTRONIC SALES DIVISION • DeJUR-AMSCO CORPORATION
45-01 Northern Blvd., Long Island City 1, New York

"You're always sure with DeJUR instruments."

See us at Booth 200 Production Road, Radio Engineering Show

**What to See at the
Radio Engineering Show**

(Continued from page 266A)

**NORDEN-KETAY
CORPORATION**

Booths 629-631 Circuits Avenue

Servo Mechanism Components Computers
Gears & Gear Trains Digital Converters
Fire Control Systems Airborne Instruments
Navigational Systems Gyro Components
Automatic Control Systems Servo Amplifiers
99 PARK AVE. NEW YORK 16, N. Y.

A Division of Norden-Ketay Corporation

**THE NORDEN
LABORATORIES**

Booths 629-631 Circuits Avenue

Automatic Control Systems Computers
Electro-Mechanical Devices Instruments

North Electric Mfg. Co.

857 Audio Ave.

Hermetically sealed aircraft relays, industrial relays, relays for computers and calculating machines and communication equipment as voice frequency and narrow band signaling carrier.

North Shore Nameplate Inc.

844 Audio Ave.

Speedy-Cal Aluminum Foil Anodized Pressure Sensitive Nameplates, Instruction Plates, Circuit Diagrams, Speedy-Marx Wire Code Markers, Cable, Conduit and Pipe Markers, Industrial Safety Signs, Container Markers, Hi-Temp Markers, *F.O.A. Markers, both tape and metal. *Multi-color Aluminum Foil Anodized, Etched, Pressure Sensitive Nameplates.

**Northeast Scientific Corporation, 113
Television Ave.**

*Precision Regulated High-Voltage supplies in the kilovolt region. *Stabilized Constant-Current Supply. *Modulated Millimeter-Wave Signal Generator. *High-Frequency LP, HP, and BP filters.

**Northern Radio Co., Inc., 197, 198 Tele-
vision Ave. & Broadcast Way**

SEE a demonstration of the latest techniques in the FREQUENCY SHIFT communication field as embodied in the NORTHERN RADIO TWINPLEX units, FS DIVERSITY CONVERTER & VARIABLE MASTER OSCILLATOR with 1 part per million stability!

*Indicates new product

(Continued on page 270A)

Show Hours: Monday 10 AM-10 PM
Tuesday 10 AM-10 PM
Wednesday 10 AM- 5 PM
Thursday 10 AM-10 PM

A NEW
TECHNIQUE
FOR
BETTER
VISIBILITY

by **NIGHT**
by **DAY**

ILLUMINATED

- SWITCH ASSEMBLIES
- CONTROL PANELS
- KNOBS
- DIALS

Because of a unique technique, characteristics never before achieved are available in panels, knobs, switches, flat and drum dials. The lettering is flush, on a non-reflecting black background, providing maximum angle visibility with no eye fatigue. When lighted from behind, there is no after-image. An illustrated booklet showing some of the present applications of this new technique (and perhaps provoking some new ideas) is available.

Write for Booklet #11.

See us at Booth 214
Instruments Avenue
I.R.E. Show

UNIVERSAL AVIATION
EQUIPMENT, INC.
362 Fifth Ave., New York 1, N. Y.
Wisconsin 7-3574-5

For Printed Wiring Applications

Specify **ERIE** TRADE MARK
TUBULAR CERAMICONS®

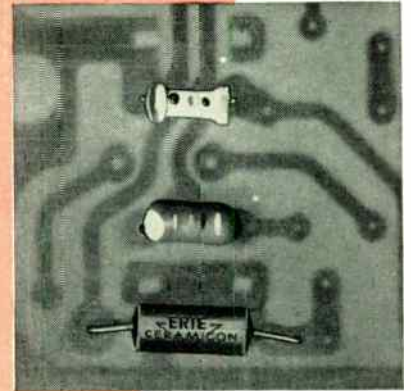

- ERIE TUBULAR CERAMICONS offer a convenient form factor for printed wiring board applications. This is especially significant when above-board space is at a premium.
- ERIE Tubulars offer added printed wiring layout flexibility. The smallest unit is capable of spanning a range from $\frac{3}{8}$ " to $2\frac{3}{4}$ "
- Leads of ERIE Radial Lead Tubular Ceramicons are tinned with a minimum of .001" coating of solder to assure continued ease of soldering even after long storage.
- The uniform case size of the ERIE Molded Tubular Ceramicon is particularly adapted to automatic loading and is available packaged on tape,—2000 to a reel.
- ERIE Tubular dielectric design is inherently strong. Lead wires are wrapped around the dielectric and soldered. This feature assures unusual ruggedness in withstanding stress on leads in any direction.
- Temperature Compensating and General Purpose Tubular CERAMICONS are available in a wide capacity range with tolerances as close as $\pm 1\%$ or $\pm .1$ mmf. and in Hi-K types for by-pass and coupling applications.

Write for a copy of Bulletin 313-2 for a complete description of ERIE TUBULAR CERAMICONS.

ERIE
Electronics

ERIE ELECTRONICS DIVISION

ERIE RESISTOR CORPORATION

Main Offices and Factories: ERIE, PA.

Manufacturing Subsidiaries

HOLLY SPRINGS, MISSISSIPPI • LONDON, ENGLAND • TRENTON, ONTARIO



**VISIT
PRECISION
PAPER TUBE CO.**

**AT THE
RADIO ENGINEERING SHOW**



**1955
IRE
NATIONAL
CONVENTION**
New York City
MARCH 21-24
**BOOTH
791**

Kingsbridge Armory,
Airborne Ave.

**DIELECTRIC KRAFT • FISH PAPER • CELLULOSE ACETATE
COMBINATIONS • PHENOL IMPREGNATED**

Round, square, rectangular, triangular, any shape, any size— Precision Paper Tube Co. can provide *all* your paper tubing needs. Your specifications are met to the most exacting tolerances. Precision Paper Tubes are sturdy, crush resistant, have high tensile strength and excellent dimensional stability.



HIGH DIELECTRIC BOBBINS FOR BETTER COILS

Precision-made on specially designed equipment, using the finest materials, to provide maximum tensile strength, light weight, more winding space and other essential electrical and mechanical characteristics.

Furnished in any size or shape. Supplied plain or fitted with leads, slots or holes. Flanges cut to specification, plain or embossed.

The only complete coil form service available. Get full information at our booth.

Sales Representatives in:

New England:
Framingham, Massachusetts, Framingham 7091
Metropolitan New York, New Jersey:
Jersey City, New Jersey, Journal Square 4-3574
Upstate New York:
Syracuse, New York, Syracuse 76-8056
Northern Ohio, Western Pennsylvania:
Cleveland, Ohio, Atlantic 1-1060
Indiana, Southern Ohio:
Logansport, Indiana, Logansport 2555

Missouri, Southern Illinois, Iowa:
St. Louis, Missouri, Sterling 2318
Maryland:
Baltimore, Maryland, Plaza 2-3211
Philadelphia, Camden:
Philadelphia, Pa., Chestnut Hill 8-0282
California:
Pasadena, California, Sycamore 8-3919
Canada:
Montreal, Quebec, Canada, Walnut 2715



PRECISION PAPER TUBE CO.

2051 W. CHARLESTON ST. CHICAGO 47, ILL.
Plant No. 2: 79 Chapel St., Hartford, Conn.

**What to See at the
Radio Engineering Show**

(Continued from page 268A)

A Subsidiary of Norden-Ketay Corporation
*Nuclear Science
and Engineering Corporation*
Booths 629-631 Circuits Avenue
Industrial Applications of Radioactivity
P.O. Box 10901 Pittsburgh 36, Penna.

Nucleonics, 126 Television Ave.
See McGraw-Hill Pub. Co.

Oak Mfg. Co., 641 Circuits Ave.
Rotary, pushbutton, slider and level switches;
Ledex type rotary solenoids; vibrators; 60 to
500 cycle choppers; television and automobile
tuners; special electro-mechanical assemblies.

**Be Right with
OHMITE**

Rheostats • Resistors
RF Chokes • Tap Switches
AMRECON RELAYS

OHMITE MFG. CO.
554 Components Ave.

**Olympic Metal Products
Company, Inc.**

336 Computer Ave.

*Deep Drawn Cases, Fabricated Cases, Hypersil Core Brackets, Channels, Shields for Transformer Industry. Also Chassis, Panels, Stampings for Electronic Industry in general.

Olympic Radio & Television Inc., 73 Palace

*Introducing compact, light weight, low cost VHF Automatic Direction Finder—Industrial TV Receivers—Radar Equipment—offering extensive environmental testing facilities and developmental engineering.

**Optical Film Engineering
Co.**

865 Audio Ave.

For a complete line of high vacuum equipment, vacuum exhaust systems, automatic TV-tube aluminizers, package pumping systems, dielectric filters, front surface mirrors, electrically conductive transparent coatings, low reflection coatings and specialized thin films of all descriptions.

*Indicates new product

(Continued on page 272A)

Busses every eight minutes
Kingsbridge to Waldorf Astoria
FREE



New Items at the Show!

- Coaxial Directional Couples from 100 mc to 3000 mc
- Power Dividers
- Band Pass Filters

Also on display—

is our regular line of component parts for the frequency range of 1000 to 40,000 megacycles

Specialists in Radar-Microwave Components and Test Equipment



the **630**

IS STILL THE FINEST
TV CHASSIS EVER DESIGNED

*...and there is no finer
630 chassis than the*

GOLD MEDAL

by **TECH-MASTER**

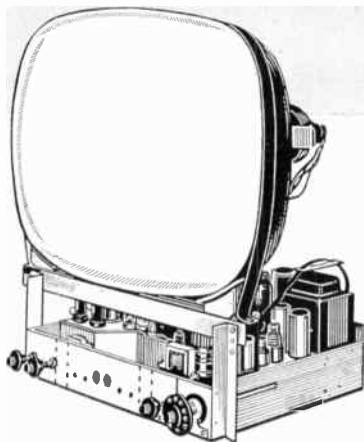

... featuring a new and improved system of Picture-Sound synchronization which affords simple pin-point tuning with highest picture resolution and drift-free undistorted sound under all signal conditions ... UHF or VHF.

- MODEL 2430: For picture tubes up to 24" Audio connection for optional use of external amplifier.
Net Price..... (Less Kine)\$189.50
- MODEL 2431: Same as 2430, but with true fidelity Push-Pull audio amplifier.
Net Price..... (Less Kine).....\$199.50
- MODEL 2439: For 90° Kinescopes up to 27" Net Price..... (Less Kine).....\$262.50

All Models Available UHF/VHF

Send For Literature

TECH-MASTER TV Chassis

TECH-MASTER TV Kits

TECH-MASTER Audio Equipment



TECH-MASTER CORPORATION

TELEVISION and RADIO

75 FRONT STREET, BROOKLYN 1, NEW YORK

See the
SERVO
all-star line-up
at the
IRE SHOW
BOOTHS
203 AND 300,
PRODUCTION ROAD



★ Radio Instrument Line

- Navigation Direction Finding
- Radar Facsimile Recorder
- Measurement Instruments
- Communication Receivers
- High Voltage Power Supplies

★ Servolab Instrument Line

- Servoscope*
- Servoboard*
- Servo Amplifiers
- Servolab Building Blocks

★ Infrared Measurements Line

- Bolometer and Preamplifier
- Recorder Amplifier
- Pyrometers

*
REG
TRADE
MARK



8C-12B

SERVO CORPORATION
OF AMERICA

NEW HYDE PARK, NEW YORK



VARIABLE FREQUENCY GENERATORS

50-6000 CPS



MODEL 1425
900 V.A.

For powering your shake table or production test facility, the *new* CML model 1425 features low distortion (3%) and well regulated output voltage ($\pm 1\%$). Low dynamic output impedance is a feature of all CML Generators.

Other frequency ranges within the 20 CPS to 60 KC range available on special order.

Other CML Generators from 50 watts to 13.5 KVA-single and 3 phase.

COMMUNICATION MEASUREMENTS LABORATORY, INC.

350 LELAND AVE., PLAINFIELD, N.J.

What to See at the Radio Engineering Show

(Continued from page 270A)

John Oster Mfg. Co. 747 Airborne Ave.

Instrument control motors—servos, synchros, resolvers; Tachometer generators; Servo Torque units; AC-DC drive motors; AC-DC blower and fan motors; Rotary and linear actuators.

Overlakes Corporation, 45 Palace
See Garfield Wire Div.

PM Industries Inc. 602 Circuits Ave.

Manufacturers of slip ring (collector ring) and brush assemblies of all types and sizes. Molded or fabricated to your specifications.

PSC Applied Research Limited, 54, 56 Palace

*Automatic Tri-Film Processor. MK 6 Instrumentation Camera. Custom microwave plumbing. The automatic ice detection and shedding control system and the T249 Armament Intervalometer as installed on the Avro Aircraft Ltd., CF 100 MK 4.

Pacent Engineering Corp., 680 Circuits Ave.

Representing: Moloney Electric Co., Roller-Smith Corp., Transistor Products, Inc., Van Dyke Textigraph Co., S. A. Asquith Co.

Pacific Semiconductors 475 Electronics Ave.

Manufacturers of germanium diodes and silicon junction diodes; research, development, and engineering in the fields of semiconductor devices and semiconductor circuits.

Packard-Bell Company, 30 Palace
See the best in color TV Delay Lines, lumped & distributed Delay Lines, Filters, Printed Wiring Circuit Assemblies, Engineering, Development & Production Services.

Panoramic Radio Products, Inc. 230, 232 Instruments Ave.

*Sub-sonic waveform analyzer. *Model SC-8b Panoramic Indicator. *Improved SA-8b Pan-adaptors and SB-8b Panalyzers. *Frequency Calibrators for AP-1 & LP-1 Panoramic Sone Analyzers. *TMC-211 simultaneous eleven-point calibrator for telemetry discriminators.

*Indicates new product

(Continued on page 274A)

TOP HAT FOR PLUG-IN UNITS

A widely used, dependable, improved clamp for electron tubes, relays and capacitors.



WRITE FOR NEW 1955 CATALOG

EASY TO APPLY
INSTANTLY RELEASED
POSITIVE LOCKING ACTION



TIMES FACSIMILE CORPORATION

540 West 58 St., New York 19, N. Y.
1523 L St., N. W. Washington 5, D. C.

Pioneer in Radio Engineering Instruction Since 1927

Accredited
Technical
Institute
Curricula



Request your free Home Study or Resident School Catalog by writing to: Dept. 26B3

3224 16th St., N. W. Washington 10, D. C.

Approved for Veteran Training

CAPITOL RADIO ENGINEERING INSTITUTE

Advanced Home Study and Residence Courses in Practical Radio-Electronics and Television Engineering

*Superior
in every way*

Moldite Core "Standards"



They are precision mixed, precision made, and precision controlled for every electronic use.

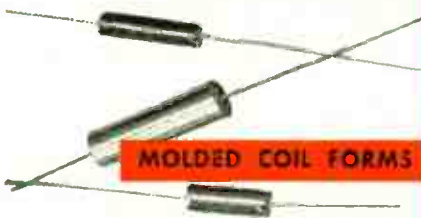

Give your products the advantages of MOLDITE Core Standards that offer you . . .

ECONOMY	INTERCHANGE- ABILITY
AVAILABILITY	HIGH QUALITY
UNIFORMITY	FLEXIBILITY



NATIONAL MOLDITE COMPANY

MOLDITE "WROTE THE BOOK" for IRON CORES



MOLDITE'S record of performance for the past ten years in producing millions of cores, coil forms and ferrites has contributed substantially to the accomplishments of the electronic industry.

To check with MOLDITE is a Must, because only MOLDITE leads in all three . . . iron cores, coil forms and ferrites.

MOLDITE *iron cores, ferrites and molded coil forms* (iron and phenolic) are being selected for use in high quality equipment by all leading television, radio and electronic manufacturers as well as all branches of the Armed Forces. Only MOLDITE makes them all . . . for your service and convenience. One source for all three — iron cores, ferrites and molded coil forms.

We are particularly proud of a Certificate of Cooperation awarded us by the U. S. Foreign Operations Administration for furnishing technical assistance.

Our success is measured by the ever increasing number of loyal satisfied customers. MOLDITE'S quality, service and spirit of progress sets the keynote for tomorrow. No specifica-

tion is too difficult, no order too small, no requirement too rigid. The MOLDITE label is your guarantee of complete satisfaction.

MOLDITE'S world-wide reputation is a result of . . .

1. Creative research and engineering.
2. Specialized materials processing techniques.
3. High quality mass production facilities
4. Modern core manufacturing facilities for precision molding.
5. Exclusive, specially designed, press controls.



Send for our Catalog NM #110

1410 CHESTNUT AVE., HILLSIDE 3, N. J.

Bill Franklin
3 Holly Road
North Syracuse, N. Y.

Robert T. Murray Co
614 Central Avenue
East Orange, N. J.

Jerry Golten Co.
2750 W. North Ave.
Chicago 22, Ill.

Perlmuth-Coleman Assoc.
2419 So. Grand Ave.
Los Angeles 7, Calif.

Jose Luis Ponte
Cardaba 1472
Buenos Aires

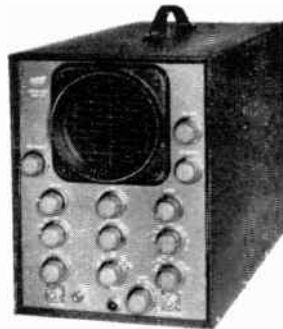
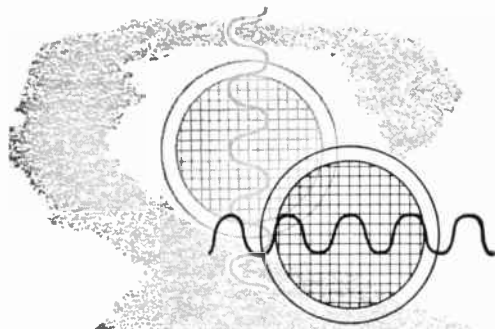

IDENTICAL AMPLIFICATION

for perfect performance

Precision measurement of phase shift is practically distortion free in the CROSBY Wideband Oscilloscope, Model 320. Identical horizontal and vertical amplifiers allow phase shift indication for frequencies up to 5 megacycles.

A deflection sensitivity of 35 millivolts RMS per inch, on both amplifiers, makes the Model 320 ideally suited for use in laboratories requiring accurate phase shift evaluation.

A general purpose, high-gain instrument particularly adapted to color television measurements. An Oscilloscope designed by engineers for use by engineers.

See Booth
No. 481
IRE Show 1955



Write for
literature

CROSBY LABORATORIES, Inc.

BOX 233 • HICKSVILLE, N. Y.



Custom-made Metal Enclosures and Components for Radio - Electronic Industries

*A prime and dependable source in metal
fabrication since 1906.*

Cabinets • Consoles • Enclosures
Panels • Chassis • Frames

Shock-mounted cabinet, telescoping chassis.

Stainless and non-ferrous cases and chassis.

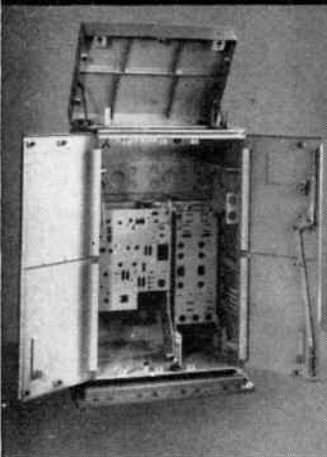

Custom-fabricated products made to your specifications in all metals: ferrous and non-ferrous; up to 3/16" sheet in steel, aluminum, magnesium and alloys. Also light structurals. Any specified finish.

BENNETT

MANUFACTURING COMPANY

38 RAILROAD STREET
ALDEN, NEW YORK

*WRITE TODAY for our new
FACILITIES CATALOG —
a colorful 16-page brochure.*

VISIT US AT OUR EXHIBIT—
Booth 779—
1955 Radio Engineering Show,
March 21-24



What to See at the Radio Engineering Show

(Continued from page 272A)

Par-Metal Products Corp., 292 Instru- ments Ave.

Featuring a complete line of Universal Cabinet Racks with Solid or Detachable Sides, Single or Multi-Rack Assemblies for Standard 19" Wide Panels—and single, double, and triple Utility Desk Assemblies for electronic apparatus.

Paramount Paper Tube Corp.

385 Microwave Ave.

Coil Forms—"Paraformed" or "Regular." The largest and smallest coil and transformer manufacturers depend on "Paramount" quality. Begin with the best—check our prices.

PARK NAMEPLATE CO., INC.
61-07 32ND AVE. WOODSIDE 77, NEW YORK

FOIL NAMEPLATES

0.003 AND 0.005 ANODIZED
MULTICOLOR BACKED WITH ADHESIVE

* INSTRUMENT PANELS

ETCHED AND MULTICOLOR ANODIZED

Booth 6

Penta Laboratories, Inc., 440 Electronic Ave.

Electron Tubes, new transmitting and special purpose types; Beam Pentodes and Tetrodes; grounded-grid Triodes, low-jitter Hydrogen Thyratrons; traveling-wave Amplifiers and Oscillators; Vacuum Switches.

Dynacord

PROFESSIONAL
TAPE RECORDER

1 to 6 channels on 1/4" tape

PENTRON CORP., 856 Audio Ave.

PERKIN ENGINEERING CORP.



LABORATORY
RADAR, MISSILE
POWER SUPPLIES

BOOTH 13

345 Kansas St., El Segundo, Calif.

Perkin-Elmer Corp., 20 Palace
See Vernistat Div.

*Indicates new product.

(Continued on page 276A)

A complete list of all Radio Engineering Show visitors registered will be found on the balcony at Kingsbridge Palace.

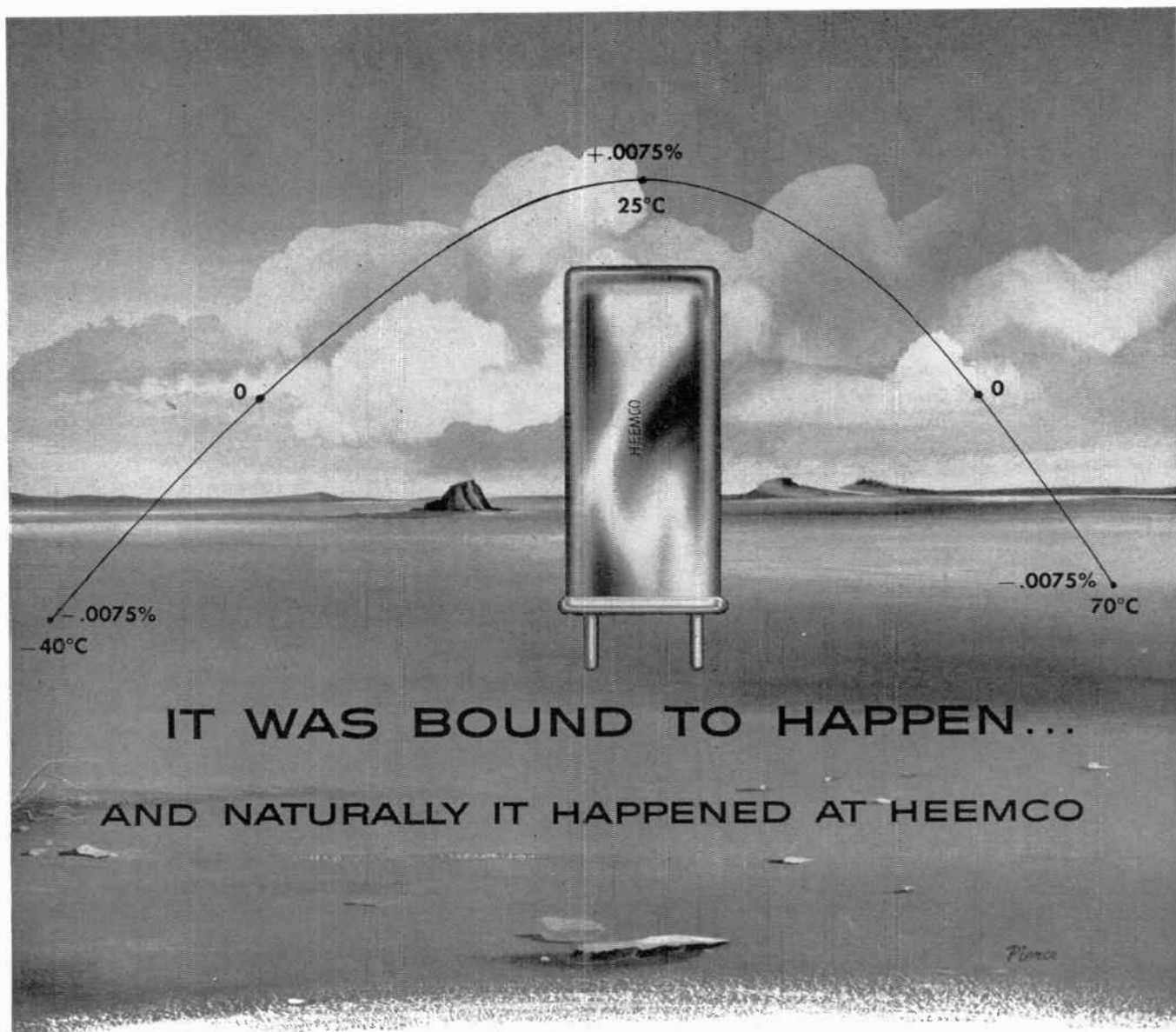

For the First Time, Miniature 2.5–20KC Audio Frequency Crystals

In a continuing effort to lead the crystal industry in the development of new products for the electronic industry, Heemco ingenuity has fostered another outstanding development... a miniature 2.5–20KC audio frequency crystal which is now available in production line quantities.

This sturdy unit, hermetically sealed in the standard Heemco holder, MIL HC-13/U, shows deviation in frequency of less than $\pm 0.010\%$ over the temperature range of -40°C to $+70^{\circ}\text{C}$ and will meet the vibration and shock requirement MIL-C-3098A.

Orders of any quantity accepted for schedules as required.

HILL ELECTRONIC ENGINEERING AND MANUFACTURING COMPANY, INC.

New Kingstown, Pennsylvania

for all applications requiring exceptionally high insulation resistance and unusual stability at high temperature

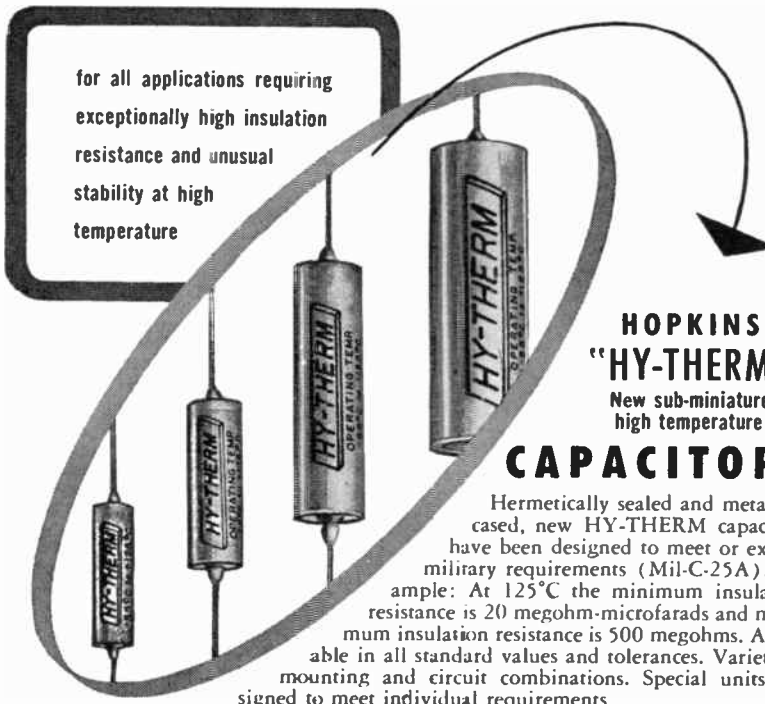

**HOPKINS
"HY-THERM"**

New sub-miniature high temperature

CAPACITORS

Hermetically sealed and metal encased, new HY-THERM capacitors have been designed to meet or exceed military requirements (Mil-C-25A). Example: At 125°C the minimum insulation resistance is 20 megohm-microfarads and maximum insulation resistance is 500 megohms. Available in all standard values and tolerances. Variety of mounting and circuit combinations. Special units designed to meet individual requirements.

Have a special problem? Write, wire or phone for details, TODAY!



Catalog available

2082 Lincoln Ave., Altadena, Calif.,
Sycamore 8-1185 • Offices in
WASHINGTON, D.C. and DETROIT

**What to See at the
Radio Engineering Show**

(Continued from page 274A)

Permacel Tape Corp., 605 Circuits Ave.
Featuring the full line of Permacel 2-in-1 electrical tapes which are both pressure-sensitive and heat-curing. Also Permacel plastic tape for splicing.

Phalo Plastics Corp., 564 Components Ave.

Thermoplastic insulated wires, cables, power supply cords, cord sets, harnesses and assemblies. *Molded-on grounding, Octal, miniature, snap-in TV, plugs and connectors.

Phaotron Co., 428 Electronic Ave.

"555" AC, DC, metal-cased pocket size multimeter, Type TS352 B/U multimeter available to military and industrial users; complete line of custom and ruggedized panel instruments including null indicators, and a 6" custom meter with mirror scales, and 1% reading accuracy.

**Phelps Dodge Copper
Products Corp.**

683 Circuits Ave.

See our outstanding magnet wire products for radio, television, and electronic devices. Bondeze and Solderize lead the way to solve your electronic problems.

Phen-O-Tron, Inc., 19 Palace
3 Types of Geiger Counters using Etched Wiring, Small Multi-Vibrator Kit given to accredited Engineers Gratis. Various Computer Boards. Etched wiring on various copper clad materials.

Philamon Labs., Inc., 511 Circuits Ave.
Precision Frequency Standards. Line of tuning fork resonators, oscillators, frequency dividers and power amplifiers. Oscilloscope demonstration of stability and accuracy of two tuning fork resonators.

Philco Corp., 489-493 Electronic Ave.
See the Philco "Surface Barrier" Transistor—industry's first high frequency transistor; also *transistor applications and circuitry; the latest in industrial television systems, *test equipment for color television; *tubes.

Phillips Control Corporation, 687 Circuits Ave.
See the latest custom-engineered relays and solenoids, including the *type 8 (400 cycle), "Taper-Tab" terminal relays, and also our "Printed Circuit" relays.

**Photo Chemical Products
Inc.**

635 Circuits Ave.

WRINLAY PROCESS for Permanent Markings on dials, panels, schematic diagrams. Complete drafting and photography department. Design assistance. Metal preparation. Fluorescent and radium application. Research and development in plated circuits.

*Indicates new product

(Continued on page 280A)

Show Hours: Monday 10 AM-10 PM
Tuesday 10 AM-10 PM
Wednesday 10 AM- 5 PM
Thursday 10 AM-10 PM

Teflon...*

*Trademark for DuPont tetrafluoroethylene resin.

INQUIRIES INVITED ON
TAPE • SHEET • ROD • TUBES

Molded and Machined Parts

O. J. Maigne Co.

321 PEARL STREET • NEW YORK 38, N. Y. • WORTH 2-1165



HARDWARE FOR ELECTRONICS
ONE SOURCE OF SUPPLY FOR FASTENINGS

We carry in stock thousands of STANDARD and SPECIAL items used in the ELECTRONIC INDUSTRY. SCREWS—NUTS—WASHERS—TERMINALS—GROMMETS—RIVETS—EYELETS—ACCESSORIES.

SPECIAL Cold Headed Products—Stampings—Screw Machine Parts—Made to order in all metals.

WRITE FOR CATALOG 54

FEDERAL SCREW PRODUCTS INC.
3917 N. KEDZIE AVE. CHICAGO 18, ILL.

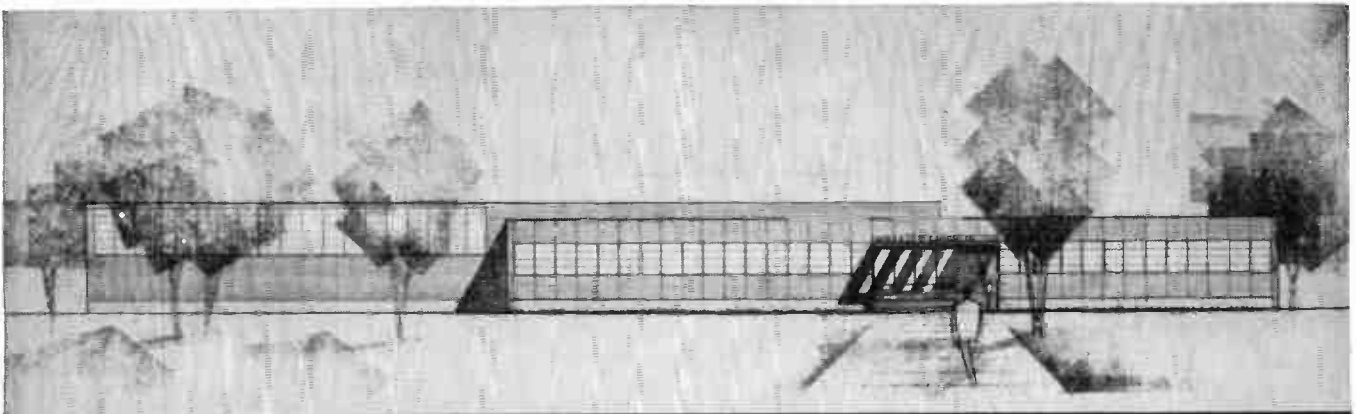

We're Curing Our Growing Pains

Due to the tremendous increased demand made upon us by our many customers, for which we are truly grateful, we are pleased to announce the commencement of construction of our new quarters at West Caldwell, New Jersey, having six times as much space and ten times as much production potential as here-to-fore.

This means that we can maintain faster production schedules and at the same time carry on greater research and development projects to meet every requirement.

I. C. I. engineers have always been available for consultation and cooperation at every stage of manufacture of any printed circuit or printed circuit assembly . . . ready to work with you from the inception of the idea to the completion of the project. With our new working space and production equipment their creative planning will be even broader.

KEEP YOUR EYE ON I.C.I.

Watch for the first announcement of a startling new high insulation resistance development for printed circuits. This patented process will open your eyes to new fields of electronic development.



Insulated Circuits

INCORPORATED

115 Roosevelt Avenue, Belleville, N. J. PLymouth 9-0700

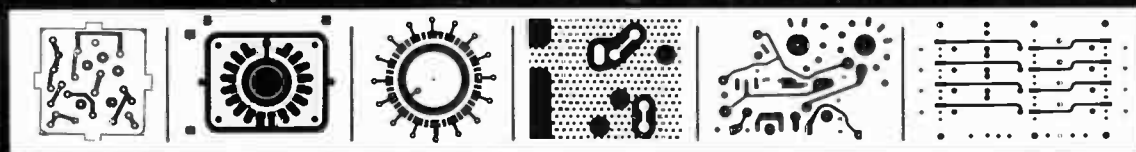

"Manufacturers of Quality Printed Circuits"

INSULATED CIRCUITS, INC. SALES OFFICES:

Albuquerque, New Mexico, 327 Wyoming, S. E.	5-8606	Minneapolis, Minn., 1645 Hennepin Ave.	GEneva 2111
Belmont, Calif., 1334 Old County Road	LYtell 3-3438	New York, N. Y., 77-44 Austin St., Forest Hills, L. I.	
Boston, Mass., 43 Leon Street	Highlands 5-4676		BOulevard 8-5136
Bridgeport, Conn., 64 Hillandale Rd., Fairfield	EDison 4-3602	Pittsfield, Mass., 50 South Street	8618
Camden, New Jersey, 201 North 6th St.	WOodlawn 4-3970	Rochester, New York, 144 Collingsworth Drive	Hillside 4095
Chicago, Ill., 2800 N. Milwaukee Ave.	HUMboldt 9-2550	Seattle, Washington, King County Airport, Rm. 101	
Detroit, Mich., 20158 Santa Rosa Drive	UNiversity 3-5189		LAnder 3320
Hollywood, Calif., 1550 N. Highland Drive	HOLLYwood 2-1195	St. Louis, Missouri, 6635 Delmar Blvd.	VOlunteer 3-3661



More IRC resistors are used by manufacturers



of military devices, instruments, computers,



electronic and electrical equipment, appliances,



radio and television sets than any other brand.

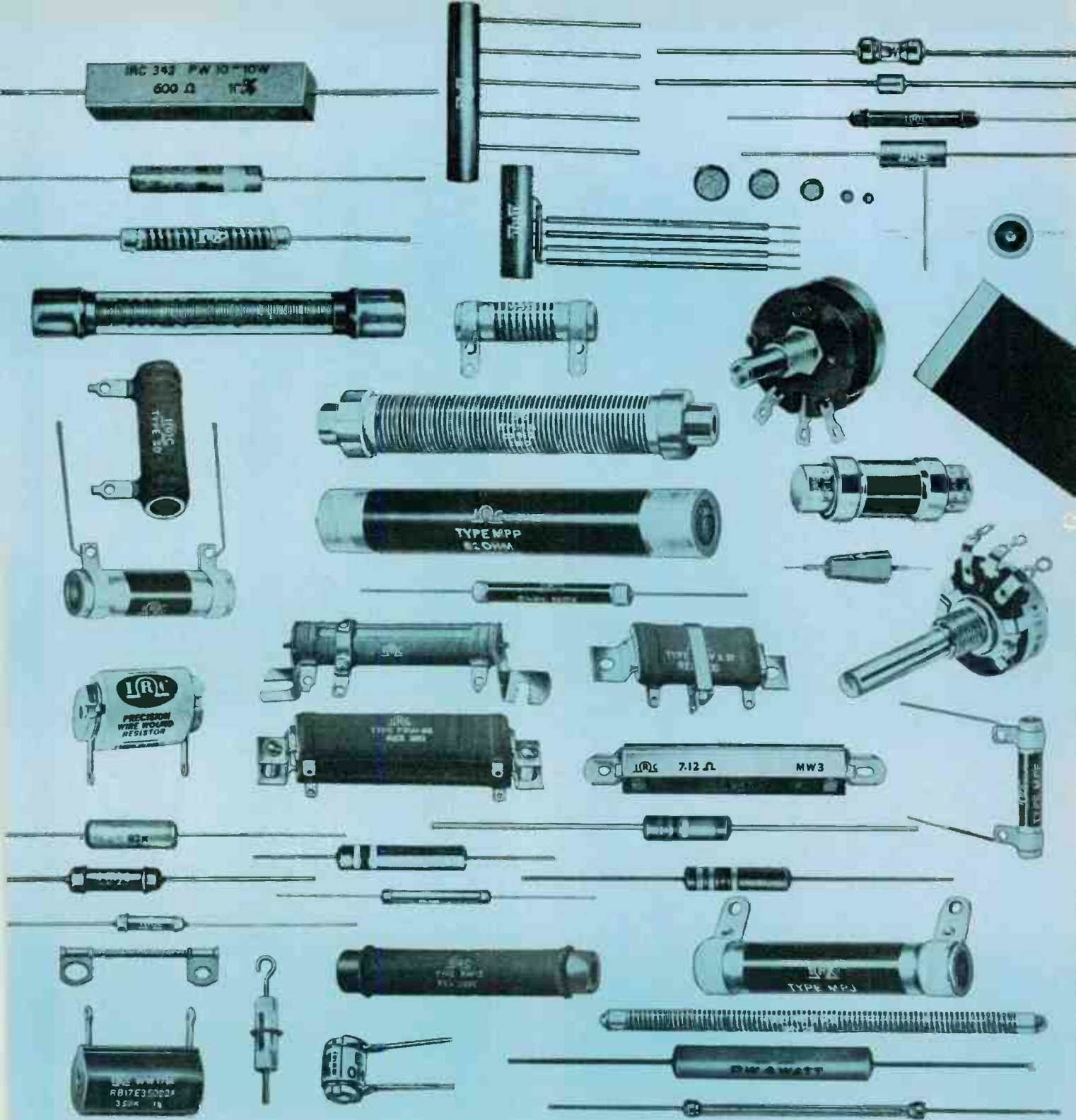

*IRC makes over 140 types of resistors
 . . . can afford to recommend without bias.*



International Resistance Company, 401 North Broad Street, Philadelphia 8, Pa.

Wholly Owned Subsidiaries: IRCAL INDUSTRIES, Los Angeles, California
 VAN DYKE INSTRUMENTS, Inc., St. Petersburg, Florida
 INTERNATIONAL RESISTANCE CO., Ltd., London, England

World Radio History
 Canadian Licensee: International Resistance Co. Ltd. 319 Carlaw Ave. Toronto

STABILITY

±1°C



**NEW . . TCO-22
SERIES
CRYSTAL OVEN**

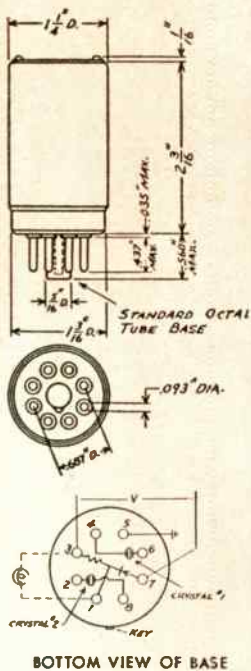

BOTTOM VIEW OF BASE

A new concept of frequency stability, with compact design, is introduced by the TCO-22 series oven. Features include provision for mounting two BH6A crystal holders (MIL type HC-6/U), quick heating, easy access for frequency change, in addition to a stability of $\pm 1^\circ\text{C}$.

STANDARD UNITS

Type	Heater Voltage	Watts	Nominal Temperature	★ Stability
TCO-22	6.3	7.75	+75°C or +85°C	$\pm 1^\circ\text{C}$
TCO-22D	26.5	7.75	+75°C or +85°C	$\pm 1^\circ\text{C}$

★ Stability shown applies to quartz blank in Bliley BH6A holder over ambient range between minus 55° C and nominal temperature.

For special applications, where higher operating temperatures exist, the TCO-22 series will be supplied on special order as follows:

Nominal Temp.	Ambient	Stability
100°C	-40°C to +100°C	$\pm 1^\circ\text{C}$
110°C	-40°C to +110°C	$\pm 1.5^\circ\text{C}$

Bliley ELECTRIC COMPANY
UNION STATION BUILDING
ERIE, PENNSYLVANIA

**SEE OUR I. R. E. EXHIBIT:
585 COMPONENTS AVE.**



What to See at the Radio Engineering Show

(Continued from page 276A)

PC Photocircuits CORPORATION
GLEN COVE
NEW YORK

NEW "MELACON" | 661-663
Process features | **CIRCUITS AVE.**

... electro-formed circuitry "flush" surfaced with Melamine for low torque, long wearing switch plates, commutator and code discs. Printed Circuit radio chassis, amplifiers, filters, terminal boards, miniaturized packages, plug-in computer units.

Pickard & Burns, Inc., 626 Circuits Ave.
Serving industry and the military in the fields of antenna and electronics research and development. See our Bolometer Amplifiers and the *LOG LINEAR CONVERTER.

Pilot International Corp., 28 Palace
See Robco Mfg. Div.

Plastic Capacitors, Inc., 60 Palace
Plastic film dielectric capacitors specializing in high temperature, high voltage, ultra stability, ultra high resistance. Pulse forming networks with low losses. 60 and 400 cycle low current high voltage power supplies. *Type I.S. miniature. New Zero coefficient capacitors.

Plastoid Corp., 162, 164 Television Ave.
Plastic Insulated Wire & Cable Products.

POLARAD

ELECTRONICS CORPORATION
43-20 34th Street, Long Island City 1, N. Y.
BROADBAND MICROWAVE (10 MC to 50,000 MC):
Spectrum Analyzers and Selectors; Signal Generators and Sources; Receivers; Code Modulated Generators; X-Band Oscillators; Components.
NTSC TV EQUIPMENT: Sync, Bar, and subcarrier Frequency Generators; Color Slide Scanners; Colorplexers- Monitors.
TEST EQUIPMENT: Micro Power Meters, Klystron Tube Testers.
BOOTH 277-279 INSTRUMENTS AVE.

Polymer Corp. of Pa., 811 Audio Ave.
Non-metallic for insulation and mechanical applications is the theme of Polymer's booth. New materials designed for specific end uses are shown. Materials engineers can assist visitors with their problems.

Polyphase Instrument Co., 767 Airborne Ave.
*Transistor family curve tracer for power transistors. Other transistor analyzers. Pulse transformers, low pass and *band pass telemetering filters. *Strain gage preamplifier and other strain measuring equipment.

Polytechnic RESEARCH & DEVELOPMENT CO. INC
293, 295 INSTRUMENTS AVE.

- Precision Microwave and VHF-UHF Instruments
- Magnetic Amplifiers, Standard and Custom Units
- Evaporated Metal Film 1% Resistors



Popper & Sons, Inc., 437 Electronic Ave.
Marking Equipment to print on capacitors, resistors, rectifiers, cores, coils, cans, tube bases, relays, fuses; hand operated and automatic.

*Indicates new product

(Continued on page 282A)

NOW!

PRECISION ENGINEERED I.F. AMPLIFIERS at assembly line prices!

for RADAR • COMMUNICATION • LABORATORY • COMPUTERS

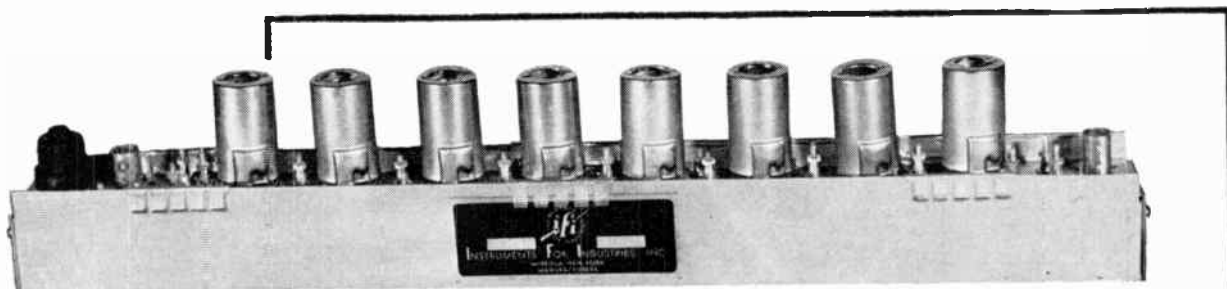

\$150⁰⁰
incl. tubes

F.O.B. Mineola, N. Y.

Standard adaptable models — volume production — individual attention . . . three good reasons why I.F.I. can offer these top quality i.f. strips at such low prices. These are not the ordinary commercial type mass-produced units, suitable only for low priced assemblies. Each unit is precision-engineered and thoroughly tested to meet quality standards that rival military specifications.

A wide variety of standard units, each adaptable for many applications, is available for prompt delivery from stock. I.F.I.'s fast convenient service on i.f. strips and other types of broad band amplifiers has saved valuable design and production time for many leading companies. Write for complete details.

P.S. Preliminary data on I.F.I.'s new 100 watt Distributed Amplifier is now available. Ask for data sheet #400.

SPECIFICATIONS OF TYPICAL STANDARD UNITS

Note:

Several exclusive sales franchises available.

Manufacturers' representatives please write.

	M260	M230	M235
Band Center.....	60 mc	30 mc	30 mc
Band width.....	10 mc	2 mc	10 mc
Voltage gain.....	90 db	110 db	90 db
Output power.....	0.02 W	0.1 W	0.04 W
Input impedance.....	50 ohms	50 ohms	50 ohms
Input V. S. W. R. less than.....	1.3:1	1.3:1	1.3:1

Note: M230 model available with 1.5 db noise figure

INSTRUMENTS FOR INDUSTRY, Inc.

152 GLEN COVE ROAD, MINEOLA, N. Y. • PHONE: Pioneer 2-5300

REPRESENTATIVES

G. E. Moxon Sales
422 La Jolla Ave.
San Mateo, Calif.

Hunter & Salsbury, Inc.
258 Herricks Road
Mineola, N. Y.

"SEE US AT THE I. R. E. SHOW-BOOTH #741-AIRBORNE AVE."



Universal Mounting Assembly

for simplified system planning and installation

The UNERAC (Universal Electronic Regulator, Amplifier and Calibrator) is a self-contained junction box for all elements of the transmitter system. It supplies or distributes all power, signal, calibration and transducer instrumentation voltages. Provides for transmitter deviation control, stepping relay circuits for 3 or 5 point calibration, and manual calibration.

The Universal Mount Section has mounting facilities for three RREP-type plug-in oscillators, plus necessary distribution and supply circuitry. Each building block section is constructed so that power is fed to the entire assembly, each section taking only that power required for its own oscillators and transducers.

Write for Technical Bulletin.

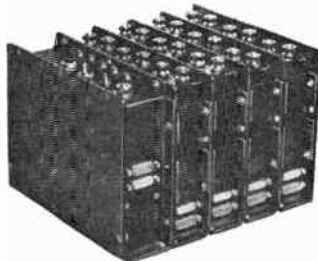

UNIVERSAL MOUNTING ASSEMBLY



TYPE 1401A UNERAC

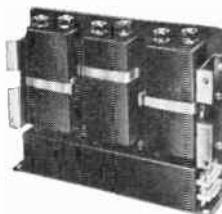

TYPE 1402A UNIVERSAL MOUNT



RAYMOND ROSEN ENGINEERING PRODUCTS, INC.
 32nd & Walnut Streets • Philadelphia 4, Penna.
 15166 Ventura Boulevard • Sherman Oaks, California



... a complete line

ULTRA-LOW-TORQUE EXTREME PRECISION POTENTIOMETERS

by
ELECTRO-MEC

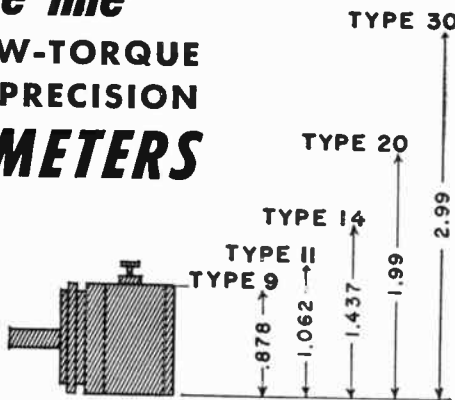

- Proven by designers and manufacturers of high performance computers.
- Available in many sizes for all applications of ultra-low-torque potentiometers.
- Custom-engineered for your special needs. Never a compromise.
- Ganged assemblies available in all sizes.
- For detailed specifications and information on all types contact our engineering department (Stillwell 6-3402).

ELECTRO-MEC Laboratory, Inc.

21-09 43 Avenue Long Island City 1, N. Y.

Sales representatives needed for several territories.

What to See at the Radio Engineering Show

(Continued from page 280A)

Potter & Brumfield, Subsidiary of American Machine & Foundry Co., 106, 108, 110 Television Ave.

Custom-made and standard relays designed to meet quantity production for unusual applications. Demonstration of newly developed bi-directional stepping switch.

POTTER

INSTRUMENT CO., INC.

115 Cutter Mill Road, Great Neck, L.I.,
346 Computer Avenue

High-Speed Digital Magnetic Handler, Flying Typewriter, Magnetic Computer Components, Counter Translation Matrix and Teledeltos Printer, Frequency-Time Counters, Data handling equipment, shift registers.

BOOTH 338 *Reliable* **POWER SUPPLIES**
VOLTAGE and CURRENT STABILIZED
 WRITE: *Power Designs inc.*
 ATLANTIC AVE. AT 120 ST., RICHMOND HILL, N. Y.

Precise Development Corporation, 282, 284 Instruments Ave.

Be sure to see the custom switch kit; *industrial oscilloscope; pre-amplifier, 8½" color scope; generators; power supplies, VTVMs and accessories.

PRECISION
APPARATUS COMPANY INC.
 Glendale, L. I., N. Y.
438 ELECTRONIC AVENUE
 High quality electrical indicating instruments; meters, electronic test and measuring instruments and accessories, cathode-ray oscillographs, vacuum tube voltmeters, cathode-ray tube testers, AM, Sweep, Sine-Square signal generators, volt-ohm milliameters, etc.

Precision Metal Products Co. of Malden, 96 Palace
 Complete line of turret soldering lugs, insulated terminals, terminal board assemblies, plastic fabrication, and various items of hardware for the electronic industry.

PRECISION PAPER TUBE CO.
 Chicago 47, Illinois
 791 Airborne Ave.

The Only Complete Coil Form Service Available. Square-round—special shape tubes and bobbins . . . kraft, fish paper, acetate, combinations and resin impregnated.

*Indicates new product

(Continued on page 284A)

Engineer Savings in your TV Picture and Receiving Tubes by using Johnson & Hoffman NEW techniques

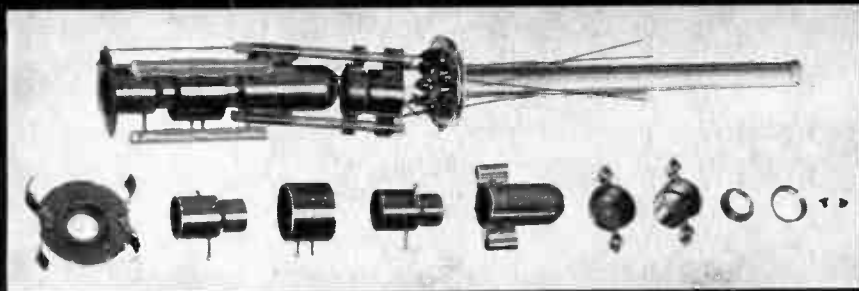

GUN ASSEMBLY FOR ELECTRO-STATIC TYPE TV PICTURE TUBES.

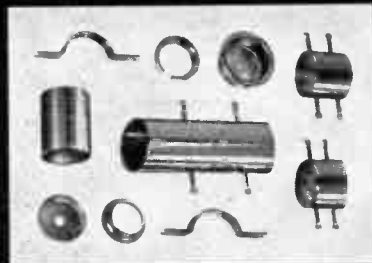

New Developmental $\frac{3}{8}$ " Diameter Parts
for "small neck" TV picture tubes

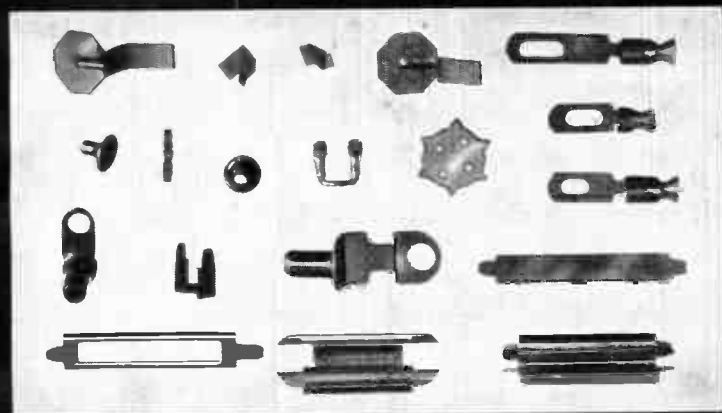

Illustrated above are typical examples of our line of standard and special
electronic items currently being produced for leading manufacturers.

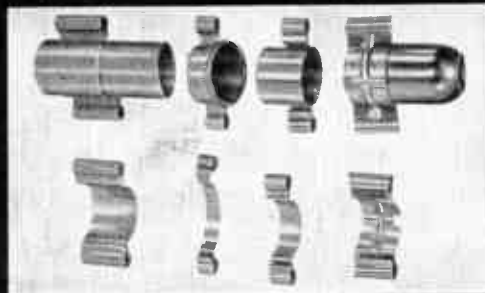

Low cost one piece wrap-around
ceramic post support straps

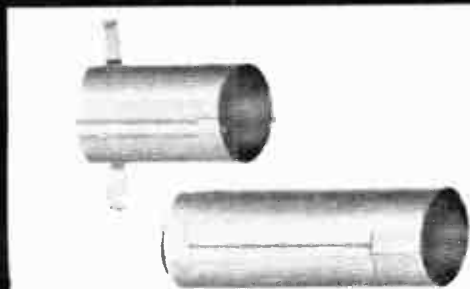

Illustrated are lockseam anodes which are now available in various lengths and are being produced on new U. S. tool multi slide equipment which we have acquired as a further expansion of our present metal fabricating facilities. These parts, along with other radio and electronic items such as plates, supports, shields, and other staked and lockseam products will be cataloged as they are made available to the industry.

Your inquiries for these and any other parts components will receive courteous and prompt consideration.



Johnson & Hoffman Mfg. Corp.

31 East Second Street, Mineola, L. I., N. Y.

RETMA

Telephone — Pioneer 2-3333

ELECTRONIC AND MECHANICAL ENGINEERING CONSULTING SERVICE AVAILABLE

electronic engineers:

THIS IS AIR ARM . . .



Outlined area shows addition to Air Arm's multi-million dollar facility.

CREATE WITH US!

This is Air Arm . . . leader in electronic development for America's Air superiority.

Air Arm . . . where creative engineering offers unlimited opportunities to experienced engineers.

Can you fill a top-level design and development position? You will find a stimulating and satisfying atmosphere at Air Arm. You will work in professional and friendly surroundings. You will enjoy the spacious, well-equipped quarters that are a part of a modern, multi-million dollar plant.

Although Air Arm's home was completed just a little over two years ago, construction is already beginning on an expansion of engineering facilities.

This expansion creates a need for experienced electronics engineers who have a strong desire to work on the projects of tomorrow . . . creating under conditions that are conducive to creativeness.

TO APPLY—SEND LETTER OUTLINING YOUR QUALIFICATIONS TO

R. M. Swisher, Jr.
Employment Supervisor, Dept. 101
Westinghouse Electric Corp.
2519 Wilkens Ave., Baltimore 3, Md.



YOU CAN BE SURE...IF IT'S **Westinghouse**

See us in New York March 21-24

WHEN WRITING TO ADVERTISERS PLEASE MENTION — PROCEEDINGS OF THE I.R.E.

What to See at the Radio Engineering Show

(Continued from page 282A)

Premier Instrument Corp., 374 Microwave Ave.

*Introducing new remarkably miniaturized waveguide section of monopulse system making possible greater accuracy, lighter weight, lower cost homing, tracking, and search radars in all bands.

ALL FROM ONE SOURCE!

CABINETS
RACK PANELS
RELAY RACKS
TRANSMITTER RACKS
MINIATURE CASES
UTILITY CASES
CHASSIS



BOOTH NO. 671

Presto Recording Corp., 660 Circuits Ave.

*Low priced professional tape recorder, *High speed tape duplicator, *Transcription turntable, *Hi Fi turntable.

Price Electric Corp.
793 Airborne Ave.

Husky relays for military and commercial use. Sub-miniature, multipole, time delay, rotary, coaxial, general purpose, telephone, hermetically sealed and numerous other types of relays.

Prodelin, Inc., 395 Microwave Ave.
MICROWAVE ANTENNA SYSTEMS: Antennas—NEW Off-Set Feed, Parabolic, Corner, Horn, Yagi, Colinear; Coax-cable, couplings, elbows, fittings, adapters, assemblies, hangers; Semi-Portable All Aluminum Tower; pipe, tower mounts.



RBM Div., 617, 619 Circuits Ave.
See Essex Wire Corp.

REF Manufacturing Corp., 459, 461 Electronic Ave.

"Recte Erit Faciendum" (It must be made right)—symbolizing perfection in design, development, fabrication and assembly. Precision sheet metal products, through anodizing, alodizing, heat treatment and finish. A house of distinction, catering to the finest customers, members of the I.R.E.

*Indicates new product

(Continued on page 304A)

Ride to the parking areas FREE on the IRE busses.



LOOKING FOR A FUTURE?

- **Electronic Design and Development Engineering**

- **Mechanical Engineering**

- **Test Engineering**

- **Project Engineering**

- **Publications Engineering**

- **Field Engineering**

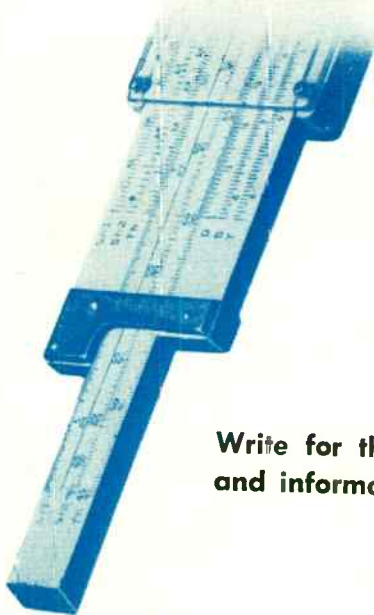
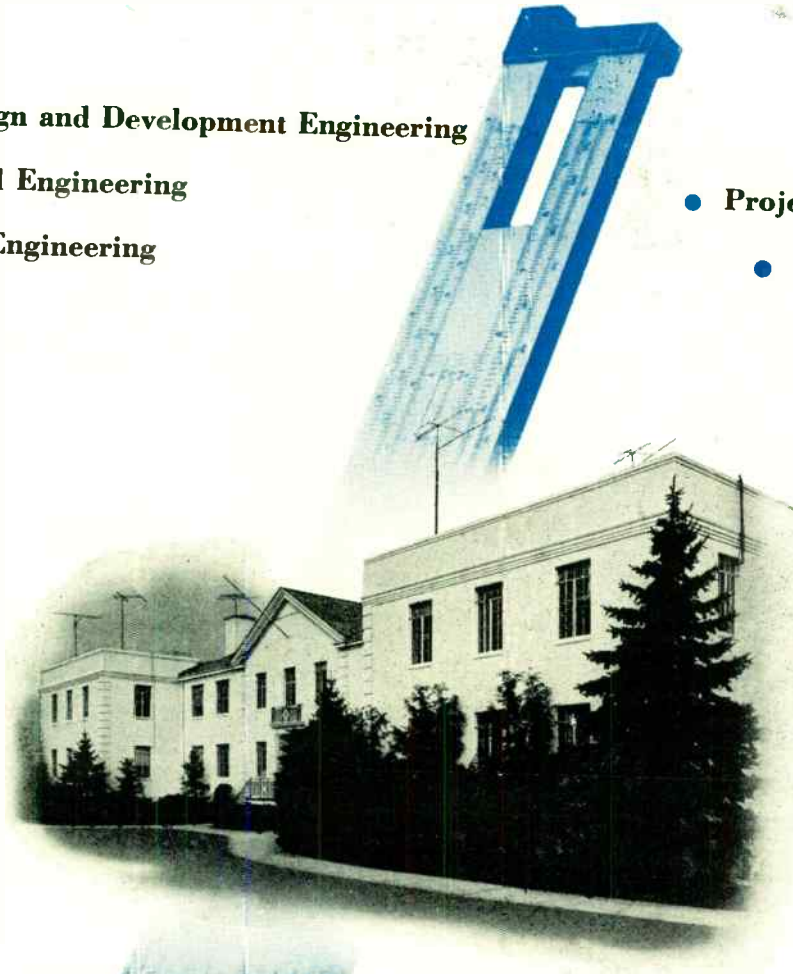

Write for this interesting and informative brochure 



Administrator of Personnel

HAZELTINE ELECTRONICS CORPORATION

58-25 Little Neck Parkway

Little Neck, Long Island

This spring, drop in for an **Interview**

write for our brochure

RADIATION Inc. Melbourne, Fla.
Orlando, Fla.

Electronics • Avionics • Instrumentation



The following positions of interest to I.R.E. members have been reported as open. Apply in writing, addressing reply to company mentioned or to Box No.

The Institute reserves the right to refuse any announcement without giving a reason for the refusal.

PROCEEDINGS of the I.R.E.

1 East 79th St., New York 21, N.Y.

ELECTRONIC ENGINEER OR PHYSICIST

Rapidly growing electronic firm has immediate need for an Electronic Engineer or Physicist in its Research and Development Dept. This work will encompass the work of various digital computer components. These components will include analog to digital computers and high precision digital to analog converter systems. We desire a person with 3 to 5 years experience in electro-mechanical input and output devices for digital computers. He must have a general knowledge of computer design. Send detailed resume to Technical Employment Manager, 1001 El Centro, South Pasadena, Calif.

INSTRUCTORS

Teaching positions for Sept. 1, 1955 are available at a university in the south east. Instructors \$3,500-\$4,300; graduate assistants (MS in 12 months) \$110.00 per month, tuition free. Box 794.

PROFESSOR—ELECTRICAL ENGINEERING

Professorial appointment at Brown University open for Electrical Engineer with established ability in teaching advanced research. Will have responsibility for organizing and directing theoretical and experimental research program in his fields of interest. Write to D. C. Drucker, Chairman, Div. of Engineering, Brown University, Providence 12, R.I.

REPRESENTATIVES

A growing Massachusetts manufacturer has openings for manufacturers representative or sales representatives, with sales background, to represent electronic laboratory furniture. Must be qualified to present product to laboratory engineers, executive and authoritative management. All territories open with exception of Illinois, Wisconsin and Massachusetts. Territory assigned; commission basis. Send resume to Formica Metal Products Co., Corporation Way, Medford 55, Mass. stating education, past experience and present employment. All replies confidential.

SALES ENGINEERS OR TRAINEES

Immediate opening for 2 intelligent, personable and imaginative electronic, vacuum or nuclear instrument engineers, with rapidly growing sales engineering organization. Exceptional opportunity for advancement and good earnings for men with initiative. Salary plus incentive compensation. Systematic sales training will be provided for otherwise qualified applicants without prior sales experience. Must be resident of upstate or metropolitan New York. Some travel required. Submit resume (picture if possible), start-salary requirements and availability date with first letter. Box 795.

(Continued on page 288A)

ELECTRONIC ENGINEERS • PHYSICISTS • MATHEMATICIANS

- Digital Computer Development
- Magnetic Components and Circuits
- Fire Control Analysis
- Systems Analysis
- Programming Research
- Computer Field Engineering

- Openings at all levels of experience.
- Training in digital techniques provided.
- Salaries commensurate with experience.
- Interview travel at our expense.
- Moving expenses paid for household goods.
- Liberal employee benefits.

The country's foremost computer development organization has permanent positions open in the above fields for qualified professional personnel. Opportunities for personal advancement and professional growth are exceptional in today's most rapidly expanding technological field.

HERE IS THE KEY TO YOUR FUTURE
... share in the satisfaction of contributing to the advancement of this important art.

Remington Rand
ENGINEERING RESEARCH ASSOCIATES DIVISION
1902 West Minnehaha • St. Paul W4, Minnesota

ELECTRONICS ENGINEERS *and* PHYSICISTS

attending the I.R.E.

National Convention
and Radio Engineering Show
March 21-24
Waldorf-Astoria Hotel
and Kingsbridge Armory

A number of significant new studies at Lockheed Missile Systems Division has created positions for those possessing outstanding ability in:

antenna design	systems engineering	instrumentation	electromechanical design	computers
communications	servomechanisms	telemetering	nuclear physics	radar research

For the convenience of those attending the convention, Karl E. Zint, C. T. Petrie and other members of the technical staff will be available for consultation at the convention hotel.

Under Construction: Lockheed's new missile systems research laboratory — especially designed to provide the most modern facilities for meeting the increasingly complex problems of guided missiles. Scheduled for occupation this fall, it is the first step in a \$10,000,000 research laboratory program.

Lockheed

MISSILE SYSTEMS DIVISION

research and engineering staff

LOCKHEED AIRCRAFT CORPORATION • VAN NUYS • CALIFORNIA

TO THE FINE ENGINEERING MIND
SEEKING THE CHALLENGING PROJECTS IN

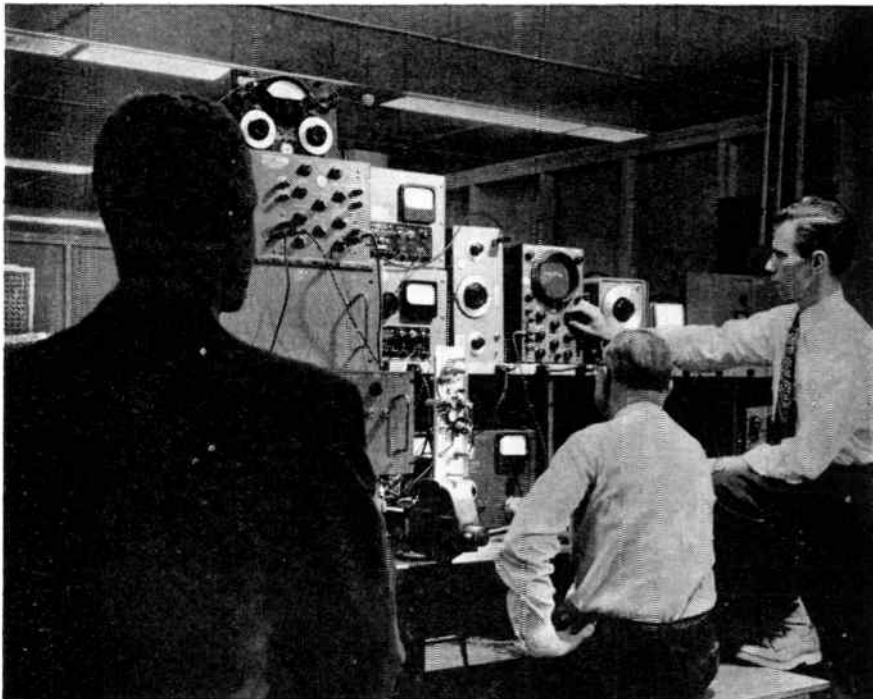

ELECTRONIC DESIGN

ELECTRONIC DESIGN ENGINEERS looking for the advanced problems in guided missile systems design are offered unusual career opportunities working on expanded, long-range programs within the Convair Engineering Department. These opportunities include work of a research and development nature in the fields of system engineering, circuit design and analysis, mechanical design and electronics packaging, electronics test and evaluation, and reliability and parts control. Experience in the entire radio frequency spectrum is applicable. Particularly applicable is experience in both electro-mechanical and all electronic servos, magnetic amplifiers, receivers, data transmission systems, digital techniques, sub-miniaturization, and data accumulation systems.

CONVAIR offers you an imaginative, explorative, energetic engineering department... truly the "engineer's" engineering department to challenge your mind, your skills, your abilities in solving the complex problems of vital, new, long-range programs. You will find salaries, facilities, engineering policies, educational opportunities and personal advantages excellent.

Generous travel allowances to engineers who are accepted. Write at once enclosing full resume to:

H. T. Brooks, Engineering Personnel, Dept. 803

CONVAIR

A Division of General Dynamics Corporation

3302 PACIFIC HIGHWAY

SAN DIEGO, CALIFORNIA

SMOG-FREE SAN DIEGO, lovely, sunny city on the coast of Southern California, offers you and your family a wonderful, new way of life... a way of life judged by most as the Nation's finest for climate, natural beauty and easy (indoor-outdoor) living. Housing is plentiful and reasonable.



(Continued from page 286A)

**ELECTRICAL ENGINEERS,
MATHEMATICIAN, PHYSICISTS**

The Moore School of Electrical Engineering of the University of Pennsylvania has openings for electrical engineers, mathematicians and physicists. Work is available in the fields of digital and analog computers, mathematical analysis, circuit design, information theory, microwaves and systems engineering. Applicants should be U. S. citizens. Salary commensurate with education and experience. For application form write to Director, Moore School, University of Pennsylvania, 200 South 33rd St., Phila. 4, Pa.

TECHNICAL EDITOR

Nationally known, rapidly growing electronic magazine, has an opening for a young, energetic associate editor. Must be a graduate electronic engineer with 2-3 years design experience and have ability to write. Publication experience preferred. Submit resume with salary required. Box 796.

ELECTRONIC ENGINEER

Laboratories located in a small midwestern town have an opening for a man experienced in the field of magnetic recording. Must be capable of building and operating a testing laboratory for the development and quality control of magnetic tape. Box 798.

(Continued on page 292A)



WANTED

*Manufacturers'
Representatives*

To sell Laboratory Type Test Equipment in the general areas of:

**CHICAGO
BOSTON
BUFFALO
DALLAS
SAN FRANCISCO
ST. LOUIS
DENVER**

Ours is a medium size organization with facilities and facilities for the design and production of a wide range of Electronic Equipment. Engaged largely by the military, we are currently marketing and expanding our commercial lines.

Please write:

James Smiley, Sales Mgr.,

Lavoie Laboratories, Inc.

Morganville, New Jersey
Telephone Matawan 1-2600 or see us at the
I.R.E. Show, Booths 400, 401, 500, Production Rd.

IBM

News

FOR ENGINEERS

THIS MONTH'S BIG CAREER OPPORTUNITIES

DEVELOPMENT ENGINEERING*

Digital computer circuit design—electronic pulse circuits for accounting and data processing machines—arithmetic, switching and logical circuitry—magnetic storage—transistor circuitry—input-output device controls—pulse amplifiers, shapers, gates, etc. **ALSO** excellent openings in systems planning, functional and reliability analysis, electronic component development, packaging, diagnostic and application program development.



MANUFACTURING ENGINEERING*

Design and development of electronic test equipment for digital computer production testing—circuit design—systems planning and analysis—test planning. **ALSO** excellent openings in functional and acceptance testing—test equipment installation and maintenance—automation engineering—manufacturing research.

*Required—a degree in E.E., M.E., or a Physics B.S. or B.A., or equivalent experience.

Desirable—experience in any of the following fields: digital and analog computers, including airborne types, radar, TV, communications equipment, relay circuitry, automation, servo-mechanisms, instrumentation, or data handling systems.

**For information
on these career opportunities**

WRITE,
giving details of education and experience, to:
William M. Hoyt
IBM, Dept. 686(27)
590 Madison Ave., New York 22, N.Y.

Your replies, of course, will be held in strictest confidence.
INTERNATIONAL BUSINESS MACHINES CORPORATION

For your convenience, Mr. Hoyt will be registered at the Waldorf-Astoria Hotel during the IRE Convention.

"IBM GREAT PLACE TO WORK"

says development engineer
now in his 8th year
with the company



"Every year with IBM is more challenging than the last," says Max E. Femmer, Development Engineer at Poughkeepsie. "It was a tremendous satisfaction in 1952 to help develop IBM's outstanding 701 Electronic Computer. Today our projects and our work are even more interesting. Both my wife and I think IBM is a wonderful company."

Mr. Femmer is Technical Administrator of the entire Electronic Data Processing Machine Development Program.

MAGNETIC CORE MEMORY DEVELOPED BY IBM STAFF

This is a Microsecond Memory—developed and perfected by IBM engineers—with data transmission in and out of storage at the rate of more than 43,500 characters a second. A random access unit, the IBM magnetic core can locate and move 5 characters to a programmed location in 35 millionths of a second.



*World's Leading
Producer of
Electronic
Accounting
Machines
and Computers*



To the Engineer who is Very Particular



RCA expansion opens the kind of permanent opportunities you'll find most desirable

A whole new program of expansion at RCA—in Research, Systems, Design, Development and Manufacturing—opens a broad variety of permanent positions with all the features that appeal to the alert, creative engineer. These are opportunities with a future . . . available *today* for the man who wants to move ahead professionally with the world leader in electronics. They include work in fields of phenomenal growth. At the RCA engineering laboratories *listed in the chart on the right*, you'll find the kind of living and working conditions attractive to the professional man and his family.

Engineers and scientists find every important factor that stimulates creative

effort . . . including a quality and quantity of laboratory facilities unsurpassed in the electronics industry . . . and everyday association with men recognized at the top of their profession.

RCA's benefits add up to an impressive list of "extras." Among them: tuition for advanced study at recognized universities . . . a complete program of company-paid insurance for you and your family . . . a modern retirement program . . . relocation assistance available.

Your individual accomplishments and progress are recognized and rewarded through carefully planned advancement programs. Financially as well as professionally, you move ahead at RCA!

about His Future . . .

AVIATION ELECTRONICS
ELECTRON TUBES
COMPUTERS
MISSILE GUIDANCE
RADIO SYSTEMS

What can RCA offer you? Check the chart below for your career opportunity in

FIELDS OF ENGINEERING ACTIVITY	TYPE OF DEGREE AND YEARS OF EXPERIENCE PREFERRED											
	Electrical Engineers			Mechanical Engineers			Physical Science			Chemistry Ceramics Glass Technology Metallurgy		
	1-2	2-3	4+	1-2	2-3	4+	1-2	2-3	4+	1-2	2-3	4+
SYSTEMS <i>(Integration of theory, equipments, and environment to create and optimize major electronic concepts.)</i>												
AIRBORNE FIRE CONTROL			W							W		
DIGITAL DATA HANDLING DEVICES			C			C				C		
MISSILE GUIDANCE			M			M				M		
INERTIAL NAVIGATION			M			M				M		
COMMUNICATIONS			C O F							C O F		
DESIGN • DEVELOPMENT												
COLOR TV TUBES —Electron Optics—Instrumental Analysis—Solid States (Phosphors, High Temperature Phenomena, Photo Sensitive Materials and Glass to Metal Sealing)	L	L	L	L	L	L	L	L		L	L	L
RECEIVING TUBES —Circuitry—Life Test and Rating—Tube Testing—Thermionic Emission	H	H	H		H	H		H			H	H
MICROWAVE TUBES —Tube Development and Manufacture (Traveling Wave—Backward Wave)		H	H	H				H	H		H	H
GAS, POWER AND PHOTO TUBES —Photo Sensitive Devices—Glass to Metal Sealing	L	L	L	L	L			L	L		L	L
AVIATION ELECTRONICS —Radar—Computers—Servo Mechanisms—Shock and Vibration—Circuitry—Remote Control—Heat Transfer—Sub-Miniaturization—Automatic Flight—Design for Automation—Transistorization		F	M C F		F	M C F		F	M C F			
RADAR —Circuitry—Antenna Design—Servo Systems—Gear Trains—Intricate Mechanisms—Fire Control		F	M C F		F	M C F		F	M C F			
COMPUTERS —Systems—Advanced Development—Circuitry—Assembly Design—Mechanisms—Programming	C	C	M C F	C	C	M C F	C	C	M C F			
COMMUNICATIONS —Microwave—Aviation—Specialized Military Systems		F	M C F		F	M C F		F	M C F			
RADIO SYSTEMS —HF-VHF—Microwave—Propagation Analysis—Telephone, Telegraph Terminal Equipment		O	O F		O	O F		O	O F			
MISSILE GUIDANCE —Systems Planning and Design—Radar—Fire Control—Shock Problems—Servo Mechanisms		F	M F		F	M F		F	M F			
COMPONENTS —Transformers—Coils—TV Deflection Yokes (Color or Monochrome)—Resistors		C	C		C	C		C	C			
MACHINE DESIGN Mech. and Elec.—Automatic or Semi-Automatic Machines		H	H		H	H		H	H			

Location Code

- C—Camden, N. J.—in Greater Philadelphia near many suburban communities.
- F—Florida—on east central coast.
- H—Harrison, N. J.—just 18 minutes from downtown New York.

- L—Lancaster, Pa.—about an hour's drive west of Philadelphia.
- M—Moorestown, N. J.—quiet, attractive community close to Phila.
- O—Overseas—domestic and overseas locations.
- W—Waltham, Mass.—near the cultural center of Boston.

Please send resume of education and experience, with location preferred, to:

Mr. John R. Weld, Employment Manager
 Dept. C-1C Radio Corporation of America
 30 Rockefeller Plaza
 New York 20, N. Y.



RADIO CORPORATION OF AMERICA

Copyright 1955 Radio Corporation of America



A Rewarding Career at Airtron inc.

Here is an excellent opportunity to work in the intriguing and continually expanding field of microwaves. Your work will be stimulating and your advancement gratifying when you participate in the tasks of a professional, competent staff of fellow engineers.

Your place in a field with a future can be secured by joining one of America's leading designers and producers of microwave equipment and radar components. Assure yourself of a career position in a company with a future. Investigate these advantages now!

1. Profit sharing incentive bonus plan.
2. Thrift savings pension plan.
3. Subsidized tuition for advanced study.
4. Ideal suburban location in Metropolitan New York area.
5. Excellent schools and recreational facilities.
6. All the other usual benefits . . . paid holidays, vacations, credit union, etc.

If you have an EE or ME degree and/or related experience in electronics or microwaves you will be interested in the opportunities for junior and senior engineers now open at Airtron, Inc.

Write or call Mr. Arthur Eckerson, Industrial Relations Department, Linden 3-3762.



1107 West Elizabeth Avenue
Linden, New Jersey

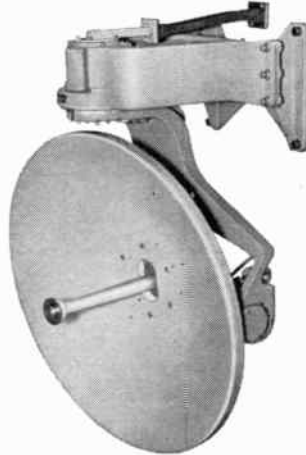

(Continued from page 288A)

SALES ENGINEER

To sell advertising space of **ELECTRONIC DESIGN** to industrial management. This is an exceptional opportunity for a career in industrial marketing and publishing. Young man between 25 and 32, should have technical background, proven sales record and management potential. New England, New York City territory, salary plus expenses and commissions. Send detailed resume to Hayden Publishing Company, Inc., 19 East 62 St., New York 21, N.Y.

ELECTRONIC ENGINEER

Edgerton, Germeshausen & Grier, Inc., 160 Brookline Ave., Boston, Mass. has a position open for an electronic engineer experienced in the development of instrumentation including oscilloscopic pulse techniques and allied circuitry. Send resume or call Personnel Dept. at Copley 7-3520.

ELECTRONICS ENGINEER

Electronics manufacturer on San Francisco peninsula has openings for engineers qualified to handle design and development of specialized electronic circuits involving amplifiers, telemetering and related systems. Must have BSEE and at least 2 years experience in related fields. Salary commensurate with experience. Please send resume to Dalmo Victor Co., 1414 El Camino Real, San Carlos, Calif.

COMPONENTS APPLICATION ENGINEER

Wanted for an intriguing job. *Essentials:* knowledge of military electronics; an interest in a skill at writing technical information; freedom to travel; ability to communicate with other engineers; organizing power and punch. *Opportunity:* this job will make your reputation in an important phase of electronics. *Location:* New York City. Box 804.

ELECTRONICS ENGINEERS

The Civil Aeronautics Administration urgently needs electronics engineers who have had or who wish experience and training in electronics research and development. Salaries range from \$3410 to \$5940 per annum. Write or send application or Standard Form 57, which can be obtained at Post Office, to Personnel Officer, Civil Aeronautics Admn., Technical Development & Evaluation Center, P. O. Box 5767, Indianapolis, Ind.

ENGINEERS

Engineers with EE and MEE degrees for radar systems development, radio beacons, UHF transmitter design, programs embodying latest concepts in radar field. Opportunities for graduate studies sponsored by company. Sperry Gyroscope Co. (Div. of the Sperry Corp.) Great Neck, Long Island, N.Y.

ENGINEERS IN ELECTRO-ACOUSTICS

ELECTRO-VOICE, INC. has positions open for engineers with degrees in electrical engineering or physics. Positions are open for experienced men in speaker, microphone or phonograph pickup design and development and for recent graduates. Excellent future for the exceptional man. Write to Vice President, Engineering, Electro-Voice, Inc., Buchanan, Michigan.

(Continued on page 296A)

ELECTRONIC ENGINEERS for

RESEARCH
PRODUCT DEVELOPMENT
PRODUCTION
SUB-SYSTEM DEVELOPMENT



VARIAN associates

PALO ALTO 2, CALIFORNIA

Please send resume to Personnel Dept.

YOUR OPPORTUNITY

To work in a modern electronics laboratory on the San Francisco peninsula

To work with a highly qualified staff on creative assignments

To continue your professional advancement through a Company sponsored program at Stanford University

To participate in Company ownership through an employee stock purchase plan

To share in an excellent personal benefits program

A JOB FOR YOU WITHIN THIS EXPANDING FRAMEWORK

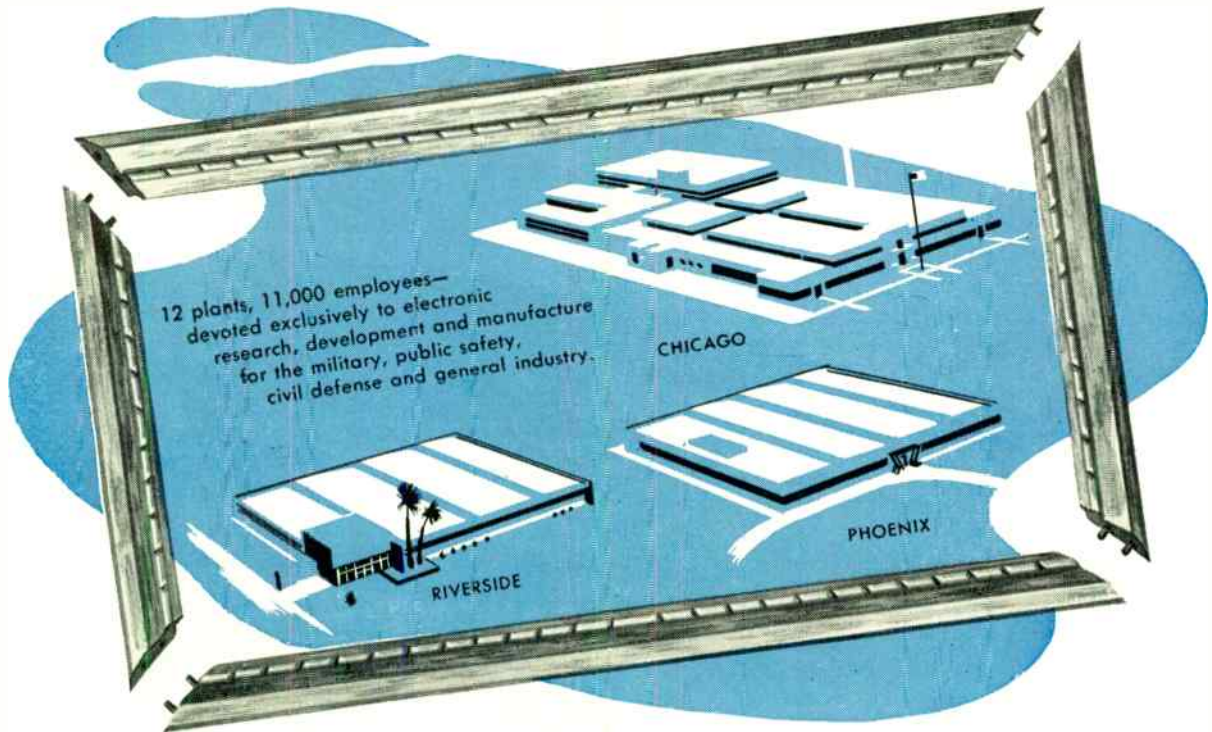

Your preferred assignment in your preferred location

*A place in
Military
Electronics
for YOU . . .*

navigational devices
radar
countermeasures
analog computers
communications equipment
carrier transmitters
VHF receivers
UHF multiplexing
microwave systems
data transmission
data processing and presentation
indicators
plotting systems
telemetry
remote control
servomechanisms
transistor circuitry
operations research
dynamic systems analysis
subminiaturization
solid state physics*
semiconductor research*
transistor development*

*Phoenix only

PHOENIX, ARIZONA Motorola Research Laboratories. A staff of 800 enthusiastic scientists and engineers working in a resort climate. Special opportunities for experienced men in transistor research. (Chemists, Physicists, Metallurgists)

RIVERSIDE, CALIFORNIA Motorola Research Laboratories. Missile systems, guidance and control. Dynamic systems analysis. All electronic military weapons systems. New modern laboratory building surrounded by orange trees.

CHICAGO, ILLINOIS Motorola Headquarters. Three laboratories. Grow with Chicago, the communications and transportation center of the country.

Here is your opportunity to become associated with one of America's fastest growing, dynamic organizations . . . where you can set your own challenging course of growth with security, within a broad framework of military and allied industrial projects.

Note the great diversity of Motorola activities. Write us today. Select your preferred area of interest and location. State the important facts of your education, training and professional career. Minimum of 4 years experience required.

**Write, Attention: Daniel E. Noble
Vice-President in charge**

Motorola

COMMUNICATIONS & ELECTRONICS DIVISION
4501 Augusta Blvd., Dept. I.R. • Chicago, Ill.

ENGINEERS

Success Comes Early to Men of Talent AT SYLVANIA

Engineering BUFFALO

Majors in E.E., M.E., or Physics, with 5 or more years experience in Product Design and Advanced Development in:

Mechanical Design
Shock & Vibration
Subminiaturization
Microwave Applications
Pulse Techniques
Servo Mechanisms
F.M. Techniques
Equipment Specifications
Circuit Design
Heat Transfer
Systems Development
Components
Mechanization

Please forward complete resume to:
Randall A. Kenyon
Professional Placement Supervisor
Sylvania Electric Products Inc.
175 Great Arrow Avenue
Buffalo 7, N. Y.

Electronics Division BOSTON

Opportunities in:
Development
Production
Sales Engineering

In the fields of:
Semi-Conductor Devices:
Transistors • Microwave Diodes
Germanium Diodes
Microwave Tubes:
Magnetrons • Thyrotrons
T.R. and A.T.R. Tubes

College graduates, preferably with a degree in Electrical Engineering, Physics, Chemistry or Metallurgy with 1 to 5 years experience are invited to apply.

Positions located in suburban Boston plants—Woburn, Newton, Ipswich. A few in Seneca Falls, near Syracuse, N. Y.

Please forward complete resume to:
Miles Weaver
Professional Placement Supervisor
Sylvania Electric Products Inc.
Electronics Division
Woburn, Massachusetts

Engineering Laboratory BOSTON

Majors in E.E., M.E., Math, or Physics with 5 or more years Research and Development experience in:

Countermeasures
Systems Analysis
Transistor Applications
Noise Studies
Antenna Res. & Dev.
Systems Development
Mechanical Design
Miniaturization
Digital Computer
circuits & systems
Circuit Design
Shock & Vibration
Technical Writing
Missile Analysis

Please forward complete resume to:
Thomas A. Tierney
Professional Placement Supervisor
Sylvania Electric Products Inc.
70 Forsyth Street
Boston, Massachusetts

INTERVIEWS AT IRE CONVENTION

- For more information and interviews with responsible engineering personnel, be sure to visit Sylvania's IRE Convention
- Headquarters, Hotel Billmore, Madison Ave. at 43rd St., N. Y. C.

For **STABILITY, DIVERSITY** and **GROWTH**, few can match the record of Sylvania. Today, this dynamic, forward-looking company is reaching out in more new directions, with an ever-heavier emphasis on research and development of new products.

And please note that Sylvania:

- **WILL PAY RELOCATION AND INTERVIEW EXPENSES**
- **Provides financial support for advanced educational studies**
- **Has highly-rated pension, medical and insurance benefit programs**
- **Fills positions on the open market only after its "Promotion-from-Within" program has screened all company candidates**

**Missile Systems Laboratory
NEW YORK CITY
& BOSTON**

Engineers and Physicists with a minimum of 3 years experience in one of the following fields:

- Analysis & Design of Search Radar Systems
- Antenna Theory & Design
- Analysis of Missile Guidance Systems
- Mathematical Analysis & System Design of Fire Control & Computer Equipment
- Inertial Guidance or Infra-Red for Detection & Tracking
- Servo System Design & Analysis:
- Aerodynamics
- Propulsion
- Aircraft or Missile Structures

Please forward complete resume to:
Clyde Casanave
Professional Placement Supervisor
Sylvania Electric Products Inc.
20-21 Francis Lewis Boulevard
Whitestone, Long Island, N. Y.

**Radio & Television Division
BUFFALO &
BATAVIA**

Experienced
**MECHANICAL
and
ELECTRICAL
Engineers**

Work on advanced TV receiver design for Black & White and Color Television.

Also

SUPERVISORY ENGINEERS

Several unusual openings for men experienced in working with and supervising groups of engineers.

Please forward complete resume to:
John Weld
Professional Placement Supervisor
Sylvania Electric Products Inc.
254 Rano Street
Buffalo 7, N. Y.

**Electronic Defense Laboratory
MOUNTAIN VIEW,
CALIFORNIA
(Close to San Francisco)**

Senior Engineers and Engineering Specialists are needed in the following fields:

- Systems Analysis
- Systems Development
- Microwave Circuit Development
- Transmitter Development
- Receiver Development
- Field Engineering
- Equipment Engineering

Please forward complete resume to:
John C. Richards
Professional Placement Supervisor
Electronic Defense Laboratory
Sylvania Electric Products Inc.
Mountain View, California

Written Inquiries Will Be Answered Within Two Weeks



SYLVANIA
ELECTRIC PRODUCTS INC.

LIGHTING • RADIO • ELECTRONICS • TELEVISION • ATOMIC ENERGY

ENGINEERS, EE

You'll Find These Advantages at Kollsman:

1. An organization small enough to provide diversity & recognition of achievement, large enough for stability and continuing growth.
2. Intricate design and development work on America's finest aircraft instruments, with the best facilities available in a modern plant.
3. Convenient location in a quiet residential section only 20 minutes from Times Square by IND subway to Elmhurst Ave. local station—2 short blocks to plant.

A Few Positions Available for Work Associated with Airborne Navigational Systems

1. **Systems Work**
2. **Field Service**
3. **Handbook Preparation**
4. **Preparation of Test Procedures and Specifications**

Some previous experience with electronic and electro-mechanical computers and instruments desirable.

For appointment, send resume to the Employment Manager. Or if in the New York metropolitan area, phone NEwtown 9-2900.



KOLLSMAN Instrument Corp.

80-08 45th Ave., Elmhurst, L.I., New York

ENGINEERS

Electronic:

Minimum of five years experience in circuit design with primary emphasis on pulse circuitry and high frequency RF technique.

Mechanical:

Minimum of five years experience in packaging electronic equipment as well as in mechanical design of small electro-mechanical devices.

This company, engaged in the field of telemetering, development and producing transmitters, receivers, data treating equipment and special electronic and electro-mechanical devices, offers permanent positions with liberal benefits including paid vacations, sick leave, bonus, insurance plan, etc.



Please Send Complete Resumes to:

ASCOP

WE PROVIDE ▲ THE LEVER • YOU MOVE THE WORLD

APPLIED SCIENCE CORP. OF PRINCETON

Post Office Box 44, Princeton, N.J.

Plainsboro 3-4141



Positions Open

(Continued from page 292A)

ENGINEER, CHEMIST OR PHYSICIST

Opening for research and product development in the field of semi-conductors and semi-conductor devices. Prefer direct experience with growth of silicon crystals and use for transistors. Also opening for research and product development of thermistors. Direct experience required. With a midwest manufacturer of electrical components. Capable of taking complete responsibility. Excellent working conditions in new laboratory. Reply in detail giving experience, training and salary desired. Box 801.

RADIO ENGINEERS

Consulting engineering firm requires senior and junior radio engineers for permanent staff positions. Experience in design and development of military radio and radar systems required. Work is of unusual interest and offers sound opportunities for advancement. Location, midwest. Salary open. Send summary of qualifications and background to Box 802.

RADIO ENGINEER

As technical consultant to large national trade association in two-way mobile and microwave radio fields. Also act as contact man with FCC and other associations on technical matters and frequency allocations. Location Washington, D.C. Send complete details on first application. Salary \$600. per month. Reply Box 803.

TELEVISION ENGINEERS

Television Engineers for civilian production of both new color and conventional black and white sets. Development and manufacturing engineers are needed. Employers pay our fee and interviewing and relocation expenses. Write Guilford Personnel, 308 American Bldg., Baltimore 2, Md.

PROFESSORS

The USAF Institute of Technology has several vacancies for qualified professors or engineers to teach on a graduate and undergraduate level in electrical engineering. Employment will be effected in accordance with Civil Service regulations. Grade levels range from GS-9, \$5,060 per annum to GS-13, \$8,360 per annum. Applications should be made by letter to the Dean, Resident College, USAF Institute of Technology, Wright-Patterson Air Force Base, Dayton, Ohio.

TECHNICIAN

Positions open. Community antenna system in growing community located in desirable valley southwest Oregon, needs technician capable adjusting RCA and Jerrold amplifier equipment. An excellent opportunity for the right man in an area with good schools, moderate climate, outstanding recreational inducements. Reply Umpqua TV, Inc. 1500 Harvard Ave., Roseburg, Oregon, giving qualifications, experience, etc.

SOLID STATE METALLURGIST

Experience in semiconductors preferred; Ph.D. level or equivalent. Salary will reflect applicant's ability, education and experience, and will satisfy the professional man. All replies confidential. Reply: P.O. Box 407, Waltham 54, Mass.

METALLURGIST—MATERIAL MAN

Experience in germanium essential, silicon experience in addition preferred. Good salary for competent man. All replies confidential. Reply: P.O. Box 407, Waltham 54, Mass.

EXPAND YOUR HORIZON!

ELECTRONIC ENGINEERS
ELECTRONIC PHYSICISTS

*Bendix Radio has new,
exceptional opportunities for advancement
while working on:*

RADAR
MISSILE GUIDANCE
AIRBORNE COMMUNICATIONS
MOBILE COMMUNICATIONS
AUTO RADIO

Expand the horizon of your future with Bendix Radio—a leader & pioneer in the electronics field, one that has the knowledge, strength and resources to stay out front during the competitive days ahead! Your part is EASY! Wire, phone, write . . . or send us a post card. Simply state your name, address and phone number, your education and experience. We'll carry the ball from there! All replies held in strictest confidence, and we guarantee speedy action!

*Address: Mr. L. H. Noggle
Dept. M
Bendix Radio
Baltimore 4, Md.
Phone: VALley 3-2200*

Bendix Radio

DIVISION OF
BENDIX AVIATION
CORPORATION
Baltimore 4, Maryland

ELECTRONICS! CAREER OPPORTUNITIES WITH Westinghouse

SENIOR AND INTERMEDIATE ENGINEERS
AND PHYSICISTS FOR ADVANCED
PROJECTS

OPPORTUNITY for long range development project in color television and transistor application. Design and development experience in electronics, or advanced degree, desirable.

ADVANCEMENT and recognition under supervision of outstanding electronic leaders.

BENEFITS include excellent salaries, modern research facilities and equipment, retirement plan, convenient city-country living.

PHONE COLLECT or write:

Mr. Gordon Ley, Manager
Advanced Development Engineering
Phone: Metuchen, N.J., 6-5000

WESTINGHOUSE ELECTRIC CORPORATION
Television-Radio Division, Metuchen, N.J.

MECHANICAL ENGINEERS ELECTRICAL ENGINEERS PHYSICISTS

A continuing and expanding activity in development for markets in aviation communication and navigation, point to point communication services, servomechanisms, flight control, guided missiles, radio astronomy, propagation studies, radio control equipment, and radar devices requires the services of additional engineers in the Collins Radio Company, Research and Development organization. Engineers with three or more years of experience in these or the general electronic fields are especially desired. Employment offers will be for location at Collins' new laboratories in Cedar Rapids, Iowa.

Complete information regarding these positions and the company may be secured by arranging an interview in New York City during the week of the IRE Show, March 21-25, with L. R. Nuss, Collins representative. Phone Mr. Nuss in New York at Eldorado 5-3000 for appointment on or after March 21. If unable to interview, write to L. R. Nuss,

**COLLINS RADIO COMPANY
CEDAR RAPIDS, IOWA**



Positions Wanted

By Armed Forces Veterans

In order to give a reasonably equal opportunity to all applicants and to avoid overcrowding of the corresponding column, the following rules have been adopted:

The Institute publishes free of charge notices of positions wanted by I.R.E. members who are now in the Service or have received an honorable discharge. Such notices should not have more than five lines. They may be inserted only after a lapse of one month or more following a previous insertion and the maximum number of insertions is three per year. The Institute necessarily reserves the right to decline any announcement without assignment of reason.

BIOPHYSICIST

BSEE, MS Physiology, receiving Ph.D. Biophysics, industrial and academic instrumentation experience. Wishes position utilizing background. Box 784 W.

FIELD—SALES ENGINEER

Experienced in electronic field engineering with a diversified background in servomechanisms, analog computers, radio aids to navigation, and simulators. Attended U.S. Naval Academy and George Washington University. Desires sonar, as well as flight field or sales engineering position. Box 795 W.

ENGINEER

Industrial Relations officer, largest Naval Air Stations (Employment, employee relations, training and safety). Electronics background (short Navy radar course, M.I.T.). Commander, USNR, 15 years active duty. Age 52 A.B. (personnel and engineering) . . . Desires placement. Box 796 W.

ENGINEER

Audio, electronic development and testing; broadcast. Experience includes 2 years RCA Institutes, 3 years Army communications-intelligence. 1st class radio operator license. Some radio and electronic repair. Member IRE, IRE Audio Group, AES. Age 22, single. Will consider classified work. Prefer commuting distance New York-Long Island area. Box 797 W.

PATENT ENGINEER

BEE, MS EE, LLB February 1955. Senior Engineer, 5 years tube and transistor circuit research, design, development experience. Desires electronics patent work. Box 798 W.

DEVELOPMENT ENGINEER

BS, M.I.T. 1950. Development experience in Airborne radar and microwave multiplex communications equipment. Capable of mature thinking and group leadership. Have done original work on several projects, several invention credits. Desires a challenging position with an aggressive company in New York, New Jersey or Boston area. Other location will be considered. Box 799 W.

(Continued on page 300A)



Boeing offers a real creative challenge to electrical engineers

This Boeing electrical engineer is determining antenna properties that will influence the design of supersonic airplanes which still are in their preliminary study stage. His job—to help develop equipment for tasks never done before, at altitudes and speeds never reached before—is typical of the creative challenge to electrical engineers at Boeing.

Electronic and electrical equipment are vital to high-performance Boeing jet aircraft. And the importance of the electrical engineer's art is growing steadily in guided missile control, structural and flight test instrumentation, acoustics, evaluation of electronic systems, and other fields. If you want a chance to grow, there's a place for you on a Boeing research, design or production team.

Recent Boeing developments like the B-47 and B-52 jet bombers, the F-99 guided missile, and America's first jet tanker-transport are evidences of solid growth and engineering skill. New projects are already under way in widely diversified engineering fields: rocket, ram jet and nuclear propulsion, supersonic flight, guided missiles, research in new materials, and much more.

Boeing now employs nearly twice as many engineers as at the peak of World War II. And more engineers are needed. As a Boeing engineer, you will work with the most advanced equipment, like electronic computers, the world's most versatile privately owned wind tunnel, super laboratories, and the huge new Flight Test Center.

You can be sure of individual recognition at Boeing as a member of a tightly knit "team." Promotions come from within the organization, after regular merit reviews. You will be encouraged to take graduate studies while working, and will be reimbursed for all tuition expenses.

- JOHN C. SANDERS, Staff Engineer—Personnel
- Boeing Airplane Co., Dept. 16-G, Seattle 14, Wash.
- Please send further information for my analysis.
- I am interested in the advantages of a career with Boeing.

• Name _____

• University or college(s) _____ Degree(s) _____ Year(s) _____

• Address _____

• City _____ Zone _____ State _____

BOEING

Aviation leadership since 1916

SEATTLE, WASHINGTON WICHITA, KANSAS

Admiral

Increases ENGINEERING STAFF

Diversification at ADMIRAL is making itself felt in more and better engineering careers.

Real ability and originality can find new challenge and opportunity with a leader in electronic development and manufacturing.

Positions available for engineers with the following backgrounds:

★ MICROWAVE ENGINEERS

Experienced in UHF and SHF circuitry and components, with understanding of wave guides, cavities, and duplexers.

★ ELECTRONIC ENGINEERS

Junior and Senior engineers for television receiver circuit design. Experienced men also needed for V.H.F. and U.H.F. tuner work.

★ RADIO ENGINEERS

Duties involve designing household and portable radio receivers. FM and AM experience preferred.

★ MECHANICAL ENGINEERS

Electro-Mechanical designers. Assignments involve the design and layout of small mechanical devices at the development level.

★ COMMUNICATIONS ENGINEERS (MILITARY)

Applied development and design of radar and other specialized military systems.

★ AUTOMATION ENGINEERS

A special opportunity exists in the field of applying automation and printed circuit techniques in the above categories. Your imagination and engineering talents can be used in furthering this development.

Good starting salaries and working conditions with complete program of employee benefits. Opportunity for professional development with excellent facilities in Chicago area to carry on University graduate work while working full time.

• Send complete resume to Mr. Walter Wecker, Personnel Department, to get more information on these opportunities.

Admiral Corporation

3800 W. Cortland St.
Chicago 47, Illinois



Positions Wanted

By Armed Forces Veterans

(Continued from page 298A)

EXPORT ENGINEER

BS degree in RE and EE. Large experience in radio communications, technical writer, sales promotion in U. S. and foreign countries. Excellent connections with TV and electrical distributors in all export markets. Well known as Consulting Engineer in radio and TV transmitter field, U. S. and abroad. Fluent knowledge of French, Spanish and Italian. Efficient correspondent. Able to travel and appoint dealers. Married, children. Box 800 W.

PROJECT ENGINEER—SALES

BEE, MEE, Tau Beta Pi, Eta Kappa Nu. Age 38, 3 children. 8 years broad technical background in electronics, computers. Supervised and directed large engineering group. Desires Project and/or Sales engineering position in New York area. Box 801 W.

MANUFACTURER'S REPRESENTATIVE

Wanted: High quality, low cost aeronautical products with a primary market in private aviation. WW II and Korean Emergency USNR veteran desires to act as manufacturer's representative. Address: Aeroconomy Agency, P. O. Box 1001, Schenectady, N.Y.

AUTOMATION ENGINEER

Experienced computer engineer desires affiliation at management level with firms concerned with automatic data, handling and automation. Consulting, developing, etc. Further information supplied on request. Box 806 W.

SALES ENGINEER

Five years experience in electronic sales, test engineering, quality control, Government inspection and procurement. Will receive BEE in June. Age 31. Desires sales, administrative or advertising position with electronic manufacturer. Prefer New York metropolitan area. Box 807 W.

ELECTRONIC ENGINEER— ADMINISTRATIVE

BSEE 1945, MS Eng. ADM, 1954, BSIE (lacks 12 hours). Age 32, married. Lt. USNR. 1 year Navy ETM, 1 year as electronic laboratory assistant. 15 years amateur radio. Last 8 years in nucleonic industry. 1 year electronic engineer, 1 year production manager, 2½ years factory manager, 3½ years controller. Desires position which utilizes this background. Box 808 W.

PATENT ENGINEER

BEE N.Y.U. 1949. In second year Law School. 2 years radio transmitter, and 2½ years components and color TV design and development experience. 1st Lt. U. S. Signal Corps, Korean veteran. Age 25, married. Prefer position doing patent work in New York City area. Will consider out of town. Box 809 W.

BROADCAST ENGINEER

RCA graduate (with honors) desires position as broadcast engineer, anywhere. No experience, but capable, salary secondary. With a little help I can become a valuable engineer, just try me. Box 810 W.

(Continued on page 302A)

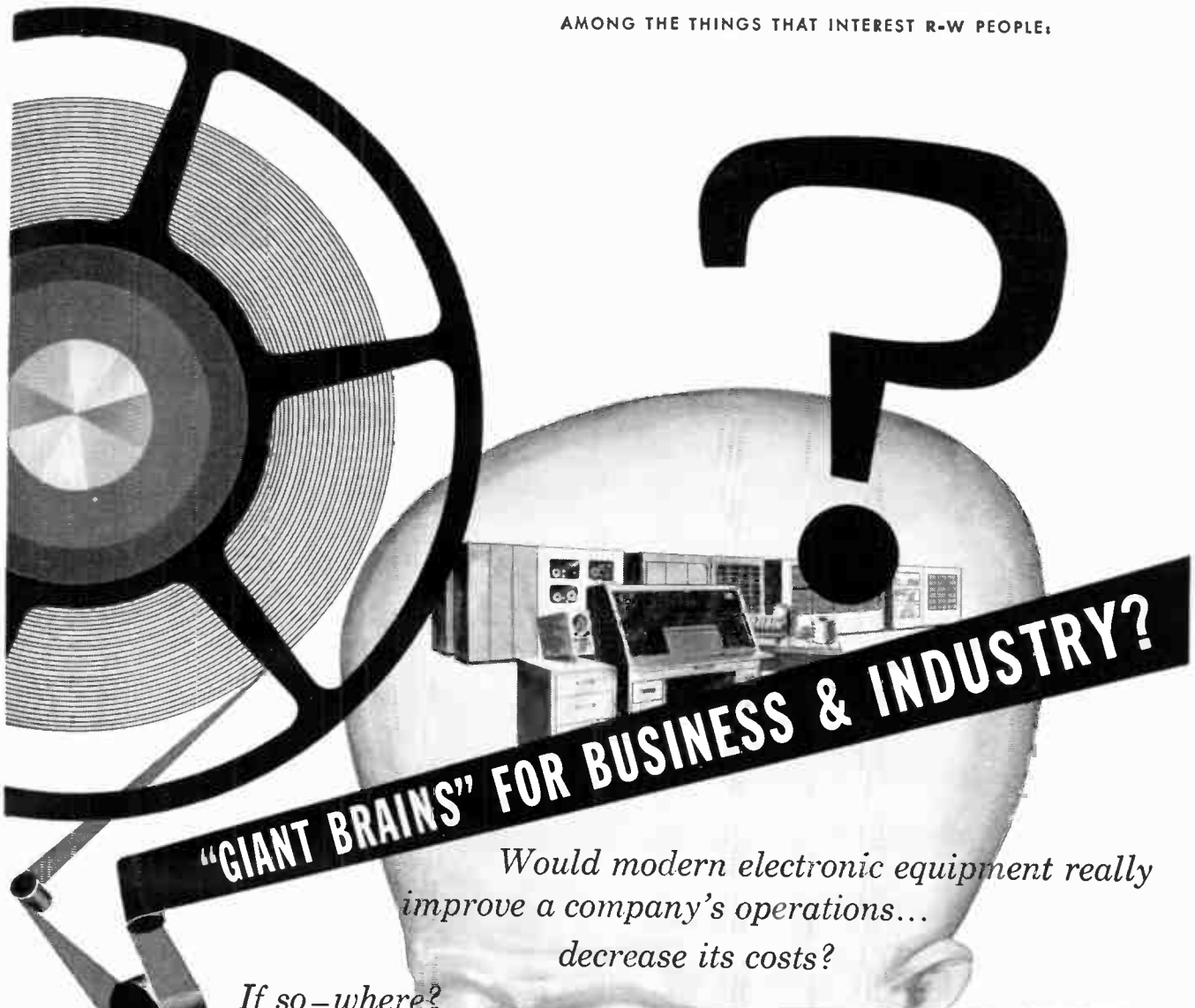

Would modern electronic equipment really improve a company's operations... decrease its costs?

If so—where?

In production control? Payroll accounting? Customer billing?

Factory automation?

What make of equipment is best?

What changes in company methods and procedures would be required?

To assist managements in answering such questions, The Ramo-Wooldridge Corporation through its Computer Systems Division, offers to business and industry the consulting services of a team of scientists, engineers and business methods and procedure analysts experienced in the application of modern analytical and machine methods. With no equipment of their own to sell to non-military customers, but with understanding of available machines and techniques, this group is in a position to be objective in its recommendations.

Positions are available at The Ramo-Wooldridge Corporation for scientists and engineers in these fields of current activity:

- Guided Missile Research and Development
- Radar and Control Systems Development
- Digital Computer Research and Development
- Communication Systems Development
- Business Data Systems Development

Representatives will be available for information or personal interviews at the I. R. E. National Convention in New York City, March 21-24

The Ramo-Wooldridge Corporation

DEPT. P-7, 8820 BELLANCA AVENUE, LOS ANGELES 45, CALIFORNIA

COMMUNICATIONS and ELECTRONICS

are but two of the many scientific disciplines in which the Operations Research Office of The Johns Hopkins University offers most unusual and challenging opportunities to the experienced researcher. Salaries are commensurate with experience. Inquiries are invited. Address:

W. P. Champlain, Research Personnel Officer
Operations Research Office, 7100 Connecticut Ave.
Chevy Chase 15, Maryland

EXPERIENCED TRANSFORMER DESIGNER

required for key position in an expanding company. Should be thoroughly familiar with designing for low-cost mass production all types of communication transformers.

We offer a good salary, excellent fringe benefits and fine facilities for doing your job. You have the unusual chance to live in the country but close to Rochester, New York.

Write to Engineering Personnel

Caledonia Electronics & Transformer Corp.
Caledonia, New York

TECHNICAL EDITOR

Immediate opening for man with B.S.E.E. or equivalent to become editor of The Lenkurt Demodulator, monthly publication for telephone and communications engineers. Should have some writing experience, but previous editorial background is not required. Salary \$5,700 a year with good advancement opportunity. Company is largest independent producer of commercial telephone carrier and microwave. Call or write Employment Manager, Lenkurt Electric Co., San Carlos, California.



Positions Wanted

By Armed Forces Veterans

(Continued from page 300A)

ENGINEER

MSEE 1952, 13 years experience with fire control equipment; 2½ years directing broad research, development, and testing program for radars, missiles, and electro-mechanical and electronic computers. Age 34, married. Despite managerial or organizational engineering work in New York or Los Angeles area. Box 819 W.

ADMINISTRATIVE ENGINEER

BSEE, I.L.B., Senior Member IRE, under 40. 6 years Signal Corps technical-administrative, 9 years research and manufacturing, extensive patent knowledge. Experienced in organizing and supervising group, personnel training, technical specification drafting, liaison. Desires supervisory position with coming research or manufacturing concern. Box 820 W.

ELECTRONIC ENGINEER

Capable engineer, age 29, with 5 years professional experience desires responsible position in electronic circuit design and development work. Experience includes BSEE 1949, project supervision for 3 years, instrumentation, airborne systems, sonar, and fundamental research. Location in south or southwest preferred. Box 821 W.

ELECTRONIC ENGINEER

Striving, conscientious engineer for automation or missile development. BSEE 1951 Ill. Institute of Technology. 3 years' experience in phono amplifiers, tape recording, multiplex communication in microwave. Box 822 W.

FIELD OR SALES ENGINEER

Experienced in electronics field engineering with diversified background in guided missile systems, test equipment and prototype electronics work. Retired Army Warrant Officer. Desires field or sales engineering position in Florida area. Box 823 W.

ENGINEER

2 years toward BEE degree. Age 27, married, 3 children. 1½ years Navy ETM 2cl, WW 11. 3 years field experience in radar and communication equipment. Presently engaged in flight simulator field. Desires any work permitting completion of studies toward degree. Box 824 W.

SALES—ADMINISTRATIVE ENGINEER

BSEE 1948. 7 years experience administrative engineering and military electronics equipment design in U.S. and abroad; present advancement too slow; age 34, married, 2 children; Tau Beta Pi; desires sales or administrative engineering electronics or allied field Southern California or Mediterranean area; present salary \$7700. Box 825 W.

PATENT ENGINEER

Professor engineering, Senior Member IRE; Registered to practice before U. S. Patent Office; Available on part time basis because of change in employer's operations. Full time offer considered. Box 826 W.

ELECTRICAL ENGINEER

BSEE 1950. Experience in petroleum geophysics, broadcast, communications radio, military electronics. Interested in electronic design, development, test or field engineering. Location preference southwestern or southern area. Will carefully consider any offer. Box 827 W.

*Hughes, pioneer developer of
airborne digital computers, and
leader in radar fire control,
now enters the field
of ground radar and data
processing systems.*

Important new programs are under way in the Radar Research and Development Division for the development of ground radar and data processing networks. In these projects, Hughes engineers are drawing on their extensive experience in the successful development of radar fire control systems and airborne computers.

The data gathering for these ground networks will be performed by very high power radar using advanced high-speed scanning techniques developed by Hughes under sponsorship of the U. S. Navy. The processing, transmission, and correlation of the great mass of data involved will be handled by large-scale digital systems. This equipment must be designed to meet stringent tactical requirements for reliability and maintainability.

Visit the
HUGHES EXHIBITS

Booths 753 • 755 • 757

I. R. E.

**NATIONAL CONVENTION
and
RADIO ENGINEERING SHOW**

New York City, March 21, 22, 23, 24
Headquarters, Waldorf-Astoria Hotel
Exhibits, Kingsbridge Armory

**SCANNING
A NEW
HORIZON**



Shown here is a new magnetic drum memory for the Hughes airborne digital computer. Many of the techniques it employs will be used in the ground radar data processing systems.

Here are some of the types of work included:

TRANSISTOR CIRCUITS
DIGITAL CIRCUITS
MAGNETIC DRUM AND
CORE MEMORIES
LOGICAL DESIGN
PROGRAMMING
ADVANCED RADAR TECHNIQUES

*Engineers
and Physicists*

Application of the techniques, special knowledges and individual talents indicated here is creating positions at all levels in the Ground Systems Department. Engineers and physicists with experience in the fields listed, or those with exceptional ability in these directions, are invited to consider joining our Staff.

*Scientific
and
Engineering
Staff*

HUGHES

**RESEARCH
AND DEVELOPMENT
LABORATORIES**

*Culver City, Los Angeles County,
California*

In the field of Electronics

... the Glenn L. Martin Company is further expanding its operation. This expansion is creating new and more varied job opportunities.

Opportunities for engineers exist to carry on long-range programs.

You will fill a highly responsible position working on projects involving missiles, ground based electronics equipment and aircraft.

Typical of the positions to be filled are:

- **Systems Analyst**
- **Supervisor—Servo Design**
- **Digital Computer Specialist**
- **Circuit Theory Specialist**
- **Antenna and Microwave Specialist**
- **Staff Advisor—Component Design**
- **Project Director**

(To direct and coordinate major electronic projects)

You will be working with the finest creative engineering resources and production facilities. You will have unlimited opportunity in this expanding organization. Your ability is the decisive factor.

MARTIN
BALTIMORE · MARYLAND



Mr. Charles Heintz, Martin representative, welcomes IRE members to the annual conference at the Hotel Waldorf.

What to See at the Radio Engineering Show

(Continued from page 284A)

RS

- INTERCONNECTING POWER SUPPLIES
- NOISE MEASURING EQUIPMENT
- SUBMINIATURE I-F AMPLIFIERS
- RADAR SCANNERS

639 CIRCUITS AVE.

RS ELECTRONICS CORPORATION
433 PORTAGE AVENUE - PALO ALTO, CALIFORNIA

Racon Electric Co., Inc., 830 Audio Ave.
Loudspeakers for industrial, armed forces and high fidelity use.

Radell Division, I.D.E.A., Inc., 408 Electronic Ave.

RADELL MIL-Line, INDUSTRIAL-Line and *Hermetically Sealed deposited carbon resistors to fill a wide range of precision resistor requirements.

Radiation, Inc.

10 Palace

Airborne and ground instrumentation equipments, including a high capacity digital recording system, telemetering system, miniaturized packaging technique and super regulated power supplies.

Radio City Products Co., Inc., 220 Instruments Ave.

*Compatible All Electronic Sweep Generators.
*DC Oscilloscopes—frequency meters—megohm meters—industrial measurealls—and a complete line of VT Voltmeters—tube testers—multitesters—signal generators.

Radio Condenser Co., 780 Airborne Ave.

Transistors Gangs, Television Tuners—VHF & UHF, automobile radio tuners, home radio variable air capacitors, special applications variable air capacitors, custom built tuning devices, electro-mechanical assemblies & coil products, color phasing control.

Radio Corporation of America

151, 153, 155 Television Ave.

RCA 21-inch color kinescope, components, receiving tubes and color test equipment. Also, transistors, diodes, batteries and industrial tubes.

Radio-Electronic Engineering, 839 Audio Ave.

A technical magazine for engineers and executives in all branches of the electronics industry, presents essential, usable information on important engineering, research and development activities.

*Indicates new product

(Continued on page 306A)

Show Hours: Monday 10 AM-10 PM
Tuesday 10 AM-10 PM
Wednesday 10 AM- 5 PM
Thursday 10 AM-10 PM

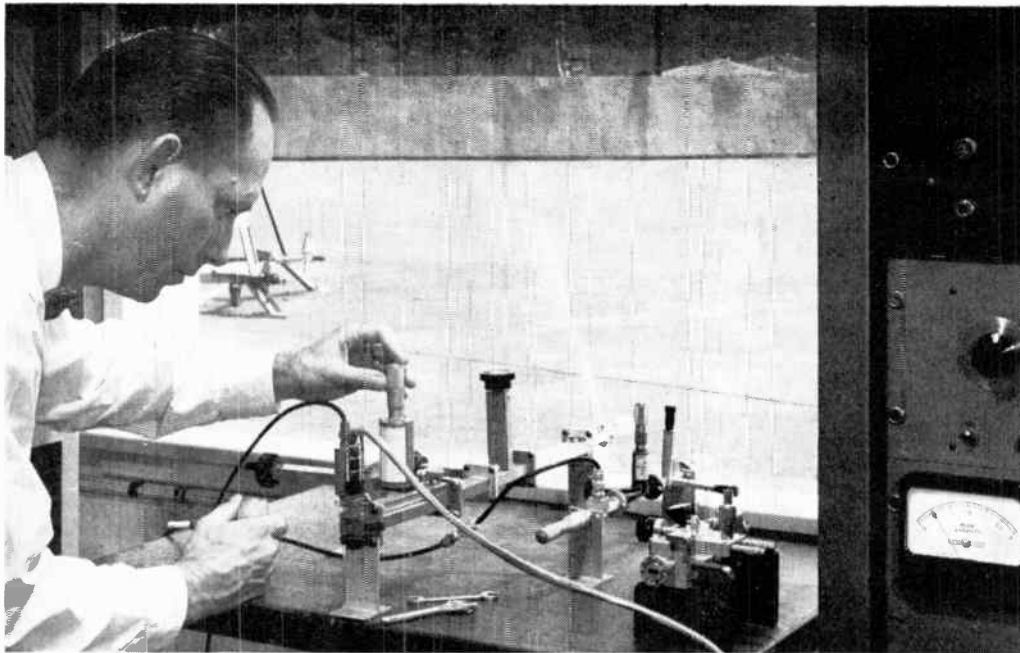

Research Specialist Edward Lovick measures reflection coefficient of dielectric materials in the K-band region. Lockheed is expanding K-band studies to meet future radar requirements.

Lockheed expands airborne antenna program

Lockheed's diversified expansion program is causing a major increase in airborne antenna research and development. Antenna design is one of the fastest growing areas at Lockheed, with research and development being applied to: extremely high-speed fighters, advanced jet trainers and jet transports; advanced versions of vertical-rising aircraft, turbo-prop transports, radar search planes (developed and produced exclusively by Lockheed) and a number of significant classified projects.

New positions at Lockheed

The program presents Physicists and Electronic Engineers qualified for airborne antenna design with a wide range of assignments in communication, navigation and microwaves.

In addition to the compensation of challenging work, Lockheed offers you increased salary rates now in effect; generous travel and moving allowances; an opportunity to enjoy Southern California life; and an extremely wide range of extra employe benefits which add approximately 14% to your salary in the form of insurance, retirement pension, etc.



Electronics Research Engineer Irving Alne records radiation antenna patterns. Twenty-two foot plastic tower in background eliminates ground reflections, approximates free space. Tower is of Lockheed design, as are pattern integrator, high gain amplifier, square root amplifier, logarithmic amplifier.



E. O. Richter, Electronics Research department manager (seated), **W. R. Martin**, antenna laboratory group engineer (standing), and **J. L. Rodgers**, electronics research engineer, discuss design of corrugated surface antenna.

Lockheed

AIRCRAFT CORPORATION

BURBANK **California**

FIRE CONTROL ANALYSTS

Mathematicians • Electrical Engineers • Physicists

needed for immediate openings in all levels of employment. These are top ranking technical positions together with training positions leading to top responsibility in mathematical analysis for electronic fire control, computers, and servomechanisms.

- Household goods moved
- Liberal employee benefits
- Interview expense paid

Send written resume to

REMINGTON RAND, Inc.

ERA DIVISION

1902 W. Minnehaha Ave., St. Paul 4, Minn.

PROJECT ADMINISTRATORS

SENIOR ELECTRONIC ENGINEER
SENIOR PHYSICIST

We have openings for one Senior Physicist and one Senior Electronic Engineer with considerable experience in Project Administration of challenging and extremely interesting research and development contracts. Ability to administer a contract, meet schedules and perform within estimates is a prime requisite. They must also have the following qualifications:

SENIOR PHYSICIST: A satisfactory background is required with particular emphasis on physical and geometrical optics. At least five years experience in electronic circuitry and/or ultrasonics, radar, infra-red techniques, preferably in industry, is necessary.

SENIOR ELECTRONIC ENGINEER: Experience and educational background must be solid in radar and pulse circuitry and wide-band video, with a good background in general physics. Some experience in microwave techniques, analog or digital computers and servos in industry would be desirable.

Submit resume, including salary requirement, to

Engineering Employment Division

FREED ELECTRONICS AND CONTROLS CORPORATION

200 Hudson Street, New York 13, New York

What to See at the Radio Engineering Show

(Continued from page 304A)

RADIO - ELECTRONICS

452 Electronic Ave.

Covers TV, radio, audio, high fidelity and electronics with special emphasis on servicing. Also the Gernsback Library of low cost technical books on electronics at the service technician level.

Radio Frequency Laboratories, Inc., 823 Audio Ave.

Audio Frequency Transmitter and Receiver Terminals, Audio Frequency two-way Terminal, 2W-2W Voice Terminal, "COMVOR" Data Transmission Terminals for Frequency Multiplexing systems and Special Hardware items.

Radio Magazines, Inc., 852 Audio Ave. Latest issue of Audio Magazine, also just off the press, "Electronic Musical Instruments" by Richard H. Dorf, recognized as one of the few independent authorities on electronic music.

Radio Materials Corporation

518 Components Ave.

Ceramic Disc Capacitors

RP RADIO RECEPTOR CO., INC.
251 WEST 19TH ST., NEW YORK 11

See our display | Booths 511—513
Components Avenue

GERMANIUM DIODES • SILICON DIODES
TRANSISTORS • SELENIUM RECTIFIERS
THERMATRON HF DIELECTRIC HEATING
GENERATORS & PRESSES • NAVIGATION,
RADAR & COMMUNICATIONS EQUIPMENT

Radio & Television News, 839 Audio Ave.
See Radio-Electronic Engineering.

Raleigh Engineering Division of American Machine & Foundry Co., 106, 108, 110 Television Ave.

Demonstration of AMF's Silver Zinc Batteries which offer high power output per unit weight and volume at constant discharge voltage. Capable of unusually high drain rates, they operate over a wide range of environmental conditions.

Rawson Electrical Instr. Co., 210 Instruments Ave.

Laboratory Meters for AC or DC featuring high sensitivity and high accuracy. Electrostatic Voltmeters, Fluxmeters and Rotating Coil Gaussmeters for magnetic measurements. Sine-Cosine Potentiometers.

Raydist Navigation, 410 Electronic Ave.
See Hastings Instrument Co.

(Continued on page 309A)

SENIOR ELECTRONICS ENGINEERS

EE degree or equivalent experience. Background in communications and navigation desirable. Permanent positions in design and development. Citizenship required. Position at Rochester, New York. Excellent living and recreational conditions in this area.

ADDRESS:

Chief Electronics Engineer
Stromberg-Carlson Company
Rochester 3, New York

Messages by TV

AT KINGSBRIDGE ARMORY AND PALACE

Through the courtesy

of the Federal Telephone & Radio Co. and Farnsworth Electronics Corp. (Capehart-Farnsworth Corp.), a closed circuit message paging system will post calls on seven monitor units in the Kingsbridge Armory and Palace. Calls placed at our Information Centre will be re-broadcast through television receivers at the IRE information counters and one receiver in the Federal Telephone and Radio Co. booth during the Show.

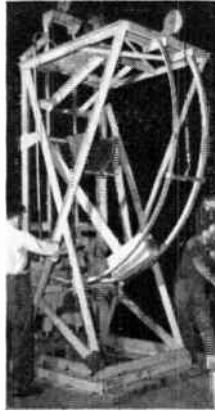

SANDIA CORPORATION

invites you to compare

- ✓ **OPPORTUNITIES**
- ✓ **ADVANTAGES**

... with those of other research and development organizations. The "good" job is one in which you can be happy. You alone can decide the relative importance of such things as professional challenge of the work, promotion possibilities, work environment, job security, geographical location, climate, etc. In all these respects, Sandia Laboratory can meet the expectations of most engineers and scientists in the following fields —

- mechanical engineers
- electronics engineers
- electrical engineers
- physicists
- mathematicians
- aerodynamicists
- systems engineers

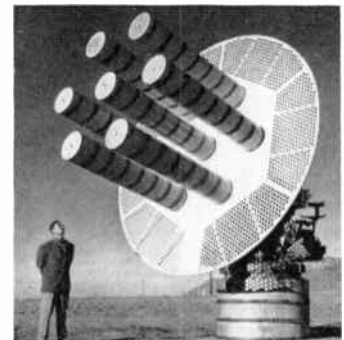

SANDIA CORPORATION, a subsidiary of the Western Electric Company, operates Sandia Laboratory under contract with the Atomic Energy Commission. Simply stated, Sandia's job is to build usable weapons around the explosive nuclear components developed at nearby Los Alamos Scientific Laboratory. Graduate engineers and scientists will find excellent opportunities in the fields of component development, systems engineering, applied research, testing and production.

COMPENSATION is competitive with that offered in other industry. Working conditions are excellent and employee benefits include liberal paid vacations, free group life insurance, sickness benefits and a generous contributory retirement plan. Opportunities for advancement in this young and growing laboratory are many.

SANDIA LABORATORY is located in Albuquerque — a modern, cosmopolitan city of 150,000, rich in cultural and recreational attractions and famous for its excellent year-around climate. Adequate housing is easily obtained. For descriptive literature giving more detailed information on Sandia Laboratory and its activities — or to make application for employment — please write:

PROFESSIONAL EMPLOYMENT DIVISION 1A1

SANDIA
Corporation

SANDIA BASE • ALBUQUERQUE, NEW MEXICO

MICROWAVE & ELECTRONIC ENGINEERS

*A Few Positions Available
in the Small Engineering Groups
Engaged in Missile Guidance,
Component Development and
Microwave Engineering, on
Both Civilian & Military Projects*

Sanders Associates, Inc. is one of the fastest growing electronics laboratories in America. Run BY engineers, FOR engineers, Sanders provides unlimited opportunity for the ambitious man who would like his future to be determined solely by his own capabilities.

Sanders' outstanding record of growth and achievement in 3 short years (including the development of the world's smallest rate gyro) attests to the high calibre of the men already on the staff.

The location in Nashua, New Hampshire provides year-round healthful living for the whole family (one hour from the White and Monadnock Mountains, less than one hour from downtown Boston).

If you feel your talents need more room for expression . . . if you'd like to join a small progressive company where recognition comes quickly . . . send a complete resume to Mr. J. I. Chesterley.

Or See Mr. Chesterley at the Park Lane Hotel, 49th St. & Park Ave. in New York during the IRE Convention, March 20-24.

137 CANAL ST. NASHUA, NEW HAMPSHIRE



ENGINEERS

Which Matters Most

The **SIZE** of the **COMPANY**

OR

The **SIZE** of the **OPPORTUNITY?**

Many engineers have found that the size of a company does not always determine the size of the opportunity it offers.

Consider the National Company, for example: solidly-established since 1914, recognized as a quality pioneer in the electronics industry, we have remained comparatively small by choice, growing slowly while consistently increasing our scope of operations.

Ours is an organization where the accent has always been on individuality, on encouragement of initiative, on personal interest in each engineer's progress. In this kind of environment, opportunity is inherent, and an engineer can do his best work, knowing it will not go unnoticed.

National invites engineers who are "Tuned to Tomorrow" to apply now for the following positions:

**ELECTRONIC ENGINEERING
RESEARCH PHYSICS
MECHANICAL ENGINEERING
MECHANICAL DESIGN**

You will participate in the research, development and design of:

COMMUNICATIONS SYSTEMS—Microwave components, transmitters, radar & terminal equipment

COMPUTING DEVICES—Digital & analog techniques

AUDIO DEVICES—Tape recording, high fidelity amplifiers, tuners

INSTRUMENTATION—Sensing elements, high vacuum techniques, specialized circuits & frequency multipliers

RECEIVERS—Specialized, diversity, low noise & microwave

COMPONENTS — Hardware, capacitors, inductors

INTERVIEWS AT THE I. R. E. CONVENTION

Be sure to visit with National at its I. R. E.

convention headquarters Hotel Barclay

111 East 48th Street, New York City (Between Park and Lexington Avenues)

Or write directly to John A. Bigelow

National



NATIONAL COMPANY, INC.
61 Sherman St. Malden, Mass.

ENGINEERS . . .

Westinghouse

the dynamic way to success

with our

ELECTRONIC TUBE DIVISION

in Elmira, New York

You'll "go places" . . . share in our world-renowned growth and leadership. Based on merit, your achievements will receive tangible recognition. And Elmira, in the heart of upper N. Y. state's lakeland, is a pleasant place to live.

Opportunities for:

DESIGN, DEVELOPMENT and APPLICATION ENGINEERS: Receiving, image orthicon or vidicon tubes; solid state devices.

MICRO-WAVE TUBE DESIGN ENGINEERS: 2 or more years experience, for designing magnetrons, traveling-wave tubes, TR and ATR tubes, reference cavities, etc.

Above openings are for Engineers and Physicists with Bachelor's, Master's or Doctor's degree. Also . . .

ELECTRICAL ENGINEERS, for EQUIPMENT DESIGN: designing, costing, and guiding construction of processing and testing equipment, e.g. atmosphere furnaces, electrical welders, induction heaters, X-ray seasoning and test units, waveguide apparatus, transistor life test units.

Interviews arranged in your area, or travel expenses paid if invited to Elmira for interview. Send resume:

WESTINGHOUSE Electronic Tube Division

P.O. Box 284, Elmira, N. Y.

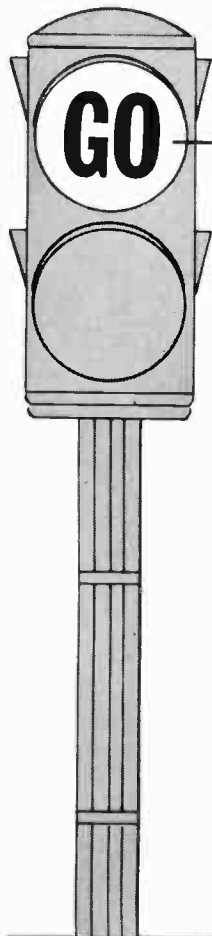

What to See at the Radio Engineering Show

(Continued from page 306A)

Raytheon Manufacturing Co.

Excellence in Electronics

2-4 Palace

Magnetic Components
Industrial Equipment
Telecasting Equipment
Tubes and Transistors
Magnetrons and Klystrons

Raytheon Manufacturing Co.

Excellence in Electronics

145-149 Television Ave.

Magnetrons and Klystrons
Telecommunications Equipment
Receiving and Special Purpose Tubes
Semi-Conductor Diodes and Transistors
Microwave, Servo and Computer
Components
Backward Wave Oscillators and
Travelling Wave Tubes

Reeves Instrument Corp., 341-347 Com- puter Ave.

*Complete line REAC analog computer equip-
ment, *model 2" floated type Hermetic Inte-
grating gyro, high precision accelerometers, re-
solvers, and servo mechanical parts. *Rotary
waveguide coupling automation systems.

Reinhold Publishing Corp., 46 Palace
AUTOMATIC CONTROL—the applications
magazine of systems engineering that reaches
30,000 readers. Its editorial content is geared
to the needs of a primarily engineering audi-
ence, with emphasis heaviest on applications
of components and other control equipment.

Remington-Rand, Inc., Electronic Com- puter Div., 51, 53, 55 Palace

Working model of Univac High-Speed Printer,
*ultra-fast wheel printer with novel actuator
technique . . . other new Univac auxiliaries
displayed.

Republic Steel Corp., 327 Computer Ave.

See Truscon Steel Division

Resin Industries, 706 Airborne Ave.

**"Resinite Vinyl Glass" vinyl impregnated
fiberglass sleeving; also resinite commercial
and specification grade vinyl insulation sleeving
lacing cords and tapes.

Resinite Corp.

791 Airborne Ave.

The coil form with the highest res-
istivity of any resinated product.

Threaded and embossed tubes, col-
lars and flyback transformer coil
forms.

Rex Corp., 515, 517 Components Ave.

Rexolite #1422 UHF Insulation, Rexolite #2200
Glass Reinforced UHF Insulation, K-F Wires,
Microwall Wires, Plastic Insulated Hook-Up
Wires, Multiple conductor cables and Coaxial
Cables, Electrical Tubing.

*Indicates new product

(Continued on page 310A)

CHALLENGING CAREERS AT RAYTHEON



Raytheon TCR-12 Series Microwave Communication Systems (above) operates on industrial and common carrier bands for telephone, telemetering, teletype, telegraph and control. First to use strip-line plumbing, this equipment incorporates latest design features for all-weather reliability, economy and compactness.

Here's wide-open opportunity

Long-range communications engineering development has estab-
lished Raytheon as a leader in the field. Another major commu-
nications product is the KTR-100 Series Color TV Microwave
Relay which operates on the broadcast, common carrier and gov-
ernment bands with a multiplex audio-visual range to 25 miles.

When you join Raytheon you work in an atmosphere of progress.
Openings now for engineers, scientists in many areas including:

**microwave tubes • special purpose tubes • guided missiles
transistors • diodes • receiving tubes
radar • sonar • computers • ultrasonics
metallurgy • ceramics • communications systems
servomechanisms • control equipment • solid state physics**

Join a team where performance pays off. Please address inquiries
to L. B. Landall, Professional Personnel Section.



RAYTHEON MANUFACTURING COMPANY

190 Willow St., Waltham 54, Mass.

Plants also located in California and Illinois

**Engineers —
DESIGNERS-DRAFTSMEN
Electronic and Mechanical**

*"You just can't hardly
find them no more"*

OPPORTUNITIES like those now available at Melpar are difficult to find. Melpar, leader in electronic research and development, offers unlimited opportunities for personal advancement . . . unexcelled laboratory facilities at its new plant . . . diversified and challenging projects . . . long-range military and industrial program . . . and a new way of life in pleasant suburban Fairfax County in northern Virginia. Yes, "you just can't hardly find opportunities like them no more."

For personal interview send resume to
Technical Personnel Representative,



melpar, inc.

Subsidiary of Westinghouse Air Brake Co.

3000 Arlington Blvd., Dept. IRE-15
Falls Church, Virginia
or 11 Golen St., Watertown, Mass.



New positions created
by our expansion require men
with experience in the following fields:

- Network Theory
- Microwave Technique
- UHF, VHF or SHF Receivers
- Analog Computers
- Digital Computers
- Magnetic Tape Handling Equipment
- Radar and Countermeasures
- Packaging Electronic Equipment
- Pulse Circuitry
- Microwave Filters
- Flight Simulators
- Servomechanisms
- Electro-Mechanical Design

Representative will be available for
interviews in New York City
during IRE Show.

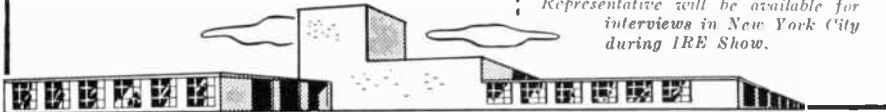

**PHYSICIST
OR
ELECTRICAL ENGINEER**

With Ph.D. or comparable training. Knowledge of electro-dynamics and microwave analysis is essential. Some experience in microwave measurement techniques is desirable. Proficiency along other lines will be an asset for future work. For aggressive independent research laboratory in midwestern university town. Salary \$9,500.

Box 799

Institute of Radio Engineers, 1 East 79th St., New York 21, N.Y.



Large well-financed electronic manufacturer is interested in finding new products suitable to our established national distribution through electronic parts jobbers.

We particularly want:

- Radio and Television service aids
- Radically new TV antenna types - indoor, outdoor, UHF, VHF, or combinations.

Liberal compensation for a good item!
Outright purchase or royalty.

WRITE NOW! - Manufacturer will arrange personal contact.

Send a brief resume on your new product or idea to:

Box 806, Institute of Radio Engineers
1 East 79th St., New York 21, N.Y.

**What to See at the
Radio Engineering Show**

(Continued from page 309A)

Rheem Mfg. Co., 87 Palace

The Rheem Electronics Laboratory presents four of its outstanding missile instrumentation units. Designed for telemetering and other instrumentation applications, they feature reliability under severe environments.

**THE
RIESTER & THESMACHER
COMPANY**

1526 W. 25th St. Cleveland, O.

354 Microwave Ave.

**SHEET METALS
FABRICATIONS**

*Custom Built Cases and Covers
for Electrical Equipment*

**Robco Mfg. Div., Pilot International
Corp., 28 Palace**

*Hermetic Seal Terminals, Headers of Ceramic Compression or Rubber Seal Soldered type. Contract manufacturing for the Electronics Industry, specializing in electro-mechanical and electronic assemblies.



Booth, 751 Airborne Ave.

All-metal (MET-L-FLEX) vibration and shock mounts and engineered mounting systems.

PIONEERS IN ALL-METAL MOUNTING SYSTEMS FOR AIRBORNE, SHIPBOARD, MOBILE, INDUSTRIAL AND PACKAGING APPLICATIONS.

Roger White Electron Devices, 80 Palace
See White Electron Devices, Roger

**Roller-Smith Corporation
Instrument Division**

702 Airborne Ave.

Exhibiting AC and DC ruggedized meters, *core magnet mechanisms, *elapsed time meters, *relays. Precision Balances, rotary switches, *new styling in panel and switchboard meters, *250° switchboard meters.

**Ronette Acoustical Corp., 125 Television
Ave.**

High fidelity audio components including "Fonofluid" System Cartridges, Pickup Arm, microphones, crystal tweeters and filtercells.

Rotron Mfg. Co.

581, 583 Components Ave.

*Radial wheelblowers, *Aircraft motors; Hi-altitude blowers and fans; Inverted blowers; Transmitting tube supports; Utility blowers and fans; Airflow interlocks.

*Indicates new product

(Continued on page 312A)

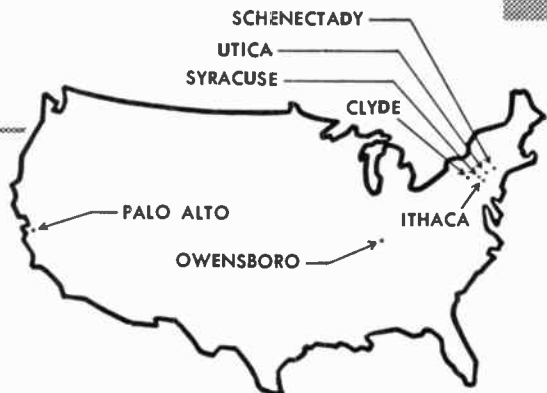

New
GENERAL ELECTRIC
*Opportunities
 Throughout the Country
 In Advanced Electronic
 Developments*

At General Electric plants and laboratories from New York to California, G.E. engineers are constantly planning new and revolutionary advances in the field of electronics.

And with each new development, they are broadening the scope and opening new challenges and new opportunities in this young and fast-growing field.

Thus, the opportunity is ever-increasing at General Electric. If you are interested in taking on new challenges...in working with the finest facilities...in growing along with this leader in industry, you are invited to apply now for positions open at Schenectady, Utica, Ithaca, Syracuse, and Clyde, New York; Owensboro, Kentucky; and Palo Alto, Calif.

ENGINEERS • PHYSICISTS

Positions available in the following fields:

Advanced Development, Design, Field Service and Technical Writing in connection with:

**MILITARY RADIO & RADAR • MULTIPLEX MICROWAVE
 MOBILE COMMUNICATION • COMMUNICATIONS
 ELECTRONIC COMPONENTS
 TELEVISION, TUBES & ANTENNAS**

Bachelor's or advanced degrees in Electrical or Mechanical Engineering, Physics, and experience in electronics industry necessary.

*Please send resume to:
 Dept. 3-5-P, Technical Personnel*



ELECTRONICS PARK, SYRACUSE, N. Y.

**Guilford
 Personnel Service**

The confidential Professional Placement Service **ENGINEERED** to your requirements.

GPS interviewers understand your resume.

GPS knows where your skills will bring the highest return.

GPS charges you **NO FEE.**

E.E.'s, M.E.'s, Aero Electronic Engrs., Physicists, Computers, Mfg. Engrs., Tube Men, Systems, Analysts, Technical Writers and Illustrators, Ceramists, Metallurgists, Thermodynamicists and Marketing and Admin. Engrs.

Interview & relocation expenses **PAID.**

Send 3 copies of your resume to Box R-1-C.

**308 American Bldg.
 Baltimore 2, Md.**

ENGINEERS PHYSICISTS

Research . . . Development . . . Production

REQUIRED BY CHATHAM for new expanding tube and equipment development program. New plant with ultra-modern facilities located in an attractive community near the metropolitan area.

Fields open include:

- **NUCLEAR PHYSICS INSTRUMENTATION**
- **PANEL INSTRUMENT DESIGN**
- **VACUUM AND GAS TUBES**
 - Hydrogen Thyratrons
 - Receiving
 - Cold Cathode Discharge
 - Gas and Mercury Vapor Rectifiers and Thyratrons
- Computer and Counting
- Photo Multiplier
- Switching
- **PULSE CIRCUITS**
 - Low and High Power
- **TRANSMITTERS**
- **MAGNETIC AMPLIFIERS**
- **AUDIO**
 - Low and High Power
- **EQUIPMENT COSTING**
- **COMPUTERS**

Visit **CHATHAM** AT THE I.R.E. SHOW! Booths 474, 476 and 478, **ELECTRONIC AVENUE, Kingsbridge Army** or forward complete resume to our Livingston offices.



CHATHAM ELECTRONICS
 Division of **GERA CORPORATION**
LIVINGSTON, NEW JERSEY

ELECTRONIC RESEARCH & DEVELOPMENT ENGINEERS JUNIOR & SENIOR

Continued expansion of varied commercial and military activities of our electronics divisions offers positions for specialists or those capable of handling from beginning-to-end circuit design, breadboarding and packaging—in:

- ANALOG & DIGITAL COMPUTERS
- MAGNETIC AMPLIFIERS
- SERVO MECHANISMS
- FIRE CONTROL SYSTEMS
- GUIDED MISSILES
- SUBMINIATURIZATION
- FLIGHT SIMULATION
- NAVIGATIONAL RADIO AIDS

Local interviews will be arranged for immediate positions with:

ACF Electronics—Alexandria, Va.
(Suburb of Washington, D.C.)

Avion Instrument Corp.—Paramus, N.J.
(N.Y. Metropolitan Area)

Engineering & Research—Riverdale, Md.
(Suburb of Washington, D.C.)

Submit resumes to:

ACF INDUSTRIES, INC.

(Formerly American Car & Foundry Co.)

P.O. BOX 55
Church Street Annex
New York 8, N.Y.

CHIEF ENGINEER

Are you experienced in electronics, phonograph cartridges and pickup arms, microphones, television boosters and converters? Do you have the ability to administer and co-ordinate the activities of the mechanical, acoustical and electronic divisions of a leading midwest manufacturer of these parts? Send us a resume of your background. You may be the man we are seeking. All replies confidential.

Box 805, Institute of Radio Engineers
1 East 79th Street, New York 21, N.Y.

What to See at the Radio Engineering Show

(Continued from page 310A)

Rutherford Electronics Co. 424 Electronic Ave.

Rutherford Electronic Company display Pulse and Time Delay Generators, featuring their Model B-2A high repetition rate, wide range pulse generator, Time Delay Generators Models A-2, A-4 and A-5, providing accurate and variable time delay from 1 microsecond to 10 seconds.

Sage Electronics Corp., 15 Palace Miniature Precision Power resistors. *"Silicohm" line provides unequalled characteristics in both silicone-coated and metal-clad types. Unique and exclusive "feed through" metal-clad design.

Sanborn Company 455, 457 Electronic Ave.

The 150 Series family will include the single-, two-, four-, six-, and eight-channel Recording Systems. A variety of interchangeable preamplifiers or front ends are available. These include AC-DC, Carrier, Servo-Monitor, DC Coupling, Log Audio, Low Level and AC Watt Meter. Dual channel DC amplifiers designed for use with analog computers will be shown in four- and eight-channel Recording Systems.

San Fernando Elec. Mfg. Co., 483 Electronic Ave.

Capacitors—paper dielectric, tubular and rectangular (bathtub type), metal cased, hermetically sealed with glass to metal terminals. MIL C-25A specification. *Metallized paper and polyester film capacitors.

Schutter Mfg. Co., Carl W., 563, 565 Components Ave.

Microwave components, such as choke and cover flanges, for waveguides, twists, elbows, magic and shunt tees, flap attenuators, waveguide terminations, adapters, and many like parts of similar nature.

SCOVILL MANUFACTURING CO. Booth #41 Kingsbridge Palace

PANELOC Rotary Latches*
PANELOC Aircraft Fasteners
Waterbury 20, Conn.



"PRESS-FIT"
TEFLON TERMINALS
Sealectro
CORPORATION
BOOTH 48 KINGSBRIDGE PALACE

*Indicates new product

(Continued on page 314A)

ELECTRONICS ENGINEER PROJECT

CALIFORNIA LOCATION

Manufacturer of carrier telephone and microwave equipment offers permanent position for project engineer, minimum five years' developmental engineering experience, including some supervisory background. B.S.E.E. required. Optimum in living and working conditions near San Francisco. Salary open. Send resume of education and experience to Employment Manager:

LENKURT ELECTRIC CO., INC.
1105 County Road
San Carlos, California

CONVAIR POMONA offers ENGINEERING OPPORTUNITIES

- ELECTRONICS
- DYNAMICS
- AERODYNAMICS
- THERMODYNAMICS

Guided Missiles



Employment Dept.
1675 West 5th St.
P. O. Box 1011, Pomona, Calif.



CONVAIR
A DIVISION OF
GENERAL DYNAMICS
CORPORATION
(POMONA)

FOR ENGINEERS

with heads in the clouds

Chances are the men we seek are not looking for just a job . . . they already have that along with a satisfactory income. Yet these men are not happy . . . their vision clouded with lack of opportunity . . . their creative effort diverted into detail and frustrations.

To engineers and scientists with significant professional potential Farnsworth offers a future limited only by their own initiative . . . facilities, equipment and operational procedures designed to fit their special needs . . . living conditions in a community famed as America's happiest city . . . working with associates and problems that inspire creative accomplishment in these fields: Pulse Circuitry, Antennas, Information Theory, Receivers, Data Recording, Microwaves, Radar, Electronic Countermeasures, Missile Guidance and Control, Systems Test Equipment.

*but who have
their feet
on the ground*

Farnsworth 

Address Inquiries to

FARNSWORTH ELECTRONICS CO.,
Fort Wayne, Indiana

ENGINEERS • SCIENTISTS

Radio

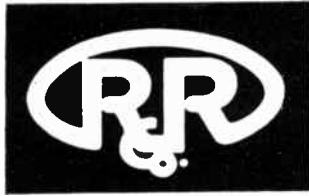

Receptor

once again opens new careers for men of high professional caliber. An organization owned, operated and managed by engineers offers job variety, high pay and unusual opportunities for rapid professional growth.

THERMATRON DIVISION

Dielectric heat sealers for plastic and woodweld industries.

- **ELECTRICAL ENGINEERS**

Circuit design: new applications.

ENGINEERING PRODUCTS DIVISION

Research and development in microwave and radar fields, pursuant to long-term contracts.

- **ELECTRONIC ENGINEERS**

At all experience levels. For circuit design and development.

SEMI-CONDUCTOR DIVISION

Transistors and diodes: research, development applications and production.

- **PHYSICISTS**

For semi-conductor research.

- **CHEMICAL ENGINEERS**

For production process development.

- **ELECTRONIC ENGINEERS**

For transistor circuit applications.

- **MECHANICAL ENGINEERS**

For research in electronic device encapsulation.

- **AUTOMATIC MACHINE DESIGNERS**

For transistor production machinery.

Send resume to: Mr. Stanley Winston, Personnel Manager

Radio Receptor Company, Inc.

240 WYTHE AVENUE BROOKLYN 11, N.Y.

CAREER OPPORTUNITIES for MICROWAVE ENGINEERS and PHYSICISTS

Capable of engaging in and directing both theoretical and experimental studies related to the propagation of electromagnetic fields through dielectric and semiconducting materials. Two to five years experience in either antenna design, radome design, microwave circuit design or associated fields is essential. In addition, a knowledge of advanced electromagnetic field theory, electrical characteristics of materials or the techniques of microwave measurements would be highly desirable.

Service facilities include digital and nonlinear computation laboratories, technician service, pattern shop facilities, modern antenna test facilities, excellent library as well as other specialized services.

Send resume or request application from: C. G. Jones, Mgr., Salary Personnel

THE GOODYEAR AIRCRAFT CORPORATION

AKRON 15, OHIO

What to See at the Radio Engineering Show

(Continued from page 312A)

SENSITIVE RESEARCH INSTRUMENT CORPORATION

MOUNT VERNON, N.Y.

BOOTH 278

- PRECISION ELECTRICAL MEASURING INSTRUMENTS
- LABORATORY STANDARDS & SUB STANDARDS
- Instruments Ave. .25 of 1% and .5 of 1% PANEL INSTRUMENTS
- PEAK AND RMS READING ELECTROSTATIC VOLT-METERS
- UNIVERSAL MAGNETIC MEASURING TEST SET

Service Magazine, 892 Audio Ave.
See Bryan Davis Publishing Co.

Servo Corp. of America 203, 300 Production Rd.

Direction Finders,
Communications,
Servo Test Equipment, *Radar Recording



Servomechanisms, Inc., 740, 724 Airborne Ave.

Servo Amplifiers, Power Supplies, Servo Motors, Mechanical Development Apparatus, Pressure Transducers, Positioning Mechanism, Film Potentiometers, Magnetic Amplifiers, Relative Wind Transducers, Accelerometers, Analog Computers, Air Data Computation, Mach Computers, 60 to 400 cycle plug-in Components and Systems.

Servo-Tek Products Co., Inc., 816 Audio Ave.

*"200" series of electronic adjustable speed drives, velocity servos, miniature dc motors and tachometer generators. Also electronic relays and constant reference voltage supplies.

Sessions Clock Co., 510, 512 Components Ave.

*Clock Timers for TV—Sing-I-Knob all-features clock timers—Radio and Blanket timers—Low-Priced 24-hour alarm timers—Industrial Timing Motors.

Shakeproof, Division of Illinois Tool Works, 739 Airborne Ave.

How SHAKEPROOF fastenings cut production costs and speed assembly—demonstration of plastic fasteners, special fasteners for TV and radio, automatic power screw drivers, standard SHAKEPROOF products.

Shallcross Mfg. Co.

559, 561 Components Ave.

Resistors: Precision Wirewound, Encapsulated, Ceramic Power; Boro-Carbon, Miniature Precision Power Switches; Rotary Selector; Multi-Deck rotary, Push-Button Instruments, Delay Lines, Attenuators.

*Indicates new product

(Continued on page 316A)

Show Hours: Monday 10 AM-10 PM
Tuesday 10 AM-10 PM
Wednesday 10 AM- 5 PM
Thursday 10 AM-10 PM

Electrical Engineers and Physicists

- Radar Simulation
- Advanced Circuitry
- Analog Computers
- Ballistics
- Mapping
- Telemetering

Senior and Junior Engineers

Monotony Unknown . . .

Here is your opportunity to join with an organization where your skill will be utilized in association with an entire project, not just a segment of a job. We are small but growing . . . we offer you the opportunity to grow and advance with us. Gain individual recognition by working closely with technical management. Associate with other top-notch engineers . . . live and work in suburban surroundings, just 8 miles from metropolitan Baltimore. If you are interested in an organization where monotony is unknown . . . write:

Industrial Research Laboratories

Division of Aeronca Manufacturing Corp.
Dept. B-3, Hilltop & Frederick Rds.
Baltimore 28, Maryland

DESIGN ENGINEER

Excellent opportunity available for Design Engineer in the field of Magnetic Materials. Electrical Engineering degree and two or more years' experience in permanent magnet design work desirable. Equivalent experience in electromagnet or electric machine design may be satisfactory.

The company is a growing organization well known for specialization in the manufacture of all types of magnetic materials. Electrical and Metallurgical Laboratories are exceptionally well equipped with modern apparatus and testing devices.

Midwestern location (70 miles from Chicago), salary open.

For interview during the I.R.E. Show, call Mr. D. P. O'Brien at the New York Office, Empire State Building, Oxford 5-1685 . . . or

Send full background
and experience data to

Mr. Charles S. Brand
THE ARNOLD ENGINEERING CO.
Marengo, Illinois



Increasingly important to the guided missile program at Bell Aircraft, the development and broadened application of these and allied devices offers an opportunity and challenge to:

ELECTRONIC DEVELOPMENT ENGINEERS

including specialists in magnetic amplifiers, transistor circuits and airborne digital computer techniques to design and develop electronic components such as precise integrators, accelerometers, computers, feedback amplifiers, and instrument servos for use in inertial guidance.

SERVO SYSTEM ENGINEER

Analyze, design and develop complete systems for inertial guidance, with the help of a team of specialists.

SERVO VALVE DEVELOPMENT ENGINEERS

Design and develop high performance servo valves for autopilots in special aircraft, helicopters, and missiles.

To qualified personnel, these positions are well worth investigating.

Get complete facts by writing (or sending resumé) to:

Manager, Engineering Personnel

BELL

Aircraft CORPORATION

P. O. BOX ONE • BUFFALO 5, N. Y.

THERE WILL BE A REPRESENTATIVE AT THE IRE SHOW

Electronic Engineers

A NEW CHALLENGING HORIZON!



Unusual opportunities for professional development and recognition

Sperry, a pioneer in many fields for 43 years takes another forward step in its consistent growth and expansion. You are invited to investigate these new openings.

Over 1500 employees have been associated with Sperry for more than 15 years . . . ample evidence of opportunity, good salaries, excellent benefits and fine working conditions that make for a bright future.

Digital Computer Engineers—Positions require familiarity with Digital to analogue data converters, Pulse circuits, Logical design, Sampled data system studies, Memory devices.

Electronic Engineers and Physicists—Interesting, Non-routine assignments in the fields of Radars, Missile test equipment, Microwave ferrites, Solid state devices, U.H.F. receivers and transmitters, Klystron and traveling wave tubes.

Interviews can be arranged on Saturday at our plant and may be arranged in your city.

SPERRY GYROSCOPE CO.

DIVISION OF THE SPERRY CORP.

Great Neck, Long Island, New York

- RELOCATION ALLOWANCES
- LIBERAL EMPLOYEE BENEFITS
- ADEQUATE HOUSING IN BEAUTIFUL SUBURBAN COUNTRY TYPE AREA
- TUITION REFUND PROGRAM (9 graduate schools in area of plant)
- MODERN PLANT WITH LATEST TECHNICAL FACILITIES
- ASSOCIATION WITH OUTSTANDING PROFESSIONAL PERSONNEL



ELECTRONICS DESIGNERS

System • Circuit • Receiver • Microwave

AIRCRAFT ARMAMENTS' radar, fire control and associated weapons system development engineering program continues to provide attractive opportunities for individuals of excellent training and experience as CIRCUIT, MICROWAVE, RECEIVER or SYSTEMS DESIGNERS.

AIRCRAFT ARMAMENTS' program and its design engineering approach require men who can accept responsibility and work with a high degree of independence from conception to completion of assignments at both the major component and project level.

AIRCRAFT ARMAMENTS, INC., is particularly interested in able young men who are now ready for difficult design assignments not presently available to them. Address complete background and interest data to

D. J. WISHART
Director of Personnel



P.O. BOX 126
COCKEYSVILLE, MARYLAND

ELECTRONIC ENGINEERS

For Research & Development in . . .

RADIO SYSTEMS

ANTENNA SYSTEMS

Interesting, challenging, and varied assignments on advanced industrial and military projects with a Western applied research organization. Association with an outstanding professional research staff, working under conditions favorable for individual accomplishment.

Please send resume to

Personnel Department
STANFORD RESEARCH INSTITUTE
Palo Alto, California

New York interviews may be arranged during IRE convention.

What to See at the Radio Engineering Show

(Continued from page 314A)

Shasta Division Beckman Instruments, Inc.

750 Airborne Ave.

*Expanded Scale Voltmeters & frequency Meters; *Log-Scale AC-VTVM; *Audio Oscillator; *Impedance Bridge, plus resistance bridges, WWV Receivers, Wide Band Amplifiers, Power Supplies.

SHIELDING, INC.



Booths 894-895 BROADCAST WAY

SHIELDING, INC., RIVERSIDE, N.J.

Phone: HOBART 2-1202

*Indicates new product

(Continued on page 319A)

Follow the yellow lights to the industry's newest exhibitors in Kingsbridge Palace. Ride to the parking areas FREE

ENGINEERS •

ELECTRICAL AND ELECTRONIC

Creative, imaginative men to work in the forefront of the fabulous electronics world (substantial laboratory work) . . . with a science leader since 1891. Additionally, consider the advantages of suburban living in the rolling hills of Connecticut . . . the ideal environment for the whole family.

ELECTRICAL & ELECTRONIC:

Coordination and production on the manufacture of high frequency radar altimeters. 500 to 1000 megacycles. Require E.E. degree or equivalent in the field.

ELECTRICAL:

Must be experienced in the design of switching circuits for AF-RF-UHF or airborne electronic equipment.

Analysis of audio and/or radio UHF circuits.

Please forward complete resume to:
MR. NORMAN L. MARKEL

THE GRAY MFG. CO.

(Creators of Pay Station Telephone)
16 Arbor Street, Hartford, Conn.

ENGINEERS

The APPLIED PHYSICS LABORATORY OF THE JOHNS HOPKINS UNIVERSITY offers an exceptional opportunity for professional advancement in a well-established laboratory with a reputation for the encouragement of individual responsibility and self-direction. Our program of

GUIDED MISSILE
RESEARCH AND
DEVELOPMENT

provides such an opportunity for men qualified in:

ELECTRONIC CIRCUIT DESIGN AND ANALYSIS
DEVELOPMENT AND APPLICATION OF TRANSISTOR CIRCUITRY
SERVOMECHANISMS AND CONTROL SYSTEM ANALYSIS
ELECTRONIC EQUIPMENT PACKAGING
INSTRUMENT DESIGN
MISSILE SYSTEMS DEVELOPMENT
FLIGHT TESTING

Please send your resume to

Glover B. Mayfield

APPLIED PHYSICS LABORATORY
THE JOHNS HOPKINS UNIVERSITY
8621 Georgia Avenue
Silver Spring, Maryland

ELECTRONIC ENGINEERS

Research & Development
Physicists—Engineers
(SENIORS)

Experienced in research and development of various radar systems including: beacons, missile guidance and counter measures. Advanced training in applied mathematics, noise theory and probability analysis desirable. EE degree or equivalent required.

FIELD ENGINEERS (Seniors)

Local & Field Assignments

Must have EE degree, with 3-5 years experience in one of the following:

- Flight Simulators
- Radar & Sonar Trainers
- Fire Control Radar
- Electronic installation and maintenance

● EQUIPMENT ENGINEERS

3-5 years experience with at least 3 years in circuit packaging. EE degree with mechanical background.

● APPLICATION ENGINEERS

5-10 years experience on coil and transformer development.

Salary and advancement commensurate with ability; liberal vacation, sick leave 9 paid holidays, group life, sickness and accident insurance plans, and a worthwhile pension system.

STAVID
Engineering, Inc.

Personnel Office, 312 Park Avenue
Plainfield, N.J.—Plainfield 6-4806



"MR. GCA RADAR" also holds prime contracts in highly diversified electronics fields

RESULT: Important, permanent career opportunities for electronics engineers.

Gilfillan has been so closely associated with GCA radar since its inception that the two names are practically synonymous.

Less well known is the fact that Gilfillan holds prime long-range research and development contracts in many electronics fields. This is due to the Gilfillan ability to approach a whole problem and arrive at a whole solution, as was so clearly demonstrated by their development of GCA Radar.

One that can now be announced is Gilfillan's prime contract for the guidance system of the Army's "Corporal." Others concern more advanced systems for the missiles of tomorrow. Still other classified projects deal with advanced and unsolved techniques for all branches of the military services.

This adds up to unusually advantageous career opportunities for electronics engineers. More details about this pioneer and progressive firm can convince you that your place in the sun is with Gilfillan.

WRITE: R. E. Bell, Gilfillan Bros.,
Dept. 35, 1815 Venice Blvd.,
Los Angeles, Calif.
Personal interview will
be arranged at a location
convenient for you.



ENGINEERS

Electronics

Systems

Electromechanical

Analogue

Computer

Environmental

Test

Senior

Microwave Research

To those engineers who prefer a variety of assignments on interesting, long-range projects, General Precision Laboratory offers an exceptional opportunity.

This growing research laboratory combines the challenge of exploring new fields with the stability afforded by a large and diversified parent organization—General Precision Equipment Corporation.

The location in New York's well-known Westchester County provides an ideal living and working environment—beautiful surroundings, high standard of living, and just one hour from New York City with its many cultural and educational facilities.

Men with interests in the above and related fields should submit resumes to Mr. H. F. Ware. Expenses will be paid for qualified applicants who come for interviews. We regret we can consider only U. S. citizens.

I.R.E. MEMBERS ATTENDING THE CONVENTION—
FOR FURTHER CAREER INFORMATION,
SEE OUR REPRESENTATIVES AT THE WALDORF
MARCH 20 THROUGH 24

GENERAL PRECISION LABORATORY INCORPORATED

A Subsidiary of General Precision Equipment Corporation
63 Bedford Road Pleasantville, New York

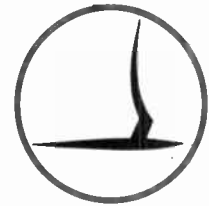

ELECTRONIC ENGINEERS

You can work in the stimulating atmosphere of an applied research and development laboratory where ideas are important, initiative is encouraged and associates are competent. The project areas listed below are typical of our extensive electronics interest; a complete list would include almost every branch of modern electronics. We are interested in men of all levels with sound training, imagination and potential, regardless of their specialty.

Communications

Dynamic Control Systems

Aircraft Instrumentation

Radar

Computers

Electrical Measurements

Varied Electronic Circuits

Servo-Mechanisms

Missile Guidance

Microwave

ENGINEER WRITER

Must be a competent Electronics Engineer with an avocation for technical writing. Writing will include specifications, test procedures, operating procedures and reports.

If you are interested in working at your maximum professional level in an organization that combines the most desirable elements of academic and industrial research and development, we invite you to communicate with our Employment Manager.

B.S. degree and experience required; advanced degree with experience to back it up is even better.

Hospitalization, surgery; group life, sickness, accident and retirement insurance is available with most of the cost paid by the Laboratory. Salaries are comparable with industry. Merit reviews occur semi-yearly assuring recognition of work well done and expediting advancement. Other personnel policies are very liberal, such as our self-sponsored internal research program. Graduate study at University of Buffalo is encouraged through generous tuition refund program.

CORNELL AERONAUTICAL LABORATORY

Buffalo 21, New York
wholly owned by Cornell University

EDGERTON

GERMESHUSEN

and GRIER, INC.

... offers excellent opportunities to Senior ELECTRONIC ENGINEERS who have a background of design and development of test equipment, including experience in pulse techniques. Junior Engineers who have skills in this field are also required to assist in our long-range program.

SENIOR TUBE ENGINEER ... fine opportunity for a man who has the proper background in the development of Special Tubes.

Edgerton, Germeshausen and Grier is a steady-growth company firmly established in the instrumentation field working closely with the A.E.C. Our plants are located in Boston, Massachusetts and Las Vegas, Nevada.

Send resume to or contact Personnel Manager
160 Brookline Avenue, Boston 15, Massachusetts.

What to See at the Radio Engineering Show

(Continued from page 316A)

Sierra

711 AIRBORNE AVE.

Sierra Electronic Corporation
1050 Brittan Ave. • San Carlos 2, Calif.

Sigma Instruments, Inc., 636, 638 Circuits Ave.

Exhibiting: Sensitive Relays—High speed telegraph, midjet polar for missiles, 25 ampere contactor 2.5 ma coil, 130 per second step-motor, 8000 per minute counter.

Simpson Electric Company

448 Electronic Ave.

Testers: *Varidot Generator. *Oscilloscopes. *Therm-O-Meter. *Field Strength Meters. *Tube Testers. Panel Instruments: *5-1/2" Modernistic. Meter Movements: *Simpson-Greibach. *Core Magnet.

* Indicates new product

(Continued on page 320A)

ELECTRONICS SALES ENGINEER 25-35

CALIFORNIA LOCATION

Manufacturer of carrier telephone and microwave equipment has immediate opening for graduate engineer with minimum two years experience in radio multiplexing or telephone carrier engineering. Some travel. Salary open. Excellent opportunity. Send resume of education and experience to Employment Manager:

LENKURT ELECTRIC CO., INC.
1105 County Road
San Carlos, California

WANTED

Design and Process Engineers for Aeronautical Controls

Honeywell's Aeronautical Division is expanding—creating new and unusual opportunities for trained engineers with the world's largest control manufacturer. Honeywell Aero specializes in four vital areas of air-borne control systems:

1. Autopilots and Dampers—Honeywell Aero has built more autopilots than any other company. Has autopilots and damper equipment on the latest supersonic aircraft.

2. Air-borne Instrumentation—Honeywell Aero is the largest manufacturer of electronic fuel gage systems—now on more than 80 different types of military aircraft—plus every type of commercial transport in production. Other instruments include: pressure ratio indicators, exhaust gas temperature indicators, thermistor level switches and accelerometers.

3. Precision Gyros—Honeywell Aero is first in floated gyros—makes the world's most accurate gyro. Also manufactures a complete line of precision rate, vertical and cageable gyros, plus actuators and amplifiers for servo systems.

4. Engine Controls—As the leader in piston aircraft controls: turbo regulator systems and remote throttle controls—Honeywell Aero is now designing electro-mechanical and hydraulic jet engine control systems.

Positions Open

Design Engineers — Gyros—New concepts in gyro design now in our research group require new design teams to develop and produce. Excellent opportunities for engineers with experience in design of gyros, accelerometers, magnetic pickoffs, spin motors and other electro-mechanical devices.

System Engineers — Autopilot—Additional flight control projects offer design and supervisory opportunities for experienced analysts and designers on components such as mach sensors, altitude controllers, hydraulic servos, velocity generators and for complete autopilot systems.

Instrumentation Engineers—New commitments require additional experienced designers for transistorized fuel gages, thermistor switches, pressure ratio indicators and exhaust gas temperature indicators.

Process Engineers—Additional process engineers are needed to devise methods, processes and assembly techniques for economical mass production for components and systems mentioned above.

Call Mr. C. A. Koepke, our Engineering Placement Manager, at the Belmont Plaza Hotel, New York, March 21-24. Or write Mr. C. A. Koepke, Honeywell, Dept. IR-3-44, Minneapolis 8, Minnesota.

MINNEAPOLIS Honeywell

Aeronautical Division





YOUR CALLING CARD FOR A BRILLIANT FUTURE...

Bendix Missile Section is a major contractor in the U. S. Navy's guided missile program - a part of the "new look" in our defense plan. Our expanding program has many opportunities for senior engineering personnel: Electronics Engineers, Dynamicists, Servo-Analysts, Stress Analysts, Project Coordinators, and Designers. Take time now to look into the opportunities which Bendix can offer you. Write Employment Dept. M, 401 Bendix Drive, South Bend, Indiana.

DU MONT Instrument Division

needs additional high calibre
engineers for

Electronic Instrumentation
Missile Work
Test Equipment
Timing and Pulse Circuits
Video Circuits
Electro-Mechanical Devices
Recording Systems

for both commercial
and government output

Contact
Mr. George A. Kaye
Employment Manager

**ALLEN B. DU MONT
LABORATORIES, INC.**

35 Market Street
East Paterson, New Jersey

ENGINEERS

MICROWAVE

Development of microwave instru-
ments & test equipment

ELECTRONIC

Development of electronic instru-
ments

Precision instrument manufacturer
requires men with good academic
& practical background. At least
2-3 years design & development
experience required. Should ex-
hibit qualities of leadership, with
the ability to meet & deal with
people. Men who fill the bill will
be substantially compensated.

**POLYTECHNIC
RESEARCH &
DEVELOPMENT CO., INC.**
202 Tillary St.
Brooklyn 1, New York

What to See at the Radio Engineering Show

(Continued from page 319A)

**Herman H. Smith, Inc., 578 Components
Ave.**

Vibrex Expanding Panel Fasteners—A radical-
ly new device which combines a fastening and
a shock and vibration absorption in one
fastener. Phone tip and banana plug with
molded plastic handles and various types
phone tip banana jacks.

Sola Electric Co.

537, 539 Components Ave.

*Voltage regulated DC power sup-
plies; regulated, adjustable AC vol-
tage supplies; constant voltage trans-
formers; regulated plate-filament
power transformers; voltage-sensitive
controls, and related products.

Sorensen & Co., Inc.

646 Circuits Ave.

AC Line Regulators, electronic; AC Mag-
netic Voltage Regulators*; Regulated DC
High Current Sources and B-Supplies; Tube-
less AC and DC Sources*; Electronic Fre-
quency Changers, 0.01% accuracy; High Pre-
cision AC Regulators and DC Power Sources.

Southco Division, 93 Palace

*Standard fully retractable screw fasteners for
removable panels and doors. Complete line of
door and panel fasteners and hammer-driven
blind rivets.

**Southern Electronics
Company**

509 Components Ave.

Ultra high precision polystyrene ca-
pacitors and RC filters to 0.1% toler-
ance. Adjustable polystyrene capaci-
tors. "MYLAR" capacitors to 1%
tolerance smallest case sizes.

**Southwestern Industrial
Electronics Co.**

213, 215 Instruments Ave.

The SIE line of electronic laboratory test in-
struments will include new recording equip-
ment, oscillators, resistance meters, dc am-
plifiers, and comparison bridges, in addition
to the famous Model R-1 Voltmeter and
hermetically sealed transformers.

**Spaulding Fibre Company, Inc., 42 Pal-
ace**

Spauldite Laminated Thermosetting Plastics
including High Insulation Resistant and
Flame Retardant Grades.* Copperclad materi-
als for Printed Circuits. Vulcanized Fibre.
Spauldo, Fibre Board insulation. Fabricated
parts.

*Indicates new product

(Continued on page 323A)

Developers
of the
Corporal
Guided
Missile.

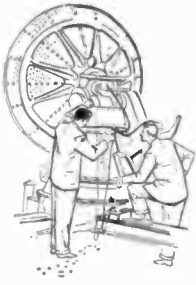

JET PROPULSION LABORATORY

CALIFORNIA
INSTITUTE OF
TECHNOLOGY

*Active in all phases
of electronics and physics
related to guided missiles
and jet propulsion.*

The nation's foremost guided-missile research and development facility, established in 1940, offers exceptional opportunity for engineers and research scientists in the fields of guidance and control, information theory, computers, electro-mechanical devices, instrumentation, and related aspects of electronic research. The Laboratory offers an ideal blend of academic and industrial environments and maintains a high level of technical competence. Attractive salaries are offered.

*A brochure describing
opportunities and activities
at the Laboratory will be
sent upon request.*

JET PROPULSION LABORATORY



California Institute of Technology
4800 OAK GROVE DR.,
PASADENA 3, CALIFORNIA

Electronic Data Processing Systems For BUSINESS...

Provide an exciting new challenge for those with ingenuity and analytic ability. **ENGINEERS, PHYSICISTS, MATHEMATICIANS** and **PROGRAMMERS** now have the opportunity to participate in the growth of a great new industry. Positions are open in research, development and application of:

**MAGNETIC CIRCUITS
SEMI-CONDUCTOR
APPLICATIONS
VACUUM TUBE CIRCUITS
LOGICAL TECHNIQUES
SYSTEM DESIGN
PRODUCT DEVELOPMENT
COMPUTER APPLICATIONS
SYSTEMS ANALYSIS**

Personnel with ability in the above or allied fields are invited to submit a resume or write for an application. Recent and prospective college graduates with high scholastic standing are also invited to apply. Training will be given at full pay. Liberal company benefits and advancement on merit are offered to those who would like to work and play in sunny Southern California.

National

WRITE TO DIRECTOR OF PERSONNEL

The National Cash Register Company
ELECTRONICS DIVISION

3348 WEST EL SEGUNDO BOULEVARD * HAWTHORNE, CALIFORNIA

*TRADE MARK REG. U.S. PAT. OFF.

ELECTRONIC ENGINEERS PHYSICISTS MATHEMATICIANS

Permanent positions in the Vitro Laboratories for career-minded men providing challenging assignments in:

**Systems Studies Design
& Evaluation
Equipment Development
Circuit Analysis**

in the fields of
**Underwater Techniques
Guided Missiles
Test Facilities
Data Processing
Instrumentation
Ballistics
Optics**

● For personal interview, contact our representatives at the Waldorf Astoria Hotel during the IRE Convention, March 20 to 24.

● Direct Transportation will be available for qualified applicants to visit the West Orange Laboratory.

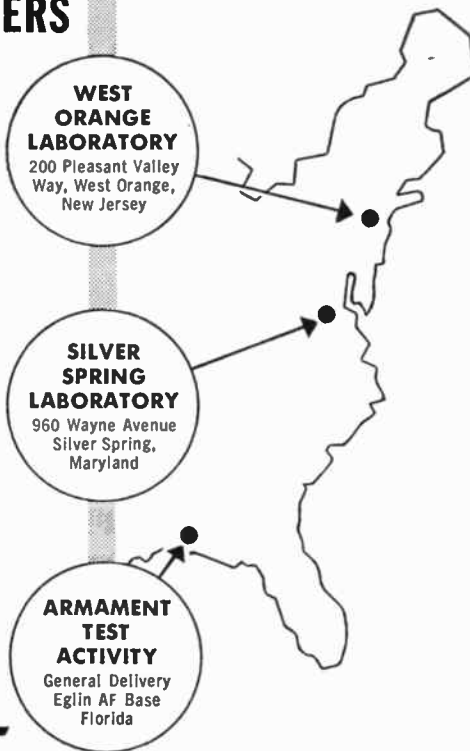

Vitro LABORATORIES
DIVISION OF VITRO CORPORATION OF AMERICA

ELECTRONICS ENGINEERS

TO COMPLETE OUR STAFF

We need men with theoretical knowledge or practical experience in:

- Airborne and ground communications.
- Airborne electronic camera.
- Test Equipment.
- Electronic countermeasures equipment.
- Active and passive radar.
- Direction finders.
- Electronic scalars.
- Infra red detection equipment.
- Manufacturing equipment.
- Antennas and accessories.
- Television equipment.
- Telephone equipment.
- Teletypewriter equipment.

Good steady employment in a firm that is gaining increased recognition in the technical publishing field. You will find it worth the time to check into this very substantial opportunity. If unable to have personal interview, send for our pamphlet "Our Service to Industry."

CONTACT MR. ARTHUR PEARDON
Manager
PHONE LASSEL 7-0987
BOSTON, MASS.

CONTACT M. HUBERT KING,
Chief Engineer
PHONE ST. CHARLES 5510

NTE
NELSON
TECHNICAL ENTERPRISES, INC.
ST. CHARLES, ILLINOIS

electronic engineers applied physicists

wanted to work in basic research and development for commercial and military applications. You will find unusual opportunities for rapid advancement and professional growth as part of a team of recognized scientists and engineers.

*Positions at
all levels available
for work in:*

- Advance pulse circuits
- Digital system testing
- Magnetic core techniques
- Data conversion systems
- Electronic packaging
- Logical design
- Semi-conductor circuits
- Materials research

*For personal interview,
send resume to*

MAGNAVOX RESEARCH LABORATORIES*
2255 South Carmelina Avenue, Los Angeles 64, Calif.

*A DIVISION OF THE MAGNAVOX COMPANY

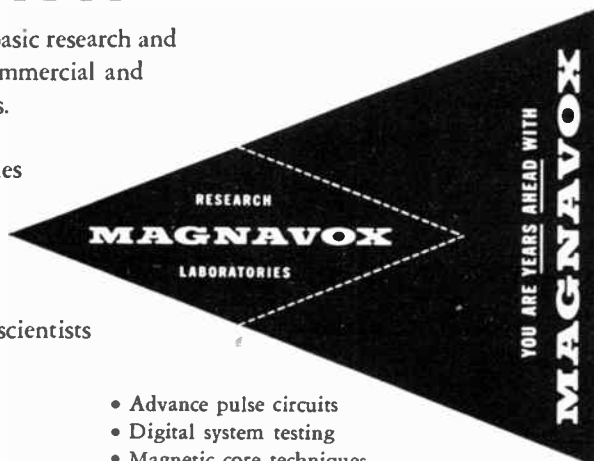

What to See at the Radio Engineering Show

(Continued from page 320A)

Specific Products

814 Audio Ave.

Manufacturers of WWVR Re-
ceivers and Speed-Chassis.

Spencer-Kennedy Labs., Inc., 257, 259
Instruments Ave.

New square wave generator and high speed
oscilloscope as well as Continuous Variable
filters. Wide band amplifiers. Pulse and square
generators and a Community television system.

Sperry Gyroscope Company

351, 353 Microwave Ave.

Klystron tubes and microline
test equipment.

(Continued on page 326A)

ELECTRONIC ENGINEERS

**ADVANCE YOUR CAREER
WITH A LEADER IN
WESTERN ELECTRONICS**

An expanding program of:

- research
- development
- production
- specialized military
equipment
- advanced commercial design
- real creative challenge

Special receivers and trans-
mitters, DF and DME, various
instruments and Transistor
applications—special devices.
Studies in noise, radar, minia-
turization and test equipment.
Relocating expenses, good in-
surance plan, central location,
steady advancement.

Send resume to L. D. Stearns
Engineering Employment Manager

Hoffman

LABORATORIES, INC.

(SUBSIDIARY OF HOFFMAN RADIO CORP.)

3761 S. HILL ST., LOS ANGELES,
CALIF.

Creative Engineering Opportunities with Republic

Dynamics

Senior Computing Engineer

Administrative and supervisory position with excellent op-
portunity in a rapidly expanding large-scale digital comput-
ing laboratory. Position involves important responsibility
where knowledge of computing equipment and methods must
be utilized for maximum efficiency of total operation. Com-
puting applications cover a wide range of complex technical
problems associated with supersonic aircraft, so that ability
to develop effective liaison with engineering personnel is
essential. Suitable experience in a computing installation on
a supervisory level is essential, along with sound mathematical
background.

Senior Mathematician

Outstanding opportunity for a person with real mathematical
ability. Here's your chance to build a firm professional back-
ground in Applied Mathematics by working with Engineers
in the Mathematical formulation of complex problems for
high speed digital computers. Dealing with the complex
problems associated with supersonic aircraft is a real pro-
fessional challenge and the person with outstanding ability
can earn rapid, solid advancement. An M.A. or Ph.D. in
mathematics is required and computing experience desirable
but not essential.

Research

Antenna Engineer

To conduct pattern studies, design prototype antennas and
supervise flight tests of new antenna installations. College
graduate in Physics, Math or E.E.

Electronic Instrumentation Engineer

Three to five years aircraft instrumentation experience re-
quired. Knowledge of transducers, amplifiers and recording
equipment used in experimental research testing of hi-speed
jet aircraft is essential. Knowledge of servo loop theory as
applied to aircraft systems coupled with ability to properly
instrument, record and analyze is desirable. Graduate with
E.E. degree preferred.

- Please address complete resume,
• outlining details of your
• technical background, to:
• **Mr. R. L. Bortner**
• Administrative Engineer



REPUBLIC AVIATION
FARMINGDALE, LONG ISLAND, NEW YORK

OPPORTUNITIES
FOR
GROWTH
IN
ELECTRONIC
INSTRUMENTATION
CLEVITE'S
NEW
RESEARCH
CENTER
A FAST-
GROWING
PERSONALIZED
ORGANIZATION

Industrial controls and automation
Magnetic recording and memory devices
Data processing systems
Feedback electronic devices
Transistor applications
Analog and digital computers

For interviews in New York
March 21-24, during the Annual Show
telephone
E. A. Gentry, Personnel Manager,
at Hotel Roosevelt;
or write for new brochure.

CLEVITE-BRUSH DEVELOPMENT CO.
Division of Clevite Corporation
540 East 105th St., Cleveland 8, Ohio

ELECTRONIC FIELD ENGINEERS

*An outstanding
opportunity awaits
you in our nation-
wide ELECTRONIC
COMPUTER and
DATA HANDLING
SYSTEMS program*

- **TRAINING** at our expense with full salary.
- **PERMANENT** installation assignment, perhaps in your own locality.
- **HOUSEHOLD** goods moved at our expense.
- **INSURANCE, PENSION** and other liberal employee benefits.
- **INTERVIEWS** arranged at our expense.

Send written résumé to:

REMINGTON RAND Inc.
ERA DIVISION
1902 W. Minnehaha
St. Paul W4, Minn.

SENIOR PROJECT ENGINEERS

●
Top leadership qualifications together with previous management level experience are necessary for these rare opportunities with American Machine & Foundry Company in our Greenwich, Connecticut location. These are growth opportunities with AMF, one of America's foremost companies in the field of automatic machinery and electronics. Ages 35 to 40.

M.S. in E.E.

10 years' experience in design and development of radar equipment; electrical and electronic equipment.

JUNIOR PROJECT ENGINEERS

We also require a number of engineers with:

B.S. in M.E. or E.E.

Ages 25 to 30; 3 to 5 years' experience. This experience should be in the same fields as required for ME's and EE's above.

Security clearance will be required.



Please forward complete resume to:

Mr. T. N. Hunsbedt

American Machine & Foundry Co.
261 Madison Ave., New York, N.Y.

A New Role for the ELECTRONIC ENGINEER

Pioneering in
Automatic Control

The automation of industrial processes, the elimination of tedious paper work, the safeguarding of human lives and creative energy through split-second sensing, thinking and deciding machines that act with intelligence and discretion are part of the second industrial revolution that is changing the life and work patterns of us all.

ECA's engineers are creating the automatic industrial controls, the electronic business machines, the digital and analog computers that are bringing this revolution into focus day by day. Until they can design a machine that can do it better, these engineers are encouraged to bend their best thoughts to this work in an atmosphere that allows for professional freedom, where there are open channels for the propagation of new ideas, where work executed with imagination is remembered, where there is opportunity to grow in the profession.

As one of the leaders in this change, ECA is daily stretching out into new fields, and enlarging its interest in old ones. Nevertheless, the corporation rests on a sound base of well-established commercial products, which provide the ECA engineer with stability, and assure him of compensation on a high industrial pay scale.

There are now a few positions open for electronic engineers with a good theoretical background and a few years' experience. Address all inquiries to: Mr. W. F. Davis, Dept. 706.



**ELECTRONICS CORPORATION
OF AMERICA**

77 Broadway
Cambridge 42, Mass.

...is this the kind of PERFORMANCE YOU NEED FROM RESISTORS

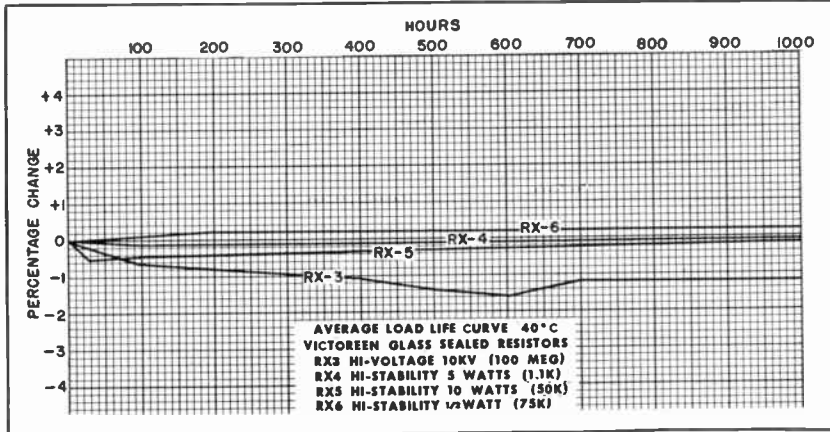

The performance of Victoreen glass sealed resistors as indicated by this 1000 hour life-test, surpasses all expectations. If this performance is almost unbelievable, we invite you to duplicate this test in your own laboratory. We will furnish samples.

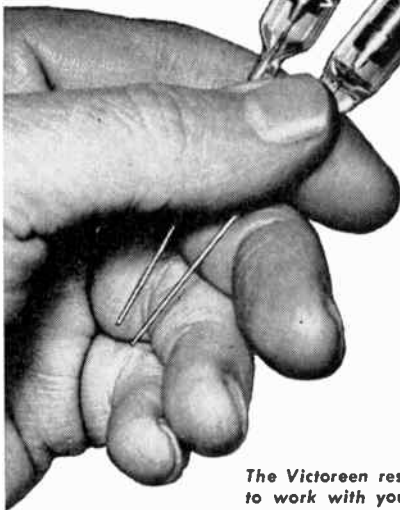

The new Victoreen developed carbon resistors, encapsulated in inert, gas-filled, glass tubes provide high wattage dissipation or high voltage capacity with unusually high stability and long life. The high performance standards of these new resistors make them especially desirable in avionic, sonic, radar, computer, television circuits and other applications where quality is important. Victoreen should be your first choice of resistors.

The Victoreen research staff are available to work with you on electronic problems.



The Victoreen Instrument Co.

COMPONENTS DIVISION: 3813 Perkins Ave., Cleveland 14, Ohio

What to See at the Radio Engineering Show

(Continued from page 323A)

Sprague Electric Co.

247, 249 Instruments Ave.

El. encapsulated and Metal-Encased, Hermetically-Sealed Component Assemblies—Magnetic Shift Registers—Pulse Transformers—125°C Subminiature Paper and Metallized Paper Capacitors — Telephone-Quality Electrolytic Capacitors—Power and Precision Wirewound Resistors—Film Resistors—Pulse Forming Networks—Interference Filters.

Standard Coil Products, 790 Airborne Ave.

See Kollsman Inst. Corp.

Standard Electric Time Co., 632 Circuits Ave.

Precision Electric Timers and Tachometers. Chrono-Tachometers. Strobe Check Tachometers.

Standard Piezo Company, 540 Components Ave.

Presents display of: Precision Quartz Crystals, Color TV Crystals, Electronic Frequency Control Devices, Cadmium Sulfide Photocells, Photo Electric Devices, Infra-Red Cells, Infra-Red Devices, Automatic Headlight Dimmers, Deflection Yokes, Special Audio and Power Transformers, Microwave Communication Systems.

Standard Pressed Steel Co., 115 Television Ave.

"Micro" socket screws, self-locking spring pins; also self-locking nuts, steel work benches, cabinets, shelving, and other shop equipment.

(Continued on page 328A)

KAY LAB

SAN DIEGO, CALIFORNIA

Electronics

for Communication,
Measurement, and Control

**Absolute DC Power
Supplies**

DC Decade Amplifiers

DC Microvoltmeters

Meter Calibrators

AC Decade Amplifiers

Micro-Mixers

Logarithmic Attenuator

**Industrial Television Systems
Broadcast Television Systems**

See these instruments at our
booths 261-263 at IRE Show

REPRESENTATIVES IN
ALL MAJOR CITIES

NEW Lowell CONSOLES



● OFFER

- custom-console efficiency!
- mass-production price!
- prompt delivery from stock!

Lowell designed consoles offer every advantage. Equipment is well protected and all controls may be located for maximum comfort and convenience of the operator. There is a Lowell console model for any budget because of low, mass-production prices.

Handsome Lowell consoles are made of 18 gauge steel with gray hammertone finish. Gray, heavy-duty linoleum top is an attractive feature that provides a comfortable, durable work surface. There are models especially designed for use in airports, broadcast studios, manufacturing plants, schools and similar applications.

Included are:

Small single turret console available with or without sliding drawers large enough for 16" transcription player. Designed for use in airports or broadcast studios. (See small illustration)

4 ft. console with single shelf area. Equipped to handle one to two turrets; includes sliding phono drawer. Ideal for schools of approximately 15 rooms. (See large illustration)

6 ft. console, with double shelf space in both right and left, for up to three turrets. Can serve schools of about 60 rooms.

Write for complete data to

HEARD EVERYWHERE
Lowell MANUFACTURING COMPANY

Manufacturer of famous Lowell "ear-level" sound speaker baffles, protective enclosures and intercom equipment.

3030 Laclede Station Rd., St. Louis 17, Mo., U.S.A.

In Canada: Atlas Radio Corp.,
560 King St., West, Toronto, Ontario

One-Half the Size of a Standard BNC!

ACTUAL
SIZE



NEW DAGE DM SERIES

COAXIAL CABLE CONNECTORS

- weatherproofed and sealed
- quick disconnect
- vibration proof
- mechanically rugged
- withstand extreme temperatures
- heavy silver plating
- can be adapted to any miniature cable
- requires no special tools for assembly
- all general types available

"BE SURE TO SEE DAGE DM SERIES,
BOOTH 719, THE IRE SHOW!"

DAGE

Phone • Write • Wire for samples and detailed information

DAGE ELECTRIC COMPANY, INC. • BEECH GROVE, INDIANA

a complete line of relays

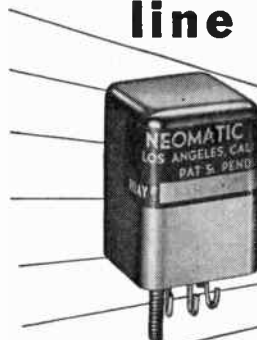

SUPER RUGGED

Vibration 10 G's—500 cps
MIL R 5757B

SUB-MINIATURE

½ cu. in.—½ oz.

HIGH CONTACT RATINGS

5 amp., 24VDC, 115 VAC
RESISTIVE

SENSITIVE
from .020 Watts

HI-TEMPERATURE
— 65° to 200° C.

FAST OPERATING

TIME DELAY

HERMETICALLY SEALED

ALL TO MIL R 5757B
SPECIFICATIONS

Manufacturer's of High Precision Sub-Miniature
Electro-Mechanical Devices

EARLY
DELIVERIES

ELGIN-NEOMATIC, INC.

A SUBSIDIARY OF ELGIN NATIONAL WATCH COMPANY
9010 BELLANCA AVE. • LOS ANGELES 45, CALIF. • OR 8-3814

What to See at the Radio Engineering Show

(Continued from page 326A)

Steel Company, Herman D., 836 Audio Ave.

Precision screw machine products, pinions, gears and components.

Stelma, Inc., 690 Circuits Ave.

*A portable telegraph distortion analyzer. Teletypewriter Regenerative Repeaters. Bias Test Sets. Receiver Carrier Telegraph. Electronic Ry Generator. Radio teletype telegraph monitor. Teletype communications equipment.

Sterling Transformer Corp., 99 Palace TRANSFORMERS AND CHOKES: Aircraft, Military and Industrial; Power, Audio, Filter Chokes. Class H molded and open transformers. Transistor & R-F transformers. Saturable Reactors. Custom Transformers.

Stevens Mfg. Co., Inc., 662 Circuits Ave.

Miniature Bimetal Thermostats—snap or positive acting—open or hermetically sealed for electronic and avionic circuits. Also thermostats for domestic and industrial appliances.

George Stevens Mfg. Co.

429, 431 Electronic Ave.

Complete line of coil winding equipment *featuring universal winder with adjustable width control and *external stator winder.

Stewart Stamping Co., 615 Circuits Ave.

Highspeed automatic metal stampings and wireformings for the electrical and electronic industry. Economic volume production methods. Automation our specialty.

Stokes Machine Company, F. J., 84 Palace

*TV dolly for aluminizing black and white and color tubes using new high-speed Stokes "Ring-Jet" pumps. *New Stokes "Ring-Jet" oil diffusion pumps.

FOR LATEST DEVELOPMENTS IN

CERAMIC PRODUCTS—Resistors, Titanates, Assemblies, Components; HERMETIC SEALS—Glass-to-Metal and Ceramic-to-Metal; PRINTED CIRCUITS; KOVAR Glass-sealing alloy; THERMISTORS . . .

Visit Booth 866, 868

Stupakoff

CERAMIC AND MANUFACTURING COMPANY
LATROBE, PENNSYLVANIA

Division of the CARBORUNDUM Company

Lackon

Dials • Panels • Scales
689 CIRCUITS AVE.

Sun Dial Corp., Caldwell, N. J.

*Indicates new product

(Continued on page 330A)

DON'T MISS SEEING Mullard



ULTRA SONIC SOLDERING EQUIPMENT

Solves Soldering Problems
without the Use of Flux

The new Mullard Ultrasonic Soldering Equipment is now a successful industrial tool, used in the tinning and soldering of metals such as: Aluminum, Germanium, Copper, Brass, Magnesium, Alclad Alloys, etc., without the use of flux!

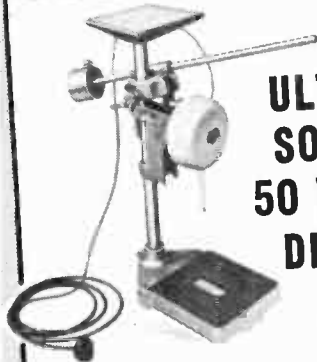

ULTRA SONIC 50 WATT DRILL

Working with a vertical reciprocating action, holes of any shape and complexity may be produced in hard and brittle materials such as glass, ceramics, germanium, tungsten and titanium carbides, diamond, synthetic gems, etc.



HIGH SPEED TUBE TESTER

Automatic operation with punched card circuit condition selection. Clear indication on Cathode Ray tube. Needs no skill or experience in use. Covers small transmitting tubes and 1500 additional receiving tubes of world manufacture.

An Interesting Display of
MULLARD Meteorological Radar Sonde & Wind
System, capable of allowing accurate measure-
ments at heights to 80,000 ft., will be shown in
Theatre #2—DON'T MISS THIS IMPORTANT
EXHIBIT!

Mullard



SPECIALIZED ELECTRONIC EQUIPMENT
Ultrasonic Equipment • Communications
Equipment • Electro-Chemical Apparatus
Measuring Instruments • Radar

PROCEEDINGS OF THE I.R.E. March, 1955

Mullard Tubes



HIGH STABILITY WITH THIS MINIATURE VOLTAGE REFERENCE TUBE



Another
FIRST
by Mullard!
85A2

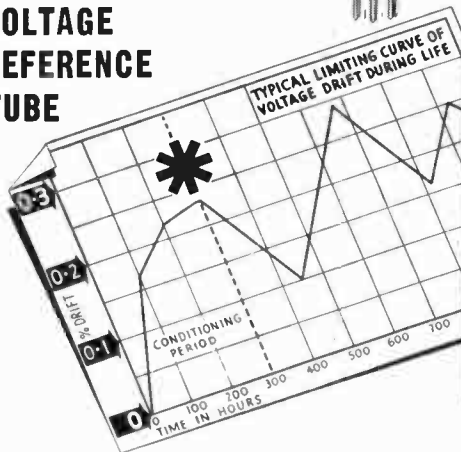

TUBE DATA	
Short-term stability	0.1%
Long-term stability	0.2%
Preferred quiescent current	6 mA
Nominal operating voltage	85 V
Operating current range	1 to 10 mA
Max. A.C. resistance	450 Ohms
Base	Small Button Miniature 7 pin.

FOR INDUSTRY AND

Makers of the IMAGE CONVERTER, World's Fastest Electronic Device for High Speed Photography.

- Voltage Reference and Stabilizer Tubes
- Photocells
- Decade Counter Tubes
- Cold Cathode Trigger Tubes
- Transistors
- Image Converter Tubes
- Electrometer Tubes
- Rectifiers
- High Fidelity Amplifier Tubes
- Receiving Tubes
- Special Purpose Tubes
- Communication VHF and UHF Tubes

COMMUNICATIONS

For details of tubes in the Mullard range write to:

INTERNATIONAL ELECTRONICS CORP.

81 SPRING STREET • NEW YORK 12, N. Y.
TELEPHONE: WOrth 6-0790

AT THE I.R.E. SHOW
Theatre No. 2
BOOTH 841

Complete MULLARD Line

MEASURE NOISE AND FIELD INTENSITY FROM 150 KC TO 1000 MC— WITH ONE METER!

Quickly • Accurately • Reliably

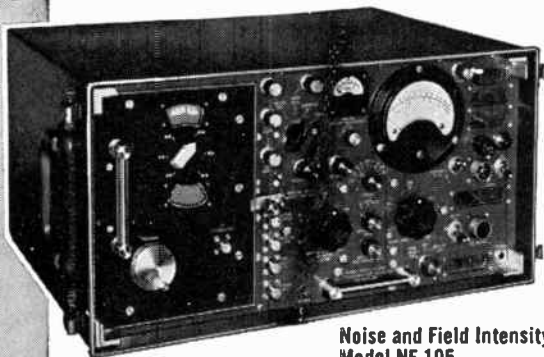

Noise and Field Intensity Meter
Model NF-105
(Commercial Equivalent of AN/URM-7)



TA/NF-105:
150 KC-20MC



T1/NF-105:
20-200MC



T3/NF-105:
400-1000MC



T2/NF-105:
200-400MC

Empire Devices Noise and Field Intensity Meter Model NF-105 permits measurements of RF interference and field intensity over the entire frequency range from 150 kilocycles to 1000 megacycles. It is merely necessary to select one of four individual plug-in tuning units, depending on the frequency range desired. Tuning units are readily interchangeable... can be used with all Empire Devices Noise and Field Intensity Meters Model NF-105 now in the field.

Each of the four separate tuning units employs at least one RF amplifier stage with tuned input. Calibration for noise measurements is easily accomplished by means of the built-in impulse noise calibrator. With this instrument costly repetition of components common to all frequency ranges is eliminated because only the tuners need be changed. The same components... indicating circuits, calibrators, RF attenuators, detectors and audio amplifier... are used at all times.

Noise and Field Intensity Meter Model NF-105 is accurate and versatile, it may be used for measuring field intensity, RF interference, or as an ultra-sensitive VTVM. A complete line of accessories is available.

Additional information and literature upon request

Visit us at 252 Instruments Avenue, at the I.R.E. Show

NEW YORK—Digby 9-1240 • SYRACUSE—SYracuse 2-6253 • PHILADELPHIA—
5Herwood 7-9080 • BOSTON—Walham 5-1955 • WASHINGTON, D. C.—DEcatur
2-8000 • DETROIT—BRoadway 3-2900 • CLEVELAND—Evergreen 2-4114
DAYTON—Fulton 8794 • CHICAGO—Columbus 1-1566 • DENVER—MAin 3-0343
FORT WORTH—WEBster 8811 • ALBUQUERQUE 5-9632 • LOS ANGELES—REpublic
2-8103 • CANADA: MONTREAL—UNiversity 6-5149 • TORONTO—WAlnut 4-1226
HALIFAX 4-6487 • EXPORT: NEW YORK—MURray Hill 2-3760

**EMPIRE DEVICES
PRODUCTS CORPORATION**

38-15 BELL BOULEVARD • BAYSIDE 61 • NEW YORK
manufacturers of

FIELD INTENSITY METERS • DISTORTION ANALYZERS • IMPULSE GENERATORS • COAXIAL ATTENUATORS • CRYSTAL MIXERS

What to See at the Radio Engineering Show

(Continued from page 328A)

Superior Electric Co., 101, 102, 103, 104
Television Ave. & Production Rd.
*Stabiline Automatic Voltage Regulator with
no moving parts—no tubes—A New method of
controlling light intensity of fluorescent lamps
and standard Powerstat Variable Transformers.
Stabiline Automatic Voltage Regulators, Vari-
cell DC Power Supplies, Voltbox AC Power
Supplies and Superior 5-way Binding Posts.

Superior Tube Company 825 Audio Ave.

See the new Catalogs. Also anodes, cathodes,
disc cathodes, plus fabricated tubular parts.
More than 1,000 samples in over 55 analyses
in tubing form ranging in size from .010" to
2½" in diameter.

Surprenant Mfg. Co. 729, 731 Airborne Ave.

Miniature Teflon Coaxial cables; Extruded
Teflon and Kel-F insulated wire, color coded
in solid colors or striped colors on white
background; Low temperature tubing and
jackets; High temperature hook-up wires;
wires for miniaturization; Complete range of
wires and cables for electronic and aircraft
industry; Many types of wires and cables with
broad temperature ranges and excellent elec-
trical properties, in standard construction or
custom engineered.

Sutton Publishing Co., Inc., 864 Audio Ave.

ELECTRONIC EQUIPMENT is a monthly
publication serving design-engineering and
technical personnel in electronic manufacturing
plants and industrial plants using electronic
equipment.

Swiss Jewel Company, 836 Audio Ave. Jewel Bearings—Sapphire Products.

Switchcraft, Inc. 435 Electronic Ave.

*"Tini-Plugs"; *"Tini-Jax"; *Multiple sta-
tion push button switches; Miniature audio
mixers; Adapters; Complete line telephone
jacks and plugs; Switches—lever, push but-
ton and lever action types; Multiple switch
assemblies; Cable assemblies.

*Indicates new product

(Continued on page 332A)

Visit
our
complete
display
Booth 388



TROUBLE-FREE
*low impedance**
MERCURY BATTERIES
for transistor circuits



**SEE
OUR
8
NEW
TRANSISTOR
BATTERIES**

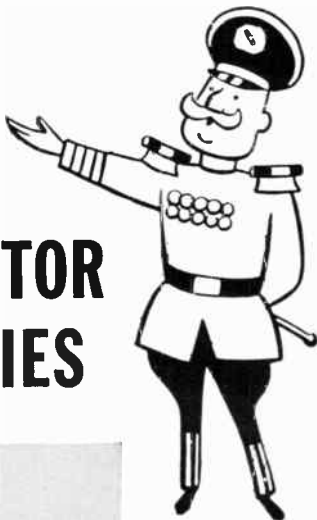

General gives you a choice of 8 batteries, four mercury, from the RG1 to the B-3, made with General's exclusive non-shorting surge weld process. Four sizes in carbon-zinc batteries round out the line. Here is a transistor power supply, versatile to meet almost any requirement, with proven performance.

*Internal impedance of General's RG1 varies only from 2.5 to 4 ohms throughout the service life of the battery.

MERCURY CELLS . . . No's RG1, 1.3 volts; B-1, 2.6 volts; B-2, 2.6 volts; B-3, 3.9 volts. Exclusive General construction prevents contamination of chemicals and shorting . . . provides full guaranteed shelf and service life. (RG1 guaranteed at full 1100 milliamp hours.)

"N" SERIES . . . No's. EP-671, 1.5 volts; EP-672, 3.0 volts; EP-673, 1.5 volts. These carbon-zinc, metal clad cells give over 50% of the service life of comparable mercury cells . . . cost less than one-half and weigh 20% less. (400 milliamp hour rating on drains of 5 to 6 M/A.)

EP-921 . . . This 1.5 volt cell gives outstanding performance in low-drain transistor service. (2000 milliamp hour rating on drains up to 6 M/A.)

**GENERAL
DRY BATTERIES, INCORPORATED**
13000 ATHENS AVENUE CLEVELAND 7, OHIO

Offices in Principal Cities

CURTIS
TERMINAL BLOCKS
for
EVERY PURPOSE
in Factory Assembled
and Kit Form
SEE THEM
BOOTH 644
Radio Engineering Show
Kingsbridge Armory
Bronx, New York
March 21-24

TYPE "FT" TYPE "FTS"
TYPE "BTH"
TYPE "H"
TYPE "BT"
TYPE "E"
TYPE "K"
TYPE "M" TYPE "MT"

CURTIS DEVELOPMENT & MFG. CO.
3234 North 33rd Street, Milwaukee 16, Wisconsin

What to See at the Radio Engineering Show

(Continued from page 330A)

Syncor Products Co., 85 Palace
Specialists in the fabrication of fused quartz
in a wide variety of sizes and shapes in
production and research for electricity, chem-
istry, and physics.

SYNTHANE
SYNTHANE CORPORATION
OAKS, PENNSYLVANIA
532 and 534 Components Ave.
Synthane laminated plastics. Sheets, rods,
tubes, and fabricated parts; molded-
laminated and molded-macerated parts.
Hundreds of samples demonstrate the
combined electrical, mechanical, physical
and chemical properties of Synthane.

Syntronic Instruments, Inc.
621 Circuits Ave.
Specialists in military or special
yokes and focus coils designed to
your specifications. Production yokes
for TV sets.

Syrkus & Guttman, Inc., 713 Airborne
Ave.
See Associated American Trading Div.

T.L.G. Electric Corp.,
58 Palace
Introducing our *Mark I Oscilloscope—the
only oscilloscope compositely-designed to
embody all the features wanted by engineers
—at the industry's lowest cost. Also on
display will be our Model C-04 Synchronoscope
which has received wide acceptance in the
field of high power pulse measurement.

Taylor Fibre Company, 675 Circuits Ave.
Electronic & Electrical Insulating Materials.
Vulcanized Fibre-Laminated Plastics—Colored
Polyester Glass Rod. Taylor also has facilities
for fabricating these materials to your speci-
fications.

Tech Laboratories, Inc.,
656 Circuits Ave.
*Vertical attenuators, R.F. at-
tenuators, *Switches, mobile
power supply, etc.

*Indicates new product

(Continued on page 334A)

IRE membership information:
Kingsbridge Armory—center of floor
Waldorf Astoria—Ballroom lobby.

WE CARRY IN STOCK ALL SIZES, ALL SHAPES, ALL ALNICO GRADES

When you
need them—
as you need them . . .

HIGH ENERGY, PRECISION
ALNICO PERMANENT **MAGNETS**

Experimental or
production
quantities

Catalog upon request

PERMAG
ENGINEERING
PRECISION CUTTING
PRECISION GRINDING
MAGNETIZING

24 HOUR DELIVERY

PERMAG CORP., 210 TAAFFE PLACE, BROOKLYN 5, N. Y. — Phone: MAin 2-0114

SUBMINIATURE TRANSFORMER



Field tested—used with transistors by leading
manufacturers in large quantities.

FRANK KESSLER CO.
41-45 47th St., Long Island City 4, N.Y.
Tel: Stillwell 4-0263

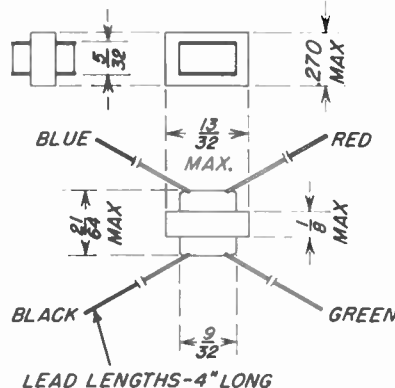

YOU FURNISH THE PRINT, WE'LL FURNISH THE PART

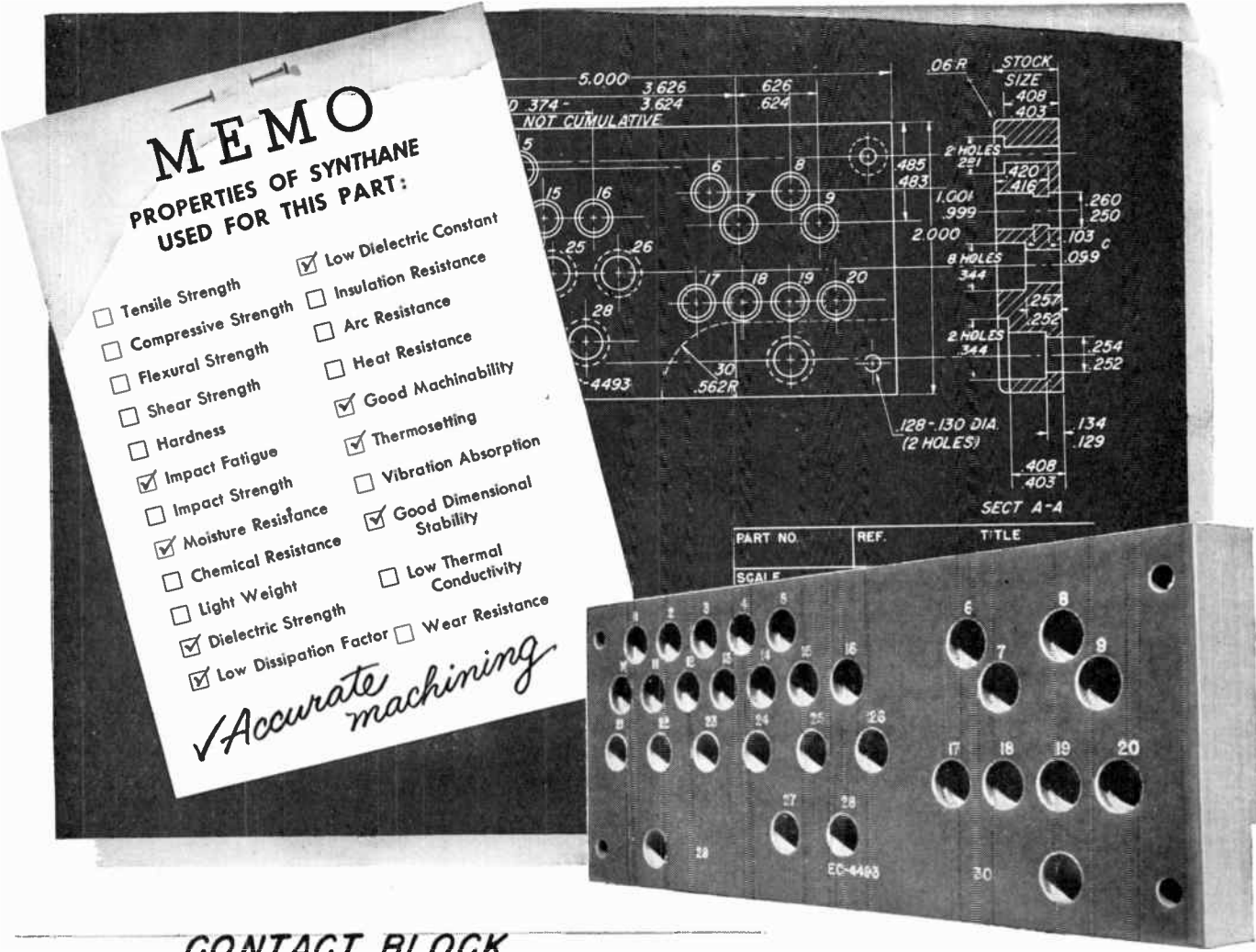

- MEMO**
PROPERTIES OF SYNTHANE
USED FOR THIS PART:
- Tensile Strength
 - Compressive Strength
 - Flexural Strength
 - Shear Strength
 - Hardness
 - Impact Fatigue
 - Impact Strength
 - Moisture Resistance
 - Chemical Resistance
 - Light Weight
 - Dielectric Strength
 - Low Dissipation Factor
 - Low Dielectric Constant
 - Insulation Resistance
 - Arc Resistance
 - Heat Resistance
 - Good Machinability
 - Thermosetting
 - Vibration Absorption
 - Good Dimensional Stability
 - Low Thermal Conductivity
 - Wear Resistance
- ✓ Accurate machining*

CONTACT BLOCK

OF SYNTHANE LAMINATED PLASTIC

MEETS MANY ELECTRICAL, MECHANICAL REQUIREMENTS

This contact block—for an electronic device—illustrates the rising demand for materials with many properties in combination. High dielectric strength, mechanical strength and dimensional stability are essential for the application; accurate machining is a must for proper mating of components.

The customer supplied the blueprint; Synthane Corporation did the rest—first producing the proper grade of material and then fabricating—accurately and without waste or delay.

The more than 33 grades of *Synthane* laminated plastics offer you a very wide range of properties in combination—physical, mechanical, electrical, and chemical. And good service and quality characterize *Synthane* fabrication. The coupon will bring you further information and technical data covering *Synthane* sheets, rods, tubes, and molded parts, and *Synthane* service.

SYNTHANE CORPORATION, 8 River Road, Oaks, Pa.

Please send me more information about Synthane laminated plastics and the Synthane fabrication service.

Name _____

Title _____

Company _____

Address _____

City _____ Zone _____ State _____



SYNTHANE CORPORATION • OAKS, PENNSYLVANIA

Add New Authority and Usefulness to your Library with these McGraw-Hill books

1. TRANSISTORS: Theory and Applications

JUST OUT! Provides both the theory and the practical knowledge of the properties and applications of transistors. Covers silicon and germanium transistors, manufacturing techniques, use in circuits, etc. By Abraham Coblenz, Transistor Products Co., and Harry L. Owens, Chief, Solid State Devices Branch, Signal Corps Engr. Lab. 313 pp., 115 illus., \$6.00



2. ALTERNATING-CURRENT and TRANSIENT CIRCUIT ANALYSIS

JUST OUT! A modern introduction to fundamental concepts of practical steady-state a-c circuit analysis and transient analysis. Gives help on application of analysis techniques, and emphasizes applications and understanding of basic behavior of electrical circuit parameters. By Harris A. Thompson, Assoc. Prof. of Elec. Engr., Univ. of Colo.; Chief Engr., J. J. Monaghan Co., Denver. 317 pp., 240 illus., \$6.75

3. AUTOMATIC FEEDBACK CONTROL SYSTEM SYNTHESIS

JUST OUT! An advanced development of feedback theory putting particular emphasis on synthesis of feedback control systems. Gives maximum use of the Laplace transform as a design tool, and reviews and unifies the mathematical background and basic theory forming the foundation for various analysis and design procedures. By John G. Truxal, Assoc. Prof. of Elec. Engr., Polytechnic Inst. of Brooklyn. 675 pp., 579 illus., \$12.50

4. ELEMENTS OF SERVO-MECHANISM THEORY

JUST OUT! A basic coverage of the elements of feedback control theory and normal methods of applying them. Emphasizes frequency response methods, and covers single loop systems with sufficient material on multiloop systems to introduce the problems involved and approach to solutions. By George J. Thaler, Assoc. Prof. of Elec. Engr., U. S. Naval Postgraduate School. About 300 pp., 180 illus., \$7.50

5. ENGINEERING CYBERNETICS

JUST OUT! Organizes the scientific principles of control into an orderly system, in effect establishing a new branch of engineering science, Engineering Cybernetics. Affords a new approach to the whole field, from conventional servomechanisms to very complex controlled and guided systems. By H. S. Tsien, Daniel and Florence Guggenheim Jet Propulsion Center, Calif. Inst. of Tech. 375 pp., 153 illus., \$6.50

6. SERVO-MECHANISM PRACTICE

JUST OUT! Shows how to handle the practical problems of servo design, manufacture, testing, and adjustment, emphasizing how to get the maximum performance from components. Gives you step-by-step design methods . . . trouble-shooting . . . testing procedures . . . etc. By William R. Ahrendt, Pres., the Ahrendt Instrument Co. 341 pp., 282 illus., \$7.00

7. MILLIMICROSECOND PULSE TECHNIQUES

JUST OUT! An account of electronic circuits and devices operating in the millimicrosecond range. Covers advances in the field . . . describes applications . . . and gives methods for better and more accurate results in your work. By I. A. D. Lewis, Senior Scientific Officer, and F. H. Wells, Principal Scientific Officer, both of the Ministry of Supply, Atomic Energy Research Establishment, Harwell, England. 310 pp., 149 illus., \$7.50

8. CONTROL-SYSTEM DYNAMICS

An exposition of the "Root Locus Method," of analyzing feedback control systems—invented and developed by the author. Demonstrates techniques for determining response of linear control systems. Each solution establishes a concept which permits a simpler technique to be applied to the next more complicated problem. By W. R. Evans, North American Aviation, Downey, Calif. 282 pp., 282 illus., \$7.00

9. MODERN PHYSICS for the ENGINEER

JUST OUT! Nineteen eminent scientists explore with you advances in basic physical sciences on which tomorrow's engineering is being built. Covers the laws of nature . . . man's physical environment . . . and information and its communication. Edited by Louis N. Ridenour, Vice Pres., International Telemeter Corp. 490 pp., 211 illus., \$7.50

READ THESE BOOKS 10 DAYS FREE

McGraw-Hill Book Co., Dept. IRE-3
330 W. 42nd St., NYC 36

Send me book(s) circled at right for 10 days' examination on approval. In 10 days, I will remit for book(s) I keep, plus small delivery costs, or return book(s) postpaid. (We pay delivery costs if you remit with this coupon; same return privilege.)

For price and terms outside U.S., write McGraw-Hill Int'l., NYC

1 2 3 4 5 6 7 8 9

(PRINT)
Name
Address
City, Zone State
Company
Position

IRE-3

What to See at the Radio Engineering Show

(Continued from page 332A)

TECH-MASTER

CORPORATION
BROOKLYN, N. Y.

121 MILITARY AVE.

TV CHASSIS • TV KITS
CONVERSION KITS
UHF ADAPTERS
HIGH FIDELITY AUDIO KITS

Technical Materiel Corp., 449, 451 Electronic Ave.

A new Communications Receiver & Transmitter; Remote Control Receiver System; High Stability Oscillators; Frequency Shift Terminal Equipment; Variable Frequency Carrier Systems; Amplifiers, Power Supplies and Multicouplers.

Technicraft Labs., Inc., 828 Audio Ave. Matched magic tees, step attenuators, high power phase shifters, folded tees, mixers—a few of the "Firsts" to be shown along with our regular line.

Technology Instrument Corp., 226, 228 Instruments Ave.

See TIC's *Miniature Multiturn Potentiometers, Pressure Transducers; Oscillographic Recorder, Z-Angle Meter, Phase Meters and Standards, all new.

Techron Corporation, 44 Palace
"America's Most Reliable Name in Printed Circuitry." Design and Production of printed circuits for Computers—Pulse Circuits—Industrial Controls—Instrumentation—Automation.

See and Try SEVEN NEW Instruments at booths 129, 131

Telechrome Inc., 181, 183 Television Ave.

Color TV *3-V Color Film Chain, Color Flying Spot Scanner, Automatic Balance Controlled Colorplexer, Finest New Color Monitor, Newest Color and Monochrome Test and Measuring Equipment.

Telechron Dept. of General Electric Co., 446 Electronic Ave.

"Telechron Timers and Motors." Featuring a look at the future in radio and TV timers.

*Indicates new product

(Continued on page 337A)

Follow the yellow lights to the industry's newest exhibitors in Kingsbridge Palace.



BURLINGAME ASSOCIATES

Invites you to SEE these NEW Instruments



Model DV51B Digital Voltmeter
ACCURACY: 0.01%

NEW!

Direct Reading Digital Voltmeter

- Simple, Instant, Accurate D.C. Voltage Measurements
- Voltage Ranges Available from 1 Millivolt to 999.99 Volts D.C.
- Input Resistance in Standard Models »1000 Megohms
- Internally Connected Standard Cell for Instant Calibration
- » Available Features include: Automatic Polarity Indicator, Automatic Decimal Shift, Automatic Printout of Readings

Ask for more Data—See it at the Show

ELECTRO-INSTRUMENTS, P.O. Box 5, Old San Diego Station, San Diego, Calif.
Phone: Cypress 8-3555

LABSCOPE, INC., Equal Amplifier, General Purpose, D.C. Oscilloscopes

Models 115 and 115R

- Equal "X" and "Y" Amplifiers. High Sensitivity, 3.5MV-/IN, RMS
- D.C. to 200KC Gaussian Response
- 4000 Volts on Anode No. 3 insures finer, brighter trace
- Electronically regulated power supply—Spot drift under 0.1 in.
- Functionally grouped controls—Simple operation
- Zero centered 20X sweep expansion
- Price: Model 115 \$375.00 Model 115R \$395.00

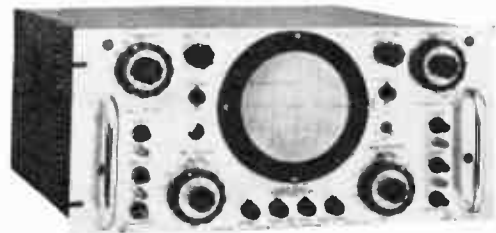

Model 115R LABSCOPE

For the first time an oscilloscope designed especially for rack mounting is offered in the Model 115R Lab-scope. The panel height is only 8¾". Electrically, the Models 115R and 115 Labsopes are identical.

LABSCOPE, INC. 728 Garden Street Carlstadt, N.J.

As usual we'll also be on hand to greet you at the booths of:

- | | |
|---|--------------------------------------|
| • BRUSH ELECTRONICS COMPANY | • HYCOR SALES COMPANY |
| • CASCADE RESEARCH CORP. | • LABORATORY FOR ELECTRONICS |
| • DONNER SCIENTIFIC COMPANY | • NARDA CORPORATION |
| • ELECTRONIC MEASUREMENTS COMPANY, INC. | • ROGER WHITE ELECTRON DEVICES, INC. |
| • ELECTRO-PULSE, INC. | • SERVO CORP. OF AMERICA |
| • EMPIRE DEVICES PRODUCTS CORP. | • SIERRA ELECTRONIC CORP. |

BURLINGAME ASSOCIATES

103 LAFAYETTE ST., NEW YORK 13, N.Y. TELEPHONE DiGby 9-1240

Washington 9, D.C.
DEcatur 2-8000

Waltham, Mass.
Waltham 5-1955

Upper Darby, Pa.
Sherwood 7-9080

Syracuse 2, N.Y.
Syracuse 2-6253

234, 236
Instruments Ave.

KINGSBRIDGE ARMY
KINGSBRIDGE PALACE
WALDORF-ASTORIA NEW YORK CITY

MARCH 21-24, 1955

NEW! "TINI-PLUGS" and "TINI-JAX"

FOR MINIATURE RADIOS, TAPE RECORDERS, ETC.

BY SWITCHCRAFT INC.

Incorporating the features of "Littel-Jax" and "Littel-Plugs" that have made them the preferred components of Design Engineers.

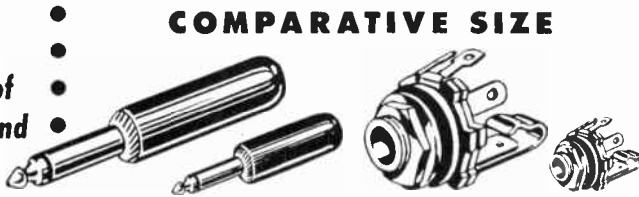

- COMPARATIVE SIZE**
- "LITTEL-PLUG"
 - "TINI-PLUG"
 - "LITTEL-JAX"
 - "TINI-JAX"
- High grade insulation throughout; one piece tip rod staked into tip terminal to insure tightness; terminals and body of plug interlock eliminating any shifting; available in black and red Tenite handles and Shielded handles.
- Switchcraft design eliminates probability of electrical shorts or change in adjustment; mating plug held firmly; springs of special alloy of nickel silver insure maximum spring life.



1332 N. Halsted St.
Chicago 22, Ill.

Canadian representative
Atlas Radio Corp., Ltd.
560 King St. W., Toronto 28, Canada
Phone: Waverly 4761

Write for details
See these and other
NEW products at
BOOTH No. 435
RADIO ENGINEERING SHOW
Kingsbridge Armory
New York, N.Y.
March 21-24

FOR HIGH FREQUENCY HIGH VOLTAGE
SPACE SAVING APPLICATIONS
GARDE
Miniature & Sub-Miniature
INSULATED STAND-OFFS,
FEED THROUGH & SPACERS

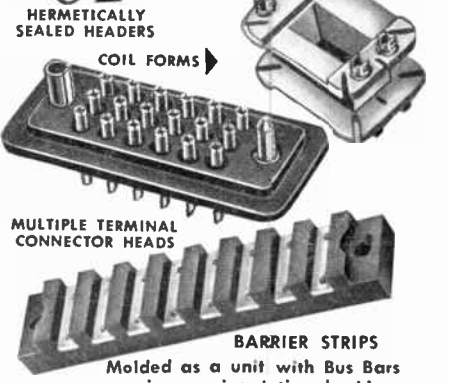
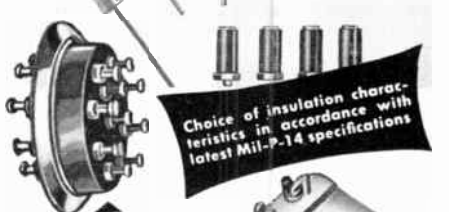
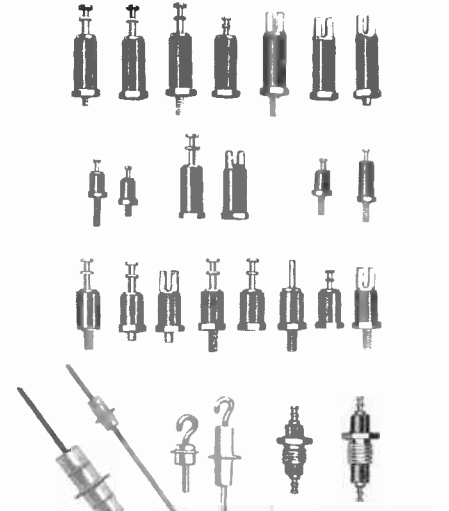

Molded as a unit with Bus Bars require no insulating backing.

For users to properly assess the outstanding features and advantages of Garde Components, samples will be sent on request. A detailed technical catalog is now available. Be sure your name is on our mailing list.

We have complete facilities to accommodate your special requirements, ranging from Engineering Consulting Service to Precision Design and Production.

GARDE
MANUFACTURING COMPANY
MOLDERS OF THERMOPLASTIC AND THERMOSETTING MATERIALS
588 Eddy Street, Providence 3, Rhode Island
Sales Representatives in Principal Cities

High Potential Test Set!!!

(to 3,000 Volts)



NON-DESTRUCTIVE

- YOU SET THE CURRENT LIMIT (20 to 3,000 micro-amps)
- USED FOR MILITARY CONTRACTS

COMBINED WITH A MEGOHM-METER (1 Megohm to 10 Million Megohms)

Write for Folder:
"The Ultimate in Test Equipment"

SEE US AT
BOOTH 803

GENERAL HERMETIC SEALING CORP.

97 East Hawthorne Avenue Valley Stream, New York VA 5-6363
*MFRS of Panel-Sealed Hermetronic K-W Toggle Switches

"DUPLICAN"

Photo-Contact Process
High Precision Markings on Flat and Irregular Shaped Materials

Luminous Applications on Dials, Panels, Nameplates, Etc. to all Government Specifications

ENGINEERING AND RESEARCH FACILITIES

A COMPLETE SOURCE

CANADIAN RADIUM & URANIUM CORPORATION

630 Fifth Avenue N.Y. 20, N.Y.
I.R.E. SHOW: 414 Electronic Avenue

What to See at the Radio Engineering Show

(Continued from page 334A)

See the TFM-186
FREQUENCY METER

52 Palace
TELERAD

1440 BROADWAY, N.Y.C.

Tele-Tech & Electronic Industries, 542
Circuits Ave.

This TV-electronic engineering magazine published by Caldwell-Clements, Inc. is exhibited in blown-up form in a display which also includes Tele-Tech supplements, maps, charts, directories, etc.

Teletronics Laboratory, Inc., 302 Computer Ave.

Fast Rise Pulse Generator, *Millimicrosecond Pulse Generator, Double Pulse Generator, Electronic Switch, Diode Test Instrument, Constant Current or Constant Voltage Power Supply, Push Button Test Oscillator.

Tel-Instrument Co. Inc., 256, 258 Instruments Ave.

"New unitized plug-in Distribution Amplifiers for Video, Color Burst and Color Sub-carrier, 10 mc Video Sweep Generator equipped with 10 pulse type crystal markers, single and 12-channel Transmitters (Color and B&W), NTSC and TV Test Equipment."

Telrex, Inc., 26 Palace

Antennas for Amateur and Exacting Commercial Service, includes multi-element Rotary Beams, directional wide band systems, spaced arrays, screen and corner reflectors, verticals and coaxials.

BOOTH 715 AIRBORNE
AVENUE

Environmental simulating chambers used for moisture resistance cycling, cold testing, altitude testing, humidity cycling, etc.

Tenney
ENGINEERING, INC.

1090 SPRINGFIELD ROAD, UNION, N. J.
Plants: Union, N. J. and Baltimore, Md.

Tensolite
INSULATED WIRE CO. INC
647 CIRCUITS AVENUE

SUPER-FLEXIBLE, MINIATURE
TEFLON INSULATED
WIRE and CABLE

Teflon, Nylon, Vinyl, MIL - Hook-Up Wire

Tetrad Company, Inc., 807 Audio Ave.
Diamond Phonograph Needles.

*Indicates new product

(Continued on page 340A)

IRE membership information:
Kingsbridge Armory—center of floor
Waldorf Astoria—Ballroom lobby.

Engineer assembles pulse system in 30 minutes, using Burroughs "do-it-yourself" units

Standard, matched units, performing basic functions, connect together to form even the most complex pulse systems

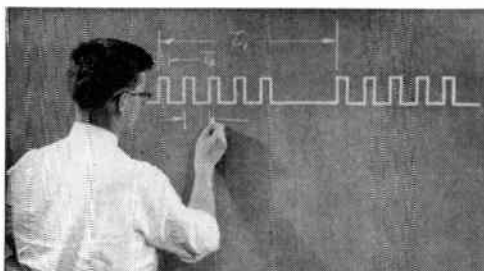

1. START

Engineer studies time chart of the desired pulse sequence. This is the output he wants the pulse system to produce.

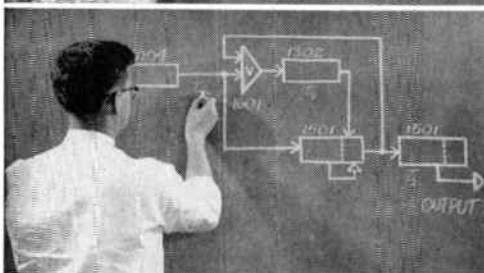

2. PLANNING THE SYSTEM

He determines which Burroughs units he needs and how they should be connected together. This can be done by means of a simplified block diagram. Time: 10 minutes.

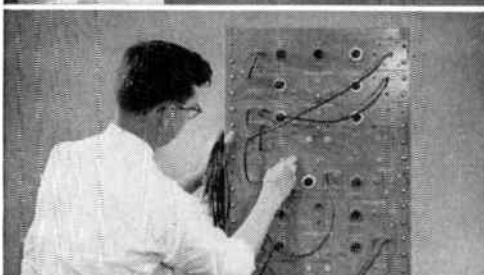

3. ASSEMBLING THE UNITS

Using standard coaxial cables, he completes his pulse system by connecting the units together according to his block diagram. Time: 20 minutes.

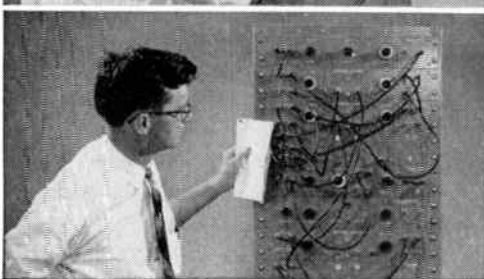

4. JOB COMPLETED

System now produces the exact pulse sequence desired. Engineer saves weeks of breadboard engineering, vital time, uncertainty, and considerable equipment cost. And his Burroughs "Unitized" pulse handling equipment can be used over and over again on different future projects.

GET THE FACTS

No matter how complex the pulse sequence you need, you can produce it quickly and at relatively low cost with Burroughs "Unitized" pulse handling equipment. If you prefer, send us a timing diagram of the pulse sequence required, and we'll advise you what Burroughs units you need and the cost. Immediate delivery from stock. Write Burroughs Corporation, Electronic Instruments Division, Dept. 11 C, 1209 Vine St., Phila. 7, Pa.

Burroughs
ELECTRONIC INSTRUMENTS DIVISION

FIRST IN PULSE HANDLING EQUIPMENT

GRAYHILL Switches • Test Clips • Molded Plastic Parts

Grayhill Rotary Tap Switch SERIES 3000

For Special Circuit Combination Applications

Available 1 to 12 decks, 2 to 11 contacts per deck.

A rugged index action assures rotor contact coming to rest at next position once thrown past center.

Diameter of switch 3-1/2"

Rated—20 amps., 115 v., A.C., non-inductive

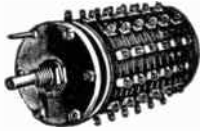

Grayhill Miniature Tap Switches SERIES 5000

For Commercial Applications

Available 1 to 6 decks—2 to 10 contacts per deck.

Shorting (make before break) or Non-shorting (break before make).

Switch rotates 360° with 10 positions—stops provided with 9 or less positions.

Bushings, 1/4" long—3/8" —32 thread

Diameter of switch 1-1/32"

Rated to break—1 amp., 115 v., A.C., non-inductive.

To carry—5 amps., 115 v., A.C.

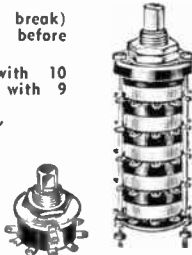

SERIES 12

For Military Applications

Available 1 to 6 decks—2 to 10 contacts per deck.

Shorting (make before break) or Non-shorting (break before make).

360° rotation with 10 positions—stops provided with 9 or less positions.

Bushings, 1/4" long—3/8" —32 thread

Diameter of switch 1-1/32"

Rated to break—1 amp., 115 v., A.C., non-inductive

To carry—5 amps., 115 v., A.C.

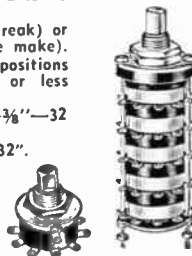

SERIES 24

Positive Detent Action and better feel for precision requirements.

Available 1 to 6 decks—2 to 10 contacts per deck.

Shorting (make before break) or Non-shorting (break before make).

360° rotation with 10 positions—stops provided for less than 10 positions.

Bushings, 1/4" long—3/8" —32 thread

Diameter of switch 1—1/32"

Rated to break—1 amp., 115 v., A.C., non-inductive

To carry—5 amps., 115 v., A.C.



Grayhill Push Button Switch

SERIES 2000—Snap Action

For Manual Operation

Audible click when actuated

Momentary contact, single pole, single throw type.

O.D.—7/8" dia. x 1-59/64" high

Bushings, 7/16" long—15/32" —32 thread

Rated—10 amps., 115 v., A.C., non-inductive

1 amp., 115 v., D.C.

Rated Life—Approx. 50,000 operations

No. 2201—Normally open
No. 2202—Normally closed



SERIES 4000—Momentary Contact

Momentary contact, single pole, single throw type.

O.D.—51/64" dia. x 1-17/32" high

Bushings, 3/8" long—15/32" —32 thread

Rated—1/2 amp., 115 v., A.C.—non-inductive

Rated Life—Approx. 800,000 operations

No. 4001—Normally open
No. 4002—Normally closed



SERIES 23—Miniature, Momentary Contact

Momentary contact, single pole, single throw

O.D. 1/2" dia. x 1-3/64" high

Bushings, 1/4" long—5/16" —32 thread

Rated—1/4 amp., 115 v., A.C., non-inductive

Rated Life—Approx. 500,000 operations

No. 23-1—Normally open



Grayhill Test Clips

SERIES 16—Completely insulated, alligator type

Even hinge pin is insulated.

Low contact resistance (approx. .0015 ohm)—.008" silver overlay on contact surfaces

Terminals—silver plated

Finger grips—molded phenolic



SERIES 2



No. 2-2—Plug-in Adapter for equipment employing 3/4" jack centers.

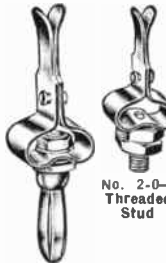

No. 2-1—Banana Plug

Clips—Cadmium plated
Plugs—Nickel plated
Base—General purpose phenolic electrical grade, per Mil-P-14 type CFG.

Grayhill Molded Plastic Parts



Thermo-Setting Insulated Washers



Thermo-Setting Coil Forms



Coil Form Terminal Board
Mica Filled
E-4 Powder



Thermo-Setting Germanium Crystal Holder



Thermo-Setting Stand-off Insulators

Grayhill

501 Hillgrove Ave., La Grange, Illinois
Phone: Fleetwood 4-1040
See us at the I.R.E. Show—Booth 743

Announcing

NEW LOW PRICES MAKE AVAILABLE GROWN JUNCTION RF TRANSISTORS for use in New Fields!

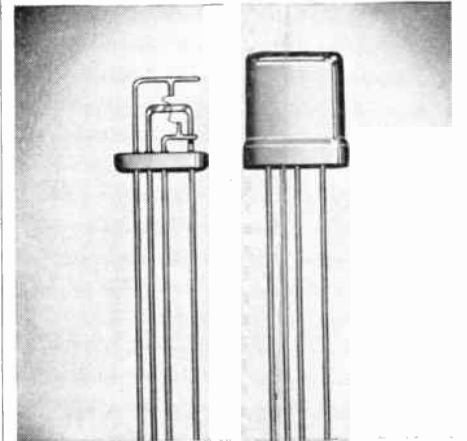

TETRODE TYPE

Available from local distributor stocks:

1. No change with age
2. Greater power gains
3. Hermetically sealed
4. No temperature hysteresis
5. I_{co} lowest available
6. Better frequency response

REPRESENTATIVE APPLICATIONS

D.C. amplifiers, multivibrators and high speed switches, pulse amplifiers, radar timers, computers, radio receivers, transmitters, etc.

GPC

GERMANIUM PRODUCTS CORPORATION

28 CORNELISON AVENUE
JERSEY CITY 4, NEW JERSEY

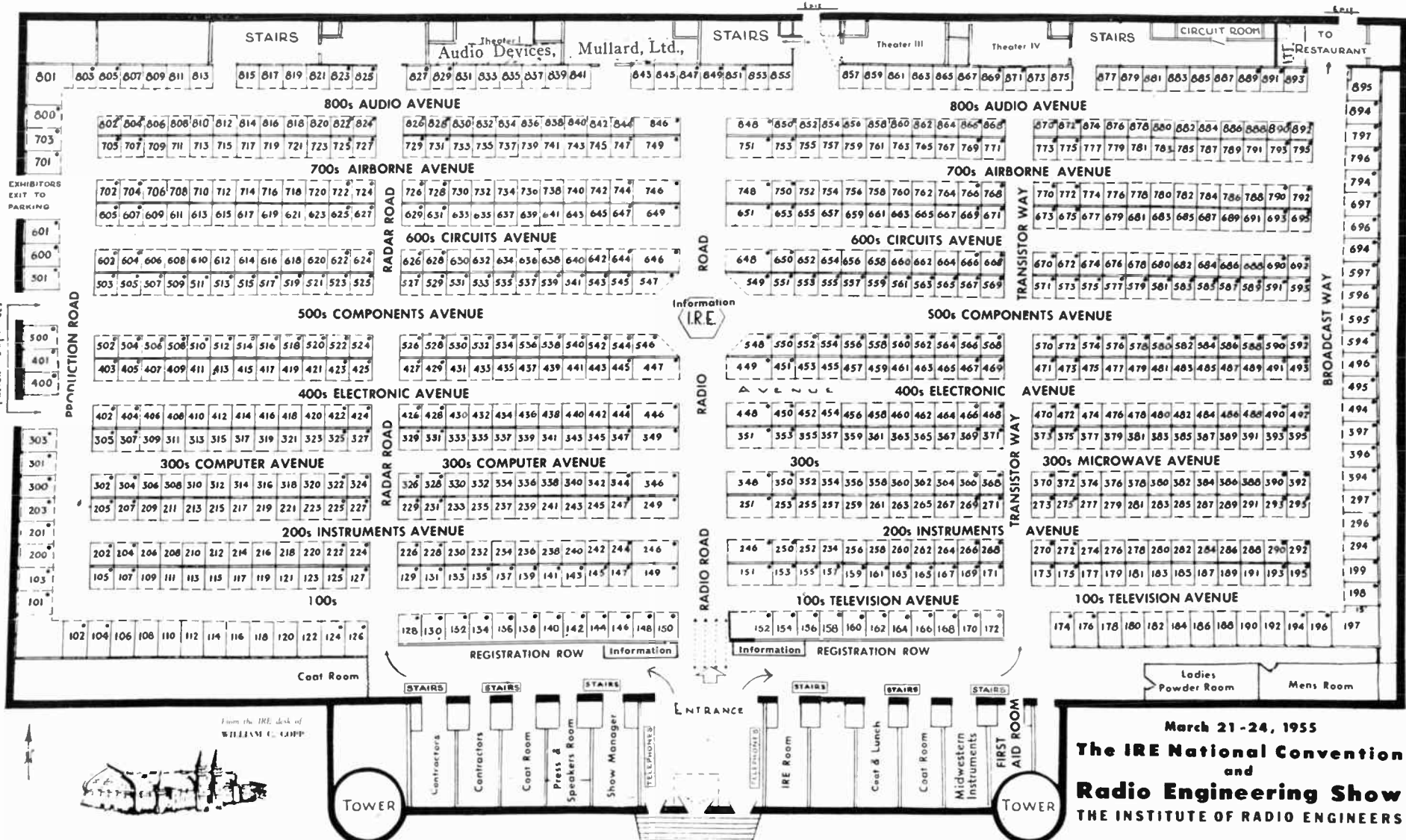

Kingsbridge Armory

NEW YORK CITY

March 21-24, 1955
The IRE National Convention
 and
Radio Engineering Show
 THE INSTITUTE OF RADIO ENGINEERS



From the IRE desk of
 WILLIAM C. COPP

ONE SOURCE FOR ALL YOUR METAL HOUSINGS

SEND FOR COMPLETE
NEW CATALOG

**PREMIER
METAL PRODUCTS CO.**

PRECISION-BUILT METAL HOUSINGS
DEPT. I 3160 WEBSTER AVE., N. Y. 67, N. Y.

What to See at the Radio Engineering Show

(Continued from page 337A)

BOOTH 796
Broadcast Way
SILICON AND GERMANIUM TRANSISTORS AND DIODES
SUBMINIATURE TRANSFORMERS AND CONDENSERS • RECORDING MILLIAMMETERS

TEXAS INSTRUMENTS
INCORPORATED
6000 LEMMON AVE. DALLAS 9, TEXAS

Thermistor Corporation of America, 850 Audio Ave.

*New wafer type thermistor has advantages including higher power handling. Temperature sensitive resistors (thermistors) of all types. Design service to solve temperature compensation problems.

Thomas Electronics, Inc., 773, 775 Airborne Ave.

Aluminized Monochrome and Color Cathode Ray Picture Tubes—21" low deflected, reduced diameter neck, Monochrome Picture Tube—21" rectangular Color Picture Tube.

Thomas & Skinner Steel Products Co.

304 Computer Ave.

Permanent Magnets Alnico 5Cb. Orthosil wound "C" and toroidal cores. Orthosil transformer laminations with watt and VA specifications.

Thompson-Bremer & Co., Subsidiary of American Machine & Foundry Co., 106, 108, 110 Television Ave.

See the exclusive design features of "Ever-lock" lightweight, low-cost, lock-nuts, terminals, lockwashers, providing vibration-proof, stronger, positive grip. Standard and special order units.

Thompson Products, Inc.

471-475 Electronic Ave.

See our latest exhibit outlining our *new designs in waveguide, coaxial, sensing, and rotary selector switches. Also, we are showing wavemeters, rectangular and polar recorders.

BOOTH 844 AUDIO AVE.

Has the **GREATEST IMPROVEMENT**
in Multi-Color, Anodized **FOIL**
NAMEPLATES In History.

★
Be sure to get your **Free Samples.**

North Shore **NAMEPLATE INC.**

214-27 NORTHERN BLVD. BAYSIDE, NEW YORK PHONE BAYSIDE 4-4000

THOR BOOTH No. 334
Computer Avenue

NEW! EPOXIDE BOBBINS
for HERMETICALLY SEALED RESISTORS

A complete display of STEATITE INSULATORS including bushings, bobbins, stand-offs, machined and metalized components for electronic and electrical applications.

THOR CERAMICS, Inc.
225 Belleville Ave.—Bloomfield, N. J.

*Indicates new product

What to See at the Radio Engineering Show

Times Facsimile Corp.
886 Audio Ave.

Precision fork frequency generators;
Constant angular velocity synchro-
nous motors; Optical systems for
single point recording or pick up;
Tube clamps.

Tinnerman Products, Inc., 643, 645 Cir-
cuits Ave.

Displaying hundreds of electronic components,
sub-assemblies, chassis, etc. Demonstrating
high quality, low-cost attachments with speed
nut brand fasteners. Also special fasteners cre-
ated for miniaturized program.

Torngren Company, Inc., C. W., 11 Pal-
ace.

Reflectors, mechanical antenna components
from new plastic-and-metal sandwich construc-
tion aluminum, magnesium, steel.

Tracerlab, Inc., 317 Computer Ave.

BG-5 Light Materials Beta Gauge for sheet
process control and a complete line of nuclear
instruments, including a unique integrating
Cutie Pie.

Trad Television Corp.
688 Circuits Ave.

Standard RF Signal Generator—Standard
VHF Signal Generator—Portable Pulse Oscil-
loscope—Precision RF Step Attenuator, 1000
mc—12-position Coaxial Switch, 1000 mc—3
connector Crystal Detector Mount, 1000 mc.

Transformer Engineers, 288 Instruments
Ave.

Designers and Manufacturers of Transformers,
Chokes, and Filters.

Transitron
Electronic Corporation
580 Components Avenue

**SILICON POWER RECTIFIERS
FOR 135°C OPERATION**

- Transistors
- Gold Bonded Germanium Diodes
- Silicon Junction Diodes

Tresco, 654 Circuits Ave.

*Golden Line Transforms—guaranteed perform-
ance with complete engineering data. Also
custom-engineered transformers for MIL-T-27,
Class II, Miniature, Magnetic Amplifiers,
Pulse, Audio, Power, other applications.

(Continued on page 343A)

FIRST AID ROOM

A nurse is in charge at all times. First Aid
Room is the sixth room to right of Lobby
directly off registration area in Kingsbridge
Armory.

7 good reasons for specifying MEPCO Precision Resistors

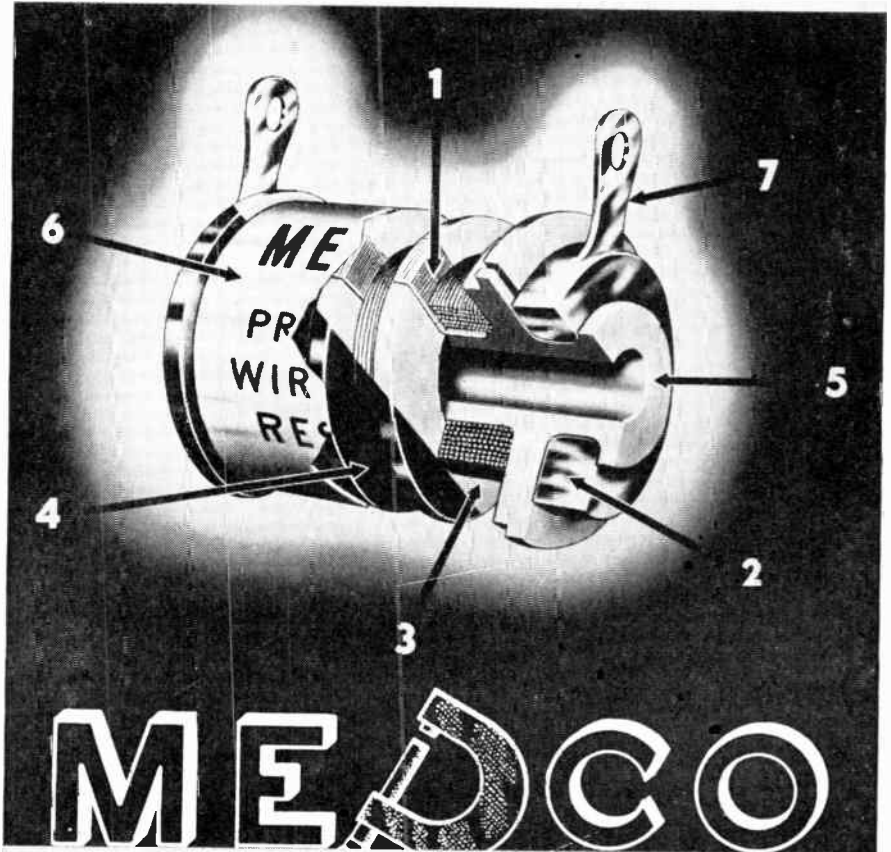

- ① Crossover wire insulated from each winding by 2000v. insulation (patented).
- ② Special metal molded connecting feature, which bonds end of winding and terminal in a non-corrosive and mechanically secure manner—no solder or flux used.
- ③ Reversed and balanced PI-windings for low inductance, with use of only the finest resistance alloys.
- ④ Impregnated with approved fungus, moisture and salt water-proofing compounds.
- ⑤ JAN approved non-hygroscopic steatite bobbin, specially treated prior to winding in order to provide additional protection for fine enameled wire.
- ⑥ Protective fungus resistant acetate label.
- ⑦ Rigid hot solder coated brass terminals for easier soldering.

MEPCO, INC.,
MORRISTOWN, NEW JERSEY

Booths 439-441 Electronics Ave., Radio Engineering Show

World Radio History

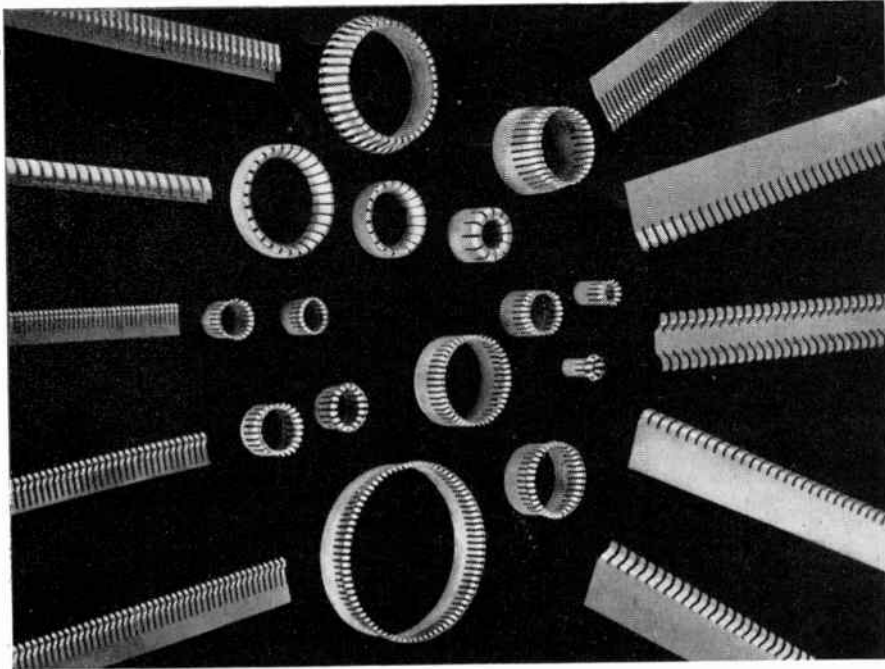

How to CUT Development Time And Costs

Exclusive I-S Services for Electronic Design Engineers

Product development costs frequently become excessive—both in time and dollars. This can be critical in a fast-moving industry like electronics, where today's preliminary drawing is on tomorrow's production-line. Hastily-conceived short-cuts are not the answer. Essential prototype-testing should not be by-passed—production standards should not be down-graded to compensate for development overhead. Many leading manufacturers have found I-S service of value in overcoming these ever-present headaches confronting the design engineer.

Put these I-S services to work for you, now . . .

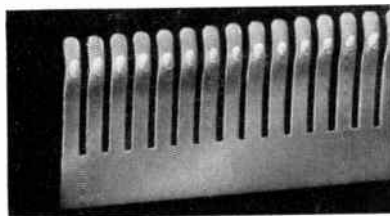
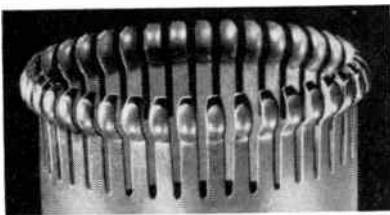

1. I-S ENGINEERS' MICRO-WAVE KIT

The new enlarged kit contains 15 circular contact rings and 10 finger contact strips, 12"-16" long. All jig-hardened beryllium copper, cleaned for soldering. Used for tuning slides, tube sockets, grounding and bonding components. Available from stock, order by catalog number 97-270.

2. I-S SHORT-RUN SERVICE

For pilot runs and regular small-production on beryllium copper springs—instead of costly "special orders". Checks your design against production tolerances—assures prototype reliability—speeds transition to full production.

3. I-S CONTIPS

Beryllium copper contact strips and rings (spherical radii) with localized deposit of silver for high-frequency applications where mechanical or electrical wear is a problem. Retains peak spring performance, ideal for miniaturization.

4. I-S ENGINEERING

I-S' specialized abilities in manufacturing problem springs and electronic components are available to your designers. This usually results in substantial cost reduction.

5. I-S EXCLUSIVE PRODUCTION TECHNIQUES

Exclusive I-S methods and patented equipment can produce a better spring or contact . . . faster, at lower cost—and usually to a higher performance than specified.

6. I-S NEW CATALOG No. 9

Our latest Catalog is in Sweet's Product Design file—but we'll be glad to send you an additional copy for your own personal file, if you desire.

Instrument Specialties Co. Inc.

232 BERGEN BOULEVARD
LITTLE FALLS, NEW JERSEY

Telephone Little Falls 4-0280



Decalator Model 100

- Crystal-Controlled Signal Generator
- Decade Switching with continuous Interpolation
 - Crystal Accuracy
 - Wide Range Calibrated Output

SPECIFICATIONS

Range, 10 kc to 1.5 mc; Steps, 1 kc in 3 decades; Interpolation, Calibrated 0.1 kc; Accuracy, 100 cps; Short Term Stability, ± 5 cps; Harmonic Content, 1% maximum; Output, 3 volts r.m.s.; Attenuator, 3v-1v-0.3v-0.1v-0.03v-0.01v full scale; Meter, Calibrated 0-1 and 0-3v; Price, \$995, f.o.b. Caldwell, N.J.



Sweepalator Combined Signal and Sweep Generator

- Decade Switching
- Crystal CW or Center Frequencies
- Wide Range Calibrated Output

SPECIFICATIONS

Range, 10 kc to 1.5 mc; Steps, 1 kc in 3 decades; Interpolation, Calibrated 0.1 kc; Accuracy, 100 cps; Harmonic Content, 3% maximum; Output, 3 volts r.m.s.; Attenuator, 3v-1v-0.3v-0.1v-0.03v-0.01v full scale; Meter, Calibrated 0-1 and 0-3v; Sweep Widths, 0 to 27.5 kc, except 2.5 kc below 25 kc; Price \$1,095, f.o.b. Caldwell, N.J.

For Complete Information, write:

Decade Instrument Co.

Box 153

Caldwell, N.J.

WIRE STRIPPING: Your jobs are peculiar to your own business and may be governed by such variables as kind and size of wire, what you use it for, your production requirements, and other similar factors.

So we may serve you promptly and efficiently, tell us what you are now doing and your hopes in the way of improved quality, increased production and lower costs.

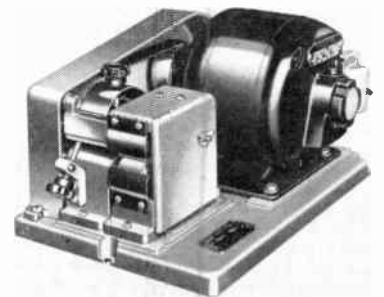

Illustration shows a MODEL "D-1" Two-Wheel Stripper, which is but one of the many different types of machines made. This one uses 1 1/4" diameter stripping wheels and is ordinarily used to strip any type of Film Insulation from wires in the range of AWG #25 to AWG #44. A wide variety of stripping wheels are available, made from FybRglass and Brush Wire, all designed to provide economical service.

This particular machine is only \$156.25, f.o.b. Syracuse, exclusive of stripping wheels. It is available on a Test-Rental Plan or may be purchased out of savings over a ten month period.

For a confidential report containing our recommendations, send samples and complete information to

Rush Wire Stripping Division
The Eraser Company, Inc.
1060 South Clinton Street
Syracuse 4, New York

March 21-24, 1955
**The IRE National Convention
 and
 Radio Engineering Show**
 THE INSTITUTE OF RADIO ENGINEERS

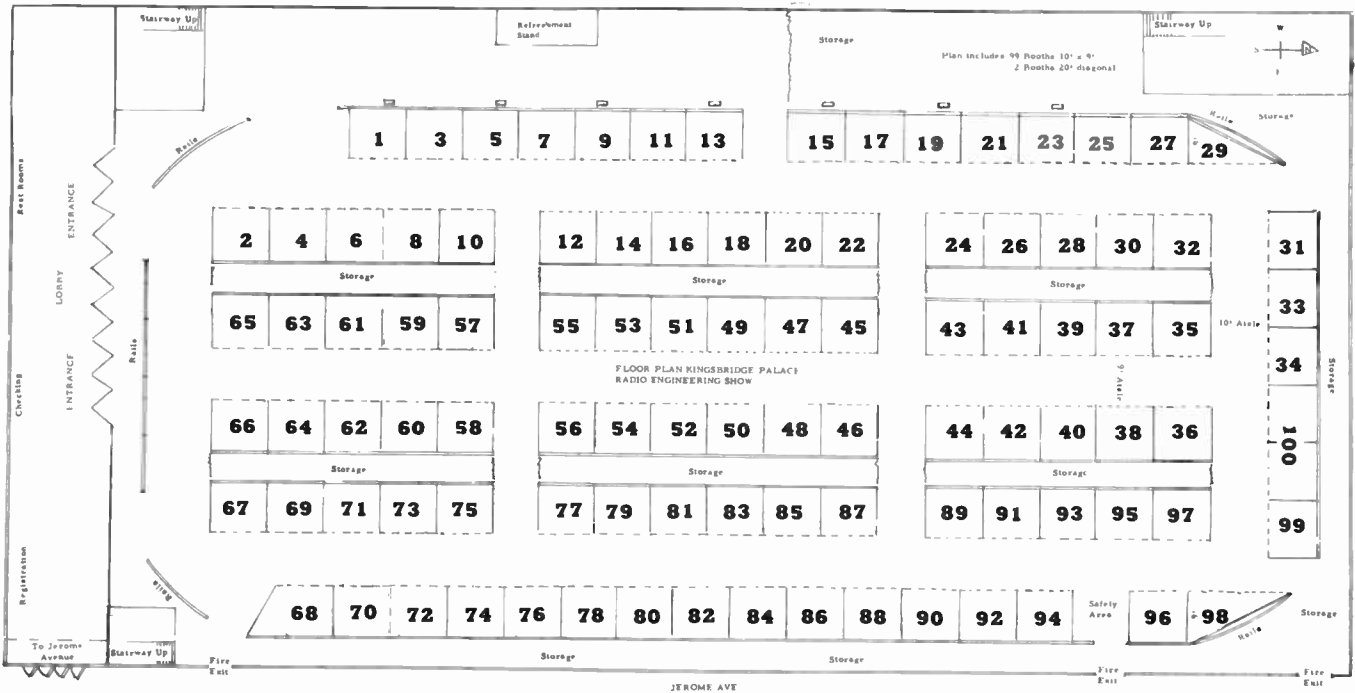

the ANSWER to
 greater flexibility and simplification
 of installation — a combination
Photo-Electric Control & Beacon Flasher

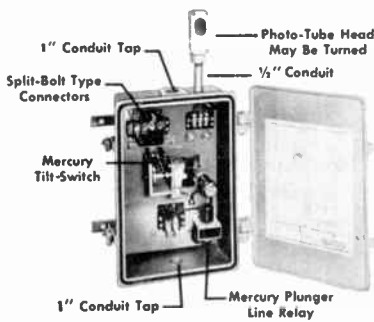

Model LC 2074 Tower Lighting Control Unit

Three Models: for two, three, four, and five light level categories.
 Models LC 2072 and LC 2073 provide for alternate flashing of two beacon levels.

Write for Bulletin HPS-135

HUGHEY & PHILLIPS, INC.

Manufacturers of

300MM Code Beacons, Obstruction Lights, Photo-Electric Controls, Beacon Flashers, Microwave Tower Control & Alarm Units, Remote Lamp Failure Indicator Systems, and Complete Tower Lighting Kits.

3300 North San Fernando Blvd.
 BURBANK, CALIF.

**What to See at the
 Radio Engineering Show**

(Continued from page 341A)

Triplett Electrical Instrument Co., 217, 219 Instruments Ave.

Note to Engineers and Designers. See the new style Triplett meters. They will add new appeal to your product. *Multirange meter for engineers with 70 ranges.

**Tru-Ohm Products Division
 Model Engineering & Mfg.**

444 Electronic Ave.

A full display of vitreous enamel resistors, silicone coated resistors and power rheostats.

(Continued on page 344A)

**OPEN for
 Switch or Relay
 LINE**

Aggressive and experienced representatives to the electronic jobbers and industrial in Northern Ohio.

WRITE

PHILIP & SON COMPANY

316 Marion Bldg.,
 Cleveland 13, Ohio
 Superior 1-1855

Will attend IRE Show March 21-24. Check Bulletin Board for Hotel.

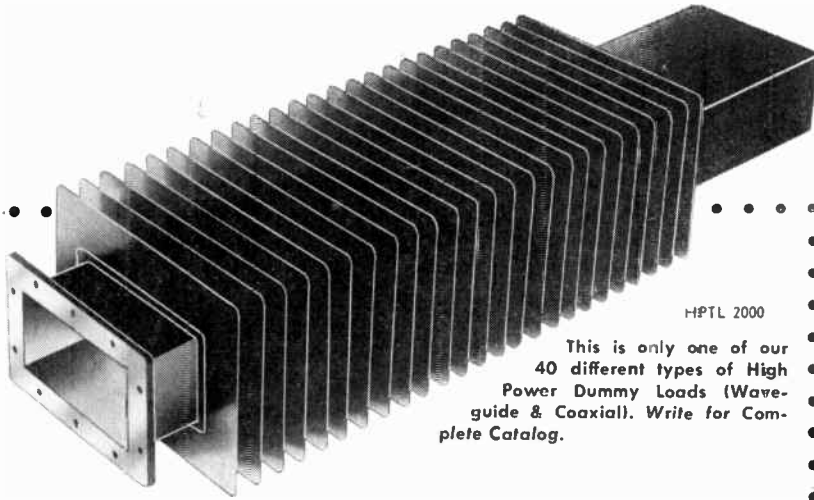

HP1L 2000

This is only one of our 40 different types of High Power Dummy Loads (Waveguide & Coaxial). Write for Complete Catalog.

L BAND Waveguide TERMINATION

SEE US AT
THE IRE SHOW
BOOTH
No. 384

CHARACTERISTICS

VSWR1.15	.9-1.7 KMC
Power Dissipation2000 watts	average continuously in still air
Waveguide6.66" x 3.41"	
FlangeUG417/U	
Weight65 lbs.	
Length40 inches.	

ELECTRO IMPULSE Laboratory

62 WHITE STREET • RED BANK, N.J. • Phone: Red Bank 6-0404

METER-RELAYS

For Sensitive and Accurate Control

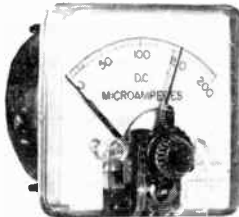

Model 261-C Range 0/200 D.C. Microamperes Price \$33.00

RANGES:

0/20 Ua. to
0/50 A.
0/5 Mv. to
0/500 V.

The trip point is adjustable to any point on the scale arc.

These meter-relays are sensitive to changes of as little as 1%. One contact is carried on moving pointer. The other is on a semi-fixed pointer. When two pointers meet contacts close and lock. Holding coil is wound directly over moving coil. Reset can be manual or automatic. Spring action in contacts kicks them apart forcefully. Three sizes of clear plastic case models, 2½, 3¾ and 4½ inches (all rectangular). Two ruggedized and sealed models, 2½ and 3½ inches (round metal cases). Contact arrangements: High Limit Single, Low Limit Single or Double (both high and low). Contact rating is 5 to 25 milliamperes D.C.

Suggested circuits for meter-relays and complete specifications including prices are covered in new 16-page Bulletin G-6, which you can get by writing Assembly Products, Inc., Chesterland 2, Ohio.

Booth 311. I.R.E. Show, March 21-24

printed circuits

Write for bulletin "laboratory quality at mass production cost" covering basic printed circuit design and production information.

Specialists in advanced Circuitry design and production.

printed circuits, inc.
BLOOMFIELD, CONN.

What to See at the Radio Engineering Show

(Continued from page 343A)

Truscon Steel Division, Republic Steel Corp., 327 Computer Ave.
Radio Towers for AM, FM, TV and Microwave Systems.

Tung-Sol Electric Inc.
716 Airborne Ave.

Will show the latest color TV picture tube, semiconductors, electron tubes for special purposes and entertainment, relays and dial lamps.

U.M.&F. Mfg. Corp., 86 Palace
Circuit building devices: SEEZAK Circuit Assembler for breadboarding, SeeZak Expandable Chassis for prototypes, SeeZak Bench Rack, "Pegboard" for printed circuit prototypes, "Presto" snap-in solder terminals.

See a complete display of Hermetically Sealed & Miniature Thermostats & Time Delay Switches at BOOTH 834



GEORGE ULANET COMPANY
411-16 Market St., Newark, N. J.

Underwood Corp., 801 Audio Ave.
See Electronic Computer Div.

Unimax Switch Division, The W. L. Maxson Corporation, 620, 622, 624 Circuits Ave.
See W. L. Maxson Corp.

Union Carbide & Carbon Corp., 527, 529, 531 Components Ave.
See National Carbon Co.

Union Plate & Wire Co., 403, 405 Electronic Ave.
See D. E. Makepeace Co.

Union Switch & Signal Div. Westinghouse Air Brake Co.
112, 114 Television Ave.

Relays; Copper Oxide and Selenium Rectifiers; Carrier Type Communications and Control Equipment; Railroad, Aircraft, Pipe Line, and Vehicular Traffic Control Systems; Electronic Simulator-Type Training Devices.

Unisco, Inc., 357 Microwave Ave.
See Miller Dial & Name Plate Co.

United-Carr Fastener Corp., 613 Circuits Ave.
Vibrator grounding clamps, lamp sockets, teenuts, plug buttons, spacer sleeves, trimounts, mounting feet, snap-in nuts, palnuts, coil form fasteners.

(Continued on page 346A)

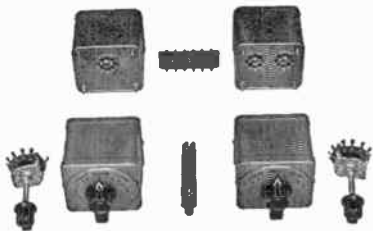

simplify custom installation

The 4200 Sound Effects Filter and 4201 Program Equalizer are now available in component form, as illustrated, for the custom builder.

In addition to the flexibility of installation, all the features and characteristics of the standard models are retained.

The high and low sections of either model may be obtained separately. Complete wiring instructions included.

Send for Bulletin TB-4



Model 4200 Sound Effects Filter
(Send for Bulletin S)



Model 4201, Program Equalizer
(Send for Bulletin E)

Representatives in
Principal Cities

HYCOR
Company, Inc.

11423 Vanowen Street
North Hollywood 6, Calif.



have a cooling problem?

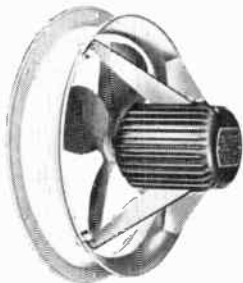

Discuss it with confidence at Rotron. If secret, military clearance covers our advisory staff.

For each cooling application there is one type which gives optimum performance. Rotron manufactures all types of cooling devices.

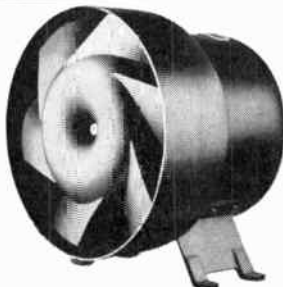

- MULTISTAGE BLOWERS
- PROPELLER FANS
- VANEAXIAL FANS
- RADIAL-WHEEL BLOWERS
- SQUIREL-CAGE BLOWERS

Your prototypes and mock-ups may be submitted to our affiliate, Rotron Research Corp., for performance evaluation and design refinement. Laboratory equipment is complete and of high quality.

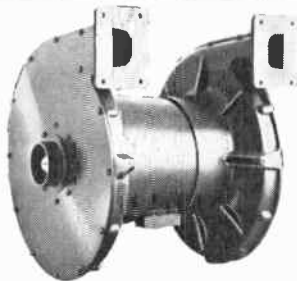

Our 170 page RING BINDER CATALOG is packed with engineering information. Frequent inserts keep it up-to-date.

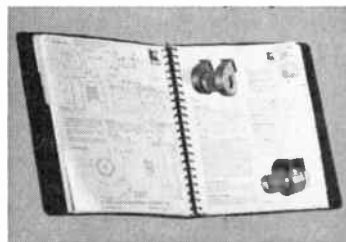

ROTRON

MANUFACTURING CO., INC.

7 SCHOONMAKER LANE • WOODSTOCK • NEW YORK

What to See at the
Radio Engineering Show

(Continued from page 344A)



KUTHE

Hydrogen Thyatron TUBES

Kuthe Laboratories, Inc.
730 South 13th Street Newark 3, New Jersey
Telephone: Blgelow 2-6000

BOOTH 842

Radio's MASTER - New! 1955 Edition. Official buying guide of the electronic parts and equipment industry.

FILE-O-MATIC - Perpetually up to date electronic catalog service.

Pricing Service - Industry-wide electronic parts and equipment pricing book.

842 AUDIO AVE.
UNITED CATALOG PUBLISHERS, INC., N. Y. 13

U. S. Components, Inc.
625 Circuits Ave.

Multi-Contact-Connectors — Power, Miniature, Sub-Miniature in Draw-Pull, Hooded, and Hooded Screw-Lock Type. Printed Card Receptacles, Adapters, Cable Clamps, Cable-Connector assemblies.

U.S. Engineering Co., 774 Airborne Ave. Electronic Hardware, Terminal Lugs, Spacers, Knobs, Handles, Terminal Boards, *Etched and Printed Circuits.

**QUALITY CONTROLLED
FLUOROCARBON PRODUCTS**

Booth 68-70 Kingsbridge Palace; TEFLON and KEL-F insulating materials, electronic components, special fabricated parts and sub-assemblies. Of unusual interest—specialized techniques in handling metal inserts, molding around metal structures and cementing to TEFLON.

UNITED STATES GASKET CO.
Fluorocarbon Products Inc. Div.
Comden 1, New Jersey



United States Motors Corp.
718 Airborne Ave.

Manufacturers of "Micro Power," an assurance of uninterrupted and continuous electrical current. Manufacturers of emergency standby engine alternators, Gas, Gasoline, Diesel, 300 watts to 300 kilowatts.

Booth 81 at the IRE Show



201M

U-47M

TELEFUNKEN
world's finest Microphones

AMERICAN ELITE, INC.
Dept. P, 7 Park Avenue • New York City
Sole Importer, and U. S. Agent

PRECISION



POTENTIOMETERS

LINEAR — NON-LINEAR

Ratray precision potentiometers have a wide scope and cover many types and sizes, in the field of wire-wound units of high accuracy, long life and stability.

If you have a requirement involving procurement of precision potentiometers, in small or large quantities — see us first for the best in standard and special designs.

Model 162-C shown here is typical of our compact design, with mechanical and electrical capabilities of highest quality, as shown by comparative tests.

Technical Bulletin 3-54 RE Now Available

GEORGE RATRAY & CO., Inc.
116-08 MYRTLE AVENUE
RICHMOND HILL 18, N. Y.



UNITED STATES RADIIUM CORPORATION
806 AUDIO AVENUE

- EDGE-LIGHTED PANELS • METAL DIALS, PANELS and NAMEPLATES • ISOTOPE ACTIVATED LIGHT SOURCES • RADIATION SOURCES including Isotopes, Radium, Ra D, and Polonium
- LUMINESCENT MATERIALS • TV PHOSPHORS

Literature on above items available at booth.

*Indicates new product

(Continued on page 348A)

TRAD

PRECISION ELECTRONIC EQUIPMENT

Will Be Displayed At The
1955 I.R.E. SHOW

• STANDARD SIGNAL GENERATOR

MODEL SG-25 10 KC - 50 MC

Commercial equivalent of the famous AN/URM-25D used by our Armed Forces.

Frequency accuracy 0.5% when using calibrated dial, 0.05% when using internal crystal calibrator.

High output 2V-500 ohms. Calibrated output 0.1 to 100,000 uv into 50 ohms. Negligible incidental FM. Internal modulation at 400 and 1200 cps. External modulator 100 to 10,000 cps.

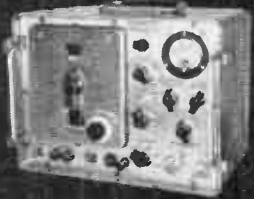

• PRECISION RF STEP ATTENUATOR

MODEL AT-120 0-1000 MC

Small, rugged, ladder attenuator of high accuracy and low vswr from ac to uhf.

Adaptable for various types of test equipment. Attenuation range up to 120 db total. Up to 10 steps of 6, 10 or 20 db. Impedance 50 or 75 ohms. Direct or gear drive. Weighs only 11 oz.



• COAXIAL SWITCH

MODEL CS-200 0-1000 MC

Up to 12 POSITIONS are available in this radial connector coaxial switch.

Nominal impedance is 50 ohms.

Crosstalk for 12 position switch is greater than 75 db down at 1000 MC

and 120 db down at 250 MC. For a 6

position switch, crosstalk is greater

than 100 db down at 1000 MC.

VSWR is 1.2:1 at 500 MC and 1.3:1 at 1000 MC.

Rugged, compact and lightweight construction.



• CRYSTAL DETECTOR MOUNT

MODEL CM-300 10-1000 MC

Accuracy: Better than 1/2 db

A three-connector, tee type crystal mount for general purpose in rf monitoring 50 or 75 ohm coaxial systems

Available in 50, 100, 150, 75, 50, 225

ohm impedances for use with Trod

Step Attenuator AT-120 for minimum

insertion loss.

BNC connectors facilitate direct connection to AT-120 Step

Attenuators forming a complete monitored output system

to 1000 MC.



Visit our exhibit and see our complete line of Precision Electronic Test Equipment.

Write for details to

TRAD TELEVISION CORPORATION

1001 FIRST AVE., ASBURY PARK, N. J.

VLF

... Very Low Frequencies



• RADIO INTERFERENCE
• and FIELD INTENSITY*
• measuring equipment

• Stoddart NM-10A • 14kc to 250kc
• Commercial Equivalent of AN/URM-6B

VERSATILITY... The NM-10A is designed to meet the most exacting laboratory standards for the precise measurements, analysis and interpretation of VLF radiated and conducted radio-frequency signals and interference. Thoroughly portable, yet rugged, the NM-10A can be supplied with accessories to fulfill every conceivable laboratory and field requirement.

EXCELLENT SENSITIVITY... The NM-10A sensitivity ranges from one microvolt-per-meter to 100 microvolts-per-meter, depending upon whether rod or shielded loop antennas or line probe are used.

ACCURACY... Each equipment is "hand calibrated" in the Stoddart Test Laboratories by competent engineers. This data is presented in simplified chart form.

DRIPPROOF... Sturdy dripproof construction allows long periods of operation in driving rain or snow without adverse effects.

FLEXIBLE POWER REQUIREMENTS... The ac power supply permits operation from either 105 to 125 volts or 210 to 250 volts ac, at any frequency between 50 cps and 1600 cps.

Stoddart RI-FI* Meters cover the frequency range 14kc to 1000mc

HF NM-20B, 150kc to 25mc
Commercial Equivalent of AN/PRM-1A. Self-contained batteries. A.C. supply optional. Includes standard broadcast band, radio range, WWV, and communications frequencies.
Has BFO.

VHF NM-30A, 20mc to 400mc
Commercial Equivalent of AN/URM-47. Frequency range includes FM and TV bands.

UHF NM-50A, 375mc to 1000mc
Commercial Equivalent of AN/URM-17. Frequency range includes Citizens band and UHF color TV band.

STODDART AIRCRAFT RADIO Co., Inc.

6644-C Santa Monica Blvd., Hollywood 38, California • Hollywood 4-9294

CONTINUOUS, DIRECT-READING X-BAND VSWR MEASUREMENT

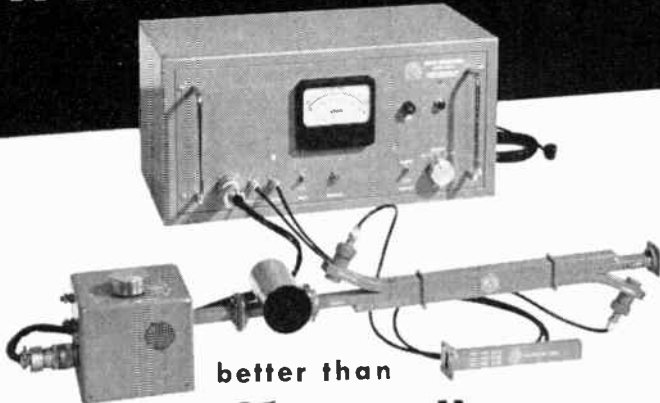

better than
2% overall accuracy!

For speedy and accurate VSWR measurements in laboratory or production use, the CTI Model 110B Measuring System reads directly, is continuously tunable from 8,500 to 9,600 mc.

SPECIFICATIONS

Two VSWR Ranges: 1.02 to 1.2; 1.2 to 2.5
Attenuation Scale: 0 to ∞; 1.5 db midscale
Waveguide Fitting UG-39/U
Directional Couplers, directivity over 40 db

See this equipment
at the IRE show
BOOTH 137

COLOR TELEVISION INCORPORATED

SAN CARLOS 2, CALIFORNIA



**"PRINTED CIRCUIT" SWITCH PLATES
COMMUTATOR and CODE DISCS with**

New "MELACON" Process

ELECTRO-FORMED
**FLUSH
CIRCUITRY**

with smooth, long-wearing, bounceless, low torque

**MELAMINE
SURFACE**



The bounceless surface... the conductor embedded flush in pure tempered Melamine... combined with appropriate brush pressures and contact materials, has resulted in long life of 100 million revolutions in many applications.

Write or phone for full information!



Glen Cove
4-4000
Flushing
3-5050

Photocircuits
CORPORATION

Dept. IRE3, GLEN COVE, NEW YORK

PHAZOR **PHASE
METER**
Pat. Pend. MODEL 200A



\$34950 F.O.B. New York, N. Y.

Measures phase shift in transformers, amplifiers, filters, and phase displacement networks.

- Measures from 0 to 360 degrees.
- Readings not affected by noise and harmonics.
- Phase shifts of the order of .01 degree can be measured employing special circuit techniques.
- Measures in-phase and quadrature components separately.

SPECIFICATIONS

Accuracy—Basic accuracy plus or minus 2 degrees. Plus or minus 1 degree due to meter error.

Noise and Harmonic Rejection... 40 db. down
Sensitivity... 6 millivolts full scale
Maximum Input Voltage... 125 volts RMS
Peak Input Signal... 400 volts
Frequency Range... 20 to 20,000 cps.
Input Impedance
High Gain... 2.0 megohm shunted by 25 mmfd.
Low Gain... 2.5 megohm shunted by 10 mmfd.
Reference Input Impedance... 4000 ohms
Power Supply... 105 to 125 volts, 60 cps., 25 watts
Dimensions—Length 15 in., Hgt. 9 in., Depth 8 in.
Weight... 25 pounds

INDUSTRIAL TEST EQUIPMENT CO.
55 EAST 11th ST., N. Y. 3 - Tel: GR. 3-4684

What to See at the Radio Engineering Show

(Continued from page 346A)

The United States Time Corporation,
709 Airborne Ave.

Sub-miniature precision rate gyroscopes—Developed by Sanders Associates—World's smallest, lightest, most rugged. Fast starting, excellent resolution and linearity. Unusually insensitive to shock and vibration.

United Transformer Co.

NEW YORK 13, N.Y.

547 Components Ave.

Corner of RADIO ROW



AUDIO, POWER TRANSFORMERS; FILTERS; MAGNETIC AMPLIFIERS; HIGH PASS, BAND PASS, LOW PASS, FILTERS; PULSE TRANSFORMERS; MILITARY and AIRCRAFT TRANSFORMERS.

BOOTH 817

PRECISION STORED-ENERGY WELDERS

**Unitek
WELDMATIC**

For Electronics and Instruments Industry

UNITEK CORPORATION

275 N. HALSTEAD AVE. • PASADENA 8, CALIF.

BOOTH 214 Instruments Ave.

ILLUMINATED

- SWITCH ASSEMBLIES • KNOBS
 - CONTROL PANELS • DIALS
- by DAY
by NIGHT

*A NEW TECHNIQUE FOR BETTER VISIBILITY

Testing equipment for organic coatings

UNIVERSAL AVIATION EQUIPMENT INC.

362 Fifth Ave., New York 1, N. Y. Wisconsin 7-3574-5

Universal Electronics Co., 88 Palace
Regulated DC Power Supplies—Standard Line and Precision Regulated Power Supplies. *Ultra-Precision DC Regulated Power Supply. Specifications 0-500 volts to 0-000 M.A. Regulated to 0.001% Stability Approaching Standard Cell Performance, Model LP-300A.

Universal Winding Company, 560, 562 Components Ave.

Coil Winding Machines with new features. No. 108 model with quick set-up and direct drive from adjustable speed motor. No. 107 type, fully automatic with electronic drive.

Vacuum-Electronic Engineering Co., 280 Instruments Ave.

Vacuum equipment including leak detectors, pumps, valves and gauges, featuring automatic leak testing units, non-burnout ionization gauge, improved air-cooled diffusion pump.

Van Dyke Textigraph Co., 680 Circuits Ave.

See Pacent Engineering Corp.

*Indicates new product

(Continued on page 350A)

Show Hours: **Monday 10 AM-10 PM**
Tuesday 10 AM-10 PM
Wednesday 10 AM- 5 PM
Thursday 10 AM-10 PM

RF Leakage can be

STOPPED!



... simply and economically

**A MUST in MILITARY
and MANY COMMERCIAL
EQUIPMENTS**

**YOU CAN IMPROVE
YOUR DESIGNS GREATLY,
THIS SIMPLE, INEXPENSIVE WAY**

The place to stop RF leakage is "on the drawing board." In other words if you design your product so that RF leakage is reduced to a minimum you'll have no difficulty in meeting military radio noise specs and FCC regulations, and you'll have a better product too. In the design of many military equipments during the last 10 years effective sealing in of RF leakage has been accomplished with a simple application of METEX Electronic Weather-strip and other METEX Shielding Products made from Metal Textile's highly resilient compressed knitted wire. You can achieve comparable results in your own designs. Send today for our new brochure describing METEX Shielding Products in detail with a most helpful section on design.

See us at the show...
433 Electronic Ave

get your
copy today



METAL TEXTILE CORPORATION

Knitters of Wire Mesh for more than a Quarter Century
ROSELLE, NEW JERSEY

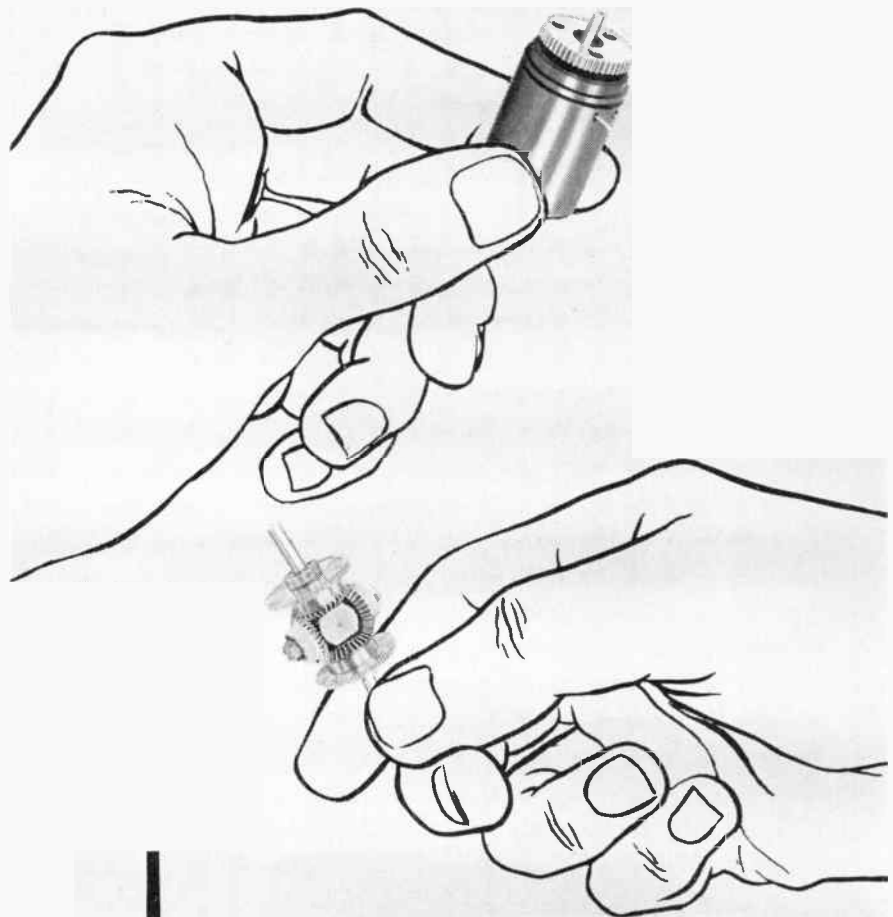

background of perfection

Behind each product by Belock are the years of experience, the uncompromising precision, and the absolute perfection you would want in your own products.

Instrument gears, differentials, gearheads, remote control positioners, ball and disc integrators, and magnetic clutches are a few of the many precision electromechanical servo components available from stock.

In addition, we manufacture computers, radar units, gyroscopes, power drives, and bombsights for the United States Armed Forces.

Visit us at the I.R.E. Show, Booth No. 7,
Kingsbridge Palace.



INSTRUMENT COMPONENTS, INC.

14-35 112th Street
College Point, N. Y.

division of
BELOCK INSTRUMENT CORPORATION

Condenser Products C O M P A N Y



Cordially Invites
You To Their Exhibit At The

1955 RADIO ENGINEERING SHOW

Booth 423

Manufacturers of

Glassmike Capacitors
Plasticon Capacitors
Molded Capacitors
HiVolt Power Supplies
Pulse Forming Networks

Condenser Products Company

Division of New Haven Clock & Watch Company
140 Hamilton St.—New Haven, Conn.



Why wonder . . .

Yardney Silverclad[®], smalt, light, night-
est storage battery—at Booth 765, IRE Show, or
Yardney Electric Corp., 40 Leonard St., N.Y. 13.
[®] Reg.

Low Cost Shaded Pole F. H. P. MOTORS

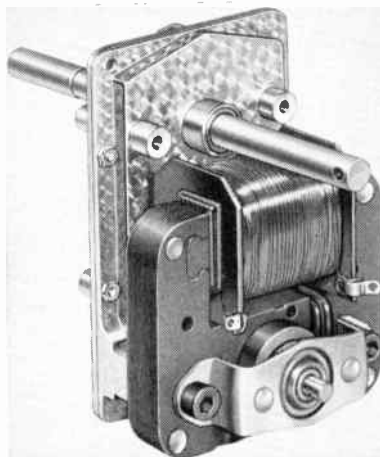

Clutch-gear types featuring hi-starting torque, fast disengagement time, standard speeds of 4 to 328 rpm., simplified mounting. Skeleton types 1/500 to 1/4 hp., operating speed 1200-3500 rpm. Voltage range, 6 VAC to 220 VAC. Custom-manufactured to specifications. Efficient, dependable, low cost. Send for complete details.

Molon Motors & Coil Co.

3349 W. Addison • Chicago 18, Illinois

What to See at the Radio Engineering Show

(Continued from page 348A)

	VARIAN associates
	542,544 COMPONENTS AVE.
	KLYSTRONS for every application

Vari-L Company, Inc., 712 Airborne Ave. The "VARI-L" line of electrically variable inductors. Interesting applications demonstrated. Automatic curve plotter for tracking multiple units on display.

A Subsidiary of Norden-Ketay Corporation

VARI-OHM CORPORATION

Booths 629-631 Circuits Avenue

PRECISION POTENTIOMETERS

Sunrise Highway Amityville, L. I., N. Y.

VISIT **VECTRON, inc.**
at 381 MICROWAVE AVE.

N 45-2000 CYCLE
250 VA POWER SUPPLY

E K-BAND MICROWAVE
SPECTRUM ANALYZERS

W PRECISION POTENTIOMETERS

Other Electronic and
Electro-mechanical Equipment

Vernistat Div. of Perkin-Elmer Corp.
20 Palace

Vernistat, a new type of transducer, combines desirable features of precision potentiometer and variable autotransformer—low output impedance, high resolution and linearity, may be used for power transmission, low power dissipation.

Vibro-Ceramics Corp., 850 Audio Ave.
*Ultrasonic drills and soldering irons. Ultrasonic probes. Ultrasonic attenuation analyzers for materials uniformity test. Ultrasonic generators for industrial cleaning and processing.

Victoreen Instrument Co.
481, 486 Electronic Ave.

High quality components including precision hermetically sealed resistors, ballast tubes, high voltage corona regulating tubes, sub-miniature tubes, featuring dynamic display of component characteristics.

*Indicates new product

(Continued on page 353A)

THE KENYON TWINS



M LINE

Meets All MIL-T-27 Requirements

Completely hermetically sealed to meet MIL-T-27 specifications. Military Standard types are included. Catalog Listing M L

C LINE

Meets All Commercial Requirements

A complete line to MIL electrical specifications, housed in conventional cases. Satisfactory performance at substantial savings. Catalog Listing C L

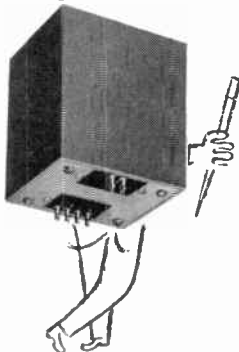

HOUSED IN CASES WITH STANDARD MIL-T-27 DIMENSIONS... BOTH LINES CARRY THE USUAL KENYON GUARANTEE

The new Kenyon Military and Commercial Lines feature the very latest practice, using the best class "A" wire and insulation now available, and the latest types of core material, to obtain minimum size at reasonable cost... Cases are identical to the requirements in the MIL-T-27 specifications. Full rating information and schematic is furnished in the form of a stencil on each case... Special units with other ratings and the same or similar cases are available on short delivery, in any quantity. Write for catalog. Your inquiry will receive prompt attention.



Kenyon
TRANSFORMER CO., INC.
840 Barry Street, New York 59, N. Y.

See us at Booth 541—I.R.E. Show



PROCEEDINGS OF THE I.R.E. March, 1955

Analysis of a basic magnet problem:

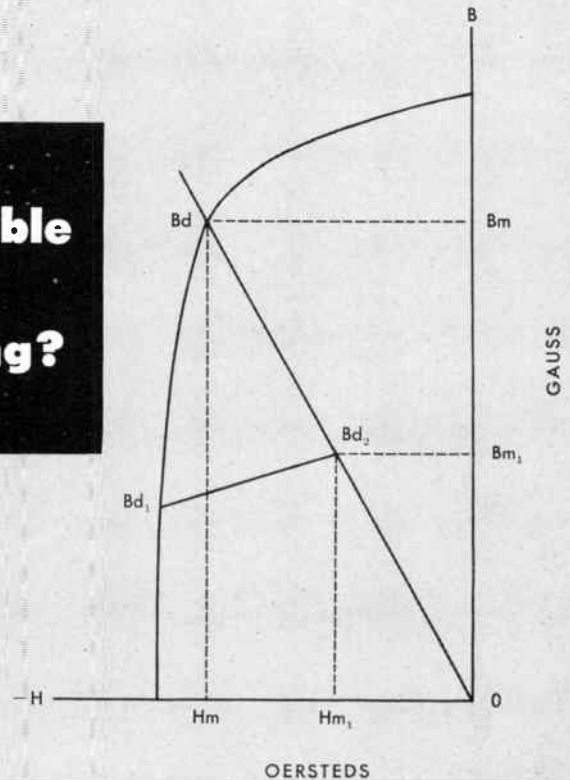
Why assemble before magnetizing?



A closed circuit magnet exists when the magnet is magnetized in its assembly of soft iron or other magnetic materials and is not removed later. Normally, there is a specified air gap. The chart illustrates the demagnetization curve for Alnico permanent magnet material.

To illustrate the advantage of magnetizing the complete circuit after assembly, let's use an example: The magnet  is to be assembled with pole pieces . If the magnet is charged *before* assembly, it will operate at point Bd_1 on the curve. When the poles are placed on this saturated magnet , it will move up a minor hysteresis loop to point Bd_2 , resulting in Bm_1 flux density. How-

ever, if the entire circuit is magnetized *after* assembly, it will operate at point Bd with Bm flux density, or a 100% increase in flux density in this example. The percentage of increase is a function of the gap length and area.

This is a very brief explanation of a basic design problem. For a detailed discussion of this and other design considerations, we suggest our Design Bulletin #151. *The Thomas & Skinner research and engineering staffs are at your disposal . . . write today for engineering assistance in the design of your magnetic applications.*



T&S at I.R.E. Show
Computer Ave.
Booth 304

SPECIALISTS IN MAGNETIC MATERIALS . . .

Permanent Magnets  Laminations  and Wound Cores 



THOMAS & SKINNER Steel Products Company, Inc.

1125 E. 23rd Street, Indianapolis 7, Indiana



They're here in quantity...

"Selenium Slims"

**NEW HI-VOLTAGE
SELENIUM RECTIFIERS**

...at low prices



Highest quality and low prices seldom come together—but you get them in these new UNION Tubular Selenium Rectifiers.

The secret lies in a new manufacturing process perfected by Union Switch & Signal engineers, the original developers of the copper-oxide rectifiers more than 30 years ago. Higher quality selenium discs are now being produced with greater precision and at lower cost than ever before.

You can snap these rectifiers into your circuits with standard fuse clips or solder in with pig-tail leads. They outlast rectifier tubes, stand up better under vibration, use less power and give trouble-free service... all this at low cost.

Maximum peak inverse voltages run from 36 to 9360 volts with condenser input filter. Maximum DC current rating is 2.5 ma., but other current ratings can be supplied on special order. Stacks may be combined in series, as full-wave bridge circuits, or as voltage doublers.

Send for complete specifications. These new UNION Selenium Rectifiers can lower your costs and give you the big advantage of rugged, trouble-free operation.

EXPLODED VIEW showing symmetrical arrangement of selenium cells (spacers not required), spring-loaded in a tough, durable phenolic tube.

GENERAL APPARATUS SALES

UNION SWITCH & SIGNAL

DIVISION OF WESTINGHOUSE AIR BRAKE COMPANY

PITTSBURGH 18  PENNSYLVANIA

NEW YORK
IVonhoe 3-2424
(Hempstead)

HARTFORD
JACKSON 9-3122
(Wethersfield)

BALTIMORE
VALLEY 5-3431

CHICAGO
LONGBEACH 1-2042

ST. LOUIS
JEFFERSON 5-7300

LOS ANGELES
CLINTON 6-2255

352A

WHEN WRITING TO ADVERTISERS PLEASE MENTION — PROCEEDINGS OF THE I.R.B.

World Radio History

advanced
technique



AVIONICS

electronic chopper
model **307** by AVION

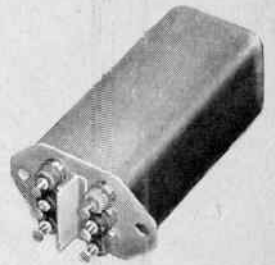

Modulation of DC voltages is achieved by the illumination at line frequency of the photo-conductive element in a voltage divider.

- NO moving parts
- HIGH temperature 100°C
- HIGH conversion ratio... over .5
- MODULATION to 400 cps
- TEMPERATURE independent
- LIFE...3000 hours minimum
- LOW noise...200 μV
- SIZE...7/8" x 7/8" x 2"
- WEIGHT...1.6 ounces
- EXCITATION...115 VAC 3 ma
- DELIVERY...from stock
- PRICE...\$35.00 each (single units)
\$25.00 each (in quantity)

Avion's flexibility and ingenuity, coupled with extensive experience in Electronics, Mechanics and Optics can better serve you.

Investigate the career opportunities in our expanding organization.

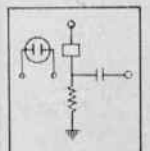

AVION

INSTRUMENT CORP.

SUBSIDIARY OF Q C F INDUSTRIES, INC.

299 Highway No. 17, Paramus, N.J.

March, 1955

What to See at the Radio Engineering Show

(Continued from page 350A)



Booths 657, 659

thermistors

- Liquid Level Indicator
 - Temprobe
 - Combustion Analyzer
 - Hypsometer-Altitude
 - Multi-channel Remote Temperature Indicator
- VICTORY ENGINEERING CORPORATION**
Springfield Road, Union, N. J.

Vitramon CAPACITORS

Miniaturized fused-porcelain components with phenomenal stability, low loss, wide temperature range.

Booth 566—Components Avenue
VITRAMON, INCORPORATED
Box 544, Bridgeport 1, Conn.

Wall Manufacturing Co., P., 820, 822
Audio Ave.
Electric soldering irons and miscellaneous soldering products.

Waltham Horological Corp., 808 Audio
Ave.
Complete JAN approved *telephone plugs, *telephone jacks, coaxial connectors from *sub-miniature to heavy duty. *pulse type, standard and special RF fittings and connectors.

Wang Laboratories, 319 Computer Ave.
*Digital-Analogue Differential Computer (A new computer DIGITAL in operation and ANALOGUE in form); *Angular Position Data Recorder; *Magnetic Scalars; Static Magnetic Memories.

Ward Leonard Electric Co., 870 Audio
Ave.
It's here . . . One-stop shopping for control components at Ward Leonard. Power Resistors (MIL Types), ring rheostats, relays, contactors, TV studio lighting controls, motor controls, etc.

Warren Wire Co., 860 Audio Ave.
*Extruded Teflon Lead Wire. *Teflon Impregnated Glass Insulations. *Silicon Magnet Wire. *Special Teflon Cables. Magnet, Tinned and Bare Copper Wire Products.

Waterman Products Co., Inc.

158, 160 Television Ave.

POCKETscopes, PULSCOPES,
RAKScopes, RAYONIC Cathode Ray
Tubes.

Waveforms, Inc., 618 Circuits Ave.
Precision-In-Miniature Laboratory Instruments. Audio oscillators from below one cycle to over one megacycle, down to 1/10% distortion, power to two watts. Wide range AC millivoltmeter. Contract development of special instrumentation.

Waveline, Inc., 367 Microwave Ave.
Microwave test equipment; standing wave indicator; *noise generators; *wide band frequency meters, *standard gain horns. KU and millimeter instruments, *phase shifters.

*Indicates new product

(Continued on page 354A)

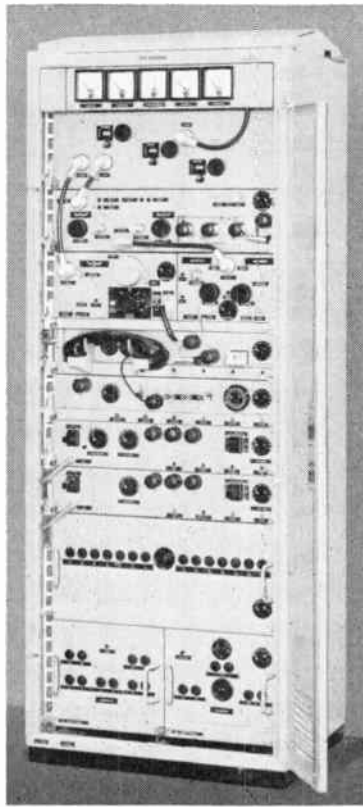

SIXTY-CHANNEL UHF FM RADIO SYSTEM OF ADVANCED DESIGN

Type FM60/2000 Radio System transmits up to 60 voice channels in a frequency range of 1700 to 2300 mc. Transmitting power is 5 watts and a single antenna is employed for both transmitting and receiving. The maximum frequency swing is 0.5 mc, and the transmitted frequency band is 12 to 252 kc. A similar system type FM60/300 operating in the frequency band 235 to 328 mc is also available. These radio systems operate in conjunction with the type F60 carrier-telephone system, which provides up to 60 3400-cycle telephone channels in 5 12-channel groups.

◀ A complete FM60/2000 Radio Terminal requires a single cabinet.

RADIO ENGINEERING PRODUCTS

1080 UNIVERSITY STREET, MONTREAL 3, CANADA

Telephone: UNIVERSITY 6-6887

Cable Address: Radenpro, Montreal

MANUFACTURERS OF CARRIER-TELEGRAPH, CARRIER-TELEPHONE AND BROAD-BAND RADIO SYSTEMS

announcing

ALPHA WIRE

New

ALPHLEX

line of
Tubing and
Sleeving

Conforms to
MIL specs
and UL standards.

- Extruded Plastic Tubing
- Impregnated Tubing & Sleeving (Fiberglass or Organic Base)
- High Temperature Fiberglass Sleeving
- Plastic Coated Fiberglass Tubing & Sleeving
- Silicone Impregnated Fiberglass Sleeving
- Silicone Rubber Coated Fiberglass Tubing

FREE!

The industry's first and only complete ENGINEER'S CROSS-REFERENCE TUBING & SLEEVING CHART. Helps you spot the specific tubing and sleeving you need for any particular application — at a glance!

Available at our IRE BOOTH 454,
Electronic Avenue—or write for free copy.

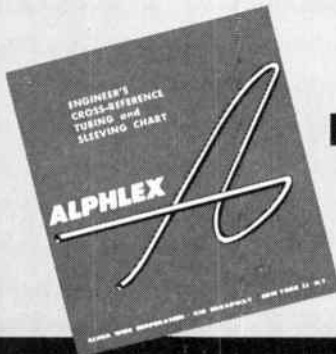

First in Quality Wire for over 30 years.



ALPHA WIRE CORP. 430 B'WAY • N. Y. 13, N. Y.

Decorate or Print DIRECTLY ON YOUR PRODUCTAND SAVE!

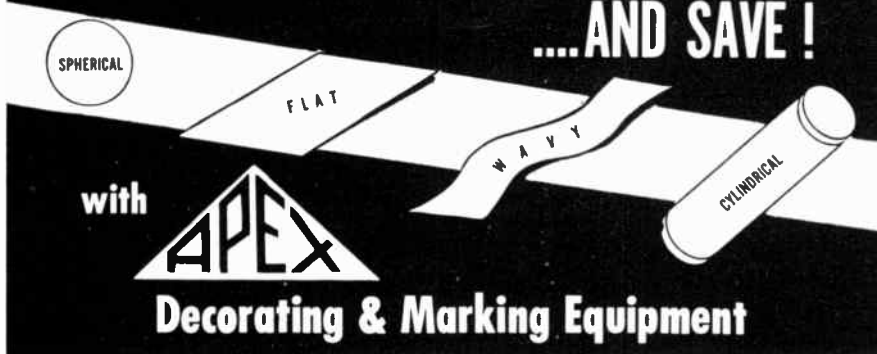

- 1, 2 or more colors in perfect register
- automatic or hand feed machines.
- rapid changeover
- inexpensive plates
- permanent inks in all colors.

OVER 40 STANDARD MODELS TO CHOOSE FROM in America's Largest and Most Complete Selection

There's an Apex machine that can mark, label or decorate directly on your product, no matter the size or shape. Anything that can be printed on paper can be printed by an Apex. No item is too large or small . . . no run too long or too short. Apex eliminates label inventory problems, gives you unmatched versatility and relief from production headaches. Get all the facts today.

Exhibiting at
The I.R.E. Show
Booth 62
Kingsbridge Palace



MACHINE COMPANY
14-13 118th STREET COLLEGE POINT 56, N. Y.
Largest and Oldest Mfr. of Multicolor Ink
Printing and Hot Stamping Machines.

GORN



aircraft controls

Absolute, Differential and Gauge Type Pressure Switches, Liquid Level Switches and Controls, Fuel and Hydraulic System Components (Pressure Switch GP8000 shown at left).

electronic connectors

Miniature Multiple, Rapid Disconnect, Pressurized High Voltage and Printed Circuit Connectors (shown at right).



COME TO BOOTH 49, KINGSBRIDGE PALACE

EST.



1923

845 MAIN ST.

STAMFORD, CONN.

FIRESIDE 8-7591

What to See at the Radio Engineering Show

(Continued from page 353A)

WECKESSER CO.

Booth 33, Palace

5269 N. Avondale Ave., Chicago 30
NyGrip + EthoLoc

PLASTIC CABLE CLIPS
WIDEST RANGE OF SIZES IN
THE INDUSTRY

Also complete line of clips, D washers and perforated nylon strapping.

Welch Manufacturing Co., W. M., 223
Instruments Ave.

Duo Seal Vacuum Pumps including the *Vented exhaust for pumping condensable vapors. Also vacuum gauges and accessories.

Western Gear Works, 827 Audio Ave.
Miniature and subminiature electric motors, fans, blowers, rotary electrical equipment. Precision fine pitch gears and gear trains, gear drives and actuating units.

Western Lithograph Co., 805 Audio Ave.
Adhesive Labels, E-Z Code wire identification markers, N.E.M.A. color code markers, TEL-A-PIPE cable, conduit, and pipe markers, Westline contact labels, Breakaway labels.

Westinghouse Air Brake Co., 112, 114
Television Ave.
See Union Switch & Signal Div.

Westinghouse Electric Corp.

843-855 Audio Ave.
Audio Ave.

Will exhibit and demonstrate electrical instruments, specialty transformers, cores, electronic tubes, electric controls for circuits and air arm.

Westline Products Div. of Western
Lithograph Co., 805 Audio Ave.

Industrial labeling to identify wires, pipes, parts, chassis, products, brands, hazardous areas, safety programs using pressure sensitive materials. Protective coatings of acrylic and zinc chromate.

Weston Electrical Instrument Corp., 533,
535 Components Ave.

Service Instruments for TV Radio and Industrial Maintenance. Panel Instruments including Ruggedized-INDUCRONIC Instruments for precision measurement and control—*Weston 980 line TV Test Equipment, *Panel Instrument with CORMAG self-shielded mechanisms, *Miniature Clamp Volt-Ammeter AC and DC, Portable Instruments, Aircraft Instruments, Sensitive Relays.

Westrex Corp., 94 Palace

Westrex DIVATEL—Ultimate in frequency shift radioteletype receiving equipment and Westrex Recording Equipment—Single and Stereo Magnetic—*Lateral Disk Cutter and Award Winning Editor.

White Electron Devices Inc., Roger, 80
Palace

Traveling wave tubes, backward wave oscillators, packaged traveling wave amplifiers. Microwave gas tubes, including noise sources, electronic attenuators, modulators, and switches. Ion gauge control units.

White Dental Mfg. Co., S. S., 707 Air-
borne Ave.

"Airabrasive" Unit for cutting hard brittle materials and removing deposited surface coatings on printed circuits, film resistors, etc. Also remote control and power drive flexible shafts and molded resistors.

*Indicates new product

(Continued on page 356A)

MAGNETIC—ELECTROSTATIC

SHIELDING MATERIALS
IN THE FERRITE FIELD

COLOR T.V.	TRANSFORMERS
OSCILLOSCOPES	MAGNETIC RECORDERS (Tape & Wire)
OSCILLOGRAPH	TELEMETERING GUIDANCE SYSTEMS (Guided Missiles)
COMPUTERS	COMMUNICATIONS GEAR
RADIOSONDES	CHOPPERS, INVERTERS
RADAR & SONAR	VIBRATORS, INDUC- TERS, REACTORS
PRECISION TIMING (Devices)	POWER TRANSMIS- SION EQUIPMENT (Utility)
TRANSDUCERS	TEST EQUIPMENT
TELETYPE	KINESCOPE RECEIVERS
TELEGRAPH	TELEPHONES: PORT- ABLE FIELD SOUND POWERED
RADIO & T.V.	CIRCUIT BREAKERS
TRANSMITTER GEAR	SELSYN EQUIPMENT
AIRCRAFT INSTRUMENTS	DIATHERMY EQUIPMENT
AUDIO EQUIPMENT	MAGNETIC ENERGY DEVICES
SERVO MECHANISMS	MOTION PICTURE SOUND PROJECTORS
RADIO NAVIGATION	AUTOMATIC TELEPHONE, DIAL & CROSSBAR SYSTEMS
AMPLIFIERS	ELECTROMAGNETIC EQUIPMENT
RADIOACTIVITY EQUIPMENT	ELECTRONIC MEMORY SYSTEMS
MICROPHONES	ELECTROMAGNETIC VOLTAGE REGULATORS

PERFECTION MICA COMPANY

1316 No. Elston Avenue Chicago 22, Ill.

PANELOC ROTARY LATCHES

... for use on hinged or removable parts, and as inspection doors, access panels, etc.

... engineered to save

- . SPACE
- . WEIGHT
- . TIME
- . COST

... designed to provide
MAXIMUM ACCESS

... with
ENTIRE LATCH
IN ONE PANEL

SCOVILL
MANUFACTURING CO.
Waterbury 20, Conn.

THESE HANDS ARE OUR MOST PRECIOUS ASSET

For over 28 years they have built a reputation
for manufacturing instruments that are
known the world over for their quality. We
invite you to visit a working display
of our fine instruments at the annual
NEW YORK CITY I.R.E. SHOW
BOOTH 278 INSTRUMENTS AVE.



MODEL DYL

12 inch mirrored
vernier scale
Accuracy .1 of 1%
from 50 to 500
cycles
18 full scale current
and voltage ranges



Our exhibit has been designed
to give you a practical insight into the
unusual capabilities of our products. We would like you to see . . .
*Instruments that multiply and divide, add and subtract — High accuracy
voltmeters with an input impedance of 10^{14} ohms that will read RMS
and peak voltage — The new Dynamometer Polyrange Laboratory
Standard pictured above . . .* In short, we would like you to see a
collection of the highest quality and most imaginative instruments
produced today.

For the finest in Laboratory Standards, panel instruments, and versatile
test sets visit "SENSITIVE".

A Descriptive Bulletin on any of the above instruments is yours for the asking



Symbol of Quality

**SENSITIVE RESEARCH
INSTRUMENT CORPORATION**

MOUNT VERNON, N.Y.

ELECTRICAL INSTRUMENTS OF PRECISION SINCE 1927

HERMETICALLY SEALED THERMOSTATS



These miniature thermostats illustrated actual size are ideal for control electronic applications.



THE ULTIMATE CHOICE
OF THOSE WHO KNOW!

CARTRIDGE THERMOSTATS



Series FM Thermostats offer the only unit that can withstand mechanical clamping or pinching without effect on set calibration.

● The Ulanet catalog, illustrating and describing the worlds' largest line of precision thermostats is available without obligation. Write on your letterhead.

GEORGE ULANET COMPANY 416 MARKET STREET
NEWARK 5, N. J.

Rely on
Ulanet
CONTROLS

What to See at the Radio Engineering Show

(Continued from page 354A)

White Industries, Inc.
761 Airborne Ave.

Wholly Owned Subsidiary of
Mack Trucks, Inc.

Contract manufacturers of precision
quality electronic, mechanical and
electro-mechanical equipment.

Development · Research
Engineering

Producers of Power Convertors

Who's Who in Electronic Distribution,
27 Palace

Electronic directory, hard bound, thumb indexed, contains over 400 pages. Supplies source and distribution data. Saves time and effort. Makes procurement possible at local level.

**Wickes Engineering &
Construction Co.**

139 Television Ave.

Color TV Signal Generating and Test Instruments. *Phase Display Equipment and *Network Synthesizer. Integrated Air Traffic Control Systems. Fixed and Portable Control Towers. Direct-Reading 24-Hour Clocks. Special Communications Equipment.



JOHN WILEY
Technical Books

on display at
588 Components Ave.

New Books on Radio
and Electronics

Willys Motors, Inc., 704 Airborne Ave.
Automatic production machinery.

Wilkor Div., 548 Components Ave.
See Gabriel Company.

Winchester Electronics, Inc.
628 Circuits Ave.

Multi-contact electrical connectors including miniatures, sub-miniatures, hermetics and quick-disconnects. Complete line of Connectors for printed circuit boards. Many unique connector designs.

*Indicates new product

(Continued on page 358A)

THE INSTRUMENT FOR YOUR MAGNETIC PROBLEMS

D-79 GAUSSMETER

FEATURES —

- Reads 10 to 30,000 Gauss Flux Fields
- Probe is only .025" thick
- Active area .01 square inches
- Net Weight only 10½ lbs.
- Power Supply 105-125 Volts, 50-60 Cycle
- Overall size 13" high, 10½" wide, 6¾" deep



A complete precision built unit that will measure flux density and determine the direction of "flow". It will locate and measure "stray fields", plot variations in strength and offers a fine use for checking production lots against a standard. It is simple to operate—no ballistic readings . . . no jerking or pulling. Comes in protective carrying case.

Write for literature, Dept. IR 355.

Dyna-Labs
INC.



1075 STEWART AVE.
GARDEN CITY, N. Y.
Phone
Pioneer 1-2700

See us at Booth No. 480, Radio Engineering Show

FIRST AID ROOM

A nurse is in charge at all times. First Aid Room is the sixth room to right of Lobby directly off registration area in Kingsbridge Armory.

Electronic circuitry design and construction simplified by mechanical components to provide:

- 

1 Circuitry sub-divided function by function into plug-in units.

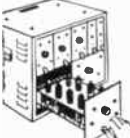

ALDEN TERMINAL CARD SYSTEM
- 

2 Plug in replacement spares in 30 seconds.



ALDEN BASIC CHASSIS & PLUG-IN PACKAGES
- 

3 Tiny tell-tales spot trouble instantly.

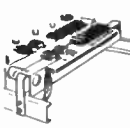

ALDEN "TELL TALES"
- 

4 All leads brought to single, accessible point of check, color coded and numbered so layman can make first-level check.



ALDEN BACK CONNECTORS

At the Alden Products Co. IRE Booth #185 & 187, or write Brockton, Mass.

Scientific recording now accomplished by Alfax Paper, where previously photography had seemed necessary.

New Alfax Paper — in which electricity is the ink — makes possible simple, uncomplicated recorders that operate unattended, get great amounts of related information compactly with high accuracy. Alfax paper is different-non-toxic, stable in storage, requires little current yet cannot overload, records at slow or high speeds, does not smudge or transfer.



See the Alfax Paper and Engineering Co. IRE Show Booth No. 191 or write Westboro, Massachusetts.

Helix recording simplified by new "assemble yourself" recorders.

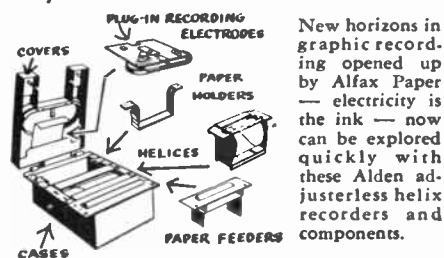

See the Alden Electronic and Impulse Recording Equipment Co. IRE Booth No. 189 or write Westboro, Mass.

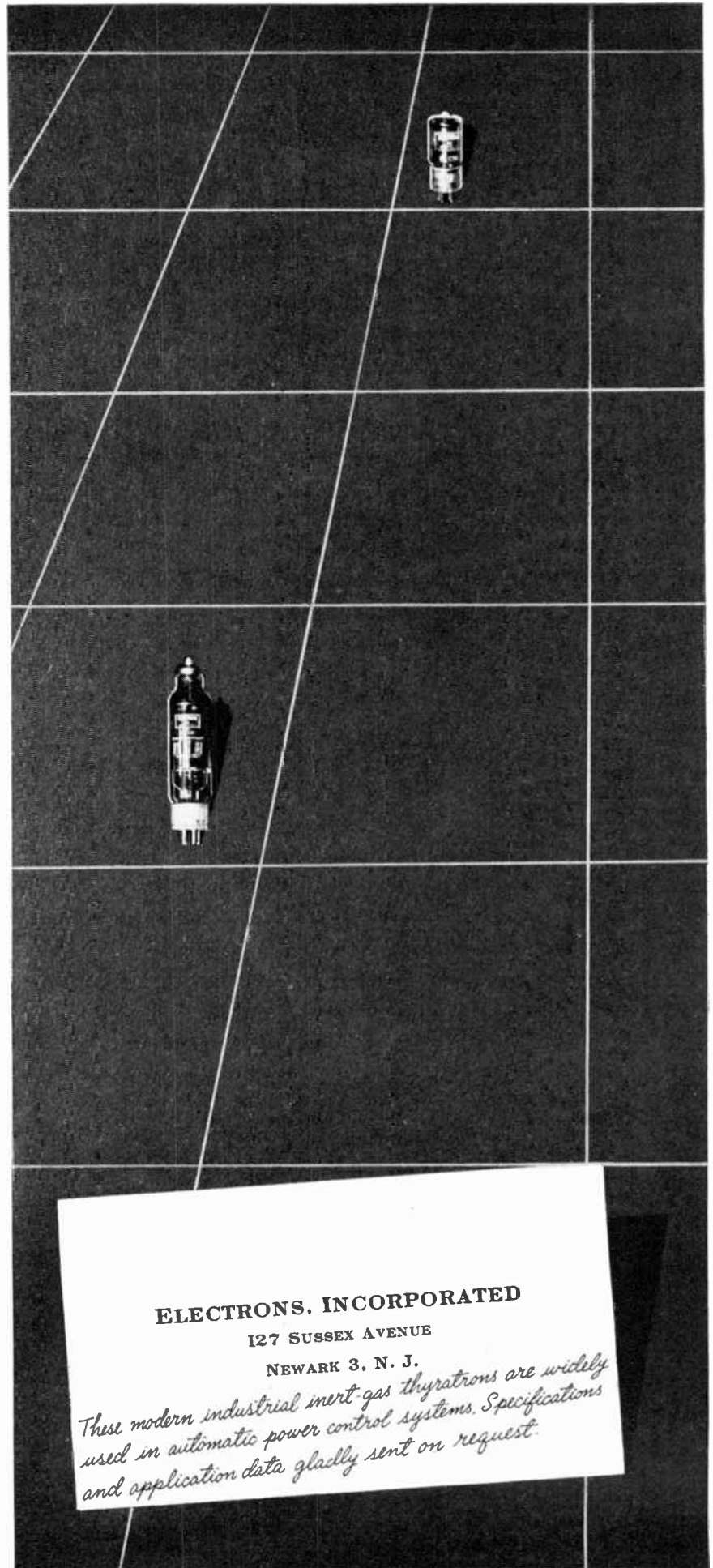

ELECTRONS, INCORPORATED

127 SUSSEX AVENUE
NEWARK 3, N. J.

These modern industrial inert-gas thyratrons are widely used in automatic power control systems. Specifications and application data gladly sent on request.

FORM-FLEX TRANSFORMERS

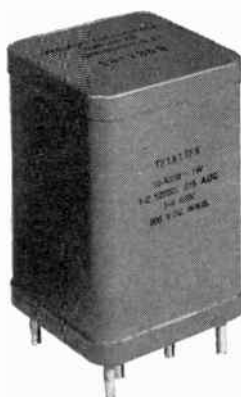

See How FORM-FLEX Saves!
CUTS WEIGHT BY 40%—BULK BY 30%

... gives Absolute Transformer Protection at Lower Cost

Pioneering the development of encapsulation in transformer manufacture has brought Aircraft Transformer a high degree of proficiency in the production of hermetically sealed high and low temp. transformers that far exceed the requirements of MIL-T-27, Grade I.

If you are faced with weight, space or cost limitations in your components, we invite you to explore the possibilities of our advanced methods. Our engineers and production people will gladly consult with you.

Write for complete data on transformer encapsulation with neoprene and other materials.

AIRCRAFT TRANSFORMER CORPORATION

Manufacturers of Inductive Equipment
Long Branch, New Jersey

What to See at the Radio Engineering Show

(Continued from page 356A)

Wind Turbine Co., 591, 593 Components
*Broadband Curtain Antenna. *Corner Reflector Antenna. Towers and Masts.

Workshop Associates, 193-195, Television Ave.

See Gabriel Company

Yardney Electric Corp. 765 Airborne Ave.

Yardney Silvercel®, world's smallest, lightest, mightiest storage batteries—silver-zinc alkaline cells featuring constant output voltage and high current drain capacities—*1/10th AH and 250 AH high-rate, long-life Cells. *AN 3151 and *AN 3154 size-equivalent, high-capacity aircraft batteries.

Ziff-Davis Publishing Co., 839 Audio Ave.

See "Radio-Electronic-Engineering."

*Indicates new product

Show Hours: Monday 10 AM-10 PM

Tuesday 10 AM-10 PM

Wednesday 10 AM- 5 PM

Thursday 10 AM-10 PM

CAPACITORS

**STABLE
RUGGED**

LOW LOSS

MINIATURE

LOW NOISE

VAPORPROOF

WIDE TEMP. RANGE

There are many kinds of capacitors . . . some stable . . . or rugged . . . or vaporproof . . . or tiny . . . some very good at averting loss or noise . . . or efficient over a wide temperature range. Some capacitors combine two, or even three of these features.

VITRAMON CAPACITORS GIVE YOU ALL 7

Only two materials go into Vitramon Capacitors . . . porcelain enamel for the dielectric and encasing insulation . . . fine-silver for the electrodes. Perfectly banded, the two become, effectively, one homogenous unit —

Stable over a Wide Temperature range.

The solid block of "quality crackery" in which the silver electrodes are immersed makes Vitramon Capacitors both

Rugged and vaporproof.

Pure materials plus perfect bonding combine to eliminate both

Loss and Noise.

Finally . . . Vitramon's unique construction allows for "layering" the electrodes so that much greater active dielectric area can be squeezed into the same cubic content . . . they're

Miniature.

ONLY VITRAMON GIVES YOU ALL 7

**IF YOUR CAPACITOR PROBLEM IS CRITICAL
WRITE TODAY FOR COMPLETE DATA...**



Two materials — a monolithic block of porcelain enamel and fine-silver electrodes — fused into one strong, stable, efficient and effectively homogenous unit.

Vitramon
INCORPORATED
BOX 544R • BRIDGEPORT 1 • CONN.



D. B. Sinclair (J'30-A'33-M'38-SM'43-F'43) has been appointed Vice-President for Engineering of the General Radio Company. Dr. Sinclair joined the company in 1936, after receiving the Doctor of Science degree from M.I.T. He has served the company as Engineer, Assistant Chief Engineer, and, since 1949, as Chief Engineer.



D. B. SINCLAIR

During World War II, Dr. Sinclair was associated with the National Defense Research Committee program under Dr. Vannevar Bush, working on radar countermeasures and guided missiles. For his work overseas on the former project, he received the President's Certificate of Merit.

He is a Fellow of the American Institute of Electrical Engineers, a member of the American Association for the Advancement of Science, and of Sigma Xi, honorary scientific fraternity.

(Continued on page 360A)

ANNOUNCING!

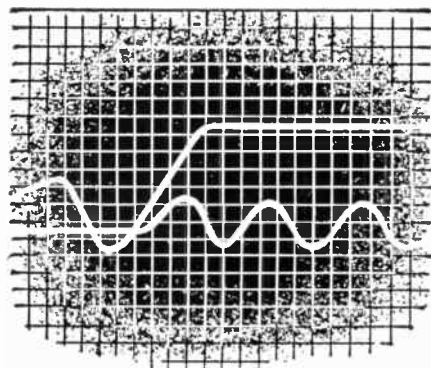

EPSC

EPIC FAST PULSE AND COUNTING EQUIPMENT

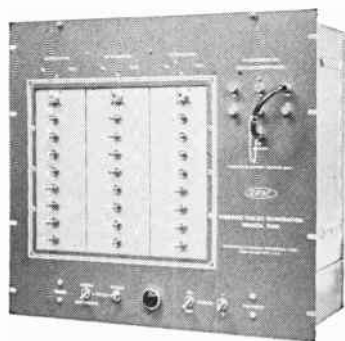

Proved Dependability In A Versatile Range Of Assemblies

0.001 MICROSECOND RISE TIME SQUARE PULSE GENERATORS

for the millimicrosecond to microsecond range.

0-10 MC DECADE AND BINARY SCALERS FULLY AUTOMATIC 0-10 MC NUCLEAR SCALERS with predetermined count, predetermined time operation, precision high voltage power supplies, preamplifiers and discriminators.

- PLUG IN COUNTING STRIPS
- 0.1 MICROSECOND COUNTER CHRONOGRAPHS
- PRECISION DC HIGH VOLTAGE SUPPLIES
- WIDE BAND AMPLIFIERS

ALSO CUSTOM DESIGNED EQUIPMENT TO MEET YOUR INDIVIDUAL REQUIREMENTS!

Write for detailed engineering bulletin No. 405

EPSC

ELECTRICAL AND PHYSICAL INSTRUMENT CORPORATION

Engineering Division

42-19 27th Street, Long Island City 1, N. Y.

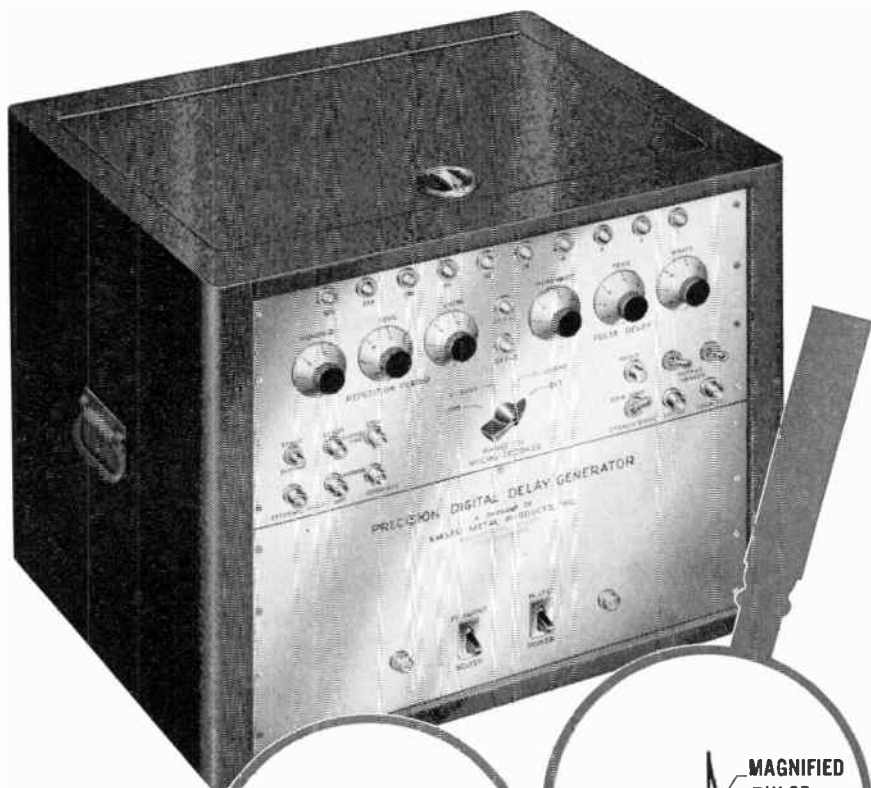

Observed pulse as viewed on a suitable synchroscope (magnification: 1000 to 1)

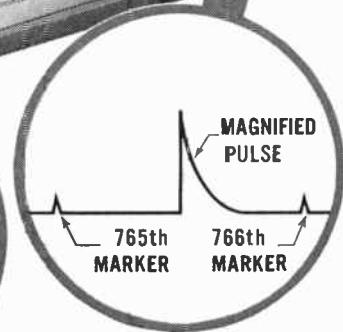

A Precision Digital Delay Generator Providing Accuracies of Better Than .01 in 1000 Microseconds

Through unique application of digital circuitry and crystal controlled stability, this new development enables you to achieve accuracies never before approached in a unit of this type.

Continuous calibration is unnecessary with digital circuitry. Self-contained decimal to binary converters save many hours of costly laboratory set-up time. This advance in delay generators has many applications. It can be used for accurately measuring time delays; as a radar simulator; for supplying

a single output pulse precisely delayed in time with respect to a reference pulse; as a secondary frequency standard, generating crystal controlled frequencies from 20 cycles to 1 megacycle in 3000 discrete steps; as an elapsed time indicator; and in many other similar functions.

Engineers working with radar, pulse circuitry, digital computer and navigational electronics find the Precision Digital Delay Generator an indispensable addition to the laboratory. Write for details.

FLEETWINGS DIVISION

KAISER METAL PRODUCTS, INC.

BRISTOL, PA.

IN THE HEART OF THE DELAWARE VALLEY

See us at the Radio Engineering Show, Booth #16, Kingsbridge Palace

NEW!

delay lines are 30% smaller

variable
if needed

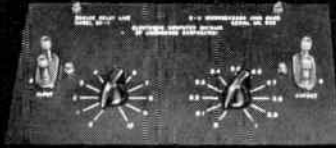

Designed to meet your needs!

NOTE THESE FEATURES!

- High figures of merit
- Low attenuation
- Stabilized delay over wide temperature ranges
- Custom built to military requirements

electronic computer division

UNDERWOOD CORPORATION



35-10 36th Avenue
Long Island City 6, N. Y.
Phone EX 2-3400



(Continued from page 358A)

A. M. Skellett (M'44-SM'50) has been named director of color television tube planning and development for Tung-Sol Electric Incorporated.



A. M. SKELLETT

For the past 25 years he has been active in the electronics industry in research and administration, including 15 years on the technical staff of Bell Telephone Laboratories. He has also served the government as a

consultant to the Research and Development Board of the Department of Defense. Among Dr. Skellett's patents is one for a radial beam tube which serves as an electronic commutator in military equipment and industrial instruments. Another, developed two years ago, is a magnetic tape pickup tube designed for recording equipment for high fidelity sound reproduction.

Dr. Skellett is a graduate of Washington University and received the A.B. degree in 1924 and the M.S., in 1927. Princeton University awarded him a Ph.D. degree in 1933. After graduation, he served two years on the University of Florida faculty, first as an instructor in electrical engineering and then as Assistant Professor of physics. Concurrent with his latter position, he was Chief Engineer of state-owned radio station WRUF in Gainesville, Fla.

He has written more than 30 articles and is a member of the American Physical Society and the American Astronomical Society.



M. V. Kiebert, Jr. (A'31-M'38-SM'43) has recently been appointed Assistant to the Chief Engineer of Convair, a division of General Dynamics Corporation, Pomona, California.

He was formerly Director of the Special Products Research Department of Bendix Aviation where he was in charge of the LOKI Missile Project and various other related Army Ordnance programs.



M. V. KIEBERT

He has had long association with guided missile programs and related activities having been a member of the Aeronautical Board, Guided Missile Committee while serving as a Commander in charge of the Guided Missile Branch, Electronics Division, Bureau of Aeronautics, U. S. Navy.

(Continued on page 363A)

"INDUSTRIAL" for ELECTRONIC COMPONENTS

Precision engineered electronic components and connecting devices for all your needs.

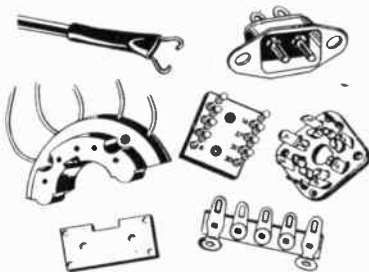

- LAMINATED SOCKETS
- TERMINAL STRIPS
- METAL AND BAKELITE STAMPINGS
- TERMINAL BOARD ASSEMBLIES
- TUNER STRIPS, SOCKETS AND BRACKETS FOR UHF
- DUD-DECAL SOCKETS
- ANODE CONNECTORS
- WIRED ASSEMBLIES

VISIT WITH
US AT THE
I.R.E. SHDW
BDDTH 579

Our extensive design and production facilities are available for developing your special requirements and applications. Representatives in principal cities throughout U.S.A. Write for samples and information. Dept. P-3.



INDUSTRIAL HARDWARE Mfg. Co., Inc.
109 PRINCE STREET • NEW YORK 12, N. Y.

MICO

**PANTOGRAPH
ENGRAVERS** for
Engraving Nameplates
Duplicating Master-copy
Fine Routing Work
Profiling Small Objects

Priced from
\$250 up



**TOROID COIL WINDERS
UHF COAXIAL WAVEMETERS
FERRITE-CORED TRANSFORMERS
AND INDUCTORS**

Send for Illustrated Catalogs

MICO INSTRUMENT CO.

79 Trowbridge St. Cambridge 38, Mass.



ultra-sensitive relays

help solve control problems in wide range of industrial applications



Operating on input powers of 50 to 1000 microwatts, the Barber-Colman Micro-positioner is ideal for use as a null detector in resistance bridge circuits, a differential relay in electronic plate circuits, and an amplifier in photo-electric circuits. Standard contact arrangement is SPDT, null seeking. Can be operated in excess of 100 cps. This ultra-sensitive polarized d-c relay has been widely used in many control applications . . . in nucleonics, communications, instrumentation, process control, railway signal transmission, and aircraft temperature control and remote positioning. Write for Bulletin F 3961-4.

See demonstrated at
IRE SHOW — BOOTH 783
New York City, March 21-24

Barber-Colman Company
Dept. O, 1456 Rock Street, Rockford, Illinois

New at EBY

BOOTH 577 IRE SHOW

- Color TV Sockets and Components**
- High Voltage Sockets**
- UHF Sockets—Radiation Sockets**
- Printed Circuit Sockets and Components**
- Printed Circuits**
- Rack and Panel Connectors**
- Computer Components (Complete Plug-In Units)**
- Sub-Miniature and Miniature Sockets**
- Custom Molded Components**
- Switches—Push**
- Collector Rings and Commutators**

Plus the complete standard line of Eby Components.

**BOOTH 577
IRE SHOW**

HUGH H. EBY CO.

4702 Stenton Avenue, Philadelphia 44, Pa.



SEE AT THE I.R.E. SHOW!

$\frac{1}{16}$ " I.D. Toroids . . .
Bobbin and Transformer Coils . . .
Toroidal Taping . . .
wound on these revolutionary
BOESCH Winding Machines

SUBMINIATURE TOROIDAL WINDER
winding $\frac{1}{16}$ " I.D. fine-wire Toroids

AUTOMATIC TOROIDAL WINDER
sector winding with
variable speed control

AUTOMATIC TOROIDAL WINDER
360° winding with 7" shuttle
and variable speed control

SEMI-AUTOMATIC TOROIDAL WINDER
4" shuttle with
variable speed control

TOROIDAL TAPE WINDER
winding Mylar Tape

BOBBIN WINDER

TRANSFORMER COIL WINDER

All these machines will be
demonstrated at booths 705 and 802

Write or wire today for additional information
Teletype: Danbury 468



BOESCH
MANUFACTURING CO., INC.
DANBURY, CONN.

A NEW ALLISON FILTER... CUT-OFFS DOWN TO 15 CPS

The Model 2A CONTINUOUSLY VARIABLE PASSIVE NETWORK AUDIO FREQUENCY FILTER

NO VACUUM TUBES • NO POWER SUPPLY

Another Allison First... the Model 2-A Filter engineered for extreme low frequency application, ranges from 15 cps to 10,000 cps. It is a modified version of the tested and proven ALLISON Model 1-A Filter.

FEATURES

- Low Pass, High Pass and Band Pass with Continuously Variable Frequency from 15 to 10,000 cps.
- Passive Network... No Power Supply, No Vacuum Tubes.
- Low Loss... Approximately 1 db. in Pass Band.
- High Attenuation Outside Pass Band... 30 db/octave.
- Maximum Input 5 Watts.
- Designed for 600 Ohm Circuits.



Model 2-A Filter
(15 to 10,000 cps.)

395⁰⁰

Model 2-B Filter
(60 to 20,000 cps.)

295⁰⁰

PRICES F.O.B. FACTORY

Write for Engineering Bulletin
with Complete Technical Data.



allison laboratories

14184 SKYLINE DRIVE • PUENTE, CALIFORNIA

Representatives in Principal Cities.

COMING
SOON!

DRAKE SOLDER DIP POTS

For Printed
Circuits

(THERMOSTAT
CONTROLLED)



DRAKE INDUSTRIAL SOLDERING EQUIPMENT



VAPOR-PROOF IRONS

Sealed elements impervious to flux and other vapors. Field-proved longer life, greater efficiency. Heat radiating fins. 125 watts— $\frac{3}{8}$ " tip... 225 watts— $\frac{1}{4}$ " tip.

THERMOSTATIC HEAT CONTROL

- Keeps any iron at right temperature.
- Removes oxide with twist of wrist.
- Increases operator's efficiency.
- Protects against fires and burns.
- Assures longer service life for irons.
- Cuts operating costs.

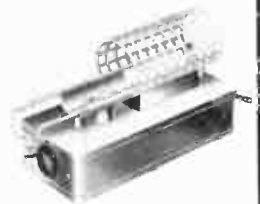

SOLDER POTS

A range of sizes and shapes for every requirement of production soldering. Long-lasting, replaceable elements. Superior Drake quality throughout. Detachable cords and plugs.



Coming Soon—Thermostatic Controlled Solder Dip Pots for Printed Circuits

Write today for catalog

DRAKE ELECTRIC WORKS, INC. 3656 LINCOLN AVENUE
CHICAGO 13, ILLINOIS

(Continued from page 360A)

During this period, Mr. Kiebert was responsible for technical design and coordination of the guidance and control problems of LARK, the initiation of the SPARROW project, major Navy computer projects, and Military Standardization programs in Telemetry. He has served on a number of panels and committees relating to missile, rocket and aeronautical electronics activities. He is a member of the Institute of the Aeronautical Sciences, the American Institute of Electrical Engineers, the American Ordnance Association, the American Rocket Society, the Society of Motion Picture and Television Engineers, the Franklin Institute, the Engineering Society of Detroit, and the Audio Engineering Society. He is also National Chairman of the Professional Group on Telemetry and Remote Control.



R. C. Johnson (A'50), an engineer with the Alaskan Air Command, was recently presented the Meritorious Civilian Service award by Major General George R. Acheson, commander of the Alaskan Air Command. The award to Johnson was one of only two such awards ever presented in this overseas theater.

Mr. Johnson was presented the award for his chairmanship of the Traffic and Circuit Requirements Panel to the Alaskan Communications Study Group. This panel "established an integrated point-to-point communications circuit to tie in radar sites to military base areas in the Territory." Mr. Johnson recommended that all government and civil communication requirements be consolidated into a single, multi-channel system to prevent duplication in engineering, manpower, equipment and circuits. The recommendation was then approved by Washington officials.

Prior to his arrival in Alaska in 1950, Mr. Johnson was employed by the Bell Telephone and Telegraph Company in Boston for 15 years. A native of Harmony, Maine, Johnson graduated from the University of Maine in 1930. He is a member of the American Institute of Electrical Engineers.



J. E. Gall (A'37-VA'39) has been awarded the Navy's highest civilian award for his "outstanding" work in the development of improved electronic techniques and equipment. Mr. Gall is an electronics engineer with the Army Signal Corps in Washington.

The award was made by Assistant Secretary of the Navy James H. Smith and the citation reads:

"By your outstanding achievements in the development of improved electronic techniques and equipment while employed in the Naval Research Laboratory, Washington, D. C., you have made exceptionally significant contributions to the Navy. Your appreciation of human engineering

(Continued on page 365A)

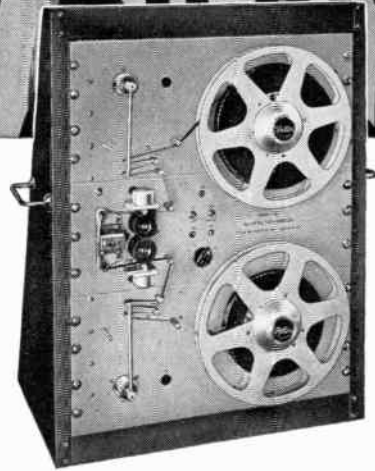
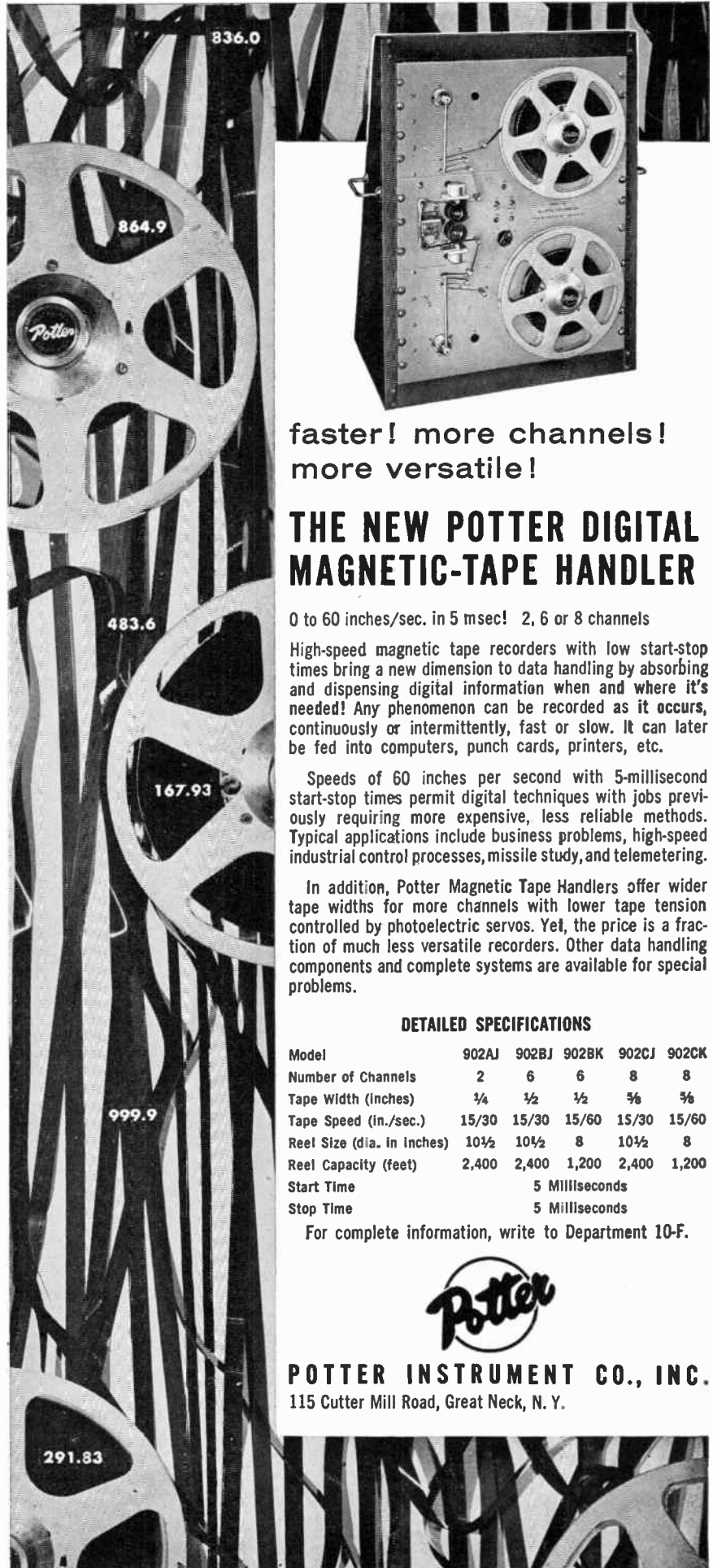

**faster! more channels!
more versatile!**

THE NEW POTTER DIGITAL MAGNETIC-TAPE HANDLER

0 to 60 inches/sec. in 5 msec! 2, 6 or 8 channels

High-speed magnetic tape recorders with low start-stop times bring a new dimension to data handling by absorbing and dispensing digital information when and where it's needed! Any phenomenon can be recorded as it occurs, continuously or intermittently, fast or slow. It can later be fed into computers, punch cards, printers, etc.

Speeds of 60 inches per second with 5-millisecond start-stop times permit digital techniques with jobs previously requiring more expensive, less reliable methods. Typical applications include business problems, high-speed industrial control processes, missile study, and telemetry.

In addition, Potter Magnetic Tape Handlers offer wider tape widths for more channels with lower tape tension controlled by photoelectric servos. Yet, the price is a fraction of much less versatile recorders. Other data handling components and complete systems are available for special problems.

DETAILED SPECIFICATIONS

Model	902AJ	902BJ	902BK	902CJ	902CK
Number of Channels	2	6	6	8	8
Tape Width (inches)	¼	½	½	¾	¾
Tape Speed (in./sec.)	15/30	15/30	15/60	15/30	15/60
Reel Size (dia. in inches)	10½	10½	8	10½	8
Reel Capacity (feet)	2,400	2,400	1,200	2,400	1,200
Start Time	5 Milliseconds				
Stop Time	5 Milliseconds				

For complete information, write to Department 10-F.



POTTER INSTRUMENT CO., INC.
115 Cutter Mill Road, Great Neck, N. Y.

LIGHT

RUGGED

traveling-wave tubes

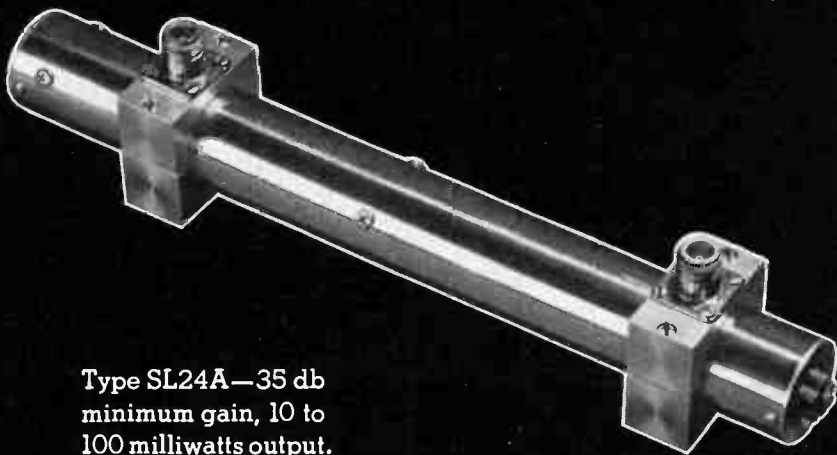

Type SL24A—35 db minimum gain, 10 to 100 milliwatts output.

A series of tubes, as illustrated, is available, operating from 2 to 12 kilomegacycles—also complete amplifiers.

Note that the unit shown combines solenoid and tube with a total weight of only four pounds.

Write for detailed information.

An unusually comprehensive research facility is maintained at SLC for contract work in many phases of applied physics.



KLYSTRONS • PARTICLE ACCELERATORS

HENRY P. SEGEL'S

*New Building
Creates an Entirely
New Concept in*

MANUFACTURERS' REPRESENTATION

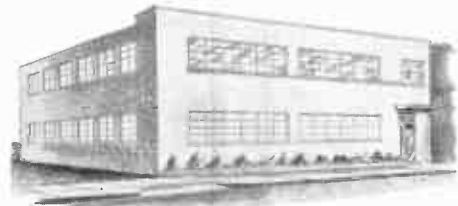

This architect's sketch illustrates the new headquarters building now under construction by the HENRY P. SEGEL COMPANY in Brookline (Boston Postal District) Massachusetts.

Here in these air-conditioned surroundings, industrial users and distributors will be able to view complete displays, inspect samples and obtain sales and engineering counsel regarding products made by the following manufacturers:

- BUD RADIO, INC.
- CAMPBELL INDUSTRIES, INC.
- CIRCUITRON, INC.
- CLAROSTAT MFG. CO., INC.
- CONNECTICUT TELEPHONE & ELECTRIC CORP.
- FREED TRANSFORMER CO., INC.
- GARDE MANUFACTURING COMPANY
- TV PRODUCTS COMPANY
- THE TURNER COMPANY

This modern building is strategically located in close proximity to all major routes in and out of Metropolitan Boston, the country's leading research and development center. A thorough survey of the New England market indicates that this structure will provide a long-needed facility to properly serve the requirements of the industry.

Manufacturers, wherever located, interested in having a type of representation in New England which will fulfill ALL requirements with vision and efficiency, plus warehousing facilities if desired, are invited to write for further information about this far-sighted and aggressive project.

HENRY P. SEGEL

Company Inc.

131 Newbury St., Boston 16, Mass.
Phone: KEnmore 6-3012, 6333, 9755



(Continued from page 363A)

problems, complex electronic equipment and operational needs, has resulted in noteworthy pioneering accomplishment in the field of signal analysis. The new and revolutionary signal analysis equipment development on the basis of your endeavor has met with continuing success and has culminated in the production of valuable electronic equipment now in use by various components of the Armed Services. For these reasons, you are richly deserving of the Navy's Distinguished Civilian Service Award."

Mr. Gall, a native of Trenton, New Jersey, joined the Naval Research Laboratory in 1940, following work as an engineer with several radio manufacturing companies. He transferred to the Navy's Bureau of Aeronautics in 1950, and, in 1953, to the Army Signal Corps. Mr. Gall attended Purdue, Northwestern and George Washington universities.



Vincent Salmon (SM'46), manager of Stanford Research Institute's sonics section, has been appointed editor of the "Journal of the Audio Engineering Society." He succeeds Lewis S. Goodfriend, now editor of "Noise Control" published by the Acoustical Society of America. The journal deals with advances in techniques and instruments for high fidelity recording and reproduction of sound, in studio acoustics, audio components and measuring gear, public address and stereophonic sound systems design and in electronic musical instruments.

Before joining SRI in 1949, Dr. Salmon headed research and development at Jensen Radio Manufacturing Company, where he worked on horn theory, multiple-source loudspeaker units and the design of devices used in radar countermeasures.

In 1946 Dr. Salmon received the biennial award of the Acoustical Society of America for the invention of a new family of horns. He is a Fellow of the AES and ASA.



E. C. Ballentine (A'25-M'29-SM'43) has been promoted to Director of Engineering for KORCAD, RCA distributors for Korea. In his new position he is responsible for all engineering activities and policies of the new company. Mr. Ballentine is also serving as consulting engineer for several associated companies in Korea.



E. C. BALLENTINE

A graduate of the University of North Carolina

with the B.S. degree in electrical engineering, he was, for a number of years, with General Electric Company.

(Continued on page 366A)

new
non-slip lacing tape

GUDELACE - H*
rubber-coated nylon

FUNGUS-RESISTANT... FLAME-RESISTANT

This new braided nylon lacing tape has a unique rubber coating to prevent slipping. It is easy to handle, ties securely, speeds production because knots stay put!

Another Gudebrod development!

Write for complete information
and a free trial supply today.

GUDEBROD BROS. SILK CO., INC.

ELECTRONICS DIVISION

EXECUTIVE OFFICES

225 W. 34th Street, New York 1, N.Y.

12 S. 12th Street, Phila. 7, Pa.

*T.M.

**HEYCO NYLON STRAIN RELIEF BUSHINGS
CUT PRODUCTION COSTS AND IMPROVE
PRODUCT QUALITY**

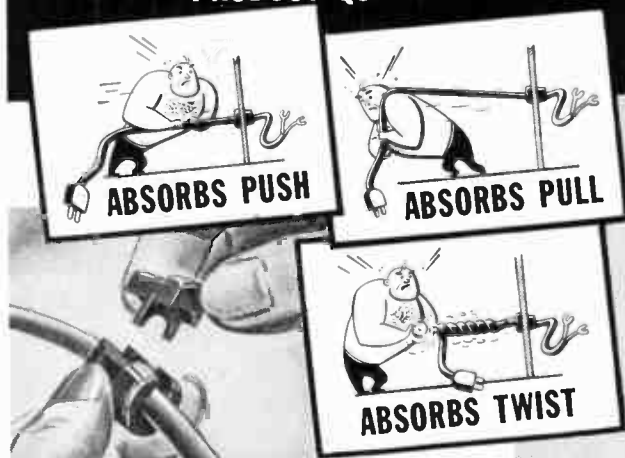

1—SLIP OVER WIRE
2—SNAP INTO HOLE

Approved

With Heycos it's no longer necessary to tie wire knots or use insulating grommets. Product life is increased and product appearance is greatly enhanced.

HEYMAN MANUFACTURING COMPANY
Kenilworth 7 New Jersey



Send wire sizes for free
samples and specifications.





"Sure, We'll Ship From Stock!"

ENGINEERS • TECHNICIANS •
DEPEND ON HUDSON

FOR
COMPLETE STOCKS
COMPLETE SERVICE

Call HUDSON
Central Office **Circle 6-4060**

Yes, you'll get TOP SERVICE, every time you write or phone — Because, as one of the largest distributors in the East, HUDSON is GEARED to serve the needs of industrial Users of Electronic equipment and components. You can count on HUDSON for:

- Huge and Complete Stocks of all Standard Brands.
- Technically Trained Telephone Staff.
- Engineering Consultation Service.
- Outside Sales Staff.

1955 HUDSON MASTER CATALOG 1000 page reference work, needed by every Engineer, Technician, Purchasing Agent. Send today, on company letterhead for your FREE COPY. Dept. P-3.

AUTHORIZED FACTORY DISTRIBUTORS
Hudson
RADIO & TELEVISION CORP.
ELECTRONIC & SOUND EQUIPMENT

Central Office:
48 West 48th Street
New York 36, N. Y.
Phone: Circle 6-4060

Convenient
Warehouses
in New York
and New Jersey

RCA
REGISTERED DISTRIBUTOR
TRANSMITTING AND RECEIVING TUBES, BATTERIES, TEST EQUIPMENT & COMPONENTS



WESGO... for the best vacuum tube ceramic



WESGO AL-300
a very high alumina ceramic

Non-gassing at elevated temperatures • Extremely high strength • Very low loss at all frequencies • Vacuum tight • Very high bond strength to a "moly-manganese" metallized coating • Ceramics molded or ground to precise tolerances.

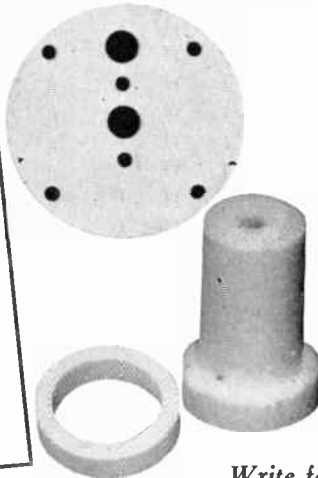

Write for additional information

WESTERN GOLD & PLATINUM WORKS
589 BRYANT • SAN FRANCISCO 7, CALIF.



(Continued from page 365A)

G. K. Teal, Assistant Vice-President, has been appointed to head the Research Division of Texas Instruments Incorporated. As Assistant Vice-President for Research, he now has charge of all research; the work involving many phases of electronics and geophysics. Previously he headed the Materials and Components Research Department, with primary responsibility for semiconductor research.



G. K. TEAL

Dr. Teal was associated with Bell Telephone Laboratories for 22 years before coming to Texas Instruments in January of 1953. He has conducted research in photoelectricity, secondary emission, photoconductance, electron multipliers, silicon carbide varistors, heavy hydrogen, germanium and silicon rectifiers, microwave attenuators, borocarbon resistors, germanium and silicon single crystals, and transistors. He has some 46 patents granted or applied for as a result of his research in these fields.

A native Texan, Dr. Teal was born in Dallas and was graduated from Baylor University in 1927. He received the Master's and Doctor's degrees in chemistry from Brown University, and later was research associate in Prof. Harold C. Urey's laboratories at Columbia University. He is a member of the American Chemical Society, American Physical Society, the Texas Academy of Science, Sigma Xi, and is presently Secretary-Treasurer of the Dallas-Fort Worth section of the I.R.E.

Servomechanisms, Incorporated has named Robert Tate (A'53) to the position of Sales and Service Manager for its Eastern Division. Prior to this appointment, Mr. Tate, who is well known in the field of aircraft instrumentation and control, was Contracts and Service Manager for Kearfott Company, Incorporated.



ROBERT TATE

Mr. Tate is a member of the Institute of Navigation and the American Ordnance Association.

H. H. Newby (A'50-M'51), Chief Engineer for KAKE Radio since it went on the air seven years ago, has been confirmed as

(Continued on page 368A)

**for EFFICIENCY
for SALES APPEAL**

Drake Signal and Jewel Light Assemblies will serve you better—that's why so many well-known appliances have used them for years..

DRAKE

Assemblies are known for *expert design, patented features, top performance*—used by leading manufacturers in many fields—produced with the skill which comes with more than 20 years of specialization.. **DRAKE** can help you select or develop the unit which will do most for your appliance in both production and sales..

**LET
DRAKE
QUOTE ON
YOUR NEEDS...**

**STYLES, SIZES, COMBINATIONS OF
ALL KINDS!**

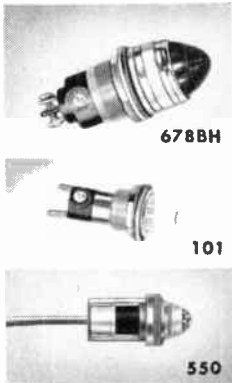

It's usually easy to select the exact unit to serve you best from those already available in the big **DRAKE** line.. But we can develop a special design for you if required, as we have done for dozens of users.

★
**SEE US AT
BOOTH 812
I.R.E. SHOW**



**DRAKE
MANUFACTURING
COMPANY**

1711 West Hubbard Street
CHICAGO 22, ILLINOIS

*Socket and Jewel
LIGHT ASSEMBLIES*



Now you can
WELD almost any electronic assembly

Ultra-fine whiskers in semi-conductor devices, shunts and header pins in relays, slit and filament assemblies for isotron and mass spectrometer guns, and electronic sub-assemblies of wide variation are now reliably and precisely joined at greatly increased production rates by the **WELDMATIC** Model 1015.

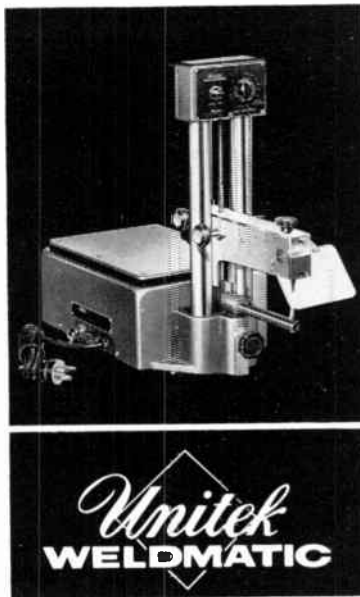

The **WELDMATIC** Model 1015 is a bench-mounted precision resistance welder, compactly self-contained. Weldmatic's stored-energy principle permits welding of copper, silver, high-carbon steel, tungsten, molybdenum, and other "difficult" materials. Weldmatic millisecond weld-time insures reliable welds without discoloration, excessive deformation, or metallurgical change. Dissimilar metals and parts of widely different thicknesses are joined with ease. The Model 1015 performs outstandingly in both laboratory and production line operation.

SEE THE COMPLETE WELDMATIC LINE DEMONSTRATED. VISIT BOOTH 817, AUDIO AVENUE, KINGSBRIDGE ARMORY • I. R. E. SHOW • MARCH 21-24, 1955

UNITEK CORPORATION

256 North Halstead Pasadena 8, California



ABOVE ALL... U. S. C. CONNECTORS



HEAVY DUTY CONNECTORS

980-34F2
980-34HRSL 980-34M2SL



For use on rack and panel type equipment in communication and power circuits. U. S. C. heavy duty multi-contact connectors offer

- Maximum number of heavy current contacts
- Mechanical and electrical dependability of operation in a minimum of space.
- available 7 to 34 contacts

PRINTED CARD RECEPTACLES

UPCR-18



U. S. C. Printed Card Receptacles offer

- Channel Strength and Snap-in Contacts
- Dependability of operation over range of printed card thickness
- Available - Single and double Row, Wire Solder and Wire Wrap - From 6 to 44 contacts

MINIATURE CONNECTORS

MI-34F MI-34M



For Multi-Contact Plug-in

- Maximum Strength
- Dependable Electrical Performance
- Minimum of Space
- Available 5 to 75 contacts

Over 1000 types available

Write us for information on your connector problems



U. S. COMPONENTS, Inc.

Associated with U. S. Tool and Mfg. Co., Inc.
454-462 East 148th Street, New York 55, N. Y. CYPress 2-6525-6



(Continued from page 366A)



H. H. NEWBY

Chief Engineer for KAKE-TV, Wichita's first VHF station to begin telecasting operations. He has been in charge of engineering operations since last May.

Separate transmitting and studio plants are now under construction. A 50 kw RCA transmitter and 1,000 feet Parkersburg tower topped by a 12-bay RCA antenna are a part of the station's equipment. A three-quarter million dollar facility in the city houses operations. The main studio measures 60 by 80 feet and a second studio is 40 by 30 feet.

L. M. Orman (SM'52) has been made Chief of the Fire Control Division, Development and Proof Services, Aberdeen Proving Ground, Md. Colonel Orman's division is responsible for acceptance testing and development work on the Army's fire control systems.



L. M. ORMAN

Last year he held the position of Head of Test Group OCAFF Bd #4, Fort Bliss, Texas. He is the author of "Electronic Navigation" and many articles in service journals on radar and related subjects.

Lt. Col. Orman holds the B.S. degree from the U. S. Military Academy and the M.S. degree from the Moore School of Electrical Engineering, University of Pennsylvania.

Promotion of R. L. Rod (S'42-A'43-M'46-SM'50) to assistant to Vice-President of Bogue Electric Manufacturing Company has been announced.



R. L. ROD

Mr. Rod will assist J. A. Herbst, Vice-President-Engineering, in the administration of engineering activities of the firm.

Previously, Mr. Rod was Assistant Director of Research and Development and headed the company's activities in the development of electronic devices. Before joining Bogue in 1951, he was associated with Melpar, Incorporated and Radiomarine Corporation of America. He has assisted in the development of radar, microwave communications systems and ultrasonic instruments.

For the Communications Industry

A NEW SINGLE-SIDEBAND TRANSMITTING SYSTEM

It is now possible to adapt AM transmitters to twin-channel single-sideband telephone, telegraph and facsimile operation. Single-Sideband operation, besides providing additional channels, improves the signal-to-noise and jamming ratios, as well as appreciably reducing fading effects. This new system uses Class-C amplifiers and therefore is the most efficient and non-critical method of producing single-sideband waves.

We also have available a new system for producing Phase-Locked FSK waves and by the use of this equipment up to 12 channels of teletype may be transmitted over one transmitter.

KAHN RESEARCH LABORATORIES

Elizabeth Bldg., 22 Pine St.
Freeport, L.I., New York
Freeport 9-8800

Export: RCA International
30 Rockefeller Plaza, New York 20, N.Y.

Microwave Development Laboratories INTRODUCES the Hughes H-Plane Folded T



The outstanding H-plane folded hybrid T, invented and licensed by the Hughes Aircraft Company, is now made available in production quantities by the Microwave Development Laboratories. Aluminum or beryllium copper precision castings, terminated in flat flanges, available in two classes of performance in the frequency range 8500-9600 mcs for RG 52/U waveguide.

	Standard	Special
V.S.W.R.: (all arms)	≤1.12	≤1.1
Isolation: (⊥ arms)	≥40 db	≥45 db
Isolation: (// arms)	≥28 db	≥30 db
Power Balance: equal	±.1 db	equal ±.1 db
Peak Power:	250 K.W.	250 K.W.

Send for complete data, prices, and delivery information. See new Microwave developments at Booth 377, the IRE Show.



Microwave Development Laboratories, Inc.
92 Broad St., Wellesley 57, Mass.

design • development • manufacture

COMMUNICATIONS EQUIPMENT CO.

MICROWAVE COMPONENTS

10 CM.—RG48/U Waveguide

10CM ECHO BOX: Tunable from 3200-3333 Mc. For checking out radar transmitters, for spectrum analysis, etc. Complete with pickup antenna and coupling devices. \$17.50

POWER SPLITTER (for use with type 726 or any 10 CM Shepher Klystron. Energy is fed from Klystron antenna through dual pick-up system to 2 type "N" connectors. \$12.50

LHTR, LIGHTHOUSE ASSEMBLY: Parts of RT39 APG 5 & APG 15, Receiver and Trans. Cavities w/assoc. Tr. Carvly and Type N CP/G. To Recv. Uses 2C40, 2C43, 1B27. Tunable APX 2400-2700 M/C'S. Silver Plated. \$15.00

BEACON LIGHTHOUSE cavity p/o DPN-2 Beacon 10 cm. Mfg. Bernard Bloch each. \$27.50

MAGNETRON TO WAVEGUIDE Coupler with 721-A Duplexer Cavity, gold plated. \$31.50

721A TR BOX complete with tube and tuning plungers. \$12.50

MCGALLY KLYSTRON CAVITIES for 707B or 2K28, 2700-2900 Mc. \$4.00

AS14A AP-10 CM Pick up Dipole with "N" Cable. \$4.50

HOLMDELL-TO-TYPE "N" Male Adapters, W. E. 2D167284. \$2.75

I.F. AMP. STRIP: 30 MC, 30 db. gain, 4 MC Band-width, uses 6AC7's—with video detector. A.P.C. less tubes. \$17.50

BEACON ANTENNA, AS31/APN-7 In Lucite Ball. Type "N" feed. \$22.50

ANTENNA, AT49A/APR: Broadband Conical, 300-3300 MC Type "N" Feed. \$12.50

"E" PLANE BENDS, 90 deg. less flanges. \$7.50

3 CM.—RG 52/U Waveguide

3CM. DIPOLE FEED, 15" L. for APS-15. \$14.50

MITRED ELBOW, Cast aluminum, 1 1/4" x 5/8" W.G. W.E. Flanges, "E" Plane. \$3.50

FLEX. WAVEGUIDE SECTION, 1 ft. long. With UG-40 UG-39 flanges. Attenuation is less than 0.1 db. at 9375 mc. and VSWR is less than 1.02. \$7.50

3 CM. ANTENNA ASSEMBLY: Uses 17" paraboloidal dish, operating from 24 vdc motor. Beam pattern: 5 deg. in both Azimuth and elevation. Sector Scan: over 160 deg. at 35 scans per minute. Elevation Scan: over 2 deg. Tilt: Over 24 deg. \$35.00

Cross-Guide Directional Coupler, UG-40 output flange. Main Guide is 6" Long, with 90 Deg. "E" Plane bend at one end, and is fitted with Std. UG 39/UG 40 flanges. Coupling figure: 20 db Nominal. \$22.50

RG52/U Waveguide in 5' lengths, fitted with UG 39 flanges to UG40. Silver plated. per length \$5.00

Rotating Joints supplied either with or without deck mountings. With UG39 flanges. each. \$17.50

Bulkhead Feed-thru Assembly. \$15.00

Pressure Gauge Section with 1 1/2" gauge. \$10.00

Directional Coupler, UG-10 U Take off 20db \$17.50

MAGNET AND STABILIZER CAVITY For 2141 Magnetron. \$24.50

Rotary joint choke to choke with deck mounting. \$17.50

90 degree elbows. "E" plane 2 1/2" radius. \$8.50

ADAPTER, waveguide to type "N", UG R1-F, 1/2" to TS 12. \$7.50

ADAPTER, UG-163/U round cover to special I.T.L. Flanges for TS 45, etc. \$2.50 ea.

PULSE NETWORKS

15A-1-400 50 15 KV "A" CRT 1 microsec 400 PPS. 50 ohms Imp. \$22.50

G.E. 23E (3.25/810) 8.2/4 4051 50P4T 3KV "E" CRT Dual Unit: Unit 1, 3 sections. 0.84 Microsec. 100 PPS, 50 ohms Imp.; Unit 2, 8 Sections. 2.24 microsec. 405 PPS 50 ohms Imp. \$36.50

7-5E3-1-200-67P. 7.5 KV "E" Circuit. 1 microsec. 200 PPS. 67 ohms impedance 3 sections. \$7.50

7-5E4-16-60. 67P. 7.5 KV "E" Circuit. 4 sections 16 microsec. 60 PPS. 67 ohms impedance. \$15.00

7-5E3-3-200-67P. 7.5 KV "E" Circuit. 3 microsec. 200 PPS. ohms Imp. 3 sections. \$12.50

H-616 10KV. 2.2 usec. 375 PPS. 50 ohms Imp. \$27.50

H-615 10KV. 0.85 usec. 750 PPS. 50 ohms Imp. \$27.50

KS8865 CHARGING CHOKE: 115-150 H @ .02A 32 —1011 @ .08A. 21KV Test. \$37.50

G.E. 25E5-1-350-50 P2T. "E" SKT. 1 Microsec. Pulse usec @ 60/000 PPS. Pk. Power 200/150 KW. \$59.50

KS9623 CHARGING CHOKE: 16H @ 75 MA. 380 Ohms DCR. 9000 Vac test. \$14.95

G.E. 6E3-5-2000 50 P2T: 6 KV. "E" Circuit 0.5 usec /2000 PPS/50 ohms/2 sections. \$7.50

PULSE TRANSFORMERS

GE 2K2748-A. 0.5 usec @ 2000 PPS. Pk. Pwr. out is 32 KW. impedance 40-100 ohm. Pri volts 2.3 KV Pk. Sec. volts 11.5 KV Pk. Bifilar rated at 1.3 Amp. Fitted with magnetron well. \$24.50

K-2745 Primary: 3.1/2.8 KV. 50 ohms Z. Secondary: 14/12.6 KV. 1025 ohms Z. Pulse Length: 0.25/1.0 usec @ 60/000 PPS. Pk. Power 200/150 KW. Bifilar. 1.3 Amp. Has "built-in" magnetron well. \$32.50

K-2461-A. Primary: 3.1/2.6 KV—50 ohms (line). Secondary 14/11.5 KV—1000 ohms Z. Pulse Length: 1 usec @ 600 PPS. Pk. Power Out: 200/130 KV Bifilar. 1.3 Amp. Fitted with magnetron well \$29.50

I. F. AMPLIFIER STRIPS

Model 15: 30 Mc center frequency. Bandwidth 2.5 Mc. Gain figure: 65 db. Uses 5 stages of 6AC7's. Has D. C. Restorer and Video Detector. A.P.C. Strip Included. Input impedance: 50 ohms. Less tubes. \$17.50

60 MC. Miniature VIF strip, using 6AK5's 60 Mc center Freq. Gain: 95db at Bandwidth of 2.7 Mc. New. Complete with tubes. \$17.50

DELAY NETWORKS

D-168184: 0.5 usec. up to 2000 PPS. 1800 ohms. \$4.00

D-170499: 0.25/5475/usec. 8 KV., 50 ohms. \$8.50

D-165997 Delay 1.25 usec. 2000 PPS. \$3.50

RCA 2255686-502: 1.7 usec. 1400 ohm impedance \$2.00

D-162311. Delay of 0.5 usec. 72 ohms with 4 MC. Bandwidth. \$4.75

D-168435. Delay 0.5 usec. 555 ohms. 5mc. BW. \$4.50

D-172578. 410 ohms Imp. 0.22 usec. Delay. \$4.75

D-150979: Oscillating network. Oscillates at 81.955 mc. When normal current of 10ma. is interrupted. Has built-in temperature control for stability. Assembled in shielded can 3" L x 4" Diam. \$4.35

MAGNETRONS

Type	Peak Range (MC)	Peak Power Out (KW)	Duty Ratio	Price
2J21A	3345-9405	50		\$ 8.75
2J22	3267-3333	265		7.50
2J26	2992-3019	275	.002	7.49
2J27	2965-2992	275	.002	13.50
2J29	2914-2939	275	.002	24.95
2J31	2820-2860	285	.002	21.50
2J32	2780-2820	285	.002	21.50
2J38*	3249-3263	5		8.50
2J39*	3267-3333	6,7		8.50
2J48	910-9320	50	.001	24.00
2J49	9000-9160	50	.001	54.50
2J56*	9215-9275	50	.001	132.50
2J62*	2914-3010	35	.002	32.50
3J31	24-27K MC	50	.001	85.00
4J34	2740-2780	900	.001	87.50
4J38	3550-3600	750	.001	125.00
4J42†	670-730	30	.003	160.50
5J23	1044-1056	475	.001	49.50
700B	690-700	40	.002	22.50
700D	710-720	40	.002	39.75
706EY	3038-3069	200	.001	32.50
706CY	2976-3007	200	.001	39.50
OK259†	2700-2900	800	.001	249.50
OK60†	2840-3005	100	CW	65.00
OK61†	2975-3170	100	CW	65.00
OK62†	3135-3350	100	CW	65.00

*—Packaged with magnet.
†—Tunable over indicated range.

TEST EQUIPMENT

- L&N #1553 RATIO BOXES.....\$275
- ESTERLINE-ANGUS RECORDING MILLIAMMETERS, 0-1 MA.....\$155

400 CYCLE TRANSFORMERS

(All Primaries 115V 400 Cycles)

KS13101	6.3V/15A, 6.3V/0.9A, 6.3V/0.4A, 6.3V/0.2A	\$ 3.85
KS13104	1450VCT/0.283A, 1050VCT/0.217A	7.50
KS9615	6.3V/4A, 3V/1A	1.57
KS9318	6.3V/4A, P/O R-55/ARQ-9	1.35
KS9608	1233/35MA, 1140VCT/0.7A	5.79
352-7102	6.3V/2.5A	1.45
M-7472426	1450V/1.0MA, 2.5V/7.5A, 6.4V/3.9A, 5V/2A, 6.5V/3.7A, P/O ID-39/APG-13	4.95
352-7039	840 VCT @ 380MA, 6.3V/1.9A, 6.3V/6A 5V/6A	5.49
707274	9800/8600 @ 32MA	8.95
KS9584	5000V/290MA, 5V/10A	22.50
KS9607	734VCT/1.77A, 1710VCT/1.77A	6.79
352-7273	25A, 6.3V/0.8A, 6.3V/0.9A, 6.3V/2x2.5V/2.5A (2KV TEST) 6.3V/2.25A, 1200/100/750V @ .005A	6.95
352-7196	1140/1.25MA, 2.5V/1.75A, 2.5V/1.75MA—5KV TEST	3.95
352-7176	320VCT/50MA, 4.5V/3A, 6.3V/CT 20A, 2x6.3VCT/6A	4.75
RA6400-1	2.5/1.75A, 6.3V/2A—5KV Test	2.39
901692	13V/9A	2.49
901699-501	2.77V @ 4.25A—10KV Test	3.45
901698-501	900V/75MA, 100V/0.4A	4.29
UX8855C	900VCT/0.67A, 5V/3A	3.79
RA6405-1	800VCT/65MA, 5VCT/3A	3.69
T-48852	700VCT/806MA, 5V/3A, 6V/1.75A	4.25
352-7098	2500V/6MA, 300VCT/135MA	5.95
KS9336	110V/50MA TAPPED 625V 2.5V/5A	3.95
M-7474319	6.3V/2.7A, 6.3V/66A, 6.3VCT/21A	4.25
KS8984	27V/4.3A, 63V/2.9A, 1.25V/0.2A	2.95
52C080	650VCT/59MA, 6.3VCT/2A, 5VCT/2A	3.75
32332	400VCT/35MA, 6.4V/2.5A, 6.4V/15A	3.85
68C631	1150-0-1150V 2MA	2.75
80G198	6VCT/0.0006 KVA	1.75
302433A	6.3V/9.1A, 6.3VCT/6.5A, 2.5V/3.5A, 2.5/3.5A	4.85
KS 9445	592VCT/118MA, 6.3V/8.1A, 5V/2A	5.39
KS9685	6.4/7.5A, 6.4V/3.8A, 6.4/2.5A	4.79
70G3061	500VCT/36MA	2.65

DYNAMOTORS

TYPE	INPUT		OUTPUT		Price
	VOLTS	AMPS	VOLTS	AMPS	
35X.059	19	3.8	405	.095	\$4.35
POX-15	14	2.8	220	.08	8.95
DA-7A	28	27	1100	.400	15.00
DM 33A	28	7	540	.250	3.95
23350	27	1.75	285	.075	3.95
B-19	12	9.4	275	.110	6.95
			500	.050	
DA-3A*	28	10	300	.260	6.95
			150	.010	
			14.5	5.	
PE 73 CM	28	19	1000	.350	17.50
BD 69†	14	2.8	220	.08	8.95
DAG-33A	18	3.2	450	.06	2.50
OM 25†	12	2.3	250	.05	6.95
BDAR 93†	28	3.25	375	.150	6.95

† Less Filter.
* Replacement for PE 94.
† Used, Excellent.
PE 94, Brand New.....5.95

INVERTERS

800-1B Input 24 vdc, 62 A. Output: 115 V, 800 cy. 7A. 1 phase. Used, excellent. \$18.75

PE-218H: Input: 25/28 vdc, 92 amp. Output: 115V 350/500 cy 1500 Volt-ampere. NEW. \$32.50

PE 206: Input: 28 vdc, 36 amps. Output: 80 V 800 cy, 500 volt-amp. Dim. 13 x 5 1/2 x 10 1/2. New. \$22.50

EICOR—ML 301-5. Input: 13.75V; 18.4A. Output: 115 V/400—, 3c, 0.95 PF. New. \$59

PU 7/AP. Input: 28 vdc/160A. Output: 115 VAC. 400—, 1c, 2500 VA., 21.6 Amp. Volt, and Freq. Req. Used, Exc. \$75

MICROWAVE ANTENNAS



3 cm. Horn, 1" x 1/2", with twist and 180 deg. bend. With dielectric window. As shown \$22.50

AT49/APR—Broadband Conical, 300-3300 MC, Type N Feed. \$8.95

Discone Antenna. AS 125 APN. 1000-8200 mc. Stub supported with type "N" Connector. \$14.50

AS14A/AP. 10 CM pick up dipole assy. complete w/length of coax and "N" connectors. \$4.50

AS46A/APG-4 Yagi Antenna. 5 element array. \$22.50

30" Parabolic Reflector Spin Aluminum dish. \$4.85

AN/APA-12 Sector Scan adaptor for APS-2 radar. Complete Kit. \$37.50

TPS-3. 10 Ft. Dish, "Chicken Wire" Parabolic. Extremely lightweight, portable. \$125.00

AN-154 3 vertical dipoles working against a rectangular mesh approx. 3'x4'. Freq. 140-200 mc. with inlining switch (115v, 60 cy) and portable started crate. Extremely rugged. \$27.95

LP-24 Alford loop, for use with glide-path transmitters (MRN-1, etc.) 100-108 mc. \$32.50

POWER TRANSFORMERS

COMBINATION—115V/60 ~ INPUT

CT-133	150-C-150V/65MA, 6.3V/2.5A, 6.3V/0.6A	\$1.79
CT-127	900V/25MA PK. 5V/2A, 2V/7.5A	2.79
CT-006	350-0-350V/120MA, 5VCT/3A, 2.5VCT/12.5A, 2.5VCT/3.5A	4.39
CT-965	78V/0.6A, 6.3V/2A	1.95
CT-004	350-0-350V/90MA, 5VCT/3A, 2.5VCT/12.5A	4.60
CT-002	350-0-350V/50MA, 5VCT/2A, 2.5VCT/7.5A	3.65
CT-479	7000V/0.018A (2 X Ind. V. Test) 2.5V 5A/17,800 V. Test	29.50
CT-013	450-0-450V @ 200MA, 10V/1.5A, 2.5V 3.5A 5V/3A	6.95
CT-403	350VCT .026A 5V/3A, 6.3V/6A	2.75
CT-931	585VCT .086A 5V/3A, 6.3V/6A	4.25
CT-929	4200V/.001A, 2.5V/2A, 6.3VCT/.6A	5.35

PLATE—115V/60 ~ INPUT

PT 07	400VCT/4.0 AMPS For RA43	\$17.50
PT 034	125V/45MA	1.15
PT 157	660-0-660VAC (500VDC) or 550-0-550VAC (400VDC) at 250 MA DC	8.70
PT 167	1400-0-1400 VAC (300MADC) or 1175-0-1175 VAC (1000VDC) at 300 MA DC	25.50
PT 168	2100-0-2100 VAC (1750VDC) or 1800-0-1800 VAC (1500VDC) at 300 MA DC	33.00
PT 371	210-0-210V at 2.12 Amp.	9.45
PT 133	3140/1570V, 2.36V/VA	105.00
PT 801	22,000V/234 MA., 5.35 KVA	135.00
PT 521	7500V/0.06A, Half-Wave	85.00
PT 913	2500V/1/2 MA H/SLD	4.95
PT 12A	280VCT/1.2A	3.95
PT-36-2	37.5/40V AT 70 MA	2.15

FILAMENT—115V/60 ~ INPUT

FT-140	5VCT @ 10A 25KV Test	17.50
FT-157	4V/16A, 2.5V/2.75A	2.95
FT-101	6V/25A	.79
FT-924	5.25A/21A, 2x7.75V/6.5A	14.95

THERMISTORS

D-164699 Bead Type DCR: 1525-2550 Ohms @ 75 Deg. F. Coefficient: 2% Per. Deg. Fahr. Max. Current 25 MA @ 0°C

D-16732 Bead Type DCR is 1525-2550 Ohms. Fitted 25 MA at 825-1.175 VDC. \$1.00

D-167613 Disk Type DCR: 355 Ohms @ 75 Deg. F. P.M. 2.5%. 1 Watt

D-166228 Disk Type 7120 Ohms @ 60°F. 4220 Ohms @ 80°F. 2590 Ohms @ 100°F., 1640 Ohms @ 120°F. \$1.00

MAIL ORDERS PROMPTLY FILLED. ALL PRICES F.O.B. NEW YORK CITY. 25% DEPOSIT WITH ORDER. BALANCE C.O.D. RATED CONCERNS SEND P. O.

131 Liberty St., New York 7, N. Y. Dept L-3 Chas. Rosen Phone: Dlgy 9-4124

PROFESSIONAL ENGINEERING CARDS

ALFRED W. BARBER LABORATORIES

Specializing in the Communications Field and
in Laboratory Equipment
Offices, Laboratory and Model Shop at:
32-44 Francis Lewis Blvd., Flushing, L.I., N.Y.
Telephone: Independence 3-3306

THOMAS H. BRIGGS

Electronics Consultant

ELECTRON TUBES—Materials, processing, ap-
plications and reliability
AUTOMATION—Printed wiring, and electro-
mechanical device developments
Box 185, RD#2 Tel. No. 8-7671
Norristown, Pennsylvania

Edward J. Content, P.E. and Staff INTERNATIONAL RADIO CONSULTANTS

Pan American Radio Tangier Int'l Zone
Bldg., 16 Rue Delacroix Morocco
Specialized in the design, construction,
foreign, Electronic, projects, and advising
governments at Int'l Telecommunications
Union.

CROSBY LABORATORIES, INC.

MURRAY G. CROSBY & STAFF
RADIO-ELECTRONIC RESEARCH
DEVELOPMENT & ENGINEERING
COMMUNICATIONS, FM & TV
ROBBINS LANE
HICKSVILLE, NEW YORK
HICKSVILLE 3-3191

TRANSISTOR ENGINEERING

S. Moskowitz D. D. Grieg N. J. Gottfried
Product Transistorization. Complete service in
consulting, research, development, and produc-
tion on transistor circuitry, products and in-
strumentation.
c/o Electronic Research Associates, Inc.
67 East Centre Street, Nutley, N.J.
NUTLEY 2-5410

ELK ELECTRONIC LABORATORIES, INC.

Jack Rosenbaum
Specializing in design and development of
Test Equipment for the communications,
radar and allied fields.
333 West 52nd St., New York 19, PL-7-0520

FREDERICK RESEARCH CORPORATION

Carl L. Frederick, D.Sc., President
Bethesda 14, Maryland • OLiver 4-5897
Engineering Research and Development, Eval-
uation, Technical Writing and Publishing—Elec-
tronic and Electro-mechanical Systems, Test
Equipment, Radio Interference, Instrumentation,
Controls.

PAUL GODLEY CO.

Consulting Radio Engineers
P.O. Box J, Upper Montclair, N.J.
Offs & Lab.: Great Notch, N.J.
Phone: Montclair 3-3000
Established 1926

GOVERNMENT CONTRACT LIAISON AND CONSULTANTS

GORDON ASSOCIATES, INC.

Specializing in Signal Corps Electronic Require-
ments, Technical Manuals, Tabular List of
Parts, Drawings
L. Gordon, Pres. P. Treston, Ch. Engr.
167 Broad Street Telephone
Red Bank, New Jersey Red Bank 6-2743

HIGHLAND ENGINEERING CO.

William R. Spittal & Staff
Specialize in Design and Development of
Transformers, Chokes, etc.
for the
Electronic, Industrial and Allied Fields.
Westbury, L.I., N.Y. WEstbury 7-2933

HOGAN LABORATORIES, INC.

John V. L. Hogan, Pres.
APPLIED RESEARCH, DEVELOPMENT,
ENGINEERING
Est. 1929. Electronics, Optics, Mechanisms,
Facsimile Communication, Digital Computers,
Electro-sensitive recording media, Instrumenta-
tion.
155 Perry Street, New York 14 CHelsea 2-7855

INTERFERENCE TESTING AND RESEARCH LABORATORY, INC.

Rexford Daniels E. T. Buxton P. B. Wilson
150 Causeway Street, Boston 14, Mass.
Lafayette 3-7826
Specializing in the design and testing of
equipment to meet Military and FCC specifica-
tions for radio interference.

LEONARD R. KAHN

Consultant in Communications and Electronics
Single-Sideband and Frequency-Shift Systems
Diversity Reception - Modulation Theory
Television Systems
Elizabeth Bldg., 22 Pine St., Freeport, L.I., N.Y.
Freeport 9-8800

George W. Baker, Pres. KIP ELECTRONICS CORPORATION

Electron tube consulting and design.
Research and development and preparation of
prototype electron tubes.
29 Holly Place,
Stamford, Connecticut
Phone 48-5328

Harry W. Houck Martial A. Honnell John M. van Beuren

RESEARCH ENGINEERS

Specialists in the Design and
Development of Electronic Test Instruments
c/o MEASUREMENTS CORP.
BOONTON, N.J.

L. J. CASTRIOTA M. WIND S. W. ROSENTHAL P. G. MARIOTTI

Microwave Consultants

Radio Frequency and Microwave Components
Cable—Waveguide—Coax
Dielectric Evaluation
Telephone G.P.O. Box 844
BOulevard 3-2096 Brooklyn 1, N.Y.

Olympic Radio & Television, Inc.

Radio—Electronics
Consulting—Research—Development
Environmental Tests Performed
for the Industry
B. Parzen — E. Bradburd
Olympic Building, Long Island City 1, N.Y.
Stillwell 4-6961

**1955
RADIO ENGINEERING
SHOW
March 21-24, 1955**

EVERT M. OSTLUND

Consulting Radio Engineer
Radio—Microwave
Communication—Control
Systems and Equipment
Planning, Research, Development
ANDOVER, NEW JERSEY
Tel.: Lake Mohawk 8635

N. G. Parke S. J. O'Neil

Parke Mathematical Laboratories, Inc.

Specialists in engineering analysis and
computation in the fields of electronics and
aeronautics.
Independence Court • Concord, Massachusetts
Telephone Concord 827

PENN-EAST ENGINEERING CORPORATION

(Formerly—Atlantic Electronics Corp.
of Port Washington, N.Y.)
Designers of Industrial Controls
Gerold L. Tawney, Robert R. Sparacino,
Warren M. Janes, Arthur J. Pretty,
Richard C. Tawney
P.O. Box 240, Telephone Kutztown 2675

PICKARD AND BURNS, INC.

Consulting Electronic Engineers
Analysis and Evaluation of Radio Systems
Research, Development, Design and Production
of Special Electronic Equipment and Antennas.
240 Highland Ave. Needham 94, Mass.

SIDNEY PICKLES

Consulting Radio Engineer
Antennas & Transmission Lines
Phone: Post Office Box 643
Monterey 5-3379 MONTEREY, CALIFORNIA

RADIO SONIC CORP.

ENGINEERS—QUALITY ASSURANCE
Testing, Processing
Electron Tubes, Semiconductors, Models, Produc-
tion Test Equipment, Antennas, Analyzers, Power
Supplies, Ultrasonics, Advanced Development
G. EMERSON PRAY, PRESIDENT
32 W. 22nd St., New York 10, N.Y. ORegon 5-0088

Paul Rosenberg Associates

Consulting Physicists
100 STEVENS AVE • MOUNT VERNON, NEW YORK
CABLE: PHYSICIST Mount Vernon 7-8040

M. D. Ercolino and Associates ANTENNA CONSULTANTS

Research and Development
Communication Arrays
Commercial and Amateur
FM and TV
c/o TELREX, INC. ASBURY PARK, N.J.
Phone Prospect 5-7252

WHEELER LABORATORIES, INC.

Radio and Electronics
Consulting — Research — Development
R-F Circuits — Lines — Antennas
Microwave Components—Test Equipment
Harold A. Wheeler and Engineering Staff
Great Neck, N.Y. Hunter 2-7876



THE NEW PRECISION MODEL 120

GIVES YOU WHAT YOU WANTED
IN A

**HIGH SENSITIVITY
MULTI-RANGE TEST SET**

20,000 OHMS PER VOLT D.C.
5,000 OHMS PER VOLT A.C.

The '120' gives you . . .

- ✓ MORE RANGES
- ✓ AN EXTRA-LOW RESISTANCE RANGE
- ✓ AN EXTRA-LOW VOLTAGE RANGE
- ✓ AN EXTENDED LOW CURRENT RANGE
- ✓ A LARGER METER SCALE FACE
- ✓ SIMPLE, POSITIVE RANGE SELECTION
- ✓ POSITIVE CONTACT JACKS and PLUGS

Compare These Wide Spread Ranges and Special Features:

- ★ **8 DC VOLTAGE RANGES:** 20,000 ohms per volt.
- ★ **8 AC VOLTAGE RANGES:** 5,000 ohms per volt.
0-1.2-3-12-60-300-600-1200-6000 volts.
- ★ **8 AC OUTPUT RANGES:** same as AC volt ranges.
Built-in 600 volt blocking capacitor.
- ★ **7 DC CURRENT RANGES:**
0-60-300 Microamperes. 0-1.2-12-120-600 Ma.
0-12 Amperes.
- ★ **5 RESISTANCE RANGES:** self-contained.
0-200-2000-200,000 ohms. 0-2-20 megohms.
- ★ **8 DECIBEL RANGES:** -20 DB to +77DB.
0 DB = 1 Milliwatt, 600 ohms.
- ★ **EXTRA LARGE 5/4" RUGGED 'PACE' METER:**
40 microamperes sensitivity, 2% accuracy.
- ★ **1% MULTIPLIERS and SHUNTS:**
Wire-wound and deposited film types.
- ★ **TWO JACKS SERVE ALL STANDARD RANGES:**
Separately identified and isolated jacks
provide for extra high ranges.
- ★ **"TRANSIT" SAFETY POSITION** on range selector
protects meter during transport and storage.
- ★ **CUSTOM-MOLDED PHENOLIC CASE and PANEL:**
Compact, laboratory styled instrument.

MODEL 120... complete with internal ohmmeter
batteries, banana-plug test leads and detailed
operating manual. Overall case dimensions,
5 3/4" x 7" x 3 1/4" Net Price \$39.95

PRECISION APPARATUS CO., INC.

70-31 84th Street, Glendale 27, L. I., N. Y.
Exports: 458 Broadway, New York 13, U. S. A.
Canada: Atlas Radio Corp., Ltd., 560 King St. W., Toronto 2B

INDEX AND DISPLAY ADVERTISERS

What to See at the Radio Engineering Show	1A
Meetings with Exhibits	6A
News—New Products	42A
Industrial Engineering Notes	52A
Professional Group Meetings	63A
Section Meetings	100A
Positions Open	286A
Positions Wanted by Armed Forces Veterans	298A
IRE People	358A

DISPLAY ADVERTISERS

ACF Industries, Inc.	312A
Admiral Corp.	300A
Advance Electronics Co.	371A
Aerovox Corp.	76A, 77A
Air Marine Motors, Inc.	178A
Airborne Instruments Lab., Inc.	167A
Aircraft Armaments, Inc.	316A
Aircraft Marine Products, Inc.	47A, 177A
Aircraft Radio Corp.	372A
Aircraft Transformer Co.	358A
Airpax Products Co.	189A
Airtron, Inc.	224A, 292A
Alden Products Co.	357A
Alford Mfg. Co., Inc.	112A, 234A
Allen-Bradley Co.	84A
Allied Radio Corp.	202A
Allison Laboratories	362A
Alpha Wire Corp.	353A
Altec Lansing Corp., Peerless Div.	192A
American Elite, Inc.	346A
American Lava Corp.	17A
American Machine & Foundry Co.	325A
American Phenolic Corp.	57A, 59A, 61A, 63A
American Television & Radio Co.	198A
American Time Products, Inc.	86A
Amperex Electronic Corp.	157A
Ampex Corp.	34A
Andrew Corp.	81A
Apex Coated Fabrics, Inc.	222A
Apex Machine Company	354A
Applied Science Corp. of Princeton	296A
Arco Electronics, Inc.	220A
Aremac Associates	245A
Arnold Engineering Company	106A, 315A
Assembly Products, Inc.	344A
Astron Corp.	228A
Automatic Electric Corp.	219A
Avion Instrument Corp.	352A
Ballantine Laboratories, Inc.	22A
Barber Laboratories, Alfred W.	370A
Barber-Colman Co., Aircraft Div.	361A
Barker & Williamson, Inc.	80A
Bart Laboratories Co.	249A
Bell Aircraft Corp.	315A
Bell Telephone Laboratories	4A
Bendix Aviation Corp., Institutional	9A
Bendix Aviation (Eclipse-Pioneer)	154A
Bendix Aviation (Missile Section)	320A
Bendix Aviation (Pacific Div.)	97A
Bendix Aviation (Radio Comm. Div.)	297A
Bendix Aviation Corp. (Scintilla Div.)	237A
Bennett Mfg. Co.	274A
Bliley Electric Co.	280A
Blonder-Tongue Labs.	206A
Bodnar Industries, Inc.	186A
Boeing Airplane Company	299A
Boesch Mfg. Co., Inc.	362A
Bogart Mfg. Corp.	213A
Bogue Electric Mfg. Co.	5A
Bomac Laboratories, Inc.	109A
Boonton Radio Corp.	45A
Bourns Laboratories	240A

PHASE MEASURING INSTRUMENTS

0 CPS to 500 MC



PHASE METER

TYPE 405

- 8 CPS to 100 KC with 0.5° relative accuracy.
- Meter Reading independent of signal amplitude.

PHASE DETECTOR

TYPE 205

- 100 KC to 15 Megacycles.
- Measures Time Delay, Envelope Delay with 1% Accuracy.

PHASE ANGLE COUNTER

TYPE 1011-2-6

- 0 CPS to 1000 CPS
- ±1 Count per 100,000 Accuracy

H-F PHASE METER

TYPE 213

- 15 KC to 500 Megacycles
- Measures phase angle between two voltages, vector difference of two voltages.

VARIABLE

DELAY LINES

CONTINUOUSLY VARIABLE

with less than 5×10^{-10} Seconds
Resolution Time

TYPE	TIME DELAY	TYPE	TIME DELAY
505	0 to 0.05 us	506b	0 to 0.28 us
505a	0 to 0.1 us	506c	0 to 0.32 us
506	0 to 0.25 us	506d	0 to 0.38 us
506a	0 to 0.17 us	508	0 to 0.4 us

STEP VARIABLE

with equal input and
output impedance

TYPE	SPECIFICATIONS	
	MAXIMUM DELAY	MAXIMUM RISE TIME
601	2.2 us	0.22 us
602	2.75 us	0.14 us
603	27.5 us	1.4 us

WRITE FOR DATA!

ADVANCE
ELECTRONICS CO., INC.
451 HIGHLAND AVENUE, PASSAIC, N. J.
VISIT BOOTH 787 I.R.E. SHOW

DISPLAY ADVERTISERS

Braun Tool & Instrument Co., H.266A
 Briggs, Thomas H.370A
 Buckbee Mears Co.40A
 Budd-Stanley Co., Inc.50A
 Budelman Radio Corp.166A
 Burlingame Associates335A
 Burlington Instrument Co.244A
 Burroughs Corporation337A
 Bussmann Mfg. Co.24A

Caledonia Electr. & Transf. Corp.236A, 302A
 Calif. Inst. of Technology, Jet Prop. Lab.321A
 Cambridge Thermionic Corp.66-67A
 Canadian Radium & Uranium Corp.336A
 Cannon Electric Co.21A
 Capitol Radio Engineering Institute272A
 Carter Motor Co.239A
 Chatham Electronics Corp.98A, 99A, 311A
 Chester Cable Corp.36A
 Chicago Standard Transformer Corp.140A
 Chicago Telephone Supply Corp. facing 72A & 73A
 Cinch Manufacturing Co.141A
 Clare & Co., C. P.145A
 Cleveland Container Co.163A
 Clevite-Brush Development Co.324A
 Clifton Precision Products Co., Inc.233A
 Cohn Corp., Sigmund210A
 Coil Winding Equipment Co.262A, 263A
 Collins Radio Co.23A, 298A
 Color Television, Inc.348A
 Comar Electric Co.241A
 Communication Accessories Co.104A
 Communication Measurements Lab., Inc.272A
 Communication Products Co.82A, 83A
 Communications Equipment Co.369A
 Compagnie Générale de Métrologie174A
 Condenser Products Co.350A
 Constantin & Co., L. L.119A
 Content, Edward J.370A
 Continental Carbon, Inc.373A
 Convair Div., General Dynamics Corp.288A, 313A
 Cornell Aeronautical Lab., Inc.318A
 Cornell-Dubilier Electric Co.Cover 3
 Cornish Wire Co., Inc.260A
 Cosmic Condenser Co.340A
 Crosby Laboratories, Inc.274A, 370A
 Crucible Steel Co. of America223A
 Cubic Corp.375A
 Curtis Development & Mfg. Co.332A

Dage Electric Company, Inc.328A
 Daven Company43A
 Daystrom Instrument Div.231A
 Decade Instrument Co.342A
 DeJur Amsco Corp. (Continental)155A
 DeJur Amsco Corp. (Industrial)176A, 268A
 DeMornay-Bonardi, Inc.136A
 Detron Corp.216A
 Dialight Corp.244A
 Diamond Microwave Corp.254A
 Douglas Microwave Co., Inc.271A
 Drake Electric Works, Inc.362A
 Drake Mfg. Co.367A
 Driver Co., Wilbur B.179A
 Driver-Harris Company215A
 DuMont Labs., Inc., Allen B.320A, 53-56A
 Dyna-Labs., Inc.356A

ESC Corp.159A
 Eby, Inc., Hugh H.361A
 Edgerton, Germeshausen & Grier, Inc.318A
 Edison, Inc., Thomas A.230A
 Eitel-McCullough, Inc.32A
 Elco Corporation69A
 Electrical Industries143A
 Electrical & Physical Instr. Corp.359A
 Electro-Impulse Laboratory344A
 Electro-Mec Laboratory282A
 Electro Motive Mfg. Co., Inc.117A
 Electro-Pulse, Inc.374A
 Electro-Tec Corp.211A
 Electronic Associates, Inc.256A
 Electronic Computer Div., Underwood360A
 Electronic Research Associates, Inc.236A, 370A
 Electronic Tube Corp.164A
 Electronics Corp. of America325A
 Electrons, Inc.357A
 Eigin-Neomatic, Inc.328A



when there's
NO margin for
ERROR-

you can rely on ARC Test Equipment!

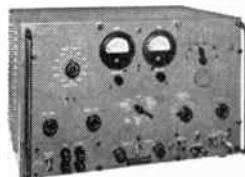

Type H-14 Signal Generator

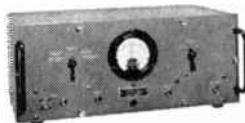

Type H-16 Standard Course Checker

Unerring precision is yours in the ARC Type H-14 Signal Generator! For either pre-flight or bench checks, this instrument tests *all* ARC Omni and Localizer Receivers with vital accuracy and speed. The H-14 clears one unit or a complete squadron ... in under sixty seconds!

Checking up to 24 omni courses, to-from and flag-alarm operation, omni course sensitivity, calibration accuracy and left-center-right on localizer, the versatile H-14 also may be used to transmit voice instructions to pilots along with test signals.

ARC supplies the watchdog H-16 Standard Course Checker for *exact* course accuracy and phase measurement checks on the H-14, or any other omni signal generator. Both instruments available from factory only. Write for literature.

Dependable Airborne Electronic Equipment Since 1928

Aircraft Radio Corporation

BOONTON, NEW JERSEY

Omni Receivers • 900-2100 Mc Signal Generators • UHF and VHF Receivers and Transmitters • 8-Watt Audio Amplifiers • 10-Channel Isolation Amplifiers • LF Receivers and Loop Direction Finders



METAL FILM RESISTORS

now available with

RADIAL or AXIAL LEADS

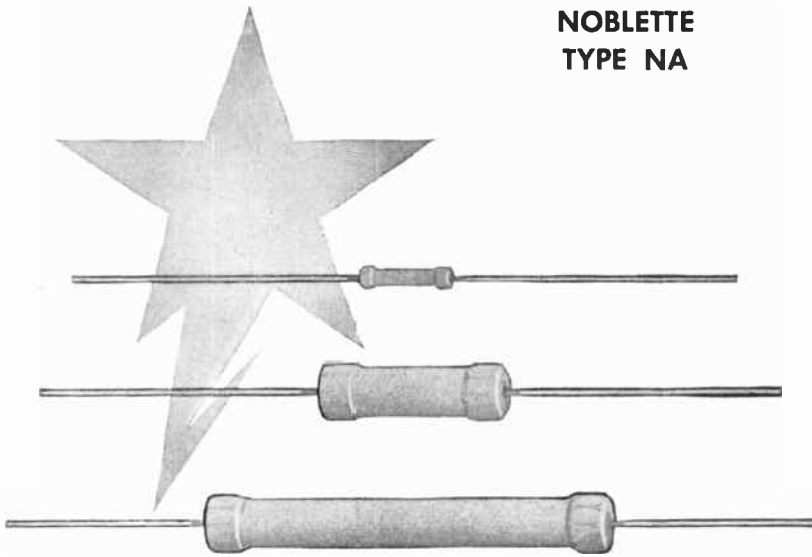

**NOBLETTE
TYPE NA**

The two types of terminals make possible a wider range of application. A layer of vitreous enamel protects metal film against unusual atmosphere conditions.

The NOBLETTE type NA is available in 1/2, 1 and 2 watt, in resistance range of 1 ohm to 10 megohms. The NOBLELOY type NR is available in 1/2, 1, 2 and 5 watt, in resistance range of 1 ohm to 30 megohms. Both types in standard tolerances of 1, 2 and 5%, available in 1/2% on special order.



**NOBLELOY
TYPE NR**

WM WIRE WOUND RESISTORS

Composed with a minimum of .0015 inch wire that is wound automatically for true parallel winding to prevent shorting at turns. They are RETMA standard and available in 1/3, 1/2 and 1 watt.

WRITE FOR NEW 1955 CATALOG
Visit Booth No. 456 I.R.E. Show

CONTINENTAL CARBON, INC.

13900 LORAIN AVE. CLEVELAND 11, OHIO

CLEARWATER 1-6500



DISPLAY ADVERTISERS

Elk Electronic Labs., Inc.	370A
Empire Devices Products Corp.	330A
Engineering Associates	226A
Engineering Research Associates 286A, 306A, 324A	
Eraser Co., Inc., The	342A
Erie Resistor Corp.	269A
Eugene Engineering Co., Inc.	234A
F-R Machine Works, Inc.	115A
Fairchild Camera & Instr. Corp.	72A
Fairchild Engine & Airplane Corp.	221A
Falstrom Co.	238A
Farnsworth Electronics Co.	313A
Fast & Co., John E.	248A
Federal Screw Products, Inc.	276A
Federal Telephone & Radio Co.	227A
Filtors, Inc.	173A
Filtron Co., Inc.	12A
Ford Instrument Co.	36A, 173A
Frederick & Assoc., Carl L.	256A
Frederick Research Corp.	370A
Freed Electronics & Controls Corp.	306A
Freed Transformer Co., Inc.	197A
Frequency Standards	58A
Furst Electronics, Inc.	222A
Garde Mfg. Co.	336A
Garfield Wire Div., Overlakes	240A
General Ceramics Corp.	193A
General Dry Batteries, Inc.	331A
General Electric Co., Capacitor Sls.	16A
General Electric Co. (Employment)	311A
General Electric Co., Tube Div.	24A & 25A, 78A, 79A
General Hermetic Sealing Corp.	336A
General Precision Equipment Corp.	94A & 95A
General Precision Lab., Inc.	318A
General Radio Co.	Cover 4
Germanium Products Corp.	338A
Gernsback Publications, Inc.	162A
Gerry & Co., Inc., M. E.	174A
Gilfillan Bros., Inc.	317A
Glaser-Steers Corp.	85A
Godley Co., Paul	370A
Goodyear Aircraft Corp.	314A
Gordon Associates	370A
Gorn Electric Co., Inc.	354A
Gray Manufacturing Co.	316A
Grayhill, Inc.	338A
Greenleaf Mfg. Co.	127A
Guardian Electric Mfg. Co.	105A
Gudebrod Bros. Silk Co., Inc.	365A
Gudeman Company	123A
Guilford Personnel Service	311A
Gulton Industries, Inc.	129A
Haydu Brothers	190A, 191A
Hazeltine Electronics Corp.	285A
Heath Company	186A
Helipot Corp.	131A
Henry & Miller Industries	228A
Heppner Mfg. Co.	182A
Hermetic Seal Products Co.	187A
Hewlett-Packard Co.	134A, 135A
Heyman Mfg. Co.	365A
Hickok Electrical Instr. Co.	248A
Highland Engineering Co.	370A
Hill Electronic Eng. & Mfg. Co.	275A
Hitemp Wires, Inc.	208A
Hoffman Laboratories, Inc.	323A
Hogan Laboratories, Inc.	370A
Hopkins Engineering Co.	276A
Hudson Radio & Television Corp.	366A
Hudson Tool & Die Co.	171A
Huggins Laboratories	172A
Hughes Aircraft Co.	183A
Hughes Research & Dev. Labs.	303A
Hughey & Phillips	343A
Hycor Mfg. Co.	150A, 151A
Hycor Co., Inc.	345A
Illinois Condenser Co.	162A
Induction Motors Corp.	217A
Industrial Hardware Mfg. Co.	360A
Industrial Research Labs.	315A
Industrial Test Equipment Co.	348A
Industrial Transformer Corp.	264A
Institute of Radio Engineers	2A, 52A

DISPLAY ADVERTISERS

Instrument Components, Inc.	349A
Instrument Corp. of America	161A
Instrument Specialties Co., Inc.	342A
Instruments for Industry, Inc.	281A
Insulated Circuits, Inc.	277A
Interference Testing & Resch. Lab., Inc.	370A
International Business Machines Corp.	269A
International Electronic Research Corp.	204A
International Electronics Corp.	329A
International Radiant Corp.	266A
International Rectifier Corp.	243A
International Resistance Co.	278A, 279A
JFD Mfg. Co., Inc.	87A
Jeffers Electronics, Inc.	96A
Jennings Radio Mfg. Co.	168A
Johns Hopkins U., Applied Physics Lab.	317A
Johns Hopkins U., Operations Research Office	302A
Johnson & Hoffman Mfg. Co.	283A
Jones Div., Howard B., Cinch Mfg.	172A
Jones Electronics Co., M. C.	260A
Kahle Engineering Co.	196A
Kahn Research Laboratories	368A
Kahn, Leonard R.	370A
Kaiser Metal Products, Inc.	359A
Karp Metal Products Co., Inc.	51A
Kaup & Sons, C. B.	255A
Kay Electric Company	7A
Kay Lab.	326A
Kearfott Co., Inc.	146A
Kenyon Transformer Co., Inc.	351A
Kepeco Laboratories, Inc.	88A
Kessler Co., Frank	332A
Kester Solder Co.	185A
Keystone Electronics Co.	262A
Keystone Products Co.	125A
Kings Electronics Co., Inc.	93A
Kip Electronics Corp.	370A
Klipsch & Associates	254A
Knights Co., James	110A, 111A
Kollman Instrument Corp.	175A, 296A
Kulka Electric Mfg. Co., Inc.	248A
Kuthe Laboratories, Inc.	346A
Laboratory for Electronics, Inc.	27A
Lambda Electronics Corp.	253A
Lambda-Pacific Engineering, Inc.	122A
Lapp Insulator Co., Inc.	156A
Lavoie Laboratories, Inc.	252A, 288A
Lee Laboratories, Inc.	196A
Lenkurt Electric Co., Inc.	302A, 313A, 319A
Lennard Co., P. M.	68A
Lewyt Corporation	207A
Librascope, Inc.	124A
Lieco, Inc.	142A
Linear Equipment Labs., Inc.	238A
Little Falls Alloys, Inc.	264A
Litton Industries	40A
Lockheed Aircraft Corp.	287A, 305A
Loral Electronics Corp.	205A
Lowell Mfg. Co.	327A
Machlett Laboratories, Inc.	64A, 65A
Magnavox Research Labs.	322A
Magnetic Research Corp.	225A
Magnetics, Inc.	38A
Maigne Co., O. J.	276A
Makepeace Company, D. E.	195A
Mallory & Co., P. R.	26A, 60A
Marconi Instruments, Ltd.	108A
Marion Electrical Instr. Co.	112A
Martin Co., Glenn L.	304A
Maxson Corp., W. L.	33A
McCoy Electronics Co.	200A
McGraw-Hill Book Co., Inc.	334A
Measurements Corp.	14A, 370A
Melpar, Inc.	310A
Mepco, Inc.	341A
Metal Textile Corp.	349A
Micamold Radio Corp.	259A
Mico Instrument Co.	360A
Microdot Div., Felts Corp.	256A
Microwave Associates, Inc.	8A
Microwave Consultants	370A
Microwave Development Labs., Inc.	368A
Midland Manufacturing Co., Inc.	44A
Millen Mfg. Co., Inc., James	28A

Visit our Complete Display—
BOOTH 221 at the IRE Show.

FOR SCIENCE and INDUSTRY

Electro-Pulse's **NEWEST PULSE GENERATOR**

- Operation to 330 KC
- Variable Duration and Delay
- Low Internal Impedance

LOW COST ...

HIGH PERFORMANCE



VARIABLE PULSE GENERATOR... Model 4120A

A truly wide-range laboratory-type unit — a basic instrument for pulse circuit test and development. Its versatility, compactness and simplicity of operation allow wide application in production and laboratory testing of:
Computers... Telemetry... Television... Magnetics
... Nuclear Research and Development... Radar
... Navigational Systems.

- 33 CPS to 330 KC Rep. Rate • 1 to 100 μ s Delay • .3 to 100 μ s Pulse Width • At least 50 V Amplitude • .1 μ s Rise Time • Blocking Oscillator Sync. Pulse • 3 1/2" x 19" Standard Rack Panel • Complete with Regulated Power Supply

Write for Complete Data: Our Bulletin 4120A/1



Model 2120A PULSE GENERATOR

The Model 4120A Variable Pulse Generator is the latest addition to the Electro-Pulse line of pulse instrumentation which includes Analog and Digital Time Delay Generators, Pulse Oscillators and the 2100 series precision Pulse Generators

Representatives in Major Cities

EP *Electro-Pulse, Inc.*

11811 MAJOR STREET, CULVER CITY, CALIFORNIA
Telephones: EXbrook 8-6764 and TEXas 0-8006

MICROWAVE POWER MEASUREMENT FROM DEGREES...

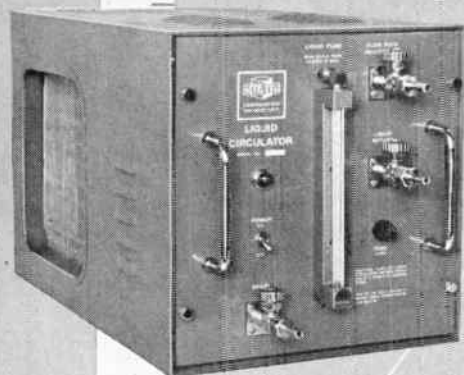

CIRCULATOR

SPECIFICATIONS
 Av. Power 0-600 watts
 Peak 600 KW
 VSWR 1.1 max.
 Freq. range
 Basic unit 2.6 to 3.95 kmc
 With Adapters 2.6 to 18.0 kmc

...TO **WATTS**
directly!

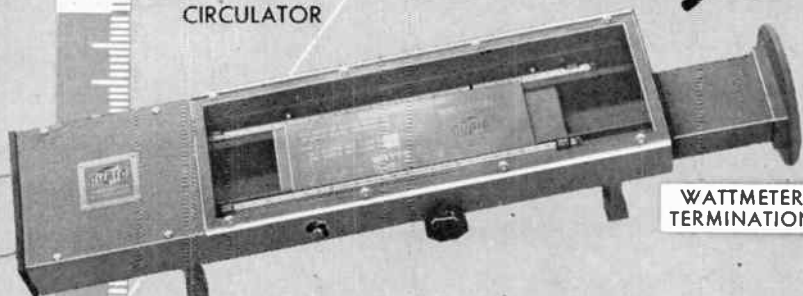

WATTMETER
TERMINATION

CUBIC'S 2-UNIT CALORIMETRIC WATTMETERS

... for obtaining direct power
readings in testing electronic
equipment—without guessing!

Three of the world's largest producers of electronic equipment have recently made CUBIC Calorimetric Wattmeters standard test equipment in their laboratories and plants.

For very good reason. No other instrument designed for power measurement gives you direct power readings... with such precision, and yet so simple in its application.

The model shown is the MC-1B for power measurement from 2600 to 26,500 MC. Also available are the models MCX-1A (coaxial type) for power measurement from 100 to 3000 MC, and MCL-1A (L-Band waveguide type) for power measurement from 1120 to 2600 MC.

Whether checking field equipment, developing or making acceptance tests on new equipment or magnetrons in the lab, or in production, one of CUBIC'S Calorimetric Wattmeters will be an invaluable addition to your test equipment. Standard laboratories calibrate secondary power devices, especially bridge type bolometer instruments. Exact calibration is provided month to month.

Write for more information, and ask for our catalog of other test equipment and waveguide components. Or if you have a problem in development or engineering, CUBIC offers the services of its engineering staff and facilities in its solution.



CUBIC
CORPORATION

ELECTRONIC EQUIPMENT
RESEARCH...DEVELOPMENT
2481 CANON STREET,
SAN DIEGO, 6, CALIFORNIA

DISPLAY ADVERTISERS

Miniature Switch Corp.	142A
Minneapolis-Honeywell, Aero. Div.	319A
Model Engineering & Mfg. Co., Inc.	31A
Molon Motors & Coil Co.	350A
Moloney Electric Company	251A
Motorola, Inc.	293A
Mycalex Corp. of America	188A
N. R. K. Mfg. & Eng. Co.	206A
Narda Corp.	118A
National Carbon Co.	116A
National Cash Register Corp.	321A
National Co., Inc.	308A
National Moldite Co.	273A
National Research Corp.	236A
Nelson Technical Enterprises, Inc.	322A
New Jersey Electronics Corp.	201A
Norden-Ketay Corp.	facing 96A, 97A
North Electric Mfg. Co.	170A
North Shore Nameplate Co.	340A
Ohmite Mfg. Co.	13A
Olympic Metal Products Co., Inc.	174A
Olympic Radio & Television, Inc.	370A
Optical Film Engineering Co.	228A
Oster Mfg. Co., John	41A
Ostlund, Evert M.	370A
PM Industries, Inc.	265A
Pacific Semiconductors, Inc.	70A, 71A
Panoramic Radio Products, Inc.	232A
Paramount Paper Tube Co.	214A
Park Nameplate Co.	164A
Parke Mathematical Labs	370A
Penn-East Engineering Corp.	370A
Pentron Corp.	212A
Perfection Mica Company	355A
Perkin-Elmer Corp.	149A
Perkin Engineering Corp.	46A
Permag Corp.	332A
Phelps Dodge Copper Prods. Corp.	114A
Philip and Son Company	343A
Photo Chemical Products, Inc.	261A
Photocircuits Corp.	348A
Pickard & Burns, Inc.	370A
Pickles, Sidney	370A
Polarad Electronics Corp.	18A, 19A, 89A, 247A
Polytechnic Research & Dev. Co., Inc.	229A, 320A
Potter Instrument Co., Inc.	363A
Power Designs, Inc.	249A
Precision Apparatus Co., Inc.	371A
Precision Paper Tube Co.	270A
Premier Metal Products Co.	340A
Price Electric Corp.	234A
Printed Circuits, Inc.	344A
Pyramid Electric Co.	37A
RS Electronics Corp.	265A
Radiation, Inc.	286A
Radio Corp. of America (Empl.)	290A, 291A
Radio Corp. of America (Designers)	128A
Radio Engineering Products, Ltd.	353A
Radio Materials Corp.	181A
Radio Receptor Co., Inc.	121A, 314A
Radio Sonic Corp.	370A
Ramo-Wooldridge Corp.	301A
Ratray & Co., Inc., George	346A
Raytheon Mfg. Co., Rcvng. Tubes	10A, 11A
Raytheon Mfg. Co. Rcvng. Tubes	15A
Raytheon Mfg. Co., Power Tube Div.	49A
Raytheon Mfg. Co., Equip. Markng.	101A
Raytheon Mfg. Co., Equip. Sales	261A
Raytheon Mfg. Co. (Empl.)	309A
Republic Aviation Corp.	323A
Resinite Corp., Div. Prec. Paper Tube	144A
Riester & Thesmacher Co.	180A
Robinson Aviation, Inc.	20A
Roller-Smith Corp.	30A, 113A
Rosen Eng. Products, Inc., Raymond	282A
Rosenberg Associates, Paul	370A
Rotron Mfg. Co., Inc.	345A
Rutherford Electronics Co.	218A
Sanborn Co.	165A
Sanders Associates, Inc.	308A
Sandia Corp.	307A
Scovill Mfg. Co.	355A
Selectro Corp.	246A

DISPLAY ADVERTISERS

Secor Metals Corp.	202A
Segel Company, Henry P.	364A
Sensitive Research Instrument Corp.	355A
Servo Corp. of America	271A
Shallcross Mfg. Co.	152A
Shasta Div., Beckman Instr., Inc.	107A
Shielding, Inc.	235A
Shure Brothers, Inc.	158A
Sierra Electronic Corp.	48A
Simpson Electric Co.	138A, 139A
Sola Electric Co.	126A
Sorensen & Co.	90A-92A
Southern Electronics Co.	250A
Southwestern Indus. Electronic Co.	100A
Specific Products	192A
Sperry Gyroscope Co. (Empl.)	316A
Sperry Gyroscope Co., Div. Sperry Corp.	102A, 103A
Sprague Electric Co.	3A, 112A, 147A
Stackpole Carbon Co.	209A
Stanford Laboratories Co.	364A
Stanford Research Institute	316A
Stavid Engineering, Inc.	317A
Stevens Mfg. Co., Inc., George	258A
Stoddart Aircraft Radio Co.	130A, 347A
Stromberg-Carlson Co.	307A
Stupakoff Ceramic & Mfg. Co.	184A
Sun Dial Corp.	240A
Superior Tube Co.	267A
Surprenant Mfg. Co.	148A
Switchcraft, Inc.	336A
Sylvania Electric Products, Inc.	203A, 294A, 295A
Synthane Corp.	333A
Syntronic Instruments, Inc.	210A
TLG Electric Corp.	244A
Tech Laboratories, Inc.	120A
Tech-Master Products Co.	271A
Technology Instrument Corp.	199A
Tektronix, Inc.	35A
Telerad Mfg. Corp.	153A
Telrex, Inc.	370A
Tenney Engineering, Inc.	25A
Tensolite Insulated Wire Co., Inc.	257A
Texas Instruments, Inc.	137A
Thomas & Skinner Steel Prods. Co.	351A
Thompson Products, Inc.	242A
Thor Ceramics, Inc.	263A
Times Facsimile Corp.	272A
Trad Television Corp.	347A
Transitron Electronic Corp.	73A-75A
Transradio, Ltd.	166A
Triad Transformer Corp.	80A
Tru-Ohm Products Div., Model	31A
Tung-Sol Electric, Inc.	29A
Ulanet Co., George	356A
Union Switch & Signal Co.	352A
United Air Lines	6A
United Catalog Publishers, Inc.	186A
United Mfg. Co., Div. W. L. Maxson	226A
U.S. Components, Inc.	368A
United States Gasket Co.	376A
United States Motors Corp.	160A
United States Radium Corp.	214A
United States Wire & Cable Corp.	254A
United Transformer Co.	Cover 2
Unitek Corp.	367A
Universal Aviation Equipment, Inc.	269A
Varflex Corp.	218A
Varian Associates	39A, 292A
Vectron, Inc.	62A
Victoreen Instrument Co.	326A
Victory Engineering Corp.	232A
Vitramon, Inc.	358A
Vitro Laboratories	322A
Waterman Products Co., Inc.	132A, 133A
Weckesser Co.	261A
Western Gold & Platinum Works	366A
Westinghouse Electric Corp.	284A, 298A, 308A
Wheeler Labs., Inc.	370A
White Industries, Inc.	169A
Wickes Engineering & Constr. Co.	264A
Wiley & Sons, Inc., John	194A
Winchester Electronics, Inc.	44A
Yardney Electric Corp.	350A

high quality TEFLON TAPE

● TEFLON'S superior insulating properties make Chemelec tape better for high frequency, high voltage, high temperature service. Surface resistivity 3.5×10^{13} ohms. Loss factor less than 0.0005. Dielectric constant 2.0 (60 cycles to 30,000 megacycles). Serviceable at temperatures from minus 110°F to plus 500°F. Won't carbonize under arcing or DC plate. Zero water absorption by ASTM Test. Chemically inert, non-gassing, immune to corrosive atmospheres, fungus, oil and solvents. Non-flammable.

Available in thicknesses from .002" to .06", in widths from 1/4" to 12" and in standard N.E.M.A. colors for circuit identification.

● See our exhibit at the Radio Engineering Show, Booth 68-70, Kingsbridge Palace.

Fluorocarbon Products, Inc.
Division of
UNITED STATES GASKET COMPANY
Camden, 1, New Jersey

USG

FABRICATORS OF
FLUOROCARBONS & OTHER PLASTICS
Representatives in principal
cities throughout the world



NEW

900 to 2000 Mc Oscillator

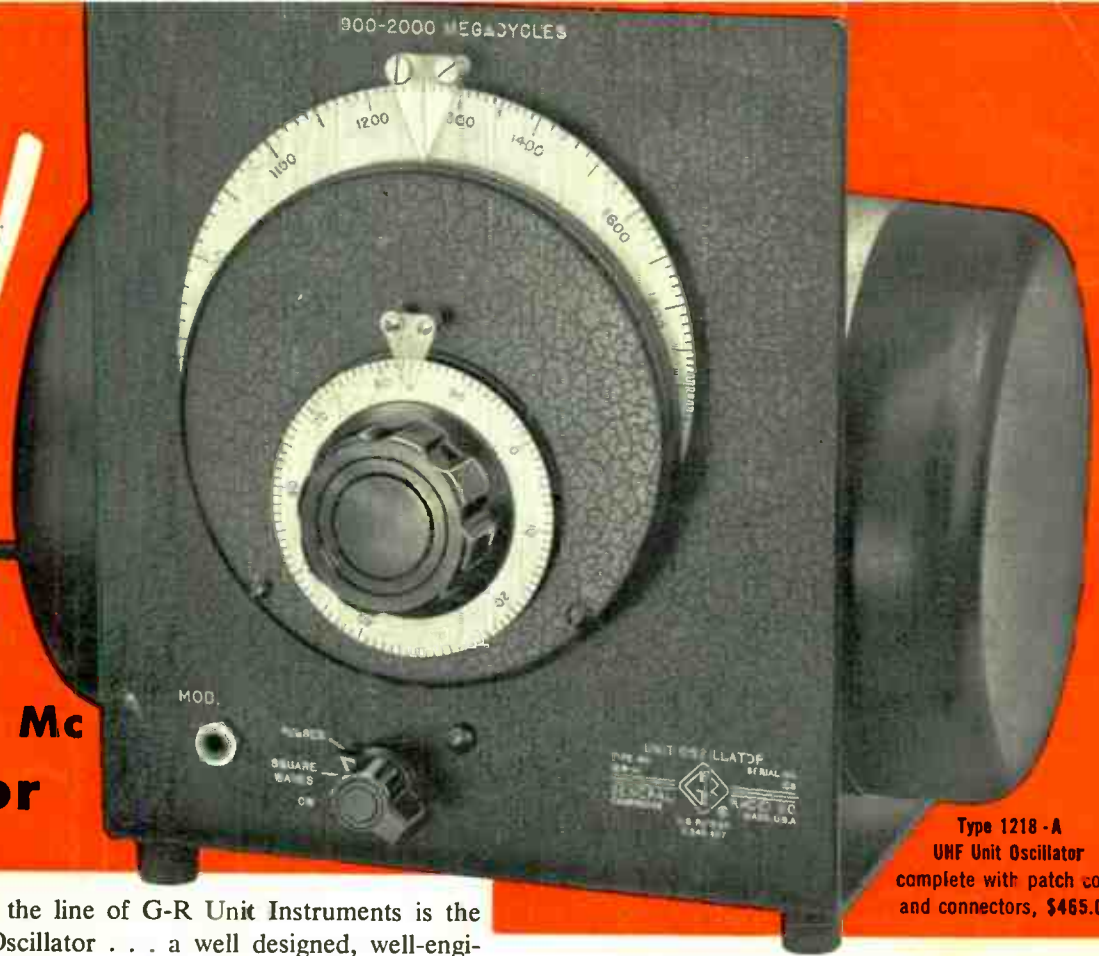

Type 1218-A
UHF Unit Oscillator
complete with patch cord
and connectors, \$465.00

The latest addition to the line of G-R Unit Instruments is the Type 1218-A UHF Unit Oscillator . . . a well designed, well-engineered signal source which provides high power at ultra-high frequencies, and costs much less than existing u-h-f generators.

This instrument is remarkably versatile. It can be modulated with either square waves or pulses. Its frequency can be adjusted accurately in slight increments at any point over its wide range. It is a general-purpose, thoroughly shielded source of power for use in laboratory or field. It is useful not only for driving slotted lines and the Admittance Meter but also for exciting antennas for field-strength measurements, and for high-frequency research and development work on pulse-type equipment of all kinds.

The Oscillator is designed to work with the many other G-R Unit Instruments — Oscillators, Amplifiers, Null Detectors, Pulse Generators, High-Frequency Detectors, Crystal-Controlled Oscillators, Power Supplies — to form a wide variety of flexible, economical measuring systems. These "building blocks" provide, without frills, the most in performance at lowest cost.

CIRCUIT: Grid-separation triode oscillator uses Type 5675 UHF Pencil Tube. Line sections with sliding contacts used to tune plate and cathode.

FREQUENCY RANGE: 900-2000 Mc.

HIGH UHF OUTPUT POWER: Continuously adjustable from low values to minimum of 200 milliwatts into 50-ohm load.

FREQUENCY CALIBRATION: Direct reading to 1% with slow-motion drive.

INCREMENTAL FREQUENCY CONTROL: (cannot be seen in photo).

FREQUENCY DRIFT: Not over 0.1% per day.

MODULATION: Many kinds of external modulation can be applied: Sinusoidal amplitude modulation, pulse modulation and square-wave modulation from about 100 to 5000 cps.

AUTOMATIC CONTROL: Voltages can be inserted in series with the plate to hold the amplitude constant as frequency is varied. Voltages also can be inserted in series with the grid for electronic control of frequency.

LOW NOISE: f-m noise due to vibration and microphonics is unusually low. Rectifier and filter for the heater voltage are built in to reduce modulation by the power-line frequency.

POWER SUPPLY REQUIRED: Type 1203-A Unit Power Supply (\$40) for operation from 115-volt, 50-60 cycle power. The Type 1202-A Unit Vibrator Power Supply (\$125) for operation in the field from 6 or 12-volt storage battery.

ACCESSORIES: Type 1217-A Unit Pulser for direct pulse modulation.

Type 1000-P7 Balanced Modulator for amplitude modulation up to 100% with negligible fm and pulsing with fast rise time and short duration.

Type 874 Coaxial Elements such as adaptors, attenuators, filters, voltmeters, mixers.

Type 1750-A and 1263-A Sweep Drive and Amplitude-Regulated Power Supply for automatic sweeping over the oscillator frequency range.

Type 480-P7UI Panel for mounting Type 1218-A UHF Oscillator in standard laboratory relay rack.

Types 1217-A \$225, 1000-P7 \$225, 480-P7UI \$14, and 874 Coaxial Elements are available from stock for immediate shipment. Types 1750-A and 1263-A will be available shortly.

SEE OUR EXHIBIT at the IRE SHOW 251-255 INSTRUMENTS AVENUE

A preview of new G-R measuring
equipment for 1955 including:

Universal Z-Y Bridge . . . measures any a-f impedance from short circuit to open circuit, balanced or unbalanced, grounded or direct.

Radio-Frequency Bridge . . . for measuring directly the reactance and resistance of antennas, transmission lines and r-f circuit elements.

Sweep Drive . . . a unique mechanical drive to simplify measurements by automation; attaches to any shaft for automatic sweeping of oscillators, potentiometers, switches and other devices.

900-2000 Mc Signal Generator . . . a companion unit to the popular 50-250 Mc and 250-920 Mc Type 1021-AV and AU Signal Generators; three interchangeable oscillator sections and one power supply make possible complete coverage of the 50-2000 Mc range.

Polystyrene Decade Capacitors . . . feature low and constant loss with frequency; capacitance is essentially independent of frequency to dc; low absorption makes these "boxes" ideal for use in computer integrating circuits.

WE SELL DIRECT—Prices are net, FOB Cambridge or West Concord, Mass.

GENERAL RADIO Company

275 Massachusetts Avenue, Cambridge 39, Massachusetts S.A.

94 West Street NEW YORK 4
8055 13th St., Silver Spring, Md. WASHINGTON, D. C.

920 S. Michigan Avenue CHICAGO

1000 N. Seward Street LOS ANGELES 38



1915-1955

40 Years of Pioneering

in Electronics

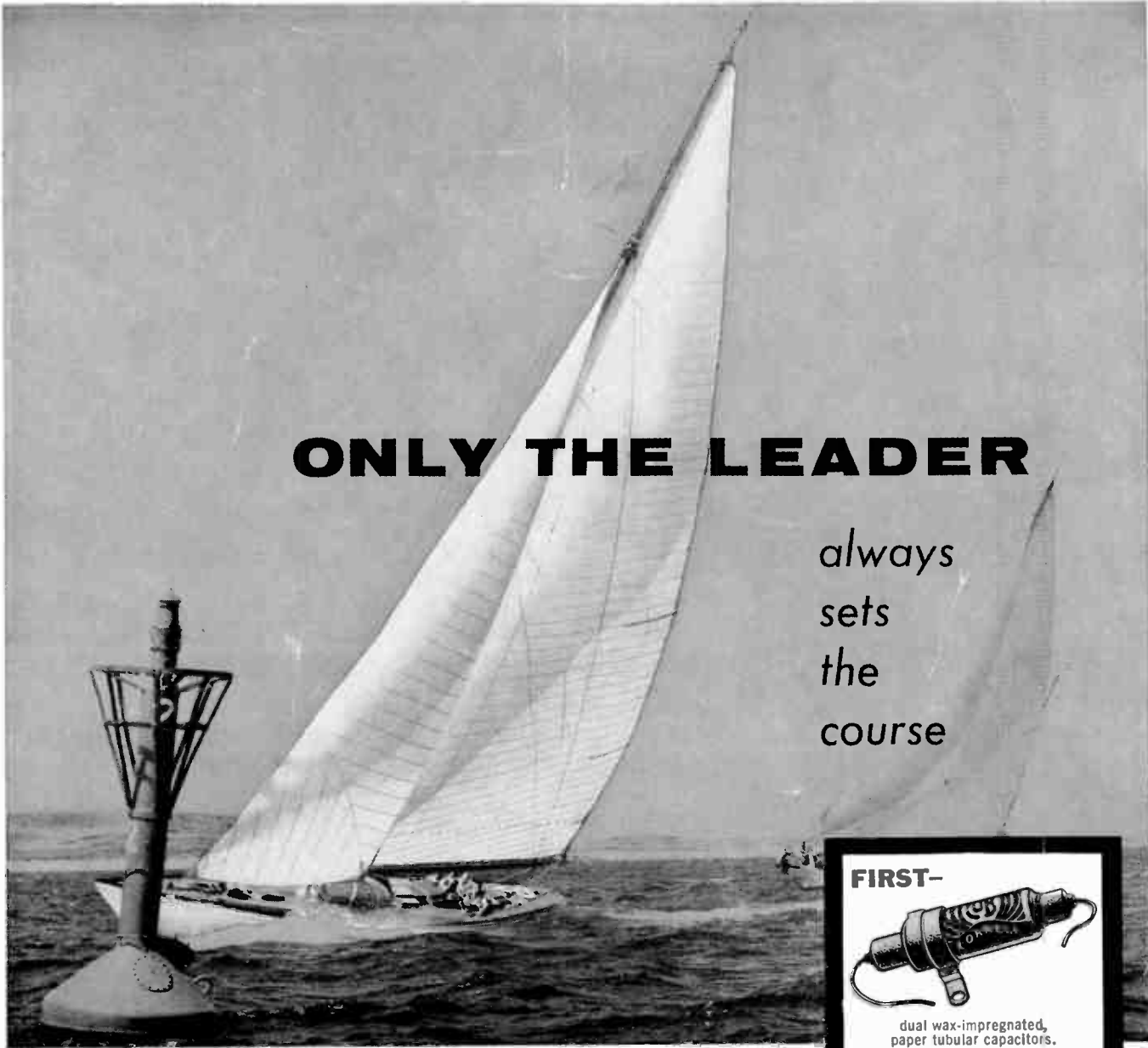

ONLY THE LEADER

*always
sets
the
course*

Charting the course of the future in the manufacture of capacitors has always been the practice at Cornell-Dubilier. Proof of this leadership is that capacitor developments originated at C-D invariably become the standards of comparison for the entire industry.

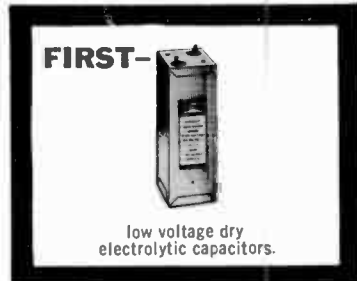
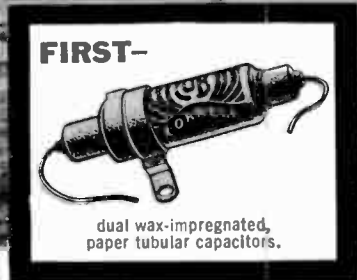

C·D...45 YEARS OF FAMOUS FIRSTS

Typical of these "famous firsts" are the three examples shown here . . . proof that whatever your capacitor requirements may be, your needs can be filled by C-D. Write to Cornell-Dubilier Electric Corp., Dept. M-35, South Plainfield, N. J.

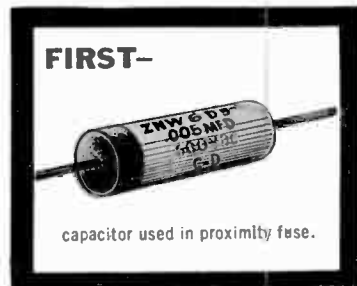

CONSISTENTLY DEPENDABLE CORNELL-DUBILIER CAPACITORS

PLANTS IN SD. PLAINFIELD, N. J.; NEW BEDFORD, WORCESTER AND CAMBRIDGE, MASS.; PROVIDENCE AND HDPE VALLEY, R. I.; INDIANAPOLIS, IND.; SANFORD AND FUGUAY SPRINGS, N. C.; SUBSIDIARY, RADIART CORP., CLEVELAND, OHIO.

THERE ARE MORE C-D CAPACITORS IN USE TODAY THAN ANY OTHER MAKE
See us at Booths 294 and 296, Radio Engineering Show