

Proceedings



of the I·R·E

A Journal of Communications and Electronic Engineering

November, 1950

Volume 38

Number 11

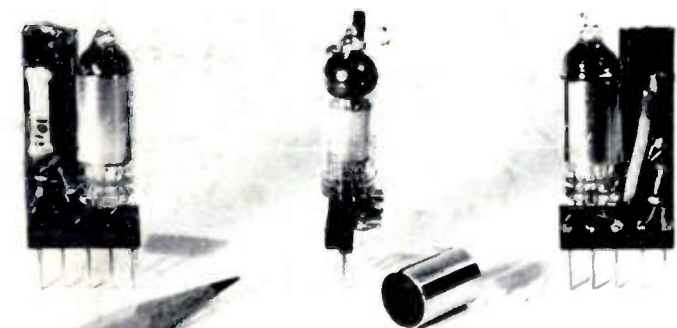

Sylvania Electric Products Inc.

Pre-Assembled Circuit

Subminiature tubes and associated circuit elements combine into compact plug-in units.

The following IRE Standards appear in this issue: Methods of Measurement of Time of Rise, Pulse Width, and Pulse Timing of Video Pulses in Television; and Wave Propagation, Definitions of Terms.

PROCEEDINGS OF THE I.R.E.

Management in Research and Development
Statistical Methods in Research and Development

IRE Standards on Television

IRE Standards on Wave Propagation

Quality Rating of Television Images

Tone Rendition in Photography

Tone Rendition in Television

A Router for Video Signals

Calibrating Frequency Records

Combined Search and AFC of Oscillators

450-Mc Transmission to a Mobile Receiver

Mobile Telephone with 60-Kc Spacing

Antennas for Multichannel Mobile Telephony

Cross Talk in Time-Division Multiplex

Application of Remainder Theorem to Operational Calculus

Band-Pass Low-Pass Transformation

Correlation Functions in Variable Networks

Nyquist and Routh-Hurwitz Stability Criterion

Steady State of a Linear Variable Network

Abstracts and References

TABLE OF CONTENTS, INDICATED BY BLACK-AND-WHITE MARGIN, FOLLOWS PAGE 32A

**1951 Convention Authors,
See Page 1356**

The Institute of Radio Engineers

NEW MORE EFFICIENT LOWER PRICED

WIDE BAND Television Operation to 220 MC with

AMPEREX

TYPE 9904/5923 — WATER COOLED

TYPE 9904-R/5924 — AIR COOLED

TUBES

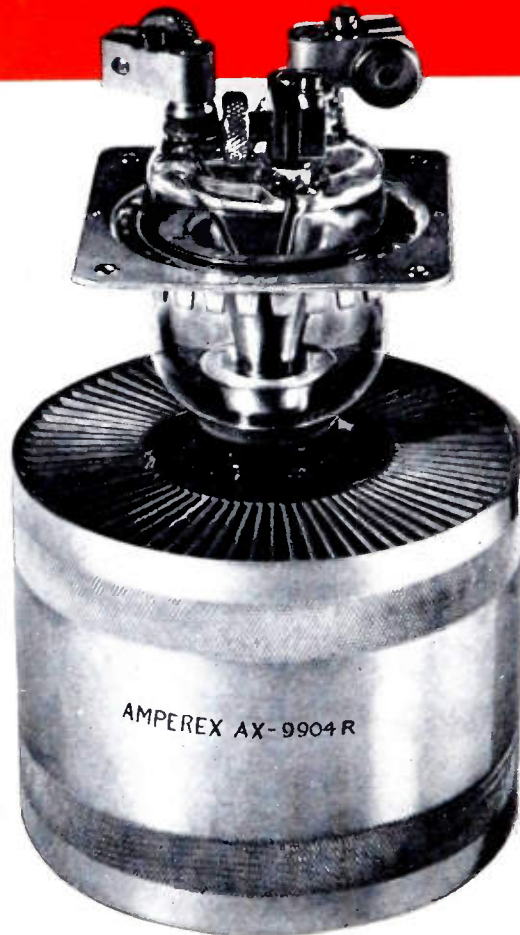

14 MC Band Width at 220 MC

Outputs of 5.7 KW

Filaments of THORIATED TUNGSTEN

Non-Emitting Grid

Disc Type Grid Seal for MINIMIZED INDUCTANCE

OPTIMUM Design Minimum Capacitance at Maximum Transconductance

Grid and Filament Connectors Available

Proven Life

CONSERVATIVELY RATED

re-tube with **AMPEREX**



TYPE 9904/5923

TYPICAL TELEVISION OPERATION

GROUNDING GRID

(Two tubes in Push-Pull)

Frequency (MC)	220
Band Width (MC)	14
D.C. Plate Voltage	4000
D.C. Grid Voltage	
Synchronizing Level	—200
Black Level	—290
White Level	—550
Peak RF Grid Voltage (Grid to Grid)	1000
D.C. Plate Current (AMP)	
Synchronizing Level	2.5
Black Level	1.76
D.C. Grid Current (MA)	
Synchronizing Level	400
Black Level	160
Driving Power (approx. watts)	1000
Power Output (KW)	
Synchronizing Level	5+0.7
Black Level	3

Data Sheets and Charts Available . . .



AMPEREX ELECTRONIC CORP.

25 WASHINGTON STREET, BROOKLYN 1, NEW YORK
In Canada and Newfoundland: Rogers Majestic Limited
11-19 Brentcliffe Road, Leaside, Toronto, Ontario, Canada

THE INSIDE STORY: WHY SPRAGUE MOLDED TUBULARS OUTPERFORM ALL OTHERS!

Molded paper tubulars may look alike from the outside. But there's a whale of a difference inside—the part that really counts in the performance of your products.

The *exclusive* difference in Sprague molded phenolic tubulars is that: *each is made by the same dry-assembly process as large metal-encased oil capacitors.* They cannot be contaminated during manufacture!

Every Sprague molded tubular from 200 to 12,500 volts is molded *dry*. After molding it is impregnated under high vacuum through an opening in the eyelet terminal. A lead is then inserted and the terminal solder sealed. Result? A capacitor that offers you superior heat and moisture protection . . . top insulation resistance . . . high capacitance stability and retrace under wide temperature variations.

Small wonder then why Sprague molded tubulars are preferred for the toughest television and auto radio applications. Take advantage of this superiority by calling in a Sprague representative today. Or, write for Engineering Bulletins 210B and 214.

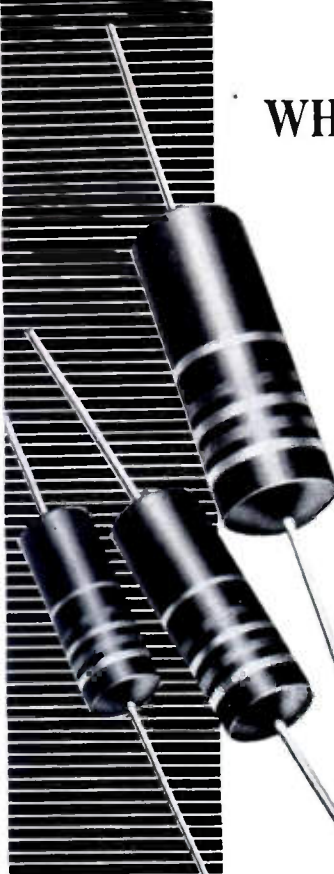

Hollow eyelet terminal for impregnation after molding

Solder seal as in large metal-encased oil capacitors

Non-flammable, dense bakelite phenolic-molded housing

CUT-AWAY VIEW

Uniform windings of high purity paper and aluminum foil

SPRAGUE[®]
PIONEERS IN

SPRAGUE ELECTRIC COMPANY
North Adams, Massachusetts

ELECTRIC AND ELECTRONIC DEVELOPMENT



How a whiff of stibine led toward lower telephone costs

At the New York Telephone Company's Triangle exchange in Brooklyn, emergency batteries stand ready to deliver 3000 amperes for several hours.

In the Bell System there are a million lead storage battery cells connected to telephone circuits in the central offices. Current seldom flows in or out of these cells beyond the trickle which keeps them charged. In the rare event of power failure, however, they stand ready to supply the current for your telephone service.

Even in this stand-by service, cells require water to make up for electrolysis. And they consume power and eventually wear out. But Bell Laboratories chemists discovered how to make a battery which lasts many more years and requires less attention — by changing a single ingredient, the clue to

which came unexpectedly from another line of their research.

The clue was a minute trace of stibine gas in battery rooms which electrochemists detected while on the lookout for atmospheric causes of relay contact corrosion. In small traces the gas wasn't harmful but to battery chemists it offered a powerful hint.

For stibine is a compound of antimony—and antimony is used to harden the lead grids which serve as mechanical supports for a battery's active materials. Tracing the stibine, the chemists discovered that antimony is leached out of the positive grid and enters into chemical reactions which

hasten self-discharge and shorten battery life.

Meanwhile, in the field of cable sheath research Bell metallurgists had discovered that calcium could be used instead of antimony to harden lead. And theory showed that calcium would not react destructively in a battery. The result is the new long-life calcium-lead battery which cuts battery replacement costs, goes for months without additional water, and needs but $\frac{1}{5}$ the trickle current to keep its charge.

It demonstrates again how diverse lines of research come together at Bell Telephone Laboratories to keep down the cost of telephone service.

BELL TELEPHONE LABORATORIES

Working continually to keep your telephone service big in value and low in cost.





Precision Voltmeters... FAST ACCURATE READINGS

2 cps to 700 mc

ANOTHER -hp- SERVICE

Person-to-Person Help With Your Measuring Problems

Almost anywhere in America, -hp- field representatives can give you personal help with your measuring problems. They have complete data on -hp- instruments, their performance, servicing and adaptability. Call the nearest -hp- field representative whenever, wherever you need help with a measuring problem.

ALBUQUERQUE, NEW MEXICO

Neely Enterprises
302½ W. Central Ave., Albuquerque 3-2245

BOSTON 16, MASSACHUSETTS

Burlingame Associates
270 Commonwealth Ave., KEnmore 6-8100

CHICAGO 40, ILLINOIS

Alfred Crossley & Associates
4501 Ravenswood Ave., UPtown 8-1141

CLEVELAND 15, OHIO

M. P. Odell Co.
2536 Euclid Ave., PRospect 1-6171

DALLAS 5, TEXAS

Earl Lipscomb Associates
4433 Stanford St., LOgan 6-5097

DAYTON 2, OHIO

Alfred Crossley & Associates
410 W. First St., Michigan 8721

DENVER 3, COLORADO

Ronald G. Bowen
852 Broadway, AComa 5211

DETROIT 5, MICHIGAN

S. Sterling Company
13331 Linwood Ave., TOwnsend 8-3130

FORT MYERS, FLORIDA

Arthur Lynch & Associates
P. O. Box 466, Fort Myers 1269M

HOUSTON 5, TEXAS

Earl Lipscomb Associates
3919 Riley St., LInden 9303

HIGH POINT, NORTH CAROLINA

Bivins & Caldwell
Rm. 807, Security Bk. Bldg., High Point 3672

LOS ANGELES 46, CALIFORNIA

Neely Enterprises
7422 Melrose Ave., WHitney 1147

NEW YORK 13, NEW YORK

Burlingame Associates
103 Lafayette St., Dlgby 9-1240

PHILADELPHIA 44, PENN.

Burlingame Associates
422 Coulter St., TENnessee 9-2006

SAN FRANCISCO 3, CALIFORNIA

Neely Enterprises
954 Howard St., DOuglas 2-2609

ST. LOUIS 3, MISSOURI

Harris-Hanson Company
208 North 22nd St., MAIn 5464

SYRACUSE, NEW YORK

Burlingame Associates
712 State Tower Bldg., SYracuse 2-0194

TORONTO 2-B, ONTARIO, CANADA

Atlas Radio Corporation, Ltd.
560 King St. West, WAverley 4761

WASHINGTON 9, D. C.

Burlingame Associates
2017 S Street N. W., DEcatur 8000

-hp- MODEL 400C



From 2 cycles to 700 megacycles, there's an accurate, easy-to-operate -hp- voltmeter to fit every voltage measurement requirement. You can choose from 5 precision voltmeters (including a battery-operated instrument) the ones which precisely fill your measuring need. Each has the familiar -hp- characteristics of high sensitivity, wide range, versatility, compact size, and time-saving ease of operation. These -hp- precision voltmeters are used by radio stations, manufacturers, research laboratories and scientific men throughout the world.

INSTRUMENT	FREQ. RANGE	VOLTAGE RANGE	ACCURACY	INPUT IMPEDANCE	PRICE
-hp- 400A	10 cps to 1 mc	.005 to 300 v 9 ranges	Within 3%	1 meg., 16 μ fd shunt	\$185.00
-hp- 400B	2 cps to 100 kc	.005 to 300 v 9 ranges	Within 3%	10 meg., 20 μ fd shunt	195.00
-hp- 400C	20 cps to 2 mc	.0001 v to 300 v 12 ranges	Within 3%	10 meg., 15 μ fd shunt	200.00
-hp- 404A (Battery Op'd.)	2 cps to 50 kc	.0005 v to 300 v 11 ranges	Within 5%	10 meg., 20 μ fd shunt	185.00
-hp- 410A	20 cps to 700 mc	0.1 v to 300 v 7 ranges	Within 3%	10 meg., 1.3 μ fd shunt	245.00

For complete data on any -hp- instrument, write direct to factory or contact the nearest -hp- technical representative.

HEWLETT-PACKARD CO.

1876-D PAGE MILL ROAD • PALO ALTO, CALIF.

Export Agents: Frazar & Hansen, Ltd.

301 Clay Street, San Francisco 11, California, U.S.A.

hp laboratory instruments
FOR SPEED AND ACCURACY



Mallory Capacitors Deliver *Extreme Dependability in Critical Applications!*

MALLORY NP CAPACITORS

Mallory NP Capacitors are non-polarized and designed for heavy-duty applications where extreme dependability is essential. Priced competitively at ordinary capacitor levels, they are ideal for controls and other unusual circuits. Write for your copy of the Mallory NP Capacitor data folder.

Long trouble-free service has become so synonymous with Mallory Capacitors that customers have come to assign critical responsibilities to them without hesitation.

For example . . . a complex rpm control for diesel-electric locomotives. The failure of a single component would stall the train, blocking rail traffic for hours. For absolute safety and dependability, the manufacturer specified Mallory NP Capacitors in this control.

The Mallory-originated NP Capacitor is widely used in such important applications. This complete confidence is the result of years of *demonstration* of Mallory superiority. Yet Mallory Capacitors cost you no more.

That's results beyond specifications!

And whether your problem is electronic or metallurgical, what Mallory has done for others can be done for you!

P. R. MALLORY & CO., Inc.
MALLORY

P. R. MALLORY & CO., Inc., INDIANAPOLIS 6, INDIANA

SERVING INDUSTRY WITH

Capacitors	Contacts
Controls	Resistors
Rectifiers	Vibrators
Special	Power
Switches	Supplies
Resistance Welding Materials	

now **color** tv for industry!

THE DU MONT TA-164A CLOSED CIRCUIT INDUSTRIAL COLOR TV SYSTEM



Now available! The Du Mont tried-and-proved industrial color television system in a complete, packaged, ready-to-operate form. Designed specifically for industrial applications, the new Du Mont TA-164A Industrial Color TV System provides bandwidth of 18 mc. and picture resolution of 525 lines. Full high fidelity color from light pastels to deep colors.

Engineered to provide dependable day-in day-out service required by industry, research, medicine, merchandising and countless other fields. Compact, lightweight, portable units are joined by interconnecting cables utilizing the famous Du Mont "Jiffy" connectors assuring complete flexibility and the Du Mont kind of dependability. May be plugged into power line anywhere. Operates on 110 volt 60-cycle AC.

► DETAILS ON REQUEST

DUMONT



First with the Finest in Television ALLEN B. DU MONT LABORATORIES, INC.
Television Transmitter Division, Clifton, N.J.

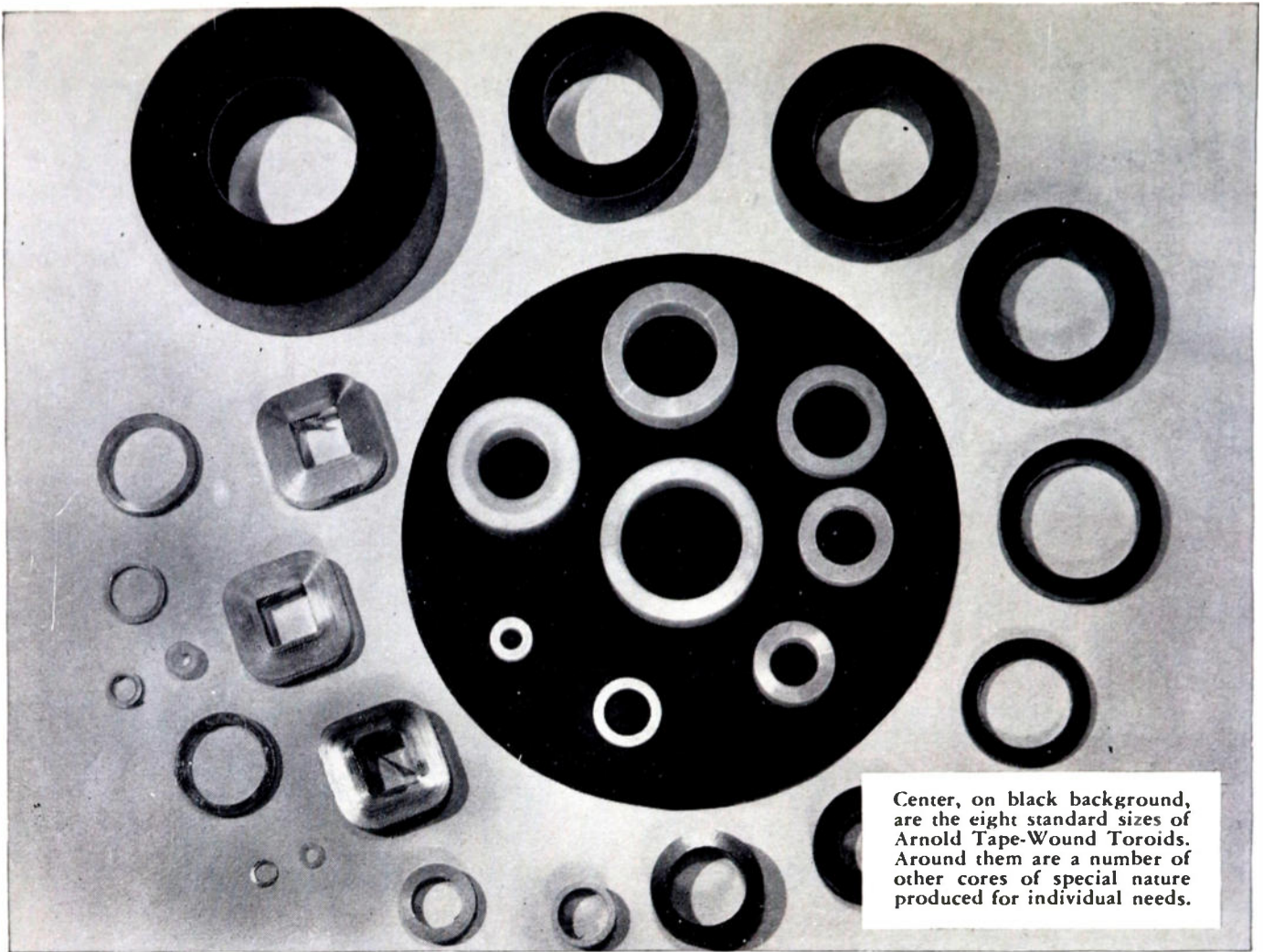

Center, on black background, are the eight standard sizes of Arnold Tape-Wound Toroids. Around them are a number of other cores of special nature produced for individual needs.

ARNOLD TAPE-WOUND TOROIDAL CORES

of DELTAMAX 4-79 MO-PERMALLOY SUPERMALLOY*

APPLICATIONS

MAGNETIC AMPLIFIERS
PULSE TRANSFORMERS
NON-LINEAR RETARD COILS
and TRANSFORMERS
PEAKING STRIPS, and many other
specialized applications.

RANGE OF SIZES

Arnold Tape-Wound Toroids are available in eight sizes of standard cores—all furnished encased in molded nylon containers, and ranging in size from 1/2" to 2 1/2" I.D., 3/4" to 3" O.D., and 1/8" to 1/2" high.

RANGE OF TYPES

These standard core sizes are available in each of the three magnetic materials named, made from either .004", .002" or .001" tape, as required.

In addition to the standard toroids described at left, Arnold Tape-Wound Cores are available in special sizes manufactured to meet your requirements—toroidal, rectangular or square. Toroidal cores are supplied in protective cases.

*Manufactured under licensing arrangements with Western Electric Company.

W80 3102

THE ARNOLD ENGINEERING COMPANY



SUBSIDIARY OF ALLEGHENY LUDLUM STEEL CORPORATION

General Office & Plant: Marengo, Illinois

PRODUCED BY THE MILLIONS



HI-Q
Engineering
Laboratory



Hi-Q Components

-Under keenly competent engineering supervision

HI-Q COMPONENTS

Capacitors
Trimmers • Choke Coils
Wire Wound Resistors

BETTER 4 WAYS

- ✓ PRECISION
- ✓ UNIFORMITY
- ✓ DEPENDABILITY
- ✓ MINIATURIZATION

● The engineering laboratory is the alert guardian of **HI-Q** quality. No component can be put into production until it has proven that it meets **HI-Q's** exacting standards to the complete satisfaction of these technicians. It is their further responsibility to see that standards are rigidly maintained during production runs. In addition, **HI-Q** engineers are always available to work with your engineers in the development of components to meet your specific needs. Feel free to call on them whenever and as often as you see fit.

If you haven't received your copy of the new Hi-Q Catalog, write today.

JOBBERS — ADDRESS: 740 Belleville Ave., New Bedford, Mass.

HI-Q

Electrical Reactance Corp.

OLEAN, N. Y.

SALES OFFICES: New York, Philadelphia
Detroit, Chicago, Los Angeles

PLANTS: Olean, N. Y., Franklinville, N. Y.
Jessup, Pa., Myrtle Beach, S. C.

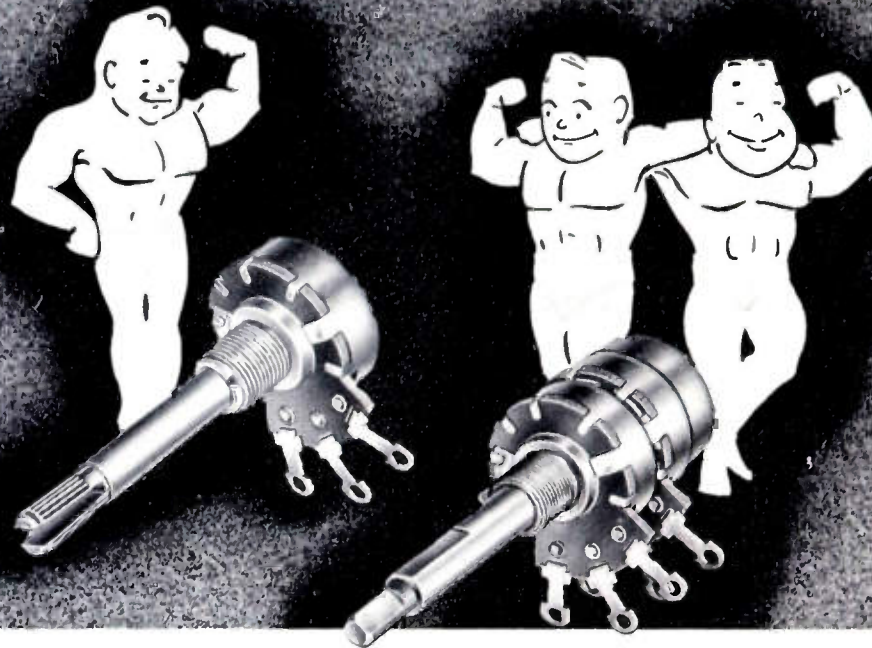

SMALLEST SIZE YET for conservatively rated .5 watt controls!

You save appreciable space with Stackpole LR variable resistors—yet still have ample wattage capacity for most TV and mobile radio applications. Only 57/64" in diameter, these sturdy controls are conservatively rated at 1/2 watt* and are outstandingly quiet, fully dependable.

Single LR controls are supplied with or without SP-ST or DP-ST line switches. Dual concentric controls—tops for dozens of space-saving applications—are available with practically any needed shaft or switch arrangement.

Write for details or samples to your specifications.

Electronic Components Division
STACKPOLE CARBON COMPANY, ST. MARYS, PENNA.

*1/2 watt rating where voltage across units does not exceed 350 volts for linear tapers, or for non-linear controls having a taper of no less than 10% of the total resistance at 50% rotation and when voltage is not in excess of 225 volts.

STACKPOLE

FIXED AND VARIABLE CARBON RESISTORS • IRON CORES • CERAMAG® CORES
MOLDED COIL FORMS • MOLDED "GIMMICK" CAPACITORS • INEXPENSIVE
LINE AND SLIDE SWITCHES



Those in the Radio and Television Industries know from actual use the fine performance of these Tubes.

They also know that our large production capacity assures them of a dependable source of supply with prompt delivery.

Ask us about these spirally laminated paper base phenolic tubes in diameters, wall thicknesses and lengths that will meet your needs.

CLEVELITE*

and

COSMALITE*

LAMINATED PHENOLIC TUBING

is used also for many other electrical products at a considerable saving where exacting specifications must be carefully followed. For the best . . . "Call Cleveland."

*Trade Marks

The **CLEVELAND CONTAINER Co.**
6201 BARBERTON AVE. CLEVELAND 2, OHIO

PLANTS AND SALES OFFICES at Plymouth, Wis., Chicago, Detroit, Ogdensburg, N.Y., Jamesburg, N.J.
ABRASIVE DIVISION at Cleveland, Ohio
CANADIAN PLANT: The Cleveland Container, Canada, Ltd., Prescott, Ontario

REPRESENTATIVES

NEW YORK AREA R. T. MURRAY, 614 CENTRAL AVE., EAST ORANGE, N. J.
NEW ENGLAND R. S. PETTIGREW & CO., 968 FARMINGTON AVE.
WEST HARTFORD, CONN.
CANADA WM. T. BARRON, EIGHTH LINE, RR #1, OAKVILLE, ONTARIO



ELECTRONICS



Designers



ELECTRONIC COMPONENTS

A HIGHEST QUALITY LINE

— constantly improved and added to —

for your equipment designs

APPARATUS DEPARTMENT

- Meters and instruments
- Capacitors
- Transformers
- Pulse-forming networks
- Delay line
- Reactors
- Thyrite
- Inductrols
- Voltage stabilizers
- Fractional hp motors
- Timers
- Control switches
- Selsyns
- Relays
- Amplidynes
- Amplistats
- Terminal boards
- Glass bushings
- Thermistors
- Dynamotors

ELECTRONICS DEPARTMENT

- Tubes
- Television components
- Phono pickups
- Speakers
- Quartz crystal units
- Germanium diodes

When you're building any of thousands of complex industrial and military electronic devices, reliable components are a must.

To give you, the designers of these devices, the utmost in reliability, General Electric is constantly at work improving and redesigning in its ever growing line of electronic components.

The list at left only partially covers the thousands of parts in the complete G-E line. We'll tell you about as many of them as space will permit in these pages from month to month. *Apparatus Department, General Electric Company, Schenectady 5, N. Y.*



GENERAL



ELECTRIC

667-8

Digest

TIMELY HIGHLIGHTS ON G-E COMPONENTS



LINE-VOLTAGE STABILIZERS —get rid of ups and downs!

When you're after a steady 115 volts at the input of your equipment and the line is fluctuating anywhere between 95 and 130, use a G-E voltage stabilizer. These units use a special transformer circuit to provide a stabilized output voltage within $\pm 1\%$ of 115 volts for fixed, unity-power-factor loads. Fast response of G-E stabilizer restores normal output voltage in less than three cycles. 15-, 25- and 50-va stabilizers are small enough to mount on radio or electronic instrument chassis (2 inches high, 9 inches long). Standard ratings up to 5000 va are available in larger sizes. Write for Bulletin GEA-3634.

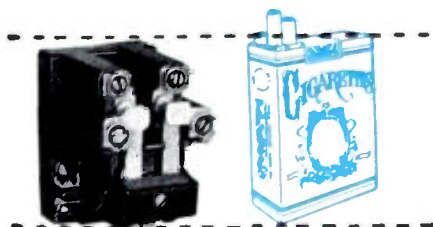

TYPE HMA RELAYS—up to 30 amps, closing

The G-E Type HMA relay is only the size of cigarette package, but it closes at currents up to 30 amperes! HMA relays have self-aligning, silver-to-silver contacts; are positive in action, instantaneous in operation. They're available in either back or front connected models. For coil voltages of 6, 12, 24, 32, 48, or 125 d-c; 115 or 230 a-c. Single- or double-break contacts. Bulletin GEA-5457.

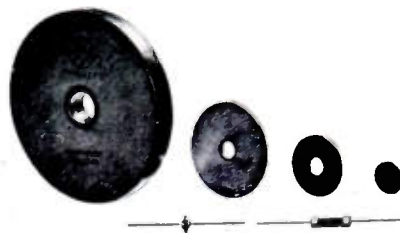

THYRITE— R varies inversely as E^4

With the unique electrical property of varying inversely in resistance as the fourth power (or even higher) of the applied voltage, Thyrite* resistance material has solved many problems for the design engineer.

Use it with a-c, d-c, or short duration pulses; for such applications as the limiting of voltage surges, stabilization of rectifier output voltages, controlling of voltage-selective circuits, and potentiometer division of voltages.

Thyrite comes in disk form in diameters from 0.25 to 6.00 inches, with or without mounting holes. Smaller sizes are furnished with wire leads. See Bulletin GEA-4138.

*Registered Trade Mark of General Electric Co.

General Electric Company, Section B667-P
Apparatus Department, Schenectady 5, N. Y.

Please send me the following bulletins:

- | | | |
|---------------------------------------|--------------------------|------------------------------|
| Indicate | <input type="checkbox"/> | GEA-3634 Voltage stabilizers |
| (V) for reference only | <input type="checkbox"/> | GEA-4138 Thyrite |
| (X) for planning an immediate project | <input type="checkbox"/> | GEA-5457 HMA relays |

Name _____

Company _____

Address _____

City _____ State _____

WTCH Helps Shawano Evening Leader Reach The Northeastern Wisconsin Market

WTCH serves more than 150,000 families in north-eastern Wisconsin. It is a 1000 watt daytime station operated in conjunction with the Shawano Evening Leader, Shawano, Wisconsin. The 240 foot Truscon Tower with 52 x 48 Truscon Ground Screen assures an excellent signal.

"We are very well satisfied with our Truscon Radio Tower" says WTCH Manager, D. W. Hodgins. "Recently the tower withstood 80-mile-an-hour winds with no damage and no loss of operation. It has also withstood heavy sleet storms and other adverse weather conditions which we in northern Wisconsin experience, especially in the winter."

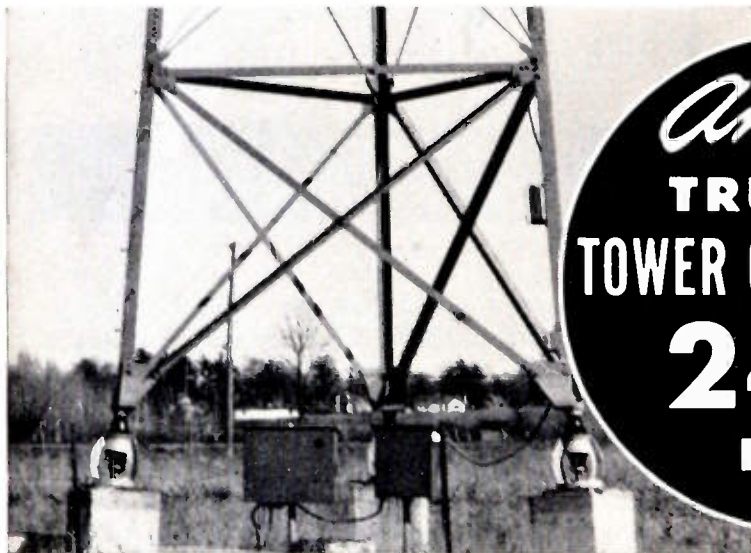

Another
TRUSCON
TOWER OF STRENGTH
240 FT.
HIGH

Truscon Radio Towers have a world-wide reputation for "staying in business" under all types of topographical and meteorological conditions. Each installation is engineered to the particular requirements of the job.

Whether you're planning in terms of AM, FM, or TV, call or write your nearest Truscon district office. Capable technicians will work with you in selecting location and type of tower—guyed or self-supporting, uniform or tapered cross-section, tall or small—which best will serve you and your audience.

TRUSCON STEEL COMPANY

YOUNGSTOWN 1, OHIO

Subsidiary of Republic Steel Corporation



OHMITE ...

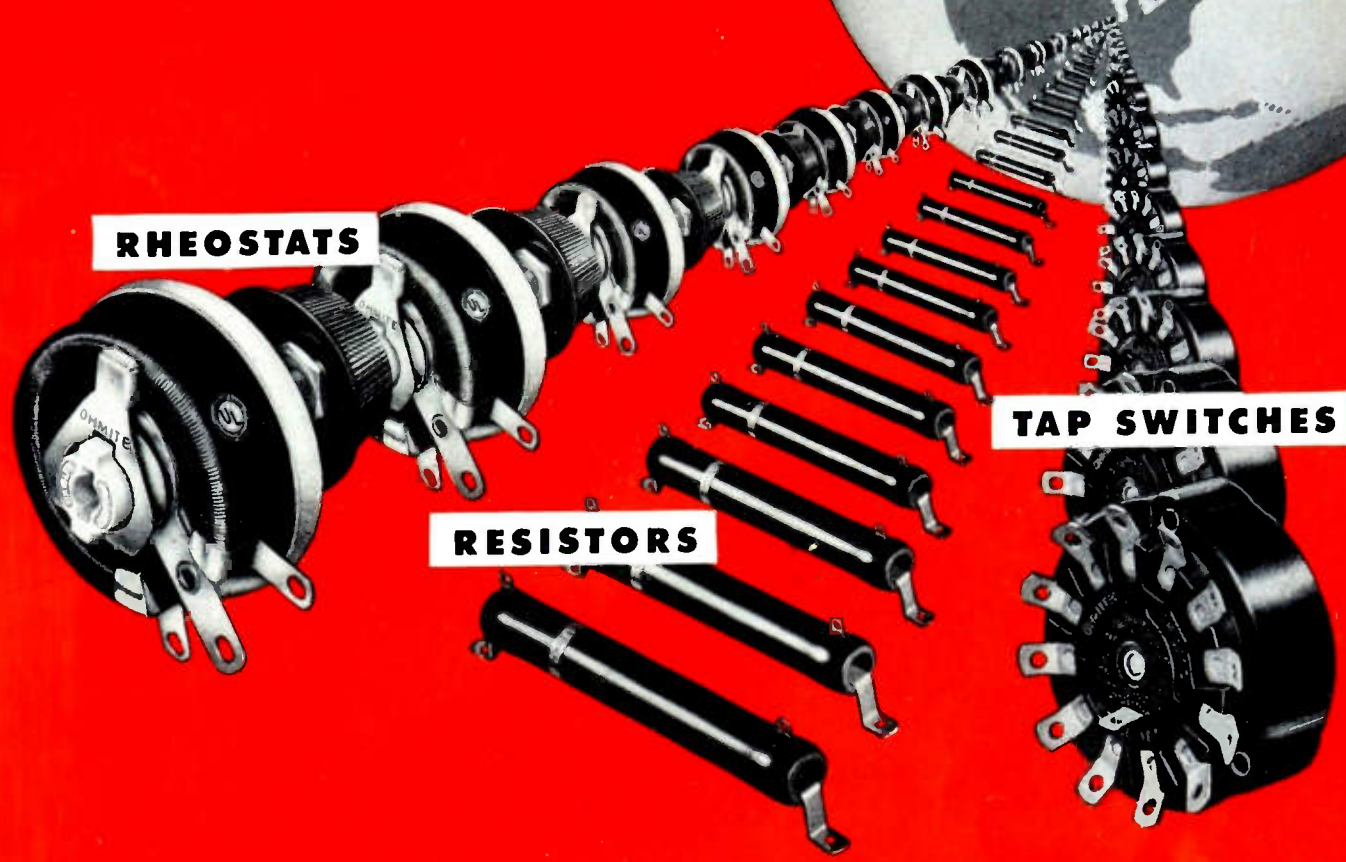

World Renowned for Dependability

To thousands of equipment manufacturers the world over—the name OHMITE has become synonymous with *QUALITY*. These manufacturers have put OHMITE resistance products through the most rigid of all tests—performance in the field—and these superior units have provided consistently dependable performance and long life under the most difficult operating conditions.

“Be Right with OHMITE” is more than just a slogan to these users. They know that when they specify OHMITE, they get the finest resistance equipment available—anywhere!

OHMITE MFG. CO.
4861 Flournoy St.
Chicago 44, Ill.

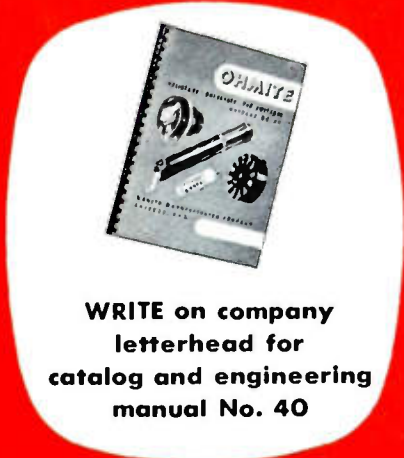

WRITE on company letterhead for catalog and engineering manual No. 40

Be Right with

OHMITE

Reg. U. S. Pat. Off.

RHEOSTATS

RESISTORS

TAP SWITCHES

*A page
from the
note-book
of Sylvania
Research*

New Sylvania instrument speeds tracing of receiving tube curves

Families of characteristic curves of electronic tubes, complete with all horizontal and vertical graph lines, are automatically traced on a cathode ray tube face and photographed with this new Sylvania-engineered equipment.

Precise calibration is assured by automatic compensation for circuit non-linearities and tracing errors.

Rapid operation yields accurate data even in regions of high current operation as encountered in Class C and pulse applications. This instrument, result of years of Sylvania development and research, provides tube engineers with more accurate evaluation of new designs. Radio and television circuit designers gain from it better application data over a wider range of applied voltages.

It marks one more Sylvania advance toward better product performance—better design—better service.

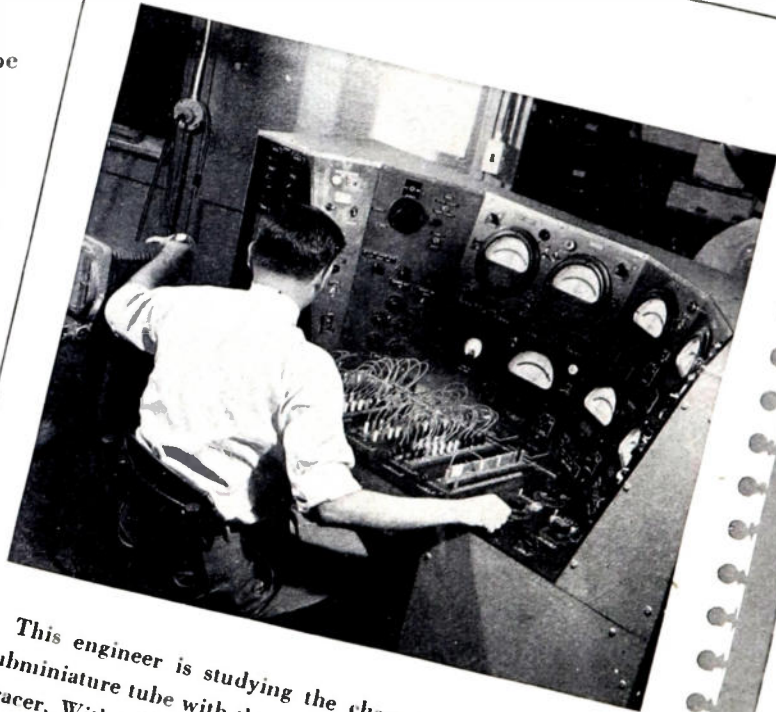

This engineer is studying the characteristic curves of a subminiature tube with the new Sylvania Cathode-ray Curve Tracer. With this instrument he quickly obtains families of curves for more accurate data about tube behavior under a wide variety of conditions.

SYLVANIA ELECTRIC

ELECTRONIC DEVICES; RADIO TUBES; TELEVISION PICTURE TUBES; ELECTRONIC TEST EQUIPMENT; FLUORESCENT TUBES, FIXTURES, SIGN TUBING, WIRING DEVICES; LIGHT BULBS; PHOTOLAMPS; TELEVISION SETS

EL-MENCO CM-15 CAPACITOR

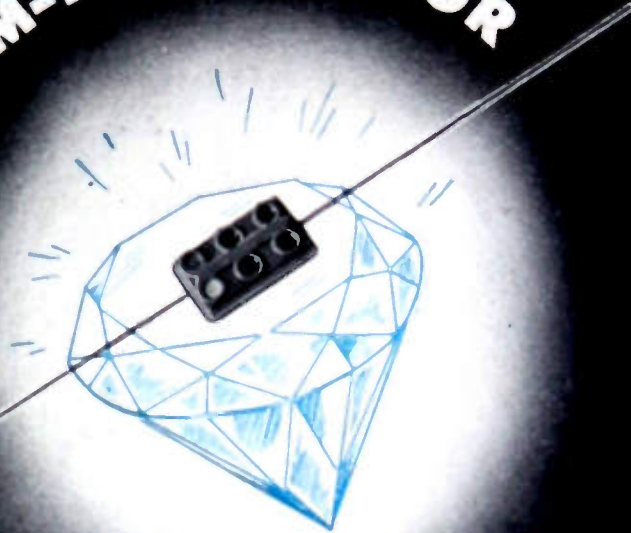

THIS GEM-SIZED UNIT DOES A

GIGANTIC JOB

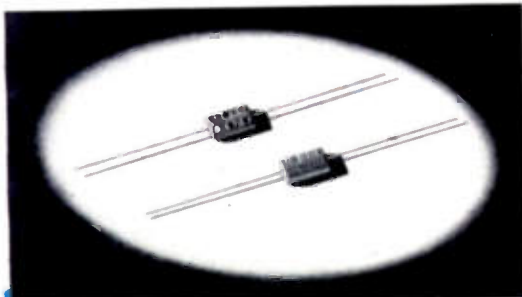

CM-15 MINIATURE CAPACITOR

Actual Size $9/32" \times 1/2" \times 3/16"$

For Television, Radio and other Electronic Applications.

2 to 420 mmf. cap. at 500v DCw.

2 to 525 mmf. cap. at 300v DCw.

Temp. Co-efficient ± 50 parts per million per degree C for most capacity values.

6-dot color coded.

Each tiny El-Menco CM-15 capacitor performs at maximum efficiency regardless of climate or critical operating conditions. Before leaving the factory, it is tested for dielectric strength at *double* working voltage—for insulation resistance and capacity value. Every gem-sized El-Menco capacitor meets and beats the strictest Army-Navy standards. That's why *you* can always depend on this tiny condenser to give gigantic performance in your product.

A COMPLETE LINE OF CAPACITORS TO MEET EVERY REQUIREMENT

THE ELECTRO MOTIVE MFG. CO., Inc.
WILLIMANTIC CONNECTICUT

Write on your firm letterhead for
Catalog and Samples.



MOLDED MICA

EL-Menco

CAPACITORS

MICA TRIMMER

FOREIGN RADIO AND ELECTRONIC MANUFACTURERS COMMUNICATE DIRECT WITH OUR EXPORT DEPT. AT WILLIMANTIC, CONN. FOR INFORMATION.

ARCO ELECTRONICS, INC. 103 Lafayette St., New York, N. Y.—Sole Agent for Jobbers and Distributors in U.S. and Canada

SIGNAL GENERATORS by

AIRCRAFT RADIO CORPORATION

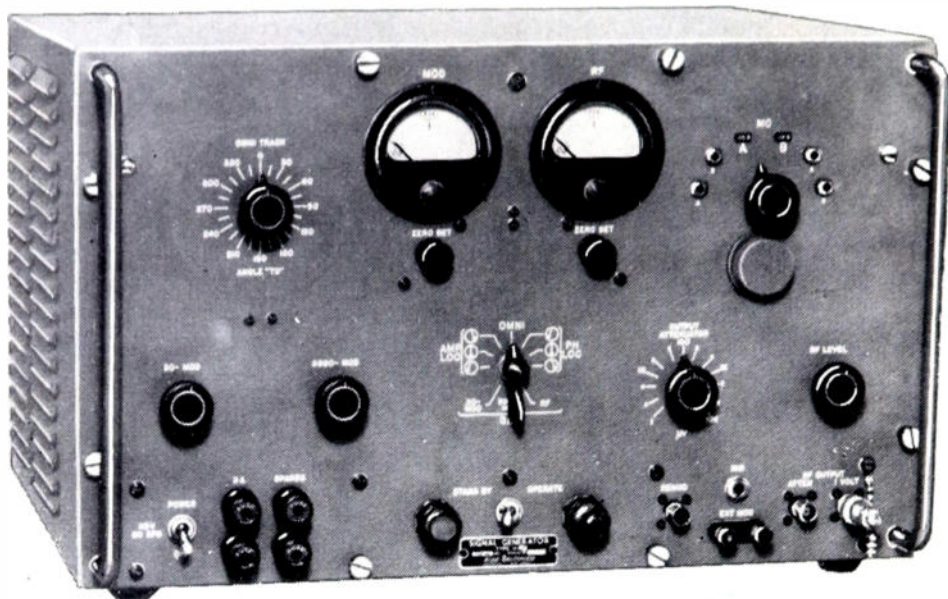

TYPE H-14

108-118 MEGACYCLES

Tests OMNI Receiving Units in Aircraft or on the Bench

Checks on:

- 24 Omni courses
- Left-center-right on Phase-localizer
- Left-center-right on Amplitude-localizer
- Omni course sensitivity
- To-From and Flag-alarm operation
- All necessary quantitative bench tests

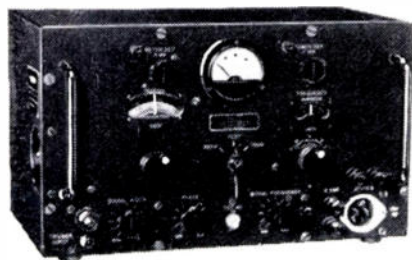

The Type H-14 Signal Generator, 108-118 megacycles, provides a standard signal source for the complete testing of VHF airborne omnirange and localizer receivers in aircraft or on the bench. It provides for testing 24 omni courses, plus left-center-right checks on both amplitude and phase localizers. Aircraft may be checked out

quickly and accurately just before take-off. RF output for ramp checks, 1 volt into 52 ohm line and for bench checks, 0-10,000 microvolts. Provision for external voice or other modulation. AF output available for bench maintenance and trouble shooting.

Price: \$885.00 net, f.o.b. Boonton, N. J.

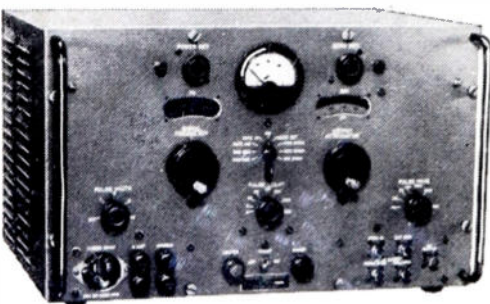

ARC Communication and Navigation Equipment



Aircraft Radio Corporation also manufactures LF and VHF airborne communication and navigation equipments—all CAA-Type-Certificated for scheduled air-carrier use or for those whose type of flying requires a high degree of reliability and performance. Equipment consists of light, small units which can be combined to provide the required operation, whether it be the 1 Receiver/1 Transmitter (15 pound) installation in a 2-place helicopter, or a 3 Receiver/2 Transmitter/ VHF Omni installation (70 pounds) in larger 2-engine aircraft.

TYPE H-10—Microwave Test Set; 23,500-24,500 Megacycles

Provides source of cw or pulse frequency-modulated RF, power level -37 to -90 dbm. RF power meter measures levels from +7 to +30 dbm. Frequency meter for measuring output or input RF accurate to better than 20 mc. Primary purpose of the H-10 is to

measure receiver sensitivity, bandwidth, frequency, recovery time, and overload characteristics, plus transmitter power and frequency. Recommended as a standard source of RF for research or production testing. Equal to military TS-223/AP.

Price: \$1692.00 net, f.o.b. Boonton, N. J.

TYPE H-12—VHF Signal Generator; 900-2100 Megacycles

Provides source of cw or pulse amplitude-modulated RF, power level 0 to -120 dbm. Internal pulse circuits with controls for width, delay, and rate, and provision for external pulsing. Single

dial tuning, frequency calibration accurate to better than 1%. Built to Navy specifications for research and production testing. Equal to military TS-419/U.

Price: \$1950.00 net, f.o.b. Boonton, N. J.



WRITE TODAY for descriptive literature on A.R.C. Signal Generators or airborne LF and VHF communication and navigation equipments, CAA Type Certificated for transport or private use.

Aircraft Radio Corporation

Boonton, N. J.

Dependable Electronic Equipment Since 1928

It's a fact that



AlSiMag is impervious to moisture



AlSiMag is as light as aluminum



AlSiMag is harder than granite



AlSiMag does not rust, oxidize or corrode



AlSiMag is non-magnetic



AlSiMag has higher insulation at high temperature than fused quartz



AlSiMag withstands higher compressive loads than steel



AlSiMag is chemically inert



AlSiMag is permanently rigid



AlSiMag has lower coefficient of expansion than any commonly used metal



ALSiMAG

TRADE MARK REGISTERED U.S. PATENT OFFICE

CUSTOM MADE TECHNICAL CERAMICS

AlSiMag is the trade name of a large family of versatile ceramics. Among the many AlSiMag compositions, you may find one which has exactly the physical characteristics you need. AlSiMag makes parts to your blue prints, cooperates on design when desired. These parts come to you ready for your assembly line. They are uniform, dimensionally accurate, and are economically fabricated in quantity. The AlSiMag Property Chart is sent free on request.

AMERICAN LAVA CORPORATION

49TH YEAR OF CERAMIC LEADERSHIP
CHATTANOOGA 5, TENNESSEE

OFFICES: METROPOLITAN AREA: 671 Broad St., Newark, N. J., Mitchell 2-8159 • CHICAGO, 228 North LaSalle St., Central 6-1721
PHILADELPHIA, 1649 North Broad St., Stevenson 4-2823 • LOS ANGELES, 232 South Hill St., Mutual 9076
NEW ENGLAND, 38-B Brattle St., Cambridge, Mass., Kirkland 7-4498 • ST. LOUIS, 1123 Washington Ave., Garfield 8959

the 4-400A

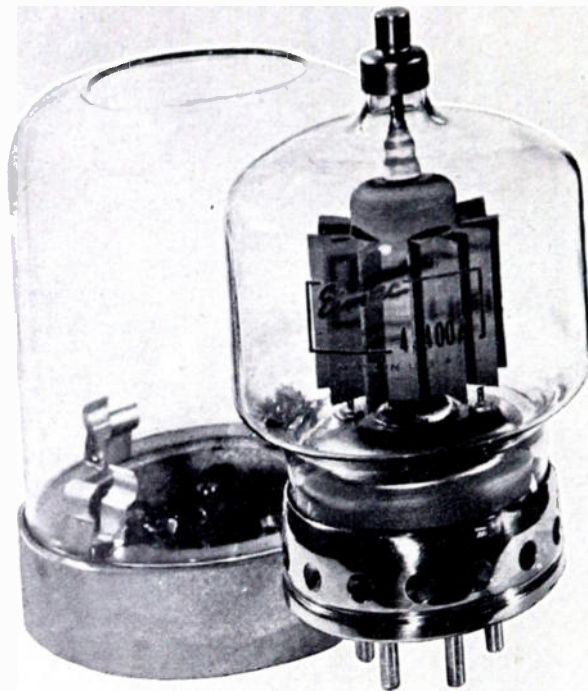

- ★ Long Life
- ★ Low Drive
- ★ RF Amplifier
- ★ Audio Amplifier
- ★ Simplified Cooling
- ★ Pyrovac Plate
- ★ Non-Emitting Grids
- ★ And . . . thoroughly proved in service.

EIMAC 4-400A POWER TETRODE
TYPICAL OPERATION
AUDIO FREQUENCY POWER AMPLIFIER
AND MODULATOR

Class AB₁ (Sinusoidal wave, two tubes,
unless otherwise specified)

DC PLATE VOLTAGE	3000	4000	Volts
DC SCREEN VOLTAGE	750	600	Volts
DC GRID VOLTAGE (approx.)*	-136	-116	Volts
ZERO SIGNAL DC PLATE CURRENT	160	130	Ma
MAX. SIGNAL DC PLATE CURRENT	620	510	Amp
ZERO SIGNAL DC SCREEN CURRENT	0	0	Ma
MAX. SIGNAL DC SCREEN CURRENT	28	10	Ma
EFFECTIVE LOAD PLATE TO PLATE	9200	16,000	Ohms
PEAK AF GRID INPUT VOLTAGE (per tube)	136	116	Volts
DRIVING POWER	0	0	Watts
MAX. SIGNAL PLATE POWER OUTPUT	1100	1280	Watts

*Adjust to give stated zero-signal plate current.

A pair of Eimac 4-400A tetrodes provides the ideal answer for a one-kilowatt AM or FM broadcast power amplifier stage. The 400-watt plate dissipation rating of these tubes allows extremely conservative operation at the 1-kw level, thus assuring long, trouble-free tube operation.

In AM service, the 4-400A is FCC rated for 500 watts output per tube in high level modulated amplifiers. In FM applications, the superlative performance of the 4-400A at VHF allows an easy 1-kw of useful power output from a pair of tubes.

The low driving-power requirement of these tetrodes allows the driving equipment to be reduced to simple low power stages employing low cost tubes. The rugged construction of the 4-400A, plus a Pyrovac plate and the use of other time-proven materials and manufacturing processes, contributes to the tube's long life and ability to withstand both physical and electrical abuse.

To simplify transmitter design, an Eimac air system socket and chimney assembly is available for the 4-400A. This assembly provides a balanced flow of cooling air to the tube with minimum air waste, as well as completing the shielding between input and output circuits.

The low driving-power required by the 4-400A makes it an ideal choice for audio as well as r-f application. High audio power at low distortion can easily be obtained with zero driving power. (See accompanying data.)

For tube economy in one-kilowatt equipment, consider the service-proven 4-400A developed by America's foremost tetrode manufacturer . . . Eimac. Complete technical data are available . . . write today.

Follow the Leaders to

Eimac
TUBES
The Power for R-F

EITEL-McCULLOUGH, INC.
San Bruno, California

Export Agents: Frazer & Hansen, 301 Clay St., San Francisco, California

KILOVOLTS for KLYSTRONS

NEW **PRD**

**POWER SUPPLY for
microwave oscillators**



NOW!

**DIRECT
READING
CONTROLS**

— coarse and fine —
allow repeller voltage to be accurately adjusted from -20 to -750 volts.

GRID VOLTAGE

may be varied continuously from -300 volts to a positive value limited by the klystron grid current.

**PANEL
METERS**

Indicate beam voltage and current directly.

**CONTINUOUSLY
VARIABLE**

Carefully regulated beam voltage supply provides cathode-to-grounded-anode potential in two ranges with choice of operation from 300 to 1500 volts of 65 ma or to 3600 volts of 25 ma.

The Type 801-A Universal Klystron Power Supply has been developed by PRD to meet the increasing need of research and production engineers for a unit to operate the many different klystrons now in use throughout the microwave spectrum.

Provision is made for c-w, square-wave, sawtooth, and external modulation of conventional internal cavity klystrons, external cavity oscillators, and the new millimeter tubes now coming into use in microwave spectroscopy.

Excellent voltage stabilization guarantees a maximum of oscillator frequency stability. Carefully controlled modulation wave-shapes insure accuracy of standing wave measurements and spectrum analysis when made with oscillators powered by this supply.

The new 95-page catalog describing the complete PRD line of precision test equipment is now available—write for your copy today to Dept. R-9.



Polytechnic **RESEARCH
& DEVELOPMENT COMPANY, Inc.**

202 TILLARY ST., BROOKLYN 1, NEW YORK



MYCALEX

MINIATURE TUBE SOCKETS

7-PIN and 9-PIN...and SUBMINIATURES

**PREMIUM INSULATION
PRICED COMPETITIVELY**

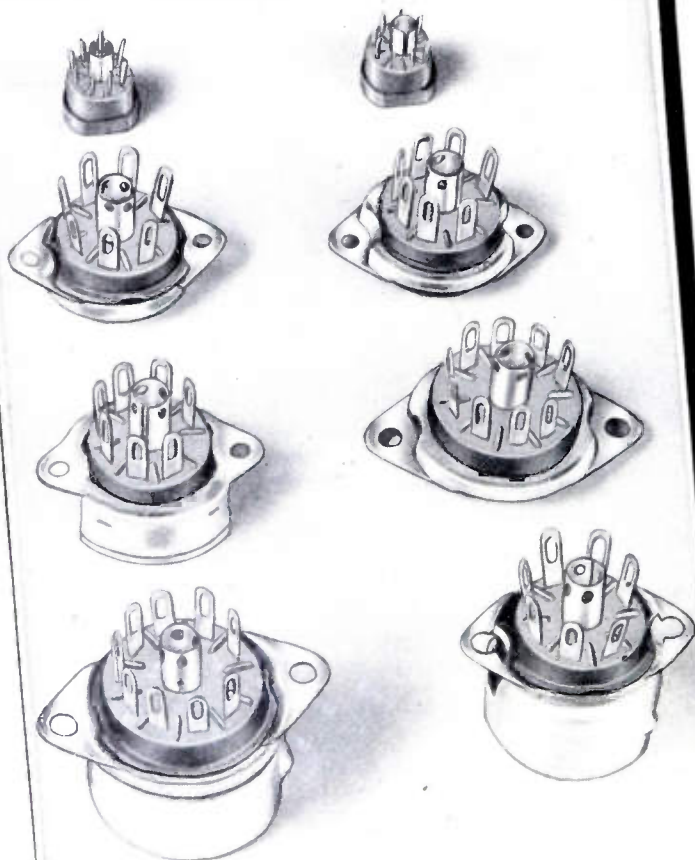

Now MYCALEX offers both 7-pin and 9-pin miniature tube sockets . . . with superior low loss insulating properties, at *new low prices* that offer ceramic quality for the cost of phenolics.

MYCALEX miniature tube sockets are injection molded with precision that affords uniformity and extremely close tolerances. MYCALEX insulation has high dielectric strength, very low dielectric loss, high arc resistance and great dimensional stability.

Produced in two grades: MYCALEX 410 conforms to Grade L4 specifications, having a loss factor of only .015 at 1 MC. It is priced comparably with mica filled phenolics.

MYCALEX 410X is for applications where low cost of parts is vital. It has a loss factor only one-fourth that of "everyday" quality insulating materials, and a cost no greater.

Prices gladly quoted on your specific requirements. Samples and data sheets by return mail. Our engineers will cooperate in solving your problems of design and cost.

Mycalex Tube Socket Corporation

"Under Exclusive License of Mycalex Corporation of America"

30 Rockefeller Plaza, New York 20, N.Y.



MYCALEX CORP. OF AMERICA

"Owners of 'MYCALEX' Patents"

Executive Offices: 30 Rockefeller Plaza, New York 20, N. Y.

Plant and General Offices: Clifton, N. J.

Another exclusive
GPL Development

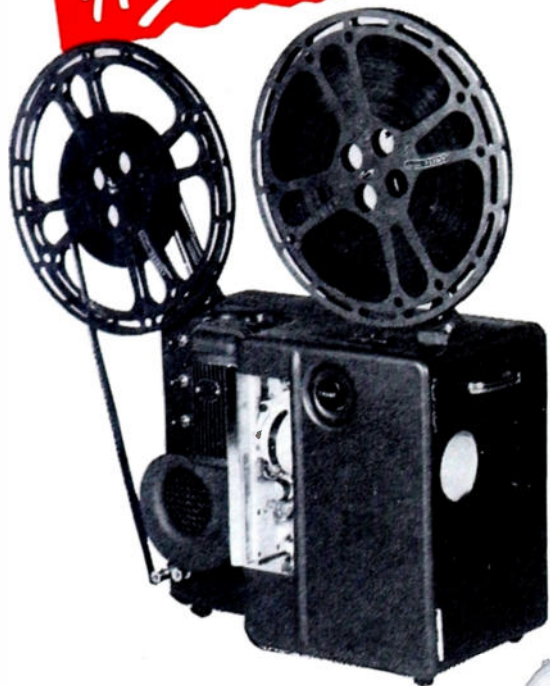

ABC

Pioneers New
Telecast Technique
with
GPL
UTILITY PROJECTOR



Mobile Unit Handles Film Commercials on the Spot for Better Control and Economy

Using the new GPL 16-mm Utility Projector, the American Broadcasting Company scored another television "first" by handling filmed commercials direct from its mobile units at football games. This new technique eliminates the need for expensive studio stand-by facilities and film-chain tie up. It results in smoother programming. And it gives the director on location full control of timing.

The GPL Utility Projector (PA-101) is used with a standard image orthicon camera without special phasing facilities. It projects either direct into the camera, or on an intermediate screen in

a shadow box. With the latter, one of the cameras used for game pick-up can be swung around to the shadow box to take commercials.

The PA-101 is not only a professional auxiliary projector for the larger station, it is ideal for studio as well as field work in smaller stations. Easily portable, it may be used for film preview or rear screen projection. And for film telecasts, it may be used with regular studio cameras to provide quality equal to specialized iconoscope film-chain equipment.

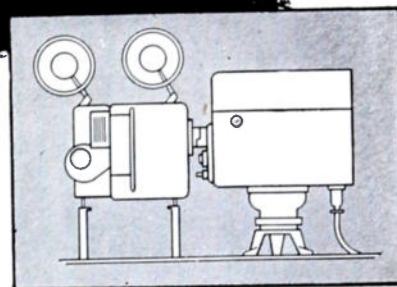

ABC ENGINEERS designed a special projector-camera mount for their mobile units. Set-up is easily removable; camera rotates on base for adjustment. Split coupling keeps out light.

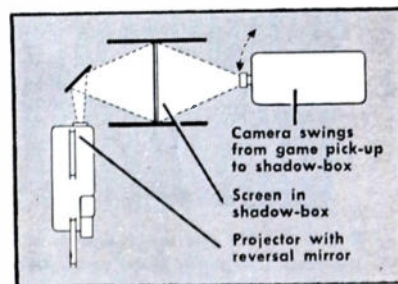

NO EXTRA CAMERA required with this alternate arrangement which uses shadow-box screen in stadium camera booth. Camera used for game pick-up may be swung to shadow-box to make commercials.



Write, wire or phone for details . . .

TV Camera Chains • TV Film Chains
TV Field and Studio Equipment
Theatre TV Equipment

General Precision Laboratory

INCORPORATED

PLEASANTVILLE

NEW YORK

NEW DESIGN THRILLS AT YOUR FINGER TIPS...

Type SRE Bantams*—The smallest electrolytics yet. Especially suitable for personal radios, filler circuits and similar functions. Hermetically-sealed aluminum can with diameter-reducing stud terminals. Improved processing and materials combined with more efficient space utilization, means smaller sizes—but no reduction in life.

Type '87 Aerocans—Self-molded plastic tubulars with new impregnant, Aerolene*; new rock-hard Duranite* end seals. All the performance characteristics of molded-plastic capacitors at a price close to that of conventional paper tubulars. Excellent heat and humidity resisting qualities. Operating temperatures of -30°C to $+100^{\circ}\text{C}$.

Type 89ZXY Aerolites*—Aerovox-improved metallized paper capacitors were developed to meet present-day requirements for capacitors of improved reliability and reduced size. Type 89ZXY Aerolites* are metallized-paper capacitors in hermetically-sealed metal cases. Other Aerolite* capacitors are available in tubular, baitub and other case designs.

Type P1232G Miniatures—Metal-cased, metallized-paper capacitors featuring vitrified ceramic terminal seals for maximum immunity to climatic conditions—heat, cold, humidity. For severe-service applications and for usage in critical as well as ultra-compact radio-electronic assemblies.

Type P83Z Micro-Miniatures*—Smaller than previous "smallest"—a distinct departure from conventional foil-paper and previous metallized-paper constructions. Radically new metallized dielectric makes possible exceptionally small physical sizes. Available in two case sizes ($3/16'' \times 7/16''$ and $1/4'' \times 9/16''$); voltages of 200, 400, 600; operating temperatures range from -15°C to $+85^{\circ}\text{C}$ without derating.

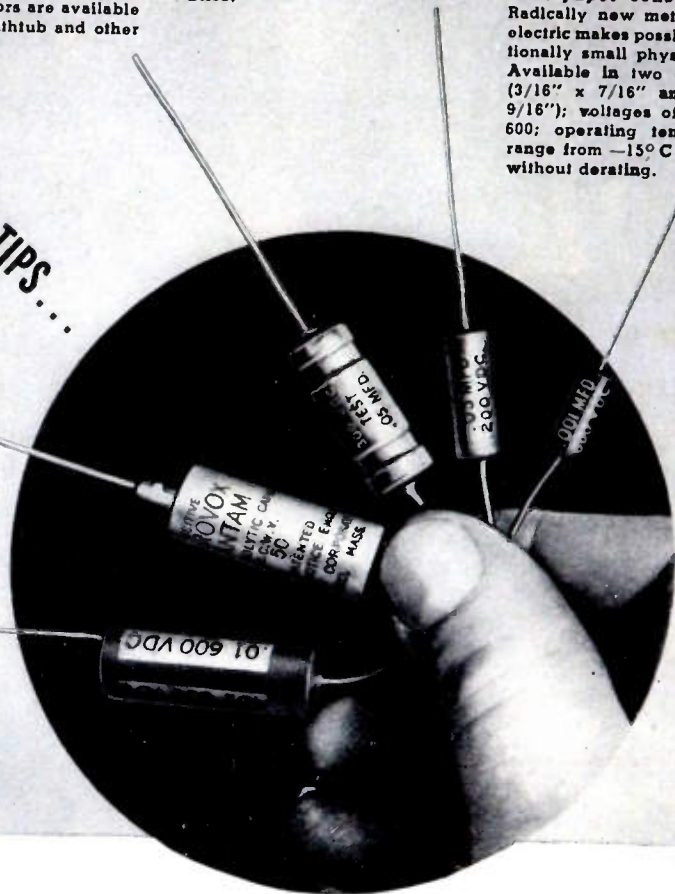

*Trade-mark

AEROVOX
"Space Miser"
CAPACITORS

● Tell us what you are designing or producing. Our engineers will gladly show you better assembly possibilities with marked economies. Literature on request. Write on your letterhead to Aerovox Corporation, Dept. DF-65, New Bedford, Mass.

There is something new in sizes!

● Never was so much capacitance packed into so little bulk. And with improved performance and life, too. Aerovox Research and Engineering have developed capacitor materials that now challenge the thinking of the progressive radio-electronic designer on several counts:

For *elevated temperatures*: Immunity of Aerolene impregnant and Duranite end fills. For *humidity extremes*: perfected hermetically-sealed metal-can casings

even in tiniest sizes. For *miniaturizations*: perfected metallized-paper sections. For *compact filters*: smallest electrolytics yet. For *maximum reliability*: the most conservative ratings. For *lower prices*: advanced engineering backed by highly mechanized fabrication.

New design thrills at your finger tips! That's what these latest Aerovox capacitors mean to you by way of still better radio-electronic assemblies.



CAPACITORS • VIBRATORS • TEST INSTRUMENTS

For Radio-Electronic and Industrial Applications

AEROVOX CORPORATION, NEW BEDFORD, MASS., U. S. A. • Sales Offices in All Principal Cities
 Export: 41 E. 42nd St., New York 17, N. Y. • Cable: AEROCAP, N. Y. • In Canada: AEROVOX CANADA LTD., Hamilton, Ont.

WORLD WIDE STANDARD OF *Constant Voltage*



SOLA Constant Voltage Transformers are manufactured and employed throughout the world for automatic, instantaneous regulation of voltage. They do not have moving parts, or require manual adjustments.



ENGLAND

Advance Components Ltd.
Walthamstow, E., England



FRANCE

M. C. B. & Veritable Alter
Courbevoie (Seine), France



ARGENTINA

Ucoa Radio S. A.
Buenos Aires, Argentina



AUSTRALIA

Endurance Electric Company
Concord West. N. S. W., Australia



Type CV—Standard:

Wide range of capacities and voltages . . . regulation $\pm 1\%$ or less with a total primary variation of 30% . . . for electronic equipment requiring close regulation.



Type CVH—With Harmonic Filter:

Incorporates harmonic neutralizer circuit . . . $\pm 1\%$ regulated voltage . . . less than 3% harmonic distortion.



Type CVE—Plate and Filament Supply:

A single, compact source of filament and plate supply voltages . . . regulated to within $\pm 3\%$ or less with line voltage variations of 100-130 volts.



Type CVA—For Television Receivers:

Voltage regulation of home TV Receivers at moderate price . . . plug-in type . . . regulation $\pm 3\%$ or less.

SOLA *Constant Voltage* TRANSFORMERS

We invite your inquiry on the application and benefits of SOLA regulators to your product. BOOKLET K CV-102 is available on request.

Transformers for: Constant Voltage • Fluorescent Lighting • Cold Cathode Lighting • Airport Lighting • Series Lighting • Luminous Tube Signs
Oil Burner Ignition • X-Ray • Power • Controls • Signal Systems • etc. • SOLA ELECTRIC COMPANY, 4633 W. 16th Street, Chicago 30, Illinois
Manufactured under license by: ADVANCE COMPONENTS LTD., Walthamstow, E., England • M. C. B. & VERITABLE ALTER, Courbevoie (Seine), France
ENDURANCE ELECTRIC CO., Concord West, N. S. W., Australia • UCOA RADIO S.A., Buenos Aires, Argentina

STANDARD RI-FI* METERS

14 kc to 1000 mc!

DEVELOPED BY **STODDART**
FOR THE ARMED FORCES.

AVAILABLE COMMERCIALY.



VHF!
15 MC
to
400 MC
NMA - 5

Commercial equivalent of TS-587/U.
Sensitivity as two-terminal voltmeter, (95 ohms balanced)
2 microvolts 15-125 MC; 5 microvolts 88-400 MC. Field
intensity measurements using calibrated dipole. Frequency
range includes FM and TV Bands.



VLF!
14 KC
to
250 KC
NM - 10A

Commercial equivalent of AN/URM-6.
A new achievement in sensitivity! Field intensity measure-
ments, 1 microvolt-per-meter using rod; 10 microvolts-per-
meter using shielded directive loop. As two-terminal volt-
meter, 1 microvolt.

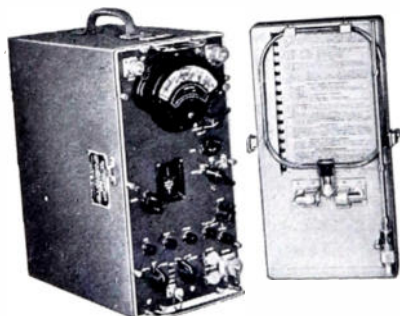

HF!
150 KC
to
25 MC
NM - 20A

Commercial equivalent of AN/PRM-1.
Self-contained batteries. A.C. supply optional. Sensitivity as
two-terminal voltmeter, 1 microvolt. Field intensity with 1/2
meter rod antenna, 2 microvolts-per-meter; rotatable loop
supplied. Includes standard broadcast band, radio range,
WWV, and communications frequencies.



UHF!
375 MC
to
1000 MC
NM - 50A

Commercial equivalent of AN/URM-17.
Sensitivity as two-terminal voltmeter, (50-ohm coaxial input)
10 microvolts. Field intensity measurements using calibrated
dipole. Frequency range includes Citizens Band and UHF
color TV Band.

Since 1944 Stoddart RI-FI* instruments have established the
standard for superior quality and unexcelled performance.
These instruments fully comply with test equipment require-
ments of such radio interference specifications as JAN-I-225,
ASA C63.2, 16E4(SHIPS), AN-I-24a, AN-I-42, AN-I-27a, AN-I-40
and others. Many of these specifications were written or re-
vised to the standards of performance demonstrated in
Stoddart equipment.

The rugged and reliable instruments illustrated above serve
equally well in field or laboratory. Individually calibrated
for consistent results using internal standard of reference.
Meter scales marked in microvolts and DB above one microvolt.
Function selector enables measurement of sinusoidal or complex
waveforms, giving average, peak or quasi-peak values.
Accessories provide means for measuring either conducted
or radiated r.f. voltages. Graphic recorder available.

*Radio Interference and Field Intensity.

STODDART AIRCRAFT RADIO CO.

6644 SANTA MONICA BLVD., HOLLYWOOD 38, CALIF.

9294

Precision Attenuation for UHF!

Less than 1.2 VSWR to 3000 MC.

Turret Attenuator:

0, 10, 20, 30, 40, 50 DB.

Accuracy \pm .5 DB.

Patents applied for.

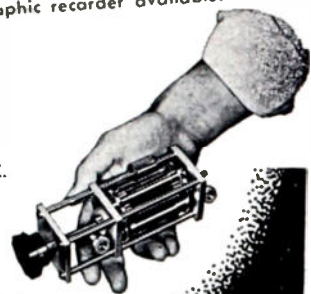



Linear Standard Units...

THE ULTIMATE IN QUALITY...

UTC Linear Standard Audio Transformers represent the closest approach to the ideal component from the standpoint of uniform frequency response, low wave form distortion, high efficiency, thorough shielding and utmost dependability.

UTC Linear Standard Transformers feature...

- True Hum Balancing Coil Structure... maximum neutralization of stray fields.
- Balanced Variable Impedance Line... permits highest fidelity on every tap of a universal unit... no line reflections or transverse coupling.
- Reversible Mounting... permits above chassis or sub-chassis wiring.
- Alloy Shields... maximum shielding from inductive pickup.
- Hiperm-Alloy... a stable, high permeability nickel-iron core material.
- Semi-Toroidal Multiple Coil Structure... minimum distributed capacity and leakage reactance.
- Precision Winding... accuracy of winding .1%, perfect balance of inductance and capacity; exact impedance reflection.
- High Fidelity... UTC Linear Standard Transformers are the only audio units with a guaranteed uniform response of ± 1 DB from 20-20,000 cycles.

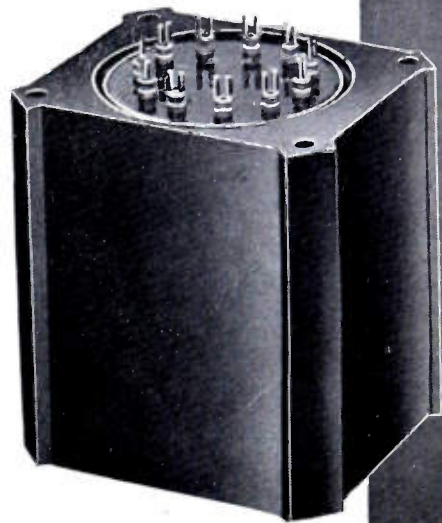

TYPICAL LS LOW LEVEL TRANSFORMERS

Type No.	Application	Primary Impedance	Secondary Impedance	± 1 db from	Max. Level	Relative hum-pickup reduction	Max. Unbalanced DC in prim'y	List Price
LS-10	Low impedance mike. pickup, or multiple line to grid	50, 125, 200, 250, 333, 500/600 ohms	60,000 ohms in two sections	20-20,000	+15 DB	-74 DB	5 MA	\$25.00
LS-10X	As Above	As above	50,000 ohms	20-20,000	+14 DB	-92 DB	5 MA	32.00
LS-12	Low impedance mike. pickup, or multiple line to push pull grids	50, 125, 200, 250, 333, 500/600 ohms	120,000 ohms overall, in two sections	20-20,000	+15 DB	-74 DB	5 MA	28.00
LS-12X	As above	As above	80,000 ohms overall, in two sections	20-20,000	+14 DB	-92 DB	5 MA	35.00
LS-26	Bridging line to single or push pull grids	5,000 ohms	60,000 ohms in two sections	15-20,000	+20 DB	-74 DB	0 MA	25.00
LS-19	Single plate to push pull grids like 2A3, 6L6, 300A, Split secondary	15,000 ohms	95,000 ohms; 1.25:1 each side	20-20,000	+17 DB	-50 DB	0 MA	24.00
LS-21	Single plate to push pull grids. Split primary and secondary	15,000 ohms	135,000 ohms; turn ratio 3:1 overall	20-20,000	+14 DB	-74 DB	0 MA	24.00
LS-22	Push pull plates to push pull grids. Split primary and secondary	30,000 ohms plate to plate	80,000 ohms; turn ratio 1.6:1 overall	20-20,000	+26 DB	-50 DB	.25 MA	31.00
LS-30	Mixing, low impedance mike. pickup, or multiple line to multiple line	50, 125, 200, 250, 333, 500/600 ohms	50, 125, 200, 250, 333, 500/600 ohms	20-20,000	+17 DB	-74 DB	5 MA	25.00
LS-30X	As above	As above	As above	20-20,000	+15 DB	-92 DB	3 MA	32.00
LS-27	Single plate to multiple line	15,000 ohms	50, 125, 200, 250, 333, 500/600 ohms cycles	30-12,000	+20 DB	-74 DB	8 MA	24.00
LS-50	Single plate to multiple line	15,000 ohms	50, 125, 200, 250, 333, 500/600 ohms	20-20,000	+17 DB	-74 DB	0 MA	24.00
LS-51	Push pull low level plates to multiple line	30,000 ohms plate to plate	50, 125, 200, 250, 333, 500/600 ohms	20-20,000	+20 DB	-74 DB	1 MA	24.00
LS-141	Three sets of balanced windings for hybrid service, centertapped	500/600 ohms	500/600 ohms	30-12,000	+10 DB	-74 DB	0 MA	28.00

TYPICAL LS OUTPUT TRANSFORMERS

Type No.	Primary will match following typical tubes	Primary Impedance	Secondary Impedance	± 1 db from	Max. Level	List Price
LS-52	Push pull 2A5, 250, 6V6, 42 or 2A3 A prime	8,000 ohms	500, 333, 250, 200, 125, 50, 30, 20, 15, 10, 7.5, 5, 2.5, 1.2	25-20,000	15 watts	\$28.00
LS-55	Push pull 2A3's, 6A5G's, 300A's, 275A's, 6A3's, 6L6's	5,000 ohms plate to plate and 3,000 ohms plate to plate	500, 333, 250, 200, 125, 50, 30, 20, 15, 10, 7.5, 5, 2.5, 1.2	25-20,000	20 watts	28.00
LS-57	Same as above	5,000 ohms plate to plate and 3,000 ohms plate to plate	30, 20, 15, 10, 7.5, 5, 2.5, 1.2	25-20,000	20 watts	20.00
LS-58	Push, pull parallel 2A3's, 6A5G's, 300A's, 6A3's	2,500 ohms plate to plate and 1,500 ohms plate to plate	500, 333, 250, 200, 125, 50, 30, 20, 15, 10, 7.5, 5, 2.5, 1.2	25-20,000	40 watts	50.00
LS-6L1	Push pull 6L6's self bias	9,000 ohms plate to plate	500, 333, 250, 200, 125, 50, 30, 20, 15, 10, 7.5, 5, 2.5, 1.2	25-20,000	30 watts	42.00

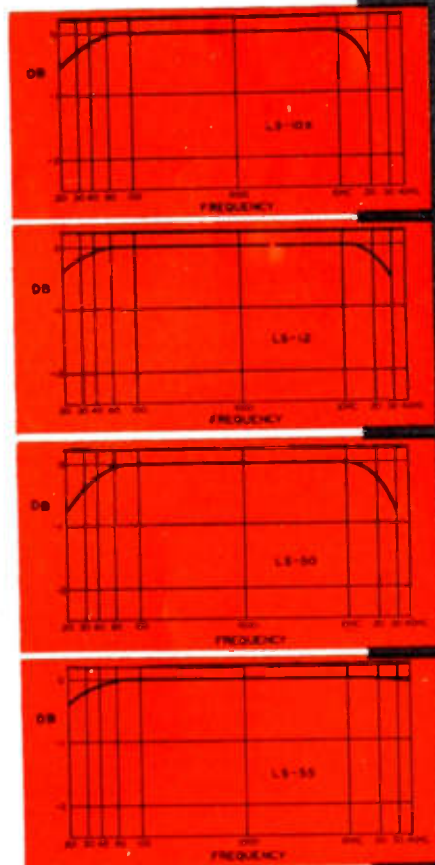

Write for our Catalog PS-409

United Transformer Co.

150 VARICK STREET NEW YORK 13, N. Y.
EXPORT DIVISION: 13 EAST 40th STREET, NEW YORK 16, N. Y., CABLES: "ARLAB"

The New ML-2C39A*...

Proving once again that

MACHLETT .. makes the Difference

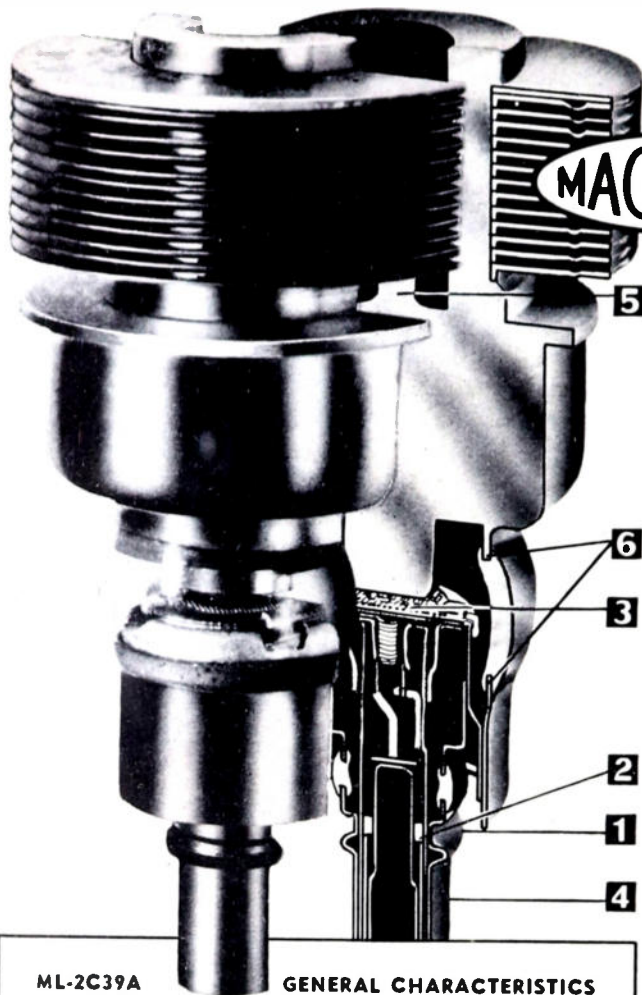

1. Design of cathode lead for positive adjustment and control of transconductance; limits are 20,000-23,000 μ mhos or only 25% of permissible specified range.
2. High temperature ceramic in hot cathode end eliminates danger of gas evolution from glass at high temperatures. Assures better protection under overload conditions.
3. Uniquely processed mesh grid assures greater frequency stability with variation in grid dissipation.
4. Gold over silver plating to maintain optimum surface conductivity even in corrosive atmospheres.
5. Machlett's high vacuum processing for good cathode activation and freedom from gasiness.
6. Stronger glass-metal seals. Less breakage inserting and removing tubes.

* Conforms with recently issued JAN specifications.

ML-2C39A GENERAL CHARACTERISTICS

Electrical

Cathode: Coated Unipotential	
Heater Voltage	6.3 volts
Heater Current	1.0 amperes
Amplification Factor (Average)	100
Direct Interelectrode Capacitances (Average)	
Grid Plate	1.95 μ mf.
Grid Cathode	6.50 μ mf.
Plate Cathode	0.035 μ mf.
Transconductance	
($i_b = 70$ ma., $E_b = 600$ v.) (Average)	23,000 μ mhos

Radio Frequency Power Amplifier

Class-C FM Telephony or Telegraphy
(key-down conditions, 1 tube)

Maximum Ratings	
D-C Plate Voltage	1000 max. volts
D-C Cathode Current	125 max. ma.
D-C Grid Voltage	-1.50 max. volts
Peak Positive R-F Grid Voltage	30 max. volts
Peak Negative R-F Grid Voltage	-400 max. volts
Plate Dissipation	100 max. watts
Grid Dissipation	2 max. watts

ML-381 FOR PULSED APPLICATIONS

Maximum Ratings (Tentative)

e_p , peak	3500 volts
i_p , peak	4.5 amps
i_g , peak	2.0 amps
i_p , ave	30 MA
i_g , ave	15 MA
T, pulse length	5 μ sec.
duty	1%
E_f	5.5 volts \pm 5%

In all other respects the ML-381 is electrically and mechanically interchangeable with the 2C39A.

"Look to the Tube Specialist"

Long experience in the development and manufacture of the 2C39A electron tube has given Machlett Laboratories a comprehensive understanding of the operating problems encountered in a wide variety of applications of this tube type.

For assistance on your specific problem, write to Machlett Laboratories

or contact your local Graybar office.



MACHLETT

OVER 50 YEARS OF ELECTRON TUBE EXPERIENCE

VHF

IMPEDANCE MEASUREMENTS

UHF

SPEED AND CONVENIENCE

Rapid, accurate measurement of impedance, reflection coefficient and standing wave ratio. Small size, convenient for field use.

50 to 500 Mc.

Can be inserted in various sizes of solid coaxial line or flexible cables.

Make three readings, plot diagram and read off impedance to $\pm 5\%$.

\$400.00.

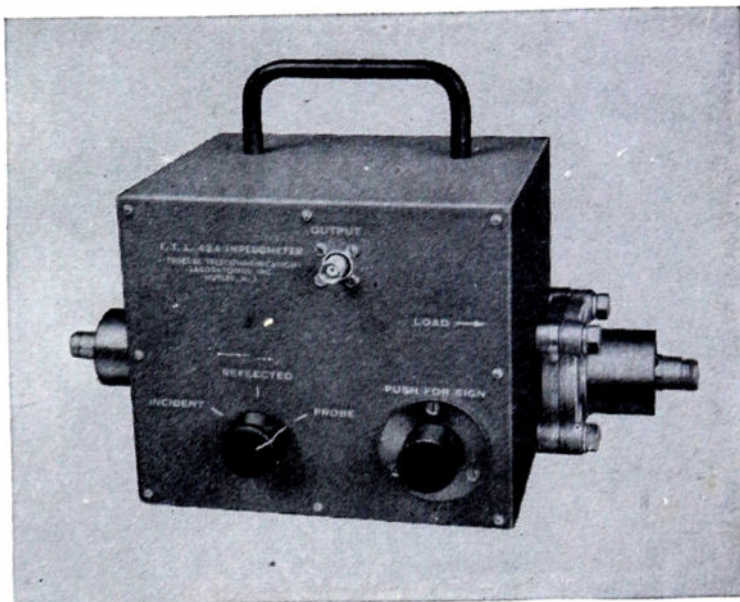

FTL-42A IMPEDOMETER

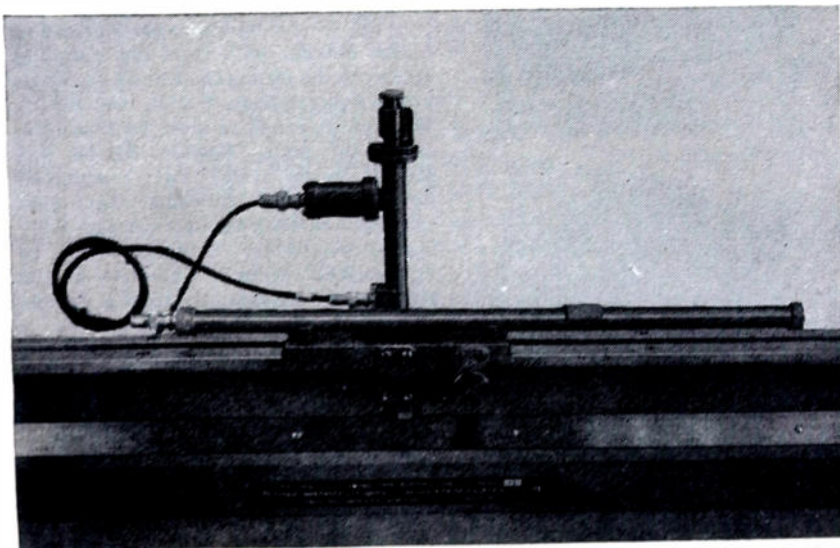

PRECISION

Precise impedance measurements in the range of 60 to 1000 megacycles per second. Accuracy $\pm 2\%$.

1000 to 2000 Mc range covered with slightly reduced accuracy.

Coaxial line 250 centimeters long having a surge impedance of 51.0 ohms ± 0.5 ohms.

\$2,495.00.

FTL-30A SLOTTED LINE

Write for FTL-30A and FTL-42A brochures



Federal Telecommunication Laboratories, Inc.

500 Washington Avenue

Nutley 10, New Jersey

HERE'S *Fast, Accurate* LABOR PRODUCTION

Something New

NEW OVAL SELECTOR SWITCHES



Several new oval rotary selector switches are described in Bulletin L13 just issued by the Shallcross Manufacturing Co., Collingdale, Pa. Six basic plates and three rotor types produce switches having from one to three poles per deck or gang and with other desired mechanical and electrical details. As many as 18, 9 or 6 positions may be obtained in single-, double-, or triple-pole types respectively. These may be single-, double-, or triple-pole decks exclusively or a combination of different types.

A QUICK CHECK OF LOW RESISTANCE CONNECTIONS, BONDS, CONTACTS, etc.

Shallcross low resistance test sets greatly facilitate comparison tests between 2 and 800,000 micro-ohms. Their uses range from testing the electrical conductivity of bonds, welds and seals to contacts, filaments, armatures or for making any measurement under 1 ohm. Suitable units are available for either field, laboratory or production line use. Write for Bulletin LRT-1.



KELVIN plus WHEATSTONE RANGES IN ONE HANDY BRIDGE

Why pay for two instruments when one will do both jobs? Providing both Kelvin and Wheatstone ranges from 0.0001 ohm to 11.11 megohms, this Shallcross No. 638-R combined bridge is highly accurate and outstandingly convenient. Priced at only a little more than a single bridge with a limited range, it is a typical example of Shallcross instrument efficiency and economy.



VERTICAL STYLE PRECISION RESISTORS FOR JAN USES



Improved vertical style precision wire-bound resistors for use where mounting requirements make it desirable to have both terminals at the same end of the resistor have been introduced by the Shallcross Manufacturing Co., Collingdale Pa. These units provide a longer leakage path from the mounting screws to the terminals. Known as Shallcross Types BX120, BX140, and BX160, they are designed to meet JAN requirements for styles RB40B, RB41B and RB42B respectively. For commercial uses, the resistors carry somewhat higher ratings than for JAN applications. Wire leads instead of terminals can be furnished if desired. Complete details will gladly be sent on request to the manufacturer.

DECADE RESISTANCE BOXES TO MATCH YOUR NEED... exactly

Over 40 Shallcross standard Resistance Boxes provide the widest assortment available today. Types range from 1 to 7 dials from 0.01 ohm to 111 megohms and are available in styles, sizes and prices for practically any laboratory or production testing need. Write for Bulletin.



FLAT, METAL-ENCASED WIRE-WOUND RESISTORS

Flat, metal-encased, Type 265A wire-wound power resistors introduced by the Shallcross Manufacturing Company, Collingdale, Pa., are space wound, have mica insulation, and are encased in aluminum for mounting flat against a metal chassis. At 175° C. continuous use they are conservatively rated for 7½ watts in still air and 15 watts when mounted on a metal chassis. Write for Bulletin 122.

SHALLCROSS

SHALLCROSS MANUFACTURING COMPANY
Collingdale • Penna.



States **HERSCHEL WOLF**
of American Airlines

"with **AMERICAN**  **AIRLINES**
EXTRA SAFETY IS A MUST..."



**"...G-E High-Reliability Tubes
Lift SAFETY and SAVINGS, Too!"**

SAYS Herschel Wolf, in charge of aircraft radio communications for American Airlines: "You can trust G-E High-reliability Tubes to do their job *all* the time. They've helped us lift our high safety standards still higher."

You can't heat these special G-E miniatures for steady performance "under fire"—the kind of day-in, day-out job you can count on. So take a tip from American and other enthusiastic users, and specify G-E High-reliability Tubes in the equipment now on your drawing-boards! You'll lower upkeep costs, increase safety factor, widen your product's acceptance.

Altimeters, radio compasses, radio control apparatus, h-f aircraft receivers—all are employing G-E High-reliability miniatures with marked success. Every tube gets 50 hours' service at the factory under Class A conditions. Also, frequent samples are chosen for life tests, during which the tube is operated normally but intermittently by turning the heater on and off at one-minute intervals.

Communications . . . industry . . . along with aviation, find numerous applications for G-E High-reliability miniatures—the *better* tubes for *better* service where conditions are exacting! Write for further information. Learn more about what these tubes are; what they will do; how they can serve *your* needs more efficiently. *Electronics Department, General Electric Co., Schenectady 5, N. Y.*



GL-5654



GL-5670



GL-5686



- GL-5654** Sharp-cutoff r-f pentode
- GL-5670** H-f twin triode
- GL-5686** Power-amplifier pentode
- GL-5725** Semi-remote-cutoff r-f pentode
- GL-5726** Twin diode
- GL-5749** Remote-cutoff r-f pentode
- GL-5750** Pentagrid converter
- GL-5751** High-mu twin triode
- GL-5814** Medium-mu twin triode

GENERAL  **ELECTRIC**
180-J8

SPEED TV TUBE PRODUCTION



WITH TEINER-SPUN CONES

For faster production of jet parts, TV cones, or experimental designs, call Teiner.

Capacity is immediately available for sheet metal working and spinning of all metals.

Automatic machines for TV cones, power tools for spinnings up to 16 ft. and facilities for handling stainless steel and new Timken alloy can be applied to your fabrication needs.

For shrouds, reflectors, hemispheres, guards, baffles, conical, spherical or parabolic shapes, flanged or dished heads or special designs, send samples or drawings for prompt estimates.

Save time and money — Consult Teiner



ROLAND TEINER

COMPANY, INCORPORATED
134 TREMONT ST., EVERETT 49, MASS. Tel. EV 7-7800

News—New Products

These manufacturers have invited PROCEEDINGS readers to write for literature and further technical information. Please mention your I.R.E. affiliation.

Marked Brushes Aid in Brush Replacement

Carter Motor Co., 2644 N. Maplewood Ave., Chicago 47, Ill., has developed a way to measure brush life so that replacements may be made before service fails or damage occurs.



Described as Line-O-Life, these brushes are interchangeable with older types of similar size, and are in all respects similar, except for the addition of a visual indicator line impressed across the top of the brush at a point indicating full service life. When worn down to this Line-O-Life, brushes should be replaced.

Excessive brush wear results in poor contact, sparking, worn and grooved commutators. These brushes avoid serious trouble by showing you when replacements should be made.

For descriptive literature on converters and dynamotor power supplies equipped with new Line-O-Life brushes, write to Carter Motor Co.

New Nuclear Scaler

Described as the first of a series of "building block" units, the Atomic Instrument Co., 84 Massachusetts Ave., Boston 39, Mass., announced that their new 1010 scaler is now in production and is available for delivery.

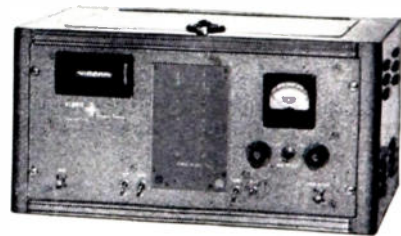

The standard Model 1010 is furnished optionally with a scale-of-100 or scale-of-256, and added scaling assemblies to make either a scale-of-1,000 or a scale-of-4,096 may be specified without appreciably affecting delivery.

A partial list of the standard features and modifications now available includes: Optional scale of-100 or scale-of-256; plug-in input and diode-coupled scaling strips (binary or decade); resolving time less than 5 microseconds; inputs: G-M probe 9.25 volt sensitivity and external preamplifier, pulse height discriminator, adjustable, 2,500 v line and load regulated high voltage supply, etc.

(Continued on page 44A)



UHF

DEVELOPMENT

DESIGN

MANUFACTURE

EQUIPMENT

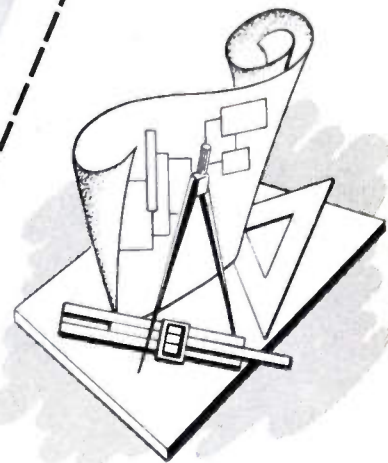

- ... *If* UHF design or development is a major problem with you, or ...
- ... *If* low-unit manufacturing cost is essential to satisfactorily meet competition, or ...
- ... *If* trustworthy, confidential collaboration is a highly necessary factor ...

**LAVOIE PRODUCTS
INCLUDE:**

RADAR RECEIVERS
RADIO RECEIVERS
SIGNAL GENERATORS
FREQUENCY METERS
ANTENNA EQUIPMENT
PULSE GENERATORS
OSCILLOSCOPES
RADAR BEACONS
COMMUNICATION
SYSTEMS
CRYSTAL IMPEDANCE
METERS
ETC., ETC.

THEN Lavoie Laboratories, Inc. can be of invaluable assistance. We have the Engineering Staff ... the shop techniques ... a competent understanding of government contract procedures ... and the reputation for satisfactorily meeting *all* of these requirements.

We welcome your inquiries on any phase of UHF design, development or production.

Lavoie Laboratories, Inc.

MORGANVILLE, N. J.

KEEP POSTED

on Electron Tubes

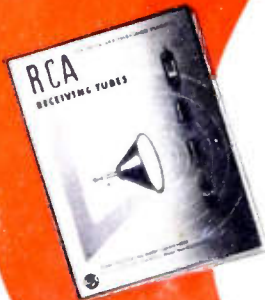

with the most authoritative technical literature in the field

A Tube Handbook—All Types HB-3 (7 $\frac{3}{8}$ " x 5") The "bible" of the industry—contains over 2500 pages of loose-leaf data and curves on all RCA receiving tubes, power tubes, cathode-ray tubes, phototubes, and special tubes. Three de luxe 4-prong binders imprinted in gold. Available on subscription basis. Price, \$10.00 including service for first year. Write to Commercial Engineering for descriptive folder and order form.

B Receiving Tube Manual—RC-16 (8 $\frac{3}{4}$ " x 5 $\frac{1}{2}$ ")—300 pages. New, completely up-to-date. Covers technical information on more than 460 RCA receiving tubes and kinescopes. Includes an expanded circuit section, enlarged section on resistance-coupled amplifiers, new data on cathode-follower design, and completely revised tube classification charts, including miniature types and their GI equivalents. Features lie-flat binding. Price, 50 cents.

C Radiotron Designer's Handbook—(9" x 6")—356 pages. Edited by F. Langford Smith of Amalgamated Wireless Valve Company Pty. Ltd. in Australia. Of value to anyone interested in fundamental principles of practical circuit design. Copiously illustrated. Price, \$1.25.

D Power and Gas Tubes for Radio and Industry—Bulletin PG-101-A (11" x 8 $\frac{1}{2}$ ")—20 pages. Contains basic data on more than 150 air-and-water-cooled transmitting tubes,

rectifier tubes, thyratrons, ignitrons, and voltage regulators. Features brief descriptions, applications, terminal connection diagrams, and photos of representative types. Price, 15 cents.

E Phototubes, Cathode-Ray and Special Types—Bulletin CRPS-102A (11" x 8 $\frac{1}{2}$ ")—20 pages. Contains basic data on more than 145 single-unit, twin-unit, and multiplier phototubes, cathode-ray tubes, camera tubes, monoscopes and types for special applications. Includes brief descriptions, applications, terminal connections, and photos of many types. Spectral response curves are given for all phototubes. Price, 15 cents.

F Receiving Tubes for AM, FM, and Television Broadcast—Bulletin 1275-E—24 pages. Completely revised and brought up to date. Contains characteristics on more than 450 RCA receiving tubes including kinescopes and a classification chart which lists all types according to function, and group types having similar characteristics and same cathode voltage. Socket connection diagrams arranged for quick and easy reference. Price, 10 cents.

G Instruction Booklets—Complete authorized information on individual RCA transmitting tubes and other tubes for communications and industry. Be sure to mention tube-type booklet desired. Single copy on any type free on request.

Use this convenient coupon for obtaining the RCA tube literature you need.

RCA, Commercial Engineering
Section K47R, Harrison, N. J.
Send me the RCA publications checked below. I am enclosing \$..... to cover cost of the books for which there is a charge.

Name _____
Address _____
City _____ Zone _____ State _____

- HB-3 Tube Handbook (\$10)* (A)
- RC-16 Receiving Tube Manual (50 cents) (B)
- Radiotron Designer's Handbook (\$1.25)* (C)
- Power and Gas Tubes for Radio and Industry (15 cents) (D)
- Phototubes, Cathode-Ray and Special Types (15 cents) (E)
- Receiving Tubes for AM, FM, and TV (10 cents) (F)
- Instruction Booklet on tube types..... (Free) (G)

*Prices apply to U.S. and possessions only



RADIO CORPORATION of AMERICA

ELECTRON TUBES

HARRISON, N. J.

PROCEEDINGS OF THE I.R.E.

Published Monthly by

The Institute of Radio Engineers, Inc.

BOARD OF DIRECTORS, 1950*

Raymond F. Guy
President

R. A. Watson-Watt
Vice-President

D. B. Sinclair
Treasurer

Haraden Pratt
Secretary

Alfred N. Goldsmith
Editor

B. E. Shackelford
Senior Past President

Stuart L. Bailey
Junior Past President

1950

Ben Akerman (6)

W. R. G. Baker

T. H. Clark

J. V. L. Hogan (2)

T. A. Hunter

H. E. Kranz (4)

F. H. R. Pounsett (8)

J. E. Shepherd

J. A. Stratton

1950-1951

A. V. Eastman (7)

W. L. Everitt

D. G. Fink

F. Panbarger, Jr. (3)

H. J. Reich (1)

J. D. Reid (5)

1950-1952

W. R. Hewlett

J. W. McRae

Harold R. Zeamans
General Counsel

George W. Bailey
Executive Secretary

Laurence G. Cumming
Technical Secretary

Changes of address (with advance notice of fifteen days) and communications regarding subscriptions and payments should be mailed to the Secretary of the Institute, at 450 Ahnaip St., Menasha, Wisconsin, or 1 East 79 Street, New York 21, N. Y.

All rights of republication, including translation into foreign languages, are reserved by the Institute. Abstracts of papers, with mention of their source, may be printed. Requests for republication privileges should be addressed to The Institute of Radio Engineers.

*Numerals in parenthesis following Directors names designate Region number.

VOLUME 38

November, 1950

NUMBER 11

PROCEEDINGS OF THE I.R.E.

Harry L. Thorson and Fred M. Ashbrook, Chairmen of Recent IRE Sections.....	1250
Quality in Engineering..... Allen B. DuMont	1251
3753. Management's Role in Research and Development of Electronic Systems..... Ralph I. Cole	1252
3754. Statistical Methods in Research and Development..... L. Lutzker	1253
3755. Standards on Television: Methods of Measurement of Time of Rise, Pulse Width, and Pulse Timing of Video Pulses in Television, 1950.....	1258
3756. Standards on Wave Propagation: Definitions of Terms, 1950.....	1264
3757. Quality Rating of Television Images.....	1269
3640. Correction to "Feedback in Very-High-Frequency and Ultra-High-Frequency Oscillators"..... F. J. Kamphoefner	1283
3641. Correction to "Ultra-High-Frequency Triode Oscillator Using a Series-Tuned Circuit"..... J. M. Pettit	1283
3758. Tone Rendition in Photography..... W. T. Wintringham	1284
3659. Correction to "The Recording Storage Tube"..... R. C. Hergenrother and B. C. Gardner	1287
3759. Tone Rendition in Television..... B. M. Oliver	1288
3760. A Rooter for Video Signals..... B. M. Oliver	1301
3761. Methods of Calibrating Frequency Records..... R. C. Moyer, D. R. Andrews, and H. E. Roys	1306
3762. Combined Search and Automatic Frequency Control of Mechanically Tuned Oscillators..... J. Gregg Stephenson	1314
3763. A Test of 450-Megacycle Urban Area Transmission to a Mobile Receiver..... A. J. Aikens and L. Y. Lacy	1317
3764. A Six-System Urban Mobile Telephone Installation with 60-Kc Spacing..... R. C. Shaw, P. V. Dimock, W. Strack, Jr., and W. C. Hunter	1320
3765. Antenna Systems for Multichannel Mobile Telephony..... W. C. Babcock and H. W. Nylund	1324
3766. Cross-Talk Considerations in Time-Division Multiplex Systems..... S. Moskowitz, L. Diven, and L. Feit	1330
3767. The Remainder Theorem and Its Application to Operational Calculus Techniques..... Albert S. Richardson, Jr.	1336
3768. Band-Pass Low-Pass Transformation in Variable Networks..... L. A. Zadeh	1339
3769. Correlation Functions and Power Spectra in Variable Networks..... L. A. Zadeh	1342
3770. Nyquist Diagrams and the Routh-Hurwitz Stability Criterion..... Frank E. Bothwell	1345
3771. On the Approach to Steady State of a Linear Variable Network Containing One Reactance..... Alan A. Grometstein	1349
Contributors to PROCEEDINGS OF THE I.R.E.....	1351
Correspondence:	
3772. Fourier Transforms in the Theory of Inhomogeneous Transmission Lines..... Folke Bolinder	1354

INSTITUTE NEWS AND RADIO NOTES SECTION

Technical Committee Notes.....	1355
IRE People.....	1357
Industrial Engineering Notes.....	1359
Books:	
3773. "Electron Tube Circuits" by S. Seely. Reviewed by S. N. Van Voorhis	1360
3774. "Practical Television Servicing and Trouble-Shooting Manual" by The Technical Staff of Coyne Electrical and Radio-Television School..... Reviewed by Frank R. Arams	1360
Professional Groups.....	1361
3775. Abstracts and References.....	1362
Books: (cont'd)	
3776. "Aerials for Centimetre Wave-lengths" by D. W. Fry and F. K. Goward..... Reviewed by Salvatore Milazzo	1376
3777. "Questions and Answers in Television Engineering" by Carter V. Rabinoff and Magdalena E. Walbrecht..... Reviewed by J. E. Smith	1376
3778. "Handbook H42, Safe Handling of Radioactive Isotopes".....	1376
News—New Products..... 30A	Membership..... 40A
Section Meetings..... 38A	Positions Open..... 50A
Student Branch Meetings..... 38A	Positions Wanted..... 56A
Advertising Index.....	86A

EDITORIAL DEPARTMENT

Alfred N. Goldsmith
Editor

E. K. Gannett
Technical Editor

Mary L. Potter
Assistant Editor

ADVERTISING DEPARTMENT

William C. Copp
Advertising Manager

Lillian Petranek
Assistant Advertising Manager

BOARD OF EDITORS

Alfred N. Goldsmith
Chairman

PAPERS REVIEW COMMITTEE

George F. Metcalf
Chairman

Responsibility for the contents of papers published in the PROCEEDINGS OF THE I.R.E. rests upon the authors. Statements made in papers are not binding on the Institute or its members.



Chairmen of Recent IRE Sections



Harry L. Thorson

SCHENECTADY SECTION

Harry L. Thorson, Chairman of the Schenectady Section, was born in Minneapolis, Minn., on September 28, 1908. Upon graduation from the University of Minnesota in 1931 with the B.S. degree in electrical engineering, he joined the General Electric Company test course at Schenectady. Mr. Thorson became associated in 1934 with the Vacuum Tube Engineering Department, which later became the Tube Division of the Electronics Department of that company, as a design engineer on the initial development of the metal receiving tube. Following this assignment he had design engineering responsibilities for television picture tubes, industrial power-control tubes, and transmitting tubes. In 1942 he was made assistant section engineer on transmitting tubes and in 1947 he was appointed section engineer, responsible for the design and application engineering of power control and rectifier tubes.

Mr. Thorson joined the Institute in 1942 as an Associate and became a Senior Member in 1950. He is Chairman of the IRE Gas Tube Subcommittee and is a member of the parent Committee on Electron Tubes and Solid-State Devices. In addition to his IRE activities, he has been active in several committees of the Joint Electron Tube Engineering Council of NEMA and RTMA. Active in the formation of the Schenectady Section, Mr. Thorson became the first Chairman in March, 1950, and will continue in office until June, 1951.



Fred M. Ashbrook

INYOKERN SECTION

Fred M. Ashbrook, Chairman of Inyokern Section, was born in Alhambra, Calif., in 1918, and received the B.S. degree in electrical engineering from California Institute of Technology in June, 1942. Upon graduation he went directly to the Massachusetts Institute of Technology to join the staff of the Radiation Laboratory. While there he worked on the development of receiving equipment for microwave radars, and later joined a specialized group engaged in the research and development of antijamming techniques and equipment.

In January, 1946, Mr. Ashbrook transferred to the Naval Ordnance Test Station, Inyokern, Calif., to work on problems of electronic instrumentation for the rocket and missile ranges. At present he is head of the Missile Instrumentation Section at NOTS.

Mr. Ashbrook was active in the organization of the Inyokern Section of the IRE and was the first Vice-Chairman of the Section. He presented a paper on the "Problems of Rocket and Missile Range Instrumentation" at the 1950 National Convention of the IRE in New York, N. Y.

Mr. Ashbrook joined the Institute as a Student Member in 1941 and became an Associate in 1944. He was elevated to the rank of Member in 1945, and in 1949 advanced to the grade of Senior Member. He became Chairman of the Inyokern Section on January 26, 1950, and will hold office for a year.

The achievements of engineers stand in such high repute that they are often taken for granted by the public. Most products of engineering design generally function satisfactorily. As a result, it is usually assumed that engineers are competent and that the devices or mechanisms which they produce will function adequately.

The more complex—and costly—any product which is sold to the public, the more critical will be the purchasers. For this reason television receivers in the home represent a real responsibility imposed upon the engineer, the production experts, and the test personnel.

This subject has been treated in stimulating fashion by a pioneering television engineer who is as well an industrialist, a Fellow of The Institute of Radio Engineers, a past member of certain of the IRE Committees, and the recipient of awards from the Television Broadcasters Association and from the Veteran Wireless Operators Association.—*The Editor.*

Quality in Engineering

ALLEN B. DUMONT

As a manufacturer of cathode-ray tubes, oscillographs, and television equipment, I have from the very beginning insisted that quality should be the first consideration in all of the products bearing our company name. I have always believed that thorough inspection and testing were necessary to insure that material and workmanship were kept at high levels.

I would like to stress one fact which is commonly overlooked in connection with quality control. I find that many people, who are aware of the necessity for quality control, feel that because they have a staff of inspectors who are familiar with the latest sampling techniques, tables, and formulas, can talk knowingly of X-bars and A.Q.L., and utilize control charts and methods, they have done about all they can, so far as quality control goes.

I say to you that quality control can and must go far beyond that. In my plants, we have numerous placards posted which read "Quality cannot be inspected in, it must be built in." This is an excellent slogan, but it does not really get down to basic fact. I feel that quality *must be designed in!*

Every single component and piece of material used in the assembly may be thoroughly tested, every connection and solder joint may be perfect, every individual set may, on its completion, meet all of the operating specifications. However, if the basic design was not made with the idea of quality constantly in the mind of the engineer, the final result will be just another radio or television set.

Quality control must commence on the drawing board, not on the assembly line, and it is up to each engineer to recognize the need for quality. Don't leave it up to the assembly line inspectors. They can't produce a quality product no matter how hard they try, if the basic design is weak. Specifications should be made as complete as possible, and components should be included therein only after thorough investigation and test to determine their suitability for the work in hand. A television receiver, for example, can only be as good as its poorest component, and even the best components will fail if they are used in applications for which they were not intended.

I realize all too well that, in these days of competition in the industry, production costs are of vital importance and that, in many cases, top management has agreed to compromise in design or construction in order to shave a few cents here and there. However, too much of this type of economy will result in field failures or poor operation which will be reflected first, in excessive replacement costs under guarantee, and second, in the attitude of the buying public. In these early days of the giant new television industry, we should all as engineers and manufacturers strive constantly to bring the design of television equipment up to the highest standards possible.

In closing, I would like to quote a brief but eloquent thought on quality, the author of which is unknown to me, but which should be kept before us always:

"Quality is never an accident. It is always the result of high intentions, sincere effort, intelligent direction, and skillful execution."

Management's Role in Research and Development of Electronic Systems*

RALPH I. COLE†, SENIOR MEMBER, IRE

INTRODUCTION

SYSTEMS ENGINEERING has many meanings to different engineering groups. To some, "systems" thinking involves mere assemblage and installation of a group of equipments which have been gathered together to work at a common site, followed by the preparation of an overall instruction book as a guide in the operation. To others, it means the planning effort that goes into detailed study of the operation of a number of separate equipments, together with the design of whatever additional interconnection black boxes that are necessary. Other equally prevalent systems concepts involve methods and procedures of evaluating data channelled through a plurality of equipments, and being able thereby to express predicted operational characteristics from the engineering point of view. Not only do the divergent points of view of systems actively complicate the role of management in order to insure completeness of action, but equally important is the fact that it is very difficult clearly to distinguish, using concepts derived from "equipment" thinking, between any one system and an assemblage of integral systems. Generally speaking, the latter type or "Comprehensive Electronic System" may be regarded as made up of *minor systems* or *elements* to accomplish the following:

- Data gathering or data receiving element.
- Data processing, including such items as special treatment of data, storage of information as well as intercommunications with all directly related elements.
- Data utilization—final output information—display techniques.
- Data transfer—external communications.

While it is possible to catalogue most systems as to types using the above "Data" concepts, it will be shown that in most instances "systems engineering" thinking must be extremely broad and encompassing, possibly influencing the design of even minor components. Research and development management must ever be on the alert to keep the end objectives in the forefront to insure compatibility of the various elements of the systems and to achieve greatest efficiency in the use of men and facilities. Vagueness of systems concepts must be reduced if full advantage is to be taken of performance of individual elements.

"Systems" research and development of the type discussed herein is confined to that effort involved in the design, development, and evaluation of experimental systems ending with the preparation of procurement in-

formation for quantity production. This line of demarkation usually provides an acceptable basis for management, assisting in clarification of over-all responsibilities.

I. GENERATING AND DIRECTING "SYSTEMS THINKING"

Realizing that adequate electronics "systems" do not merely evolve from an assemblage of separate equipment concepts, it is well to consider in detail how management may plant the seeds that will create the atmosphere of systems thinking. Of initial importance is the interpretation of the desired end goals in terms of possible electronic performance. Having once set forth these engineering parameters required for the end objectives, it is logical to next consider the necessary basic electronic systems standards to be utilized, taking into account other established systems as well as *equipment standards* which have already been generally accepted. For example, the standards on electronic and electrical interference levels, power input voltage characteristics, ambient operating conditions, relay rack assemblages, and the like, as well as the influence of component standards back on the over-all system. In this latter regard, the interchangeability of electrical connectors and cables is a prime example of the need of possible continuous review by management of the over-all research and development program in order to insure that the various departments having cognizance over their own particular activity are able to produce devices to form integrated systems. Such thinking is necessary to create the atmosphere on the part of the design engineer wherein he becomes cognizant of the fact that he no longer may have free reign on the choice of his individual components, if by so doing he unnecessarily increases the number of types of parts or minor components without achieving material gain. Electronic systems engineering should therefore be accepted by management as a necessary and highly desirable specialization and given adequate support and backing.

II. PLANNING OF ACTUAL SPECIFIC SYSTEMS

While many electronic systems may initially evolve from an assemblage of already developed components, this is regarded as the exception, and not the type of operation that management can depend upon. Starting with the end objectives clearly enunciated, one of the first steps in the research and development of systems is the determination of the specific functional elements necessary to achieve the end results. In deciding upon these characteristics, adequate safety factors and tolerances must be added to each of the data processors in order that end results will not fall short of goals. At this stage, effective management insures that proper channels of co-ordina-

tion are set up between the equipment designers and the required systems engineers and should act in the role of arbitrators as difficulties and problems occur which cannot be readily adjudicated. As has been stated heretofore, the "system engineer" must have intimate knowledge of the performance capabilities of the elements chosen to make up the entire entity. The over-all systems engineer must insure the minimum of complexity and have the authority to make overriding decisions on the individual component characteristics. In merging the individual elements into an electronic system he must also take into account ancillary items such as test equipment, to insure that the final systems list does not include unnecessary duplication that would normally occur from merely adding together the test items considered necessary with each major equipment. This same philosophy must permeate into the systems engineering thinking to such other items as instruction books, spare parts, and the like, where undue cost will result if he and management do not play an active role in avoiding duplication. Furthermore, the electronic systems engineer must keep in mind that systems are often united with other systems, and hence their data output circuits and arrangements must be such as to provide for interconnection to form master operational entities.

III. PROGRAMMING OF THE ASSEMBLY OF ELECTRONIC SYSTEMS

Those engineers who are actively engaged in research and development of electronic components and/or equipments realize careful scheduling of the parts that are to make up the electronics systems is but one of the many items that management, in association with the systems project engineer, should give their utmost attention. This involves frequent reexamination of progress on the research and development of individual equipments and a great deal of flexibility in control of rate of completion of items. Furthermore, care must be exercised in avoiding premature assembly of the system prior to first having the opportunity of completely checking each major item to assure that when assembled into the final groupings the expected performance has a chance of being achieved. This pretesting phase should be carefully scheduled and due allowance made for a reasonable amount of replacement of such items as vacuum tubes, the life of which is not always correctly predictable.

IV. EVALUATION OF SYSTEMS

It is recognized that it is most difficult to give adjective ratings of the manner of performance of a complete electronic system, be it a minor one or an all-encompassing entity. This is due in large part to the inability to foresee the deleterious effect of one equipment upon another, as well as to have

* Decimal classification: R010. Original manuscript received by the Institute, May 17, 1950.

† Watson Laboratories, AMC, Red Bank, N. J.

foreseen the exact effect of individual tolerances upon the system objectives. Preparing a comprehensive systems testing program, setting forth clearly the individual objectives of each phase, should be considered by management to be as important as the actual research and development of the individual items. Co-ordination of this program prior to initiation of tests permits alerting of all separate departments who may be involved, as well as providing an excellent document for the briefing of all testing personnel on detailed procedures and techniques to be followed. Only after engineering management is satisfied that the evaluation program is the one which will have the greatest chance of yielding the most trustworthy appraisal should the actual taking of data begin. Furthermore, each step of the data taking process should be under careful supervision to insure that a sufficient quantity of information is recorded under controlled conditions in order to prevent unnecessary redoing of any phase of the program. This may mean that some tests may be temporarily delayed until it has been ascertained that the data recorded will suffice for the appraisal of the systems objective.

Of late there has come the realization that human engineering plays a large part in what may be called the efficiency of systems operations, and an excellent opportunity is afforded for appraising human engineering during the actual conducting of the test. In general, it may be well to request the systems engineer to carefully make comment upon the following items:

- (a) Is the physical arrangement of equipments optimum?
- (b) Have the environment factors, such as seating, lighting, operator fatigue, been taken into account?
- (c) Processing of internal data through the system by the human operators involved. Stated in another manner,

have the optimum time-motion factors been considered?

- (d) Processing of the final output data. In this regard, is the output data in such form as to require the minimum of operator processing time?

As has been previously mentioned, engineering appraisal must be made from time to time of all data as it is taken and analyzed. The final formal engineering report, however, should present only that information which is vital to the rating of the system and clearly delineate engineering conclusions based upon thorough reliable information. The defects as well as the good points should be discussed, and management's role is to determine whether or not the system will satisfactorily meet the objectives. Furthermore, this group of reports can well serve as the background for preparation of the instructional literature which will later be issued to the operating personnel when and if quantity production is undertaken.

V. PREPARING OF PROCUREMENT SPECIFICATIONS FOR QUANTITY PRODUCTION

The problem of preparing adequate procurement specifications for systems requires an appreciation on the part of management and systems engineers that the reproducibility of a complete system involves far more than production of individual elements. Particular attention must be paid to setting of the performance requirements below that actually obtained on the full engineering model in order to allow for tolerances beyond the control of either the *Single System* or the *"Comprehensive" Systems Engineer*. Furthermore, test procedures that can be accomplished at the source of manufacture must be analyzed to permit, insofar as possible, synthesis of the actual test that may have been accomplished in the field under controls not now available. Analysis of

test procedures used on other possibly similar types of systems usually provide guide lines to be followed. Reports from the field on operation of other items of similar nature may also prove of great value.

Another phase of procurement information preparation concerns requirements for test equipments of the systems type. This must not be overlooked, since the systems performance may well deteriorate far below safe values and will therefore require readjustment at sometime in the future. The systems engineer must also be concerned with the spare parts requirement, and should carefully appraise this factor and take it into account. The requirements for instructional literature of the systems type must also be very carefully scrutinized to insure that the operating personnel would be able to achieve the best possible results from the assemblage of equipments making up the individual systems. The tying together of all of the above factors can best be insured by the use of check lists applicable to the system under consideration which lists all the separate items making up the system, plus their individual identifiable separate components.

VI. CONCLUSIONS

It is recognized that there are other aspects of systems engineering, such as "Installation," which may be as important as any discussed herein. However, research and development personnel are usually not directly involved. The phases of systems engineering which have been discussed point up the importance of this effort and indicate that management must play a vital role in view of the wide scope of this type of activity involving many diverse types of engineering talent. The success of systems engineering of the type discussed will be in a large measure governed by the keenness of engineering management to appreciate the many problems involved.

Statistical Methods in Research and Development*

L. LUTZKER†, ASSOCIATE, IRE

Manufacture or construction, in the early stages of their development, are conducted vigorously but in somewhat haphazard fashion. As these processes evolve, orderly controls are essential to determine statistically the quality of the product or service at any time. Thus waste, defective output, and resulting disorganization are largely avoided.

The following paper on this subject has received the approval of the IRE Professional Group on Quality Control, and is published through the good offices of that Group.—*The Editor*.

Summary—Many engineers have heard of the recent advances in the field of applied statistics. It is the purpose of this paper to introduce and demonstrate one of the many statistical tools that can

be of considerable aid in reducing trial and error experimentation for the design, development, or research engineer.

Some variability enters into every experiment that may be undertaken. Some of the variability is due to chance errors of measurement and some is due to definitely assignable causes operating on the factors producing the data. Separation of the various assignable causes entering the experiment and their comparison with experimental error is known as the "analysis of variance."

* Decimal classification: R010. Original manuscript received by the Institute, May 8, 1950. Presented, 1950 IRE National Convention, New York, N. Y., March 6, 1950.

† Allen B. DuMont Laboratories, Inc., Passaic, N. J.

In order to most efficiently determine the significance and magnitude of the assignable variabilities, experimental error must be minimized. Methods of accomplishing this end are discussed. Following a discussion of some basic concepts, a computational example of an analysis is shown. The paper concludes with a summary of steps used in carrying a development problem to completion.

MANY ENGINEERS have probably heard of the recent advances made in the field of applied statistics and have wondered how these advances could be of use to the design, development, or research engineer. It is the purpose of this paper to answer this question in part by introducing and demonstrating one of the many statistical tools that the engineer can use. By using this tool, many needless hours of trial-and-error experimentation can often be eliminated, in addition to making more information obtainable from the data than is usually possible with conventional methods of analysis. The underlying theory of this tool will not be treated as it may be found in the literature listed in the bibliography. However, several important terms will be defined and discussed to help you understand the tool.

All are aware of the fact that some degree of experimental error is attendant upon every observation that we make, whether it be in a laboratory or on the production line. In order to determine the reliability and value of a given set of data, it is therefore necessary to compare the data with an estimate of the chance errors inherent in the data. This comparison is called a "test of significance" by the statistician.

In performing an experiment, the engineer always seeks to minimize the magnitude of error in order that any significant details in the results may show up clearly and not be masked by the errors involved in the experiment. Minimization of errors may be accomplished in a number of ways. One is the use of precision measuring apparatus. Another is to replicate or repeat the experiment a number of times and average the results. Still another method is to control all factors except the particular one in which the experimenter is interested. In designing the experiment to yield the most effective data, all the factors in the experiment that cannot be kept constant must be allocated at random throughout the entire experiment. The reason for this statement will become clear very shortly.

The development of the technique under consideration, hereafter called "analysis of variance," may be followed most easily by considering a hypothetical experiment and noting how the problems arising in connection with it are solved. Let us assume that a company wishes to develop an ultra-high-frequency tube. Four men are assigned to the project to work independently for a specified period of time. At the end of this period, each one has developed a tube. The company now wishes to know which, if any, of the four tubes will perform most satisfactorily.

The variables that enter in the experiment are conditions of construction, materials used, tools used, and

technique of the technicians building the tubes. There are undoubtedly many others but, for our purposes, let us assume that the above-mentioned are the only ones. Since one of the methods of minimizing experimental error is control of the variables, the tubes will be built under the same conditions in so far as possible. In addition, the materials used will be drawn from batches of material known to be homogeneous. To speed completion of the project, four technicians and four machines (tools) are assigned. The explanation will be simplified by referring to the tube developments as I, II, III, and IV; to technicians as A, B, C, and D; and to machines as 1, 2, 3, and 4. As the experiment can be carried out in a number of ways, several of these will be considered and the best determined.

The first method that suggests itself is to assign one tube development and one machine to each technician, letting each one build eight tubes (replication or repetition of each tube development so that some of the error is averaged out). The performance data would then be recorded as shown in Table I. Each letter-number

TABLE I

Tube Developments			
I	II	III	IV
A 1	B 2	C 3	D 4
A 1	B 2	C 3	D 4
A 1	B 2	C 3	D 4
A 1	B 2	C 3	D 4
A 1	B 2	C 3	D 4
A 1	B 2	C 3	D 4
A 1	B 2	C 3	D 4
A 1	B 2	C 3	D 4

combination represents the technician-machine combination that built the tube development models indicated at the top of the column. In this form, the averages or totals for each column may be compared to determine whether or not they are essentially alike. By examining this array of data, it is immediately obvious that any significant differences¹ among the four columns may be attributed to differences among tube developments, technicians, machines, or some combination of these factors. Since the experimenter is interested only in differences that may exist among tube developments, it becomes necessary for him to assign the technicians and machines differently in order that significant differences among columns be due only to tube developments. As was suggested earlier, technicians and machines are assigned at random for the construction of each development. Randomization is carried out in such a manner that each of the four levels of a given variable appears in each column once and only once. Thus, each column will contain the same factors an equal number of times and permit the averaging out of error due to these factors.

This step results in the layout shown in Table II.

¹ See Appendix I for a discussion of significant differences.

Each row now contains each technician and each machine only once. Thus any real differences among technicians or machines are averaged out. Any real differences that now exist among the columns can be due only to differences among tube developments. It can now be stated that the reason for allocating all factors, except the ones with which the experiment is concerned, at random is to average out the effects of the variables that could not be controlled.

TABLE II

Tube Developments			
I	II	III	IV
C 2	A 4	B 3	C 1
C 2	A 4	B 3	C 1
A 1	D 1	C 4	B 3
A 1	D 1	C 4	B 3
B 4	C 3	A 2	D 2
B 4	C 3	A 2	D 2
D 3	B 2	D 1	A 4
D 3	B 2	D 1	A 4

Table III represents a set of hypothetical data collected in the form indicated by Table II. The analysis of variance consists of breaking the total variance in the data into its component parts. In the experiment at hand, these are the variance among tube developments (among-column variance) and the error variance (within-column variance).

TABLE III

Tube Developments			
I	II	III	IV
144	147	160	141
147	143	156	146
154	141	154	148
156	148	159	142
153	154	150	144
145	145	155	153
149	155	158	153
156	157	155	143

The computational arithmetic, though essentially of a very elementary nature, may be simplified by reducing the magnitude of the numbers dealt with. This is done by shifting the mean of the data so that the converted data has a mean of approximately zero. In this case, subtracting 150 from each observation accomplishes this purpose. Shifting the mean is permissible since the variance of the data is not affected.

Table IV shows the data after the mean has been shifted. The figures in parenthesis are the squares of each observation to the left of the parenthesis. Before undertaking the formal analysis of variance,² the classi-

cal theory requires the assumption that the samples come from normal populations of the same variance be verified. If the variances were not the same but were significantly different from each other, it would not be possible to ascertain whether the source of the significant differences in the data was the differences among means or the differences among the variances. The above stated assumption is tested by calculating

$$L_1 = \left(\frac{s_1^2 \cdot s_2^2 \cdot \dots \cdot s_k^2}{s_a^2 \cdot s_a^2 \cdot \dots \cdot s_a^2} \right)^{1/k}$$

and finding the level of significance at which the value of L_1 falls. In the above equation for L_1

$$ns_1^2 = \sum_1^n (x - \bar{x}_1)^2 \quad ns_2^2 = \sum_1^n (x - \bar{x}_2)^2, \dots$$

$$Ns_a^2 = n \sum_1^k (s_i^2).$$

TABLE IV

Tube Developments			
I	II	III	IV
-6 (36)	-3 (9)	+10 (100)	-9 (81)
-3 (9)	-7 (49)	+6 (36)	-4 (16)
+4 (16)	-9 (81)	+4 (16)	-2 (4)
+6 (36)	-2 (4)	+8 (64)	-8 (64)
+3 (9)	+4 (16)	+0 (0)	-6 (36)
-5 (25)	-5 (25)	+5 (25)	+3 (9)
-1 (1)	+5 (25)	+8 (64)	+3 (9)
+6 (36)	+7 (49)	+5 (25)	-7 (49)
(168)	(258)	(330)	(268)
+4 (16)	-10 (100)	+46 (2,116)	-30 (900)

The level of significance is determined by looking up the value of L_1 in a table of L_1 values.³ The data shown in Table IV yield a value of 0.903 for L_1 . Since this does not reach the 5-per cent level of significance, the hypothesis that the populations from which the data originate are normal and have no significant differences among their variances is verified. The analysis of variance may therefore continue. The arithmetical computations follow.

Square the individual observations and add.

$$\sum X^2 = 168 + 258 + 330 + 268 = 1,024.$$

Square each column total, add, and divide by the number of observations in each column.

$$\sum X_c^2/n_c = (16 + 100 + 2,116 + 900)/8 = 391.5. \quad (2)$$

² This is testing the hypothesis that the observed sample means come from normal populations whose means are essentially the same and whose variances are assumed the same.

³ H. A. Freeman, "Industrial Statistics," John Wiley and Sons, Inc., New York, N. Y., Table X, p. 175; 1942.

Square the grand total, and divide by the total number of observations in the data.

$$(\sum X)^2/N = (10)^2/32 = 3.125. \quad (3)$$

Table V is the table summarizing the analysis of variance.

TABLE V

Source of Variance	Sum of Squares	Degrees of Freedom	Mean Squares
Among tube developments (among columns)	(2)-(3) = 391.5	$(c-1)$ $4-1=3$	388.375/3
	-3.125		
	388.375		129.46
Error (within columns)	(1)-(2) = 1,024	$c(n_c-1)$ $4(8-1) = 28$	632.5/28
	-391.5		
	632.5		22.59
Total	(1)-(3) = 1,024		
	-3.125		
	1,020.875		

Before continuing the discussion, it would be well to interject a few words about degrees of freedom. The degrees of freedom that a given statistic has is usually "the number of ways that a group concerned can be arbitrarily filled in if the total is determined. . . ." ⁴ Thus, when $c-1$ column totals have been filled and the grand total is known, the last column total is uniquely determined. For within column degrees of freedom, each column can be filled (n_c-1) ways; since there are c columns, there are $c(n_c-1)$ degrees of freedom for the within-column variance. Finally, the total degrees of freedom is equal to the sum of the components, which is $c-1+c(n_c-1)$ or cn_c-1 . Having determined the degrees of freedom associated with each source of variance, the mean squares are found by dividing each sum of squares by its respective degrees of freedom.

The last step in the analysis of variance is to compare the various sources of variance with the error variance for significance. This is done by means of the variance ratio or F test which consists of finding the ratio source variance/error variance and determining the level of significance at which the ratio falls, from a table of variance ratios. ⁵ Table V shows that the source (among columns) variance or mean square is 129.46 while the error mean square is 22.59. The variance ratio, $129.46/22.59=5.73$, is significant below the 0.01- or 1-per cent level of probability but not quite at the 0.001- or 0.1-per cent level. Thus, there are grounds for believing that the tube developments are not alike in their performance.

⁴ K. A. Brownlee, "Industrial Experimentation," Chemical Publishing Company, New York, N. Y., p. 50; 1948.

⁵ See Table VIII, pp. 170-173, of footnote reference 3.

This being the case, which development or developments are best? If the larger observation implies better performance, Development III would appear to be the best. This hypothesis may be tested with a second table of variances. If tube I, II, and IV are alike, the resulting variance ratio should not reach the 0.05 level of significance. Table VI is the table for this analysis. The calculations necessary for this table are

$$\sum X^2 = 168 + 258 + 268 = 674 \quad (4)$$

$$\sum X_c^2 = (16 + 100 + 900)/8 = 1,016/8 = 127 \quad (5)$$

$$(\sum X)^2/N_{24} = (-36)^2/24 = 54. \quad (6)$$

$$F = 36.5/26/05 = 1.41.$$

TABLE VI

Source of Variance	Sums of Squares	Degrees of Freedom	Mean Squares
Among columns I, II, and IV	(5)-(6) = 127.0	$(c-1)$ $3-1=2$	73.0/2
	-54.0		
	73.0		36.5
Within columns I, II, and IV (error)	(4)-(5) = 674.0	$c(n_c-1)$ $3(8-1) = 21$	547.0/21
	-127.0		
	547.0		26.05
Total	(4)-(6) = 674.0		
	-54.0		
	620.0		

Since an F ratio of 3.47 is required for the 0.05 level of significance, the hypothesis that the tubes I, II, and IV are alike is true.

If, on the other hand, a small observation had implied better performance, the company would have had to choose among three developments to determine the one to use. In this case, economy and ease of manufacture would probably have been the deciding factors since the data did not support any particular one of the three developments.

In the same manner that I, II, and IV were hypothesized to be alike, any other combination might have been tested. For example, if the variance ratio from Table VI had actually been significant, one of the three developments could have been assumed superior or inferior to the remaining two, and the latter tested for differences. The analysis of any given set of data can be carried on until no further conclusions can be drawn from the data.

To summarize, the steps followed in analyzing a development or research problem are:

1. Several designs are developed and it is desired to find out which, if any, are superior to the rest.
2. An experiment is designed to yield data in systematic groupings to permit the analysis of the varia-

tions in the data into its components. All factors that are not being studied are controlled at the same level. If this is not practical, these variables are allocated at random.

3. Replication or repetition of the experiment is used to reduce the estimate of experimental error.

4. The data are analyzed by comparing the source variances with the error variance.

5. If the resulting ratio is significant at or below the 0.01 level of significance, a second analysis is made to determine which groups are alike and which are responsible for the significance in the data.

6. If the resulting ratio is significant between the 0.05 and 0.01 levels, additional replications are desirable. This will reduce the estimate of error and the level of significance if significant differences in the data really exist.

7. If the resulting ratio is not significant at or below the 0.05 level, there are insufficient grounds for believing that any differences exist.

The advantages gained from a systematic analysis such as described herein are:

1. Elimination of trial-and-error experimentation to a great extent, thereby obtaining accurate information from fewer data.

2. Attainment of conclusions based upon objective tests.

APPENDIX I

Significant Differences

One of the important concepts that one deals with in statistical work is that of significant differences. If one were to build a large number of tubes of design I, using any particular combination of technician, machine, material, and the like, the measurements of a given characteristic would be found to array themselves in the form of a frequency distribution popularly known as "the normal curve of distribution." Let this curve, arising from design or development I, be called distribution I. Similarly, a large number of measurements of the same characteristic on development II would form a normal curve which would be called distribution II.

Suppose now that both developments were exactly alike with regard to the performance characteristic being studied. It could be expected that distribution I could be superimposed upon distribution II and there would be no differences between the two.

If the parent distributions are alike, it is natural to expect that samples drawn from these distributions should also be alike. In a statistical sense, they are alike. However, the means and variances (measure of variation of the data about the mean) of successive samples differ. When the means of a large number of successive samples, taken from the same or like parent distributions, are arranged in the form of a frequency distribution, it is found that this also approximates the normal curve. The distribution of sample means is similar to

the parent distribution in that the central tendencies or means of the two curves are the same. The difference is that the variance of the parent distribution is larger than the variance of the curve of sample means. To be exact, the variance of the parent curve is n times as large as the variance of the curve of sample means, where n is the sample size. Thus, for each value of the variable, there will be a certain probability that a sample mean will occur at that value when the sample was drawn from the assumed parent distribution.

In order to determine whether a given sample came from the assumed distribution, the statistician sets up the hypothesis that the sample actually did come from the assumed population. The probability that the hypothesis is correct is the probability figure discussed at the end of the last paragraph. If the probability is high, the hypothesis is considered to have been borne out. If, on the other hand, the probability is low, doubt is cast upon the hypothesis since it informs the statistician that it is improbable that the sample came from the assumed population.

The probability figure that is found is termed the "level of significance." As a rule, 0.05 is used as the level below which the difference between the sample and the population is said to be significant. In other words, the probability is 1 in 20 that the sample did come from the assumed population. Since the probability that the sample did not come from the assumed distribution is 19 in 20, it may be stated that the odds are 19 to 1 against the occurrence of a sample which appears at the 0.05 level of significance. In some cases, the experimenter may wish to be more certain that the differences exist and consequently will adopt a lower figure such as 0.01 probability as the level below which the difference is considered significant. In this case the odds would be 99 to 1 against the hypothesis that the observed sample came from the assumed distribution or was like the sample with which it was compared.

The best practical compromise is to consider all results at or near the 0.05- or 5-per cent level as worth following up and all results at or below the 0.01 or 1-per cent level indicative of significant differences. If the test for significance yields a result at or near the 5-per cent level and the significant difference really exists, gathering more data will usually result in a lowering of the level of significance toward or below 1 per cent.

BIBLIOGRAPHY

1. K. A. Brownlee, "Industrial Experimentation," Chemical Publishing Co., New York, N. Y.; 1948.
2. F. E. Croxton and D. J. Cowden, "Applied General Statistics," Prentice-Hall, Inc., New York, N. Y.; 1939.
3. R. A. Fisher, "Statistical Method for Research Workers," Oliver and Boyd, Edinburgh, Scotland; 1938.
4. H. A. Freeman, "Industrial Statistics," John Wiley and Sons, Inc., New York, N. Y.; 1942.

Standards on Television: Methods of Measurement of Time of Rise, Pulse Width, and Pulse Timing of Video Pulses in Television, 1950*

COMMITTEE PERSONNEL

Standards Committee

J. G. BRAINERD, *Chairman*
L. G. CUMMING, *Vice-Chairman*
A. G. JENSEN, *Vice-Chairman*

M. W. Baldwin, Jr.	A. G. Fox	A. F. Pomeroy	Bertram Trevor
R. R. Batcher	R. A. Hackbusch	George Rappaport	W. N. Tuttle
H. G. Booker	J. V. L. Hogan	H. E. Roys	L. C. Van Atta
F. T. Budelman	J. E. Keister	P. C. Sandretto	K. S. Van Dyke
W. G. Cady	E. A. Laport	E. S. Seeley	D. E. Watts
P. S. Carter	Wayne Mason	R. F. Shea	Ernst Weber
J. W. Forrester	R. A. Miller	J. R. Steen	L. E. Whittemore
	L. S. Nergaard	Henry Tanck	

Video Techniques Committee

J. E. KEISTER, *Chairman*
W. J. POCH, *Vice-Chairman*

M. W. Baldwin, Jr.	R. H. Daughterty, Jr.	R. L. Garman	R. S. O'Brien
A. J. Baracket	V. J. Duke	L. L. Lewis	C. G. Pierce
P. F. Brown	G. L. Fredendall	L. W. Morrison, Jr.	J. F. Wiggin

Subcommittee on Video Systems and Components

W. J. POCH, *Chairman*

I. C. Abrahams	R. Cotelesso	G. L. Fredendall	J. H. Mulligan, Jr.
A. J. Baracket	R. DeBaun	J. R. Hefele	J. F. Wiggin
R. W. Clark			

1. INTRODUCTION

1.1 General Description

Fig. 1 portrays a typical composite picture signal wave form. The timing, the pulse widths or durations, and the time of rise or decay of various pulses are specified within definite limits. In order to insure conformance to these specifications, a measurement method must be available. This technique is applicable to the measurement of other television pulses.

The tolerances prescribed for the steepness of wave fronts, as well as the duration and timing of the various pulses that make up the composite synchronizing signal, require measuring methods capable of determining fractional microsecond time intervals. Along with the required high precision, it is necessary that the methods be

as simple and easy to use as possible under operating conditions.

1.2 Definitions

1.2.1 Time of Rise (Decay) of Video Pulses in Television

The duration of the rising (decaying) portion of a pulse measured between specified levels.

1.2.2 Pulse Width of Video Pulses in Television

The duration of a pulse measured at a specified level.

1.2.3 Pulse Timing of Video Pulses in Television

The determination of an occurrence of a pulse or a specified portion thereof at a particular time.

* Reprint orders of this Standard, 50 IRE 23.S2, may be purchased while available from The Institute of Radio Engineers, 1 East

79 Street, New York 21, N. Y., at \$0.75 per copy. A 20 per cent discount will be allowed for 100 or more copies mailed to one address.

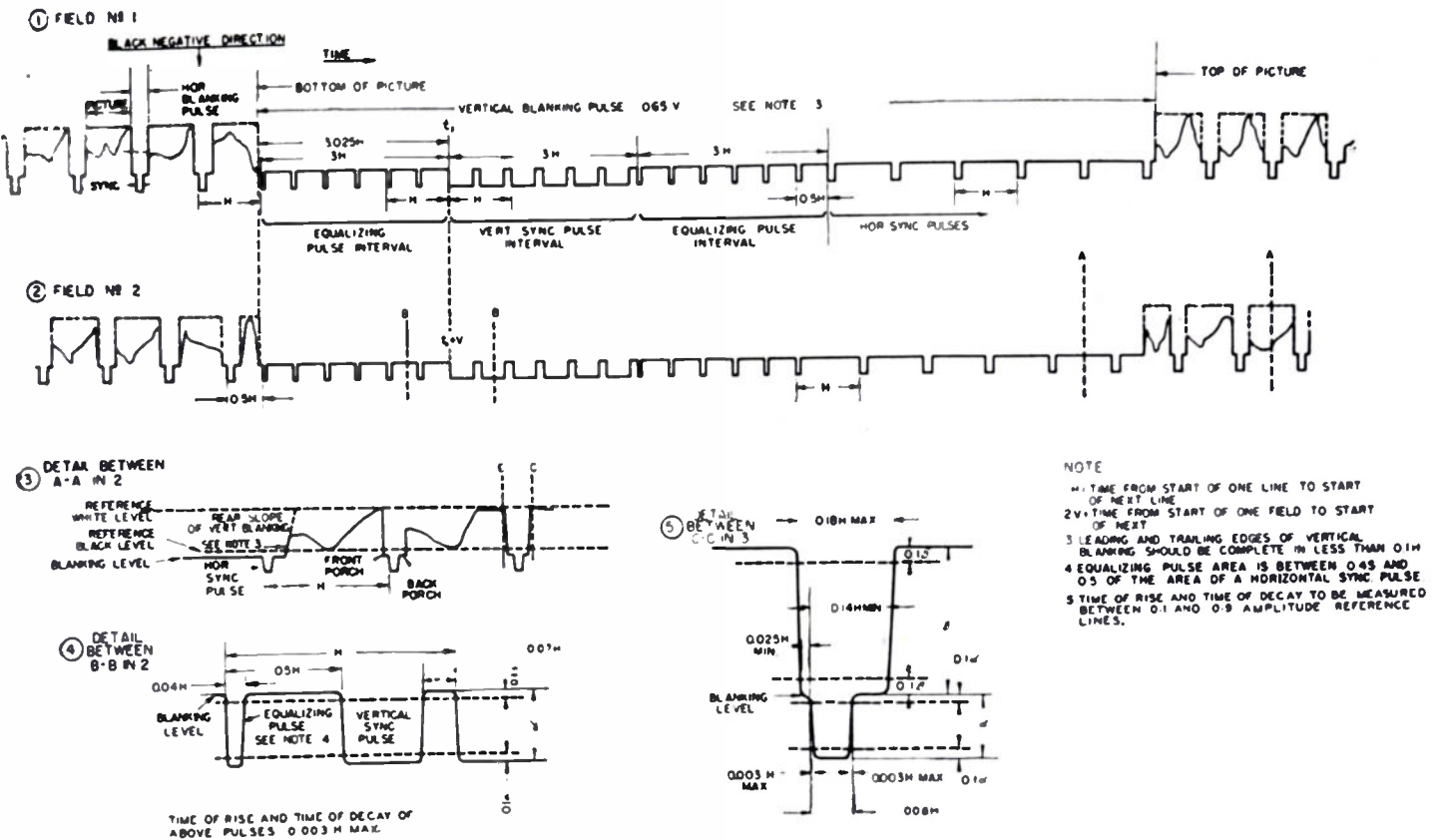

Fig. 1—A typical composite picture signal wave form. The pulse dimensions and notes 1 to 5 are given merely to portray the scope of measurement required.

2. APPARATUS AND CIRCUITS

2.1 Basic Method for Measurement of Time of Rise, Pulse Width, and Pulse Timing of Synchronizing Pulses

2.1.1 Time of Rise, Pulse Width, and Pulse Timing by Means of an Expanded-Sweep Method

A convenient method of measuring the small time intervals involved in the rise and decay of line synchronizing pulses, as well as the larger time intervals in pulse duration and timing measurements, is the use of an oscilloscope incorporating some form of expanded sweep. The measurement is made by varying the phase of the sweep a known amount or by noting the relationship of the pulse portions to timing markers.¹⁻³

¹ R. P. Abbehouse, "A cathode-ray oscillograph for precision time measurement," Presented, IRE National Convention, New York, N. Y., March 25, 1948.

² T. Soller, M. Starr, and G. Valley, "Cathode Ray Tube Displays," *MIT Rad. Lab. Series*, McGraw-Hill Pub. Co., Chap. 7; pp. 251-302.

³ IRE Standards on Television: Methods of Testing Television Transmitters, 1947.

2.1.2 Time of Rise, Pulse Width, and Pulse Timing by Means of a Phased Sine-Wave Sweep Method

In this method, a sine-wave sweep, synchronized to the pulses it is desired to measure, is so phased that the proper pulse section appears in the center or the fastest portion of the sweep. The portion of the center of the sine wave sweep that the pulse section occupies bears a known relationship to the sweep period. The measurement may then be obtained by calculation or by reference to a nomographic chart.^{3,4}

2.1.3 Time of Rise, Pulse Width, and Pulse Timing by Means of a Sine-Wave Sweep and a Phased Marker

A sine-wave sweep is synchronized to the pulses it is desired to measure. A blanking marker signal synchronized to the sweep frequency, the delay of which is capa-

⁴ R. A. Montfort and F. J. Somers, "Measurement of the slope and duration of television synchronizing impulses," *RCA Rev.*, vol. 6, pp. 370-389; January, 1942.

3. PROCEDURE

3.1 Measurement Technique

3.1.1 Time of Rise, Pulse Width, and Pulse Timing by an Expanded-Sweep Method

With the synchronizing signal applied to the oscilloscope vertical amplifier and the gain adjusted for a wave form amplitude convenient for measurement, the sweep length should be adjusted to permit a spread on the screen of the signal portions to be measured. The measurements may then be made by means of the electronic time markers or by advancing the pulse sections past a fixed scale reference point by means of the calibrated phase shifter or sweep delay control.

3.1.2 Time of Rise, Pulse Width, and Pulse Timing by Means of a Phased Sine-Wave Sweep Method

3.1.2.1 Pulse Width. The pulse to be measured is applied to the vertical-deflection amplifier, and the sinusoidal time base is applied to the horizontal-deflection plates. By means of the variable phase-shifting device, the pulse is shifted to the center of the horizontal trace. With a transparent millimeter scale, the width of the pulse is measured at the 10 per cent amplitude point (Fig. 5). This width in per cent of sweep frequency time can be found by means of the following equation:

$$\text{per cent} = \frac{\sin^{-1}(C/D)}{1.8}$$

where C is the measured width of the pulse and D is the width of sinusoidal trace on the oscilloscope screen. The angle is expressed in degrees.

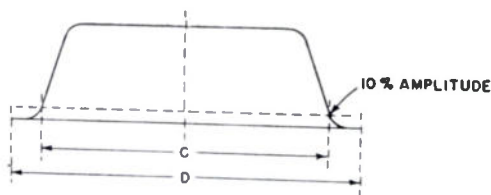

Fig. 5—Measurement points on cathode-ray oscilloscope trace.

In order to minimize the amount of calculation, a nomographic chart is provided in Fig. 6.

3.1.2.2 Pulse Timing. The above method may be used to determine the timing of pulses. Another method makes use of a calibrated phase shifter. The first part of the wave is lined up with a reference point or cross hair on the oscilloscope, the setting of the calibrated phase shifter being noted. The phase is then shifted to bring the second part of the wave back to the reference point. Knowing the frequency of the sine wave and the

phase shift in fraction of a cycle, the timing in microseconds is found by dividing this phase shift by the frequency in megacycles per second.

3.1.2.3 Time of Rise (Decay). A harmonic generator developing a sine-wave time base which is the 10th harmonic of the line frequency is used to increase the accuracy of measurement of the time of rise (decay) of pulses. The pulse edge is centered by means of a phase-shift control and measurements are made as above with the transparent scale. The values obtained from the nomographic chart or by substitution in the equation are divided by 10 to give the duration of the time of rise in per cent of the line period.

3.1.3 Time of Rise, Pulse Width, and Pulse Timing by Means of a Sine-Wave Sweep and a Phased Marker

In this method, the pulse to be measured is applied to the oscilloscope vertical-deflection amplifier and the sine-wave time base to the horizontal amplifier. By means of the marker variable phase-shifting control, the marker is aligned with the beginning of the interval to be measured, and dial reading noted. The control is then adjusted for alignment of the marker with the end of the interval, and a second dial reading taken. The difference in dial readings corresponds to a definite time interval in per cent of the horizontal period or in microseconds, obtained from a calibration chart.

3.1.4 Area of Equalizing Pulses by an Integration Method

After being fed through the RC circuit, the integrated synchronizing signal is viewed on an oscilloscope with an expanded sweep phased so as to view the field retrace period of the signal. A sharp rise representing the integrated vertical pulses will then be observed; preceding this will be the equalizing pulse period and the horizontal pulse period. The integrated amplitude during the equalizing-pulse region will be the same as during the horizontal-pulse region if the equalizing-pulse area is one half the horizontal pulse area. An increase or decrease in equalizing-pulse area will cause the integrated output to rise or fall during the equalizing-pulse region. Correct adjustment, therefore, is obtained when the integrated amplitude decreases slightly or does not change during the equalizing-pulse region.

3.1.5 Pulse Timing by the "Pulse-Cross" Method

The display on the monitor picture tube is in the form of a "pulse cross." This is a useful operational test by which it is possible to count the number of equalizing pulses and vertical pulses, and obtain a rough check on the width of the front porch and back porch in relation to the width of horizontal sync. For observation of the field synchronizing region, the central portion of the field sweep should be expanded to three or four times normal scanning amplitude.

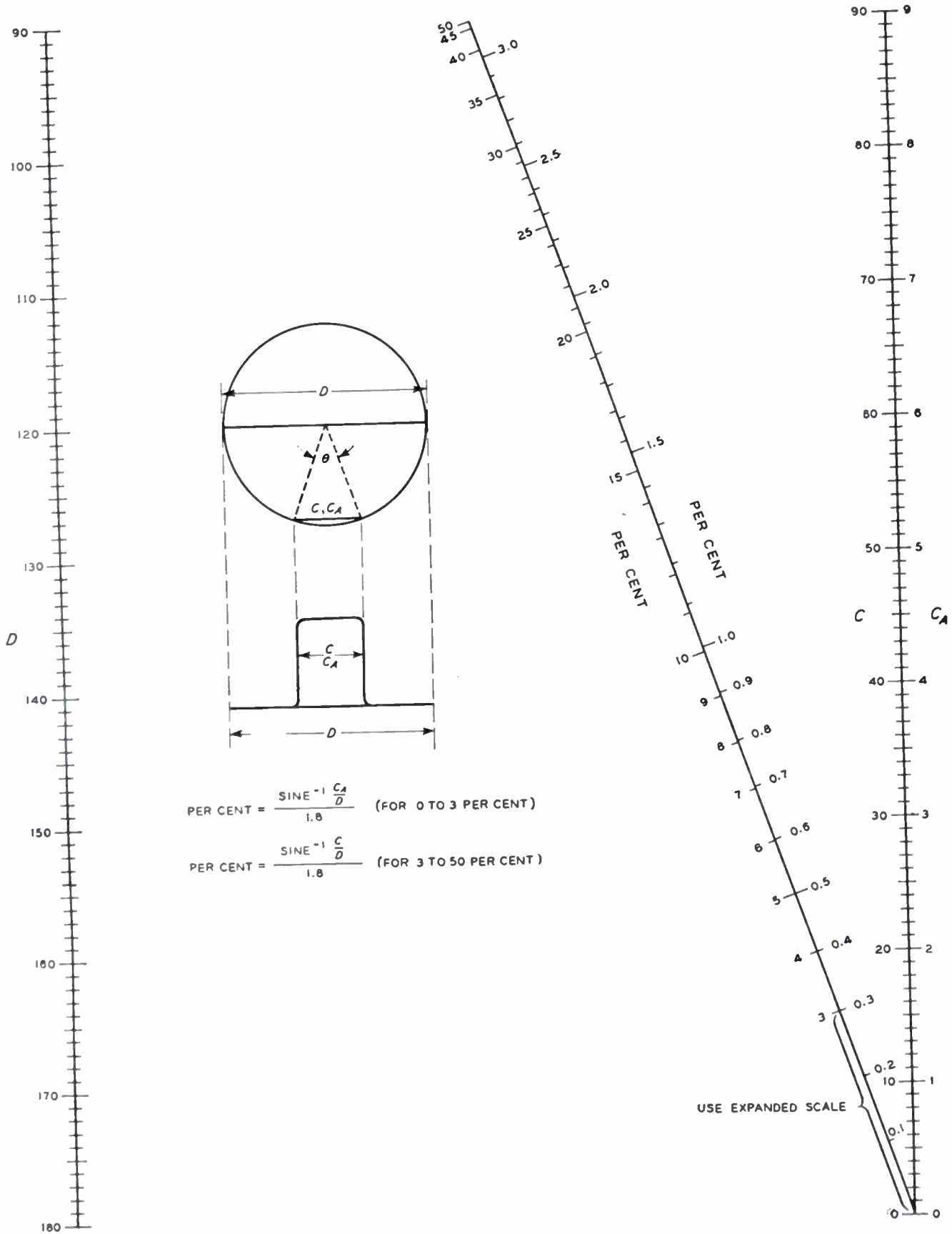

Fig. 6—Impulse-measurement chart. For measuring impulse widths in per cent, using sine-wave horizontal deflection on the cathode-ray oscillograph.

Standards on Wave Propagation: Definitions of Terms, 1950*

COMMITTEE PERSONNEL

Standards Committee, 1950-1951

J. G. BRAINERD, *Chairman*
L. G. CUMMING, *Vice-Chairman*
A. G. JENSEN, *Vice-Chairman*

M. W. Baldwin, Jr.	A. G. Fox	A. F. Pomerooy	Bertram Trevor
R. R. Batcher	R. A. Hackbusch	George Rappaport	W. N. Tuttle
H. G. Booker	J. V. L. Hogan	H. E. Roys	L. C. Van Atta
F. T. Budelman	J. E. Keister	P. C. Sandretto	K. S. Van Dyke
W. G. Cady	E. A. Laport	E. S. Seeley	D. E. Watts
P. S. Carter	Wayne Mason	R. F. Shea	Ernst Weber
J. W. Forrester	R. A. Miller	J. R. Steen	L. E. Whittemore
	L. S. Nergaard	Henry Tanck	

Wave Propagation Committee, 1946-1950

H. G. BOOKER, *Chairman*
H. W. WELLS, *Vice-Chairman*
C. R. BURROWS, *Chairman, 1949*
A. E. CULLUM, JR., *Chairman, 1948*
S. A. SCHELKUNOFF, *Chairman, 1947*
J. A. STRATTON, *Chairman, 1946*

E. W. Allen, Jr.	A. G. Fox	Morris Kline	Newbern Smith
S. L. Bailey	E. G. Fubini	M. G. Morgan	R. L. Smith-Rose
J. E. Boyd	I. H. Gerks	K. A. Norton	A. W. Straiton
T. J. Carroll	M. C. Gray	H. O. Peterson	E. F. Vandivere
A. B. Crawford	D. E. Kerr	J. A. Pierce	A. H. Waynick
W. S. Duttera	J. E. Keto	George Sinclair	J. W. Wright

Subcommittee on Wave Propagation Definitions, 1948-1950

GEORGE SINCLAIR, *Chairman*
A. G. FOX, *Chairman, 1948, 1949*

A. B. Crawford	E. G. Fubini	Karl Jansky	Grote Reber
J. E. Eaton	I. H. Gerks	Martin Katzin	S. W. Stewart
	M. C. Gray	D. E. Kerr	

* Reprints of this Standard, 50 IRE 24.S1, may be purchased while available from The Institute of Radio Engineers, 1 East 79 Street, New York 21, N. Y., at \$0.60 per copy. A 20 per cent discount will be allowed for 100 or more copies mailed to one address

Absorption. The irreversible conversion of the energy of a radio wave into other forms of energy as a result of its interaction with matter.

Angular Frequency. The frequency expressed in radians per second. It is equal to the frequency in cycles per second multiplied by 2π .

Atmospheric Duct. An almost horizontal layer in the troposphere, extending from the level of a local minimum of the modified refractive index as a function of height, down to the level where the minimum value is again encountered, or, down to the earth's surface if the minimum value is not again encountered.

Atmospheric Radio Wave. A radio wave that is propagated by reflections in the atmosphere. It may include either or both of the components, ionospheric wave and tropospheric wave.

Attenuation. Of a quantity associated with a traveling wave in a homogeneous medium, the decrease with distance in the direction of propagation. (Note—In a diverging wave, attenuation includes the effect of divergence.)

Attenuation Constant. For a traveling plane wave at a given frequency, the rate of exponential decrease of the amplitude of a field component (or of the voltage or current) in the direction of propagation, in nepers or decibels per unit length.

Attenuation Ratio. The magnitude of the propagation ratio.

Circularly Polarized Wave. An electromagnetic wave for which the electric and/or the magnetic field vector at a point describes a circle. (Note—This term is usually applied to transverse waves.)

Critical Frequency. The limiting frequency below which a magneto-ionic wave component is reflected by, and above which it penetrates through, an ionospheric layer at vertical incidence.

Cylindrical Wave. A wave whose equiphase surfaces form a family of coaxial or confocal cylinders.

D Region. The region of the ionosphere up to about 90 kilometers above the earth's surface.

Direct Wave. A wave that is propagated directly through space.

Direction of Polarization. For a linearly polarized wave, the direction of the electric vector.

Direction of Propagation. At any point in a homogeneous, isotropic medium, the direction of time average energy flow.

E Layer. An ionized layer in the *E* region.

E Region. The region of the ionosphere between about 90 and 160 kilometers above the earth's surface.

Effective Radius of the Earth. An effective value for the radius of the earth, which is used in place of the geometrical radius to correct for atmospheric refraction when the index of refraction in the atmosphere changes linearly with height. (Note—Under conditions of Standard Refraction the effective radius of the earth is 8.5×10^6 meters, or $4/3$ the geometrical radius.)

Electric Displacement Density. Electric Flux Density.

Electric Field. A state of the medium in which stationary electrified bodies are subject to forces by virtue of their electrifications.

Electric Field Strength. The magnitude of the electric field vector (Note—This term is sometimes called the electric field intensity, but such use of the word intensity is deprecated in favor of field strength, since intensity connotes power in optics and radiation.)

Electric Field Vector. At a point in an electric field, the force on a stationary positive charge per unit charge. (Note—This may be measured either in newtons per coulomb or in volts per meter. This term is sometimes called the *electric field intensity* but such use of the word intensity is deprecated in favor of field strength since intensity connotes power in optics and radiation.)

Electric Flux Density. At a point, the vector whose magnitude is equal to the charge per unit area which would appear on one face of a thin metal plate introduced in the electric field at the point and so oriented that this charge is a maximum. The vector is normal to the plate from the negative to the positive face. (Note—The term *electric displacement density* or *electric displacement* is also in use for this term.)

Electric Vector. See: Electric Field Vector.

Electrical Length. The physical length expressed in wavelengths, radians or degrees.

Electromagnetic Wave. A wave characterized by variations of electric and magnetic fields. (Note—Electromagnetic waves are known as radio waves, heat waves, light waves, etc., depending on the frequency.)

Elliptically Polarized Wave. An electromagnetic wave for which the electric and/or the magnetic field vector at a point describes an ellipse.

Envelope Delay. The time of propagation, between two points, of the envelope of a wave. It is equal to the rate of change with angular frequency of the difference in phase between these two points. It has significance over the band of frequencies occupied by the wave only if this rate is approximately constant over that band.

Equiphase Surface. Any surface in a wave over which the field vectors at the same instant are in the same phase or 180° out of phase.

Extraordinary-Wave Component. The magneto-ionic wave component in which the electric vector rotates in the opposite sense to that for the ordinary-wave component. (See: Ordinary-Wave Component.)

F Region. The region of the ionosphere above the E region.

F₁ Layer. The lower of the two ionized layers normally existing in the F region in the day hemisphere.

F₂ Layer. The single ionized layer normally existing in the F region in the night hemisphere and the higher of the two layers normally existing in the F region in the day hemisphere.

Fading. The variation of radio field strength caused by changes in the transmission medium with time.

Ground Wave. A radio wave that is propagated over the earth and is ordinarily affected by the presence of the ground and the troposphere. The ground wave includes all components of a radio wave over the earth except ionospheric and tropospheric waves. (Note—The ground wave is refracted because of variations in the dielectric constant of the troposphere including the condition known as a surface duct.)

Group Velocity. Of a traveling plane wave, the velocity of propagation of the envelope of a wave occupying a frequency band over which the envelope delay is approximately constant. It is equal to the reciprocal of the rate of change of phase constant with angular frequency. (Note—Group velocity differs from phase velocity in a medium in which the phase velocity varies with frequency.)

Guided Wave. A wave whose energy is concentrated near a boundary, or between substantially parallel boundaries, separating materials of different properties, and whose direction of propagation is effectively parallel to these boundaries.

Horizontally Polarized Wave. A linearly polarized wave whose electric field vector is horizontal.

Incident Wave. In a medium of certain propagation characteristics, a wave which impinges on a discontinuity or a medium of different propagation characteristics.

Incoherent Scattering. When radio waves encounter matter, a disordered change in the direction of propagation of the waves.

Ionosphere. The part of the earth's outer atmosphere where ions and electrons are present in quantities sufficient to affect the propagation of radio waves. (Note—According to current opinion, the lowest level is approximately 50 kilometers above the earth's surface.)

Ionospheric Wave. A radio wave that is propagated by way of the ionosphere. (Note—This is sometimes called a *sky wave*.)

Left-Handed (Counter Clockwise) Polarized Wave. An elliptically polarized transverse electromagnetic wave in which the rotation of the electric field vector is counter clockwise for an observer looking in the direction of propagation.

Linearly Polarized Wave. At a point in a homogeneous, isotropic medium, a transverse electromagnetic wave whose electric field vector at all times lies along a fixed line.

Lowest Useful High Frequency. The lowest high frequency effective at a specified time for ionospheric propagation of radio waves between two specified points. (Note—This is determined by factors such as absorption, transmitter power, antenna gain, receiver characteristics, type of service, and noise conditions.)

Magnetic Field. A state of the medium in which moving electrified bodies are subject to forces by virtue of both their electrifications and motion.

Magneto-Ionic Wave Component. Either of the two elliptically polarized wave components into which a linearly polarized wave incident on the ionosphere is separated because of the earth's magnetic field.

Maximum Usable Frequency. The upper limit of the frequencies that can be used at a specified time for radio transmission between two points and involving propagation by reflection from the regular ionized layers of the ionosphere. (Note—Higher frequencies may be transmitted by sporadic and scattered reflections.)

Modified Index of Refraction. In the troposphere, the index of refraction at any height increased by h/a , where h is the height above sea level and a is the mean geometrical radius of the earth. When the index of refraction in the troposphere is horizontally stratified, propagation over a hypothetical flat earth through an atmosphere with the modified index of refraction is substantially equivalent to propagation over a curved earth through the real atmosphere.

O Wave. Ordinary-Wave Component.

Optimum Working Frequency. The most effective frequency at a specified time for ionospheric propagation of radio waves between two specified points. (Note—In predictions of useful frequencies the optimum working frequency is commonly taken as 15 per cent below the monthly median value of the maximum usable frequency, for the specified time and path.)

Ordinary-Wave Component. That magneto-ionic wave component deviating the least, in most of its propagation characteristics, relative to those expected for a wave in the absence of the earth's magnetic field. More exactly, if at fixed electron density, the direction of the earth's magnetic field were rotated until its direction is transverse to the direction of phase propagation, the wave component whose propagation is then independent of the magnitude of the earth's magnetic field.

Penetration Frequency. *See:* Critical Frequency.

Periodic Electromagnetic Wave. A wave in which the electric field vector is repeated in detail in either of two ways: (1) At a fixed point, after the lapse of a time known as the period, (2) At a fixed time, after the addition of a distance known as the wavelength.

Phase Constant. For a traveling plane wave at a given frequency, the rate of linear increase of phase lag of a field component (for the voltage or current) in the direction of propagation, in radians per unit length.

Phase-Propagation Ratio. The propagation ratio divided by its magnitude.

Phase Velocity. Of a traveling plane wave at a single frequency, the velocity of an equiphase surface along the wave normal.

Plane Earth Factor. The ratio of the electric field strength that would result from propagation over an imperfectly conducting plane earth to that which would result from propagation over a perfectly conducting plane.

Plane of Polarization. For a plane polarized wave, the plane containing the electric field vector and the direction of propagation.

Plane Polarized Wave. At a point in a homogeneous isotropic medium, an electromagnetic wave whose electric field vector at all times lies in a fixed plane which contains the direction of propagation.

Plane Wave. A wave whose equiphase surfaces form a family of parallel planes.

Propagation Constant. For a traveling plane wave at a given frequency, the complex quantity whose real part is the attenuation constant in nepers per unit length and whose imaginary part is the phase constant in radians per unit length.

Propagation Factor. *See:* Propagation Ratio.

Propagation Ratio. For a wave propagating from one point to another, the ratio of the complex electric field strength at the second point to that at the first point.

Radio Field Strength. The electric or magnetic field strength at a given location resulting from the passage of radio waves. In the case of a sinusoidal wave, the root-mean-square value is commonly used. Unless otherwise stated, it is taken in the direction of maximum.

Radio Frequency. A frequency at which coherent electromagnetic radiation of energy is useful for communication purposes.

Radio Horizon. The locus of points at which direct rays from the transmitter become tangential to the earth's surface. (Note—On a spherical surface the horizon is a circle. The distance to the horizon is affected by atmospheric refraction.)

Radio Wave Propagation. The transfer of energy by electromagnetic radiation at frequencies lower than about 3×10^{12} cycles per second.

Refracted Wave. That part of an incident wave which travels from one medium into a second medium.

Refractive Index. Of a wave transmission medium, the ratio of the phase velocity in free space to that in the medium.

Refractive Modulus. In the troposphere, the excess over unity of the modified index of refraction, expressed in millionths. It is represented by M and is given by the equation

$$M = (n + h/a - 1)10^6,$$

where n is the index of refraction at a height h above sea level, and a is the radius of the earth.

Relative Refractive Index. Of two media, the ratio of their refractive indices.

Right-Handed (Clockwise) Polarized Wave. An elliptically polarized transverse electromagnetic wave in which the rotation of the electric field vector is clockwise for an observer looking in the direction of propagation.

Selective Fading. Fading which is different at different frequencies in a frequency band occupied by a modulated wave.

Shadow Factor. The ratio of the electric field strength which would result from propagation over a sphere to that which would result from propagation over a plane, other factors being the same.

Sinusoidal Electromagnetic Wave. In a homogeneous medium a wave whose electric field strength is proportional to the sine (or cosine) of an angle that is a linear function of time, or a distance, or of both.

Sky Wave. *See:* Ionospheric Wave.

Spherical-Earth Factor. The ratio of the electric field strength that would result from propagation over an imperfectly conducting spherical earth to that which would result from propagation over a perfectly conducting plane.

Spherical Wave. A wave whose equiphase surfaces form a family of concentric spheres.

Standard Propagation. The propagation of radio waves over a smooth spherical earth of uniform dielectric constant and conductivity, under conditions of standard refraction in the atmosphere.

Standard Refraction. The refraction which would occur in an idealized atmosphere in which the index of refraction decreases uniformly with height at the rate of 39×10^{-6} per kilometer. (Note—*Standard refraction* may be included in ground wave calculations by use of an effec-

tive earth radius of 8.5×10^6 meters, or $4/3$ the geometrical radius of the earth.)

Standing Wave. A wave in which, for any component of the field, the ratio of its instantaneous value at one point to that at any other point does not vary with time.

Surface Duct. An atmospheric duct for which the lower boundary is the surface of the earth.

Tangential Wave Path. In radio wave propagation over the earth, a path of propagation of a direct wave, which is tangential to the surface of the earth. The tangential wave path is curved by atmospheric refraction.

Transmitted Wave. *See:* Refracted Wave.

Transverse Electric Wave. In a homogeneous isotropic medium, an electromagnetic wave in which the electric field vector is everywhere perpendicular to the direction of propagation. (Note—This is abbreviated “*TE Wave*”.)

Transverse Electromagnetic Wave. In a homogeneous isotropic medium, an electromagnetic wave in which both the electric and magnetic field vectors are everywhere perpendicular to the direction of propagation. (Note—This is abbreviated “*TEM Wave*”.)

Transverse Magnetic Wave. In a homogeneous isotropic medium, an electromagnetic wave in which the magnetic field vector is everywhere perpendicular to the direction of propagation. (Note—This is abbreviated “*TM Wave*”.)

Traveling Plane Wave. A plane wave each of whose frequency components has an exponential variation of amplitude and a linear variation of phase in the direction of propagation.

Troposphere. That part of the earth's atmosphere in which temperature generally decreases with altitude, clouds form, and convection is active. (Note—Experiments indicate that the troposphere occupies the space above the earth's surface to a height of about 10 kilometers.)

Tropospheric Wave. A radio wave that is propagated by reflection from a place of abrupt change in the dielectric constant or its gradient in the troposphere.

(Note—In some cases the ground wave may be so altered that new components appear to arise from reflections in regions of rapidly changing dielectric constants; when these components are distinguishable from the other components, they are called tropospheric waves.)

Uniform Plane Wave. A plane wave in which the electric and magnetic field vectors have constant amplitude over the equiphase surfaces. (Note—Such a wave can only be found in free space at an infinite distance from the source.)

Vertically Polarized Wave. A linearly polarized wave whose magnetic field vector is horizontal.

Virtual Height. The apparent height of an ionized layer determined from the time interval between the transmitted signal and the ionospheric echo at vertical incidence, assuming that the velocity of propagation is the velocity of light in a vacuum over the entire path.

Wave. A physical activity in a medium such that at any point in the medium some of the associated quantities vary with time, while at any instant of time, they vary with position.

Waveguide. A system of material boundaries capable of guiding waves.

Wave Interference. The variation of wave amplitude with distance or time, caused by the superposition of two or more waves. (Note—As most commonly used, the term refers to the interference of waves of the same or nearly the same frequency.)

Wavelength. In a periodic wave, the distance between points of corresponding phase of two consecutive cycles. The wavelength λ is related to the phase velocity, v , and the frequency, f , by $\lambda = v/f$.

Wave Normal. A unit vector normal to an equiphase surface with its positive direction taken on the same side of the surface as the direction of propagation. In isotropic media, the wave normal is in the direction of propagation.

X Wave. *See:* Extraordinary-Wave Component.

Quality Rating of Television Images*

PIERRE MERTZ†, FELLOW, IRE, A. D. FOWLER†, AND H. N. CHRISTOPHER†

Summary—Two methods of evaluating impairments in television images are described. Both employ observers and, therefore, yield subjective evaluations. The first is an extension of Baldwin's in which observers vote a preference between pictures with different impairments; one of the pictures is optically projected somewhat out of focus and is used as a reference. In the second method, the impairment is rated by observers in terms of pre-worded comments which are numbered and form a rating scale. Both methods permit an evaluation in terms of liminal increments as computed from the distribution of votes of the observers. These methods have been used to evaluate the impairing effects of echoes and noise in television pictures, and also to relate picture sharpness to other quality parameters.

INTRODUCTION

TELEVISION images are subject to various degrees of impairment from any one or more of numerous causes broadly classified as distortion or interference. Regardless of the source of the distortion or interference, whether in the camera chain, the transmission path, or in the receiver, the impairing effect on the final image is only as slight or as serious as the viewer judges it to be. Impairment is, therefore, a subjective quantity and is measurable in terms of the reaction of observers. For engineering purposes, it is desirable that evaluations by observers be expressed in numbers which apply equally well to all kinds of impairments, and which serve as a scale of quality of television images.

This paper reports the results of experiments in which observers were used to evaluate the quality of pictures. Two techniques, a comparison and a direct method, were used to determine the impairing effects of noise and echoes in television images. The comparison method was also used to obtain some rough estimates of the relative importance of sharpness, contrast, and brightness in determining the quality of pictures.

I. RECAPITULATION

Two methods of rating impairments of pictures were investigated. The first method establishes the equivalence of a pair of pictures having different impairments. For example, one picture, a lantern slide projection, is defocused until its quality, in the judgment of observers, equals that of another impaired picture of the same subject. The second method makes use of pre-worded comments in terms of which observers rate various impairments.

The ratings obtained by these two methods can be expressed in three ways: (1) in terms of the defocusing of the reference picture, as determined directly from

the first method; (2) in terms of pre-worded comments, as determined directly from the second method; and (3) in terms of liminal units, as derived from the distribution of votes in either method. (One liminal unit indicates a 75 per cent vote preference for one picture condition over another.)

The ratings obtained by the two methods can be compared. The data show that the two methods agree reasonably well.

As part of this investigation, data were gathered on the impairment to television pictures caused by single echoes and noise. These data, which are summarized in this paper, have already been found useful in the study of transmission requirements and tolerances.

Initial data are also presented on the relative importance of sharpness, contrast ratio, and highlight brightness as parameters of the quality of pictures.

A calibration of the defocused projections used in the comparison method was made in terms of resolvable test lines and equivalent television bandwidth. The results of this supplementary study are given in the Appendix.

II. COMPARISON TECHNIQUE

In this procedure, observers were asked to indicate their preference for one of a pair of pictures derived from duplicate lantern slides and viewed side by side as illustrated in Fig. 1. One of the pictures (a) was a tele-

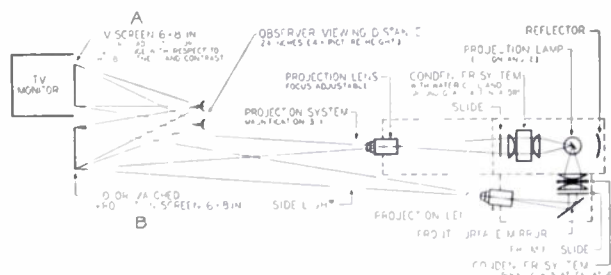

Fig. 1—Arrangement of apparatus for comparison tests.

vision image with controlled amounts of echo. The other picture (b) was optically projected with controlled amounts of defocusing. In all other respects, including size, contrast, brightness, and color temperature, the two pictures were made as nearly identical as practicable. The projection optics are similar in principle to those described by Baldwin.¹ In order to match contrast, an adjustable fraction of the light from the side of the projection lamp was directed, by reflection, approximately uniformly over the area of the screen.

* Decimal classification: R583.11. Original manuscript received by the Institute, August 17, 1950. Presented, 1950 National IRE Convention, New York, N. Y., March 8, 1950.

† Bell Telephone Laboratories, Inc., New York, N. Y.

¹ M. W. Baldwin, Jr., "The subjective sharpness of simulated television images," *Bell Sys. Tech. Jour.*, vol. 19, pp. 563-587; October, 1940.

By this procedure the impairing effect of a known amount of echo in a television picture is compared to that of a sharpness degradation in the projected picture. An illustration of such data is given in Fig. 2. The

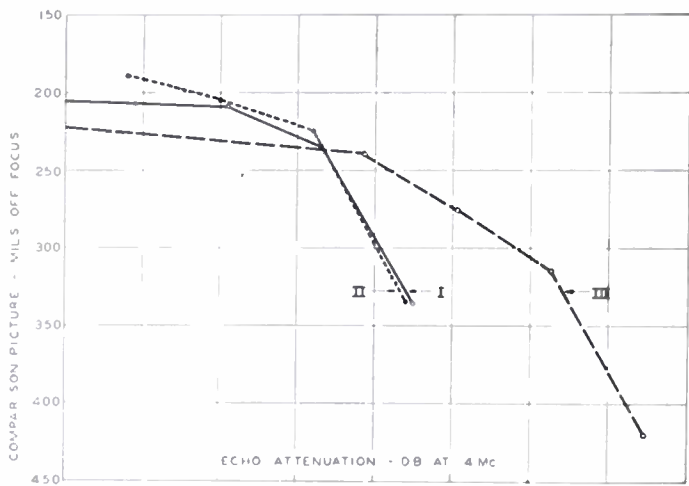

Fig. 2—Measure of echo impairment by defocusing of comparison picture, "Teacup Lady" slide. I—Undistorted echo, delayed 2 microseconds. II—Undistorted echo, delayed 12 microseconds. III—"Partially differentiated" echo, delayed 2 microseconds.

points plotted are those for which 50 per cent of the observations favored the television picture with its echo, and 50 per cent favored the optical picture out of focus by the amount indicated. The abscissae, "Echo Attenuation—DB," denote the number of decibels by which the 4-Mc picture signal intensity from the echo path was lower than the picture signal intensity from the main transmission path. The attenuation frequency distortions in the echo path for the indicated test conditions are shown in Fig. 3. The ordinates of Fig. 2 de-

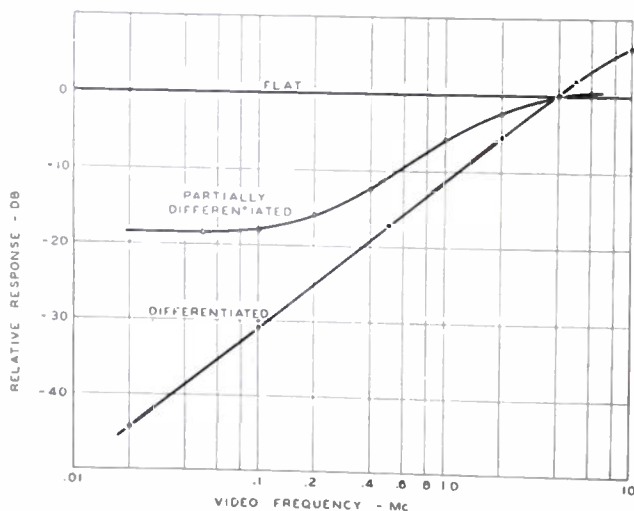

Fig. 3—Attenuation-frequency distortion of echoes used.

note the distance in thousandths of an inch, or mils, by which the projection lens was off focus, and indicate the degradation in sharpness of the projected picture.

Data were obtained for both "positive" and "nega-

tive" echoes. Positive echoes are such that a white picture feature leads to a white echo, and a black picture feature to a black echo. Negative echoes are the reverse. The data for positive and negative echoes show no marked differences, and, therefore, have been pooled in all of the experiments described here.

By analyzing the distribution of the vote resulting in the median curves of Fig. 2, it is possible to evaluate how much the preference amounts to for any given comparison. This follows a method used by the psychologists and applied by Baldwin¹ to measure the subjective appreciation of sharpness in pictures. It can also be used as the basis of a system of rating picture quality.

The vote analysis, in brief, consists merely of setting as one "limen" the difference between two pictures where 75 per cent of the observers prefer the one to the other. The vote distribution is found in practice to follow approximately the normal error law, so that the difference becomes two limens where the preference vote is about 91.1 per cent, and three limens where it is about 97.8 per cent. The difference in quality between two pictures of a pair in this system of rating is measured by the number of "liminal units" computed from the preference vote.

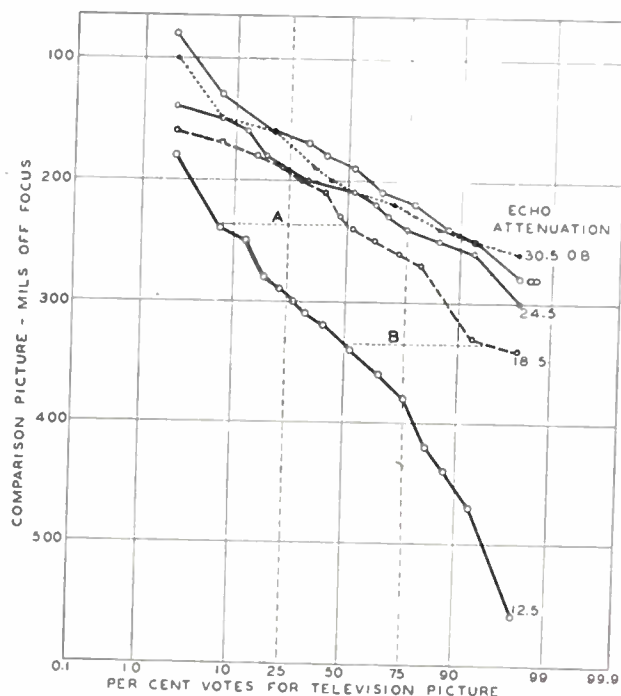

Fig. 4—Distribution of preferences between television and comparison pictures—Case I of Fig. 2.

The distributions of votes from which the median points were taken for curve I in Fig. 2 are shown in Fig. 4. Each curve in Fig. 4 represents the distribution for a given attenuation of echo with respect to the main picture. This plot is used to compute the differences in liminal unit rating between two television pictures having differing echo amplitudes. At A, television pictures with echoes respectively 12.5 and 18.5 db down were

both compared with projected pictures 235 mils off focus. The preference vote in the first case was 7 per cent, and in the second case 50 per cent. Assuming a normal law, this gives a difference of 2.2 liminal units. The same television pictures were both compared at *B* with projected pictures 334 mils off focus, with preference votes respectively of 50 and 95 per cent, giving a difference of 2.47 liminal units. An average difference of $2\frac{1}{3}$ liminal units is therefore deduced between the impairment for an echo 12.5 db down and one 18.5 db down.

When the difference in impairment is large, e.g., between an unimpaired picture (infinite attenuation of echo) and one impaired by an echo only 12.5 db below the main picture, it is preferable to take the sum of the successive differences between intermediate impairments, rather than the total difference in a single step. This was done using the distribution curves of Fig. 4 for both increasing and decreasing impairments, as outlined in the previous paragraph. The resulting two sets of values of liminal units are plotted as small circles in Fig. 5. The averages of the two sets of values are repre-

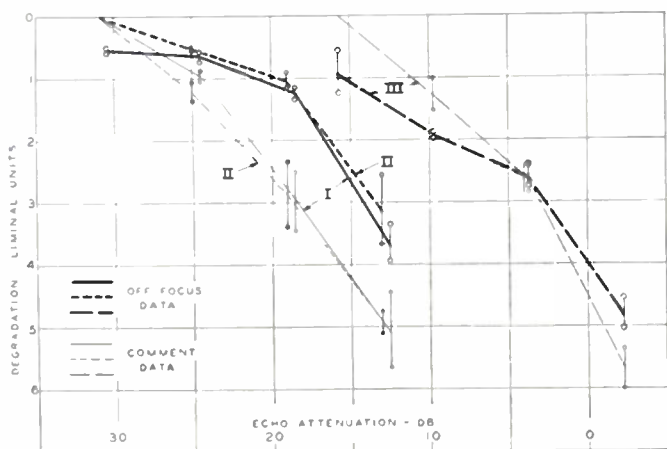

Fig. 5—Measure of echo impairment in liminal units. Data of Figs. 2 and 6.

sented by the heavy solid line (curve I). Similarly, the results for the other echo conditions are shown as heavy curves (II and III) in the same figure.

III. COMMENT TECHNIQUE

The second technique which has been explored was also derived from the psychologists, though some changes (which will be discussed below) have been made for its application here. It consists in presenting to the observer a picture affected by differing and controlled amounts of the given impairment, in irregular sequence. The observer is given a list of comments, and asked to specify which comment most nearly characterizes his judgment regarding the impairment to the picture. The comments which have been used are

1. Not perceptible
2. Just perceptible
3. Definitely perceptible, but only slight impairment to picture

4. Impairment to picture but not objectionable
5. Somewhat objectionable
6. Definitely objectionable
7. Not usable.

This technique has been applied to rating the seriousness of the effect of a greater variety of impairments than the first, or comparison technique. To permit of a ready comparison between the two techniques, there will first be described the results of a series of experiments performed at the same time, and on the same impairments, as those used to illustrate the first technique. These results, for the same three echo cases as before, are plotted as a set of curves in Fig. 6. The curves, as before, represent median results. A typical distribution for Case I (paralleling that for mils off focus of Fig. 4) is shown in Fig. 7. From this distribution it is also possible to evaluate the ratings in liminal units, exactly as was done for Fig. 4. This was carried out for the three

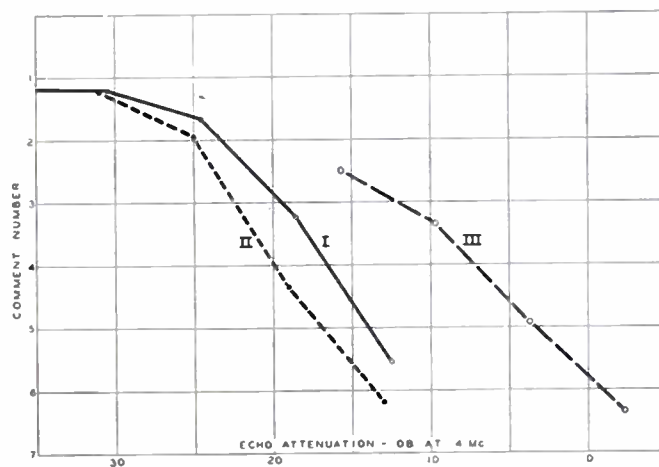

Fig. 6—Measure of echo impairment by comment number. Same subject matter as Fig. 2.

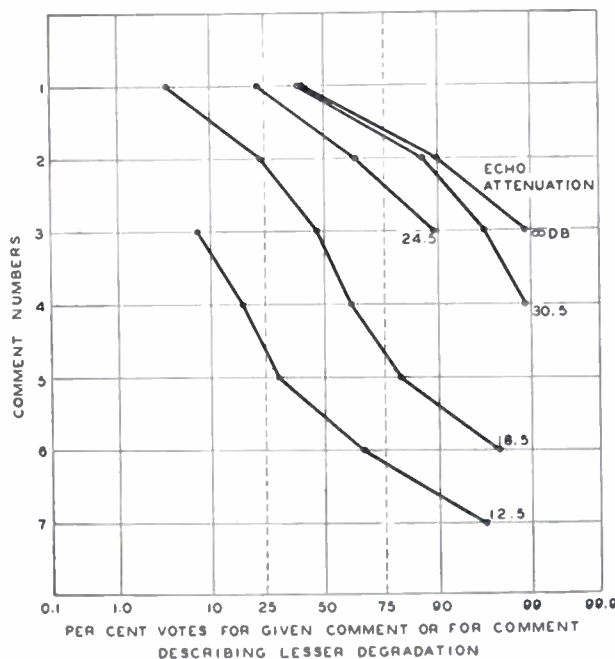

Fig. 7—Distribution of comment votes—Case I of Fig. 6.

cases, and the cumulative impairments obtained thereby have been plotted as the fine lines in Fig. 5. The comparison between the ratings determined by these various procedures will be discussed in the next section.

In addition to the above, a considerable number of other data were taken on different subject material. The data on five motion picture film subjects have been consolidated, and are depicted in a somewhat different manner in Fig. 8. The co-ordinates here are like those of Fig. 6, but the points shown represent the original observations, without any averaging or other processing. The area of each point, as designated in the legend, is used to indicate the number of individual multiplicate observations falling at the same location.

If the observations are cumulated, from those indicating the minimum perception of degradation to those indicating the maximum perception of degradation, a solid figure is built upon the co-ordinates of Fig. 8. A perspective sketch of the nature of this solid figure when smoothed, is shown in Fig. 9. Contour lines are dotted in to indicate various cumulated proportions of observations in the progression from lenient to exacting demands.

In the process of smoothing the data of Fig. 8 auxiliary plots are made, shown in Figs. 10 and 11. These,

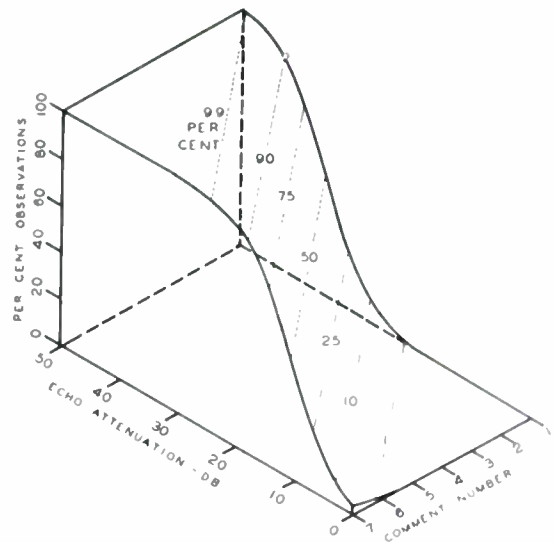

Fig. 9—Three-dimensional schematic plot of array of Fig. 8.

when individually smoothed, can then be conceived of as sections of Fig. 9 parallel to the comment number axis or to the echo attenuation axis. The first are shown in Fig. 10 and the second in Fig. 11. The common experience is that averaging by either set of sections alone leads to lines of regression, which are in general different

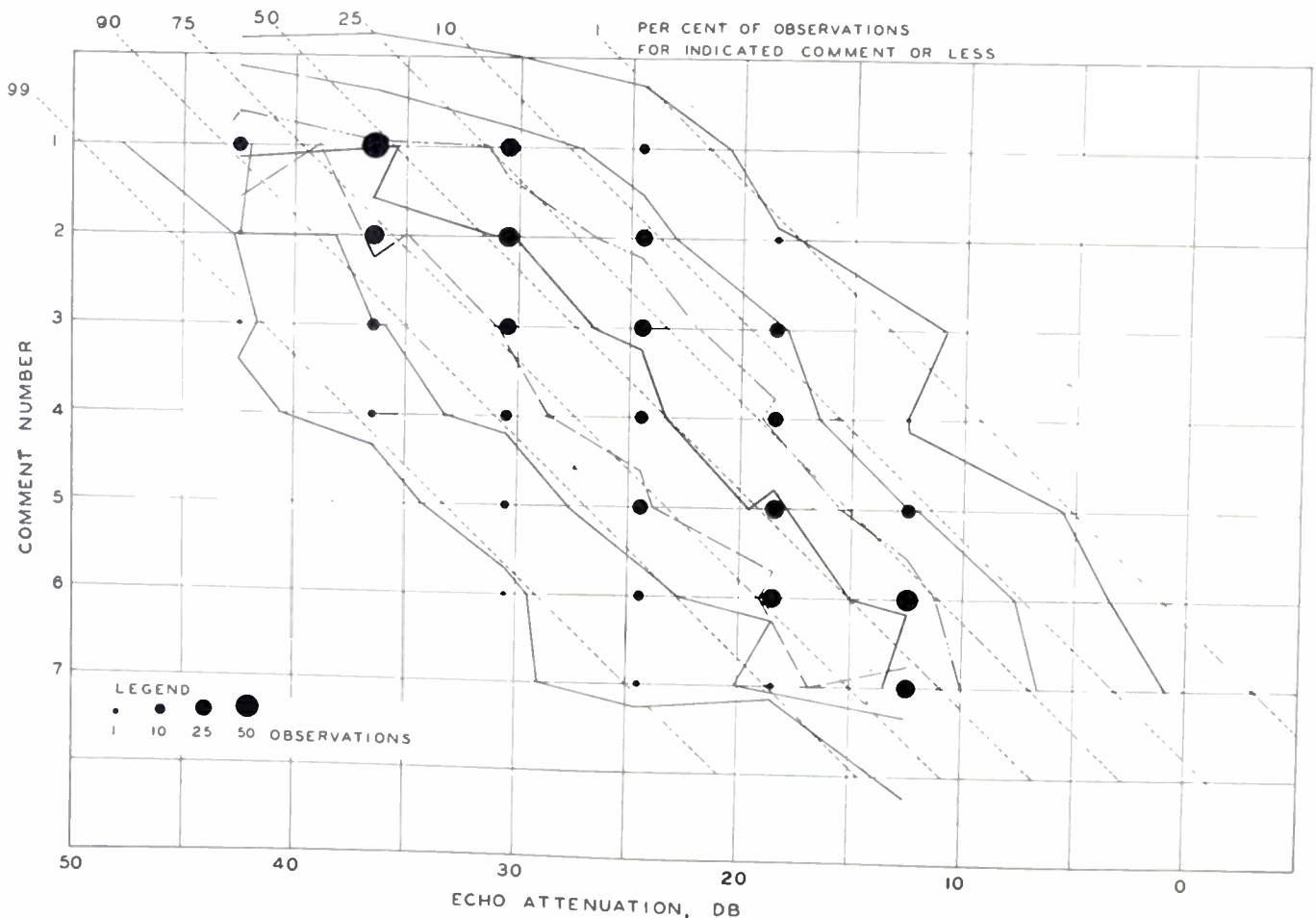

Fig. 8—Array of comment observations. Pool of 5 film subjects listed in Fig. 12. Undistorted echo delayed 2 microseconds.

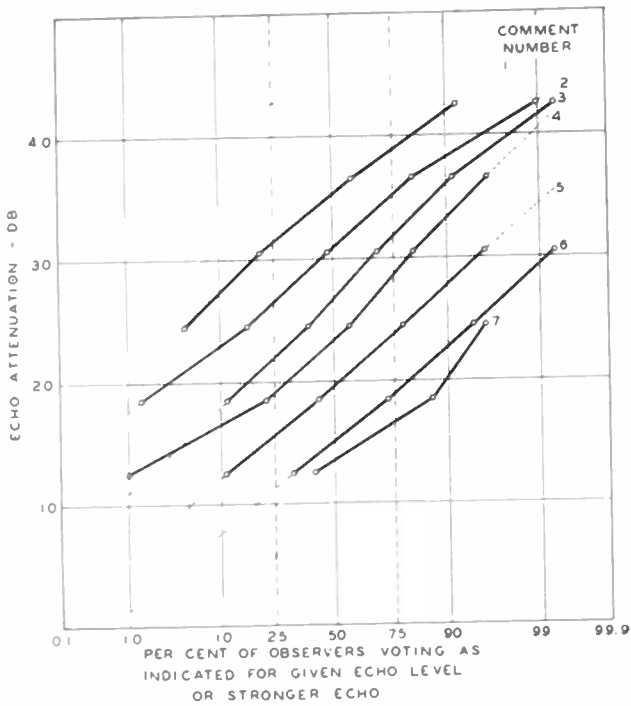

Fig. 10—Cross section of array of Fig. 8 at comment number contours.

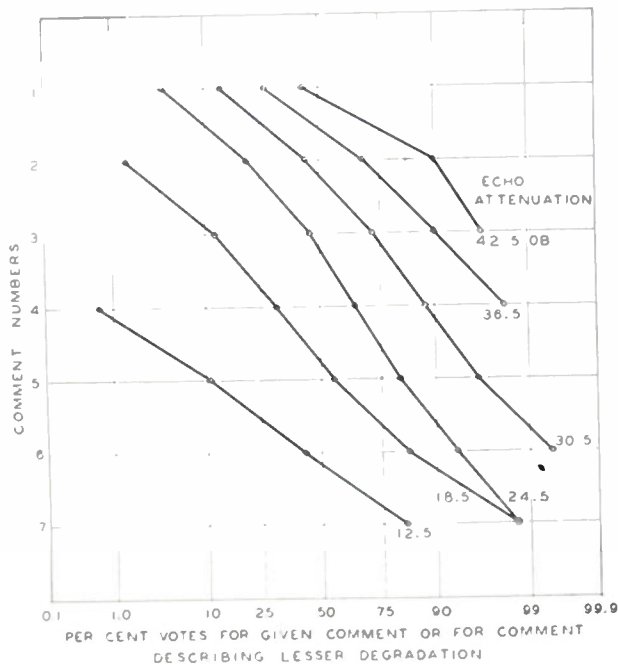

Fig. 11—Cross section of array of Fig. 8 at echo level contours.

for the two.² To avoid a bias it is therefore desirable to smooth in both ways and use both sets of results in plotting the final curve. This has been done in plotting the broken lines in Fig. 8, which indicate the contour lines corresponding to the various cumulated percentages of observations. These broken curves are not reliable, of course, near the extreme ends of the comment number scale, because no better comment rating

² H. L. Rietz, "Handbook of Mathematical Statistics," p. 126, Houghton Mifflin Company, New York, N. Y.; 1924.

can be given than "not perceptible," and none was supplied worse than "not usable." The dotted lines in Fig. 8 have then been drawn in as expressing about the best trend of the broken lines, except near the ends of the comment number scale. These represent the projections upon the horizontal plane (comment number versus echo attenuation) of the corresponding dotted contour line, of Fig. 9.

As stated above, the data of Figs. 8, 10, and 11 are taken from consolidated tests on five motion pictures. The smoothed 50 per cent curves for the individual film subjects (whose general nature is indicated by the captions) are shown in Fig. 12, and there compared with

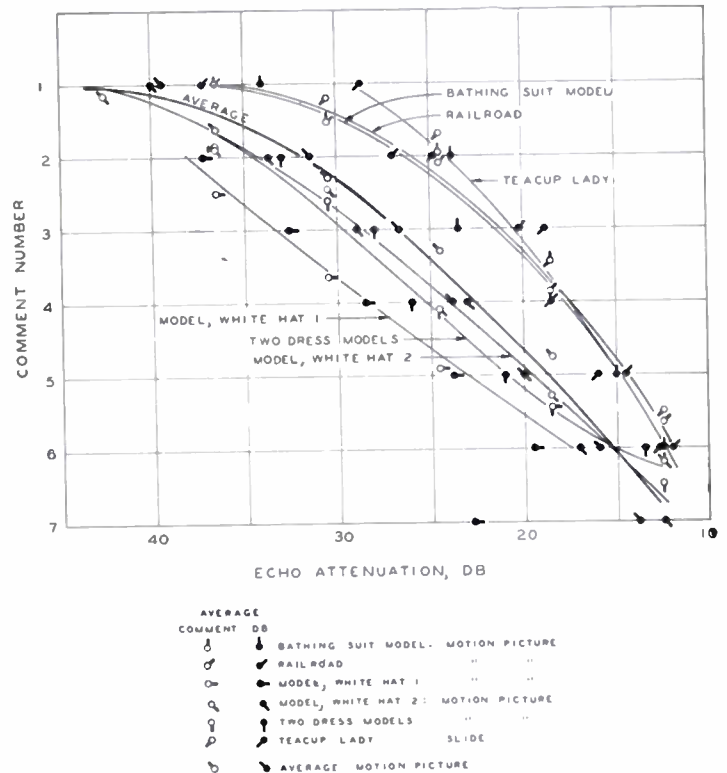

Fig. 12—Median distributions of individual subjects and average of Fig. 8, compared with same for "Teacup Lady" slide. Undistorted echo delayed 2 microseconds from cross-sectional plots like Figs. 10 and 11.

the curve for the "Teacup Lady" lantern slide subject which was plotted as curve I in Fig. 6. It will be noted from Fig. 12 that there is a range of over 10 db in the susceptibilities of the various subjects to echo, for a given rating of impairment, and that this range is somewhat greater for slight than for serious impairments. The consolidated (or "average") curve is not far from the center of the range, i.e., about 5 db more lenient than for the most susceptible picture. It is also to be observed that the "Teacup Lady" slide, which was used for the common data to compare the two broad procedures, turns out to be a subject which is about the least susceptible to echo impairment of the whole group. The curves are shown here as curves and not as their best straight-line approximations, as was done in Fig. 8.

Data, similar to that of Figs. 8 and 12, have also been obtained for an undistorted echo delayed 12 microseconds, and are shown in Figs. 13 and 14. In Fig. 13 it is observed that the impairment rating follows the same course as in Fig. 8, but that echo amplitudes for the same rating are about 5 db lower (more severe judgment). This is shown again in the comparison between Figs. 14 and 12, where it is also seen that the spread between picture subjects is larger (namely, about 15 db) than for the echoes delayed 2 microseconds.

Data on additional types of echoes were taken for two subject pictures, and are illustrated in Figs. 15 and 16, respectively. The first is with the "Teacup Lady" lantern slide subject used for Fig. 6, and the second with one of the more sensitive film subjects of Figs. 12 and 14 ("Model with White Hat 2").

As was the case with the echoes discussed in connection with Fig. 2, the distortion of the echo picture corresponds to the transmission of its signal through a path having one or the other of the attenuation characteristics illustrated in Fig. 3. The "differentiated" echo is one equivalent to passing the signal through a path having a response rising with frequency at the rate of 6 db per octave over the major part of the transmitted band. For "partial differentiation" the rise is somewhat less fast than this, and not uniform.

It is to be observed from Figs. 15 and 16, first, that the impairing effect of the undistorted ("flat") echo increases with its delay (as has already been noted);

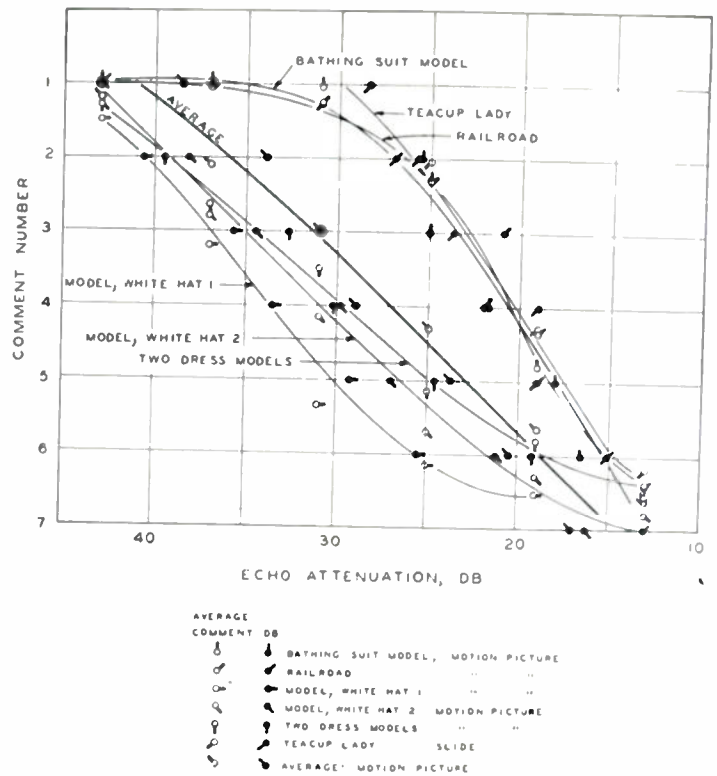

Fig. 14—Median distributions of individual subjects and average of Fig. 13, compared with same for "Teacup Lady" slide. Undistorted echo delayed 12 microseconds. From cross-sectional plots like Figs. 10 and 11.

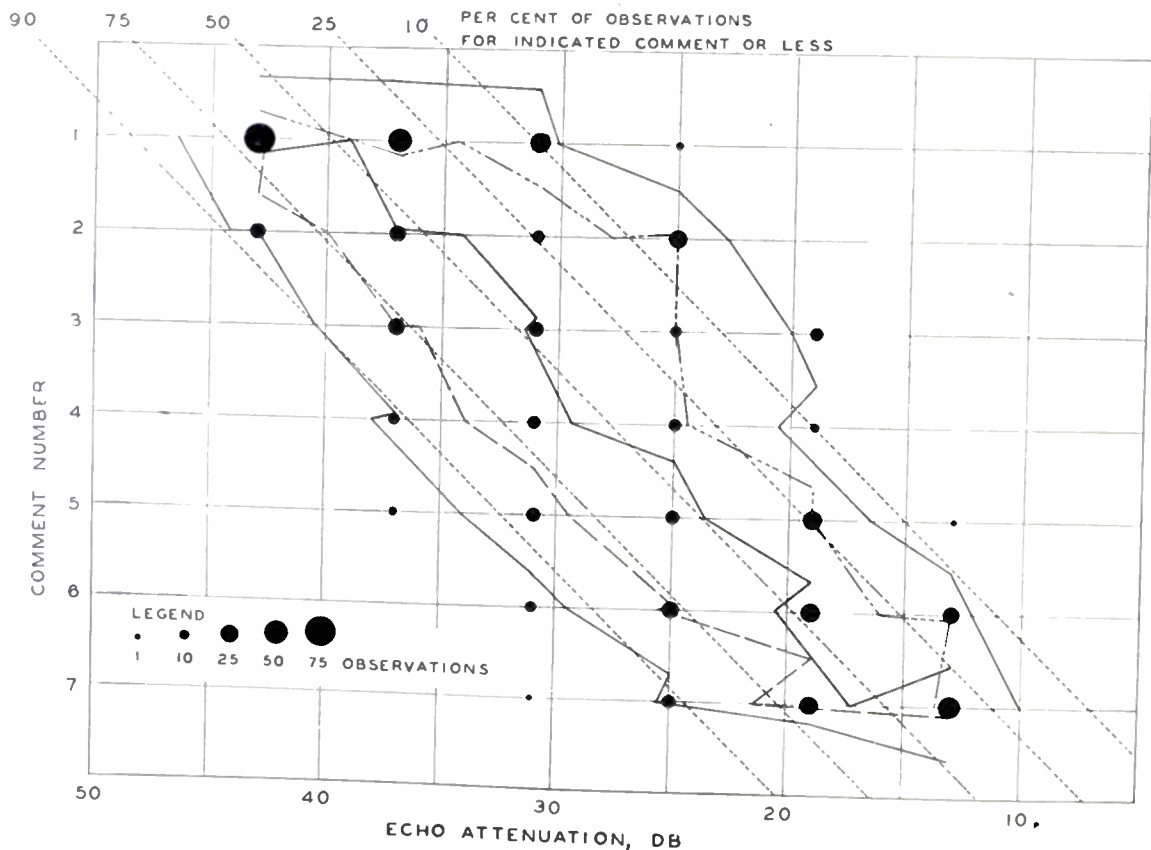

Fig. 13—Array of comment observations. Pool of 5 film subjects listed in Fig. 14. Undistorted echo delayed 12 microseconds.

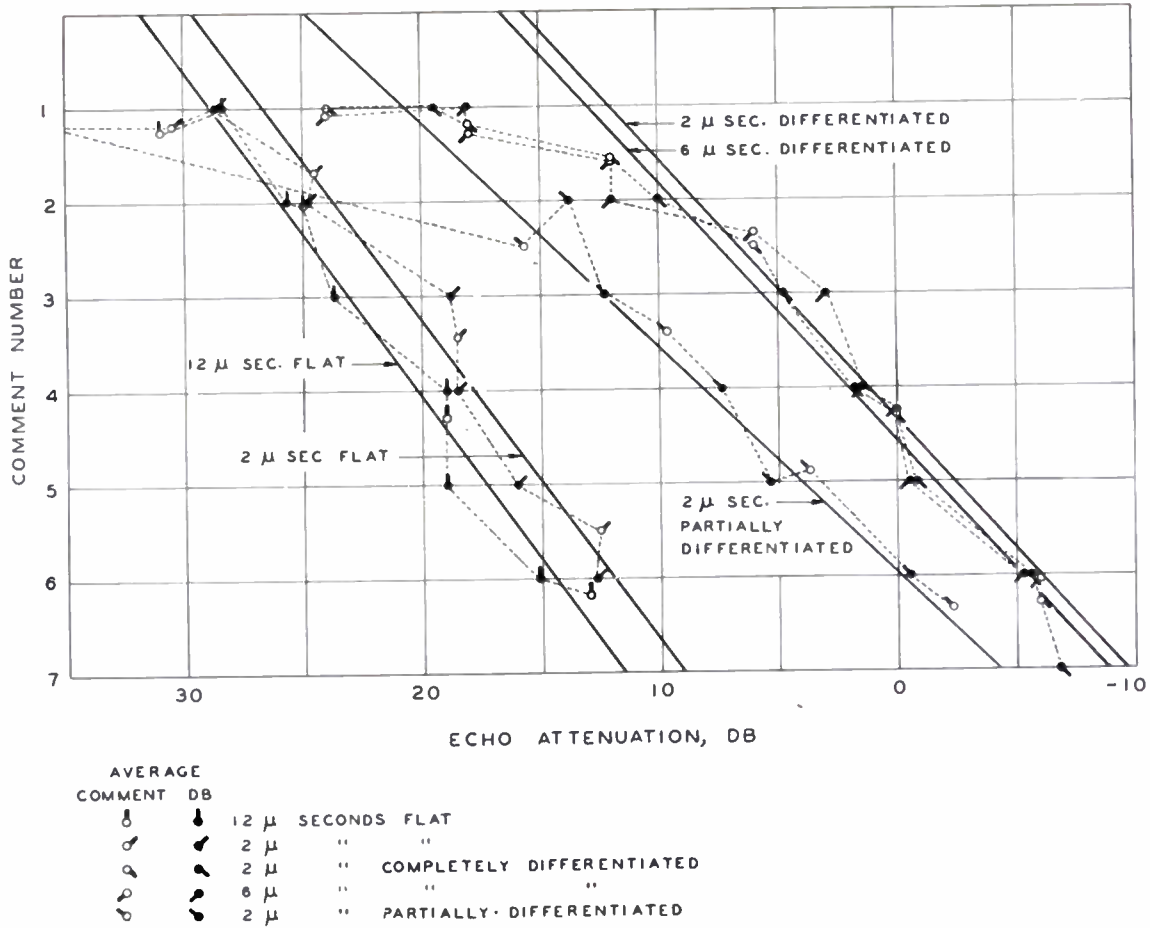

Fig. 15—Median distributions on "Teacup Lady" slide, variety of echoes as shown, from cross-sectional plots like Figs. 10 and 11.

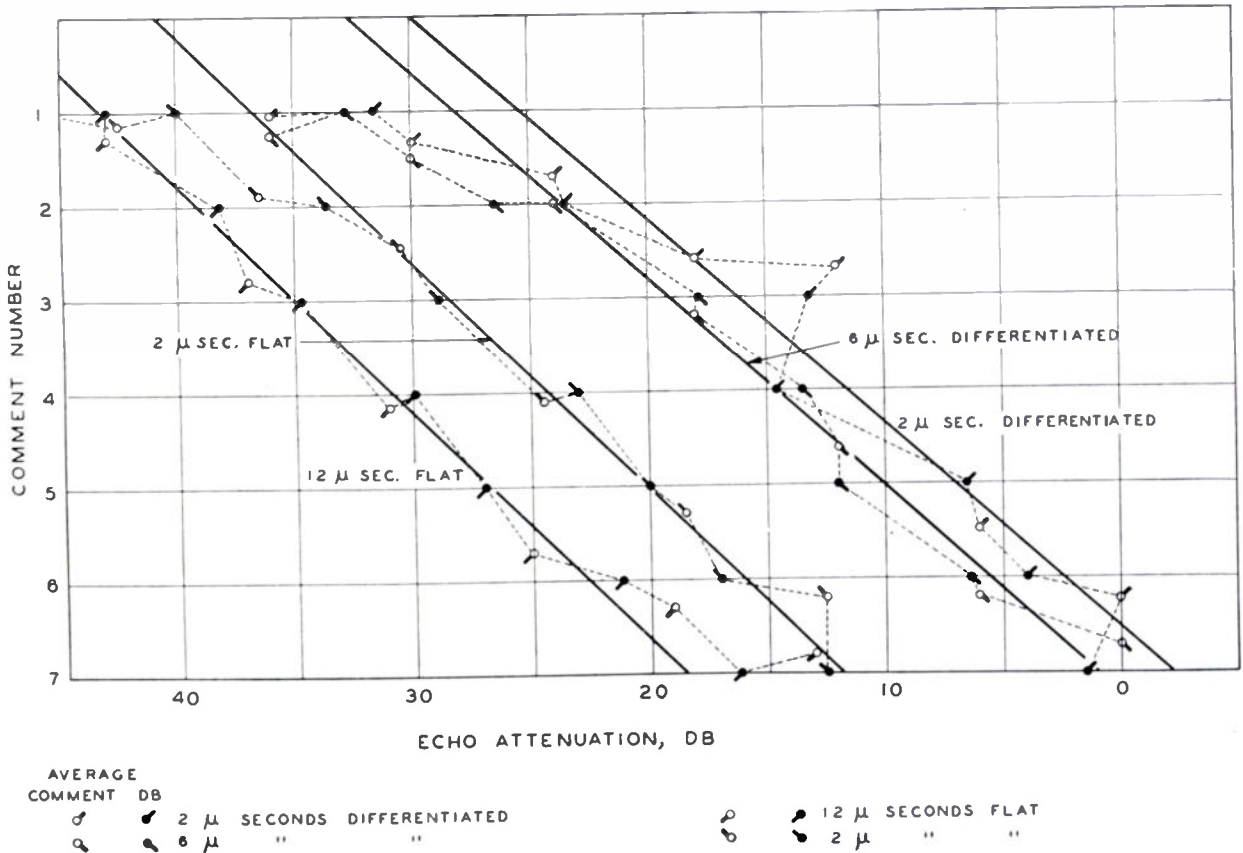

Fig. 16—Median distributions on "Model with White Hat, series 2" film, variety of echoes as shown, from cross-sectional plots like Figs. 10 and 11.

second, that distorting the echo reduces the impairing effect (by some 15 to 20 db for "differentiation," and somewhat less than this for "partial differentiation"); and third, that the effect of differences in delay is less clear for the distorted echoes.

For engineering use of the data, given for example in Fig. 8, it is preferable to simplify this plot and present it on "probability" paper instead of drawing in the normal distribution scale. For that purpose Fig. 8 would be converted to the plot of Fig. 17.

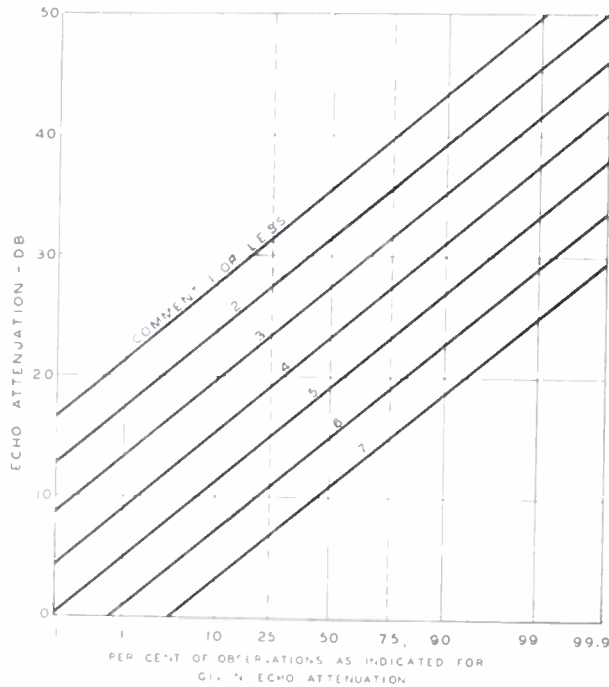

Fig. 17—Characterization of 2-microsecond delayed echoes on pool of 5 film subjects. Processed data of Fig. 8 presented for engineering use.

The technique making use of pre-worded comments has also been applied to rating pictures impaired by random noise having a particular power frequency distribution. The distribution studied is one which is expected in some hypothetical coaxial cable system designs, and is plotted as "unweighted noise" in Fig. 18. The scale of ordinates in that figure represents specifically the ratio, expressed in decibels, of the watts per 100 kc to the watts in the entire band, in the electrical signal. It has been shown^{3,4} that in the perception of such noise the eye is less sensitive to the higher frequencies in this noise than it is to the lower frequencies. A weighting function mentioned in the literature,³ corresponding to the viewing of a standard television picture from a distance equal to 4 times its height, has been assumed in evaluating the electrical noise. It, and the distribution of the noise after this weighting, are also shown in Fig. 18. The weighted noise represents a power 6.9 db below the unweighted noise. For a "flat" distribution of noise

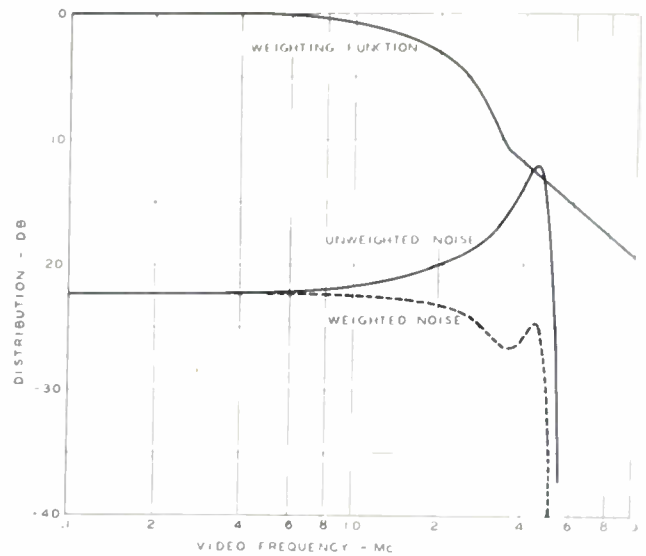

Fig. 18—Random noise distributions and weighting function used for tests.

the weighting would represent a power reduction of 2.2 db from the unweighted noise.

The data on impairments caused by noise have been plotted, in a manner similar to Figs. 8 and 13, in Fig. 19. These cover the consolidated results on three slides (the "Teacup Lady," a white vase and a two-character scene from a play). The abscissae represent the ratio of the peak-to-peak amplitude of a standard video signal including synchronizing pulses to the rms amplitude of the weighted noise, as measured in decibels.

Observation of the broken lines in Fig. 19 shows the usual erratic behavior at the extreme comment numbers, but aside from this there is a distinct curvature downwards towards low values of noise. It had been obvious in setting up the pictures for these tests that there was a low but visible random noise on the pictures before any external noise was applied. If such a constant noise were assumed, then to the nominal noise indicated by the abscissae would be added (on an rms basis) a fixed noise having dominant weight where the nominal noise is low but negligible weight where it is high. This would increase the comment numbers in the first case, but leave them unchanged in the second, and is therefore in the direction indicated by the curvature of the lines. The dotted lines have been drawn in the figure first by assuming straight lines asymptotic to the trend of the broken lines for the higher comment numbers. Then the straight lines have been distorted by finding, for each value of abscissa, a new nominal value which yields the old value when an estimated magnitude of fixed noise is added; and plotting the curves through these points. The fixed noise was adjusted to give the best fit for the 50 per cent curve, and the same value then used for the other percentage curves. The fit is seen to be good enough for the present exploratory work, though there is enough deviation for the extreme percentage curves to warrant reconsideration in a more definitive study.

³ P. Mertz, "Perception of television random noise," *Jour. Soc. Mot. Pic. and Telev. Eng.*, vol. 54, pp. 8-34; January, 1950.

⁴ O. H. Schade, "Electro-optical characteristics of television," *RCA Rev.*, vol. 9, Parts I-IV, pp. 5, 245, 490 and 653; March, June, September, and December, 1948.

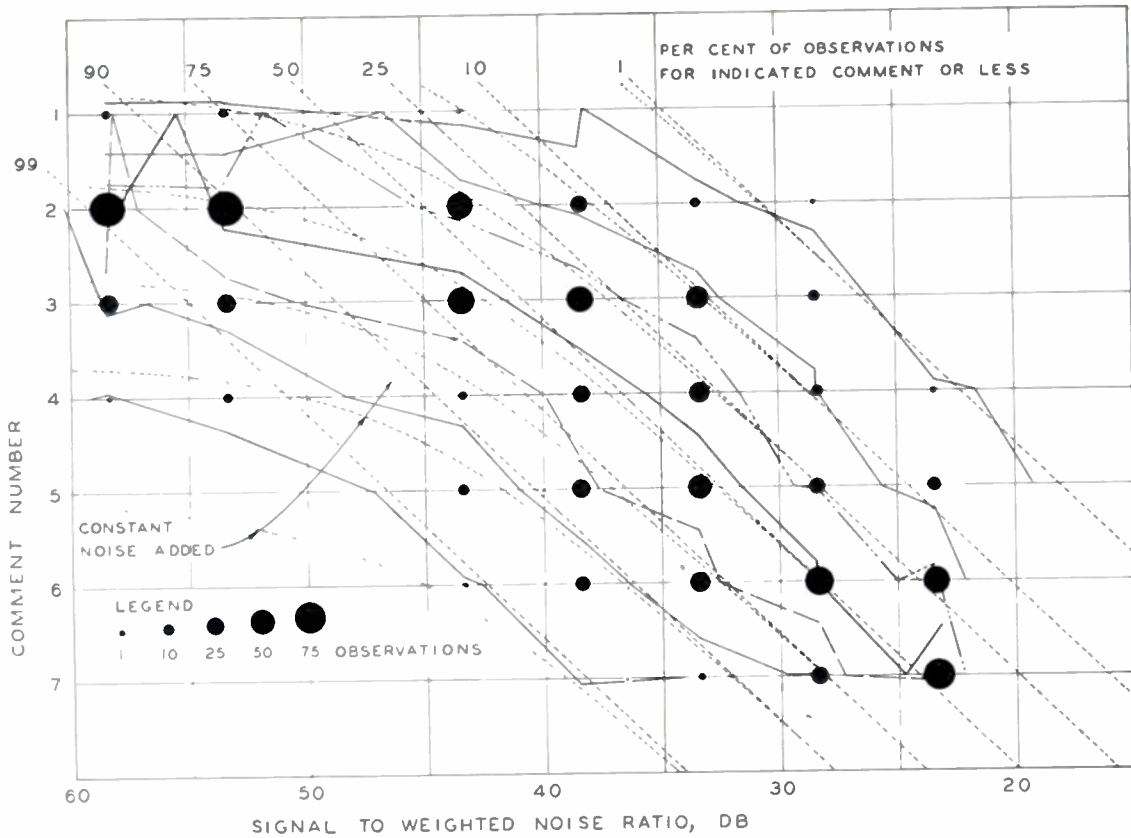

Fig. 19—Array of comment observations. Pool of 3 slide subjects. Random noise distribution of Fig. 18.

IV. COMPARISON BETWEEN TECHNIQUES

If systems of rating are to be realistic it is necessary, of course, that they lead approximately to the same rating, irrespective of the system or technique used. It is to check this that a portion of the experiments were performed using the two techniques substantially at the same time. From the plots of Figs. 2 and 6 it is possible to show the relationship between impairments resulting from echoes as measured in mils off focus of a comparison picture, and in comment numbers. This relationship has been plotted in Fig. 20. The curve expressing this relationship should of course be independent of the cases I, II, and III, particularly for comment number 1, for which there is no picture impairment. The curves of Fig. 20, however, do show some variation in this relationship, enough to warrant an explanation. The tests, from which the points were plotted, occupied a period of 10 days. The preliminary adjustments of both the television picture and the projected picture were made with great care to get the first as good as possible, and the second to match the first as nearly as possible. The judgments of several observers were used to set the adjustments. In the subsequent adjustments during the tests, however, only the highlight luminance and contrast ratio were measured several times each day. The collective judgments were not repeated.

It appears in retrospect that this technique was not sufficient to prevent the television picture from becom-

ing degraded over such a period of time. The projected picture, however, retained its original quality. Thus a separate smoothed curve, indicated by the dotted parabolas, has been plotted for each case. If the television picture had been readjusted at frequent enough intervals, the curves would obviously have coincided at comment number 1. The plot of the smoothed curves shows that there would probably have then been reasonably good coincidence for the other comment numbers.

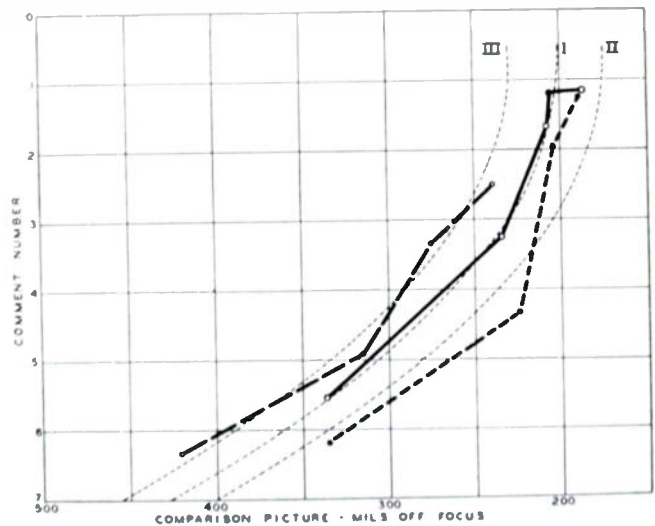

Fig. 20—Relation between defocusing and comment numbers. Subject and cases of Figs. 2 and 6.

The correlation of the image ratings among the various techniques and methods of deriving the results, as exemplified by Figs. 2, 5, and 6, is seen to run from fair to extremely good. Some of the uncertainties in the correlation, for example in the evaluation of the relative susceptibilities to echoes in cases I, II, and III, show evidence of the effect of the limited number of observations. Where more observations were taken, as illustrated in Figs. 15 and 16, the relative susceptibilities appear much more distinctly.

In a relative evaluation of the techniques, the comparison method is found to be more difficult for the experimenter to set up, and it requires more observations to obtain a significant result than the comment method. However, the observations are much simpler and easier to make, requiring only an indication of picture preference, instead of an evaluation in terms of words. The observer judgments are more nearly independent of previous training. They are also more absolute, as was indicated in the discussion of Fig. 20, because a projected picture is more reproducible, in the present state of the art, than a television picture.

At this point it is appropriate to consider some criticism which has been made of the language of the comments used in the second technique. In the usual technique employed by the psychologists, some aspect or dimension of the picture quality is specified, and the observer is asked to report in terms of predetermined steps or categories of the dimension. In the present case there are four dimensions, i.e., perceptibility, impairment, objectionableness, and utility. The first is given three steps, the second two, the third three, and the fourth one, and some of the steps of one dimension are identified with other steps of another. The objection is made that the observer may be confused by this, and rank the picture in a single dimension of his own and following the ordered comment numbers.

There is some validity to such an objection, but it is necessary to note that the information on picture impairments is sought over a great range of these, and the observer's interest centers upon the successive aspects of the impairment over the course of this range. The prime objective of the technique is to catch the successive points at which these aspects reach importance, and the few steps are all that is necessary for each aspect for such a determination. The aspects themselves were chosen to reach importance successively.

The criticisms were voiced in general form before the experiments reported were carried out. In view of the exploratory character of the experiments, it was decided to carry them out with the comment wordings as prepared. To thwart the observer as far as possible in setting up an arbitrary numerical rating of his own, which might differ from observer to observer, the successive objective degradations in the picture were presented in irregular order, and sometimes two different types of degradations were interleaved in irregular order.

The general experience with the comment wordings chosen, during the course of the experiments, was quite favorable. There seemed to be little if any confusion in the observer's minds as to the meaning to them of the comments, and it is guessed that there was far more uniformity in their interpretations than is usually attached to the words "just tolerable," which have been conventional in the past. There was still some suspicion that the observers were constructing scales of their own, but there was repeated evidence that the great majority of the observers were using the comment scale, in that the observers made numerous references to the sheet of paper on which the comments were written and frequently would audibly read the words of two or more of the numbered comments before deciding which comment suited the particular impairment.

When the comment wordings were chosen, it was not known whether they would be spaced uniformly on a general quality scale, nor was this an objective, although it has desirable aspects. The spacing of the comments in liminal units can be determined directly from the vote distributions on the comment numbers. For example, in Fig. 7 it is possible to measure off the number of comment spacings between the 25 and 75 per cent votes (corresponding to 2 liminal units), divide this by 2, and plot the result against the comment number at the 50 per cent vote. This has been done for the cases I, II, and III that were plotted in Fig. 6, and the results are

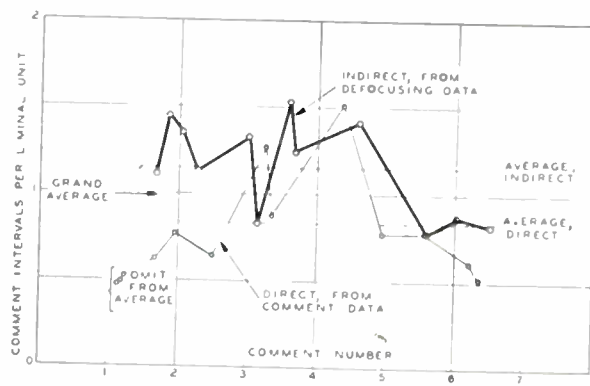

Fig. 21—Liminal differences measured in comment intervals from data on subject and cases of Figs. 2 and 6.

shown by the line lines in Fig. 21. A few values very close to comment 1 undoubtedly are affected by the saturation near the extremes of the comment scale, and have therefore been omitted from an average of the data.

Similarly the mils off focus spacings as recorded in Fig. 4 between the 25 and 75 per cent votes on the defocused picture have been computed. These have been converted to comment number spacings per liminal unit by using the smoothed curves correlating the two in Fig. 20, and divided by two. The results form the indirect data connected by the heavy lines in Fig. 21, and these were also averaged.

Examination of Fig. 21 shows that the comment interval spacings per liminal unit are systematically some-

what greater for the indirect than for the direct data. It also shows that while the data are a bit scant, there is no strong evidence for variation in the spacing as a function of comment level except near the very ends of the comment number scale.

Omitting the points near comment number 1, the grand average of Fig. 21 indicates a comment number spacing of about one liminal unit. The additional data, reported on Figs. 8, 13, and 19, as smoothed, indicate a constant averaged value for each figure. The comparison of all these is about as follows:

Fig. 2 (Cases I, II, and II, indirect)	1.15
Fig. 6 (Cases I, II, and II, direct)	.83
Fig. 8	1.00
Fig. 13	1.155
Fig. 19	1.00
Average	1.03

The broad conclusion, therefore, is that the comment spacings, at least as used by the observers, are uniform, and are about one liminal unit.

V. COMPARISONS BETWEEN PICTURE QUALITY PARAMETERS

The comparison technique has also been used to compare sharpness or definition as a quality parameter of the picture with the other quality parameters.

Two pictures have been exhibited to the observer side by side, say, A and B. Picture A has a given definition and contrast ratio. Picture B has, say, a lower contrast range and its definition is varied over a range of values, all higher than for A. The observer is asked, for each value, presented in irregular sequence, to choose his preference for A or B. For some value of definition the vote is 50-50. Picture B at this sharpness and its contrast is then equally chosen with picture A at a higher contrast but lower definition. A line can then be drawn joining these two points on a graph, as in Fig. 22. This then can represent a segment of a curve of presumed equal quality, which could be plotted on the graph. By taking other pairs of pictures, other such segments can

be drawn. This would permit sketching in the graph a succession of contours of presumed equal quality. From the 25 and 75 per cent votes the quality spacing between the contours can be estimated in liminal units. These are indicated in the figure by light lines. The contours have not, however, been drawn in the plot. In plotting the curves the mills off focus have been squared to give a quantity approximately following frequency bandwidth. They have also been plotted from right to left, so that increasing sharpness, as bandwidth, goes from left to right.

In Fig. 23 a similar comparison has been plotted between contrast and highlight luminance, and in Fig. 24 between sharpness and highlight luminance.

The three quality parameters can be presented in a unified composite graph having three dimensions. The

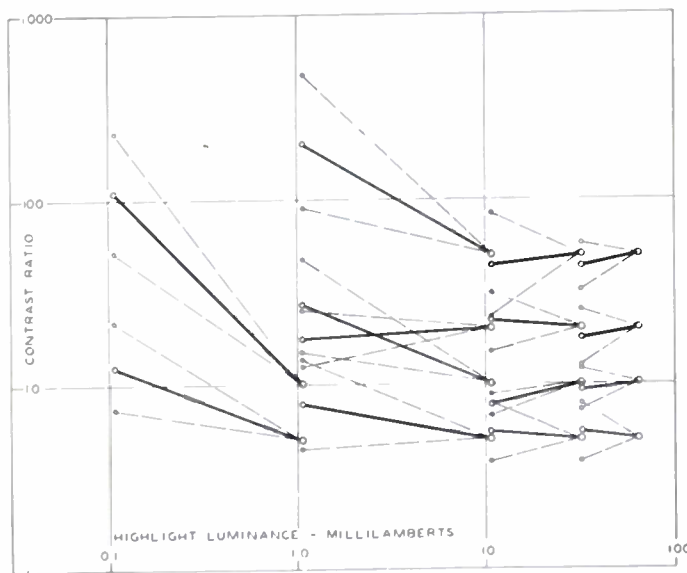

Fig. 23—Contrast versus highlight luminance. "Swan" slide, 80 mils off focus.

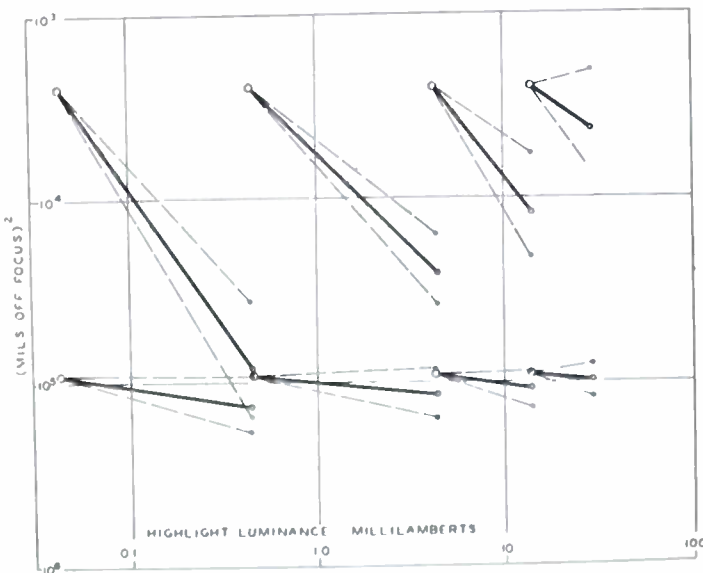

Fig. 24—Sharpness versus highlight luminance. "Dinner table" slide at 50:1 contrast ratio.

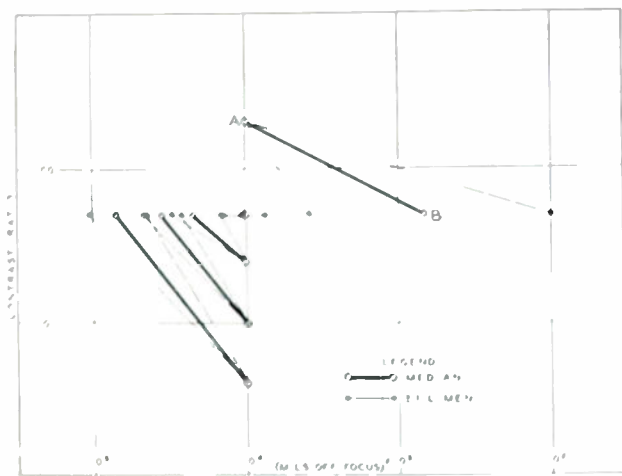

Fig. 22—Contrast versus definition. "Swan" slide at 27 millilamberts highlight luminance.

three planes of Figs. 22, 23, and 24 have been shown as intersecting to form this graph in Fig. 25. In such a figure the locus of pictures of presumed equal quality is a curved surface, and its intersection with the three planes forms a contour curve on each of the planes. In Fig. 25 one such contour curve has been sketched in for each of the three planes, and some idea of the curved surface may be derived from the perspective drawing. Other curved surfaces may be sketched, differing from that shown by any given number of liminal units. These have not been shown, however, in order to avoid complicating the drawing.

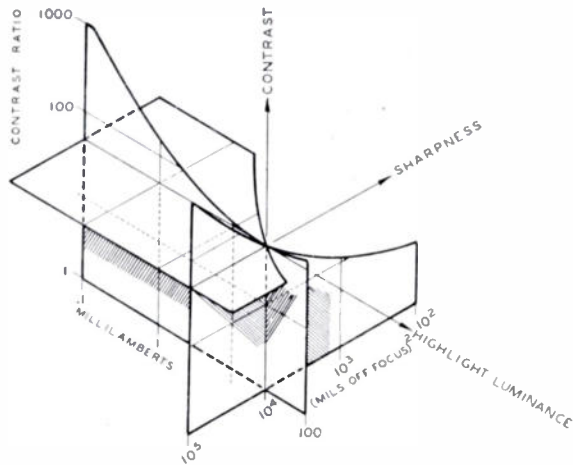

Fig. 25—Solid of picture quality parameters.

VI. APPENDIX

The defocused projected picture has been used extensively in these tests as an illustration of a picture of reduced sharpness that permits comparison with a television picture of limited frequency bandwidth. As part of the test, a calibration of the bandwidth corresponding to the defocused picture was carried out, as a function of the defocusing.

The calibration could of course have been carried out by comparing an actual television picture of known frequency bandwidth with the defocused picture. It was desired, however, to project the comparison to a picture of more perfect scanning spot structure than at present available on television screens. The telephotograph system⁵ developed some years ago gives an excellent and almost perfect structure of conventional type. Consequently several pictures of various subject material were made into projection lantern slides and also transmitted locally over a telephotograph system of known band-pass characteristics (see Fig. 26—the influence of the transmitting and receiving scanning apertures has been estimated) and made into positive transparencies. By

⁵ F. W. Reynolds, "A new telephotograph system," *Bell Sys. Tech. Jour.*, vol. 15, p. 549; October, 1936.

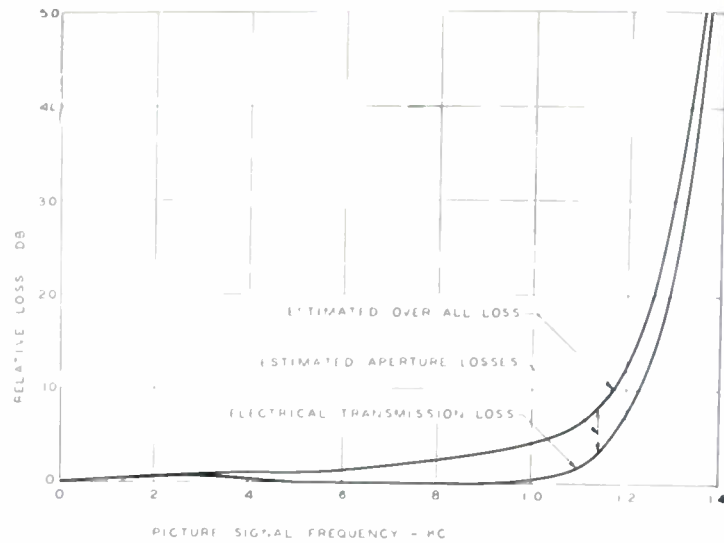

Fig. 26—Over-all band-pass characteristics, telephotograph system.

transmitting the pictures at varying amounts of magnification varying numbers of scanning lines could be obtained.

The transparencies (suitably illuminated from the rear) replaced the television picture in Fig. 1 and were compared with the defocused projections. The results of these comparisons are shown in Fig. 27. The ordinates here are expressed in terms of a normalized variable αg which characterizes defocusing under varied projection conditions. The quantity g is the actual lens displacement off focus in mils. The factor α is defined by

$$\alpha = \pi(m - 1)/(2FH) \tag{1}$$

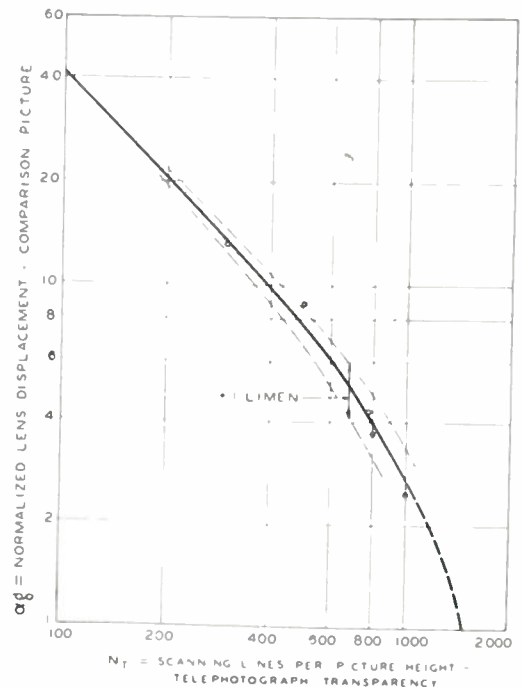

Fig. 27—Subjective correlation of telephotographed transparencies with off-focus projections.

where

- m = in-focus magnification
- F = ratio of focal length to diameter of aperture of projection lens
- H = height of picture in inches.

With α as above, and g in mils, the variable αg comes out in convenient numbers, which are 1,000 times what they would be if g were expressed in inches.

The points shown represent the averages of the observations. A smoothed curve has been drawn, with a doubtful dotted extrapolation. The 25 and 75 per cent votes have also been represented by smoothed dotted lines.

The frequency conversion from the telephotograph to the television bands is accomplished by multiplying the frequencies in Fig. 26 by the ratio of the scanning speeds for the assumed television systems to that for the telephotograph systems. Each telephotograph transparency has a number of scanning lines in height, designated as N_T . The scanning is done on the machine itself at 100 lines to the inch, and at 20 inches per second, consequently covers a horizontal distance along a scanning line equal to N_T scanning line widths in $0.0005 N_T$ seconds. In the corresponding television systems it is assumed that all of them have a frame frequency of 30 per second, and horizontal and vertical blanking intervals of 17.25 and 6.5 per cent, respectively (present standards). Then the time required to cover N_T scanning line widths, in a horizontal direction, is $0.774/(40N_T)$ seconds. The ratio of the two speeds is consequently $0.02584N_T^2$.

The "bandwidth" of a transmitted signal is, of course, an elastic concept, depending upon the purposes for which the quantity is to be used. For the present it will be assumed as the frequency band up to the 45-db cut-off, including electrical and aperture losses. This gives, in Fig. 26, a "bandwidth" of 1.345 kc, and, for varying

values of N_T , the equivalent bandwidths indicated in Fig. 28. Translating the scanning line numbers of Fig. 27 into frequency bands gives Fig. 29, which gives the calibration of the mils off focus used in Figs. 2 to 4 and 20, for which $\alpha = 0.0654$.

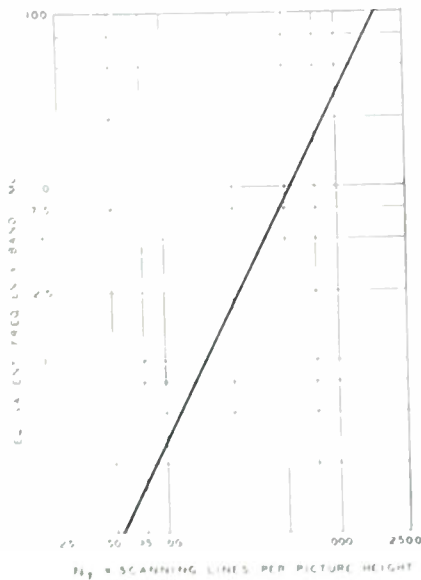

Fig. 28—Equivalent frequency bands for telephotographed transparencies.

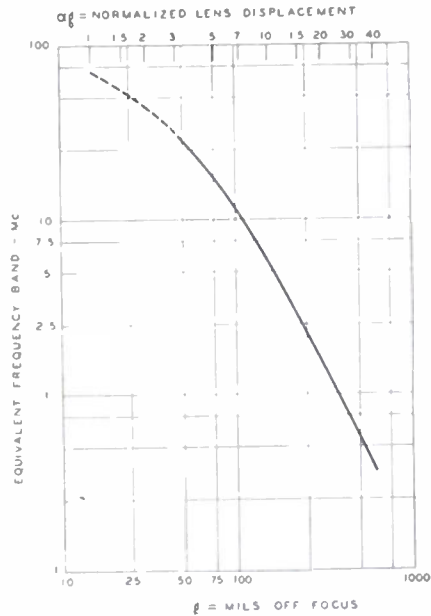

Fig. 29—Calibration of off-focus displacement in terms of equivalent frequency band. $\alpha = 0.0654$.

For many purposes it is desirable that the calibration shall be given in terms of resolving power. This is done by viewing a parallel line test chart and measured in terms of lines just resolved (counting black lines and white lines) in a picture height. For this test it turned out to be more convenient to measure just beyond this, i.e., lines just not resolved. The experimental indications were that the difference in lens displacements satisfying these two criteria is probably less than 2 per cent. These resolving powers for the various lens displacements, for three different projection setups all viewed at 4 times picture height are plotted as the various points in Fig. 30.

A theoretical curve has been derived for the data shown in Fig. 30, briefly as follows. The influence upon resolution of bar patterns of eye limitations, lens limitations, and defocusing is considered as an attenuation or loss varying with the closeness of the lines.^{1,3,4} For convenience the losses are measured logarithmically, as $20 \log_{10} \rho$, where ρ is the luminance ratio. Then

$$L(N, \alpha g) = L_1(N) + L_2(N) + L_3(N, \alpha g), \quad (2)$$

where

- L = over-all loss
- L_1 = loss due to eye limitation
- L_2 = loss due to lens limitation
- L_3 = loss due to lens defocusing
- N = number of lines in picture height
- αg = normalized lens displacement.

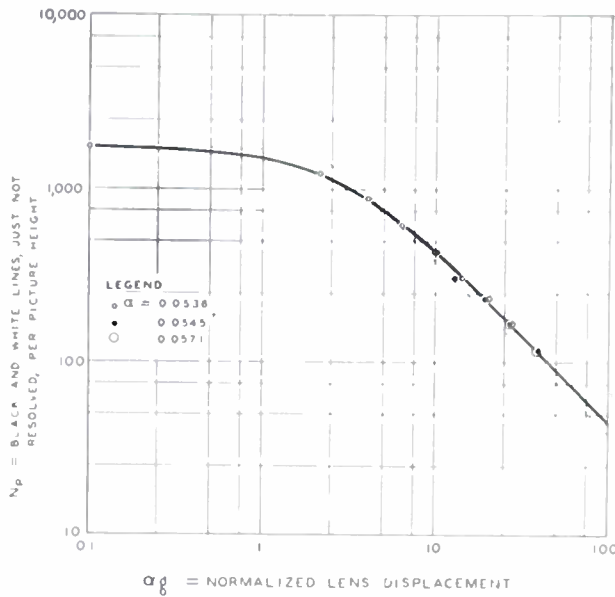

Fig. 30—Subjective correlation of off-focus displacement with test lines just not resolved.

The eye and lens limitations are independent of defocusing, as noted. The over-all loss, near threshold, can be taken as a constant figure (say L_0), which establishes then an implicit functional relation between N and αg determined by (2).

The eye and lens losses are in general approximately parabolic⁶ near the origin, but they are exactly parabolic if the distribution in their figures of confusion is Gaussian. This distribution is indicated by experiment to be approximately the case for most lenses. I.e.,

$$L_1(N) + L_2(N) = k_1 N^2 + k_2 N^2 = k_3 N^2. \quad (3)$$

The proportionality constant can be measured from the resolution at sharp focus N_0 for which $L_3 = 0$.

Hence

$$k_3 = L_0/N_0^2. \quad (4)$$

The defocusing loss is⁶

$$L_3(N, \alpha g) = 20 \log_{10} [(\alpha g N/1,000)/2J_1(\alpha g N/1,000)], \quad (5)$$

where

$J_1(\)$ = Bessel function of first kind and order 1.

The factor of 1/1,000 in the argument is needed to offset the measure of g in mils as explained under (1).

Thus the implicit equation between N and αg is

$$20 \log_{10} [(\alpha g N/1,000)/2J_1(\alpha g N/1,000)] = L_0 [1 - (N/N_0)^2]. \quad (6)$$

This is the equation shown by the fine dotted line in Fig. 30, for $L_0 = 45$, and $N_0 = 1,750$. The Bessel function is used for arguments between zero (for zero value of g) and its first root (for small values of N). As N approaches zero, the right-hand member of the equation

approaches constancy, and therefore the argument of the Bessel function also approaches constancy. Thus g becomes nearly inversely proportional to N . This corresponds to the portion of the curve toward the right of Fig. 30. It is to be noted that this portion is displaced somewhat from the actual points. The exact reason for this displacement is not clear, but it has been noted before⁷ that the effective size of an optical figure of confusion tends to run to about 85 per cent of its calculated value from geometrical optics.

The experimental points in Fig. 30 group themselves about a quite smooth curve, indicating the general validity of the normalized variable which has been derived from (1). Because of this the smoothed empirical curve, shown as a solid line in Fig. 30, has been used rather than the theoretical curve, for the application to calibration of the line resolution in effective frequency bandwidth.

This calibration is effected by using the relationship determined in Fig. 29 between the normalized lens displacement and frequency bandwidth to substitute the latter for the former in Fig. 30. This then gives Fig. 31, which is the calibration desired.

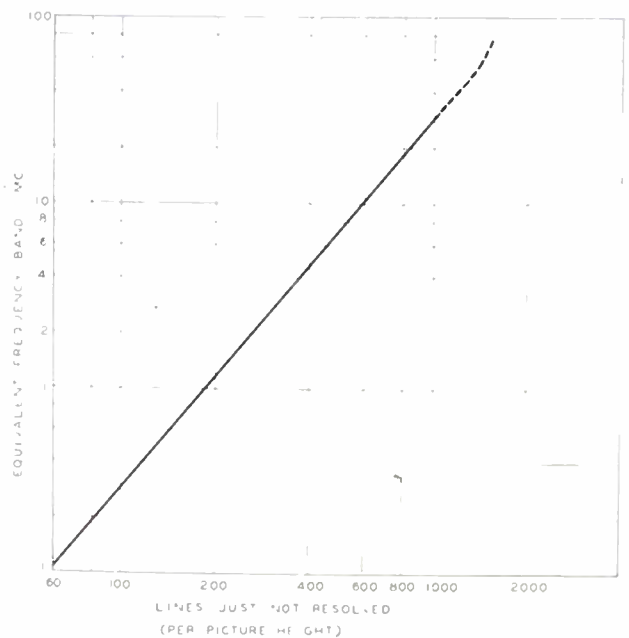

Fig. 31—Calibration of lines just not resolved, in terms of equivalent frequency band.

This calibration, it will be noted, permits an independent determination of the factor⁷ which has been referred to as the "Kell factor." This, in a conventionally used television system, is the ratio of the vertical definition, in resolved lines, to the actual number of scanning lines. Calling the first N_p , and the second N_r , (it will not do simply to use N_T from Fig. 27, because this was determined from over-all subjective evaluation

⁶ P. Mertz and F. Gray, "Theory of scanning," *Bell Sys. Tech. Jour.*, vol. 13, p. 464; July, 1934.

⁷ R. D. Kell, A. V. Bedford, and M. A. Trainer, "An experimental television system," *Proc. I.R.E.*, vol. 22, pp. 1246-1266; November, 1934.

with a different horizontal resolution), the ratio gives the relation

$$N_p = kN_v \tag{7}$$

The frequency bandwidth required is

$$F = (1/2) \times M \times B \times N_v \times (4/3)N_p \tag{8}$$

where M is the frame frequency, B is the allowance required for horizontal and vertical blanking (equal to $1/0.774$ or 1.292 in present standards, and already made in Fig. 28), and it is assumed that the horizontal resolution is N_p (measured along a length equal to picture height, and aspect ratio 4 to 3). Thus with the vertical resolution also N_p

$$F = (2/3)MBN_p^2/k \tag{9}$$

or

$$k = (2MBN_p^2)/3F \tag{10}$$

The value of k as determined from substituting F and N_p from the straight line part of Fig. 31 is 0.89. This is somewhat higher than the figures which have up to the present been given.¹ In part of course it is due to the measurement in Fig. 30 of "lines just not resolved" instead of "lines just resolved." The figure is also however very sensitive to the smooth curve plotted through the rather irregular points of Fig. 27. It is to be hoped that further measurements can some time be made either with telephotograph transmitted transparencies or good quality television pictures to permit a more precise plot in this figure.

The viewing conditions for the major part of the work have been sketched in Fig. 1. They were chosen largely for simplicity and ease of reproduction, and to permit of a generally critical evaluation, but do not pretend to be a standard. For the data in Figs. 22 to 25, inclusive, a somewhat larger picture, namely 15 by 20 inches, was projected on the screen, and the value of α for the lens was 0.0852. The viewing was in as complete darkness as could easily be obtained. It was realized that this was an artificial condition, but for exploratory purposes it was deemed not too far off, it was easily reproducible, and it did not interfere with the high picture contrast possibilities which were desired. To secure relaxed vision at

the comparatively close viewing distances, lens pairs were made available to the observers to hook on over their own spectacles (or over empty frames) if they wished. These moved back the virtual plane of the viewed screens, by an amount depending upon their focal lengths. The lenses were available in a variety of focal lengths.

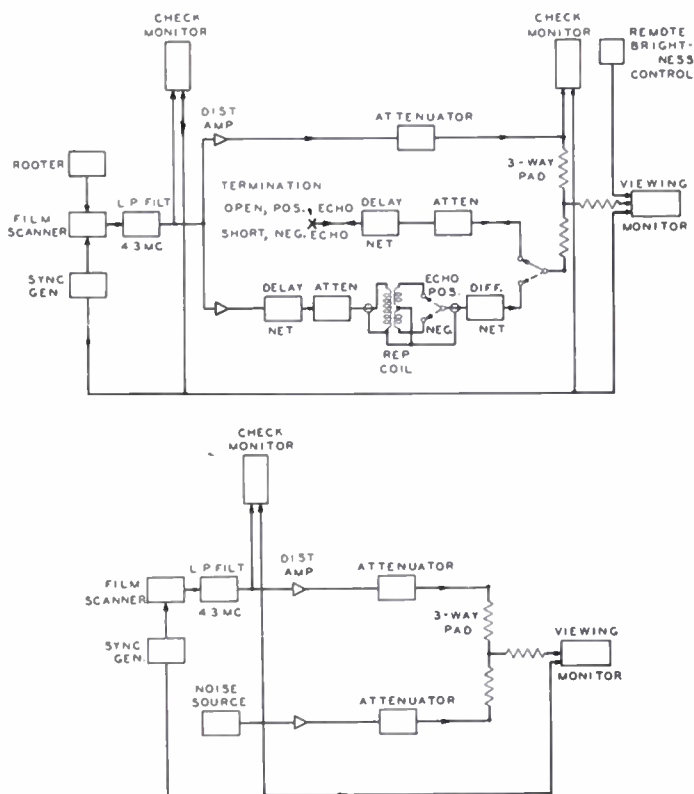

Fig. 32—Circuits for echo and noise tests.

Block schematics of the circuits used for the echo and noise tests are illustrated in Fig. 32. These are conventional in character and self-explanatory. The networks used to obtain differentiation and partial differentiation were of the minimum phase type. As picture source a film scanner of a general type which has already been described⁸ was used. An arrangement on it permitted scanning still slides.

⁸ A. G. Jensen, "Film scanner for use in television transmission tests," *Proc. I.R.E.*, vol. 29, pp. 243-250; May, 1941.

CORRECTION

J. M. Pettit, author of the paper, "Ultra-High-Frequency Triode Oscillator Using a Series-Tuned Circuit," which appeared on pages 633-635 of the June, 1950, issue of the *PROCEEDINGS OF THE I.R.E.*, and F. J. Kamphoefner, author of the paper, "Feedback in Very-High-Frequency and Ultra-High-Frequency Oscillators," which appeared on pages 630-632 of the same issue, have brought the following omission to the attention of the editors:

The authors wish to acknowledge the support of the Office of Naval Research in the work reported in their respective papers.

Tone Rendition in Photography*

W. T. WINTRINGHAM†, SENIOR MEMBER, IRE

Summary—The photographic field is reviewed to find whether the tone rendition of a good picture can be predicted. The television engineer can find no solace in the fact that good photographs were made before measurements were made of the photographic media. He will be thwarted further when he learns that the best print is the result of experienced criticism of a work print. However, the experience of the photographer in obtaining pleasing results in spite of the limitations and distortions of the photographic process should be useful to the television engineer.

INTRODUCTION

TONE RENDITION is one of the important factors which make up a pleasing picture. However, it would appear to be poorly understood, even in the century-old photographic field. Nevertheless, what little data we have was collected in that field, where some work has been attempted in correlating sensitometry and the end result—a pleasing picture. First, let us understand the fact which should be obvious, that the most usual task for any reproduction system (including television systems) is the production of a pleasing picture with the appearance of realism.

Let this statement of the aim of reproducing processes be considered as biased in favor of artists and pictorialists, let us examine the technical photographic literature. Mees¹ points out that the problem of tone rendition may be considered from two points of view; first, the objective one where brightness in the original and in the reproduction are compared; and second, the subjective, where the appearance of the reproduction conveys an impression of realism. Similarly Neblette² and Miller³ preface their discussions of tone rendition with statements that the end result of the photographic process is the impression conveyed to the viewer. This same thought is found in an unemotional source as a manual prepared for the use of technicians in motion picture laboratories.⁴

Is it so surprising that level-headed scientists should write in this vein? If it were otherwise, good pictures could have been only fortunate accidents before the practice of sensitometry. And as you know, good pictures were the rule during a part of the half century that preceded even the first experiments in sensitometry. Of course it is not stated that daguerreotypes showed good tone values—quite the contrary was the fact. But Brady's wet-plate pictures of the Civil War era were good. Examine his portraits, say, of Lincoln, and you will see realistic and

pleasing pictures seldom equaled today. Similarly, Jackson's pictures of the West were marvelous. The photographers of that time used color-blind negative materials and printing-out papers. Sensitometry, being unknown, contributed not at all to their results. In fact, sensitometric descriptions of the materials they used are almost nonexistent. So sensitometry can not be said to have contributed to good still photography, except in that it may have made the process somewhat easier.

But, you say, how about the movies? Compare, if you will, a clean print from one of Strauss' best negatives with any modern picture you choose. And remember, now, that sensitometry only came to Hollywood with sound.⁴ Exact duplication of brightness became important in the movie field only when each release print carried a sound track along its edge.

So, in discussing tone rendition, do not forget the purpose of a picture, which is to produce a realistic and pleasing impression of the original. Now, let us set down some of the things we know about photographic reproductions, not necessarily in the order of importance, for we do not know how to do that.

PHYSICAL FACTS IN PHOTOGRAPHIC REPRODUCTION

One of the most obvious differences between an original scene and a photograph is that the scene is three-dimensional and the photograph two-dimensional (excepting, of course, the effect produced by the stereoscope).

A scene is in color and most photographs are in monochrome.

A scene is boundless, and a photograph is bounded by a border which in most cases is foreign to the subject.

A photograph generally shows objects at other than their natural sizes.

The depth of field is fixed in making the picture, and the effect may be quite different from what you see in the original.

The picture always is noisy (grainy), and usually it is viewed on paper or a screen which has texture.

We have been able to describe the differences so far without mentioning tone rendition. It requires no stretch of the imagination to suppose that the effect of some of these physical differences can be partially compensated by control of the gradation in the picture.⁵

The maximum brightness in a scene usually is much larger than that in the reproduction.

The brightness range, or ratio of maximum to minimum brightness in a scene is usually different from that in the picture.

There is seldom a uniform distortion of the brightness scale in reproduction.

All of these latter items can be described in sensitometric terms. Since distortion in the sensitometric sense must exist and since some compensation for the first group of physical distortions may be possible, it should be apparent that a good deal more than physical measurement is required to produce a good picture.

SENSITOMETRIC TERMINOLOGY

Before we consider how a good picture might be produced, let us recall the terminology of sensitometry so that we may at least think we know what we are talking about.

An over-all characteristic for a photographic process is shown in Fig. 1. Here the logarithms of luminances of points in the reproduction are plotted against the logarithms of luminances of corresponding points in the original. This S-shaped curve is typical of all photographic processes, showing as it does a concave upward region called the toe, a concave downward region called the shoulder, and an intermediate linear part. Various processes differ in the relative length of the three parts into which the curve may be divided. This curve is typical also in that the range of luminances in the reproduction is different from the range of luminances in the original.

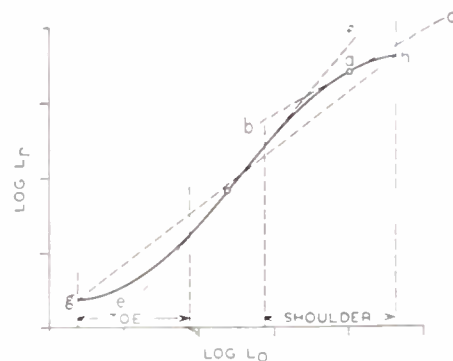

Fig. 1—Diagram showing sensitometry. L_o = luminance of a point in the object
 L_r = luminance of a point in the reproduction
Slope of $b-c$ = gradient at a
Slope of $e-f$ = maximum gradient = γ
Slope of $g-h$ = average gradient.

The slope of this curve at any point, for example, point a , is the gradient at that point. It is customary to designate the maximum value of the gradient as gamma, in accordance with the nomenclature introduced by Hurter and Driffield.⁶ The slope of the line connecting the two ends of the curve in Fig. 1 (line $g-h$) is called the average gradient of the reproduction. This is a measure of the change in luminance range between the original and the reproduction, or more correctly of the logarithms of these ranges.

⁶ F. Hurter and V. C. Driffield, "Photochemical investigations and a new method of determination of the sensitiveness of photographic plates," *Jour. Soc. Chem. Ind.*, vol. 9, p. 455; 1890.

* Decimal classification: 770.2836 X R 583. Original manuscript received by the Institute, December 9, 1949; revised manuscript received, July 11, 1950.

† Bell Telephone Laboratories, Inc., Murray Hill, N. J.

¹ C. E. Kenneth Mees, "The Theory of the Photographic Process," The Macmillan Co., New York, N. Y.; 1944.

² C. B. Neblette, "Photography—Its Principles and Practice," D. Van Nostrand and Co., New York, N. Y., Fourth Ed.; 1942.

³ Carl W. Miller, "Principles of Photographic Reproduction," The Macmillan Co., New York, N. Y.; 1942.

⁴ "Motion Picture Laboratory Practice," Eastman Kodak Co., Rochester, N. Y.; 1936.

⁵ Ralph M. Evans, "An Introduction to Color," John Wiley & Sons, Inc., New York, N. Y.; 1948.

It may not be amiss to repeat one point. The term gamma applies to the maximum gradient in the characteristic. The value of gamma is larger than the average gradient. Only if the whole characteristic were a straight line would the value of the average gradient become equal to gamma. Therefore gamma is none too significant a description of a reproduction.

Returning to the names given the three regions of the characteristic curve, Hurter and Driffield⁶ called the toe and shoulder regions, respectively, the regions of under and of over exposure. They called the intermediate linear part of the curve the region of correct exposure. This choice of words unfortunately suggests that linearity in this logarithmic plot is desirable, i.e., that good pictures are a result of a simple power law relation between object and image luminances. It is only in recent years that experiments made in the Kodak laboratories¹ have demonstrated that such linearity is not necessary and possibly is undesirable in the making of good pictures. Neblette² points out too that it would be well to drop the designation "correct exposure," because it carries such an unfortunate connotation.

The over-all characteristic shown in Fig. 1 is not to be confused with the more common characteristic of a negative or a positive material. Both of these characteristics are combined into this curve which includes as well the effect of stray light (or flare) in the camera and of room lights on the screen in the case of a projected picture. In case the print is made by projection from the negative, the effect of stray light or flare in this process is included likewise in the over-all characteristic.

THE PHOTOGRAPHIC PROCESS

If we assume that linearity is required for good reproduction, it is hard to see how good photographs occur, since this process seldom is linear. Even if we know how a photographer proceeds in making a picture, we are still at a loss. No small part of the difficulty in understanding arises because a good photographer does not talk the kind of language that television engineers understand. His jargon and ours are different. However, let us examine each step in the over-all problem of reproducing a scene, and see if we can guess the significance of the photographer's manipulation.⁷

The various technical elements which determine the quality of a picture, aside from matters of composition are:

- (1) The brightnesses in the original scene.
- (2) Quality of the image produced by the camera lens, including resolution and stray light (or flare).
- (3) The negative material used, including its sensitometric characteristics, and its spectral sensitivity.
- (4) The exposure given the negative, including the effects of any filter that might be used.
- (5) The development of the negative.
- (6) After-treatment of the negative.

- (7) The material chosen for the positive.
- (8) Exposure and development of the positive.
- (9) After-treatment of the positive.
- (10) Conditions under which the print is viewed.

We have some technical information about every one of these factors and likewise some idea of how a good photographer might work. If we put these bits of knowledge together, we may learn something about tone rendition in photography.

Scene Brightnesses

Mees¹ quotes quite liberally from a paper by Jones and Condit reporting work carried out on the measurement of scene luminances in the Kodak Research Laboratories. Observations were made on 150 outdoor scenes and photographs made of each. In these scenes, the maximum observed luminance was 11,500 foot-lamberts; and the minimum 0.82. It was found that the luminance range of each of these scenes varied from 750:1 to 27:1, where the largest range occurred in sunlit scenes with objects of interest in open shade and illuminated from the sky. Quoting from Mees:

"The logarithm of 160, the average brightness scale found in this work, is 2.2. Since the available density scale of a glossy developing-out paper is approximately 1.8, the entire brightness range of an average scene cannot be rendered without some compression. Most exterior scenes have brightness scales which greatly exceed the average value, and in many cases a very considerable compression of the brightness scale must be accepted in photographic reproduction."⁸

The scenes chosen in the Kodak study undoubtedly include some which a good photographer would not attempt to photograph. He despises deep shadows and will wait for fleecy clouds to form to throw light into them. If nature fails him, reflectors or even artificial lights are used to illuminate the shadow areas. Just how much this reduces the luminance range of the subjects of good pictures is unknown but it is likely that the average value 160 to 1 of the Kodak study is close to the good photographer's maximum.⁹ In this connection Mees states that the range of luminance on portrait and movie sets seldom exceeds 150 to 1.

The Camera Lens

The lens in the camera has two defects in producing the image in the negative material. The imagery may be poor (in a variety of ways) and non-imaged light may fall on the negative. The sharpness of the image has a complicated and little understood effect on the desirable over-all gradient of the photographic process. It is known that some compensation for lack of sharpness can be gained by increasing the over-all gradients.⁵ This compensation is only partially explained on technical grounds.

In an otherwise perfect lens, there will be stray light on the negative due to multiple reflection from the glass-air surfaces of the lens elements. Such flare is increased by

dust, moisture films, or thumb prints in the lens surfaces. Mees¹ devotes considerable space to this question, and we may summarize it in this rough way. The flare light increases by a factor of about 2 for each pair of glass-air surfaces added. The flare for a lens with four glass-air surfaces was such that the average luminance range for the 150 scenes measured was reduced from 160:1 to 68:1. The major effect of the flare light is to illuminate the shadows in the image. The gradient of the scene luminance-negative exposure characteristic therefore is less than unity in the shadows, and a toe is introduced in the over-all characteristic from this cause. Fortunately, the present trend toward anti-reflection coatings on lenses reduces the flare, provided, of course, that the lens surfaces are kept clean.

It is possible that the preference of some photographers for double-anastigmats or even such meniscuses as the single Protar, over lenses with more elements, is due to this cause. Certainly such preference exists, especially among the older photographers, and is stated in terms of the greater crispness of the photograph. In my own experience, the shadow gradation of a negative taken with a single Protar element is noticeably superior to that when the taking lens has six or eight glass-air surfaces.

The Negative Material

The photographer has a choice of a wide variety of negative materials, varying in sensitivity and spectral sensitivity, maximum density range, maximum gradient, length of the straight part of the D-log E characteristic, graininess, etc. Since there are so many different negative materials available, the selection of a particular one for a picture must depend on more than objective accuracy in tone rendering. Mees¹⁰ shows that the toe of the characteristic of available materials may be long and sweeping, covering log-E ranges greater than one, or may be short and sharp covering much smaller ranges in log E. However, he points out that the linear parts of the characteristics of available materials are adequate to record the range of luminances of all of the 150 scenes in the Kodak study in which the camera lens (without coating) had nominal flare.

It seems that the use of a negative material with a long sweeping toe in its characteristic is not a bar to producing a good picture.¹¹ Since we cannot tell too much about how the typical good picture was made, and since emulsions having such characteristics have been used to make good pictures, we should not weigh linearity in this stage of the process too heavily.

Exposure of the Negative

Photographers use one of two rules in exposing the negative. The one might be stated as follows: Expose for the shadows and let the highlights fall where they may. The other is similar, except that the words shadows and highlights are interchanged. The photographer using the first rule will place the exposure corresponding to the

⁷ Individual references to photographer's techniques will not be cited. The information used here has been obtained over a long period from a wide field of references and by discussion with successful photographers.

⁸ See page 775 of footnote reference 1.

⁹ In this connection, see footnote reference 3, page 130.

¹⁰ See page 787 of footnote reference 1.

¹¹ For example, see page 454 of footnote reference 2.

deepest shadow at some point on the toe of the curve which his experience indicates is desirable. Unless the luminance range of the subject is excessive, the highlights will fall on the linear part of the characteristic. If the second rule is followed, the maximum highlight will fall near the lower end of the shoulder of the curve and the shadows will work down toward the toe. In either case, Mees' data discussed in the preceding paragraph indicate that the greater part of the exposure range of the negative falls on the linear part of its characteristic, unless the photographer makes conscious use of the more curved part of a long sweeping toe.

The exposure of the negative is modified by the use of color filters. Besides changing the over-all color sensitivity of the photographic process, color filters modify the exposure range of the negative. Part of this effect comes about because we talk of exposure in visual terms (meter-candle-seconds, for example) and the spectral-sensitivity of the negative material is quite different from that of the eye. However, the photographer takes into account the effect of the filter when he makes his exposure.

Development of the Negative

The published characteristics of any emulsion apply only to certain restricted conditions. The shape of the characteristic depends on the spectral distribution of the radiance producing the exposure and the duration of the exposure. The shape depends also, and to a marked degree, on the development.¹²

There is possible a wide range of development methods, extending from physical to the more customary chemical development. In the one case, the final image is produced by silver deposited from the developing solution; in the other, the silver halide grains in the emulsion are converted to silver. Chemical development may be accompanied by stain image formation, as is the case with pyrogallol as a developing agent. Each development procedure results in a different characteristic of the negative material. Even more important changes in the shape of the characteristic result from variations in the concentration of antifogging agents (alkali bromides, etc.) in the developer. In particular, such restrainers tend to reduce the apparent speed (sensitivity) of the negative material and to shorten the toe of the characteristic.

The photographer may make use of all of these variations. He does, however, adjust his exposures to his processing methods. Therefore, about the only generality we can draw about exposure and development is that some effort is made to place most of the middle and upper tones in the original on the linear part of the negative characteristic.

After-Treatment of the Negative

No photographer is infallible. Even in the movie industry, intensification and reduction of a negative to correct for incorrect exposure and development sometimes are necessary. However, quoting Mees:³

"None of them, however, gives a final result equal to that obtained by correct

exposure and development; their use is an expedient and not a practice."

For our purpose we may forget about the sensitometry of intensification and reduction.¹³

There is another type of after-treatment that is practiced in still photography, and that is the local alteration of the scale of tones on the negative through the use of stains, pencil marks, etc. Here again we may neglect safely consideration of the sensitometry of such processes.

Résumé of the Sensitometry of the Negative

Before we consider the production of a final print, let us bring together what we know about the negative. If it represents the work of a good photographer, the negative is a record of a scene in which the range of luminances was somewhat less than 150:1. Flare from the surfaces of the camera lens increased the relative exposure of the shadows, so that the range of illumination of the negative was less than half as great as the original scene, or less than 70:1. The deepest shadows were recorded on the toe of the negative characteristic, while most of the middle tones and the highlights were recorded on the linear portion of the curve. If the negative is a portrait or a movie, the maximum gradient (gamma) most likely is between 0.6 and 0.8.² In the case of a commercial photograph it may be close to unity.² In any case, the average gradient of the negative is most apt to be appreciably less than unity. (You will recall that gradients or gammas refer to the exponent of the input which produces the output, since these terms refer to a log-log plot.)

Positive Materials

The photographer has a very wide choice of positive materials, ranging from transparency stock (lantern slides and movie film) to all sorts of light sensitive materials on paper. He is not limited to emulsions of silver halides in gelatine, and in fact he may not use such emulsions.¹³ The sensitometric characteristics of these various printing media vary. The density range required in the negative to print in each of these mediums may be different too. The good photographer, however, has chosen his procedure in making the negative with his printing process in mind. If he had changed his mind after making the negative, there are ways of altering the negative or of making another negative from it, so that the printing medium is used properly.

Let us consider first a movie positive (assuming that all of the intermediate duplication processes ordinarily used do not affect the over-all result). The characteristic curve for positive film has the general shape shown in Fig. 1, with a relatively long straight portion. Quoting from the literature:⁴

"It is well known, however, that the shape of the characteristic curve for positive film can be modified profoundly by the composition of the developer, and many laboratories use developers which produce curves quite different from those

shown in Figure 25. In some cases, for example, the transition between 'toe' and the 'straight-line' portions of the curve takes place at relatively low densities, while in other cases this transition may occur at much higher densities. In the first case the 'toe' is comparatively short, while in the second case it is much longer and is frequently referred to as 'basket-shaped.' . . .

"The point of transition between the straight-line portion of the curve and the 'shoulder' is also influenced by processing conditions. However, this is generally of minor importance, as the density at which the transition occurs is, in the vast majority of cases, beyond that which is practically useful in a positive for projection."

As we have seen, the highlights of the original scene generally fall on the linear part of the negative characteristic, and the shadows are compressed to some extent. When such a negative is printed on the positive film, the denser part of the negative corresponding to the highlights will be printed on or near the toe of the positive characteristic, and the shadows in the negative will fall on the linear part of the positive characteristic. Obviously there will be some, and there may be considerable, compression of both the shadows and the highlights in the over-all process.

In case the print is made on a silver-halide-gelatin paper, the result is much the same. However, in this case the shoulder of the characteristic of the positive material cannot be avoided, so that additional compression of the shadows over that present in the negative is to be expected. It must be kept in mind that the density range in such a print cannot be greater than 1.1 to 1.8, depending on the paper surface.²

The pictorialist of today still may utilize media for his best prints which were used by the better photographers of a generation past. Instead of silver halides in gelatine, the light-sensitive material might be a bichromated colloid, or ferric oxalate in the presence of potassium chloroplatinate. Anderson¹³ as a representative of those interested in pictorial photography, recommends platinum or platinum overprinted with bichromated gum arabic as the best process, with carbon as a second choice.

Characteristics of these printing media are presented by Miller.³ The platinotype paper has an extremely long linear portion in its characteristic, with substantially no toe. The maximum density is not very high (about 1.2), so that Anderson¹³ recommends overprinting the shadows with gum. This latter process has a density range of only 0.6 or 0.7, but it requires a correspondingly small exposure range. In combination, these two processes result in a printing characteristic which is linear over an extremely large range of densities. (It should be noted that Anderson considers the highlight gradation of platinum the best of all printing processes, indicating again that the toe covers a small part of the total exposure range.)

The characteristics of carbon are shown by Miller.³ This process is another which produces characteristics with very short toes and long linear portions. As Anderson¹³

¹³ Paul L. Anderson, "The Technique of Pictorial Photography," J. B. Lippincott Co., New York, N. Y.; 1939.

¹² See Part III of footnote reference 1.

points out, the minimum density in a carbon print often is undesirably high, and for this reason he prefers platinum.

These latter printing processes differ from silver for another reason. The density range of 1.8 is obtained with a silver print only when the surface is glossy. However, equally high density ranges can be obtained from some of these processes on matte surfaces. The reason, of course, is that the light absorbing particles in one case are imbedded in a constant thickness film of gelatine which is not present in the other cases.

The net result of this discussion is to conclude that the characteristics of paper prints or transparencies need not be much different.

Exposure and Development of the Positive

As indicated in the preceding paragraphs, the characteristic produced in a printing process depends on the processing conditions (the composition of the developer, etc.). It does not seem profitable even to try to summarize all the variables that can be introduced at this point.

It might pay to point out that the method of exposing the positive may introduce nonlinearity. If the print is made by contact, the relation between the diffuse density of the negative and the log-exposure of the positive is linear, and a one to one correspondence exists. If projection printing is used, the difference between diffuse density and printing density of the negative, under the conditions existing in the printer, disturbs this direct correspondence (the Callier effect).¹ In addition, flare light in the printer illuminates the highlights in the print more than should be. In consequence, projection printing reduces the gradient in the highlights.

After-Treatment of the Positive

The positive print may be used following development and fixation, or it may be worked over. Of the after-treatments possible, the most useful is reduction using a subtractive reducer. As Mees² shows, a subtractive reducer decreases all densities of a silver image equally. This, therefore, is a means for suppressing the toe of the characteristic of the printing emulsion.

This process does not seem to be used to any extent in the production of movies.³

However, it is used commonly to "clear the highlights" of lantern slides. It is used, with the same justification, by some older photographers with silver prints on paper.

Some of the toning processes have similar reduction characteristics.² In these processes, changes of the color of the silver image is accompanied by a suppression of the toe of the characteristic. Obviously, it is necessary to lengthen the printing exposure when such processes are used.

Viewing Conditions

One of the favorable qualities of a paper print is that the range of luminances in it is not modified by the viewing conditions, except for specular reflection which can be avoided easily. In the case of a projected transparency, conditions are not so simple. The projection density of the print differs from the diffuse density by amounts which depend on the projector;⁴ the projector introduces flare light; and the room lighting, if present, dilutes the shadows. The net effect is a decrease of the shadow gradient over that in the highlights, and usually an increase in the highlight gradient.

Over-all Tone Rendering

We have seen how each step in the production of a photograph may alter the shape of the overall relation between scene luminance and reproduction luminance. We can generalize to the extent that the over-all characteristic has the general shape shown in Fig. 1 with the proviso that the toe, the straight portion, and the shoulder of the curve each may have any relative importance. In practice there seems to be some effort to produce an over-all average gradient of unity, with as small a departure therefrom as is possible.

There is little information on the effect on the observer of the change in absolute level of luminance between the original and the reproduction. Mees² has some discussion of this effect, and concludes that it produces a further reduction of the gradient of the over-all process in both the shadows and the highlights.¹⁴

¹⁴ See Fig. 273 of footnote reference 1.

As a part of a study of negative speeds by judgment of print quality, Jones investigated the effect of changes of the over-all characteristic, but for one scene only.¹⁵ These results are not conclusive, since it was not possible to produce average over-all gradients much greater than unity. With this limitation, it was found that the preferred average gradient was unity, without much effect from variations of maximum gradient in the range 1.29 to 1.57.

CONCLUSIONS

It should be obvious that it is difficult to describe a good photograph in technical terms.¹⁶ There is some evidence that the average gradient of a good photographic reproduction is not far from unity. Since the typical characteristic is S-shaped, the maximum gradient is somewhat greater than the average. We may conclude that an effort is made in good photography to produce and use a long linear over-all characteristic.

It appears further that by suitable choices in the several steps of the photographic process, the maximum gradient may fall in any region of the characteristic curve. It is pointed out in the laboratory handbook⁴ that the final choice of characteristic is based on experienced criticism of the print, and that the position of the maximum gradient should depend on the part of the tone scale in which the greatest interest is centered.

The conclusions, applied to television, might be summarized as follows:

(1) The television tube should be capable of making a picture with a luminance range of the order of 100 to 1.

(2) The average gradient of the system, from light to light, averaged over an output luminance range of 100 to 1 should not be far from unity, possibly being slightly greater than 1.

(3) Means should be available to the program director to shape the over-all system characteristic so that the picture pleases him.

¹⁵ See page 818, et seq., of footnote reference 1.

¹⁶ Bearing on this, Anderson says, "It will also be obvious that although gamma is extremely useful to the research worker or to the laboratory technician, it has no value whatever to the pictorialist . . ."

CORRECTION

R. C. Hergenrother and B. C. Gardner, authors of the paper, "The Recording Storage Tube," which appeared on pages 740-747 of the July, 1950, issue of the PROCEEDINGS OF THE I.R.E., have brought the following error to the attention of the editors:

In Appendix B on page 746, in equation (3), the term preceding the integral on the right-hand side of the equation should read

$$\frac{i_w}{S/v} \quad \text{instead of} \quad \frac{i_w}{S/2}$$

Tone Rendition in Television*

B. M. OLIVER†, MEMBER, IRE

Summary—This paper is a review of some of the brightness transfer characteristics which may be obtained in television using present-day apparatus and techniques. Several families of curves are presented which show the effects of varying one or more of the relevant factors, the remainder being held constant at reasonable values.

I. INTRODUCTION

TELEVISION today is passing out of the novelty stage and more attention will be given as time goes on to the pleasing reproduction of intermediate brightnesses. Not until this is done will the full capabilities of television as an artistic medium be realized. Just as the end result in photography is secured by a proper balance of negative and positive film characteristics, so also in television the transmitter and receiver characteristics must be properly matched to secure good results. This in turn implies a standardization of both the transmitter and receiver characteristics, so that any receiver can be used to best advantage with any transmitter. But there is more to the story than merely matching the two characteristics. If we assume for the moment that linear reproduction of brightness at the receiver is desired (reproduced brightness everywhere proportional to original scene brightness) then this result could be achieved with a linear transmitter and a linear receiver, or a square root transmitter and a square law receiver, or with a logarithmic transmitter and an exponential receiver; in fact with any two single valued functions such that one is the inverse of the other. Which pair of matched characteristics is best, depends upon other considerations, such as the relative amount of disturbance produced by added noise or signal level changes which may occur between the transmitter and receiver.

This paper is a review of some of the various characteristics which are obtainable with present day techniques. Some of the virtues of certain of these characteristics as compared with others are pointed out. An attempt has been made to normalize the scales and quantities involved so that results are generally applicable and not specifically limited to the present standards as to sync. pulse height, set-up etc.

II. DEFINITION OF TERMS

The following terms are used throughout the paper, and their definitions are collected here for ready reference.

- B = elemental scene brightness
- B_{max} = maximum scene brightness
- B_{min} = minimum scene brightness

* Decimal classification: R583. Original manuscript received by the Institute, December 9, 1949; revised manuscript received, June 2, 1950.

† Bell Telephone Laboratories, Inc., Murray Hill, N. J.

- b = reproduced brightness corresponding to B
- b_{max} = value of b when $B = B_{max}$
- b_{min} = value of b when $B = B_{min}$
- $R = B_{max}/B_{min}$ = brightness ratio of original scene
- $r = b_{max}/b_{min}$ = brightness ratio of reproduced image
- $X = B/B_{min}$
- $x = b/b_{min}$
- A = normalized signal amplitude (i.e., $A = 0$ when $B = B_{min}$, $A = 1$ when $B = B_{max}$)
- S = transmitter brightness sensitivity = $dA/(dB/B)$
- s = receiver brightness sensitivity = $(db/b)'dA$
- g = gradient = $(db/b)'/(dB/B)$
- $1/m$ = exponent of transmitter characteristic
- n = exponent of receiver characteristic.

III. TRANSMITTER CHARACTERISTICS

We will call the functional relation between the elemental scene brightness and the corresponding signal amplitude at some convenient measuring point (such as the video line from the studio or the current in the radio transmitter antenna) the transmitter brightness characteristic. This does not imply that the radio transmitter itself has a nonlinear relation between video signal amplitude in, and rf signal out. On the contrary, the radio transmitter would probably in all cases be reasonably linear, and the brightness characteristic would be determined principally by the characteristics of earlier parts of the system, notably the camera and any associated corrective amplifiers.

All ordinary cathode-ray tubes exhibit a power law characteristic of screen brightness versus control grid voltage. Since such tubes are almost universally used in receivers which are otherwise fairly linear, the most natural class of transmitter characteristics to consider would appear to be those in which the output signal amplitude is proportional to some *root*, say the m th root of brightness. Then

$$A = K_1 I^{1/m} + K_2$$

Adjusting the constants K_1 and K_2 so that $A = 0$ when $B = B_{min}$ and $A = 1$ when $B = B_{max}$, we obtain:

$$A = \frac{X^{1/m} - 1}{R^{1/m} - 1} \quad (1)$$

If $m = 1$, the transmitter is linear, if $m = 2$ it has a square root characteristic, and so on. For $m = \infty$, (1) becomes indeterminate, but the limiting form can be found by L'Hospital's rule. Thus as $m \rightarrow \infty$:

$$A = \lim_{m \rightarrow \infty} \frac{\frac{d}{dm} (X^{1/m} - 1)}{\frac{d}{dm} (R^{1/m} - 1)}$$

and we obtain

$$A = \frac{\ln X}{\ln R} \tag{2}$$

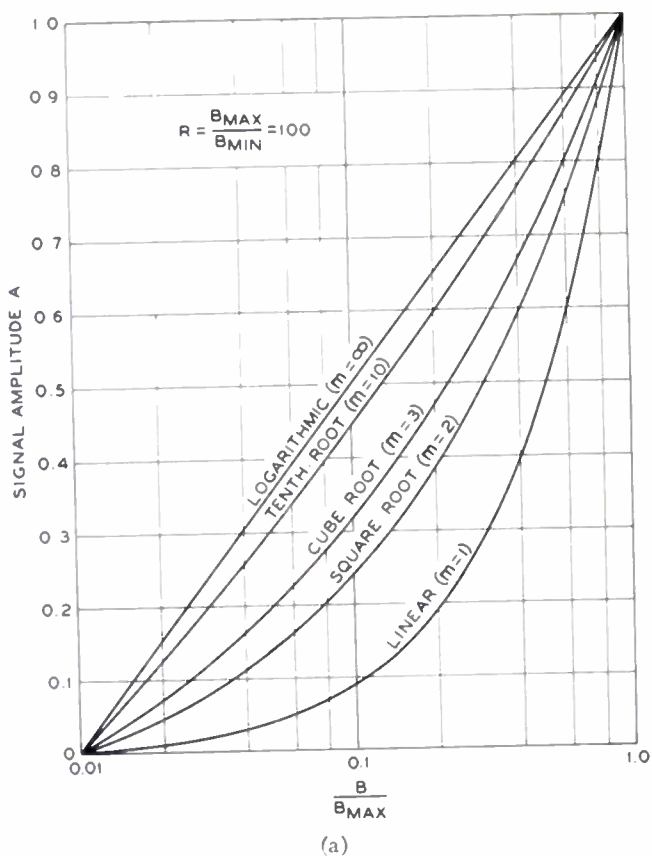

Thus a logarithmic transmitter characteristic can be regarded as the limit of an m th root characteristic as $m \rightarrow \infty$:

The characteristics (1) and (2) for several values of m are shown on Fig. 1(a) for $R=100$, and on Fig. 1(b) for $R=30$. Since the scale chosen for A is linear, and that for B/B_{max} is logarithmic, the logarithmic characteristic ($m = \infty$) plots as a straight line, while the linear characteristic ($m=1$) plots as an exponential curve. The log scale for B/B_{max} was selected on the basis of the Weber-Fechner law of sensation as applied to the eye. Over the range of brightness commonly encountered in television, equal percentage changes in B are almost equally perceptible, i.e., over this range of B , the value of $\Delta B/B$ required to produce a perceptible change is almost constant. Now

$$d\left(\ln \frac{B}{B_{max}}\right) = \frac{dB}{B},$$

so that equal distance increments along the abscissa correspond to equally perceptible changes in B . A linear scale for B/B_{max} would seriously compress the low brightness end of the curves. The subjective midpoint of the brightness range is the geometric mean of B_{max} and B_{min} and the scale used should show this point in the middle. A log scale does this. On the other hand noise and other added disturbances produce equal changes in A , regardless of its value. Thus the scale for A is chosen to be linear.

It will be noticed that the curves for $m=2$ and $m=3$ lie about midway between $m=1$ and $m=\infty$. Thus, in a sense, a logarithmic transmitter is as bad a match for a 2.5-power receiver ($n=2.5$) as a linear transmitter. This will appear more clearly in some of the later curves.

Another quantity of interest, in connection with the transmitter, is the slope of the characteristics shown in Figs. 1(a) and (b). This we will call the transmitter brightness sensitivity S , although transmitter log-brightness sensitivity would be a more accurate term. We define $S = dA/(dB/E)$. Thus from (1)

$$S = \frac{1}{m} \frac{X^{1/m}}{R^{1/m} - 1}, \quad (m < \infty), \tag{3}$$

and from (2)

$$S = \frac{1}{\ln R} \quad (m = \infty). \tag{4}$$

S is a measure of how much response the transmitter gives to equally perceptible changes in B , over the range of B . Fig. 2(a) shows some curves of S for $R=100$, while Fig. 2(b) shows the case for $R=30$. Referring to Fig. 2(a), it will be seen that for equally perceptible changes in B , the linear transmitter has only 1/100 the response at $B/B_{max}=0.01$ that it has at $B/B_{min}=1$. The matching receiver, in this case linear, must construct an equally perceptible change in b out 1/100 the signal change at $B=B_{min}$ that it has to work with a $B=B_{max}$. The logarithmic transmitter, on the other hand, responds

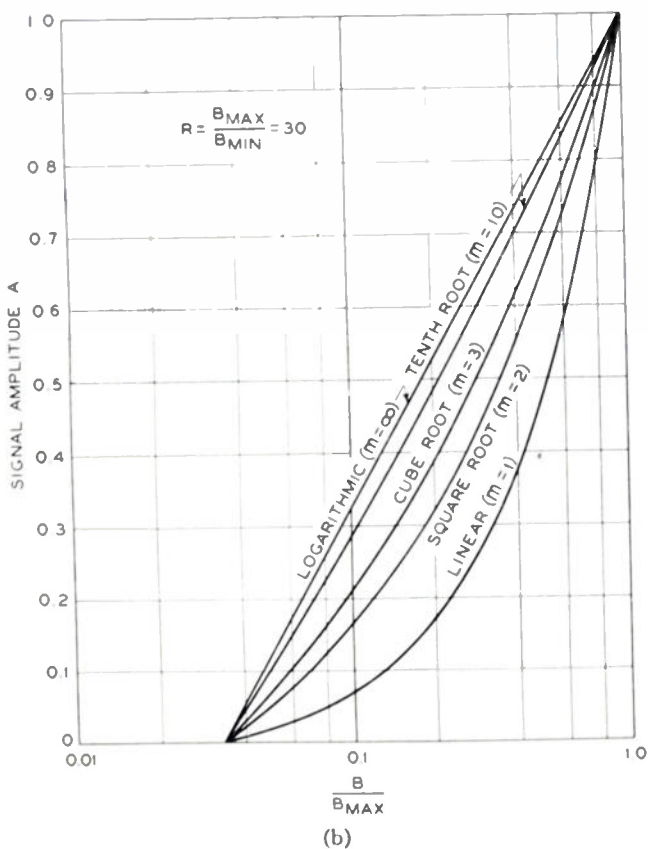

Fig. 1—Transmitter brightness characteristics. (a) $R = B_{max}/B_{min} = 100$; (b) $R = B_{max}/B_{min} = 30$.

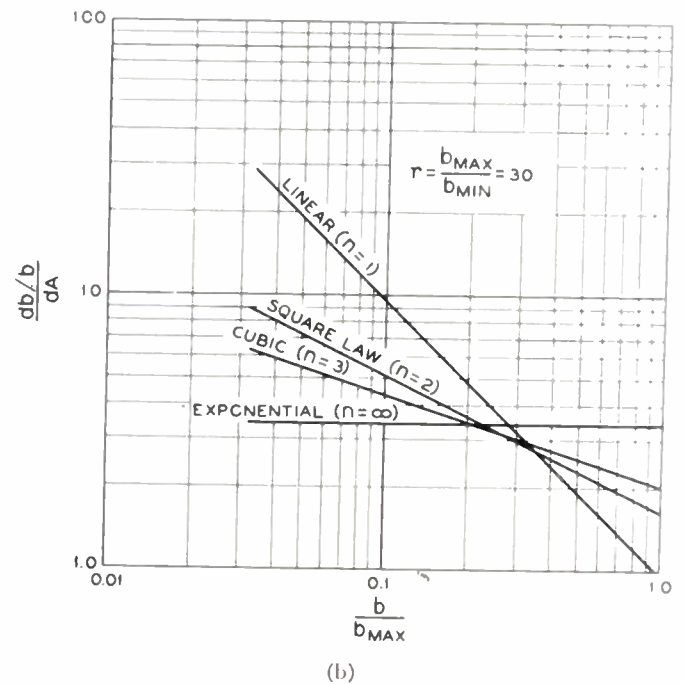
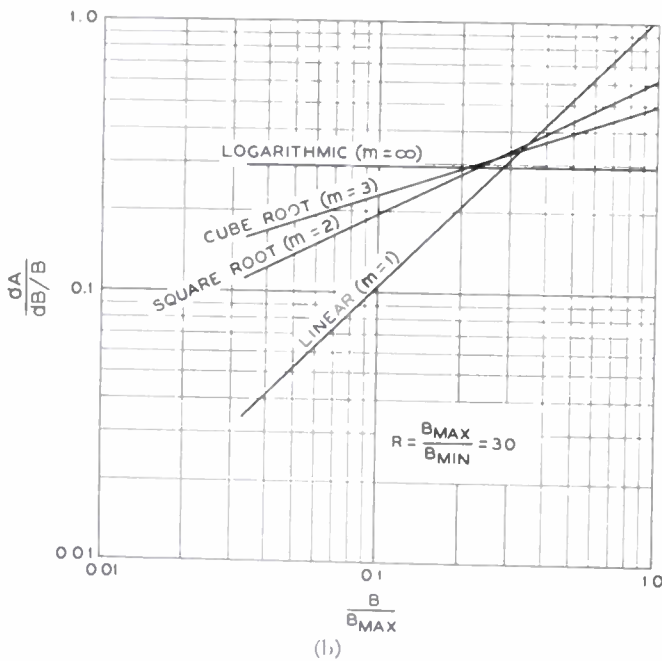
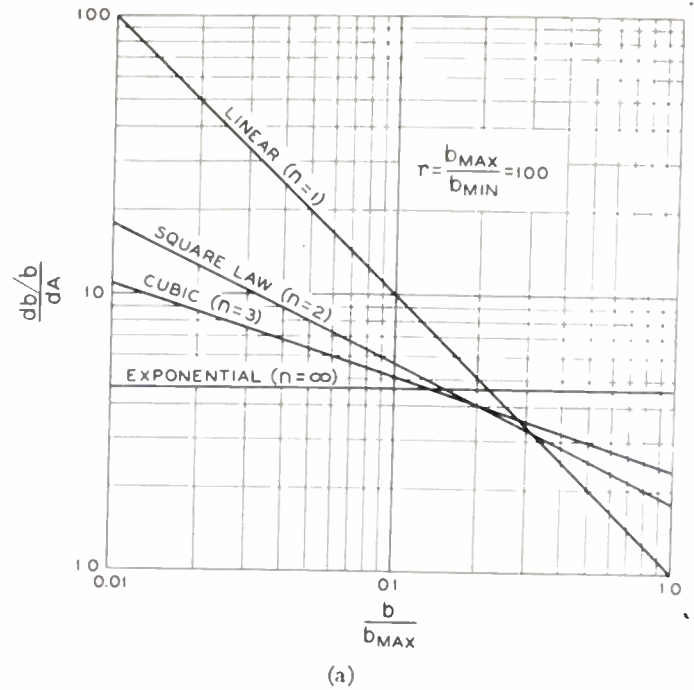
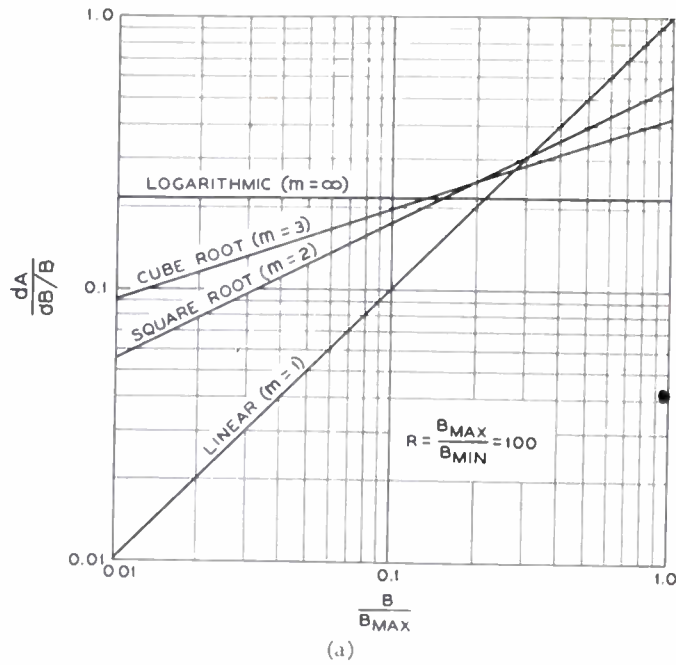

Fig. 2—Transmitter brightness sensitivity. (a) $R = B_{max}/B_{min} = 100$; (b) $R = B_{max}/B_{min} = 30$.

Fig. 3—Receiver brightness sensitivity. (a) $r = b_{max}/b_{min} = 100$; (b) $r = b_{max}/b_{min} = 30$.

equally over the range to equally perceptible changes in B .

IV. RECEIVER CHARACTERISTICS

We will assume in accordance with the actual facts, that the receiving tube characteristic closely approximates a power law, with some exponent n , and take as the form for the receiver characteristic:

$$b = k_1 + k_2 A^n.$$

Adjusting the constants k_1 and k_2 so that when $A = 0$, $b = b_{min}$, and when $A = 1$, $b = b_{max}$, we obtain

$$x = \frac{b}{b_{min}} = [1 + (r^{1/n} - 1)A]^n, \quad (5)$$

$$\frac{b}{b_{max}} = \frac{x}{r},$$

for $n < \infty$. For $n = \infty$, we obtain by taking the limit as before:

$$x = e^{-1 \ln r} = 10^{4 \log r}, \quad (6)$$

$$\frac{b}{b_{max}} = \frac{x}{r} = e^{-(A-1) \ln r}.$$

Thus the exponential receiver characteristic may be regarded as the limit approached by an n th power characteristic as $n \rightarrow \infty$.

A quantity which is very useful in describing receiver performance is the receiver brightness sensitivity (or log brightness sensitivity) s , defined as $(db/b)/dA$. From (5) we have:

$$\frac{db}{b} = \frac{dx}{x} = n \frac{r^{1/n} - 1}{[1 + (r^{1/n} - 1)A]} dA,$$

$$s = n \frac{r^{1/n} - 1}{[1 + (r^{1/n} - 1)A]} = n \frac{r^{1/n} - 1}{x^{1/n}}, \quad (7)$$

and from (7) for $n = \infty$:

$$s = \ln r. \quad (8)$$

The receiver brightness sensitivity is a measure of the response of the receiver in *relative* brightness change to a given change in signal amplitude, over the operating range. The larger s is, the smaller will be the increment in signal amplitude which just produces a perceptible brightness change. By the same token, the smaller s is, the greater will be the noise amplitude which can be present in the signal without being visible on the screen.

Fig. 3(a) shows some receiver brightness sensitivity curves for $R=100$. Fig. 3(b) shows the case for $R=30$. Referring to Fig. 3(a), it will be seen that the linear receiver is 100 times as sensitive to noise at $b/b_{max}=0.01$ as it is at $b=b_{max}$. The exponential tube, on the other hand, is equally sensitive to noise at all brightnesses.

Let us imagine four receivers, one linear, one square law, one cubic, and one exponential, all supplied with the same initially noise-free signal, and all adjusted to the same r . If noise is now added to the signal and gradually increased in level, it will become visible first in the shadows in the linear receiver, then in the shadows in the square-law receiver, then in the shadows in the cubic receiver, and finally all over the picture in the exponential receiver. By this time, the noise would be quite bad in the linear receiver. The ratio of the value of s at $b=b_{min}$ for an n th power receiver to the value of s for an exponential receiver, is a measure of how much greater the signal-to-noise ratio must be for the n th power receiver to keep the noise below threshold. This ratio (expressed in db) has been plotted against n in Fig. 4 for the cases $r=100$ and $r=30$. We see that the threshold noise penalty for a 2.5-power receiver is about 8 db; for a 5th power receiver, about 4 db; and for a 10th power receiver about 2 db. In appraising these figures it must be remembered that they apply only to noise added at points in the system between the non-linear transducers which determine the transmitter and receiver brightness characteristics (e.g., input circuit noise), and that further they apply only when this added noise is at or near threshold. For larger amounts of noise, the difference must be estimated in other ways. For example, if the noise level is high enough to show up on an exponential receiver, it will be visible all over the picture, while on a cubic receiver under these conditions the noise would be worse in the shadows, but less visible in the highlights. It is hard to say without tests which picture would be more pleasing.

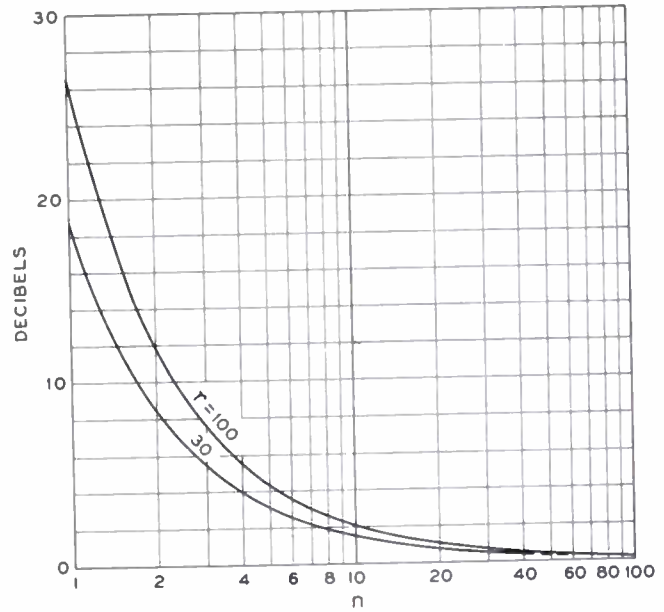

Fig. 4—Threshold noise penalty.

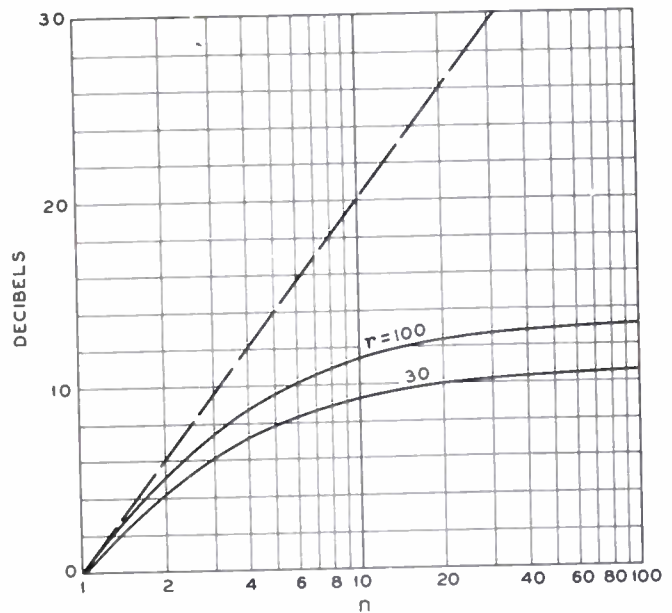

Fig. 5—Relative sensitivity to level changes.

The received signal may be disturbed in other ways besides the addition of noise or interference. When the direct path transmission is poor, as when the receiver is located behind buildings or a hill, reflection off aircraft by combining in and out of phase with the direct ray can produce large level fluctuations. Unless the receiver is provided with a fast automatic volume control, these signal level changes will appear in the picture. If the signal is clamped in the receiver at $A=0$, then the brightness fluctuations will be most pronounced in the highlights. The relative sensitivity of various receiving brightness characteristics to level changes when the signal is clamped at $A=0$ is thus given by the relative values of s at $b=b_{max}$. In Fig. 5, $20 \log s$ at $b=b_{max}$ is plotted against n for $r=100$, and $r=30$ (solid curves). The dashed line in Fig. 5 shows the relative sensitivity to

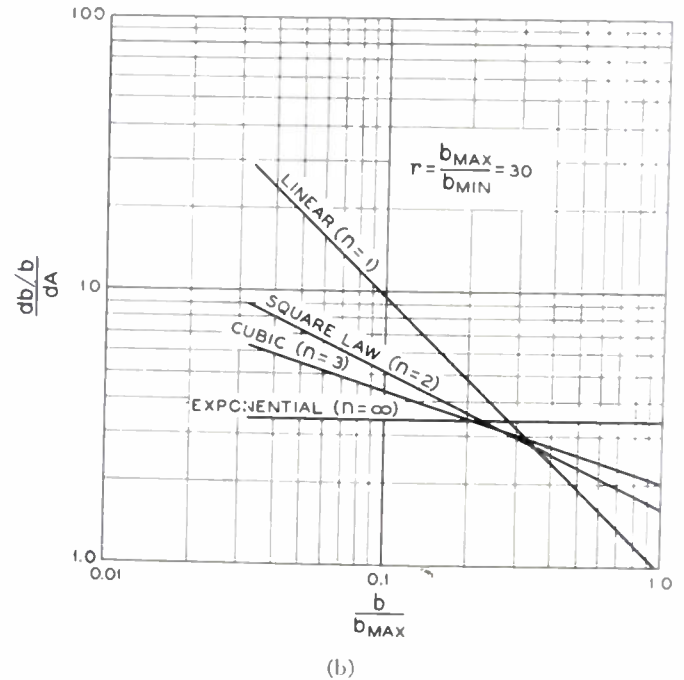
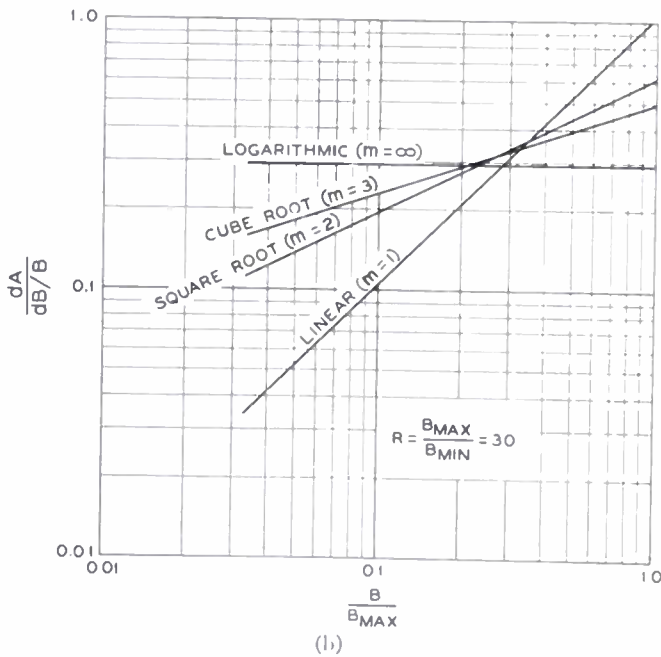
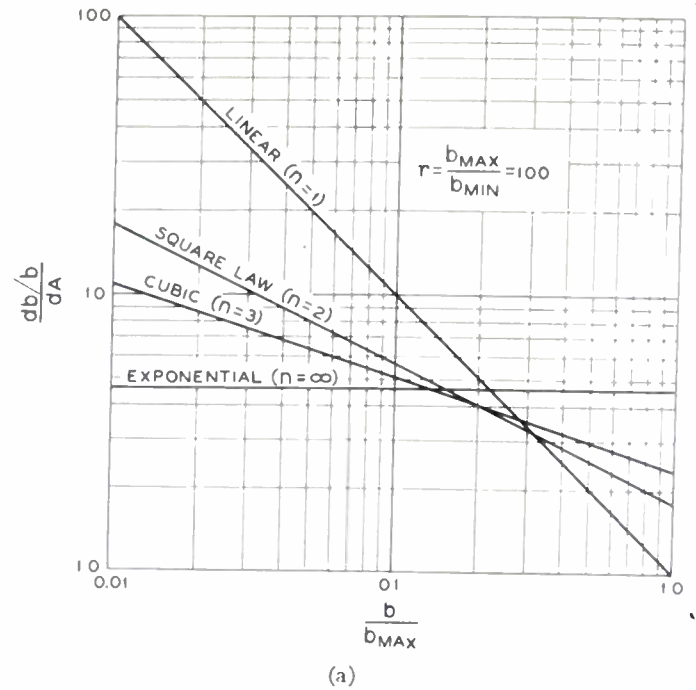
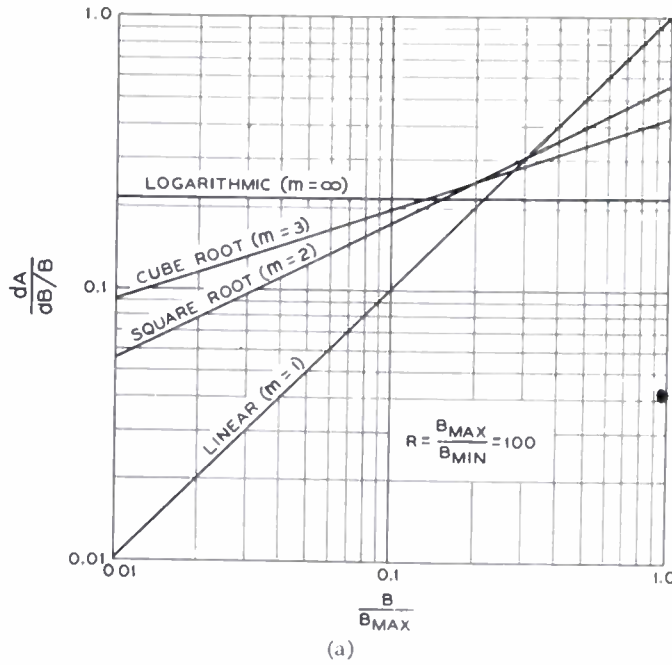

Fig. 2—Transmitter brightness sensitivity. (a) $R = B_{max}/B_{min} = 100$;
(b) $R = B_{max}/B_{min} = 30$.

Fig. 3—Receiver brightness sensitivity. (a) $r = b_{max}/b_{min} = 100$;
(b) $r = b_{max}/b_{min} = 30$.

equally over the range to equally perceptible changes in B .

IV. RECEIVER CHARACTERISTICS

We will assume in accordance with the actual facts, that the receiving tube characteristic closely approximates a power law, with some exponent n , and take as the form for the receiver characteristic:

$$b = k_1 + k_2 A^n.$$

Adjusting the constants k_1 and k_2 so that when $A = 0$, $b = b_{min}$, and when $A = 1$, $b = b_{max}$, we obtain

$$x = \frac{b}{b_{min}} = [1 + (r^{1/n} - 1)A]^n, \quad (5)$$

$$\frac{b}{b_{max}} = \frac{x}{r},$$

for $n < \infty$. For $n = \infty$, we obtain by taking the limit as before:

$$x = e^{A \ln r} = 10^{A \log r}, \quad (6)$$

$$\frac{b}{b_{max}} = \frac{x}{r} = e^{(A-1) \ln r}.$$

Thus the exponential receiver characteristic may be regarded as the limit approached by an n th power characteristic as $n \rightarrow \infty$.

A quantity which is very useful in describing receiver performance is the receiver brightness sensitivity (or log brightness sensitivity) s , defined as $(db/b)/dA$. From (5) we have:

$$\frac{db}{b} = \frac{dx}{x} = n \frac{r^{1/n} - 1}{[1 + (r^{1/n} - 1)A]} dA,$$

$$s = n \frac{r^{1/n} - 1}{[1 + (r^{1/n} - 1)A]} = n \frac{r^{1/n} - 1}{x^{1/n}}, \quad (7)$$

and from (7) for $n = \infty$:

$$s = \ln r. \quad (8)$$

The receiver brightness sensitivity is a measure of the response of the receiver in *relative* brightness change to a given change in signal amplitude, over the operating range. The larger s is, the smaller will be the increment in signal amplitude which just produces a perceptible brightness change. By the same token, the smaller s is, the greater will be the noise amplitude which can be present in the signal without being visible on the screen.

Fig. 3(a) shows some receiver brightness sensitivity curves for $R=100$. Fig. 3(b) shows the case for $R=30$. Referring to Fig. 3(a), it will be seen that the linear receiver is 100 times as sensitive to noise at $b/b_{max}=0.01$ as it is at $b=b_{max}$. The exponential tube, on the other hand, is equally sensitive to noise at all brightnesses.

Let us imagine four receivers, one linear, one square law, one cubic, and one exponential, all supplied with the same initially noise-free signal, and all adjusted to the same r . If noise is now added to the signal and gradually increased in level, it will become visible first in the shadows in the linear receiver, then in the shadows in the square-law receiver, then in the shadows in the cubic receiver, and finally all over the picture in the exponential receiver. By this time, the noise would be quite bad in the linear receiver. The ratio of the value of s at $b=b_{min}$ for an n th power receiver to the value of s for an exponential receiver, is a measure of how much greater the signal-to-noise ratio must be for the n th power receiver to keep the noise below threshold. This ratio (expressed in db) has been plotted against n in Fig. 4 for the cases $r=100$ and $r=30$. We see that the threshold noise penalty for a 2.5-power receiver is about 8 db; for a 5th power receiver, about 4 db; and for a 10th power receiver about 2 db. In appraising these figures it must be remembered that they apply only to noise added at points in the system between the non-linear transducers which determine the transmitter and receiver brightness characteristics (e.g., input circuit noise), and that further they apply only when this added noise is at or near threshold. For larger amounts of noise, the difference must be estimated in other ways. For example, if the noise level is high enough to show up on an exponential receiver, it will be visible all over the picture, while on a cubic receiver under these conditions the noise would be worse in the shadows, but less visible in the highlights. It is hard to say without tests which picture would be more pleasing.

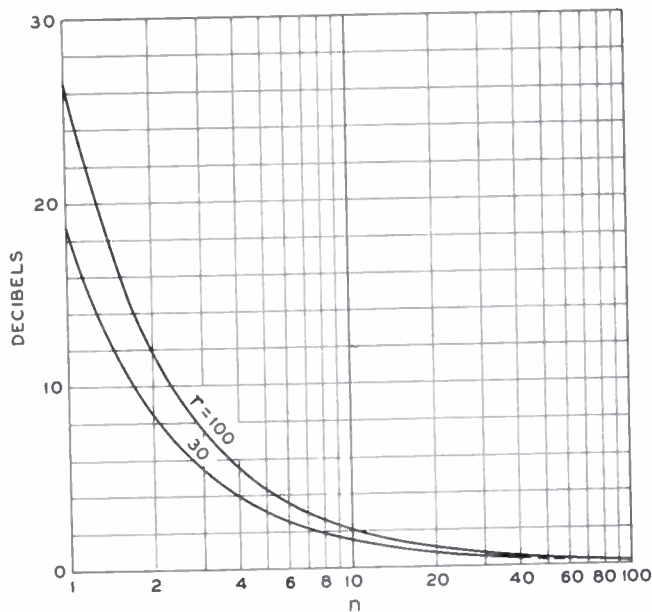

Fig. 4—Threshold noise penalty.

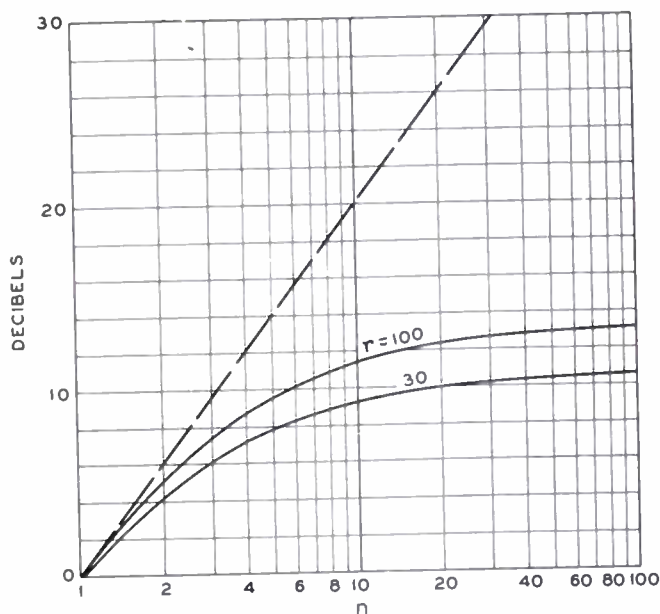

Fig. 5—Relative sensitivity to level changes.

The received signal may be disturbed in other ways besides the addition of noise or interference. When the direct path transmission is poor, as when the receiver is located behind buildings or a hill, reflection off aircraft by combining in and out of phase with the direct ray can produce large level fluctuations. Unless the receiver is provided with a fast automatic volume control, these signal level changes will appear in the picture. If the signal is clamped in the receiver at $A=0$, then the brightness fluctuations will be most pronounced in the highlights. The relative sensitivity of various receiving brightness characteristics to level changes when the signal is clamped at $A=0$ is thus given by the relative values of s at $b=b_{max}$. In Fig. 5, $20 \log s$ at $b=b_{max}$ is plotted against n for $r=100$, and $r=30$ (solid curves). The dashed line in Fig. 5 shows the relative sensitivity to

level changes, for all r , when the signal is clamped at a level corresponding to $b=0$ (cutoff). The effect is larger in this case but corresponds to a pure brightness change, with no effect on picture contrast, as will be seen later.

Summarizing the above briefly, then, we may say that the lower the exponent of the receiver brightness characteristic, the greater will be the sensitivity to changes which affect the signal amplitude in the shadows, and the smaller will be the sensitivity to changes which affect the signal amplitude in the highlights.

It should be mentioned that the receiver exponent need not be fixed by the picture tube characteristic alone. The video amplifier can easily be made nonlinear so as to raise or lower the exponent considerably, but this nonlinearity must be introduced *after* the de rein-

*m*th Root Transmitter, Exponential Receiver

From (1) and (6)

$$x = \exp \left[\frac{X^{1/m} - 1}{R^{1/m} - 1} \ln r \right] \tag{11}$$

From (3) and (8)

$$g = \frac{\ln r}{m} \frac{X^{1/m}}{R^{1/m} - 1} \tag{12}$$

Logarithmic Transmitter, *n*th Power Receiver

From (2) and (5)

$$x = \left[1 + (r^{1/n} - 1) \frac{\log X}{\log R} \right]^n \tag{13}$$

V. OVER-ALL BRIGHTNESS CHARACTERISTICS

The expressions given in the previous two sections can readily be combined to give expressions for any combination of transmitter and receiver. Aside from camera color response and halation effects which are not representable here, the over-all brightness characteristic completely defines the system so far as tone rendition is concerned, but in addition it is useful to know another quantity: the system gradient, g . This is the slope of the over-all brightness characteristic when plotted on log paper, and is defined as:

$$g = \frac{d(\ln b)}{d(\ln B)} = \frac{db}{dB} \frac{b}{B}$$

A 1 per cent change in scene brightness produces g per cent change in reproduced brightness. When $g > 1$, the contrast is enhanced; when $g < 1$, the contrast is reduced. In the curves to follow, g is plotted on a log scale. The rationale for this is that the suppression of contrast represented by $g = \frac{1}{2}$ or $\frac{1}{4}$, say, is as serious as the enhancement represented by $g = 2$ or 4, and that therefore any value of g should plot as far from the line $g = 1$ as the reciprocal of this value.

Because the m th root and n th power expressions become indeterminate when m or n is infinite, and must be replaced by the limiting logarithmic or exponential forms, four sets of expressions are necessary for the over-all characteristics. These are given below.

*m*th Root Transmitter, *n*th Power Receiver

From (1) and (5)

$$x = \left[1 + \frac{r^{1/n} - 1}{R^{1/n} - 1} (X^{1/m} - 1) \right]^n \tag{9}$$

From (3) and (7)

$$g = \frac{n}{m} \left[1 + \frac{R^{1/m} - 1}{(r^{1/n} - 1) X^{1/m}} \right]^{-1} \tag{10}$$

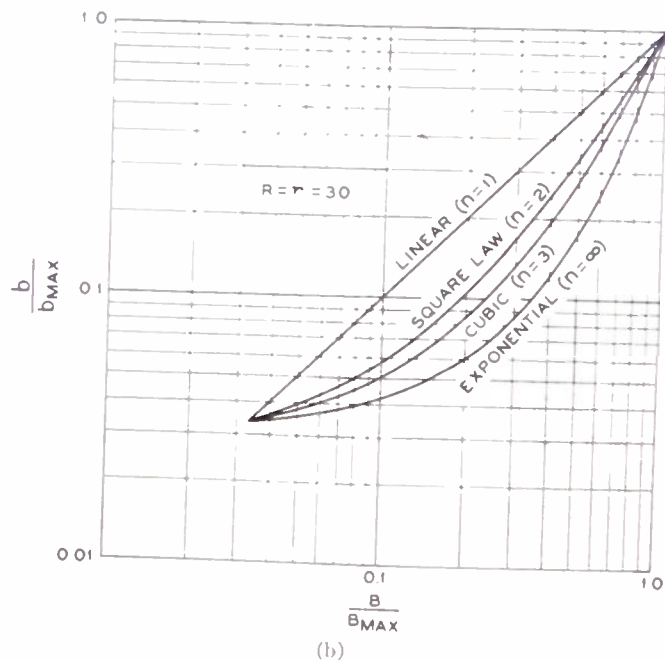
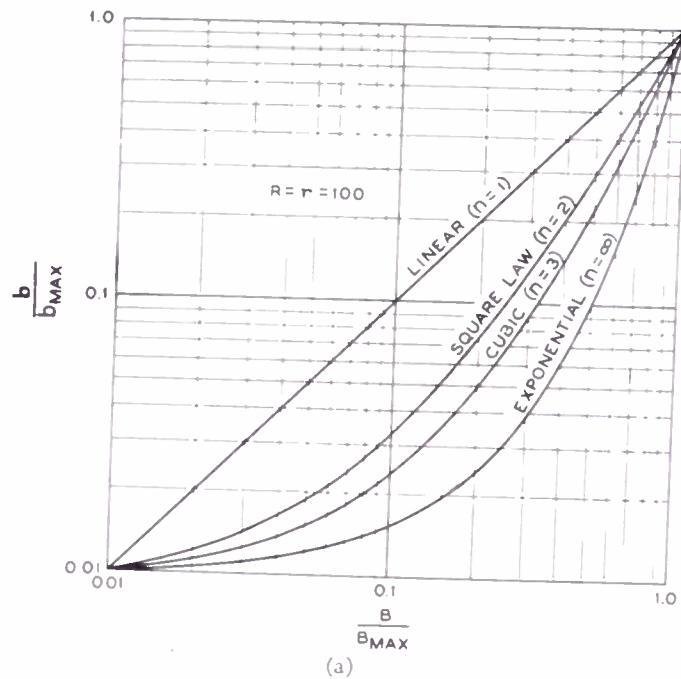

Fig. 6—Over-all brightness characteristics with a linear transmitter (a) $R=r=100$; (b) $R=r=30$.

From (4) and (7)

$$g = n \left[\ln X + \frac{\ln R}{r^{1/n} - 1} \right]^{-1} \quad (14)$$

Logarithmic Transmitter, Exponential Receiver

From (2) and (6)

$$x = \exp \left[\frac{\ln r}{\ln R} \ln X \right] \quad (15)$$

From (4) and (8)

$$g = \frac{\ln r}{\ln R} \quad (16)$$

Using these expressions, the brightness characteristics and the corresponding gradient curves have been calculated for three transmitters: linear, 2.5-root, and logarithmic, together with four receivers: linear, square law, cubic, and exponential, in all combinations. The receivers are assumed to be adjusted so that the reproduced brightness range, r is equal to the original scene brightness range R . Two cases are considered; the figures designated by the subscript a are for the case $R=r=100$, while those designated b are for the case $R=r=30$.

Figs. 6(a) and 6(b) show the over-all brightness characteristics which result from the use of a linear transmitter and various receivers, while Figs. 7(a) and 7(b)

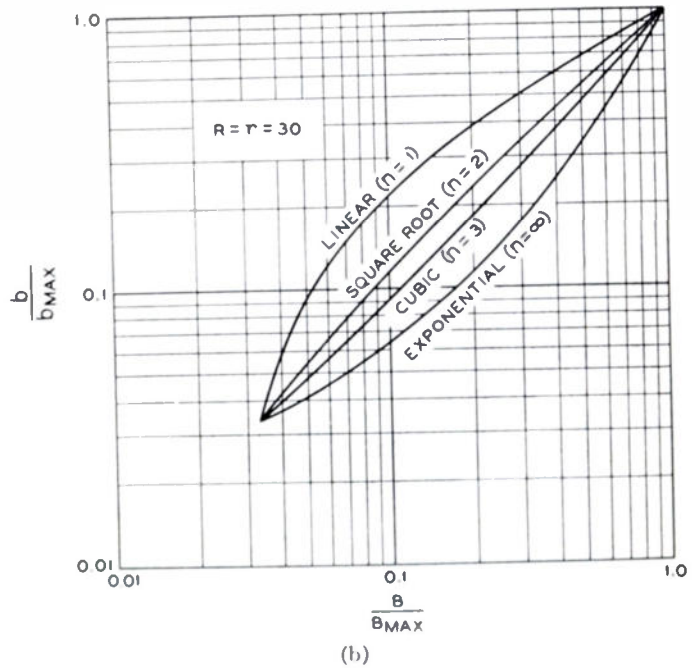
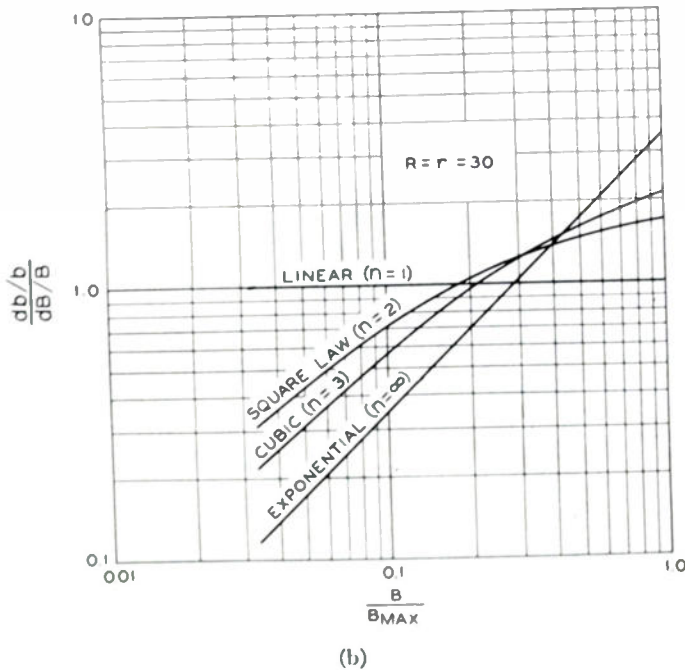
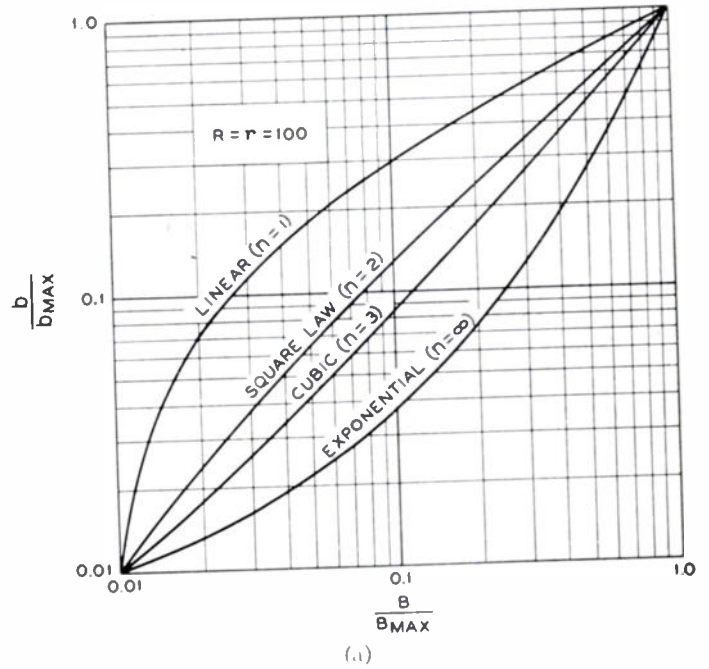
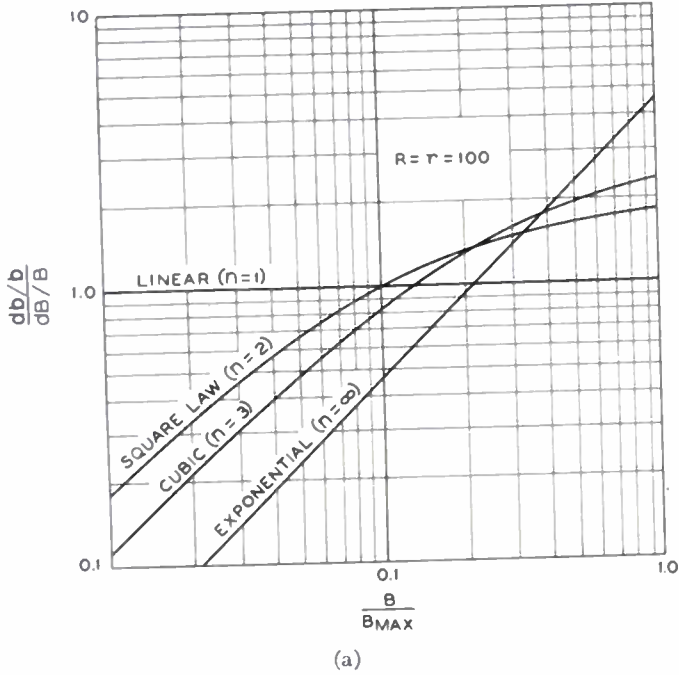

Fig. 7—Over-all gradient with a linear transmitter. (a) $R=r=100$; (b) $R=r=30$.

Fig. 8—Over-all brightness characteristics with a 2.5 root transmitter. (a) $R=r=100$; (b) $R=r=30$.

show the corresponding gradients. In this case, the linear receiver naturally gives linear brightness reproduction, while the (higher) power law receivers all show contrast suppression in the shadows and contrast enhancement in the highlights. When operated so that highlight saturation is avoided, many modern camera tubes are linear devices. The exponent n for typical cathode-ray tubes ranges from about two to three with the metal backed tubes lying near the upper end of this range. Thus the curves on Figs. 6 and 7 for $n=2$ and $n=3$ may be considered to bracket the range of brightness characteristics obtained with present-day camera and viewing tubes, when no gradient correction is em-

ployed. It will be seen from the curves that the contrast in the highlights is enhanced. This uses up most of the reproducing brightness range to portray a relatively narrow highlight range in the original, with the result that the shadow detail is all too dark, and the shadow contrast is suppressed.

Figs. 8(a) and 8(b) show the over-all brightness characteristics produced by a 2.5-root transmitter in combination with various receivers, while Figs. 9(a) and 9(b) show the corresponding gradients. With a 2.5-root transmitter, a 2.5-power receiver, properly adjusted, would give linear reproduction. It is evident from the curves that any receiver exponent lying between 2 and 3 is

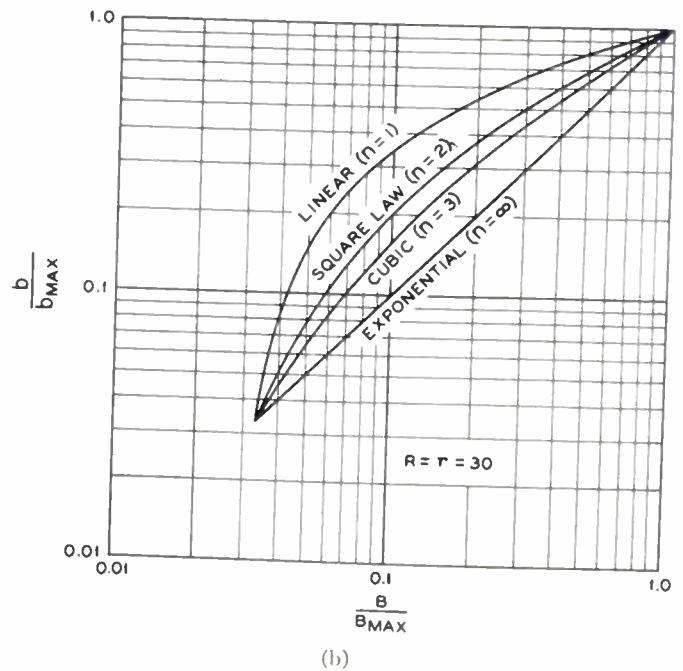
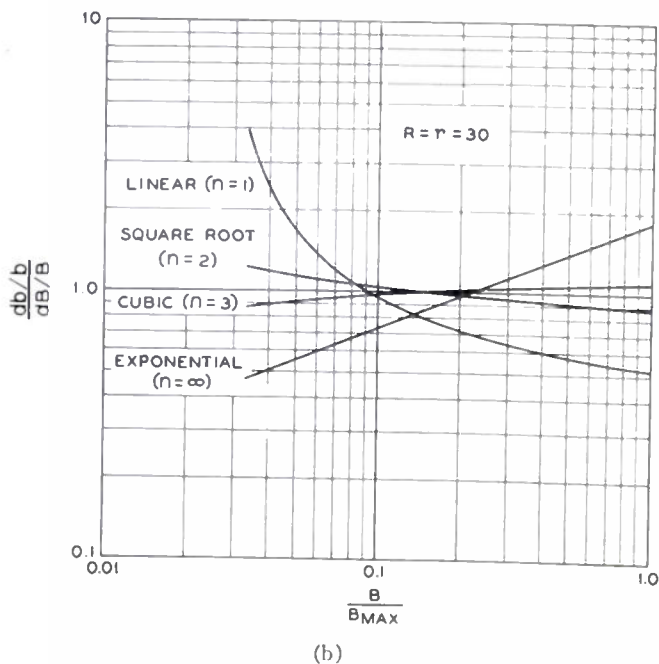
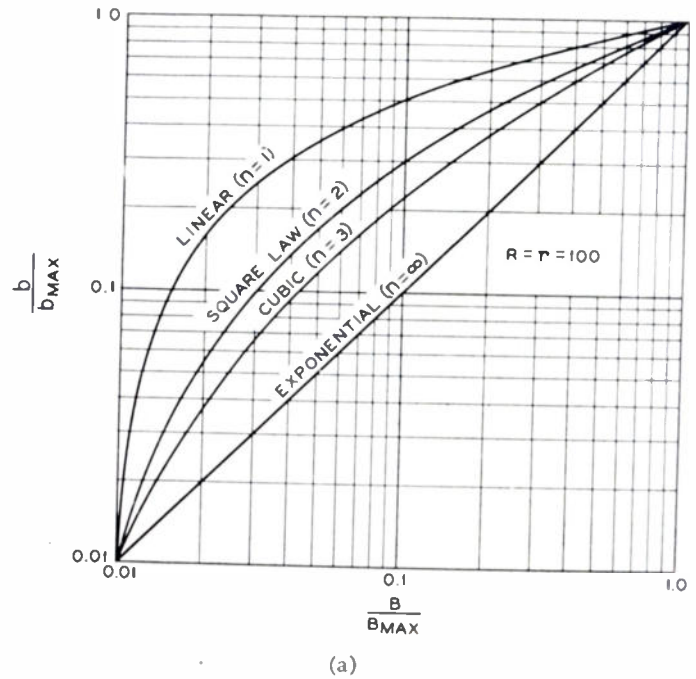
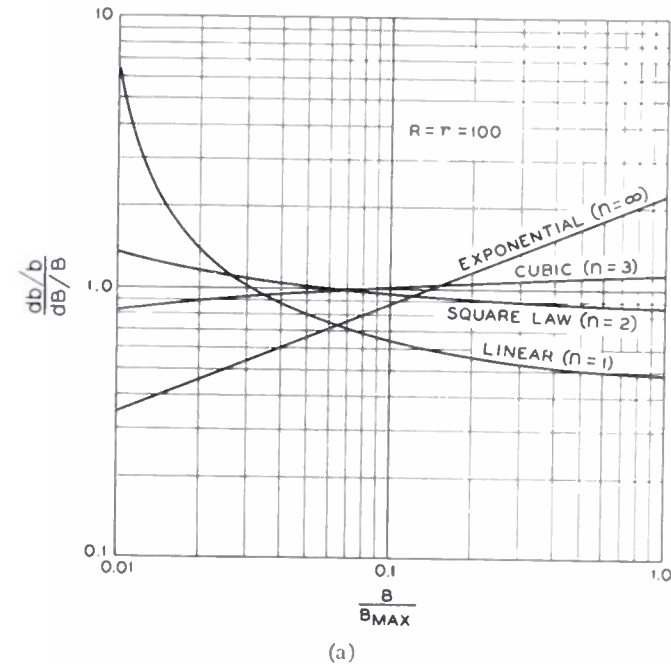

Fig. 9—Over-all gradients with a 2.5-root transmitter. (a) $R=r=100$; (b) $R=r=30$.

Fig. 10—Over-all brightness characteristics with a logarithmic transmitter. (a) $R=r=100$; (b) $R=r=30$.

not too bad a match. With $n=2$, the brightness in the middle of the range is only about 25 per cent too high, and with $n=3$ it is about 15 per cent too low. Also from the gradient curves it is apparent that the contrast in the reproduced image is nowhere seriously enhanced or suppressed for $2 < n < 3$.

Finally, Figs. 10(a) and 10(b) show the brightness characteristics obtained when the same four receivers are used with a logarithmic transmitter. Figs. 11(a)

and 11(b) are the corresponding gradients. Here the situation is the reverse of that obtained with a linear transmitter. The exponential receiving tube gives linear brightness reproduction while all the (lower) power law receivers show contrast enhancement in the shadows, and contrast suppression in the highlights. For the cases $n=2$ and $n=3$ the intermediate brightnesses are reproduced much too brightly. Most of the available reproducing range is absorbed in exaggerating the contrast in the shadows.

These figures show that if the brightness range of the reproduced picture is set approximately equal to the brightness range of the original subject matter, then neither a linear transmitter nor a logarithmic transmitter comes close to producing an over-all linear characteristic when used with receiver characteristics having exponents on the order of 2 to 3. Furthermore, it is evident that a 2.5-root transmitter characteristic provides a reasonably good match, with receiver characteristics having exponents lying anywhere in the range from 2 up to 3 or 4.

Up to this point, all the over-all brightness characteristics and gradients we have considered have assumed the reproduced brightness range r to be equal to the original scene brightness range R . The over-all gradient is then constant and equal to unity when the transmitter and receiver exponents are matched, i.e., when $m=n$. From (10) it will be seen that for an m th root transmitter and an n th power receiver, the gradient will be constant, and equal to n/m , if

$$r^{1/n} = R^{1/m}$$

$$r = R^{n/m}$$

This is also the adjustment which would make physical black in the image coincide with physical black in the

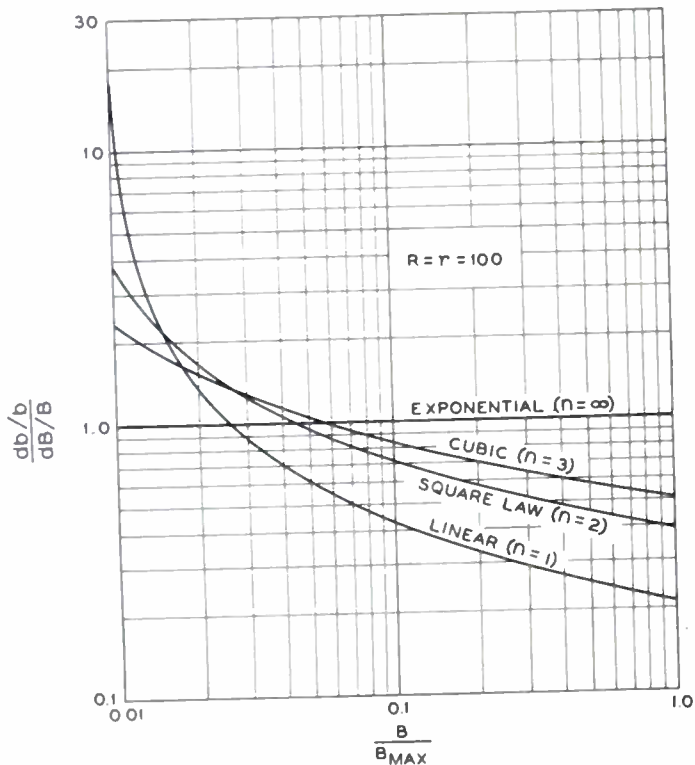

(a)

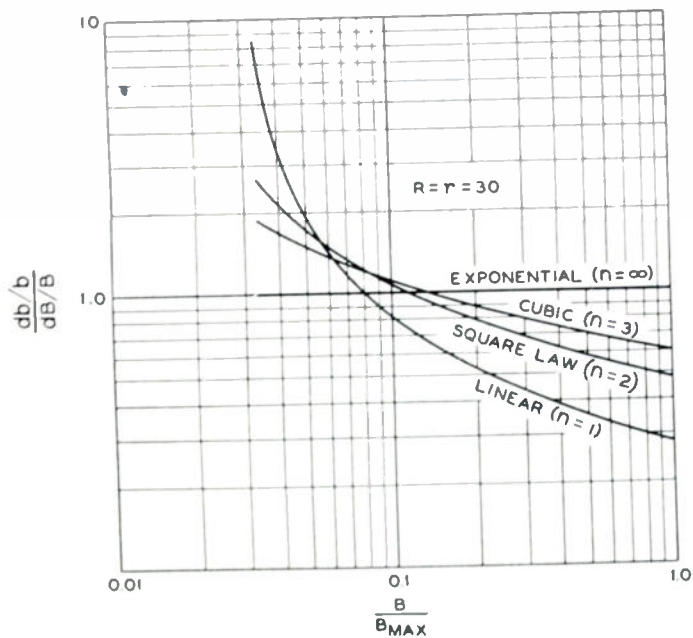

(b)

Fig. 11—Over-all gradients with a logarithmic transmitter. (a) $R=r=100$; (b) $R=r=30$.

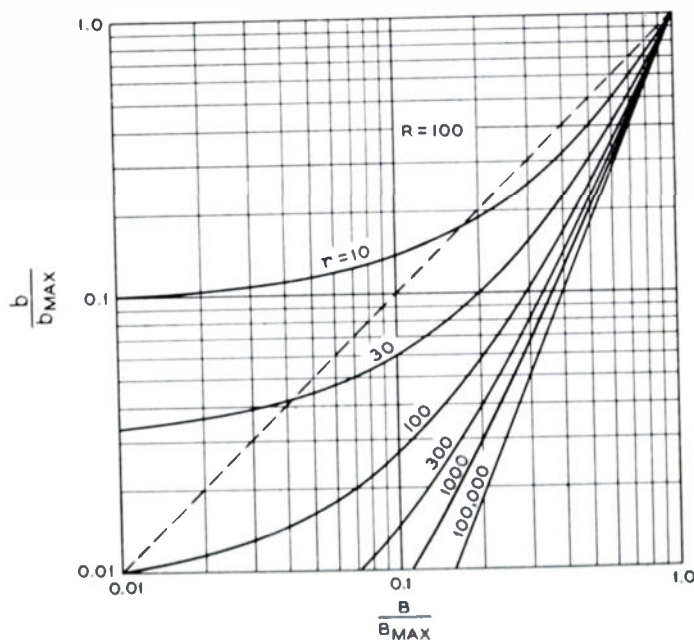

Fig. 12—Over-all brightness characteristics of a linear transmitter, 2.5-power receiver.

original, provided the assumed brightness characteristics held over that range. If g is constant in a given system we may integrate directly and obtain the same result:

$$\int_{b_{\min}}^{b_{\max}} \frac{db}{b} = g \int_{B_{\min}}^{B_{\max}} \frac{dB}{B}$$

$$\log \left(\frac{b_{\max}}{b_{\min}} \right) = g \log \left(\frac{B_{\max}}{B_{\min}} \right)$$

$$r = R^g.$$

The average gradient, \bar{g} , of any system, may be defined

as the gradient of a constant gradient system having the same R and r as the system in question. Thus $\bar{g} \equiv \log r / \log R$.

In photography the term "gamma" is commonly used to denote the maximum gradient of the over-all photographic process, i.e., $\gamma = g_{\max}$. The actual gradient will be equal to γ at only one point in the range (or at most over a relatively small range of brightness). At higher or lower brightnesses, the gradient will be less than γ . The average gradient, \bar{g} , will therefore also be less than γ , and may in some cases, be less than unity. The fact that good pictures are often made with γ on the order

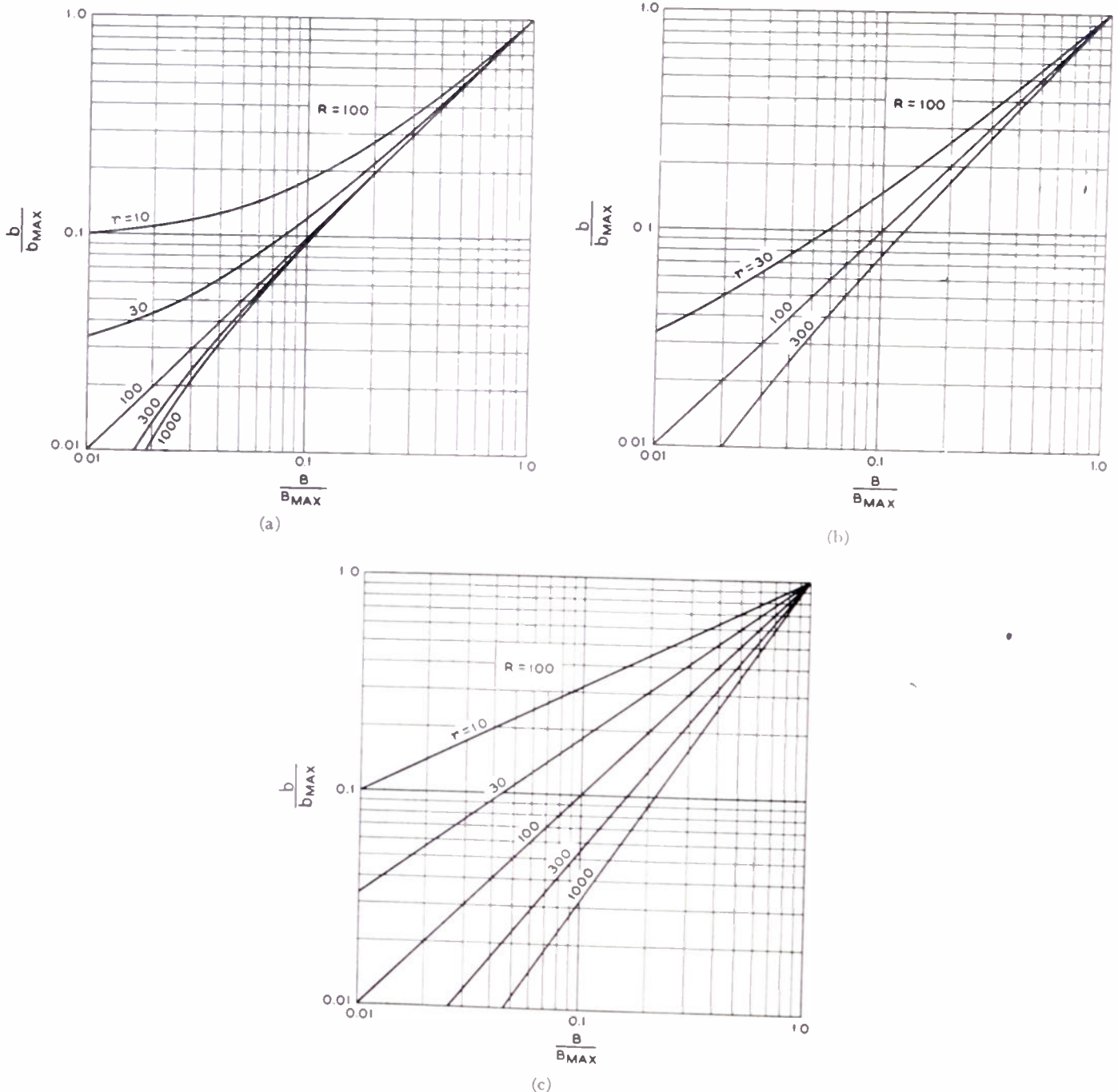

Fig. 13 Over-all brightness characteristics of (a) linear transmitter and linear receiver, $R = 100$; (b) 2.5-root transmitter and 2.5-power receiver, $R = 100$; (c) logarithmic transmitter, and an exponential receiver, $R = 100$.

of 1.5 is thus certainly no justification for assuming that a constant gradient system with $g = 1.5$ would be desirable in television.

To reproduce an original brightness range of 100 to 1 with a constant gradient of 1.5 requires a brightness range of 1,000 to 1 in the reproducing means. Conversely, if the reproducing means has a usable brightness range of 100 to 1, then the range of original scene brightnesses which can be reproduced with a constant gradient of 1.5 is only 21.5 to 1. In a constant gradient system, therefore, g cannot be much greater than unity without either demanding an excessive brightness range in the reproducer or else seriously limiting the usable brightness range of the subject matter.

In television, the reproduced brightness range is under control of the receiver operator. He can vary the so-called "brightness" and "contrast" controls to suit himself, and thus has at his disposal a whole family of brightness characteristics. Fig. 12 shows some of the possible characteristics obtainable when the transmitter is linear and the receiver obeys a 2.5-power law. The curves are all concave upward for $r < 100,000$. For $r = 100,000 = 100^{2.5}$, the gradient is constant and equal to 2.5.

Figs. 13(a), (b), and (c) show the types of characteristics obtained for various r and with $m = n = 1, 2.5,$ and ∞ . Comparing these figures, it will be seen that when $r \neq R$, the system gradient becomes more nearly constant as $m = n$ is increased. With the matched linear system ($m = n = 1$) of Fig. 13(a), the increase or decrease in r is produced principally by gradient changes in the shadows with relatively little effect upon the highlights. Small changes in r distort the shadow repro-

over the brightness range, and relatively large changes in r can be accommodated without serious contrast suppression or enhancement in any particular part of the range. Finally, a logarithmic transmitter, exponential receiver combination ($m = n = \infty$) is inherently a constant gradient system as may be seen from Fig. 13(c). Regardless of r , the gradient will be constant over the range and will be given by $g = \log r / \log R$.

Fig. 14 shows part of the family of characteristics obtainable with a logarithmic transmitter and a 2.5-power receiver. All these characteristics are markedly convex upward. Contrast, and camera noise in the shadows is enhanced for all values of r greater than 14. No setting of the controls results in a linear characteristic (except the trivial case $r = 1$). The characteristics are, if anything, less usable than those for the linear transmitter.

VI. CHANGE OF OPERATING CONDITIONS

In this section we shall assume that transmitter and receiver are matched, i.e., that $m = n$, and investigate the effect on the brightness characteristic of a change in operating conditions, for various values of n .

Suppose the bias control in the receiver is maladjusted, or the bias potential drifts, or the setup in the signal changes. What effect does this have? If the bias control and gain control in the receiver are set initially so that $r = R$, then the brightness characteristic will be a straight line of unity slope for all $m = n$, as shown by the line marked *A* in Fig. 15. If now, for any reason,

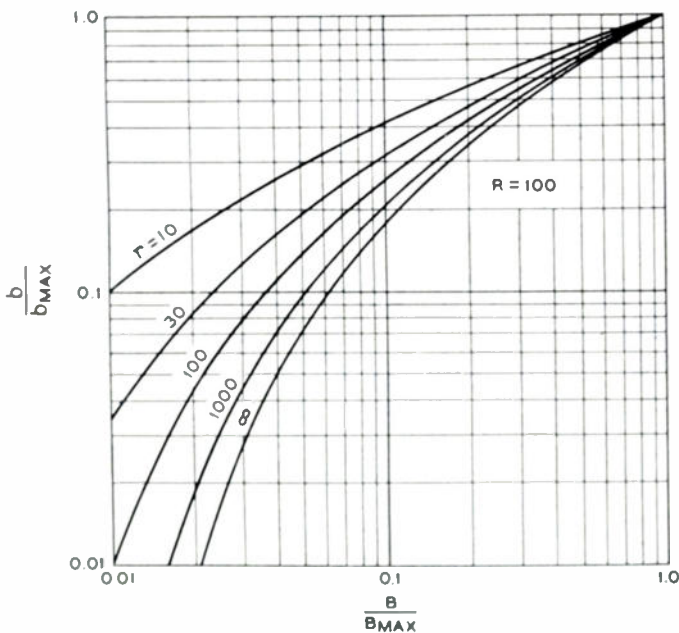

Fig. 14—Over-all brightness characteristics of a logarithmic transmitter, 2.5-power receiver; $R = 100$.

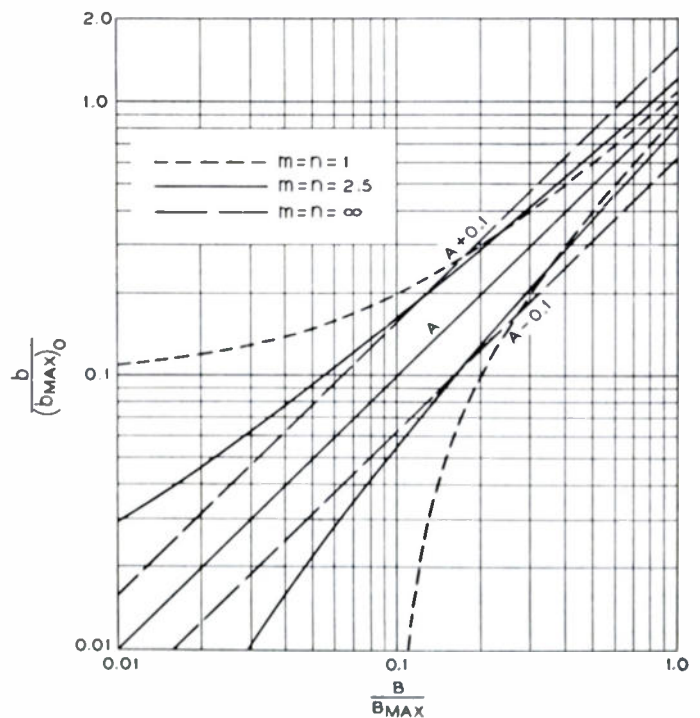

Fig. 15—The effect of 10 per cent bias shift.

duction greatly. For higher $m = n$ the deviation from linear reproduction (i.e., $g = 1$) is spread more uniformly

the applied signal shifts by 10 per cent in the white direction, so that all signal amplitudes are changed from *A* to *A* + 0.1, the resulting characteristics for different

$m = n$ are as shown by the curves marked $A + 0.1$. Similarly if the applied signal shifts 10 per cent in the black direction, we obtain the set of curves marked $A - 0.1$. Fig. 16 shows the gradient curves under these same conditions.

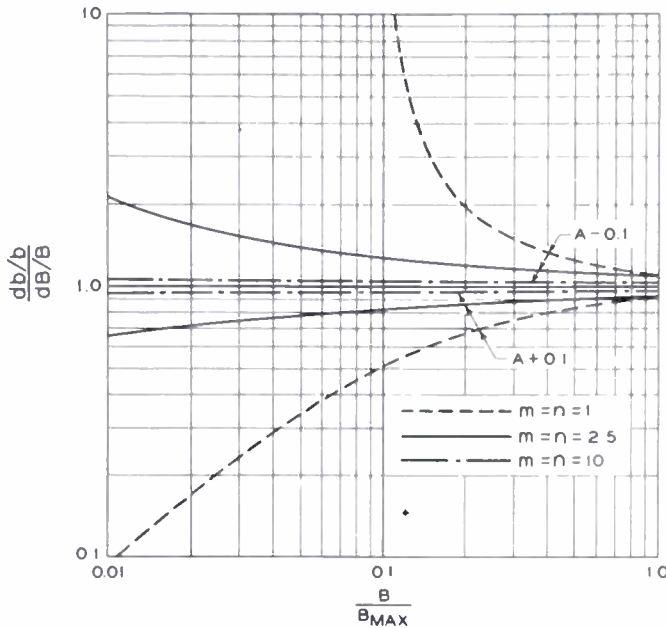

Fig. 16—The effect of 10 per cent bias shift.

Obviously the linear system ($m = n = 1$) is very sensitive to these bias changes. With such a system, the setup at the transmitter and the bias control at the receiver would be very critical. Small changes would wreck the picture quality. The way in which the brightness characteristic for the linear system swings around at the low brightness end with small bias shifts is in keeping with the high noise sensitivity of a linear receiver for low brightness. Both bias changes and noise are signals added to the correct signal.

As the system exponent is increased, the effect of bias shift becomes less at low brightnesses and greater at high brightnesses, as one might expect. Finally for $m = n = \infty$, a bias shift produces only a change in brightness. The characteristics remain straight lines of unity slope, and all reproduced brightnesses are increased or decreased by the same factor.

Fig. 17 shows what happens to the initially linear brightness characteristic when the signal amplitude is changed by 10 per cent; that is from A to $1.1A$ or $0.9A$. In this figure it is assumed that the signal is clamped at $A = 0$ (black level) in the receiver. As a result, no change in brightness is produced at $b = b_{min}$, but the gradient is changed to 1.1 or 0.9 at this brightness for all system exponents. This change in initial gradient is maintained over the entire range for the logarithmic—exponential system ($m = n = \infty$) and the effect may be described as a “gradient change of 10 per cent” with the brightness corresponding to the clamping level held constant. With the linear system ($m = n = 1$) the initial contrast

change at $b = b_{min}$ is not maintained over the range, and the gradient rapidly reverts to unity at the higher brightnesses. As a result the characteristics for $m = n = 1$ diverge less than those for $m = n = \infty$, and less brightness change in the highlights is produced. The curves for $m = n = 2.5$ are naturally intermediate to the others. The highlight brightness change produced by the 10 per cent signal amplitude change is about 10 per cent

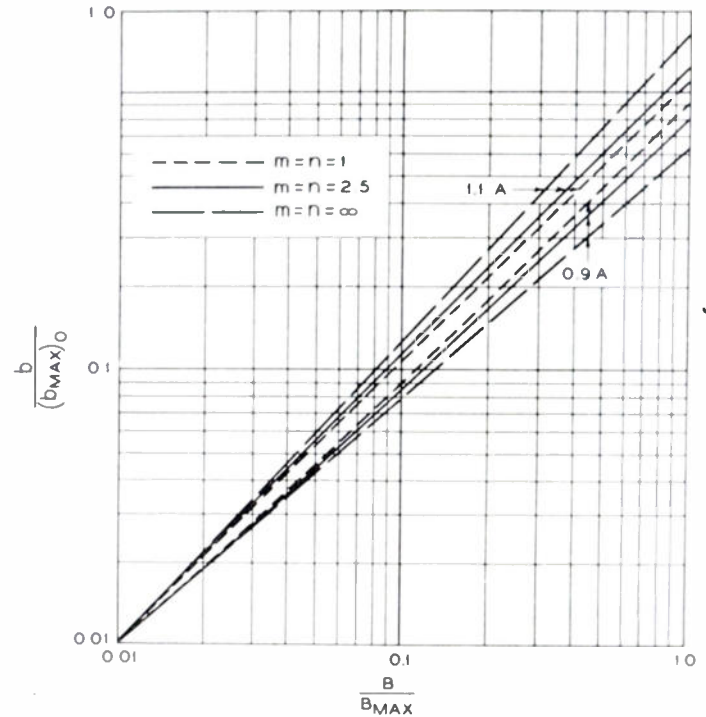

Fig. 17—The effect of 10 per cent change in signal amplitude, signal clamped at $A = 0$

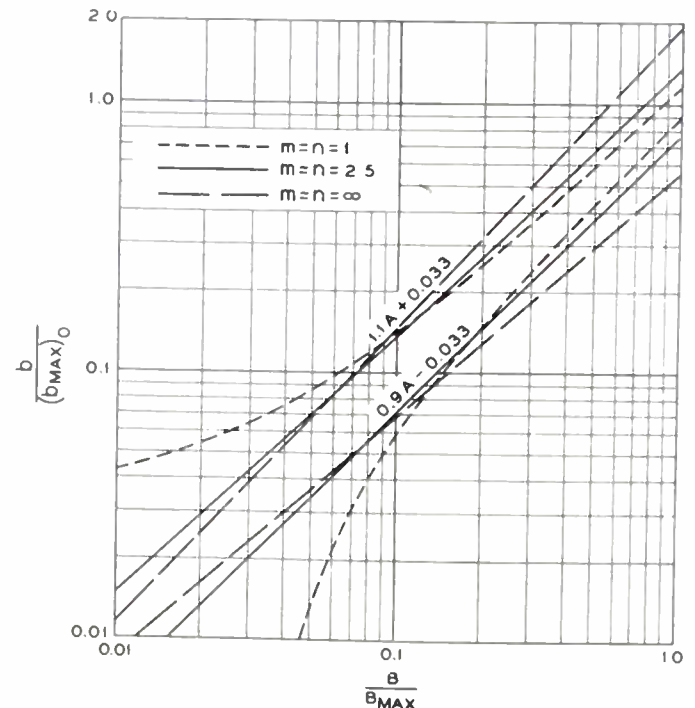

Fig. 18—The effect of 10 per cent change in signal amplitude, signal clamped at $A = -1/3$.

for $m=n=1$, 23 per cent for $m=n=2.5$, and 59 per cent for $m=n=\infty$. These figures are in accord with the earlier curves for the relative sensitivity of various receivers to level changes.

Most receivers do not clamp the signal at black level, but rather reinsert the dc by "bouncing" off the sync peaks. This corresponds to clamping the signal at $A = -\frac{1}{3}$. The effect of a 10 per cent level change under this type of operation is shown on Fig. 18. The applied signal is now changed from A to $1.1A + 0.033$ or to $0.9A - 0.033$ and the corresponding curves are so marked. The effect on the system for which $m=n=2.5$, it will be seen, is substantially that of a pure brightness change.

In many more recent receivers, the dc developed by the second detector is preserved by using dc coupling in the video amplifier. Since zero rf signal corresponds roughly to the maximum scene brightness, this amounts to clamping the signal at approximately $A=1$. The brightness characteristics resulting from a 10 per cent signal amplitude change under this type of operation are shown in Fig. 19. The highlight brightness now is unaffected, as we might expect. The linear system now shows the greatest variation, and the logarithmic-exponential system the least, while the 2.5-root-2.5-power system again is intermediate.

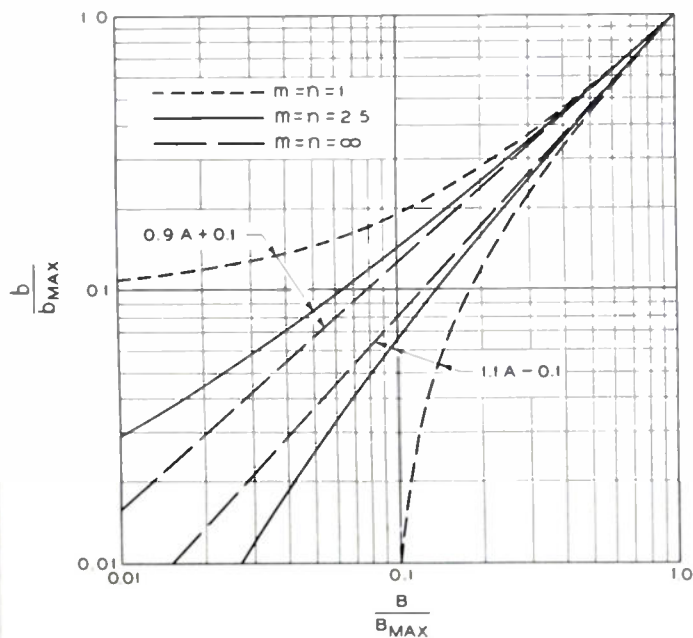

Fig. 19—The effect of 10 per cent change in signal amplitude, signal clamped at $A=1$.

Apparently, then, a linear receiver is undesirable because of its extreme sensitivity to changes which affect the signal amplitude in the shadows. Certainly n (and m) should be at least two to avoid undue trouble from this cause. On the other hand, unless the signal is clamped somewhere near "white" level ($A=1$), very high values of n (and therefore m) are undesirable from the standpoint of level changes. If the use of dc coupled

TABLE I

System	Good Features	Bad Features
n Small (any m)	Insensitive to level changes if clamped at $A=0$ Good correction for stray light possible	Sensitive to level changes if clamped at $A \neq 0$ Sensitive to bias changes and added noise
n Large (any m)	Fairly insensitive to level changes if clamped at $A \approx 1$	Sensitive to level changes if clamped at $A=0$
$m \ll n$	Insensitive to bias changes and added noise	Contrast in shadows suppressed Contrast in highlights enhanced Small usable range of scene brightness Very sensitive to stray light
$m \gg n$	Large usable range of scene brightness Less sensitive to stray light than $m \leq n$	Contrast and camera noise in shadows enhanced Contrast in highlights suppressed
$m \approx n$ (both small)		r and R must be nearly equal to avoid serious contrast distortion in shadows
$m \approx n$ (both large)	r can be varied widely with serious distortion in any one part of brightness range	

video amplifiers were adopted as standard practice, however, there would be little reason not to make m and n both quite large.

VII. STRAY LIGHT

The effect of a uniform ambient illumination of the reproducing screen is to add a constant brightness increment to all parts of the reproduced picture. If the overall system is adjusted to a linear characteristic ($g=1$) in the absence of stray light, then the principal effect of the stray light will be to "fill up" the shadows and reduce the contrast in those portions of the picture. The effect of stray light can be reduced by readjusting the receiver so that the contrast in the shadows is again increased. Not all receiver characteristics are equally suitable in this respect.

A linear receiver has the property that a simple bias change adds or subtracts a constant brightness increment over the entire brightness range (see Fig. 15). By merely changing the bias control on a linear receiver, therefore, one can subtract off the brightness added by the stray light, so that over the brightness range between the highlight brightness and that produced by the stray light alone, linear reproduction is restored. At signal amplitude corresponding to brightnesses below that produced by the stray light alone, the receiver is, of course, completely cut off, and all detail in these portions is lost. For example, if the stray light produced a screen brightness of one-tenth the highlight brightness, then the linear receiver might be biased so that the operation were along the curve $A=0.1$, $m=n=1$, in Fig. 15.

$m = n$ are as shown by the curves marked $A + 0.1$. Similarly if the applied signal shifts 10 per cent in the black direction, we obtain the set of curves marked $A - 0.1$. Fig. 16 shows the gradient curves under these same conditions.

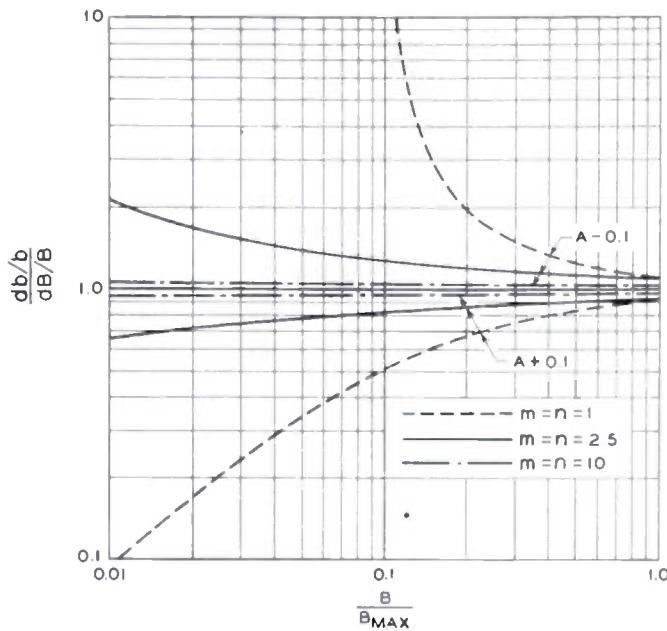

Fig. 16—The effect of 10 per cent bias shift.

Obviously the linear system ($m = n = 1$) is very sensitive to these bias changes. With such a system, the setup at the transmitter and the bias control at the receiver would be very critical. Small changes would wreck the picture quality. The way in which the brightness characteristic for the linear system swings around at the low brightness end with small bias shifts is in keeping with the high noise sensitivity of a linear receiver for low brightness. Both bias changes and noise are signals added to the correct signal.

As the system exponent is increased, the effect of bias shift becomes less at low brightnesses and greater at high brightnesses, as one might expect. Finally for $m = n = \infty$, a bias shift produces only a change in brightness. The characteristics remain straight lines of unity slope, and all reproduced brightnesses are increased or decreased by the same factor.

Fig. 17 shows what happens to the initially linear brightness characteristic when the signal amplitude is changed by 10 per cent; that is from A to $1.1A$ or $0.9A$. In this figure it is assumed that the signal is clamped at $A = 0$ (black level) in the receiver. As a result, no change in brightness is produced at $b = b_{min}$, but the gradient is changed to 1.1 or 0.9 at this brightness for all system exponents. This change in initial gradient is maintained over the entire range for the logarithmic-exponential system ($m = n = \infty$) and the effect may be described as a "gradient change of 10 per cent" with the brightness corresponding to the clamping level held constant. With the linear system ($m = n = 1$) the initial contrast

change at $b = b_{min}$ is not maintained over the range, and the gradient rapidly reverts to unity at the higher brightnesses. As a result the characteristics for $m = n = 1$ diverge less than those for $m = n = \infty$, and less brightness change in the highlights is produced. The curves for $m = n = 2.5$ are naturally intermediate to the others. The highlight brightness change produced by the 10 per cent signal amplitude change is about 10 per cent

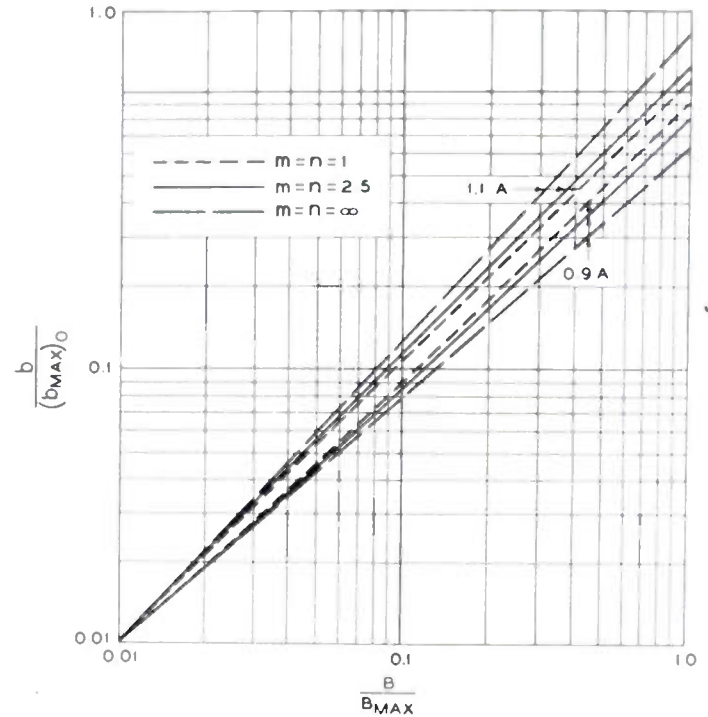

Fig. 17—The effect of 10 per cent change in signal amplitude, signal clamped at $A = 0$

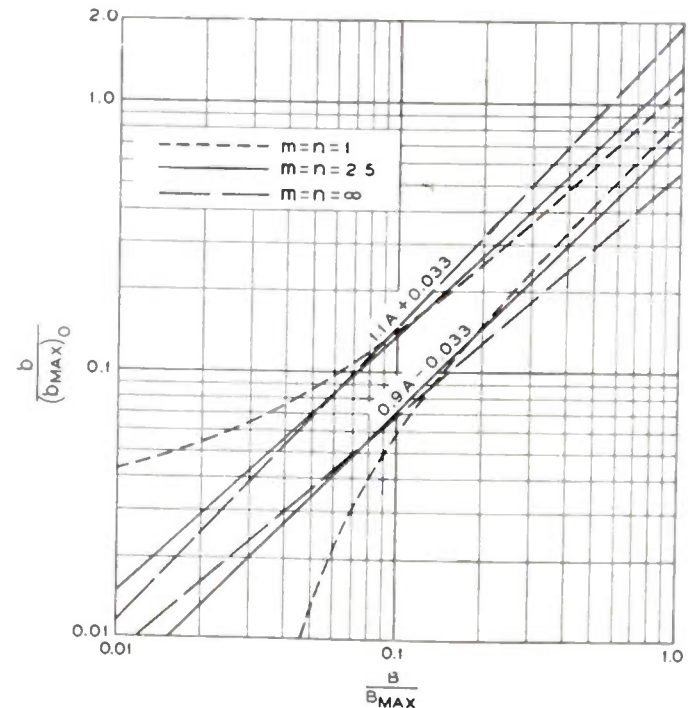

Fig. 18—The effect of 10 per cent change in signal amplitude, signal clamped at $A = -1/3$.

for $m=n=1$, 23 per cent for $m=n=2.5$, and 59 per cent for $m=n=\infty$. These figures are in accord with the earlier curves for the relative sensitivity of various receivers to level changes.

Most receivers do not clamp the signal at black level, but rather reinsert the dc by "bouncing" off the sync peaks. This corresponds to clamping the signal at $A = -\frac{1}{3}$. The effect of a 10 per cent level change under this type of operation is shown on Fig. 18. The applied signal is now changed from A to $1.1A + 0.033$ or to $0.9A - 0.033$ and the corresponding curves are so marked. The effect on the system for which $m=n=2.5$, it will be seen, is substantially that of a pure brightness change.

In many more recent receivers, the dc developed by the second detector is preserved by using dc coupling in the video amplifier. Since zero rf signal corresponds roughly to the maximum scene brightness, this amounts to clamping the signal at approximately $A=1$. The brightness characteristics resulting from a 10 per cent signal amplitude change under this type of operation are shown in Fig. 19. The highlight brightness now is unaffected, as we might expect. The linear system now shows the greatest variation, and the logarithmic-exponential system the least, while the 2.5-root-2.5-power system again is intermediate.

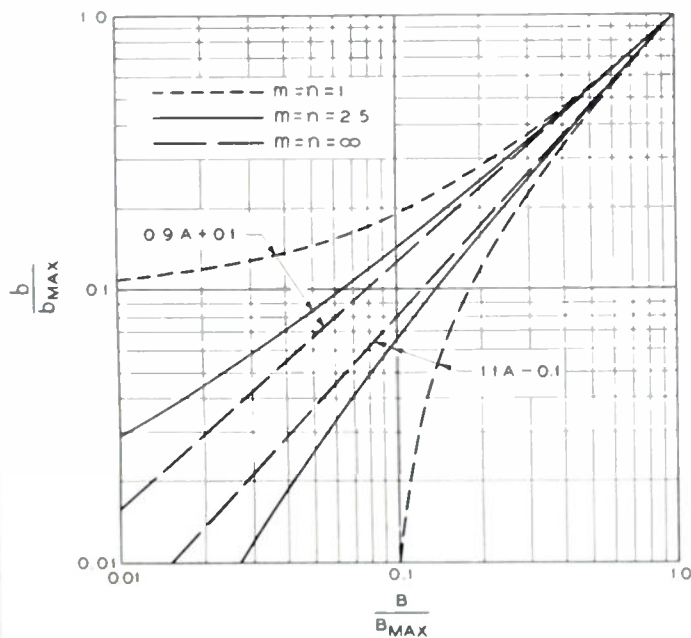

Fig. 19—The effect of 10 per cent change in signal amplitude, signal clamped at $A=1$.

Apparently, then, a linear receiver is undesirable because of its extreme sensitivity to changes which affect the signal amplitude in the shadows. Certainly n (and m) should be at least two to avoid undue trouble from this cause. On the other hand, unless the signal is clamped somewhere near "white" level ($A=1$), very high values of n (and therefore m) are undesirable from the standpoint of level changes. If the use of dc coupled

TABLE I

System	Good Features	Bad Features
n Small (any m)	Insensitive to level changes if clamped at $A=0$ Good correction for stray light possible	Sensitive to level changes if clamped at $A \neq 0$ Sensitive to bias changes and added noise
n Large (any m)	Fairly insensitive to level changes if clamped at $A \approx 1$	Sensitive to level changes if clamped at $A=0$
$m \ll n$	Insensitive to bias changes and added noise	Contrast in shadows suppressed Contrast in highlights enhanced Small usable range of scene brightness Very sensitive to stray light
$m \gg n$	Large usable range of scene brightness Less sensitive to stray light than $m \leq n$	Contrast and camera noise in shadows enhanced Contrast in highlights suppressed
$m \approx n$ (both small)		r and R must be nearly equal to avoid serious contrast distortion in shadows
$m \approx n$ (both large)	r can be varied widely with serious distortion in any one part of brightness range	

video amplifiers were adopted as standard practice, however, there would be little reason not to make m and n both quite large.

VII. STRAY LIGHT

The effect of a uniform ambient illumination of the reproducing screen is to add a constant brightness increment to all parts of the reproduced picture. If the overall system is adjusted to a linear characteristic ($g=1$) in the absence of stray light, then the principal effect of the stray light will be to "fill up" the shadows and reduce the contrast in those portions of the picture. The effect of stray light can be reduced by readjusting the receiver so that the contrast in the shadows is again increased. Not all receiver characteristics are equally suitable in this respect.

A linear receiver has the property that a simple bias change adds or subtracts a constant brightness increment over the entire brightness range (see Fig. 15). By merely changing the bias control on a linear receiver, therefore, one can subtract off the brightness added by the stray light, so that over the brightness range between the highlight brightness and that produced by the stray light alone, linear reproduction is restored. At signal amplitude corresponding to brightnesses below that produced by the stray light alone, the receiver is, of course, completely cut off, and all detail in these portions is lost. For example, if the stray light produced a screen brightness of one-tenth the highlight brightness, then the linear receiver might be biased so that the operation were along the curve $A=0.1$, $m=n=1$, in Fig. 15.

signal is applied to a linear current generator which drives a nonlinear impedance with a current directly proportional to the brightness of the area being scanned. The output stage is, in turn, driven by the voltage across this nonlinear impedance—the “rooted” signal—and delivers its output to the line. We merely need, then, a suitable nonlinear impedance.

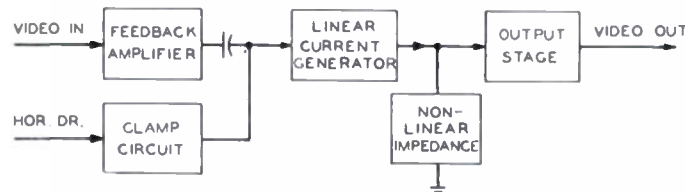

Fig. 2—Block diagram of rooter.

The plate current-versus-grid voltage characteristic of a triode, like the brightness characteristic of a cathode-ray tube, can be closely approximated by a power-law relation. In some tubes the exponent of this power law is quite high. Fig. 3 shows the plate current-versus-cathode voltage characteristic of a 2C51 with 150 volts on the plate and -7 volts fixed bias on the grid. Under

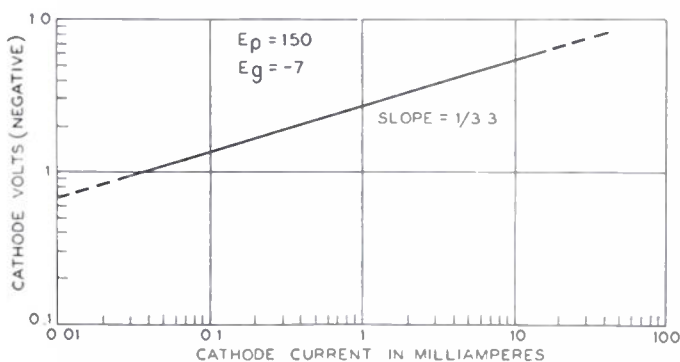

Fig. 3—Cathode current-voltage curve of 2C51.

these conditions, the plate current is quite closely proportional to the 3.3 power of the cathode voltage, i.e.,

$$I_p = KE_c^{3.3}. \quad (2)$$

Now either I_p or E_c may be considered to be the independent variable here. If the cathode is driven from a high impedance source so that the cathode current is specified, then the cathode will assume the potential required by (2) and this potential will be proportional to the 3.3 root of the applied current. This is the principle used in the present rooter.

CIRCUIT DETAILS

Fig. 4 is a schematic diagram of the complete rooter circuit including the clamp circuit.

The feedback amplifier comprises the first two tubes (404-A's) in the upper row. A 75-ohm potentiometer terminates the input cable and serves to adjust the in-

put level to the amplifier to the proper value of 0.5 volt maximum peak to peak. The applied signal must be of the standard polarity, i.e., black negative, and should not contain any excursions more negative than black level (no sync pulses). The feedback amplifier has about 20-db loop gain from low frequencies up to 4 Mc. Above 4 Mc, the loop gain falls first at 12, and then a 6 db per octave, and gain crossover is at about 14 Mc. The external gain is 26 db and is flat within about 0.2 db to 10 Mc.

The output signal from the feedback amplifier (10 volts maximum peak to peak) is applied through a 1,000- $\mu\mu\text{f}$ coupling condenser to the grid of the third 404-A. The potential drop across the 1,000- $\mu\mu\text{f}$ condenser is adjusted as required at the start of every line, by current from the clamp circuit. The clamp circuit makes ground potential on the grid of the third 404-A correspond to black at all times. The potential of this grid thus varies over the range 0 (black) to $+10$ volts (maximum white) depending on the signal. This tube is the linear current generator. It is linear because of the 18 to 20 db of local feedback provided by the unby-passed cathode resistor. It is a current generator because the plate resistance is very high compared with the load impedance. Since this stage must have flat transmission clear down to dc, the screen voltage is obtained from a gas-tube regulated supply rather than from the usual dropping resistor—bypass condenser combination.

The “black current” in the driver stage just described (i.e., the plate current corresponding to black in the picture) is about 4 ma. All but about 100 μa of this current are drawn through the 24,000-ohm fixed and 0 to 25,000-ohm variable resistors from $B+$. The remainder of the current demanded by the driver tube flows through the left half of the 2C51 and the 100-ohm resistor in series with the cathode of this tube. The nonlinear impedance shown in the block diagram thus consists of the cathode impedance of a 2C51 in series with 100 ohms, and a shunt of 24,000 ohms to 49,000 ohms around this combination. The effect of the linear resistances is to dilute the nonlinear resistance of the 2C51 cathode so that the combination obeys a power law with a smaller exponent than the 2C51 alone, as will be shown later.

The grid of the rooter tube (the left half of the 2C51) is connected to the screen supply of the driver tube. This screen supply thus effectively becomes the “ground” or reference end of the nonlinear impedance. Variations in this supply voltage will cause corresponding variations in the plate potential of the driver tube. In order to suppress these variations in the output stage (the right half of the 2C51) the cathode of this section is also returned to the screen supply. Bias for this section is obtained by the tube current as well as the screen supply current flowing through a 560-ohm cathode circuit resistor. Since plenty of signal is available to drive the output stage, this resistor is left unby-

passed. This improves the linearity and reduces the input capacity. Direct-current coupling is used into the output stage grid. This also reduces the stray capacity by eliminating a bulky condenser, and furthermore reduces the peak-to-peak plate current swing in the output stage (between extremes of pictures material) by about 4 db.

A meter is provided to read either the plate current of the roter tube or one tenth the plate current of the output stage. Under no signal (black picture) conditions the roter-tube plate current is set by the left hand 25,000-ohm control to about 100 μ a, and the plate current in the output stage is then set by the right-hand 25,000-ohm control to 10 ma (1 ma on the meter).

The lower part of Fig. 4 shows the clamp circuit. In the film scanner application for which this circuit was designed, the reference black in the video signal is obtained as follows. The flyback time of the camera horizontal sweep was made less than 6 microseconds. For the last few microseconds of the horizontal blanking time, the camera is therefore able to scan an unilluminated area to the left of the picture area on the photocathode. Flyback in the camera horizontal sweep is initiated by the leading edge of the horizontal drive pulses. A suitable clamp pulse in the roter is obtained by generating from each horizontal drive pulse, another pulse delayed by slightly more than the camera retrace time. This allows the camera flyback to be completed

and assures that the reference black edge is being scanned when clamping occurs.

Presumably the same method could be used with live pickup cameras, provided an opaque field mask were used. In a spot scanner, beam blanking during flyback might provide a suitable black reference, and in this case the delay multivibrator (the first tube in the clamp circuit) could be eliminated.

OPERATING CHARACTERISTICS

In the actual circuit the roter tube is operated with about 100 μ a of black current. There are several reasons for this. In the first place, this black current will vary several microamperes as the components warm up or age. If one tried to operate with zero black current, he would be walking right on the edge of a cliff. Any further decrease in the black current in the driver tube would find the roter tube completely cut off and the cathode presenting infinite impedance. The load impedance in the plate of the driver would then consist of the shunt resistors to *B+*, i.e., 24,000 ohms to 49,000 ohms, and relatively enormous distorted voltage waves would be applied to the output stage during the darkest portions of the picture. Besides this effect, the impedance of the cathode of the roter tube would be too high to preserve sufficient bandwidth in the shadows if the black current were less than about 100 μ a.

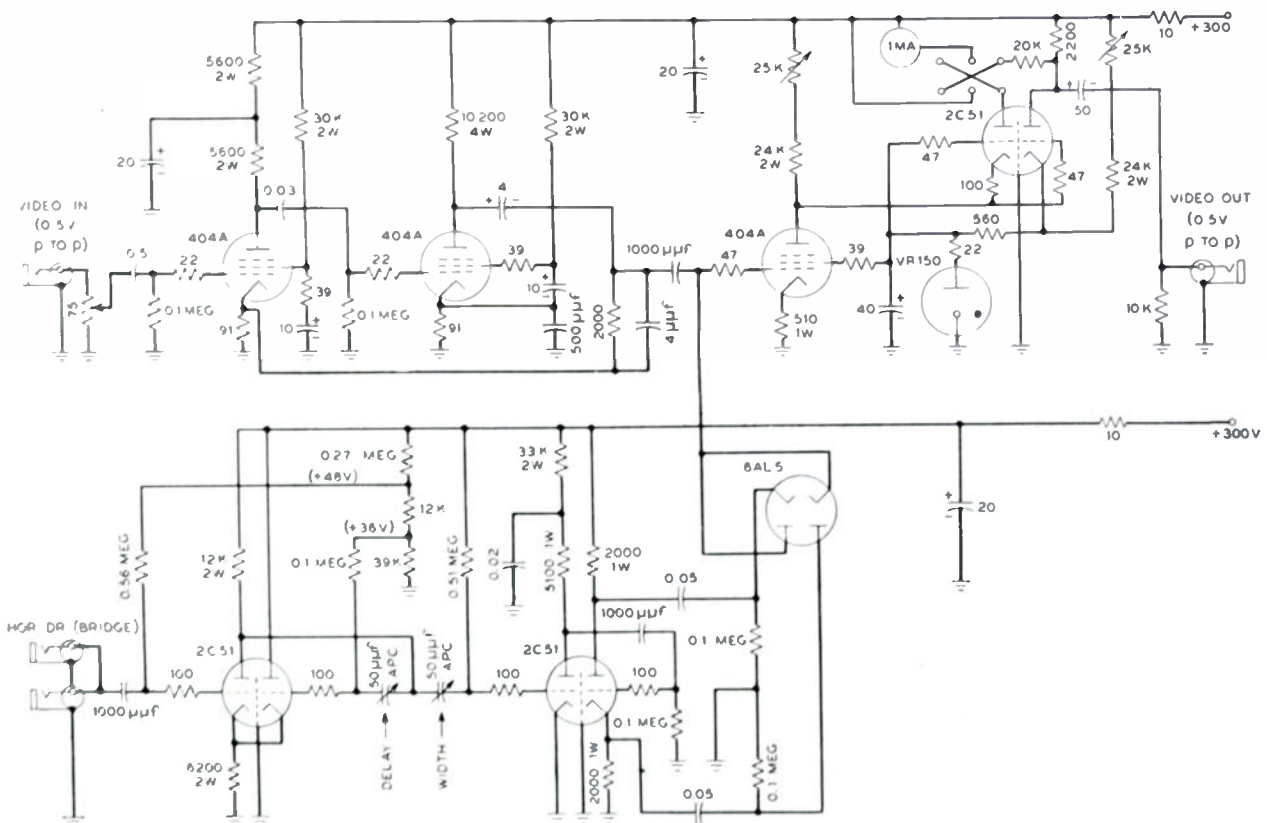

Fig. 4—Schematic of roter. Capacitance in μ f, resistance in ohms, ($k=1,000$ ohms) unless otherwise specified.

The presence of this black current in the roter tube means that the characteristic is no longer as given in Fig. 3. Rather one must plot the *change* in cathode voltage versus *change* in cathode current from the operating (black current) point. Thus the curve of Fig. 2 must be shifted down 1.36 volts and to the left 0.1 ma. When this is done one obtains the solid curve of Fig. 5. The 45° dotted lines on Fig. 5 are the current-voltage curves of the 100-ohm series resistor and an assumed value of 33,000 ohms for the shunt-feed resistor. The total resultant characteristic may now be obtained by adding the ordinates of the tube characteristics and the 100-ohm line and then adding the abscissas of that curve and the 33,000-ohm line. This resultant is the operating curve of the roter, and doesn't look much like the *n*th root law we are seeking.

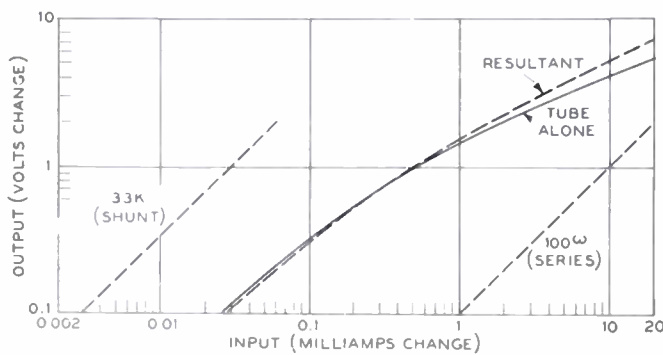

Fig. 5—Roter interstage characteristic.

However, one must remember that an arbitrary constant voltage may be added to the output voltage. This corresponds to changing the bias on the cathode-ray tube (or the setup in the line amplifier following the roter). When the resultant curve of Fig. 5 is shifted up by 0.4 volt, the result is the solid curve of Fig. 6.

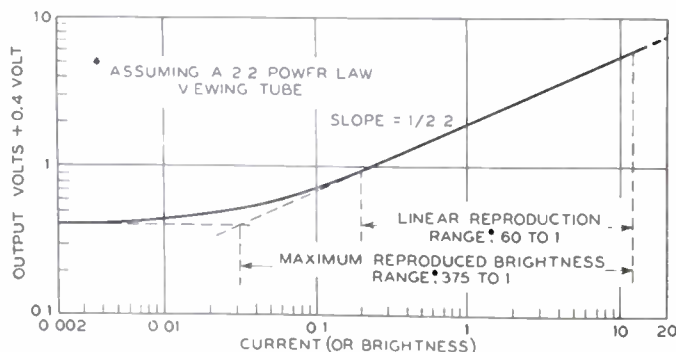

Fig. 6—Effective roter characteristics.

While the abscissa of Fig. 6 is the same as Fig. 5, i.e., "milliamperes change from operating (black) current," this abscissa may also be interpreted as proportional to subject brightness since the camera is assumed linear. We see that the effective characteristic is a good 2.2-root law over a subject brightness range of about 60

to 1. If a 2.2-power-law cathode-ray tube is used, the reproduction will be linear over this range while the reproduced brightness corresponding to physical black in the subject will be about 1/375 of the reproduced highlight brightness. All this is a distinct improvement over the situation with no roter.

As the cathode impedance of the roter tube increases, the bandwidth of the roter decreases. The decrease is not serious over the useful brightness range of the reproducing tube. Assuming a 2.2-power-law tube and a highlight brightness of 100 foot-lamberts the following figures are approximately correct:

Reproduced brightness	Response is down 3 db at
>7 foot-lamberts	>10 Mc
4 foot-lamberts	8 Mc
1.5 foot-lamberts	5 Mc
1 foot-lamberts	4 Mc

The bandwidth is thus greater than 10 Mc over a 14-to-1 brightness range and greater than 4 Mc over a 100-to-1 brightness range.

PERFORMANCE

The roter described above is in use in a laboratory film scanner employing a modified Farnsworth dissector as a camera tube. The improvement in picture quality as a result of the rooting of the signal is rather spectacular, particularly in low-key pictures.

One fear we had at the outset was that camera noise in the shadows would be intolerable when the roter was used. The small signal gain of the system is about 18 db greater in the shadows when the roter is used than without it. Noise in the shadows is therefore enhanced this much. However, with the signal-to-noise ratios present in the film scanner, the effect is not nearly so serious as had been anticipated. It is true that the shadow noise is increased, but so is the shadow detail, and the over-all effect is much more pleasing. (The roter, after all, does not *produce* any noise in the shadows, it merely prevents the reproducing tube from suppressing this noise, along with the shadow detail, as it otherwise would.) With poorer initial signal-to-noise ratios, the results would undoubtedly be different. Not only would the higher noise level in the shadows be more disturbing in itself, but the rectification of this noise by the viewing tube would dilute the blacks with unwanted light, and thus obscure the effects of the rooting.

In many respects the signal from the dissector tube, or from a flying spot scanner, is ideal for rooting. In the first place, these devices are strictly linear, and there are no appreciable shading signals, or spurious modulations of the signal from one part of the picture by detail in other parts (such as halations, and the like). Secondly, a true black reference may be obtained; there is no question as to where to begin rooting. Thirdly, the noise which is already low in the high-

lights (or can be made so with enough light) is even less in the shadows. Let us consider this last point more fully.

The action of an ideal rooter may be expressed as

$$y = x^{1/n},$$

where

- x = normalized input signal amplitude
- y = normalized output signal amplitude
(x and $y=0$ for black, 1 for maximum white)
- n = exponent of the rooting law.

The small signal transmission of the rooter is then given by

$$\frac{dy}{dx} = \frac{1}{n} x^{(1/n)-1}.$$

A small input disturbance Δx , will produce an output

$$\Delta y = \frac{1}{n} x^{(1/n)-1} \Delta x.$$

Now in a properly designed dissector or flying spot scanner, all the noise will be shot noise and the noise power will be proportional to brightness. Therefore, for such a system:

$$\Delta x = N x^{1/2}$$

where N = root-mean-square noise amplitude in the highlights. Thus the root-mean-square noise amplitude out of the rooter will be

$$\Delta y = \frac{1}{n} x^{(1/n)-(1/2)} N.$$

For $n=2$, i.e., a "square rooter," this reduces to

$$\Delta y = \frac{N}{2}.$$

The noise in the output signal is now independent of the brightness x , and everywhere 6 db less than in the highlights of the input signal. The resulting signal is indistinguishable from that which would be obtained by adding an independent noise of root-mean-square amplitude $N/2$ to a noise-free signal.

For a 2.5-root device, $n=2.5$, and

$$\Delta y = \frac{N}{2.5} x^{-1/10}.$$

Here the output noise is about 8 db less for $x=1$, and 4 db less for $x=0.01$.

Thus, if the camera noise is all shot noise, then over a 100-to-1 brightness range ($x=0.01$ to $x=1$), rooting of the type described will always produce less noise amplitude in the rooted signal than in the highlights of the unrooted signal. This is shown in Fig. 7.

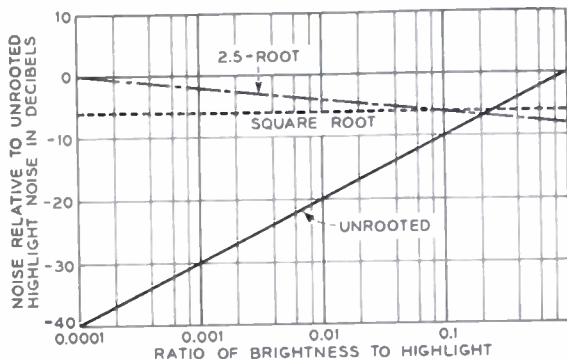

Fig. 7—Rooting of shot noise in signal.

Fig. 8 shows the situation when the camera noise is independent of brightness. In this case, the output noise exceeds the input highlight noise for all brightnesses less than one fourth to one fifth of the highlight.

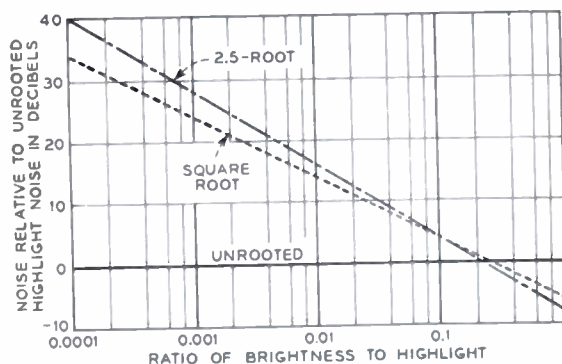

Fig. 8—Rooting of noise independent of signal.

In the film scanner in which the present rooter is used, the camera noise is all shot noise and in the highlights the ratio of peak-to-peak signal to root-mean-square noise is about 40 db. In the output of the rooter, the noise therefore is about 44 to 48 db down on the peak-to-peak signal depending on the brightness. From these figures it appears that a rooter might also be used to advantage with flying spot scanners. The successful use of a rooter with present image orthicons, where the noise is, if anything, greater in the shadows than the highlights, and where black level is harder to obtain accurately, appears questionable.



Methods of Calibrating Frequency Records*

R. C. MOYER†, D. R. ANDREWS‡, MEMBER, IRE, AND H. E. ROYS‡, SENIOR MEMBER, IRE

Summary—A frequency record cut in lacquer, while an FM calibrator was used to measure the amplitude of motion of the cutting stylus, was processed and calibrated by the following means: a "static" method in which the amplitude of the recorded groove was measured by means of a displacement sensitive gauge; a variable speed method in which the velocity was measured with a pickup while the same reproduced frequency was maintained by rotating the disk at different turntable speeds; the reflected-light-pattern method commonly used in evaluating the recorded velocity; and by direct measurement of the recorded amplitude as pictured in photomicrographs.

I. INTRODUCTION

RESPONSE MEASUREMENTS of disk reproduction systems, or of pickups, require the use of records of known frequencies and recorded levels. Normally the reproduced frequency will be the same as that used during recording unless a difference in speed exists between the playback and recording turntables. If a difference does exist, the exact frequency can usually be determined, easily and accurately, by comparing it with a known frequency and thus presents no problem. Evaluation of the recorded level, however, is more difficult and requires a knowledge of the amplitude of the recorded wave, or of its velocity, which is a function of amplitude and frequency.

It is the purpose of this paper to discuss several methods of calibration that were used during the evaluation of a particular frequency record. Since the calibration principles with which we are concerned are widely different, it seems desirable to describe the methods first, setting forth their advantages and limitations, and then to discuss the results of our experiments. It is thought that by doing so, the reader, having the different principles of calibration in mind, will find the comparison less confusing. For the same reason, it is thought desirable to explain some of the terms commonly used in disk recording before proceeding with the calibration methods.

II. GENERAL

A. Constant Amplitude and Velocity Recording

It is the usual practice in recording phonograph records to cut a groove from the outside towards the center of the disk in such a manner that the unmodulated groove has the form of a spiral. When modulation is applied, the stylus moves at right angles to the spiral and varies about the mean in accordance with the frequency and amplitude of the signal being applied. If the change in the spiral radius for each revolution of

the turntable is slight, high amplitudes of modulation may cause the stylus to cut into the adjacent grooves. To avoid this form of overcutting it has become common practice to cut the lower frequencies, where the high amplitudes are apt to occur, on a constant amplitude basis. That is, signals having the same voltage as applied to the recording amplifier, but of different frequencies, are recorded with equal amplitudes. This form of recording is illustrated by f_1 and f_2 of Fig. 1(a). For the higher frequencies it is the usual practice to design the cutter so that the amplitude of cut decreases in proportion to the frequency increase or so that the velocity of stylus motion remains constant. Constant velocity recording is illustrated by f_2 , f_3 , and f_4 of Fig. 1(a).

Actually, constant velocity and constant amplitude recording characteristics are not strictly adhered to in cutting phonograph records. It is common practice to pre-emphasize, or tip up, the higher frequencies in recording in order to obtain a better signal-to-noise ratio, and in addition, some recording companies prefer a slight pre-emphasis at the lower frequencies. The cutter is usually designed, however, for constant-amplitude and constant-velocity operation and the pre-emphasis is obtained by electrical means. The "crossover" or "transition" frequency between the two modes of operation varies with recording companies, but it usually occurs between 300 and 500 cycles. For the frequency record under discussion the transition frequency was 500 cycles; frequencies lower than this were recorded on a constant-amplitude basis, while the velocity was maintained constant for the higher frequencies.

B. Stylus Velocity

If we consider the excursion of the cutting stylus when a sine-wave signal is applied, we may express the equation of displacement as

$$y = a \sin \omega t \quad (1)$$

where

y = the displacement

a = the amplitude

$\omega = 2\pi f$

t = time.

To obtain an equation in terms of velocity, or change in displacement with respect to time, we differentiate the above equation.

Then

$$v = \frac{dy}{dt} = a\omega \cos \omega t \quad (2)$$

* Decimal classification: 621.385.971×R391.1. Original manuscript received by the Institute, April 10, 1950. Presented, 1948 IRE National Convention, New York, N. Y., March 24, 1948.

† RCA Victor Division, Indianapolis, Ind.

‡ RCA Victor Division, Camden, N. J.

where

$$v = \text{stylus velocity.}$$

Stylus velocity becomes greatest where the displacement curve (1) crosses the zero axis, which is the point where the slope is the greatest (see Fig. 1(b)). Mathematically, the maximum stylus velocity is expressed as

$$V_{\max} = 2\pi fa \tag{3}$$

and occurs whenever $\cos \omega t = 1$.

From these equations it is readily seen that in order for the slope, or the velocity, to remain constant, the amplitude must decrease as the frequency is increased (see f_2, f_3 , and f_4 of Fig. 1(b)). Likewise, for the amplitude to remain constant, the velocity, or slope, must decrease in proportion to the frequency decrease. This is illustrated in Fig. 1(b) by f_1 and f_2 . In calibrating sine-wave recordings by the optical pattern method, as will be shown, it is the maximum slope of the recorded groove that determines the last point of reflection, and hence, the width of the optical pattern. The measurements, therefore, give results in terms of maximum or "peak" velocities.

C. Groove Velocity

The speed of the medium relative to the stylus point is usually designated as "groove velocity." It depends

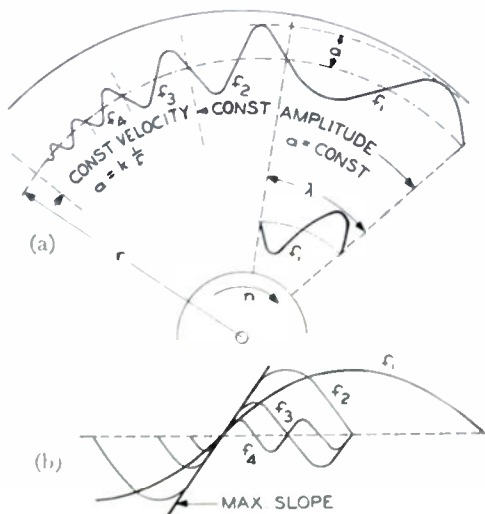

Fig. 1—Constant amplitude recording is illustrated in (a) by frequencies f_1 and f_2 and constant velocity by frequencies f_2, f_3 , and f_4 . In (b) note that the slope is the same for frequencies f_2, f_3 , and f_4 which were plotted on a constant-velocity basis. For constant-amplitude recording the slope decreases as shown by f_1 .

upon the turntable speed and the radial distance from the center of the record to the point where the stylus contacts the groove. Mathematically it is expressed as follows:

$$V_g = 2\pi rn$$

where

- V_g = groove velocity
- r = radial distance from the center of the disk to the point in question
- n = turntable speed.

Groove velocity reaches a maximum at the outside of the disk where the radius is the greatest and minimum at the inside. The change in groove velocity from outside to inside results in a decrease in wavelength as illustrated in Fig. 1(a) by the two traces of f_1 , one near the outside and the other near the center of the disk. Both traces must be maintained in the same angular displacement if the frequency is to remain the same. The maximum slope of the inner trace of f_1 (Fig. 1(a)) is greater than the outer slope, and the increase is in proportion to the decrease in radial distance to the center of the record.

III. METHODS OF CALIBRATION

A. Optical Method

A widely used method of evaluating the velocity of modulation is an optical one based upon the light reflected from the side walls of the recorded groove.^{1,2} When using this method, a light pattern is visible to an observer in front of the record when parallel light rays strike the disk at a slight angle with respect to its surface. Fig. 2 is a photograph of the light pattern of a

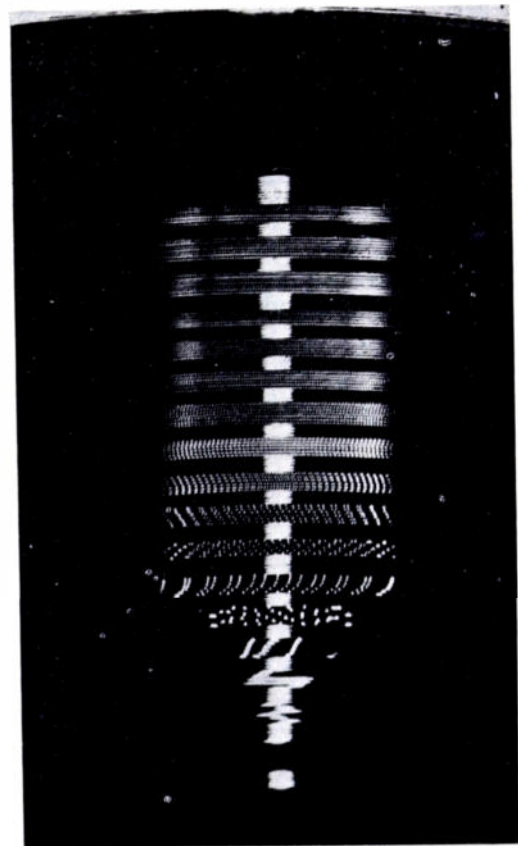

Fig. 2—Photograph of a light pattern of a frequency record. A close examination will show that the pattern is made up of numerous points of reflection.

¹ G. Buchmann and E. Meyer, "A new optical method of measurements for phonograph records," *Elek. Nach. Tech.*, vol. 7, pp. 147-152; April, 1930. Translated by J. M. Cowan, *Jour. Acous. Soc. Amer.*, vol. 12, pp. 303-306; October, 1940.

² B. B. Bauer, "Measurement of recording characteristics by means of light patterns," *Jour. Acous. Soc. Amer.*, vol. 18, pp. 387-395; October, 1946.

frequency record and shows the optical pattern that is visible to the observer. The light pattern is made up of numerous points of reflection from various parts of the recorded waves. For an unmodulated groove, reflections are visible along a radial line parallel to the incident light rays. When the groove is modulated, reflections occur either side of center at points where the slope, due to modulation offsets the angle due to the curvature that exists because the unmodulated groove is cut in the form of a spiral. When the mean curvature of the groove due to its spiral form exceeds the maximum slope of the recorded wave, the light is reflected back at an angle outside of the scope of the observer, and fixes the boundary where reflections are no longer visible. The width of the optical pattern is dependent upon the maximum slope of the recorded wave. For frequencies recorded at the same velocity, the maximum slopes of the waves are the same and hence the width of the light patterns equal. This correlation holds true across the entire surface of the disk, for as the recorded diameter is decreased, increasing the mean curvature, the wavelength is decreased and its slope increased, all in the same proportion. A measure of the width of the pattern permits calculation of the absolute magnitude of the recorded velocity.

It can be observed in Fig. 2 that the fifth recorded band from the bottom (400 cps) shows points of reflection that are distinct and separated a maximum amount at the center of the pattern. Toward the edges of the pattern, the reflection points come closer together and finally merge to form a bar of reflected light. Beyond the bar of reflection, points again appear, becoming smaller in size, and these eventually disappear.

Fig. 3 was constructed in order to illustrate how the bars are formed. Assume that the light is coming from above at a slight angle with the surface of the page. The

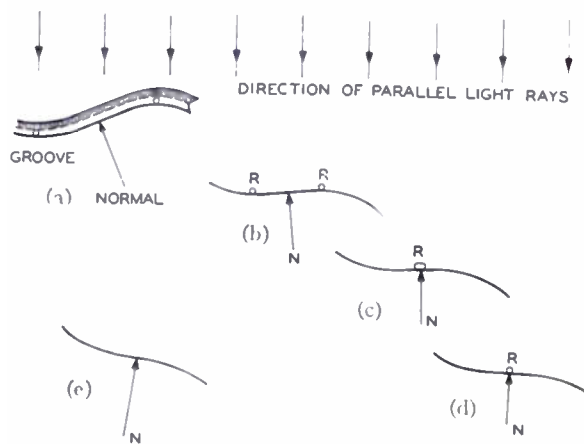

Fig. 3—These diagrams, simulating recorded grooves, show how the parallel light rays are reflected from portions of the groove side-walls to the observer. Note that when the recorded wave is tilted, as occurs when it nears the edge of the pattern, the reflection points, indicated as circles, come closer together, finally form a bar where the two merge, then appear again as a point, and eventually are no longer visible to the observer.

reflections that occur from the side walls of the simulated recorded groove are indicated as circles. When a portion of the recorded wave is in the position illustrated by Fig. 3(a), the points of reflection occur at the peaks and valleys and are separated one-half a wavelength. As we progress towards the edges of the light pattern where the recorded wave is now rotated with respect to the incident light rays due to curvature of the spiral, the reflecting points come closer together (Fig. 3(b) and merge into a bar as illustrated by Fig. 3(c). According to theory, the last point of reflection should occur as illustrated in Fig. 3(d), where a perpendicular at the point of maximum slope of the recorded wave, is parallel to the direction of the light rays. If the wavelength is further rotated as in Fig. 3(e), the surfaces can no longer reflect light back to the observer.

To illustrate this condition a photograph, Fig. 4, was taken near the boundary of an optical pattern while an additional light was spotted on the surface of the disk

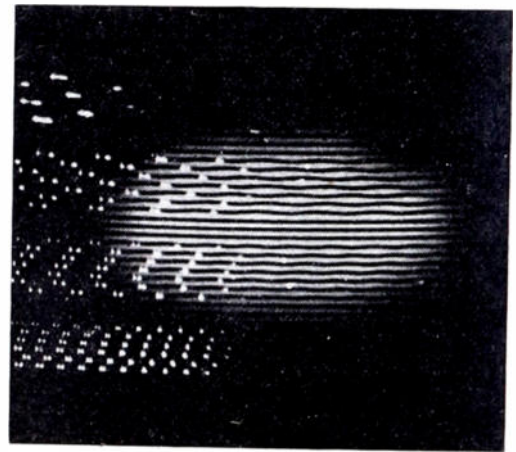

Fig. 4—A photograph near the boundary area shows the reflected points of light from the groove walls. The modulated groove is made visible by using another light to obtain a reflection from the flat surface of the disk.

to show the grooves. The merger of the two points into a bar of reflected light is clearly shown. Beyond the bar of reflection, points are again observed and these become smaller in size and finally disappear. Selecting the proper reflection points for measurements presents a problem, especially where the recorded level is to be determined accurately, for the final reflection points are not readily determined in many cases.

For recordings made at 78 rpm where the wavelengths are long, the slopes gradual and the pattern narrow, the boundary at which the reflections cease is usually sharp and well defined. But at $33\frac{1}{3}$ rpm, where the wavelengths are shorter and the slopes steeper, the pattern is wider and usually diffused and the boundary is difficult to determine. The indefinite boundary is probably due to the fact that the reflecting surfaces of the side walls have become smaller, and surface irregularities being relatively larger result in a greater diffusion of light. A sharper boundary can oftentimes be obtained

by rotating the disk so that the outermost points of reflection are continuously visible, and this expedient is resorted to in many cases. It is difficult to obtain photographs while the disk is rotating, however, since any wobble or eccentricity will result in a blurred pattern.

Better reflective surfaces may be obtained for calibrating purposes by using the metal molds or stampers from which the pressings are formed. The use of a stamper, which is a negative, with its ridges instead of grooves, is of interest, for the light pattern is now made up of reflections from the tops of the ridges, or the portions which form the bottoms of the grooves in the pressing. Since contact with the stylus is usually near the top of the groove during playback, it might be considered more appropriate to calibrate the pressing and to do so near the line of contact. This may be true; however, if the edge of the groove is included in the reflected pattern and is deformed and rough as it often is, the included surface may not be a true representation of the modulated groove and, therefore, not an ideal surface for calibration either.

The light-pattern method is difficult to apply at low frequencies since it is customary to record the lower frequencies at constant *amplitude* and not constant *velocity*, and as a result, the width of the light pattern decreases in proportion to the frequency decrease. Judging the relative flatness of recorded level by comparison then becomes difficult and, usually, measurements must be made. For a fixed position of the disk the outermost points of reflection may not be visible to the observer due to the nonoptimum position of the recorded wave with respect to the mean curvature of the groove, as can be observed in Fig. 2. This can be overcome by rotating the disk, as mentioned before, so that reflections from the outermost point are always visible.

Another factor that makes it difficult to obtain a sharply defined boundary is the appearance of interference patterns, colored or dark, that are observable throughout the reflected areas and, at some of the higher frequencies where these appear, a true pattern width is difficult to determine. A slight lateral shift in position of the observer will often change the interference patterns enough to make measurements possible.

Our measurements and observations were made using a small-filament heavy-current (10 volts, 7.5 amperes) lamp of the type used in film sound recording and reproduction. A lens, $f/6.0$, having a focal length of 23 inches was used to obtain parallel light rays.³ For direct measurements a universal type of measuring microscope having the optical system on a sliding carriage with a vernier scale was used. A telescopic objective lens was employed in this case since measurements

were made at a distance of about 10 feet from the disk. The disk was suspended vertically with its center at the same height above the floor as the light and the telescope. The angle between the surface of the disk and the observer was the one that gave the brightest pattern. Observations were tried close to the disk so that the individual reflection points were plainly discernible. Where the area of the field within focus is small and only limited numbers of reflections are visible, difficulty was encountered in determining the exact boundary. For this reason, increased spacing between disk and microscope so that more boundary area was included was found to be more desirable. Photographs were made for examination and subsequent calibration using a toolmaker's microscope which has a two-way sliding carriage with micrometer adjustment.

Buchmann and Meyer¹ gave the following equation for determining the recorded velocity from the width of the optical pattern:

$$v = \pi b n \quad (4)$$

where

v = recorded velocity

b = width of the optical pattern

n = turntable speed at which the disk was recorded.

They point out that in order to maintain good accuracy the distance between the observer and the disk should be many times the width of the optical pattern.

Bauer² has studied the problem and recommends that both reflected patterns, the one nearest the light source and the other beyond the center of the disk, be measured and combined in the following equation to give the true value of recorded velocity:

$$V = 2\pi n \frac{b_o b_i}{b_o + b_i} \quad (5)$$

where

b_i = width of the nearest reflected pattern

b_o = width of the outside reflected pattern

n = turntable speed at which the disk was recorded.

The observer should shift position slightly in order to maintain the same angle with respect to the disk when measuring b_i and b_o . If the groove shape is symmetrical and the distance between the observer and the disk is great, then the two pattern widths should be equal.

Separate pattern measurements may be used as follows:

$$v_i = n\pi b_i \left(1 + K \frac{R}{D} \right) \quad (6)$$

where

b_i = the width of the inner pattern (the one nearest the light source)

$$K = \frac{1}{1 + \cos B}$$

³ An ordinary unfrosted 120-volt lamp when placed about 15 feet away from the disk, and without a lens, has been found satisfactory for such purposes.

B = angle between the observer and the surface of the disk

R = radius (distance from the center of the record to the groove being examined)

D = distance between the observer and the disk.

For the outside pattern the equation where the subscript o refers to the outside pattern is

$$V_o = n\pi b_o \left(1 - K \frac{R}{D}\right). \quad (7)$$

B. Calibrating While Cutting

A method of measuring the amplitude of stylus excursion while cutting has been described in articles^{4,5} on the FM calibrator, and good correlation with the light-pattern method has been observed, especially for disks cut at 78 rpm. Although the calibrator may accurately measure the excursion of stylus, it does not necessarily follow that the amplitude of the resulting recorded wave is the same. For springback or cold flow of the medium and if a lacquer recording stylus is used, the width of the burnishing surface,⁶ may alter the groove shape and decrease the recorded amplitude especially at the higher frequencies. Burnishing surfaces are flats formed at a particular angle along the cutting edges of lacquer styli in order to polish the side walls and so produce quieter grooves. The burnishing edge causes some lateral loading which has been measured with the FM calibrator. Wax cutting styli do not have burnishing edges and therefore do not alter the groove shape or affect the high-frequency response when cutting wax.

The frequency record⁷ under discussion was made while using the FM calibrator. The approximate recording level for each frequency was determined beforehand and level adjustments made while cutting the unmodulated grooves between the frequency bands. A final adjustment was made immediately after the signal was applied. Such procedure results in an initial level that may not be correct and measurements must therefore be based upon the latter part of the recorded band. This secondary adjustment refinement is believed unnecessary as in most cases the final adjustment was found to be slight.

The master lacquer was cut laterally at 33½ rpm, using a stylus having a bottom radius less than ½ mil. Grooves were cut deep enough to accommodate playback styli up to 3 mils radius and still maintain contact along the side walls below the record surface. A theoretical crossover point of 500 cycles, based upon the

NAB Standard lateral recording characteristic, was chosen and frequencies above this value were recorded at constant stylus velocity while those below were cut at constant stylus amplitude. The frequencies near the crossover point were recorded at levels which would result in a smooth gradual changeover from constant amplitude to constant velocity. Frequencies from 12,000 to 1,000 cycles were recorded at 1,000-cycle intervals. To assure frequency accuracy the oscillator was set for the correct Lissajous figures on an oscilloscope while using a 1,000-cycle tuning fork as the standard. Below 1,000 cycles, frequencies were recorded which have been found useful in testing, and, where possible, these were also compared with the tuning-fork standard. These precautions were taken even though a rim-driven turntable was used, as it was thought worth while to maintain the correct ratio between frequency bands. An intermodulation band of 400 and 4,000 cycles was recorded near the outside of the 12-inch disk, for stamper control. A slight spiral was introduced just ahead of the 10,000-, 5,000-, and 1,000-cycle bands for visual identification of these bands. After processing, unfilled vinyl pressings were made and these have been subjected to the calibration tests, described in this article.

C. Static Method of Calibration

If the amplitude and the frequency is known, the velocity of the recorded wave can be calculated. For the purpose of measuring the amplitude a sensitive electro-mechanical gauge, previously used for determining the force at the stylus tip while cutting,⁸ was tried. The cutting stylus was replaced with a playback tip having a radius of 2.5 mils. The gauge was attached to a horizontal rod extending radially over and pivoted vertically about the center of the disk. Contrary to usual practice, the disk was maintained stationary while the stylus was pulled along the groove. It was moved slowly and



Fig. 5—This shows the pickup arrangement used to measure the amplitude of cut of the recorded groove. Amplitudes as low as 25 microinches were readily measured.

⁴ H. E. Roys, "Experience with an FM calibrator for disk recording heads," *Jour. Soc. Mot. Pic. Eng.*, vol. 44, pp. 461-471; June, 1945.

⁵ A. Balmaieff, "Push-pull frequency modulated circuit and its application to vibrating systems," *Jour. Soc. Mot. Pic. Eng.*, vol. 46, pp. 37-51; January, 1946.

⁶ C. J. LeBel, "Properties of the dulled lacquer cutting stylus," *Jour. Acous. Soc. Amer.*, vol. 13, pp. 265-273; January, 1942.

⁷ RCA Test Record 12-5-25 (460625-6).

⁸ H. E. Roys, "Force at the stylus tip while cutting lacquer disk recording blanks," *Proc. I.R.E.*, vol. 35, pp. 1360-1363; November, 1947.

smoothly by the simple expedient of wrapping a thread, attached to the gauge, around a shaft of small diameter. The action was so smooth and fine that the stylus tip could be stopped at the crest of even the shortest wavelength. The equipment is pictured in Fig. 5.

The method was found to be slow and tedious, but eventually sufficient measurements were made to determine the effectiveness of this method.

D. Variable Speed Method

This method is not new; it was used by Kendall and Burt as early as 1929, to measure the response of pickups. They also used the method to check the calibration of some early Victor Constant Note records. In addition, a published article⁹ reveals that it was used for calibration purposes in Germany in 1929 at the same time Kendall and Burt were independently doing their work.

The principle of operation when calibrating records requires an adjustment of the speed of the turntable so that the recorded bands are reproduced at some common reference frequency. Such procedure eliminates the necessity of amplifier and pickup calibration. In practice, where a wide range of recorded frequencies is involved, several reference tones are usually necessary but these can be selected so that a good crosscheck can be obtained between them.

The variable speed turntable¹⁰ used for these tests operates from 5 to 80 rpm and reference tones of 2,000; 700, and 200 cycles were used with an additional crosscheck at 1,000 cycles. These reference tones adequately covered the range of the 33 $\frac{1}{3}$ rpm frequency record which extended from 12,000 to 30 cycles. When the recorded frequency differs greatly from the reference tone, noise becomes a problem and band-pass filters were found necessary for attenuating the noise either side of the passed frequency.

E. Photomicrographs of Grooves

A method of determining absolute groove modulation amplitude by the use of photomicrographs is relatively simple and seems to give excellent results. A metalloscope capable of making photographs with a range of magnifications from 26 times to 2,000 times was used for these tests. It was found that a highly reflecting surface was most suitable for photographing with this equipment. Therefore, all photomicrographs were made from a chrome-faced "stamper" which is a negative metal part used for pressing records.

When record grooves are examined at high magnification, it becomes apparent that the groove walls and bottom are not perfectly smooth. Fine lines, caused by cutting stylus imperfections, are visible along the

grooves (see Fig. 6). Although these markings might normally be considered undesirable, they prove to be of considerable value in making measurements of groove modulation. Any of these lines at or near the bottom of the groove which display clear sinusoidal wave forms may be focused on. This gives a much clearer tracing than when focused on the edge of the record groove which is usually distorted or indistinct.

To insure the accuracy of magnification, the metalloscope was calibrated with a stage micrometer. A photograph of the micrometer scale was also taken for verification.

The photomicrographs may be measured with a toolmaker's microscope very easily. A toolmaker's microscope is equipped with cross hairs and a table which can be moved with micrometer adjustments in either direction. These adjustments are calibrated very accurately with divisions of 0.0001 inch. If the photographs of the higher frequencies are magnified 250 times, one division of the microscope will correspond to 0.4 microinches. A 10,000 cps signal recorded with a normal stylus velocity of 5 cm per sec will have an amplitude of approximately 62.5 microinches peak to peak. Therefore, one division of the microscope scale will be well under 1 per cent of the lowest amplitude that is likely to be encountered.

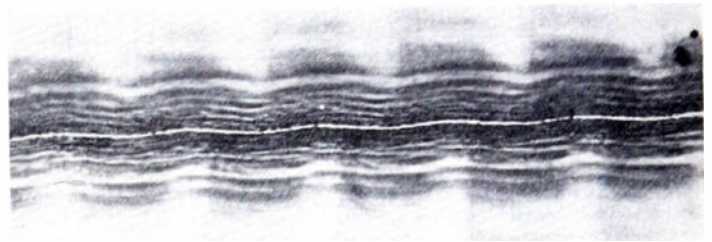

Fig. 6—A photomicrograph of a 6,000-cycle recorded wave. Because of slight nicks or imperfections in the cutting stylus the sine-wave trace is plainly visible, thus permitting a measurement of the amplitude of the recorded signal. A magnification of 250 times was used to obtain this picture.

IV. RESULTS

A. Static and Variable Speed Tests

The static and variable speed tests gave similar results. Below 1,000 cycles good agreement was observed between the two methods, and also with the FM calibration measurements which were made while cutting (see Fig. 7).

Above 1,000 cycles a progressively greater reduction in high-frequency response was observed with both methods and this loss increased as the vertical force on the stylus was increased (see Fig. 8). Playback loss,¹¹ or reduction in amplitude of stylus motion due to tip size, relative to the recorded wavelength and yield of the

⁹ E. Meyer and P. Just, "Frequency curves of electrical pickups and mechanical gramophones," *Elek. Nach. Tech.*, vol. 6, pp. 264-268; July, 1929.

¹⁰ H. E. Haynes and H. E. Roys, "A variable speed turntable and its use in the calibration of disk pickups," *Proc. I.R.E.*, vol. 38, pp. 239-243; March, 1950.

¹¹ O. Korner, "Playback loss of phonograph records," *Jour. Soc. Mot. Pic. Eng.*, vol. 37, pp. 569-590; December, 1941.

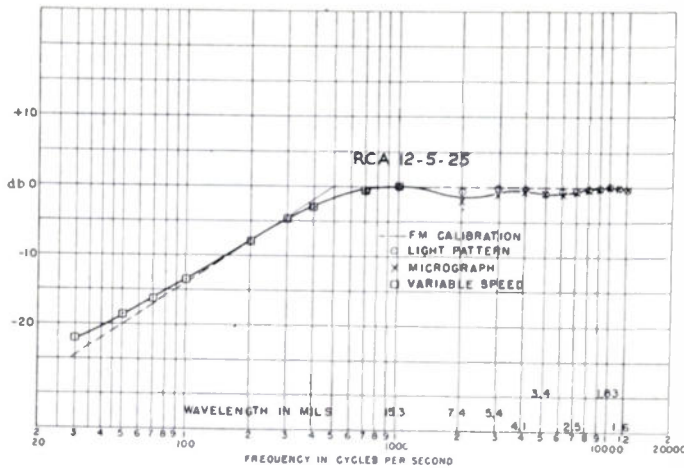

Fig. 7—Response characteristic of the record used for the investigation. The dashed curve shows the intended characteristic. The points obtained by the different methods of calibration are indicated.

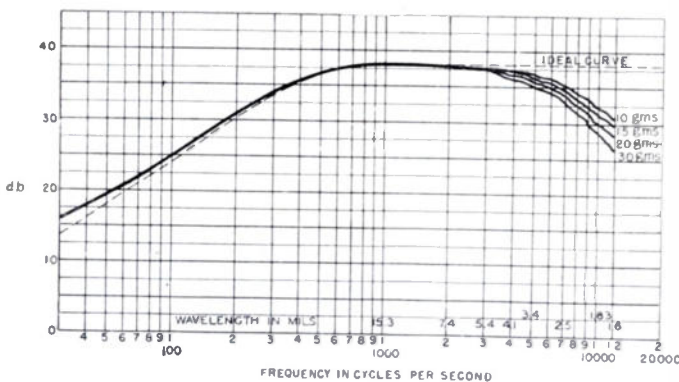

Fig. 8—Results obtained by the static method are similar to those obtained by the variable speed method illustrated here. A loss in high-frequency response exists due to the yield of the record material. The loss is dependent upon the vertical force and the radius of the stylus tip.

record material still exists even though the rotational speed of the record is reduced during playback. Decreasing the turntable speed during reproduction does not alter the recorded wavelength. Therefore, both methods are suitable for low-frequency calibration purposes only, and not higher frequencies where the wavelengths are short with respect to the stylus radius. The data illustrated in Fig. 8 were obtained with a light-weight magnetic pickup having a stylus tip of 2.9 mils radius. These data indicate that the wavelength should be at least three times the stylus radius to minimize the playback loss. The record was a vinyl pressing.

Both methods, however, offer excellent means of studying playback loss while maintaining substantially constant mechanical impedance of the pickup. In the static method where the stylus moves along the groove at an extremely low rate, the mechanical impedance is essentially that of the stiffness of the moving system. For the variable speed method the mechanical im-

pedance of the pickup depends upon the frequency at which the tests are made. For any reference frequency it should remain constant and for one such as 2,000 cps, which may be near the fundamental resonance of the moving system (free vibration in air) where the pickup is easy to actuate, the impedance should be low.

While making measurements with the static method, a slow continuous yield of the record material was noted and considerable judgment had to be exercised during these tests. What effect the dynamic elastic properties of the material may have on record reproduction is not known yet; however, it is not believed to be a serious factor.

For ease of manipulation and speed of operation the variable speed method is preferred to the static method.

B. Photomicrograph Results

Good results were obtained with this method, especially at the higher frequencies where the wavelengths are short so that many of them appear within the focusing area. At the lower frequencies a decrease in magnification of the camera is necessary in order to obtain a sufficient number of wavelengths within the focusing field since they are now longer. Accuracy is also impaired as the curvature of the modulation approaches the average curvature of the record groove. The success of the method depends largely upon tiny imperfections of the cutting stylus which is inconsistent with good recording practice where every effort is made to obtain smooth quiet grooves free from scratches.

When the method can be applied, it offers an excellent means of measuring the amplitude of cut and thus determining the recorded velocity independently of the optical pattern method. The method is less reliable for the low frequencies where the wavelengths are long and the curvature of the spiral must be taken into account.

C. FM Calibrator Results

The FM calibrator used to measure the amplitude of stylus motion while recording gave results that checked extremely well with the other methods both at the high and low frequencies. The good agreement at the high frequencies is unusual and the method cannot be relied upon when cutting lacquer where springback may occur. When cutting wax with a sharp-edged stylus without burnishing surfaces, the method may be quite accurate. It is reliable and accurate at the lower frequencies and so may supplement the optical method where difficulty is usually encountered in evaluating the longer wavelengths. In this particular record, a discrepancy at the low-frequency end between expected and actual recorded level resulted due to a forgotten low-frequency loss in the calibrating amplifier that caused us to raise the recording level in order to obtain the proper meter reading.

D. Optical Method

The optical method still appears to be the best overall method of calibrating recorded disks. If an absolute velocity measurement is wanted, the width of both reflected patterns must be measured and averaged.² Some judgment is required in determining the boundary especially at the higher frequencies. A study of the photograph of Fig. 4 reveals that it is difficult to decide which spot of reflected light represents the case of Fig. 3(d) and hence is the one that should be used. Richard Bierl¹² concludes from a geometrical study that the last point of reflection does not appear at the point of maximum slope but the error even for unfavorable conditions is less than one per cent. It is quite likely that some of the minute spots are reflections beyond the optimum point and are visible only because of irregularities in the record groove. This being the case, the boundary that we are seeking must be somewhere between the bar of reflection and the last-minute spot. In our case, the attempt was made to obtain an absolute measurement of the 1,000-cycle band and a relative width measurement of the other bands. A point between the reflected bar and the last tiny point was taken, one that appeared about equally discernible at each different high-frequency band.

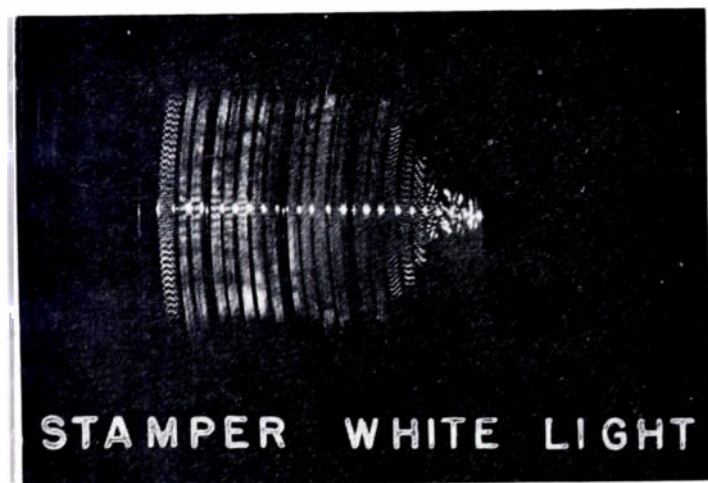

Fig. 9—Photograph of the optical pattern without any color filter.

Photographs of the reflected pattern of the metal stampers were taken, some of which were made with a red filter before the camera lens so that the result was essentially that of using a monochromatic light. In this

¹² R. Bierl, "The error in the light band width of phonograph records," *Akus. Zeit.*, vol. 5, pp. 145-147; May, 1940.

particular case a very sharp image was obtained and it took several different exposures without the red filter to obtain a negative of equivalent sharpness (see Fig. 9). However, there appears to be no advantage in using a monochromatic light source. When interference patterns are present, and they were observed in all cases, it appears desirable to use a system of uniform color sensitivity so that the color effect of the interference patterns is averaged out.

For low-frequency measurements it is necessary to rotate the disk so that a sharply defined boundary is obtained. Where two frequencies are combined such as those used for intermodulation tests, it also becomes necessary to rotate the disk in order to obtain readings.

A wide pattern such as encountered at high modulation levels and low turntable speeds may exceed the limiting conditions considered by Bierl and cause an appreciable error.

V. CONCLUSIONS

Considering the results of all of the different methods, FM calibrator, variable speed, photomicrograph, and light pattern, we came out with results remarkably close to each other as illustrated in Fig. 7. Each method offers some advantages. It is not expected that the FM calibrator will always check so well at the higher frequencies due to other factors that enter in, such as width of the burnishing edge and the hardness and cold flow of the medium being cut. If groove burnishing is not necessary and sharp cutting edges are used, then the FM calibrator may prove useful for calibration purposes. The static and variable speed methods are valuable for measurements at low frequencies where the wavelengths are long. Neither are applicable at high frequencies where losses due to yield of material and the physical size of the reproducing tip become appreciable. On the other hand, the photomicrograph method is particularly suited for short wavelengths, the disadvantage being, however, that it requires a stylus with imperfections in the cutting edges and this is contrary to good recording practice. The optical method therefore, appears to be best suited for calibration purposes. It is reliable and not too difficult to apply. Comparative measurements between frequency bands can be made easily and in many cases, the relative response, determined in this manner, is all that is wanted.

ACKNOWLEDGMENT

The authors wish to acknowledge the photographic work of H. N. Collins who produced the prints of Figs. 4 and 9, and many others not included in this paper.



Combined Search and Automatic Frequency Control of Mechanically Tuned Oscillators*

J. GREGG STEPHENSON†, MEMBER, IRE

Summary—A system is described whereby an oscillator is either swept continuously across its tuning range or is tracked to an incoming signal. The novelty of the system is that it automatically switches from the sweeping regime to the tracking regime when a signal is encountered and returns to the sweeping regime when the signal vanishes.

The control is applied to a superheterodyne receiver whose intermediate frequency is 30 Mc. In the searching mode, the local oscillator is mechanically swept back and forth across its entire tuning range. When a signal is received in the intermediate-frequency channel, the sensing circuit transfers the system to the tracking regime so that the local oscillator keeps the signal centered on the intermediate-frequency passband. In this application, the system is capable of varying the frequency of a mechanically tuned ultra-high-frequency triode oscillator over a 100-Mc range, or of holding it to within 15 parts per million at 1,300 Mc.

INTRODUCTION

THIS PAPER describes a difference-frequency servomechanical method for automatic frequency control of mechanically tuned oscillators, combined with an automatic searching feature that embraces a wide pull-in range. The method is applicable to radar, communication, or other equipments having a fixed intermediate frequency.

* Decimal classification: R361.215×R355.6. Original manuscript received by the Institute, August 8, 1949; revised manuscript received, March 31, 1950. Presented, 1949 IRE National Convention, March 10, 1949, New York, N. Y.

† Airborne Instruments Laboratory, Inc., Mineola, L. I., N. Y.

I. ILLUSTRATIVE APPLICATION

The essential features of this method are illustrated in Fig. 1. Output from the local oscillator under control is mixed with the reference signal in a conventional crystal mixer. The resulting intermediate-frequency output is amplified, limited, and connected to the automatic frequency control (AFC) unit, which drives a servo motor to tune the controlled local oscillator. The AFC unit contains one further stage of intermediate-frequency amplification, a discriminator, pulse stretcher, balanced modulator, servo amplifier, and a special sensing circuit that will later be described in detail. In the searching regime, the controlled oscillator frequency is swept continuously back and forth across its entire range until a reference signal appears at the input to the AFC unit. The sensing circuit then automatically changes to normal AFC operation, and the controlled oscillator locks in relation to the reference signal so as to maintain a constant difference frequency as long as the signal is present. Automatic frequency control (AFC) is thus made available over a pull-in range much greater than the discriminator bandwidth.

The circuit was designed for controlling an *L*-band coaxial-line triode oscillator tuning over a total range of 100 Mc at 1,300 Mc. A 30-Mc intermediate frequency having a bandwidth of 2.5 Mc was employed. Because known electronic tuning techniques were inadequate for

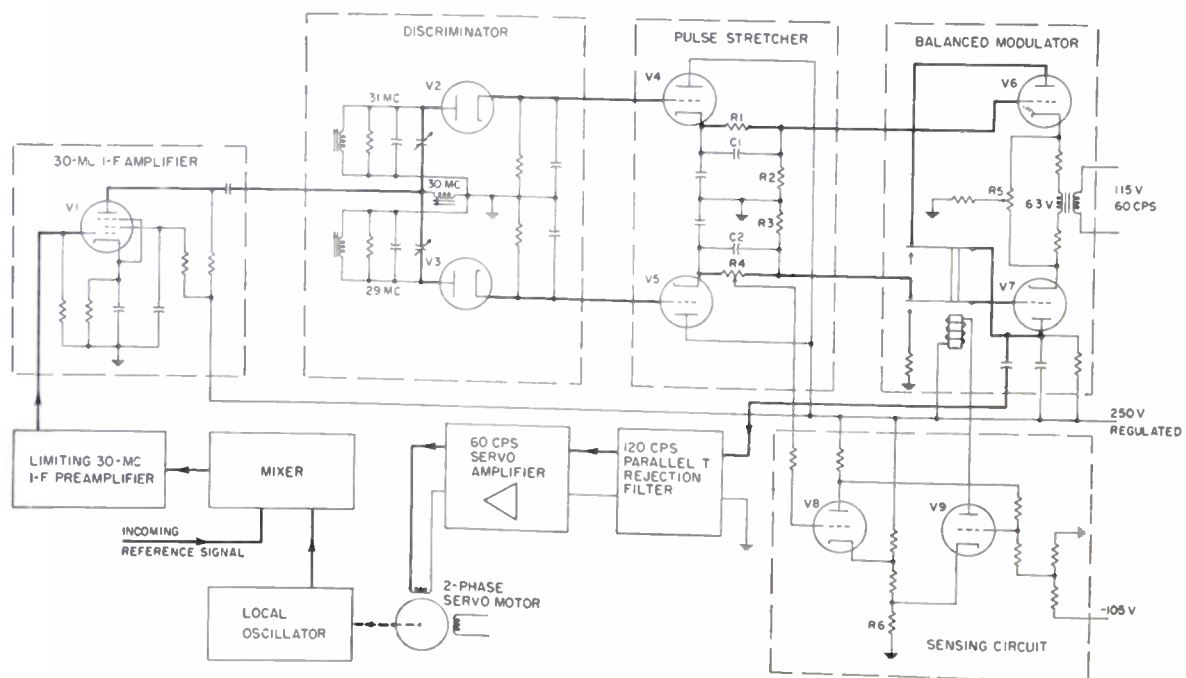

Fig. 1—Combined block diagram and schematic of AFC system.

the relatively wide pull-in range required in this case, mechanical tuning was necessary. A scheme combining an automatic searching function with normal AFC appeared to offer the simplest solution. The problem, therefore, resolved into two parts: (1), design the servomechanical AFC, and (2) design suitable control circuits to provide automatic searching. The first part involves the application of the theory of servomechanisms to AFC systems, and has been covered previously in the literature.¹⁻³ Principal emphasis in this paper will be on the control circuit requirements of wide-range difference-frequency servomechanical AFC systems.

This AFC method is ordinarily applied to heterodyne systems where the incoming signal is converted to an intermediate frequency. The following discussion will assume that the controlled local oscillator has a tuning range considerably greater than twice the intermediate center frequency, and that continuous rotation of the tuning motor produces cyclical variation of the oscillator frequency throughout the entire tuning range as shown in Fig. 2.

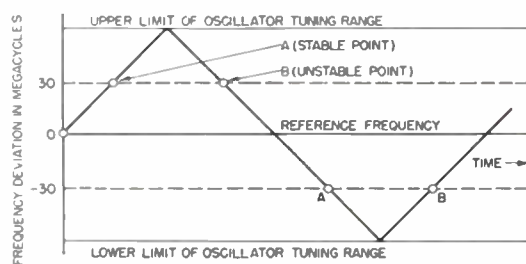

Fig. 2—Tuning characteristics of AFC system.

II. SENSING CIRCUIT

The following considerations entered into the design of the sensing circuit:

1. A positive, rapid transition between the search and normal AFC regimes must be provided.
2. The transition must be controlled by the presence or absence of the desired signal.
3. The circuit must distinguish between stable and unstable operating points, allowing locking only at stable points.

The sensing circuit and its connections in the AFC system are shown in Fig. 1. The switching between the two regimes of operation is accomplished by a small sealed relay under control of the sensing circuit. The double triode flip-flop sensing circuit is similar to one described first by Schmitt,⁴ and has been altered to achieve triggering on one of the grids with a positive

voltage of about 15 volts. This triggering voltage is derived from one side of the staggered discriminator characteristic (described later). The transition between the relaxed and energized condition of the relay is a rapid snap action resulting from the cross connection of the plate of $V8$ to the grid of $V9$, and the common coupling of the cathode resistor, $R6$. This satisfies the first design consideration.

It will be noted that a positive direct voltage derived from the supply bus is applied to the cathode of $V8$. This, together with potentiometer $R4$ in the pulse stretcher circuit, enables control of the voltage level at which conduction is transferred from $V9$ to $V8$. Common cathode coupling resistance, $R6$ is important in determining the difference between tripping and release levels at the grid of $V8$. For example, when $V9$ is conducting (relay energized), the resulting voltage drop across $R6$ serves to increase the voltage at the cathode of $V8$, and hence raise the triggering level at the grid of $V8$. But when $V8$ is conducting (with $V9$ cut off), less current flows through $R6$ and the release level is therefore lower than the triggering level. These features satisfy the second design consideration, as will be shown in later discussion.

III. SWITCHING UNDER STABLE CONDITIONS

A special problem arises in AFC systems of this type when the local-oscillator frequency may be varied over a range considerably greater than the intermediate frequency. This problem results from the presence of both stable and unstable operating points (insofar as AFC is concerned) where 30 Mc difference frequency signals are produced at the input to the AFC system, and provision must be made to distinguish between them.

Examination of Fig. 2 shows that there are, in general, four points in the oscillator tuning cycle where a signal will appear at the input to the AFC system. These points appear as conjugate pairs, marked A and B in Fig. 2, and are distinguished by the direction of travel of the signal through the intermediate-frequency passband for a given direction of motor rotation. The A points, for example, show traversal from the low- to high-frequency edges of the passband. If the servo connections are correct for stable, null-seeking operation at the points marked A , the system will lock on frequency at either A point, and normal AFC will result. At the conjugate points B , however, the servo connections are effectively reversed, because a given direction of motor rotation produces a frequency change just opposite to that at the stable points. These are unstable points, and the sensing circuit must reject them and allow the local oscillator frequency to progress to the next stable operating point and lock there.

Differentiating between stable and unstable operating points is based on time and voltage relationships, and is accomplished as follows. By arranging the sensing circuit so that it is triggered by a voltage derived from the low-frequency peak of the discriminator, it will be

¹ V. C. Rideout, "Automatic frequency control of microwave oscillators," *Proc. I.R.E.*, vol. 35, pp. 767-771; August, 1947.

² F. A. Jenks, "Simplified microwave AFC," Parts I and II, *Electronics*, vol. 20, pp. 120-125, November, 1947; and pp. 132-136, December, 1947.

³ H. Lauer, R. Lesnick, and L. E. Matson, "Servomechanism Fundamentals," McGraw-Hill Book Co., New York, N. Y.; 1947.

⁴ O. H. Schmitt, "A thermionic trigger," *Jour. Sci. Instr.*, vol. 15, pp. 24-26; January, 1938.

tripped early with reference to the intermediate-frequency passband at the stable *A* points, and late at the unstable *B* points. At the stable points there is ample time for the discriminator to take control of the tuning and pull the frequency into the proper value, but at unstable points the tripping is delayed past dead center. This causes the motor to continue tuning away from crossover frequency, because the servo connections at the unstable points are opposite to those necessary for stability. The signal is, therefore, tuned out of the passband until the decrease in signal causes the searching operation to be resumed. The choice of polarities throughout the circuit must be co-ordinated properly so that the direction of tuning on search is such as to approach stable points from the low-frequency side of the passband. Reversing the leads to one phase of the motor interchanges the stable and unstable points, but also reverses the direction of tuning in search, and the system still operates normally.

It should be noted that the intentional differential between trip and release points in the operation of the sensing circuit enables control to be retained by the discriminator at stable points for frequencies somewhat beyond the 30-Mc center frequency. The net result of this control action is that the system searches for a reference signal, and upon finding one, stops and locks at any stable point, but tunes through unstable points after only a brief hesitation. This fulfills the third design consideration.

IV. CIRCUIT DETAILS

The system shown in Fig. 1 represents a practical solution to the design requirements. For proper AFC operation the intermediate-frequency preamplifier must deliver a limited output for either continuous wave or pulsed signals, as otherwise the effective gain of the servomechanical loop would be subjected to unpredictable variations and the subsequent control circuits could not be properly adjusted.

Intermediate-frequency signals are further amplified and applied to the primary of a capacitively coupled, stagger-tuned discriminator. For continuous-wave signals, the output of the discriminator diodes may be applied directly to the following stages, but if the system must operate from a pulsed reference signal, pulse stretching is necessary to obtain direct voltage for control of following circuits. If the requirements for the servo tuning system indicate the desirability of error-rate damping, an *RC* differentiating network may be interposed at this point, as shown by *R1*, *R2*, *C1*, and *R3*, *R4*, *C2* in Fig. 1.

The output from each discriminator diode (and whatever pulse-stretching and differentiating circuits follow) consists of a positive direct voltage to ground. These voltages in each half of the symmetrical circuits will be equal when a suitable signal is centered at the crossover frequency, as illustrated in the typical discriminator characteristics of Fig. 3. In addition to performing the

error sensing function for normal AFC operation, the discriminator output is also utilized to actuate the sensing circuit as will presently be explained.

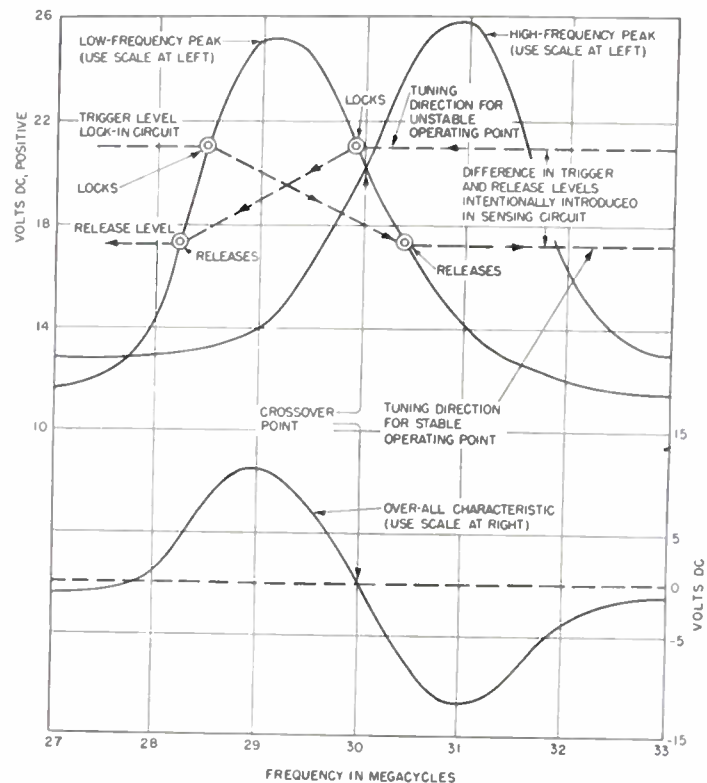

Fig. 3—Typical discriminator characteristics.

For normal AFC operation, the balanced modulator stage serves to convert the direct voltages at the discriminator output into a 60-cps voltage having a magnitude proportional to the frequency error, and with a 180-degree phase reversal occurring on each side of the 30-Mc crossover frequency. Balance potentiometer *R5* permits the center frequency to be adjusted to compensate for slight variations in discriminator alignment, and to accommodate changes due to tube replacement. Because this stage has a residual 120-cps output at the null point, it is followed by a parallel-T rejection filter tuned to 120 cps. The 60-cps voltage emerging from the balanced modulator and parallel-T filter is then amplified in a conventional servo amplifier that produces enough power to drive the variable phase of the servo motor.

The action of the discriminator on the sensing circuit is shown in Fig. 3. Each of the staggered secondary outputs appears as a positive direct voltage to ground, the system being set up so that the sensing circuit is tripped from the low-frequency peak. Assume first that there is no signal present at the input to the AFC unit. No tripping voltage will appear at the grid of *V8* so this triode will be cut off. Therefore, *V9* conducts and energizes the relay. In this condition, the modulator stage is completely unbalanced, causing the servo motor to run continuously in one direction, driving the local-oscillator frequency until a signal is intercepted.

When a signal of sufficient magnitude to exceed the tripping threshold at the grid of V8 appears, this tube conducts suddenly and cuts off V9, thus de-energizing the relay and connecting the discriminator output directly through to the modulator for normal AFC action. Thus, as long as a sufficiently large signal is present, the normal AFC regime will hold, while in the absence of a signal, the tunable oscillator will search continuously.

In the particular system described, consistent locking of oscillator frequency within about 15 parts per million is possible. Operation is automatic and, when once locked on a reference signal, the 30-Mc difference frequency will be held regardless of drifts in either the reference signal or the local oscillator. The delay in correcting for small frequency changes is well under one-tenth of a second, but because of mechanical inertia this system obviously cannot compare with electronic methods in speed of response. Where short-time stability con-

siderations in the oscillator are important (over periods up to 0.1 second or more), a mechanical AFC system of this type is more advantageous than those electronic methods that cause the oscillator frequency to vary continuously about the desired value. The time required for a complete search cycle depends on many factors such as the frequency range of the oscillator, bandwidth of the discriminator and intermediate-frequency system, inertia of moving parts, and gear ratios. For most applications, the search time will be an appreciable part of a minute.

ACKNOWLEDGMENT

The development of the system described was carried out under the sponsorship of Watson Laboratories of the Air Force. The author wishes to acknowledge the helpful co-operation of a number of his colleagues in making this development possible.

A Test of 450-Megacycle Urban Area Transmission to a Mobile Receiver*

A. J. AIKENS†, ASSOCIATE, IRE, AND L. Y. LACY†, SENIOR MEMBER, IRE

Summary—Measurements were made of mobile radio-telephone transmission at 450 Mc in New York City using frequency modulation. Comparison was made with transmission at 150 Mc using identical speech modulation. Effective radiated powers were about equal. Direct comparison tests were made with the receivers installed in a moving automobile. The transmitter and the receiver used at 450 Mc were developed especially for the job. The receivers used at the two frequencies had substantially the same noise figures. The tests permitted estimates of the relative magnitudes of the shadow losses at the two frequencies and included measurements of rf noise. Subjective tests of circuit merit comparing the two frequencies were made by a number of observers.

THE PROJECT

FROM THEORETICAL considerations it had been predicted that frequencies as high as 450 Mc might be useful for providing mobile telephone service. In order to determine whether such frequencies could be used for telephone transmission to vehicles in urban areas, a series of tests was undertaken with measuring equipment located in a test automobile and with transmitting equipment located atop the Telephone Building at 32 Avenue of the Americas, New York, N. Y.

An FM transmitter operating at 456.090 Mc¹ was located on the roof of the Telephone Building. Band-

width and frequency deviation of the system were made the same as in the present 150-Mc system (i.e., ± 10 radians at the final frequency) wherein the transmitter is also located on the roof of the Telephone Building. Both antennas were about 460 feet above street level. The effective radiated power of the 450-Mc system was equivalent to about 100 watts from a coaxial dipole (24 watts actual power plus 6-db antenna gain). Direct comparison tests were made between the experimental system and one of the channels of the regular 150-Mc system, which uses a coaxial dipole antenna radiating about 200 watts. Effective radiated power was thus about 3 db less at 450 Mc than a 150 Mc.

The experimental 450-Mc receiver consisted of a radio-frequency preamplifier and mixer, the mixer output being fed into a standard Western Electric 38B Mobile Radio Receiver operating at an input frequency of about 160 Mc. A standard 38B Radio Receiver was used directly for the 150-Mc tests so that the bandwidths of the receiving systems, which are determined entirely by the 38B Radio Receivers, were closely comparable for the 450- and 150-Mc tests. The noise figures² for both receivers were measured as about 8 db; this value implies good receiver design and alignment.

A survey was made of reception at both frequencies in a car equipped with quarter-wave whip antennas. At many locations in Manhattan, at some points in the

* Decimal classification: R630.3. Original manuscript received by the Institute, September 8, 1949; revised manuscript received, December 22, 1949. Presented, IRE National Convention, New York, N. Y., March 8, 1949.

† Bell Telephone Laboratories, Inc., New York, N. Y.

¹ The actual test frequencies of 456.090 and 152.63 Mc have been rounded off to 450 and 150 Mc for convenience in this discussion.

² H. T. Friis "Noise figures of radio receivers," Proc. I.R.E., vol. 32, pp. 419-22; July, 1944.

Bronx, and at a few spots in Westchester County, the strength of the radio-frequency signals across the radio receiver inputs was measured, as well as the audio-frequency signal and noise outputs of the two receivers; the same audio-frequency modulation was used in the two transmitters. On a separate series of test runs, judgments of circuit merit were made at several locations by four different observers. All measurements were made with the car in motion at normal driving speed.

COMPARATIVE RESULTS AT THE TWO FREQUENCIES

The radio-frequency signal strengths and circuit merits found in Manhattan are shown on Fig. 1. Signal strengths are given in the form of equal signal contours, expressed in db above 1 microvolt across the radio receiver inputs. Circuit merits³ are shown by dots with numbers beside them.

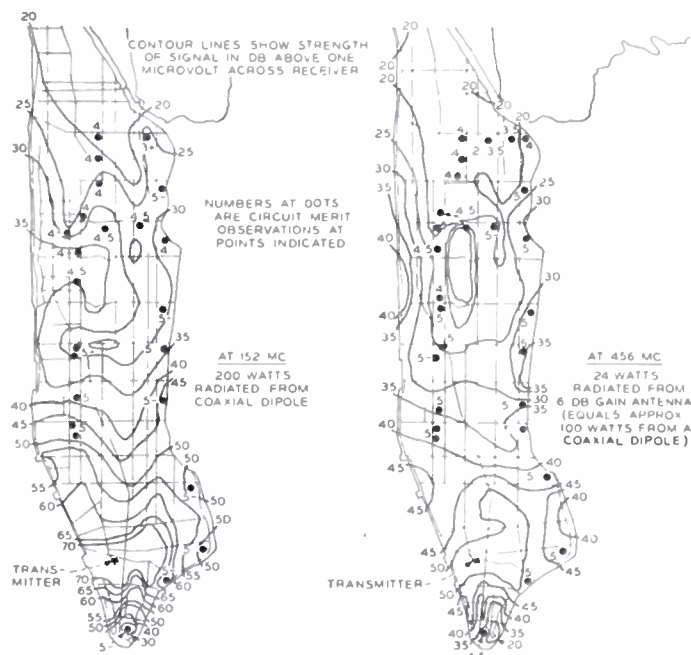

Fig. 1—Transmission on a single FM channel in New York, N. Y.

The signal strength contours must be interpreted in a rather special way. Each value represents an average over a distance of 200 to 300 feet. On the perimeter of Manhattan, the values noted represent the signals received on West Street below 72 Street, on Riverside Drive between 72 Street and 125 Street, on the Henry Hudson Parkway above 125 Street, and on South Street and the East River Drive on the other side of Manhattan. Inland, however, the values represent the signal strengths found on east-west streets in the middle of the blocks. These signal strengths are of interest because they are measured in the spots to which transmission is most likely to be marginal. It was observed that the re-

³ The scale of circuit merits is as follows:

Merit	Description
5	Excellent
4	Good
3	Just commercial
2	Poor
1	Hopeless

ceived signals averaged about 15 db higher at both frequencies on the inland north and south avenues than in adjacent crosstown streets. This latter detail is not shown on the contour maps.

Comparison indicates that the average received signal at the car at 450 Mc is about 4 db weaker than at 150 Mc.⁴ Difference in radiated power accounts for 3 of the 4 db. Close correspondence of the average received signals, when taken on an equal radiated power basis, indicates little difference in the net effect of city buildings at the two frequencies.

In tests at 21 suburban locations in the Bronx and Westchester, on parkways and numbered routes, from 13 to 26 miles from the transmitter, the received signal voltage averaged the same at the two frequencies on the basis of equal radiated powers; individual values at 450 Mc ranged from 8 db above to 14 db below corresponding 150-Mc values.

Performance of the radio circuit also depends upon the ambient radio-frequency noise. In many locations in Manhattan, and at all the test points in the Bronx and in Westchester County, measurements were made of the amount of radio-frequency signal required to override ambient noise and produce a specified audio signal-to-noise ratio at the receiver output. On the average, 10 db more radio-frequency signal was required at 150 Mc than at 450 Mc. Test car ignition noise was suppressed.

The factors of signal strength, ambient noise, and signal fluctuations are all combined in the judgment of circuit merit. Judgments of circuit merit were made at several locations in Manhattan. As noted in Fig. 1, the circuit merits at the two frequencies were estimated to be about the same (4 observers). This indicates that for equal transmitted powers, the reception would have been slightly better at 450 Mc than at 150 Mc.

All of the factors taken together tend to confirm the expectation that transmission at the higher frequency would be suitable for mobile telephone coverage in large cities.

OTHER RESULTS

Comparison with Computed Signal Amplitude

The test results are compared with computed received signal voltage across a 100-ohm receiver in Figs. 2 and 3. The measured values are corrected to a reference of 100 watts of power delivered to a coaxial dipole. The computed values are for 100 watts in a standard dipole 460 feet above ground plane and assume smooth spherical earth.

In Manhattan, the average difference between computed and measured values is about 30 db, practically all the difference lying in the range 20 to 40 db. There is no significant distinction between the two transmitted frequencies, in this regard, nor between receiving locations (all urban) from about 3 to 11 miles from the

⁴ This is an over-all average for urban and suburban locations at distances greater than about 2 miles from the transmitters. At shorter distances, the difference in vertical directivity of the two transmitting antennas tends to depress the 450-Mc signals more than 4 db below the 150-Mc signals.

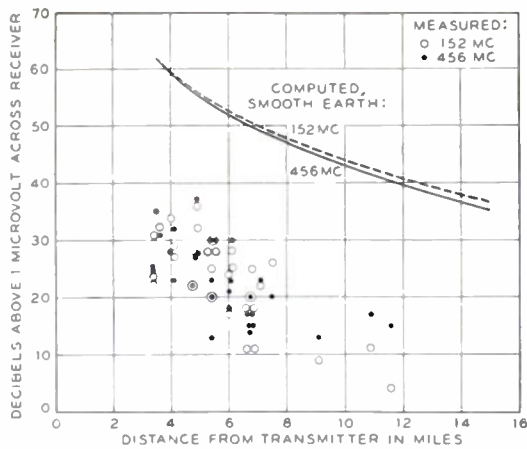

Fig. 2—Received signal strengths in Manhattan.

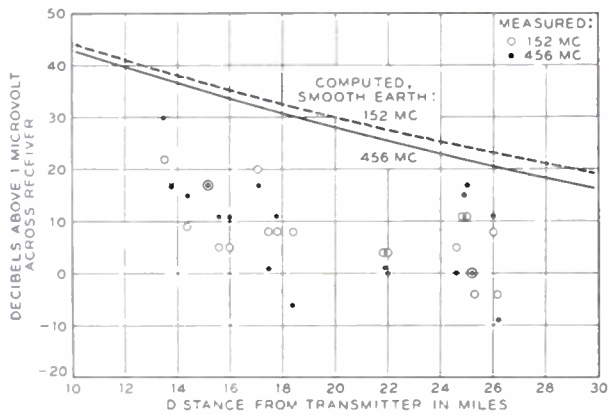

Fig. 3—Received signal strengths in Bronx-Westchester.

transmitter. In considering these values, it will be recalled that they are obtained in a city of skyscrapers, and that a large proportion of them were measured on crosstown streets, the received signals on the north and south avenues averaging some 15 db stronger than on the crosstown streets.

In Bronx-Westchester, on terrain that may roughly be described as suburban rolling country, the average difference between measured values and computed smooth-earth values is about 23 db, all the individual differences being comprised in the range 5 to 40 db; also, there is no significant distinction between the two frequencies in this regard, nor between locations from 13 to 26 miles from the transmitter.

RECEIVED SIGNAL VARIATIONS IN SHORT DISTANCES

A limited number of measurements at 450 Mc with a recording instrument in the car showed signal variations up to about 15 db in a distance of about one foot of travel (which is about one-half wavelength) on city streets; the average variation per foot of travel was probably closer to 5 db. In a car moving at normal speed, these variations tend to be averaged out. Total variation over distances of 200 to 400 feet was roughly 20 to 25 db, with either a dipole or a gain antenna. On flat open meadows, at 450 Mc the signal variation per foot of travel was around 1 or 2 db, and the total variation in 300 feet was 11 or 12 db.

NOISE VERSUS RECEIVED SIGNAL

The average audio speech-to-noise ratio plotted vs. received signal amplitude is shown on Fig. 4. These figures represent average conditions in Manhattan and cover regions of lower and higher noise and lower and higher signals.⁶ Ignition noise is controlling at both frequencies. Variations of individual locations from the average values shown, for the lower signal values, would cover a range of about ± 10 db. Both speech and noise values for the speech-to-noise ratios were measured on an audio noise meter; the speech modulation was normal for the volume-regulated urban mobile radiotelephone system.

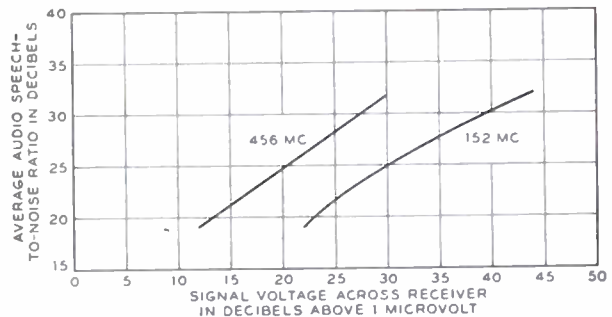

Fig. 4—Average audio speech-to-noise ratio versus radio-frequency signal strength (Manhattan tests).

It will be seen from Fig. 4 that for equal audio speech-to-noise ratios at 450 and 150 Mc, the required radio-frequency signal voltage input to the receiver was, on the average, about 10 db lower at 450 than at 150 Mc. This figure applies to urban reception, ignition noise being controlling, and assumes equal signal frequency-swings at the two frequencies. It assumes set noise low enough (noise figure of about 8 db, and a reasonable input impedance match with a quarter-wave antenna) so that the effect of the ignition noise is permitted to override set noise at both frequencies.

TEST TRANSMITTERS

Both transmitters were modulated simultaneously by the same speech source and were adjusted for equal phase deviation maxima of about ± 10 radians at the final frequency. The speech source was from talkers using standard telephone instruments. The volume was regulated to ± 4 vu by regular mobile radiotelephone control terminal equipment. Arrangements were provided for removing modulation during noise measurements.

ACKNOWLEDGMENTS

The authors wish to acknowledge the assistance of J. L. Lindner in the construction of the equipment, the help of M. Aruck in conducting tests and analyzing data, and the aid of R. S. Tucker in preparing this paper.

⁶ A source of noise, ahead of the radio transmitter, which was peculiar to the particular setup and limited the speech-to-noise ratio to a maximum of about 32 db, has been removed by computation from the values given on Fig. 4.

A Six-System Urban Mobile Telephone Installation with 60-Kilocycle Spacing*

R. C. SHAW†, SENIOR MEMBER, IRE, P. V. DIMOCK†, SENIOR MEMBER, IRE,
W. STRACK, JR.†, AND W. C. HUNTER†, MEMBER, IRE

Summary—This paper describes a 6-system mobile radiotelephone installation in Chicago, operating in the 152-162-megacycle band, and using 60-kc spacing of carrier frequencies, rather than the 120-kc spacing of previous practice. The measures required to achieve this frequency saving are described, including filters and special antenna arrangements at the land transmitter, "off-channel squelch" in the land receivers, connection of six land receivers to a common antenna, and other special co-ordinating means.

INTRODUCTION

THE DEMAND for telephone communication to vehicles in some urban areas has far exceeded the capacity of available radio channels. To cope in some measure with this demand, the Bell Telephone Laboratories, in co-operation with the Illinois Bell Telephone Company and the New York Bell Telephone Company, have engineered an installation using a block of six adjacent channels wherein the normal frequency spacing between channels has been halved. Thus, the number of useful channels has been doubled. In the allocation plan of the Federal Communications Commission for the urban frequency range of 152-162 Mc, the designated channel spacing is 60 kc. However, channels have in the past been assigned only every 120

kc within the same city. Field tests have shown that operation with 60-kc spacing, using currently available equipment, is feasible if several special measures, the most important of which is the "co-ordinated operation of land transmitters," are followed.

The six-system installation shown in Fig. 1 is essentially a group of six single-system systems which are carefully co-ordinated to minimize mutual reactions. The six land transmitting antennas are mounted on a single mast and are arranged so that the coupling between them is a minimum. Separate land receivers at each receiving location are used for each channel and are fed by a single antenna. For reasons of economy, the land and mobile equipments employ the same basic units as a single-channel installation. The frequencies of the land transmitter channels are located near the lower edge of the 152-162-Mc band and are spaced at intervals of 60 kc. The corresponding mobile transmitter channels are about 5 Mc higher in frequency and are also separated by 60 kc. Standard commercial equipment is used throughout, although in some instances minor modifications have been made to meet the requirements for adjacent channel (60-kc) operation.

The operation of several adjacent channels in the same geographical area creates certain problems that do not occur in the operation of a single isolated channel. Only those problems pertaining to the operation of adjacent channels will be considered here.

* Decimal classification: R542XR460. Original manuscript received by the Institute, August 3, 1949; revised manuscript received, June 9, 1950. Presented, 1949 IRE National Convention New York, N. Y., March 10, 1949.

† Bell Telephone Laboratories, Inc., New York, N. Y.

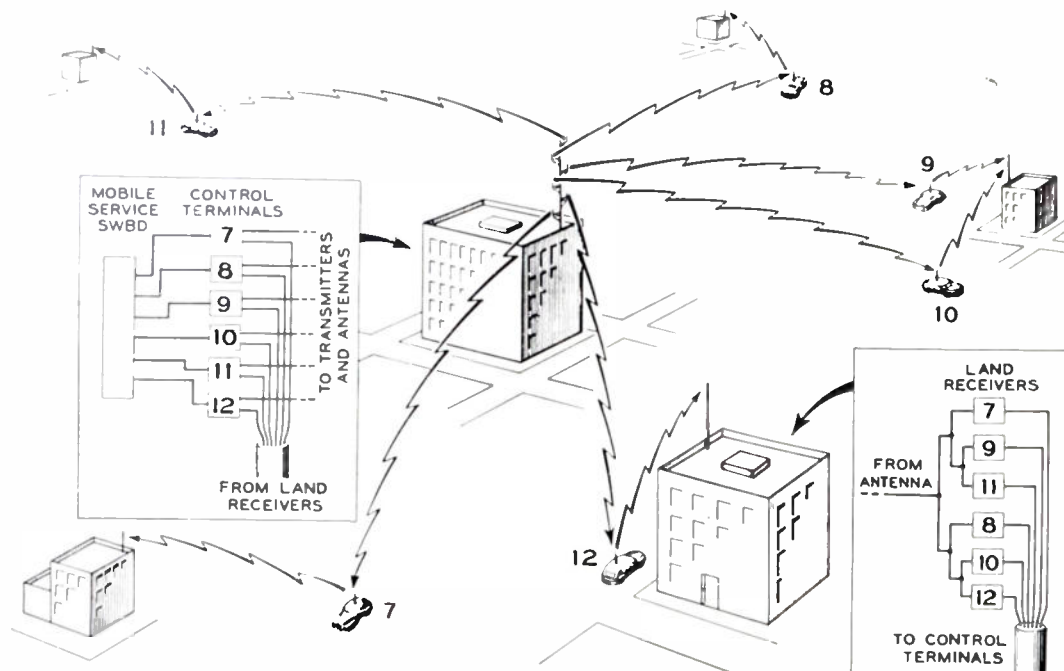

Fig. 1—A six-system urban mobile telephone installation.

MOBILE RECEIVER SELECTIVITY

The selectivity of mobile receivers now in general use is insufficient to permit the audio output of the receiver to be unaffected by a modulated carrier in an adjacent channel under many conditions of reception. When an adjacent channel carrier, but no desired channel carrier is present, a vehicle subscriber, picking up his handset to make a call, might hear distorted modulation and noise. If the desired carrier is present, but an adjacent channel carrier is received in sufficiently greater strength, intolerable cross talk may result. This may occur if the transmitters are widely separated and the vehicle is near the interfering transmitter but distant from its own transmitter.

The situations described above can be avoided if a desired channel carrier is present whenever an adjacent channel carrier is received and is strong enough to override the unwanted signal.¹ To realize this, all land transmitter antennas for a block of adjacent channels should be located at the same point and should be energized simultaneously. This may be termed "co-ordinated operation of transmitters."

The simultaneous activation of all land transmitters in a block of adjacent channels can be easily accomplished by simple relay control circuits. From the viewpoint of field distributions, it might be desirable for all transmitters to radiate from a single antenna so that differences in field strength, due to multiple-path transmissions and shadows, would be minimized. However, it is necessary to introduce appreciable attenuation between power amplifiers of the transmitters to prevent excessive intermodulation. This can be done conveniently by physical separation of the antennas.

LAND TRANSMITTER INTERMODULATION

The problem of intermodulation can be illustrated by considering the operation of two or more land transmitters with their antennas in close proximity. Voltages will be induced in each antenna due to the radiation fields of all other antennas. The resultant antenna voltage will be transmitted to the output stage of the associated transmitter which presents a nonlinear impedance, and thus intermodulation will take place between the various signals present in the plate circuit of the output stage. It can be shown that if p and q represent the output frequencies of two transmitters which are mutually coupled, the major distortion components will have the frequencies $(2p - q)$ and $(2q - p)$. Other terms will also be generated but their levels will be sufficiently low or their frequency so far removed from the useful channels that they can be attenuated by simple filters. The terms produced by six transmitters are shown in Fig. 2. Here, for convenience, channels or frequencies are referred to by numbers. The channels are numbered consecutively and are spaced 60 kc apart in frequency. Channel number 1 is the first (or lowest) channel in

the 152-162-Mc band. Channels 7 through 12 are assumed to be the active channels. Each row shows the frequencies of important intermodulation products generated by a pair of transmitters, and the 15 rows show all possible pairs for the six transmitters. A large proportion of the intermodulation products fall on channels outside the assigned group of six adjacent channels and will be referred to as "extraband radiations."

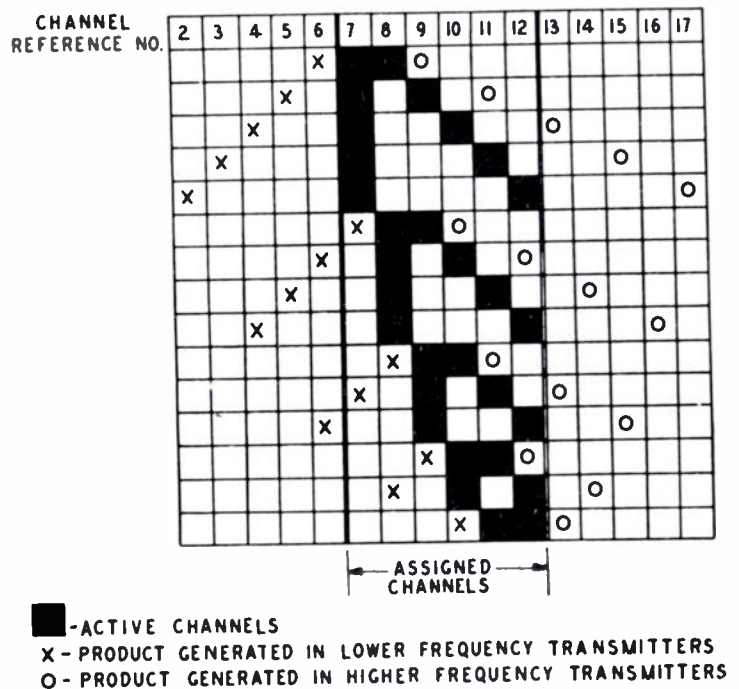

Fig. 2—Third-order intermodulation products generated in six transmitters.

It is desirable to reduce extraband radiation occurring in land transmitters to as low a level as possible. The rules² of the Federal Communications Commission, covering the subject of spurious emissions of mobile radio telephone equipment are, for apparatus of this type, that the amplitude of the spurious product shall be at least 70 db below the level of the unmodulated carrier.

In general, distortion products of the form $(2p - q)$ can be reduced by attenuating the product itself with selective circuits or by decreasing the coupling between transmitters. Two methods which appear most feasible are (1) optimum geometrical arrangement of antennas, and (2) frequency-selective circuits located between the output stage of each transmitter and its antenna.

The method of mounting antennas³ has been studied and an arrangement of staggered antennas adopted. Frequency-selective circuits located in the output transmission lines between each transmitter and its associated antenna can be designed to provide attenuation to both the incoming unwanted signal and to the generated intermodulation products. The selective circuits used in this system were distributed constant

² Federal Register, vol. 14, p. 2315; May 6, 1949.

¹ Satisfactory operation has been obtained in some instances when the level of the desired channel carrier was reduced 20 db below its normal value.

³ W. C. Babcock and H. W. Nyland, "Antenna systems for multichannel mobile telephony," PROC. I.R.E., p. 1324, this issue.

circuits of the coaxial-line type supplied by Motorola, Inc.

By measures outlined above, it was possible to reduce the extraband radiation to the desired levels. The unwanted products were, in all cases, more than 70 db below the carrier level, thus meeting the requirements of the Federal Communications Commission.

MOBILE RECEIVER INTERMODULATION

Some intermodulation may be produced in mobile receivers in channels close to the assigned 6-channel group. When such receivers are operated close to the transmitter site and the desired transmitter is at a considerable distance, these distortion products may override the desired signal. The susceptibility of receivers to this type of difficulty increases as the field strength of the unwanted signals becomes stronger but is a problem only in the immediate vicinity of the unwanted transmitters.

LAND RECEIVER SELECTIVITY

Insufficient selectivity in the land receivers may result in interference from adjacent channel signals when the desired channel is inactive.

The traffic operator in a mobile telephone system is notified of a call from a vehicle by a signaling circuit actuated by a reduction in noise output of the detector of a land receiver. This operation takes place when an on-channel carrier of sufficient strength to give acceptable service is received. However, it is possible for a strong carrier on an adjacent channel, in the absence of a carrier on the desired channel, to reduce the noise sufficiently to cause a false signal to be sent to the traffic operator. To overcome this fault, a relatively simple "off-channel" squelch was developed.

The off-channel squelch is controlled by the second limiter grid voltage. This voltage has to exceed a certain limit in order for the receiver to be enabled. Gain and selectivity of the intermediate-frequency stages of the receiver are such that an adjacent channel carrier will never produce a limiter grid voltage exceeding the threshold value. The off-channel squelch serves only to decrease the susceptibility to interference when no carrier is present in the desired channel. Experience indicates that other types of interference in land receivers are of negligible proportions.

DESCRIPTION OF CHICAGO SIX-SYSTEM INSTALLATION

A six-system urban mobile telephone installation has been placed in operation by the Illinois Bell Telephone Company in Chicago, Ill. Following is a description of the essential components of this system.

Land Transmitters

The land station transmitters are operated on channels 7 through 12 inclusive from 152.390 Mc, with 60-ke channel spacing, to 152.690 Mc as assigned by the Federal Communications Commission.⁴ Fig. 3 is a functional block diagram of the land transmitting equipment.

One Western Electric Company 540A Radio Transmitting Equipment is used for each of the six urban mobile telephone channels. A seventh serves as a standby in the event of a transmitter failure and to facilitate routine maintenance with a minimum loss of service. A trunk terminating equipment panel provides

⁴ Effective July 1, 1949, channels 9 through 14 were assigned for this service.

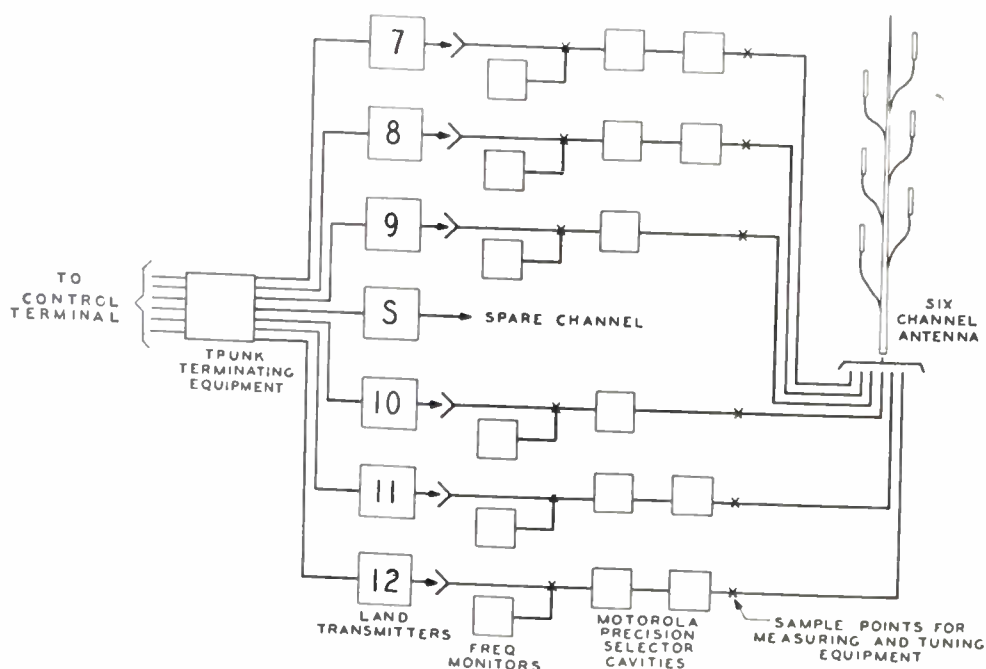

Fig. 3—Block diagram of land transmitter installation.

patching facilities for rapid switching of the audio, remote control, and frequency monitor alarm circuits.

Two cavities in cascade are interposed between each transmitter and its antenna for channels 7, 8, 11, and 12. A single cavity is used in conjunction with the transmitters on channels 9 and 10. Fig. 4 shows the bank of transmitters and high- Q filters.

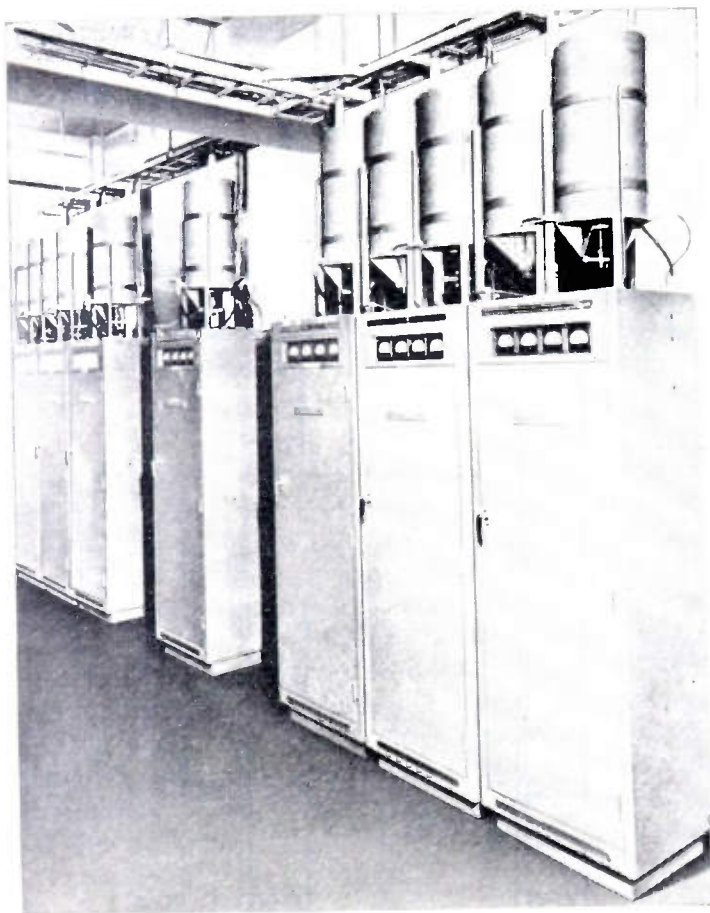

Fig. 4—Land transmitter installation at Chicago.

Land Receivers

The land receivers used in the Chicago six-system installation are Western Electric 40A and 40B Radio Receivers. These are double-heterodyne FM receivers specifically designed for mobile telephone applications. The receivers are rated at 40-db selectivity to an unmodulated adjacent channel carrier. Each receiver has been modified to incorporate an off-channel squelch circuit.

Each receiver installation, of which there are ten in the Chicago area, consists of six receivers, one for each of the six adjacent channels. The receivers are connected to a single antenna, as shown in Fig. 5, through a coaxial-line bridging network that provides satisfactory impedance matches. The incoming power divides equally among the six receivers, thus giving a bridging loss of about 8 db relative to a single receiver connected to the antenna. For most urban receiver locations, this reduction of input is not important because ambient noise rather than receiver noise is controlling. In a few locations where receiver noise is expected to

control, antennas have been installed having gain in the horizontal plane to partially offset the bridging loss.

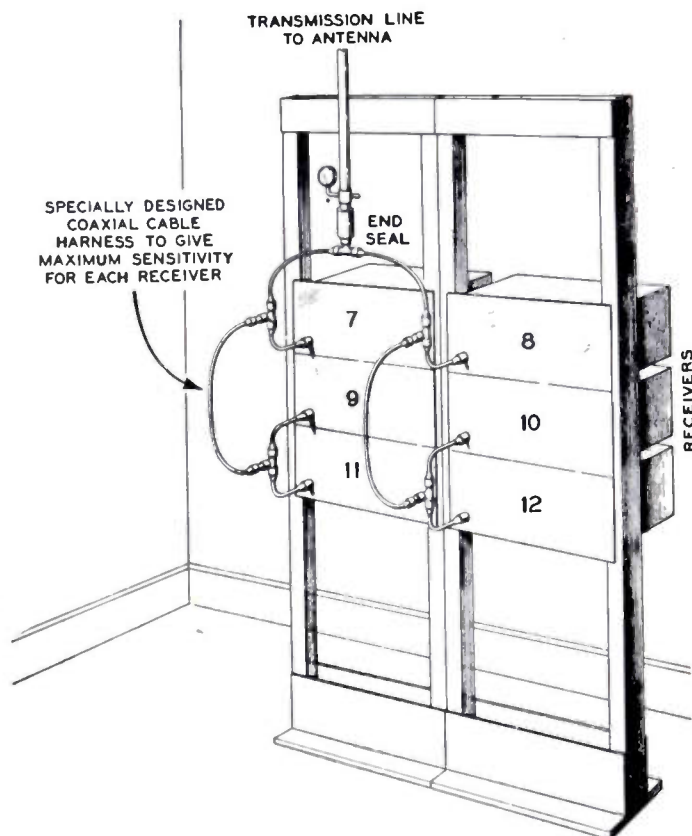

Fig. 5—Land receiver installation.

Mobile Equipment

Western Electric 238B (6-volt) or 238C (12-volt) Mobile Radio Equipments are installed in the subscribers' vehicles. Each installation consists of a receiver, a transmitter, a quarter-wave whip antenna, and a control unit which includes a handset, a power switch, and a bell.

The receiver is a double-heterodyne FM type designed to operate from the car battery. The selectivity is rated at 50 db to an unmodulated adjacent channel carrier. An automatic-gain-control circuit reduces the gain of the radio-frequency amplifier as the first limiter grid voltage increases.

The transmitter is a crystal-controlled phase-modulated transmitter with a frequency multiplication of 36. The radiated power is 20 watts. Modulation limiters are employed to prevent extraband radiation.

CONCLUSIONS

This Chicago six-system installation has been in commercial operation since November, 1948. A similar installation in New York City, having three channels with 60-kc spacing, has also been in service for about the same length of time. A highly satisfactory grade of service has been provided by both of these installations. Systems of this type will permit doubling the number of available channels in most of the large cities without any major equipment redesign.

Antenna Systems for Multichannel Mobile Telephony*

W. C. BABCOCK†, MEMBER, IRE, AND H. W. NYLUND†

Summary—This paper describes an arrangement whereby several antennas may be mounted on a single mast at the transmitting site of a multichannel system operating in the 152-162-megacycle band. The antennas are so disposed as to minimize shadowing effect of the mounting structure, while keeping intertransmitter coupling to a tolerable minimum. Measurements of the electrical characteristics are presented for arrangements of 6 antennas mounted on a 62-foot steel mast. These measurements on a full-scale structure are supplemented by tests at a higher frequency on reduced-scale, simplified models.

ONE OF THE EARLY problems that had to be solved in the development of multichannel mobile telephone systems was that of interchannel cross talk. This was troublesome because of the close frequency spacing between adjacent channels, which was 60 kilocycles in a frequency-modulated system operating in the 152-158-Mc band, and because the mobile unit might be considerably closer to the transmitting antenna which served an adjacent channel than to the antenna which served its own channel. This problem was very appreciably reduced by locating all of the transmitting antennas serving a given area at the same site.

When mounted on the same rooftop, however, the proximity of the transmitting antennas, which proved so useful in solving the interchannel cross-talk problem, introduced another of almost equal magnitude. The simultaneous operation of two or more transmitters, serving antennas closely coupled because of their proximity to each other, gives rise to the generation of intermodulation products. These products are radiated, and, if uncontrolled, will appear as interfering signals at unwanted points in the frequency spectrum.

The problem posed, therefore, was to locate as many antennas as possible in as limited space as possible without at the same time permitting the coupling between them to get completely out of hand. To be more specific, system requirements demand that the coupling between most of the antennas be of the order of 40 db or more whereas that between a few of them may be of the order of 30 db. Furthermore, each antenna should radiate a vertically polarized wave having a more or less uniform radiation pattern in the horizontal plane.

For the same coupling two radiators collinearly disposed can be located much closer to one another, as is well known, than when placed broadside. This suggests that a collinear arrangement of radiators might be suitable for our purpose. With one-wavelength spacing an over-all length of eight wavelengths is required to ac-

commodate six half-wave antennas. At urban mobile telephone frequencies, which are around 152 Mc, eight wavelengths are of the order of 50 feet so that a mast about 65 feet in the clear is required if the lowermost antenna is to be elevated some 15 feet above the mounting surface.

Coaxial antennas are currently used at urban land stations and are readily available commercially. Fig. 1 shows schematically two arrangements of six such antennas mounted on brackets attached to a mast. The question now arises: How does the presence of the mast, cross arms, and transmission lines affect the electrical characteristics of the several antennas? A 62-foot unguaged steel mast was erected on Bell Laboratories prop-

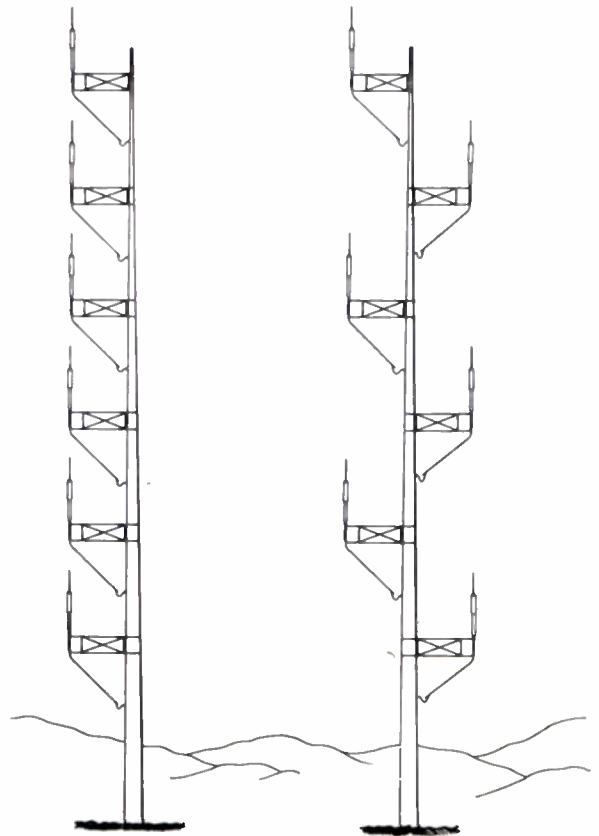

Fig. 1—Two mounting arrangements, six antennas on one mast.

erty at Murray Hill, N. J., to answer that question. This mast, shown in Fig. 2, was designed by J. H. Gray of our Outside Plant Department and fabricated by "The Pole and Tube Works" at Newark, N. J. It is 14 inches in diameter at the base, tapering to 3½ inches at the top. The brackets are telescoping affairs so that the spacing between mast and antennas is variable over the limited range of 3½ to 6 feet. The brackets can also be swung around the pole so that the antennas may be oriented in any desired azimuthal direction.

* Decimal classification: R326.2. Original manuscript received by the Institute, August 3, 1949; revised manuscript received, June 9, 1950. Presented, 1949 IRE National Convention, New York, N. Y., March 8, 1949.

† Bell Telephone Laboratories, Inc., New York, N. Y.



Fig. 2—The Murray Hill mast.

At the conclusion of experimental work conducted on this Murray Hill mast, a similar structure was erected on the roof of the Morton Building in Chicago where commercial mobile telephone service is now being given on six separate channels. Still more recently, the New York skyline has been modified by the appearance of a somewhat similar structure on the Long Lines Building of the American Telephone and Telegraph Company at 32 Avenue of the Americas. Fig. 3 shows the Morton Building mast with its six urban system antennas and, in addition, a single highway system antenna operating at approximately 35.5 Mc mounted at the very top of the mast.

OBJECTIVES

The tests herein described were made with the following objectives in mind:

1. To determine the best antenna arrangement for use in the six-channel system that was later installed in Chicago.
2. To develop a standard multichannel arrangement for general use if such standardization appears desirable and feasible.

DESCRIPTION OF INDIVIDUAL ANTENNAS AND THEIR TEST LEADS

The antennas used in the tests as well as in the Chicago installation are half-wave coaxial-type antennas, which are readily available commercially. Those used in the tests at Murray Hill were provided with a length of RG-12/U coaxial cable which extended six feet below the bottom of the support staff. For most of the tests this cable was connected through type-N weatherproof fittings to another section of similar cable of sufficient length to connect to the test equipment.

In the Chicago installation, however, the length of RG-12/U cable provided with the antenna is connected to an end seal terminating a length of 7/8-inch pressurized cable mounted on the mast. This pressurized cable connects the end seal at the transmitter end of the line to the end seal at the antenna end of the line. Voltage standing-wave measurements were therefore made on a setup simulating this arrangement to insure that the load presented to the transmitter by the antenna and its associated connecting cable and fittings would be satisfactory.

TESTS

Three types of tests were made for each of several antenna arrangements. These tests may be described as follows:

1. The voltage standing-wave ratio on the several transmission lines feeding the antennas was determined.
2. The couplings were determined for all antenna combinations.
3. The radiation pattern in the horizontal plane was determined for representative antennas.

IMPEDANCE MEASUREMENTS

Impedance measurements were made on a slotted line using standard techniques. The antennas were measured at different mast spacings and at different positions with respect to one another. The voltage

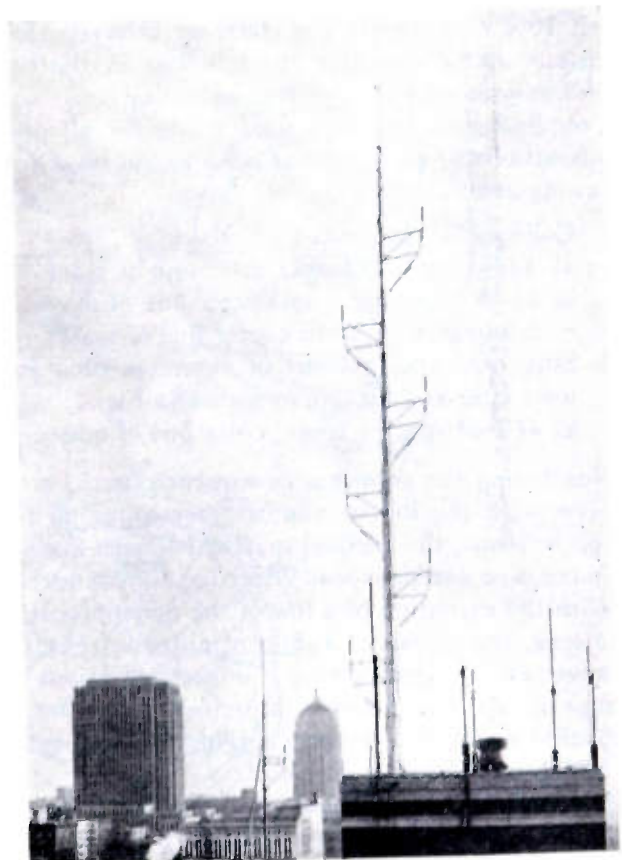

Fig. 3—The Chicago mast.

standing-wave ratios on a 70-ohm transmission line, which included two end seals and associated N-type connectors, ranged between 1.1 and 1.3 and were considered satisfactory.

ANTENNA COUPLING

The setup used in measuring the antenna coupling is shown in Fig. 4. Referring to this figure, the measuring procedure was as follows: The microvoltage was connected initially through the variable attenuator box to the transmission line leading to one of the antennas while another antenna was connected through a fixed 10-db pad to the receiver and associated audio detector. A convenient reading was obtained on the

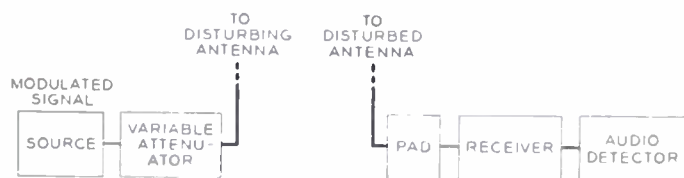

Fig. 4—Setup for measuring antenna coupling.

audio detector with 10 db in the attenuator box to stabilize the impedance seen by the microvoltage. To calibrate this reading the microvoltage was connected through the variable attenuator box directly into the pad preceding the receiver. The attenuator was then adjusted until the same reading was again obtained on the audio detector. The final setting of the attenuator down 10 db represents the coupling between the two antennas under test plus the line loss in the coaxial cables associated with the test antennas.

Coupling measurements were made for all possible combinations of six antennas on a single mast for the following arrangements:

1. Collinear arrangement of antennas.
 - a. 4-foot spacing from center line of mast.
 - b. $4\frac{1}{2}$ -foot spacing from center line of mast.
 - c. 5-foot spacing from center line of mast.
2. Staggered arrangement of antennas such as was used later at Chicago, as shown in Fig. 2.
 - a. $4\frac{1}{2}$ -foot spacing from center line of mast.

Numbering the antennas in sequence from 1 to 6 inclusive, with the lowest number corresponding to the lowest antenna, the vertical spacing between like points on successive antennas was 9 feet for all arrangements.

With the exception of a few of the nonadjacent combinations, the measured values of antenna coupling in arrangement 1 showed only minor variations with change of spacing between antennas and mast. The measured values of antenna coupling for arrangements 1b and 2a are shown in Table I.

Arrangement 2a represents an effort to reduce the coupling between adjacent antennas by rotating alternate antennas 180 degrees around the mast in such fashion that the mast itself constitutes a shield lying be-

tween all antennas having a vertical separation of only 9 feet. The measurements indicate that the coupling between successive antennas was decreased from 3 to 6 db by this rearrangement of alternate antennas.

TABLE I
MEASURED VALUES OF ANTENNA COUPLING

Collinear antenna arrangement 1b (coupling in db)					
	2	3	4	5	6
1	35	47	57	58	61
2		35	47	48	53
3			34	43	46
4				33	49
5					33

Staggered antenna arrangement 2a (coupling in db)					
	2	3	4	5	6
1	39	45	51	51	66
2		41	42	62	69
3			37	40	46
4				37	38
5					38

RADIATION PATTERNS

It is extremely difficult to obtain reliable radiation patterns of mast-mounted antennas. It is usually impractical to move a test antenna around the fixed mast-mounted antenna, since at any reasonable testing distance there are obstacles between the two antennas in some directions unlike those in others, which would therefore distort the measured pattern. Electrically it would be desirable to locate a test antenna at an optimum testing distance in a direction that is free of obstacles and then rotate the mast and mounting fixtures around an axis that is coincident with the mast-mounted antenna. This is unfortunately not feasible mechanically. The procedure that was employed at Murray Hill involved locating a test antenna at an optimum testing distance in a direction that was free of obstacles and rotating the mast-mounted antenna around the mast. The deviations in the horizontal plane pattern from a true circle may not all be attributed to the mast and associated trappings since a pattern obtained by moving the antenna around the same orbit in the absence of the mast would doubtless exhibit deviations from a true circle. For this reason patterns were also taken on a model basis at a testing frequency of 456 Mc to confirm, if possible, the patterns obtained on the actual mast-mounted antennas. Fig. 5 shows patterns of antenna number 1, the lowermost antenna on the mast, obtained at a frequency of 153 Mc at spacings of 4.0, 4.5, 5.0, 5.5 and 6.0 feet, respectively, with the test antenna located at a point approximately 144 feet west of the mast. Patterns of this and other antennas on the mast were also obtained with the test antenna

located at different points both west, north, and south of the mast. The circular patterns also shown in Fig. 5 represent estimates of the patterns that would have been obtained if the antennas had been located in free space and hence had not been influenced by the presence of the mast and its associated trappings. These idealized patterns were derived by replotting the measured pattern in terms of arbitrary microvolts, integrating the area of the resulting pattern with a planimeter, determining the radius of a circle having an equivalent area, and finally reconvertng the microvolts corresponding to that radius back into decibels.

An inspection of Fig. 5 shows that the response of antenna number 1 when spaced $4\frac{1}{2}$ feet from the center line of the pole was about 5 db below normal in some directions and about 2 db above normal in other directions. At all other spacings the loss was 6 db or more in some directions while the gain remained about 2db in certain other directions. The shadow of the mast is very pronounced at the 4-foot spacing whereas rather deep nulls occur at the sides of the pattern at the higher spacings. These nulls are apparently produced by the wave that is bounced off the mast in such fashion as to partially cancel the direct wave impinging on the antenna.

Pattern measurements (not shown in Fig. 5) were also obtained on antenna number 5 when spaced $4\frac{1}{2}$ feet from the center line of the mast. It is of interest to note that this pattern is essentially a carbon copy of that obtained on antenna number 1 at the same spacing although the diameter of the mast is 13 inches at the point of

attachment of antenna number 1 and only 4 inches at the point of attachment of antenna number 5. The similarity of the two patterns is all the more remarkable in that the test antenna was located west of the mast for the pattern measurements on antenna number 1 and south of the mast for those on antenna number 5.

MODEL TESTS

Supplemental studies, using model techniques, were made at a frequency of 456 Mc on a reduced-scale mast and antenna. These studies were made to obtain confirmation of the results already obtained from the full-scale model tests and to obtain whatever additional information some simple tests might yield. These tests were designed to determine the effect upon the pattern of a single antenna of mounting the antenna at various distances from a metal mast.

SETUP FOR MODEL TESTS

The measurements were made at 456 Mc (with a few exceptions noted) which is very nearly three times the normal transmitting frequency. This permitted scaling down the physical dimensions of the mast and antenna to one-third full size, which greatly facilitated setting up the desired test conditions.

The mast and antenna arrangements are shown in Fig. 6. The coaxial antenna used was an early model, urban vehicular type, with whip and skirt shortened to give a good match to a 73-ohm feed line at 456 Mc. Two different masts, one of 2-inch brass pipe and one of

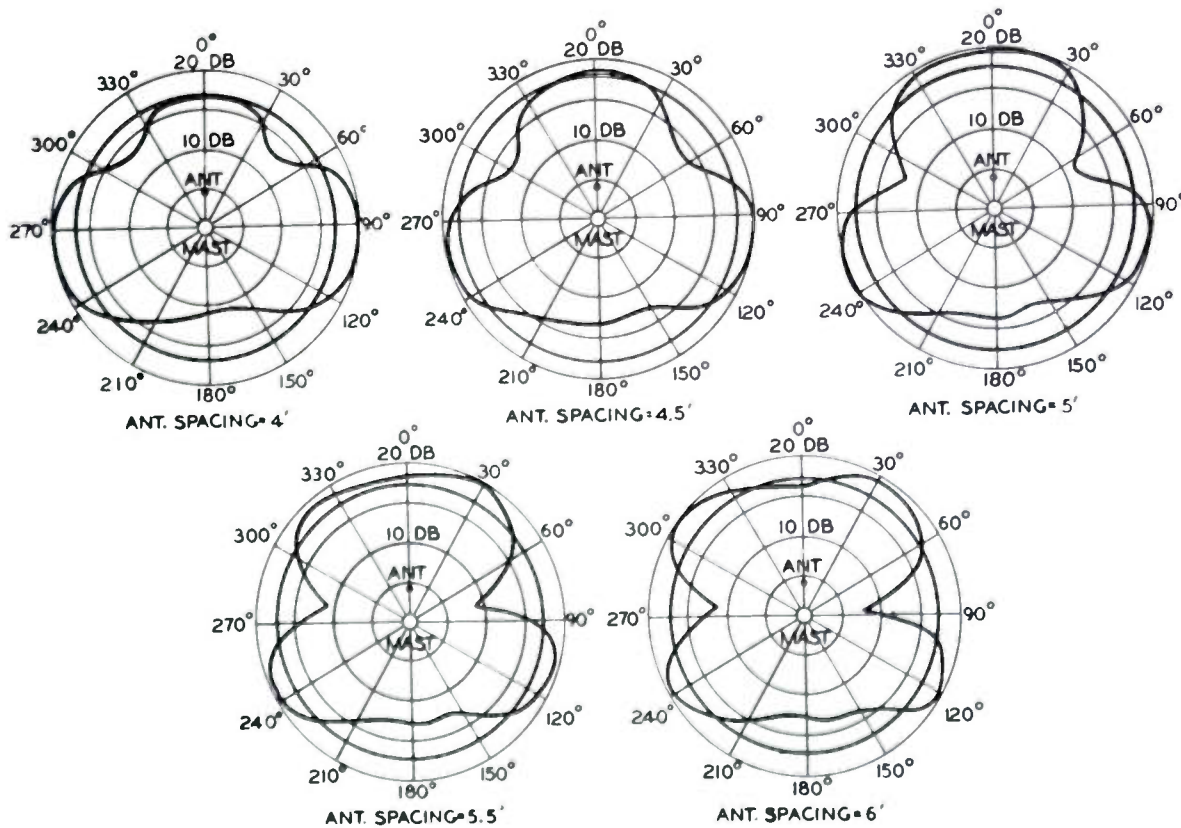

Fig. 5—Antenna patterns, full-scale tests.

4-inch galvanized leader pipe, were used. Both were 12 feet tall above ground, equivalent (at 152 Mc) to a 6- or 12-inch mast 36 feet tall. This is less than the height of the steel mast, but as only one antenna was used in the tests it was felt that mast height was not critical in pat-

tern measurements. The antenna was mounted on the mast by means of an aluminum bar yardarm, 3/16 x 2 inch in cross section, with provision for varying the spacing of the antenna from the mast by 2-inch increments from about 6 to 30 inches. The mast was free to rotate about its vertical axis, and a graduated azimuth scale was provided at the base to measure rotation.

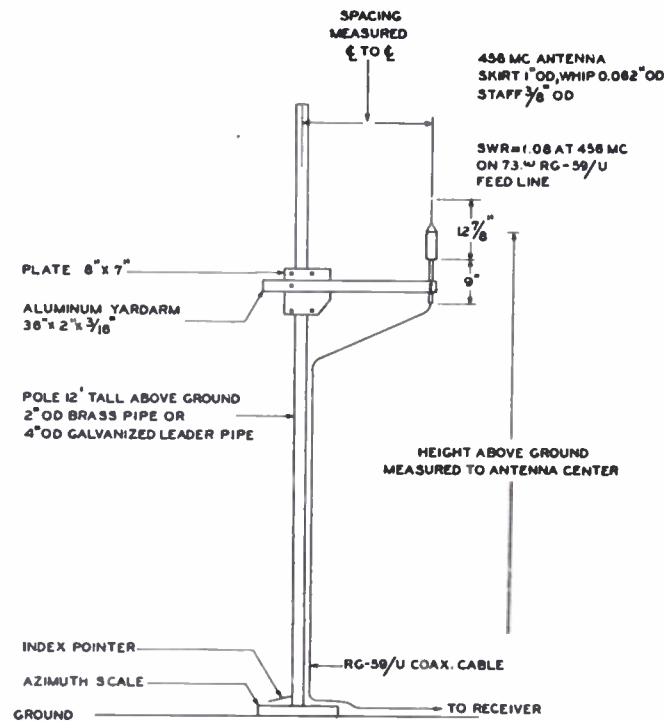

Fig. 6—Mast and antenna arrangements, model tests.

tern measurements. The antenna was mounted on the mast by means of an aluminum bar yardarm, 3/16 x 2 inch in cross section, with provision for varying the spacing of the antenna from the mast by 2-inch increments from about 6 to 30 inches. The mast was free to rotate about its vertical axis, and a graduated azimuth scale was provided at the base to measure rotation.

The over-all arrangements for the tests are shown in Fig. 7. The coaxial antenna on the mast was used as a receiving antenna, connected to a receiver through about 30 feet of RG-59/U line with a coaxial attenuator and impedance-stabilizing pad inserted near the receiver. A test signal was provided by a signal generator

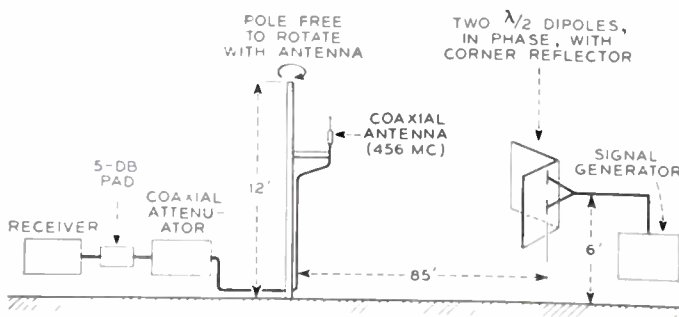

Fig. 7—Setup for measuring antenna patterns, model tests.

METHOD OF MEASUREMENT

Pattern measurements were made by setting up the desired conditions on the mast, rotating it in small angular increments and noting at each step the attenuator setting required to bring the field-strength meter on the receiver back to an arbitrary reference reading. At intervals, the mast was removed and the antenna held in place on a wooden support to determine the response obtained in the absence of obstructions.

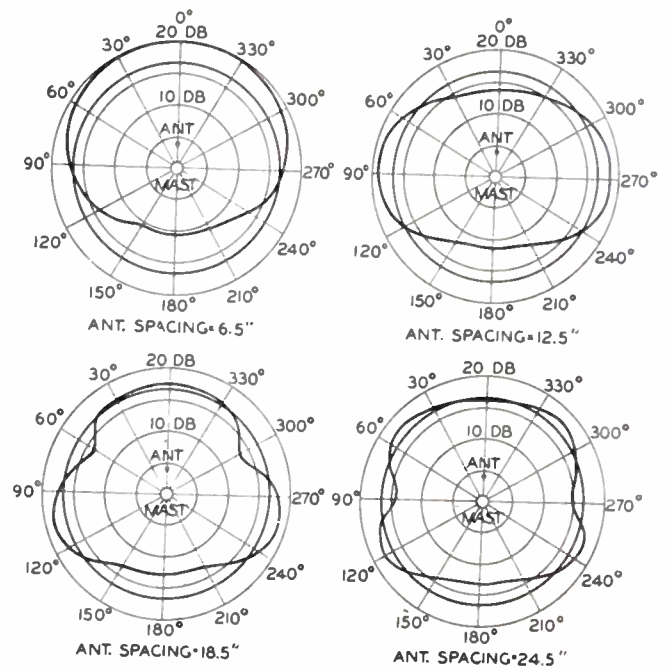

Fig. 8—Antenna patterns, 2-inch mast.

TESTS ON THE TWO-INCH MAST

The first series of pattern measurements was made with the antenna mounted on the 2-inch diameter mast, 12 feet tall. The antenna was located with its center 9 feet 4 inches off ground, and its distance from the mast was varied in 2-inch steps from 6.5 to 28.5 inches, as measured between the axis of the mast and the antenna. Typical patterns thus obtained are shown in Fig. 8. The response obtained with the mast removed is shown on each pattern for comparison as a superimposed circle. It is interesting to note that, whereas the shape of the pattern is essentially the same as that obtained on the full-scale mast at a spacing of 0.715 wavelength, the deep

nulls obtained at larger spacings on the full-scale mast are not in evidence on these perhaps oversimplified model measurements.

The curves shown in Fig. 9 portray the effect of antenna spacing from mast on the horizontal-plane pattern distortion introduced by the mast. Curve *A* shows that in the direction of maximum field intensity the field strength has been increased about 2 db regardless of the spacing. This confirms similar results obtained in the tests on the full-scale mast. Curve *B* shows that at 0°

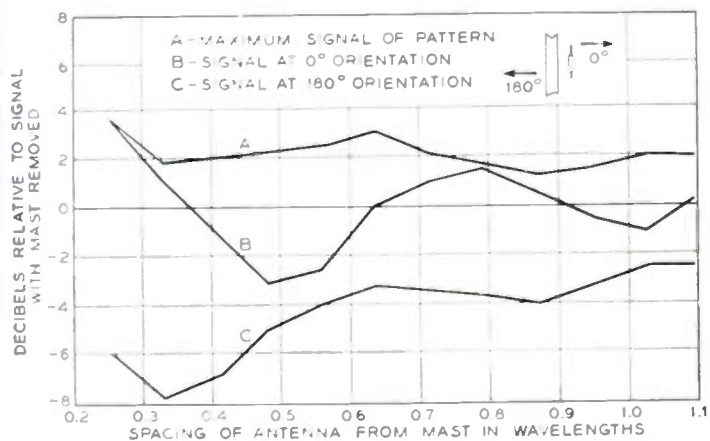

Fig. 9—Horizontal-plane pattern distortion, 2-inch mast.

orientation with the mast acting as a parasitic reflector, reinforcement of signal occurs when the spacing is an odd number of quarter wavelengths and degradation of signal occurs when the spacing is an even number of quarter wavelengths. Curve *C* shows in general that at 180° orientation the shadowing effect of the mast varies inversely with the spacing.

TESTS ON THE FOUR-INCH MAST

While the model measurements at 456 Mc on the 2-inch mast tended to confirm the full-scale measurements at 153 Mc, there was nevertheless a discrepancy in the pattern measurements at spacings between mast and antenna in excess of 0.75 wavelength. The relatively sharp deep minima observed at these spacings in the full-scale tests were much less prominent in the model tests. It appeared that this discrepancy might be attributable to the difference in mast sizes since the full-scale measurements were made at a point where the mast was 13 inches (0.168 wavelength) in diameter while the model measurements were made on a 2-inch (0.0773 wavelength) mast.

Accordingly, further measurements were made on a 4-inch mast that was 12 feet tall. A pattern obtained at 456 Mc with 23.5-inch (0.91 wavelength) spacing of antenna from mast is shown in Fig. 10. Since this pattern showed no sharp side minima, the frequency was raised to 497 Mc at which frequency the 4-inch mast diameter is 0.168 wavelength (the same as the 13-inch mast diameter at 153 Mc) and further data were taken. Com-

plete patterns were not obtained, but the radiation was measured at 0° and 180° and at those intervening positions which gave a maximum or a minimum reading. The side minima were not pronounced and observation of the signal as the antenna and mast were slowly rotated confirmed the fact that they were not sharp, but rather of a smooth character like those shown in Fig. 10.

At present, therefore, this point of disagreement between the full-scale tests and the model measurements cannot be explained. It may be caused by the presence on the large mast of other antennas than the one being studied, which, with their yardarms, make the entire structure more complex than the model setup.

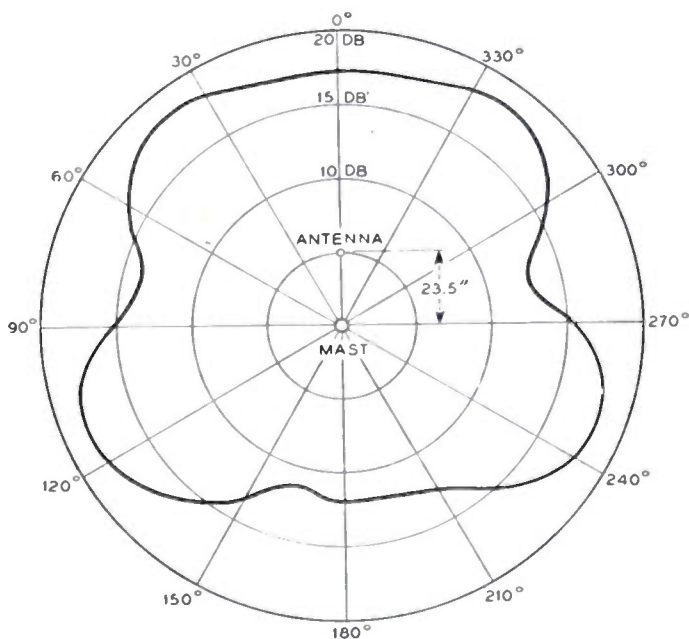

Fig. 10—Antenna pattern, 4-inch mast.

CONCLUSIONS

1. A staggered arrangement of antennas which takes advantage of the shielding effect of the mast to reduce the coupling between successive antennas is somewhat preferable to a collinear arrangement of antennas from the standpoint of realizing lower over-all antenna coupling.
2. Horizontal-plane pattern measurements obtained on the full-scale mast at 153 Mc indicated the optimum spacing of antenna from mast center line to be about 4.5 feet (0.70 wavelength). At this spacing the total spread of signal strength between the most favored and least favored directions of transmission was about 7 db.
3. Simplified model measurements gave good over-all confirmation of the results obtained on the full-scale mast; the model tests, however, did not show such pronounced nulls in the patterns as was experienced on the full-scale mast for antenna spacings in excess of 0.75 wavelength.

Cross-Talk Considerations in Time-Division Multiplex Systems*

S. MOSKOWITZ†, MEMBER, IRE, L. DIVEN†, AND L. FEIT†, ASSOCIATE, IRE

Summary—An experimental study was made of the effects on interchannel cross talk of the bandwidth characteristics of the transmission medium in pulse-time multiplex systems. Pulse-amplitude modulation and pulse-position modulation systems are considered. The effects of various types of high- and low-frequency response are discussed from both experimental and theoretical points of view.

I. INTRODUCTION

ONE OF THE significant problems present in the development of pulse-multiplex communication systems is interchannel cross talk. An investigation was conducted to determine the factors that would permit the design of a system combining high interchannel cross-talk ratios with maximum economy of bandwidth. Pulse-position and pulse-amplitude modulation^{1,2} were investigated.

Pulse-amplitude modulation is of considerable importance, inasmuch as some form of it is used in many pulse-multiplex systems. In its simplest form, it is derived by sampling a signal at fixed time intervals. These pulse samples comprise the pulse-amplitude-modulated signal. If these modulation samples are transformed to time displacement of the pulses with respect to a fixed time reference (such as a marker pulse), pulse-position modulation results.

One common form of cross talk is caused by carry over of energy from one pulse to the following pulse. Thus, cross talk may occur from one channel to the following channel, decreasing rapidly as the pulses are further separated in time. This cross talk may be expressed as the ratio of the signal output of a given channel under normal modulation to the signal output of the same channel resulting from the modulation of some other channel. This ratio is customarily expressed in decibels.

II. PULSE-POSITION MODULATION

In analyzing the effect of bandwidth on pulse carry-over, it is necessary to investigate the effect of the response-frequency characteristic of the transmission system on the shape of the pulses. Two types of high-frequency response will be considered, a slow and an extremely rapid rate of high-frequency cutoff.

* Decimal classification: R148.19×R148.6. Original manuscript received by the Institute, August 17, 1949; revised manuscript received, May 22, 1950. Presented, 1949 IRE National Convention, New York, N. Y., March 7, 1949.

† Federal Telecommunication Laboratories, Inc., Nutley, N. J.
¹ F. F. Roberts and J. C. Simmonds, "Multichannel communication systems," *Wireless Eng.*, vol. 22, pp. 538-549; November, 1945, and pp. 576-580; December, 1945.

² V. D. Landon, "Theoretical analysis of various systems of multiplex transmission," *RCA Rev.*, vol. 9, pp. 287-351, June, 1948; and pp. 438-482, September, 1948.

A. Slow Rate of High-Frequency Cutoff

A slow rate of cutoff may be obtained by a resistance-capacitance circuit of the type shown in Fig. 1. Such a circuit represents either the standard resistance-coupled amplifier without peaking circuits or its band-pass analogue, the single-tuned circuit.

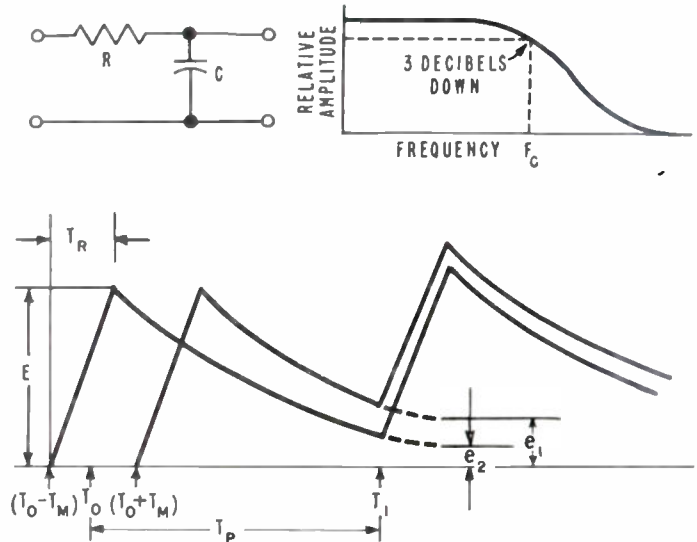

Fig. 1—Effect of high-frequency response on cross talk in pulse-position modulation using a resistance-capacitance filter.

$$\text{Cross talk ratio} = \frac{\exp(T_P/RC)}{\sinh(T_M/RC)} \left(\frac{T_M}{T_R} \right)$$

The relative amplitude-frequency response of such a circuit may be expressed as

$$E_0 = E_I \cos [\tan^{-1}(F/F_c)] \quad (1)$$

where F is the frequency considered and F_c is the cutoff frequency, which is equal to $1/(2\pi RC)$, at which point the relative amplitude drops 3 db. Fig. 1 shows the type of response given by this circuit. The rate of cutoff approaches 6 db per octave.

The effect of such a response on a pulse of voltage may be calculated by simple transient analysis. With a rectangular input pulse, the rise time T_R of the received pulse increases with increasing transmission-circuit time constant RC until a value of T_R equal to the width of the original pulse is obtained. If RC is increased further, T_R remains constant.

The cross talk introduced by transmission of time-modulated pulses through a medium having the type of frequency characteristic described can be calculated as follows.

Referring to Fig. 1, two adjacent pulses of period T_P and rise time T_R are shown. The first pulse is time modulated by a displacement T_M from its resting position

and therefore moves between $T_0 + T_M$ and $T_0 - T_M$, producing carryover e_1 and e_2 .

At one extreme, the carryover is

$$e_1 = E \exp - [(T_P - T_M)/RC].$$

At the other extreme, the carryover is

$$e_2 = E \exp - [(T_P + T_M)/RC].$$

The peak-to-peak variation in amplitude of the pulse, because of carryover, is then

$$e_1 - e_2 = E \left\{ \exp \left[- \left(\frac{T_P - T_M}{RC} \right) \right] - \exp \left[- \left(\frac{T_P + T_M}{RC} \right) \right] \right\}.$$

This may be rewritten as

$$\begin{aligned} e_1 - e_2 &= E [\exp - (T_P/RC) \exp (T_M/RC) \\ &\quad - \exp - (T_P/RC) \exp - (T_M/RC)] \\ &= E \exp - (T_P/RC) [\exp (T_M/RC) \\ &\quad - \exp - (T_M/RC)]. \end{aligned}$$

This formula may also be expressed in terms of the time constant RC .

$$\text{Cross-talk ratio} = \frac{\exp (T_P/RC)}{\sinh (T_M/RC)} \left(\frac{T_M}{T_R} \right). \quad (2a)$$

To check the results that might be expected from the use of (2), a series of experiments were run using a commercial pulse-position-modulation multiplex system in which

- $T_M = 1$ microsecond
- $T_R = 0.3$ microsecond (for low values of F_c)
- $T_P = 5$ microseconds.

The inherent cross talk in the terminals was 66 db, and this was therefore the highest cross-talk ratio that could be measured. A block diagram of the setup used is shown in Fig. 2. Resistance-capacitance filters of various cutoff frequencies were inserted at the point indicated, and cross talk at a modulating frequency of 1,000 cycles was measured with a General Radio 736A wave analyzer. Only adjacent-channel cross talk was considered.



Fig. 2—Equipment used for cross-talk measurements on pulse-position modulation.

The ratio of pulse amplitude to carryover is then

$$\begin{aligned} \frac{E}{e_1 - e_2} &= \frac{1}{\exp - (T_P/RC) [\exp (T_M/RC) - \exp - (T_M/RC)]} \\ &= \frac{\exp (T_P/RC)}{\exp (T_M/RC) - \exp - (T_M/RC)} \\ &= \frac{\exp (T_P/RC)}{2 \sinh (T_M/RC)}. \end{aligned}$$

Since $F_c = 1/(2\pi RC)$,

$$\frac{E}{e_1 - e_2} = \frac{\exp (2\pi F_c T_P)}{2 \sinh (2\pi F_c T_M)}.$$

This cross talk is expressed in terms of amplitude variation. It can be shown^{3,4} that in pulse-position modulation there is an improvement factor of $2(T_M/T_R)$ which may be applied to signal-to-noise ratio or to cross talk.

The output cross-talk ratio then becomes

$$\text{cross-talk ratio} = \frac{\exp (2\pi F_c T_P)}{\sinh (2\pi F_c T_M)} \left(\frac{T_M}{T_R} \right). \quad (2)$$

³ E. M. Deloraine and E. Labin, "Pulse-time modulation," *Elec. Commun.*, vol. 22, pp. 91-98; 1944.

⁴ S. Moskowitz and D. D. Grieg, "Noise-suppression characteristics of pulse-time modulation," *Proc. I.R.E.*, vol. 36, pp. 446-450; April, 1948.

The results of these tests, together with the values derived from (2), are plotted in Fig. 3. It will be noted that the experimental results agree closely with theory, except at high cutoff frequencies, where the inherent cross talk in the equipment used becomes the limiting factor.

B. Rapid Rate of High-Frequency Cutoff

The cross talk arising from sharp cutoff of the transmission response was also studied. Such a response is approached in intermediate-frequency amplifiers. If a rectangular pulse is passed through a low-pass system having uniform frequency and linear phase characteristics up to a certain frequency, and zero response above this frequency, the equation of the resulting pulse can be shown to be⁵

$$e = E \{ \text{Si} [n\pi(t' + \frac{1}{2})] - \text{Si} [n\pi(t' - \frac{1}{2})] \},$$

where

$$\text{Si}(X) = \int_0^X (\sin u)/u du$$

e = output voltage at any instant

E = input pulse amplitude

$$n = 2F_c W$$

⁵ E. A. Guillemin, "Communication Networks," vol. 2, John Wiley and Sons, Inc., New York, N. Y., p. 485; 1935.

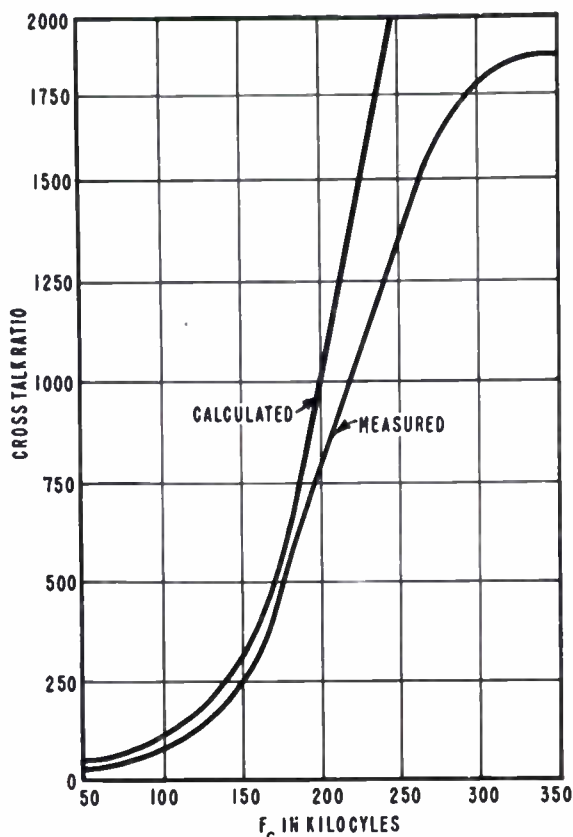

Fig. 3—Cross-talk ratio versus bandwidth for pulse-position modulation. High frequencies have been attenuated by a filter as shown in Fig. 2, where $F_c = 1/(2\pi RC)$.

$$F_c = \text{cutoff frequency}$$

$$W = \text{width of input pulse}$$

$$t' = T_p/W$$

$$T_p = \text{pulse period.}$$

For such a theoretical transmission system, the cross talk may be derived as follows.

The carryover at one extreme of modulation is

$$e_1 = E \left\{ \text{Si} \left[n\pi \left(\frac{T_p - T_M}{W} + \frac{1}{2} \right) \right] - \text{Si} \left[n\pi \left(\frac{T_p - T_M}{W} - \frac{1}{2} \right) \right] \right\}$$

and at the other extreme it is

$$e_2 = E \left\{ \text{Si} \left[n\pi \left(\frac{T_p + T_M}{W} + \frac{1}{2} \right) \right] - \text{Si} \left[n\pi \left(\frac{T_p + T_M}{W} - \frac{1}{2} \right) \right] \right\}$$

The peak-to-peak carryover ratio is then

$$\frac{E}{e_1 - e_2} = \left\{ \text{Si} \left[n\pi \left(\frac{T_p - T_M}{W} + \frac{1}{2} \right) \right] - \text{Si} \left[n\pi \left(\frac{T_p + T_M}{W} + \frac{1}{2} \right) \right] + \text{Si} \left[n\pi \left(\frac{T_p + T_M}{W} - \frac{1}{2} \right) \right] \right\}^{-1}$$

$$- \text{Si} \left[n\pi \left(\frac{T_p - T_M}{W} - \frac{1}{2} \right) \right] \right\}^{-1} \quad (3)$$

The build-up time of the pulse, after transmission through this system, is $1/(2F_c)$ so that, if $E/(e_1 - e_2)$ is denoted by ψ , the net cross-talk ratio will be

$$\text{cross-talk ratio} = 4\psi T_M F_c \quad (4)$$

The characteristics of a filter or transmission medium as given in the above analysis cannot be met in practice. A fair approximation can be made, however, by means of a low-pass π -section filter having a general characteristic as shown in Fig. 4. This filter had a rate of cutoff of approximately 20 db per octave. Tests on the same terminal equipment were made using such filters be-

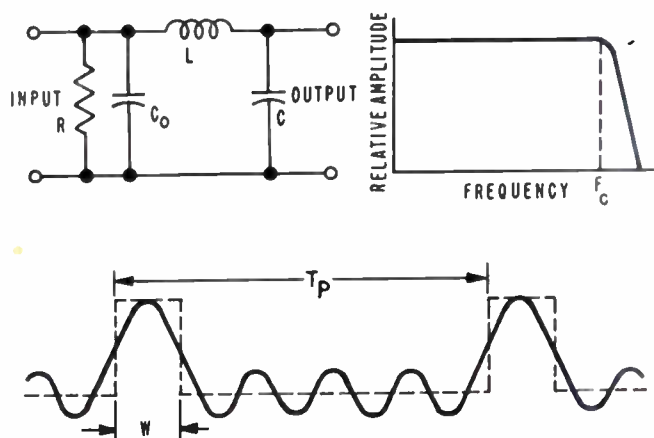

Fig. 4—Effect of high-frequency response on cross talk in pulse-position modulation using a low-pass filter. For the π network $C_0 RC_0 = 78,900$, $C = 2C_0$, $C_0 L F_c^2 = 12,670$, in micromicrofarads, microhenries, ohms, and megacycles.

tween modulator and demodulator. The results of these tests are shown in Fig. 5. From these data, substantiated by theory, a high-frequency cutoff of about 500 kilocycles is sufficient to obtain a cross-talk ratio of about 70 db. If a slow rate of cutoff is maintained such as that given by low-Q transmission circuits, transmission lines, or resistance-capacitance video-frequency circuits, a half-power point at about 350 kilocycles would give an equally satisfactory cross-talk ratio.

C. Low-Frequency Cutoff

The effect of low-frequency cutoff has also been considered. If a slow rate of cutoff such as that given by the resistance-capacitance circuit of Fig. 6 characterizes the transmitting medium, the pulse will be distorted as shown. The response-frequency plot of such a circuit is also shown in this figure and is given by

$$\text{relative amplitude} = \cos \tan^{-1} F_c/F, \quad (5)$$

where $F_c = 1/(2\pi RC)$.

The voltage e at any time $(T - W)$, where W is the width of the pulse, is

$$e = -E[1 - \exp -(W/RC)] \exp - [(T - W)/RC].$$

At one extreme of modulation, the carryover to the next pulse is

$$e_1 = -E[1 - \exp -(W/RC)] \exp - [(T_P - W + T_M)/RC].$$

At the other extreme, the carryover is

$$e_2 = -E[1 - \exp -(W/RC)] \exp - [(T_P - W - T_M)/RC].$$

The peak-to-peak carryover is then

$$\begin{aligned} 2e_1 - e_2 &= -E[1 - \exp -(W/RC)] \{ \exp - [(T_P - W)/RC] \} \\ &\quad [\exp (T_M/RC) - \exp - (T_M/RC)] \\ &= -E[1 - \exp -(W/RC)] \{ \exp - [(T_P - W)/RC] \} \\ &\quad [2 \sinh (T_M/RC)]. \end{aligned}$$

The ratio of pulse amplitude to carryover is

$$\frac{E}{e_2 - e_1} = \frac{-\exp [(T_P - W)/RC]}{2[1 - \exp -(W/RC)] \sinh (T_M/RC)}.$$

Applying the pulse-position-modulation improvement factor $2T_M/T_R$, the following equation is obtained.

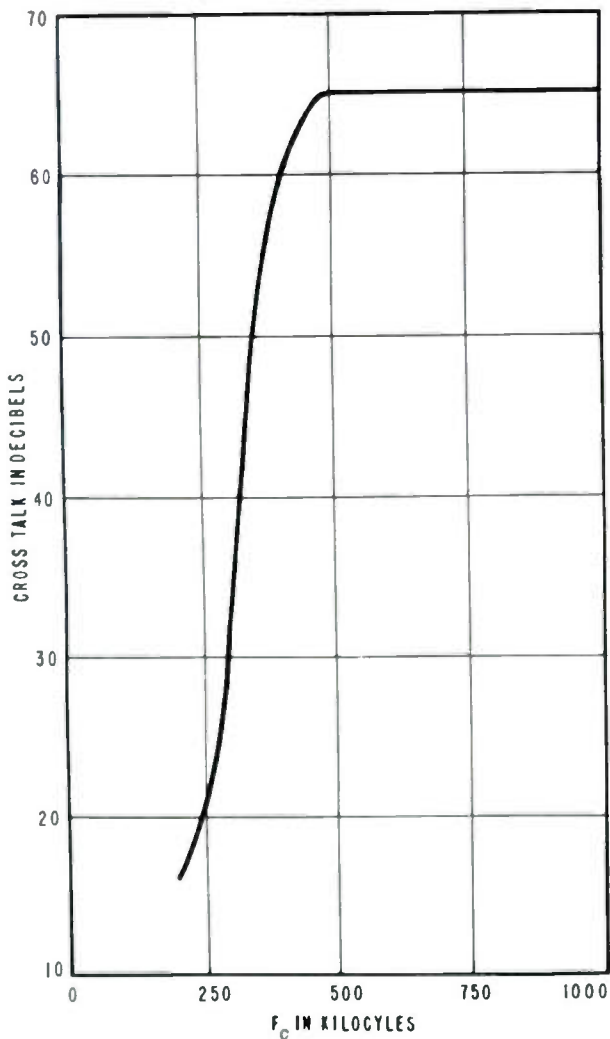

Fig. 5—Cross talk plotted against bandwidth for pulse-position modulation. High frequencies have been attenuated by the π filter shown in Fig. 4.

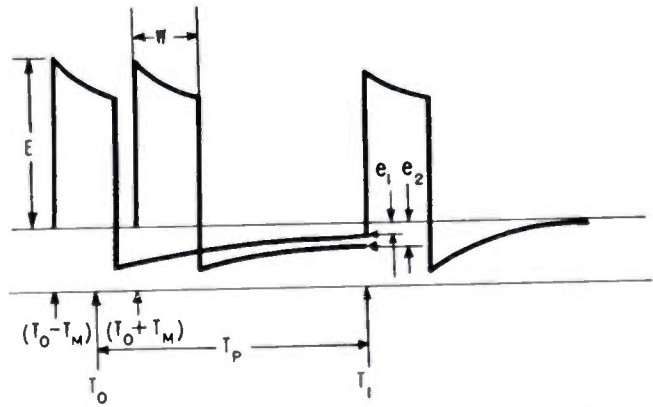

Fig. 6—Effect of low-frequency response on cross talk in pulse-position modulation using a resistance-capacitance filter.

$$\text{Cross-talk ratio} = \frac{-T_M \exp [(T_P - W)/RC]}{T_R [1 - \exp -(W/RC)] [\sinh (T_M/RC)]}.$$

Output cross-talk ratio

$$= \frac{-T_M \exp [(T_P - W)/RC]}{T_R [1 - \exp -(W/RC)] [\sinh (T_M/RC)]} \quad (6)$$

Substituting $F_c = 1/(2\pi RC)$,

Output cross-talk ratio

$$= - \frac{T_M \exp [2\pi F_c (T_P - W)]}{T_R [1 - \exp (-2\pi F_c W)] (\sinh 2\pi F_c T_M)} \quad (6a)$$

Note that the cross talk introduced by poor low-frequency response is opposite in polarity to that caused by poor high-frequency response. Further inspection of (6a) shows that the cross-talk ratio may be high at two values of F_c . The latter fact is borne out by the experimental results plotted in Fig. 7.

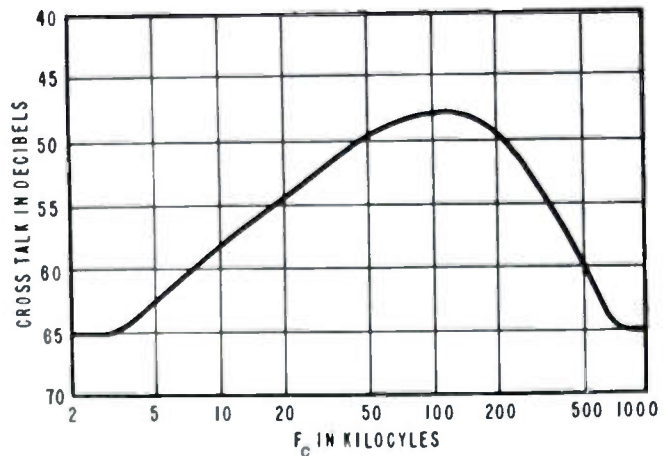

Fig. 7—Cross talk plotted against bandwidth for pulse-position modulation. Low frequencies have been attenuated by a resistance-capacitance filter having a cutoff frequency of $F_c = 1/(2\pi RC)$. The high-frequency cutoff is at 3 Mc.

The physical explanation of this curve is simply that, at very low values of cutoff frequency, the pulse is passed by the coupling network without distortion, so that no appreciable carryover occurs. At higher values of cutoff frequency, cross talk is present because of the carryover from channel to channel as shown in Fig. 6. As the cutoff frequency is raised still further, the pulse becomes differentiated and returns to the base line some time before the next channel occurs, again resulting in negligible carryover.

D. Combined High- and Low-Frequency Cutoff

The fact that cross talk due to high-frequency attenuation is of opposite phase from cross talk due to low-frequency attenuation indicates that by suitably choosing the high and low cutoff frequencies some form of cancellation might produce a system featuring high cross-talk ratios with very narrow bandwidth. Results of experiments along this line are plotted in Fig. 8. In each case, the high-frequency response was kept to a value that would not greatly affect cross talk, and the

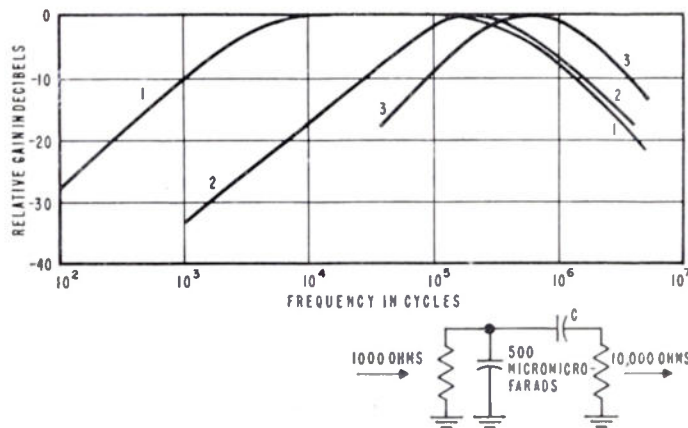

Fig. 8—Relative gain plotted against frequency for pulse-position modulation with filter network shown. Values of *C* in micro-microfarads and of cross talk in decibels are, respectively, for curve 1, 4,500 and 62; curve 2, 132 and 38; and curve 3, 4.8 and 73.

low-frequency cutoff was varied. Notice that in curve 3, where the over-all bandwidth between the 3-db points was considerably less than 1 Mc, a cross-talk ratio of 73 db was obtained, whereas the inherent cross talk in the system was only 66 db. Thus, some of this inherent cross talk was actually cancelled out. In investigating causes of cross talk in a given system, it is important to remember that a good cross-talk figure may be the result of some form of accidental cancellation of two forms of cross talk arising from different sources.

E. Miscellaneous Considerations

The formula given in Fig. 1 is also useful in determining the spacing between adjacent pulses, and thus the number of channels that may be employed in a given bandwidth. The smaller the pulse spacing, the larger is the required bandwidth for a given deviation and cross-talk figure. In the case of the sharp-cutoff filter,

however, this is not necessarily true. Because of the oscillations on the base line resulting from the distortion of the pulse, the pulses may be positioned such that the peaks and troughs of the overshoot can cause cross-talk cancellation. Thus, a position may be found where cross-talk ratio is a maximum, whereas moving the pulse in either direction will cause the cross-talk ratio to decrease. With pulse-position modulation, it will be found that this type of cross talk varies considerably with percentage modulation, depending on the peak deviation used. Such cross talk also may occur accidentally, due to ringing resulting from long inductive leads, insufficient decoupling of circuits containing inductances, and other causes.

III. PULSE-AMPLITUDE MODULATION

A. High-Frequency Cutoff

The interchannel cross talk caused by poor high-frequency response may be studied in a manner similar to that used in the above discussion. The expression is derived by the same procedure, with the exception that the displacement of the pulse under modulation is one of amplitude and not a time deviation, and that there is no pulse-position-modulation improvement factor in this case. Referring to Fig. 9, at one extreme of modulation, the carryover is

$$e_1 = E \exp [-(T_P/RC)](1 + M).$$

At the other extreme of modulation, the carryover is

$$e_2 = E \exp [-(T_P/RC)](1 - M).$$

The peak-to-peak amplitude variation of the pulse due to carryover is then

$$e_1 - e_2 = 2ME \exp -(T_P/RC).$$

Since the peak-to-peak output of the channel when modulated in the normal fashion is $2ME$, the cross-talk ratio becomes

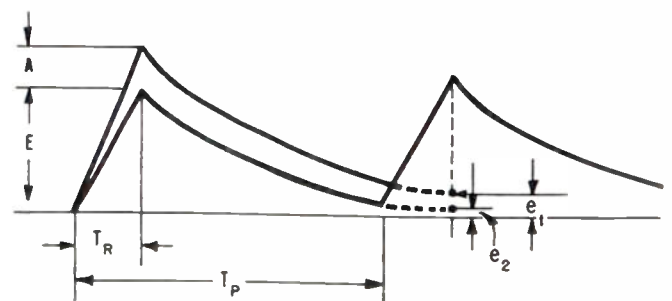
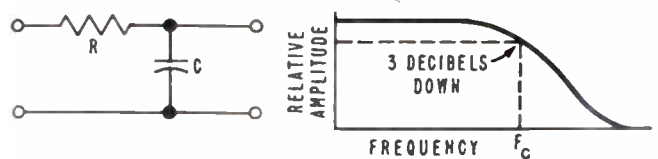

Fig. 9—Effect of high-frequency response on cross talk in pulse-amplitude modulation using a resistance-capacitance filter. $M = A/E =$ modulation factor. Cross-talk ratio = $\exp (T_P/RC)$. Cross talk in decibels for 100-per cent modulation = $8.68 T_P/RC$.

$$\frac{2ME}{e_1 - e_2} = \frac{2ME}{2ME \exp - (T_P/RC)}$$

Cross-talk ratio = $\exp (T_P/RC)$. (7)

Taking the logarithm to the base 10 of both sides and multiplying by 20, gives

cross-talk ratio in decibels = $\frac{8.68T_P}{RC}$. (8)

B. Low-Frequency Cutoff

Because of the presence of an audio-frequency component in pulse-amplitude modulation, the effect of low-frequency attenuation must be considered from a different standpoint. This audio-frequency component represents a change in the average value of the signal with modulation. When a pulse-amplitude-modulated signal is passed through a coupling network that does not transmit the direct-current component, displacement of the base line occurs. This displacement will vary in accordance with the modulation. The result is that when one channel is modulated, *all other channels* are affected.

Since an exact mathematical analysis is rather involved, an experimental procedure was followed similar to that used in the experiments with pulse-position modulation. A block diagram of the equipment is shown in Fig. 10.

The transmitter consisted of a two-channel pulse-amplitude modulator with a pulse-repetition rate of 8 kilocycles and a pulse width of approximately 3 microseconds. A phasing network was incorporated so that the relative position in time of the two channels could be adjusted at will. Standard resistance-capacitance coupling networks of the type shown in Fig. 6 and having various time constants were inserted at the point marked "transmission network." The desired channel was demodulated and cross talk measured by means of a wave analyzer as previously described.

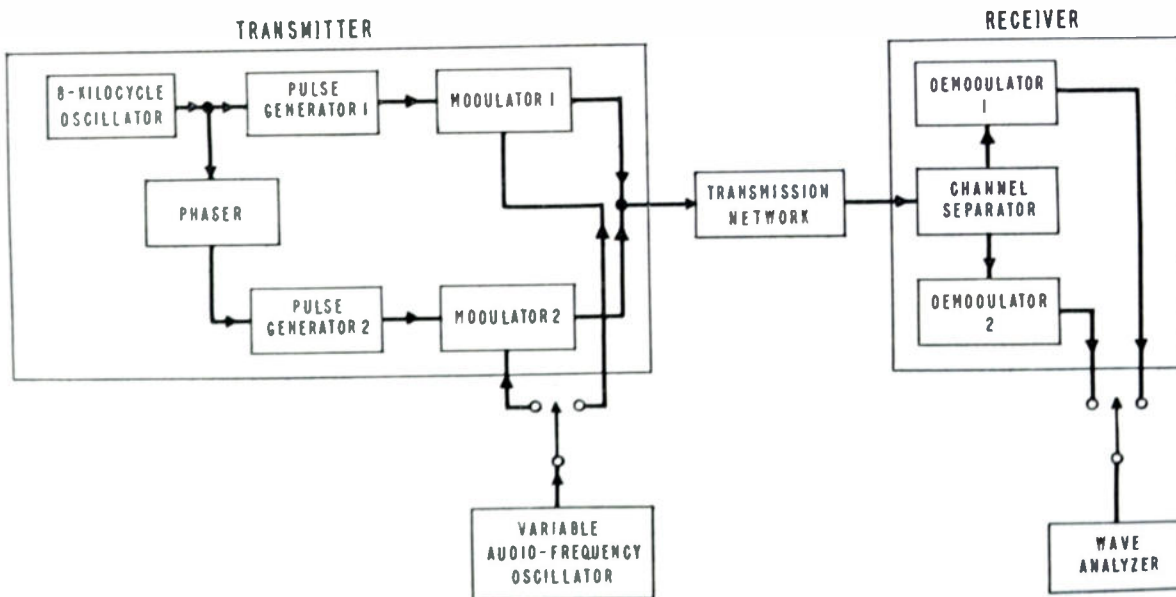

Fig. 10—Equipment used for cross-talk measurements on pulse-amplitude modulation.

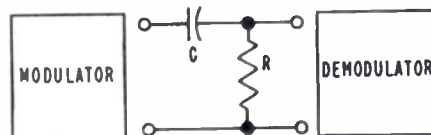
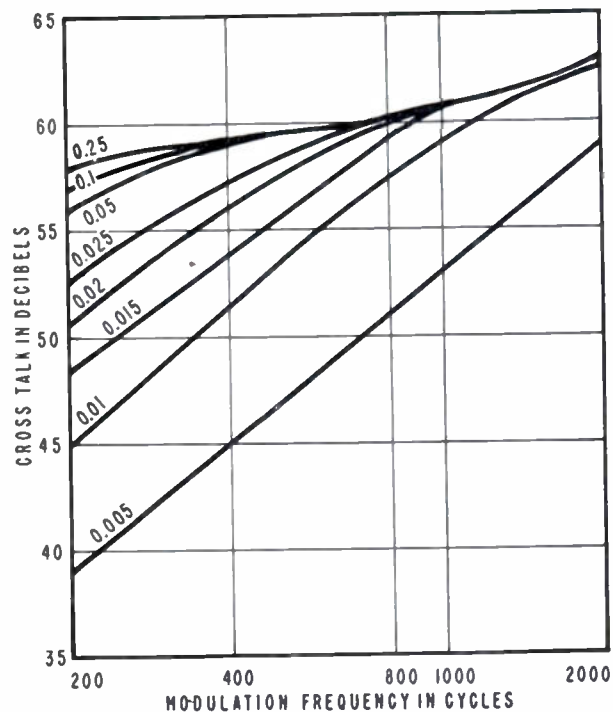

Fig. 11—Cross talk plotted against modulation frequency for 2 pulse-amplitude-modulated channels. The pulse-repetition rate is 8,000 cycles. The designations on the curves correspond to the product of *C* and *R* (microfarads \times megohms) in the coupling circuit shown.

The results are shown in Fig. 11. The inherent cross talk in the system due to high-frequency carryover was 70 db. It is interesting to note the dependence on modulating frequency, and the extremely large time constants that are required if high cross-talk ratios are to be obtained at low modulating frequencies. For example, to obtain a figure of 56 db with a modulat-

ing frequency of 200 cycles, a 0.25-microfarad coupling capacitor and a 1-megohm grid resistor would be required. The cutoff frequency of this network is only 0.6 cycle! This, of course, represents only one coupling network. The requirements become far more severe in a multistage amplifier having several such networks in cascade. The use of such large coupling capacitors introduces new problems, such as the effect on the high-frequency response of capacitance to ground, and changes in the direct-current grid bias of the following tube resulting from leakage currents.

The separation between the two channels was varied and the cross talk at 1,000 cycles measured for two values of transmission time constant. Cross-talk ratio was found to be independent of channel spacing.

The effect of the coupling network may be expressed in several ways: in terms of time constant, cutoff frequency, or in phase shift at a certain frequency. A convenient empirical relation may be derived by taking the data of Fig. 11 and plotting cross talk in decibels against \log_{10} phase shift in degrees, where $\tan \theta = F_c/F$. This is shown in Fig. 12. Since the result is a straight line, the equation of the curve is

$$\text{cross-talk in decibels} = 56.7 - 15.8 \log_{10} \theta. \quad (9)$$

To obtain a cross-talk figure of better than 56.7 db, a phase shift of less than one degree is required. In applications where it may be found impractical

to obtain the required low-frequency response by using large coupling capacitors, the usual methods of correcting the low-frequency response may be applied, providing all the stages involved are linear. However, it is advisable to determine the effect on the phase response of slight variations in component tolerances. Adjustment of such compensating networks may be found to be extremely critical. Any other networks that may affect low-frequency response must also be controlled, such as screen-grid and cathode by-pass networks.

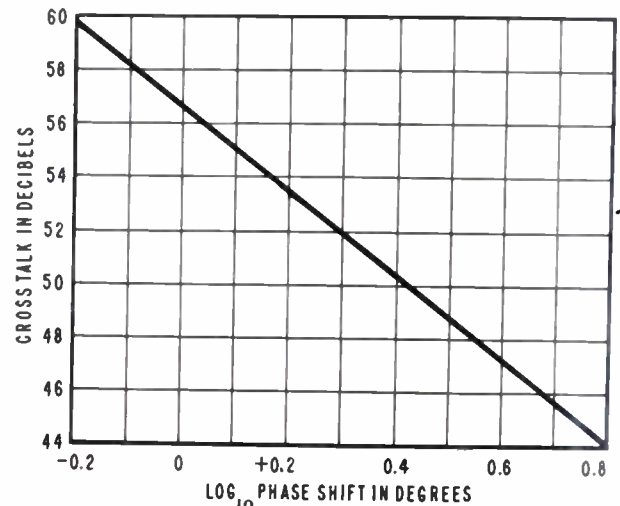

Fig. 12—Cross talk as a function of the logarithm of the phase shift of the coupling network for pulse-amplitude modulation.

The Remainder Theorem and Its Application to Operational Calculus Techniques*

ALBERT S. RICHARDSON, JR.†

Summary—The necessary procedure involved in the transition from the Laplace transformation to the solution of linear differential equations is summarized, and a particular form of partial-fraction expansion which may be advantageous in special cases is noted. The remainder theorem with regard to algebraic polynomials is restated, and it is shown how this theorem may be applied to the evaluation of high-degree polynomials for real and complex numbers. A numerical example is treated to illustrate application to a typical transfer function. Finally, the method is shown to be useful in the evaluation of the frequency response of such a transfer function.

INTRODUCTION

MANY ENGINEERING PROBLEMS, particularly those associated with the design of automatic-control systems, are readily handled by

means of the Laplace transform method. Although the method is widely recognized as a powerful tool of analysis, some difficulties are encountered in formulating a numerical solution to any given problem. Accordingly, the following is presented in the interest of those whose have encountered such difficulties.

THE INVERSE TRANSFORM

One of the properties of the Laplace transform is that it reduces a set of linear differential equations in terms of the dependent variables and a real independent variable to a set of linear algebraic equations in terms of the transform of the dependent variables and the complex Laplace variable. This set of equations is usually solved by Cramer's rule and the transformed dependent variables are given by equations of the form

$$L(\theta) = \frac{N(S)}{S^n D(S)} \equiv \frac{a_0 S^r + a_1 S^{r-1} + \dots + a_{r-1} S + a_r}{S^n (S^q + b_1 S^{q-1} \dots + b_{q-1} S + b_q)} \quad (1)$$

* Decimal classification: 510. Original manuscript received by the Institute, December 9, 1949; revised manuscript received, June 14, 1950.

† Massachusetts Institute of Technology, Cambridge, Mass.

where S is the Laplace variable, and the degree of the denominator is at least twice greater than the degree of the numerator, i.e., $-1+n+q>r$. Equation (1) may be written alternatively, if the roots of the numerator and denominator are known, as follows:

$$L(\theta) = \frac{a_0(S - S_{1r})(S - S_{2r}) \cdots (S - S_{rr})}{S^n(S - S_{1q})(S - S_{2q}) \cdots (S - S_{qq})}$$

$$\equiv \frac{a_0 \prod_{i=1}^r (S - S_{ir})}{S^n \prod_{i=1}^q (S - S_{iq})} \tag{2}$$

where the S_{ir} and the S_{iq} are the real and/or complex roots of the numerator and denominator respectively. Note that there are n zero roots in the denominator.

The procedure then followed in the solution of any practical problem at this point is to obtain the inverse transform $L^{-1}(\theta)$. This constitutes a solution to the problem because $L^{-1}(\theta)$ is actually $\theta(t)$ if t is the original independent variable. In general, if there are N dependent variables associated with the problem, there will be N such inverse transforms to determine. The usual manner of obtaining the inverse transform is to expand (2) in partial fractions, evaluate the residues at the poles S_{iq} , and identify the expansion form with inverse transforms which are tabulated.

EVALUATING THE RESIDUES

Thus the right-hand side (2) may be expanded in partial fractions as follows:

$$\frac{a_0(S - S_{1r}) \cdots (S - S_{rr})}{S^n(S - S_{1q}) \cdots (S - S_{qq})}$$

$$\equiv \frac{K_{01}}{S^n} + \frac{K_{02}}{S^{n-1}} + \cdots + \frac{K_{0n}}{S} \tag{3}$$

$$\frac{K_1}{S - S_{1q}} + \frac{K_2}{S - S_{2q}} + \cdots + \frac{K_q}{S - S_{qq}}$$

and the inverse transform of (3) is

$$\theta(t) = \frac{K_{01}}{(n-1)!} t^{n-1} + \frac{K_{02}}{(n-2)!} t^{n-2} + \cdots + K_{0n} \tag{4}$$

$$K_1 e^{S_{1q}t} + K_2 e^{S_{2q}t} + \cdots + K_q e^{S_{qq}t}$$

The basic difficulty so often the plague of those attempting a solution in the above manner may now be stated. That is, it is always necessary to obtain the constants (residues) on the right-hand side of (4) such that the initial conditions of the problem are uniquely satisfied. If, for example, at $t=0$, $\theta(0)=0$, the residues must then satisfy the equation

$$\sum_{i=1}^q K_i = -K_{0n} \tag{5}$$

Note that this condition requires a reasonable degree of accuracy in the determination of the various K 's.

This is especially so, if the K_i 's are of the same order of magnitude and if K_{0n} is a relatively small quantity.

We will now review, briefly, the usual procedure of evaluating the residues. Referring to (3), both sides of this identity are multiplied by $S - S_{jq}$ which is a factor in the denominator on the left-hand side. Since the identity is not changed by this operation, S is assigned the value S_{jq} ; therefore, all terms on the right-hand side drop out except K_j —corresponding to the root S_{jq} —and the left-hand side becomes a number. Hence K_j is given by the formula

$$K_j = \frac{a_0 \prod_{i=1}^r (S_{jq} - S_{ir})}{S_{jq}^n \prod_{i=1, i \neq j}^q (S_{jq} - S_{iq})} \tag{6}$$

But

$$\prod_{i=1, i \neq j}^q (S_{jq} - S_{iq}) = D'(S_{jq})$$

where $D'(S_{jq})$ is the derivative of the polynomial in the denominator evaluated for $S=S_{jq}$. The K_j is therefore

$$K_j = \left. \frac{N(S)}{S^n D'(S)} \right|_{S=S_{jq}} \tag{7}$$

ANOTHER FORM OF EXPANSION

It will now be shown that the same result will be obtained for the K_j when one considers an alternative form of partial fraction expansion for the right-hand side of (3). The form of the expansion will be chosen in such a manner that the initial condition $\theta(0)=0$ at $t=0$ is satisfied by the inverse transform—thus obviating the conditional (5). Alternatively, (3) may be written

$$a_0 \frac{N(S)}{S^n D(S)} \equiv \frac{K_{01}}{S^n} + \frac{K_{02}}{S^{n-1}} + \cdots + \frac{K_{0n-1}}{S^2}$$

$$\frac{K_1 S_{1q}}{S(S - S_{1q})} + \frac{K_2 S_{2q}}{S(S - S_{2q})} + \cdots + \frac{K_q S_{qq}}{S(S - S_{qq})} \tag{8}$$

Following the familiar procedure of multiplying both sides of the identity by $S - S_{jq}$ and letting $S=S_{jq}$, the K_j are given by

$$K_j = a_0 \left. \frac{(S - S_{1r}) \cdots (S - S_{rr})(S - S_{jq})}{S^n (S - S_{1q}) \cdots (S - S_{iq}) \cdots (S - S_{qq})} \right|_{S=S_{jq}} \tag{9}$$

$$K_j = \frac{a_0 \prod_{i=1}^r (S_{jq} - S_{ir})}{S_{jq}^n \prod_{i=1, i \neq j}^q (S_{jq} - S_{iq})} \tag{10}$$

which is the result obtained previously. We note that

$$L^{-1} \left[\frac{S_{jq}}{S(S - S_{jq})} \right] = [e^{-S_{jq}t} - 1]$$

and hence the condition $\theta(0)=0$ is satisfied uniquely by this form of expansion.

THE REMAINDER THEOREM

The remainder theorem states that if $Q(S)$ is the quotient obtained by dividing a polynomial $P(S)$ by $f(S)$, and $R(S)$ is the remainder after the division, then

$$T.F. = \frac{1573.34S^3 + 887.048S^2 + 36.0956S - 0.39513}{S(S + 0.0125)^2(S + 0.284718)(S^2 + 0.0789479S + 0.00181788)} = \frac{K_1}{S} + \frac{K_2}{(S + 0.0125)^2} + \frac{K_3}{S + 0.0125} + \frac{K_4}{S + 0.284718} + \frac{K_5}{S + 0.0394739 - 0.0161148j} + \frac{K_6}{S + 0.0394739 + 0.0161148j}$$

the following relationship exists:

$$P(S) \equiv f(S)Q(S) + R(S) \tag{11}$$

in which $P, Q, f,$ and R may all be polynomial functions of S . If $f(S)$ is a linear factor of form $(S-r)$, the remainder $R(S)$ will be a constant, and we may deduce the following:

$$\left. \begin{aligned} \lim_{s \rightarrow r} P(S) &\equiv \lim_{s \rightarrow r} (S - r)Q(S) + R_0 \\ P(r) &= R_0 \end{aligned} \right\} \tag{12}$$

Thus if we wish to evaluate a polynomial $P(S)$ for $S=r$ we divide $P(S)$ by $S-r$ and note the remainder. A convenient and rapid way of doing this is by synthetic division.

If r is of complex form $re^{j\alpha}$, it is more convenient to treat $f(S)$ as a quadratic factor in which case the remainder is a linear function of S . We may perform the same limiting process as before, and show that

$$\left. \begin{aligned} \lim_{s \rightarrow re^{j\alpha}} P(S) &= \lim_{s \rightarrow re^{j\alpha}} [S^2 - 2r \cos \alpha S + r^2]Q(S) \\ &+ \lim_{s \rightarrow re^{j\alpha}} [R_1 S] + R_0 \end{aligned} \right\} \tag{13}$$

$$P(re^{j\alpha}) = R_1[re^{j\alpha}] + R_0.$$

Thus if we wish to evaluate a polynomial for $S=re^{j\alpha}$, we divide $P(S)$ by the quadratic factor associated with $re^{j\alpha}$ and note the remainder. In particular we see that if r is a root of $P(S)=0$ the remainder is zero. Also we may show that an extension of the above considerations yields the result

$$\left. \begin{aligned} \lim_{s \rightarrow r} \frac{dP(S)}{dS} &= \lim_{s \rightarrow r} f'(S)Q(S) + \lim_{s \rightarrow r} f(S)Q'(S) \\ &+ \lim_{s \rightarrow r} R'(S) \end{aligned} \right\} \tag{14}$$

$$P'(r) = Q(r)$$

if $f(S)$ is taken to be a linear function of S .

For the vast majority of problems that are solved by the present method, (12), (13), and (14) will provide a convenient and easy means of evaluating the residues of all rational functions that occur in those problems.

NUMERICAL EXAMPLE

We now consider the evaluation of a typical transfer function. In this regard we express the transfer func-

tion as a rational function of S and consider only those residues which serve to illustrate the present method. For real values the division is performed synthetically.

PARTIAL FRACTION EXPANSION

Evaluation of Residues

K_2 —Real

$$(\text{Residue at } S = r) = \frac{N(r)}{rD'(r)}$$

K_2 —Numerator: $N(r)$

$$\begin{array}{r} 1573.34 + 887.048 + 36.0956 - 0.395130 \\ - 19.666 - 10.8422 - 0.315667 \\ \hline 1573.34 + 867.382 + 25.2534 - 0.710797 \end{array} \quad \begin{array}{l} -0.0125 \\ \hline \text{Remainder} \end{array}$$

K_2 —Denominator: $D'(r)$

$$\begin{array}{r} 1 + 0.363666 + 0.0242958 + 0.000517583 \\ 1 - 0.0125000 - 0.0043895 - 0.000248828 \\ \hline + 0.351166 + 0.0199063 + 0.000268755 \end{array} \quad \begin{array}{l} -0.0125 \\ \hline \text{Remainder} \end{array}$$

$$K_2 = \frac{-0.710797}{-0.0125 \times 0.000268755} = 2.115826 \times 10^5$$

By continuation of the above method we may determine all the remaining residues.

Summarizing we have:

	Pole	Residue $\times 10^{-5}$
1	S	-48.8585
2	$(S+0.0125)^2$	2.11582
3	$S+0.0125$	2.24833
4	$S+0.284718$	-0.195556
5	$S+0.0394739 - 0.0161147j$	23.4025 + 9.17831j
6	$S+0.0394739 + 0.0161147j$	23.4025 - 9.17831j

FREQUENCY RESPONSE

We recall that the procedure followed in evaluating the frequency response of a system is to substitute $j\omega$ for S in the system transfer function and evaluate the resulting expression throughout the frequency range of interest. For example, we would be interested in evaluating the expression $N(j\omega)/(j\omega)^n D(j\omega)$ for a selected range of ω .

It is not difficult to show, with the help of the remainder theorem, that we may evaluate the poly-

omials individually if we divide each by $S^2 - \omega^2$ and note the remainder. This is a considerable simplification over the usual method of substituting $j\omega$ directly, separating real and imaginary parts and then carrying out the calculations for all ω of interest. In addition we may show that the artifice of synthetic division may be applied if we skip every other coefficient in the polynomial.

As an illustration we consider the same transfer function as before, confining our attention to an evaluation of the numerator because nothing new will be learned by continuing the calculation further than this.

Frequency Response: Numerator: $N(j\omega)$

$$\begin{array}{r} \omega = 1 \text{ rad/sec} \\ 1573.34 + 887.048 + \quad 36.0956 - \quad 0.39513 \quad | \quad -1 \\ \quad \quad \quad -1573.34 \quad -887.048 \\ \hline 1573.34 + 887.048 - 1537.25j - 887.443 \\ \hline \text{Remainder} = N(j) \\ \quad \quad \quad = -887.443 - 1537.25j \\ \omega = \sqrt{2} \text{ rad/sec} \end{array}$$

$$\begin{array}{r} 1573.34 + 887.048 + \quad 36.0956 - \quad 0.39513 \quad | \quad -2 \\ \quad \quad \quad -3146.68 \quad -1774.096 \\ \hline 1573.34 + 887.048 - 3110.59\sqrt{2}j - 1774.491 \\ \hline \text{Remainder} = N(\sqrt{2}j) \\ \quad \quad \quad = -1774.491 - 4398.8j. \end{array}$$

Thus we see from the above results that the frequency response method may be considerably augmented by the use of the remainder theorem. We note that a polynomial of very high degree, say eight or ten, may be evaluated with little additional labor. Synthetic division is easy to apply, and a whole range of ω may be investigated in relatively short order. It should be mentioned however, that since we are effectively dividing by $S^2 - \omega^2$ the remainder will always be of the form $A\omega j + B$.

CONCLUSIONS

We have shown that Laplace transform methods of analysis may be simplified somewhat by the use of the remainder theorem as applied to the numerical evaluation of polynomials of high degree.

BIBLIOGRAPHY

1. L. A. Pipes, "Applied Mathematics for Engineers and Physicists," McGraw-Hill Book Co., New York, N. Y.; 1946.
2. M. F. Gardner and J. L. Barnes, "Transients in Linear Systems," John Wiley and Sons, Inc., New York, N. Y.; 1942.

Band-Pass Low-Pass Transformation in Variable Networks*

L. A. ZADEH†, MEMBER, IRE

Summary—An extension of the band-pass low-pass transformation to linear varying-parameter systems is developed. It is shown that this transformation in conjunction with the use of frequency analysis techniques can be applied with advantage to the analysis of a superregenerator operating in the linear mode.

INTRODUCTION

IN RECENT YEARS the technique of band-pass low-pass transformation has gained wide recognition among communication engineers as a valuable tool in the analysis of various types of carrier transmission systems.¹ This technique has proved particularly useful in connection with the determination of the envelope response of band-pass systems and also, though to a lesser degree, in the analysis of assymetrical carrier systems.

Heretofore, the use of band-pass low-pass transformation has been limited to fixed networks. The purpose of the present paper is to show that the technique of band-pass low-pass transformation may be extended to linear varying-parameter networks² and used in the case of the latter in much the same manner as in the case of fixed networks. In particular, it will be shown that this technique may be used with advantage in the analysis of a superregenerator operated in the linear mode. An interesting aspect of the extended form of the transformation and its possible generalizations is that it suggests an unorthodox mathematical technique for solving certain forms of linear differential equations with time-dependent coefficients.

GENERAL THEORY

A linear varying-parameter network is essentially a linear system in which one or more parameter values are functions of time. The external behavior of such a

* Decimal classification: R143.2. Original manuscript received by the Institute, January 19, 1950; revised manuscript received, May 16, 1950.

† Columbia University, New York, N. Y.

¹ P. R. Aigrain, B. R. Teare, Jr., and E. M. Williams, "Generalized theory of the band-pass low-pass analogy," Proc. I.R.E., vol. 37, pp. 1152-1155; October, 1949. Additional references may be found in the text of this paper.

² To simplify the terminology, such networks will frequently be referred to in the present paper as variable networks.

network is usually described by a linear differential equation of the form

$$[a_n(t)p^n + \cdots + a_1(t)p + a_0(t)]v(t) = [b_m(t)p^m + \cdots + b_1(t)p + b_0(t)]u(t) \quad (1)$$

where $p = d/dt$, the a 's and b 's are known functions of time, and $u(t)$ and $v(t)$ represent respectively the input (voltage or current) and the output (voltage or current) of the network. For convenience (1) may be written in a compact form

$$L(p; t)v(t) = K(p; t)u(t) \quad (2)$$

where $L(p; t)$ and $K(p; t)$ denote respectively the left-hand and right-hand operators in (1).

The behavior of a variable network may be described explicitly by means of the system function³ of the network. This function is denoted by the symbol $H(j\omega; t)$ and is defined by the relation

$$H(j\omega; t) = \frac{v(t)}{u(t)} \Big|_{u(t) = e^{j\omega t}} \quad (3)$$

In other words, $H(j\omega; t)$ is a function of $j\omega$ and t such that $H(j\omega; t)e^{j\omega t}$ represents the response of the system to an exponential input $u(t) = e^{j\omega t}$. It may readily be shown³ that the determination of $H(j\omega; t)$ requires in general the solution of the differential equation

$$L(p + j\omega; t)H(j\omega; t) = K(j\omega; t). \quad (4)$$

The problem of solving this equation for $H(j\omega; t)$ is discussed in footnote reference 3.

The system function of a variable network has the same basic properties as the system function of a fixed network. Thus, for example, using operational notation the response $v(t)$ to an arbitrary input $u(t)$ may be expressed as

$$v(t) = H(p; t)u(t) \quad (5)$$

where $H(p; t)$ should be treated as a usual Heaviside operator; that is, the variable t in $H(p; t)$ should be treated as a fixed parameter. The physical significance of $H(j\omega; t)$ may assume various forms. For instance, when $u(t)$ and $v(t)$ represent respectively the terminal current and voltage of a two-terminal network N , $H(j\omega; t)$ may be called the *instantaneous input impedance* of N and accordingly might be denoted as $Z(j\omega; t)$. In other cases, $H(j\omega; t)$ may represent the instantaneous gain, instantaneous admittance, and so forth, depending on the physical significance of $u(t)$ and $v(t)$.

The notion of the system function of a variable network provides the necessary basis for the extension to linear varying-parameter networks of the technique of band-pass low-pass transformation. As a preliminary, it will be recalled that, in general, any real signal $f(t)$ may be written as

$$f(t) = \text{Re}\{F(t)e^{j\omega_0 t}\} \quad (6)$$

where Re means "real part of," ω_0 is an arbitrary frequency, and $F(t)$ is a complex function of time usually referred to as the *complex envelope* of the signal relative to a carrier of frequency ω_0 . It is important to note that ω_0 is completely arbitrary. Thus when $f(t)$ is actually an amplitude modulated carrier of frequency ω , the frequency ω_0 need not be equal to ω .

Expressing $u(t)$ and $v(t)$ in the above form and representing their complex envelopes by $U(t)$ and $V(t)$ respectively, (5) becomes, dropping Re ,

$$V(t)e^{j\omega_0 t} = H(p; t)\{U(t)e^{j\omega_0 t}\} \quad (7)$$

or, equivalently

$$V(t) = H(p + j\omega_0; t)U(t). \quad (8)$$

Equation (8) shows that the complex envelopes of the input and the output may be regarded as being themselves the input and the output of a network whose system function is $H(p + j\omega_0; t)$. Under general conditions this point of view is of little practical value, for in the first place $H(p + j\omega_0; t)$ is not a real function of p and hence does not represent a physical system. In the second place, there is no reason to assume that $H(p + j\omega_0; t)$ would, in general, be simpler than $H(p; t)$ and hence there would be little, if any, advantage in using (8) in place of (5).

In the case of band-pass systems, however, it frequently happens that for ω_0 equal to the midband frequency of the system, $H(p + j\omega_0; t)$ is very nearly a real function of p and t (for small values of p) and furthermore $H(p + j\omega_0; t)$ is simpler than $H(p; t)$. It is only in such cases that the process of passing from $H(p; t)$ to $H(p + j\omega_0; t)$, which involves essentially nothing more than a translation in the frequency domain, is given the distinctive name of the band-pass low-pass transformation. More precisely, assume that there is a frequency ω_0 and a frequency band Δ ($\Delta \ll \omega_0$), such that for $|p| < \Delta$, $H(p + j\omega_0; t)$ is very nearly a real function of p and t , i.e.,

$$H(p + j\omega_0; t) \simeq H_L(p; t), \quad (|p| < \Delta) \quad (9)$$

where $H_L(p; t)$ is a real function of p and t resulting from neglecting small terms in $H(p + j\omega_0; t)$. If these conditions are satisfied, then it will be said that the given network N whose system function is $H(p; t)$ possesses a low-pass analogue N_L whose system function is $H_L(p; t)$. The complex envelopes of the input and output of N may be regarded as being themselves the input and output of N_L . This is expressed by the relation

$$V(t) = H_L(p; t)U(t) \quad (10)$$

which follows directly from (8) and (9).

The definition given above is not the most general one possible but is sufficiently general to be useful in many practical applications. The usefulness of the band-pass low-pass transformation in the case of variable net-

³ L. A. Zadeh, "Frequency analysis of variable networks," *Proc. I.R.E.*, vol. 38, pp. 291-299, March, 1950.

works is due primarily to the fact that the differential equation satisfied by $H_L(j\omega; t)$, which is (see (4))

$$L(p + j\omega + j\omega_0; t)H_L(j\omega; t) = K(j\omega + j\omega_0; t), \quad (11)$$

is, in general, much easier to solve than the differential equation satisfied by $H(j\omega; t)$. In other words, it is simpler in most practical cases to determine the system function of the low-pass analogue of a band-pass variable network than it is to determine the system function of the network itself.

As an illustration of the use of the above relations, consider the case of a superregenerator operating in the linear mode.^{4,5} The equivalent circuit of the superregenerator is shown in Fig. 1(a); it consists of a tank circuit in parallel with a periodically varying conductance $G(t)$. The input to the circuit is $i(t)$ and the output is $v(t)$. The problem is to find the response $v(t)$ to a given input $i(t)$.

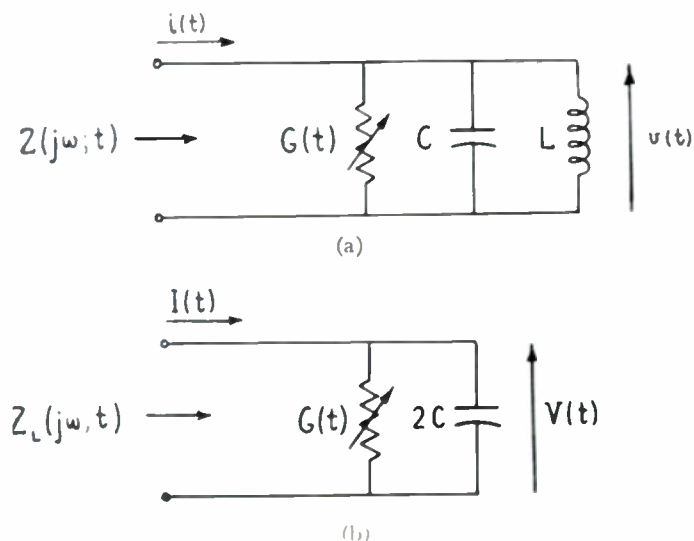

Fig. 1—The equivalent circuit of the superregenerator and its low-pass analogue.

Since the system function connecting $v(t)$ and $i(t)$ is the instantaneous input impedance of the superregenerator, it follows that the problem is essentially that of determining the instantaneous input impedance of the circuit shown in Fig. 1(a). It is evident, however, that by using the band-pass low-pass transformation the same result may be achieved in conjunction with (6) and (8) by finding the instantaneous input impedance of the low-pass analogue of the superregenerator. This, of course, should be a much simpler problem.

The differential equation connecting $v(t)$ and $i(t)$ is

$$[Cp^2 + G(t)p + \dot{G}(t) + \omega_0^2]v(t) = pi(t) \quad (12)$$

where the dot represents differentiation with respect to time and $\omega_0^2 = (LC)^{-1}$. Forming the differential equation

satisfied by the instantaneous input impedance of the low-pass analogue (11) and neglecting the small terms in this equation the following relation is obtained:

$$[2Cp + 2Cj\omega + G(t)]Z_L(j\omega; t) = 1 \quad (13)$$

where $Z_L(j\omega; t)$ denotes the instantaneous input impedance of the low-pass analogue, the equivalent circuit of which is shown in Fig. 1(b). Since (13) is a first-order differential equation its solution and hence the expression for $Z_L(j\omega; t)$ is readily found to be

$$Z_L(j\omega; t) = \frac{1}{2C} \int_{-\infty}^t \exp \left[-j\omega(t - \tau) - \frac{1}{2C} \int_{\tau}^t G(t) dt \right] d\tau. \quad (14)$$

From the general relation (10) it follows that the complex envelopes of the input and the output of the superregenerator are related to each other by the operational relation

$$V(t) = Z_L(p; t)I(t) \quad (15)$$

where $V(t)$ and $I(t)$ represent the complex envelopes of $v(t)$ and $i(t)$, respectively, and the variable t in $Z_L(p; t)$ should be treated as if it were a fixed parameter. Equation (15), in conjunction with (14) and (6), provides the desired solution of the problem.

It should be remarked that what is usually referred to as the "superregenerator selectivity" is in fact the function

$$F(\omega) = |Z_L(j\omega; t_0)| \quad (16)$$

where t_0 is the instant at which the conductance $G(t)$ reaches zero and is in the process of becoming positive. In a similar manner, other parameters and functions usually associated with a superregenerator operating in the linear mode may be interpreted in terms of the properties of the instantaneous input impedance of the low-pass analogue of the superregenerator.

CONCLUDING REMARKS

The extended form of the band-pass low-pass transformation described in this paper is useful in the analysis of band-pass linear varying-parameter networks having fixed midband frequency. It is possible to broaden the applicability of this transformation by relaxing the requirement that the system function of the low-pass analogue be a purely real function of p and t . It is also possible to use a more general form of transformation than a simple translation in the frequency domain. On the whole, it appears that the band-pass low-pass transformation considered in this paper is just one of the many commonly used frequency transformations that may usefully be extended to linear varying-parameter networks. The extension of these transformations to such networks should provide a fruitful field for further study and investigation.

⁴ H. A. Wheeler, "A simple theory and design formulas for superregenerative receivers," *Wheeler Monographs*, no. 3; June, 1948.
⁵ H. A. Glucksman, "Superregeneration—an analysis of the linear mode," *Proc. I.R.E.*, vol. 37, pp. 500-504; May, 1949. Additional references may be found in the text of this paper.

Correlation Functions and Power Spectra in Variable Networks*

L. A. ZADEH†, MEMBER, IRE

Summary—The problem considered in this paper is that of establishing a relation between the correlation functions and also the power spectra of the input and output of a linear varying-parameter network (variable network) whose transmission characteristics are random-periodic functions of time. The notion of the correlation function of such a network is introduced and the following theorem is established:

The correlation functions of the input and output of a variable network N may formally be regarded as the input and output of a variable network N^* whose system function is the correlation function of the system function of N .

This theorem has many practical applications, particularly in connection with the determination of the correlation functions and power spectra of various random-periodic wave forms.

INTRODUCTION

ONE OF THE basic problems in the analysis of signal transmission systems is that of relating the statistical parameters of the output signal to those of the input signal and the transmission characteristics of the system. The purpose of the present paper is to establish such a relation between the correlation functions and also the power spectra of the input and the output of a linear transmission system in which one or more parameter-values are functions of time. Such systems are usually referred to as linear varying-parameter systems or, more simply but less precisely, as variable networks. Familiar examples of systems of this type are the various kinds of modulators, dynamic amplifiers, and—as a limiting case—the ordinary fixed linear networks.

On the basis of the obtained results it appears that the above problem and its solution can be formulated best in terms of the notion of the *system function*¹ of a variable network. Briefly, the system function of a variable network N is defined as a function $H(j\omega; t)$ such that $H(j\omega; t)e^{j\omega t}$ is the response of N to the exponential input $e^{j\omega t}$. Thus denoting the input and output of N by the symbols $e_1(t)$ and $e_2(t)$, respectively, the definition of $H(j\omega; t)$ reads

$$H(j\omega; t) = \left. \frac{e_2(t)}{e_1(t)} \right]_{e_1(t) = e^{j\omega t}} \quad (1)$$

This definition is of the same form as the conventional definition of the system function of a fixed network and, as is shown in the literature,¹ $H(j\omega; t)$ has the same basic properties as the system function of a fixed network. The physical significance of $H(j\omega; t)$ depends on the

meaning attached to $e_1(t)$ and $e_2(t)$. Thus, for example, when N is a two-terminal network and $e_1(t)$ and $e_2(t)$ represent respectively the terminal current and voltage of N , $H(j\omega; t)$ may be interpreted as the *instantaneous* input impedance of N and might appropriately be denoted as $Z(j\omega; t)$. In other cases $H(j\omega; t)$ may be interpreted as the instantaneous transfer impedance, instantaneous admittance, and so forth, depending on the physical significance of $e_1(t)$ and $e_2(t)$.

The most important property of the system function of a variable network N is that it relates the output and input signal of N in much the same manner as the system function of a fixed network relates its output and input signals. The relation between the output and input of N may be expressed in several different, but equivalent forms which are given below. In all of the following relations the variable t in the expression for the system function should be treated as if it were a constant parameter.

1. Contour integral form.

$$e_2(t) = \frac{1}{2\pi} \int_{-\infty}^{\infty} H(j\omega; t) E_1(j\omega) e^{j\omega t} d\omega \quad (2)$$

where $E_1(j\omega)$ is the Fourier transform of $e_1(t)$.

2. Fourier transform form.

$$e_2(t) = F^{-1}\{H(j\omega; t)E_1(j\omega)\}, \quad (3)$$

where F^{-1} represents the operation of inverse Fourier transformation.

3. Laplace transform form.

$$e_2(t) = L^{-1}\{H(s; t)E_1(s)\}, \quad (4)$$

where $E_1(s)$ is the Laplace transform of $e_1(t)$ and L^{-1} represents the operation of inverse Laplace transformation.

4. Operational form.

$$e_2(t) = H(p; t)e_1(t) \quad (5)$$

where p is the usual differential operator.

A simple illustration of the use of the above relations is provided by a delay network whose delay Δ is a periodic function of time, say

$$\Delta = a + b \cos t. \quad (6)$$

The system function of this network is (in operational form):

$$H(p; t) = e^{-p(a+b \cos t)}. \quad (7)$$

Using (5) the response of the network to a signal $e_1(t)$ may be written as

$$e_2(t) = e^{-p(a+b \cos t)} e_1(t). \quad (8)$$

* Decimal classification: R143. Original manuscript received by the Institute, February 8, 1950; revised manuscript received, June 13, 1950.

† Columbia University, New York, N. Y.

¹ L. A. Zadeh, "Frequency analysis of variable networks," *Proc. I.R.E.*, vol. 38, pp. 291-299; March, 1950.

Since the variable t in $e^{-p(a+b \cos t)}$ should be treated as a constant, therefore

$$e_2(t) = e_1(t - a - b \cos t) \tag{9}$$

which is the desired result.

The properties of the system function as outlined above will now be used to establish a general relation between the correlation functions of the output and input of a variable network.

GENERAL THEORY

It will be recalled that the correlation function² of a signal $e(t)$ is defined by the relation

$$\psi(\tau) = \lim_{T \rightarrow \infty} \frac{1}{T} \int_0^T e(t)e(t + \tau)dt \tag{10}$$

where $\psi(\tau)$ denotes the correlation function of $e(t)$. This definition applies to any random-periodic signal—that is, a signal whose amplitude distribution at any one instant is a periodic function of time. In particular, it applies to the two extreme forms of random-periodic signals, namely, periodic signals and stationary signals. The latter are signals in which the amplitude distribution is independent of time. For stationary signals the correlation function may be written as

$$\psi(\tau) = \overline{e(t)\overline{e(t + \tau)}}, \tag{11}$$

where the bar represents the operation of averaging over the ensemble.

As is well known, the correlation function and the power spectrum of a signal are Fourier transforms of each other. Thus, denoting the power spectrum³ of a signal by the symbol $S(\omega)$, the relation between $S(\omega)$ and $\psi(\tau)$ reads

$$S(\omega) = \int_{-\infty}^{\infty} \psi(\tau)e^{-j\omega\tau}d\tau \tag{12}$$

and

$$\psi(\tau) = \frac{1}{2\pi} \int_{-\infty}^{\infty} S(\omega)e^{j\omega\tau}d\omega. \tag{13}$$

It is evident that $S(\omega)$ may be found from the knowledge of $\psi(\tau)$ and vice versa. In general, the determination of the correlation function is simpler than that of the power spectrum. In many cases, knowledge of the correlation function alone is sufficient. In cases in which the power spectrum is required, its indirect determination through the use of the correlation function and (12) is frequently the most convenient procedure.

Turning to the problem under consideration, it will be assumed that the transmission characteristics of a

network N vary with time in a random-periodic manner. In terms of the system function of N this means that $H(j\omega; t)$ is a random-periodic function of time involving $j\omega$ as a parameter. The input to N is assumed to be a random-periodic function of time which is uncorrelated with $H(j\omega; t)$. The correlation functions of the input and output of N will be denoted by the symbol $\psi_1(\tau)$ and $\psi_2(\tau)$, respectively. The problem is to establish a relation between $\psi_1(\tau)$, $\psi_2(\tau)$, and a function describing the pertinent statistical properties of $H(j\omega; t)$.

It will be seen later that the pertinent statistical properties of N are represented by a function which in view of its form might appropriately be called the *correlation function of the system function of the network*, or, more simply, the correlation function of N . This function is denoted by the symbol $\Psi_H(\tau; \omega)$ and is defined by the relation

$$\Psi_H(\tau; \omega) = \lim_{T \rightarrow \infty} \frac{1}{T} \int_0^T H(j\omega; t)H(-j\omega; t + \tau)dt, \tag{14}$$

which in the case of stationary system functions is equivalent to

$$\Psi_H(\tau; \omega) = \overline{H(j\omega; t)H(-j\omega; t + \tau)}. \tag{15}$$

It will be demonstrated later that $\Psi_H(\tau; \omega)$ has a remarkable property which is that $\Psi_H(\tau; \omega)$ may be regarded as the system function of a variable network N^* such that the correlation functions $\psi_1(\tau)$ and $\psi_2(\tau)$ are the input and output of this network, respectively. This result, which is essentially the main result of this paper, is expressed by the following relation

$$\psi_2(\tau) = F^{-1}\{\Psi_H(\tau; \omega)S_1(\omega)\}, \tag{16}$$

where $S_1(\omega)$ is the power spectrum of the input (the Fourier transform of $\psi_1(\tau)$), $\Psi_H(\tau; \omega)$ is the correlation function of $H(j\omega; t)$, and F^{-1} represents the operation of inverse Fourier transformation.⁴

Comparison of (16) with the relation connecting the output and input of a variable network

$$e_2(t) = F^{-1}\{H(j\omega; t)E_1(j\omega)\} \tag{3}$$

leads to the interpretation⁵ of (16) stated above. The result expressed by (16) may conveniently be stated in the form of a theorem, as follows:

The correlation functions of the input and output of a variable network N may formally be regarded as the input and output of a variable network N^ whose system function is the correlation function of the system function of N .*

To simplify the proof of the theorem it will be assumed that the input $e_1(t)$ and the system function $H(j\omega; t)$ are stationary functions of time.⁶ With this

² A comprehensive discussion of the properties of random signals may be found in S. O. Rice, "Mathematical analysis of random noise," *Bell Sys. Tech. Jour.*, vol. 23, pp. 282-332; July, 1944. Also vol. 24, pp. 146-156; January, 1945.

³ Contrary to the usual practice, the power spectrum $S(\omega)$ is assumed to extend over both the negative and positive frequencies, i.e., $S(-\omega) = S(\omega)$. This assumption facilitates the mathematical analysis of the problem.

⁴ It should be remembered that in the process of evaluating the inverse Fourier transform of $\Psi_H(\tau; \omega)S_1(\omega)$, the variable τ in $\Psi_H(\tau; \omega)$ should be treated as if it were a constant parameter.

⁵ It will be recognized, of course, that N^* is not a physical system since its system function $\Psi_H(\tau; \omega)$ is an even function of ω .

⁶ For the general case where the input and the system function are uncorrelated random-periodic functions of time, the proof is similar but somewhat more involved.

II. THE NYQUIST CRITERION

The Nyquist criterion in its most general form as it is used today is not easily stated. It was originally derived for a single-loop feedback circuit and involves the numerical calculation of the complex open-loop transfer characteristic of the network. The question of stability is decided by whether or not the transfer characteristic encloses the critical point (1, 0). In case the system contains several feedback loops it is necessary to calculate the open-loop characteristic for each loop and to record the algebraic number of counter-clockwise encirclements of the critical points. Stability of the over-all circuit is subsequently decided by the sum of these encirclements. This procedure is confusing to the uninitiated and to the engineer not familiar with the mathematical logic behind these rules, and has consequently led to many misconceptions concerning the interpretation of the Nyquist diagrams. Moreover, there are complicated circuits in which it is difficult or impossible to decide on the number and location of these loops.

For the reasons just outlined, the Nyquist criterion will be stated as a condition on the characteristic equation of the system under investigation. In any linear dynamical or electrical system, the determination of the characteristic equation is straightforward and usually a simple matter. Let the characteristic equation (always an algebraic equation) be

$$f(p) = a_0 p^n + a_1 p^{n-1} + \dots + a_n = 0. \tag{1}$$

The question of stability is decided by the signs of the real parts of the roots of (1). In fact the necessary and sufficient condition that the system be stable is that all n roots of (1) have negative real parts. That is, all roots of (1) must lie to the left of the axis of imaginaries in the p plane. Let the imaginary axis, $p=i\omega$, be mapped on the $f(p)$ plane. If, as ω is increased from negative to positive infinity, the origin of the f plane lies to the left of the curve $f(i\omega)$, the roots of $f(p)$ all lie in the negative half p plane, and consequently, the system is stable.

III. THE ROUTH-HURWITZ CRITERION

The Routh criterion may be stated as follows.^{4,5} Form the equation

$$\begin{vmatrix} a_0 & a_{-1} & a_{-2} & a_{-3} & \dots & a_{-n} \\ a_2 & a_1 & a_0 & a_{-1} & \dots & a_{2-n} \\ a_4 & a_3 & a_2 & a_1 & \dots & a_{4-n} \\ a_6 & a_5 & a_4 & a_3 & \dots & a_{6-n} \\ \dots & \dots & \dots & \dots & \dots & \dots \\ a_{2n} & a_{2n-1} & a_{2n-2} & a_{2n-3} & \dots & a_n \end{vmatrix} = \Delta \tag{2}$$

⁴ A. Hurwitz, "Ueber die Bedingungen, unter welchen eine Gleichung nur Wurzeln mit negativen reellen Theilen besitzt," *Math. Ann.*, vol. 46, pp. 273-284; 1895.

⁵ P. A. Samuelson, "Foundations of Economic Analysis," Harvard University Press, Cambridge, Mass., p. 435; 1948.

from the coefficients of the characteristic equation (1). All elements with subscripts greater than n or less than zero are set equal to zero. For example, a characteristic equation which is a quartic yields the expression

$$\Delta = a_0[(a_1 a_2 - a_0 a_3) a_3 - a_1^2 a_4] a_4.$$

The stability boundary of the system whose characteristic equation is (1) consists of certain branches of the equation $\Delta=0$. In general, not all branches are boundaries, but the equation does contain the entire boundary. In order to establish the boundary, it is necessary to check each branch by a numerical computation.

The coefficients a_0 and a_n are factors of Δ . When Δ becomes zero through a_n changing sign, the corresponding unstable root of (1) is real and represents a non-oscillatory case, whereas if a_n does not pass through zero as Δ passes through zero, the corresponding unstable root of (1) produces oscillations.

By means of certain transformations of (1), additional information concerning the location of its roots may be obtained^{6,7} and in fact either the Nyquist or Routh method, together with these transformations, may be used to obtain the roots with any degree of accuracy.⁸ For example, if either criterion is applied successfully to the polynomial

$$\begin{aligned} (f - b) &= a_0(p - b)^n + a_1(p - b)^{n-1} + \dots + a_n \\ &= \bar{a}_0 p^n + \bar{a}_1 p^{n-1} + \dots + \bar{a}_n = 0, \end{aligned} \tag{3}$$

the real part of each root of $f(p)$ must be less than $-b$.

The history of the development of the Routh criterion is interesting. The initial work was due to Routh in 1877.² In 1895, Hurwitz, who apparently was unfamiliar with the work of Routh, independently derived the conditions for stability in the form of determinants.⁴ In 1929 Frazer and Duncan, apparently unfamiliar with the work of Hurwitz, and starting with the results of Routh, deduced exactly the criterion as presented by Hurwitz.⁹ Finally in 1945, Wall (however, familiar with the work of each) deduced the results of Hurwitz by an entirely different method, namely, by means of a partial fraction expansion.¹⁰ Most British texts on advanced dynamics refer to Routh but never to Hurwitz, while the German authors usually refer to Hurwitz and not Routh. In this country the Routh-Hurwitz criterion has received a great deal of attention

⁶ P. A. Samuelson, "Conditions that the roots of a polynomial be less than unity in absolute value," *Ann. Math. Statistics*, vol. 12, pp. 360-364; September, 1941.

⁷ A. Vazsonyi, "A generalization of Nyquist's stability criteria," *Jour. Appl. Phys.*, vol. 20, pp. 863-867; September, 1949.

⁸ E. Frank, "The location of the zeros of polynomials with complex coefficients," *Bull. Amer. Math. Soc.*, vol. 52, pp. 890-898; October, 1946.

⁹ R. A. Frazer and W. J. Duncan, "On the criteria of the stability of small motions," *Proc. Roy. Soc. (London)*, series A, vol. 124, p. 642; July, 1929.

¹⁰ H. S. Wall, "Polynomials whose zeros have negative real parts," *Amer. Math.*, vol. 52, pp. 308-322; June-July, 1945.

recently among mathematicians¹¹ and engineers.^{12,13}

It is interesting that Nyquist, Routh, and Hurwitz all employed the same mapping of the axis of imaginaries of the p plane. Nyquist stopped at this point and stated his criterion, whereas Routh and Hurwitz went beyond to deduce analytical relationships for the stability boundary.

IV. EXAMPLES

As an example of the use of the Routh-Hurwitz criterion, consider the three-stage, two-loop, shunt feedback amplifier of Fig. 1, initially described by Llewellyn.¹⁴ For simplicity, all the admittances have been

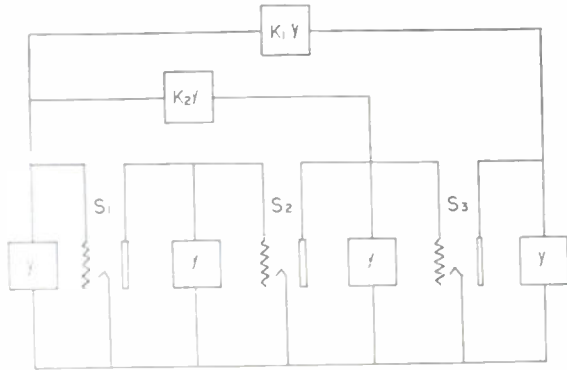

Fig. 1—Illustrative circuit, shunt feedback amplifier.

taken equal. By setting up the network equations on the node basis, the characteristic equation of the network under the assumptions

$$K_1 \cong \frac{1}{10}, \quad K_2 \cong \frac{1}{10}, \quad S_3 \cong 10 \quad (4)$$

is

$$y(y^3 + K_1K_2S_3y^2 - K_2S_1S_2y + K_1S_1S_2S_3) = 0. \quad (5)$$

Some indication of the application of the Nyquist criterion to this circuit under the assumptions of (4) is given by Bode.¹⁵

Let us investigate the case in which the admittance y is composed of a resistance and capacitance in parallel, that is,

$$y = Cp + \frac{1}{R}. \quad (6)$$

Of course, one root of the characteristic equation always occurs at $y=0$, that is, at $p = -1/RC$. Let

¹¹ L. Frank, "On the zeros of polynomials with complex coefficients," *Bull. Amer. Math. Soc.*, vol. 52, pp. 144-157; February, 1946.

¹² M. F. Gardner and J. L. Barnes, "Transients in Linear Systems," John Wiley and Sons, Inc., New York, N. Y., pp. 197-201; 1942.

¹³ E. A. Guillemin, "The Mathematics of Circuit Analysis," John Wiley and Sons, Inc., New York, N. Y., pp. 395-409; 1949.

¹⁴ F. B. Llewellyn, U. S. Patent No. 2,215,598, June 17, 1941.

¹⁵ H. W. Bode, "Network Analysis and Feedback Amplifier Design," D. Van Nostrand Co., Inc., New York, N. Y., pp. 158-162; 1945.

$$p = \frac{1}{RC} [(1 - b)x - b], \quad b < 1, \quad (7)$$

and substitute (7) in (5). The result is the equation

$$(x + 1)(a_0x^3 + a_1x^2 + a_2x + a_3) = 0 \quad (8)$$

in which

$$\begin{aligned} a_0 &= 1 \\ a_1 &= 3 + \alpha_1\alpha_2 \\ a_2 &= 3 + 2\alpha_1\alpha_2 - \alpha_1\alpha_3 \\ a_3 &= 1 + \alpha_1\alpha_2 - \alpha_1\alpha_3 + \alpha_2\alpha_3 \end{aligned} \quad (9)$$

where

$$\begin{aligned} \alpha_1 &= K_2 \\ \alpha_2 &= \frac{K_1RS_3}{1 - b} \\ \alpha_3 &= \frac{R^2S_1S_2}{(1 - b)^2} \end{aligned} \quad (10)$$

Now the condition that the real parts of the roots of (8) be negative insures that the real parts of the roots of (5) be less than $-(b/RC)$. In fact, the stability boundary of (8) is the locus of points such that the maximum time constant of the system is just equal to RC/b . The stability region of (8) according to the Routh-Hurwitz criterion is given by the inequalities (since $a_0 = 1 > 0$)

$$\begin{aligned} a_3 &> 0 \\ a_1a_2 - a_0a_3 &> 0. \end{aligned} \quad (11)$$

Substituting (9) into (11), it is found that the stability conditions are

$$\begin{aligned} \alpha_3 &< \frac{1}{\alpha_1 - \alpha_2} \quad \text{for } \alpha_2 < \frac{2}{3}\alpha_1 \\ &< \frac{2(2 + \alpha_1\alpha_2)^2}{2\alpha_1 + \alpha_2} \quad \text{for } \alpha_2 > \frac{2}{3}\alpha_1. \end{aligned} \quad (12)$$

It is noted that the time constants of the circuit are determined by the three parameters, K_2 , K_1RS_3 , and $R^2S_1S_2$. If the inequality signs in (12) are replaced by equality signs, the result is the locus of parameter values for which the maximum time constant of the system is just equal to RC/b . This locus is shown in Fig. 2. The only restriction on b is that it be less than unity; it may be positive or negative. For the case $b=0$, the curves of Fig. 2 are the stability boundaries of the circuit of Fig. 1. To the left of the peak, the root with maximum time constant is real, whereas to the right of the peak, the root is complex, corresponding to an oscillatory term.

A considerable amount of information can be gathered from Fig. 2. Suppose that for $b=0$ and $K_2=10^{-2}$, the operating point is located at A in Fig. 2. The circuit is stable, but if tube 3 fails, S_3 is reduced to zero

and the operating point moves across the stability boundary as indicated by the arrow. However, failure of either tube S_1 or S_2 never causes instability. Notice that as S_3 is increased from zero, the circuit may pass from an unstable situation successively through stability, then instability, and finally to a stable situation. Notice also that the direction of movement of the stability boundaries as K_2 is increased from zero depends markedly on the value of the parameter K_1RS_3 .

An advantage of the Routh-Hurwitz method over the Nyquist method is clearly illustrated by this example. The former yields the single analytical expressions (12) for the stability boundaries or maximum time constants. A complete description of the situation is given by graphs in Fig. 2.

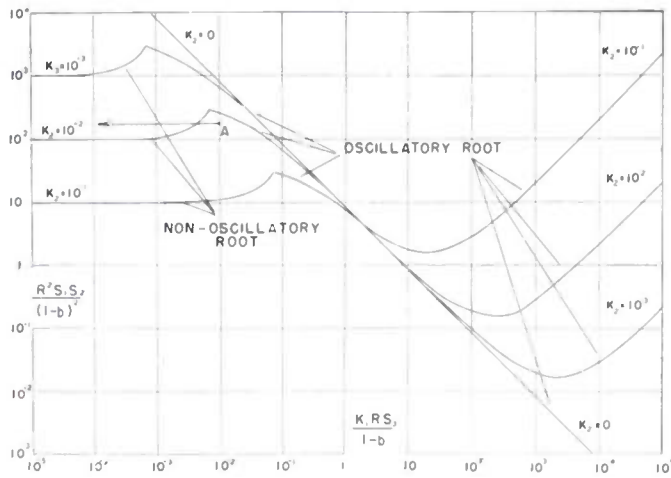

Fig. 2—Locus of points for which the maximum time constant of the circuit of Fig. 1 is RC/b .

On the other hand, the Nyquist method is essentially a numerical process, and the problem of locating stability boundaries is a trial-and-error procedure. One may start with (8), but for each choice of the parameters $\alpha_1, \alpha_2,$ and α_3 , it is necessary to make a Nyquist diagram. One then varies one parameter, say α_3 , recalculating the diagram after each choice, until the boundary is located. If one has no idea of the order of magnitude of α_3 on the boundary, the actual location of the boundary is tedious. The location of the peaks in Fig. 2 by the Nyquist method is particularly difficult.

A second example, suggested by James, Nichols, and Phillips,¹⁶ is afforded by the multiloop servo system

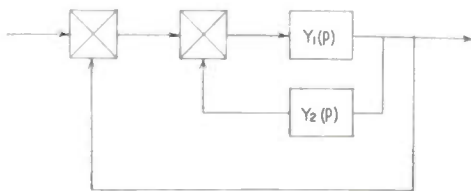

Fig. 3—Illustrative circuit, multiloop servomechanism.

shown in Fig. 3. The circuit consists of an amplifier and motor with transfer characteristic

$$Y_1(p) = \frac{K_2}{p(T_m p + 1)} \tag{13}$$

and a tachometer and filter combination with characteristic

$$Y_2(p) = K_1 p \left(\frac{T_0 p}{T_0 p + 1} \right)^3 \tag{14}$$

The stability boundaries are shown in Fig. 4.

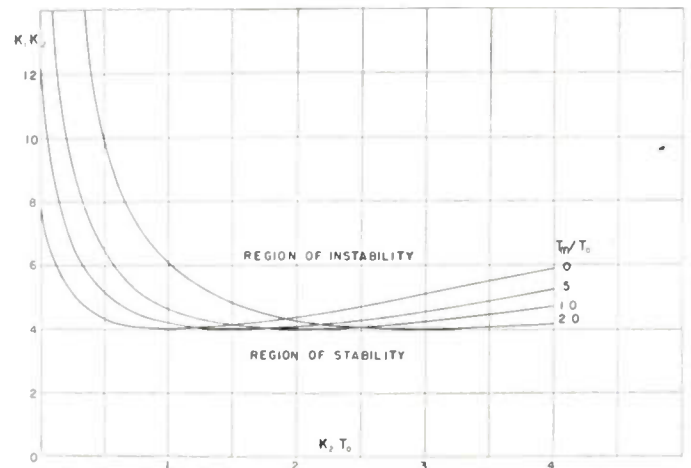

Fig. 4—Stability boundaries for the multiloop servo system of Fig. 3 and equations (13) and (14).

Expressions relating the parameters $\alpha_1, \alpha_2, \alpha_3$ to the maximum time constant may be obtained in much the same manner as in the first example. However, they are somewhat involved and will not be presented here.

V. CONCLUDING REMARKS

A few final remarks are worthy of note. One might be somewhat dismayed at the size of the Hurwitz determinant in certain involved cases in which the characteristic equation is of high order. However, it is usually found that the expanded determinantal equation (always an algebraic equation in the circuit parameters) is of low degree in at least one of the parameters under consideration, so that it is a simple matter to compute the stability boundary. In the last example, although the characteristic equation is of fifth degree, the stability boundary is a second-degree equation in the parameter K_1K_2 .

For a fair comparison of Nyquist and Routh methods it must be mentioned that the former permits stability investigation from experimentally determined transfer functions not in analytical form, whereas the latter does not. Also, in cases in which the expansion of the Hurwitz determinant is too laborious or does not lead to a low-order equation in any parameter, a numerical procedure must be followed.

¹⁶ H. M. James, N. B. Nichols, and R. S. Phillips, "The Theory of Servomechanisms," McGraw-Hill Book Co., Inc., New York, N. Y., pp. 74-75; 1947.

On the Approach to Steady State of a Linear Variable Network Containing One Reactance*

ALAN A. GROMETSTEIN†, ASSOCIATE, IRE

Summary—It is often desirable to determine the manner in which a circuit approaches steady-state operation after a periodic input is applied. More precisely, an answer is sought to the question: "After how many cycles of input may the voltages and currents within the circuit be considered periodic, to within a certain error?"

If the circuit is linear, an answer can always be obtained by the ordinary methods of mathematical attack. All too often, however, such procedures are little more than tours de force of tedious calculations. This is particularly true when some of the circuit component values are variable with time, as is sometimes the case when relays, tubes, switches, and the like are present.

In this paper a method will be developed for answering the question posed above for a restricted, but still quite general, class of linear circuits. Practically speaking, the main restriction is that there be only one reactive component in the circuit. The analysis proceeds by development of a linear, first-order difference equation, whose solution characterizes the circuit's transition from quiescence to transient to steady operation.

DISCUSSION

THE CIRCUIT

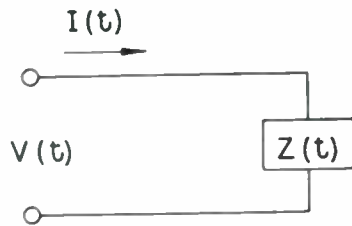

- if (1) it is linear,
- (2) it can be reduced to a circuit having only one reactive component,
- (3) all variables involved possess Laplace transforms,
- (4) all variable circuit components (resistances and reactances) are periodic in value and all have the same over-all period as
- (5) $V(t)$, which is periodic,

will, with time, gradually approach steady-state operation, once the input has been applied. The condition of steady state is distinguished from transient operation by the fact that in the former the circuit voltages and currents during one cycle of input are virtually identical with the same quantities during any succeeding cycle. From the practical point of view, it is often of interest to know how a circuit such as the above approaches steady state, and in how short a time the transients become of negligible value.

Let us ignore for a moment the precise wave forms in the circuit. Consider the value of the voltage across the reactance at the beginning of a certain input cycle. If this value is the same as that of the same reactance

voltage at the beginning of the previous input cycle, then the circuit has obviously entered upon a closed, periodic (i.e. steady-state) operation. If the two values of reactance voltages mentioned are "almost the same," then the circuit is "almost at steady state."

We shall proceed to derive a general expression for the current $I(t)$, in terms of the circuit components and $V(t)$.

SYMBOLISM

$i(p)$, $v(p)$, $r_k(p)$, $x(p)$ are the Laplace transforms of the quantities $I(t)$, $V(t)$, $R_k(t)$, $Z(t)$.

$X(t)$ and $R_k(t)$ are, respectively, the unique reactive and the various resistive components of the circuit. As indicated, they may all or severally vary with time. They must, however, be independent in value of any other quantity, since the circuit is linear. Further, by the restrictions before listed, if they are periodic they must have the same period as $V(t)$.

$E(t)$ is the voltage across the reactance. In particular, $E(0)$ is the reactance voltage at the beginning of transform time. The choice of $E(0)$ is not restrictive, since the circuit admits of no two independent parameters of state.

Now the circuit has a governing equation in the transform variable p , which may be found by common methods of analysis:¹

$$i(p) = F[p; v(p); r_1(p); r_2(p) \cdots; x(p); E(0)] \equiv F(p) \quad (1)$$

and which can be solved for $I(t)$ by means of the Mellin Inversion Theorem.²

$$I(t) = \frac{1}{2\pi j} \int_{n_r} i(\lambda) e^{\lambda t} d\lambda = \frac{1}{2\pi j} \int_{n_r} F(\lambda) e^{\lambda t} d\lambda \quad (2)$$

where

$$\int_{n_r} (\cdots) d\lambda \equiv \lim_{\zeta \rightarrow \infty} \int_{\gamma - j\zeta}^{\gamma + j\zeta} (\cdots) d\lambda$$

γ , ζ being real; and $\gamma >$ (real part of any singular point of the integrand).³

Having found $I(t)$ as in (2), let us trace the circuit throughout its first cycle of input. At the beginning of this cycle the reactance voltage is $E(0)$, by definition. At any point during this cycle the reactance voltage $E(t)$, can be expressed in terms of $I(t)$ and $E(0)$

$$E(t) = G[t, I(t), E(0)] \quad (3)$$

and $I(t)$ can be eliminated from the expression by using

¹ Ernest A. Guillemin, "Communication Networks," John Wiley and Sons, New York, N. Y.; 1931. Also, M. F. Gardner and J. L. Barnes, "Transients in Linear Systems," vol. I, John Wiley and Sons; 1942.

² H. S. Carslaw and J. C. Jaeger, "Operational Methods in Applied Mathematics," Oxford University Press, chap. IV; 1941.

³ The symbol " $\int_{n_r} \cdots d\lambda$ " is chosen because of the intimate relation between equation (2) and Bromwich's contours.

* Decimal classification: R140. Original manuscript received by the Institute, November 2, 1949; revised manuscript received, April 20, 1950.

† Sylvania Electric Products Inc., Boston, Mass.

(2), giving

$$E(t) = H[t, E(O)]. \quad (4)$$

We have, in (4), an expression of the reactance voltage at any time during the first input cycle. If the period of $V(t)$ is T , then at the end of this first cycle the reactance voltage has reached the value

$$E(T) = H[T, E(O)]. \quad (4a)$$

The equation (4a) is vital to further development. It expresses the reactance voltage at the end of the first input cycle in terms of the initial reactance voltage and time, and (implicitly) the circuit parameters. From the very nature of the circuit under consideration—in particular its linearity— $E(O)$ can enter into (4a) only linearly, and so we can rewrite (4a) as

$$E(T) = \Gamma_1 E(O) + \Gamma_2, \quad (5)$$

where Γ_1, Γ_2 are parameters which characterize the circuit and its input, but do not depend on $E(O)$.

It is quite apparent that though (5) was derived through an argument relating to the *first* cycle of input, the restriction is unessential. In fact the succession of equations

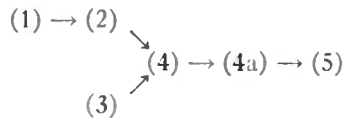

is valid for any cycle of input, if $E(O)$ and $E(T)$ are reinterpreted as the reactance voltage at the beginning and end, respectively, of that particular cycle. If we introduce the symbol

$E_N \equiv$ reactance voltage at the end of the N th cycle, then we can write

$$E_N = \Gamma_1 E_{N-1} + \Gamma_2. \quad (6)$$

Equation (6) is a linear, first-order difference equation with constant coefficients (Γ_1, Γ_2 are calculable from (4)) and applies to the circuit for all cycles of input. Being of the first order, (6) has a general solution containing one arbitrary constant, C :

$$E_N = C\Gamma_1^N + \frac{\Gamma_2}{1 - \Gamma_1}. \quad (7)$$

C may be calculated by setting $N=0$, and realizing that the symbol E_0 is to be interpreted as the reactance voltage at the beginning of the first input cycle (which was originally symbolized $E(O)$). Then

$$C = E_0 - \frac{\Gamma_2}{1 - \Gamma_1}$$

and

$$E_N = \left(E_0 - \frac{\Gamma_2}{1 - \Gamma_1} \right) \Gamma_1^N + \frac{\Gamma_2}{1 - \Gamma_1}. \quad (8)^4$$

⁴ It is interesting to note the implications of (8):

- (1) $|\Gamma_1| \leq 1$ (for practical circuits)
- (2) if $\Gamma_1 = 1$, then $\Gamma_2 = 0$, and steady state exists immediately.
- (3) if $E_0 = \Gamma_2 / (1 - \Gamma_1)$, no true transients arise.

- (4) Limit $E_N = \begin{cases} E_0 & \text{if } \Gamma_1 = 1 \\ \Gamma_2 / (1 - \Gamma_1) & \text{if } \Gamma_1 \neq 1. \end{cases}$

From (8), which determines the reactance voltage at the end of the N th cycle in terms of the initial value of this voltage and the circuit parameters Γ_1, Γ_2 , we may proceed to consider in more detail the transition from transient to steady-state operations.

Such an inquiry presupposes a precise definition of the terms used. We shall adopt the following:

DEFINITION

Transient conditions exist from the moment of application of input until steady state is reached. Steady-state conditions obtain from the S th cycle on, if, for some arbitrary $0 < \delta \ll 1$, and all positive S :

$$|E_{S+S} - E_0| \geq (1 - \delta) \left| \frac{\Gamma_2}{1 - \Gamma_1} - E_0 \right|. \quad (9)$$

Thus each determination of steady state must be accompanied by a value δ . δ plays the role of setting a maximum error to the evaluation.

The above defines steady state as obtaining after S cycles, and S is determined so that E_N , in changing from E_0 to E_∞ has, at E_S , reached a value from which it will not thereafter change by more than $100\delta / (1 - \delta)$ per cent.

If (9) is solved for S (E_N is a known function of N), we have

$$S \geq \log \delta / \log \Gamma_1. \quad (10)$$

(Note that this relation is independent of E_0 and Γ_2 .)

Therefore, the circuit will reach steady state (as determined by δ) in

$$\begin{aligned} &\log \delta / \log \Gamma_1 \text{ cycles of input, or} \\ &T \log \delta / \log \Gamma_1 \text{ seconds.} \end{aligned}$$

As an example of the use of this method, the circuit below will be analyzed:

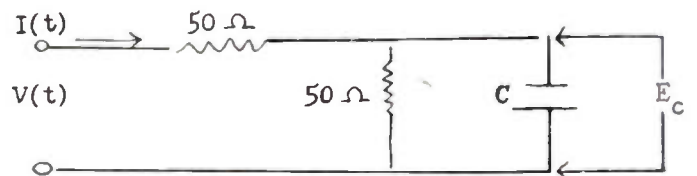

$V(t)$ consists of a series of rectangular pulses of amplitude 100 volts, duration 1 millisecond, and repetition rate 400 per second.

C has the value $\begin{cases} 200 \mu\text{f} & \text{during an input pulse} \\ 50 \mu\text{f} & \text{during the inter-pulse periods.} \end{cases}$
 C is a potential E_0 at the beginning of the first pulse ($t=0$).

Then the general lines of the argument established previously may be followed to deduce:

- 1. During the first pulse ($0 \leq t \leq 10^{-3}$)

$$E_c(p) = \left(\frac{50}{p} + \frac{E_0 - 50}{p + 200} \right)$$

or $E_c(t) = 50 + (E_0 - 50)e^{-200t}$ and $E_c(10^{-3}) = 9.070 + 0.8186 E_0$.

2. During the first discharge period ($10^{-3} \leq t \leq 2.5 \times 10^{-3}$)

$$E_c(t) = (9.070 + 0.8186 E_0)e^{-400(t-10^{-3})}$$

and $E_c(2.5 \times 10^{-3}) = 4.997 + .4492 E_0$. The difference equation is therefore,

$$E_{cN} = 4.977 + 0.4492E_0$$

and has the solution

$$E_{cN} = (E_0 - 9.036)(0.4492)^N + 9.036.$$

Steady-state condition—for any value of δ —will occur within

$$S = \frac{\log \delta}{\log \Gamma_1} = 2.877(\log \delta) \text{ cycles}$$

or, equivalently, within

$$T_s = 2.5 \times 10^{-3} S = -7.192(\log \delta) \text{ milliseconds.}$$

For example, if $\delta = 2$ per cent, $S = 5$ cycles, and the circuit reaches steady state, on this basis, in 12.5 milliseconds.

It is quite simple at this point to proceed a bit further and find the precise wave form. For if we designate the reactance voltage at the end of the N th input pulse by E_{cN}' (occurring in time between E_{cN-1} and E_{cN}), then

$$E_{cN}' = E_{cN}e^{0.6} = 1.822E_{cN}.$$

With the additional information the accompanying graph, Fig. 1 (for which E_0 is taken equal to 100 volts), may be plotted in its entirety. Points E_{cN} and E_{cN}' for $0 \leq N \leq 12$ are located, and then connected with exponential arcs of the appropriate time constant.

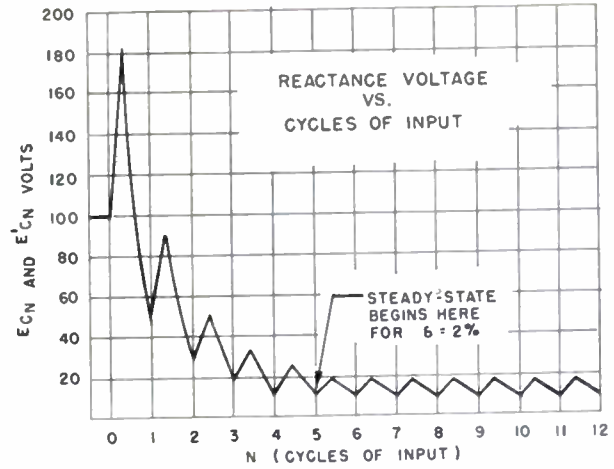

Fig. 1

CONCLUSION

A method has been presented herein which is quite suitable for the analysis of linear variable circuits containing but one reactance. It is most readily applicable where the variation in circuit components takes the form of abrupt level changes, but can be adapted, though less handily, to circuits containing continuously varying parameters.

Circuits fitting the restrictions listed in the first part of this paper are often encountered in many applications of counting and switching considerations, as well as in simple networks depending on an arc or glow-discharge operation. The presence of a linear voltage or current source does not prevent the use of the method.

A procedure analogous to the one set forth above may be developed for circuits of the same type, but containing several distinct reactances. However, a system of several difference equations in several variables results, and may be extremely difficult of solution.

Contributors to Proceedings of the I.R.E.

Andrew J. Aikens (A'48) was born in Milwaukee, Wis., on March 22, 1896. After serving in the first World War he received the degree of B.S. in electrical engineering from the University of Nevada in 1918.



ANDREW J. AIKENS

In 1922 he joined the engineering staff of the Pacific Telephone and Telegraph Company, and transferred in 1926 to the department of development and research of the American Telephone and Telegraph Company. This department was consolidated with Bell Telephone Laboratories in 1934, where Mr. Aikens is still employed. His work has been largely concerned with noise problems in both wire and radio communication.



D. R. Andrews (M'47) was born on July 28, 1907, in Indiana. He was graduated from the Ball State Teachers College, in Muncie, Ind., and was then engaged in radio service work. He studied radio engineering at Purdue University Extension. During World War II, he was employed by the Allison Division of the General Motors Company, in charge of maintenance of electrical instruments. For the past six years Mr. Andrews has been an engineer in the advanced development group of the RCA Victor Company, in Camden, N. J. His work there is almost entirely devoted to recording. Mr. Andrews is a member of subcommittee 19.1 of the IRE, which is now writing standards for magnetic recording.



D. R. ANDREWS

Wallace C. Babcock (A'45-M'45) was born at Northport, L. I., N. Y., on January 16, 1897. After graduating from Harvard with the degree of B.S. in communication engineering in 1922, he joined the development and research department of the American Telephone and Telegraph Company, which was consolidated with Bell Telephone Laboratories in 1931. His work has been largely concerned with inductive interference problems between open-wire telephone circuits. During the war he was engaged on radio countermeasure problems for the National Defense Research Committee. Since that time he has been working on the development of mobile radio systems.



W. C. BABCOCK

with inductive interference problems between open-wire telephone circuits. During the war he was engaged on radio countermeasure problems for the National Defense Research Committee. Since that time he has been working on the development of mobile radio systems.

Frank E. Bothwell was born on February 25, 1918, in Saginaw, Mich. He received the S.B. degree in mathematics in 1940, the S.B. degree in electrical engineering in 1941, and the Ph.D. degree in applied mathematics in 1946, all from the Massachusetts Institute of Technology.



F. E. BOTHWELL

During the period from 1941 to 1945, Dr. Bothwell was a staff member at the Radiation Laboratory at MIT, and from 1945 to 1947 he was a research engineer on the Project Meteor at the same institution. Since 1947 he has been a senior mathematician at the University of Chicago and a lecturer in mathematics at Northwestern University.

Dr. Bothwell is a member of Sigma Xi, the American Mathematical Society, and the International Congress of Mathematics.



H. N. Christopher, a member of the technical staff of Bell Telephone Laboratories, is at present engaged in studies concerned with the subjective evaluation of television picture impairments. A member of the Installation Department of the New York Telephone Company in 1923, he transferred to the development and research department of the American Telephone and Telegraph Company as a technical assistant in 1925, and subsequently joined the Laboratories with that department in 1934.



H. N. CHRISTOPHER

Prior to World War II, Mr. Christopher was engaged in development and research on problems relating to the inductive co-ordination of power and telephone systems. His principal contributions in that field included the development of filters for reducing wave-shape distortion caused by the operation of power rectifiers and special testing equipment including harmonic analyzers, noise meters, and carrier frequency analyzers. During the war, he took an active part in special projects for the Armed Services and for NDRC.



Paul V. Dimock (SM'48) was born at East Smithfield, Pa., on July 14, 1915. He received the B.S. degree in electrical engineering from the Pennsylvania State College in 1937. After graduation, he became a member of the technical staff of the Bell Telephone Laboratories, where he engaged in fundamental studies of transmission rating problems, including methods for calculating the loudness



PAUL V. DIMOCK

and intelligibility of speech as affected by telephone circuits. During the period from 1942 to 1945 he was on leave of absence at Columbia University, where he worked on various projects with the Underwater Sound Laboratory and Airborne Instruments Laboratory.

Since 1945 he has been associated with the radio transmission engineering department of Bell Telephone Laboratories, and has been concerned with transmission problems related to mobile radiotelephony and microwave relay systems.

Mr. Dimock is a member of Tau Beta Pi, Eta Kappa Nu, Pi Mu Epsilon, and Sigma Pi Sigma.



Liscum Diven was born in New York, N. Y., on September 18, 1918. He received the B.A. degree from Columbia University in 1940, majoring in physics.



LISCUM DIVEN

He was employed by Western Electric Company until 1943, at which time he joined the engineering staff of Federal Telecommunication Laboratories, in Nutley, N. J. He has specialized in pulse communication systems and is at present engaged in selenium-rectifier development.



Louis Feit (A'50) was born in Union City, N. J., on May 11, 1921. He received the B.A. degree from New York University in 1943, majoring in physics and mathematics, and the M.S. degree in 1948. He served in the United States Army from June to October, 1943, following which he taught physics at the College of the City of New York.



LOUIS FEIT

Mr. Feit joined the engineering staff of Federal Telecommunication Laboratories in 1944. He has done development work on pulse-multiplex communication systems and is now concerned with selenium-rectifier engineering.

He is a member of the American Physical Society and the Association for Computing Machinery.



For a biography and photograph of RALPH I. COLE, see page 822, of the July, 1950, issue of the PROCEEDINGS OF THE I.R.E.



A. D. Fowler was born on June 10, 1901, in Hopkinsville, Ky. He attended Cornell University for one year and transferred to the Massachusetts Institute of Technology. Interrupting his studies for a period of four years to engage in hydro-electric engineering at Muscle Shoals, Ala., he returned to MIT, where he received the degree of S.B. in 1928. Immediately after graduation he joined the department of development and research of the American Telephone and Telegraph Company, and with that department, transferred to the Bell Telephone Laboratories, Inc., in 1934. He is presently engaged in studies concerned with the subjective evaluation of television picture impairments.



A. D. FOWLER

Prior to World War II, Mr. Fowler's principal contributions were in the field of analysis of special transmission problems and in the evaluation of proposed transmission systems. During the war he was actively employed in several projects for the Armed Services and for the National Defense Research Council.



Alan A. Grometstein (A'49) was born in New York, N. Y., on May 7, 1926. He received the A.B. degree in physics from Columbia College in 1947, and the A.M. in mathematics from Columbia University in 1948. Since the end of 1948 he has been employed by Sylvania Electric Products Inc., in its theoretical analysis and statistical analysis departments.



A. A. GROMETSTEIN

Mr. Grometstein is a member of the American Physical Society and the American Institute of Physics.



Walter C. Hunter (M'47) was born in Helena, Okla., on July 1, 1913. He received the A.B. degree in physics and the M.Ed. degree in administration from Phillips University, Enid, Okla., in 1936 and 1937, respectively.



WALTER C. HUNTER

He was an instructor in the Enid secondary schools from 1936 to 1942, and an instructor in the electrical engineering department of Oklahoma Agricultural and Mechanical College, Stillwater, Okla., from 1942 to 1944.

In 1944, Mr. Hunter joined the Western Electric Company as a radar field engineer. In 1945, he transferred to the Bell Telephone Laboratories as a member of the technical staff, and has since been engaged in the development of railroad and mobile radiotelephone equipment.

Lawrence Lutzker (S'47-A'48) was born on March 13, 1927, in New York, N. Y. He received part of his engineering training at the Cooper Union School of Engineering and the remainder at the University of Michigan, graduating from the latter in 1947 with B.Sc. degree in electrical engineering.



L. LUTZKER

During the war, he served in the Navy as an electronic technician. After leaving Michigan, he was employed as a quality control engineer by the Allen B. DuMont Laboratories, Inc., where he introduced statistical methods to deal with problems of inspection and manufacturing. Since then he has taken an active part in the promotion of statistical quality control within the company.

Mr. Lutzker is a Senior Member of the American Society for Quality Control and a member of Tau Beta Pi and Eta Kappa Nu.



Pierre Mertz (SM'44-F'50) was born in France on April 2, 1897. He received the A.B. degree in 1918, and the Ph.D. degree in 1926, both from Cornell University. In 1919 he entered the department of development and research of the American Telephone and Telegraph Company, where he served until 1935, with some interruption, when this department was merged with the Bell Telephone Laboratories, Inc.



PIERRE MERTZ

Mr. Mertz is now in the transmission engineering department at Bell, where his principal work has dealt with problems in television and telephotograph transmission.

During World War II he served as section chief and division member with the National Defense Research Council, and also as investigator for THIC. In 1948 he received the Army-Navy Certificate of Appreciation.



Sidney Moskowitz (M'45) was born in Brooklyn, N. Y., on February 23, 1919. In 1940, he received the B.E.E. degree from the College of the City of New York. From 1941 to 1945 he was a member of the evening-session staff at that college.

While teaching evenings, he was also engaged in the development of electronic apparatus for the Industrial Scientific Corporation in New York. In 1943,

Mr. Moskowitz joined Federal Telecommunication Laboratories, where he has been active in the design and development of pulse time-modulation systems. He is serving also as an adjunct assistant professor in

the graduate school of engineering of New York University.

Mr. Moskowitz is a member of Tau Beta Pi.



R. C. Moyer was born in Boston, Mass., on June 24, 1909. He received the B.A. degree from Bowdoin College in 1932, majoring in mathematics. After a brief association with Radio Television Industries Inc., he joined the RCA Victor Distributors in Cambridge, Mass., where he worked in both engineering and sales in the commercial sound department. From 1942 to 1945 he was on the staff of the Radio Research Laboratory at Harvard University as a special research associate.



R. C. MOYER

Since 1945 Mr. Moyer has been associated with RCA Victor as a supervisor in the engineering section of the record department.



Harry W. Nylund was born near Altoona, Iowa, on September 20, 1903. He received the B.S. degree in electrical engineering from Iowa State College in 1925, and joined the Bell Telephone Laboratories staff immediately thereafter. He spent some years in field engineering work, and during the war was engaged in various underwater sound projects and in antenna studies. His work recently has been concerned with development of antennas and related devices for the mobile radio services.



HARRY W. NYLUND

His work recently has been concerned with development of antennas and related devices for the mobile radio services.



Bernard M. Oliver (S'40-A'40-M'46) was born on May 27, 1916, at Santa Cruz, Calif. He received the B.A. degree in electrical engineering from Stanford University in 1935, and the M.S. degree from the California Institute of Technology in 1936. Following a year of study in Germany from 1936 to 1937 under an exchange scholarship, he returned to the California Institute of Technology and in 1940 received the Ph.D. degree. Since that time he has been employed as a research engineer with the Bell Telephone Laboratories. During the war he was active in the development of Army and Navy automatic tracking radar equipment.



B. M. OLIVER

For a photograph and biography of L. V. LACY, see page 312 of the March, 1950, issue of the PROCEEDINGS OF THE I.R.E.



For a photograph and biography of L. V. LACY, see page 312 of the March, 1950, issue of the PROCEEDINGS OF THE I.R.E.

Albert S. Richardson, Jr., was born on August 7, 1924 in Canton, Ohio. He received the B.S. degree in aeronautical engineering in 1947 from the Massachusetts Institute of Technology.



A. RICHARDSON, JR.

As an analytical engineer during 1948 with United Aircraft in East Hartford, Conn., he conducted theoretical flutter and vibration studies of a new type of supersonic propeller and investigated effects of power plant gyroscopic coupling on turbo jet-powered aircraft. From 1948 to 1949 he was a development engineer with the Goodyear Aircraft Corporation, where he participated in the development of automatic control systems for aircraft. Since December, 1949, Mr. Richardson has been engaged, as a research engineer, in conducting theoretical studies of dynamic response of elastic aircraft at the Aero-Elastic and Structures Research Laboratory at MIT.



J. Gregg Stephenson (A'45-M'47) was born in Kansas City, Mo., on September 21, 1917. He was awarded the B.E. degree from Yale University in 1939, and the Engineer Degree from Stanford University in 1941. He was employed as assistant laboratory engineer at the Ohio Brass Company, in Barberton, Ohio, during 1941 and 1942, engaged in high-voltage testing and measurements. For the next two years he worked as a research associate in the Radio Research Laboratory of Harvard University, engaged in the development of ultra-high-frequency transmitters. This was followed by a year at the American British Laboratory in 1945, where he was concerned with radar countermeasures for the United States Navy and the 8th Air Force and as a Technical Observer in the Mediterranean Area. Mr. Stephenson was assigned as RCM consultant to the Operational Analysis Section of the 8th Air Force Headquarters for four months in 1945.



J. G. STEPHENSON

Since December, 1945, Mr. Stephenson has been in the receiver group at the Airborne Instruments Laboratory, in Mineola, L. I., New York, engaged in uhf receiver development. He is a member of Sigma Xi, Tau Beta Pi, the American Institute of Electrical Engineers, and the Yale Engineering Association.



For a photograph and biography of H. E. ROYS, see page 313 of the March, 1950, issue of the PROCEEDINGS OF THE I.R.E.



For a photograph and biography of LOUIS A. ZADEH, see page 314 of the March, 1950, issue of the PROCEEDINGS OF THE I.R.E.

Robert C. Shaw was born on September 8, 1902, at Templeton, Mass. He received the B.S. degree in electrical engineering from Michigan University in 1926.



ROBERT C SHAW

From 1927 to 1945 he was a member of the technical staff of the Bell Telephone Laboratories, where he was engaged in radio research. During 1944 and 1945 he was on leave of absence to the National Defense Research Committee in the Office of Scientific Research and Development and was Chairman of the Antenna Co-ordinating Committee. From 1945 to 1946 he was a partner in the firm of McKey and Shaw, consulting radio engineers.

He returned to the Bell Laboratories in 1947 where he has been associated with the radio transmission engineering department, and concerned with problems related to mobile radiotelephony.



Walter Strack, Jr., was born in Astoria, N. Y., on January 4, 1925. He received the B.S. degree in electrical engineering in 1944 from the Polytechnic Institute of Brooklyn.



W. STRACK, JR.

During World War II, Mr. Strack served with the Navy at the Naval Ordnance Laboratory in Washington, D. C., where he worked on the development of influence detectors for underwater explosives. In November, 1945, he joined the Bell Telephone Laboratories where he has been concerned with the development and testing of mobile radio equipment. He is a member of Eta Kappa Nu.



W. T. Wintringham (A'26 SM'45) was born in Brooklyn, N. Y., on January 18, 1901. He received the B.S. degree in electrical communication engineering from Harvard University in 1924, and immediately joined the American Telephone and Telegraph Company in the department of development and research. In 1935 he transferred to the Bell Telephone Laboratories.



W.T. WINTRINGHAM

Before World War II, Mr. Wintringham was associated closely with the development of radio telephone systems for spanning natural barriers; the long-wave transatlantic telephone; the short-wave MUSA receiving system; and the multiplex telephone system used between the Virginia Capes and operated in the vhf region. During the war he worked on a number of classified projects. Recently his work has been in the television field, with particular emphasis on color.

Correspondence

Fourier Transforms in the Theory of Inhomogeneous Transmission Lines*

It is well known that the Fourier Integral Theorem may be used in different technical fields. Thus, for instance, it can be used in the theory of communication¹ and in the antenna theory.² Now it also appears to be applicable in the theory of inhomogeneous transmission lines. Starting with the differential equations of an inhomogeneous line,

$$\begin{cases} \frac{d^2 V}{dx^2} - \frac{d \ln Z_0}{dx} \frac{dV}{dx} - \gamma^2 V = 0 & (1) \\ \frac{d^2 I}{dx^2} + \frac{d \ln Z_0}{dx} \frac{dI}{dx} - \gamma^2 I = 0 & (2) \end{cases}$$

where

- V = voltage
- I = current, and
- Z₀ = characteristic impedance

are all functions of the length x and γ = the propagation constant, in this note assumed to be constant = jβ, it is possible, after some substitutions, to deduce a Rice³ differential equation for the reflection coefficient ρ at the sending end, when the receiving end is matched:

$$\frac{j}{\beta} \left[2 \frac{d\rho}{dx} + \frac{d \ln Z_0}{dx} (1 - \rho^2) \right] + 4\rho = 0. \quad (3)$$

Assuming ρ² to be small compared to 1, one obtains the approximate solution

$$|\rho| = \left| \frac{1}{2} \int_{-\infty}^{\infty} \frac{d \ln Z_0}{dx} e^{-j2\beta x} dx \right|. \quad (4)$$

This is a Fourier integral. The Fourier transforms will be ρ and d ln Z₀/dx multiplied by some constant factors, one of which includes Z₂/Z₁, where Z₁ = impedance at the sending end and Z₂ = impedance at the receiving end of the inhomogeneous line. With the integral above, it is possible to examine and deduce the approximate solutions already made by other authors. With the Fourier Integral Theorem it is possible not only to determine |ρ| as a function of (l/λ) (l = the length of the line, λ = wavelength) for an arbitrary Z₀(x), but also, on the contrary, to determine Z₀(x) from the |ρ| - diagram. As a special example, there is shown in Fig. 1 the behavior of an inhomogeneous line, whose d ln Z₀/dx - function is triangular. In Fig. 1 (a) the impedances Z₁ and Z₂ are chosen to be 50 and 100 ohms, respectively.

The analogy of treatment in other fields is obvious: Thus, for instance, the problem of constructing an optimized transmission line transformer will be analogous to the problem of finding the antenna distribution that will give the best diffraction pattern with respect to sidelobes and width of the main lobe.

The way of treatment described above may be applied to waves in general, and can

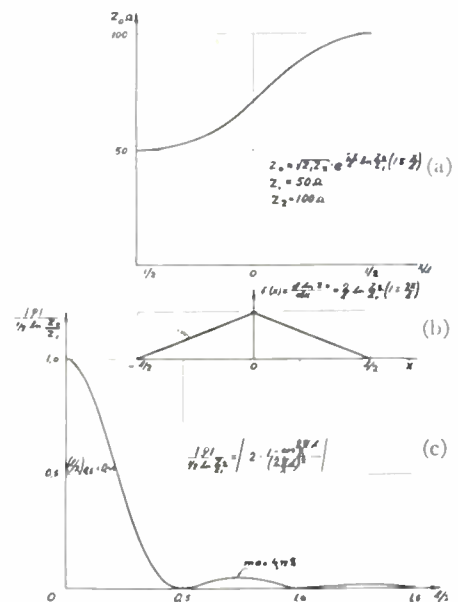

Fig. 1—Diagrams for an inhomogeneous transmission line, whose d ln z₀/dx function is triangular.

be extended to other fields; for instance, to the acoustical.

Further details of this work will be published later.

FOLKE BOLINDER
The Research Institute of National Defense
117 Valhallavägen
Stockholm
Sweden

* Received by the Institute, June 19, 1950.

¹ S. Goldman, "Frequency Analysis, Modulation and Noise," McGraw-Hill Book Co., New York, N. Y.; 1948.

² J. F. Ramsay, "Fourier transforms in aerial theory," *Marconi Rev.*, 6 parts in vol. IX: 4, X: 1-4 and XI: 2; 1946-1948.

Institute News and Radio Notes

TECHNICAL COMMITTEE AND PROFESSIONAL GROUP NOTES

The Executive Committee appointed the following persons to serve as IRE representatives on various ASA Sectional Committees: A. F. Pomeroy, ASA Drawings and Correlating Committee; J. R. Steen, C67, Preferred Voltages-100 Volts and Under; and A. G. Clavier, Z10, Letter Symbols and Abbreviations. Mr. Clavier has been appointed as alternate to Austin Bailey, IRE Representative on Z14, Standards for Drawing and Drafting Room. Mr. Clavier has also been selected as the IRE Representative on Z15, Standards for Graphical Presentation. A. F. Pomeroy will be the alternate on this Committee. . . . The Second High-Frequency Measurements Conference sponsored jointly by IRE/AIEE and the National Bureau of Standards will be held at the Hotel Statler in Washington, D. C., on January 10 to 12, 1951. This will be the first scientific gathering of national scope to be brought to Washington in 1951 in celebration of the semicentennial of the National Bureau of Standards. This Conference is under the general direction of Professor Ernst Weber, Chairman of the IRE Measurements and Instrumentation Committee. Technical Sessions will be held in the spacious auditorium of the Department of the Interior. The program will include about twenty-five outstanding technical papers, an evening demonstration of a spectacular nature, a luncheon, and conducted inspection tours of selected local and nearby institutions. Chartered buses will be provided for transportation to the auditorium, and for the inspection tour. . . . A two-day conference on Electron Tubes for Computers, under the sponsorship of The Institute of Radio Engineers and the American Institute of Electrical Engineers, in collaboration with the Panel on Electron Tubes, is being held on December 11-12, 1950, at the Haddon Hall Hotel in Atlantic City, N. J. The emphasis of the Conference will be on reliability of tubes for use in digital computers, with some attention to be devoted to special tubes developed specifically for computers. Further information may be obtained by writing to the Conference Secretary, A. Lederman, Panel on Electron Tubes, Room 601, 139 Centre Street, New York 13, N. Y. . . . The Audio Techniques Committee held a meeting on August 16, under the Chairmanship of R. A. Miller. . . . The Electronic Computers Committee held a meeting on September 8 in Washington, D. C., under the Chairmanship of J. W. Forrester. . . . A meeting of

the Circuits Committee was held on September 15, with W. N. Tuttle, Chairman, presiding. . . . A National Meeting of the Professional Group on Vehicular and Railroad Radio Communications will be held on November 3, 1950, in Detroit, Mich.

✧

BROADCAST TRANSMISSION GROUP

The IRE Professional Group on Broadcast Transmission Systems is tentatively planning to hold a "broadcast day" on Tuesday, March 20, during the 1951 IRE National Convention. Eight papers will be presented during the day.

Plans for "broadcast day" were discussed at the Group Administrative Committee meeting on September 29. Plans were also discussed for sending letters to chief engineers of broadcast stations and to manufacturers of broadcast equipment in order to increase the Group membership and to organize groups locally, as has been done in Boston and Cleveland.

✧

IRE WEST COAST CONVENTION HELD IN FALL IS SUCCESSFUL

The annual IRE West Coast Convention held September 13-15 at the Municipal Auditorium, Long Beach, Calif., was the largest convention of its kind in the West Coast history of The Institute of Radio Engineers. Approximately 1,400 registrations were recorded for the technical sessions, and 159 booth spaces were sold to 138 manufacturers. The program was sponsored jointly by the Los Angeles Section of the IRE and the West Coast Electronics Manufacturers Association.

The 1951 West Coast Convention has been scheduled for August 29-31 at San Francisco.



Shown at the IRE West Coast Convention from left to right are: R. L. Slink, Chairman of the Los Angeles Section; G. W. Bailey, IRE Executive Secretary; R. F. Guy, IRE President; F. E. Terman, Past Director of Region 7; and S. P. Johnson, Convention Chairman.

Vacancies at Indiana Navy Station

Vacancies have been announced by the Navy Department at the U. S. Naval Ordnance Plant, Indianapolis 6, Ind., for mechanical, electronic, electrical and ordnance engineers. These positions are at various grade levels under Federal Civil Service at annual salaries ranging from \$3,825 to \$7,400. The engineering development, research, and testing program at this station is rapidly expanding and qualified personnel in these classifications is urgently needed.

Details concerning employment at this station may be obtained from Commander M. K. Coleman, USNR, Industrial Relations Officer.

OAK RIDGE INSTITUTE TO GIVE COURSES ON RADIOISOTOPES

The eighteenth, nineteenth, and twentieth courses in the techniques of using radioisotopes in research will be given by the Special Training Division of the Oak Ridge Institute of Nuclear Studies, Oak Ridge, Tenn., during the winter and spring of 1951. Dates for the courses are as follows: January 8-February 2, February 19-March 16, and April 16-May 11.

The courses are designed to acquaint research workers with the safe and efficient use of radioisotopes in research. The course work consists of laboratory work, lectures on laboratory experiments, general background lectures, and special-topic seminars. Experiments are conducted covering the use and calibration of instruments, the purification and separation of radioactive materials from inert and other radioactive materials, measurement and use of Carbon-14,

pile activations, radioautographs, and the like. Seminars include such topics as the use of radioisotopes in animal experimentation, use of radioisotopes in humans, principles and practice of health physics, design of radiochemical laboratories, effect of radiation on cells, and similar topics.

The Special Training Division can accommodate thirty-two participants at each of the three courses. A registration fee of \$25 is charged, and participants will bear their own living and traveling expenses.

Additional information and application blanks may be obtained from Dr. Ralph T. Overman, Chairman, Special Training Division, Oak Ridge Institute of Nuclear Studies, P.O. Box 117, Oak Ridge, Tenn.

Calendar of COMING EVENTS

National Conference of the IRE Professional Group On Vehicular Communications, Detroit, Mich., November 3

UHF-Microwave Conference, IRE Kansas City Section, Kansas City, Mo., November 3-4

IRE-AIEE Conference on Electron Tubes for Computers, Atlantic City, N. J., December 11-12.

AAAS Annual Meeting, Cleveland, Ohio, December 26-30

AIEE-IRE-NBS High-Frequency Measurements Conference, Hotel Statler, Washington, D. C., January 10-12, 1951

1951 IRE National Convention, Waldorf-Astoria Hotel and Grand Central Palace, New York, N. Y., March 19-22, 1951

IRE Southwestern Conference, Dallas, Texas, April 20-21, 1951

1951 Annual Meeting of the Engineering Institute of Canada, Mount Royal Hotel, Montreal, May 9-11, 1951

NATIONAL BUREAU OF STANDARDS OFFERS CALIBRATION SERVICES

The National Bureau of Standards is now offering a calibration service for field-intensity meters at all radio frequencies of broadcast and commercial importance up to 300 megacycles. Of special interest are the new standards and methods which have been developed at the Bureau for calibrating field-intensity meters in the very-high frequency region from 30 to 300 megacycles. The new standards were developed to meet a need for an improvement in the available accuracy of field-intensity measurements required because of the greatly increased use of vhf bands by FM and TV stations. Prior calibration service for field-intensity meters had already accommodated meters operating in the range from 10 kilocycles to 30 megacycles.

The extended field-intensity-meter calibration service necessitated the development of new and accurate field-intensity standards. The vhf standards are similar to those already employed at lower frequencies, but several special techniques, particularly in the measurement of antenna current and voltage, have developed to meet the peculiarities of vhf calibration work.

Two distinct experimental methods are used in the Bureau's field-intensity standardization work: the standard-antenna method and the standard-field method. Both methods have been employed in establishing the standards used in calibrating commercial field-intensity meters. It has been found most practical to use the standard-antenna method for frequencies greater than 30 megacycles, and the standard-field method for lower frequencies.

HIGH-FREQUENCY MEASUREMENTS CONFERENCE STATED IN JANUARY

The second High Frequency Measurements Conference sponsored jointly by the American Institute of Electrical Engineers, The Institute of Radio Engineers, and the National Bureau of Standards will be held in Washington, D. C., on January 10 to 12, 1951. Conference Headquarters will be at the Hotel Statler with the technical session held in the spacious auditorium of the Department of the Interior. The Conference program will include about 25 important technical papers, an outstanding evening demonstration, a luncheon, and conducted inspection tours of selected local and nearby scientific institutions. Chartered buses will provide transportation to the auditorium and for the inspection tour.

The conference will be a forum at which the nation's leading engineers from educational, governmental, and industrial laboratories will exchange information on progress since the successful 1949 conference. While most of the papers will deal with measurements in the hf through chf frequency regions, some interesting video measuring techniques will be disclosed. Among the technical sessions being organized are those on Frequency and Time, Transmissions and Reception, Impedance, and Power and Attenuation. Preprints and Proceedings are being dispensed with to encourage active workers to report their latest findings. Brief abstracts will probably appear in *Electrical Engineering* and PROCEEDINGS OF THE I.R.E. following the meeting.

The Conference is under the general direction of the Joint AIEE-IRE Committee on High Frequency Measurements, of which Professor Ernst Weber of the Microwave Research Institute of the Polytechnic Institute of Brooklyn is Chairman. Harold Lyons of the National Bureau of Standards is Chairman of the Local Arrangements Committee, and Frank Gattney of the Polytechnic Research and Development Company is Chairman of the Technical Program Committee. Finances are being handled by Ivan Easton of General Radio Company, and publicity by E. P. Felch of the Bell Telephone Laboratories.

It will be the first scientific gathering of national scope to be brought to Washington in 1951 in celebration of the Semi-Centennial of the National Bureau of Standards.

WILLIAM A. WILDHACK WILL HEAD BASIC INSTRUMENTATION OFFICE

William A. Wildhack, formerly chief of the Missile Instrumentation Section of the National Bureau of Standards, will head the Office of Basic Instrumentation just established at the Bureau. The new office will co-ordinate a program of evaluation and improvement of instruments for measuring basic physical quantities which has been initiated in co-operation with the Department of Defense. Such instruments are vital to all advances in science and technology.

Mr. Wildhack has been with the National Bureau of Standards since 1935, working in the fields of aeronautical, mechanical, and electronic instruments. He received the

B.S. degree in electrical engineering and the M.S. in physics at the University of Colorado.

LAST CALL!

AUTHORS FOR IRE NATIONAL CON- VENTION!

E. Weber, Chairman of the Technical Program Committee for the 1951 IRE National Convention, requests that prospective authors submit the following information:

1. Name and address of author
2. Title of paper
3. A 100-word abstract and additional information up to 500 words (both in triplicate) to permit an accurate evaluation of the paper for inclusion in the Technical Program.

Please address all material to E. Weber, Microwave Research Institute, Polytechnic Institute of Brooklyn, 55 Johnson Street, Brooklyn 1, N. Y. The deadline for acceptance is November 20, 1950. Your prompt submissions will be appreciated.



AAAS ANNUAL MEETING IN CLEVELAND, DECEMBER 26-30

The 117th annual meeting of the American Association for the Advancement of Science, scheduled for December 26-30 at Cleveland, Ohio, will feature programs in every field of science from astronomy and botany to, and including, zoology. All 17 of the Association's sections and subsections, and more than 40 participating societies and organizations, are completing plans for an aggregate of more than 200 sessions. An extensive series of tours to museums, laboratories, and industrial plants of the Cleveland area has been planned.

The Annual Science Exposition in the arena of Cleveland's Public Auditorium will be almost twice as large as the New York meeting, and will display about 150 booths. In the Exposition, publishers, supply houses, microscope manufacturers, instrument makers, and industrial concerns will exhibit their latest products and portray their technical accomplishments.

The program for the Section on Engineering will include: (a) joint program with the Cleveland Engineering Society of Mechanical Engineers, December 26; (b) joint program with the Cleveland Engineering Society, December 27; (c) joint program with Case Institute of Technology, December 28; (d) three day session symposium on "Partnership of Industry and Science in Research," jointly sponsored by the Illinois Institute of Technology, Armour Research Foundation, Mellon Institute of Industrial Research, and the Battelle Memorial Institute, December 29.

IRE People

Lloyd T. De Vore (A'42-SM'44) has been appointed manager of Electronic Laboratory at the General Electric Electronics Park, according to an announcement by



L. T. DE VORE

I. J. Kaar (J'22-A'24-M'29-F'41), manager of engineering for the Electronics Department which is responsible for much of the company's advanced development in the field of electronics. He assumed his new duties on July 1.

Mr. De Vore has been a member of the staff of the electrical engineering department at the University of Illinois, Urbana, Ill., since 1946. He has also been Chairman of the Research Committee and Coordinator of Research for the University's Electrical Engineering Department.

A native of Monongahela, Pa., he received the B.S., M.S., and Ph.D. degrees in physics from Pennsylvania State College in 1930, 1931, and 1933, respectively. He held a research fellowship under a grant from the National Research Council from 1930 to 1934, following which he was appointed to the staff of the physics department at Pennsylvania State College.

In 1943 he went to Wright Field, Dayton, Ohio, as a radio engineer with the Aircraft Radio Laboratories of the Army Air Force. He served there also as chief engineer of the Research Division, and as chief engineer of the Special Projects Laboratory. He resigned his War Department appointment in 1946 to go to the University of Illinois.

Dr. De Vore is a member of the American Physical Society, Sigma Xi, Phi Kappa Phi, Sigma Pi Sigma, Pi Mu Epsilon, and Tau Kappa Epsilon. He holds the War Department Exceptional Civilian Service Medal.



H. J. MACLEOD

Dr. MacLeod has combined a distinguished academic career with an extraordinary interest in undergraduate problems and activities that has won him many student friends. Twice he has been honorary president of graduating classes and last year he was awarded a gold medal by the Students' Literary and Scientific Executive for outstanding work with student organizations.

Born on Prince Edward Island, Dr. MacLeod started his academic career by winning the British Association Medal upon graduation from McGill in 1914. He was graduated from Harvard in 1921 with the Ph.D. degree.

Prior to his association at UBS, where he took over as head of electrical and mechanical engineering in 1936, he taught at the University of Alberta.

Dr. MacLeod has served with distinction in two wars; first as Captain and Major in the Canadian Expeditionary Force in France and Belgium during World War I. Following this he commanded the 196th Western Universities Battalion. Here for the first time he met student representatives of UBC in the contingent sent by this University. In the recent war he received the Order of the British Empire for his work on ship protection against magnetic mines for the National Research Council.

He has acted as consultant on many occasions, and from 1939 to 1944 was technical advisor to the Public Utilities Commission of British Columbia. For his distinguished work in the field of electrical communications he was awarded a Fellowship in the AIEE in 1946.



Royal V. Howard (M'41-SM'43) has recently become owner and president of radio station KIKI, Honolulu. The station,



R. V. HOWARD

which went on the air September 1, operates on 860 kc and employs a General Electric 250-watt transmitter and 285-foot tower to cover the Island of Oahu and adjacent islands. Programming will consist chiefly of news, sports, and music. Mr. Howard is well known in the broadcasting field. He was director of the Department of Engineering of the National Association of Broadcasters, Washington, D. C., from 1947 until his resignation a few months ago. From 1933 to 1947 he was vice president in charge of engineering for Associated Broadcasters, Inc., (KSFO and KPIX), San Francisco. During the war, he served as director of special combat scientist group for the Office of Scientific Research and Development, U. S. Army Headquarters, European Theatre of Operations.

Active in all phases of broadcasting since 1922, Mr. Howard is also a member of the Institute of Electrical Engineers, and the American Academy for the Advancement of Science, among others. He has been an expert member of the United States delegations to world conferences on telecommunications held at Atlantic City, Havana, Mexico City, Washington, and Montreal.

Edwin L. White (A'24-M'31-SM'43) has been appointed chief of the new Safety and Special Radio Services Bureau of the Federal Communications Commission. He is also chief of the Aviation Division, Bureau of Engineering. He has been associated with the Commission since the latter's creation, and, before that, with its predecessor, the Federal Radio Commission.

Mr. White, who was born at Valley City, N. D., on July 5, 1896, began his radio career as an amateur in 1912 and, professionally, with the Naval Research Laboratory in 1922, where he served as a research engineer and was active in designing equipment, both transmitting and receiving, for various naval operations. In 1926 he joined the staff of the Signal Corps, and while a civilian engineer in the Office of the Department Signal Officer at Fort Shafter, Hawaii, was in charge of the technical maintenance and operation of the radiocommunication system of the Hawaiian Department of the Army.

In June, 1930, Mr. White joined the Federal Radio Commission and, except for periods of military duty, has been continuously associated with radio regulation. In the days of the FRC he specialized in television. Previous to World War II he was active in police, fire, and experimental radio supervision; since the war he has been concerned mainly with aviation radio.

Mr. White served as a commissioned officer in both World Wars. He left the University of North Dakota in his junior year for Navy duty. Later he went with the Signal Corps Reserve and entered the late war as a lieutenant colonel. Shortly thereafter he transferred to the Air Corps, and the major part of his war service was as Communications Officer in the Air Transport Command. He served in the Pacific Theater for nine months; for 15 months in the China-Burma-India Theater, and three months with the Military Government in Germany.

He holds a reserve commission as a colonel in the Air Force.



Fred E. Osgood (A'45) has been advanced to the position of technical supervisor of WBZ-TV, succeeding Sidney V. Stadig (M'50) who has been recalled to active duty with the United States Navy.

Mr. Stadig, who will serve as a communications technician, spent three years in the Navy during World War II in the European Theater, during which service he received a letter of commendation. He joined WBZ in 1940 as a transmitter technician at Hull. He has been in charge of WBZ-TV technical facilities since the inauguration of video in Boston.

Mr. Osgood has been supervisor of WBZ's Hull transmitting facilities since December, 1943. He has been with the station for twenty years.

Paul Rosenberg (A'43) has been elected president of the Institute of Navigation for the academic year 1950-1951 and will succeed Rear Admiral Gordon McLintock, USMS. Dr. Rosenberg has been elected also as the General Chairman of the joint meeting and the symposium, which will be held by the Institute of Navigation, the Radio Technical Commission for Aeronautics, as well as the Radio Technical Commission for Marine in New York, N. Y., on September 19, 20, and 21. The general theme of his three-day meeting will be "The Application of Electronics to the Related Problems of Air, Marine, and Land Navigation."



PAUL ROSENBERG

He is also president of Paul Rosenberg Associates, consulting physicist, in New York, N. Y., a firm which he has headed since its founding in 1945. He directs the firm's work of consultation, research, and development in the industrial and military applications of physics and related sciences.

During the war Dr. Rosenberg was a staff member of the NDRC Radiation Laboratory at the Massachusetts Institute of Technology, where he did work in radar, synthetic training devices, and ultrasonics. Before the war he was lecturer in physics at Columbia University, doing research in molecular beams. He was also instructor of physics at Hunter College.

He served for three years as technical advisor to the president in the Institute of Navigation. He was co-chairman of the National Committee on Upper Atmosphere and Interplanetary Navigation.

❖

Glenn H. Browning (A'24-M'28-SM'43), was honored at the annual commencement exercises of Cornell College, Mount Vernon, Iowa, when he received the honorary degree of Doctor of Science.



GLENN H. BROWNING

Mr. Browning, who has been president of Browning Laboratories, Inc., Winchester, Mass., since 1937 when the company was formed, was born in Mount Vernon in 1897. He was graduated from Cornell College with the B.A. degree in 1921 and earned highest honors in the class. He was elected to membership in Phi Beta Kappa.

He was awarded the Lydia C. Perkins Scholarship to Cruft Laboratory graduate work at Harvard University. From 1923 to 1924 he was a research fellow in electrical engineering at Harvard. In conjunction with F. H. Drake, he developed a special mathematically designed tuned radio-frequency transformer which was incorporated

in a circuit later known as the Browning-Drake Circuit.

From 1924 until 1937 he was a radio and research consulting engineer, as well as president of Browning-Drake Corp.

He is listed in "Who's Who in Engineering," "Who's Who In New England," and "Biographical Encyclopedia of the World."

❖

Lynn C. Holmes (M'44-SM'48-F'49), has been appointed associate director of research of the Stromberg-Carlson research laboratory, and will share with Director Benjamin Olney the guidance of the firm's research activities.



LYNN C. HOLMES

He has been senior electrical engineer ever since he joined the company in 1943. Mr. Holmes, who was graduated from Rensselaer Polytechnic Institute in 1925, taught there for the following 18 years. He earned the degrees of E.E. and M.I.T.

Awarded the honor of Fellow grade in the IRE last year, Mr. Holmes is well known in the field of magnetic sound recording, where he has made important contributions to the theory and practice in the field. He is also affiliated with the M.I.L., R.M.A., the American Standards Association, the Acoustical Society of America, and Sigma Xi. He is the alternate Stromberg-Carlson representative in the Industrial Research Institute.

❖

John M. Ide (A'47) has been promoted to one of the top 400 positions in the federal civil service. His post as chief scientist and director of research at Navy Underwater Sound Laboratory has been allocated to civil service grade GS 16.

Dr. Ide, who has served in his present capacity since March 1, 1945, has devoted almost 20 years to teaching and research in communications engineering at Harvard University, industrial research in geophysics for the Shell Oil Co., and research and development for the Navy in the field of underwater sound at the Naval Research Laboratory, Washington, D. C., and the Sound Laboratory.

❖

R. C. Cheek (M'47), Central Station Engineer of the Westinghouse Electric Corp., is the 1949 winner of the award given by the Eta Kappa Nu Association an electrical engineering honor society, to the most outstanding young electrical engineer of the year.

Given annually since 1936, the award has been won by many other IRE members including the following: **W. E. Kock (SM'45)** in 1938; **L. A. Meacham (A'38-SM'45-F'48)** in 1939; **J. E. Hobson (M'45)** in 1940; **Cledo Brunetti (A'37-SM'46-F'49)** in 1940; **J. R. Pierce (S'35-A'38-SM'46-F'48)** in 1942; **N. I. Hall (SM'47)** in 1943; **R. R. Hough (S'40-A'43-SM'46)** in 1947; and **A. M. Zarem (S'42-A'46)** in 1948.

Peter C. Goldmark (A'36-M'38-F'42) has been appointed vice-president in charge of engineering research and development at the Columbia Broadcasting System. Formerly, he was director of engineering and research development where he and his associates developed the CBS color television system and its long-playing records.



PETER C. GOLDMARK

Dr. Goldmark, who developed the long-microgroove phonograph record through nearly three years of intensive laboratory work, joined CBS in 1936 to take part in research and television activities. Within a short time he was named chief television engineer, and in September, 1940, demonstrated the CBS full color television system which he developed for ultra-high frequency broadcasting. During the war Dr. Goldmark and his associates were engaged exclusively in electronic research for the Armed Services. Much of this work took him to the European and South Pacific theaters of war.

Born on December 2, 1906, in Budapest, Hungary, Dr. Goldmark is a graduate of Vienna Technical College, Vienna, Austria, from which institution he also holds the Ph.D. degree.

He was awarded the IRE Morris Liebmann Memorial Prize in 1945 for his "contributions to the development of television systems, particularly in the field of color." He has served on several IRE committees.

❖

Russel H. Varian (A'40) and **Sigurd F. Varian** have been awarded the John Price Wetherill Medals by the Franklin Institute, Philadelphia, Pa., for their development of the klystron, a new kind of radio tube which played a major role in World War II. The tube has made it possible to transmit telephone conversations over long distances without the use of wires, and has contributed to much peacetime exploratory work in the electromagnetic spectrum.

Dr. Russell Varian, who was born in Washington, D. C., in 1898, was graduated from Stanford University in 1925 and received the M.A. degree from the same institution two years later. He also holds an honorable D.Eng. from Brooklyn Polytechnic Institute. In 1929 he became a research physicist with the Humble Oil Company in Texas, and then went to Farnsworth Television Corporation in 1930.

He is a Stanford Research Associate, and also president of Varian Associates, organized in 1948. He holds membership in several scientific organizations.

❖

Walter F. Kram (A'49) has joined the engineering staff of the Ballantine Laboratories, Inc., at Boonton, N. J., as a senior engineer. Mr. Kram specialized for over 10 years in instrument development work for the Standard Telephone and Cable Company of London.

Industrial Engineering Notes¹

RTMA ENGINEERS ATTACK FM INTERFERENCE DATA

W. R. G. Baker, Director of the RTMA Engineering Department, has supplied each RTMA Board member with the latest information concerning FM radiation interference problems.

Dr. Baker noted that each company had been asked to prepare FM receivers with the latest interference reducing circuits, shields, etc., and to submit it for test. The sets should be sent to Stuart W. Seeley, of the RCA Laboratories, who will conduct the interference test.

It was also pointed out that a meeting with the FCC on both FM and TV interference has been scheduled for September 12 at the Carlton Hotel in Washington, D. C. Dr. Baker told the Directors: "This letter is being directed to you personally to call your specific attention to the importance of this matter and urge you to have your engineers pay particular attention to this important subject."

MOBILIZATION

The Government has announced its general deferment policy for Army, Navy, and Air Force reserves, and National Guardsmen in key civilian jobs. The new policy does not apply to the draft. The Commerce Department has published a list of "essential" industries and the Department of Labor made public its list of "critical" occupations. Defense Department officials said the three armed services would use both lists in deciding whether a worker should be left at his civilian job, or called to active duty. Copies of the lists may be obtained by writing to either Department, Washington 25, D. C., and asking for "Tentative Lists of Essential Activities" from Commerce and the "List of Critical Occupations" from the Labor Department. . . . It appears that the military will give more weight to the "critical occupations" list than to the "essential activities" list. In the Labor Department list of "critical occupations" submitted to the Department of Defense, Secretary of Labor Maurice J. Tobin said: "In the preparation of the list of critical occupations, selection of specific occupations was made on the basis of three major considerations. These were: (a) The demand, in essential industries and activities for persons qualified to work in the occupations would exceed the total supply under conditions of full mobilization; (b) a minimum training time of 2 years (or the equivalent in work experience) is necessary to the satisfactory performance of all the major tasks found in the occupation; (c) the occupation is essential to the functioning of the industries or activities in which it occurs."

Key personnel of the radio and television manufacturing industry is in the Labor list

under Engineer, Electrical. The definition submitted to the military is:

Engineer, Electrical (Electrical Engineer 0-17.01, DOT P. 447) Performs one or more the following functions in the field of electrical engineering requiring fulfillment of educational, experience or legal qualifications established by engineering colleges or licensing authorities: Plan and supervise construction and operation of electric power generating plants, transmission lines and distribution systems; plan and supervise construction and installation of illumination, wire communication, and electric transportation systems; design and develop radio, television, electronic and allied equipment and supervise manufacture of various types of electrical machinery and apparatus, such as motors and generators, converters and regulators, switch gear, and welding equipment. May also specialize in research, consulting, inspection, testing, teaching at the university level, specification and other technical writing, and sales and service of complex electrical equipment. This title includes all related titles with the same Dictionary of Occupational Titles code number.

If a key member of industry is a reservist or a National Guardsman, and is called up by the military, he can, if desired, apply for deferment. Such a request should be made only after a man is called to active duty.

Any deferment request should be handled as follows:

Army—If you are in the Army's organized reserves you should apply through your unit commander or unit instructor to the commanding general of the Army area in which you live. However, if your unit doesn't meet often, or you are an inactive reservist, it would be wise to save time by sending your request direct to the commanding general. He is the one who has the final decision on deferment in each individual case.

Navy—If you're a non-aviation reserve officer you should write The Chief, Bureau of Naval Personnel, through your naval district commandant. Aviation officers and enlisted men should apply to the Chief of Naval Air Reserve Training, Naval Air Station, Glenview, Ill. Non-aviation enlisted men write to their naval district commandant.

Marine Corps—You should apply through the usual "chain of command," starting with your local instructor.

Air Force—Write the headquarters of the numbered Air Force for the area in which you live.

National Guard (Army or Air)—Apply to the adjutant general of the state where your unit is organized.

BROADER INDUSTRY COVERAGE IS SOUGHT ON UNITED STATES LIST

Upon authorization of President Robert C. Sprague, Chairman John W. Craig of the RTMA Industrial Relations Committee has appointed a subcommittee with instructions to review the U. S. Labor Department's critical occupations list (RTMA Industry Report, Vol. 6, No. 34) and make recommendations for expanding it to give the radio-television industry adequate protection.

Harold W. Butler of the Philco Corp. was named Chairman of the subcommittee, and other members are E. M. Tuft of the RCA Victor Division, and Harvey T. Stephens of International Resistance Co.

Under the present critical occupations list, only engineers in the radio-television industry are clearly identified as subject to temporary deferments in calls for reserve officers. These are covered under the listing, "Engineers, Electrical."

The matter previously had been brought to the attention of the U. S. Labor Department, as well as manpower officials of the Munitions Board and the National Security Resources Board by General Manager James D. Secrest.

CCIR STUDY GROUP REPORTS ACTIONS TAKEN AT GENEVA

The U. S. State Department has received a telegraphic report on actions taken by a subgroup of CCIR Study Group No. 11 which met in July at Geneva, Switzerland. RTMA was represented at this international television session by I. J. Kaar of General Electric Co., Chairman of the Committee on Television, Receiver Section of the RTMA Engineering Department.

The subcommittee under the chairmanship of W. Geber of Switzerland met in an effort to secure uniformity of characteristics of a standard using 625 lines. The group arrived at the following conclusions: (1) A 7-Mc channel; (2) 625 lines per picture interlaced 2 to 1; (3) operation independent of power supply frequency; (4) standard line scanning frequency of 15,625 with a tolerance of 1/10 per cent and a field frequency of 50 per second; (5) aspect ratio of 4 horizontally and 3 vertically; scanning left to right horizontally and top to bottom vertically; (7) amplitude modulation for video with specified asymmetric sideband characteristics; (8) negative video modulation; and (9) FM for sound with 50-kc deviation.

AIR MATÉRIEL COMMAND SURVEYS REQUIREMENTS FOR PERSONNEL

The Intelligence Department of the Air Matériel Command is completing a re-analysis of its functions and the determination of personnel requirements for the resultant organization. The survey has revealed an urgent need for certain types of highly qualified technical or scientific personnel in positions, most of which are established by Air Technical Intelligence Specialists.

The Air Technical Intelligence Specialists perform, direct, and control air technical intelligence research to determine the accomplishments of foreign nations in conducting aerial warfare. In assessing the capabilities of foreign countries in their various fields it is often necessary to use incomplete and fragmentary information. This type of work requires personnel capable of performing and supervising a high level of technical analysis work, so they must be well qualified as engineers or scientists in their specialized fields. In addition, they are required to be adaptable to intelligence research work, in that they must be capable of

¹ The data on which these NOTES are based were selected, by permission, from *Industry Reports*, issues of August 4, August 11, August 18, and August 25, published by the Radio-Television Manufacturers Association, whose helpful attitude is gladly acknowledged.

conducting studies utilizing fragmentary and incomplete information, employing to a considerable degree deductive reasoning based on their knowledge of sound application of scientific and engineering principles and good common sense. They must also be familiar with the significance of the technical capabilities of equipment with respect to air power in order to appreciate the intelligence significance of information with which they are dealing.

Starting salaries of positions for which personnel are most urgently needed at the present time range from \$5400 to \$8800 per annum. For further information write to Intelligence Dept., Air Matériel Command, Wright-Patterson Air Force Base, Dayton, Ohio.

RADIO AND TELEVISION NEWS ABROAD

Sales of radio receiving sets by Canadian producers in May totaled 51,616 units, valued at \$3,805,166 at list prices, according to the U. S. Department of Commerce. Included are 686 television sets valued at \$314,480. Producer sales for the first five months totaled 256,781 units valued at \$20,920,969, including 4,248 television sets valued at \$1,791,280. In the first five months of 1950, imports of radio receiving sets totaled 10,785 units and exports 13,956 units. . . . Radio and television receiving licenses in force June 30, 1950, in the United Kingdom were as follows: Radio, 11,871,312, of which 1,184,282 were in London; television, 400,375, of which 113,848 were in London.

RTMA-NSIA COMMITTEE NAME CHANGE

The name of the National Electronics Mobilization Committee, formed August 8 by RTMA and the National Security Industrial Association, (RTMA Industry Report, Vol. 6, No. 33) has been changed to the Joint Electronics Industry Committee, Chairman F. R. Lack has announced.

He has also stated that the Committee has retained John L. Sullivan, former Secretary of Navy and now associated with the law firm of Sullivan, Bernard, and Shea, as special counsel.

H. G. Beauregard has been appointed Secretary of the Committee, and a headquarters has been established at 801 Ring Building, 1200 18 Street, N.W., Washington 6, D. C.

Books

Electron Tube Circuits by Samuel Seely

Published (1950) by McGraw-Hill Book Co., 330 W. 42 St., New York, N. Y. 488 pages+16-page index+23-page appendix+ix pages. 509 figures. 9x6 $\frac{1}{2}$. \$6.00.

With the ever-widening sphere of application of electron tubes there has come the need of a presentation of their properties on a somewhat more general level than is customary in texts devoted to the communications field. The nuclear physicist building an amplifier for detecting fast particles, the mathematician designing an electronic computer, or the process-control engineer making an electronic servomechanism are only a sample of the enlarged group now concerned with tubes and their application. The present text is an approach to this need, comprising a presentation of fundamentals with illustrations from both communications, and other fields. It is intended as a beginning text, presupposing a knowledge of basic ac circuit theory and some slight acquaintance with the physics of electron tubes. The first part of the book is devoted to a review of the fundamental properties of tubes and their circuits. Equivalent circuits are introduced on both current and voltage bases. The next section deals with untuned amplifiers including some of the fundamental computing circuits as well as switching and gating circuits. Then come sections on tuned amplifiers, oscillators, rectifiers, and filters (including a good discussion of stabilized power supplies) amplitude modulation and demodulation, frequency modulation and detection, and finally chapters devoted to special circuits originating largely in radar and television.

On the whole, the choice of topics seems to be excellent. To the reviewer it is a source of regret that no room is found for any mention of fluctuation noise as a limit to useful amplification, and of the factors in tube and circuit design that tend to mini-

mize such noise. In addition, it seems that some topics are not treated as carefully as they should be; for example, on page 378 two circuits are shown labelled as pre-emphasis circuits. Actually one is and the other is not, as is borne out by the accompanying mathematical treatment, although the correct expression for a pre-emphasis circuit does not appear anywhere in the entire section. Some reservations must also be expressed concerning the treatment of feedback amplifiers in Chapter V. In spite of such points of criticism, the book should prove eminently useful, particularly after exposure to the eagle eyes of a few classes has caught the various errors that seem to be inevitable in a new book.

S. N. VAN VOORHIS
University of Rochester
Rochester, N. Y.

Practical Television Servicing and Trouble-Shooting Manual by The Technical Staff of Coyne Electrical and Radio-Television School

Published (1949) by Greenberg Publishers, 201 57 St., New York 22, N.Y. 392 pages+7-page index+iv pages. 265 figures. 5 $\frac{1}{2}$ x8 $\frac{1}{2}$. \$4.25.

The purpose of this new book is to bring the radio serviceman up-to-date in television. Presupposing a knowledge of elementary radio theory, an authoritative discussion of television servicing and trouble-shooting is presented.

The book is fairly complete and clearly written. No mathematics is used. Its chief attribute is that it tells the reader exactly what to do and how to go about servicing a modern television receiver.

It is the opinion of this reviewer that this book serves the above purpose well and that an excellent effort to explain TV circuits and circuit behavior has been made. Further-

more, the book abounds with illustrations. There are many reproductions of faulty kinescope test patterns, circuit diagrams, sketches of response curves and pulse shapes, and photographs of important TV set sections. Many of the circuit diagrams are taken from modern commercial receivers.

There are nine chapters cover TV servicing methods, service instruments, tuners, TV sound, IF amplifiers, video IF alignment, sound alignment, tuner alignment, the video detector, and amplifier. The next eight chapters cover kinescope input circuits, the sync section, sweep oscillators, afc circuits, sweep amplifier and deflection circuits, kinescope tube servicing and adjustment, TV power supplies, and TV antennas. (Built-in antennas, unfortunately, have been overlooked in the chapter on antennas.)

The eighteenth chapter is timely, covering color TV. Illustrative diagrams are actually printed in three colors and the rudiments of the simultaneous, field-sequential color systems are discussed. However, no mention is made of the RCA dot-interlace time-multiplex color system. A short discussion is also given on uhf and distributed-constant effects at these frequencies.

The book "Television Servicing and Trouble-Shooting" would make a useful addition to the library of anyone working in this field.

It should be kept in mind, however, that TV receiver design is undergoing a rapid development not only because of heavy consumer demand, but also because of improvements in transmitting methods, a possible shift in emphasis from vhf to uhf in view of new channel assignments, and other reasons. It should, therefore, very likely become necessary to revise this book (and most other books on TV servicing) within a few years.

FRANK R. ARAMS
Special Development Group
Radio Corporation of America
Harrison, N. J.

Sections*

Chairman		Secretary	Chairman		Secretary
J. S. Hill Box 298 Hudson, Ohio	AKRON (4)	R. L. Burtner Goodyear Aircraft Corp. 1210 Massillon Rd. Akron, Ohio	R. J. Pierce 160 Hind Dr. Honolulu, T. H.	TERRITORY OF HAWAII (7)	R. R. Hill Mutual Tel. Co. Box 2200 Honolulu 5, T. H.
W. J. Miller 1074 Springdale Rd. Atlanta 6, Ga.	ATLANTA (6) Nov. 17-Dec. 15	D. B. Buchanan 5130 Powers Ferry Rd. Atlanta, Ga.	G. K. Miller 1622 W. Alabama Houston 6, Texas	HOUSTON (6)	Wayne Phelps 26 N. Wynden Dr. Houston 19, Texas
J. W. Hammond 4 Alabama Ct. Towson 4, Md.	BALTIMORE (3)	C. E. McClellan Westinghouse Elec. Corp. 2519 Wilkins Ave. Baltimore 3, Md.	G. H. Fathauer 4125 E. 10 St. Indianapolis 1, Ind.	INDIANAPOLIS (5)	J. H. Schultz Indianapolis Elec. School 312 E. Washington St. Indianapolis 4, Ind.
J. Petkovsek 1015 Ave. E. Beaumont, Texas	BEAUMONT- PORT ARTHUR (6)	C. B. Trevey 2555 Pierce St. Beaumont, Texas	F. M. Ashbrook 111-A Ellis China Lake, Calif.	INYO KERN (7)	D. L. Ewing 309-B Fowler China Lake, Calif.
W. H. Hauser WBZ, WBZ-FM, WBZ- TV 1170 Soldiers Field Rd. Boston, Mass.	BOSTON (1)	Frank D. Lewis General Radio Co. 275 Mass. Ave. Cambridge, Mass.	J. B. Heffelfinger 815 E. 83 St. Kansas City 5, Mo.	KANSAS CITY (5)	Mrs. G. L. Curtis 6005 El Monte Mission, Kan.
M. J. Koblisky Fabrica Argentina De Prod. Vedia Y AR. Forest Buenos Aires, Argentina, S.A.	BUENOS AIRES (1)	H. T. Magno Mirasol 451 Buenos Aires, Argentina, S.A.	F. P. Kehoe 1338 Brydes St. London, Ont., Canada	LONDON, ONTARIO (8)	R. B. Lumsden Bell Telephone Co. London, Ont., Canada
K. R. Wendt Colonial Radio Corp. 1280 Main St. Buffalo 9, N. Y.	BUFFALO-NIAGARA (4) Nov. 15-Dec. 20	H. G. Kuhn 211 Frankhauser Rd. R.F.D. #3 Williamsville, N. Y.	R. L. Sink Consolidated Eng. Co. 620 N. Lake Ave. Pasadena 4, Calif.	LOS ANGELES (7)	W. G. Hodson 524 Hampton Rd. Burbank, Calif.
D. B. Harris 2003 Glenway Dr. Cedar Rapids, Iowa	CEDAR RAPIDS (5)	J. L. Hollis 2900 E. Ave. N.E. Cedar Rapids, Iowa	S. T. Fife Univ. of Louisville Louisville, Ky.	LOUISVILLE (5)	I. W. Lyle Route 3 Jeffersonton, Ky.
Kipling Adams General Radio Co. 920 S. Michigan Ave. Chicago 5, Ill.	CHICAGO (5)	R. M. Krueger Am. Phenolic Corp. 1830 S. 54 Ave. Chicago 50, Ill.	H. F. Loeffler 845 N. 35 St. Milwaukee 8, Wis.	MILWAUKEE (5)	D. E. Meece 805 S. Fifth St. Milwaukee 4, Wis.
A. B. Bereskin 452 Riddle Rd. Cincinnati 20, Ohio	CINCINNATI (5)	W. B. Shirk 6342 Hamilton Ave. Cincinnati 24, Ohio	J. C. Bernier Ecole Polytechnique 1430 St. Denis Montreal, Que., Canada	MONTREAL, QUEBEC (8) Nov. 8-Dec. 13	N. R. Olding Canadian Broad. Corp. Box 6000 Montreal, Que., Canada
J. B. Epperson Scripps-Howard Radio Box 228 Berea, Ohio	CLEVELAND (4) Nov. 23-Dec. 28	J. L. Hunter John Carroll Univ. Cleveland, Ohio	T. S. Church 3325 49th Loop Sandia Base Branch Albuquerque, N. M.	NEW MEXICO (7)	B. J. Bittner 3110 42 Pl. Sandia Base Branch Albuquerque, N. M.
G. E. Mueller Elec. Eng. Dept. Ohio State Un. Columbus, Ohio	COLUMBUS (4) Nov. 10-Dec. 8	W. F. Rite 95 E. Ninth Ave. Columbus, Ohio	R. D. Clupp Dumont Tel. Network 515 Madison Ave. N. Y. 22, N. Y.	NEW YORK (2)	H. T. Budenbom Bell Tel. Lab., Inc. Whippany, N. J.
Herbert L. Krauss Dunham Laboratory Yale University New Haven, Conn.	CONNECTICUT VALLEY (1)	John Merrill 16 Granada Terr. New London, Conn.	C. M. Smith Radio Station WMIT 419 N. Spruce St. Winston Salem, N. Car.	NORTH CAROLINA- VIRGINIA (3)	V. S. Carson Elec. Eng. Dept. N. C. State College Raleigh, N. Car.
J. H. Hoiny 6022 Vanderbilt Dallas, Texas	DALLAS-FORT WORTH (6)	R. A. Abnett Box 7166 Dallas, Texas	M. W. Bullock Capital Broadcasting Co. 501 Federal Securities Bldg. Lincoln 8, Neb.	OMAHA-LINCOLN (5)	C. W. Rook Dept. of Elec. Eng. Univ. of Nebraska Lincoln 8, Nebr.
C. J. Marshall 2412 Rosewood Ave. Dayton 9, Ohio	DAYTON (5)	R. W. Ittelson 551 Daytona Pkwy. Dayton, Ohio	J. T. Henderson 11 Primrose St. Ottawa, Ont., Can.	OTTAWA, ONTARIO (8)	E. L. R. Webb 31 Dunvegan Rd. Ottawa, Ont., Canada
W. E. Clyne 4255 Marshall St. Wheatridge, Colo.	DENVER (5)	R. E. Swanson 1777 Kipling St. Denver 15, Colo.	C. A. Gunther E.D. E.P.D. Bld. 10-7 RCA Victor Div. Camden, N. J.	PHILADELPHIA (3) Oct. 5	C. M. Sinnott Adv. Dev. Sec. RCA Victor Div. Camden, N. J.
G. A. Richardson Dept. of Elec. Eng. Iowa State College Ames, Iowa	DES MOINES- AMES (5)	A. D. Parrott Northwestern Bell Tel. Co. 604—Ninth St. Des Moines 9, Iowa	W. H. Hamilton Westinghouse Res. Labs. East Pittsburgh, Pa.	PITTSBURGH (4) Sept. 11-Oct. 9	V. G. Shaw Farmer's Eng. & Mfg. Co. 549 Brushton Ave. Pittsburgh, Pa.
N. C. Fisk 3005 W. Chicago Ave. Detroit 6, Mich.	DETROIT (4) Nov. 17-Dec. 15	P. L. Gundy 55 W. Canfield Ave. Detroit, Mich.	F. E. Miller 3122 S.E. 73 Ave. Portland 6, Ore.	PORTLAND (7)	Henry Sturtevant 8211 S.W. Westgard Ave. Portland 19, Ore.
W. J. Peterson 322 E. Allegheny Ave. Emporium, Pa.	EMPORIUM (4)	W. R. Roll 364 E. Fifth St. Emporium, Pa.	L. J. Giacchetto RCA Laboratories Princeton, N. J.	PRINCETON (3)	W. H. Surber School of Engineering Princeton University Princeton, N. J.
R. E. Moe Eng. Dept. General Elec. Co. Owensboro, Ky.	EVANSVILLE- OWENSBORO	H. W. A. Chalberg 316 E. Ninth St. Owensboro, Ky.	J. A. Rodgers Huntington Hills Rochester, N. Y.	ROCHESTER (4) Nov. 16-Dec. 21	J. C. O'Brien 283 Malden St. Rochester 13, N. Y.
B. H. Ratus 2506 Terrace Rd. Ft. Wayne 3, Ind.	FORT WAYNE (5)	R. B. Jones 4322 Arlington Ave. Ft. Wayne, Ind.			

* Numerals in parentheses following Section designate Region number.

Sections

Chairman		Secretary		Chairman		Secretary	
N. D. Webster 515 Blackwood N. Sacramento, Calif.	SACRAMENTO (7)	J. R. Miller 3991 3rd Ave. Sacramento, Calif.		H. W. Wells Carnegie Inst. of Wash. 5241 Broad Branch Rd. N.W. Washington, D. C.	WASHINGTON (3)	Mark Swanson 8704 Maywood Ave. Silver Spring, Md.	
C. E. Harrison 4530-A W. Papin St. St. Louis 10, Mo.	ST. LOUIS (5)	Keron C. Morrill Dept. of Elect. Engr. Washington University St. Louis 5, Mo.		Richard Blythe Dept. of Physics Bucknell Univ. Lewisburg, Pa.	WILLIAMSPORT (4) Sept. 27-Oct. 24	R. C. Walker Box 414, Bucknell Univ. Lewisburg, Pa.	
C. R. Evans Radio Station KSL Salt Lake City, Utah	SALT LAKE (7)	E. C. Madsen Dept. of Elec. Engr. University of Utah Salt Lake City, Utah		SUBSECTIONS			
F. E. Brooks 143 Eng. Bldg. University of Texas Austin, Texas	SAN ANTONIO (6)	A. H. La Grone Box F University Sta. Austin 12, Texas		Chairman		Secretary	
E. W. Thatcher 1661 Poinsettia Dr. San Diego 6, Calif.	SAN DIEGO (7) Nov. 7-Dec	J. P. Day 3565 Ingraham St. San Diego 9, Calif.		C. E. Houston Dept. of Elec. Engr. Texas Tech. College Lubbock, Texas	AMARILLO-LUBBOCK (6) (Dallas-Ft. Worth Subsection)	R. F. Lee 2704-31 St. Lubbock, Texas	
R. A. Isberg Radio Station KRON 901 Mission St. San Francisco, Calif.	SAN FRANCISCO (7)	A. R. Ogilvie Remler Co., Ltd. 2101 Bryant St. San Francisco, Calif.		E. I. Hall Dept. of Elec. Engr. Pennsylvania St. College State College, Pa.	CENTRE COUNTY (4) (Emporium Subsection)	J. H. Slaton Dept. of Electrical Eng. Pennsylvania St. College State College, Pa.	
S. D. Bennett 3437-36 Ave. W. Seattle 99, Wash.	SEATTLE (7)	J. E. Mason 2318 Tenth St. Bremerton, Wash.		A. H. Sievert Canadian Westinghouse Co. Hamilton, Ont., Canada	HAMILTON (8) (Toronto Sub section)	J. H. Pickett Aerovox Canada Ltd. 1551 Barton St. E. Hamilton, Ont., Canada	
H. L. Thorson General Elec. Co. Bldg. 269 Schenectady, N. Y.	SCHENECTADY (2)	J. D. Cobine General Elec. Res. Lab. The Knolls Schenectady, N. Y.		S. K. Waldorf Penn. Water & Power Co. Fulton Bank Bldg. Lancaster, Pa.	LANCASTER (3) (Philadelphia Subsection)	A. C. Gimm RCA Victor Div. Dept. 970 Lancaster, Pa.	
L. R. Fink 416 Cherry Rd. Syracuse 9, N. Y.	SYRACUSE (4)	Samuel Seely Dept. of Applied Science Syracuse University Syracuse 10, N. Y.		O. M. Dunning Hazeltime Elec. Corp. 5825 Little Neck Pkwy. Little Neck, L. I., N. Y.	LONG ISLAND (2) (New York Subsection)	David Dettinger Wheeler Labs. 259 09 Northern Bldg. Great Neck, L. I., N. Y.	
M. W. Keck 2231 Oak Grove Pl. Toledo, Ohio	TOLEDO (4)	E. V. Birk 723 Lodge Ave. Toledo 9, Ohio		A. C. Beck Bell Telephone Labs. Holmdel, N. J.	MONMOUTH (2) (New York Subsection)	W. M. Goodall Bell Telephone Labs. Whalepond Rd. Deal, N. J.	
T. I. Millen Philco Corp. of Canada, Ltd. 1244 Dufferin St. Toronto, Ont., Canada	TORONTO, ONTARIO (8)	G. E. McCurdy McCurdy Radio Ind. 33 Melinda St. Toronto, Ont., Canada		A. W. Parkes, Jr. Aircraft Radio Corp. Boonton, N. J.	NORTHERN N. J. (2) (New York Subsection)	A. G. Richardson 180 Vreeland Ave. Boonton, N. J.	
Orville A. Becklund Dept. of Elect. Engr. University of Minnesota Minneapolis 14, Minn.	TWIN CITIES (5)	Arnold A. Cohen Engr. Research Assoc. 1902 W. Minnehaha Ave. St. Paul 4, Minn.		George Weiler 1429 E. Monroe South Bend, Ind.	SOUTH BEND (5) (Chicago Subsection)	A. R. O'Neal Radio Sta. WSBT 1525 N. Adams South Bend 16, Ind.	
				R. M. Wainwright Elec. Eng. Department University of Illinois Urbana, Ill.	URBANA (5) (Chicago Subsection)	M. H. Crothers Elec. Eng. Department University of Illinois Urbana, Ill.	
				R. D. Cahoon C.B.C. Winnipeg, Man., Canada	WINNIPEG (8) (Toronto Subsection)	J. R. B. Brown Suite 2 642 St. Marys Rd. Winnipeg, Man., Canada	

Professional Groups

Chairman		Chairman	
ANTENNAS AND PROPAGATION	Newbern Smith National Bureau of Standards Washington 25, D. C.	INSURUMENTATION	Ernst Weber Polytechnic Institute of Brooklyn Brooklyn, N. Y.
AUDIO	Leo L. Beranek Massachusetts Institute of Technology Cambridge 39, Mass.	NUCLEAR SCIENCE	M. M. Hubbard Massachusetts Institute of Technology Cambridge 39, Mass.
BROADCAST AND TELEVISION RECEIVERS	Virgil M. Graham Sylvania Electric Products Inc. 40-22 Lawrence St. Flushing, L. I., N. Y.	QUALITY CONTROL	R. F. Rollman Allen B. DuMont Laboratories 1000 Main Ave. Clifton, N. J.
BROADCAST TRANSMISSION SYS- TEMS	Lewis Winner Bryan Davis Publishing Co., Inc. 52 Vanderbilt Ave. New York 17, N. Y.	RADIO TELEMETRY AND REMOTE CONTROL	W. J. Mayo-Wells The Johns Hopkins University Silver Spring, Md.
CIRCUIT THEORY	J. G. Brainerd University of Pennsylvania Philadelphia, Pa.	VEHICULAR COMMUNICATIONS	Austin Bailey American Telephone and Telegraph Co. 195 Broadway N. Y., N. Y.

Abstracts and References

Prepared by the National Physical Laboratory, Teddington, England, Published by Arrangement with the Department of Scientific and Industrial Research, England, and *Wireless Engineer*, London, England

NOTE: The Institute of Radio Engineers does not have available copies of the publications mentioned in these pages, nor does it have reprints of the articles abstracted. Correspondence regarding these articles and requests for their procurement should be addressed to the individual publications, and not to the IRE.

Acoustics and Audio Frequencies.....	1363
Antennas and Transmission Lines.....	1364
Circuits and Circuit Elements.....	1365
General Physics.....	1367
Geophysical and Extraterrestrial Phenomena.....	1368
Location and Aids to Navigation.....	1368
Materials and Subsidiary Techniques..	1369
Mathematics.....	1370
Measurements and Test Gear.....	1370
Other Applications of Radio and Electronics.....	1372
Propagation of Waves.....	1372
Reception.....	1373
Subsidiary Apparatus.....	1374
Television and Phototelegraphy.....	1374
Transmission.....	1375
Tubes and Thermionics.....	1375

The number in heavy type at the upper left of each Abstract is its Universal Decimal Classification number and is not to be confused with the Decimal Classification used by the United States National Bureau of Standards. The number in heavy type at the top right is the serial number of the Abstract. DC numbers marked with a dagger (†) must be regarded as provisional.

ACOUSTICS AND AUDIO FREQUENCIES

534.016:534.223:534.224:534.225:534.226:534.227:534.228:534.229:534.230:534.231:534.232:534.233:534.234:534.235:534.236:534.237:534.238:534.239:534.240:534.241:534.242:534.243:534.244:534.245:534.246:534.247:534.248:534.249:534.250:534.251:534.252:534.253:534.254:534.255:534.256:534.257:534.258:534.259:534.260:534.261:534.262:534.263:534.264:534.265:534.266:534.267:534.268:534.269:534.270:534.271:534.272:534.273:534.274:534.275:534.276:534.277:534.278:534.279:534.280:534.281:534.282:534.283:534.284:534.285:534.286:534.287:534.288:534.289:534.290:534.291:534.292:534.293:534.294:534.295:534.296:534.297:534.298:534.299:534.300:534.301:534.302:534.303:534.304:534.305:534.306:534.307:534.308:534.309:534.310:534.311:534.312:534.313:534.314:534.315:534.316:534.317:534.318:534.319:534.320:534.321:534.322:534.323:534.324:534.325:534.326:534.327:534.328:534.329:534.330:534.331:534.332:534.333:534.334:534.335:534.336:534.337:534.338:534.339:534.340:534.341:534.342:534.343:534.344:534.345:534.346:534.347:534.348:534.349:534.350:534.351:534.352:534.353:534.354:534.355:534.356:534.357:534.358:534.359:534.360:534.361:534.362:534.363:534.364:534.365:534.366:534.367:534.368:534.369:534.370:534.371:534.372:534.373:534.374:534.375:534.376:534.377:534.378:534.379:534.380:534.381:534.382:534.383:534.384:534.385:534.386:534.387:534.388:534.389:534.390:534.391:534.392:534.393:534.394:534.395:534.396:534.397:534.398:534.399:534.400:534.401:534.402:534.403:534.404:534.405:534.406:534.407:534.408:534.409:534.410:534.411:534.412:534.413:534.414:534.415:534.416:534.417:534.418:534.419:534.420:534.421:534.422:534.423:534.424:534.425:534.426:534.427:534.428:534.429:534.430:534.431:534.432:534.433:534.434:534.435:534.436:534.437:534.438:534.439:534.440:534.441:534.442:534.443:534.444:534.445:534.446:534.447:534.448:534.449:534.450:534.451:534.452:534.453:534.454:534.455:534.456:534.457:534.458:534.459:534.460:534.461:534.462:534.463:534.464:534.465:534.466:534.467:534.468:534.469:534.470:534.471:534.472:534.473:534.474:534.475:534.476:534.477:534.478:534.479:534.480:534.481:534.482:534.483:534.484:534.485:534.486:534.487:534.488:534.489:534.490:534.491:534.492:534.493:534.494:534.495:534.496:534.497:534.498:534.499:534.500:534.501:534.502:534.503:534.504:534.505:534.506:534.507:534.508:534.509:534.510:534.511:534.512:534.513:534.514:534.515:534.516:534.517:534.518:534.519:534.520:534.521:534.522:534.523:534.524:534.525:534.526:534.527:534.528:534.529:534.530:534.531:534.532:534.533:534.534:534.535:534.536:534.537:534.538:534.539:534.540:534.541:534.542:534.543:534.544:534.545:534.546:534.547:534.548:534.549:534.550:534.551:534.552:534.553:534.554:534.555:534.556:534.557:534.558:534.559:534.560:534.561:534.562:534.563:534.564:534.565:534.566:534.567:534.568:534.569:534.570:534.571:534.572:534.573:534.574:534.575:534.576:534.577:534.578:534.579:534.580:534.581:534.582:534.583:534.584:534.585:534.586:534.587:534.588:534.589:534.590:534.591:534.592:534.593:534.594:534.595:534.596:534.597:534.598:534.599:534.600:534.601:534.602:534.603:534.604:534.605:534.606:534.607:534.608:534.609:534.610:534.611:534.612:534.613:534.614:534.615:534.616:534.617:534.618:534.619:534.620:534.621:534.622:534.623:534.624:534.625:534.626:534.627:534.628:534.629:534.630:534.631:534.632:534.633:534.634:534.635:534.636:534.637:534.638:534.639:534.640:534.641:534.642:534.643:534.644:534.645:534.646:534.647:534.648:534.649:534.650:534.651:534.652:534.653:534.654:534.655:534.656:534.657:534.658:534.659:534.660:534.661:534.662:534.663:534.664:534.665:534.666:534.667:534.668:534.669:534.670:534.671:534.672:534.673:534.674:534.675:534.676:534.677:534.678:534.679:534.680:534.681:534.682:534.683:534.684:534.685:534.686:534.687:534.688:534.689:534.690:534.691:534.692:534.693:534.694:534.695:534.696:534.697:534.698:534.699:534.700:534.701:534.702:534.703:534.704:534.705:534.706:534.707:534.708:534.709:534.710:534.711:534.712:534.713:534.714:534.715:534.716:534.717:534.718:534.719:534.720:534.721:534.722:534.723:534.724:534.725:534.726:534.727:534.728:534.729:534.730:534.731:534.732:534.733:534.734:534.735:534.736:534.737:534.738:534.739:534.740:534.741:534.742:534.743:534.744:534.745:534.746:534.747:534.748:534.749:534.750:534.751:534.752:534.753:534.754:534.755:534.756:534.757:534.758:534.759:534.760:534.761:534.762:534.763:534.764:534.765:534.766:534.767:534.768:534.769:534.770:534.771:534.772:534.773:534.774:534.775:534.776:534.777:534.778:534.779:534.780:534.781:534.782:534.783:534.784:534.785:534.786:534.787:534.788:534.789:534.790:534.791:534.792:534.793:534.794:534.795:534.796:534.797:534.798:534.799:534.800:534.801:534.802:534.803:534.804:534.805:534.806:534.807:534.808:534.809:534.810:534.811:534.812:534.813:534.814:534.815:534.816:534.817:534.818:534.819:534.820:534.821:534.822:534.823:534.824:534.825:534.826:534.827:534.828:534.829:534.830:534.831:534.832:534.833:534.834:534.835:534.836:534.837:534.838:534.839:534.840:534.841:534.842:534.843:534.844:534.845:534.846:534.847:534.848:534.849:534.850:534.851:534.852:534.853:534.854:534.855:534.856:534.857:534.858:534.859:534.860:534.861:534.862:534.863:534.864:534.865:534.866:534.867:534.868:534.869:534.870:534.871:534.872:534.873:534.874:534.875:534.876:534.877:534.878:534.879:534.880:534.881:534.882:534.883:534.884:534.885:534.886:534.887:534.888:534.889:534.890:534.891:534.892:534.893:534.894:534.895:534.896:534.897:534.898:534.899:534.900:534.901:534.902:534.903:534.904:534.905:534.906:534.907:534.908:534.909:534.910:534.911:534.912:534.913:534.914:534.915:534.916:534.917:534.918:534.919:534.920:534.921:534.922:534.923:534.924:534.925:534.926:534.927:534.928:534.929:534.930:534.931:534.932:534.933:534.934:534.935:534.936:534.937:534.938:534.939:534.940:534.941:534.942:534.943:534.944:534.945:534.946:534.947:534.948:534.949:534.950:534.951:534.952:534.953:534.954:534.955:534.956:534.957:534.958:534.959:534.960:534.961:534.962:534.963:534.964:534.965:534.966:534.967:534.968:534.969:534.970:534.971:534.972:534.973:534.974:534.975:534.976:534.977:534.978:534.979:534.980:534.981:534.982:534.983:534.984:534.985:534.986:534.987:534.988:534.989:534.990:534.991:534.992:534.993:534.994:534.995:534.996:534.997:534.998:534.999:535.000

534.012:[532.111+534.22] 2396
The Mean Pressure and Velocity in a Plane Acoustic Wave in a Gas—P. J. Westervelt. (*Jour. Acous. Soc. Amer.*, vol. 22, pp. 319–327; May, 1950.) The one-dimensional equation for a travelling wave is discussed to the second order of approximation, using Airy's solution to the Lagrangean form of the equation as a basis; second-order effects are reviewed and correlated. Forces on a particle in the wave have a time-average component which is opposed to the radiation pressure and whose magnitude may exceed that of the radiation pressure; this may result in a particle drift velocity, in a direction opposed to wave propagation, of about 1 cm per second for a sound pressure level of 151 db in air. Standing waves of large amplitude are also considered.

534.321.9:061.3 2397
International Convention on Ultrasonics—G. Bradfield. (*Nature* (London), vol. 166, pp. 143–144; July 22, 1950.) A short report of the proceedings at the convention held in Rome, June, 1950, with an outline of some of the subjects discussed. Slightly more than 50 per cent of all the contributions were concerned with biology and medicine.

534.321.9:615 2398
Ultrasonic Apparatus for Therapeutic Applications—H. Thiede. (*Elektrotechnik* (Berlin), vol. 4, pp. 219–223; June, 1950.) Discussion of the physical characteristics of ultrasonic waves and description of piezoelectric and magneto-

striction generators for frequencies up to about 3 Mc, including some giving focused beams.

534.322.3:534.6:621.396.822 2399
Background Noise and the Use of White Noise in Acoustics—P. Chavasse and R. Lehmann. (*Ann. Télécommun.*, vol. 5, pp. 229–236; June, 1950.) The theory of background noise is reviewed. A neon tube is preferred to a pentagrid tube as a practical generator of white noise. The circuit of the artificial voice (3404 of 1947) is shown. Architectural, physiological, and electroacoustic applications of noise sources are indicated. Some 50 references are given.

534.415 2400
Stroboscopic Audio-Frequency Spectrometer—F. A. Fischer. (*Fernmeldelech. Z.*, vol. 3, pp. 174–180; May, 1950.) The stroboscopic method of measurement is discussed and two instruments are described. A light source is modulated with the signal to be measured and viewed through a revolving stroboscopic screen characteristically sectioned. Alternatively, a fixed screen suitably sectioned, e.g., with a hyperbolic pattern for a linear frequency scale, is viewed in a revolving mirror. Frequency range is 60 to 6,000 cps.

534.613 2401
On the Radiation Pressure of Spherical Waves—R. Lucas. (*Compt. Rend. Acad. Sci.* (Paris), vol. 230, pp. 2004–2006; June 5, 1950.) An expression is derived for the acoustic pressure due to the pulsation of a sphere of dimensions small compared with wavelength. Near the surface of the sphere the value is twice the density of the kinetic energy; this greatly exceeds the total energy density, and agrees with the value deduced from Brillouin's pressure tensor. Consideration of the pressure exerted by a stationary spherical wave on a reflecting boundary surface leads to an expression involving the factor 3, characteristic of spherically symmetrical systems. The limiting case of a stationary plane wave acting on a finite plane parallel reflector is considered, and the formula here developed is reconciled with that previously given by Brillouin.

534.7 2402
Auditory Sensation Produced by Rectangular Waves—R. Chocholle. (*Ann. Télécommun.*, vol. 5, pp. 237–242; June, 1950.) Discussion of the results of an experimental study. The wave form of the sound waves resulting from application of square waves to an acoustic transducer depends largely on the ratio between the fundamental frequency of the applied square waves and the resonance frequencies of the transducer. The character of the sensation produced is distinct in the very low-, low-, medium-, and

high-frequency ranges. In certain narrow frequency bands, slight variation of frequency produces a marked change in sensation, i.e., intensity and general timbre. The ear is found to respond rather to the wave envelope and total effective amplitude than to the individual components of the sound spectrum.

534.78:621.395 2403
The Perception of Speech and Its Relation to Telephony—H. Fletcher and R. H. Galt. (*Jour. Acous. Soc. Amer.*, vol. 22, p. 327; May, 1950.) Correction to paper abstracted in 1844 of September.

534.833.4 2404
A Review of the Absorption Coefficient Problem—H. J. Sabine. (*Jour. Acous. Soc. Amer.*, vol. 22, pp. 387–392; May, 1950.) The problem of discrepancies between measurements of acoustic absorption coefficient obtained by different workers is discussed from the viewpoint of the materials manufacturer. Suggestions are made for further theoretical and experimental investigations.

534.843 2405
Transient Sounds in Rooms—D. Mintzer. (*Jour. Acous. Soc. Amer.*, vol. 22, pp. 341–352; May, 1950.) Laplace-transform methods are used for investigating the propagation of transient sound waves. In the one-dimensional case propagation of a plane wave in a rigid-walled tube is considered. The velocity potential for an arbitrary particle-displacement input is found as a series, each term of which represents the effect of a reflection from an end of the tube. In the three-dimensional case a spherical wave is considered in unbounded and variously bounded regions, and the case of a point source in a rectangular room is solved. An image method is used. Examples are calculated for both one- and three-dimensional systems.

534.844.1:621.3.015.33 2406
Pulse Statistics Analysis of Room Acoustics—R. H. Bolt, P. E. Doak, and P. J. Westervelt. (*Jour. Acous. Soc. Amer.*, vol. 22, pp. 328–340; May, 1950.) Reverberation time is not by itself an adequate index of the acoustic quality of a room, since it does not give information about the response to transients. To take account of the pulse-like nature of common sounds, an analytical technique has been developed in which the walls of the room are replaced by an infinite array of image sources; a statistical consideration of this array gives the long-term average response to transients. To illustrate the technique a description is given of experiments carried out in a rectangular room with hard plastered walls, using a sound source emitting 2-ms pulses of 3,600-cps damped waves.

- 534.846:621.396.712.3 2407
Rooms with Reverberation Time Adjustable over a Wide Frequency Band—P. Arni. (*Jour. Acous. Soc. Amer.*, vol. 22, pp. 353-354; May, 1950.) Description of a broadcasting studio at Helsinki having wall elements with variable absorption characteristics.
- 621.395.623.7 2408
A Contribution to the Design of Horn Loudspeakers—J. Merhaut. (*Tesla Tech. Rep.* (Prague), pp. 41-43; December, 1949.) The high-frequency response may be improved by subdividing the throat of the exponential horn, since the phase differences between the sound waves emanating from different parts of the diaphragm may thereby be reduced. A new design described gives a 4.5-db improvement at 8 kc.
- 621.395.623.7 2409
A New Loudspeaker Combination—H. Schmidt. (*Funk. und Ton*, vol. 4, pp. 226-232; May, 1950.) A high-efficiency loudspeaker with a strong electromagnet for transient damping has a "spherical-wave" modified exponential horn. In front of the light metal spherical membrane is a slotted acoustic cone for equalizing sound-path lengths in the neck of the horn, giving a further increase of the electroacoustic efficiency. With the associated filter circuit it is mounted above a bass-response loudspeaker which has a conical diaphragm of diameter 35 cm. The response curve of the combination is shown. It is nearly level between 50 cps and 10 kc. Crossover occurs at 500 cps.
- 621.395.623.8:621.398 2410
Remote Control of the Tesla RU Rack and Panel Public Address System—L. Pravenc. (*Tesla Tech. Rep.* (Prague), pp. 33-40; December, 1949.) Panel units are described, (a) for use at a main station, making remote control of up to ten substations possible, and (b) for use at a substation, enabling it to accept remote control from a main station while retaining the possibility of independent operation.
- 621.395.625.3+681.84/.85:061.4 2411
Sound Reproduction—(*Wireless World*, vol. 56, pp. 255-258; July, 1950.) Short descriptions of equipment at the exhibition arranged by the British Sound-Recording Associations in London, May, 1950. In addition to disk, magnetic wire and tape, and film recorders, many examples of amplifiers, loudspeakers, pickups, microphones, and auxiliary and test equipment were shown, as well as BBC and Radio Luxembourg sound-recording vans.
- 681.85.001.4 2412
A Feedback-Controlled Calibrator for Phonograph Pickups—J. G. Woodward. (*RCA Rev.*, vol. 11, pp. 301-309; June, 1950.) The phonograph-pickup calibrator is an electromechanical device for imparting known and controllable lateral motions to the stylus of a pickup under test. The calibrator employs a dynamic driving system, and electromechanical feedback is used to secure a uniform response between 20 cps and 20 kc. The absolute as well as the relative response of a pickup can be conveniently and quickly measured within this frequency range.
- 681.85.004.62 2413
Record and Stylus Wear—G. H. H. Wood. (*Wireless World*, vol. 56, pp. 245-248; July, 1950.) Neither low stylus pressure nor sapphire points which are dimensionally correct can, of themselves, provide a satisfactory solution to the problem of record wear. It is shown, with the aid of photomicrographs, that greatly prolonged stylus life and low record wear result from the use of a crystal pickup head with a correctly designed sapphire stylus so mounted that the coupling is comparatively flexible in

the vertical direction. Vertical movement of the stylus is not transmitted to the pickup head and the system reduces the effective mass of the stylus to a very low value compared with that of conventional stylus systems.

- 621.395.625+534.862.4 2414
The Recording and Reproduction of Sound [Book Review]—O. Read. Publishers: H. W. Sams & Co., Indianapolis, Ind., 1949, 364 pp., \$5.00. (*Electronics*, vol. 23, pp. 136, 138; July, 1950.) The book brings together information which until now has been scattered in periodicals and instruction manuals; it is of interest more to the technician and the phonograph enthusiast than to the engineer. See also 632 of 1949 and back references.

ANTENNAS AND TRANSMISSION LINES

- 621.315.212 2415
Coaxial Cable and its Optimum Design—P. Ya. Shiniberov. (*Priroda*, No. 1, pp. 69-74; January, 1949. In Russian.) Cable theory is discussed and methods are indicated for determining the capacitance and attenuation for different types of cable. The ratio of the radii of the conductors for maximum dielectric strength is also determined. Multicore cables with several coaxial pairs are briefly considered.
- 621.315.34.011.4 2416
Capacity of a Pair of Insulated Wires—W. H. Wise. (*Quart. Appl. Math.*, vol. 7, pp. 432-436; January, 1950.) A method of calculating capacitance is given which is related to but involves less numerical computation than that noted in 660 and 1446 of 1946 (Craggs and Tranter). Certain analytical difficulties which arise when the insulating jackets are in contact are indicated.
- 621.392 2417
Unbalanced Terminations on a Shielded-Pair Line—K. Tomiyasu. (*Jour. Appl. Phys.*, vol. 21, pp. 552-556; June, 1950.) The simultaneous propagation of balanced and unbalanced modes along a shielded-pair line results in an unbalanced component of current. This can be determined by comparing the different standing-wave distributions on the two conductors. Measurements of the components of waves reflected from unbalanced radiative terminations (e.g., end-coupled antennas) on a slotted shielded-pair line are described.
- 621.392.1 2418
The Effect of a Bend and Other Discontinuities on a Two-Wire Transmission Line—K. Tomiyasu. (*Proc. I.R.E.*, vol. 38, pp. 679-682; June, 1950.) The effect is analyzed by the vector-potential method, the equivalent-circuit elements being obtained by comparing the variable-line parameters near the bend with the conventional-line parameters found on an infinite line. Good agreement is found between theoretical and experimental values of the circuit elements for the bend and also for open-end and bridged-end lines. See also 28 of February (King and Tomiyasu).
- 621.392.26†:621.3.09 2419
Propagation of the TM_{01} Mode in a Metal Tube Containing an Imperfect Dielectric—D. L. Hetrick. (*Jour. Appl. Phys.*, vol. 21, pp. 561-564; June, 1950.) Losses in both the metal wall and the dielectric are taken into account in this analysis, the subject being treated as a boundary-value problem. General expressions are derived for the attenuation and phase constant, and the percentage error introduced by (a) neglecting wall losses and (b) assuming total attenuation to be the sum of the dielectric and wall-loss attenuations is computed for a particular case.
- 621.392.26†:621.392.52 2420
Ring Mode Filter for Type H_{11} Waves in Circular Waveguides—Z. Szepeši. (*Onde Elec.*, vol. 30, pp. 230-234 & 293-298; May and June, 1950.) Experimental investigation of ring mode filters of different dimensions in a waveguide of 8 cm diameter, using a wavelength of 11 cm. Results are tabulated. Good reflection occurs when the circumference of the ring is slightly greater than the free-space wavelength. The characteristics of the filter are practically independent of its conductivity. Impedance of the ring varies linearly with its circumference; when the circumference is less than that required for resonance the impedance is capacitive; when greater, it is inductive. Bandwidth increases with the cross section of the ring. Measured bandwidth is considerably greater than the value given by the theory of Feuer and Akeley (640 of 1949). Using a combination of two filters, $3\lambda_0/4$ spacing is the most effective where λ_0 is the wavelength in the waveguide. The characteristics of a filter may be determined from its distance from a filter of known characteristics when the transmission coefficient of the combination has its maximum value.
- 621.392.43 2421
A Tapered Line Termination at Microwaves—G. J. Clemens. (*Quart. Appl. Math.*, vol. 7, pp. 425-432; January, 1950.) The termination considered is a short-circuited section of coaxial line with a uniformly tapered metallic outer conductor and an inner conductor consisting of a glass tube coated with a thin resistive metal film. The distribution of voltage and current is investigated theoretically, and the measured values of voltage SWR for the termination over the range 990-3,968 Mc are compared with those calculated for an exponential line, which is considered in the analysis as a convenient approximation.
- 621.396.67 2422
The Effect of an Obstacle in the Fresnel Field on the Distant Field of a Linear Radiator—G. A. Wootton. (*Jour. Appl. Phys.*, vol. 21, pp. 577-580; June, 1950.) An analytical method is developed for determining the errors due to diffraction which arise when measurements on microwaves are made by optical methods. The analysis is applied to the particular problem of determining the distant field of a horn radiator with the aperture of a large screen in front of it at an arbitrary angle. Satisfactory agreement is obtained between calculated and measured values (2133 of October).
- 621.396.67 2423
Effect of a Finite Groundplane on Antenna Radiation—A. Leitner and R. D. Spence. (*Phys. Rev.*, vol. 79, p. 199; July 1, 1950.) Summary of American Physical Society paper. The field of a $\lambda/4$ dipole over a circular ground plane is calculated exactly. Both the current in the ground plane and the radiation at great distances are found. As the radius of the ground plane is increased, the radiation resistance and the surface current oscillate about the values which characterize a $\lambda/4$ antenna above an infinite ground plane, but the radiation pattern is entirely different. The results are in good quantitative agreement with the experimental results of Meier and Summers (2440 of 1949).
- 621.396.67 2424
The Directive Properties of Receiving Aerials—É. Roubine. (*Onde Elec.*, vol. 30, pp. 259-266; June, 1950.) Full paper of which an abridged version was given in *Compt. Rend. Acad. Sci.* (Paris), vol. 230, pp. 1590-1592, May 3, 1950.) Distinction is made between the case of rectilinear polarization and the general case of elliptical polarization. A simple fundamental formula is derived expressing the current in a receiving antenna as a function of the incident field, the load, and the radiating properties of the antenna in the direction from

which the waves are received. The question of the identity of the directive properties of antennas for transmission and reception is in general not well defined. The directivity for emission is, in fact, controlled by a single characteristic, while for reception this characteristic is altered by the intensity and polarization of the incident field, so that all comparisons of the directive properties necessitate an arbitrary convention in respect of the incident field. When considering gain, this convention is modified. The effect of polarization is discussed by means of an optical analogy. Current formulas for the absorption surface and the effective length of a receiving antenna are generalized.

621.396.67:621.397.6 **2425**
Ultra-High-Frequency Antenna and System for Television Transmission—O. O. Ficht. (*RC.A Rev.*, vol. 11, pp. 212-227; June, 1950.) The construction and performance are described of an omnidirectional, horizontal-polarization antenna consisting of two coaxial tubes. The inner one acts as a transmission line, feeding groups of slot antennas in the outer tube by means of radial probes. A power gain of 17.3 db is obtained at 530 Mc.

An account is also given of the design and performance of the waveguide feed between the transmitter and the antenna, the vestigial-sideband filter and a notch diplexer which enables the sound and vision signals to be fed along the common transmission line.

The antenna system was developed for operation at Bridgeport, Conn., [1795 of August (Guy, Seibert, and Smith)].

621.396.67.029.62/63 **2426**
Experimental Investigations on Wide-Band Metre- and Decimetre-Wave Aerials—K. Lamberts and L. Pungs. (*Fernmeldetechn. Z.*, vol. 3, pp. 165-173; May, 1950.) Study made in 1942 of the characteristics of single dipoles with reflectors. A greater bandwidth can be obtained by increasing the diameter when tubes are used as the dipole elements, or by the use of specially shaped flat elements. Circle diagrams show the influence of tube diameter, antenna length, and reflector distance on the frequency dependence of the antenna input impedance.

621.396.671:621.3.011.2 **2427**
Input Impedance of Two Crossed Dipoles—L. G. Chambers. (*Wireless Eng.*, vol. 27, pp. 209-211; July, 1950.) The mutual impedance is calculated by applying Carter's method; the input impedance is then found from a simple formula. These impedances are, to a good degree of approximation, expressible as simple functions of the angle between the dipoles.

621.396.671.029.63/64 **2428**
Relations Concerning Wave Fronts and Reflectors—K. S. Kollerer. (*Jour. Appl. Phys.*, vol. 21, pp. 573-576; June, 1950.) Vector formulas are derived relating the incident and reflected wave fronts and the reflector surface. The analysis is applied to particular microwave problems, including the determination of the reflector surface which will transform an arbitrary incident wave front into a plane wave front.

621.396.677 **2429**
Rotatable Directive Antenna—J. Břiza. (*Tepla Tech. Rep.* (Prague), pp. 10-32; December, 1949.) The apex of a rhombic antenna is attached by means of insulators to the rotatable head of a wooden mast, the other three junctions being attached by sectioned cables to carriages running on a circular track round the mast. The positions of the carriages, which form a symmetrical system, are controlled to alter the direction of transmission or reception and also to adjust the apex angle to suit different frequencies. The antenna is fed at its lowest point by twin cable which is carried round with

it. Computed polar diagrams are compared with experimental results for scale models.

621.396.677:621.397.828 **2430**
TV Antenna Phase Control—Carmichael. (*See 2655.*)

621.396.677.2:621.396.97 **2431**
Nine-Tower Broadcast Array—C. W. Winkler and M. Brasseur. (*Electronics*, vol. 23, pp. 102-104; July, 1950.) Brief illustrated account, with details of phasing and antenna-tuning equipment, of the WDGY station at Minneapolis, which produces a radiation pattern with suppression over an angle of 247°.

621.396.67.029.64 **2432**
Aerials for Centimetre Wavelengths [Book Review]—D. W. Fry and F. K. Howard. Publishers: Cambridge University Press, 1950, 172 pp., 18s. (*Jour. Brit. IRE*, vol. 10, p. vi; July, 1950.) "This book deals specifically with radiating systems for radar applications, but design principles are outlined in sufficient detail to enable the engineer to design a radiator for other applications."

CIRCUITS AND CIRCUIT ELEMENTS

517.41:621.3.016.352 **2433**
On the Representation of the Stability Region for Oscillation Phenomena by use of Hurwitz Determinants—E. Sponder. (*Schweiz. Arch. Angew. Wiss. Tech.*, vol. 16, pp. 93-96; March, 1950.)

621.3.012.2 **2434**
Classes of Circle Diagrams—C. E. Moorhouse. (*J. Inst. Eng.*, vol. 22, pp. 69-74; March, 1950.) Consideration of the properties of a general 4-pole network under specified terminal conditions leads to a general method of establishing the conditions for the existence of circle diagrams. Two classes of diagrams are discussed; variants of these include many of the circle diagrams used in electrical engineering.

621.316.8.029.55/62 **2435**
Behavior of Resistors at High Frequencies—G. R. Arthur and S. E. Church. (*TV Eng.*, vol. 1, pp. 4-7; June, 1950.) The variation of resistance with frequency is discussed for various types of resistors by consideration of circuit equivalents which include a capacitive element. Theoretical results agree with measured values for commercial resistors in the frequency range 5-60 Mc to within 10 per cent. Except possibly for special high-frequency resistors, the effective resistance of resistors decreases more rapidly with frequency the higher the value of the dc resistance. For the same dc resistance, the smaller the physical dimensions the better are the high-frequency characteristics. Resistors using a carbon coating on insulating material were found better for high-frequency work than either carbon-block or composition resistors.

621.318.371 **2436**
Calculation of the Inductance of Circular Conductors and Single-Layer Close- or Open-Wound Solenoids—W. Koller. (*Bull. Schweiz. Elektrotech. Ver.*, vol. 41, pp. 442-450; May 27, 1950. In German.) A method of calculation is developed and a series of equations derived. Curves are plotted from which the value of inductance is readily determined when length, cross section, etc., are known.

621.318.5 **2437**
Magnetic Triggers—An Wang. (*Proc. I. R. E.*, vol. 38, pp. 626-629; June, 1950.) Magnetic cores with fairly rectangular hysteresis loop are used in a trigger device in which magnetic fluxes are used instead of electrical currents to indicate the two stable states. The magnetic-flux polarity can be detected without mechanical motion. The construction and operation of several types of

magnetic triggers are described. See also 1183 of June (An Wang and Way Dong Woo).

621.319.4 **2438**
The Theory of a Three-Terminal Capacitor—R. E. Corby. (*Proc. I. R. E.*, vol. 38, pp. 635-636; June, 1950.) Equations are derived for the insertion loss of a 3-terminal capacitor and their solution gives results in agreement with experiment. The capacitor is assumed to function like a transmission line and the constants of the equivalent line are determined as a function of frequency. Skin effect and proximity effect are taken into consideration, and curves are plotted to facilitate computation.

621.389:681.142 **2439**
A Fast Multiplying Circuit—Chance, Busser, and Williams. (*See 2558.*)

621.392:512.831 **2440**
An Introduction to the Matrix Method of Solving Electrical-Network Problems—R. Guertler. (*Jour. Inst. Eng.*, vol. 22, pp. 46-52; March, 1950.) The fundamental principles of matrix algebra are outlined and simple working rules are given. The transformation matrices of series-impedance and shunt-admittance 4-pole networks are derived and these matrices, together with the rules of matrix algebra, are applied to discussion of networks in cascade, of L, T and π networks, and to calculation of the frequency response of a class-B modulator, this calculation being considerably simpler than that by ordinary methods, as given in Appendix 2. A simple application of matrix methods is given in Appendix 1, where the conditions are derived for the current or voltage in a circuit to remain constant under varying load.

621.392:517.512.2 **2441**
Application of Fourier Transforms to Variable-Frequency Circuit Analysis—A. G. Clavier. (*Elec. Commun.*, vol. 27, pp. 159-163; June, 1950.) Reprint. See 307 of March.

621.392:517.512.6 **2442**
A Note on the Solution of Certain Approximation Problems in Network Synthesis—R. M. Fano. (*Jour. Frank. Inst.*, vol. 249, pp. 189-205; March, 1950.) A method is given for the determination of appropriate functions to define the amplitude characteristics of networks when certain ideal responses are to be approached within specified limits. The method is based on simplification of the geometry of the problem by transformation in the complex plane.

621.392:621.3.016.35]:681.142 **2443**
Mathematical Problems of Feedback—H. Freudenthal. (*Ned. Tijdschr. Natuurk.*, vol. 15, pp. 275-281; November, 1949.) Paper given at the Symposium on Modern Calculating Machines, Amsterdam, May, 1949. From both the mathematical and the physical viewpoints, it is preferable to treat feedback circuit problems by the method of continuous rather than discrete iteration. Analysis establishes the necessary and sufficient conditions for convergence and hence for circuit stability.

621.392.011.2 **2444**
Reciprocity between Generalized Mutual Impedances for Closed or Open Circuits—A. G. Clavier. (*Elec. Commun.*, vol. 27, pp. 152-158; June, 1950.) Reprint. See 1358 of July.

621.392.43 **2445**
Wideband Series-Parallel Transformer Design—V. C. Rideout. (*Electronics*, vol. 23, pp. 122, 162; July, 1950.) Formulas for obtaining maximum flatness of the response curve are derived from filter-theory considerations. The circuit constants of a matching transformer to connect a coaxial line to the first tube of an amplifier are calculated numerically.

621.392.5 2446

The Bridged-T Network and its Properties—W. Taeger. (*Funk. und Ton*, vol. 4, pp. 253-259; May, 1950.) Mathematical analysis deriving expressions for attenuation and phase constant.

621.396.611.1 2447

Oscillation Phenomena in a Circuit with a Discontinuous Linear Characteristic—G. J. Elias and S. Duinker. (*Tijdschr. ned. Radio-genoot.*, vol. 15, pp. 79-91; May, 1950. In Dutch, with English summary.) A series circuit of negligible resistance is considered which comprises a capacitor and an inductor with a core material such as mumetal or permalloy having a sharp knee in its magnetization curve. To facilitate analysis, an approximation to the curve is used which consists of three straight lines. In such a circuit, forced subharmonic oscillations can be maintained, but transition phenomena occur when the amplitude of the applied electromotive force is great enough to extend the operation beyond the knee of the curve. When operation is largely in the saturation region, the initial amplitude of the free oscillations is related to the magnitude of the corresponding transition; the oscillations are damped, owing to hysteresis losses. Each transition adds a fresh inner loop to the main hysteresis loop, corresponding to a pair of new real branch points in the hyperelliptic expression for the oscillations. See also 582 of April.

621.396.611.4:538.56 2448

Forced Oscillations in a Spherical Cavity Resonator—A. A. Piotrovski. (*Zh. Tekh. Fiz.*, vol. 20, pp. 282-294; 1950. In Russian.) Mathematical discussion of the excitation of a spherical cavity resonator by a single turn of wire at its center. An equivalent oscillatory circuit is derived and methods are indicated for determining its impedance and main parameters such as Q , damping factor, and loss resistance.

621.396.611.4:621.396.615.142.2 2449

Wide-Range Tunable Waveguide Resonators—W. W. Harman. (*Proc. I. R. E.*, vol. 38, pp. 671-679; June, 1950.) See 2476 of 1949.

621.396.615.12 2450

LC Oscillators and their Frequency Stability—J. Vackar. (*Tesla Tech. Rep.* (Prague), pp. 1-9; December, 1949.) Factors affecting stability are considered and their specific effects tabulated; the mechanical and electrical design and construction of highly stable circuits are discussed. A general analysis is given of the oscillator circuit and a formula for change of frequency with change of tube capacitance is derived. Known variable-frequency oscillators are reviewed and new circuits used in Tesla broadcasting transmitters and having a tuning range of 1.5:1 are described.

621.396.615.14:621.385.3 2451

Feedback in Very-High-Frequency and Ultra-High-Frequency Oscillators—F. J. Kamphoefner. (*Proc. I.R.E.*, vol. 38, pp. 630-632; June, 1950.) A study of feedback considerations in low-power negative-grid triode oscillators for the frequency range 100-1,000 Mc. Discussion is mainly confined to oscillators using a single tuned circuit between grid and anode in the modified Colpitts circuit in which feedback is provided by the tube interelectrode capacitances. The optimum feedback conditions are deduced and the analysis is applied to several typical oscillators.

621.396.615.14:621.385.3 2452

Ultra-High-Frequency Triode Oscillator using a Series-Tuned Circuit—J. M. Pettit. (*Proc. I. R. E.*, vol. 38, pp. 633-635; June, 1950.) Analysis of a modified Colpitts circuit for a particular triode gives, as a function of

frequency, the series resistive and reactive components of the two-terminal impedance looking at the grid-anode terminals. Use of a series-tuned external circuit instead of the usual parallel-tuned circuit permits oscillation above the self-resonance frequency of the triode, provided transit time effects are unimportant.

621.396.615.17 2453

Linear Sweep Generation—D. Sayre. (*Electronics*, vol. 23, pp. 171-175; July, 1950.) Linear positive or negative sweeps are produced by charging an electronically switched capacitor through a constant-current triode. The linearity obtained is between that of the bootstrap circuit and that of the Miller feedback circuit.

621.396.615.17 2454

Cathode-Coupled Multivibrator Operation—K. Glegg. (*Proc. I. R. E.*, vol. 38, pp. 655-656; June, 1950.) An approximate analysis results in an expression for the period of the output pulse in terms of the values of the circuit elements. A series expansion shows that the output period is nearly a linear function of one of the circuit voltages.

621.396.615.17:621.397.62 2455

A Hard-Valve Time-Base—C. H. Banthorpe. (*Electronic Eng.* (London), vol. 22, p. 339; August, 1950.) Full circuit details and description of the action of a linear frame timebase in which the start of the scan is triggered and which is unaffected by line pulses which may be introduced owing to imperfect line/frame synchronization separation.

621.396.645 2456

Design of Cathode-Coupled Amplifiers—S. G. F. Ross. (*Wireless Eng.*, vol. 27, No. 322, pp. 212-215; July, 1950.) Previously published theoretical work on the subject is reviewed, and a new rigorous analysis is presented. Experimental results indicate that this analysis can be relied on within the accuracy of published tube data.

621.396.645 2457

Modern Methods of Power Amplification—M. Strutt. (*Bull. Schweiz. Elektrotech. Ver.*, vol. 41, pp. 479-484; June 10, 1950. In German.) Definition of power gain and discussion of its application in tube, semiconductor, magnetic, and amplidyne amplifiers.

621.396.645:621.316.722.078.3 2458

Stabilization of Wide-Band Direct-Current Amplifiers for Zero and Gain—E. A. Goldberg. (*RCA Rev.*, vol. 11, pp. 296-300; June, 1950.) Stabilization is obtained through the application of a mechanical chopper to detect any zero offset error voltage. The circuit is such that the stabilization device does not alter the high-frequency response characteristics of the amplifier. Primary application has been in the field of analogue electronic computers.

621.396.645:621.385.3:621.315.592† 2459

High-Frequency Operation of Transistors—C. B. Brown. (*Electronics*, vol. 23, pp. 81-83; July, 1950.) Dispersion in transit-time values, resulting from differences in lengths of flow paths between emitter and collector, is the primary cause of loss of high-frequency response. Magnetic bias of appropriate sign applied at right angles to the plane containing the axes of the collector and emitter electrodes reduces transit time and dispersion, with consequent increase of frequency range. The circuit of a 23-Mc amplifier for testing the high-frequency response is described, the transistor being biased by a field of strength 16,000 lines per square inch. A gain of 8 is obtained between

1,000- Ω input and output. Time and temperature stability of the transistors are discussed briefly. See also 2089 of September.

621.396.645:621.396.61 2460

Maximum Tank Voltage in Class-C Amplifiers—L. E. Dwork. (*Proc. I. R. E.*, vol. 38, pp. 637-644; June, 1950.) Theoretical considerations are presented to justify the frequent appearance in class-C amplifiers of radio-frequency anode voltages which are greater than the dc anode voltage. A method is developed for predicting the magnitude of this radio-frequency voltage under any given set of conditions. The method is verified experimentally for a particular case.

621.396.645.37 2461

Intermediate-Frequency Gain Stabilization with Inverse Feedback—G. F. Montgomery. (*Proc. I. R. E.*, vol. 38, pp. 662-667; June, 1950.) "Improvement in gain stability is related to the number of cascaded stages, the stage gain, and the magnitude of the feedback. A circuit is described which uses feedback over a pair of cascaded stages. Generalized selectivity curves for this feedback couple are shown, and the design procedure is outlined."

621.396.645.37 2462

General Formulae for Feedback Amplifiers—F. Job. (*Ann. Télécommun.*, vol. 3, pp. 436-444; December, 1948.) The general theory of linear networks including amplifying tubes, has been given in a very complete manner by Bode (3381 of 1948). A simple demonstration is here given of the most important formulae of Bode's theory. Examples and applications illustrate the extreme generality of the formulae.

621.396.645.37 2463

More about Positive Feedback—T. Roddam. (*Wireless World*, vol. 56, pp. 242-244; July, 1950.) When applied to those stages of an amplifier in which distortion is not inherently large, positive feedback permits a considerable increase in over-all gain with little increase in over-all distortion. The negative feedback applied to the whole amplifier may then be increased, reducing the over-all gain to the original level with a considerable reduction in the over-all distortion. Positive feedback increases phase shift, making it more difficult to keep the over-all system stable. Its use should therefore be confined to the frequency range over which it is particularly needed.

621.396.645.371 2464

Negative-Feedback Amplifiers—J. E. Flood. (*Wireless Eng.*, vol. 27, pp. 201-209; July, 1950.) Negative-feedback amplifiers designed to obtain a flat response curve may give an oscillatory response to transients if the feedback exceeds a certain amount. The present analysis shows that by suitably adjusting the time constants for the various stages and by modifying the feedback path, critical damping with resulting absence of overshoot for transients can be attained together with a flat response curve throughout the frequency band for both 2-stage and 3-stage amplifiers. Experimental results are in fair agreement with calculated values.

519.242:621.3 2465

The Extrapolation, Interpolation and Smoothing of Stationary Time Series with Engineering Applications [Book Review]—N. Wiener. Publishers: John Wiley & Sons, Inc. New York, N. Y. 1949. 163 pp., \$4.00. (*Jour. Frank. Inst.*, vol. 249, p. 259; March, 1950.) This was issued as a classified report during the war. "The theory set forth is widely used and has guided modern thinking in filter and predictor theory."

21.314.3 2466

The Magnetic Amplifier [Book Review]—H. Keyner. Publishers: Stuart & Richards, London, England. 119 pp., 15s. (*Wireless Eng.*, vol. 27, p. 216; July, 1950.) The presentation is mainly descriptive; where mathematical reasoning is used it is expressed as far as possible in terms of elementary ac theory.

GENERAL PHYSICS

3.081+621.3.081 2467

The Introduction of the Giorgi System of Units—H. König, N. Kronold, and M. Landolt. *Tech. Mitt. Schweiz. Telegr.—Telephverw.*, vol. 28, pp. 207-208; May 1, 1950. In French and German.) Corrections to paper noted in .125 of June, for which the UDC number should be as above.

3.081.5 2468

On the Theory of the Dimensions of Physical Quantities—M. Landolt. (*Bull. Schweiz. Elektrotech. Ver.*, vol. 41, pp. 473-479; June 10, 1950. In German.) Review of different definitions of dimension and proposal of a new variant.

535.34-1:546.28+546.289 2469

Theory of Infra-Red Absorption in Silicon and Germanium—J. Bardeen. (*Phys. Rev.*, vol. 79, p. 216; July 1, 1950.) Summary of American Physical Society paper.

535.37 2470

Scattering and Absorption of Luminescence Light in Polycrystalline Luminescent Layers under Excitation by High-Energy Quantic and Corpuscular Rays—I. Broser. (*Ann. Phys. (Lpz.)*, vol. 5, pp. 401-416; January 16, 1950.) Experiments with a ZnS-Cu phosphor, using α particles, γ - and X rays for excitation, indicate that the scattering and absorption factors for the luminescence light are independent of the type of excitation. Measurements of the effect of grain size in the phosphor layer on the scattering and absorption are described and discussed.

535.42 2471

Diffraction by a Plane Screen—E. T. Copson. (*Proc. Roy. Soc. A*, vol. 202, pp. 277-284; July 7, 1950.) Boundary conditions involved when solving the problem of diffraction by a perfectly conducting plane screen using the integral-equation method are analyzed. Theorems given in a previous paper (*ibid.*, vol. 186, pp. 100-118; 1946) are recast in a form which meets the criticism of Bouwkamp (2772 of 1948), and the integral-equation method is applied to the problem of diffraction by a half-plane. The form of the arbitrary function of integration is adjusted to limit the order of the singularity at the boundary.

535.42 2472

The Edge Condition in the Theory of the Diffraction of Electromagnetic Waves at Perfectly Conducting Plane Screens—J. Meixner. (*Ann. Phys. (Lpz.)*, vol. 6, pp. 2-9; September 19, 1949.) The edge condition is based on the physically plausible requirement that the electromagnetic energy density in the neighborhood of the edge be integrable, i.e., that the field energy in each finite volume be finite. A particularly simple mathematical expression of the edge condition is given by the Debye electromagnetic field potentials. In the diffraction of sound waves at the edge of a screen the electromagnetic edge condition corresponds to the requirement that at the edge the sound pressure must remain finite.

535.42 2473

Energy Flow in the Near Field of a Diffraction Edge—W. Braunbeck. (*Ann. Phys. (Lpz.)*, vol. 6, pp. 53-58; September 19, 1949.) For the region near the edge (distance λ) the field

can be found very simply by application of Sommerfeld's solution for diffraction at a semi-infinite plane. For the special case of perpendicular incidence on an infinitely thin, perfectly conducting screen, the electric vector being parallel to the diffracting edge, the phase surfaces of the field near the edge are calculated and also the surfaces of energy flow, which to a first approximation are confocal parabolic cylinders with the edge as focal line.

537.226.001.11:546.431.82-3 2474

Electronic Theory of Ferroelectrics—E. T. Jaynes and E. P. Wigner. (*Phys. Rev.*, vol. 79, pp. 213-214; July 1, 1950.) Summary of American Physical Society paper.

537.311.1:537.311.32/.33 2475

Conduction Electrons in Non-Metallic Solids—H. Fröhlich. (*Research (London)*, vol. 3, pp. 202-207; May, 1950.) A review of the action of electrons in substances which in their normal state are nonconductors, including consideration of various processes where the conduction-electron concentration varies with time. The problems of polarization, self-trapping, and mean free path in crystals are discussed, assuming the number of interelectron collisions to be negligible. The increase of conductivity produced by a strong field and the decay after excitation by an ionizing radiation should be governed by the same time constant.

537.311.1:621.315.592† 2476

Potential Fluctuations in Homogeneous Semiconductors—H. M. James and G. W. Lehman. (*Phys. Rev.*, vol. 79, p. 216; July 1, 1950.) Summary of American Physical Society paper.

537.311.1:621.315.592 2477

On the Theory of Noise in Semiconductors—R. L. Petritz and A. J. F. Siegert. (*Phys. Rev.*, vol. 79, pp. 215-216; July 1, 1950.) Summary of American Physical Society paper.

537.311.3+621.315.592† 2478

Electrical Conductivity—Roulaud. (*See* 2543.)

537.312.8 2479

Effect of Magnetic Fields on Conduction: "Tube Integrals"—W. Shockley. (*Phys. Rev.*, vol. 79, pp. 191-192; July 1, 1950.) The mathematical expression for the effect of a magnetic field on conduction in a material can be reduced to integrals by using "tubes," which are specified regions in the Brillouin zone. The case of simple closed tubes, which are of interest for the case of semiconductors, is discussed. An expression for the total electron current is derived, evaluation of which may prove a means of determining the energy-surface parameters for Ge from magneto-resistance measurements on single crystals.

537.32+537.312.8 2480

Theory of Magnetic Resistance Effects in Metals—M. Kohler. (*Ann. Phys. (Lpz.)*, vol. 6, pp. 18-38; September 19, 1949.) Approximate formulas are derived for the change of the electrical and the thermal resistance of a metal when a transverse magnetic field is applied. Theoretical results are compared with experimental values.

537.525.5:538.6 2481

Supersonic Wind at Low Pressures Produced by Arc in Magnetic Field—H. C. Early and W. G. Dow. (*Phys. Rev.*, vol. 79, p. 186; July 1, 1950.) Discussion of the effects of a transverse magnetic field on a low-pressure gas discharge. When the arc is in a large unconfined region, e.g., a vacuum chamber of 1 cubic meter, wind effects are observed. Power input and current density become many times larger; gas temperature is generally low be-

cause of the cooling effect of the wind; ion mobility is little reduced; equipotentials occur at skewed positions. In the case of an arc between a copper cylinder and surrounding ring, an axial magnetic field causes the arc to revolve at a speed of about 17,000 rps under particular conditions. The air inside the cylinder also revolves, but at a slower rate, its speed being estimated at 3,000-4,500 mph.

537.562 2482

Dispersive Power and Natural Oscillation of an Ionized Gas—G. Burkhardt. (*Ann. Phys. (Lpz.)*, vol. 5, pp. 373-380; January 16, 1950.) The dispersion theory for an ionized gas can be derived from the Lorentz theory for a neutral gas if the natural frequency of the polarization electrons is assumed equal to a certain limiting frequency, which is the natural frequency of the oscillating plasma. This theory indicates unconditionally that the Lorentz polarization term should not appear in the dispersion formula for a plasma. See also 738 of 1944 (Darwin).

538.114 2483

Time Decrease of Magnetic Permeability in Alnico—R. Street and J. C. Woolley. (*Proc. Phys. Soc.*, vol. 63, pp. 509-519; July 1, 1950.)

538.221:538.569.4.029.64 2484

Ferromagnetic Resonance in Manganese Ferrite and the Theory of the Ferrites—C. Guillaud, W. A. Yager, F. R. Merritt, and C. Kittel. (*Phys. Rev.*, vol. 79, p. 181; July 1, 1950.) Discussion of observations of resonance absorption at 24,164 Mc in polycrystalline $\text{Fe}(\text{MnFe})\text{O}_4$ at room temperature.

538.221:538.569.4.029.64 2485

Ferromagnetic Resonance in Single Crystals of Nickel Ferrite—W. A. Yager, J. K. Galt, F. R. Merritt, E. A. Wood, and B. T. Matthias. (*Phys. Rev.*, vol. 79, p. 214; July 1, 1950.) Summary of American Physical Society paper.

538.221:539.23 2486

Thin Ferromagnetic Films—M. J. Klein and R. S. Smith. (*Phys. Rev.*, vol. 79, p. 214; July 1, 1950.) Summary of American Physical Society paper.

538.221.001.11 2487

Theory of Magnetic Dispersion in Ferrites—C. Kittel. (*Phys. Rev.*, vol. 79, p. 214; July 1, 1950.) Summary of American Physical Society paper.

538.521:517.948.32 2488

The Induction of Electric Currents in a Uniform Circular Disk—A. A. Ashour. (*Quart. Jour. Mech. Appl. Math.*, vol. 3, Pt. 1, pp. 119-128; March, 1950.) By regarding a uniform disk, or any symmetrically conducting surface of revolution, as composed of an infinite number of coaxial annular circuits, the determination of the electric currents induced by an external field is reduced to the solution of a Fredholm integral equation. Two methods of solving this equation are described.

538.566+[537.226.2:546.217 2489

The Velocity of Electromagnetic Waves and the Dielectric Constant of Dry Air—J. V. Hughes. (*Phys. Rev.*, vol. 79, p. 222; July 1, 1950.) Summary of American Physical Society paper. To obtain agreement between the commonly accepted value of the velocity of light (299,775 km) and the mean (299,790 km) of six recent determinations of the velocity of radio waves, it would be necessary to use a value of 1.00048 for the dielectric constant k of air when correcting measurements in air to vacuo. Values of k obtained by various experimenters, using frequencies from those of light waves down to 1 Mc, range from 1.000572 to 1.00060. The source of the discrepancy

must consequently be sought elsewhere. See also 1751 of August (Essen).

538.566:537.562 2490

Electro-Magneto-Ionic Optics—V. A. Bailey. (*Jour. Roy. Soc. NSW*, vol. 82, Pt. 2, pp. 107-113; 1948.) Theoretical study of the modes of propagation of electric waves in a medium composed of electrons, positive ions and molecules (or atoms) in the presence of static electric and magnetic fields. The solution for plane waves is found in a general form which specifies the refractive indices and attenuation coefficients (positive or negative) as a function of frequency. The theory has application to the ionosphere, to the solar atmosphere and to discharge tubes. A deduction from it is that certain waves will grow as they progress in space or with passage of time; this suggests a possible explanation of the origin of stellar, solar, and ionospheric noise. See also 2785 of 1949.

538.632:621.315.592† 2491

Theoretical Hall-Coefficient Expressions for Impurity Semiconductors—V. A. Johnson and K. Lark-Horovitz. (*Phys. Rev.*, vol. 79, pp. 176-177; July 1, 1950.)

538.652:621.317.4 2492

A New Method of Measuring Magnetostriction. Application to the Ferrite of Cobalt—L. Weil, M. Gallay, and P. Poensin. (*Compt. Rend. Acad. Sci. (Paris)*, vol. 231, pp. 224-226; July 17, 1950.) For measurements under widely different conditions of temperature or material, a method using a simple strain gauge of the resistance type has particular advantages. Accuracy of measurement is within about 1 per cent, but the method can be applied to material of any shape and its simplicity recommends it for investigations in connection with industrial equipment. Results obtained for Co ferrite, made highly magnetostrictive by cooling for 18 hours after heat treatment at 1,200° C, are presented.

GEOPHYSICAL AND EXTRATERRESTRIAL PHENOMENA

061.3:[55+621.396.11 2493

Summary of Proceedings of Australian National Committee of Radio Science, URSI, Sydney, January 16-20, 1950.—(*Jour. Geophys. Res.*, vol. 55, pp. 191-210; June, 1950.) Summaries are given of 33 papers presented at the conference.

523.746 2494

Final Relative Sunspot-Numbers for 1949—M. Waldmeier. (*Jour. Geophys. Res.*, vol. 55, pp. 211-213; June, 1950.)

523.746 2495

Provisional Sunspot-Numbers for January to March, 1950—M. Waldmeier. (*Jour. Geophys. Res.*, vol. 55, p. 217; June, 1950.)

537.562:538.566 2496

Electro-Magneto-Ionic Optics.—Bailey. (See 2490.)

538.711 2497

Measurement of the Earth's Magnetic Field at High Altitudes at White Sands, New Mexico—E. Maple, W. A. Bowen and S. F. Singer. (*Jour. Geophys. Res.*, vol. 55, pp. 115-126; June, 1950.) Measurements by means of a total-field magnetometer fitted in an Aerobee rocket showed that at a height of 368,000 ft the decrease in field strength was 28 milligauss. The results for the whole flight agree to within 2 milligauss with calculations based on the dipole theory. No evidence of the existence of magnetic fields due to current sheets was obtained.

550.384 2498

International Data on Magnetic Disturbances, Fourth Quarter, 1949—J. Bartels and J. Veldkamp. (*Jour. Geophys. Res.*, vol. 55, pp. 214-216; June, 1950.)

550.384 2499

Cheltenham Three-Hour-Range Indices K for January to March, 1950—R. R. Boyle. (*Jour. Geophys. Res.*, vol. 55, p. 217; June, 1950.)

550.385 2500

Principal Magnetic Storms [Oct. 1949-March 1950]—(*Jour. Geophys. Res.*, vol. 55, pp. 218-220; June, 1950.)

550.385:551.594.52 2501

Development of a Magnetic Storm: The Southward Shifting of the Auroral Zone—T. Nagata. (*Jour. Geophys. Res.*, vol. 55, pp. 127-142; June, 1950.) "The southward extension with the increased intensity of disturbance in the northern auroral zone is derived hour by hour for the geomagnetic storm of April 30, 1933."

551.510.535 2502

An Approach to the Approximate Solution of the Ionosphere Absorption Problem—J. E. Hacke, Jr. (*Proc. I. R. E.*, vol. 38, pp. 683-684; June, 1950.) Discussion on 3115 of 1948.

551.510.535 2503

The Diurnal Variation of the Vertical-Ionosphere Absorption at 150 kc/s—A. H. Benner. (*Proc. I. R. E.*, vol. 38, p. 685; June, 1950.) Measurements of the virtual height of the layer and the relative amplitudes of ground pulse and first and second echoes enable the diurnal variation of $\log \rho$ to be plotted. Marked absorption-curve transitions occur at ground sunrise and sunset. When $\log |\log \rho|$ is plotted against $\log \cos \chi$ (where χ is the sun's zenith angle), approximately straight lines are obtained for the morning and afternoon periods, the slopes being 0.675 and 0.76, respectively.

551.510.535 2504

Travelling Disturbances in the Ionosphere—G. H. Munro. (*Proc. Roy. Soc. A*, vol. 202, pp. 208-223; July 7, 1950.) The motion of disturbances of the vertical distribution of F region ionization density has been investigated by means of synchronized signals from three spaced common-frequency pulse transmitters. $P'f$ data from Sydney, Brisbane, and Canberra show that the larger disturbances can travel 900 km without major change in type or in velocity, which ranges from 5 to 10 km per minute. Quasicyclical variations of ionization density with periods of 10-60 minute are found which show a progressive phase lag with decrease in height. The magnitude of the disturbance appears, in general, to decrease with decrease of the period. The mean direction of horizontal motion is about 20° E of N in winter and about 110° E of N in summer, the changes in direction of occurring rather abruptly near the equinoxes. Some of the effects observed by Wells, Watts, and George (3279 of 1946) may be due to disturbances of the type here considered.

551.510.535:[537.568+533.15 2505

Diffusion in the Ionosphere—M. H. Johnson and F. O. Hulburt. (*Phys. Rev.*, vol. 79, p. 222; July 1, 1950.) Summary of American Physical Society paper. The nonlinear differential equations relating the ionic density in the atmosphere to the rate of ionization by solar radiation and the loss of ions by recombination and diffusion, have been integrated on the Naval Research Laboratory computer and ionic-density curves, have been obtained. Diffusion broadens the curve, thereby changing the relations between real and virtual heights, and shifts its maximum downwards, modifying

the dependence of the height of the ionized region on the solar zenith angle.

551.510.535:621.396.11 2506

Ionosphere Observations at 50 kc/s—J. N. Brown and J. M. Watts. (*Jour. Geophys. Res.*, vol. 55, pp. 179-181; June, 1950.) A high-power pulse transmitter giving an output of about 200 kw into a large loop antenna has been used at Sterling, Va., by the CRPL for measurements of the height of the reflecting layer for signals of frequency about 50 kc. The record for one day is reproduced, the virtual height of the reflecting layer being about 80 km. Height changes are not great, and morning and evening peaks do not seem to occur every day. Double echoes are sometimes observed.

551.594.21 2507

The Free Electrical Charge on Precipitation Inside an Active Thunderstorm—R. Gunn. (*Jour. Geophys. Res.*, vol. 55, pp. 171-178; June, 1950.) An induction method was used in an aircraft to measure the charges on individual droplets. Results are given for seven different levels in the cloud. With the freezing level at 14,000 ft, the maximum electrification occurred at about 7,500 ft and at a temperature of 10° C, the electric field strength at the surface of the droplets being a large fraction of the dielectric strength of air.

551.594.6 2508

The Fine Structure of Atmospherics: Ionospheric and Meteorological Applications of Type 4—R. Rivault. (*Compt. Rend. Acad. Sci. (Paris)*, vol. 230, pp. 1846-1847; May 22, 1950.) Daily recordings made at Poitiers during October, 1949, enable the investigation of type 4 atmospherics to be carried further (see 2519, 2520, and 2521 of 1948). Oscillograms corresponding to sources in moving air masses exhibit rounded peaks, whereas those corresponding to sources in stationary air masses show a true short pulse clearly separated from its echoes. The normal value of h , the height of the reflecting layer, is found to be 75 km, with variations up to 12 km during the period 1700-2100. Uniformity of observations of atmospherics from different directions leads to the view that the D region is homogeneous and parallel to the ground. On days when large time variations were observed magnetic storms were also recorded.

521.03 2509

Some Recent Researches in Solar Physics [Book Review]—E. Hoyle. Publishers: Cambridge University Press, London, England, and New York, N. Y., 1949, 134 pp., 12s. 6d. or \$3.00. (*Science*, vol. 111, p. 414; April 21, 1950. *Quart. J. R. Met. Soc.*, vol. 76, p. 112; January, 1950.) "This book in the new series of Cambridge Monographs on Physics deals mainly with Hoyle's own recent work on the corona and chromosphere..." Terrestrial phenomena directly influenced by the sun, and the emission of radio waves from the sun, are dealt with.

LOCATION AND AIDS TO NAVIGATION

527.5:518.12 2510

The Computation of Great-Circle Bearings and Distances—G. Millington. (*Marconi Rev.*, vol. 13, pp. 89-101; 3rd quarter, 1950.) To avoid the necessity of using seven-figure logarithms to obtain four-figure accuracy when using the standard formulas, trigonometrical transformations are used, a simplified rule of signs is adopted and the resulting computation is presented in a standard tabular form.

021.396.9:551.578.1 2511

The Effect of Rain on Marine Radar Echoes—S. E. Burden. (*Marconi Rev.*, vol.

3, pp. 102-109; 3rd quarter, 1950.) The failure of PPI radar gear to detect targets when heavy rain is falling is analyzed and curves are given to assist operators to determine the approximate ranges within which target echoes should be obtainable under different conditions.

621.396.933 2512
A Simple Localizer—J. W. Alexander. *Tijdschr. ned. Radiogenoot.*, vol. 14, pp. 119-133; July, 1949. Discussion, p. 134.) Critical discussion of the SCS51 instrument landing system, and description of the Schiphol installation, in which an electrical method of modulation is used. It is suggested that PICAO specifications be redrafted to give a course angle of 2.5° on either side of the true direction.

621.396.933 2513
ILS-2 Instrument Landing Equipment—R. A. Hampshire and B. V. Thompson. (*Elec. Commun.*, vol. 27, pp. 112-122; June, 1950.) A description of equipment which complies with PICAO requirements. The localizer, operating in the 108-112 Mc band, provides a beam along the runway and extending for at least 25 nautical miles, the two halves of the beam being modulated at 90 cps and 150 cps, respectively. The glide path, adjustable from 2° to 4° , operates in the 329-335 Mc band, modulating frequencies of 90 cps and 150 cps being again used. Three marker beacons, all on 75 Mc but with different modulation frequencies, give distance indication. Secondary transmission from the localizer can be made without interrupting its course modulation. Monitor and control circuits have been specially designed to ensure reliability of operation.

621.396.933 2514
Characteristics and Adjustment of 335-Mc/s Equisignal Glide Slopes—S. Pickles. (*Elec. Commun.*, vol. 27, pp. 140-151; June, 1950.) Different factors influencing the radiated signals are examined with a view to improved performance and increased safety of operation.

621.396.933 2515
A Source of Error in Radio Phase-Measuring Systems—R. Bateman, E. F. Florman, and A. Tait. (*Proc. I. R. E.*, vol. 38, pp. 612-614; June, 1950.) When a mobile transmitter was moved between two points over different particular paths around reradiating structures, the measured total phase changes differed by $2\pi n$ radians, where n is an integer. If reradiation from a reflector is of the same order of magnitude as the radiation from an antenna, analysis of the resultant field shows that singularities occur and each traverse of a closed path around a point of singularity gives a total phase change of 360° .

621.396.933 2516
An Analysis of Some Anomalous Properties of Equiphasic Contours—G. A. Hufford. (*Proc. I. R. E.*, vol. 38, pp. 614-618; June, 1950.) Further investigation of cases, of importance in radio surveying or navigation systems, where the phase at certain points may be multivalued (see 2515 above).

621.396.9 2517
British Standard 204:1943. Supplement No. 4, Glossary of Terms used in Radar. [Book Notice] Publishers: British Standards Institution, London, England, 1950, 8 pp., 2s. (*Brit. Stand. Int. Mon. Inform. Sheet*, p. 1; June, 1950.)

MATERIALS AND SUBSIDIARY TECHNIQUES

531.788 2518
A Philips-Type Ionization Gauge for Measuring of Vacuum from 10^{-7} to 10^{-1} mm

of Mercury—E. C. Evans and K. E. Burmaster. (*Proc. I. R. E.*, vol. 38, pp. 651-654; June, 1950.) Description and detailed diagrams showing the construction of a modified gauge. For an account of an instrument giving similar performance see 1423 of July (Penning & Nienhuis).

535.215:546.23 2519
Photoconductivity in Amorphous Selenium—P. K. Weimer. (*Phys. Rev.*, vol. 79, p. 171; July 1, 1950.) Experimental results are given which indicate that the red amorphous form of Se is photoconductive and possesses properties very different from those of the common metallic form and of the red monoclinic-crystal form.

535.215:546.23 2520
Electron-Bombardment-Induced Conductivity in Selenium—L. Pensak. (*Phys. Rev.*, vol. 79, pp. 171-172; July 1, 1950.) An account of measurements on evaporated films of red amorphous Se.

535.37:546.42.221 2521
Two Infra-Red-Sensitive SrS Phosphors with Zn Dominant Activator—D. S. Bersis. (*Jour. Opt. Soc. Amer.*, vol. 40, p. 335; May, 1950.)

535.37:546.46.45.284 2522
Variation of Emission Spectrum of Manganese-Activated Zinc Beryllium Silicate with Decay Time—J. H. Schulman, C. C. Klick, and R. J. Ginther. (*Jour. Opt. Soc. Amer.*, vol. 40, pp. 337-338; May, 1950.)

535.37:546.47-31 2523
Sulphide in Zinc-Oxide Luminophors—S. M. Thomsen. (*Jour. Chem. Phys.*, vol. 18, p. 770; May, 1950.) The presence of a small amount of ZnS, rather than free Zn, is responsible for the green luminescence of ZnO phosphors fired in hydrogen.

535.37:546.472.21 2524
Comparison of the Luminescence-Extinction Effects of Nickel and Cobalt on Zinc Sulphide—J. Saddy and N. Arpajian. (*Compt. Rend. Acad. Sci.* (Paris), vol. 230, pp. 1948-1950; May 31, 1950.)

537.228.1:621.39 2525
Piezoelectric Elements in Telecommunications Technique—J. J. Vormer. (*Tijdschr. ned. Radiogenoot.*, vol. 15, pp. 93-127; May, 1950. In Dutch, with English summary.) Review of the physical and electrical properties of crystals of different cuts commonly used, with a tabular summary.

537.533.8 2526
Secondary-Electron Emission from Metal Mixtures—H. Salow. (*Ann. Phys.* (Lpz.), vol. 5, pp. 417-428; January 16, 1950.) Mixtures produced by simultaneous evaporation of either Ag or Cu and either Mg, Al, or Be were found to have secondary-emission properties similar to those of alloys of the two components formed by melting. After a forming process in the presence of small quantities of O_2 , secondary-emission factors of about 10 were obtained with 500 v primary electrons. The Cu/Mg metal mixture is easy to form, electrically and thermally stable, insensitive to dry CO_2 free gases, and very suitable for coating secondary-emission cathodes.

538.221 2527
The Magnetic Properties of Stainless Steels—W. A. Stein. (*Trans. AIEE*, vol. 67, Part II, pp. 1534-1537; 1948.) A comprehensive account of the magnetic properties of five stainless steels. Steel may contain up to 3 per cent Ni without serious detrimental effect on its magnetic properties; the inclusion of over 8 per cent Ni renders the steel non-magnetic.

538.221 2528
Magnetic Properties of Ferrites—C. Guiland. (*J. Rech. Centre Nat. Rech. Sci.*, No. 12, pp. 113-122; 1950.) Experimental study and discussion of the saturation magnetization of simple and mixed ferrites. See also 1166 and 1171 of June (Néel).

538.221 2529
Properties of Single Crystals of Nickel Ferrite—J. K. Galt, B. T. Matthias, and J. P. Remeika. (*Phys. Rev.*, vol. 79, p. 214; July 1, 1950.) Summary of American Physical Society paper.

538.221 2530
Relation between the Crystalline Structure and the Magnetic Properties of Mixed Ferrites of Nickel and Zinc—M. Sage and C. Guiland. (*Compt. Rend. Acad. Sci.* (Paris), vol. 230, pp. 1751-1753; May 15, 1950.)

538.221 2531
Thermal Variation of the Spontaneous Magnetization of Ferrites of Nickel, Cobalt, Iron and Manganese—R. Pauthenet. (*Compt. Rend. Acad. Sci.* (Paris), vol. 230, pp. 1842-1843; May 22, 1950.)

538.221 2532
A New Series of Ferromagnetic Substances: Ferrites of Rare Earths—H. Forestier and G. Guilot-Guillain. (*Compt. Rend. Acad. Sci.* (Paris), vol. 230, pp. 1844-1845; May 22, 1950.)

538.221:538.65:536.413 2533
Length Anomaly in Ferrites—L. Weil. (*Compt. Rend. Acad. Sci.* (Paris), vol. 231, pp. 122-124; July 10, 1950.) Experimental study of the expansion coefficients of magnetized ferrites when slowly heated and then cooled.

538.221:538.653.11 2534
Effect of Tension on Magnetic Properties in Iron-Cobalt—H. H. Plotkin and J. E. Goldman. (*Phys. Rev.*, vol. 79, p. 215; July 1, 1950.) Summary of American Physical Society paper.

539.23:537.311.31 2535
On the Law of Variation of the Electrical Resistance of Very Thin Deposited Metal Films as a Function of the Applied Potential—B. Vodar and N. Mostovetch. (*Compt. Rend. Acad. Sci.* (Paris), vol. 230, pp. 2008-2010; June 5, 1950.) Previous experimental results (1701 of August) indicate that $\log(R_V/R_0)$ is a linear function of the applied potential except at very low potentials, R_0 being the resistance at potential V . The change in conductivity is attributed to the lowering of the potential barrier between adjacent particles of the layer by the applied field. This effect is discussed in relation to a formula established by Schottky for the case of thermionic emission.

539.23:546.57:621.314.6 2536
On Certain Detector Properties of Thin Silver Films—A. Blanc-Lapierre and M. Perrot. (*Compt. Rend. Acad. Sci.* (Paris), vol. 230, pp. 1749-1751; May 15, 1950.) Measurements were made of the variation of current with applied direct and alternating voltages and with frequency. Appreciable detection effects were observed when the total power dissipated in the film was $>1 \mu\text{w}$. See also 2242 of October.

539.23:546.81 2537
The Structure of Lead Sulfide Films—J. Doughty, K. Lark-Horowitz, L. M. Roth, and B. Shapiro. (*Phys. Rev.*, vol. 79, p. 203; July 1, 1950.) Summary of American Physical Society paper. Investigation of films of PbS, PbSe, and PbTe by X rays, electron diffraction, and electron microscope.

539.23:546.81:535.215 2538
Temperature Variation of Properties of Photo-Sensitive Lead Sulfide Films—R. H.

McFee. (*Phys. Rev.*, vol. 79, p. 203; July 1, 1950.) Summary of American Physical Society paper. Measurements made of dark current, photo current and noise as functions of temperature between 90° K and 300° K.

546.841-3:537.311.3 2539
Electrical Resistance of Thoria—W. E. Danforth and F. H. Morgan. (*Phys. Rev.*, vol. 79, pp. 142-144; July 1, 1950.) Measurements were made in vacuo at temperatures up to 2073° K. On activation, values of 1 Ω-cm at 1,900° and 10Ω-cm at 1,000° were obtained. Activation energies determined from pulse measurements were between 3.2 v and 0.58 v. The density of impurity centers was calculated as 10¹⁹ per cm³ and was found independent of the degree of activation by current. This result does not agree with the hypothesis of the electrolytic origin of impurity centers.

546.92:537.323 2540
Effect of Heat Treatment on the Electrical Properties of Platinum—R. J. Corruccini. (*Phys. Rev.*, vol. 79, p. 202; July 1, 1950.) Summary of American Physical Society paper.

620.197:679.5 2541
Casting-Resin Techniques—J. Bayha. (*Electronics*, vol. 23, pp. 100-101; July, 1950.) Practical details are given about the materials and methods of preparation and use of NBS casting resin.

621.314.632 2542
Metallurgical Study of Germanium Point-Contact Rectifiers—M. H. Dawson and B. H. Alexander. (*Phys. Rev.*, vol. 79, p. 217; July 1, 1950.) Summary of American Physical Society paper.

621.315.592†+537.311.3 2543
Electrical Conductivity—R. Roulaud. (*Rev. Gén. Élec.*, vol. 59, pp. 211-225; May, 1950.) In Part 1 different theories which have been proposed to account for the conductivity of solid bodies are discussed, particularly the contributions made by the quantum theory and wave mechanics. The classification of conductors according to electron activity is outlined and the potential barrier is discussed with reference to thermionic emission and the Schottky effect. Part 2 deals with semiconductors and discusses the effect of impurities on resistivity and also their physical characteristics and rectifying properties. Part 3 reviews the properties of Ge, particularly those made use of in the transistor.

621.315.592† 2544
Electrical Properties of Semiconductors with Macroscopic Discontinuities—J. C. M. Brentano and D. H. Davis. (*Phys. Rev.*, vol. 79, p. 216; July 1, 1950.) Summary of American Physical Society paper.

621.315.592†:546.28 2545
The Transition from Insulating to Metallic Behavior in Semiconducting Silicon—G. W. Castellan and F. Seitz. (*Phys. Rev.*, vol. 79, p. 216; July 1, 1950.) Summary of American Physical Society paper.

621.315.61.011.5:577.3 2546
The Determination of the Dielectric and Magnetic Properties of Inhomogeneous Dielectrics, Particularly Biological Substances, in the Decimetre-Wave Region—H. Schwan. (*Ann. Phys. (Lpz.)*, vol. 5, pp. 253-310; January 16, 1950.) In three parts, dealing with (a) theory of resonance methods of determining complex resistance, (b) effect of the support at the end of the Lecher line used in such methods, (c) practical methods and appropriate formulas for determining the required constants of the materials tested.

621.315.61.011.5:621.317.3.029.63 2547
Decimetre-Wave Measurements of Tem-

perature-Dependent Dielectric Properties of Insulating Materials—Kreft. (See 2559.)

621.315.612.4.011.5 2548
The Ferroelectric Properties of Certain Titanates and Zirconates of Bivalent Metals Having Perovskite Structure—G. A. Sinoleski. (*Zh. Tekh. Fiz.*, vol. 20, pp. 137-148; 1950. In Russian.) An experimental as well as a theoretical investigation which shows that CdTiO₃, PbTiO₃, PbZrO₃, and the solid solutions (Ca, Pb)TiO₃ and (Sr,Pb)TiO₃ possess ferroelectric properties.

621.318.2:621.3.016.35 2549
Stabilized Permanent Magnets—P. P. Cioffi. (*Trans. AIEE*, vol. 67, Part II, pp. 1540-1543; 1948.) Permanent magnets are stabilized against forces tending to demagnetize them, by partial demagnetization. After stabilization the magnet operates on a secondary demagnetization curve. The derivation of this curve and its applications to magnet design problems are discussed.

621.396.822:539.23:621.315.616.9 2550
Random Noise in Dielectric Materials—R. F. Boyer. (*Jour. Appl. Phys.*, vol. 21, pp. 469-477; June, 1950.) An account is given of observations on fluctuating currents resulting from the application of direct-voltage gradients of 10-300 volts per mil to thin films of polar dielectrics containing moisture. The fluctuations have frequencies of 60-1,000 cps and last for some minutes, even persisting for a few seconds after removal of the voltage; after dying out they can usually be restored by reversing the voltage. The corresponding noise level is about 1,000 times higher than that of the circuit noise. The noise is the greater the more polar the polymer and the higher the moisture content of the material. Groups of ions rather than single ions are believed to act as the random charge carriers.

669.15:538.652 2551
Magnetostriction in Magnetic Alloys with Preferred Crystal Orientation—J. E. Goldman. (*Phys. Rev.*, vol. 79, p. 215; July 1, 1950.) Summary of American Physical Society paper.

MATHEMATICS

517.392 2552
Numerical Evaluation of Integrals of the Form $I = \int_{x_1}^{x_2} f(x)e^{i\phi(x)} dx$ and the Tabulation of the Function $Gi(z) = (1/\pi) \int_0^\pi \sin(uz + \frac{1}{2}u^2) du$ —R. S. Scorer. (*Quart. Jour. Mech. Appl. Math.*, vol. 3, Part 1, pp. 107-112; March, 1950.)

517.564 2553
On the Fourier and Mellin Transforms of Inverse Bessel Functions—P. Barrucand. (*Compt. Rend. Acad. Sci. (Paris)*, vol. 231, pp. 102-104; July 10, 1950.) The transforms are applied to derive a formula by means of which many integrals can be developed in the form of series.

517.942:621.3.09 2554
The B.W.K. Approximation and Hill's Equation: Part 2—L. Brillouin. (*Quart. Math.*, vol. 7, pp. 363-380; January, 1950.) The BWK procedure, developed in connection with wave mechanics, is shown capable of yielding a good approximate solution for problems in many other fields, including the propagation of em waves along a transmission line whose properties vary from point to point. The validity of various approximations is examined.

517.942.82:517.522 2555
The Laplace Transformation and Summation Formulae—P. Barrucand. (*Compt. Rend. Acad. Sci. (Paris)*, vol. 231, pp. 20-22; July 3, 1950.) The Poisson, Hardy, and other summa-

tion formulas are derived by use of the Laplace transformation.

517.942.932 1556
Notes on the Solution of the Equation $y'' - xy = f(x)$ —J. C. P. Miller and Z. Mursi. (*Quart. Jour. Mech. Appl. Math.*, vol. 3, Part 1, pp. 113-118; March, 1950.)

681.142 2557
A Differential Analyzer for the Schrödinger Equation—R. L. Garwin. (*Rev. Sci. Instr.*, vol. 21, pp. 411-416; May, 1950.) A simple and rapid analyzer is discussed having an accuracy within about 0.5 per cent. Possible extensions of its application are mentioned.

681.142:621.389 2558
A Fast Multiplying Circuit—B. Chance, J. Busser, and F. C. Williams. (*Phys. Rev.*, vol. 79, p. 244; July 1, 1950.) Summary of American Physical Society paper. A development on the principle of the "quarter-square" multiplication method. A single parabolic characteristic is used to square the amplitudes of alternate half-cycles of an 82-kc square wave which represent respectively the sum and difference of the two input voltages A and B. The difference of the squares gives the desired product 4AB. The circuit gives the product of the inputs every 12 μ seconds to within 1 per cent.

MEASUREMENTS AND TEST GEAR

621.317.3.029.63:621.315.61.011.5 2559
Decimetre-Wave Measurements of Temperature-Dependent Dielectric Properties of Insulating Materials—W. Kreft. (*Fernmelde- tech. Z.*, vol. 3, pp. 203-211; June, 1950.) A resonance method is described for measuring loss angle and permittivity, using two tubular concentric lines short-circuited at one end and capacitively coupled. One line, with a coupled current-meter, serves as indicator of the changes in the other line when a test sample is inserted which completely fills a certain length of the space between inner and outer conductor. Measurements in the wavelength range 10-75 cm were made on various insulating materials at temperatures from 20° to 80°C. Results are given graphically and show that in general the loss angle increases very considerably with temperature, but the permittivity only slightly.

621.317.31 2560
Measurement of Current Intensity with an Ammeter of Apparent Resistance Zero—M. Matschinski. (*Compt. Rend. Acad. Sci. (Paris)*, vol. 230, pp. 1937-1939; May 31, 1950.) The principle is analogous to that of the potentiometer method of voltage measurement. An auxiliary voltage source and variable resistor in series are connected across the ammeter and adjusted so as to compensate for the voltage drop due to the resistance of the ammeter. Applications of the method in the measurement of very weak currents are indicated.

621.317.32 2561
Negative-Feedback D.C. Amplifier with Grid-Controlled Valve Converter—W. Geyger. (*Arch. Tech. (Messen)*, No. 172, p. T57; May, 1950.) The magnetic amplifier of the instrument described in 1450 of July is replaced by a differential double-triode circuit which acts as an anode-modulated converter. Voltage range becomes approximately 0.1-1 v with input resistance 1-100 MΩ.

621.317.332 2562
Resistance Measurement at High Frequencies by means of Lossless Quadripoles—A. Egger and H. H. Meinke. (*Funk. und Ton.*, vol. 4, pp. 233-238; May, 1950.) Two equal, lossless, and symmetrical 4-terminal networks

are connected in series and terminated with the resistor R_1 to be measured. Measurements are made of the voltages across the two ends of the whole network and across the junction of the two networks. From these voltages and the known characteristic impedances and phase constants of the networks, R_1 may be determined. The method is suitable for the measurement of resistors of 20–300 Ω in the frequency range 30–100 Mc, but its applications are not restricted to this range.

621.317.335.3†+621.317.374 2563

Measurement of the Specific Inductive Capacity and Loss Angle of Dielectrics between 50 kc/s and 100 Mc/s—J. Jourdan. (*Onde Élec.*, vol. 30, pp. 285–292; June, 1950.) Description of a Marconi high-precision instrument, using the reactance-variation method, for industrial use. A Hartley oscillator is loosely coupled to the measurement circuit, which comprises a coupling inductor and two capacitors C_1 and C_2 in parallel across it. The dielectric material is placed between the plates of C_1 which has a micrometer adjustment; C_2 is tuned for resonance, as indicated on the 50-cm scale of a mirror galvanometer in the circuit of a square-law tube voltmeter; C_2 is then adjusted to give equal deflections on either side of resonance; the procedure is repeated without the dielectric. Loss angle and dielectric constant (and also resistance and capacitance) may be simply calculated from the formula given. The theory of the method of measurement and accuracy of the instrument are discussed.

621.317.335.3.029.64† 2564

Recording Microwave Refractive Index—(*Electronics*, vol. 23, pp. 120, 122; July, 1950.) The difference in resonance frequency produced by introducing a sample of a substance under test into one of two otherwise identical cavity resonators is a measure of the dielectric constant of the sample. The equipment described, which was developed at the National Bureau of Standards, is sensitive to Q changes in the test cavity, hence its use is restricted to testing samples of low loss materials. Possible application to the measurement of atmospheric refractive index at frequencies above 30 Mc is considered.

621.317.335.3.029.64†:546.217 2565

Apparatus for Recording Fluctuations in the Refractive Index of the Atmosphere at 3.2 Centimeters Wave-Length—C. M. Crain. (*Rev. Sci. Instr.*, vol. 21, pp. 456–457; May, 1950.) A modified version of apparatus previously used for measuring dielectric constants of gases. Two microwave oscillators have their frequencies controlled respectively by two invar cavity resonators, one of which is sealed off while the other has air drawn through it. By appropriate circuit arrangements, changes in the resonance frequency of this second cavity, due to fluctuations in the dielectric constant of the air, produce proportional deflections in a recording millimeter.

621.317.36:621.396.611.21.001.4 2566

Checking Crystals—I. O. Farnham. (*Electronics*, vol. 23, pp. 150–151; July, 1950.) The method and apparatus described are for crystals whose fundamental frequencies lie between 6 and 13 Mc. Modifications may be made to suit other applications.

621.317.7:621.392.26† 2567

An Automatic Standing-Wave Indicator—P. J. Allen. (*Trans. AIEE*, vol. 67, Part II, pp. 1299–1302, 1948.) The probe of a conventional standing wave indicator is moved over a distance exceeding one wavelength (3 cm) by a reciprocating device operated by a 100-rpm motor. The output from the probe is amplified and applied to the vertical-deflection plates of a cro. A voltage derived from a potentiometer attached to the probe carrier is

simultaneously applied to the horizontal-deflection plates to give a deflection corresponding to the position of the probe, so that the waveform is displayed on the long-persistence screen. A graticule on the face of the cathode-ray tube permits the SWR to be read directly. A cursor is provided for measuring the position of the standing-wave pattern.

621.317.7.029.62 2568

V.H.F. Testing and Measuring Equipment—(*Electronic Eng.*, vol. 22, pp. 349–350; August, 1950.) A brief review of British very-high-frequency electronic equipment, with technical details supplied by the manufacturers, who will give further details on request.

621.317.7.029.64 2569

Measurement Apparatus for Ultra-High Frequencies—M. Bouix. (*Ann. Télécommun.*, vol. 5, pp. 210–218; June, 1950.) Descriptions and illustrations of cavity wavemeters, slotted-line and coaxial-line sections, attenuators and matched terminations for waveguides, power meters, and the like, developed in the Centre National d'Études des Télécommunications for measurements at wavelengths of about 3 cm and 10 cm.

621.317.725 2570

The Diotron—An Aid to R.M.S. Instrumentation—R. D. Campbell. (*Electronics*, vol. 23, pp. 93–95; July, 1950.) A circuit is described comprising basically a temperature-limited diode and a dc amplifier connected in a feedback arrangement. It can be used as a voltmeter giving true rms readings. The voltage to be measured is applied to the diode filament terminals together with the dc heating voltage, the effect of feedback then being to maintain the filament heating power constant. A linear power scale is obtained for small inputs. Details are given of an instrument covering the frequency range 40 cps–10 Mc and having a response time of 15 ms for frequencies above 1 kc; full-scale deflection on the highest voltage range corresponds to 10w across a 600- Ω load. Possible applications to computing circuits are outlined.

621.317.725:621.3.018.78† 2571

Distortion-Measurement Apparatus—H. Boucke and H. Lennartz. (*Funk. und Ton*, vol. 4, pp. 217–225; May, 1950.) Descriptions are given of (a) a simple instrument for harmonic measurement for input frequencies of 10, 20, 40, 160 kc; (b) an improved instrument for the same frequencies; (c) a distortion meter for 800 cps. Circuits are shown; selective feedback and multiple harmonic filters are used. Harmonic voltages down to 0.5 per cent of that of the fundamental can be measured with negligible error.

621.317.74:621.315.212 2572

Test Set for Impedance Frequency Measurement on Coaxial Cables—A. F. Boff. (*Blec. Commun.*, vol. 27, pp. 123–137; June, 1950.) Determination of the characteristic impedance, attenuation constant, phase constant, and velocity ratio of long lengths of coaxial cable is discussed. By avoiding frequency-dependent parameters in the measuring circuits, precise measurements may be made with a rapidity impossible with previous methods. A description is given of a portable test set covering the range from 5 to 30 Mc.

621.317.757 2573

Simple Wave Analyser—D. M. Tombs. (*Wireless Eng.*, vol. 27, pp. 197–200; July, 1950.) The selective property of a simple tuned circuit is used to isolate a particular frequency existing in a complex wave, the isolated harmonic and the wave to be analyzed being both displayed on a double-beam cro. The Q value of the tuned circuit governs the amplitude of the selected harmonic component and is adjusted

over a wide range by means of a negative-resistance element.

The ratio of two harmonic amplitudes may be found by adjusting the Q values to make the magnified voltages the same for both in succession. The ratio is then given by a simple relation involving the frequency of the harmonics and the incremental adjustments of the tuning capacitor to obtain the half-power points, both these quantities being easily measured.

621.317.772 2574

High-Frequency Phase Measurement with Direct Indication: Part I—With a Cathode-Ray Tube as Indicator—A. Ruhlmann. (*Arch. Tech. (Messing)*, No. 172, pp. T52–T53; May, 1950.)

621.317.799†:621.396.813+621.396.822 2575

A Set for Noise and Distortion Tests on Carrier and Broadcast Systems—A. F. Boff. (*Marconi Rev.*, vol. 13, pp. 110–118; 3rd Quarter, 1950.) The use of two simultaneous test tones enables distortion measurements to be made at frequencies up to the limit of the pass band and overcomes the limitations of conventional harmonic testing methods. Description and circuit and performance details are given of a compact test unit suitable for noise and distortion measurements on very-high-frequency links.

621.385.012:621.317.79 2576

The Application of Direct-Current Resonant-Line-Type Pulsers to the Measurement of Vacuum-Tube Static Characteristics—J. Leferson. (*Proc. I.R.E.*, vol. 38, pp. 668–670; June, 1950.) A method is described for obtaining the static characteristics of a tube in the positive-grid region by applying to the grid 4- μ s pulses obtained from a conventional line-type pulse generator using a resonance method of charging. Grid and anode currents are observed on a synchroscope by means of voltages developed across noninductive resistors.

621.392.3:621.316.849:621.396.67.029.62 2577

High-Load H.F. Resistors of the Transmission-Line Type with Uniform Damping—A. Kraus. (*Fernmeldetechn. Z.*, vol. 3, pp. 157–160; May, 1950.) Expressions are derived for the dimensions of a 60- Ω air-cooled dummy antenna in which a length of resistance wire is wound spirally on a grooved metal cylinder which constitutes the low-loss return line. Three such units illustrated are for use in the 30–200 Mc band for powers of 250 w, 1 kw and 10 kw; the last is cooled by air blast. Resistance is within 10 per cent of 60 Ω over the whole frequency range.

621.396.615:621.316.726.078.3 2578

A Method of Locking Oscillators in Integral and Non-Integral Frequency Ratios—E. A. G. Shaw. (*Brit. Jour. Appl. Phys.*, vol. 1, pp. 154–157; June, 1950.) The output voltages of the two audio-frequency oscillators to be locked are applied to a nonlinear mixer. A selected beat provides a suitable correction voltage to operate a reactance tube controlling the frequency of one oscillator. A practical circuit is described, giving locking with a 1,000-cps signal over quite a large range of frequency ratios. Further developments are discussed. The method appears to be applicable to any frequencies.

621.396.615.17 2579

Various Applications of the Square-Wave Generator—R. de L. Ortueta and J. M. H. Botas. (*Rev. Telecomun. (Madrid)*, vol. 5, pp. 40–52; September, 1949.)

621.396.615.17:621.318.572]:621.392.018 2580

An Impulse-Generator Electronic-Switch for Visual Testing of Wide-Band Networks—T. R. Finch. (*Proc. I.R.E.*, vol. 38, pp. 657–661;

June, 1950.) The instrument may be used to test any network that can be arranged to store a dc charge, the discharge characteristics produced by the network under test and by a reference network being simultaneously displayed for comparison. Representative applications are illustrated with the aid of oscilloscope traces and the circuit functions are described in detail.

621.396.616.029.64.001.4 2581
Kilomegacycle Buzzer Test Oscillator—G. L. Davies, C. B. Pear, Jr., and P. E. P. White. (*Electronics*, vol. 23, pp. 96-99; July, 1950.) Voltage pulses with repetition frequency 800 per second derived from a battery-driven buzzer are applied to a cavity resonator-tuned buzzer in the range 3-11 kMc. Outputs up to 200 μ v across a 50- Ω load are obtained by adjustment of a simple piston attenuator.

OTHER APPLICATIONS OF RADIO AND ELECTRONICS

534.321.9:061.3 2582
International Convention on Ultrasonics—Bradfield. (See 2397.)

534.321.9:542.952.6 2583
Emulsion Polymerization with Ultrasonic Vibration—A. S. Ostroski and R. B. Stambaugh. (*Jour. Appl. Phys.*, vol. 21, pp. 478-482; June, 1950.) Magnetostriction and piezoelectric oscillators, operating at 15 kc and 500 kc, respectively, were used to study the effect of ultrasonic vibrations on the formation of such products as polystyrene and synthetic rubber. Above the threshold intensity required to produce cavitation, the time taken to reach a given yield of polymer is approximately inversely proportional to the power used.

534.415:621.396.615.141.2 2584
Stroboscopic Mapping of Time-Variable Fields—L. Marton and D. L. Reverdin. (*Jour. Appl. Phys.*, vol. 21, pp. 617-618; June, 1950.) During investigations of the static field of a cutoff magnetron it was found that the space-charge field was completely masked by the magnetic field due to the filament heating current. To avoid this a half-wave rectifier was used to feed the filament and observation of the space-charge distribution was restricted to the half cycle when no heating current was flowing. Pulse operation of the electron beam used for observation of the space charge was effected by square-wave modulation of the electron-gun bias voltage. The stroboscopic method is applicable in principle to the observation of recurrent, time-variable fields up to very high frequencies, a practical upper frequency limit being estimated at about 300 Mc.

621.57:621.318 2585
The Magnetic-Fluid Clutch—J. Rabinow. (*Trans. AIEE*, vol. 67, Part II, pp. 1308-1315; 1948.) A detailed discussion of principles and applications. See also 969 of May and back references.

621.316.86:536.581 2586
Thermistor Thermostats—A. H. Taylor. (*Electronics*, vol. 23, pp. 154-159; July, 1950.) Two simple low-cost circuits suitable for controlling refrigerators and using Western Electric thermistors Type V-514 are described.

621.318.572:621.387.422† 2587
High-Speed Electronic Scaler—W. M. Sessler and A. V. Masket. (*Rev. Sci. Instr.*, vol. 21, p. 494; May, 1950. Ge diodes are used in a circuit developed from one described in vol. 19 of the MIT Radiation Laboratory series (2006 of 1949).

621.38.001.8:616.07 2588
Electronic Instruments in Diagnostic Medicine—S. N. Pocock, W. Grey Walter, H. A. Hughes. (*Electronic Eng.*, vol. 22, pp. 355-

356; August, 1950.) Comments on 1207 of June (Hughes) and author's replies.

621.384.6 2589
200-kV Accelerator with Gas-Recovery System—E. Almquist, K. W. Allen, J. T. DeWan, T. P. Pepper, and J. H. Sanders. (*Phys. Rev.*, vol. 79, p. 209; July 1, 1950.) Summary of American Physical Society paper.

621.384.6 2590
Optimum Parameters for Particle Acceleration by TM₀₁₀ Cylindrical Cavities—B. L. Miller. (*Phys. Rev.*, vol. 79, p. 209; July 1, 1950.) Summary of American Physical Society paper.

621.384.6 2591
Production of High-Current Electron Pulses by a Resonant-Cavity Accelerator—G. W. Clark and L. B. Snoddy. (*Phys. Rev.*, vol. 79, p. 232; July 1, 1950.) Summary of American Physical Society paper. Pulses of duration $<10^{-7}$ second with electron energies >40 keV are obtained by use of a doubly reentrant cylindrical cavity operating at 400 Mc in conjunction with a pulsed electron source.

621.384.6 2592
Theory of the Radial Oscillations of the Electrons in an Electron Accelerator—H. Jahn and H. Kopfermann. (*Ann. Phys.*, (Lpz.), vol. 6, pp. 305-320; September 19, 1949.) Approximate formulas for the oscillation amplitude of the electrons about their instantaneous orbits, and for the damping of the oscillations, are derived and applied to the field of the 6-MeV electron accelerator of the Siemens-Reimiger Werke.

621.384.611.1† 2593
An 80-MeV Model of a 300-MeV Betatron—D. W. Kerst, G. D. Adams, H. W. Koch, and C. S. Robinson. (*Rev. Sci. Instr.*, vol. 21, pp. 462-480; May, 1950.)

621.384.611.1† 2594
Performance of 300-MeV Betatron—G. D. Adams, D. W. Kerst and C. S. Robinson. (*Phys. Rev.*, vol. 79, p. 208; July 1, 1950.) Summary of American Physical Society paper.

621.384.611.2† 2595
Operation of the M.I.T. 350-MeV Electron Synchrotron—I. A. Getting, J. S. Clark, J. E. Thomas, Jr., I. G. Swope, and M. L. Sands. (*Phys. Rev.*, vol. 79, p. 208; July 1, 1950.) Summary of American Physical Society paper.

621.384.611.2† 2596
Electron Injection Gun for the M.I.T. 350-MeV Synchrotron—O. Stone. (*Phys. Rev.*, vol. 79, p. 209; July 1, 1950.) Summary of American Physical Society paper.

621.384.611.2† 2597
Design of Magnet Ends and Straight Sections for a Racetrack Synchrotron—G. B. Beard, J. L. Levy, W. A. Nierenberg, and R. W. Pidd. (*Phys. Rev.*, vol. 79, p. 209; July 1, 1950.) Summary of American Physical Society paper.

621.384.611.2† 2598
Synchrotron Radiofrequency System—M. H. Dazey, J. V. Franck, A. C. Helmholtz, C. S. Numan, and J. M. Peterson. (*Rev. Sci. Instr.*, vol. 21, pp. 436-439; May, 1950.) Description of the radio-frequency system of the Berkeley synchrotron.

621.384.611.2† 2599
Theory of the Capture Process in a Betatron-Injected Synchrotron—D. C. de Paekh and M. Birnbaum. (*Rev. Sci. Instr.*, vol. 21, pp. 451-456; May, 1950.)

621.384.612.1† 2600
A Focusing Device for the External 350-

MeV Proton Beam of the 184-Inch Cyclotron at Berkeley—W. K. H. Panofsky and W. R. Baker. (*Rev. Sci. Instr.*, vol. 21, pp. 445-447; May, 1950.)

621.385.833† 535.822 2601
Electrons vs Photons: A Comparison of Microscopes—L. Marton. (*Jour. Opt. Soc. Amer.*, vol. 40, pp. 269-274; May, 1950.) Comparison of electron and light microscopes with discussion of the discrepancy between the theoretical resolving power of the electron microscope and the values obtained in practice.

621.387.4†:549.211 2602
Some Phenomena in Diamond Gamma-Ray Counters—E. Pearlstein and R. B. Sutton. (*Phys. Rev.*, vol. 79, p. 217; July 1, 1950.) Summary of American Physical Society paper.

621.387.424 2603
Geiger Counter for Lectures—R. L. Ives. (*Electronics*, vol. 23, pp. 105-107; July, 1950.) Circuit details are given of a portable instrument capable of delivering 50 w amplitude frequency output at 1,000 counts per second, and provided with strobotron flasher and thyratron-driven rate meter as auxiliary indicators.

778.37:537.523.4 2604
A Barium Titanate Coaxial Cable for the Production of a Short-Duration Spark—J. A. Fitzpatrick and W. J. Thaler. (*Phys. Rev.*, vol. 79, p. 231; July 1, 1950.) Summary of American Physical Society paper. A coaxial capacitor of overall length 16.5 cm, with BaTiO₃ dielectric of permittivity 1,575 giving a capacitance of 0.02 μ F, was used in spark photography of ultrasonic waves in water at frequencies up to 7 Mc.

621.387.4† 2605
Ionization Chambers and Counters, Experimental Techniques [Book Review]—B. B. Rossi and H. H. Staub. Publishers: McGraw-Hill Book Co., New York, N. Y. 1st ed. 1949. 243 pp., 198.6d. (in Great Britain). (*Electronic Eng.*, vol. 22, pp. 352-353; August, 1950.)

PROPAGATION OF WAVES

061.3:[621.396.11† 55 2606
Summary of Proceedings of Australian National Committee of Radio Science, U.R.S.I., Sydney, January 16-20, 1950—(*Jour. Geophys. Res.*, vol. 55, pp. 191-210; June, 1950.) Summaries are given of 33 papers presented at the conference.

538.566†[537.226.2:546.217 2607
The Velocity of Electromagnetic Waves and the Dielectric Constant of Dry Air—Hughes. (See 2489.)

538.566 2608
Higher-Order Approximations in Ionospheric Wave-Propagation—J. Feinstein. (*Jour. Geophys. Res.*, vol. 55, pp. 161-170; June, 1950.) The ionosphere, even when assumed homogeneous, can be considered as a linear medium for the propagation of em waves only as a first approximation. Second-order terms give rise to harmonics, and to sum and difference frequencies when two independent waves traverse the same physical region. These new frequencies are, in general, of the nature of forced vibrations, except in the case where their propagation characteristics are those of a natural mode capable of existing in the region. A resonance effect then occurs, the new wave increasing its energy at the expense of the interacting waves, and assuming an independent existence. While these effects couple energy from the primary wave, they do not affect its propagation characteristics.

As a result of the degeneracy of the determinantal equation for the propagation constant, the introduction of any disturbing physical

effects, such as a layer drift velocity, raises the degree of the equation, resulting not merely in changes in the values of the propagation constants of the usual modes, but, in addition, introducing new ones. For the usual disturbing effects encountered in the ionosphere, the energy content of these new modes is negligibly small.

538.566:537.562 2609

Electromagnetic Waves in Bounded Magneto-Ionic Media—B. Lax. (*Phys. Rev.*, vol. 79, p. 222; July 1, 1950.) Summary of American Physical Society paper. Discussion and theoretical study of high-frequency waves in ionized gases in the presence of an external magnetic field, particularly the determination of the complex frequency when the value of the propagation vector is fixed or limited, as might be the case in a finite cavity resonator or waveguide.

621.396.11+535.222 2610

Can the Velocity of Propagation of Radio Waves be Measured by Shoran?—C. I. Aslakson. (*Trans. Amer. Geophys. Union*, vol. 30, pp. 475-487; August, 1949.) An account is given of radar methods used to measure 47 lines of a shoran system of lengths ranging from 67 to 367 miles. Six of these lines could be compared with distances determined by first-order triangulation. Coordination of the shoran results with the geodetic measurements gave a mean value of 299 792.3 km for the velocity of propagation of radio waves, after making various corrections. See also 2010 of September (Essen).

621.396.11:551.510.535 2611

Ionosphere Observations at 50 kc/s—Brown and Watts. (See 2506.)

621.396.11:551.57 2612

The Importance of Water Vapor in Microwave Propagation at Temperatures below Freezing—D. G. Yerg. (*Bull. Amer. Met. Soc.*, vol. 31, pp. 175-177; May, 1950.) Calculations based on experimental results indicate that the vapor-pressure term in the refractive-index equation cannot be neglected for temperatures above -35°C . For temperatures between -35°C and -20°C the vapor-pressure gradient may be quite significant and at temperatures above -20°C it may be the dominant factor.

621.396.81 2613

Propagation of Waves of Frequencies from 2.5 to 35 Mc/s between Washington and Madrid—(*Rev. Telecomun.* (Madrid) vol. 5, pp. 2-18; September, 1949.) An account of NBS prediction methods, and of an experimental investigation into quality of reception for these frequencies, with a view to obtaining data on which predictions might be based. Observations were made hourly from 0700 to 2200 for the period December, 1948 to March, 1949. Graphs of receiver output power against time of day, and of muf and optimum working frequency against time of day, display the results for each fortnight of the period. These are discussed and compared with NBS charts, and suggestions are made for extension of the WWV standard-frequency transmissions.

621.396.81 2614

"Probable Law" of Propagation of Short Waves for Ranges of 1,300 km from Europe—R. G. Sacasa. (*Rev. Telecomun.* (Madrid), vol. 5, pp. 19-35; September, 1949.) Observations were made in 1945 and 1947-1949 of the times at which reception in Madrid of various standing-wave signals from London commenced or ceased to be of practical value. From the results obtained a simple numerical relation is deduced between the optimum working frequency F Mc at sunrise (or sunset) and the optimum frequency f Mc at a time n hours

later or earlier (n being respectively positive or negative). $f = F \pm 2n$, the sign depending on whether the interval is measured from sunrise or from sunset, for which the value of F is much higher than for sunrise. For E-W or W-E transmissions a different value of the factor of n is required. Graphs of the signal strength of transmissions from London around 1,300 GMT indicate some dependence on the length of day.

621.396.81 2615

Optimum Working Frequencies for Ranges from 0 to 2,500 km—R. G. Sacasa. (*Rev. Telecomun.* (Madrid), vol. 5, pp. 36-39; September, 1949.) An adaptation of a NBS abac is reproduced and explained; from this either the muf or the optimum working frequency can easily be determined for any range up to 2,500 km.

621.396.81:029.63/.64 2616

A Microwave Propagation Test—J. Z. Millar and L. A. Byam, Jr. (*Proc. I.R.E.*, vol. 38, pp. 619-626; June, 1950.) A description is given of a microwave propagation test which was conducted over a period of a year with simultaneous transmission on wavelengths of 16.2, 7.2, 4.7, and 3.1 cm over an unobstructed 42-mile overland path. Comparative charts depict variations in daily fading range, illustrate diurnal and seasonal characteristics of fading, and reveal the marked difference between winter and summer fading. Curves are presented showing relative field-strength distribution for both winter and summer periods, and also the distribution of hourly minima. These curves may be useful in considerations bearing on the continuity of service that may be expected for different wavelengths and times of day in winter or in summer.

621.396.812 2617

Effects of Radio Gyrointeraction and Their Interpretation—M. Cutolo. (*Nature* (London), vol. 166, pp. 98-100; July 15, 1950.) Experiments performed in Italy during June-July 1949 are described, using Taranto as the wanted station with Turin as the receiving station and Radio Florence II as the interfering station. The interfering carrier frequency was varied from 1092 kc to 1333.33 kc to pass through the gyrofrequency, estimated to be 1190 kc at 90 km above the earth. The results obtained were in agreement with the theoretical double-humped curve given by Bailey (9 of 1939) and are used to explain earlier results (1476, 1477 and 1767 of 1949). Minimum interaction was obtained on a frequency corresponding to the local gyrofrequency at Montefalco, midway between transmitter and receiver, the presumed reflection point of the wanted wave. Solar activity was also observed to influence gyrointeraction, the phenomenon being weak or absent for a Wolf's number up to 100.

RECEPTION

621.396.621 2618

Low-Noise F.M. Front End—J. Marshall. (*Radio and Electronics*, vol. 21, pp. 58-63; June, 1950.) Construction details are given of a ganged, low-noise radio-frequency amplifier and mixer circuit which converts signals in the FM band to an intermediate frequency of 10.7 Mc. A high-gain intermediate-frequency amplifier for use with this equipment will be described in a subsequent article.

621.396.621:621.396.822 2619

Note on Low-Noise-Figure Input Circuits—A. C. Hudson. (*Proc. I.R.E.*, vol. 38, pp. 684-685; June, 1950.) Comment on 1504 of July (Lebenbaum).

621.396.823 2620

Measurement of Interference from Radio-Frequency Heating Equipment—G. H. Brown.

(*Trans. A.I.E.E.*, vol. 67, Part II, pp. 1102-1106; 1948.) Discussion of medium-frequency and very-high-frequency radiation from dielectric- and induction-heating equipment, and a comparison of the theoretical radio-frequency field strengths with measurements.

621.394.3+621.396.3 2621

Military Teletypewriter Systems of World War II—F. J. Singer. (*Trans. A.I.E.E.*, vol. 67, Part II, pp. 1398-1408; 1948.) An illustrated review of equipment developed by the Bell Telephone Laboratories for line and radio links, with discussion and block diagrams of the various systems used.

621.395:06.053 2622

Fifteenth Plenary Assembly of the Comité Consultatif International Téléphonique, Paris, 1949—P. E. Erikson. (*Elec. Commun.*, vol. 27, pp. 87-100; June, 1950.) See also 455 of March and 994 of May.

621.396.13:621.396.619.2 2623

The Single-Sideband System of Radio-Communication—H. D. B. Kirby. (*Electronic Eng.* (London) vol. 22, pp. 259-263; July, 1950.) The advantages of the ssb system over the normal dsb method of operating a radio link are discussed and a short description is given of ssb equipment in *SS Coronica*.

621.396.65:029.63 2624

Decimetre Waves in the German Telephone Service—E. Dietrich and P. Barkow. (*Fernmeldetechn. Z.*, vol. 3, pp. 145-154; May, 1950.) Description of two multichannel FM systems in use and brief discussion of optimum operating conditions.

621.396.73:621.396.61 2625

V.H.F. Equipment for Sound Broadcasting—(*Electronic Eng.* (London), vol. 22, p. 309; August, 1950.) A pack-set transmitter-receiver has been designed for use by BBC commentators at golf matches, race meetings etc. It is carried on the commentator's back. The FM transmitter operates in the 90-Mc band and has an output of about 1 w, with a frequency response curve sensibly flat from 50 cps to 6 kc. A 250-v HgO anode battery and accumulator filament battery are adequate for three hours continuous working. The 70-Mc receiver enables the commentator to receive information from the engineer at the control point, where a small AM transmitter is installed. The portable transmitter, complete with batteries, $\lambda/4$ whip antenna and harness, weighs 17 lbs; the receiver brings the total weight to 26 lbs.

621.396.931/.932 2626

The Metropolitan Police Radio Communication System—E. C. Brown. (*Electronic Eng.* (London), vol. 22, pp. 316-322; August, 1950.) A review of developments from 1923 onwards, with a description of the present radio-telephone system which provides two-way communication between New Scotland Yard and some 200 vehicles, besides 13 launches of the River Thames Division. The present scheme uses two main frequency channels, but will eventually use four main and two subsidiary channels. A system of coaxial filters at the main station enables separate transmitters on different frequencies to feed into a common wide-band antenna. A similar system is used for the station receivers. Phase modulation is used and all transmitting equipment is crystal controlled. The output of the main-station transmitter is 250 w in the 95-100 Mc band, that of the mobile transmitters being 10 w in the 80-84 Mc band. The receivers are of the double-superheterodyne type. Further developments envisaged are the provision of radio-telephone equipment for motorcycles,

with selective calling arrangements and the use of similar equipment for cars.

621.396.931/.932 2627

Multi-Station V.H.F. Schemes—J. R. Brinkley. (*Electronic Eng.* (London), vol. 22, pp. 323-325; August, 1950.) Many very-high-frequency mobile-communication problems can be solved by the single-station method, but for large rural areas, estuaries, trunk roads and railways, multistation systems have decided advantages, though they are necessarily more complex. A 2-station scheme using A.M. has been in use by the Hertfordshire county police since 1947 with complete reliability. Ten further multicarrier schemes have been installed in various counties in England, seven being 2-station and the rest 3-station schemes. A 3-station scheme is also in use by the Lanarkshire Fire Service. For estuary and coastal problems the GPO authorities have decided to use multicarrier AM equipment.

621.396.931/.932 2628

Design Problems of V.H.F. Mobile Equipment—L. W. D. Sharp. (*Electronic Eng.* (London), vol. 22, pp. 331-337; August, 1950.) Operating requirements of very-high-frequency mobile systems and equipment are outlined and transmitter and receiver design problems are discussed with particular reference to transmitter power, receiver sensitivity and the type of modulation adopted. Block diagrams illustrate the essential differences between FM and AM transmitters and receivers. Tubes, components, power-supply units, and types of construction to make equipment suitable for use under the adverse conditions frequently met and to permit easy servicing are also discussed.

621.396.931/.932 2629

Planning V.H.F. Mobile Systems—E. R. Burroughes. (*Electronic Eng.* (London), vol. 22, pp. 298-304; August, 1950.) See also 1248 of June.

621.396.931/.932:621.396.6 2630

V.H.F. [mobile] Equipment—(*Electronic Eng.* (London), vol. 22, pp. 340-348; August, 1950.) A review, with illustrations and technical details, of a wide-range of British transmitting and receiving equipment available for very-high-frequency mobile radio services. The information has been supplied by the manufacturers, who will give further details on request. Both AM and FM systems are included.

621.396.931 2631

Mobile Radio—A. Bailey. (*Trans. AIEE* vol. 67, Part II, pp. 923-931, Discussion, pp. 932-933; 1948.) An account of the development of mobile communication systems for police, taxicab, and general telephone services from 1921 onwards, with details of the Bell System general mobile service for urban and highway use.

621.396.931:621.396.619.13 2632

Multi-Station V.H.F. Communication Systems Using Frequency Modulation—W. P. Cole and E. G. Hamer. (*Jour. Brit. I.R.E.*, vol. 10, pp. 244-258; July, 1950.) Reasons for the use of multistation systems for mobile communications are discussed and previous tests with FM equipment are reviewed. Standard equipment for a single-station scheme is examined and from this the performance requirements for multistation equipment are derived. Suitable frequencies for the main carriers and for a control link are discussed and equipment used in a multistation scheme is described in detail. Distortion due to multipath transmission is analysed and practical tests of multistation systems in the London area and in Scotland are described. Future trends in development of such systems are indicated.

621.396.932 2633

New Marine V.H.F. Radio System—(*Overseas Eng.*, vol. 23, pp. 449-450; July, 1950.) General description of the ship/shore telephony system for the port of Liverpool. Transmitters and receivers are crystal controlled and AM is used. Six channels are provided; the shore stations transmit on frequencies in the range 163.1-163.6 Mc, the frequencies for the mobile equipment being 4.5 Mc lower in each case. The weight of the portable sets, which are both rain- and waterproof, is <20 lb. Good communication is obtained within a range of 25 miles.

SUBSIDIARY APPARATUS

621-526 2634

Note on the Maximum Accuracy of Perfectly Stable Servomechanisms—G. Lehmann. (*Onde Elec.*, vol. 30, pp. 267-270; June, 1950.) If an unconditionally stable servomechanism includes an element which introduces a phase change not effectively zero, its accuracy at relatively low frequencies is necessarily limited. This limiting value is calculated for a simple case. Attention is drawn to the possible danger of exceeding this limit in a system only conditionally stable.

621.313.3:621.3.026.441† 2635

Flea-Power Industrial Synchronous Motors—A. B. Poole. (*Elec. Mfg.*, vol. 43, pp. 74-77 . . . 172; January, 1949.) Operational principles, design features and output characteristics of three basic types of clock motor: the hysteresis, shaded-pole induction, and inductor types.

621.314.622 2636

Rectifiers with Mechanical Contacts—A. Mongault. (*Rev. Gén. Elec.*, vol. 59, pp. 208-210; May, 1950.) Discussion of requirements for efficient commutation in a polyphase generator, i.e., minimum sparking and optimum inductance of the windings.

TELEVISION AND PHOTOTELEGRAPHY

621.397.5 2637

Distiant Electric Vision—J. D. McGee. (*Proc. I. R. E.*, vol. 38, pp. 596-608; June, 1950.) Reprint. See 761 of April.

621.397.5 2638

Television in Relief and in Colour—Y. Delbord. (*Ann. Télécommun.*, vol. 5, pp. 219-228; June, 1950.) Paper presented at the Television Congress in Milan, September, 1949. Four methods are discussed and their advantages, disadvantages, and applicability to black-and-white, relief, or color television are tabulated. These are (a) fixed vertical-band scanning frame; (b) rotating disk; (c) multiple channel; (d) multiple image. The basic principles of the methods are described with regard to transmission and reception. For relief television, method (d) is regarded as affording the simplest satisfactory solution. For color television a combination of the best features of (b), (c) and (d) is desirable.

621.397.5 2639

Kell-Factor and Picture Definition in Television Transmissions with Constant Bandwidth—E. Schwartz. (*Fernmeldelech. Z.*, vol. 3, pp. 185-190; June, 1950.) Discussion of the optimum "K factor" (ratio of horizontal to vertical resolution) and comparison of different systems. See also 3942 of 1940 (Kell, Bedford, and Fredendall).

621.397.5 2640

An Analysis of the Sampling Principles of the Dot-Sequential Color-Television System—RCA Laboratories Division. (*RCA Rev.*, vol. 11, pp. 255-286; June, 1950.) A quantita-

tive treatment of the influence of the width of the sampling pulse on color crosstalk, the response of standard monochrome-television receivers and color-television receivers to sinusoidal variations and to step functions, the way in which the method of "mixed highs" combines with the sampling procedure to produce high-frequency detail, and circuit methods of eliminating crosstalk.

621.397.5:535.88:532.62 2641

The Eidophor Method for Theater Television—E. Labin. (*Jour. Soc. Mot. Pic. Telev. Eng.*, vol. 54, pp. 393-406; April, 1950.) See also 3561 of 1949 (Thiemann).

621.397.5:083.74) 2642

Choice of Television Standards—(*Wireless World*, vol. 56, pp. 249-250; July, 1950.) Reasons are given for considering that the choice of the 405-line standard is fundamentally sound, both from an engineering and an economic viewpoint. When the capabilities of 405-line television have been fully exploited, any small improvement that might be obtained by increasing the number of lines will be offset by the difficulties which will be encountered in maintaining the larger bandwidth required and in ensuring that the degree of overall distortion does not exceed the more stringent limits of tolerance.

621.397.6:535.88 2643

Projection Television—J. Haantjes and J. J. P. Valetton. (*Tydschr. ned. Radiogenoot.*, vol. 14, pp. 99-117; July, 1949.) Description of the MW'6-2 cr tube, Schmidt-type optical system and high-voltage supply unit. See also 2387 of 1948 (Rinia et al.)

621.397.6:621.396.67 2644

Ultra-High-Frequency Antenna and System for Television Transmission—Fiet. (*See* 2425.)

621.397.6.001.8 2645

Industrial Television System—R. W. Sanders. (*Elec. Commun.*, vol. 27, pp. 101-111; June, 1950.) Detailed description of equipment which uses a new type of image-dissector tube with a translucent instead of a solid photo cathode. See also *Electronics*, vol. 23, pp. 88-92; July, 1950.

621.397.61 2646

A New Ultra-High-Frequency Television Transmitter—Lappin and Bennett. (*See* 2659.)

621.397.61(47) 2647

Television in the Soviet Union—(*Fernmeldelech. Z.*, vol. 3, p. 218; June, 1950.) Brief note of what is known of the two transmitters in service at Moscow and Leningrad. Two other stations are under construction, one in Kiev to serve South Russia, the other in Sverdlovsk to serve eastern Russia and the Ural region.

621.397.62 2648

General Description of Receivers for the Dot-Sequential Color-Television System which Employ Direct-View Tri-Colour Kinescopes—RCA Laboratories Division and RCA Victor Division. (*RCA Rev.*, vol. 11, pp. 228-232; June, 1950.) See also 2363 of October.

621.397.62 2649

Sync-Separator Analysis—W. Heiser. (*Electronics*, vol. 23, pp. 108-111; July, 1950.) The response of a particular clipper circuit for separating synchronizing signals from the composite television signal is analyzed. Formulas are derived for use in designing such circuits, and calculated results are compared with measured results for test signals.

621.397.62:621.396.615.16 2650

A Hard-Valve Time-Base—Banthorpe. (*See* 2455.)

621.397.67:[621.317.733+621.392.52] 2651
Television Antenna Diplexers—W. H. Sayer, Jr. and J. M. De Bell, Jr. (*Electronics*, vol. 23, pp. 74-77; July, 1950.) Methods are described which enable two or more closely spaced radio-frequency signals (e.g., vision and sound carriers) to be transmitted from one antenna, with a minimum of interaction between signal sources. Impedance bridges or "notch" filters formed of coaxial lines are used. Diplexers may also be used to add together the synchronized outputs of two generators so as to obtain high power; waveguide and coaxial-ring (rat-race) hybrids for this purpose are described. See also 1355 of July, No. 80.

621.397.81 2652
Midlands Television Area—(*Wireless World* vol. 56, pp. 266; July, 1950.) A map, based on a BBC survey, showing approximate field-strength contours for the vision signals from the Sutton Coldfield transmitter.

621.397.82 2653
A Study of Cochannel and Adjacent-Channel Interference of Television Signals: Part 2—Adjacent-Channel Studies—RCA Laboratories Division. (*RCA Rev.*, vol. 11, pp. 287-295; June, 1950.) In the observer tests, color signals characteristic of the field-sequential, line-sequential, and dot-sequential systems were included. A standard monochrome signal was paired with a monochrome signal and the color signals in some of the tests. In all instances, the interfering sound signal was present. From the standpoint of allocation, no substantial difference in the tolerable ratios was found for the various combinations of color and monochrome signals used. Part 1: 1798 of August.

621.397.828:621.396.61 2654
Tackling TVI at the Output End—Tapson. (See 2661.)

621.397.828:621.396.677 2655
TV Antenna Phase Control—G. N. Carmichael. (*Radio-Electronics*, vol. 21, pp. 54, 56; June, 1950.) A method of reducing co-channel interference and increasing wanted signal strength in fringe areas. Two Yagi arrays are used, spaced to give a phase difference of about 90° for angles of incidence of the downcoming wave commonly found in fringe areas. The outputs from the two arrays are fed separately to a variable phase control, which partially cancels unwanted, and adds wanted signal voltages. Depending on the angle between the directions of the incoming signals, the combination can give a rejection ratio of 35-40 db, and a forward gain of 15 db, compared with a dipole.

621.397 2656
Facsimile [Book Review]—C. R. Jones. Publishers: Murray Hill Books, New York, N. Y. 1949, 422 pp., \$6.00. (*Jour. Franklin Inst.*, vol. 249, p. 255; March, 1950.) Apparently intended for those concerned with the use and maintenance of facsimile equipment rather than with its design.

TRANSMISSION

621.396.61:621.396.645 2657
Maximum Tank Voltage in Class-C Amplifiers—Dwork. (See 2460.)

621.396.61:621.396.97 2658
A New 150-kW Transmitter for Standard-Band Broadcasting—T. J. Boerner. (*Trans. AIEE*, vol. 67, Part II, pp. 943-951; 1948.) A detailed description of a 540-1600-kc transmitter with high-level modulation. A class-B modulator is used for AM of the class-C final radio-frequency amplifier, thus permitting the highest over-all efficiency with relative ease of adjustment.

621.397.61 2659
A New Ultra-High-Frequency Television Transmitter—L. S. Lappin and J. R. Bennett. (*RCA Rev.*, vol. 11, pp. 190-211; June, 1950.) Detailed description of the 1-kW Type-TTU-1A transmitter recently installed and now in operation at Bridgeport, Conn. The high-frequency tripler and power amplifier are operated as grounded-cathode grounded-screen amplifiers, each using eight Type-4X150A tubes mounted in a single cavity. A sectional diagram of the cavity is given. See also 1795 of August (Guy, Seiberg, and Smith).

621.397.67:[621.317.733+621.392.52] 2660
Television Antenna Diplexers—Sayer and De Bell (See 2651.)

621.397.828:621.396.61 2661
Tackling TVI at the Output End—M. E. Tapson. (*Short Wave Mag.*, vol. 8, pp. 265-266; June, 1950.) Use of 3rd-harmonic anode traps in the power amplifier link coupling to the antenna system, and a folded dipole adjusted for low feeder SWR, minimized interference from a 100-w 14-Mc amateur transmitter, so that television reception was practicable within about 20 yards.

TUBES AND THERMIONICS

537.533.8 2662
Secondary—Electron Emission from Metal Mixtures—Salow. (See 2526.)

621.383.27† 2663
Calculation of the Elements of an Electron-Multiplier Tube and Its Realization—A. Lallemand. (*Le Vide* (Paris), vol. 4, pp. 618-624; May, 1949.) Various factors relevant to the design of photoelectric multiplier tubes are discussed, including type of cathode, form and coating of multiplier surfaces, and arrangements for obtaining suitable electron trajectories. The multiplier grids finally adopted consisted of parallel narrow strips inclined at about 45° to the mean grid plane, a grid of fine wires maintained at the same potential as the multiplier being fixed a little in front of each multiplier. Tubes using this type of construction have been produced with 7, 12, 17 and 19 stages, the multiplication factors for 120-v operation ranging from 1,215 to 3.7+10⁶.

621.383.27† 2664
Rise Times of Voltage Pulses from Photo-Multipliers—O. Martinson, P. Isaacs, H. Brown, and I. W. Ruderman. (*Phys. Rev.*, vol. 79, p. 178; July 1, 1950.) Includes a brief description of a method of measuring short rise-times without the use of a high-speed oscillograph.

621.385.012:621.317.79 2665
The Application of Direct-Current Resonant-Line-Type Pulsers to the Measurement of Vacuum-Tube Static Characteristics—Loferson. (See 2576.)

621.385.029.63/.64+621.396.615.142.2 2666
Recent Developments in Amplifying Valves for Centimetre Waves—G. Goudet. (*Ann. Télécommun.*, vol. 3, pp. 445-455; December 1948.) Limitations of klystron amplifiers are discussed and a description is given of the wide-band double-resonator klystron designed by engineers of the Laboratoire Central de Télécommunications. With anode voltage 8kv, electron current 100 ma, the output is 12 w, power gain 40 and pass-band 50 Mc, or 20 w under slightly different operating conditions, with gain 100 and pass band 25 Mc. A similar 2-stage tube (3 cavity resonators) has an output of 2 w, a power gain of 290 and pass band 20 Mc.

Travelling-wave tubes are also considered briefly and a simplified theory of their operation, with derivation of design and performance

formulas, is given in an appendix. See also 1294 of June.

621.385.032.216 2667
Pulsed Operation of Oxide Cathodes—C. Bignuet. (*Le Vide* (Paris), vol. 4, pp. 661-668; July, September, 1949.) The theory of steady-state operation is reviewed briefly and a theory of pulsed operation is proposed which assumes that under the action of the electric field, a displacement of Ba ions in the thickness of the oxide layer occurs. These positive charges create a very intense field near the surface of the metal support and tear electrons out of it. Some of these electrons neutralize the positive charges, the rest play an important part in the electron emission. The time necessary for the neutralization of the positive charges appears to be of the order of 5 μ seconds, so that in pulsed operation the duration of application of the anode voltage should be less than this value. Experiments with the object of confirming the theory are described.

621.385.032.216 2668
Deterioration of Oxide-Coated Cathodes Under Low Duty-Factor Operation—J. F. Waymouth, Jr. (*Phys. Rev.*, vol. 79, p. 233; July 1, 1950.) Summary of American Physical Society paper. Investigation of the effect of emission-current duty-factor on cathode life.

621.385.032.216:621.3.011.2 2669
Electrical Conductivity of Oxide-Cathode Coatings—D. A. Wright. (*Brit. Jour. Appl. Phys.*, vol. 1, pp. 150-153; June, 1950.) See 2078 of September.

621.385.1:621.396.822 2670
Current Fluctuations in D.C. Gas-Discharge Plasma—P. Parzen and L. Goldstein. (*Phys. Rev.*, vol. 79, pp. 190-191; July 1, 1950.) Mathematical analysis deriving an expression for the effective noise power due to current fluctuations in a gas-discharge plasma in a rectangular waveguide transmitting in only its lowest mode. For ordinary gas tubes used as microwave noise sources the contribution of the frequency-dependent term in the expression for noise power is small.

621.385.2/.5].029.62 2671
A Survey of V.H.F. Valve Developments—(*Electronic Eng.* (London), vol. 22, pp. 310-315; August, 1950.) The factors limiting the upper working frequencies of ordinary tubes are discussed, together with the difficulties encountered in the development of very-high-frequency tubes; and a survey is made of the various types at present available. A list of the characteristics of a selected range of disk-seal triodes is included.

621.385.3:621.315.592†:546.815.221 2672
On the Frequency Response of PbS Transistors—P. C. Banbury and H. K. Henisch. (*Proc. Phys. Soc.*, vol. 63, pp. 540-541; July 1, 1950.) The response of PbS transistors is found to be comparable with that of Ge transistors. The high-frequency response can be extended somewhat by the use of higher collector voltages or by the application of a suitably oriented magnetic field. The variation produced by the magnetic field, though only small, shows by its sense that the charge carriers are electrons, as in the Ge p-type transistor. See also 2088 of September (Gebbie, Banbury, and Hogarth), 2089 of September (Brown) and 2459 above.

621.385.3:621.315.592†:621.396.645 2673
High-Frequency Operation of Transistors—Brown. (See 2459.)

621.385.3.029.62:621.396.822 2674
On the Space-Charge Smoothing of Shot Fluctuations in Triode Systems Responding to Very High Frequencies—I. A. Harris. (*Jour. Brit. IRE*, vol. 10, pp. 229-240; July, 1950.) Existing theoretical results are briefly

reviewed and a simplified theory of space-charge smoothing of shot fluctuations in a diode, based on the Benham-Llewellyn theory, is discussed in some detail. This theory is then applied to cases in the very-high-frequency range where electron transit times are appreciable, and it is concluded that the low-frequency smoothing factor is not appreciably changed up to transit angles of about 1 radian. Application of the theory to the noise of grounded-grid triode circuits gives results in better agreement with experiment than those based on earlier theories. The effect on noise of applying a nonuniform field at the cathode of a triode is also considered.

621.385.38 **2675**
Studies of Thyatron Behavior: Part 1—The Effect of Grid Resistance on the Recovery Time of Thyatrons—L. Malter and E. O. Johnson. (*RCA Rev.*, vol. 11, pp. 165-177; June, 1950.) Theoretical and practical investigations of the grid-voltage and current characteristics of a commercial thyatron, for different values of grid resistance and bias, during the period following the interruption of the discharge. During the recovery period electron current may flow to the grid if the voltage drop across the grid resistor due to positive-ion current exceeds the bias voltage. The increase of recovery time with increasing value of grid resistance is due to the delayed return of the grid voltage to its bias value and not to a decreased rate of deionization, this rate being essentially independent of grid resistance and voltage. The recovery time is also dependent upon the instantaneous value of the actual grid voltage. See also 2676 below.

621.385.38 **2676**
Studies of Thyatron Behavior: Part 2—

A Study of the Effect of Grid Potential Variations during the Afterglow Period upon the Recovery Time of Thyatrons—E. O. Johnson and L. Malter. (*RCA Rev.*, vol. 11, pp. 178-189; June, 1950.) Experiments with commercial thyatrons indicate that the recovery time is a function of the instantaneous effective grid potential and is independent of previous grid-potential variations provided that no abrupt changes have occurred shortly before the grid regains control. Such changes set up an unstable charge distribution in the plasma and sheaths within the tube, this unstable state passing to a quasistationary one in a time dependent on diffusion.

621.396.615.14 **2677**
A New Wide-Range, High-Frequency Oscillator—O. Heil and J. J. Ebers. (*Proc. I. R. E.*, vol. 38, pp. 645-650; June, 1950.) Wide-range tuning in a Barkhausen type of oscillator is achieved by concentrating electrons from a highly efficient electron gun and also concentrating the electric field of a cavity resonator at the point where the electron beam has its greatest density. Although efficiency is low, variation of circuit capacitance alone gives a 3:1 tuning range, since the resonator gap capacitance is small. The oscillator construction is described and operating characteristics are given, output powers of 0.1-1 w being obtained in the wavelength range 4.5-12 cm.

621.396.615.141.2 **2678**
Resonance Frequencies of the Space Charge in a Magnetron—P. Fechner. (*Compt. Rend. Acad. Sci.* (Paris), vol. 230, pp. 1848-1849; May 22, 1950.) Analysis is effected for values of anode voltage and magnetic field such that the magnetron cannot oscillate, high-frequency excitation being introduced from an

auxiliary source. Expressions are derived relating the resonance frequency of the vibrating space-charge electrons to the value of the electric field, for both whole-anode and multicavity magnetrons.

621.396.615.141.2:534.415 **2679**
Stroboscopic Mapping of Time-Variable Fields—Marton and Reverdin. (See 2584.)

621.396.615.141.2:621.317.361 **2680**
Measurement of the Resonance Frequency of the Space Charge in a Coaxial Magnetron—P. Fechner. (*Compt. Rend. Acad. Sci.* (Paris), vol. 231, pp. 124-125; July 10, 1950.) The formula connecting magnetic field H with interelectrode voltage V at resonance (see 2678 above) is verified by measurements made by the following method. The nonoscillating magnetron is energized from a klystron source coupled to it by a matched coaxial line. A probe inserted in this line serves to increase the variations of impedance as V is altered. The resonance condition is determined by means of a crystal detector at an electric-field antinode of the coupling line.

621.385 **2681**
Röhren Vade-Mecum 1950 [Book Review]
 —P. H. Brans. Publishers: Brans-Verlag, Antwerp, 8th ed. 1950, 508 pp., 15.40 Swiss francs. (*Bull. Schweiz. Elektrotech. Ver.*, vol. 41, p. 463; May 27, 1950. In German.) Includes the data of former editions combined with particulars of the latest tubes: viz. 9-element tubes, accelerometers, projection tubes, phasitrons, planar triodes, crystal diodes, etc. Contents list and instructional notes are printed in eight languages.

Books

Aerials for Centimetre Wave-lengths by D. W. Fry and F. K. Goward

Published (1950) by Cambridge University Press, 51 Madison Ave., New York 10, N. Y. 164 pages + 4-page index + 8 figures. 5 1/2 x 8 1/2. \$3.50.

This book is a welcome addition to that collection of books which have been published recently on the subject of antennas. The authors confine themselves mainly to a discussion of antennas used in scanning systems at wave lengths of 10 centimeters or less. This particular aspect of antenna theory has not been covered heretofore as completely as is done here.

Emphasis has been placed on design principles and on the advantages and disadvantages of particular types of antennas in meeting particular requirements, such as wide scanning range or accurate beam shape. The physics of antennas rather than their mathematical analysis is stressed, although applicable formulas and some simple derivations are given wherever possible.

Among the subjects covered thoroughly with reference to the scanning problem are point and line sources for use with reflectors, single and doubly curved reflectors, lenses, and horns. Optical aberrations as well as polar diagram theory are discussed briefly. Wartime developments both in the U. S. and England are reviewed.

The book is well suited to the needs of

the radar engineer since it indicates clearly how to choose an antenna to meet a particular scanning requirement. A fairly complete set of references is given to the literature. The writing style is clear and readable.

SALVATORE MILAZZO
 Sperry Gyroscope Co.
 Great Neck, L. I., N. Y.

Questions and Answers in Television Engineering by Carter V. Rabinoff and Magdalena E. Walbrecht

Published (1950) by Whittlesey House, McGraw-Hill Book Co., Inc., 330 W. 42 St., New York, N. Y. 280 pages + 15-page index + vii pages + 3-page appendix. 178 figures. 6 x 9. \$4.50.

This is the first edition of a "semi-textbook" written primarily for engineers, technicians, amateurs, service men, and students. With the exception of TV links, the book contains sections on all phases of the television broadcast field, including standards, laws, and regulations. The authors have attempted to arrange the questions and answers for maximum coherence and readability.

Section 12 describes the RCA 8-TS-30 and the GE model 802 receivers. By relating the questions to the circuit diagrams, the authors have adopted a classroom approach with excellent results. The reader interested in receivers might begin with this chapter

and study other sections of the book as needed to expand the answers given.

This reader believes the book is thorough, carefully written, and to the point. It should have great appeal for servicemen and engineering managers alike who want concise up-to-date information without technical detail.































J. ERNEST SMITH
 Raytheon Manufacturing Co.
 Newton, Mass.

Handbook H42, Safe Handling of Radioactive Isotopes, 29 pages, 15 cents a copy, is available from the Superintendent of Documents, U. S. Government Printing Office, Washington 25, D. C. Remittances from foreign countries should be in United States exchange, and should include an additional sum of one-third the publication price to cover the cost of mailing.

Recommendations for the safe handling of artificially produced radioactive isotopes in the typical laboratory or small industrial operation are concisely set forth in the booklet, which was prepared by the National Committee on Radiation Protection established by the National Bureau of Standards and drawing members from the medical organizations of the United States, radiation equipment companies, and other Government departments.

ADVENTURES IN ELECTRONIC DESIGN

Centralab's Printed Electronic Circuits May Solve a Problem for You

In a busy Washington  office during the past war  hung a sign  which said — “We do the miraculous every day — the impossible takes just a little longer.” Today, that sign  could hang in the offices of  Centralab. For example, someone wanted a *small* speech amplifier  Centralab's answer —  Ampec, a full 3 stage unit, two of which can fit inside of a regular pack of cigarettes!  A radio manufacturer  wanted a *small* audio-detection unit. Centralab's answer  Audet, a unit one-third size of an ordinary soda-cracker!  How were these things done? With Centralab's  Printed Electronic Circuits — a pioneered  development of  Centralab. Yes, and here are some of the benefits that many manufacturers of radio  TV sets  and other electronic gear  have reaped from using PEC's. They've eliminated numerous individual parts  their handling, inventory  and assembly. They've gotten more consistent and better performance results.  They've reduced finished product size and weight. They've eliminated wiring errors  and cut down on the number of  soldered connections. What's more, they've been able to stretch  their resistor supplies . . . an important factor in meeting current volume demands  for TV and radio production. Look over your own situation.  Want to cut costs?  Speed up assembly?  Then on the next two pages you may see a Centralab Printed Electronic Circuit unit  that will help you do just that! If you don't see what you want — contact us.  Tell us your problems. Maybe we can do the miraculous or take a little longer and accomplish the impossible! 

Centralab — DEVELOPMENTS THAT CAN HELP YOU 

Division of GLOBE-UNION INC., Milwaukee

CUT ASSEMBLY COSTS

Conserve Resistors

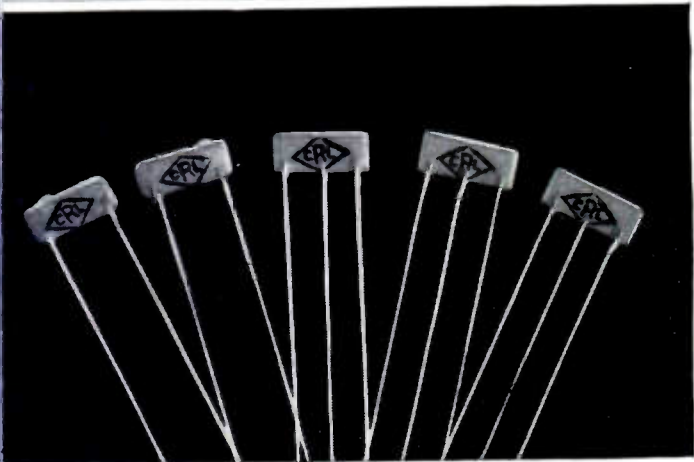

Actual size photograph of a group of plate capacitor, resistor, and resistor-capacitor units. Because of size and ease of installation, they readily fit all types of miniature and portable electronic equipment and overcome crowded conditions in TV, AM, FM and record-player chassis.

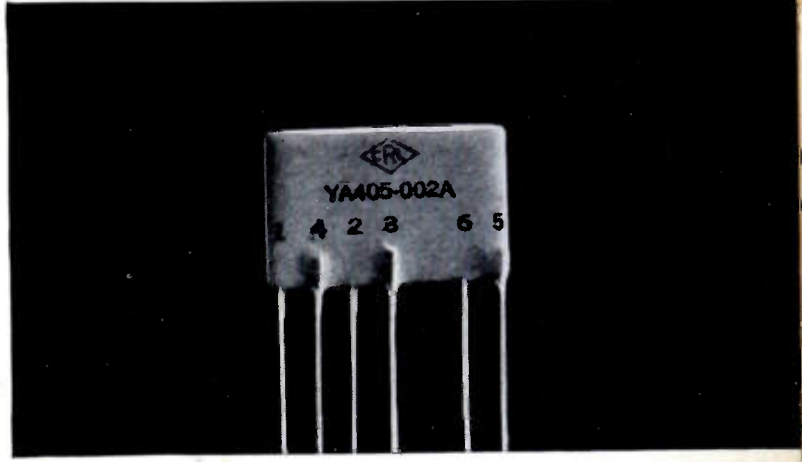

Pentode couplers are complete interstage coupling circuits consisting of 3 capacitors and 3 resistors on a small 6 lead ceramic plate. Compared with old-style audio circuits, they actually reduce soldered connections 50% — wiring errors accordingly. Saving in space and weight is obvious.

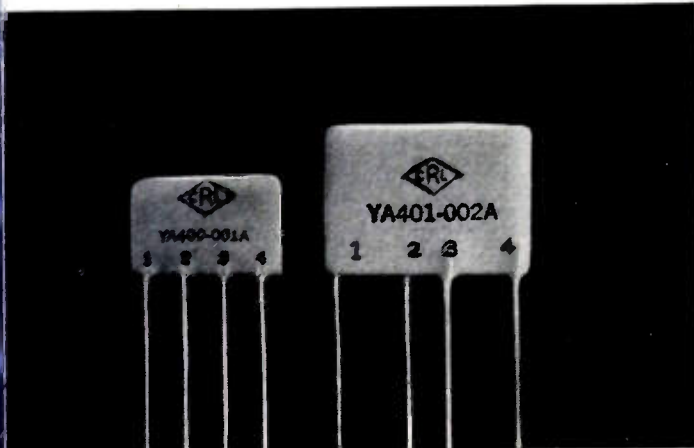

Centralab Triode Couplers save space and weight. They actually replace 5 components normally used in audio circuits. Triode Couplers are complete assemblies of 3 capacitors and 2 resistors bonded to a dielectric ceramic plate. Available in a variety of resistor and capacitor values.

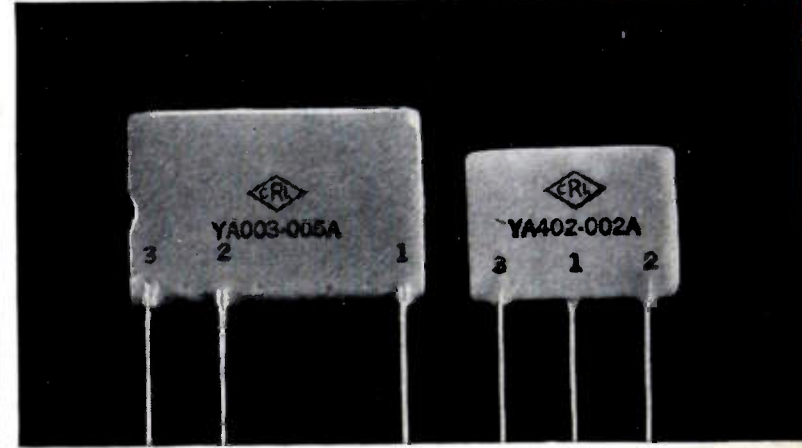

Centralab Vertical Integrators give you big savings in assembly costs, particularly in TV vertical integrator networks. One type consists of 4 resistors and 4 capacitors brought out to 3 leads . . . reducing the formerly required 16 soldered connections to only 3! There's a big saving in the number of parts handled, too!

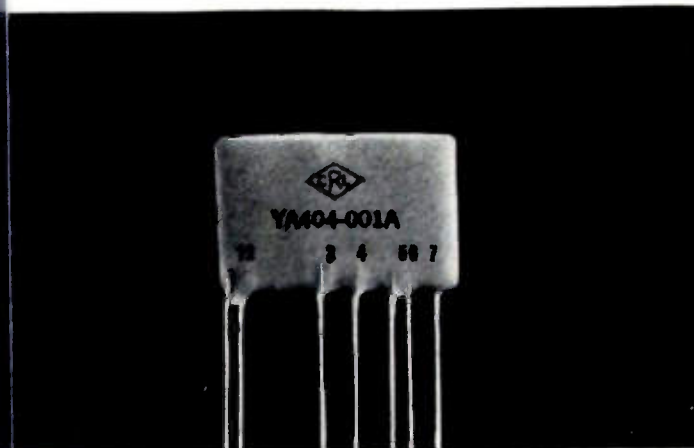

Audet P. E. C. units furnish all values of all components generally comprising the output stage of AC-DC radio receivers. They give you 4 capacitors and 3 resistors on a small plate with only 7 leads. Using Audet for output stage eliminates 50% of your usual soldered connections.

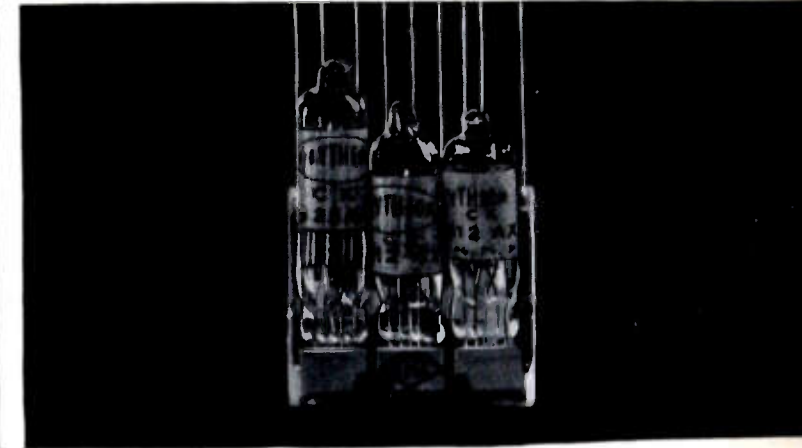

Ampec is a full 3-stage, 3-tube speech amplifier. Gives you truly highly efficient reliable performance. Size: 1 1/4" x 1 1/8" x 3/40" over tube sockets! Widely used in hearing aids, mike preamps and other amplifier applications where small size and outstanding performance counts.

IMPORTANT BULLETINS FOR YOUR TECHNICAL LIBRARY!

They're factual!



THEY'RE FREE!

Choose From This List!

Centralab Printed Electronic Circuits

- 973 — AMPEC — three-tube P. E. C. amplifier.
- 42-6 — COUPLATE — P. E. C. interstage coupling plate.
- 42-22 — VERTICAL INTEGRATOR — for TV application.
- 42-24 — CERAMIC PLATE COMPONENTS — for use in low-power miniature electronic equipment.
- 42-27 — MODEL 2 COUPLATE — for small or portable set applications.
- 999 — PENTODE COUPLATE — specialized P. E. C. coupling plate.
- 42-9 — FILPEC — Printed Electronic Circuit filter.

Centralab Capacitors

- 42-3 — BC TUBULAR HI-KAPS — capacitors for use where temperature compensation is unimportant.
- 42-4R — BC DISC HI-KAPS — miniature ceramic BC capacitors.
- 42-10 — HI-VO-KAPS — high voltage capacitors for TV application.
- 42-59 — CERAMIC TUBULAR TRIMMERS — designed for TV and VHF application.
- 695 — CERAMIC TRIMMERS — CRL trimmer catalog.

- 981 — HI-VO-KAPS — capacitors for TV application. For jobbers.
- 42-18 — TC CAPACITORS — temperature compensating capacitors.
- 814 — CAPACITORS — high-voltage capacitors.
- 975 — FT HI-KAPS — feed-thru capacitors.

Centralab Switches

- 953 — SLIDE SWITCH — applies to AM and FM switching circuits.
- 970 — LEVER SWITCH — shows indexing combinations.
- 995 — ROTARY SWITCH — schematic application diagrams.
- 722 — SWITCH CATALOG — facts on CRL'S complete line of switches.

Centralab Controls

- 42-19 — MODEL "1" RADIOHM — world's smallest commercially produced control.
- 42-85 — MODEL 2 RADIOHM — CRL's new line of 1/8" diam. controls for TV — AM — FM.

Centralab Ceramics

- 967 — CERAMIC CAPACITOR DIELECTRIC MATERIALS.
- 720 — CERAMIC CATALOG — CRL steatite, ceramic products.

Look to CENTRALAB in 1950! First in component research that means lower costs for the electronic industry. If you're planning new equipment, let Centralab's sales and engineering service work with you. For complete information on all CRL products, get in touch with your Centralab Representative. Or write direct.

CENTRALAB

Division of Globe-Union Inc.
900 East Keefe Avenue, Milwaukee, Wisconsin

Yes—I would like to have the CRL bulletins, checked below, for my technical library!

- | | | | | | | |
|--------------------------------|--------------------------------|--------------------------------|--------------------------------|--------------------------------|------------------------------|--------------------------------|
| <input type="checkbox"/> 973 | <input type="checkbox"/> 42-24 | <input type="checkbox"/> 42-9 | <input type="checkbox"/> 42-10 | <input type="checkbox"/> 981 | <input type="checkbox"/> 953 | <input type="checkbox"/> 42-19 |
| <input type="checkbox"/> 42-6 | <input type="checkbox"/> 42-27 | <input type="checkbox"/> 42-3 | <input type="checkbox"/> 42-59 | <input type="checkbox"/> 42-18 | <input type="checkbox"/> 970 | <input type="checkbox"/> 42-85 |
| <input type="checkbox"/> 42-22 | <input type="checkbox"/> 999 | <input type="checkbox"/> 42-4R | <input type="checkbox"/> 695 | <input type="checkbox"/> 814 | <input type="checkbox"/> 995 | <input type="checkbox"/> 967 |
| | | | | <input type="checkbox"/> 975 | <input type="checkbox"/> 722 | <input type="checkbox"/> 720 |

Name.....

Address.....

City..... State.....

TEAR OUT COUPON

for the Bulletins you want

Centralab

Division of GLOBE-UNION INC. • Milwaukee

MARION

... helps the OXY-CATALYST Mfg. Co.

MAKE EXHAUST GASES NON-POISONOUS

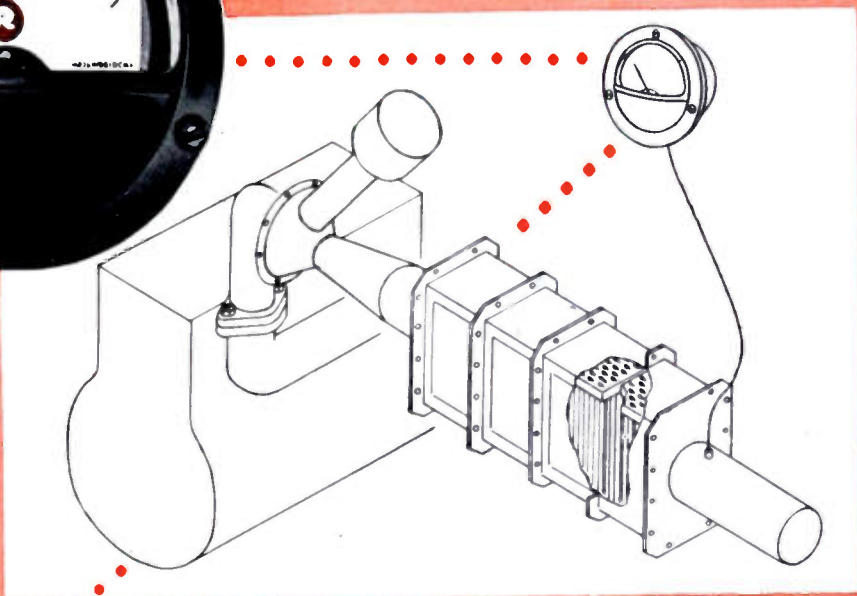

OCM manufactures a new type of Catalytic Exhaust which takes the place of the standard muffler . . . makes the exhaust gases of gasoline engines both non-poisonous and odorless. When applied to Fork Lift Trucks, for example, it makes them safe for inside use.

In developing the OCM Exhaust, a special type of ruggedized pyrometer was needed to withstand the deteriorating abuse to which OCM equipped machines are subjected. Critical accuracy, and exceptional dependability under extreme conditions of shock and vibration were necessary. Only Marion's new line of *ruggedized* instruments could meet these requirements.

This is why every OCM Exhaust now carries a Marion-made, thermocouple-operated pyrometer on the instrument panel. It indicates the temperature of the exhaust gases; tells when the unit is operating within the safe range. It also measures the air-fuel ratio while idling and so keeps a constant check on engine efficiency.

When you seek meters for unusual or standard applications, it will pay you to investigate Marion. Point for point, Marion invites comparison. Ask for catalog. There is no obligation. Marion Electrical Instrument Company, 407 Canal Street, Manchester, New Hampshire.

Canadian Representative: Astral Electric Company, 44 Danforth Road, Toronto, Ontario, Canada
Export Division: 458 Broadway, New York 13, U.S.A., Cables MORHANEX



marion meters



B&W Filter Manufacts*

- HIGH-PASS FILTERS
- LOW-PASS FILTERS
- BAND-PASS FILTERS
- BAND SUPPRESSION OR REJECTION FILTERS

For RF or audio filtering and line RF suppression . . . for harmonic attenuation and teletype communications . . . for single side band and telemetering equipment—these and many more are the uses to which B & W Filters are being applied daily. Time-tested and performance-proved, each of the filters listed above offers you a combination of accuracy and ruggedness that can't be beat in commercial equipment, military equipment . . . ANY EQUIPMENT.

That's why if your equipment requires filters—real filters built for day-in day-out dependability—B & W is the perfect answer. For details, write today to Barker & Williamson, Dept. PR-110.

*Manufacts = Manufacturing facts

BARKER & WILLIAMSON, Inc.
 237 Fairfield Avenue Upper Darby, Penna.

SECTION MEETINGS

- BALTIMORE**
 "Color Television," by A. G. Jensen, Bell Telephone Laboratories; September 20, 1950.
- DAYTON**
 "The Relation Between Science and Philosophy," by R. R. Baker, Faculty, University of Dayton; September 14, 1950.
- DENVER**
 "VHF Amplification," by W. R. Bliss, Decimeter, Inc.; September 8, 1950.
- HOUSTON**
 "Basic Systems of Color Television," and "Circuit Description of a Low-Distortion Class-B Amplifier," by F. H. McIntosh, McIntosh Engineering Laboratory; September 11, 1950.
- INDIANAPOLIS**
 "Transmission Problems on Inter-city Telephone Networks," by M. E. Striely, American Telephone and Telegraph Company; September 18, 1950.
- LONDON**
 "Low Temperature Conductivity," by A. D. Misener, Faculty, University of Western Ontario; and Election of Officers; April 17, 1950.
 "Frequency Conversion Equipment," by F. P. Kehoe, H.E.P.C. of Ontario; May 15, 1950.
- LOUISVILLE**
 "Television Networks," by M. E. Striely, American Telephone and Telegraph Company; September 19, 1950.
- PITTSBURGH**
 "Bell System Inter-city Television Networks," by M. E. Striely, American Telephone and Telegraph Company; September 11, 1950.
- SAINT LOUIS**
 "Television Receiver Circuits," by B. S. Parmet, Motorola, Inc.; June 22, 1950.
- TWIN CITIES**
 Inspection Trip of Radio Station WTC N-TV; May 25, 1950.
 "The Linear Accelerator," by W. G. Shepherd, Faculty, University of Michigan; June 8, 1950.
- WASHINGTON**
 "Measuring with the Electron," by L. Marton, National Bureau of Standards; September 11, 1950.

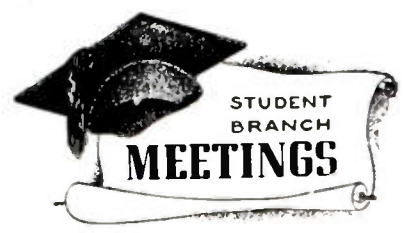

- UNIVERSITY OF KENTUCKY, IRE BRANCH**
 Election of Officers; September 21, 1950.
- SOUTHERN METHODIST UNIVERSITY, IRE-AIEE BRANCH**
 "Electronic Protection Devices," by George Smith, Smith Detective Agency; August 31, 1950.
 Film "Football Game"; September 14, 1950.

Just 60 SECONDS
from now . . .

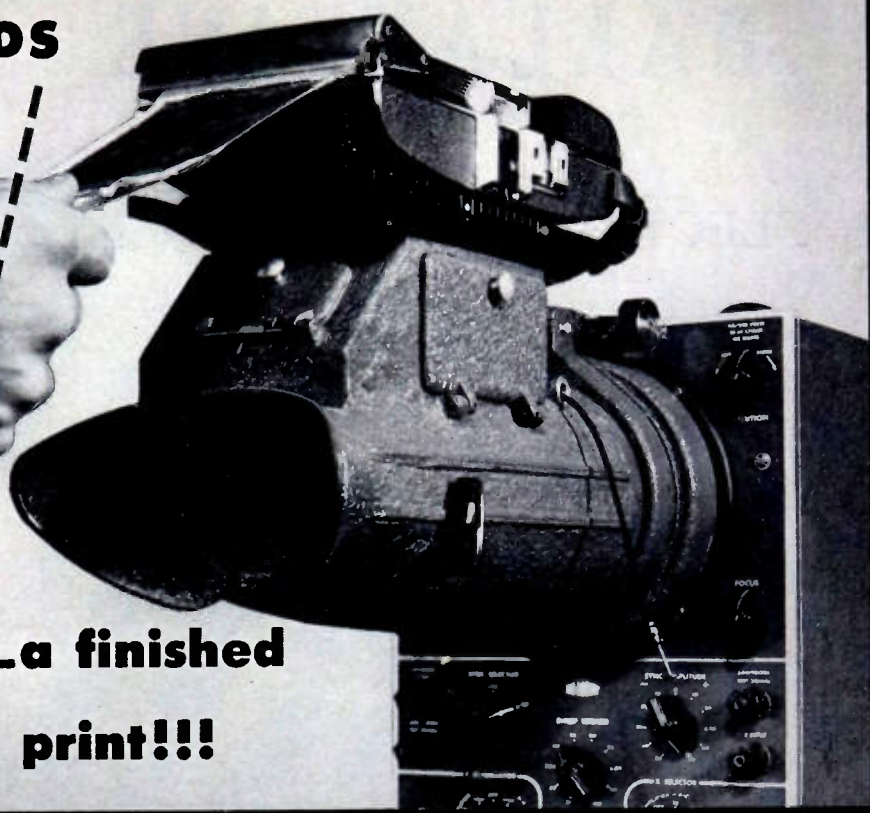
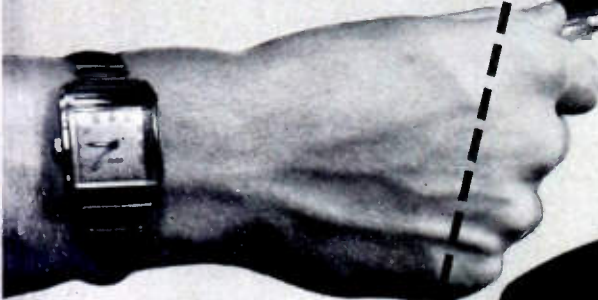

--- a finished
print!!!

... with the camera that brings a new speed and efficiency to oscillograph-recording techniques



The DUMONT TYPE 297 Oscillograph-record Camera

... and far thrifty
SINGLE-FRAME
recording



THE DU MONT TYPE 296 Oscillograph-record Camera

◆ The Type 296 is an inexpensive oscillograph-record camera, greatly improved for general-purpose application with any standard 5-inch cathode-ray oscillograph. It incorporates a compact, all-metal, 35mm camera, calibrated shutter and a high-quality f/2.8, 75mm, coated lens which increases its capability 57% over the Type 271-A which it supersedes. Construction is rugged and durable; operation simple and foolproof. The Type 296 weighs only 4½ lbs.

PRICE . . . \$149.50

◆ You've just advanced the film after making an exposure. That starts the Polaroid-Land "packaged" developing process. And while you're waiting for its completion—in just 60 seconds—you can start the next exposure or set of exposures. With the Type 297, once you've snapped the shutter, its self-contained, 60-second, developing process lets you forget

about the variables of the darkroom.

And with such special oscillographic features as simultaneous viewing and recording, an illuminated data-card, sturdy and easily attached mounting, and overall economy of the Polaroid film, Du Mont has added even greater meaning to this excitingly fast method for "printing" the oscillograph image.

SPECIFICATIONS

LENS—Du Mont-Wollensak f/2.8 or f/1.9, 75mm, coated.

SHUTTER—Wollensak Alphax; shutter speeds of 1/25, 1/50, 1/100 sec. Time and Bulb.

FOCUS—Fixed. May be adjusted for special oscillographic work.

WRITING SPEED—Writing rates of 3.5 in usec. have been recorded consistently at 12,000 volts accelerating potential.

PRINT SIZE—3¼ x 4 ¼ in.—one, two, three, or more exposures per print.

IMAGE REDUCTION RATIO—2.25:1.

PHYSICAL SIZE—Length, 14¾ in.; height, 10 in.; width, 6 in.

WEIGHT—12 lbs.

PRICE \$285.00 with f/2.8 lens
\$355.00 with f/1.9 lens

Write for bulletin on photographic techniques.

ALLEN B. DU MONT LABORATORIES, INC., INSTRUMENT DIVISION, 1000 MAIN AVENUE, CLIFTON, NEW JERSEY

BALLANTINE

STILL THE FINEST
in
ELECTRONIC VOLTMETERS

Ballantine pioneered circuitry and manufacturing integrity assures the maximum in
SENSITIVITY • ACCURACY • STABILITY

- All models have a single easy-to-read logarithmic voltage scale and a uniform DB scale.
- The logarithmic scale assures the same accuracy at *all* points on the scale.
- Multipliers, decade amplifiers and shunts also available to extend range and usefulness of voltmeters.
- Each model may also be used as a wide-band amplifier.



MODEL 300

MODEL	FREQUENCY RANGE	VOLTAGE RANGE	INPUT IMPEDANCE	ACCURACY	PRICE
300	10 to 150,000 cycles	1 millivolt to 100 volts	1.2 meg. shunted by 30 mmfds.	2% up to 100 KC 3% above 100 KC	\$200.
304	30 cycles to 5.5 megacycles	1 millivolt to 100 volts except below 5 KC where max. range is 1 volt	1 meg. shunted by 9 mmfds. on low ranges and 4 mmfds. on highest range	3% except 5% for frequencies under 100 cycles and over 3 megacycles and for voltages over 1 volt	\$225.
305	Measures peak values of pulses as short as 3 microseconds with a repetition rate as low as 20 per sec. Also measures peak values for sine waves from 10 to 150,000 cps.	1 millivolt to 1000 volts Peak to Peak	2.2 megs. shunted by 8 mmfds. on high ranges and 15 mmfds. on low range	3% on sine waves 5% on pulses	\$280.
310	10 cycles to 2 megacycles	100 microvolts to 100 volts	Some as Model 305	3% below 500 KC 5% above 500 KC	\$225.

For further information, write for catalog.

BALLANTINE LABORATORIES, INC. 
102 FANNY ROAD, BOONTON, N.J.



The following transfers and admissions were approved and will be effective as of November 1, 1950:

Transfer to Senior Member

- Carlin, H. J., Microwave Research Institute, Polytechnic Institute of Brooklyn, 55 Johnson St., Brooklyn, N. Y.
Fonda-Bonardi, G., 1551 Tenth St., Manhattan Beach, Calif.
Heck, J. R., 1233 Ten Oaks Rd., Baltimore 27, Md.
Ide, J. M., U. S. Navy Underwater Sound Laboratory, New London, Conn.
Jensen, K. S., 1835 D 18 St., Los Alamos, N. Mex.
Krawitz, M., 1522 55 St., Brooklyn 18, N. Y.
Mabry, F. S., 38 Holmehurst Ave., Baltimore 28, Md.
McCoubrey, A. O., Westinghouse Research Laboratories, Ardmore Blvd., E. Pittsburgh, Pa.
Palin, E. L., 98 Donlea Dr., Leaside 17, Ont., Canada
Rodgers, J. A., Huntington Hills, Rochester 9, N. Y.
Wolfskill, J. R., 450 Long Branch Ave., Long Branch, N. J.
Zenner, R. E., 8732 Washington Ave., Hollywood, Ill.

Admission to Senior Member

- Angel, A. G. H., Officers Mess, Royal Air Force, Manby, Louth, Lincs., England
Corrarino, C. W., 20-36 24 St., Long Island City 5, L. I., N. Y.
Erlanson, P. M., Southwest Research Institute, Box 2296, San Antonio, Tex.
Harris, C. M., Bell Telephone Laboratories, Inc., Murray Hill, N. J.
Winter, D. F., 3 Faculty Lane, St. Louis 5, Mo.

Transfer to Member

- Bark, R. S., 2012 1/2 N. 145, Seattle 33, Wash.
Boss, L. J., 6938 Hammond Ave., Dallas 10, Tex.
Day, J. L., 1614 Hilton Rd., Burlington, N. C.
Dickey, F. E., 947 Maple Ave., Schenectady, N. Y.
Ditkofsky, H., 4847 Esplanade Ave., Montreal 14, Que., Canada
Kerber, S. M., 164 Miramonte Dr., Fullerton, Calif.
Mahoney, T. F., 1585 Great Plain Ave., Needham, Mass.
Sellers, G. W., Capehart Farnsworth Corp., Fort Wayne 1, Ind.
Simmons, J. M., Jr., Box 548, State College, N. Mex.
White, G. J., 69 Beresford Ave., Coventry, Warwickshire, England
Wood, R. V., Jr., 15 Linnaean St., Cambridge 38, Mass.

Admission to Member

- Bellringer, C. C. E., 1460 Decarie Blvd., St. Laurent, Que., Canada
Borsody, B. F., 2317 N. 11 St., Arlington, Va.
Bothwell, F. E., Department of Electrical Engineering, Northwestern University, Evanston, Ill.
Bush, R. S., Radio Station KTHT, 4005 S. Travis, Houston 2, Tex.
Davis, J. N., 734 15 St., N.W., Washington 5, D. C.
Fields, M. H., 302 E. Iris St., Oxnard, Calif.
Horrigan, E. W., 36 Airport Rd., Knowle, Bristol 4, England
Johnson, H. S., 379 E. Buena Loma, Altadena, Calif.
Kellner, R. L., Raytheon Manufacturing Company, Waltham 54, Mass.
Kiriloff, A., 446 W. 23 St., New York, N. Y.
Lindsey, H. K., 2290 Liliha St., Honolulu, T. H.
Lorentz, N. A., 3338 49 Loop, Sandia Base, N. Mex.
Pomper, V. H., 385 Putnam Ave., Cambridge 39, Mass.

(Continued on page 42A)



51V-1 glideslope receiver, covers in place

Glideslope Receiver

51V-1

...inside and out

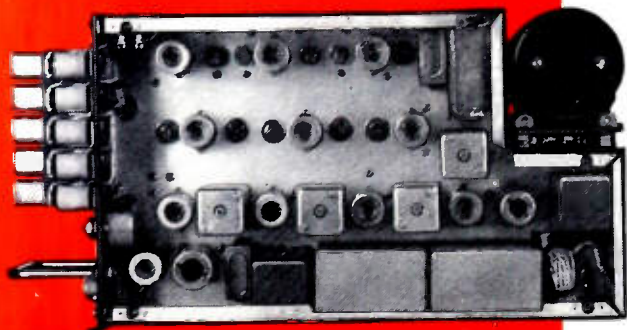

Collins 51V-1 chassis (right side)

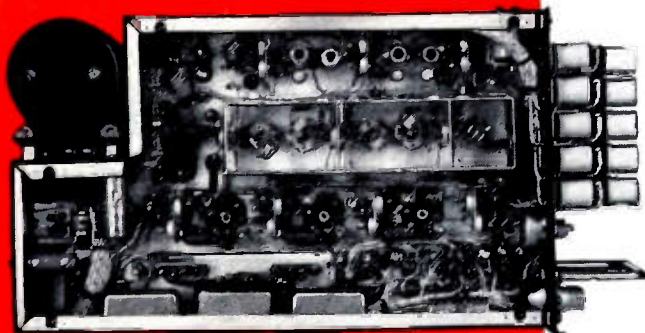

Collins 51V-1 chassis (left side)

THIS is the new Collins 51V-1 glideslope receiver for aircraft. Note the orderly design, and the accessibility of all tubes, components, and wiring.

The 51V-1 provides reception of 90/150 cps tone modulated glideslope signals on any of the twenty channels in the uhf range of 329-335 mc. This receiver together with Collins 51R navigation equipment will fulfill ILS receiving requirements for military, commercial and private aircraft. The design of the 51V-1 is based on "Glideslope Receiver Characteristics" issued by Aeronautical Radio, Inc., and on U. S. Airforce specifications.

Output circuits of the 51V-1 receiver feed standard ID-48ARN deviation indicators including flag alarm. By means of the flag alarm the pilot has a positive indication of the reliability of the glideslope signals and instrumentation.

The 51V-1 control circuits are integrated with the standardized R/θ channeling system with channel selection provided by means of a Collins 314U remote control unit.

More complete information, in the form of an illustrated bulletin, is yours on request.

IN AVIATION RADIO, IT'S...



COLLINS RADIO COMPANY, Cedar Rapids, Iowa

11 West 42nd St., NEW YORK 18

2700 West Olive Ave., BURBANK

"Controlled Reluctance"

MICROPHONES PROVED* TO BE THE
FINE-QUALITY-ECONOMICAL ANSWER TO
MANY MICROPHONE PROBLEMS



MODEL 510

The "HERCULES"—Here is a revolutionary new microphone unit that provides the ruggedness, the clear reproduction, and the high output long needed for Public Address, Communications, Recording at an amazingly low price!

List Price \$14.50



MODEL 520

The "GREEN BULLET"—Specially designed to provide quality music and speech reproduction at moderate cost. A streamlined unit that lends itself to fine-quality, low-cost installations where durability is an important factor. Features high output, good response, high impedance without the need of a transformer.

List Price \$17.50



MODEL 505C

The "RANGER"—Recommended for those applications where long lines are used and a rugged hand-held microphone is needed. Ideal for outdoor public address, mobile communications, hams, audience participation shows, etc. Designed for clear, crisp natural-voice response of high intelligibility. Has heavy-duty switch for push-to-talk operation.

List Price \$27.50



MODEL 520SL

List Price \$35.00

The "DISPATCHER"—Complete unit, includes Model 520 Microphone, A88A Grip-To-Talk Slide-To-Lock Switch, and S36A Desk Stand. Designed to handle the most severe field requirements of paging and dispatching systems. Ideal for police, railroad, taxicab, airport, bus, truck and all emergency communications work.

List Price \$9.00

CONTROLLED RELUCTANCE CARTRIDGE—Available for service installation. Ideal for replacement of crystal cartridges in Shure cases of Models 707A and 708 Series. Can also be used in most semi-directional microphones where space permits. Supplied with rubber mounting ring.

*Specific information provided on request.



MODEL R5

SHURE

Patented by Shure Brothers, Inc.

SHURE BROTHERS, Inc.

Microphones and Acoustic Devices

225 West Huron Street, Chicago 10, Ill. • Cable Address: SHUREMICRO



(Continued from page 40A)

- Ralts, E. J., 210 N. W. First Ave., Mineral Wells, Tex.
Sagert, H. T., Rm. 920, LaSalle Street Sta., Chicago 5, Ill.
Sedlacek, W. C., 628 Iris St., Oxnard, Calif.
Shields, R. R., Box 416, Emporium, Pa.
Simpson, C. L., Rich Valley Rd., Emporium, Pa.
Spear, K. B., 510 E. Hill St., Brownfield, Tex.
Staras, H., 617 S. Fillmore St., Arlington, Va.
Sullivan, H. J., 348 Lincoln Ave., Cranford, N. J.
Watson, J. T., 14 S. Euclid, Indianapolis, Ind.

The following admissions to the Associate grade were approved to be effective as of October 1, 1950:

- Agnew, N. F., 549 Brushlton Ave., Pittsburgh 21, Pa.
Aubey, L. J., Box 89, Beaumont, Tex.
Blair, H. A., Jr., 130 Wilson Dr., Pittsburgh 21, Pa.
Blake, C., 67 N. Main St., Orono, Me.
Blumkin, R., 55 Winthrop St., Brooklyn 25, N. Y.
Bokros, P., 3214 W. Columbia Ave., Philadelphia 21, Pa.
Bouffiou, C. L., 900 Riverside Dr., Aberdeen, Wash.
Bryant, C. S., 47 Northwest 94 St., Miami 38, Fla.
Caffrey, T. J., Clifford House, 2552 Clifford, Detroit 1, Mich.
Camillo, C., 4358 S. Artesian Ave., Chicago 32, Ill.
Chittenden, W. R., 3229 E. Manoa Rd., Honolulu, T. H.
Clarke, H. W., 504 32 St., Saskatoon, Sask., Canada
DeGarmo, A. V., Jr., 1257 W. Forest, Detroit 1, Mich.
Erickson, D. L., 4726 N. Rockwell St., Chicago 25, Ill.
Fahnestock, J. D., 52 Corncrib Lane, Levittown, L. I., N. Y.
Finkel, A., 338 Madison St., N.W., Washington 11, D. C.
Green, S., 59 Bay St., Brooklyn 14, N. Y.
Halle, C., 2863 Mayfield Rd., Cleveland Heights, Ohio
Hammett, T. F., 139 Bedford St., Lexington 73, Mass.
Harnett, G. H., R.F.D. 4, Bloominggrove Tpke., Newburgh, N. Y.
Havens, A. C. B., 160 W. 73 St., New York 23, N. Y.
Herbig, A. J., 150-25 Third Ave., Whitestone, L. I., N. Y.
Howe, W. F., 513 Military Dr., Coeur d'Alene, Idaho
Hull, C. J., Old Powerville Rd., Boonton, N. J.
Johnson, D. A., 627 E. 19 St., Minneapolis 4, Minn.
Kirkjian, E., 1406 Hickory St., Grand Prairie, Tex.
Mann, R. W., 602 W. Cunningham Ave., Urbana, Ill.
Mason, R. F., 25100 Fisher Ave., Euclid, Ohio
Merrill, J. A., 4028 Los Feliz Blvd., 10, Los Angeles 27, Calif.
Mohr, D. B., 375 RCN Sqdn., APO 937, c/o Postmaster, Seattle, Wash.
Moore, C. C., Jr., 208 Via Alcance, Palos Verdes Estates, Calif.
Morley, J. E., 3 Morley Rd., Twickenham, Middlesex, England
Nagy, W. Z., 179 Davis Ave., Staten Island 10, N. Y.
Noble, J. S., Radio Propagation Station, Navy 117, FPO, New York, N. Y.
Palmer, M. V., 4002 Fruit Valley Rd., Vancouver, Wash.
Sikes, R. E., 2012 Tenth Rd., S., Arlington 4, Va.
Sindelar, E. E., 2825 Portman Ave., Cleveland, Ohio
Sirinsky, R., 3329 Ridge Ave., Philadelphia, Pa.
Smollett, R. J., 656 W. Burnside, Caro, Mich.
Snider, D. A., 221 Harriet St., Alton, Ill.
Stevens, H. V., 63 Edson, Buffalo 10, N. Y.
Sweeney, P. M., 3826 N.E. 34 Ave., Portland 13, Ore.
Triantafellow, W., 120-21 142 St., South Ozone Park 20, L. I., N. Y.

(Continued on page 44A)

YOUR CONNECTIONS ARE IMPORTANT!



Spring Action
PLUGS & CAPS
Replacement, "Cord Clamp"
& Manufacturers' Assembly Plugs



Tapmaster
CUBE TAPS
One-Piece Rubber
and Bakelite

Tapmaster INDESTRUCTIBLE, SOLDERLESS, 3-WAY EXTENSION CORD SET
THE MOST EXTENSIVE CORD SET ENGINEERS FOR PRACTICAL EFFICIENCY

NOTE: Spring Action Plug will make Perfect Positive Contact in any outlet.

Special solderless internal connections of wire to plug and socket block are made with no damage to wire and strain relief to cord and strain relief to cord.

Three positive plug holding outlets in the one piece, solderable, self rubber cord block. Can be stripped on with out damaging or distorting contacting plug devices at heavy rubber construction.

Tapmaster EXTENSION CORD SET
Irvington, N. J., U. S. A.

ALLIED ELECTRIC PRODUCTS, INC.
WORLD'S LARGEST MANUFACTURERS OF ATTACHMENT PLUG CAPS

Tapmaster
EXTENSION CORD SETS
3-Way & Single-Outlet Types
6', 9', 12', and 15' Lengths

Poor contact between line plug and wall outlet can cause a heap of trouble in a T-V set or radio. A defective plug or worn outlet can produce voltage drop and arcing . . . and you know what that means to a set.

Take that ounce of prevention! Replace the line plug with a genuine Spring-Action Replacement Plug—the sure way to be sure of positive contact even in a worn outlet. If you need a multiple outlet, use a Tapmaster Cube Tap. Or, if the line cord needs lengthening, use a Tapmaster Extension Cord Set. These products have Spring-Action Blades and Internal Contacts. With them, you'll get good connections any place, all the time.

MR. SERVICEMAN—Save yourself unnecessary service calls. Carry these three connections in your kit. Your jobber can supply them to you.

YOU CAN DEPEND ON THESE OTHER

ALLIED-SHELDON PRODUCTS

FLASH
Sheldon

FLUORESCENT STARTERS

World's Largest Line—
Automatic Cutout . . . Push-Button
. . . Multi-Purpose . . . No-Blink
. . . Standard Types



Sheldon

2, 6 and 15 Amps.
RECTIFIER BULBS

Sheldon

ALUMINIZED REFLECTOR LAMPS

Infra-Red, Flood, Spot, Clear,
Photoflood, Photospot, 2,000
Hour & Outdoor Pyrex Types



WRITE FOR YOUR COPY OF THE NEW ALLIED-SHELDON CATALOG
DELIVERY ON ALL ITEMS ON THIS PAGE — Fair to Middlin'!

ALLIED ELECTRIC PRODUCTS INC.

68-98 Coit Street, Irvington 11, N. J.

Branch Offices & Warehouses: CHICAGO 7, ILL., 426 S. Clinton St. — LOS ANGELES 26, CAL., 1755 Glendale Blvd.

Airtron

DESIGNS AND PRODUCES

Flexible and Rigid

WAVEGUIDE

COMPONENTS

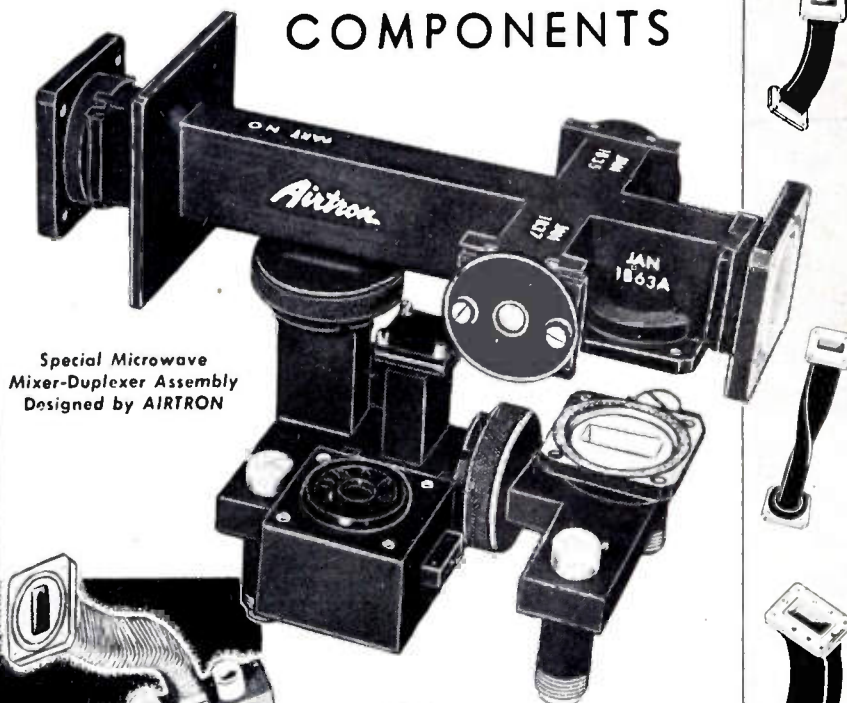

Special Microwave Mixer-Duplexer Assembly
Designed by AIRTRON

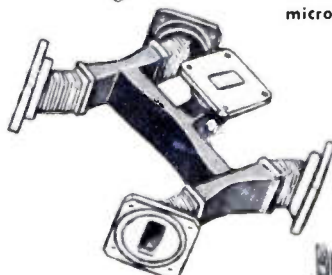
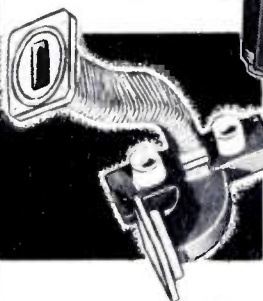

From the smallest waveguide component to complete transmission systems... from the first "doodle" memo or blueprint to the finished precision product... make AIRTRON your FIRST source for all types of microwave plumbing. Unique in background, technical savvy, plant facilities and the WILL to SERVE, this organization is prepared to engineer and manufacture your staple or special requirements in:

- Mixers
- Duplexer Assemblies
- Magic Tees
- Waveguide Switches
- Elbow Bends
- Elbow Miters
- Twisted Sections
- Rigid Twists
- Choke Fittings
- Flexible Waveguides
- Straight Section
- Rotary Joints

Send for AIRTRON Engineering Data on Microwave Plumbing



Airtron

INC.

105 East Elizabeth Ave., Linden, New Jersey
BRANCH OFFICES
Baltimore Los Angeles New York
Boston St. Louis Dallas Dayton



(Continued from page 42A)

- Vergona, A. J., 45 E. Bataan Ave., Clairton, Pa.
- Vernon, H. J., 623 W. Surf St., Chicago, Ill.
- Vogel, C. I., 1950 W. Fort St., Detroit 16, Mich.
- Washeim, W. G., 4603 Snow Rd., Parma, Ohio
- Wehrman, R. B., 624 Rockford Ave., Dayton 5, Ohio
- White, R. A., 913 N. Frederic, Burbank, Calif.
- Zilles, F. J., 918 Agatite, Chicago 40, Ill.

News—New Products

These manufacturers have invited PROCEEDINGS readers to write for literature and further technical information. Please mention your I.R.E. affiliation.

(Continued from page 30A)

Versatile Line Amplifier

A new Type MI-12160 plug-in line amplifier with self-contained power supply is available from Radio Corp. of America, RCA Victor Div., Camden, N. J.

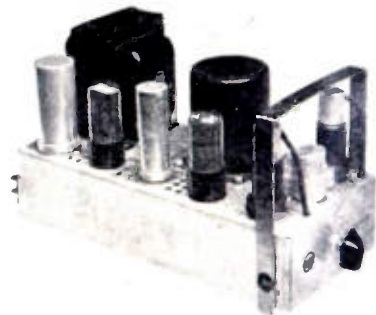

It may be used as a master mixer for supplying zero level to a telephone line, a line amplifier capable of operating from a telephone line, a driver amplifier supplying driving voltage for up to 500 power amplifiers, a monitor amplifier supplying two watts of audio power to a speaker, or a bridging amplifier for bridging a low impedance line. The instrument provides excellent frequency response from 30 to 15,000 cps with low distortion.

New Bent-Gun Features Uniform Screen Focus

Uniform focus over the entire usable screen area is now attained by means of a new bent-gun announced by the Cathode-

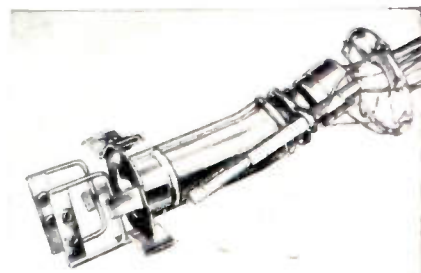

Ray Tube Div., Allen B. Du Mont Laboratories, Inc., 750 Bloomfield Ave., Clifton, N. J.

(Continued on page 48A)

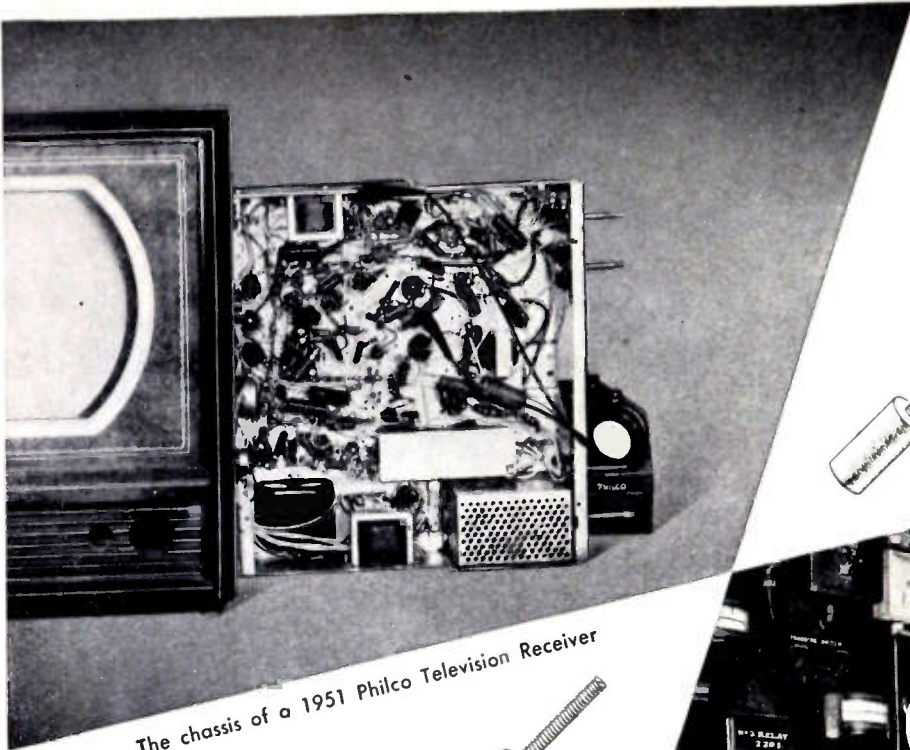

The chassis of a 1951 Philco Television Receiver

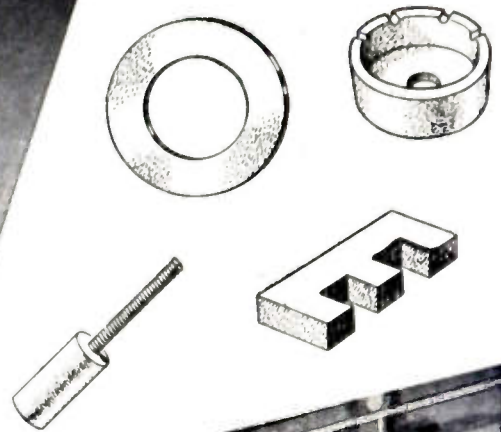

PHILCO CORPORATION

PHILADELPHIA 34
PENNSYLVANIA

September 5, 1950

Mr. T. R. Moore, Sales Manager
Antara Products - General Aniline & Film Corporation
444 Madison Avenue
New York 22, N. Y.

Dear Mr. Moore:

For the past two years Philco has tremendously increased its production of television receivers, and at the same time we have made a concerted drive to improve the quality of all components, as well as the complete receivers.

In line with this successful Quality Control program, we have found that your Carbonyl Iron Powders, used in powdered iron cores for fixed and variable inductances, in such parts as width and linearity coils, IF transformers and tuner coils, result in greater circuit efficiency. At the same time, it has also been possible to reduce the size of components which incorporated powdered iron.

Because of these advantages, reduced size and increased efficiency of components, as well as a uniformly high standard of quality, your Carbonyl Iron Powders have aided us in keeping the quality of Philco television receivers at the highest level. This has been particularly important because we have stepped up quantity of production so greatly along with quality. We are aiming at manufacturing more than 1,000,000 Philco television receivers in 1950.

Very truly yours,

PHILCO CORPORATION
F. M. Craig
F. M. Craig
Director of Engineering -
Electronics Division



In the making of G & F Carbonyl Iron Powders only the strictest methods of Quality Control are observed

G A & F[®] Carbonyl

SIZES REDUCED . . . EFFICIENCY INCREASED for components of **PHILCO** Television Receivers through use of **CARBONYL IRON POWDERS**

PHILCO Television Receivers are produced under rigid, scientific methods of Quality Control . . . So are G A & F Carbonyl Iron Powders . . . It was all but inevitable that the combination would produce components of high efficiency and top performance.

However, Philco was not blindly worshipping an abstract ideal. *Reduced sizes* became a second, highly desirable result. Third, as leading core makers have testified, it *costs*

less to work with quality materials—such as G A & F Carbonyl Iron Powders.

The savings and the gains are both more numerous and more important than are here indicated. Let us send you the book described below . . . Ask your core maker, your coil winder, your industrial designer, how G A & F Carbonyl Iron Powders can improve the performance of the equipment you manufacture. It will cost you nothing to get the facts.

THIS FREE BOOK — fully illustrated, with performance charts and application data — will help any radio engineer or electronics manufacturer to step up quality, while saving real money. Kindly address your request to Department 51.



ANTARA® PRODUCTS
DIVISION OF
GENERAL DYESTUFF CORPORATION
435 HUDSON STREET • NEW YORK 14, NEW YORK

BRANCHES

Boston • Providence • Philadelphia • Charlotte, N. C. • Chicago • Portland, Ore. • San Francisco • Oakland

Iron Powders . . .



It's CP for COAXIAL HALF-WAVE DIPOLE ANTENNAS for two-way mobile service

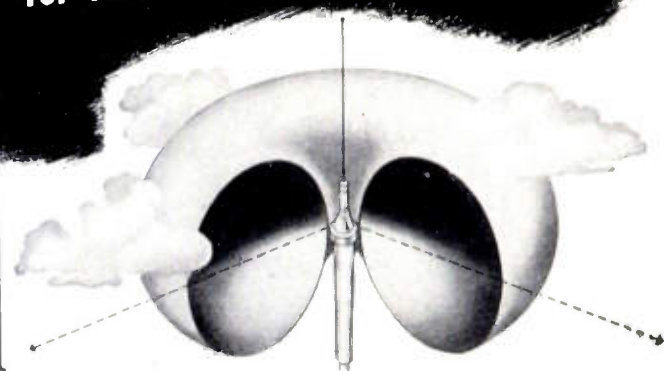

PROVEN RELIABLE AND EFFECTIVE OVER THE YEARS

CP Antennas use one of the most effective—and elemental—forms of antennas serving radio communications. Simple physically and electrically, CP Antennas have earned a reputation for reliability.

CP Coaxial Antennas are ruggedly constructed of selected materials to give satisfactory commercial service under severe operating conditions. They are recommended for both transmission and reception. Power handling capacity is limited only by the rating of the feed line. All antennas feature rust-proof construction throughout with necessary accessories for simple, positive installation.

Ask for your copy of CP Bulletin 106

This new bulletin, compiled by the engineering staff of Communication Products, provides complete data on CP antenna construction, as well as detailed specifications and operational information. Fully illustrated with photographs and schematic sketches. Call or write CP, now, for Bulletin 106 or literature on any of the products listed below.

YOU CAN DEPEND ON THESE CP PRODUCTS

- ✓ LO-LOSS SWITCHES
- ✓ TEFLON TRANSMISSION LINE
- ✓ AUTO-DRY-AIRE DEHYDRATORS
- ✓ COAXIAL DIPOLE ANTENNAS
- ✓ TOWER HARDWARE



Communication Products Company, Inc.

KEYPORT  NEW JERSEY

News—New Products

These manufacturers have invited PROCEEDINGS readers to write for literature and further technical information. Please mention your I.R.E. affiliation.

(Continued from page 44A)

A higher degree of prefocusing in the new gun passes a smaller diameter beam bundle through the deflection field. This reduces spot distortion and results in uniform focus over the entire usable screen.

A new grid-cathode assembly makes it possible to obtain this greater prefocusing without increasing the over-all length of the tube. An improved bulb spacer simplifies gun centering and insures proper anode contact. Stray emission at higher voltages is minimized by rounding the corners of pertinent gun components.

These latest developments, which retain the advantage of employing a single beam-bending magnet, are being incorporated in all Du Mont Teletrons.

UHF Admittance Meter

General Radio Co., 275 Massachusetts Ave., Cambridge 39, Mass. has developed a new Type 1602-A uhf admittance meter, a null-type instrument, based on coaxial-line techniques for making impedance measurements at ultra-high frequencies. It is simple in operation, and just as easy to use as a low-frequency bridge. It balances in the same manner as a bridge and indicates conductance and susceptance on direct-reading dials, calibrations of which are independent of frequency; and the null settings for both components are completely independent.

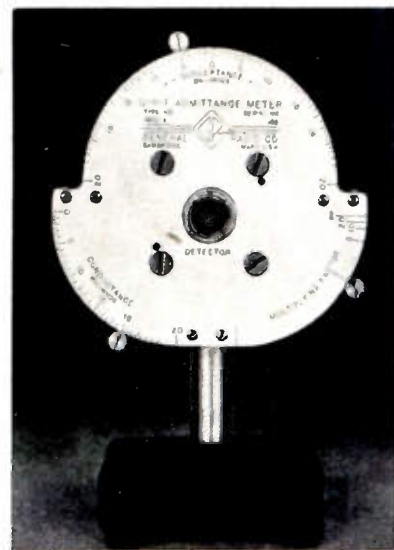

The meter can be used to measure conductances, and susceptances of either sign, from one millimho to 400 millimhos (1,000 ohms to 2.5 ohms) over a frequency range from 70 to 1,000 Mc, thus covering both the present and the proposed new uhf television bands. Accuracy is ± 5 per cent. The admittance components can be easily converted to impedance, if desired, by using a Smith chart or Smith-chart slide rule.

(Continued on page 65A)

NEW INDICATOR ION TRAP

Now in all Rauland Tubes



The response to Rauland's new Indicator Ion Trap, after its introduction in the 12LP4-A, has been so enthusiastic that this feature has now been incorporated in all Rauland tubes—as a standard feature of the new Rauland Tilted Offset Gun.

In the field or on the assembly line, this new Indicator Ion Trap reduces Ion Trap Magnet adjustment time to a matter of seconds, eliminates mirrors and guesswork, and assures accuracy of magnet adjustment. It can increase profits for every service man and service dealer—and at the same time assure better customer satisfaction.

A bright green glow on the anode of the picture tube signals when adjustment is incorrect. Correct adjustment is made instantly, by moving the magnet until the glow is extinguished or reduced to minimum.

Only Rauland offers this advanced feature—one of a half-dozen important post-war developments from Rauland.

RAULAND

The first to introduce commercially these popular features:

Tilted Offset Gun

Indicator Ion Trap

Luxide (Black) Screen

Reflection-Proof Screen

Aluminized Tube



THE RAULAND CORPORATION



Perfection Through Research

4245 N. KNOX AVENUE • CHICAGO 41, ILLINOIS



The W. L. MAXSON
CORPORATION

IS

SEEKING

Outstanding

ENGINEERS

AND

PHYSICISTS

with

AMBITION

TO

FURTHER

PRESENT

STANDING

Immediately

Minimum Requirements are:

1. Five to ten years experience in advanced electronic research and development
2. Outstanding record of ingenuity
3. Ph.D., M.S. or equivalent

Please send résumé and salary requirements to:

The W. L. MAXSON
CORPORATION
460 W. 34th St.
New York 1, N.Y.



The following positions of interest to I.R.E. members have been reported as open. Apply in writing, addressing reply to company mentioned or to Box No. . . . The Institute reserves the right to refuse any announcement without giving a reason for the refusal.

PROCEEDINGS of the I.R.E.
1 East 79th St., New York 21, N.Y.

CIRCUITS ENGINEER

Rapidly expanding company in instrumentation field has opening for senior engineer. Prefer man with masters degree and 4 or more years of experience in design of pulsing circuits, VHF and UHF. Excellent opportunity for man who can meet requirements. Location Brooklyn. Send complete resume to Box 623.

PHYSICIST

Physicist for fundamental electron tube research. Should be familiar with techniques of producing photo-electric, secondary emissive and fluorescent screens, experience with electron-optics, physical optics and solid state physics an advantage. Box 624.

SALESMAN

Salesman to organize and promote sales of high quality radio resistors now being produced by a company well established in radio and electrical component industry. Give summary of experience and availability in reply. Box 625.

ASSISTANT PROFESSOR AND JUNIOR INSTRUCTOR

Strong eastern college has opening for Assistant Professor and Instructor in electrical engineering. Master of Science in electrical engineering is required, and industrial experience is desirable. Send resume of qualifications, references and salary required. Box 626.

PHYSICISTS AND ENGINEERS

Cornell Aeronautical Laboratory, an affiliate of Cornell University, has permanent positions open in fields of pure and applied physics for men of project engineer caliber with advanced degrees and experience in physics, applied mathematics, electronics, and mechanical instrument design. The position of our laboratory is between those of universities and commercial research institutes, and combines, we believe, many of the traditional advantages of both. Inquiries confidential; address Mr. Nathaniel Stimson, Dept. R, Cornell Aeronautical Lab., P.O. Box 235, Buffalo 21, N.Y.

ELECTRONIC PHYSICIST

Electronic physicist for research and development work on instrumentation problems with major petroleum refiner. Degree in physics essential, M.S. or Ph.D. preferred. Must have a minimum of 5 years research experience on a variety of electronic problems and demonstrated ability to develop new and ingenious electronic devices. Age 28-40. Location Chicago. Salary dependent upon training and experience. Reply in confidence giving full details to Box 627.

(Continued on page 52A)

**ELECTRONICS
TECHNICIANS
WANTED**

The RCA Service Company, Inc., a Radio Corporation of America subsidiary, needs qualified electronics technicians for U. S. and overseas assignments. Candidates must be of good character and qualified in the installation or maintenance of RADAR or COMMUNICATIONS equipment or TELEVISION receivers. No age limits, but must have at least three years of practical experience.

RCA Service Company offers comprehensive Company-paid hospitalization, accident and life insurance programs; paid vacations and holidays; periodic review for salary increases; and opportunity to obtain permanent position in our national and international service organization, engaged in the installation and maintenance of AM, FM, and TV transmitters, electronic inspection devices, electron microscopes, theatre and home television, r-f heating equipment, mobile and microwave communications systems, and similar electronic equipment.

Base pay, overseas bonus, payments for actual living and other expenses, and benefits mentioned above add up to \$7,000 per year to start for overseas assignments, with periodic review of base salary thereafter. Openings also available at proportionately higher salaries for specially qualified technicians with supervisory ability.

Qualified technicians seeking an advantageous connection with a well-established company, having a broad-based, permanent peacetime and wartime service program, write to:

Mr. G. H. Metz,
Personnel Manager,
RCA Service Company, Inc.,
Camden 2, New Jersey.

Potter INSTRUMENT COMPANY

ANNOUNCES

INCREASED MANUFACTURING & DEVELOPMENT FACILITIES

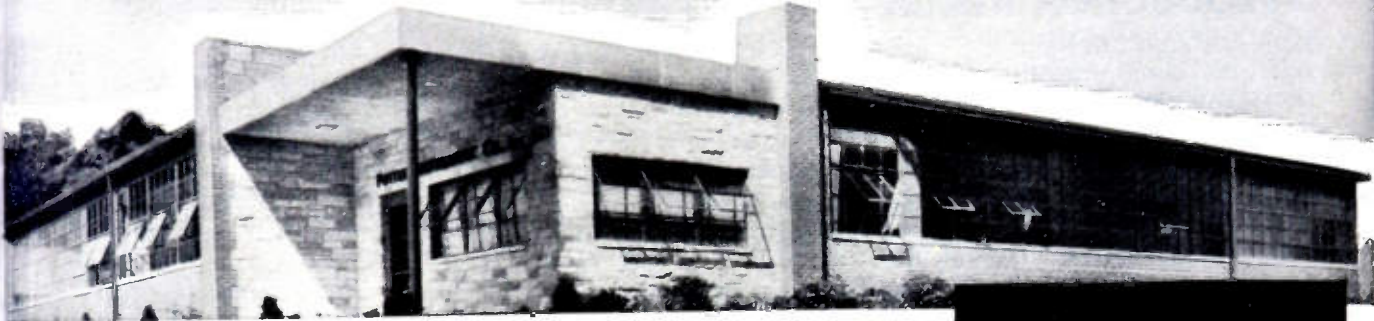

YOU, OUR CUSTOMERS, have been presenting us with problems which require skill not only in electronic circuitry but in unique mechanical design as well.

In solving many of your problems, we have found it necessary to think in terms of the most compatible combination of electronics and mechanics. Many companies are expert in one or the other of these fields, but a company which is skilled in both is rather rare. Realizing this fact, we have made a greater effort to mold our organization and facilities accordingly. Our latest step in this direction has been to construct a new plant with complete machine shop facilities and increased manufacturing space. Another goal for which we have been striving is circuit simplification. Our philosophy for the last eight years has been to design equipment with the fewest number of tubes and components without compromising on dependability. The result of this philosophy is evident in the basic 4-lamp Potter Decade and in new equipment designs yet to be announced. These include simplified and economic arithmetic units, multi-purpose shift registers, storage devices, photoelectric readers, tape handlers and a radically new high speed line-at-a-time printer. If you are concerned with problems in these fields write to Dept. 5-C for additional information.

- High Speed Electronic Counters and Scalers
- Precision Chronograph and Timing Instruments
- Frequency Measurement Counters
- Electronic Digital Computers and Memory Devices
- High Speed Printer Units and Data Handling Equipment



POTTER INSTRUMENT COMPANY

INCORPORATED

115 CUTTER MILL ROAD, GREAT NECK, NEW YORK



PREDETERMINED COUNTERS feature counting rates to 60,000 per minute, absolute accuracy, instantaneous automatic reset, simple dial selection of count.

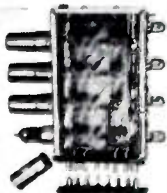

DECADE COUNTER provides direct decimal read-out with the simplest most reliable decade circuit made. Finest components, superb construction.

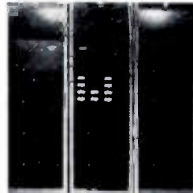

TIME STUDY COMPUTER—custom designed to compute operation waiting time for payroll applications, etc.; also computes most efficient combination of man and machine.

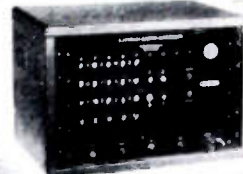

1.6 MC COUNTER CHRONOGRAPH with high resolution and accuracy (1/1,600,000 second). Indicates intervals up to 1 second. Dependable, stable, no adjustments required.

ELECTRONIC ENGINEERS

BENDIX RADIO DIVISION

Bendix Aviation Corporation

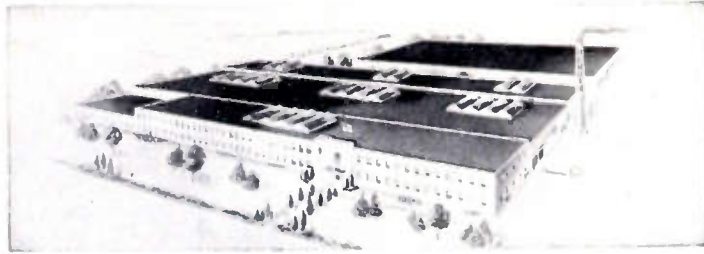

PRODUCTION DESIGN

RESEARCH

Bendix Radio Division, a leader in the field of high quality radar and communications equipment, has positions for engineers experienced in the design and development, for production, of radio and radar equipment or electronic research.

Positions are available at all salary levels.

Good advancement opportunities, air-conditioned plant in suburban location, excellently equipped laboratories, technical library, large experimental engineering model shop.

Housing and rentals in Baltimore are plentiful.

Interviews will be held in Baltimore, Chicago and New York.

Please send resume of experience promptly to:

MR. W. L. WEBB, Director Engineering and Research

BENDIX RADIO DIVISION

Bendix Aviation Corporation • Baltimore 4, Maryland

Bachelors, Masters, Ph.D.'s in PHYSICS or E.E.; Experienced Electronic Engineers; Supervisory Personnel for vital war work.

OPPORTUNITY ON LONG ISLAND

for research minded engineers

Offers attractive working conditions, salary commensurate with experience, access to graduate schools, first-rate research and development facilities; other advantages.

Projects underway in fields of microwave receivers, transmitters, antennas; radar, air traffic control; servos, motor control systems; general electronics.

Write **PERSONNEL MANAGER**

Airborne Instruments Laboratory
INCORPORATED

160 OLD COUNTRY ROAD • MINEOLA, N.Y.

ENGINEERING OPPORTUNITIES MODERN LABORATORIES IN LOS ANGELES AREA

Unusual opportunity for Senior men with degree and a background of proven accomplishment.

ELECTRONIC ENGINEERS
PHYSICISTS-CIRCUITRY
PHYSICISTS-ANALYSIS
PHYSICISTS-OPTICS

SERVOMECHANISMS
ENGINEERS
ELECTRO MECHANICAL
DESIGNERS
MECHANICAL DESIGNERS

Long term program of research and development.

Please do not answer unless you meet the above requirements.

RESEARCH AND DEVELOPMENT LABORATORIES

Hughes Aircraft Company
CULVER CITY, CALIFORNIA



(Continued from page 50A)

ENGINEER

Well known German radio manufacturer has immediate opening for engineer with design and development experience in FM-TV equipment. Factory situated in mountainous part of southern Germany (U.S. Zone) with pleasant living conditions (summer and winter sports). German language desirable. Please write to Z.G. 931—Annoncen-Expedition Carl Gabler, GMBH, Munich, Germany.

PROJECT ENGINEERS

Five years or more experience in charge of design and development of radio and communication equipment. Must be a graduate of a credited engineering school. Well equipped laboratory in modern radio and television plant, with excellent opportunities for advancement. Send resume of qualifications to Mr. S. F. Cascio, Personnel Director, Hallicrafters Company, 4401 West Fifth Avenue, Chicago 24, Illinois.

ENGINEERS

A very large vacuum tube and cathode ray tube manufacturer has attractive openings for experienced vacuum tube engineers. It will be to your benefit to investigate these possibilities. Please write to Box 628.

SENIOR ELECTRONIC ENGINEER

Opportunity with manufacturer of electronic electro-mechanical and radiation instruments. Requirements: 5 years experience in design and development of pulse circuit computers, nuclear instrumentation or video circuits required. Manufacturing or production experience desirable. Send complete resumes and salary requirement to: Berkeley Scientific Company, P.O. Box 1826, Richmond, Calif.

PRODUCTION ENGINEER

Opportunity with manufacturer of electronic, electro-mechanical and radiation instruments. Requirements: 5-10 years experience as electronic and mechanical instrument production engineer in small lot production. Thorough electronic theory grounding. Send complete resume and salary requirements to Berkeley Scientific Co., P.O. Box 1826, Richmond, Calif.

ELECTRICAL ENGINEER

Graduate with experience in design and production technique of specialized electronic tubes other than high production transmitting and receiving types. Bendix Aviation Corp., Kansas City Division, P.O. Box 1159, Kansas City, Missouri.

ELECTRONIC ENGINEER

Excellent opportunities are offered by one of the leading concerns in the electronic computer field to engineers with development or design experience in video and pulse circuitry or test and maintenance experience in the radar, television or computer fields. Send complete information to Personnel Dept., Eckert-Mauchly Computer Corporation, 3747 Ridge Avenue, Philadelphia 32, Pa.

ELECTRONIC ENGINEER

Senior graduate engineer with at least 10 years experience in receiver design.

(Continued from page 54A)

ANOTHER *New* RAYTHEON SUBMINIATURE THE CK5829 TWIN DIODE

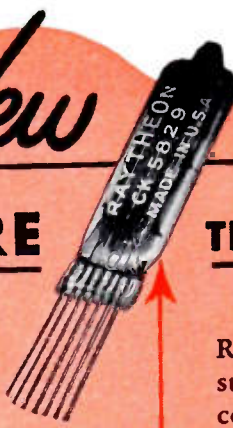

TO PROVIDE YOU WITH

1. High perveance (performance compares favorably with that of the larger 6AL5)
2. Low heater current (150 ma.); half as much as the 6AL5
3. Moderate cost

RAYTHEON *Subminiature Tubes* have long been standard throughout the world. More of them are in commercial use than all other makes combined. They assure *greater product salability* due to size reduction — *greater convenience* because they fit standard sockets or can be soldered or welded into the circuit, and because over half a million are available from stock; over 300 Raytheon Tube Distributors are at your service — *greater dependability*, backed by unsurpassed technical resources and a dozen years of production and application experience with long-life Subminiature Tubes.

— NEW TYPES

This chart gives you at a glance the characteristics of representative Raytheon Subminiature Tubes

Type No.	Remarks	Maximum Diameter Inches	Maximum Length Inches	Filament Or Heater		Mutual Conductance umhos	Power Output MW	TYPICAL OPERATING CONDITIONS				Grid Volts
				Volts	Ma.			Plate Volts	Ma.	Screen Volts	Ma.	
HEATER CATHODE TYPES												
CK626CX	Half Wave Rectifier	0.400	1.75	6.3	300			45				
CK5702/CK603CX	Characteristics of 6AR5	0.400	1.5	6.3	200	5000		120	7.5	120	2.5	Reverse peak 850 volts
CK5703/CK608CX	Triode, UHF Oscillator, 3/4 watts at 500 Mc	0.400	1.5	6.3	200	5000		120	9.0			Reverse peak 850 volts
CK5704/CK6068X	Diode, equivalent to one-half 6AL5	0.315	1.5	6.3	150			150ac	9.0			
CK5744/CK619CX	Triode, High mv.	0.400	1.5	6.3	200	4000		250	4.0			Reverse peak 850 volts
CK5784	Characteristics of 6AS6	0.400	1.5	6.3	200	3200		120	5.2	120	3.5	Reverse peak 850 volts
CK5829	Similar to 6AL5	0.300x0.400	1.5	6.3	150			117ac	5.0 per section			
FILAMENT TYPES												
1A04	Shielded RF Pentode	0.300x0.400	1.5	1.25	100	2000		45.0	2.8	45.0	0.0	Bg=2meg
2E31-32	Shielded RF Pentode for pocket radio	0.300x0.400	1.56	1.25	50	500		22.5	0.4	22.5	0.3	0
2E35-36	Output Pentode for pocket radio	0.290x0.390	1.56	1.25	30		6	45.0	0.45	45.0	0.11	-1.25
2E41-42	Diode Pentode for pocket radio	0.290x0.390	1.56	1.25	30	375		22.5	0.35	22.5	0.12	0
2G21-22	Triode Heptode for pocket radio	0.300x0.400	1.56	1.25	50	60		22.5	0.20	22.5	0.20	0
						conv. cond		45.0	1.5	Special Circuit		
8K61	Gas Triode, Exp. Radio Control	0.550	1.83	1.4	50			45.0	1.5	Special Circuit		
CK510AX	Double Space Charge Tetraode Amplifier	0.285x0.400	1.25	0.625	50	150†		45.0	0.06			0
						both units		22.5	0.125	22.5	0.04	-0.625
CK512AX	Low microphonic voltage amplifier	0.285x0.385	1.25	0.625	20	371		22.5	0.30	22.5	0.08	0
CK522AX	Output Pentode 20 ma. filament	0.285x0.385	1.5	1.25	20	450	1.2	22.5	0.30	22.5	0.08	0
CK524AX	Output Pentode	0.285x0.385	1.5	1.25	30	300	2.2	15.0	0.45	15.0	0.125	-1.75
CK525AX	Output Pentode	0.285x0.385	1.5	1.25	20	325	2.2	22.5	0.25	22.5	0.06	-1.2
CK526AX	Output Pentode	0.285x0.385	1.5	1.25	20	400	3.75	22.5	0.45	22.5	0.12	-1.5
CK527AX	Output Pentode 15 ma. filament	0.285x0.385	1.5	1.25	15	225	0.75	22.5	0.10	22.5	0.025	0
CK529AX	Shielded Output Pentode	0.290x0.390	1.515	1.25	20	350	1.6	15.0	0.32	15.0	0.075	-1.25
CK533AX	Output Pentode	0.285x0.385	1.5	1.25	15	400	1.8	22.5	0.36	22.5	0.09	0
CK534AX	Voltage Amplifier	0.285x0.385	1.25	0.625	15	301		15.0	0.0047	15.0	0.0014	-0.625
CK535AX	Output Pentode	0.285x0.385	1.5	1.25	20	350	1.6	15.0	0.32	15.0	0.075	-1.25
CK551AXA	Diode Pentode	0.300x0.400	1.56	1.25	30	235		22.5	0.17	22.5	0.043	0
CK552AXA	RF Pentode	0.300x0.400	1.56	1.25	50	550		22.5	0.42	22.5	0.13	0
CK571AX	10 ma. filament Electrometer Tube, I _g = 2x10 ⁻¹¹ amps. max.	0.285x0.400	1.5	1.25	10	1.61		10.5	0.20	Triode Conn.		-3.0
CK573AX	Triode, High-Freq. Osc.	0.300x0.400	1.5	1.25	200	2000		90.0	11.0			+4.0
CK574AX	Shielded Pentode RF Amplifier	0.290x0.390	1.25	0.625	20	160		22.5	0.125	22.5	0.04	-0.625
CK5672	Output Pentode	0.285x0.385	1.5	1.25	50	650	65.0	67.5	3.25	67.5	1.1	-6.5
CK5676/CK568AX	Triode, UHF Oscillator	0.300x0.400	1.5	1.25	120	1600		135.0	4.0			-5.0
CK5677/CK568AX	Triode, UHF Oscillator	0.300x0.400	1.5	1.25	60	650		135.0	1.9			-6.0
CK5678/CK569AX	Shielded RF Pentode	0.300x0.400	1.515	1.25	50	1100		67.5	1.8	67.5	0.48	0
CK5697/CK570AX	Electrometer Triode Max. grid current 5x10 ⁻¹¹ amps.	0.285x0.400	1.25	0.625	20	1.5†		12.0	0.22			-3.0
CK5785	High voltage rectifier	0.300x0.400	1.5	1.25	15			0.1				Inverse peak 3500 volts
CK5851	Class C, RF Beam Triode	0.400	1.6	1.25	110	1600		125	5.5	125	1.0	-7.5
CK5889	7.5 ma. filament electrometer pentode I _g = 3x10 ⁻¹¹ amps. max.	0.285x0.385	1.6	1.25	7.5	14		12.0	0.005	4.5	0.005	-2.0
VOLTAGE REGULATORS												
CK5743	Voltage reference tube — like 5651	0.400	1.625					Operating voltage 87.		Operating current range 1.5 to 3.5 ma.		
CK5787	Voltage regulator	0.400	2.06					Operating voltage 100.		Operating current range 5 to 25 ma.		

CK ® BK ®

[Voltage Gain Ratio.



RAYTHEON MANUFACTURING COMPANY

SPECIAL TUBE SECTION • Newton 58, Massachusetts

Excellence in Electronics SUBMINIATURE TUBES • GERMANIUM DIODES and TRIODES • RADIATION COUNTER TUBES • RUGGED, LONG LIFE TUBES

TECHNICAL EDITORS AND WRITERS

These are senior positions, the men selected must be able to outline, compile, edit, proofread, plan and check art, dummy, and direct the final publication of technical and scientific publications.

A good working knowledge of radio and radar theory and application is essential, in addition to extensive editorial and journalistic experience. Some knowledge of structural and mechanical engineering is desirable.

Send complete resume with first letter to:

James E. Thompson
Department 29
HUGHES AIRCRAFT
COMPANY
Culver City, California

All replies will be handled in the strictest confidence



(Continued from page 52A)

Minimum of 2 years experience UHF desirable. Must be capable of assuming project responsibility. Location Connecticut. Excellent opportunity. Salary high. Submit resume. Box 631.

ELECTRONIC ENGINEERS

Electronic engineers with a background in patent specification writing desired for an expanding Patent Dept. in a growing research and development organization located in the midwest. Unlimited opportunity for advancement for properly qualified men. Law degree unnecessary. Must be U. S. citizen and free to make occasional trips to Washington, D.C. Please give full details in first letter. Box 630.

ELECTRONIC ENGINEERS

The U. S. Naval Ordnance Experimental Unit is located at the National Bureau of Standards, Washington, D.C. The following vacancies exist in grades GS 14, \$8,800, GS 13, \$7,600 and others of Electronic Engineers (General) (Radar) (Instrumentation) and (Stabilization). Assignments will include consultation, evaluation and product engineering in the development of guided missile components. Enclose copy of Civil Service Application Form 57 (obtainable at local post office) and address completed form to Officer in Charge, U. S. Naval Ordnance Experimental Unit, National Bureau of Standards, Washington 25, D.C.

(Continued on page 56A)

ENGINEERS & DESIGNERS EQUIPMENT DEVELOPMENT

GENERAL ELECTRIC COMPANY HAS IMMEDIATE OPPORTUNITIES FOR EXPERIENCED EQUIPMENT DEVELOPMENT ENGINEERS AND DESIGNERS

Must have thorough knowledge automatic equipment and manufacturing processes for receiver tubes, television receivers and components.

Men needed must be able to supervise as well as know details of designing and developing automatic machinery.

Write Electronics Dept., General Electric Co., P.O. # 1122, Electronics Park, Syracuse, N.Y., giving detailed resume, work record, references, salary requirements and availability.

WRITE FOR JOB IN SAN DIEGO NOW

ELECTRONICS ENGINEERS

We need engineers for electronics research development and production. Real opportunity for graduate engineers with 5 or more years experience in basic circuit design, pulse, micro-wave, system analysis, electronic project coordination and administration. Openings for project leaders, senior designers, assistant project leaders and staff specialists.

Congenial associates, and superior living conditions in wonderful San Diego. Write today to H. T. Brooks, Engineering Personnel Office,

CONVAIR

(Consolidated Vultee Aircraft Corporation)
 3302 PACIFIC HIWAY, SAN DIEGO, CALIFORNIA

PHYSICISTS AND ENGINEERS

You can find plenty of positions where you will work on minor improvements on radar, telemetering systems, and other conventional devices. However, you will find very few positions where you can break ground in new fields having tremendous significance. This you can do at the JACOBS INSTRUMENT COMPANY, whose entire effort is devoted to pioneering activities in new fields that it has opened up itself. One of these fields, for example, is that of ultra-high speed, ultra-compact digital computers and controllers. This company's JAINCOMP family of computers dominates this field. Other equally important fields are being developed. Engineers and physicists with sound backgrounds and experience in the design of advanced electronic circuits or precision mechanical instruments may qualify, also individuals with good backgrounds in applied physics. A few openings exist for outstanding junior E. E.'s and physicists, also experienced technicians; applicants for these positions must apply in person.

JACOBS INSTRUMENT CO.

4718 Bethesda Ave.
 Bethesda 14, Maryland

..this letter speaks for itself!

Admiral Corporation

SERVICE DIVISION

701 E. SOUTH WATER STREET - CHICAGO 44 - TELEPHONE WOODMONT 4-4332

Mr. Mel Buchring
Simpson Electric Company
5200 West Kinzie Street
Chicago 44, Illinois

Dear Mel:

This is to tell you how delighted we are here at Admiral with the new Model 303 Simpson Vacuum Tube Volt-Ohmmeter. It certainly is a versatile instrument for television servicing.

The large meter is very legible, and yet the instrument itself is a compact size. I particularly like the AC voltage range, which is the widest I've ever seen on this type of instrument.

Our service engineers think you've done a good job on the Operator's Manual, too, because it is both complete and concise.

Of course, we've used the Simpson Model 260 Volt-Ohm-Milliammeter for years. The "303" is a fine companion instrument to the "260".

Congratulations!

Sincerely yours,

M. J. Schlink
ADMIRAL CORPORATION
M. J. Schlink
National Service Manager

MJSiar

WORLD'S LARGEST MANUFACTURERS OF RADIO PHOTOGRAPHIC AND AUTOMATIC DEVICES
50-10 Lakeside • 1000 North • Lake Parkway • Chicago, Ill. • Main Office



**Model 303
VACUUM TUBE
VOLT-OHMMETER**

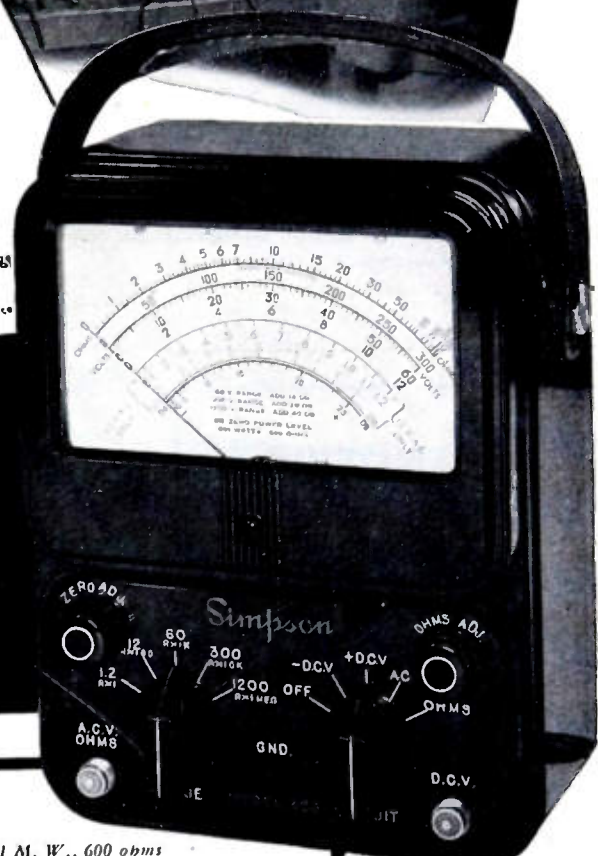

SPECIFICATIONS

DC Voltage
Ranges 1.2, 12, 60, 300, 1200 (30,000 with Accessory High Voltage Probe)
Input Resistance 10 megohms for all ranges
DC Probe with one megohm isolating resistor Polarity reversing switch

Ohms Ranges 1000 (10 ohms center)
100,000 (1000 ohms center)
1 megohm (10,000 ohms center)
10 megohms (100,000 ohms center)
1000 megohms (10 megohms center)

AC Voltage
Ranges 1.2, 12, 60, 300, 1200
Impedance (with cable) approx. 200 mmf shunted by 275,000 ohms

AF Voltage
Ranges 1.2, 12, 60
Frequency Response Flat to 100,000 cycles

Decibels
Ranges -20 to +3, -10 to +23, +4 to +37,
+18 to +51, +30 to +63

Zero Power Level 1 M. W., 600 ohms
Galvanometer
Zero center for FM discriminator alignment and other galvanometer applications

R. F. Voltage
(Signal tracing with Accessory High Frequency Crystal Probe)
Range 20 volts maximum
Frequency Flat 20 KC to 100 M.C.
105-125 V. 60 cycles

Size
3 1/4" x 7" x 3 1/4" (bakelite case). Weight: 4 lbs.
Shipping Wt.: 6 1/2 lbs.

Dealer's Net Price
Model 303, including DCV Probe, ACV-Ohms probe and Ground Lead—\$58.75;
Accessory High Frequency Probe, \$7.50;
Accessory High Voltage Probe, \$14.85
Also available with roll top case,
Model 303RT—\$64.75

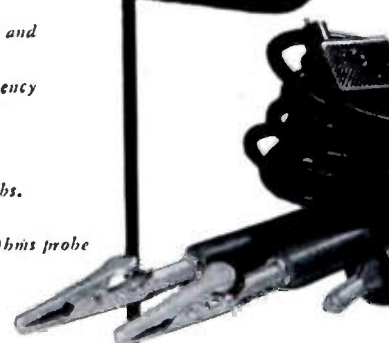

Simpson ELECTRIC COMPANY
5200 WEST KINZIE STREET, CHICAGO 44, ILLINOIS • IN CANADA: BACH-SIMPSON, LTD., LONDON, ONTARIO

Phone: COLUMBUS 1-1221

ELECTRONIC INSTRUMENTATION ENGINEERS

Manufacturer of meteorological instruments requires

PROJECT ENGINEERS

Experience in computer circuits, marker generators, display networks and pulse modulator design mainly for airborne equipment. Design experience with sub-miniature components is desirable

PROJECT ENGINEERS

Several years experience in microwave techniques in the 1 centimeter region, capable of designing antennas, direction couplings, mixers, etc.

ENGINEERS

Experience in the design of transformers, coils, etc., for electronics equipment.

Send complete resume to:

Personnel Department
**FRIEZ INSTRUMENT DIVISION
BENDIX AVIATION
CORPORATION**

Taylor Avenue at Loch Raven Blvd.
Baltimore 4, Md.

TRANSMISSION- EQUIPMENT- DESIGN- ENGINEERS

West Coast manufacturer of carrier equipment plans expansion program in United States and Canada. Wishes to contact a small number of experienced telephone and telegraph engineers interested in permanent positions offering excellent futures in a well-established but expanding industry.

Several positions will become available during the next year. Salaries commensurate with training and experience will be arranged for men selected. Please give full details in first reply.



Lenkurt Electric Co.

1105 County Rd., San Carlos, Calif.
926 East Hastings St., Vancouver, B.C.

Positions Open

(Continued from page 54A)

ELECTRONIC ENGINEER

Electronic engineer with interest in instrumentation and automatic control to join instrument development group at the Wind Tunnels Laboratory. Starting salary \$3,100-\$3,825 per annum. Apply Civilian Personnel Division, Aberdeen Proving Ground, Maryland.

PROFESSORS

Vacancies exist in the Electrical Engineering Dept. for faculty members to teach in undergraduate and post-graduate programs. Starting salaries from \$5,400 to \$7,600 depending upon experience and educational background. Write to U. S. Air Force Institute of Technology, Dept. of Electrical Engineering, Wright-Patterson Air Force Base, Dayton, Ohio.



Positions Wanted By Armed Forces Veterans

In order to give a reasonably equal opportunity to all applicants, and to avoid overcrowding of the corresponding column, the following rules have been adopted:

The Institute publishes free of charge notices of positions wanted by I.R.E. members who are now in the Service or have received an honorable discharge. Such notices should not have more than five lines. They may be inserted only after a lapse of one month or more following a previous insertion and the maximum number of insertions is three per year. The Institute necessarily reserves the right to decline any announcement without assignment of reason.

COMMUNICATIONS ENGINEER

B.S.E.E. University of Michigan, February 1950. Age 25, married, 2 children. 3 years Navy Aircraft radio operator and maintenance. Desires communications, electronics, or sales work anywhere in U. S. Box 459 W.

STATISTICAL QUALITY CONTROL ENGINEER

B.S.E.E. MIT, plus statistical quality control, mathematics, statistics, methods, accounting and time study at Columbia. Experience: 4 years industrial field coordination engineer; 4 years inspection administration, Lt. Commander. Desires position as liaison with production, inspection, engineering and sales for quality control div. Member ASQC. Box 460W.

ENGINEER

M.S.E.E., MIT, Tau Beta Pi, Sigma Xi. Age 29. 2 years experience in radar while in service. 3 years experience in microwave measurements and development. Desires electrical engineering teaching position in midwest. Box 461 W.

(Continued on page 58A)

Positions available for

SENIOR ELECTRONIC ENGINEERS

with

Development & Design
Experience

in

**MICROWAVE RECEIVERS
PULSED CIRCUITS
SONAR EQUIPMENTS
MICROWAVE
COMMUNICATIONS
SYSTEMS**

Opportunity For Advancement
Limited only by Individual
Ability

Send complete Resume to:
Personnel Department

MELPAR, INC.
452 Swann Ave.
Alexandria, Virginia

PHYSICISTS AND SENIOR RESEARCH ENGINEERS

POSITIONS NOW OPEN

Senior Engineers and Physicists having outstanding academic background and experience in the fields of:

- Microwave Techniques
- Moving Target Indication
- Servomechanisms
- Applied Physics
- Gyroscopic Equipment
- Optical Equipment
- Computers
- Pulse Techniques
- Radar
- Fire Control
- Circuit Analysis
- Autopilot Design
- Applied Mathematics
- Electronic Subminiaturization
- Instrument Design
- Automatic Production Equipment
- Test Equipment
- Electronic Design
- Flight Test Instrumentation

are offered excellent working conditions and opportunities for advancement in our Aerophysics Laboratory. Salaries are commensurate with ability, experience and background. Send information as to age, education, experience and work preference to:

NORTH AMERICAN AVIATION, INC.
Aerophysics Laboratory
Box No. N-4, 12214 South Lakewood Blvd.
Downey, California

FREED

TRANSFORMERS & INSTRUMENTS

PRODUCTS OF EXTENSIVE RESEARCH

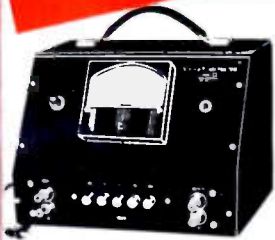

NO. 1060 VACUUM
TUBE VOLTMETER
INPUT IMPEDANCE
50 MEGOHMS

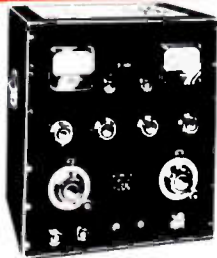

NO. 1030 LOW
FREQUENCY "O"
INDICATOR



HIGH FIDELITY
TRANSFORMERS
1/2 DB 20 CPS TO 30 KC

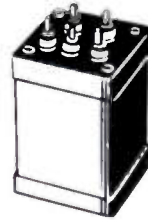

DISCRIMINATORS
10 CPS TO 1 MC

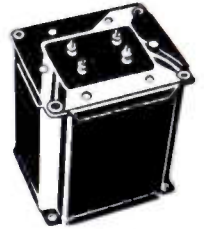

COMMERCIAL
COMPONENTS
QUALITY — PRICE
DEPENDABILITY — PRICE



NO. 1140 NULL
DETECTOR
COMPLETE WITH
SELECTIVE CIRCUITS

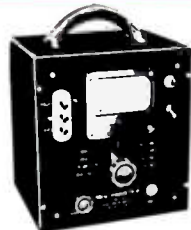

NO. 1020 MEGOHMMETER
2,000,000 MEGOHMS
DIRECT READING



HERMETICALLY
SEALED COMPONENTS
TO MEET MIL-T-27 SPECS



TOROIDAL INDUCTORS
60 CPS TO 1 MC



MINIATURE INDUCTORS
1000 CPS TO 100 KC



NO. 1210 NULL
DETECTOR & VACUUM
TUBE VOLTMETER



DECADE INDUCTORS
30 CPS TO 300 KC



SUB-MINIATURE
HERMETICALLY SEALED
TOROIDAL INDUCTORS



SUB-MINIATURE
HERMETICALLY SEALED
COMMUNICATION
COMPONENTS



SLUG TUNED
COMPONENTS
1000 CPS TO 1 MC



NO. 1150 UNIVERSAL
BRIDGE
5 AC BRIDGES IN ONE
UNIT

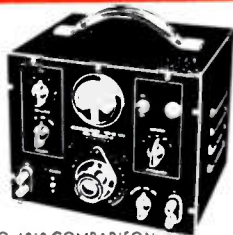

NO. 1010 COMPARISON
BRIDGE
FAST, ACCURATE,
RELIABLE



STEPDOWN
TRANSFORMERS
50 WATTS TO 3 KW



PULSE TRANSFORMERS
FROM WATTS TO
MEGAWATTS



POWER
TRANSFORMERS
RUGGED, DEPENDABLE,
INEXPENSIVE.



1170 D.C. SUPPLY
DIRECT CURRENT UP TO
500 MA.



NO. 1110 INCREMENTAL
INDUCTANCE BRIDGE
A NECESSITY FOR
EVERY LAB.



PRECISION FILTERS
10 CPS. TO 1 MC.



CHANNEL MOUNTING
INEXPENSIVE—RELIABLE

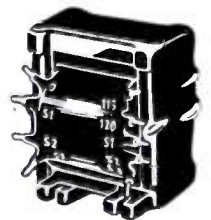

FOSTERITE TREATMENT
ANE-19 SPECS.

SEND FOR LATEST CATALOG!

FREED TRANSFORMER CO., INC.
DEPT. NP 1718-36 WEIRFIELD ST., (RIDGEWOOD) BROOKLYN 27, NEW YORK

NATIONAL UNION RESEARCH DIVISION

Electrical Engineers and Physicists are needed for research on Cathode Ray, Subminiature, Secondary Emission and other types of Vacuum Tubes.

Permanent interesting positions are available in the following fields:

Tube design & development
Tube processing
High vacuum systems
Solid state physics
Electron optics
Phosphorescence

Men qualified in any of the above are invited to send their resumes to:

Divisional Personnel Manager
National Union Research Division
350 Scotland Rd., Orange, N.J.

RCA VICTOR Camden, N. J.

Requires Experienced Electronics Engineers

RCA's steady growth in the field of electronics results in attractive opportunities for electrical and mechanical engineers and physicists. Experienced engineers are finding the "right position" in the wide scope of RCA's activities. Equipment is being developed for the following applications: communications and navigational equipment for the aviation industry, mobile transmitters, microwave relay links, radar systems and components, and ultra high frequency test equipment.

These requirements represent permanent expansion in RCA Victor's Engineering Division at Camden, which will provide excellent opportunities for men of high caliber with appropriate training and experience.

If you meet these specifications, and if you are looking for a career which will open wide the door to the complete expression of your talents in the fields of electronics, write, giving full details to:

National Recruiting Division
Box 960, RCA Victor Division
Radio Corporation of America
Camden, New Jersey

Positions Wanted

(Continued from page 56A)

SALES OR APPLICATION ENGINEER (JR.)

B.E.E. June 1950, Pratt Institute; age 24; married. Former AETM 3/c, radio and radar service in U.S. Navy. Interested in sales or application. Hard, willing worker. Any location in U. S. or Alaska. Resume. Box 462 W.

ELECTRONIC ENGINEER

B.E.E. June 1950, upper fifth, Syracuse University. Married, 1 child. Experience in radio, radar and antenna research. Interested in television, electronics, radio communication. Location anywhere in U. S. Box 467 W.

JUNIOR ENGINEER OR LABORATORY TECHNICIAN

Specialty precision instruments. 5 years experience on development of photo-electric instruments, electrocardiographs, timers, pulse transmitters and control systems. 3 years engineering college at Pratt Institute and New York University. Desires position in design or development work. Box 468 W.

COMMUNICATIONS ENGINEER

7 years experience in communications and VHF control systems in CAA and Army 2 years at supervisory level. Graduate C.R.E.I. Married. Age 26. Interested in VHF-UHF design or development. Location immaterial. Available Sept. 15. Box 469 W.

ENGINEER

B.A. New York University, physics and psychology majors; graduate RCA Institute; age 33; 6 years broadcast engineering, 4 years teaching physics, both with administrative responsibilities. Seeks position in engineering administration, New York City location to permit continuing graduate study. Available Oct. 1. Box 470 W.

ELECTRONICS ENGINEER

B.S. Applied Physics. Graduated U.C.L.A. August 1950. 3 years as Army electronic technician. Desires position in industrial electronics with good future. Prefer west coast. Married. Age 26. Box 471 W.

ELECTRICAL ENGINEER

B.S.E.E. June 1950, Polytechnic Institute of Brooklyn. Age 26, single. F.C.C. radio phone license. 3 years electronic experience including design, construction and testing; 6 months radio repairman in Air Corps. Interested in sales, service, development or broadcast engineering. Resume on request. Box 472 W.

JUNIOR ELECTRONIC ENGINEER ENGINEER

B.S.E.E. June, 1950, New York University. Age 23, single. 14 months Army. Attended Signal Corps school. 5 years radio and some television set repair part time. Desires communication or electronic work anywhere in U.S. Box 473 W.

ENGINEER

B.E.E.; M.E.E. August 1950, Syracuse University. Age 23, single. Communications major. 1 year Navy electronics technician, 1 year laboratory instructor. Tau Beta Pi, Pi Mu Epsilon, Sigma Pi Sigma. Desires communications work. Salary and location secondary. Box 474 W.

(Continued on page 62A)

PROJECT ENGINEERS

Opportunities exist for graduate engineers with design and development experience in any of the following:

ANALOGUE COMPUTERS
SERVO MECHANISMS
RADAR
ELECTRONIC CIRCUITS
COMMUNICATION
EQUIPMENT
AIRCRAFT CONTROLS
HYDRAULICS
INSTRUMENTATION
ELECTRONIC PACKAGING
PRINTED CIRCUITS
PULSE TRANSFORMERS
FRACTIONAL H. P. MOTORS

Submit Resume to
Employment Dept.

SPERRY GYROSCOPE CO.

Division of the Sperry Corp.
GREAT NECK, L.I., NEW YORK

ENGINEERING OPPORTUNITIES IN Westinghouse

Wanted:

Design Engineers
Field Engineers
Technical Writers

Must have at least one year's experience.

For work on airborne radar, shipborne radar, radio communications equip., microwave relay, or micro-wave communications.

Good pay, excellent working conditions; advancement on individual merit; location Baltimore.

Send resume of experience and education to: Manager of Industrial Relations, Westinghouse Electric Corp., 2519 Wilkens Ave., Baltimore 3, Maryland.

Specify Sorensen

AC VOLTAGE REGULATORS

Accuracy, with rugged construction, economical and trouble-free operation, reasonable cost — those are features that you expect, and get, when you specify Sorensen regulators!

- ALL SORENSEN REGULATORS HAVE THESE ADVANTAGES:**
- WIDE INPUT RANGE
 - ADJUSTABLE OUTPUT VOLTAGE THAT STAYS SET
 - REGULATION ACCURACY OF $\pm 0.1\%$
 - EXCELLENT WAVEFORM
 - FAST RECOVERY TIME
 - INSENSITIVITY TO LINE FREQUENCY FLUCTUATIONS.



MODEL NO. 500-S

STANDARD AC SPECIFICATIONS

VA capacity	150	250	2000	5000
	500	1000	3000	10000
				15000
Harmonic Distortion	3% max.	2% max.	3% max.	3% max.
Regulation accuracy	$\pm 0.1\%$ against line or load			
Input voltage	95-130 VAC; also available for 190-260 VAC single phase 50-60 cycles			
Output voltage	Adjustable between 110-120; 220-240 in 230 VAC models			
Load range	0 to full load			
P.F. range	Down to 0.7 P.F. All models temperature compensated			

NOTE: THREE PHASE AND 400 CYCLE REGULATORS ALSO AVAILABLE. ALL REGULATORS CAN BE HERMETICALLY SEALED.

Write for Complete Literature

For regulated DC problems investigate Sorensen's line of Voltage Reference Standards, DC Supplies, and NOBATRONS

POWER
controlled converted

Sorensen and company, inc.
375 FAIRFIELD AVE. • STAMFORD, CONN.

MANUFACTURERS OF AC LINE REGULATORS, 60 AND 400 CYCLES; REGULATED DC POWER SOURCES; ELECTRONIC INVERTERS; VOLTAGE REFERENCE STANDARDS; CUSTOM BUILT TRANSFORMERS; SATURABLE CORE REACTORS

One OF A LINE....

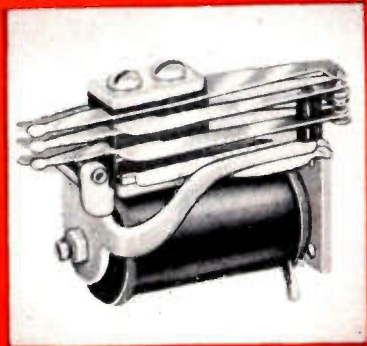
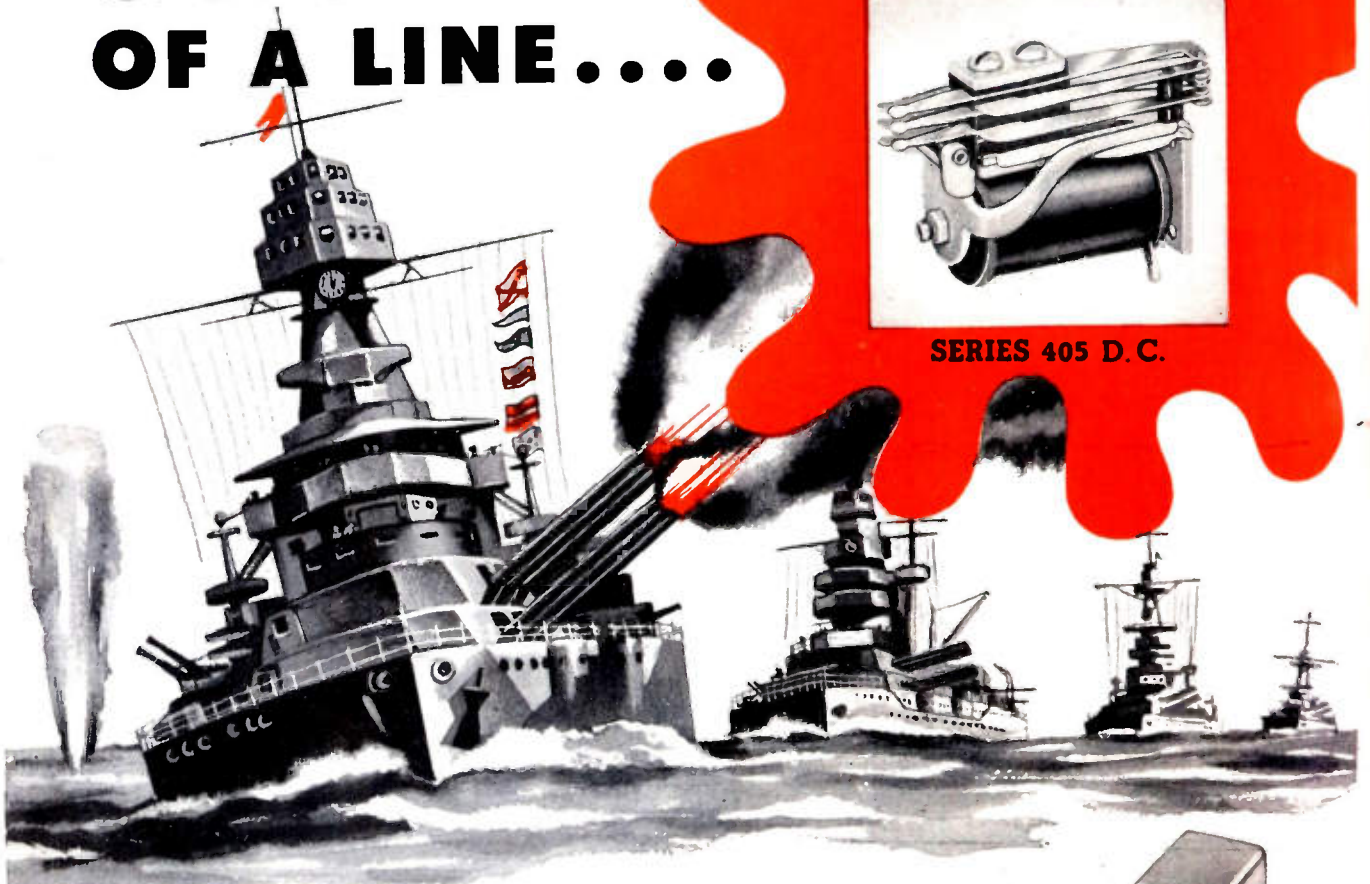

SERIES 405 D.C.

The
GUARDIAN
SERIES 405 D.C.
RELAY

No better proving place for Guardian Hermetically Sealed Relays than Uncle Sam's battlewagons that ride the oceans everywhere.



For example: the Guardian Series 405 Telephone Type Relay, used for communications, is an "all-purpose" type especially suited to sensitive applications. Instantly responsive. Operates at high speed. Provides a time delay on attract or release when equipped with a copper slug on the coil. Armature hinges on pin-type bearing to insure (1) long wear, (2) freedom from binding and (3) minimum side play. Standard weight of hermetically sealed Series 405 (DPDT) Relay: 11.5 oz. Also available with special windings.

New Hermetically Sealed Relay catalog 5-H is yours for the asking.



Series 30 A.C.



Series 210 A.C.—215 D.C.



Series 220 A.C.



Series 695 D.C.



Series 610 A.C.—615 D.C.

Write — ASK US TO MAKE SPECIFIC RECOMMENDATIONS. NO OBLIGATION.

GUARDIAN  **ELECTRIC**
1628-M W. WALNUT STREET CHICAGO 12, ILLINOIS

A COMPLETE LINE OF RELAYS SERVING AMERICAN INDUSTRY

New Instruments for Microwave Testing

COMPLEMENT SPERRY'S *Microline**

Models 348, 349 and 350, new cavity frequency meters shown below, extend to the SHF and EHF frequency ranges, techniques which are now available at lower frequencies. These broadband instruments are designed for both transmission and absorption-type indications. They are suitable for search-type frequency measurements or any other requirement where an accuracy of .1 percent frequency set is needed. These are among the many new microwave test and measuring instruments which have been added to the ever-increasing Sperry Microline.

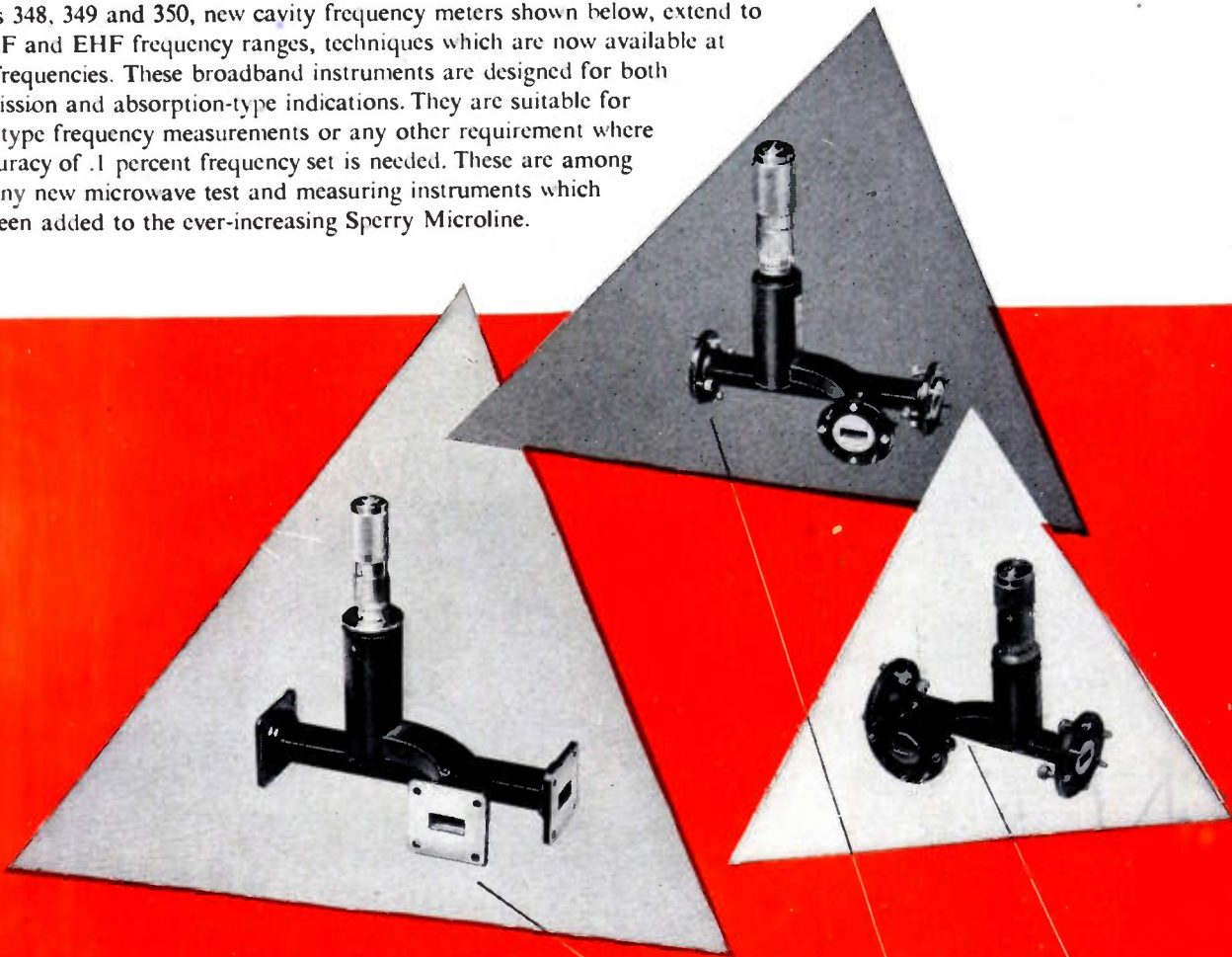

FREQUENCY METERS

Model	348	349	350
Description	CAVITY	CAVITY	CAVITY
Frequency Range mc	13,000-18,000	19,000-26,000	26,500-39,000
Absolute Accuracy	1/1000	1/1000	1/1000
Approximate Loaded Q	1000	450	1000
Fittings	R-F Video	UG-419/U UHF	UG-381/U UG-381/U

Other new instruments in the frequency ranges of the above mentioned meters are:

Instrument	Model	Frequency Range mc
Impedance Meter	320	18,000-26,500
Impedance Meter	346	26,500-40,000
Impedance Transformer	347	26,500-40,000
Directional Coupler	405	26,500-39,000
Directional Coupler	413	18,000-26,500
Directional Coupler	415	18,000-26,500
Directional Coupler	388	12,400-17,000
Directional Coupler	429	32,000-39,000
Short	371	26,500-40,000
Short	372	12,400-18,000
Termination	401	12,400-18,000
Termination	402	26,500-40,000
Detector and Mixer	357	12,400-18,000
Detector and Mixer	358	18,000-26,500
Detector and Mixer	359	26,500-40,000
Detector and Mixer	382	26,500-40,000
Magic Tee	390	18,000-26,500
Magic Tee	391	26,500-40,000

Catalog information on these and other Microline instruments is available on request.

*Trade Mark

SPERRY

GYROSCOPE COMPANY

DIVISION OF THE SPERRY CORPORATION, GREAT NECK, NEW YORK • CLEVELAND • NEW ORLEANS • NEW YORK • LOS ANGELES • SAN FRANCISCO • SEATTLE

PROCEEDINGS OF THE I.R.E. November, 1950

EXPERIENCED DEVELOPMENT ENGINEER

CAREER

for

Qualified individual with company whose reputation for leadership and progress is recognized throughout the world.

Laboratory assignment involving creative application of the physical sciences to precision electromechanical devices.

Location: South Central N.Y. State.

Give full details of education and experience, indicating age and marital status.

Box No. 635
The Institute of Radio Engineers
1 East 79th St. New York 21, N.Y.

The nonmelting **SILICONE** insulating and waterproofing compound that is stable at temperatures from -70°F. to $+400^{\circ}\text{F.}$



↑ for AIRCRAFT ignition and electrical control systems

↓ for ELECTRONIC EQUIPMENT

MEETS ALL THE REQUIREMENTS OF AN-C-128a

More water repellent than paraffin, Dow Corning 4 Compound is highly resistant to oxygen, ozone and to deterioration caused by corona discharge.
POWER FACTOR, up to 10 megacycles . . . 0.001
VOLUME RESISTIVITY, ohm centimeters . . . 10^{11}
DIELECTRIC STRENGTH, volts/mil 500

Write Today!

for your copy of our new booklet on Dow Corning 4 Compound Address Dept. D.

Dow Corning
FIRST IN SILICONES

DOW CORNING CORPORATION, Midland, Michigan

Positions Wanted

(Continued from page 58A)

TELEVISION ELECTRONICS TECHNICIAN

2½ years B.E.E. New York University. 2 years Naval Electronics Radar Technician. 2 years TV experience in production test and field engineering for New York manufacturer. Desires position New York-Long Island area. Resume on request. Box 489 W.

ENGINEER

B.E.E. electronics option, University of Minnesota, June 1949, high scholastic standing. 3 years Army Signal Corps radio repairing and operating. Desires electronic design or development position. Location immaterial. Box 490 W.

ENGINEER

Age 43, married. Extensive practical radio, FM, TV and communications experience. Desires position as Service Manager with a reputable distributor. New York, New Jersey or Conn. area. Resume on request. Box 491 W.

SUBMINIATURIZATION ENGINEER

Graduate, M.A. qualified Project Engineer. Heavy experience in subminiaturization techniques. Seeks responsible position with opportunity for doing original work. Box 492 W.

JUNIOR ENGINEER

B.E.E. June 1950, New York University. Desires position in electronics or communications field. Experience remote control repairman on AA guns. 1½ years television and radio repairman. Age 27, single. Willing to relocate anywhere in U.S. Box 493 W.

(Continued on page 65A)

An invitation from Lockheed in California to

SENIOR ELECTRONIC SYSTEMS ENGINEERS

Lockheed invites you to participate in its long-range production program, developing the aircraft of the future.

Lockheed offers an attractive salary commensurate with your ability and background, a future in aeronautical science. In addition, Lockheed provides generous travel allowances for those who qualify.

If you have:

1. An M. S. or Ph. D. in Electrical Engineering or Physics —
2. A minimum of three years' experience in advanced electronic systems development, including radar microwave techniques, servomechanisms, computers and fire control —
3. Familiarity with airborne electronics equipment requirements —

Write today—giving full details as to education, experience and salary requirements. Address:

Karl R. Kunze, Employment Manager
LOCKHEED Aircraft Corporation
Burbank, California

RADAR AND SONAR ENGINEERS

Supervisory Radar Engineer

1. Position open for top-notch radar engineer to supervise project engineers in the development and production engineering of airborne radar equipment.

Radar Engineers

2. Positions open for project, senior and junior radar engineers. Experience in airborne radar desired.

Sonar Engineers

3. Positions open for engineers with background and experience in the field of sonar.

Salary commensurate with ability and experience. Excellent opportunity for suitably qualified personnel.

Submit detailed resumé.

Attention
CHIEF ELECTRONIC ENGINEER

Pacific Division
Bendix Aviation Corporation
NORTH HOLLYWOOD, CALIF.

ANALOGUE COMPUTER ENGINEER

Experienced graduate electrical engineer with extensive background in analogue computer development, required to supervise analogue computer section. This engineer must be able to assume full technical responsibility and planning for projects ranging from single equipments to complete system development. Here is a life time opportunity for the individual who can organize a rapidly expanding facility. Submit detailed resume. Personal interview will be arranged.

ENGINEERING RESEARCH
ASSOCIATES, INC.

1902 West Minnehaha Avenue
St. Paul 4, Minnesota



GUIDED MISSILES ARE ONLY
AS GOOD AS THEIR...

Avionic

Brains!

Advanced aerodynamic design is what you expect when a top team of designers like those of the Fairchild Guided Missiles Division build a missile. But that is only part of the problem in missile manufacture.

A guided missile is packed from nose to tail with complex electronic guidance circuits that must control its flight accurately—even during the shock of launching and the high G loads of tight turns. The *avionic brain* must not "black out" even under loads well beyond those a human pilot can withstand.

In Fairchild's missiles, not only the airframe but the complete missile, including the *avionic brains*—that are squeezed into the cramped quarters of

the missile's body—are Fairchild designed and Fairchild manufactured.

To prove the ruggedness and reliability each missile is subjected to G loads never before asked of electronic equipment, while test apparatus shows how the "bird" stays locked on the target. Flight tests confirm this amazing accuracy and ruggedness.

Here is another example of Fairchild research and development, at work for the Armed Services.

Far ahead in the field, Fairchild Guided Missiles are an example of the achievement possible when top-flight aerodynamicists and ingenious electronic engineers tackle closely interrelated problems as a single, united team.



ENGINE AND AIRPLANE CORPORATION

FAIRCHILD

Guided Missiles Division

FARMINGDALE, N. Y.

Other Divisions: Fairchild-NEPA Division, Oak Ridge, Tenn. • Fairchild Aircraft Division, Hagerstown, Md.
Fairchild Engine Division, Al-Fin Division and Stratos Corporation, Farmingdale, N. Y.

You can use a battering ram to make it fit...



BUT it's simpler to design the radio around the battery!

Regardless of what size portable radio you are designing, you'll find compact, long-lasting "Eveready" batteries to fit it. "Eveready" brand batteries give longer playing life. They are the accepted standard for portable radios. Users can get replacements everywhere — they *prefer* portables that use "Eveready" batteries.

CONSULT OUR BATTERY ENGINEERING DEPARTMENT
FOR COMPLETE DATA ON "EVEREADY" BATTERIES

"Eveready", "Mini-Max", "Nine Lives"
and the Cat Symbol are trade-marks of
NATIONAL CARBON DIVISION
UNION CARBIDE AND CARBON CORPORATION
30 East 42nd Street, New York 17, N.Y.



● The No. 753 "Eveready" "A-B" battery pack provides plenty of power for compact "pickup" portables. For smaller portables, we recommend "Eveready" No. 950 "A" batteries and the No. 467 "B" battery.

District Sales Offices: Atlanta, Chicago, Dallas, Kansas City, New York, Pittsburgh, San Francisco

TESTED
Laboratory

**SCREEN ROOMS
for ACCURATE
RADIO-FREQUENCY
MEASUREMENTS**

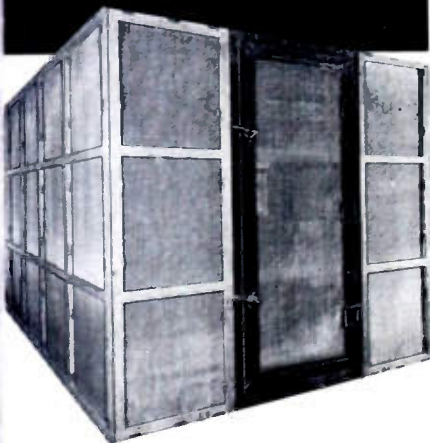

Guesswork is eliminated when you use an ACE Pre-built Screen Room. The area background level of radio interference is suppressed and the room does not introduce any errors in your measurements. Attenuations of 100 db.—and higher—at frequencies as low as 0.15 and as high as 10,000 mc. are readily obtainable. Specially designed Screen Rooms can give attenuations as high as 140 db.

ACE attenuation characteristics have been determined by reputable electronic laboratories. These Screen Rooms are used for various applications such as evaluation and suppression of radio interference; radio and radar calibration, sensitivity, susceptibility, spurious response and radiation; measurements involving electronic instruments used in medical laboratories and many others. Write for descriptive bulletin.

Easily Installed

Easy to move or to

enlarge

Low priced



**ACE ENGINEERING and
MACHINE CO., INC.**

3644 N. Lawrence Street

Philadelphia 40, Pa. Regent 9-1019

Positions Wanted

(Continued from page 62A)

SALES ENGINEER

B.E.E. June 1947, Polytechnic Institute of Brooklyn, Eta Kappa Nu. 2 years varied radar, radio, electronic technical experience. 1 year own business. Single, age 25. Box 494 W.

News—New Products

These manufacturers have invited PROCEEDINGS readers to write for literature and further technical information. Please mention your I.R.E. affiliation.

(Continued from page 48A)

Ultra-High-Speed DC Relay

The Millisec Relay, designed for long life reliable ultra-high-speed use at an operating time of one millisecond or less, is being marketed by Stevens-Arnold Inc., 22 Elkins St., South Boston 23, Mass. It is assembled in a standard metal radio tube container, but its operation is mechanical and not electronic.



Only direct current should be applied to the contacts. In contrast to conventional relays, the manufacturer does not recommend the use of ac.

Life increases from 22 million operations at $\frac{1}{2}$ ampere on the contacts to 100 million operations at $\frac{1}{4}$ ampere, at a rate of 60 operations per second. Below $\frac{1}{4}$ ampere a further increase in life can be expected.

The relay is designed for operation with a resistive load, and when so connected, does not require an external spark suppression circuit. When used with an inductive load, the actual load used must be sent to our factory for the special tests required in order for us to design and specify the circuit constants of the spark suppression circuit always needed when operating with an inductive load.

The maximum rating is $\frac{1}{2}$ ampere 110 volts dc on the contacts into a resistive load. Some overloading is possible above $\frac{1}{2}$ ampere, but the life expectancy is greatly reduced.

Each relay is enclosed in a standard 6N7 type metal radio tube container, and wax sealed in order to prevent dust and moisture from reaching the contacts.

(Continued on page 66A)

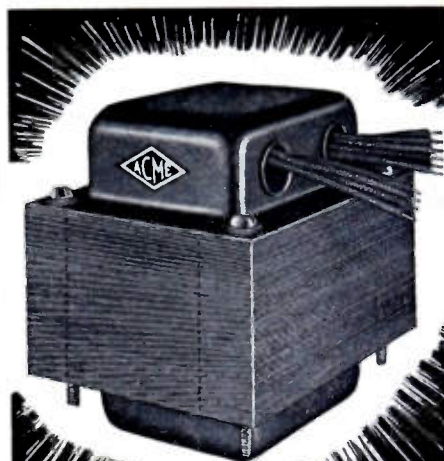

FOR
**BETTER
PERFORMANCE
BETTER BUY**
Acme  Electric
TRANSFORMERS

Acme Electric has been identified with the electronic industry since the crystal set days. The vast store of experience that Acme engineers have accumulated over these many years can be of considerable value in helping you solve your electronic transformer problems. We offer transformer engineering cooperation and facilities to build quality transformers in quantity production.

ACME ELECTRIC CORP.

4411 Water Street Cubo, N.Y., U.S.A.



MORE GEO. STEVENS COIL WINDING EQUIPMENT IS IN USE THAN ALL OTHER MAKES COMBINED!

- **MORE OUTPUT . . . LOWER COSTS . . .** from **EXCLUSIVE SPEED FEATURE.** Universal motors permit variable speeds without changing belts and pulleys. Coil design permitting, speeds as high as 7500 RPM are not uncommon.
- **PORTABILITY.** Conveniently carried from place to place. Machines come mounted on bases to constitute one complete unit.
- **MUCH LOWER ORIGINAL COST.** The same investment buys more GEO. STEVENS machines than any other coil winding machines.
- **LONG LIFE.** Most of the original

GEO. STEVENS machines bought 14 years ago are still operating daily at full capacity.

- **MUCH FASTER CHANGING OF SET-UPS** than any other general purpose coil winding machine. Quickly changed gears and cams save time between jobs.
- **VERY LOW MAINTENANCE.** Replacement parts are inexpensive, can be replaced in minutes, and are stocked for "same day" shipment, thus saving valuable production time.
- **EASIEST TO OPERATE.** In one hour, any girl can learn to operate a GEO. STEVENS machine.

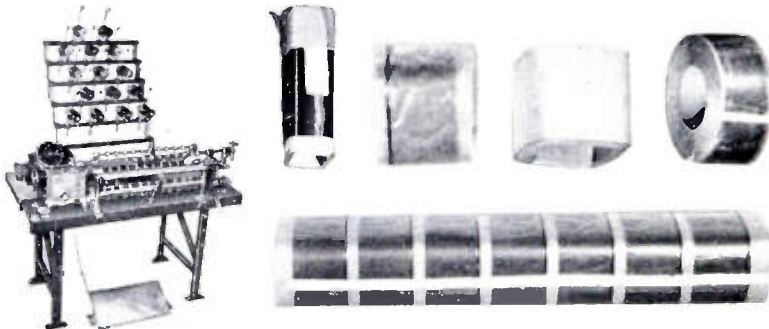

Transformer winder Model 37S multiple winds power, audio, automotive, fluorescent ballast and similar types of coils. Winds wire from No. 18 B&S up to 9" O.D. Maximum economy is possible by using mandrels up to 30" long. Thirty or more coils may be wound at one time. All turns are accurately registered by Model 50 or 51 6" full vision clock face Dial Counter. Set-ups can be changed in less than 5 minutes. A gear chart is furnished to quickly determine wire spacing.

No loss of turns (an exclusive feature) and accurate margins are assured by a screw feed traverse and an electrically controlled clutch. Highly polished wire guide rollers are ball-bearing mounted for free running. Traverse is quickly adjusted from $\frac{1}{16}$ " to 6".

Paper feed:—A tilting table for pre-cut paper is furnished making paper feed simple and fast, or a new roll paper feed for extra economy is available at a small additional cost.

Motor equipment:—Variable speed, uniform torque $\frac{1}{2}$ H.P. motor with foot treadle control.

Tension equipment:—12 T-1 tensions and spool rack. Tensions will handle 6" spools.

Mounting:—Ground steel channel base ensures rigidity and permanent alignment. Machine is shipped mounted on bench ready for use.

There is a GEO. STEVENS machine for every coil winding need. Machines that wind ANY kind of coil are available for laboratory or production line. . . . Send in a sample of your coil or a print to determine which model best fits your needs. Special designs can be made for special applications. Write for further information today.

World's Largest Manufacturer of Coil Winding Machines

REPRESENTATIVES

Frank Tatro
6022 No. Rogers Ave., Chicago 30, Illinois
Ralph K. Reid
1911 W. 9th St., Los Angeles 6, California
R. F. Staff & Co.
1213 W. 3rd St., Cleveland 13, Ohio

GEO. STEVENS
MFG. CO., INC.
Pulaski Road at Peterson
Chicago 30, Illinois

News—New Products

These manufacturers have invited PROCEEDINGS readers to write for literature and further technical information. Please mention your I.R.E. affiliation.

(Continued from page 65A)

Voltage-Regulated Power Supply

The Model 515 supply which features one regulated B supply, one regulated C supply, and one unregulated filament supply, is being marketed by Kepco Laboratories, Inc., 149-14 41st Ave., Flushing, L. I., N. Y.

The B supply is continuously variable from 0 to 500 volts and delivers from 0 to 200 ma. In the range from 20 to 500 volts the output voltage variation is less than $\frac{1}{2}$ per cent for both line fluctuations from 105 to 125 volts and load variations from minimum to maximum current. Ripple is less than 5 mv.

The C supply is continuously variable from 0 to 150 volts and delivers 5 ma. For all output voltages, the output voltage variation is less than 10 mv for line fluctuations of 105 to 125 volts. At 150 volts, the regulation is less than $\frac{1}{2}$ per cent, between 0 and 5 ma. At other settings below 150 volts the internal resistance of the supply will increase to a maximum of 25,000 ohms. Ripple is less than 5 mv.

The ac output is 6.3 volts, 10 amperes, center-tapped, unregulated.

(Continued on page 68A)



High pressure or low, there is a Giannini precision pressure transmitter that meets your requirements for remote indication, recording or control.

From less than 1 up to 10,000 psi, with various types of resistance and inductive output values, Giannini precision pressure transmitters are designed to withstand extremes of acceleration, temperature, vibration, while at the same time retaining their accuracy and their fast response characteristics. "They are standard with the Leaders." Write for booklet.

G. M. Giannini & Co., Inc., Pasadena 1, California



giannini

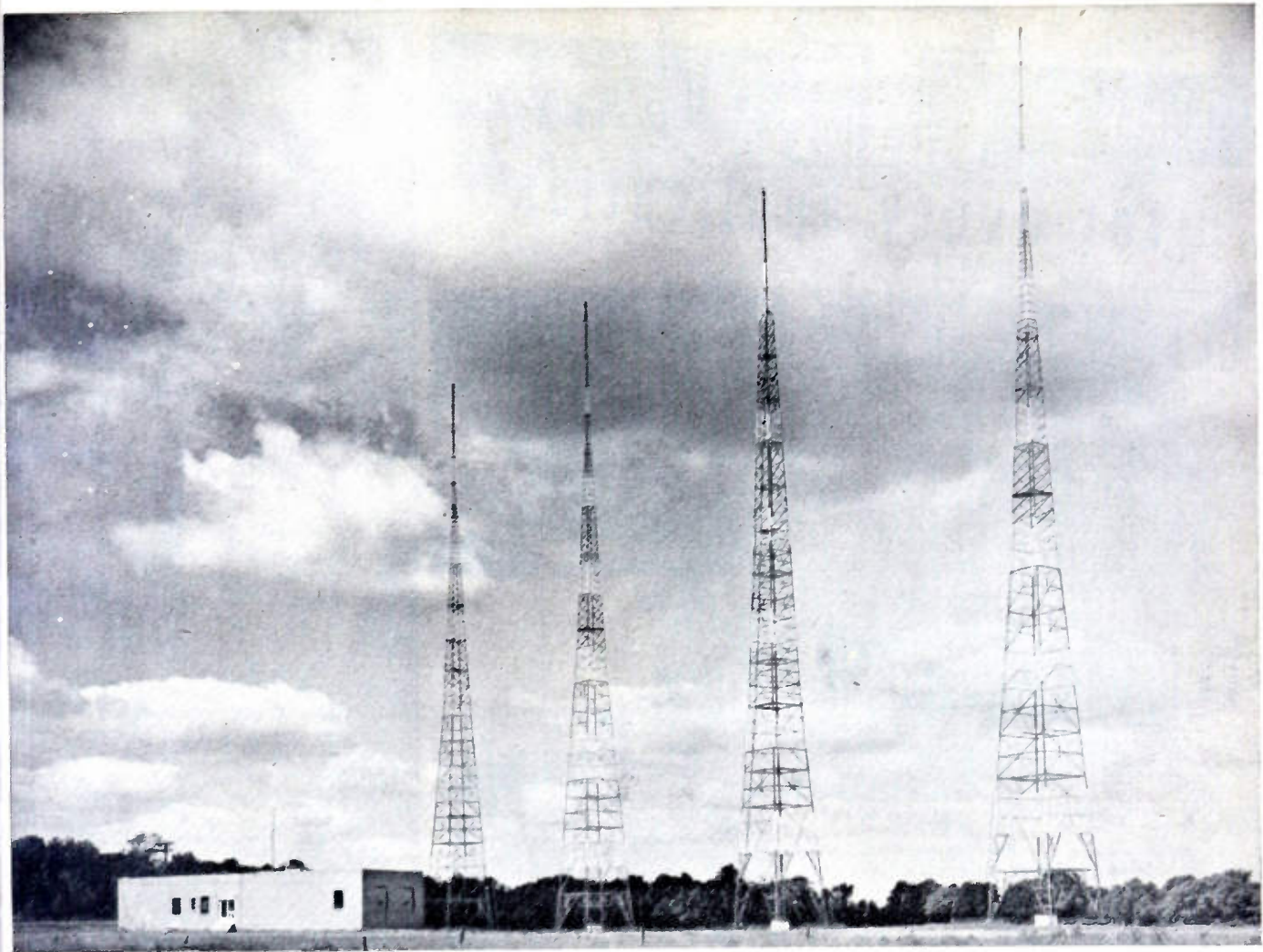

WERE
WAS
"THERE"

— when they specified
Blaw-Knox Towers
for their powerful new
AM, FM, TV station!

WERE's technicians couldn't actually *see* Blaw-Knox engineering or point to Blaw-Knox long experience in tower-building, or show off the inherent strength and efficiency of these towers—but *they knew they were all there!* Hence their choice.

... A quotation will prove that there's no premium on Blaw-Knox quality.

BLAW-KNOX DIVISION
OF BLAW-KNOX COMPANY
2037 Farmers Bank Building, Pittsburgh, Pa.



BLAW-KNOX ANTENNA TOWERS

There's a **TIC** Potentiometer for every application

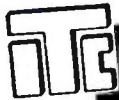

for top electrical
and mechanical
precision

Type RV2 High Precision Potentiometer

One of a series of semi-standardized types of metal-base potentiometers with exceptionally high electrical accuracy and mechanical precision. For both linear and *non-linear* functions. Designed for precision instrument, computer and military applications. Accurate phasing of individual units possible with exclusive clamping method of ganging.

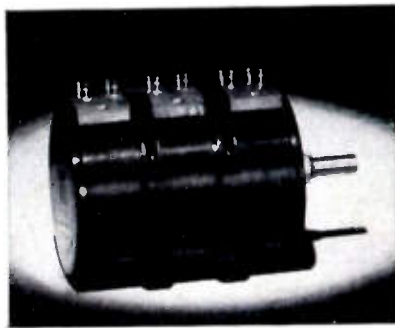

for precision
and economy

- Tapped mounting inserts
- Bronze bushing
- Totally enclosed with cover
- "Constrict-O-Grip" clamping to shaft
(no set screws)
- Precious metal contacts
- Silver overlay on rotor take-off slip ring

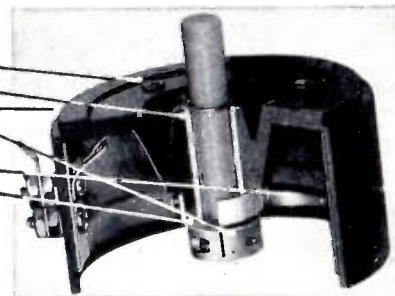

Type RV3 Precision Potentiometers

... available in models for either *linear* or *non-linear* functions with stock resistance values ranging from 100Ω to 200,000Ω and power ratings of 8 and 12 watts. 360° mechanical rotation or limited by stops as desired. Models with 5% total resistance accuracy — \$6.00 ... 1% accuracy — \$8.00. Special models available for high humidity applications.

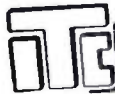

for special use ...

Type RVT Translatory Potentiometer

Actuated by longitudinal instead of rotating motion providing linear electrical output proportional to shaft displacement. Used as a position indicator, high amplitude displacement type pickup and for studying low frequency motion or vibration. Features exceptionally high linearity and resolution. Available in various lengths depending on amplitude being studied.

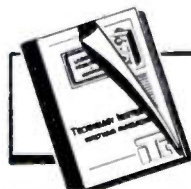
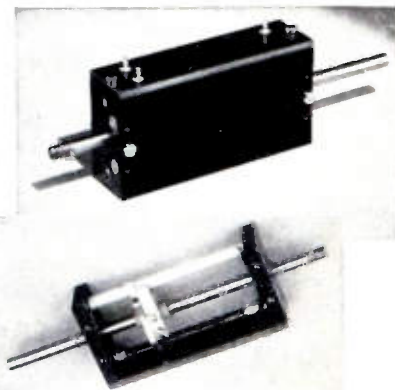

Valuable catalog — yours for the asking. Contains detailed information on all TIC Instruments, Potentiometers and other equipment. Get your copy without obligation — write today.

TIC TECHNOLOGY INSTRUMENT CORP.

1058 Main Street, Waltham 54, Massachusetts

Representatives and Telephone Numbers

Cleveland, Ohio—PRespect 1-6171 Chicago, Ill.—UPtown 8-1141 Dallas, Tex.—DIXon 9918
Rochester, N.Y.—Genesee 3547-M Cambridge, Mass.—ELiot 4-1751 Canaan, Conn.—Canaan 649
Hollywood, Cal.—HOLlywood 9-6305 Boonton, N.J.—BOonton 8-3097 Manhasset, N.Y.—
MANhasset 7-3424 Dayton, Ohio—MICHigan 8721

News—New Products

These manufacturers have invited PROCEEDINGS readers to write for literature and further technical information. Please mention your I.R.E. affiliation.

(Continued from page 66A)

Traveling-Wave Power Amplifier

The Federal Telecommunication Laboratories, Inc., 500 Washington Ave., Nutley, N. J., has begun production of a traveling-wave power amplifier in the 4,000- to 5,000-Mc frequency range.



This tube has been assigned the type number 5929 and is of the helix type. Particular attention has been given to details which allow ready replacement of tubes and a high degree of interchangeability. The tube will deliver a power output in excess of 10 watts with a power gain of 20 db. The rf terminals are arranged for wave-guide circuit, and the tube operates with an external electromagnetic field.

(Continued on page 71A)

ELECTRONICALLY REGULATED LABORATORY POWER SUPPLIES



• STABLE
• DEPENDABLE
• MODERATELY PRICED

- INPUT: 105 to 125 VAC, 50-60 cy
- OUTPUT #1: 200 to 325 Volts DC at 100 ma regulated
- OUTPUT #2: 6.3 Volts AC CT at 3A unregulated
- RIPPLE OUTPUT: Less than 10 millivolts rms

MODEL 28
STANDARD
RACK
MOUNTING
PANEL SIZE
3 1/2" x 19"
WEIGHT 16 LBS.

For complete information write for Bulletin G8



LAMBDA ELECTRONICS
CORPORATION
CORONA NEW YORK

UHF OSCILLATOR

FREQUENCY RANGE:

300 Mc. to 1000 Mc.



MODEL 112

THIS oscillator was designed for the many applications in ultra-high frequency engineering that require a high degree of frequency accuracy and stability. The direct-reading frequency dial is individually calibrated to an accuracy of $\pm 0.5\%$.

An output dial, calibrated in decibels, permits relative voltage measurements within a ratio of 100 to 1.

The MODEL 112 Provides A Signal Source For The Measurement Of—

- STANDING WAVES ON TRANSMISSION LINES
- ANTENNA PATTERNS
- FILTERS
- ATTENUATORS

Also for Alignment and Tracking of UHF Receivers and for many other applications.

FREQUENCY RANGE: 300 to 1000 Megacycles

FREQUENCY CALIBRATION ACCURACY: $\pm 0.5\%$

OUTPUT VOLTAGE: Maximum varies with frequency between 0.3 volt and 2 volts. Adjustable over 40 db range

OUTPUT IMPEDANCE: 50 ohms

POWER SUPPLY: 117 volts; 50-60 cycles; 60 watts

DIMENSIONS: 12½" x 13½" x 8". Weight 22 lbs.



MEASUREMENTS CORPORATION

BOONTON

NEW JERSEY



Gold Plated
TUNGSTEN
and
MOLYBDENUM
GRID WIRE



Made to meet your specifications... for gold content, diameter and other requirements.

Write for details and list of products



SINCE 1901

SIGMUND COHN CORP.
44 GOLD ST. NEW YORK

STILL TOPS IN THE FIELD

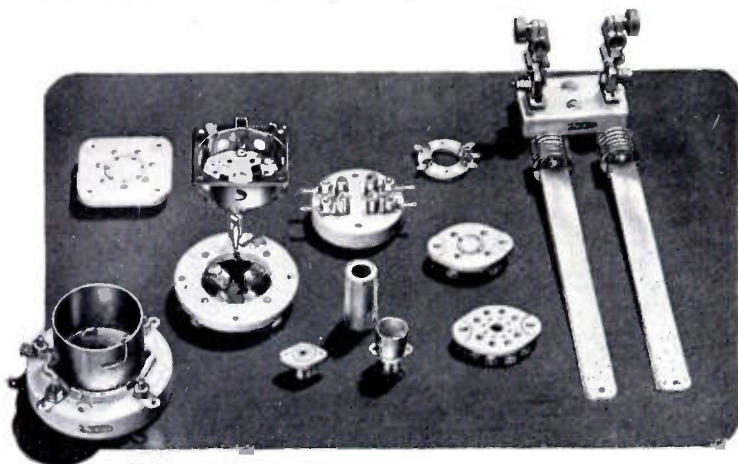

Whatever your power tube application may be, you can, in almost every case, find an ideally suited JOHNSON socket. This socket will have high frequency insulation, low contact resistance and will hold the tube securely. These are characteristics of all JOHNSON sockets.

JOHNSON sockets, furthermore, are easy to use. Design is such that mounting is simple. Insulation and spacing are more than adequate for voltages involved. High frequency tube performance is not impaired by stray capacity.

Write for catalog 971 which describes the most complete line of transmitting and industrial tube sockets on the market.

E. F. JOHNSON COMPANY ... a famous name
WASECA, MINNESOTA in radio

NEW 12 CHANNEL TELEVISION TRANSMITTER

Capable of MUSIC Modulation

PRICED AT A
NEW LOW OF
\$495.00



TYPE 2111

- The ONLY 12 channel TV transmitter that has a sound carrier capable of MUSIC modulation with full 40 KC swing.
- Has standard 75 microsecond pre-emphasis.
- All picture carriers are crystal controlled within 0.01% and modulation of picture carrier is by means of standard RMA Composite Picture Signal.
- Has standard rack mounting panel; power supply fully regulated.
- Just the thing for rapid TV checking on all 12 channels and for checking receivers for tone, speaker rattle and freedom from microphonics.

Write for Type 2111 Data Sheet for Full Details

TIC

Manufacturers of a Complete Line of TV Test Equipment

Tel-Instrument Co. Inc.

50 PATERSON AVENUE • EAST RUTHERFORD, N. J.

EMSCO ENGINEERED RADIO TOWERS

FOR AM, FM, VHF,
UHF, MICROWAVE,
TELEVISION AND RADAR

EmSCO Towers are available for all types of broadcast and communication service. Backed by years of fabricating experience, EMSCO towers are engineered for safety, performance and economy. Bolted construction and hot dip galvanizing insure long life, low maintenance cost and maximum electrical conductivity. Self-supporting triangular and square towers and guyed triangular towers are available in heights up to 1,000 feet with wind loadings up to 60 lbs. RMA design.

Shown here is an EmSCO Type 2RT 120-foot 40# RMA design tower installed for Southwestern Bell Telephone Co. in Dallas, Texas. →

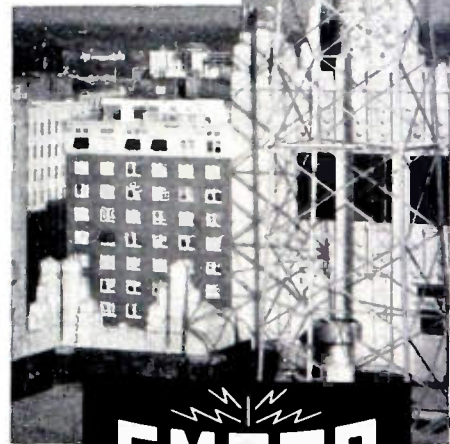

EMSCO

TOWERS OF STRENGTH

EMSCO DERRICK & EQUIPMENT COMPANY
LOS ANGELES, CALIFORNIA
Houston, Texas • Garland, Texas

News—New Products

These manufacturers have invited PROCEEDINGS readers to write for literature and further technical information. Please mention your I.R.E. affiliation
(Continued from page 68A)

New Deposited Carbon-Type Resistor

The Bell Telephone Laboratories, Inc., 463 West St., New York 14, N. Y., has developed an improved type of deposited carbon resistor which is expected to find wide-spread use in the communications and electronic fields.

In the new resistor, the element boron, as well as carbon, is pyrolytically deposited in a thin film on a suitable ceramic core. The addition of this element, it has been found, gives considerably lower temperature coefficients of resistance than those possessed by plain carbon resistors, as well as good stability. In addition, the new borocarbon resistors provide access to resistance ranges heretofore impossible to attain in stable, accurate film-type resistors.

Recent years have seen an increasing growth in the use of pyrolytic carbon resistors. Known variously as "cracked carbon resistors" or as "high stability carbon film resistors," they are composed of very thin films of microcrystalline carbon formed over the surfaces of ceramic cores.

(Continued on page 72A)

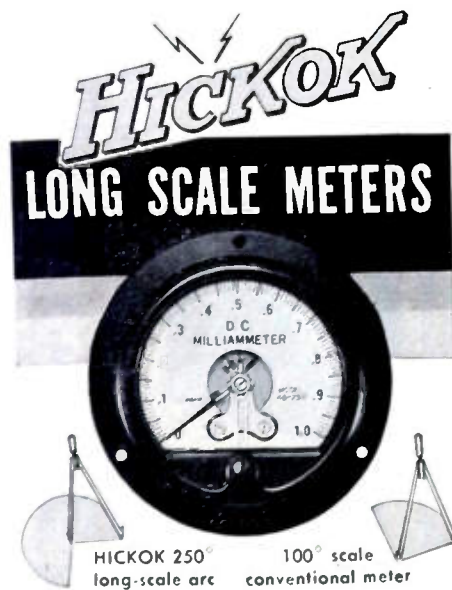

HICKOK
LONG SCALE METERS

HICKOK 250° long-scale arc 100° scale conventional meter

Easier to read accurately

The improved HICKOK meter scale is 2½ times longer than conventional meters to provide faster, more positive readings. Panel size 250° meters, pioneered by HICKOK, fit a smaller space, can be more easily read.

Accuracies to 1% of full scale reading! Available in popular AC or DC ranges. Case widths and diameters, 2½" to 5½". In reply kindly give details of your requirements.

THE HICKOK ELECTRICAL INSTRUMENT CO.
10587 DUPONT AVE. • CLEVELAND 8, OHIO
Highest Quality Electrical Meters Since 1910

S.S. WHITE FLEXIBLE SHAFTS GIVE YOUR TV SETS THIS EXTRA SALES APPEAL

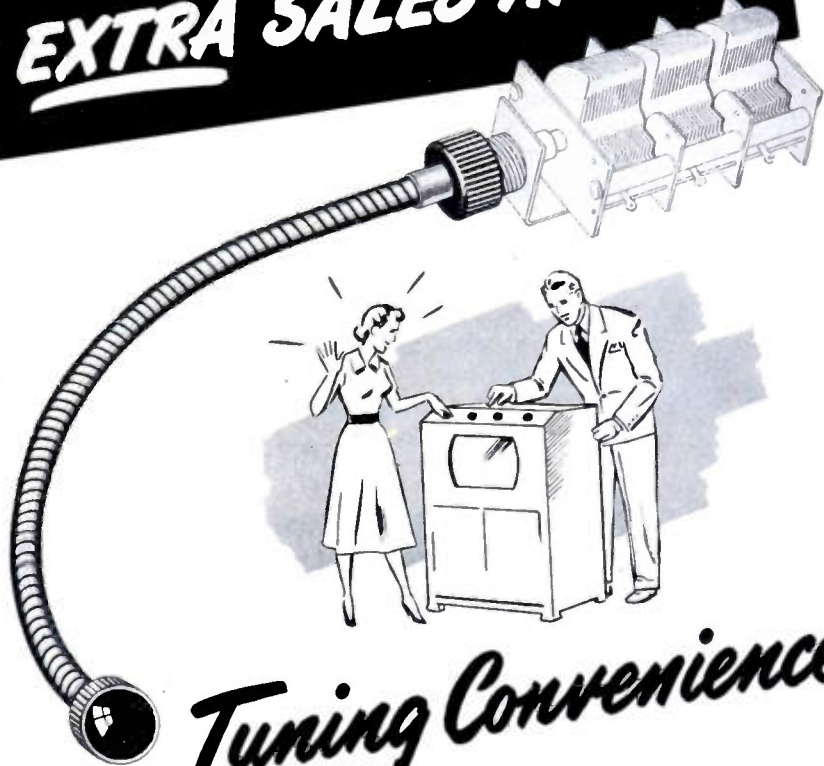

Tuning Convenience

You can make channel change and reception regulation on your TV equipment an easy, effortless task, when you couple the tuning knobs to their respective circuit elements with S.S. White flexible shafts.

The shafts will provide the sensitivity you require and at the same time will remove all limitations on the location of the control knobs. They'll permit you to position the knobs on the top of the set, on the side or even in a remote location—wherever necessary to assure maximum convenience.

Take advantage of the extra selling features S.S. White flexible shaft couplings can give your sets. Check their possibilities today. For details,

WRITE FOR NEW BULLETIN 5008



It contains the latest information and data on flexible shafts and their application. Write for a copy today.



THE **S.S. White** INDUSTRIAL DIVISION
DENTAL MFG. CO.

Dept. G-R 10 East 40th St.
NEW YORK 16, N. Y.

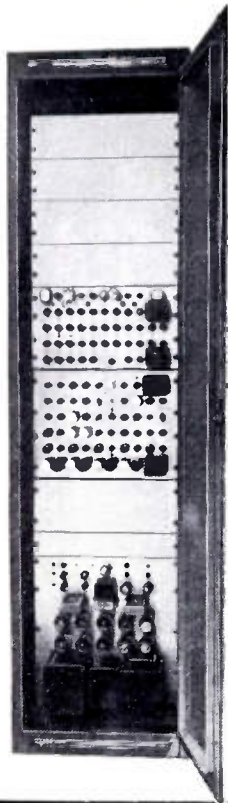

NEW TYPE 2200 SYNCHRONIZING SIGNAL GENERATOR

Featuring:

A new high for stability, performance, versatility.

- All binary dividers. No blocking tube or locked oscillators. Complete freedom from "rolling" at critical moments.
- All waveforms keyed from pulses derived from precision delay line. Absolute stability is achieved.
- Meets all RMA and FCC specifications with wide margin to spare.
- Built-in bar and dot generator for sweep linearity checking.
- Furnished with cabinet and has 33 1/4" mounting space available for type #2300 monoscope camera or other uses.

Price Complete
with Cabinet
\$1995. F.O.B. PLANT

Write for Type 2200
Data Sheet for Full
Details

TIC

Manufacturers of a Complete Line of TV Test Equipment

Tel-Instrument Co. Inc.

50 PATERSON AVENUE • EAST RUTHERFORD, N. J.

LOST db LOCATED

MEASURE CONVERSION LOSS AND NOISE TEMPERATURE OF SILICON MIXER CRYSTALS

This portable self-contained instrument will indicate directly the conversion loss of all mixer crystals intended for use at or below 10,000 Mc. Above 10,000 Mc the readings are relative (crystals may be selected in the order of their quality). The instrument also indicates 30 Mc noise temperature. Conversion loss mean deviation 1/2 db; noise temperature mean deviation 1/2.

PRODUCTION TESTING

INCOMING INSPECTION

FIELD TESTING

Order ALL Type 390 \$95.00 net
FOB Mineola, N. Y.

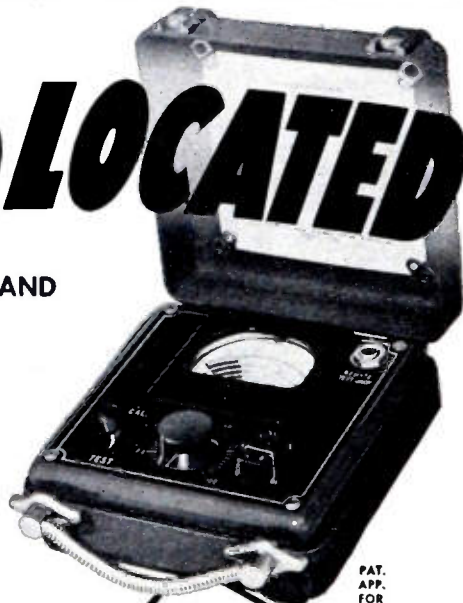

AS SIMPLE
TO USE AS A
VOLTMETER

Airborne Instruments Laboratory
INCORPORATED

160 OLD COUNTRY ROAD, MINEOLA, N. Y.

News—New Products

These manufacturers have invited PROCEEDINGS readers to write for literature and further technical information. Please mention your I.R.E. affiliation. (Continued from page 71A)

New Preamplifier

Model 230H, a new, compact, small size preamplifier to equalize low frequencies and provide necessary gain for magnetic pickups, has been developed by Pickering & Co., 308 Woods Ave., Ocean-side, L. I., N. Y.



Model 230H is self-powered, operates with any high quality, high input impedance amplifier and installs by plugging in. This new preamplifier is said to be superior to most broadcast station equipment in its frequency response and accuracy of equalization; furthermore, its intermodulation and harmonic distortion is said to be lower than good engineering practice requires of professional equipment.

(Continued on page 74A)

SYNTRON

OFFERS



SELENIUM RECTIFIERS

—made by a new process to uniform, high quality. In extra large cell sizes as well as small cells.

Write for brochure.

SYNTRON CO.

242 Lexington, Homer City, Pa.

MODEL 60 Bolometer Amplifier



- Self Contained Metering
- Pull Out Meter
- AC and DC Recorder Output
- Panel Selection of 3 Frequencies
- Adjustable and Metered Bolometer Bias

USES

The Model 60 Bolometer Amplifier is a band pass amplifier designed to amplify the output of crystal or bolometer probes used in RF measuring equipment. The amplifier is suitable for all occasions where extremely low audio voltages must be amplified. The recorder output makes the unit particularly useful for antenna pattern recorders requiring either AC or DC input voltages.

DESCRIPTION

The Model 60 Bolometer Amplifier is an audio amplifier incorporating parallel "T" null networks in a feed back circuit to provide a narrow band pass at any desired frequency within specified limits. The amplifier includes a meter amplifier and an output meter which may be removed from the panel opening for use at remote locations. The recorder output provides a choice of impedances for AC outputs as well as a DC output for those recorders requiring such an input. Input circuits are designed for operation with crystals or 300 ohm bolometers.

CHARACTERISTICS

FREQUENCY RANGE—400 cycles to 5000 cycles (choice of 1, 2, or 3 frequencies within these limits) $\pm 2\%$ frequency tolerance.
BANDWIDTH—($\frac{1}{2}$ voltage points) 8% of bandpass center frequency.
INPUT VOLTAGE RANGE
 Meter— 10^{-2} to 10^{-1} volt
 Recorder (AC)— 10^{-2} to 10^{-4} volt
INPUT IMPEDANCE—250 ohm to 350 ohm.
METER—Logarithmic meter scale (0-20 db) with 100 db decade.
RECORDER OUTPUT—AC .01-100 volts @ 50,000 ohms. Additional output impedances of 5000 ohms, 500 ohms, and 250 ohms.
 DC—0.01-0.75 volts.
BOLOMETER BIAS—Adjustable in steps of 2% current change over a range 2:1—metered directly.
POWER SUPPLY—115 volts 50/60 cycles 40 watts.
DIMENSIONS—19" wide, 8 $\frac{3}{4}$ " high, 10" deep.
WEIGHT—27 lbs.
FINISH—Blue grey wrinkle panel and mahogany cabinet (unit may be rack mounted without cabinet if desired.)

Ask for Bulletin L-60

PICKARD and BURNS, Inc.

240 Highland Ave.
Needham 94, Mass.

DIRECT WRITING RECORDERS

Records are produced by a heated writing stylus in contact with heat sensitive paper. The paper is pulled over a sharp edge in the paper drive mechanism (standard speed 25 mm/sec., slower available) and the stylus wipes along this edge as it swings, thus producing records in true rectangular coordinates. The writing arm is driven by a D'Arsonval moving coil Galvanometer with an extremely high torque movement (200,000 dyne cms per cm deflection).

This recorder assembly may be obtained in bare chassis form, as illustrated (51-600) with or without built-in timer; or, with the addition of a stylus heating transformer, temperature controls, and control panel (127); or, with the entire assembly, controls and control panel enclosed in a mahogany carrying case (127C). Complete catalog available, see below.

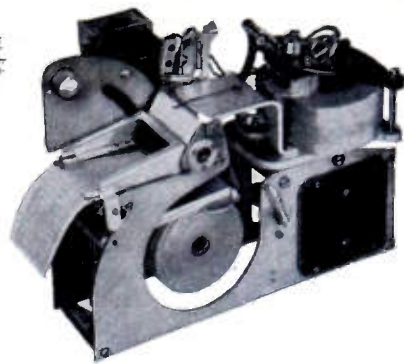

SINGLE
CHANNEL

NO INK
RECTANGULAR
COORDINATES
PERMANENT RECORDS

INSTRUMENT AMPLIFIERS

A general purpose, A.C. operated driver amplifier for use with model 127 Recorder, comprising three direct coupled push-pull stages. Maximum sensitivity 50 mv. per cm., minimum sensitivity 50 volts per cm., with four intermediate ranges. Balanced input terminals available with impedances of 5 megohms to ground. Complete information in catalog shown below.

Also available:

High Sensitivity STRAIN GAGE amplifiers

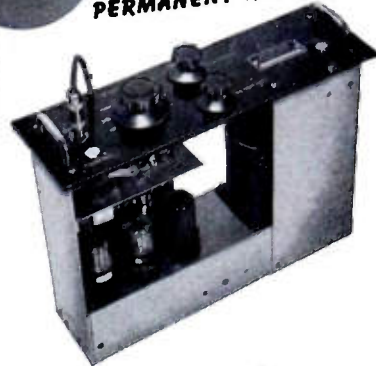

AMPLIFIER-RECORDERS

Model shown at right is a single channel unit comprising above Amplifier 126 and Recorder 127, contained in one mahogany carrying case, and designed for use in the industrial field as a direct writing vacuum tube recording voltmeter capable of reproducing any electrical phenomena from the order of a few millivolts to more than 200 volts. More complete data in catalog shown below.

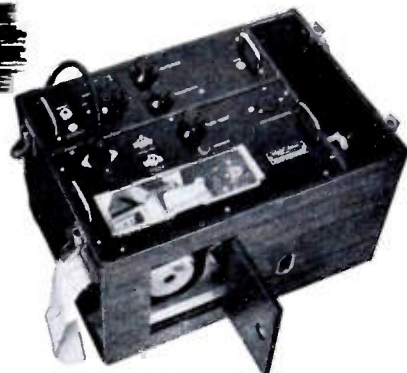

MULTI-
CHANNEL

NO INK
RECTANGULAR
COORDINATES
PERMANENT RECORDS

At lower right is a typical "Poly-Viso" multiple channel direct writing Recorder and Amplifier in console. Numerous combinations of this recording equipment and associated amplifiers and accessories are available. The Multi-channel Recorder (Model 65) provides for the simultaneous registration of up to four input phenomena, using the same principles and method as for the Recorder Assembly above. In addition, the "Poly-Viso" Recorder provides a selection of eight paper speeds: 50, 25, 10, 5, 2.5, 1.0, 0.5 and 0.25 mm/sec., and for the use of 4, 2, or 1 channel recording Permapaper. The Amplifier equipment is housed in a rack which has space for four individual driver amplifiers (electrically identical to model 126, above) and one 4-channel preamplifier.

For complete catalog giving tables of constants, sizes and weights, illustrations, general description, and prices, address:



SANBORN COMPANY
Industrial Division
CAMBRIDGE 39, MASS.

Sanborn Recorders and Amplifiers have evolved from those originally designed by Sanborn Company for use in electrocardiographs, and have, by actual practice, proven to have wide applications in the industrial field as well.

Test Equipment FOR RADAR and PULSE APPLICATIONS



MODEL 705 WOBBULATOR

Swept signal output with center frequency adjustable from 2 to 500 mc.
 Continuous swept output adjustable from 0 to 100 mc./sec. with 0.1 volt output at 50 ohms.
 Internally synchronized scope with detectors and amplifiers.
 - High and low impedance shielded traveling detectors.
 Output designed for making response measurements at 3000 mc., IF frequencies, and Video.

MODEL 708 SPECTRUM ANALYZER

Frequency range—8500 mc to 9600 mc.
 Receiver—Double conversion superheterodyne.
 IF bandwidth—approximately 10 kc.
 Sweep frequency—10 cps to 25 cps.
 Minimum frequency dispersion—1 mc/inch.
 Maximum frequency dispersion—10 mc/inch.
 Signal input attenuator—100 db linear.
 Power—115V or 230V, 50 cps to 800 cps.

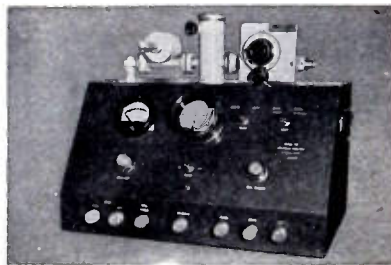

Write
for complete
technical data

Canoga Corporation

14315 Bessemer St., Van Nuys, Calif. • Box 361



Crystal Gazing Electronics Style

There's no room for "guess work" in the manufacture of crystals! That's why so many so often specify JK stabilized crystals when they want to be sure of utmost dependability.

Happily, this preference for the best costs no more. You, too, will be pleasantly surprised to find that The James Knights Company can furnish you outstanding quality at modest cost—in single units or production quantities.



JK Stabilized H17

Frequency range 200 kc to 100 mc. The pin spacing is such that two units can be mounted in a loctal socket. A small extremely light weight hermetically sealed unit. Moisture and dustproof. Designed especially for use where space is at a premium. The crystal is plated and wire mounted. Will stand maximum vibration. Pin diameter of the H17 is .050".

The H17L and the H17W are also available in the same frequency range except that the H17L has a pin diameter .093", and the H17W has wire leads.



The James Knights Company
SANDWICH, ILLINOIS

News—New Products

These manufacturers have invited PROCEEDINGS readers to write for literature and further technical information. Please mention your I.R.E. affiliation.

(Continued from page 72A)

New Rotor For Low Inertia Servo Motor

A new type 10-watt low inertia servo motor, having the highest torque-to-inertia ratio of any servo motor now available, it is claimed, has been developed by Ford Instrument Co., 31-10 Thompson Ave., Long Island City 1, N. Y.



Ford engineers have developed a rotor of pure iron which is appreciably superior to copper bar rotors. Iron rotors completely eliminate "cogging" and "single phasing" inherent in some bar-type rotors, and permit a much smaller rotor.

(Continued on page 78A)

TWIN LEAD, TELEVISION LIGHTNING ARRESTER

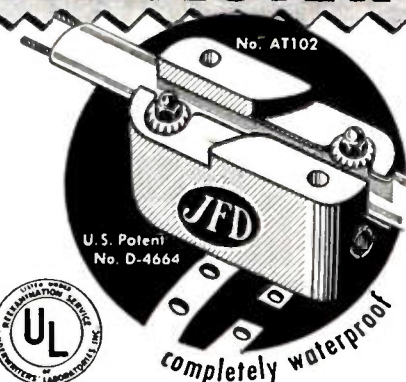

APPROVED for OUTDOOR-INDOOR Use \$ **2²⁵**
 Protects Television Sets
 Against Lightning and Static
 Charges

Twin Lead
JFD SAFE TV GUARD

Simple to install everywhere and anywhere
 ...no stripping, cutting or spreading of
 wires. More than 300,000 in use today!

SEE YOUR JOBBER OR WRITE TO

JFD MANUFACTURING CO., Inc.
 6127 16th Avenue, Brooklyn 4, N. Y.
 First in Television Antennas & Accessories

Dependable
PERFORMANCE
 at
LOWER COST



TOWER LIGHTING EQUIPMENT

H & P lighting equipment, consistently specified by outstanding radio engineers, is furnished as standard equipment by most leading tower manufacturers.

300 MM CODE BEACON

Patented ventilator dome circulates the air, assures cooler operation, longer lamp life. Concave base with drainage port at lowest point. Glass-to-glass color screen supports virtually eliminate color screen breakage. Neoprene gaskets throughout. CAA approved



MERCURY CODE FLASHER

Lifetime-lubricated ball bearings. No contact points to wear out. Highest quality bronze gears. Adjustable, 14 to 52 flashes per minute



SINGLE and DOUBLE OBSTRUCTION LIGHTS

Designed for standard A-21 traffic signal lamps. Prismatic globes meet CAA specifications.



"PECA" SERIES PHOTO-ELECTRIC CONTROL

Turns lights on at 35 f.c.; off at 58 f.c., as recommended by CAA. High-wattage industrial type resistors. Low-loss circuit insulation



ALSO COMPLETE LIGHT KITS FOR A-2, A-3, A-4 and A-5 TOWERS

PROMPT SERVICE and DELIVERY

First-day shipments out of stock. Immediate attention to specifications and unusual requirements

WRITE OR WIRE FOR CATALOG AND DETAILED INFORMATION

HUGHEY & PHILLIPS

TOWER LIGHTING DIVISION

326 N. LA CIENEGA BLVD.
 LOS ANGELES 40, CALIF.

60 E. 42ND ST. NEW YORK 17, N. Y.

HE CHOSE

Magnecorder



PT6-A Magnecorder and amplifier in rack mount. WGAR, Cleveland

THE FIRST CHOICE OF RADIO ENGINEERS

HIGH FIDELITY, LOW COST

Only Magnecord offers you such high fidelity at such low cost. Magnecorder frequency response: 50-15 kc ± 2 db. Signal-noise ratio: 50 db. Harmonic distortion less than 2%. Meets N. A. B. standards. More radio engineers use Magnecorders than all professional tape recorders combined!

GREATEST FLEXIBILITY

Mount a Magnecorder in a rack or console cabinet for delayed studio or network shows. Slip it into its really portable cases for remotes. Add to your Magnecord equipment as you need it—combine Magnecorders to suit every purpose.

MORE FEATURES

Your Magnecorder, new or old, now can have 3 heads (separate erase, record, and playback) to permit monitoring from tape. Three speeds (15"—7 1/2"—3 3/4"—up to an hour on a 7" reel) available on both PT6 and PT63 equipment. Dual track heads also available if desired.

Write for NEW CATALOG

MAGNECORD, INC., Dept. P-11

360 North Michigan Avenue, Chicago 1, Ill.

Send me latest catalog of Magnecord Equipment.

Name.....

Company.....

Address.....

City..... Zone..... State.....



Checking a second Magnecorder installation.

MAGNECORDER

For every purpose . . . every purse!



PT6 SERIES
 Most widely used professional tape recorder in the world.



PT63 SERIES
 Three heads to erase, record, and monitor from the tape.



PT7 SERIES
 A complete console for only \$950.00. Outstanding features and flexibility. Models for portable or rack mount also available.

The NEW Berkeley MODEL 1600

COUNTING RATE COMPUTER

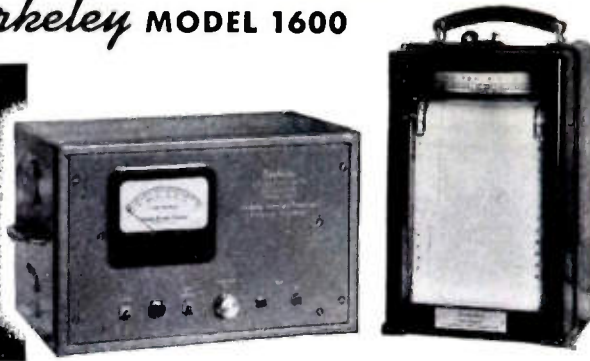

gives you these important advantages:

1. Virtually instantaneous rate of response
2. Permanent printed record of counting rate
3. Operates from either binary or decade scaler

BRIEF SPECIFICATIONS

Designed specifically for tracer applications requiring faithful response to rapid changes in counting rate, the Model 1600 will operate from any scaler that can be made to provide successive output pulses after accumulation of predetermined count. Computer then converts elapsed time between successive output pulses into average counting rate. Count-

ing rate can be read directly on visible meter of computer.

Choice of three recording rate ranges, in combination with proper scaling factors, permits selection of conditions for optimum statistical accuracy.

When designated as Model 1600A the unit includes standard recorder which provides permanent trace of counting rate.

FOR COMPLETE SPECIFICATIONS AND OPERATING DATA PLEASE WRITE FOR BULLETIN 15001RE

Berkeley Scientific Company

P. O. BOX 1826 • RICHMOND, CALIFORNIA

New Miniature Insulated Terminals to help your miniaturization program



Featuring extremely small size combined with excellent dielectric properties, three new miniature insulated terminals are now available from CTC.

Designed to meet the requirements of the miniaturization programs now being carried out by manufacturers of electrical and electronic equipment, the terminals come in three lengths of dielectric and with voltage breakdown ratings up to 5800 volts. In addition, they have an extremely low capacitance to ground.

The X1980XA is the smallest terminal, having an over-all height of only three-eighths of an inch including lug. Insulators are grade L-5 ceramic, silicone impregnated for maximum resistance to moisture and fungi.

All terminals have hex-type mounting studs with 3/48 thread or .141" OD rivet style mounting. Mounting studs are cadmium plated, terminals are of bright-alloy plated brass.

Write for additional data.

Turret Lugs Split Lugs Terminal Boards Double-End Lugs Swagers

custom or standard the guaranteed components

CAMBRIDGE THERMIONIC CORP.
456 Concord Ave., Cambridge 38, Mass.
West Coast Stock Maintained By: E. V. Roberts,
5014 Venice Blvd., Los Angeles, California

SMALL

PARTS

Cost less when made by

MULTI-SWAGE

The economy way to get
a million small parts
similar to these —

Examine the tubular metal parts shown here twice size. If you use anything similar . . . in quantities of over a million . . . important savings can be yours. Send us the part and specs. Our quotation will show why the Bead Chain Company's MULTI-SWAGE Process has long been known as the most economical method of making electronic contact pins, terminals, jacks and sleeves. And, why more and more users of mechanical parts (up to 1/4" dia. and to 2" length) employ our facilities. WRITE for Data Bulletin.

B THE BEAD CHAIN MANUFACTURING CO.,
Tr. Mark 60 MOUNTAIN GROVE ST., BRIDGEPORT 5, CONN.

THE TWIN TUBE POCKETSCOPE

BY WATERMAN

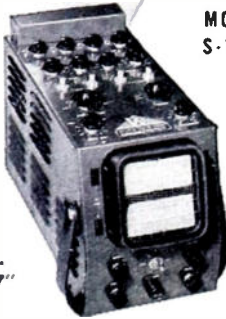

MODEL S-15-A

Wt. 16 1/4 lbs.
12" x 6" x 7"

A new concept in multiple trace oscilloscopy made possible by Waterman developed RAYONIC rectangular cathode ray tube, providing for the first time, optional screen characteristics in each channel. S-15-A is a portable twin tube, high sensitivity oscilloscope, with two independent vertical as well as horizontal channels. A "must" for investigation of electronic circuits in industry, school or laboratory.

Vertical channels: 10mv rms/inch, with response within -2DB from DC to 200kc, with pulse rise of 1.8μs. Horizontal channels: 1v rms/inch within -2DB from DC to 150kc, with pulse rise of 3μs. Non-frequency discriminating attenuators and gain controls, with internal calibration of traces. Repetitive or trigger time base, with linearization, from 1/2cps to 50kc, with ± sync. or trigger. Mu metal shield. Filter graph screen. And a host of other features.

WATERMAN PRODUCTS CO., INC.

PHILADELPHIA 25, PA.
CABLE ADDRESS: POCKETSCOPE

WATERMAN PRODUCTS INCLUDE:

- | | |
|-------------------------|-------------|
| S-10-B GENERAL | POCKETSCOPE |
| S-11-A INDUSTRIAL | POCKETSCOPE |
| S-14-A HI-GAIN | POCKETSCOPE |
| S-14-B WIDE BAND | POCKETSCOPE |
| S-21-A LINEAR TIME BASE | |

Also RAKSCOPES, LINEAR AMPLIFIERS, RAYONIC® TUBES and other equipment



... if you are commercially or professionally interested in TV, you must read **TELEVISION ENGINEERING** every month!

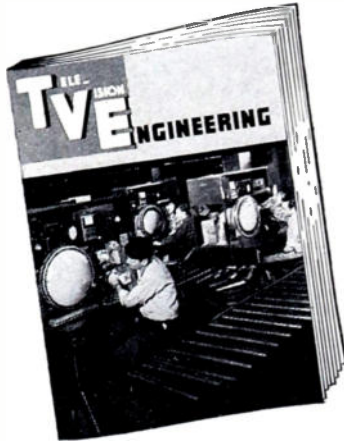

Devoted exclusively to TV
Research . . . Design
Production . . . Operation
Instrumentation

TELEVISION ENGINEERING is the *only* trade publication which directs its *entire* editorial content to executives and engineers who design, manufacture, operate and maintain television receiving and transmitting equipment—both commercial and educational.

Every issue is chock full of timely and thorough TV articles, authored by outstanding specialists. You'll find practical, carefully prepared reports and papers on such vital subjects as . . .

Color TV Systems . . . Ultrahigh Receiver-Transmitter Design Problems . . . Tube Production-Line Techniques . . . TV Broadcast Equipment . . . Camera Tube Research . . . Glass, Plastics and Metal in TV . . . TV Test Equipment in the Plant . . . Film Recording . . . Flying Spot Scanners . . . Tone Amplifiers for TV Films . . . Compact Motors for TV . . . TV Component Design . . . Mechanical Design Factors in Antennas . . . Quality Control Charting . . . Microwave Relays . . . Receiver and Transmitter Servicing . . . Production Aids . . . Instrument Activities . . . TV Sound Systems . . . Studio Lighting.

Enter your subscription NOW . . . Fill out the coupon below

TeleVision Engineering

IRE-11-50

52 Vonderbilt Ave., New York 17, N.Y.

Here is my remittance for my subscription to TeleVision Engineering at the

SPECIAL RATE . . . 3 years (36 issues) only \$5.

NAME

ADDRESS

CITY ZONE STATE

For our confidential records, open only to the Audit Bureau of Circulation, please supply the following information:

Occupation Title

Department in which employed

Operation Production Research

Employed by

Nature of Business

(State if TV Manufacturer, TV Broadcast Station, etc.)

are "SPECIALS"?

delaying your production?

Your "SPECIAL" may be our "STOCK" item

Whether you purchase sheet metal products or fabricate your own, it will pay you to check into our specialized production facilities, because you can often avoid costly delays when a SPECIAL is required.

We make over 400 different sheet metal products as stock items, any one of which may be just what you need. Often a slight change in one of our standard models will eliminate the necessity of special tools and dies, thereby reducing your cost. Since we produce thousands of sheet metal products every month for ourselves and for leading firms throughout the country, we are able to effect economies in production which mean lower prices and faster delivery.

Let us show you how you can save time and money on your sheet metal items today—send us your blue prints for estimates, or our representative will gladly call at your convenience.



BUD RADIO, INC.

2110 EAST 55TH STREET

CLEVELAND 3, OHIO

Pioneer in Radio Engineering Instruction Since 1927

CAPITOL RADIO

ENGINEERING INSTITUTE

An Accredited Technical Institute

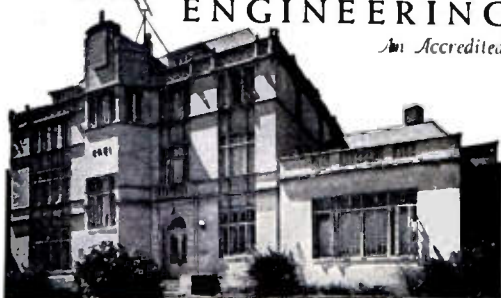

ADVANCED HOME STUDY
AND RESIDENCE COURSES IN
PRACTICAL RADIO-ELECTRONICS
AND TELEVISION ENGINEERING

Request your free home study or
resident school catalog by writing to:

DEPT. 2611B
16th and PARK ROAD, N.W.,
WASHINGTON 10, D.C.
Approved for Veteran Training

News—New Products

These manufacturers have invited PROCEEDINGS readers to write for literature and further technical information. Please mention your I.R.E. affiliation.

(Continued from page 74A)

The new 10-watt servo has a rotor diameter of only 0.665 inches, compared to 1.50 inches required in an equivalent servo having a copper bar rotor. This results in a saving of 1 pound in over-all weight, and a sevenfold increase in the torque to inertia ratio.

This servo can be foot- or flange-mounted, and the terminal block can be mounted in a choice of three positions.

Having linear torque speed characteristics over the entire operating range and a rotor inertia of 0.23 inches² ounces, this servo operates from either a single or 2 phase, 60 cps 115-volt supply, and can withstand indefinite stalling without damage.

Interesting Abstract

... Inland Testing Laboratories, Inc. 2745 N. Janssen Ave., Chicago 14, Ill. has released a new, 24-page brochure covering the test facilities, equipment, and capabilities they have to offer the industry for complete qualification testing of components and assemblies made under government contracts in accordance with JAN specifications.

New Phase Meter

A new precision phase meter, which provides means for determination of phase relationships throughout the audio spectrum of 30 to 20,000 cps, accurate to 0.1°.

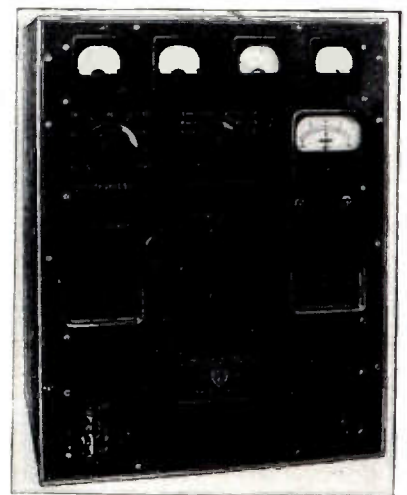

is at present in production by The W. L. Maxson Corp., 460 W. 34 St., New York 1, N. Y.

(Continued on page 79A)

News—New Products

These manufacturers have invited PROCEEDINGS readers to write for literature and further technical information. Please mention your I.R.E. affiliation.

(Continued from page 78A)

This instrument measures phase difference in terms of the calibrated phase shift required to establish phase coincidence of the voltages in the measuring circuit. Phase angle is read from two decade dials and a zero-center meter having a full-scale range of $\pm 1^\circ$. Switch-selected controls permit determination of lag or lead and of positive or negative "sense."

The power supply for the Model P-1060 electron-tube circuits is integral with the instrument chassis. It is designed to operate from an unregulated, 105/125-volt, 60-cps circuit.

High-Speed Multichannel Sampling Switch

The device illustrated, Model 2-60S-1, high-speed multichannel sampling switch, a compact unit which weighs only 8½ ounces, is announced by The Applied Science Corp., P.O. Box 44, Princeton, N. J. Dimensions are 2½ long 1¼ wide × 2½ inches high.

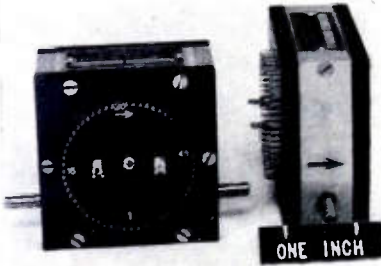

This miniature switch is designed with a 60:1 internal gear reduction and two separate poles, each of which contains 60 contacts. This design enables the two synchronized wipers to sample their respective contacts at a rate of one contact per revolution of the input shaft, thus permitting the user to correlate data from different channels with respect to angular position from a fixed reference for the drive shaft.

The shorting type wipers allow great versatility in wiring arrangements with the possibility of having as many as 60 independent channels per pole for "make-before-break" switching and 30 per pole for "break-before-make" switching when alternate contacts are left unwired.

Similar switches are available with 30:1 and 15:1 internal gear reductions.

Inexpensive L-Pad for Special Applications

Clarostat Mfg. Co., Inc., Washington St., Dover, N. H., manufacturers of resistance devices, announce a new addition to their L-Pad line. The new L-Pad has been designed for special application work, where dependability and cost are prime requisites.

(Continued on page 80A)

New Type 2A TAP SWITCHES

HAVE A CONSTANT CONTACT RESISTANCE OF **ONLY 1 or 2 MILLIOHMS!**

These high quality switches with up to 24 contacts were specifically developed to meet the need for rugged precision instrument switches that have longer operating life and are economical components in competitively priced electronic instruments and military equipment.

Write for Technical Bulletin No. 28.

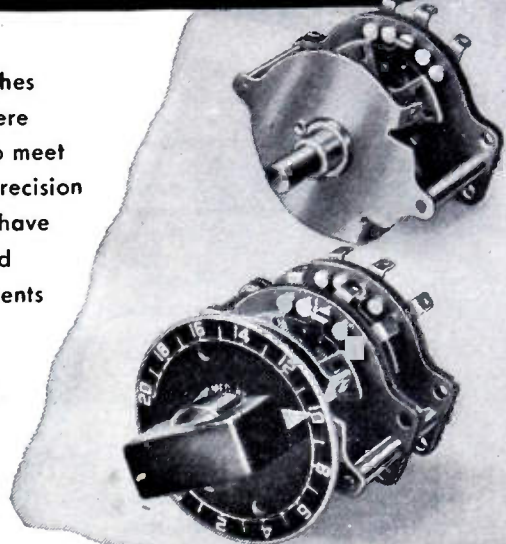

TECH LABORATORIES PALISADES PARK
NEW JERSEY

SLOW SWEEPS HIGH SENSITIVITY

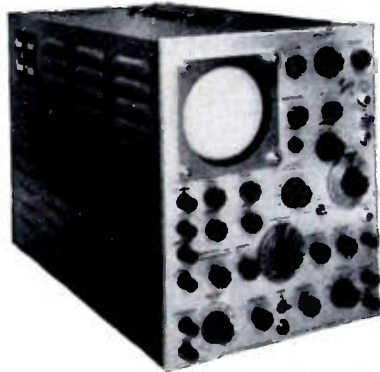

Type 512 Oscilloscope

- Band Pass—DC-2mc
- Sensitivity—5mv/cm maximum
- Sweeps—.3 sec/cm to 3 µsec/cm

Accurate observation and measurement of slowly recurring phenomena is difficult, if not impossible, by conventional oscilloscopic techniques. The Tektronix Type 512 Cathode Ray Oscilloscope, combining as it does direct-coupled amplifiers, slow sweeps and high accuracy, is recognized by a constantly increasing number of researchers as being an indispensable laboratory tool. New and fruitful approaches to the problems encountered in research are permitted by these features. \$950.00 f.o.b. Portland, Oregon.



Write today for detailed specification of Type 512 and other Tektronix instruments.

TEKTRONIX, INC.

712 S. E. Hawthorne Blvd. Portland 14, Ore.

COSSOR
for **QUALITY**

WHEN TIMING COUNTS
you can count on
Cossor Twin Beam Scopes

UNIQUE twin beam flat face tube permits EXACT time comparison of two waveforms without phase or frequency error. Beams are independent vertically and locked in horizontal direction, can be separated, superimposed or crossed for any comparative test . . . and . . . Model 1035 TWIN BEAM SCOPE (illustrated) offers these additional features: DIRECT time measurement on calibrated controls from 150 millise. to 1 microsec. DIRECT voltage measurement on each beam from 500 volts to 1 millivolt. Recurrent or triggered sweeps from 150 millise. to 5 microsec. High gain, wide-band amplifier, -3 db. at 7 Mc. Write for details on Model 1428 Scope Camera for still or moving film records. All instruments and spares in stock New York.

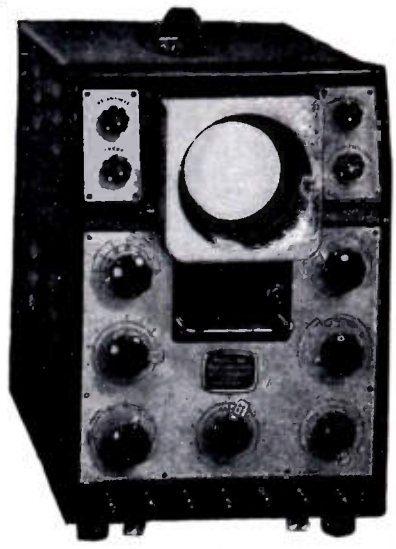

\$465 fob Halifax
\$650 fob New York

COSSOR (CANADA) LIMITED
301-303 Windsor Street, Halifax, N.S.
BEAM INSTRUMENTS CORPORATION
Room 907, 511 5th Avenue, New York 17, N.Y.

News—New Products

These manufacturers have invited PROCEEDINGS readers to write for literature and further technical information. Please mention your I.R.E. affiliation.
(Continued from page 79A)

The new Type No. CM8727, 8 ohm I-Pad, is a single unit with two separate wire windings for maintaining constant impedance. It was designed primarily for PA uses. Its compactness of size, identical to



Clarostat's Type 43 control, 1½ diameter by 9/16 inch deep, its low cost, and rugged construction are some of the advantages offered in this control. It is available upon special order within impedance ranges from 6 to 300 ohms. Rotation of the control is 120°.

Random Noise Generator

The Kay Electric Co., Maple Ave., Pine Brook, N. J., announces the Microwave Mega-Nodes, a series of random noise generators designed to produce a known output noise in the frequency range of 2,600 to 12,400 Mc.

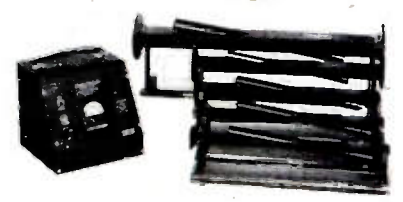

They are a group of five separate noise sources, each utilizing a standard commercial fluorescent lamp in a JAN size waveguide, each mounted on a hardwood stand. A separate cabinet houses the power supply for the noise sources. Plug-in cables are provided for direct connection of the power supply to any one of the microwave units. The following waveguide sizes are available: RG48/U, RG49/U, RG50/U, RG51/U, and RG52/U. Over the operating range, the VSWR of each generator is less than 1.1, with the exception of the RG50/U guide whose VSWR goes to 1.19 over about 20 per cent of the frequency range. The noise output of each generator is 15.84 db above thermal noise at a waveguide temperature of 32°C.

(Continued on page 81A)

E-I HERMETIC SEALING COMPONENTS

Now Available!

An extended range of types and sizes in the popular

90-G SERIES

MULTIPLE HEADERS

The 90-G Series is now supplied in a wider range of types than ever before. These include 5 and 10 amp lead sizes with from 2 to 14 terminals as well as plug-in bases for miniature 7, noval 9, and special 14-prong sockets. Voltage ratings are 1600 peak.

Write for These Descriptive Bulletins:

- 849 — Hermetically Sealed Terminals
- 850 — Hermetically Sealed Headers
- 851 — Gasket Type Bushings

90 G/40-HS-8

90 G/40-HS-14

90 G/P-7 (Miniature)

90 G/P-9 (Noval)

90 G/P-14

90 G/60-NS-12

E-I ELECTRICAL INDUSTRIES
INCORPORATED
44 SUMMER AVENUE • NEWARK 4, N. J.

News—New Products

These manufacturers have invited PROCEEDINGS readers to write for literature and further technical information. Please mention your I.R.E. affiliation.

(Continued from page 80A)

Null Detector Amplifier

A new null detector amplifier Model No. 1140 has just been introduced by Freed Transformer Co., Inc., 1718-36 Weirfield St., Brooklyn (Ridgewood) 27, N. Y.



This instrument is a high gain selective ac operated null indicator used for bridge measurements. It provides visual null indications or aural indications when used in conjunction with head phones. This unit may also be used as a high gain amplifier for general laboratory work.

(Continued on page 82A)

NEW WIDE BAND D.C. AMPLIFIER MODEL 120

A precision instrument designed for use as a preamplifier in conjunction with an oscilloscope, vacuum tube voltmeter or other instruments.

SPECIFICATIONS

FREQUENCY RESPONSE: Within ± 1 db between D.C. and 100,000 cycles per second.

GAIN: Approximately 100.

INPUT CONNECTION: Double channel, can be used for single ended and push-pull signals or as a differential amplifier.

INPUT IMPEDANCE: One Megohm shunted by approximately 15mmf in each channel.

DUAL INPUT ATTENUATOR: One to one, 10 to one, 100 to one and "off" positions in each channel independently adjustable.

OUTPUT CONNECTION: Push-pull or single ended.

OUTPUT IMPEDANCE: Less than 50 Ohms single ended or 100 Ohms push-pull.

HUM AND NOISE LEVEL: Below 40 microvolts referred to input.

LOW DRIFT due to regulated heater voltage in input stage.

MOUNTING: Metal cabinet approximately 7" wide by 7" high by 11" deep.



Write for descriptive literature on the Model 120 D.C. Amplifier and other Furst laboratory instruments including Regulated Power Supplies.



FURST ELECTRONICS

14 S. Jefferson St., Chicago 6, Ill.

All-Metal... All-Weather MOUNTS

COMPLETE and BALANCED PROTECTION



(CUP TYPE
MODEL #7002)

MET-L-FLEX

Unit mounts and mounting systems with MET-L-FLEX provide vibration isolation and true shock absorption through the widest range of operating conditions.

All-metal • no organic materials • stable characteristics from -90° C. to $+175^{\circ}$ C. • wide load tolerance • built-in damping for stability and reduced amplification at resonance.

For electronic or delicate equipment mounting, write Dept. 814 MET-L-FLEX Data Sheets available.

ROBINSON AVIATION INC.

RETIRO, NEW JERSEY

Vibration Control Engineers

IN-RES-CO

offers a complete line of standard RESISTORS that meet practically every requirement

Prompt Quotations supplied on both standard and special types

—more compact, higher accuracy!



Economical in Cost

IN-RES-CO WL series resistors were designed to meet increasing demands for a compact resistor of high accuracy priced for general use. They meet the most critical requirements — close tolerance, ability to withstand overload, long life. Write for catalog.

IN-RES-CO
APPLICATION-DESIGNED
RESISTORS



INSTRUMENT RESISTORS CO., 1036 COMMERCE AVE., UNION, N. J.

TYPES WL $\frac{5}{8}$ and WLA $\frac{5}{8}$



$\frac{1}{2}$ WATT
INDUCTIVE

MAX. RES: .01 to 7,500 ohm [331 Alloy]
.01 to 4,000 ohm [Nichrome]
.01 to 1,250 ohm [Mongonin]

BODY SIZE: $\frac{3}{8}$ " lg. by $\frac{3}{16}$ " diam.
TOLERANCE: STANDARD 1%

TYPES WL and WLA



1 WATT
INDUCTIVE

MAX. RES: .01 to 15,000 ohm [331 Alloy]
.01 to 8,000 ohm [Nichrome]
.01 to 2,500 ohm [Mongonin]

BODY SIZE: 1" lg. by $\frac{3}{16}$ " diam.
TOLERANCE: STANDARD 1%

Can be supplied non-inductive with one-half indicated maximum resistance.



MICROWAVE



23,000 to 27,000 MC. BENCH TEST PLUMBING 1/2" x 1/4" WAVEGUIDE

PRECISION SLOTTED LINE.
Adjustable probe \$200.00
**DIRECTIONAL COUPLER-
WAVEMETER MOUNT, 12DB**
..... \$60.00
**PRECISION VARIABLE AT-
TENUATOR, mfg. Bernard**
Rice \$90.00
LOW POWER LOAD \$20.00
SHUNT TEE \$35.00
WAVEGUIDE LENGTHS, 2" to
6" long, goldplated with cir-
cular flanges and coupling nuts
..... \$2.25 per inch
APS 31 Rotating Joint \$40.00
Right Angle Bend E or H Plane,
specify combination of couplings
desired \$12.00
45° Bend E or H Plane, Choke to
cover \$12.00

8500 Mc. to 9600 Mc. Bench Test Plumbing 1" x 1 1/2" WAVEGUIDE

FLAP ATTENUATOR, DB385.
Maximum Attenuation 100dB
..... \$25.00
UNI-DIRECTIONAL COUPLER,
DB390, 23DB type "N" output
..... \$18.50
PICK UP HORN, Type "N" out-
put \$4.50
WAVEMETER, 8500 to 9400 mcs.
with calibration, Micrometer ad-
just head, Reaction type \$85.00
WAVEGUIDE LENGTHS, Plated
and fitted with couplings avail-
able in 6", 12", 24", 30", 60",
90" sections \$2.00 per ft.
90 DEGREE ELBOWS, E or H
plane, 2 1/2" radius \$12.50
MITERED ELBOWS, E plane
..... \$10.00
90 DEGREE TWIST, 6" long
..... \$8.00
BULKHEAD FEED-THRU
ASSEMBLY \$15.00
PRESSURE GAUGE SECTION,
15 lb. water and press. handle
..... \$10.00
PRESSURE GAUGE, 15 lbs.
..... \$2.50
DUAL OSCILLATOR-BEACON
MOUNT, P/O APS10 Radar for
mounting two 72A/B klystrons
with crystal mts, matching
slugs, shields \$42.50
DUAL OSCILLATOR MOUNTS,
(Back to back) with crystal
mount, tunable termination, at-
tenuating slugs \$18.50
KLYSTRONS 723AB \$12.00

4000 to 6000 mcs. Bench Test Plumbing 2" x 1" WAVEGUIDE

SLOTTED LINE, DeMornay type
332 complete with probe, etc.
..... \$800.00
LAP ATTENUATOR \$48.00
VARIABLE STUB TUNER AND
LOW POWER TERMINATION
..... \$48.00
WAVEMETER TEE \$48.00
ADAPTERS:
Choke to choke \$18.00
Cover to cover \$14.00
Choke to cover \$16.00
WAVEGUIDE TO TYPE "N"
ADAPTER \$45.00
DIRECTIONAL COUPLER, Two
hole type, type "N" output
..... \$48.00
KLYSTRON MOUNT, Equipped
with tunable wdg. klystron and
micrometer adjust, klystron an-
tenna tuning \$110.00
CRYSTAL MOUNT, Equipped
with tunable termination and

MICROWAVE ANTENNAS

RELAY SYSTEM PARABOLIC REFLECTORS: approx. range: 2000
to 6000 mc. Dimensions: 4' x 3' rectangle, now \$35.00
TDY "JAM" RADAR ROTATING ANTENNA, 10 cm. 30 deg. beam,
115 v.a.c. drive, New \$100.00
OBM ANTENNA, Dual, back-to-back parabolas with dipole, Prop.
coverage 1,000-4,500 mc. No drive mechanism \$65.00
AS12/APR, Cone type receiving antenna, 1080 to 3208 megacycles,
New \$4.50
140-600 MC CONE type antenna, complete with 25' sectional steel mast,
guys, cables, carrying case, etc. New \$49.50
ASD 3 cm. antenna, used, ex. cond. \$49.50
YAGI ANTENNA AR-46A, APG-4, 5 elements \$14.50 ea.
DISH FOR PARABOLA 30" \$4.85
AS17/APB 10 CM ANTENNA, APB-2 20" Dish with 3/4 Coax Dipole
and fittings, New and Compl. with 24 V DC Drive motor, s-layn, 360
Deg. Rotation and Vertical Tilt \$94.50

COUPLINGS—UG-CONNECTORS

UG 40A \$7.75	UG 52 \$1.35	UG 65/U \$4.00	UG 18/U \$7.75
UG 40A \$1.10	UG 210 \$1.85	UG 86/U \$4.75	UG 208/U \$9.90
UG 343 \$2.35	UG 212 \$2.40	UG 65/U \$6.50	UG 87/U \$1.28
UG 344 \$2.90	UG 40U \$1.70	UG 149/U \$3.00	UG 27/U \$1.69
UG 428 \$2.00	3/4 Coax \$3.50	UG 148/U \$4.00	UG 21U \$9.89
UG 118 \$1.85	3/4 Coax \$3.95	UG 180/U \$3.00	UG 167/U \$2.28
UG 117 \$2.80	UG 53/U \$4.00	UG 39/U \$6.00	UG 29/U \$1.90
UG 51 \$1.00	UG 54/U \$4.00	UG 40/U \$8.00	UG 254/U \$1.89

RADAR SYSTEMS AND COMPONENTS IN STOCK

APS-2
10 CM AIRBORNE

APS-3
3 CM AIRBORNE

APS-4
3 CM AIRBORNE

APS-6
3 CM AIRBORNE

APS-6A
3 CM AIRBORNE

APS-10
3 CM AIRBORNE

APQ-13
3 CM AIRBORNE

APS-15
3 CM AIRBORNE

APS-31
3 CM AIRBORNE

CPN-8
10 CM GROUND
BEACON

CEXH
10 CM GROUND
BEACON

FD-MARK 4
800 MC SHIP GUNLAY-
ING

MARK-10
10 CM SHIP GUNLAY-
ING

SA
200 MC SHIP AIR
SEARCH

SC
200 MC SHIP AIR
SEARCH

SO
200 MC SUBMARINE

SE
10 CM SURFACE
SEARCH

SF
10 CM SURFACE
SEARCH

SG
10 CM SURFACE
SEARCH

SJ
10 CM SUBMARINE

SK
200 MC AIR SEARCH

SL
10 CM SURFACE
SEARCH

SN
10 CM PORTABLE

SO (ALL SERIES)
10 CM SURFACE
SEARCH

SQ
10 CM PORTABLE

SW
200 MC PORTABLE

SCR 518
400 MC ALTIMETER

SCR 520
10 CM AIRBORNE

SCR 533
200 MC AIR SEARCH

SCR 545
10 CM TRACKING 800
MC SEARCH

SCR 663
BEARLIGHT TRACK

SONAR SYSTEMS AND COMPONENTS IN STOCK

QBF

QBG

QC

QCJ

QCL

QCO

QCS

QCU

WEA

3000 MC BENCH TEST PLUMBING

TEST EQUIPMENT

10 CM Wavemeter WE type
B435490 Transmission type
Type N Fittings, Vee-der Root
Micrometer dial, Gold Plated
W/Calib. Chart P/O Freq. Meter
X66404A, New \$99.50
A514/AP-10 CM Pick up Dipole
with "N" Cables \$4.50

R. F. EQUIPMENT

**LHTR, LIGHTHOUSE ASSEM-
BLY, Part of RT-39 APG 5 &**
APG 15, Receiver and Trans
Cavities w/assoc. Tr. Cavity and
Type N CPLG, To Rev. Uses
2C40, 2K43, 1B27, Tunable APX
2400-2700 MCS, Silver Plated
..... \$49.50
Beacon Lighthouse cavity 10 cm
with miniature 28 volt DC FMI
motor, Mfg. Bernard Rice
..... \$47.50 ea.

S. BAND

Magnetron to Waveguide Coupler
with 721A Duplexer Cavity,
gold-plated \$45.00
721A TR Box complete with tube
and tuning plungers \$12.50
McNally Klystron Cavities for
707B or 2K23. Three types
available \$4.00
F-29/SI'R-2 Filters, Type "N",
input and output \$12.50

ARMY-NAVY TEST SETS

LU-1 Freq. Meter and Test Oscil-
lator, Type CRV-TVN-9HU
Power Supply, M.I.T. Rad. Lab.
TVN-8SE Klystron Power Supply,
M.I.T. Rad. Lab.
CS60AB Watt Meter—Wave-
meter, 3 centimeter.
APRS Receiver—1000 to 6000 mcv.
AN/CPM-8—10 centimeter 40 kw.
output RF package, includes
magnetron oscillator, complete
modulator, complete receiver,
complete signal and power ana-
lyzer with 5" scope, 115V AC
input.

TEST EQUIPMENT

Dehydrator Unit CPD 10137 Auto-
matic cycling.
Compressor to 50 lbs. Compl. for
Radar XSMN, Line New \$425.00
SO-3 Receiver, 30 mc. IF, 6 stages
6AC7, 10 MC. Band width Inpt.

PULSE TRANSFORMERS

G.E.K.-2745 \$39.50
G.E.K.-2744-A, 115 KV High
Voltage, 3.23 KV Low Voltage
@ 200 KW oper. (270 KW
max.) 1 microsec. or 1/4 micro-
sec. @ 600 PPS \$39.50
W.E. QD16173 Hi-Volt Input
transformer, W.E. Impedance
ratio 50 ohms to 900 ohms.
Freq. range: 10 kc. to 2 mc. 2
sections parallel connected, pot-
ted in oil \$36.00
W.E. KS 9800 Input transformer.
Winding ratio between termi-
nals 3-5 and 1-2 is 1:1:1 and
between terminals 6-7 and 1-2 is
2:1 Frequency range: 380-520
c.p.s. Permalloy core \$6.00
G.E. K62731 Repetition Rate: 635
PPS, Pri. 50 Ohm Sec.
Imp: 450 Ohm Pulse Width: 1

726 Klystron Mount, Tunable out-
put, to type "N" complete, with
socket and mounting bracket
..... \$12.50

WAVEGUIDE TO 3/4" RIGID
COAX, DOOR-OR-ADAPT-
ER, CHOK FLANGE SILVER
PLATED BRONZE BAND \$32.50
WAVEGUIDE DIRECTIONAL
COUPLER, 27 db. Navy type
CAVY-47AAN, with 4 in.
slotted section \$32.50
SQ, FLANGE to rd choke adapter,
18 in. long O 1 1/2 in. x 3 in.
guide, type "N" output and
sampling probe \$27.50
AN/APR5A 10 cm antenna equip-
ment consisting of two 10 cm
waveguide sections, each polar-
ized, 45 degrees \$75.00 per set
POWER SPLITTER: 726 Klystron
input dual \$3.00
10 CM FEEDBACK DIPOLE
ANTENNA, in lucite ball, for
use with parabola 3/4" Rigid
Coax Input \$8.00
721A TR cavities, heavy silver
plated \$2.00 ea.

7" RIGID COAX

Magnetron Coupling with TR
Loop, gold-plated \$7.50
Sperry Rotating Bend, pressurized
..... \$2.50
5' 7" Rigid Coax with Suppor. ed,
gold-plated, per length \$7.50
Short Right Angle Bends (for
above) \$2.50

5.1 mc R.W. per stg. 9.6 volt
gain per stage as desc in ch.
13 vol. 23 M.I.T. Rad. Lab.
S-riles \$99.50
APS-2 10 CM RF HEAD COM-
PLIETE WITH HARD TUBE
(715B) Pulser, 714 magnetron
417A Mixer at 3/4" rigid coax,
incl. revr. front end \$210.00
10 cm. cavity tube wavemeters 6"
deep, 6 1/2" in. diameter Coax.
Output Silver Plated, \$64.80 ea.
10 cm. echo box, Part of SFI
Radar W/115 volt DC Tuning
motor Sub Six, 1118AO, \$47.50
TS12 3 cm Slotted Line
TS13 3 cm Signal Generator
TS33 3 cm Frequency Meter
TS35 3 cm Signal Generator
TS36 3 cm Power Meter
TS45/AMP3 3 cm Signal Genera-
tor
TS62 3 cm Echo Box
TS108 Dummy Load

Microsec. Pri. Input: 9.5 KV
PK Sec. Output: 28 KV PK
Peak Output: 800 KW Rflar
2.75 Amp \$64.50
W.E. QD169277 Hi Volt Input
pulse Transformer \$27.50
G.E. K2450 Hi-Volt Receiver 13KV,
4 micro-second pulse on pri.
secondary delivers 14KV Peak
power out 100 KW G.E. \$34.50
G.E. 2K2748A, Pulse Input line to
magnetron \$37.00
23252 Utah Pulse Generator
oscillator XFMR Freq. limits 70-
810 cy-3 winding turns ratio
1:1:1 Dimensions 1 1/8 x 1 1/2"
10/32 \$1.50
Pulse 131-AWP L-421485 \$6.00
Pulse 134-EWP LF L-440886 \$2.25
RAY-WX-4298 \$93.50
GE-K6324730 \$50.00
GE-K921945 \$50.00



CW" MAGNETRONS

QK 62 3150-3375 mc.
QK 59 2675-2900 mc.
QK 61 2975-3200 mc.
QK 60 2800-3025 mc.
New, Guaranteed Each \$65.00
QK 915 \$150.00

FILAMENT TRANSFORMER
for above 115V/60 cy Pri: four 6.3V/
4A Sec. 5000VTC \$27.50
Magnetron Kit of four QK's 2675-3875
inc. w/trans special \$250.00

MAGNETRON MAGNETS

Gauss	Pole Diam.	Spacing	Price
4850	3/4 in.	3/4 in.	\$ 8.90
5200	21/32 in.	3/4 in.	\$17.50
1300	1 1/2 in.	1 1/16 in.	\$12.50
1860	1 1/2 in.	1 1/2 in.	\$14.50

Electromagnets for magnetrons \$24.50 ea.
GE Magnets type M7765115, GI Distance Between
Poles (max) variable, 2 1/16" (1900 Gauss) to
1 1/4" (12200 Gauss) Pole Dia. 1 1/4". New Par-
of SCR 584 \$34.50

MAGNETRONS 2161 706

2127

2131

2121-A 2162 723A

2122 8130 707B W/Cavity

2128 214AY 417A

2132 718DY 2K41

2137 720BY "CW" MAGNETRONS

2138 720CY QK 62 3150-3375 mc.

2139 725-A QK 59 2675-2900 mc.

2140 730-A QK 61 2975-3200 mc.

2149 728 QK 60 2800-3025 mc.

2134 700 QK 9915

THERMISTORS

O-167332 (tube) \$95
O-170396 (bead) \$95
D-167613 (button) \$95
D-164699 for MTG in
"X" band Guide
O-167016 (tube) \$2.50
..... \$3.95

VARIABLES

D-170225 \$1.28
D-167176 \$9.95
D-168687 \$9.95
O-171812 \$9.95
D-171528 \$9.95
D-168549 \$9.95
D-168442 \$3.00
D-168383 \$1.28
D-88836 \$2.00
D-161871A \$2.85
D-171121 \$9.95
D-162356(306A) \$1.50
D-163357 \$2.00
D-89946 \$2.95

**NEW TEST EQUIP-
MENT IN STOCK**

1-158 Range Calibrator
1-223 Range Calibrator
1C 488 Freq. Meter
RF Preamp.
G.R. Capacity Brdg.
..... \$216
G.I. Uni Galvo Shunt
..... \$229
G.I. 100 FL Aud. Osc.
..... \$218
TS224A/AP Pwr. Mtr.
O-1000 W
Sig. Gen. 1804 8-830
MC

All merch. guar. Mail orders promptly filled. All prices, F.O.B., N.Y.C. Send Money Order or Check. Only shipping charges sent C.O.D. Rated Concerns send P.O.

COMMUNICATIONS EQUIPMENT COMPANY

113 LIBERTY STREET, NEW YORK, N.Y. DEPT 111 P. J. PLSHNER PHONE DIGBY-9-4124

SAFE AT THE PLATE!



AND SO IS **Seletron**

SELETRON "Safe Center" plates in miniature rectifiers eliminate the danger of arc-over, short circuits and excessive heating due to high leakage current at the center contact point. Assembly pressure, or pressure applied in mounting the rectifier cannot affect its performance. This SELETRON feature is accomplished by deactivating the area of the plate under the contact washer.



There are millions of SELETRON Selenium Rectifiers in service in radio and TV; millions more in other electronic circuits. That is why you can specify SELETRON and be safe!

Look for Howard W. Sam's Red Book Supplement listing SELETRON replacements . . . and write for your copy of our new Bulletin No. RE-5

SELETRON DIVISION
RR RADIO RECEPTOR COMPANY, INC. RR
Since 1922 in Radio and Electronics
 Factory: 84 North 9th St., Brooklyn 11, N. Y. • Sales Department: 251 West 19th St., New York 11, N. Y.

CONTINUOUSLY VARIABLE FILTERS



MODEL 302
 VARIABLE ELECTRONIC FILTER

"Another SKL first"

The — SKL — Model 302 includes two independent filter sections, each having a continuously variable cut-off range of 20 cps to 200 KC. Providing a choice of filter types each section has 18 db per octave attenuation. When cascaded 36 db is obtained in the high and low pass setting and 18 db in the band pass position. With low noise level and 0 insertion loss this versatile filter can be used as an analyzer in industry and the research laboratory or to control sound in the communications laboratory, radio broadcasting, recording and moving picture industries.

SPECIFICATIONS

- CUT-OFF RANGE
20 cps to 200 KC
- SECTIONS
2—can be high, low and band pass
- ATTENUATIONS
36 db/octave maximum
- INSERTION LOSS . 0 db
- NOISE LEVEL
70 db below 1 volt
- FREQUENCY RESPONSE
2 cps to 2 MC

SKL SPENCER-KENNEDY LABORATORIES, INC.
 181 MASSACHUSETTS AVE., CAMBRIDGE 39, MASS.

News—New Products

These manufacturers have invited PROCEEDINGS readers to write for literature and further technical information. Please mention your I.R.E. affiliation.

(Continued from page 82A)

This monitor, the MTV-12, is designed for professional use; all controls are located on the front panel and are quickly available to the operating personnel.



In addition to a 12½-inch picture tube, the unit contains an audio channel and speaker which may be used for either cueing or monitoring.

(Continued on page 85A)

NOW!

SPEED UP ALL SOLDERING WITH

UNGAR

FEATHER-LIGHT SOLDERING PENCILS WITH

HI-HEAT TIPS

INCREASED WATTAGE



For use with No. 776 Handle & Cord Set

Stop wrestling with big irons. New HI-HEAT TIPS in your Ungar Electric Soldering Pencil produce a really versatile tool that'll perform on a par with the big, bulky 100-150 watt irons. If you can't get immediate delivery, please be patient, for production hasn't yet caught up with demand. Ask your supplier for No. 1236 Pyramid or No. 1239 Chisel. List price, \$1.25 each.

Ungar
 ELECTRIC TOOL CO., Inc.
 LOS ANGELES 54, CALIFORNIA

News—New Products

These manufacturers have invited PROCEEDINGS readers to write for literature and further technical information. Please mention your I.R.E. affiliation.

(Continued from page 84A)

Recent Catalogs

... Polarad Electronics Corp., 100 Metropolitan Ave., Brooklyn 11, N. Y., is issuing a new 14-page catalog on TV cameras, synchronizing generators, monitors, TV amplifiers, and power supplies for broadcast operation.

... Technical and application data on precious metal alloys being used for sliding contacts, brushes, wipers, slip rings, commutator segments, resistance wire, and noncorrosive wear-resistant parts may be obtained from The J. M. Ney Company, 71 Elm St., Hartford, Conn.

... The September, 1950, issue of *CEC Recordings*, with various articles on instrumentation, includes an article on a new Model 21-103 mass spectrometer with a new ion source, Isatron, and is available from Consolidated Engineering Corp., 620 N. Lake Ave., Pasadena 4, Calif.

... A new bulletin CS, with numerous line drawings and charts to give information concerning contact switches relative to sizes, designs and materials available in standard contact blades, lug adapters, and insulating separators may be obtained from Guardian Electric Mfg. Co., 1621 W. Walnut St., Chicago 12, Ill.



THE LOWEST EVER CAPACITANCE OR ATTENUATION

We are specially organised to give SPOT DELIVERIES TO U.S.A Cable your rush order for shipment by air freight. Settlement by your own \$ check

TRANSRADIO LTD

CONTRACTORS TO H.M. GOVERNMENT
138A CROMWELL ROAD LONDON SW7 ENGLAND
CABLES: TRANSRAD LONDON.

LOW ATTEN TYPES	IMPED OHMS	ATTEN db/100ft of 100 Mc	LOADING Mw	O.D."
A 1	74	1.7	0.11	0.36
A 2	74	1.3	0.24	0.44
A 34	73	0.6	1.5	0.88
LOW CAPAC TYPES	CAPAC mmf/ft	IMPED OHMS	ATTEN db/100ft 100Mc	O.D."
C 1	7.3	150	2.5	0.36
PC 1	10.2	132	3.1	0.36
C 11	6.3	173	3.2	0.36
C 2	6.3	171	2.15	0.44
C 22	5.5	184	2.8	0.44
C 3	5.4	197	1.9	0.64
C 33	4.8	220	2.4	0.64
C 44	4.1	252	2.1	1.03

HIGH POWER FLEXIBLE

PHOTOCELL CABLE

V. L. C. ★

★ Very Low Capacitance cable.

The New STAVER MINI-SPRING

TRADE MARK REG. AND PAT. PEND

A quality Tube Guard that is Bargain Priced



Gives support two ways—Keeps pressure downward and gives sideways support. The spring action is constant and resilient permanently. Send for catalog sheet.



PRODUCTION LINE TESTING

OF

SERVOSCOPE

SERVOMECHANISMS



SERVO CORPORATION OF AMERICA

NEW HYDE PARK
LONG ISLAND
NEW YORK

INVALUABLE IN RESEARCH

RAPID INSPECTION ON THE PRODUCTION LINE

A SERVO ANALYZER

- STANDARD RANGE: .1 TO 20 CYCLES PER SECOND
- SINE WAVE
- MODULATED CARRIER
- 50 TO 800 CYCLES
- SQUARE WAVE
- READS DIRECTLY
- SERVO LAG OR LEAD IN DEGREES

PROFESSIONAL CARDS

INDEX AND DISPLAY ADVERTISERS

LESTER W. BAILEY
Registered Patent Agent
Senior Member IRE
PATENT OFFICE PRACTICE specializing in
ELECTRONICS RADIO MECHANICS
LINCOLN-LIBERTY BUILDING
PHILADELPHIA 7
Broad & Chestnut Streets Rittenhouse 6-3267

ALFRED W. BARBER LABORATORIES
Specializing in the Communications Field and
in Laboratory Equipment
Offices, Laboratory and Model Shop at:
32-44 Francis Lewis Blvd., Flushing, L.I., N.Y.
Telephone: Independence 3-3306

HAROLD J. BROWN
Vibrators
Vibrator Power Supplies
Electrical Contact Systems
Mattapoisett, Mass.

W. J. BROWN
International Electronics Consultant
AT PRESENT IN GREAT BRITAIN
Will undertake assignments for American or
British Clients. Please address inquiries to 11
Public Square, Cleveland 13, Ohio.
TO 1-6498 FA-1-0030

EDWARD J. CONTENT
Acoustical Consultant
Functional Studio-Theater Design
FM — Television — AM
Audio Systems Engineering
Roxbury Road Stamford 3-7459
Stamford, Conn.

CROSBY LABORATORIES, INC.
Murray G. Crosby & Staff
Radio-Electronic Engineering,
Research & Development
FM, Communications, TV
Test Equipment
Offices, Laboratory & Model Shop at:
126 Herricks Rd., Mineola, N.Y.
Garden City 7-0284

ELK ELECTRONIC LABORATORIES
Jack Rosenbaum
Specializing in the design and
development of
Test Equipment for the communications,
radar and allied fields.
333 West 52nd St. Telephone:
New York 19, N.Y. PLAZA 7-0520

PAUL GODLEY CO.
Consulting Radio Engineers
P.O. Box J. Upper Montclair, N.J.
Offs & Lab.: Great Notch, N.J.
Phone: Montclair 3-3000
Established 1926

HERMAN LEWIS GORDON
Registered Patent Attorney
Patent Investigations and Opinions
Warner Building 100 Normandy Drive
Washington 4, D.C. Silver Spring, Md.
National 2497 Shepherd 2433

HOGAN LABORATORIES, INC.
John V. L. Hogan, Pres.
APPLIED RESEARCH, DEVELOPMENT,
ENGINEERING
Est. 1929. Exceptionally competent staff. Elec-
tronics, Optics, Mechanisms, Facsimile Com-
munication, Electro-sensitive recording media,
Instrumentation.
155 Perry Street, New York 14 Chelsea 2-7855

MEASUREMENTS CORP.
RESEARCH & MANUFACTURING
ENGINEERS
Harry W. Houck Jerry B. Minter
John M. van Beuren
Specialists in the Design and
Development of Electronic Test Instruments
BOONTON, N.J.

Eugene Mittelman, E.E., Ph.D.
Consulting Engineer & Physicist
High Frequency Heating—Industrial Electronics
Applied Physics and Mathematics
549 W. Washington Blvd. Chicago 6, Ill.
State 2-8021

PICKARD AND BURNS, INC.
Consulting
Electronic Engineers
240 HIGHLAND AVE.
NEEDHAM, MASS.

PAUL ROSENBERG ASSOCIATES
Consulting Physicists
Main office: Woolworth Building,
New York 7, N.Y.
Cable Address Telephone
PHYSICIST WOrth 2-1939
Laboratory: 21 Park Place, New York 7, N.Y.

SERVO CORPORATION OF AMERICA
Henry Blackstone, President
Consultants on
Electronic Control Problems
for Industry
New Hyde Park Long Island, N.Y.

TECHNICAL MATERIEL CORPORATION
COMMUNICATIONS CONSULTANTS
RADIOTELETYPE - FREQUENCY SHIFT
INK SLIP RECORDING - TELETYPE NETWORKS
121 Spencer Place, Mamaroneck, N.Y.

WHEELER LABORATORIES, INC.
Radio and Electronics
Consulting — Research — Development
R-F Circuits — Lines — Antennas
Microwave Components — Test Equipment
Harold A. Wheeler and Engineering Staff
Great Neck, N.Y. Great Neck 2-7806

WILLIAM L. FOSS, INC.
927 15th St., N.W. REpublic 3883
WASHINGTON, D.C.

Section Meetings	38A
Student Branch Meetings	38A
Membership	40A
Positions Open	50A
Positions Wanted	56A
News-New Products	30A

DISPLAY ADVERTISERS

Ace Engineering & Machine Co., Inc.	65A
Acme Electric Corp.	65A
Aerovox Corp.	22A
Airborne Instruments Lab., Inc.	52A, 72A
Aircraft Radio Corp.	16A
Airtron, Inc.	44A
Allied Electric Products, Inc.	43A
American Lava Corp.	17A
Amperex Electronic Corp.	Cover II
Antara Products, Div. of General Aniline & Film Corp.	46A & 47A
Arnold Engineering Co.	6A
Lester W. Bailey	86A
Ballantine Labs.	40A
A. W. Barber Labs.	86A
Barker & Williamson	38A
Bead Chain Mfg. Co.	76A
Bell Telephone Labs.	2A
Bendix Aviation (Friez Inst. Div.)	56A
Bendix Aviation (Pacific Div.)	62A
Bendix Aviation (Radio Div.)	52A
Berkeley Scientific Co.	76A
Blaw-Knox	67A
Harold J. Brown	86A
W. J. Brown	86A
Bud Radio, Inc.	78A
Cambridge Thermionic Corp.	76A
Canoga Corp.	74A
Capitol Radio Engineering Inst.	78A
Centralab	33A, 34A, 35A, 36A
Cleveland Container Co.	9A
Sigmund Cohn Corp.	69A
Collins Radio Co.	41A
Communication Products Co.	48A
Communications Equipment Co.	83A
E. J. Content	86A
Convair	54A
Cornell-Dubilier Electric Corp.	Cover III

INDEX AND DISPLAY ADVERTISERS—Continued

Cossor, Ltd.	80A	National Carbon Co.	64A	Sorensen & Co.	59A
Crosby Labs.	86A	National Union Radio Corp.	58A	Spencer-Kennedy Labs.	84A
Dow Corning Corp.	62A	North American Aviation	56A	Sperry Gyroscope Co.	58A, 61A
Allen B. DuMont Labs., Inc.	5A, 45A, 39A	Ohmite Mfg. Co.	13A	Sprague Electric Co.	1A
Eitel-McCullough, Inc.	18A	Panoramic Radio Products, Inc.	82A	Stackpole Carbon Co.	8A
Electrical Industries Inc.	80A	Par Metal Products	82A	Staver Co.	85A
Electrical Reactance Corp.	7A	Pickard & Burns	73A, 86A	Geo. Stevens Mfg. Co., Inc.	66A
Electro-Motive Mfg. Co., Inc.	15A	Polytechnic Research & Development Co.	19A	Stoddart Aircraft Radio Co.	24A
Elk Electronic Labs.	86A	Potter Instrument Co.	51A	Sylvania Electric Products Co.	14A
Emsco Derrick & Equipment Co.	70A	Radio Corp. of America	32A, 58A, 88A	Syntron Co.	72A
Engineering Research Associates	62A	RCA Service Co.	50A	Tech Labs.	79A
Fairchild Engine & Airplane Corp.	63A	Radio Receptor Co.	84A	Technical Materiel Corp.	86A
Federal Telecommunication Labs.	27A	Rauland Corp.	49A	Technology Instrument Corp.	68A
W. L. Foss	86A	Raytheon Mfg. Co.	53A	Roland Teiner Co.	30A
Freed Transformer Co.	57A	Robinson Aviation, Inc.	81A	Tektronix Inc.	79A
Furst Electronics	81A	Paul Rosenberg	86A	Tel Instrument	70A, 72A
General Electric Co.	10A, 11A, 29A, 54A	Sanborn Co.	73A	Television Engineering	77A
General Precision Labs.	21A	Servo Corp. of America	85A, 86A	Transradio Ltd.	85A
General Radio Co.	Cover IV	Shallcross Mfg. Co.	28A	Truscon Steel Co.	12A
G. M. Giannini	66A	Sheldon Electric	43A	Ungar Electric Co.	84A
Girard Hopkins	87A	Shure Brothers	42A	United Transformer Co.	25A
Paul Godley	86A	Simpson Electric Co.	55A	Waterman Products	77A
H. L. Gordon	86A	Sola Electric Co.	23A	Wells Sales	82A
Guardian Electric Co.	60A			Westinghouse Electric Corp.	58A
Hewlett-Packard Co.	3A			H. A. Wheeler Labs.	86A
Hickok Electrical Inst. Co.	71A			S. S. White Dental Mfg. Co.	71A
Hogan Labs.	86A				
Hughes Aircraft Co.	52A, 54A				
Hughey & Phillips	75A				
Instrument Resistors	81A				
J. F. D. Mfg. Co.	74A				
Jacobs Instrument Co.	54A				
E. F. Johnson Co.	70A				
James Knights Co.	74A				
Lambda Electronics	68A				
Lavoie Labs.	31A				
Lenkurt Electric Co.	56A				
Lockheed Aircraft Co.	62A				
Machlett Labs.	26A				
Magnecord, Inc.	75A				
P. R. Mallory & Co., Inc.	4A				
Manufacturers Thread Grinding Inc.	87A				
Marion Electrical Inst. Co.	37A				
W. L. Maxson Corp.	50A				
Measurements Corp.	69A, 86A				
Melpar Inc.	56A				
Eugene Mittelman	86A				
Mycalex Corp. of America	20A				

G-H, "CUSTOM-MANUFACTURED" CAPACITORS

Girard-Hopkins PERMANOL impregnated, paper-dielectric capacitors have consistently supplied the answer to the capacitor problem of many manufacturers of precision electronic equipment. If you require permanent, non-ageing characteristics, maximum stability, low power-factor change with frequency and utmost protection against voltage breakdown, G-H PERMANOL will meet your requirements. Custom-manufactured for you in any reasonable capacity, tolerance and working voltage . . . any type of container . . . small or production quantities.

One of the best equipped capacitor manufacturing plants on the Pacific Coast

GIRARD - HOPKINS

1000 40th Avenue, Oakland 1, Calif.

ONE OF OUR PRECISION PRODUCTS END LOADED COAXIAL WAVEMETER

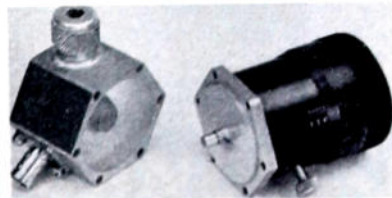

- Temperature stabilized by use of low coefficient invar
- 1700-2200 MC

MANUFACTURERS THREAD GRINDING, INC.

P. O. Box 66 EATONTOWN, N. J. ASBURY PARK 1-1019

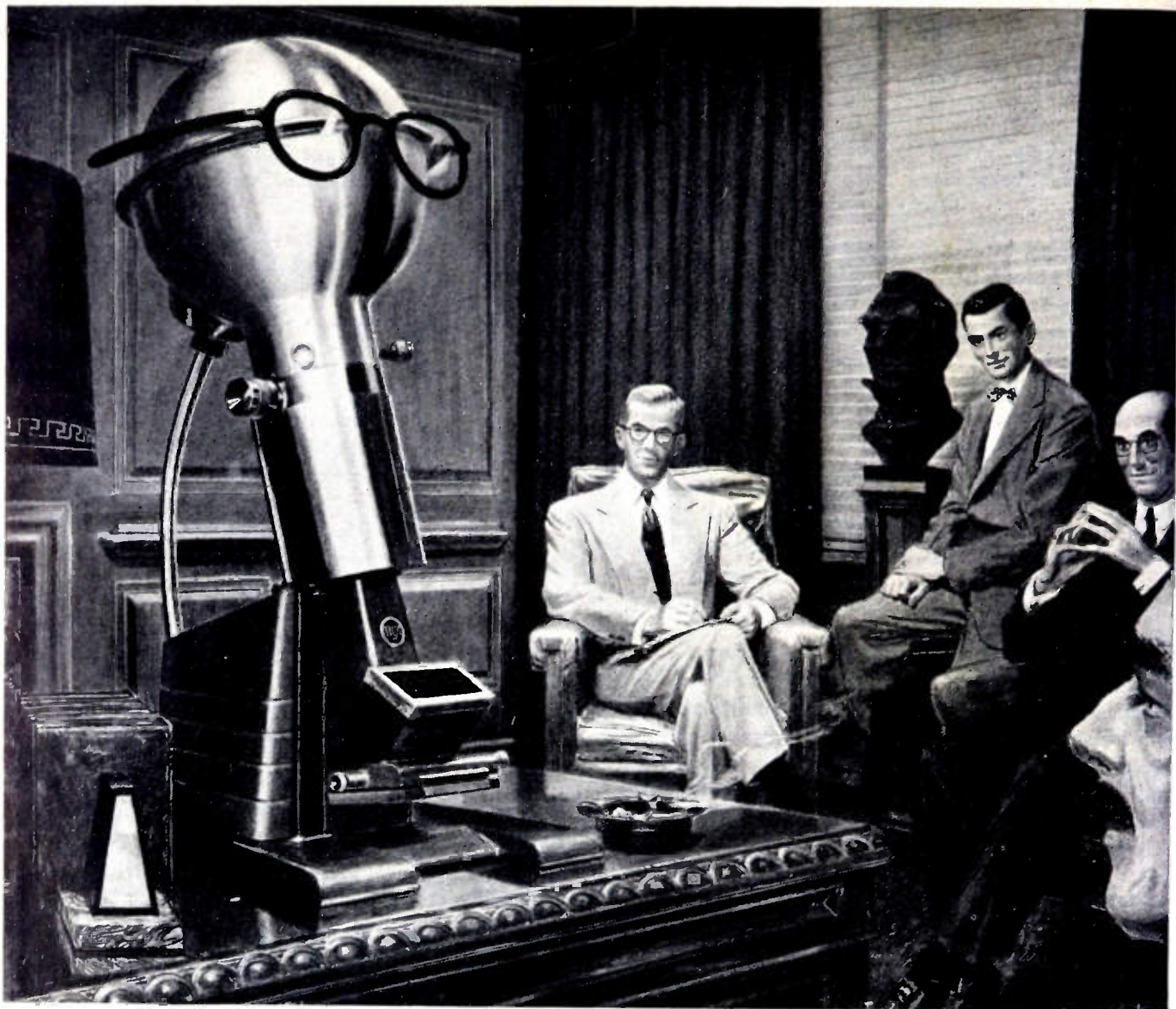

Portable electron microscope, developed by RCA, widens research in universities, industries, hospitals.

The new instructor gets a hearty welcome

You've read, in both newspapers and magazines, about the powerful electron microscope. Now this amazing "instructor" of scientists, physicians, and engineers becomes even more useful—in more research fields.

Through principles uncovered at RCA Laboratories, RCA engineers have developed a compact "table model" electron microscope, at a price which makes it practical for use in an increased number of universities, industries, hospitals, clinics. So simplified is the new instrument that even a high

school student or unskilled laboratory technician can quickly learn to use it!

Magnifications of 6000 times can be obtained directly in RCA's portable electron microscope—four times that of ordinary light microscopes—and photography lifts this to 30,000! A new "instructor," yes—and one that gets a very hearty welcome.

* * *

See the latest wonders of radio, television and electronics in action at RCA Exhibition Hall, 36 West 49th Street, N. Y. Admission is free. Radio Corporation of America, RCA Building, Radio City, New York 20, N. Y.



RCA research, which gives science and industry better instruments, also develops better television instruments for you—RCA Victor's 1951 home television receivers.



RADIO CORPORATION of AMERICA

World Leader in Radio—First in Television

they

may

look

alike,

but:

there

is

only

one

C-D

10 REASONS WHY C-D TYPE UP's ARE SUPERIOR

FOR HIGH AND LOW TEMPERATURE APPLICATIONS

1. Special formation process—a C-D development, results in low leakage and a unit that can be operated safely at ambient temperatures up to 85° C.
2. Special separator prevents breakdowns under most adverse operating conditions.
3. Special winding process results in excellent R.F. impedance.
4. Special construction results in lowest intercoupling between sections.
5. Etched cathode construction (Type UPE) results in permanence of capacity under high surge currents.
6. Exclusive C-D spot welding process of anode risers to lugs eliminates opens.
7. Cathode tabs spot welded to mounting rings results in positive, durable, low resistance contact.
8. Hermetically sealed by exclusive C-D design feature. Eliminates electrolyte leakage.
9. Electrolyte centrifuged into section—fills section completely, resulting in long life.
10. Scrupulous cleanliness in handling and assembly, strict adherence to rigid specifications for purity.

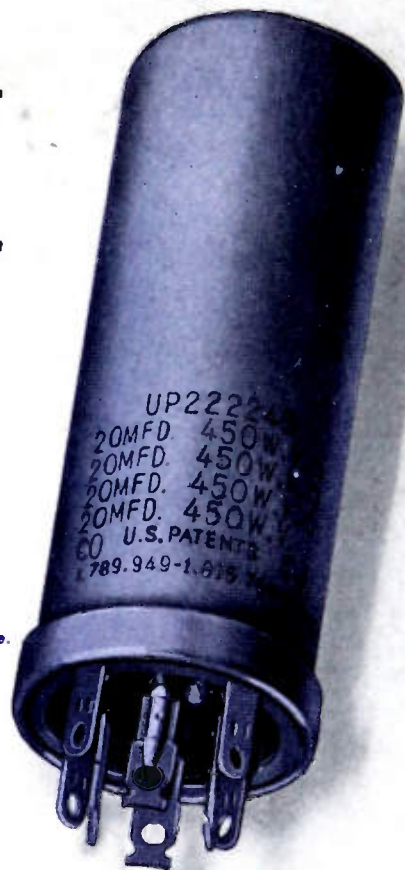

Cornell-Dubilier's extensive engineering and electrolytic manufacturing facilities — the largest in the world — are at your disposal. Your inquiries are invited. CORNELL-DUBILIER ELECTRIC CORPORATION, Dept. M11, South Plainfield, New Jersey. Other plants in New Bedford, Braakline and Worcester, Mass.; Providence, R. I.; Indianapolis, Ind., and subsidiary, The Radiant Corp., Cleveland, Ohio.

C-D Best by Field Test!



CONSISTENTLY DEPENDABLE

CORNELL-DUBILIER

CAPACITORS • VIBRATORS • ANTENNAS • CONVERTERS



A NEW BOLOMETER BRIDGE

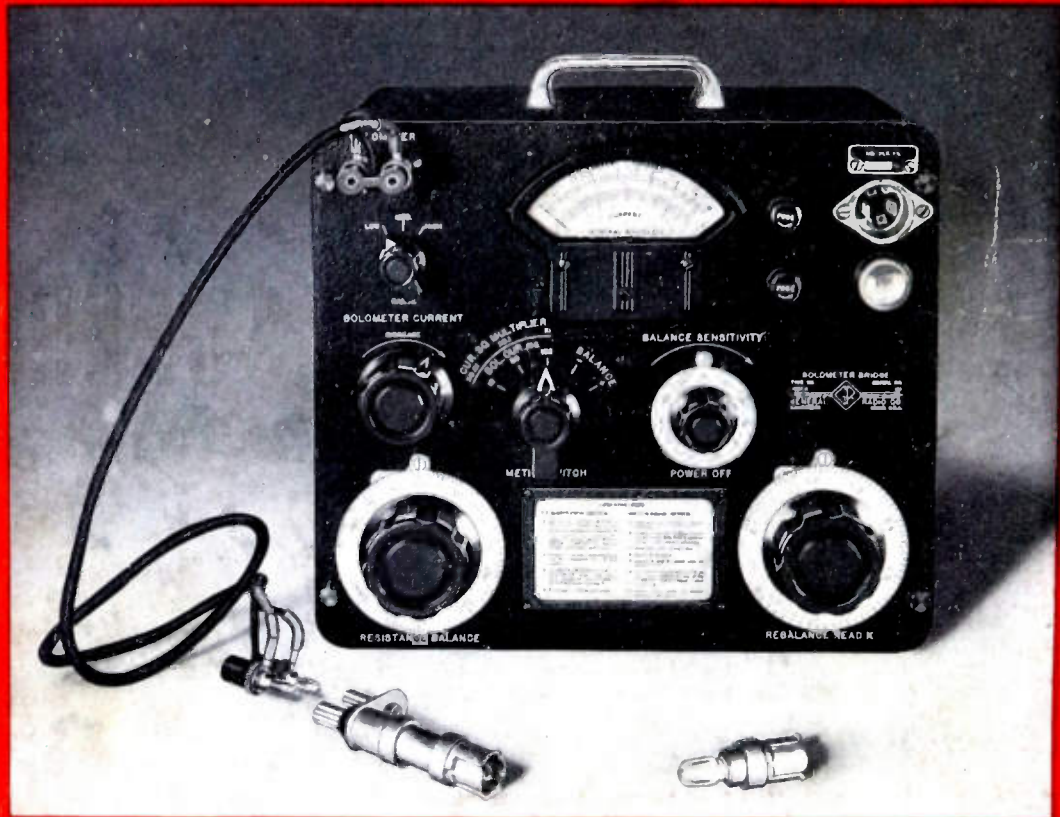

for POWER Measurements between 5 and 4,000 Mc

Simple to Use • Accurate • Adaptable to a Wide Variety of Bolometer Elements

For either **SUBSTITUTION** or **DIRECT-READING MEASUREMENTS**

Substitution Method Accuracies better than $\pm 10\%$ • Direct-Reading Accuracies better than $\pm 20\%$

Bolometer Resistances between 25 and 400 Ohms, and Bolometer Currents to 100 ma can be accommodated.

Because measurements are made AFTER final bal-

ance, and after r-f power is removed, errors due to changes in r-f power level while making readings are eliminated, and accuracies are considerably improved.

TYPICAL MEASUREMENTS

Power Output of Oscillators • Loss Measurements • Static Characteristics of Bolometers
Calibration of Voltmeters and Bolometers

Four G-R Bolometer Elements are available, with ranges and accuracies between 0 to 6 mw $\pm (10\% + 0.05 \text{ mw})$ and 0 to 500 mw $\pm (10\% + 3 \text{ mw})$. Units of other manufacture can be used with this bridge if the resistance ranges and bolo-

meter currents of the bridge are not exceeded. Expensive and specialized accessories are not required. The standard and generally available G-R Type 874 Coaxial Elements are ideal for use as tuning units and transformers.

TYPE 1651-A BOLOMETER BRIDGE . . . \$325.00 — WRITE FOR COMPLETE INFORMATION



GENERAL RADIO COMPANY

Cambridge 39,
Massachusetts

90 West St., New York 6 920 S. Michigan Ave., Chicago 5 1000 N. Seward St., Los Angeles 38