

Proceedings

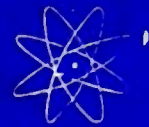

of the I·R·E

A Journal of Communications and Electronic Engineering

October, 1950

Volume 38

Number 10

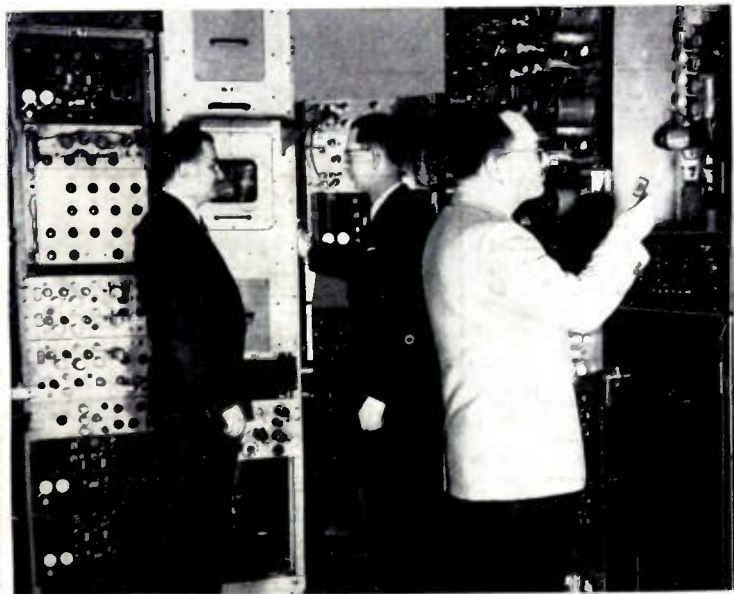

Hazeltine Electronics Corp.

STUDIES OF NEW CIRCUITS

In the Laboratories at Little Neck, L.I., N.Y., transmitting, receiving, and measuring equipment (using nearly 600 tubes) enable systematic studies of new circuits and equipment.

PROCEEDINGS OF THE I.R.E.

Professional Groups in the IRE
Electronics and the Electrostatic Generator
Electronic Miniaturization
Interference Caused by More than One Signal
The p -Germanium Transistor
Asymmetrically Driven Antennas
Detection of Periodic Signals in Noise
Traveling-Wave Cathode-Ray Tube
Conductivity Measurements at Microwave Frequencies
Cascade-Connected Attenuators (Abstract)
Frequency Compensating Matching Sections
S/N Improvement Through Integration in a Storage Tube
Distortion in Angular Modulation
Pulse Transients in Transmission Lines
Network for Measurement of Crystal Characteristics
Abstracts and References

TABLE OF CONTENTS, INDICATED BY BLACK-AND-WHITE MARGIN, FOLLOWS PAGE 32A

1951 Convention Authors, see page 1224

The Institute of Radio Engineers



ULTRA COMPACT UNITS...OUNCER UNITS

HIGH FIDELITY... SMALL SIZE... FROM STOCK

UTC Ultra compact audio units are small and light in weight, ideally suited to remote amplifier and similar compact equipment. High fidelity is obtainable in all individual units, the frequency response being ± 2 DB from 30 to 20,000 cycles.

True hum balancing coil structure combined with a high conductivity die cast outer case, effects good inductive shielding.

Type No.	Application	Primary Impedance	Secondary Impedance	List Price
A-10	Low impedance mike, pickup, or multiple line to grid	50, 125/150, 200/250, 333, 500/600 ohms	50 ohms	\$15.00
A-11	Low impedance mike, pickup, or line to 1 or 2 grids (multiple alloy shields for low hum pickup)	50, 200, 500	50,000 ohms	16.00
A-12	Low impedance mike, pickup, or multiple line to grids	50, 125/150, 200/250, 333, 500/600 ohms	80,000 ohms overall, in two sections	15.00
A-14	Dynamic microphone to one or two grids	30 ohms	50,000 ohms overall, in two sections	14.00
A-20	Mixing, mike, pickup, or multiple line to line	50, 125/150, 200/250, 333, 500/600 ohms	50, 125/150, 200/250, 333, 500/600 ohms	15.00
A-21	Mixing, low impedance mike, pickup, or line to line (multiple alloy shields for low hum pickup)	50, 200/250, 500/600	50, 200/250, 500/600	16.00
A-16	Single plate to single grid	15,000 ohms	60,000 ohms. 2:1 ratio	13.00
A-17	Single plate to single grid 8 MA unbalanced D.C.	As above	As above	15.00
A-18	Single plate to two grids. Split primary	15,000 ohms	80,000 ohms overall, 2.3:1 turn ratio	14.00
A-19	Single plate to two grids 8 MA unbalanced D.C.	15,000 ohms	80,000 ohms overall, 2.3:1 turn ratio	18.00
A-24	Single plate to multiple line	15,000 ohms	50, 125/150, 200/250, 333, 500/600 ohms	15.00
A-25	Single plate to multiple line 8 MA unbalanced D.C.	15,000 ohms	50, 125/150, 200/250, 333, 500/600 ohms	14.00
A-26	Push pull low level plates to multiple line	30,000 ohms plate to plate	50, 125/150, 200/250, 333, 500/600 ohms	15.00
A-27	Crystal microphone to multiple line	100,000 ohms	50, 125/150, 200/250, 333, 500/600 ohms	15.00
A-30	Audio choke, 250 henrys @ 5 MA 6000 ohms D.C., 65 henrys @ 10 MA 1500 ohms D.C.			10.00
A-32	Filter choke 60 henrys @ 15 MA 2000 ohms D.C., 15 henrys @ 30 MA 500 ohms D.C.			9.00



TYPE A CASE
1 1/2" x 1 1/2" x 2" high

UTC OUNCER components represent the acme in compact quality transformers. These units, which weigh one ounce, are fully impregnated and sealed in a drawn aluminum housing 7/8" diameter... mounting opposite terminal board. High fidelity characteristics are provided, uniform from 40 to 15,000 cycles, except for O-14, O-15, and units carrying DC which are intended for voice frequencies from 150 to 4,000 cycles. Maximum level 0 DB.



OUNCER CASE

7/8" Dia. x 1 1/8" high

Type No.	Application	Pri. Imp.	Sec. Imp.	List Price
O-1	Mike, pickup or line to 1 grid	50, 200/250, 500/600	50,000	\$13.25
O-2	Mike, pickup or line to 2 grids	50, 200/250, 500/600	50,000	13.25
O-3	Dynamic mike to 1 grid	7.5/30	50,000	12.00
O-4	Single plate to 1 grid	15,000	60,000	10.50
O-5	Plate to grid, D.C. in Pri.	15,000	60,000	10.50
O-6	Single plate to 2 grids	15,000	95,000	12.00
O-7	Plate to 2 grids, D.C. in Pri.	15,000	95,000	12.00
O-8	Single plate to line	15,000	50, 200/250, 500/600	13.25
O-9	Plate to line, D.C. in Pri.	15,000	50, 200/250, 500/600	13.25
O-10	Push pull plates to line	30,000 ohms plate to plate	50, 200/250, 500/600	13.25
O-11	Crystal mike to line	50,000	50, 200/250, 500/600	13.25
O-12	Mixing and matching	50, 200/250	50, 200/250, 500/600	12.00
O-13	Reactor, 300 Hys.—no D.C.; 50 Hys.—3 MA. D.C.,		6000 ohms	9.50
O-14	50:1 mike or line to grid	200	1/2 megohm	13.25
O-15	10:1 single plate to grid	15,000	1 megohm	13.25

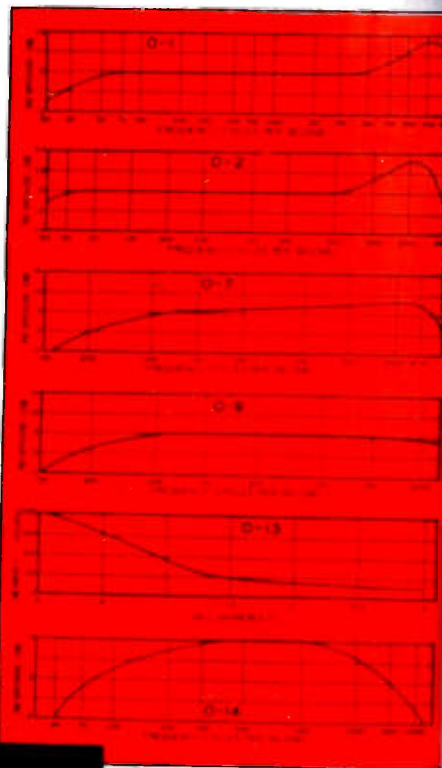

United Transformer Co.

150 VARICK STREET

NEW YORK 13, N. Y.

EXPORT DIVISION: 13 EAST 40th STREET, NEW YORK 16, N. Y.,

CABLES: "ARLAB"



Conference on Electronic Instrumentation in Nucleonics and Medicine

October 23-25, 1950 (Monday-Wednesday) Park Sheraton Hotel, New York City

MONDAY, OCTOBER 23

Presiding: Dr. Joe Howland, Atomic Energy Project, University of Rochester.

9:00 A.M.—Registration—Mezzanine Foyer—Park Sheraton Hotel.

10:00 A.M.—Morning Session.

"The Needs of Physiology and Medicine for Better Instrumentation for the Measurement of Respiratory Gases," W. O. Fenn, University of Rochester, Rochester, N.Y.

"Analysis of Respiratory Gases with Mass Spectrometer," F. A. Hitchcock, Ohio State University, Columbus, Ohio. "Analysis of Respired Air of the Rat with the Mass Spectrometer," A. W. Pratt, Bernard Burr, Murray Eden and Egon Lorenz, National Institute of Health, Bethesda, Md.

"Application of an Infrared Gas Analyzer to Problems of Sweat Physiology," E. D. Palmes, New York University, Bellevue Medical Center, N.Y.C. "The Measurement of Oxygen in Gases by Paramagnetism," A. O. Beckman, South Pasadena, Calif.

2:00 P.M.—Afternoon Session.

"An Ultrasonic Method for Outlining the Cerebral Ventricles," R. H. Bolt, T. H. Ballantine, G. D. Ludwig, and T. F. Hueter, Cambridge, Mass.

"The Medical Physics of External Localization of Brain Tumors with Radioactive Di-iodo¹³¹-fluorescein," T. Fields, G. V. LeRoy and Moses Ashkenazy, Veterans' Hospital, Hines, Ill. "The Use of Isotopes in the Measurement of Body Fluids," J. L. Nickerson, Columbia University, New York, N.Y. "Refined Sectioning Techniques for the Electron Microscope (to be read by S. G. Ellis) James Hillier, RCA Laboratories, Princeton, N.J., and Sloan-Kettering Inst. for Cancer Research, N.Y.C.

TUESDAY, OCTOBER 24

Presiding: Dr. Ward Davidson, Consolidated Edison.

10:00 A.M.—Morning Session.

"General Survey of Instrumentation for Health Physics," H. M. Parker, General Electric Co., Hanford Works, Richland, Wash.

"Calibration of Radiation Detection Instruments," L. D. Marinelli, Argonne National Laboratory.

"A Calorimetric Method of Measuring High X-Ray Intensities," W. T. Ham, Jr., Medical College of Virginia, Richmond, Va.

"X-Ray Radiation from Television Picture Tubes," O. W. Pike, General Electric Co., Schenectady, N.Y.

2:00 P.M.—Afternoon Session.

"Fast Neutron Dosimetry and Related

Problems," G. S. Hurst and R. H. Ritchie, Oak Ridge National Laboratory, Oak Ridge, Tenn.

"New Medical Applications of Tracers," A. H. Holland, Armour Research Foundation, Chicago, Ill.

"Electronics and Nucleonics Applied to Enzymes and Viruses," E. C. Pollard, Yale University, New Haven, Conn.

Following the afternoon session—Annual meeting of the IRE Professional Group on Nuclear Science.

8:00 P.M.—Evening Session.

W. R. G. Baker, Chairman
Round Table Discussion on "Effects of Atomic Weapons." Speakers to include Dr. William Bale, University of Rochester; H. L. Bowman, Drexel Institute and Consultant to AEC; Brig. Gen. J. P. Cooney, AEC; Herbert Scoville, Armed Forces Special Weapons Project; Dr. W. H. Sullivan, Naval Radiological Defense Lab., Hunters Point, San Francisco, California.

WEDNESDAY, OCTOBER 25

10:00 A.M.—Morning Session.

Presiding: Dr. Urner Liddel, Office Naval Research, Washington, D.C.

"Manufacture and Quality Control of Geiger-Mueller Tubes," D. Atchley, Tracerlab, Boston, Mass.; D. L. Collins, Victoreen Instrument Co., Cleveland, Ohio; J. A. Schoke, Nuclear Instrument and Chemical Corp., Chicago.

"Boron-Lined Neutron Counters," W. W. Schultz and R. M. Lichtenstein, General Electric Co., Schenectady, N.Y. "Design of a Commercial Scintillation Counter," W. S. Macdonald, E. W. Jervis, Jr., W. S. Macdonald Co., Cambridge, Mass.

"Testing Photomultipliers for Scintillation Counting," R. W. Engstrom, RCA Laboratories, Princeton, N.J.

2:00 P.M.—Afternoon Session.

"Scintillation Counter Instrumentation," G. Cowper, Chalk River, Ont., Canada.

"Recent Advances in Electron Techniques in Canada," N. F. Moody, Chalk River, Ont., Canada, Gordon McLusky and Michael Deighton.

"Fast Counting," Martin Deutsch, MIT, Cambridge, Mass.

"Recent Developments in Mass Spectrometry," John Hipple, National Bureau of Standards, Wash., D.C.

Conference Registration

The fee of \$3.50 covers all sessions for the three days and admission to exhibits. Registration permits unlimited "come and go" attendance. All meetings and exhibits are restricted to registered attendance.

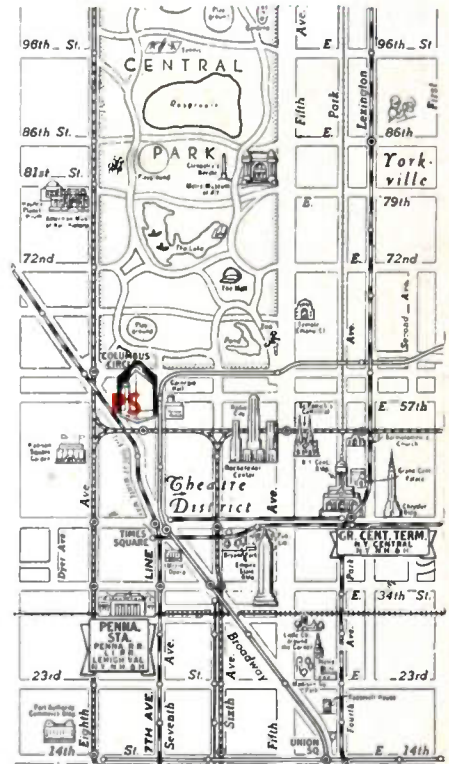

Park Sheraton Hotel

From every point of view, the Park Sheraton's location is ideal—close to Central Park, Broadway, all subway lines and the fashionable 57th Street shops. Just a step away are Times Square, the Theatre district, Rockefeller Center and Madison Square Garden.

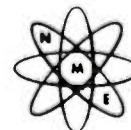

NUCLEONIC
Manufacturers
EXHIBIT

Last year 21 exhibitors of Nucleonic instruments and components, the apparatus, both electronic and mechanical, and the materials for a direct application to nucleonics exhibited concurrently with the conference. This year increased exhibit space has been provided, enough so that we will be able to accept additional exhibits up to one week before the conference. Exhibit units run from \$90 to \$100 complete including electrical outlet, backwall and furniture. For information address W. C. Copp, 303 West 42nd St., New York City.

A Meeting of the IRE Professional Group on Nuclear Science

PROCEEDINGS OF THE I.R.E. October, 1950, Vol. 38, No. 10. Published monthly by The Institute of Radio Engineers, Inc., at 1 East 79 Street, New York 21, N.Y. Price \$2.25 per copy. Subscriptions: United States and Canada, \$18.00 a year; foreign countries \$19.00 a year. Entered as second class matter, October 26, 1927, at the post office at Menasha, Wisconsin, under the act of March 3, 1879. Acceptance for mailing at a special rate of postage is provided for in the act of February 28, 1925, embodied in Paragraph 4, Section 412, P. L. and R., authorized October 26, 1927.

Table of Contents will be found following page 32A

Saving energy for better low-cost telephone service



Arrow points to tube containing a wire specimen under test for surface conductivity. The tube and wire are excited to resonance by microwaves from generator at extreme left. Conductivity is calculated from frequency values indicated by barrel-shaped wavemeter (top center) and resonance curves traced on an oscilloscope screen (not shown).

In the waveguides which conduct microwaves to and from the antennas of radio relay systems, current is concentrated in a surface layer less than 1/10,000 inch thick, on the inner surface of the waveguide. When these surfaces conduct poorly, energy is lost.

To investigate, Bell radio scientists devised exact methods to explore this skin effect at microwave frequencies.

Scratches and corrosion, they found, increase losses by 50 per cent or more. Even silver plating, smooth to the eye,

can more than double the losses of a polished metal. Very smooth conductors, like electropolished copper, are best. An inexpensive coat of clear lacquer preserves initial high conductivity for many months.

Energy saved *inside* a microwave station is available for use in the radio-relay path *outside*. So stations can sometimes be spaced farther apart, and there will always be more of a margin against fading. Here is another example of the practical value of research at Bell Telephone Laboratories.

BELL TELEPHONE LABORATORIES



WORKING CONTINUALLY TO KEEP YOUR TELEPHONE SERVICE BIG IN VALUE AND LOW IN COST

NEW GENERAL PURPOSE PULSE GENERATOR



-hp- MODEL 212A

TYPICAL 1 MICROSECOND PULSE INTO 50-OHM LOAD

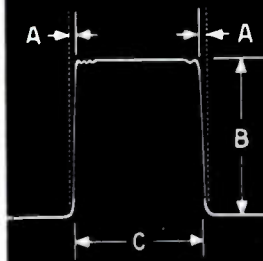

- A. 0.02 μ sec rise and decay time. Minimum overshoot.
- B. 50 watt peak power. (50 v. to 50 Ω load.)
- C. Pulse length variable 0.07 to 10 μ sec.

SPECIFICATIONS

- PULSE LENGTH:**
Continuously variable, 0.07 to 10 μ sec.
Direct reading panel control.
- PULSE AMPLITUDE:**
50 v. into 50 Ω load. Pos. & neg. pulses.
100 v. open circuit.
- AMPLITUDE CONTROL:**
Continuous control throughout range. 50 db in 10 db steps. 10 db fine adjustment.
- INTERNAL IMPEDANCE:**
50 Ω or less.
- PULSE SHAPE:**
Rise and decay time approx. 0.02 μ sec.
(10% to 90% amplitude.)
- REPETITION RATE:**
50 pps to 5,000 pps. Internally or externally controlled.
- SYNC IN:**
May be triggered by pos. or neg. pulse of 5 v. at rates up to 5,000 pps.
- SYNC OUT:**
50 v. into 200 Ω load. Approx. 2 μ sec long. Approx. 0.25 μ sec rise time.
- PULSE DELAY:**
Main pulse delayable 0 to 100 μ sec from sync output pulse.
- PULSE ADVANCE:**
Main pulse can be advanced 0 to 10 μ sec from sync output pulse.
- POWER SUPPLY:**
110/220 v; 50/60 cps.
- SIZE:**
Panel 10½" high, 19" wide. Depth 12".
- PRICE:**
\$550.00 f.o.b. Palo Alto.

Data Subject to Change Without Notice

CONTINUOUSLY VARIABLE, HIGH POWER PULSES OF SUPERIOR WAVE FORM!

THIS NEW -hp- 212A PULSE GENERATOR saves you time and work testing "fast" circuits as well as making everyday laboratory checks of other generators, rf circuits, peak-measuring equipment, etc. It is the first commercial pulse generator to successfully combine broad laboratory usefulness with the fast rise time, high power, variable pulsing and other features demanded in radar, television and nuclear work.

ACCURATE PULSES AT END OF LONG TRANSMISSION LINE

The pulse length is continuously variable from 0.07 μ sec to 10 μ sec, and is varied by a direct reading panel control. Extremely fast rise and decay time, together with freedom from ringing or overshoot

provide a virtually distortion-free pulse. A low internal impedance (50 ohms or less) insures a pulse shape virtually independent of load. This low impedance also makes it possible to deliver accurate pulses at a distance from the instrument, if the transmission lines are correctly terminated.

The Model 212A's repetition rate is continuously variable from 50 to 5,000 pps. It can be controlled internally, or from an external synchronizing source. Synchronizing pulses are available from the instrument either in advance of or following the output pulse. An amplifier-attenuator output system gives a low source impedance, and makes possible continuously variable pulse amplitude, positive or negative.

Brief specifications of this new -hp- instrument are shown in the adjoining column. For complete details... see your local -hp- representative... or write to the factory.

HEWLETT-PACKARD COMPANY

2040D Page Mill Road • Palo Alto, California

Export: FRAZAR & HANSEN, Ltd., 301 Clay St., San Francisco, Calif., U. S. A. Offices: New York, N. Y. and Los Angeles, Calif.

2040

 **laboratory instruments**
FOR SPEED AND ACCURACY

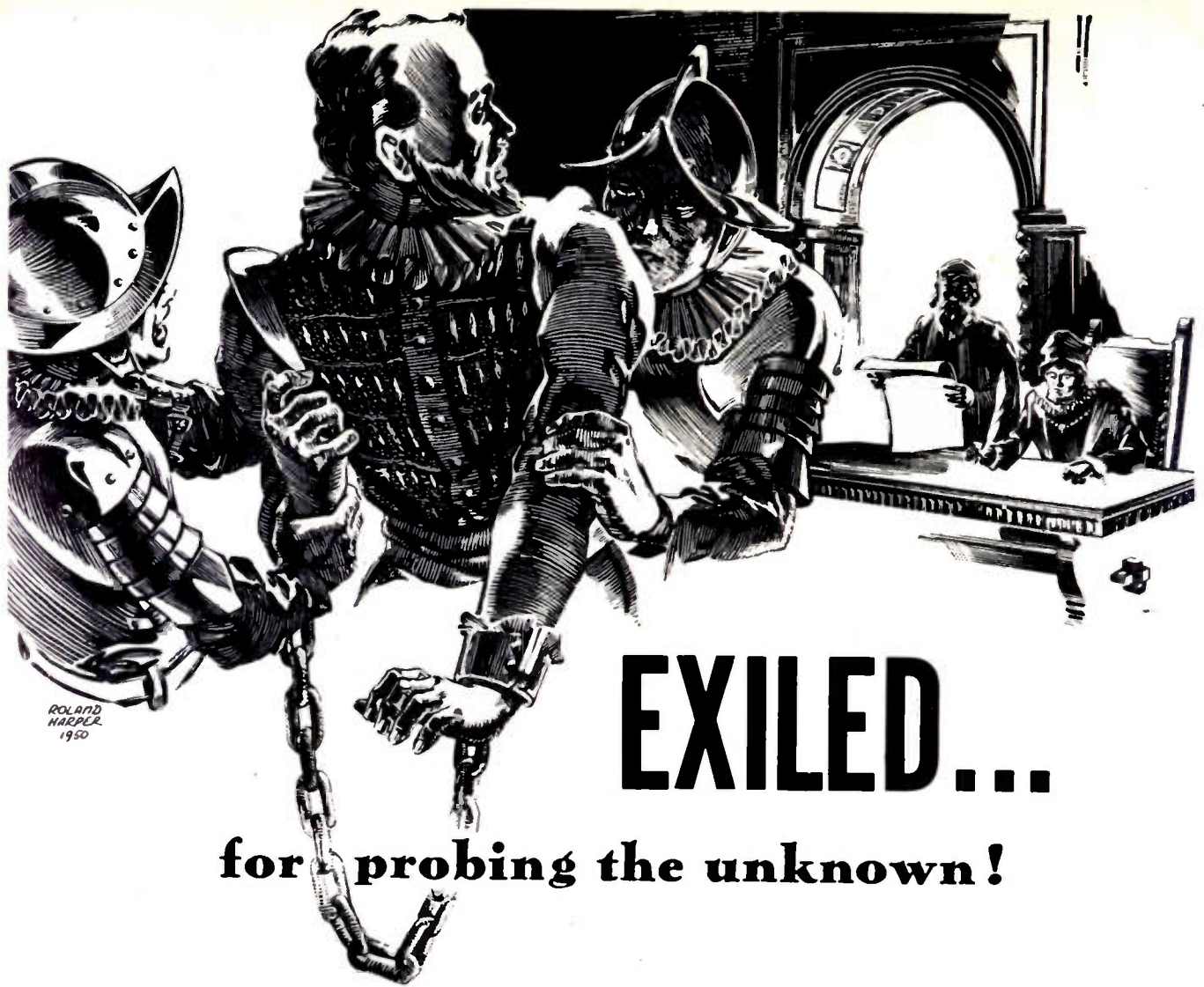

EXILED...

for probing the unknown!

"For practicing black magic, consorting with the devil, and spreading dangerous thoughts against the laws of man and nature, you are exiled forever!"

This was the import of the fateful words heard by Galileo Galilei, facing a court of inquisition in the 16th century. Scorned and ridiculed, the great mathematical and astronomical genius went to his exile an old and broken man, a brilliant, searching mind no longer permitted to probe the mysteries of the universe.

Today, free men of science labor under no such restriction. Analysis and proof are the tools employed in this enlightened era to obtain for them a hearing . . . an opportunity to substantiate their theories.

In the modern laboratories of the Sprague Electric Company, a research staff of physicists, engineers, and chemists, second to none in the electronic parts industry, is constantly striving to attain the ultimate in electronic components. Like others of their profession, they are helping to forge a level of scientific development about which Galileo, the great researcher, "born before his time", could only dream.

SPRAGUE

PIONEERS

SPRAGUE ELECTRIC COMPANY
North Adams, Massachusetts

IN ELECTRIC AND ELECTRONIC DEVELOPMENT

SUBMINIATURE PROKAR® CAPACITORS are designed especially for high-quality, minimum-size electronic equipment which must operate dependably under the most severe conditions.

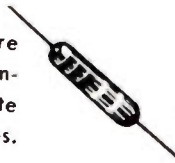

Made by an exclusive Sprague process . . . molded in a mineral-filled, high temperature plastic . . . these tiny but tough capacitors are ideal for -55°C to +125°C operation.

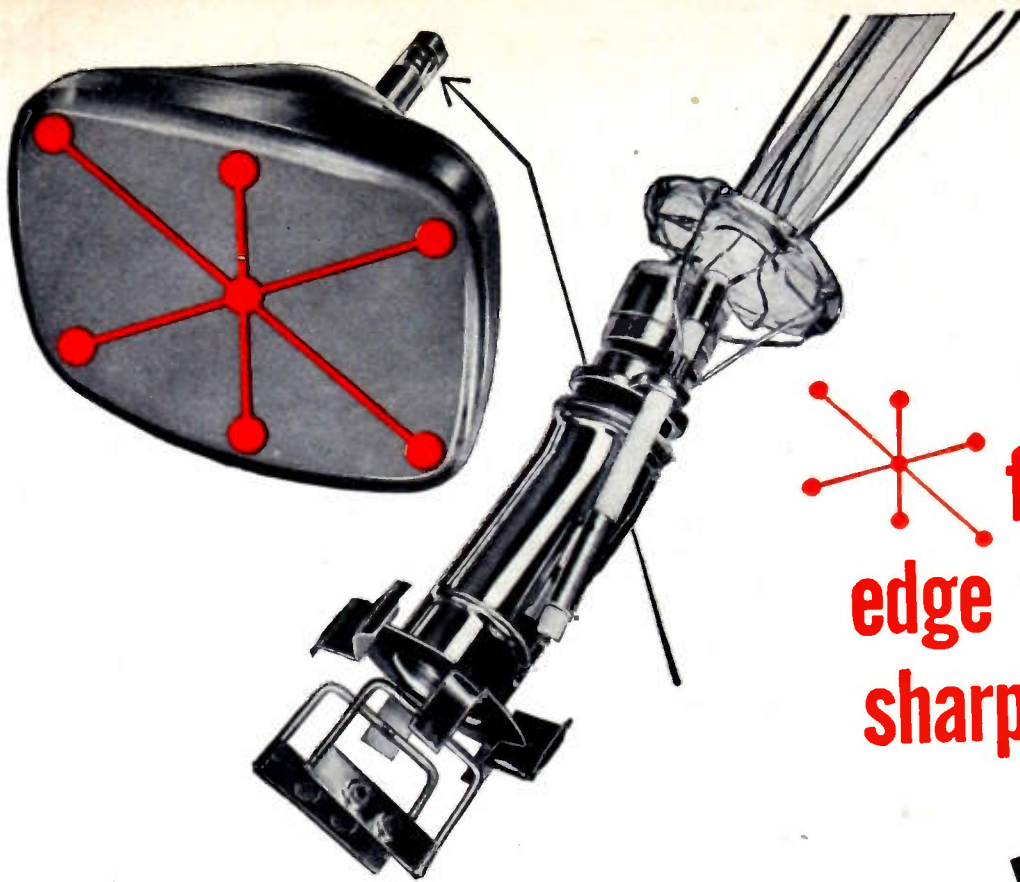

for
edge to edge
sharpness...

the **New** Du Mont Bent-Gun

the latest refinement in the most copied gun structure

Uniform sharpness of trace to the very edges of the screen distinguishes the new Du Mont Bent-Gun.

A higher degree of pre-focusing passes a smaller-diameter beam through the deflection field. Spot distortion is reduced and a uniform overall focus results. Other design changes are: Improved bulb spacer insures proper anode contact and electron gun centering; rounded corners on pertinent gun parts eliminates stray emission at higher anode voltages; new grid-cathode assembly allows a longer G-2 (second grid) without increasing overall length.

This new Du Mont Bent-Gun is now being incorporated in ALL Du Mont Teltrons. Therefore, whether planning a new TV receiver or modifying an old one, be sure to include the Du Mont Teletron for the best in TV pictures. Simply specify DU MONT.

FIRST WITH THE FINEST IN T-V TUBES

DU MONT

Teltrons^{*}

ALLEN B. DU MONT LABORATORIES, INC.,
Tube Division, Clifton, N. J.

*Trade-mark.

Mr. Isberg Proves A Point . . .

. . . regardless of how tough the service, Eimac 4E27A pentodes perform better—longer.



R. A. ISBERG, CHIEF ENGINEER, KRON-TV

The 4E27A is by no means limited to service in TV transmitters. Its rugged internal structures and pyrovac plate provide, in conventional amplifier or oscillator service, even far greater tube life than is indicated in the severe tests reported by Mr. Isberg.

This new Eimac pentode is rated at 125 watts of plate dissipation. Low grid-plate capacitances make it exceptionally stable and its high power-gain characteristics enable delivery of relatively large output with low driving power.

Follow the Leaders to

Eimac
TUBES
The Power for R-F

EITEL-McCULLOUGH, INC.
San Bruno, California
Export Agents: Frazer & Hansen, 301 Clay St., San Francisco, California



TV AND FM SERVICES OF THE
SAN FRANCISCO CHRONICLE

KRON-TV KRON-FM
CHANNEL 4
DIAL 96.5

TELEVISION AFFILIATE OF THE
NATIONAL BROADCASTING CO.

June 13, 1950

Mr. O. H. Brown
Eitel-McCullough, Inc.
San Bruno, California

Dear Hank:

You will be interested to learn that the six Eimac 4E27A/5-125B tubes which were installed in the video modulator of our RCA TT-5A transmitter on March 11, 1950 are still functioning normally even though they have operated for nearly one thousand hours, and from all indications they will continue to give good service for many more hours.

The life history of 4E27/8001 tubes prior to the development of the improved version was uncertain; some tubes would fail within 100 hours of their installation and few would last more than 700 hours. This situation was especially aggravating in the picture modulator where six tubes are operated in parallel and the malfunctioning of any one tube could seriously degrade the picture or interrupt operation.

Following is a tabulation of the individual plate currents of the six tubes after approximately 1000 hours service in the picture modulator.

Tube No.	Plate Current
807	.178 Amperes
808	.171 "
809	.190 "
810	.173 "
811	.175 "
812	.185 "

We are happy that KRON-TV has been able to assist you in the "field test" of the new 4E27A and we feel that it will be welcomed by the television broadcasters because it will afford more reliable operation, reduce tube replacement costs, and promote greater satisfaction and confidence on the part of the operating personnel.

Kindest personal regards,

Sincerely,

R. A. Isberg
R. A. Isberg
Chief Engineer

RAI/ed

301 MISSION STREET

SAN FRANCISCO 19

CARFIELD 1-1100

COMPLETE DATA ON THE EIMAC
4E27A BEAM POWER PENTODE
IS AVAILABLE UPON REQUEST.

Typical of the TOUGH POTENTIOMETER JOBS solved by Helipot

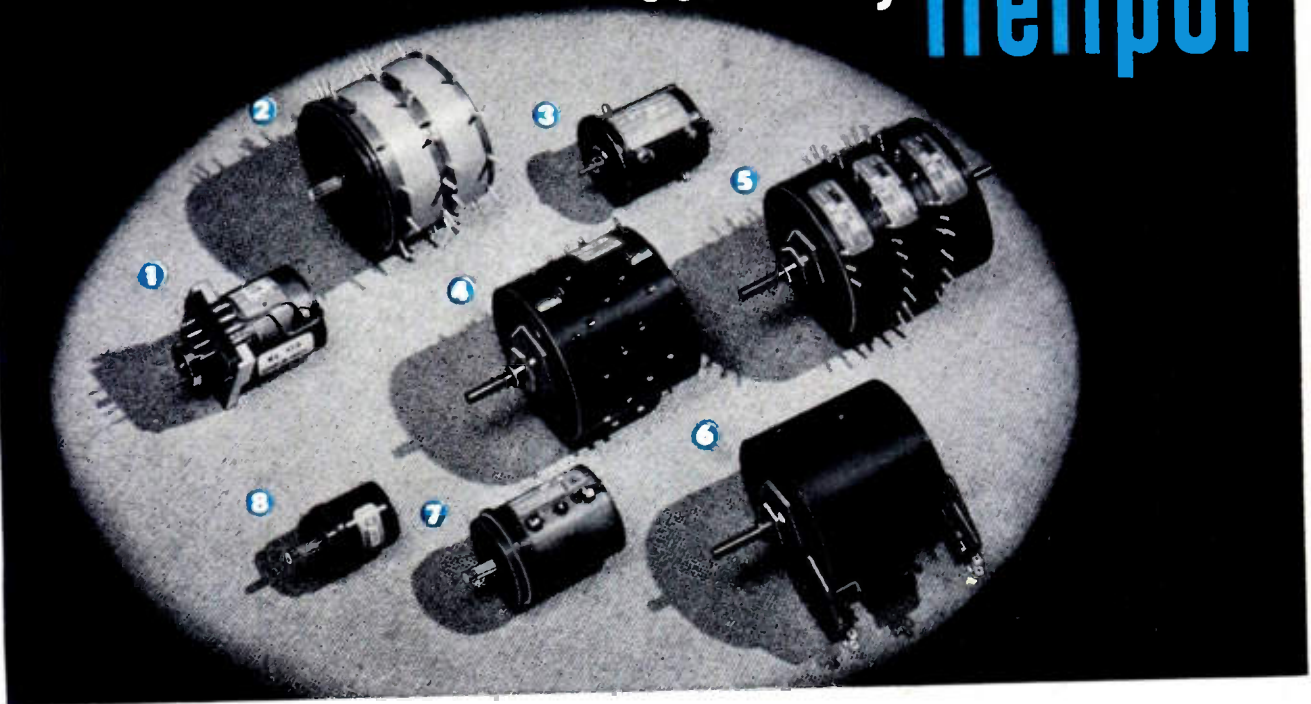

Precise Accuracy + Maximum Versatility + Space-saving Compactness

The potentiometers illustrated above are typical examples of the tough problems HELIPOT engineers are solving every day for modern electronic applications. If you have a problem calling for utmost precision in the design, construction and operation of potentiometer units—coupled with minimum space requirements and maximum adaptability to installation and operating limitations—bring your problems to HELIPOT. Here you will find advanced “know-how,” coupled with manufacturing facilities unequaled in the industry!

The HELIPOTS above—now in production for various military and industrial applications—include the following unique features . . .

① This 10-turn HELIPOT combines highest electrical accuracies with extremes in mechanical precision. It features zero electrical and mechanical backlash...a precision-supported shaft running on ball bearings at each end of the housing for low torque and long life . . . materials selected for greatest possible stability under aging and temperature extremes . . . special mounting and coupling for “plug-in” convenience . . . mechanical and electrical rotation held to a tolerance of $\frac{1}{2}^\circ$. . . resistance and linearity accuracies, $\pm 1\%$ and $\pm 0.025\%$, or better, respectively.

② This four-gang assembly of Model F single-turn potentiometers has a special machined aluminum front end for servo-type panel mounting, with shaft supported by precision ball bearings and having a splined and threaded front extension. Each of the four resistance elements contains 10 equi-spaced tap connections with terminals, and all parts are machined for greatest possible stability and accuracy.

③ This standard Model A, 10-turn HELIPOT has been modified to incorporate ball bearings on the shaft and a special flange (or

ring-type) mounting surface in place of the customary threaded bushing. This HELIPOT also contains additional taps and terminals at the $\frac{1}{4}$ - and $9\frac{3}{4}$ -turn positions.

④ This standard Model B, 15-turn HELIPOT has a total of 40 special tap connections which are located in accordance with a schedule of positions required by the user to permit external resistance padding which changes the normally-linear resistance vs. rotation curve to one having predetermined non-linear characteristics. All taps are permanently spot-welded and short out only one or two turns on the resistance element—a unique HELIPOT feature!

⑤ This six-gang assembly of standard Model F single-turn potentiometers has the customary threaded bushing mountings, and has shaft extensions at each end. The two center potentiometers each have 19 equi-spaced, spot-welded tap connections brought out to terminals. Each tap shorts only two turns of .009" diameter wire on the resistance element.

⑥ This Model B, 15-turn HELIPOT has been modified to incorporate, at the extreme

ends of mechanical and electrical rotation, switches which control circuits entirely separate from the HELIPOT coil or its slider contact.

⑦ This 10-turn HELIPOT has many design features similar to those described for unit No. 1, plus the following additional features . . . a servo-type front end mounting . . . splined and threaded shaft extension . . . and a center tap on the coil. All components are machined to the highest accuracy, with concentricities and alignments held in some places to a few *ten-thousandths* of an inch to conform to the precision of the mechanical systems in which this HELIPOT is used. Linearity accuracies frequently run as high as $\pm 0.010\%$!

⑧ This single-turn Model G Potentiometer has been modified to incorporate a ball bearing shaft and a servo-type front end mounting. Special attention is given to contact designs and pressures to insure that starting torque does not exceed 0.2 inch-ounces under all conditions of temperature.

The above precision potentiometers are only typical of the hundreds of specialized designs which have been developed and produced by HELIPOT to meet rigid customer specifications. For the utmost in accuracy, dependability and adaptability, bring your potentiometer problems to HELIPOT!

THE **Helipot** CORPORATION, SOUTH PASADENA 6, CALIFORNIA

Representatives in all major areas of the United States. Export agents: Frathom Co., 55 W. 42nd St., New York 18.

Modern is the Word for this WSAM AM-FM Masterpiece

● This is the tenth anniversary of the Saginaw Broadcasting Company, Saginaw, Michigan. In celebration, this station has completely modernized its facilities, including a new Truscon Self-Supporting Tower with an overall height of 386 feet.

This Truscon masterpiece functions as a half-wave radiator in the transmission of the 250 watt AM power of WSAM on 1400 kilocycles. A side mounted Collins 8-bay antenna transmits the 1700 watt FM power of WSAM-FM on 98.1 megacycles. The entire

Another
TRUSCON
TOWER OF STRENGTH
386 FT.
HIGH
OVERALL

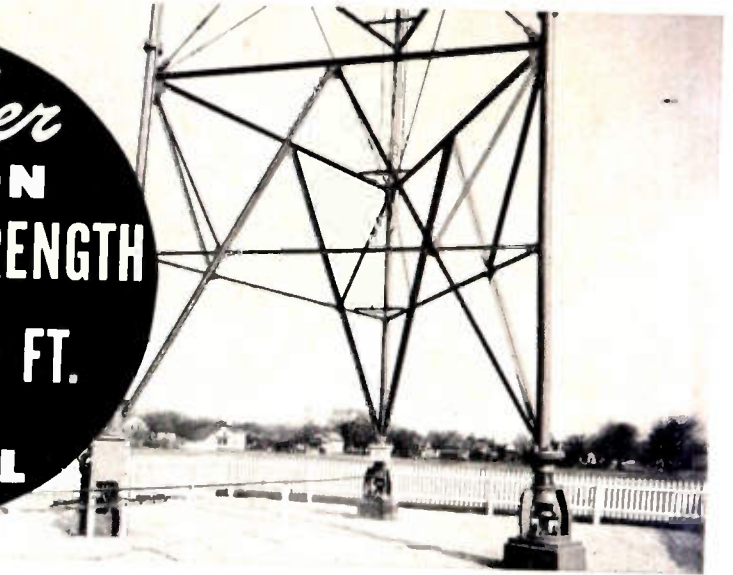

tower and transmitter house is designed for future television applications.

What are your particular tower problems to best serve your audience? Truscon can draw upon world-wide experience in engineering and erecting exactly the tower you need—tall or small . . . guyed or self-supporting . . . tapered or uniform in cross-section . . . for AM, FM and TV transmission. Your phone call or letter to any convenient Truscon district office, or to our home office in Youngstown, will bring you immediate, capable engineering assistance. Call or write today.

TRUSCON STEEL COMPANY

YOUNGSTOWN 1, OHIO
Subsidiary of Republic Steel Corporation

TRUSCON 
SELF-SUPPORTING
AND UNIFORM
CROSS SECTION GUYED **TOWERS**
TRUSCON COPPER MESH GROUND SCREEN





CLEVELITE*

and

COSMALITE*

LAMINATED PHENOLIC TUBING

is used also for many other electrical products at a considerable saving where exacting specifications must be carefully followed. For the best . . . "Call Cleveland."

Those in the Radio and Television Industries know from actual use the fine performance of these Tubes.

They also know that our large production capacity assures them of a dependable source of supply with prompt delivery.

Ask us about these spirally laminated paper base phenolic tubes in diameters, wall thicknesses and lengths that will meet your needs.

*Trade Marks

The **CLEVELAND CONTAINER Co.**
6201 BARBERTON AVE. CLEVELAND 2, OHIO

PLANTS AND SALES OFFICES at Plymouth, Wisc., Chicago, Detroit, Ogdensburg, N. Y., Jamesburg, N. J.
ABRASIVE DIVISION at Cleveland, Ohio

CANADIAN PLANT: The Cleveland Container, Canada, Ltd., Prescott, Ontario

REPRESENTATIVES

NEW YORK AREA
NEW ENGLAND
CANADA

R. T. MURRAY, 614 CENTRAL AVE., EAST ORANGE, N. J.
R. S. PETTIGREW & CO., 968 FARMINGTON AVE.
WEST HARTFORD, CONN.
WM. T. BARRON, EIGHTH LINE, RR #1, OAKVILLE, ONTARIO





Designers



PANEL INSTRUMENTS—A COMPLETE LINE

Accurate and Reliable



FOR MEASURING D-C, A-C, RF, AF, VU

General Electric panel instruments have long been known for their reliability and accuracy. Recent design changes provide for better performance, readability, durability, and appearance. G-E voltmeters, kilovoltmeters, ammeters, milliammeters, microammeters, and vu volume-level indicators; thermocouple types and rectifier types; round or square, with conventional or long 250-degree scales—all will give your measurements the accuracy required and your panel that smooth, modern appearance. To bring you up to date on the latest improvements in cases, faces, and mechanisms, G.E. offers a comprehensive 24-page bulletin containing all information necessary for ordering. Write for Bulletin GEC-368. For vu indicators, see Bulletin GEC-369.

SOLVE DESIGN PROBLEMS WITH THE SWITCH OF 10,000 USES

A member of the well known SB-1 switch family can find a useful place on almost any large electronic control panel. The precision-built parts of this all-purpose switch permit as many as 40 stages—four banks of ten stages each—to be operated in tandem. Switches with up to 16 stages and 12 positions are commonly furnished. Over 10,000 circuit-sequence combinations are possible. Ratings go to 20 amperes at 600 volts a-c or d-c. See Bulletin GEC-270.

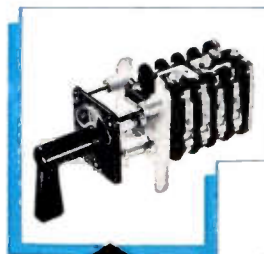

SB-1 switch, cover-removed

SAVE PANEL SPACE WITH ONE-UNIT PUSH-BUTTON AND INDICATING LIGHT



Illuminated push button

This space-saving pilot-circuit switch consists of a sturdy push-button unit, 2 3/8 inches high, with a hollow translucent cap and 6-volt lamp. The switch is the momentary contact type, single-pole, with one normally open and one normally closed circuit. It uses movable-disk type contacts. Buttons are supplied in clear, red, green, blue, amber, and white. For more data on this and other G-E push-button units, see Bulletin GEA-4254.

GENERAL  **ELECTRIC**

Digest

TIMELY HIGHLIGHTS ON G-E COMPONENTS



PERMAFIL CAPACITORS

NO DERATING AT 125° C OPERATION

For operation at high ambient temperatures, these standard-line G-E Permafil capacitors are naturals. They're paper dielectric units and can be used at temperatures up to 125° C without derating. All are metal encased, compression-sealed, and have long-life silicone bushings. Ratings: up to 2 muf for operation at 400 volts d-c and below. Case styles: 53, 61, 63, and 65 (JAN-C-25 specifications). For more data, write Capacitor Sales Div., General Electric Co., Pittsfield, Mass.



INDUCTROLS



STEPLESS VOLTAGE VARIATION

Inductrols are G-E dry-type induction voltage regulators for 120 and 240-volt operation. Hand-operated models provide smooth and extremely precise voltage adjustment for such uses as instrument calibration and rectifier control. Motor-operated models are used with automatic control to maintain voltage within narrow limits, irrespective of supply variations. Sizes range from 10¼ x 6½ x 7⅞ inches for the smallest hand-operated unit to 14 x 6 x 10⅞ for the largest motor-operated unit. One unit provides a voltage range of 10% raise and lower on 3 and 6-kva circuits, another gives 100% raise and lower for 2.4 and 3.6 kva circuits. Complete information in Bulletin GEA-4508.

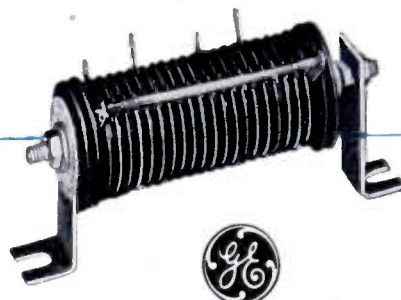

HIGH-VOLTAGE SELENIUM RECTIFIERS

WITH LIFE EXPECTANCY OF 60,000 HOURS!

Now available from G.E. are 26-volt RMS selenium rectifier cells with a continuous-service life expectancy of over 60,000 hours. Their initial forward resistance is very low and samples show an average increase in resistance of less than 6% after 10,000 hours of operation. General Electric knows of no other high-voltage selenium cell on the market that can even approach their performance.

The high output voltage permits the design of smaller stacks while the low resistance means cooler operation and the space saving that goes with it.

Stacks made with the new G-E cells may be obtained with rated outputs from 18 to 126 volts d-c at .15 to 3.75 amps. Write now for Bulletin GEA-5280.

General Electric Company, Section G667-7
Apparatus Department, Schenectady 5, N. Y.

Please send me the following bulletins:

- | | | |
|--------------|--------------------------|------------------------------------|
| Indicate | <input type="checkbox"/> | GEA-4254 Push-button units |
| for | <input type="checkbox"/> | GEA-4508 Inductrols |
| reference | <input type="checkbox"/> | GEA-5280 Selenium rectifiers |
| only (V) | <input type="checkbox"/> | GEC-270 SB-1 switch |
| for planning | <input type="checkbox"/> | GEC-368 Panel instruments |
| an immediate | <input type="checkbox"/> | GEC-369 Vu volume-level indicators |
| project (X) | | |

NAME _____

COMPANY _____

ADDRESS _____

CITY _____ STATE _____

Exploration

for resistors too!

Specialization in resistors lets IRC concentrate on research and quality control to a greater degree than any other supplier.

Result:—IRC exploration anticipates future resistor needs—improves existing products—and controls quality and uniformity in every IRC unit. Largest resistor manufacturer in the world, IRC attracts the finest of engineering talent. We're using more of such talent than ever, now, to keep step with today's electronic requirements—while we plan for tomorrow's advances.



FLAT POWER WIRE WOUND RESISTORS

For high wattage dissipation in limited space applications, IRC Type FRW Flat Wire Wound Resistors have higher space power ratios than standard tubular units. FRW's can be mounted vertically or horizontally—singly or in stacks. Non-magnetic mounting brackets permit easy, economical mounting, aid in heat distribution along the entire length, and transfer internal heat to the chassis. Available in V sizes—fixed and adjustable. Send for full details in Bulletin C-1.

is important

HIGH OHMIC RESISTORS

Engineered for high voltage applications where high resistance and power are required, IRC Type MVX Resistors are particularly suited to many types of television and electronic circuits. Unique application of IRC's proven filament resistance coating in helical turns on a ceramic tube provides a conducting path of long, effective length. Result: A unit of high resistance value with resistance materials having relatively low specific resistance. Type MVX's have 2 watt rating, are exceptionally stable—permit the use of high voltage on the resistor while keeping voltage per unit length of path comparatively low. Send coupon for complete details in Bulletin G-2.

DEPOSITED CARBON PRECISTORS

A unique combination of accuracy, stability and economy makes IRC Deposited Carbon PRECISTORS ideal for applications where carbon compositions are unsuitable or wire-wound precisions too expensive. Instrumentation, advanced electronics and critical television circuits also benefit from their wide range of values, low voltage coefficient, excellent frequency characteristics, predictable temperature characteristics, high voltage rating, low noise level and small size. Coupon brings full particulars in Bulletin B-4.

VOLTMETER MULTIPLIERS

Sealed-precision IRC Type MF Resistors are completely impervious to moisture—have proved themselves dependable voltmeter multipliers for use under the most severe humidity conditions. Each multiplier consists of a number of IRC Precision Resistors, mounted, interconnected, and encased in a glazed, hermetically sealed ceramic tube. MF's are compact, rugged, stable, easy to install, and may be used with very little drain on the power supply. Individual precision resistors may be either inductive or noninductive, so that they may be used on AC as well as DC. Mail coupon for full data in Bulletin D-2.



**INTERNATIONAL
RESISTANCE COMPANY**

401 N. Broad Street, Philadelphia 8, Pa.

In Canada: International Resistance Co., Ltd., Toronto, Licensee

Wherever the Circuit Says

Power Resistors • Voltmeter Multipliers
• Insulated Composition Resistors • Low
Wattage Wire Wounds • Volume
Controls • Voltage Dividers • Precision
Wire Wounds • Deposited Carbon
Precistors • Ultra-HF and High
Voltage Resistors • Insulated Chokes

INTERNATIONAL RESISTANCE CO.
405 N. BROAD ST., PHILADELPHIA 8, PA.

Please send me complete information on the items checked below:—

- Flat Wire Wound Resistors (C-1) Deposited Carbon PRECISTORS (B-4)
- High Voltage Resistors (G-2) Voltmeter Multipliers (D-2)
- Name and address of local IRC Distributor

NAME.....
TITLE.....
COMPANY.....
ADDRESS.....
CITY..... ZONE..... STATE.....

J. F. ARNDT & CO., ADV. AGENCY

A
 RELIABLE SOURCE
 OF SUPPLY *for*
 DEPENDABLE RESISTORS
for OVER 20 YEARS

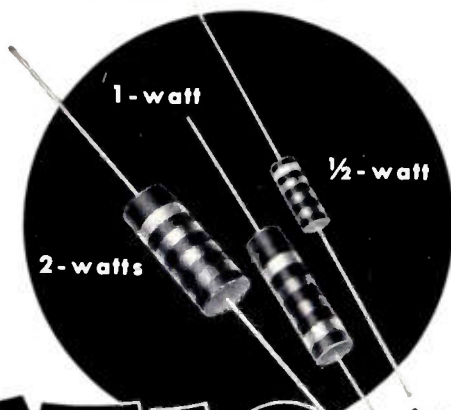

STACKPOLE

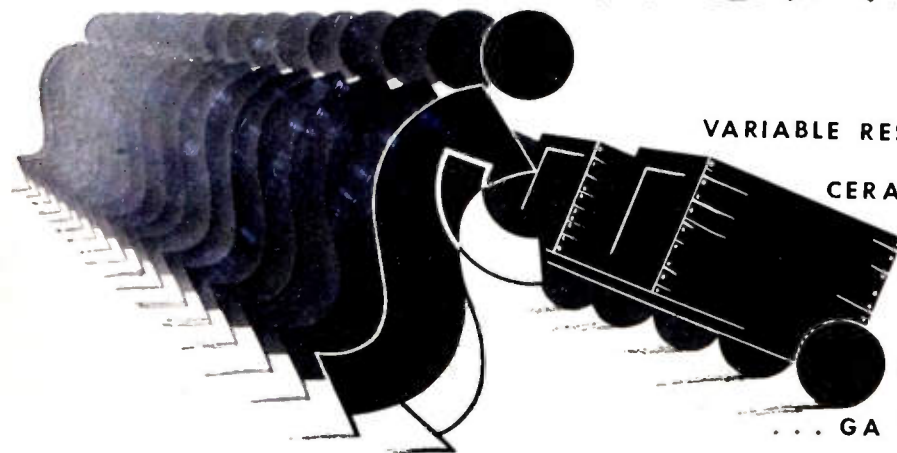

... FIXED RESISTORS
 VARIABLE RESISTORS ... IRON CORES ...
 CERAMAG® CORES ... LINE, SLIDE
 AND ROTARY SWITCHES ...
 CARBON VOLTAGE REGULATOR
 DISCS ... MOLDED COIL FORMS
 ... GA "GIMMICK" CAPACITORS, ETC.

Electronic Components Division
STACKPOLE CARBON COMPANY . ST. MARYS, PA.

How
to be sure
you get

the Best
Capacitor



YOU CAN test the paper for density . . . thickness . . . porosity . . . power factor . . . chloride content . . . dielectric constant . . . dielectric strength.

And then test the foil for thickness . . . purity . . . softness of the anneal . . . freedom from oil . . . cleanliness of surface . . . absolute smoothness.

And then test the liquid dielectric for specific gravity . . . viscosity . . . power factor . . . color . . . acidity . . . flash point . . . dielectric strength . . . dielectric constant . . . insulation resistance . . . water content.

And after that, test every single finished capacitor for shorts, grounds, and opens at overvoltage between terminals and between terminals and case . . . and measure the capacitance of every single unit . . . and then check every single capacitor to see that it has a leak-proof hermetic seal.



OR YOU CAN buy General Electric capacitors . . . product of outstanding research and know-how . . . which have already passed every one of these tests

- . . . on the materials when they were made.
- . . . and again before they were used.
- . . . and on the capacitors during manufacture.
- . . . and then, finally, on every single capacitor before shipment.

For full information on types, ratings, dimensions, types of mounting, and prices of capacitors, address the nearest *General Electric Sales Office or Apparatus Department, General Electric Company, Schenectady 5, N. Y.*

GENERAL  **ELECTRIC**

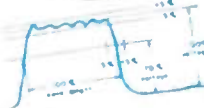
407-170

Need square waves?

Pulse-forming networks are used where the normal capacitor discharge wave shape is not suitable, and where an impulse must have definite energy content and duration. Their design involves several tricky problems—one being suitability for high temperature operation. Nevertheless, networks are one of our specialties—we have built them by the thousands, and our experienced and capable engineers will be glad to discuss any of your design problems. We invite your inquiries.

Erie DISC AND PLATE Ceramicons®

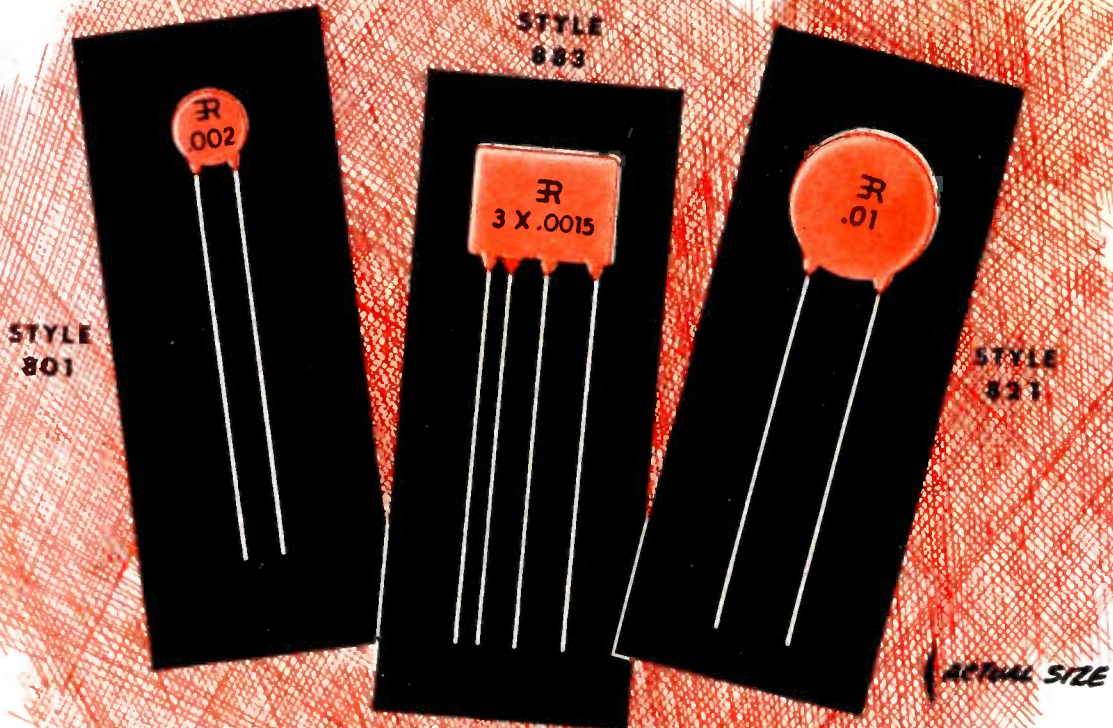

for by-passing and coupling applications

High capacity in extremely compact size is the distinguishing feature of Erie Disc and Plate Ceramicons. Illustrations are exact size, and their shape as well as their compactness make them amazingly easy to install in small spaces. They simplify soldering and wiring operations and speed up the assembly line.

Erie Disc and Plate Ceramicons consist of a flat ceramic dielectric with silver plates

fired onto the dielectric. Lead wires of 24 gauge tinned copper wire are firmly soldered to the silver electrodes and the unit is given a protective coating of phenolic.

Such simplicity of construction results in low series inductance and unusual efficiency in high frequency by-passing.

For complete information and samples to meet your particular needs, write us today.

STANDARD AVAILABLE CAPACITIES

ERIE STYLE	SIZE	CAPACITY	STAMPING
831	$\frac{5}{16}$ " Max. Dia.	800 MMF	R 800
801	$\frac{3}{8}$ " Max. Dia.	.001 MFD	R .001
		.0015 MFD	R .0015
		.002 MFD	R .002
811	$\frac{19}{32}$ " Max. Dia.	.005 MFD	R .005
821	$\frac{3}{4}$ " Max. Dia.	.01 MFD	R .01
812	$\frac{19}{32}$ " Max. Dia.	Dual .001 MFD	R 2 x .001
		Dual .0015 MFD	R 2 x .0015
		Dual .002 MFD	R 2 x .002
822	$\frac{3}{4}$ " Max. Dia.	Dual .003 MFD	R 2 x .003
		Dual .004 MFD	R 2 x .004
883	$\frac{9}{16}$ " x $\frac{3}{4}$ " Max.	Triple .0015 MFD	R 3 x .0015

SPECIFICATIONS

Voltage: Units are rated at 500 VDC. Dielectric strength test: 1,500 VDC.

Power Factor: 2.5% max. at 1 K.C. at not more than 5 volts RMS.

Insulation Resistance: 7,500 meg. Ω min.

Capacity: Capacity measurements are made at room temperature (25° C) at 1 K.C. and at not more than 5 Volts RMS. Standard tolerance is +100%, -0%.

Temperature Characteristics:

Capacitance shall not decrease more than 50%, nor increase more than 25% from its value at room temperature (25° C), as the temperature is varied from +10° C to +75° C.

Electronics Division
ERIE RESISTOR CORP., ERIE, PA.
 LONDON, ENGLAND TORONTO, CANADA



announcing
the **new** DuMont Type 303

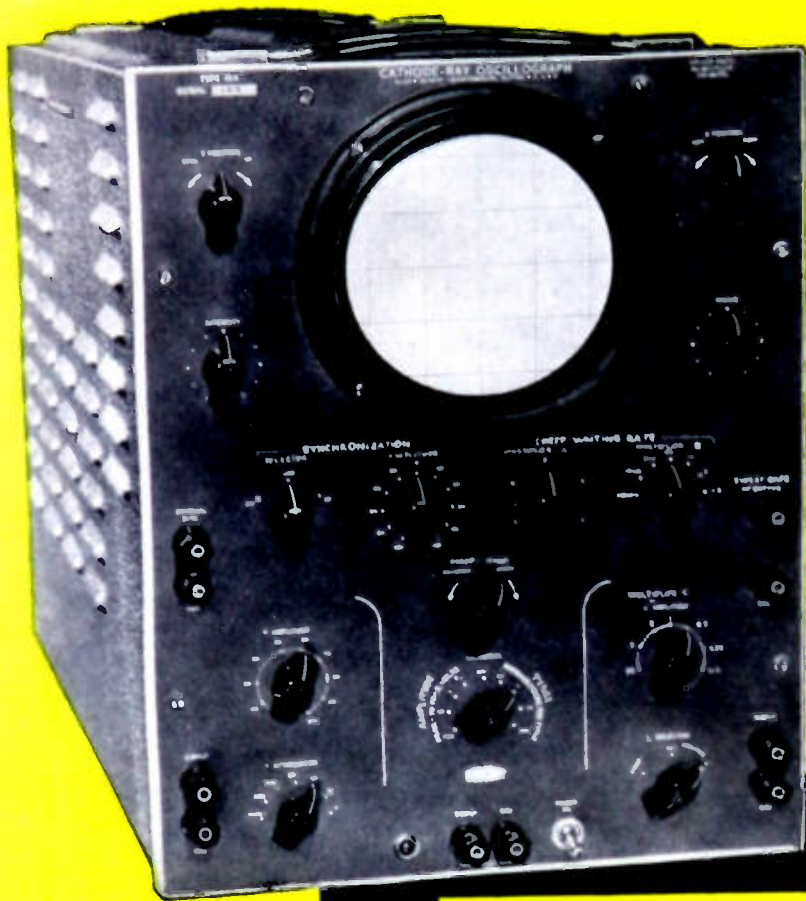

a
quantitative
10-megacycle
**CATHODE-RAY
OSCILLOGRAPH**

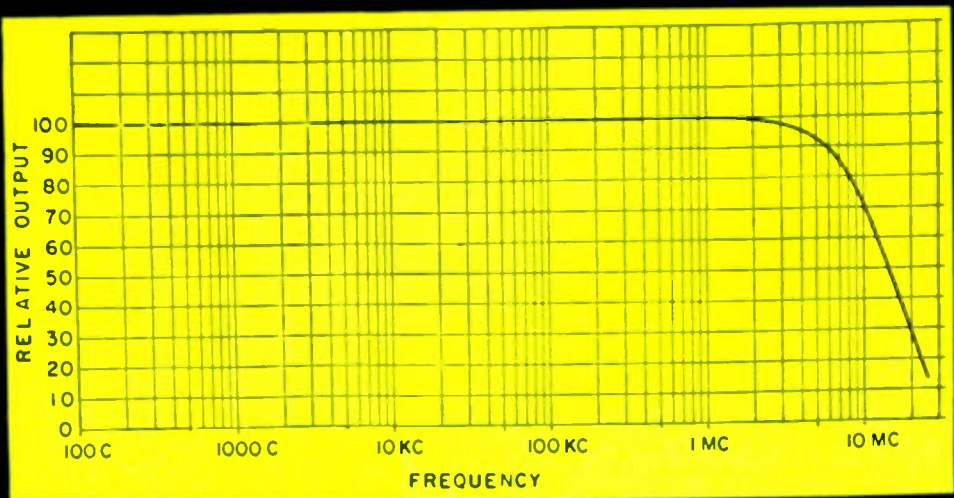

EXCELLENT FREQUENCY RESPONSE with a sensitivity of 0.1 volts, peak to peak, per inch — down 3 db at 10 megacycles.

a SINGLE OSCILLOGRAM demonstrates...

- A. Signal Delay
- B. Transient Response
- C. No High-Frequency Overshoot
- D. Undistorted Deflection
- E. Sweep Linearity and Speed
- F. Time Calibration
- G. Amplitude Calibration

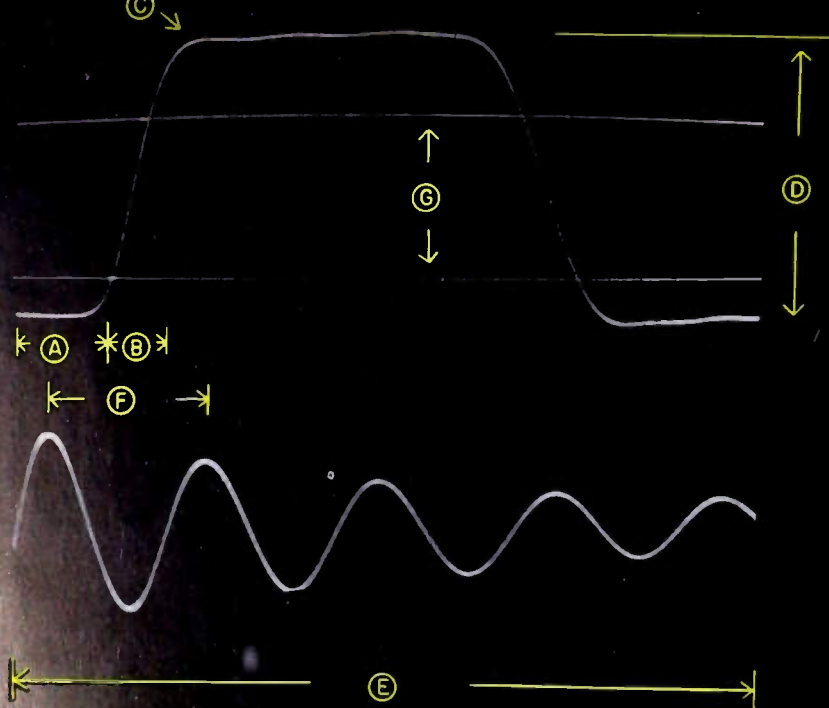

Here, woven around the quantitative investigation of a 0.25 microsecond pulse, is a graphic account of the performance features which make the Type 303 an exceptionally fine, high-frequency cathode-ray oscillograph.

Time and voltage calibration, together with circuit refinements which make possible a more accurate qualitative presentation, add to the cathode-ray oscillograph a remarkable quantitative precision — invaluable to laboratory research.

A. SIGNAL DELAY built into the Y-axis amplifier insures complete display of the steep pulse rise. As illustrated by the portion "A", the 10% point of rise does not occur until sometime after the sweep starts. Y-axis frequency response, shown on reverse side, includes the performance of the signal-delay line.

B. EXCELLENT TRANSIENT RESPONSE — wholly essential to the proper study of high-speed phenomena — is depicted by the rise time which is reproduced without appreciable degradation. A rise time of 0.01 microsecond, or greater, will be reproduced as a rise time not exceeding 0.03 microsecond.

C. NO OVERSHOOT is observed even on extremely steep wavefronts. The low-frequency response limit is a 3% slope on a 30-cycle squarewave. As shown on the frequency-response curve, there is no positive slope above the mid-frequency range. Since the response tapers off so slowly, the Type 303 is usable at frequencies beyond 10 megacycles. The synchronizing circuits will lock in sine-wave signals as high as 20 megacycles.

D. UNDISTORTED DEFLECTION provided by the Y-axis amplifier is 2.5 inches for unidirectional pulses. An equivalent undistorted deflection of 5 inches is available for symmetrical signals and may be positioned over the useful area of the cathode-ray tube. Even at the highest attenuation ratios, the Y-axis input is not frequency sensitive, as shown by the illustrated pulse which has been attenuated 4000 times. The direct-coupled X-axis amplifier of

the Type 303 will provide over 5" of undistorted deflection.

E. SWEEP SPEEDS available in the Type 303 make possible a presentation which is practical for qualitative and quantitative analysis of a pulse as short as 0.25 microsecond. Both driven and recurrent sweeps are continuously variable from 0.1 second to 5 microseconds. Through sweep expansion, sweep length is variable from a fraction of an inch to an effective 30 inches, any portion of which may be positioned on the screen. As shown above, even at the fastest sweep range, the sweep is extremely stable and linear. Notice the absence of jitter.

F. TIME CALIBRATION in the Type 303 is accomplished by substituting a damped sinewave for the signal. Double exposure by photographic recording of calibrating sinewave and signal provides a permanent quantitative analysis of the signal. In addition to the 10-megacycle signal shown above, calibrating frequencies of 10 KC, 100 KC, and 1 MC are also available. Accuracy of time calibration is within 3%.

G. AMPLITUDE CALIBRATION completes the precise, quantitative analysis of the signal. A built-in, regulated, voltage-calibrator provides peak-to-peak signals of 0.1, 1.0, 10, and 100 volts. Similar to time calibration, the amplitude calibrating square wave is substituted for the signal. Amplitude calibration is accurate within 5%.

price **\$820.00**

FOR COMPLETE DETAILS WRITE for bulletin TYPE 303

ALLEN B. DUMONT LABORATORIES, INC. Instrument Division 1000 Main Avenue, Clifton, N. J.

HOW TO **STOP TROUBLE** BEFORE IT STARTS!

It's no accident that AISiMag components give you the plus performance and the smooth assembly that they should. It's planned that way.



Every new design goes through two groups of engineers at the AISiMag plant. The first group studies the design to see if it can be made to do its job more effectively or if it can be modified for more efficient production.

Production engineers in the second group study the design to adapt it to the most efficient production methods in our plant. On complex prints, then get together for final discussions. Thus the men who are directly responsible for production see the design before the order is accepted. They point out any design features that might lead to trouble or unnecessary expense.



These engineering recommendations are sent to the customer. Specialized experience and intimate

knowledge of available production methods thus give you better AISiMag components at a saving.

In many instances, our engineering groups recommend hand made test samples of the original design and of modified designs. These can be made promptly and at reasonable cost. Once the proper design is found, production orders can be entered with assurance that the design does the job and that it is practical to produce.

When production orders are entered, Quality Control takes over. If the job gets off specification at any point, the trouble is corrected immediately. This saves a lot of time and a lot of money and helps us make delivery as promised. And it assures that your AISiMag parts will fully meet all specifications.

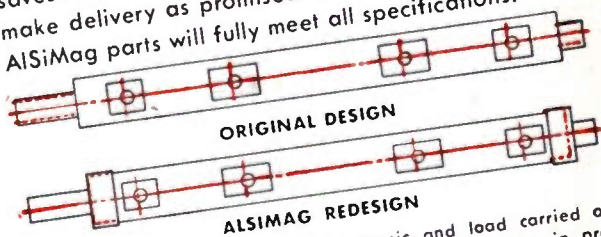

Weak points removed from the ceramic and load carried on metal caps. Overall strength greatly increased. Losses in production and in use greatly reduced. Precision manufacture at minimum cost attained through redesign.

ALSIMAG

49TH YEAR OF CERAMIC LEADERSHIP
AMERICAN LAVA CORPORATION
CHATTANOOGA 5, TENNESSEE

OFFICES: METROPOLITAN AREA: 671 Broad St., Newark, N. J., Mitchell 2-8159 • CHICAGO, 228 North LaSalle St., Central 6-1721
PHILADELPHIA, 1649 North Broad St., Stevenson 4-2823 • LOS ANGELES, 232 South Hill St., Mutual 9076
NEW ENGLAND, 38-B Brattle St., Cambridge, Mass., Kirkland 7-4498 • ST. LOUIS, 1123 Washington Ave., Garfield 4959



"AISiMag engineers have always had the answer to our ceramic problems."

"AISiMag is always right on the specifications."

"AISiMag delivers as promised and gives us parts that do the job."

"In nearly every case AISiMag engineers have helped us work out a better component that costs us less money."

"AISiMag cannot always give us the delivery date we want but they have always delivered as promised."

"AISiMag is the only one that has always met our tolerance requirements."

PRECISION *electronic* SPECIALTIES



HIGH-STABILITY PRECISION RESISTORS

Guaranteed tolerances from 0.1% to 0.02% and stabilities as low as 0.003%.

It is one thing to make an accurate resistor, but quite another to guarantee the stability as required in computer circuits, tuning circuits, precision voltage dividers, radar range units, guided missiles and other critical uses. Not only are Shallcross Akra-Ohm resistor types 116, 196, and 193 outstanding in these respects, but they can likewise be furnished in matched pairs and sets to your tolerance and with a guaranteed stability as low as 0.003%.

MULTI-POSITION SELECTOR SWITCHES

Up to 120 contacts

As long-time specialists in custom-built rotary selector switches, Shallcross offers an extremely broad line of standard and special adaptations at attractive prices. Standard designs include up to 120 contacts per deck in shorting and non-shorting types and as many decks as may be required. Ask for Bulletin L13 and Specification Sheet 6.

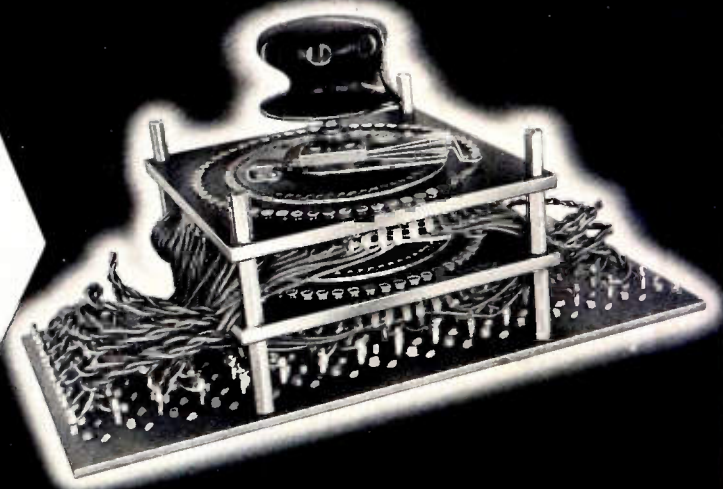

CUSTOM-BUILT SPECIALTIES

Today's complex circuits frequently call for the design, development, and production of highly specialized components, sub-assemblies, or instruments which usually fall outside the realm of standard production. Backed by a staff of electronic, electrical, instrument, mechanical, and chemical engineers and fully equipped for both research and development, Shallcross is well organized to handle such assignments. Recent developments for leading manufacturers, public utilities, and military agencies have included:

Potted Wheatstone bridge networks • High-voltage measuring equipment
Potted and thermally controlled R-C networks • Precise decades and networks for computer devices • Hermetically-sealed chokes • Calibrating instruments for strain gauge bridges
High resistance standards • Critical coil assemblies

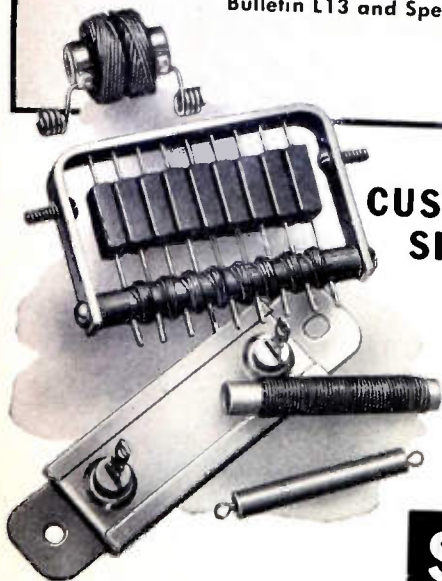

SHALLCROSS MANUFACTURING

BY SHALLCROSS

HERMETICALLY-SEALED NETWORKS

*Resistance • Capacitance
Bridge • Inductance*

To satisfy the exacting requirements of electronic computers, delay lines, tuning circuits, phase shifters, and other devices, Shallcross is fully equipped to design and produce potted networks to meet many critical electrical specifications and space requirements. The unit shown is a hermetically-sealed potted bridge network designed to control a potential of 100 volts to within ± 0.1 volt.



HIGH-RANGE KILOVOLT-METER MULTIPLIERS

and Voltage Dividers

Whether for direct high-voltage measurements or for use as standards in determining the exact voltage of a portion of a high-voltage supply, Shallcross Kilovoltmeter Multipliers combine close accuracy with safety and dependability. The No. 791 Kilovoltmeter Multiplier illustrated here provides a ready means of determining a-c and d-c potentials up to 40,000 volts with outstanding accuracy. Other Shallcross types are available. For details, see Bulletin F.



HI-MEG HI-VOLTAGE RESISTORS

Special resistance elements hermetically-sealed in ceramic tubes with ferrule type terminals. With composition elements the standard tolerance is 10% and the temperature coefficient is 0.04% per degree C. Tolerances as close as 2% are available. With special wire-wound resistance elements, accuracies of 0.05% are easily obtained. A standard temperature coefficient of 0.002% per degree C holds over a wide temperature range. Three standard sizes offer resistance values from 1000 ohms to over 100 megohms. Write for Bulletin F

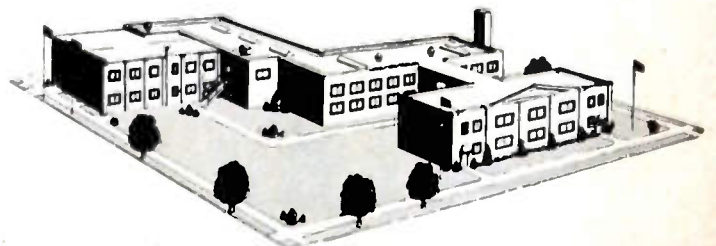

COMPANY **Dept. PR-100** **Collingdale, Pennsylvania**

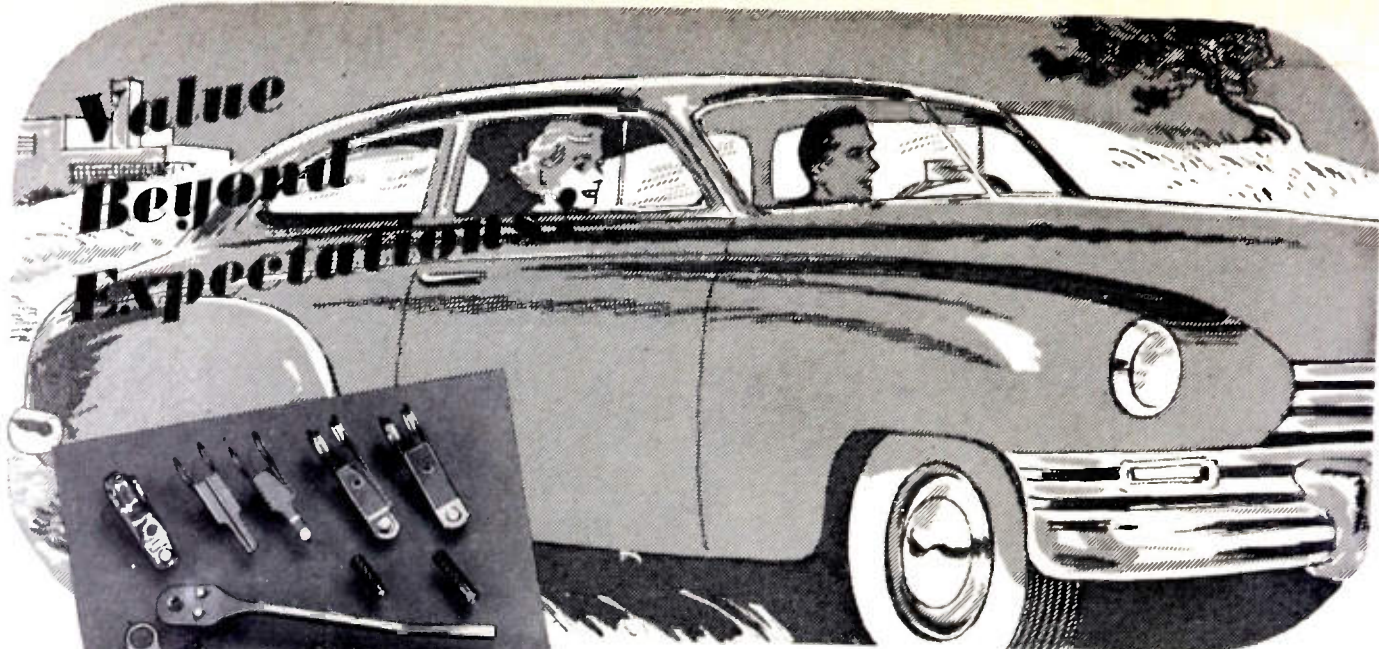

**Value
Beyond
Expectations!**

Needless Contact Costs Saved By *Mallory Know-How!*

MALLORY SILVER CONTACTS

Fine and coin silvers, while having desirable properties for many applications, do not provide the physical properties required for some applications. To cover these applications, Mallory has developed a series of silver base alloys. These alloys have such improved characteristics as greater resistance to wear, less sticking or metal transfer, and greater hardness. Mallory is fully qualified to recommend the best contact material for your design. Write today.

Important contact cost reductions usually result when Mallory is permitted to analyze applications and apply skilled attention to seemingly minor details.

In one particular case, a manufacturer of automotive voltage regulators requested that Mallory study his contact cost and performance. This study by Mallory disclosed that the amount of precious metal in the contact could be reduced considerably . . . without materially changing electrical characteristics. This reduction in silver content meant a saving to the customer of more than \$3500 per year!

That's value beyond expectations!

Mallory contact know-how is at your disposal. What Mallory has done for others can be done for you!

In Canada, made and sold by Johnson Matthey & Mallory, Ltd.,
110 Industry St., Toronto 15, Ontario

Electrical Contacts and Contact Assemblies

P. R. MALLORY & CO., Inc.
MALLORY

P. R. MALLORY & CO., Inc., INDIANAPOLIS 6, INDIANA

SERVING INDUSTRY WITH

- | | |
|------------------------------|----------------|
| Capacitors | Contacts |
| Controls | Resistors |
| Rectifiers | Vibrators |
| Special Switches | Power Supplies |
| Resistance Welding Materials | |

Performance

PROTECTION

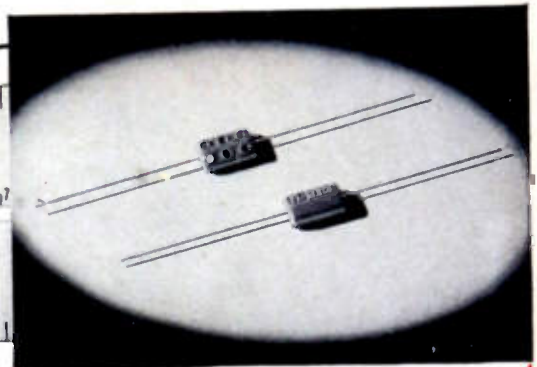
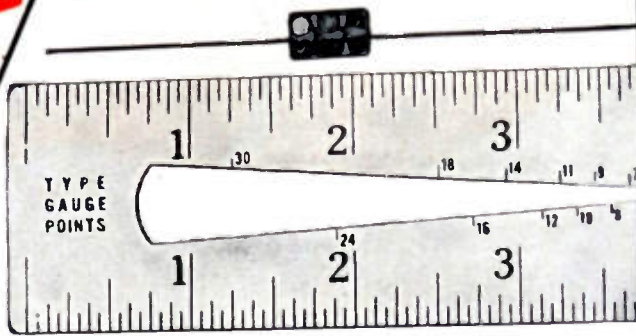

EL-MENCO CAPACITORS

Small, high-capacity fixed mica El-Menco capacitors are made to protect the performance of your products under severest operating conditions. They give long, dependable service because they must meet exacting conditions of Quality Test before they can be incorporated in your product. Tested at double their working voltage for dielectric strength, for insulation resistance and capacity value, El-Menco condensers can be depended upon for the utmost in performance protection.

CM-15

Actual Size 9/32" x 1/2" x 3/16"
For Television, Radio and other Electronic Applications.

2 mmf. — 420 mmf. cap. at 500v DCw.

2 mmf. — 525 mmf. cap. at 300v DCw.

Temp. Co-efficient 50 parts per million per degree C for most capacity values.

6-dot Color Coded.

SPECIFY EL-MENCO —

First Choice For Long Life and Dependability

THE ELECTRO MOTIVE MFG. CO., Inc.
WILLIMANTIC CONNECTICUT

Write on your
firm letterhead
for Catalog and Samples.



MOLDED MICA

EL-MENCO CAPACITORS

MICA TRIMMER

FOREIGN RADIO AND ELECTRONIC MANUFACTURERS COMMUNICATE DIRECT WITH OUR EXPORT DEPT. AT WILLIMANTIC, CONN. FOR INFORMATION.
ARCO ELECTRONICS, INC. 103 LaFayette St., New York, N.Y.—Sole Agent for Jobbers and Distributors in U.S. and Canada

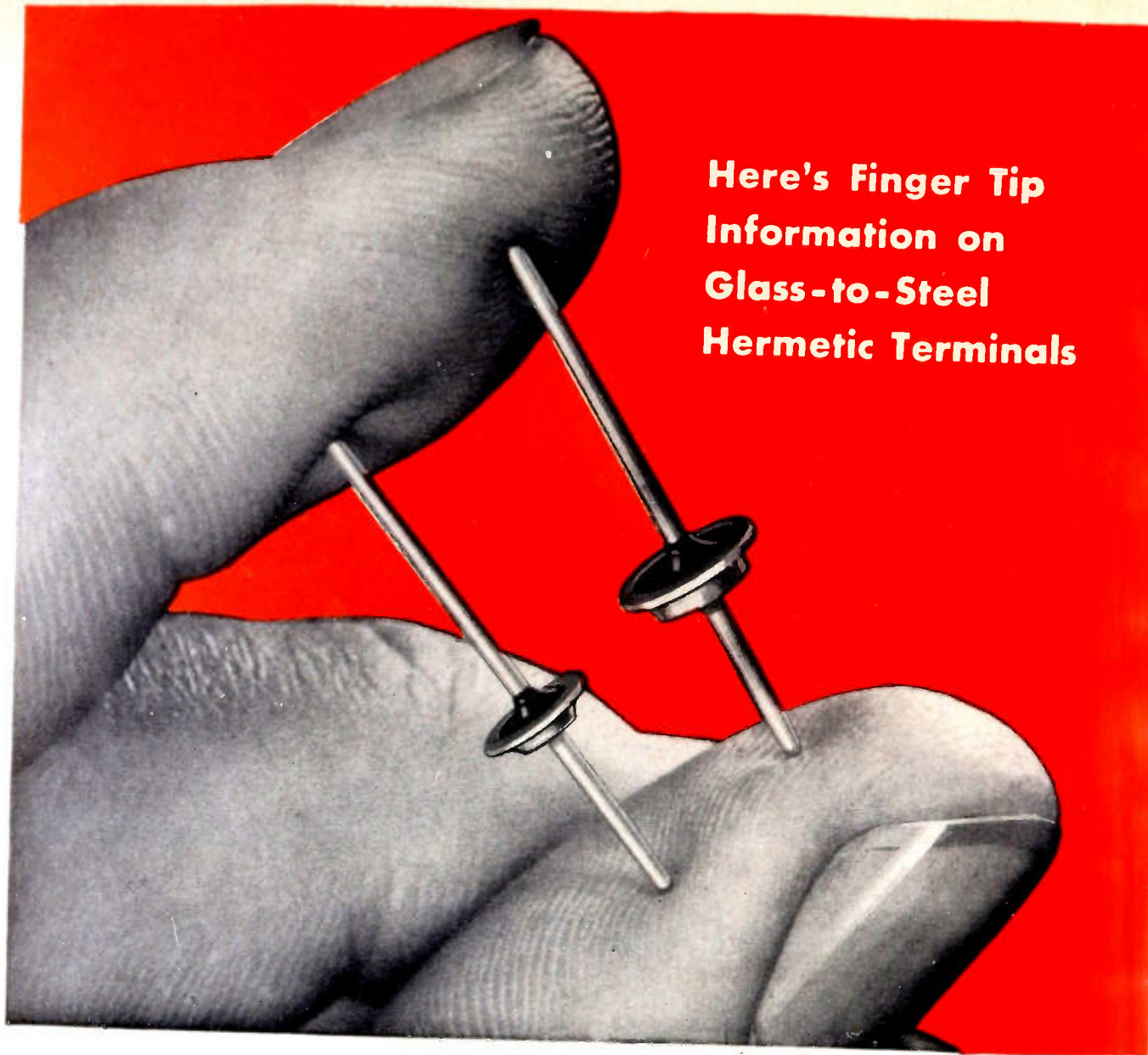

**Here's Finger Tip
Information on
Glass-to-Steel
Hermetic Terminals**



- The trend toward hermetic sealing in all phases of electrical manufacturing is gaining impetus. Fusite has pioneered in the field of glass-to-steel hermetic terminals for use in fusion sealing—the only truly hermetic process.

- We have prepared a brochure crammed full of illustrations, specifications, diagrams, and facts about the Fusite wide line of single and multiple electrode terminals.

- We assure you that regardless of your present level of knowledge concerning glass-to-steel terminals, you do not have a complete or accurate picture of the production possibilities of fusion sealing until you know the Fusite story.

Write today for your copy of this literature, to Dept.-E.

TERMINALS ILLUSTRATED: 104SW, Left, 105SW, Right.
Miniature—Straight Wire—Single—Glass-to-Steel Hermetic Terminals.

THE FUSITE CORPORATION
CARTHAGE AT HANNAFORD, NORWOOD, CINCINNATI 12, OHIO

ELECTRONIC ENGINEERS

Specify

GUARDIAN

HERMETICALLY SEALED RELAYS

TV FOCUS COILS

NEAT

EFFICIENT

EASY-TO-SERVICE

VIBRATION-PROOF



SERIES 335 RELAY



SERIES 595 RELAY



SERIES 610 AC—615 DC RELAY



THE SCREW TERMINAL TYPE



THE A. N. CONNECTOR TYPE



THE OCTAL PLUG TYPE



THE LUG HEADER TYPE

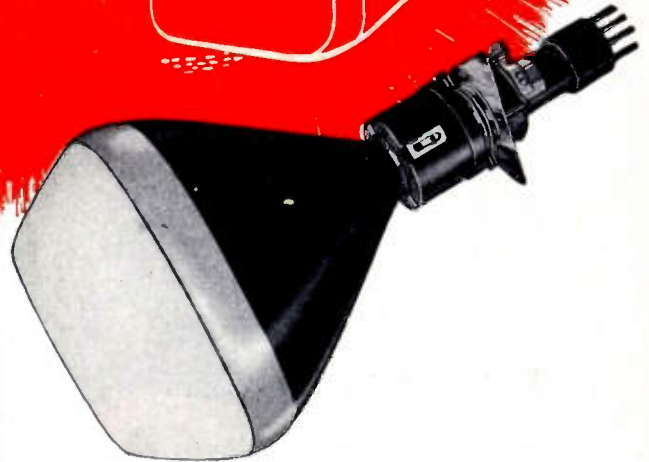

GUARDIAN FOCUS COILS

Over a million Focus Coils have rolled off Guardian's production lines into TV sets of leading manufacturers. With more than 75 types established as *Guardian Standard*, speedy delivery to meet today's replacement needs is a matter of routine.

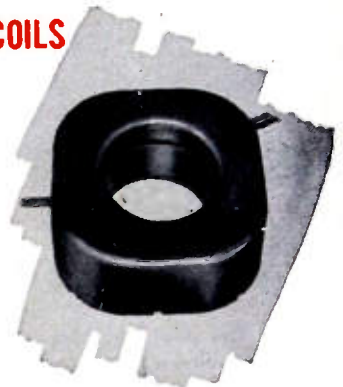

Valuable information on **HERMETICALLY SEALED** Guardian Relays is yours for the asking. Write on your business letterhead for new completely descriptive and illustrated Catalog 5-H. No cost. No obligation.

Write — ASK US TO MAKE SPECIFIC RECOMMENDATIONS. NO OBLIGATION.

GUARDIAN ELECTRIC

1628-L W. WALNUT STREET

CHICAGO 12, ILLINOIS

A COMPLETE LINE OF RELAYS SERVING AMERICAN INDUSTRY

Intermodulation can be measured quickly and accurately with MEASUREMENTS' new, portable **MODEL 31**



INTERMODULATION METER



COMPLETELY SELF-CONTAINED

- TEST SIGNAL GENERATOR
- ANALYZER
- VOLTMETER
- POWER SUPPLY

To insure peak performance from all audio systems; for correct adjustment and maintenance of AM and FM receivers and transmitters; checking linearity of film and disc recordings and reproductions; checking phonograph pickups and recording styli; checking record matrices; adjusting bias in tape recordings, etc.

MEASUREMENTS CORPORATION meets the demand for compact, easily-operated intermodulation equipment! The MODEL 31 is moderately priced, yet extremely accurate and built to the same rigid specifications of all "LABORATORY STANDARDS".

One section of the MODEL 31 supplies mixed audio frequencies to the apparatus under test; the resultant signal from the apparatus is then applied to the analyzer section of the MODEL 31 to be filtered, amplified, demodulated and metered. The meter is direct-reading in percentage of intermodulation and input volts.

MODEL 30 INTERMODULATION METER

This model has a test generator providing, a low frequency range of 40, 70 and 100 cycles, a high frequency range of 2000, 7000 and 12,000 cycles, either separate or mixed in a 1/1 or 4/1 ratio.

The analyzer will operate from 20 cycles to 200 cycles and from 2000 cycles to 20,000 cycles.

A direct-reading meter measures intermodulation percentages from 0.1% to 30%; test generator output voltages from .01 to 100 v. (-30 to +20 DBM); analyzer input voltages from .0001 to 100 v. (-70 to +40 DBM).

Detailed circular on request

Specifications:

GENERATOR

LOW FREQUENCY: 60 cycles.
 HIGH FREQUENCY: 3000 cycles.
 LF/HF VOLTAGE RATIO: Fixed 4/1.
 OUTPUT VOLTAGE: 10 v. max. into high impedance or +5 DBM matched to 600 ohms.
 OUTPUT IMPEDANCE: 2000 ohms.
 RESIDUAL INTERMODULATION: 0.2% max.

ANALYZER

INPUT VOLTAGE: Full scale ranges of 3, 10 and 30 volts RMS. Less than one volt of mixed signal is sufficient for operation.
 INPUT IMPEDANCE: Greater than 400 K ohms.
 INTERMODULATION: Full scale ranges of 3, 10 and 30%.
 ACCURACY: $\pm 10\%$ of full scale.
 OSCILLOSCOPE connection at meter.

Power supply: 117 volts, 50/60 cycles, 30 watts. Dimensions: 8" high x 19" wide x 9" deep. May be mounted in standard 7" relay rack panel space. Weight: 16 lbs.

MEASUREMENTS CORPORATION
 BOONTON NEW JERSEY

PRODUCED FOR YOUR REQUIREMENTS
*- by the top specialists in
 the ceramic field*

Hi-Q

CERAMIC PLATE CAPACITORS

Essentially similar, except in shape, to Hi-Q Disk Capacitors except that in the multiple units they do NOT have to have a common ground as is the case with disks. These Hi-Q Plates can be produced in an unlimited range of capacities, the number on a plate being limited only by the K of the material and the physical size of the unit. They offer the greatest available capacity per unit volume of any type condenser on the market.

Guaranteed minimum values of capacity up to 33,000 mmf per sq. in. are available. This is based on the use of Body 41 ceramic having 3000 as a dielectric constant "K" and .020 in. thickness and the formula:

$$C \text{ (mmf)} = \frac{.224 K A \text{ (Sq. in.)}}{D \text{ in.}}$$

If temperature compensating ceramics are used, the capacity will be considerably lower. Typical circuits are shown here, but almost any combination can be produced for your specific needs. Consult our engineers for complete details. Write for new Hi-Q datalog.

PC-100

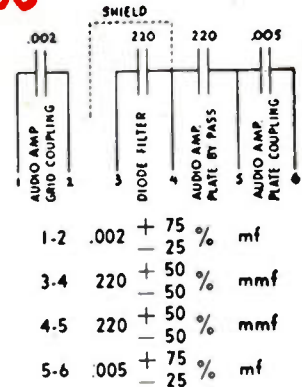
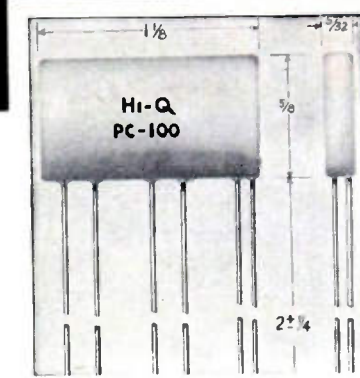

1-2	.002	+ 75 %	- 25 %	mf
3-4	220	+ 50 %	- 50 %	mmf
4-5	220	+ 50 %	- 50 %	mmf
5-6	.005	+ 75 %	- 25 %	mf

PC-101

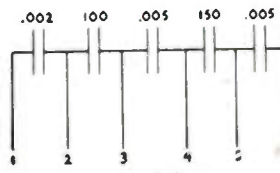

1-2	.002	+ 75 %	- 25 %	mf
2-3	100	+ 50 %	- 50 %	mmf
3-4	.005	+ 75 %	- 25 %	mf
4-5	150	+ 50 %	- 50 %	mmf
5-6	.005	+ 75 %	- 25 %	mf

PC-102

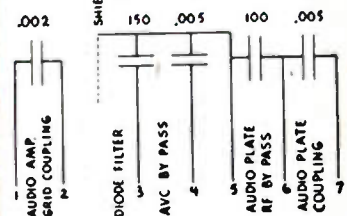

1-2	.002	+ 75 %	- 25 %	mf
3-5	150	+ 100 %	- 0 %	mmf
4-5	.005	+ 100 %	- 0 %	mf
5-6	100	+ 75 %	- 25 %	mmf
6-7	.005	+ 75 %	- 25 %	mf

PC-103

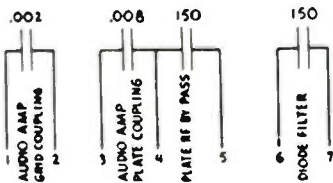

1-2	.002	+ 75 %	- 25 %	mf
3-4	.008	Min		mf
4-5	150	+ 50 %	- 50 %	mmf
6-7	150	+ 50 %	- 50 %	mmf

PC-104

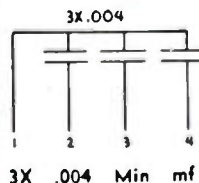

3X .004 Min mf

PC-105

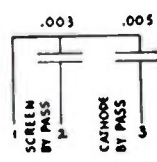

1-2	.003	+ 75 %	- 25 %	mf
1-3	.005	+ 75 %	- 25 %	mf

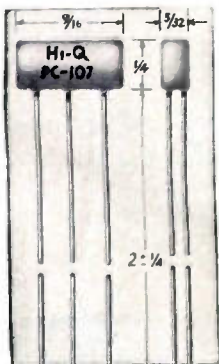

PC-107

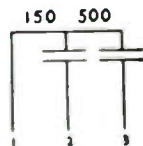

1-2	150	+ 75 %	- 25 %	mmf
1-3	500	+ 75 %	- 25 %	mmf

Hi-Q
COMPONENTS

Capacitors
 Trimmers • Choke Coils
 Wire Wound Resistors

BETTER 4 WAYS

- ✓ PRECISION
- ✓ UNIFORMITY
- ✓ DEPENDABILITY
- ✓ MINIATURIZATION

JOBBERS — ADDRESS: 740 Belleville Ave., New Bedford, Mass.

Hi-Q

Electrical Reactance Corp.

OLEAN, N. Y.

SALES OFFICES: New York, Philadelphia
 Detroit, Chicago, Los Angeles

PLANTS: Olean, N. Y., Franklinville, N. Y.
 Jessup, Pa., Myrtle Beach, S. C.

YOU GET THE "FEEL" OF LIFE



WITH THE
NEW, SENSATIONAL 19AP4D

Sheldon *VITATRON** Picture Tube

SHeldon presents, for the first time, a revolutionary advancement in television picture viewing with pictures so real . . . they're the nearest thing to a "live" performance. . . . Pictures where BLACK is BLACK, WHITE is WHITE, and between them all the natural intermediate shadings.

Sheldon "Telegenic" VITATRONS have beautiful contrast and depth. Their specially-developed Frosted Face reduces Glare and Reflections to a minimum . . . with no appreciable light transmission loss.



These strikingly different picture tubes are available** in the 19AP4D, a 19" glass-metal tube. Write for detailed specifications on the New, 19AP4D Sheldon VITATRON.

* TRADEMARK

SHELDON ELECTRIC CO.

Division of Allied Electric Products Inc.

68-98 Coit Street, Irvington 11, N. J.

Branch Offices & Warehouses: CHICAGO 7, ILL., 426 S. Clinton St. LOS ANGELES 26, CAL., 1755 Glendale Blvd.

** Delivery of 19AP4D is dependent on face plate delivery. Sheldon VITATRONS will be available in all-glass tubes if, as and when glass blanks become available.

It's that Simple...



... Automatic Push-Button Tuning

An Exclusive Feature of the New

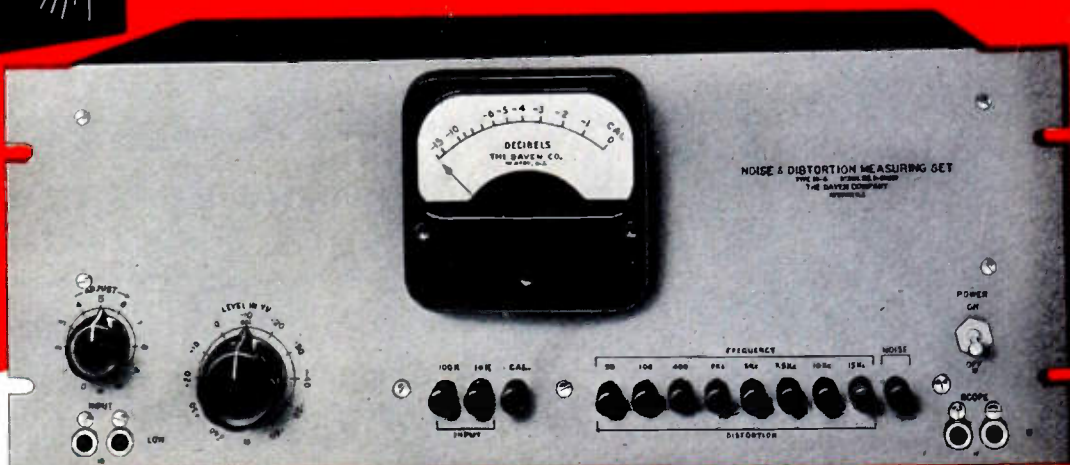

DAVEN

Distortion and Noise Meter Type 35-A

The DAVEN Type 35-A, Distortion and Noise Meter, is a new, skillfully engineered instrument that provides a rapid, accurate means of measuring distortion, noise and hum level in audio frequency equipment.

Of particular importance is the fact that there is no balancing or laborious time consuming tuning required to make measurements. The user need only push a button and the unit is automatically balanced.

This is accomplished by the use of a series of 8 fixed band rejection filters covering the range 50 cycles to 15 K.c., followed by a stable, high quality, wide range (50 cycles to 45 K.c.), high gain amplifier. There are no tube circuits or other sources of inherent distortions, making it possible to measure low levels of distortion accurately over a wide level range.

SPECIFICATIONS

RESIDUAL DISTORTION: No tube circuits or non-linear devices between input of set and filter input.

DISTORTION MEASUREMENTS: Filters provided for 50, 100, 400, 1000 cycles, 5 Kc, 7.5 Kc, 10 Kc, and 15 Kc with cut off of -70 db. Distortion measurements to 0.1% full scale meter deflection with zero level input.

NOISE MEASUREMENTS: With zero db input, limit is -80 db. At +40 input, limit is -115 db below input.

AMPLIFIER FREQUENCY RANGE: 50 cycles to 45 Kc.

ACCURACY: Filters are down 70 db at fundamental frequencies, and within ± 0.5 db of flat response at the second harmonic. Absolute accuracy of measurement can be depended upon to be within $\pm 5\%$.

RESIDUAL NOISE LEVEL: Below -80 db at gain control full on. Multiple gain control employed so that residual noise drops to -90 db. when gain control is set at -30, -100 db when gain control is set at -20, etc.

Write for detailed information

THE **DAVEN** CO.

195 CENTRAL AVENUE
NEWARK 4, N. J.

SEE DAVEN AT THE
AUDIO FAIR, ROOM 616

P
D
Q!



Shown:
Bliley type TCO-1
Crystal Oven with
Bliley type BH6
crystal

PRECISION...

DEVELOPMENT . . . QUALITY!

When the end use is military . . .
Bliley crystals are combat veterans.
Military specifications demand pre-
cision . . . development . . . quality.
These factors are basic with Bliley—
the top choice for 20 years.

Bliley
CRYSTALS

BLILEY ELECTRIC COMPANY
UNION STATION BUILDING
ERIE, PENNSYLVANIA

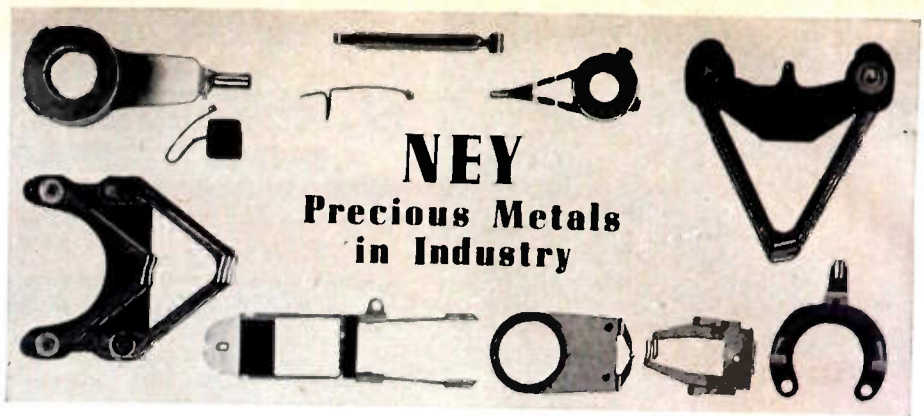

NEY
Precious Metals
in Industry

GREATLY IMPROVED LINEARITY WITH PALINEY* # 7
BRUSH CONTACTS

Results of life tests on nickel-chrome wire-wound potentiometers, using contacts of PALINEY* #7 in comparison with phosphor bronze, showed greatly improved linearity maintained through longer service life. If you have this or similar contact problems write or call our Research Department for detailed test data.

*Reg. T.M. of J. M. Ney Co.

Write or phone (HARTFORD 2-4271) our Research Department

THE J. M. NEY COMPANY

171 ELM ST. • HARTFORD 1, CONN.
SPECIALISTS IN PRECIOUS METAL
METALLURGY SINCE 1812

26NY49

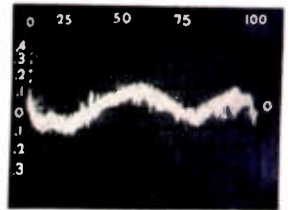

Cathode Ray Oscillograph shows performance of modified potentiometer after one million cycles or two million sweeps of PALINEY* #7 contact over wire. The initial error was reduced to $\pm .12\%$ and this linearity was maintained throughout the test.

Now SKL's NEW
100 MC BANDWIDTH
PULSE AMPLIFIER

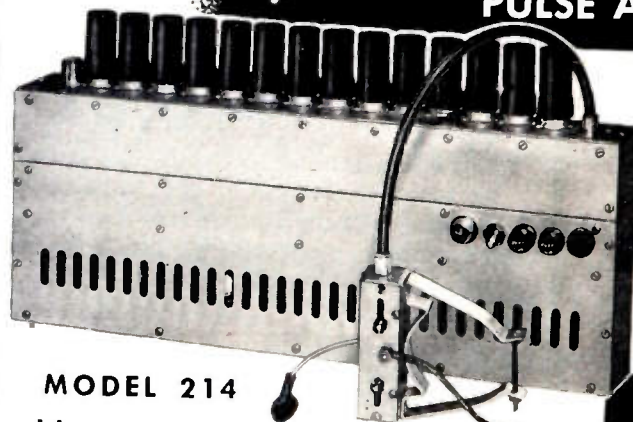

MODEL 214

High output voltage and very fast rise time with NO OVERSHOOT characterize the performance of the SKL Model 214 Chain Pulse Amplifier. The specially designed terminating cable provides a resistive output of 500 ohms and a capacitive output for connection to a cathode ray tube grid or deflection plates. Capable of deflecting a 5XP tube more than 1", the Model 214 finds extensive use in radar, oscillography, television testing, and nuclear physics.

Write today for further information.

FEATURES

OUTPUT VOLTAGE
65 volts

RISE TIME
006 usec.

GAIN
30 db

INPUT IMPEDANCE
180 ohms

BANDWIDTH
40 KC to 100 MC



Applied 20×10^{-9} rise time pulse



Amplified 20×10^{-9} rise time pulse

SKL SPENCER-KENNEDY LABORATORIES, INC.
181 MASSACHUSETTS AVE., CAMBRIDGE 39, MASS.

Another exclusive
GPL Development

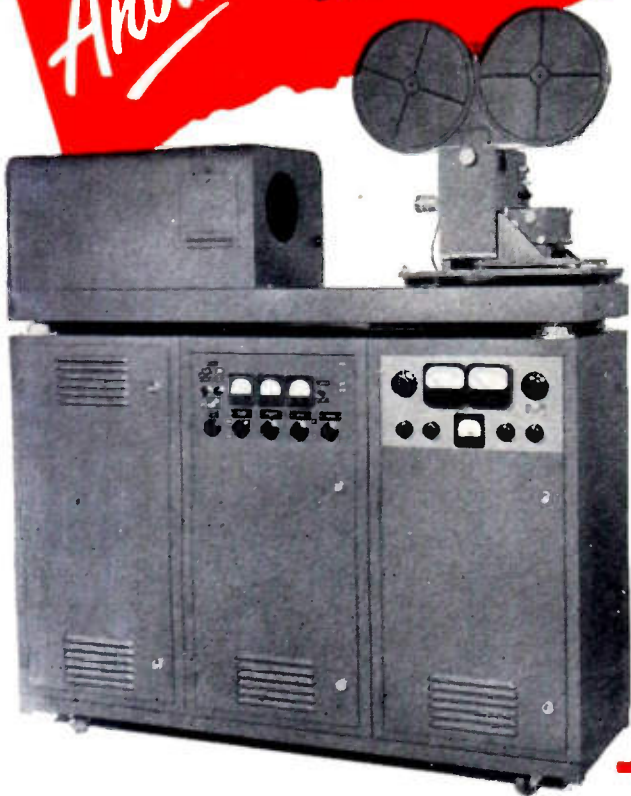

New GPL VIDEO RECORDER

WITH
Electronic Shutter

Live Show Quality - Picture and Sound - on Delayed Telecasts

These Exclusive Features put the GPL Video Recorder In a Class by Itself

ELECTRONIC SHUTTER — Limits exposure of each film frame to 525-line scanning of tube, with accuracy better than 1% of one line. Stays in adjustment; does not require camera to be locked in synchronization with video signal.

GPL VIDEOGAM — A gray scale correction amplifier that provides better video pictures than normally possible. In addition, a special deflection yoke provides perfect focus across entire screen.

GPL FILM GATE — Permits over 30 minutes of continuous camera operation without film abrasion, emulsion pile-up and consequent difficulties.

HIGH FIDELITY SOUND is recorded simultaneously. Essentially flat recording to 7 kilocycles, with low harmonic and intermodulation distortion, gives results comparable to finest 35-mm sound.

This new 16-mm Video Recorder makes possible, for the first time, delayed telecasts that are consistently as good as the original. GPL's exclusive new shutter — electronic instead of mechanical — is coupled with improvements in picture resolution, film gate design, and sound fidelity. The projected recording is markedly better than the picture obtainable on most receivers. Re-telecast with good equipment, the picture looks and sounds like a live show.

The GPL Video Recorder may be used with the GPL rapid processor to produce finished film, positive or negative, less than a minute after the program is received either over a closed circuit or from the air.

WRITE FOR RECORDINGS made on this equipment for study by studios, advertisers, agencies.

TV Camera Chains • TV Film Chains
TV Field and Studio Equipment
Theatre TV Equipment



General Precision Laboratory

INCORPORATED

PLEASANTVILLE

NEW YORK

ANTARA PRODUCTS

GENERAL ANILINE & FILM CORPORATION

444 MADISON AVENUE · NEW YORK 22, N.Y.

an open letter

October, 1950

To All Users of Powdered Iron Cores
Anywhere, U. S. A.

Next time your order is placed for cores, ask your core maker this question: What material do you use in these cores?

If his answer is Carbonyl Iron Powders, good. He's using the highest quality material on the market. If he gives you another name, ask yourself this question: Can I be sure of high Q, of temperature and atmospheric stability at no extra cost? Can I be sure I'm getting the finest core possible if he doesn't use Carbonyl Iron Powders?

The answer is obvious. Your core maker can supply you with the best -- if he uses GA&F Carbonyl Iron Powders. Ask your core maker next time you place an order. See for yourself what a difference these low-cost, high Q materials can make!

Sincerely,

ANTARA PRODUCTS
General Aniline & Film Corporation

GA & F[®] Carbonyl



to all users of powdered iron cores...

Core users—here's a tip that will guarantee you cores made of the highest quality materials on the market. Ask your core maker for cores made with Carbonyl Iron Powders. You will guarantee yourself high quality cores because Carbonyl Iron Powders are high quality products with low loss characteristics. They are manufactured and tested for quality under the most rigid conditions.

It costs no more to secure Carbonyl Iron Powder cores. On a performance basis, they offer savings not possible with other magnetic powder.

Your core maker knows about these high Q materials. He is familiar with their stability, their ease of insulation, and the controlled particle size distribution. That's why we say, next time you order, insist on Carbonyl Iron Powders for best results!

THIS FREE BOOK — fully illustrated, with performance charts and application data — will help any radio engineer or electronics manufacturer to step up quality, while saving real money. Kindly address your request to Dept. 57.



ANTARA® PRODUCTS

**GENERAL
GA** NILINE & FILM CORPORATION

444 MADISON AVENUE

NEW YORK 22, N. Y.

Iron Powders...



12 REASONS WHY...

it pays equipment manufacturers to deal with RCA

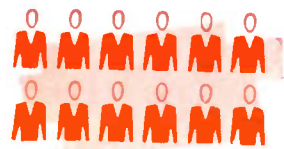

1. RCA Application Engineering Service—Twelve field engineering specialists devote their time *exclusively* to the design problems of equipment manufacturers. They're ready to pitch in and help you at any time.



2. RCA Application Engineering Laboratories—RCA maintains application laboratories at Harrison, Lancaster, and Chicago. The services of these laboratories are at the disposal of all RCA tube and component customers.



3. RCA Circuit Investigations—RCA carries on independent research in circuit design for the exclusive benefit of its tube and component customers. Engineering reports are provided as a free service.



4. RCA Tube and Component Development—RCA works years ahead in tube and component design—anticipates future requirements. That's why you get the types of tubes and components you want when you want them.



5. RCA Engineering Literature—RCA technical bulletins and data, covering the specifications and operating conditions of RCA tubes and components, are the most authoritative and comprehensive in the field.

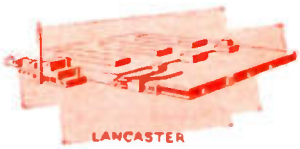

6. RCA Manufacturing Facilities—RCA tubes and components are manufactured in modern plants equipped largely with RCA-designed, precision machinery—your assurance of uniform, dependable quality tubes and components.



7. RCA Quality Control—Quality controls begin with the raw material and are followed through in every successive step of manufacture and assembly. That's why RCA tubes and components are consistently reliable.



8. RCA Sales and Customer Service—A staff of seasoned sales representatives is available within convenient reach. They're available *when* you want them. In addition, a staff at the Home Office devotes its time *exclusively* to expediting your orders.



9. RCA District Offices—RCA maintains three conveniently located district offices in Harrison, Chicago, and Los Angeles to serve equipment manufacturers. You can get prompt service from the office nearest you.



10. RCA Distribution—RCA maintains bulk tube and component stocks in three warehouses strategically located in Jersey City, Chicago, and Los Angeles for quick service.



11. RCA Pricing—Mass-production techniques and the RCA "Preferred Type Plan" have consistently operated to reduce manufacturing costs—which mean lower prices to you.



12. RCA Engineering Leadership—The vast resources of experience and ability that account for RCA's engineering leadership in tubes and components, are of direct benefit to RCA customers... a final reason why it pays to deal with RCA.

Sales and Product Directory

1. General sales information or requests for application engineering assistance on receiving and television picture tubes, communications and industrial tubes, power tube fittings, electronic components, and test and measuring equipment:

Equipment Sales Field Representatives at the RCA Sales Office nearest you:

City and State	Street Address	Telephone No.
Harrison, N. J.	415 S. 5th St.	Harrison 6-8000
Chicago 11, Ill.	589 E. Illinois St.	Whitehall 4-2900
Los Angeles 13, Calif.	420 S. San Pedro St.	Madison 9-3671

2. Inquiries relative to technical bulletins: Commercial Engineering, RCA,

415 South 5th Street, Harrison, N. J.

3. Orders and inquiries on orders: Tubes: RCA warehouse serving you:

Jersey City Warehouse, RCA 34 Exchange Place Jersey City 2, N. J. Phone: Bergen 4-2100	Chicago Warehouse, RCA 589 E. Illinois St. Chicago 11, Ill. Phone: Whitehall 4-2900
Los Angeles Warehouse, RCA, 420 S. San Pedro St. Los Angeles 13, Calif. Phone: Madison 9-3671	



RADIO CORPORATION of AMERICA
ELECTRON TUBES AND COMPONENTS
HARRISON, N. J.

PROCEEDINGS OF THE I.R.E.

Published Monthly by

The Institute of Radio Engineers, Inc.

VOLUME 38

October, 1950

NUMBER 10

BOARD OF DIRECTORS, 1950*

Raymond F. Guy
President

R. A. Watson-Watt
Vice-President

D. B. Sinclair
Treasurer

Haraden Pratt
Secretary

Alfred N. Goldsmith
Editor

B. E. Shackelford
Senior Past President

Stuart L. Bailey
Junior Past President

1950

Ben Akerman (6)

W. R. G. Baker
T. H. Clark

J. V. L. Hogan (2)

T. A. Hunter

H. E. Kranz (4)

F. H. R. Pounsett (8)

J. E. Shepherd

J. A. Stratton

1950-1951

A. V. Eastman (7)

W. L. Everitt

D. G. Fink

F. Hamburger Jr. (3)

H. J. Reich (1)

J. D. Reid (5)

1950-1952

W. R. Hewlett

J. W. McRae

Harold R. Zeamans
General Counsel

George W. Bailey
Executive Secretary

Laurence G. Cumming
Technical Secretary

Changes of address (with advance notice of fifteen days) and communications regarding subscriptions and payments should be mailed to the Secretary of the Institute, at 450 Ahnaip St., Menasha, Wisconsin, or 1 East 79 Street, New York 21, N. Y.

All rights of republication, including translation into foreign languages, are reserved by the Institute. Abstracts of papers with mention of their source, may be printed. Requests for republication privileges should be addressed to The Institute of Radio Engineers.

*Numerals in parentheses following Directors' names designate Region number.

PROCEEDINGS OF THE I.R.E.

Herman E. Kranz.....	1122
International Aspects of Radio..... R. L. Smith-Rose	1123
3728. The Role of Professional Groups in the I.R.E..... L. C. Van Atta	1124
3729. Electronics and the Electrostatic Generator..... Burrigge Jennings	1126
3730. New Techniques for Electronic Miniaturization..... Robert L. Henry, Robert K-F Scal, and Gustave Shapiro	1139
3731. Interference Caused by More than One Signal..... Raymond M. Wilmotte	1145
3732. The p -Germanium Transistor..... W. G. Pfann and J. H. Scaff	1151
3733. Asymmetrically Driven Antennas and the Sleeve Dipole..... Ronold King	1154
3734. Application of Correlation Analysis to the Detection of Periodic Signals in Noise..... Y. W. Lee, T. P. Cheatham, Jr., and J. B. Wiesner	1165
3735. The Traveling-Wave Cathode-Ray Tube..... K. Owaki, S. Terahata, T. Hada, and T. Nakamura	1172
3549. Correction to: "Speed of Electronic Switching Circuits" by E. M. Williams, D. F. Aldrich, and J. B. Woodford	1180
3736. Conductivity Measurements at Microwave Frequencies..... A. C. Beck and R. W. Dawson	1181
3737. Cascade-Connected Attenuators..... R. W. Beatty	1190
3738. The Design of Frequency-Compensating Matching Sections..... V. H. Rumsey	1191
3739. Signal-to-Noise Improvement Through Integration in a Storage Tube..... J. V. Harrington and T. F. Rogers	1197
3740. Distortion—Band-pass Considerations in Angular Modulation..... Albert A. Gerlach	1203
3741. Pulse Transients in Exponential Transmission Lines..... Edward R. Schatz and Everard M. Williams	1208
3455. Discussion on "On the Energy-Spectrum of an Almost Periodic Succession of Pulses" by G. G. Macfarlane..... T. S. George and G. G. Macfarlane	1212
3742. Measurement of the Electrical Characteristics of Quartz Crystal Units by Use of a Bridged-Tee Network..... Charles H. Rothauge and Ferdinand Hamburger, Jr.	1213
3562. Correction to: "The Transmission and Reception of Elliptically Polarized Waves" by George Sinclair	1216
Contributors to PROCEEDINGS OF THE I.R.E.....	1217
Correspondence:	
3743. "Propagation of UHF and SHF Waves Beyond the Horizon"..... Kenneth Bullington	1221
3744. "Suggestions to Technical Writers"..... Benjamin Miessner	1222
3745. "The Transistor as a Reversible Amplifier"..... W. G. Pfann	1222

INSTITUTE NEWS AND RADIO NOTES SECTION

Technical Committee and Professional Group Notes.....	1223
I.R.E. People.....	1225
Industrial Engineering Notes.....	1227
Books:	
3746. "The World's Radio Tubes, 1950 International Edition"..... Reviewed by George D. O'Neill	1228
3747. "Traveling-Wave Tubes" by J. R. Pierce..... Reviewed by Andrew Haeff	1229
3748. "Advances in Electronics, Vol. II," Edited by L. Marton..... Reviewed by E. W. Herold	1229
3749. "Radio and Television Mathematics" by Bernhard Fischer..... Reviewed by W. L. Behrend	1230
3750. "Television for Radiomen" by Edward M. Noll..... Reviewed by Ralph R. Batchler	1230
Institute Committees—1950.....	1231
Institute Representatives in Colleges—1950.....	1233
3751. Abstracts and References.....	1235
3752. Books: "Applications of the Electronic Valve in Radio Receivers and Amplifiers"..... Reviewed by W. C. White	1248
Section Meetings..... 38A	News—New Products..... 46A
Student Branch Meetings..... 38A	Positions Open..... 50A
Membership..... 40A	Positions Wanted..... 56A
Advertising Index.....	95A

EDITORIAL DEPARTMENT

Alfred N. Goldsmith
Editor

E. K. Gannett
Technical Editor

Mary L. Potter
Assistant Editor

ADVERTISING DEPARTMENT

William C. Copp
Advertising Manager

Lillian Petranek
Assistant Advertising Manager

BOARD OF EDITORS

Alfred N. Goldsmith
Chairman

PAPERS REVIEW COMMITTEE

George F. Metcalf
Chairman

Responsibility for the contents of papers published in the PROCEEDINGS OF THE I.R.E. rests upon the authors. Statements made in papers are not binding on the Institute or its members.



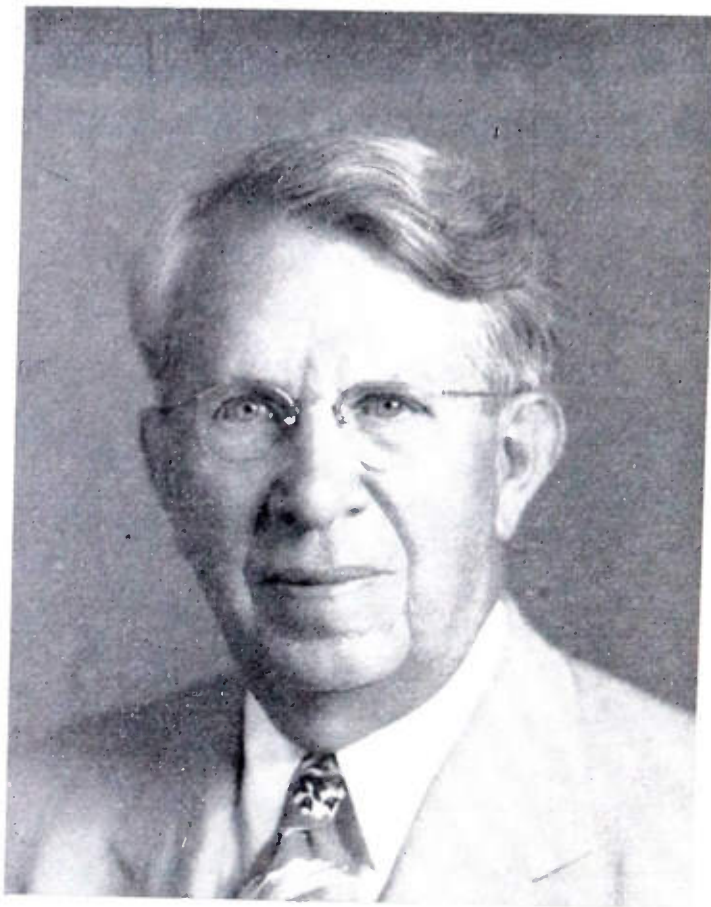

Hermann E. Kranz

REGIONAL DIRECTOR, 1950-1951

Hermann E. Kranz, Regional Director of the East Central Region, was graduated with the Bachelor of Arts degree and a summa cum laude in mathematics from Lawrence College in 1909. He entered the college of engineering at the University of Wisconsin later, where he received the B.S. degree in electrical engineering in 1914 and professional degree of electrical engineer in 1917.

He served as instructor in electrical engineering at the University of Wisconsin from 1914 to 1917. After nine years of work on manufacturing development and methods, six of which were spent at the Hawthorne Plant of the Western Electric Company, he joined the Grigsby Grunow Company as chief engineer in 1926. Under his technical guidance in 5 years this company grew from one with a daily production of a few hundred "B" battery eliminators and approximately three hundred employees to one manufacturing five thousand console radio receivers with fifteen thousand employees. He supervised facilities for the manufacture of all components which included gang condensers, rf coils, paper capacitors, tube sockets, audio and power transformers, and dynamic speakers, as well as setting up of a complete cabinet plant and a vacuum-tube plant with a capacity of seventy thousand tubes per day. In 1928 he was made plant vice-president in charge of engineering.

For nine years he served as a consultant in the radio, electronic, and automotive electrical fields. During World War II he was operations manager of the Radar Division of Research Enterprises Ltd. (a Canadian Government company) at Leaside, Ontario. One of the pioneers in the development of industrial electronic equipment, in 1933 he invented an electronic method of measuring the thickness of metallic sheet where contact could be made on one side only. He is at present the Director of the Industrial Technical Institute at Detroit.

Mr. Kranz joined The Institute of Radio Engineers as a Member in 1923 and became a Senior Member in 1947. He was one of the organizers of the Chicago Section in 1925, serving as Secretary-Treasurer from 1926 to 1928 and as Chairman, 1929-1930. He is also a past chairman of the Detroit Section, a member of its executive committee, and served for three years as a representative on the Affiliate Council of the Engineering Society of Detroit.

He is a member of the AIEE, the American Society for Engineering Education, the Radio Engineers' Club of Chicago, and the Engineering Society of Detroit. He is also a member of the Regional (III) Committee for Technical Institutes of the Engineers' Council for Professional Development.

The importance of radio communication as an agency for world-wide understanding and solidarity has been amply recognized in at least two highly diverse fashions. In the less attractive aspect, the value and influence of radio broadcasting is attested by extraordinary and large-scale efforts to interfere with broadcasts crossing the boundaries of attempted self-contained States. In the more pleasant aspect, radio is acclaimed by men of good will as a potent means for beneficial and enlightening contacts between men of all nations and modes of thought.

The following guest editorial admirably analyzes the more prepossessing facts of this situation. It has been written by a Fellow, Past Vice-President, and former Director of The Institute of Radio Engineers, who is the Director of Radio Research in the Department of Scientific and Industrial Research of the Government of Great Britain.—*The Editor.*

International Aspects of Radio

R. L. SMITH-ROSE

The present state of modern civilization makes it quite clear that the time has long since passed when any country, state, or town could lead its own self-contained life without taking full cognizance of the activities of all its neighbors. In little more than half a century, the development of radio has reached the point at which anyone in any part of the world can be made aware of, and kept informed on, the activities of all his contemporaries distributed over the earth's surface. The radio amateur shares with the philatelist a hobby which enhances his knowledge of the world's geography and the languages and customs of other countries.

But participation in the many facets of radio science and practice can and does have a much wider influence on those engaged in it than that of merely acquiring and distributing information. It is not too much to say that the professional radio engineer and scientist has unique opportunities to know and understand his fellow human beings in other countries, and the problems which confront them in the common struggle towards a better life within our modern civilization. The installation and operation of a radio transmitter may have a very profound effect in some remote corner of the world; and the designer and operator is therefore at once forced to consider the international aspects of his action.

The demand for the unrestricted use of portions of the radio-frequency spectrum by multifarious interests made it necessary many years ago to set up an international organization to decide and control the allocation of frequencies. This has, in turn, meant that all national administrations and operating organizations have had to consider not only their own requirements, but also to try to understand the needs of others in far-off lands. While much of the discussion of the technical merits of such requirements can take place by the exchange of documents, a vital part of the whole setup consists in the arrangement of international conferences, at which the various protagonists of a case or policy meet in the flesh their contemporaries from other countries. At such meetings it is natural to find that there are many informal occasions on which the discussions and exchange of ideas are not limited to radio, or even to scientific and technical matters. International conferences provide unique opportunities for each national delegate to get to know and understand his colleagues in other countries, to become acquainted with their national habits and with the political, economic, or other problems with which they are faced. It is in this way that, of all the sciences and professions, radio plays a unique part in promoting a better understanding between peoples and nations; such understanding can do so much to avoid a common misinterpretation of the word "foreigner" and to create a spirit of unity which is today so necessary for the benefit of the world at large.

The Role of Professional Groups in the IRE*

L. C. VAN ATTA†, SENIOR MEMBER, IRE

Unfailing signs of the youthfulness and potentialities of any man or institution are open-mindedness toward change and flexibility of procedure. Judged from these criteria, The Institute of Radio Engineers is truly a young society, and one with its greatest accomplishments still before it.

It has become ever clearer that the membership of the Institute, now 30,000 in number, has many and diverse interests. To serve *all* of its membership adequately therefore became a matter of major importance, and one presenting certain organizational, publication, and financial problems.

To meet present and future needs, broad statesmanship has accordingly been brought to bear by the IRE Board of Directors. In orderly fashion, and without detriment to past activities or disruption of useful processes, the Institute has been expanded from a single society to what might be regarded as a close federation of a number of societies. All of these "federalized" societies work under the aegis and with the collaboration of the parent society, acting as a broad guide and helper.

This basic change is well described in the following paper by a former Chairman of one of the IRE Professional Groups and is strongly commended to the careful attention of the membership. It points out the ways in which the Institute can serve its membership with continuously increasing effectiveness and satisfaction. It also solicits vigorous co-operation between the membership and the new IRE Professional Groups.—*The Editor.*

HISTORICAL BACKGROUND

WHEN THE IRE was formed in 1912 by the union of two local societies, radio engineers were provided with an international forum for the exchange of ideas and information. At that time engineers were broadly interested in one another's activities to a greater extent than is possible today.

In the course of the enormous growth of the radio field a great deal of specialization and divergence of interest has been inevitable. In addition to the original application of radio techniques to communication, we now have applications to navigation, radar, induction heating, and automatic computing and control. Radio techniques are combined with other techniques in such fields as acoustics, infrared, and nucleonics. Components have undergone intensive development and the operating frequency range has been greatly extended.

The Institute of Radio Engineers has grown up with the radio field to a present membership approaching 30,000. On purely quantitative grounds, any complete exchange among so many engineers is impossible. It is likewise difficult for any single engineer to encompass mentally, let alone contribute actively to the entire radio field.

Under these conditions it is natural for engineers to form, in addition, smaller, more compact groups on the basis of professional interest. This is illustrated in one field by the formation of the Acoustical Society of America some time ago, and of the Audio Engineering Society more recently. These societies attempt to meet the needs of their limited membership by specialized action.

Along with the professional advantages, which the smaller society plans to offer the individual, are attendant difficulties. The expense of the administrative staff must be carried by a smaller membership. The smaller subscription to the technical journal increases the cost per copy of publication and decreases the value of advertising space.

In general, projects assume larger proportions when undertaken by the smaller society.

These difficulties were encountered in the field of physics, where a differentiation into smaller societies occurred. The attempted solution to the problem which was worked out in this case is represented by the American Institute of Physics. It provides a number of related professional societies with a common headquarters staff and a common publications organization.

The Institute of Radio Engineers is now attempting a broadly analogous solution in the field of radio, but without the painful intermediate stage of entirely separate societies. The Professional Groups within the IRE are intended to provide for specialized professional needs without losing the economy of size in meeting overhead expenses. In addition, there is the desire to preserve that important over-all unity of interest appropriate to the field of communications and electronics.

The Professional Group principle of operation was adopted by the IRE Board of Directors in March, 1948. Since then all the necessary implementing steps have been taken, as follows:

- (1) Appropriate amendments to the By-laws of the Institute have been adopted
- (2) A permanent Professional Groups Committee has been established
- (3) A model constitution and bylaws have been prepared as general guidance to individual Groups; and finally
- (4) A detailed Professional Group Manual, revised in May, 1950, has been published for the guidance of Group promoters.

The IRE has followed the wise course of limiting itself to stimulation and guidance of the Professional Group development. It has established general policy and procedure, but has left the formation and activities of individual Groups to the initiative of interested IRE members.

Up to date there have been nine Professional Groups established with the following fields of interest and memberships:

Field of Interest	Approximate Membership
Antennas and Propagation	813
Audio	1,051

Broadcast Television Receivers	849
Broadcast Transmission Systems	514
Circuit Theory	1,227
Instrumentation	1,300
Nuclear Science	456
Quality Control	234
Vehicular and Railroad Radio Communications	246

It should be emphasized that these figures represent current and incomplete returns. These Groups have not been uniformly active, nor are their problems identical. It is not expected that they will follow altogether similar courses of development. Several additional Groups are in various stages of formation.

In carrying out their objectives the Groups have engaged in such activities as the following:

- Sponsored independent national symposia
- Sponsored sessions at the RMA/IRE Radio Fall meeting in Syracuse
- Sponsored symposia at the 1950 IRE National Convention
- Formed units co-operatively with IRE Sections
- Issued periodic Newsletters
- Undertaken the reorganization and recommendation of certain papers for publication in the PROCEEDINGS
- Arranged for the consideration and recommendation of tutorial papers for the PROCEEDINGS OF THE I.R.E.

The Groups are by no means limited to these activities.

With this background we may inquire regarding the relation of the Professional Groups to the IRE, to the individual, to the local Section, to the IRE Technical Committees, and to other societies. In considering these relations we shall obtain a clearer picture of the role of the Professional Groups.

RELATION TO THE IRE

The Professional Group is a subdivision of the membership of the IRE based on professional interests and needs, and established under a Professional Group constitution. The constitution defines the technical

* Decimal classification: R060. Original manuscript received by the Institute, June 24, 1950. Presented, IRE/URSI Antennas and Propagation Symposium, San Diego, Calif., April 3-5, 1950.

† Hughes Aircraft Company, Culver City, Calif.

field of interest of the Group, establishes an administrative committee and such supporting committees as are deemed necessary, prescribes broadly the functions and procedures, and fixes a minimum level of activity.

The Administrative Committee of the Professional Group reports periodically to the Professional Groups Committee of the IRE and depends upon it for general guidance as to policy and procedure. The Group requests of the IRE financial assistance as required, and turns over net receipts to the Institute. The Group depends upon the Headquarters Staff for maintaining mailing lists, for printing and distributing material as requested to the Group membership, for co-operative papers procurement, and for printing notices in the PROCEEDINGS. The PROCEEDINGS is the only outlet of the Group for technical publications and has the responsibility of providing adequate space for suitable publications in the field of interest of the Group, within the financial limitations of the IRE.

The Group provides the IRE with the means for decentralized control in the planning of national symposia in its field and in the arrangement of specialized sessions at Conventions. It provides the IRE with a national framework for the co-ordination of sectional activities in its field. With a view to the special needs of the field, the Group represents viewpoints or pleads cases with the IRE and proposes actions.

RELATION TO THE INDIVIDUAL

Of more immediate concern to the individual is the relation of the Professional Group to him. In many respects the Group serves the individual as the satisfactory equivalent of a small, select society in his own field of specialization. This is made possible by the freedom granted to the Administrative Committee in planning and conducting the activities of the Group. Thus the individual has all the advantages of membership in a large general society as well as a specialized smaller society.

The principal activity is now the arrangement of specialized symposia. These symposia may be made to coincide with IRE Conventions to reduce travel requirements and increase attendance. Or they may avoid the Conventions in order to achieve a greater concentration of papers and specialists and a more appropriate atmosphere. However, the keynote must be an intimate appreciation of the subject matter and of the needs of the individual member. Thus meetings may be conducted at a more leisurely pace, or a subject of current importance may be intensively explored.

In connection with its symposia, the Group may seek out papers covering interesting work and may later recommend publication in the PROCEEDINGS to the author and to the Editor. The Group may survey past issues of the PROCEEDINGS to determine whether its field has been properly represented in IRE publications. (The Groups have been asked to do this by the Editorial Department.) The possibility of the Group assuming formal responsibilities for the procurement and review of papers in its field for publication in the PROCEEDINGS has not yet been fully explored, but already close liaison

exists between the Groups and the Board of Editors, the Papers Review Committee, and the Editorial Administrative Committee. The Groups are urged to request, and will receive, adequate representation on each of these bodies.

The Group maintains a list of active members and distributes notices of national or sectional meetings in its field. These notices may be expanded to include a variety of current events of special interest. The Group may compile and distribute technical or personnel information. And, in general, it may serve as a source of information in response to specific inquiries from its members.

The general membership of the Group is simply a mailing list for announcements. The individual member remains merely an item on this mailing list, except as he changes this through participation in Group activities. After all, these activities are the work of individuals and depend upon their contributions. One type of responsibility of the Group member is to attend technical meetings, to participate in the discussion, and when possible, to present a paper. A second type of responsibility is for planning Group policy and activities through correspondence with, or membership on, appropriate technical committees. In many cases this committee service would start in the local units associated with IRE Sections.

A member who has recognized a real or fancied inadequacy in the IRE peculiar to a particular field now has a natural spokesman. The appropriate Professional Group can consider the extent of the inadequacy and defend recommendations for correction in the proper quarters in the IRE. As an example, it has been pointed out recently that the IRE has not a single Fellow in the field of Acoustics! An active Professional Group in this field in the past might have prevented this situation. It can now be readily corrected.

RELATION TO THE SECTION

We must explore the relation of the Professional Group to the IRE Sections to find its source of continuing strength. The Section respects a division of IRE activities on a geographical basis. The Professional Group is national or international in scope, but divides the field of electronics on the basis of technical subject matter.

The Sections should be informed in the near future of the status of the Professional Group movement and should be asked to indicate the extent of their interest in particular Groups. Each Group should carry on correspondence with interested Sections with a view to establishing professional units in these Sections. A less active professional unit might require only a representative on the Section Program Committee. A more active unit might require a local Planning Committee and a delegate to the Administrative Committee of the Group. The Groups should invite such delegates to attend the meetings of its Administrative Committee. These delegates would supply new ideas for expanding the activities of the Group. They would constitute an important source of new members for the Administrative Committee.

The Group publicizes through its mailing list those technical meetings in its field arranged by the Sections. It might act as a

clearing house for the scheduling of such meetings, to avoid interference with each other and with national meetings. It might assist local meetings by suggesting session topics or by locating speakers.

RELATION TO THE TECHNICAL COMMITTEE

The relation of the Professional Group to the IRE Technical Committee has been questioned with the thought that there may be overlap of function. However, this is not the case.

The Technical Committees have prescribed for them an exacting and important but very definite task: the standardization of definitions of terms and the initiation of techniques and methods of measurement. The work can be anticipated for years in advance, and must be repeated periodically to keep the standards up-to-date. In this task the Technical Committees are, as they must be, closely co-ordinated by the Standards Committee. The emphasis is on scholarship rather than initiative.

The Professional Group, on the other hand, has a very broad charter and a task only vaguely defined; in effect, to determine the professional needs in the field of the Group and to carry out or promote actions designed to meet those needs. The Group will stand or fall, depending on the imagination with which it approaches its problems and the energy with which it champions its causes. Its sphere of activity will probably increase as its possible functions are better understood by all concerned.

RELATION TO OTHER SOCIETIES

The possibility of relations between the Professional Group and other societies is established by the Group Constitution which allows for co-operative meetings with other technical organizations. These co-operative meetings have proven very successful because of the additional support of joint sponsorship. It should be recognized that the alternative would frequently be two interfering meetings.

The San Diego Symposium on Antennas and Propagation is a good example of co-operative effort. The sessions of April 3 and 4, 1950, were arranged by the Professional Group on Antennas and Propagation, were co-sponsored by Commissions 2, 3, and 6 of the USA National Committee, URSI, and were supported locally by the San Diego Section. The Armed Services arranged a technical Military Conference of four sessions on the same subject for April 6 and 7. Finally, the United States Navy Electronics Laboratory provided space and facilities for all the sessions. Actually, co-operative effort may make the difference between success and failure in a meeting of this kind.

In future meetings, we can visualize co-operation of a Professional Group with other Groups, with IRE Sections or Regions, with RMA and URSI, with the Armed Services, with units of the Research and Development Board, and with other similar groups. This co-operation in technical meetings is practicable in spite of the varied ultimate interests of the several organizations. For example, the Professional Group is concerned with providing a technical outlet for its members and proper material for the Pro-

The Role of Professional Groups in the IRE*

L. C. VAN ATTA†, SENIOR MEMBER, IRE

Unfailing signs of the youthfulness and potentialities of any man or institution are open-mindedness toward change and flexibility of procedure. Judged from these criteria, The Institute of Radio Engineers is truly a young society, and one with its greatest accomplishments still before it.

It has become ever clearer that the membership of the Institute, now 30,000 in number, has many and diverse interests. To serve *all* of its membership adequately therefore became a matter of major importance, and one presenting certain organizational, publication, and financial problems.

To meet present and future needs, broad statesmanship has accordingly been brought to bear by the IRE Board of Directors. In orderly fashion, and without detriment to past activities or disruption of useful processes, the Institute has been expanded from a single society to what might be regarded as a close federation of a number of societies. All of these "federalized" societies work under the aegis and with the collaboration of the parent society, acting as a broad guide and helper.

This basic change is well described in the following paper by a former Chairman of one of the IRE Professional Groups and is strongly commended to the careful attention of the membership. It points out the ways in which the Institute can serve its membership with continuously increasing effectiveness and satisfaction. It also solicits vigorous co-operation between the membership and the new IRE Professional Groups.—*The Editor.*

HISTORICAL BACKGROUND

WHEN THE IRE was formed in 1912 by the union of two local societies, radio engineers were provided with an international forum for the exchange of ideas and information. At that time engineers were broadly interested in one another's activities to a greater extent than is possible today.

In the course of the enormous growth of the radio field a great deal of specialization and divergence of interest has been inevitable. In addition to the original application of radio techniques to communication, we now have applications to navigation, radar, induction heating, and automatic computing and control. Radio techniques are combined with other techniques in such fields as acoustics, infrared, and nucleonics. Components have undergone intensive development and the operating frequency range has been greatly extended.

The Institute of Radio Engineers has grown up with the radio field to a present membership approaching 30,000. On purely quantitative grounds, any complete exchange among so many engineers is impossible. It is likewise difficult for any single engineer to encompass mentally, let alone contribute actively to the entire radio field.

Under these conditions it is natural for engineers to form, in addition, smaller, more compact groups on the basis of professional interest. This is illustrated in one field by the formation of the Acoustical Society of America some time ago, and of the Audio Engineering Society more recently. These societies attempt to meet the needs of their limited membership by specialized action.

Along with the professional advantages, which the smaller society plans to offer the individual, are attendant difficulties. The expense of the administrative staff must be carried by a smaller membership. The smaller subscription to the technical journal increases the cost per copy of publication and decreases the value of advertising space.

In general, projects assume larger proportions when undertaken by the smaller society.

These difficulties were encountered in the field of physics, where a differentiation into smaller societies occurred. The attempted solution to the problem which was worked out in this case is represented by the American Institute of Physics. It provides a number of related professional societies with a common headquarters staff and a common publications organization.

The Institute of Radio Engineers is now attempting a broadly analogous solution in the field of radio, but without the painful intermediate stage of entirely separate societies. The Professional Groups within the IRE are intended to provide for specialized professional needs without losing the economy of size in meeting overhead expenses. In addition, there is the desire to preserve that important over-all unity of interest appropriate to the field of communications and electronics.

The Professional Group principle of operation was adopted by the IRE Board of Directors in March, 1948. Since then all the necessary implementing steps have been taken, as follows:

- (1) Appropriate amendments to the By-laws of the Institute have been adopted
- (2) A permanent Professional Groups Committee has been established
- (3) A model constitution and bylaws have been prepared as general guidance to individual Groups; and finally
- (4) A detailed Professional Group Manual, revised in May, 1950, has been published for the guidance of Group promoters.

The IRE has followed the wise course of limiting itself to stimulation and guidance of the Professional Group development. It has established general policy and procedure, but has left the formation and activities of individual Groups to the initiative of interested IRE members.

Up to date there have been nine Professional Groups established with the following fields of interest and memberships:

Field of Interest	Approximate Membership
Antennas and Propagation	813
Audio	1,051

Broadcast Television Receivers	849
Broadcast Transmission Systems	514
Circuit Theory	1,227
Instrumentation	1,300
Nuclear Science	456
Quality Control	234
Vehicular and Railroad Radio Communications	246

It should be emphasized that these figures represent current and incomplete returns. These Groups have not been uniformly active, nor are their problems identical. It is not expected that they will follow altogether similar courses of development. Several additional Groups are in various stages of formation.

In carrying out their objectives the Groups have engaged in such activities as the following:

- Sponsored independent national symposia
- Sponsored sessions at the RMA/IRE Radio Fall meeting in Syracuse
- Sponsored symposia at the 1950 IRE National Convention
- Formed units co-operatively with IRE Sections
- Issued periodic Newsletters
- Undertaken the reorganization and recommendation of certain papers for publication in the PROCEEDINGS
- Arranged for the consideration and recommendation of tutorial papers for the PROCEEDINGS OF THE I.R.E.

The Groups are by no means limited to these activities.

With this background we may inquire regarding the relation of the Professional Groups to the IRE, to the individual, to the local Section, to the IRE Technical Committees, and to other societies. In considering these relations we shall obtain a clearer picture of the role of the Professional Groups.

RELATION TO THE IRE

The Professional Group is a subdivision of the membership of the IRE based on professional interests and needs, and established under a Professional Group constitution. The constitution defines the technical

* Decimal classification: R060. Original manuscript received by the Institute, June 24, 1950. Presented, IRE/URSI Antennas and Propagation Symposium, San Diego, Calif., April 3-5, 1950.

† Hughes Aircraft Company, Culver City, Calif.

field of interest of the Group, establishes an administrative committee and such supporting committees as are deemed necessary, prescribes broadly the functions and procedures, and fixes a minimum level of activity.

The Administrative Committee of the Professional Group reports periodically to the Professional Groups Committee of the IRE and depends upon it for general guidance as to policy and procedure. The Group requests of the IRE financial assistance as required, and turns over net receipts to the Institute. The Group depends upon the Headquarters Staff for maintaining mailing lists, for printing and distributing material as requested to the Group membership, for co-operative papers procurement, and for printing notices in the PROCEEDINGS. The PROCEEDINGS is the only outlet of the Group for technical publications and has the responsibility of providing adequate space for suitable publications in the field of interest of the Group, within the financial limitations of the IRE.

The Group provides the IRE with the means for decentralized control in the planning of national symposia in its field and in the arrangement of specialized sessions at Conventions. It provides the IRE with a national framework for the co-ordination of sectional activities in its field. With a view to the special needs of the field, the Group represents viewpoints or pleads cases with the IRE and proposes actions.

RELATION TO THE INDIVIDUAL

Of more immediate concern to the individual is the relation of the Professional Group to him. In many respects the Group serves the individual as the satisfactory equivalent of a small, select society in his own field of specialization. This is made possible by the freedom granted to the Administrative Committee in planning and conducting the activities of the Group. Thus the individual has all the advantages of membership in a large general society as well as a specialized smaller society.

The principal activity is now the arrangement of specialized symposia. These symposia may be made to coincide with IRE Conventions to reduce travel requirements and increase attendance. Or they may avoid the Conventions in order to achieve a greater concentration of papers and specialists and a more appropriate atmosphere. However, the keynote must be an intimate appreciation of the subject matter and of the needs of the individual member. Thus meetings may be conducted at a more leisurely pace, or a subject of current importance may be intensively explored.

In connection with its symposia, the Group may seek out papers covering interesting work and may later recommend publication in the PROCEEDINGS to the author and to the Editor. The Group may survey past issues of the PROCEEDINGS to determine whether its field has been properly represented in IRE publications. (The Groups have been asked to do this by the Editorial Department.) The possibility of the Group assuming formal responsibilities for the procurement and review of papers in its field for publication in the PROCEEDINGS has not yet been fully explored, but already close liaison

exists between the Groups and the Board of Editors, the Papers Review Committee, and the Editorial Administrative Committee. The Groups are urged to request, and will receive, adequate representation on each of these bodies.

The Group maintains a list of active members and distributes notices of national or sectional meetings in its field. These notices may be expanded to include a variety of current events of special interest. The Group may compile and distribute technical or personnel information. And, in general, it may serve as a source of information in response to specific inquiries from its members.

The general membership of the Group is simply a mailing list for announcements. The individual member remains merely an item on this mailing list, except as he changes this through participation in Group activities. After all, these activities are the work of individuals and depend upon their contributions. One type of responsibility of the Group member is to attend technical meetings, to participate in the discussion, and when possible, to present a paper. A second type of responsibility is for planning Group policy and activities through correspondence with, or membership on, appropriate technical committees. In many cases this committee service would start in the local units associated with IRE Sections.

A member who has recognized a real or fancied inadequacy in the IRE peculiar to a particular field now has a natural spokesman. The appropriate Professional Group can consider the extent of the inadequacy and defend recommendations for correction in the proper quarters in the IRE. As an example, it has been pointed out recently that the IRE has not a single Fellow in the field of Acoustics! An active Professional Group in this field in the past might have prevented this situation. It can now be readily corrected.

RELATION TO THE SECTION

We must explore the relation of the Professional Group to the IRE Sections to find its source of continuing strength. The Section respects a division of IRE activities on a geographical basis. The Professional Group is national or international in scope, but divides the field of electronics on the basis of technical subject matter.

The Sections should be informed in the near future of the status of the Professional Group movement and should be asked to indicate the extent of their interest in particular Groups. Each Group should carry on correspondence with interested Sections with a view to establishing professional units in these Sections. A less active professional unit might require only a representative on the Section Program Committee. A more active unit might require a local Planning Committee and a delegate to the Administrative Committee of the Group. The Groups should invite such delegates to attend the meetings of its Administrative Committee. These delegates would supply new ideas for expanding the activities of the Group. They would constitute an important source of new members for the Administrative Committee.

The Group publicizes through its mailing list those technical meetings in its field arranged by the Sections. It might act as a

clearing house for the scheduling of such meetings, to avoid interference with each other and with national meetings. It might assist local meetings by suggesting session topics or by locating speakers.

RELATION TO THE TECHNICAL COMMITTEE

The relation of the Professional Group to the IRE Technical Committee has been questioned with the thought that there may be overlap of function. However, this is not the case.

The Technical Committees have prescribed for them an exacting and important but very definite task: the standardization of definitions of terms and the initiation of techniques and methods of measurement. The work can be anticipated for years in advance, and must be repeated periodically to keep the standards up-to-date. In this task the Technical Committees are, as they must be, closely co-ordinated by the Standards Committee. The emphasis is on scholarship rather than initiative.

The Professional Group, on the other hand, has a very broad charter and a task only vaguely defined; in effect, to determine the professional needs in the field of the Group and to carry out or promote actions designed to meet those needs. The Group will stand or fall, depending on the imagination with which it approaches its problems and the energy with which it champions its causes. Its sphere of activity will probably increase as its possible functions are better understood by all concerned.

RELATION TO OTHER SOCIETIES

The possibility of relations between the Professional Group and other societies is established by the Group Constitution which allows for co-operative meetings with other technical organizations. These co-operative meetings have proven very successful because of the additional support of joint sponsorship. It should be recognized that the alternative would frequently be two interfering meetings.

The San Diego Symposium on Antennas and Propagation is a good example of co-operative effort. The sessions of April 3 and 4, 1950, were arranged by the Professional Group on Antennas and Propagation, were co-sponsored by Commissions 2, 3, and 6 of the USA National Committee, URSI, and were supported locally by the San Diego Section. The Armed Services arranged a technical Military Conference of four sessions on the same subject for April 6 and 7. Finally, the United States Navy Electronics Laboratory provided space and facilities for all the sessions. Actually, co-operative effort may make the difference between success and failure in a meeting of this kind.

In future meetings, we can visualize co-operation of a Professional Group with other Groups, with IRE Sections or Regions, with RMA and URSI, with the Armed Services, with units of the Research and Development Board, and with other similar groups. This co-operation in technical meetings is practicable in spite of the varied ultimate interests of the several organizations. For example, the Professional Group is concerned with providing a technical outlet for its members and proper material for the Pro-

CEEDINGS. By contrast, the URSI is concerned with the selection of material in this country for presentation at its international General Assembly. By further contrast, the Armed Services and the RDB are interested in stimulating any exchange of information which will result in more and better military equipment.

PROCEDURES

The common concern of those interested in taking any initiative in the Professional Group movement is necessarily with procedures: procedures for promoting a Group, for forming a professional unit in a Section, for joining an existing Group, for conducting a symposium, and for furthering the publication of papers in the PROCEEDINGS. Considerable effort has been made by the Professional Groups Committee to define procedures in the Manual. There has been some guidance from experience, but it is very easy in this work to get into new territory and to find oneself without ground rules.

The steps recommended for one who is interested in promoting a Professional Group are:

(1) Write to the Technical Secretary of the Institute for general information, stating the field of interest of the contemplated Group.

(2) Locate 5 to 15 others interested in promoting the Group.

(3) Prepare a petition and obtain at least 25 signatures.

(4) Forward the petition to the Chairman of the Professional Groups Committee through the Technical Secretary at the Institute Headquarters.

(5) After approval of the petition by the IRE Board of Directors, forward suggested names for the initial Administrative Committee through the same channel.

(6) After notification of appointment of the Administrative Committee, call a meet-

ing of the Committee. At this meeting elect a Chairman, prepare a Constitution and By-laws, and name officers and supporting committees.

(7) Submit the Constitution to the IRE Professional Groups Committee for approval. Report the other actions to the Technical Secretary for his information. With the approval of the Constitution, the Professional Group is in formal existence.

Procedures for forming a professional unit in a Section have not been so precisely defined. The first step would be to communicate with the Chairman of the corresponding Group, whose name could be obtained from the Technical Secretary of the Institute. The next step would be for the Section Program Committee to name one or more Group members to take care of local activities in the field of the Group. Finally, if invited to do so by the Group, the Section could name a delegate to the Group Administrative Committee meetings. In any case, active liaison should be maintained with the Chairman of the Administrative Committee.

When an IRE member of Associate grade or higher wishes to join an existing group, he writes the Group Chairman or the Technical Secretary of the Institute to this effect. He will be informed automatically that his name has been added to the membership list, unless the Group Constitution establishes special qualifications for membership.

For conducting a symposium, the Manual provides guidance that would take care of the most elaborate meeting. However, for an average symposium, reasonable requirements would be: (1) A Steering Committee consisting of representatives of the sponsoring organizations; (2) a symposium chairman; (3) a technical program committee which might consist of session chairmen responsible to the symposium chairman; (4) officers for finance, program publication, and

local arrangements responsible to the symposium chairman; and (5) officers for selecting and recommending papers for publication in the PROCEEDINGS.

This is enough to indicate that procedures have been defined or can be invented to take care of recognized Professional Group activities.

CONCLUSION

In conclusion, specialized professional needs within the IRE have been recognized and the Professional Group principle has been adopted to meet these needs. The Group movement is well launched and gives early promise in some areas. Progress has been made toward defining the relations of the Professional Groups to the IRE, to the individual, to the Section, to the Technical Committee, and to other societies. Detailed procedures have been established for many of the Professional Group activities.

I have dwelt at some length on each of these subjects and may have created the impression that the success of a Professional Group is guaranteed by its charter. If so, let me hasten to add some reservations. The success of a Professional Group depends upon several factors: the proper choice of field of interest, a cohesive feeling among the members of the Group, Administrative Committee members and Section representatives willing to give freely of their time and thought, and a consistently sympathetic reaction in higher IRE circles to the recommendations of the Group.

Much remains to be done in initiating and activating Groups. Their proper functions must be further explored. All this may be expected to require several years of persistent effort. I venture to predict that by the time the Professional Group principle has been fully implemented, there will have been major changes in the IRE practices, particularly with regard to meetings and some aspects and procedures of publications.

Electronics and the Electrostatic Generator*

BURRIDGE JENNINGS†

Summary—The role of the electrostatic generator as a particle accelerator in the field of nuclear physics is that of a precision instrument. It is capable of producing scientific data with high voltage accuracy and is, within its limited voltage range, an almost ideal tool for this type of research. The design of the generator, its advantages, limitations, and the auxiliary equipment necessary to make it a tool for nuclear research are discussed. Emphasis has been placed on the function of electronics in this field both in the control and measurement circuits, and in the general problem of the electrostatic generator.

INTRODUCTION

THE ELECTROSTATIC generator is one of the tools used in the experimental study of nuclear physics. It is

a source of high energy particles, like the cyclotron, betatron, and synchrotron, but differs from these machines in that it directly generates the total potential instead of accelerating the ions many times by the same small voltage increment. This machine, although limited in maximum obtainable voltage and ion current, is, within its range the best generator for precision nuclear physics. For this reason it is very important to understand its present design and extend its present limitations.

Electronics in the narrow sense, involving electronic vacuum tubes of fixed characteristics and circuits composed of resistors, condensers, inductances, and resonance circuits, has as yet little use in the electrostatic generator. This type of electronics is used in control and measurement problems, but these are usually minor and the circuits are

simple. If "electronics" is defined in a broader sense as the study of the interaction of electric and magnetic fields with electrons and ions, the electrostatic generator is just one big electronics problem. This paper will be largely concerned with present day solutions to this problem.

NUCLEAR PHYSICS

The most general problem of nuclear physics today is to understand how the heavier elements or isotopes are formed from the so-called elementary particles such as the neutron, proton, meson, neutrino, and perhaps others. It is probable that these elementary particles exist within any nucleus—at least it is possible to extract most of them by various types of natural or artificial radioactive disintegrations or transmutations. It would also seem reasonable that a knowledge

* Decimal classification: 537.23. Original manuscript received by the Institute, June 2, 1950.

† Westinghouse Electric Corporation, Research Laboratories, East Pittsburgh, Pa.

of the interaction forces—such as the magnitude, sign, and range of the forces between various elementary particles, and a knowledge of the laws of interaction of these various forces in a nucleus should aid greatly in giving an answer to this general problem.

As none of the elementary particles or the individual nuclei formed of them are directly visible, we must study them by their physical effects using various types of instruments such as Geiger counters, scintillation counters, Wilson cloud chambers, and the like, and deduce what basic phenomena we can from these effects. These experiments are, philosophically, very similar to optical processes in which one illuminates an object to be studied with a beam of light and examines the color and intensity of the light reflected from or refracted by this object and deduces its properties from these data. In the case of nuclear studies, the object, or target, may be examined by "illuminating" it with various types of beams, of protons, neutrons, deuterons or gamma radiation, etc., and investigating the results with some indicating or detecting system. In general, two things are found to occur. Particles in the original beam may be scattered from the target material without change in type but only a change in direction and energy; or, if the energy relations permit, there may be a transmutation resulting in the production of a different emergent particle with perhaps violently different energy.

The experiments resulting in simple scattering are of great importance when both the beam and target are composed only of elementary particles, since range and magnitude of the forces between these particles may sometimes be deduced from the angular distribution of the scattered beam. This type of experiment is especially important in the case where protons are scattered from protons, thereby yielding the proton-proton forces, and where neutrons are scattered from protons giving information about the forces that act between the neutron and proton. Neutron-neutron scattering experiments would be of great interest but so far are experimentally impossible.

If we use as target material some element or isotope formed of many elementary particles, scattering of the impinging beam may occur in the same way, but in addition many other processes may take place. When the beam particle strikes the target it may be scattered by the target material or, if it has enough energy, it may enter one of the nuclei and cause a reaction resulting in the emission of a particle of another type and with a very different energy. Nuclear physicists think of such a reaction as the formation by the target nucleus and beam particle of a compound nucleus of an element which has too much energy to be stable, and breaks up later with the emission of a nuclear particle and perhaps a gamma ray. This compound nucleus represents only a very short-lived step in the reaction, but nevertheless it has been found possible to find energy levels or resonance levels in this nucleus. It is possible, in analogy with the energy levels or spectral lines found in atomic studies, that the spacing and intensity of these resonance levels may provide some clue to the structure of this nucleus.

The general experimental conditions

which are necessary for studies of this type are: a beam of particles, either protons, deuterons, neutrons or perhaps electrons, small and well collimated, and traveling in a well-defined direction. The velocity or voltage of this beam must be accurately known, very constant and sufficient to excite the desired reaction. The beam must contain enough particles to allow the results of the reaction to be measured by the presently developed radiation or particle detection systems. A target element, preferably of high isotropic purity, is also necessary, either thick or thin as the experiment dictates, and counters or a Wilson cloud chamber to measure the results of the reaction. It is important that the beam is not contaminated with spurious particles formed in the generator. Unwanted disintegrations may also be caused if a portion of the beam impinges on other materials than the desired target.

The electrostatic generator developed by Van de Graaff¹ and others²⁻⁵ fortunately fulfills many of these requirements. The voltage by which the ion beam is accelerated appears as a true dc potential in the machine, so the velocity or energy of the ions striking the target is known with the same accuracy as this dc voltage. The spread in the beam voltage or the inhomogeneity of the beam energy is dependent on the stability of the generator voltage and very little else. The adjustment of the beam voltage over a very wide range can be very simply accomplished. The ion beam in such a generator, originating in an ion source inside the high voltage electrode, travels in the form of a focused beam until it strikes the target material, so that the background of radioactive disintegrations produced by high velocity particles striking other elements than those in the target is very low.

These conditions are not obtained in the cyclotron, linear accelerator, or other type of instrument in which the ion is accelerated many times by a small repetitive voltage. A cyclotron, although at present able to produce a voltage many times higher than an electrostatic generator and with much higher ion current, can, in general, produce only an ion beam of a single voltage dictated by its magnetic field and rf frequency. Reduction in the particle energy is usually made by inserting foil absorbers in the beam which causes a further increase in the beam voltage spread which may be excessive already because of the manner of acceleration. Only a part of the cyclotron ion current strikes the desired target; the remainder impinges on the interior of the cyclotron vacuum chamber. For this reason the cyclotron is itself a prolific source of neutrons and gamma rays of all energies, coming from all directions so that shielding is difficult. The

difficulty of doing precision experiments with a cyclotron increases rapidly when one attempts to greatly reduce the error of measurement.

The electrostatic generator in its present form is limited both in ion beam current and maximum operating voltage. The actual top operating range of existing generators is about 4 Mev, although a generator has attained 5 Mev, while accelerating electrons, and there are two generators now in the design stage whose designers have set 10 to 12 Mev as a goal. Many of the present generators in this country, built in the early days of generator design, have fallen short of their expectations by a factor of two or more. The reasons for this are not well known, although it is certainly true that the laws of voltage breakdown as experimentally determined in the region of a few hundred kilovolts cannot be extrapolated reliably to very high total voltages. Some progress has been made in reducing the size of electrostatic generators by using concentric electrode design and electro-negative gases such as sulfur-hexafluoride or freon instead of air.

THE ELECTROSTATIC GENERATOR

The total ion accelerating voltage in an electrostatic generator appears between an insulated electrode and ground. A belt composed of an insulating substance such as rubber or cotton is used as a conveyor to carry charge up to the electrode. Charges are placed on this belt at the ground end by a corona process and are carried up to the electrode against the repelling potential of the already charged electrode by the power of the motors driving the belt. The belt charging equipment consists of a row of sharp points, such as ordinary pins placed very close to the surface of belt, and charged to 20 or 30 kv by some type of transformer-rectifier set. Corona, formed at these sharp points, sprays charge on the rapidly moving belt just in front of them. Since the belt is an insulator, the charge cannot move freely. A set of needles of the same type removes the charge in the electrode, where it flows to the outside surface as the electrode acts as a Faraday cage. The voltage attained by the electrode is determined by the balance between the current carried up the belts and that lost by all processes to ground. A typical electrostatic generator of present design is shown in Fig. 1. The electrode is supported by a number of insulating columns of porcelain or plastic suitably protected by a potential dividing system. The electrostatic belt and ion acceleration tube are placed in the same neighborhood as the support members so that they can be protected by the same system. The belt driving motor, belt pulley, and corona spray units are at the bottom end of this column; the upper belt pulley, ion source, ion source power supply, and upper spray equipment are in the electrode.

The entire apparatus is contained in a pressure vessel capable of withstanding the desired air pressure. The high pressure air serves simply as an insulator to prevent electrical breakdown between the high voltage electrode and ground. The shell of the pressure tank as shown in Fig. 1 can be unbolted from the ground plate and lifted up for servicing.

¹ J. G. Van de Graaff, K. T. Compton, and L. C. Van Alta. "The electrostatic production of high voltage for nuclear investigations," *Phys. Rev.*, vol. 43, p. 149; February, 1933.

² R. G. Herb, D. B. Parkinson, and D. W. Kerst. "The development and performance of an electrostatic generator operating under high air pressure," *Phys. Rev.*, vol. 51, p. 75; January, 1937.

³ M. A. Tuve, L. R. Hafstad, and O. Dahl. "High voltage technique for nuclear physics studies," *Phys. Rev.*, vol. 48, p. 315; August, 1935.

⁴ W. H. Wells, R. O. Haxby, W. E. Stephens, and W. E. Shoupp. "Design and preliminary performance tests of the Westinghouse electrostatic generator," *Phys. Rev.*, vol. 58, p. 162; July, 1940.

⁵ For other references, see "Particle Accelerators," Brookhaven National Laboratories, BNL-L-101, pp. 17-26.

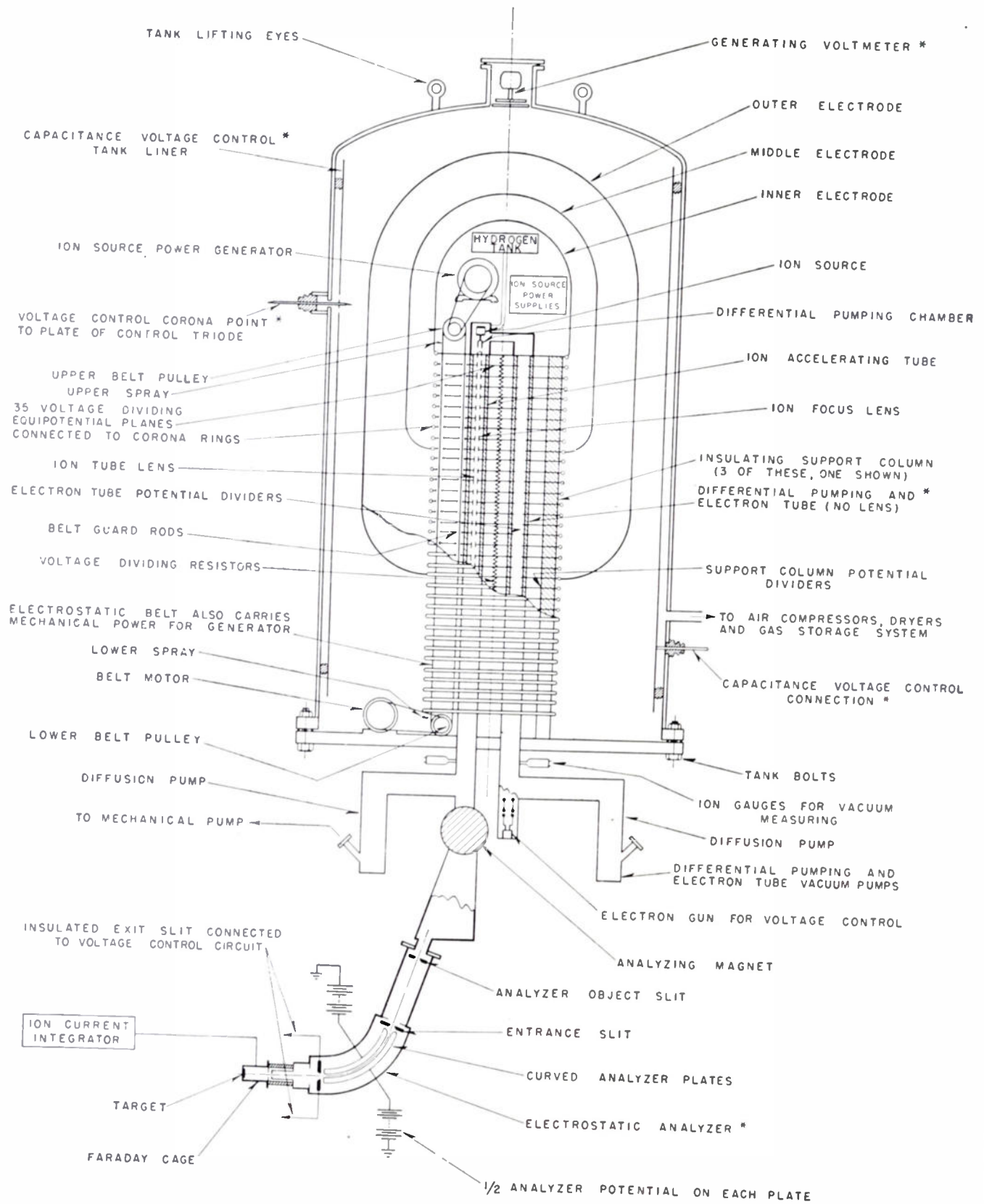

Fig. 1—Schematic of an electrostatic generator.

VOLTAGE DIVIDING SYSTEM

The design of an electrostatic generator to produce the greatest peak operating voltage in a given tank size is largely a series of compromises. The high voltage electrode size is a compromise between the space required inside for the ion source and power supplies and the best estimate of the maximum allowable field intensity of the electrode surface. This field intensity may be the maximum allowed anywhere in the generator because the gas under pressure is the best insulator. The field intensity down the support columns, belts, and accelerating tube must be reduced to the lowest possible value, because the breakdown of the insulating material in this direction is not improved by gas pressure. This field intensity is minimized by making the distance between the electrode and ground along the support columns four to six times that across the air gap and by forcing the voltage distribution to be linear in this direction. This is accomplished by constructing the support insulators and ion tube of many short insulating sections about 3 to 5 inches long, with a metal conductor between each section. Such a section in the acceleration tube is shown in Fig. 2. The ion tube and insulated support members therefore consist of a series of insulated sections and equally spaced metallic conductors which are electrically connected in each plane to form an approximation of a conducting sheet completely across the support column region. The edges of each of these planes are protected by a hoop or ring of tubing around the outside to reduce the voltage gradients at this point, and the belt runs are protected in a similar manner. Each of these metallic planes across the support column region is forced by means of a resistor or corona voltage divider to take such a potential as to make the voltage roughly linear between the electrode and ground

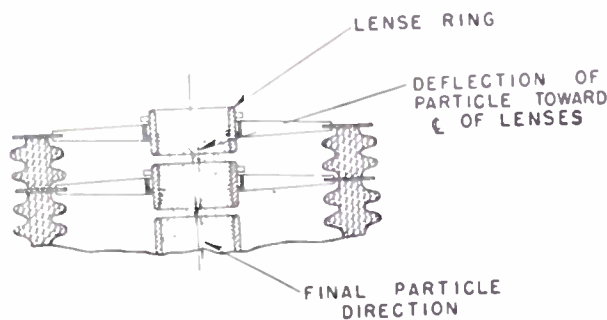

Fig. 2—Section of a vacuum tube showing electrostatic lenses.

It is very important, however, to choose the spacings between electrode and ground through the air path and down the support column such that electrical breakdown will occur first across the air path. A flashover down the support column is very likely to rip the charging belt or do other serious damage which must be absolutely avoided.

The ions are accelerated within the ion acceleration tube by a series of cylindrical electrodes, each connected to an equipotential plane of the voltage dividing system, and are focused by the lens properties of this type of electrode. Originally, simple cylindrical lens of type shown in Fig. 2 were used but these have been supplanted by the re-

entrant design shown in Fig. 3. This change was introduced to eliminate the effect on the beam of high fields which might result from the collection of charged particles on the inside insulating surfaces of the ion tube. The re-entrant lens system shields the ion beam from such fields. This type of tube design is particularly desirable for the lenses near the high voltage electrode where the ion beam is travelling with a low velocity. The efficiency of focus lenses after the initial acceleration of the beam is questionable. Focus lenses are sometimes left out, thereby increasing the ion tube pumping speed.

Recent generator design has also made use of the principle of dividing the potential between electrode and ground (see Fig. 1) by adding concentric electrodes around the main one and connecting them to the potential divider at such a voltage as to get an advantageous field distribution around the electrode. This has many advantages, but installing and supporting these shields and servicing the inside electrode and its equipment is a difficult problem. However, such a

design plus the use of various electronegative gases allow voltages of the order of 3 to 5 million to be obtained in a comparatively small pressure tank.

In the more elementary generators where the insulation was simply air at atmospheric pressure, immense machines were required to give over one million volts potential. The next step in design was to enclose a large machine in a pressure vessel and increase the operating pressure to several atmospheres. Large machines were designed in this era of development, notably those at the Westinghouse Research Laboratories and at the Department of Terrestrial Magnetism in Washington, D. C.

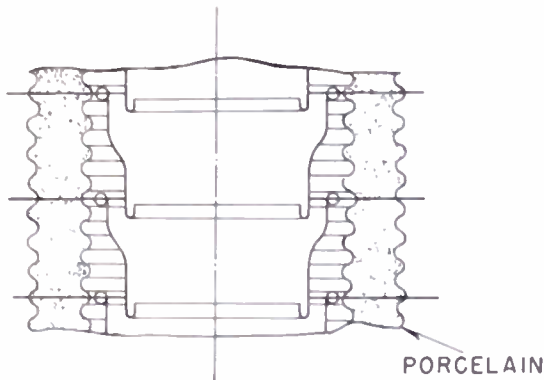

Fig. 3—Re-entrant tube design.

The use of air as an insulating gas is dictated largely by its availability. It must be dried because water vapor increases the leakage current to ground. Most electrostatic generators have large air driers of activated alumina or silica jell to reduce the humidity of the air before it is put in the tank. It has been found that the use of such electronegative gases such as Freon or sulfurhexafluoride, either pure or mixed with air, will increase the breakdown voltage by as much as a factor of 2 for a given pressure.

We encounter here the most important electronics problem of the electrostatic generator because the voltage limitation is its most serious fault. The electrical breakdown of gas under high pressure is not well understood, and its study is made more difficult because the results of small-scale experiments using low voltages and short spacings cannot be extrapolated with any accuracy to high voltages at large spacings. Although the breakdown mechanism is sufficiently well understood so that predictions can be made under ideal conditions, these conditions do not prevail in a practical design; consequently, the voltage breakdown of a generator may fall far short of that predicted from small scale measurements.

It is interesting to note, at this point, that the operating voltage of an electrostatic generator may be governed by some time dependent phenomena as the generator must operate for a very long time. It is known that impulse generators, magnetrons, and other electronic devices can operate at far higher voltages if the voltage is in the form of a very short pulse. An impulse generator can produce pulses of 5 or 6 million volts with an insulation design which would hold less than a million volts if operated as a dc generator.

Perhaps the most interesting and hopeful approach toward increasing the voltage of an electrostatic generator is in the possible use of high vacuum as insulation. Studies⁶ are now under way to better understand the breakdown in an evacuated ion acceleration tube, but one eye is being kept on this work to see if it is applicable to vacuum insulation of the entire machine. At the present time vacuum cannot compete as an insulation with high pressure insulation in an electrostatic generator. However, relatively low

⁶ J. G. Trump and R. J. Van de Graaff, "The insulation of high voltages in vacuum," *Jour. Appl. Phys.*, vol. 18, p. 327; March, 1947.

voltage studies over short spacings have indicated the possibility of holding very high voltage gradients. As the spacing is increased, the limiting gradients go down, until vacuum insulation in any reasonably designed generator would not be as good as high pressure and its use is attended by very difficult and unsolved engineering problems. However, as the process of vacuum breakdown is very poorly understood, it is possible that the ability to stand high gradients may not be a function of the spacing but rather of the vacuum, surfaces, etc., which may be under our control when a better understanding is attained.

ION SOURCES

Another electronic problem in electrostatic generators is the production of the charged particles or ion beams suitable for accelerating by the generator. Two polarities of particles can be used: electrons, and those with a positive charge, or protons, deuterons, tritium ions and helium ions. Although not in such wide use in the nuclear field, electron accelerators are used as generators of penetrating high energy X rays. In general the techniques for producing electron beams are well worked out, and the gun-type cathode emitters such as are employed in cathode-ray tubes and electron diffraction equipment are used.

Positive ion sources are much more difficult to design, build, and use. The positive ions are formed from the gas, say hydrogen, by electron bombardment in some type of discharge tube. Of the several types of ion sources in use the most common and simplest type is that of the filament supported arc shown in Fig. 4. The filament, generally of the oxide-coated type, emits electrons which are accelerated by a potential of about 50 volts between it and an anode. These electrons collide with hydrogen gas molecules in their path and ionize the atoms in these molecules to form a proton, and, of course, a free electron. The original electron, having lost much of its energy, is again accelerated by the field and may repeat the process before it has lost one of the electrodes. The electron from the ionized atom does the same thing, so the process could easily become a chain reaction of the type found in conventional discharge and be independent of the electrons from the filament. However, because it is desirable to keep the hydrogen pressure low for other reasons, the arc is usually not operated in the self-sustaining region.

The ions formed in the glow discharge in the arc chamber are extracted from the arc by a probe. This electrode is operated at a potential of 300 to 5,000 volts negative with respect to the arc chamber, and its field, penetrating into the arc chamber a short distance through the small arc chamber hole, pulls out a small number of the ions from the discharge. Those ions which happen to go into the small probe hole are accelerated by the probe potential and come out into the acceleration tube in a fairly well collimated but still divergent beam. This diverging beam must be made to converge to a focus on the distant target at the ground end of the generator by a cylindrical "focus" lens, located a few inches below the probe exist, and supplied by an adjustable source of 10 to 20 kv.

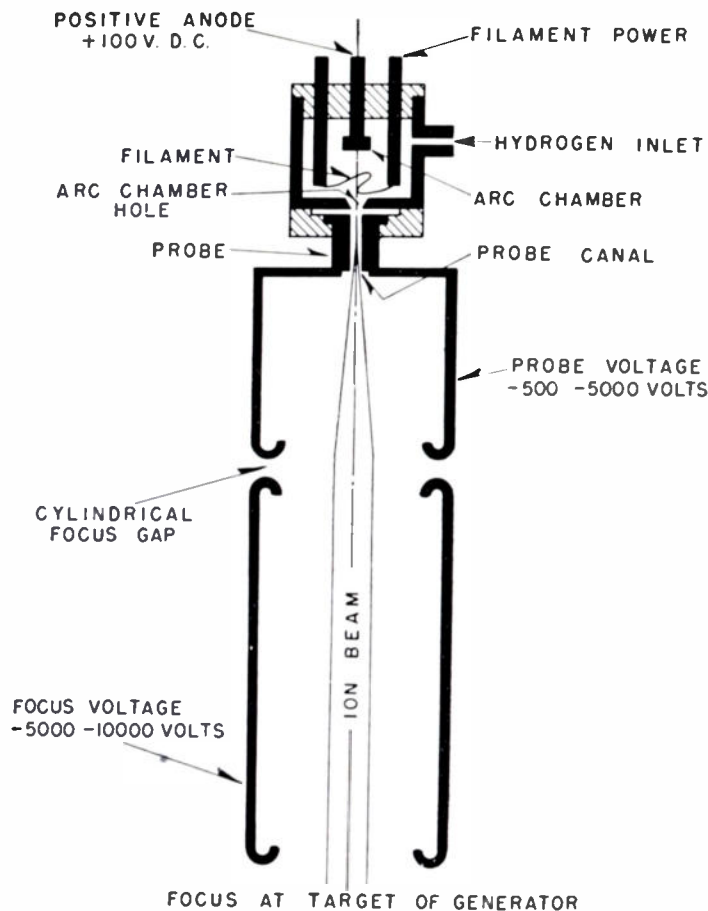

Fig. 4. Simple filament supported ion source.

More advanced designs have attempted to eliminate some of the defects in this type of ion source. The use of any filament in a hydrogen atmosphere at these low pressures is very difficult and the life of the filament may be short. Attempts to eliminate the filament have led to the use of the rf excited arc in the ion source. The arc discharge produces several types of ions; unfortunately molecular ions of the types HH^+ and HHH^+ are produced in larger quantities than protons. These ions are accelerated by the generator potential to the same total energy as the proton, but this energy is divided between either two or three particles so the effective energy in a nuclear reaction is only one-half or one-third of the proton energy. They are of little use in nuclear physics and design attempts are made to reduce their numbers. The production of these unwanted ions has been found to occur, at least partially, at the walls and metal electrodes in the arc chamber by a recombination of protons with atoms and molecules on the walls. It has been found empirically that glass or quartz walls inhibit the formation of the heavier ions.

Another closely related trouble encountered with this simple ion source is that of ion velocity distribution. For precision nuclear work it is important that the velocity distribution of the particles in the ion beam be much less than the desired error of the experiment. For example, at 2 Mev a voltage accuracy of 0.1 per cent is $\pm 2,000$ volts. The arc potential in the ion source is less than 100 volts, so the possible voltage distribu-

tion of the ions coming from the arc chamber could not be greater than this value. Consider the case when the probe potential is high—say 10 kv. The probe canal is small and a region of high gas pressure; an ideal condition for the various charged particles to change their mass numbers. Protons going unchanged through the probe system from the arc chamber will possess the 10 kv of energy from the probe potential when they enter the ion acceleration tube. A mass 2 hydrogen molecular ion will also be accelerated by the probe gap to 10 kv, but if it should suffer a collision and break up in the probe canal into an atom and a proton, the 10-kv energy gained would be divided between the particles so that the resulting proton would have only one-half the energy of a proton passing unchanged through the probe canal. Other and more complicated processes may occur, resulting in a possible spread in the energy of the ions from the ion source and consequently at the target. This can be avoided in several ways; the probe voltage can be kept lower than the desired energy spread in the beam, or the high pressure region in the probe canal can be eliminated by ion source design.

The arc discharge of this simple type of ion source is, because of the low pressure, a very thin glow which occupies all available volume in the arc chamber, and is probably independent of the position of the filament and anode. At these pressures the mean-free path of the electrons from the filament is so long that those which produce the most protons are the ones which take the longest

path. This tends to make the density of the discharge very low. An attempt to concentrate this discharge by restricting the area through which it can travel is made in the Zinn-type⁷ ion source, Fig. 5. The discharge between the filament and the anode is restricted by an anode shield, which is at the same potential as the filament. This shield forces the discharge into a small volume in a region near the arc chamber outlet so that more ions can be extracted by the probe. This type of ion source has been fairly satisfactory but it requires a large gas flow and high arc current to keep it operating. The engineering problems resulting from the heat developed by this large arc current make the source difficult to use in a pressure-type generator.

Another type of ion source whose arc chamber design is based on the same principles as the Zinn source is that developed at the Massachusetts Institute of Technology by W. W. Buechner, E. S. Lamar, and R. J. Van de Graaff.⁸

One of the many modifications of this type of ion source is shown in Fig. 6. The arc chamber design is an extension of the Zinn source in that the arc formed between the filament and anode must travel through a small restricted capillary instead of a cylindrical slit. The arc discharge will therefore be much more concentrated at the arc chamber exit hole. In the design shown in Fig. 6, however, no true probe has been used and the ions are allowed to drift out of the discharge chamber by themselves into a differentially pumped low pressure region. This eliminates the high pressure region in the probe canal with its particle mass-number change and the resulting wider spread in ion velocities from the ion source. The ions,

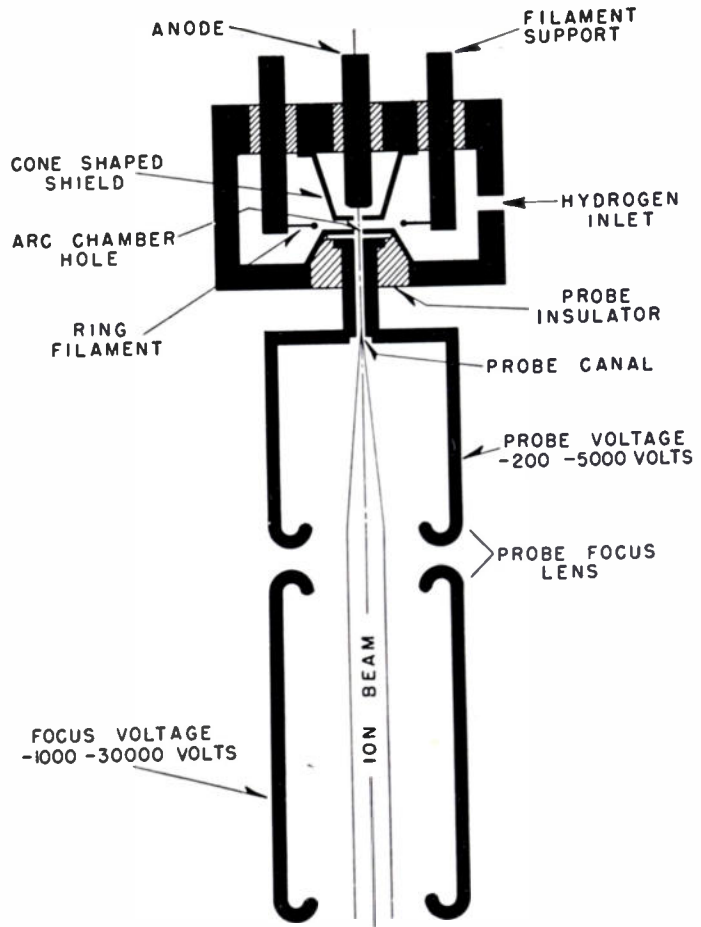

Fig. 5—A Zinn-type ion source.

drifting out of the arc chamber in a very divergent cone, are focused by the field of the first and second cylindrical focusing lenses through the exit hole into the main accelerating tube. The exit hole is small enough

to restrict gas flow into the main tube so the differential pumping system may remove most of the uncharged gas molecules which leak out of the discharge chamber. This has been modified in several ways, one

⁷ W. H. Zinn, "Low voltage positive ion source," *Phys. Rev.*, vol. 52, p. 655; September, 1937.
⁸ W. W. Buechner, E. S. Lamar, and R. J. Van de Graaff, "Production of proton beams," *Jour. Appl. Phys.*, vol. 12, p. 141; February, 1941.

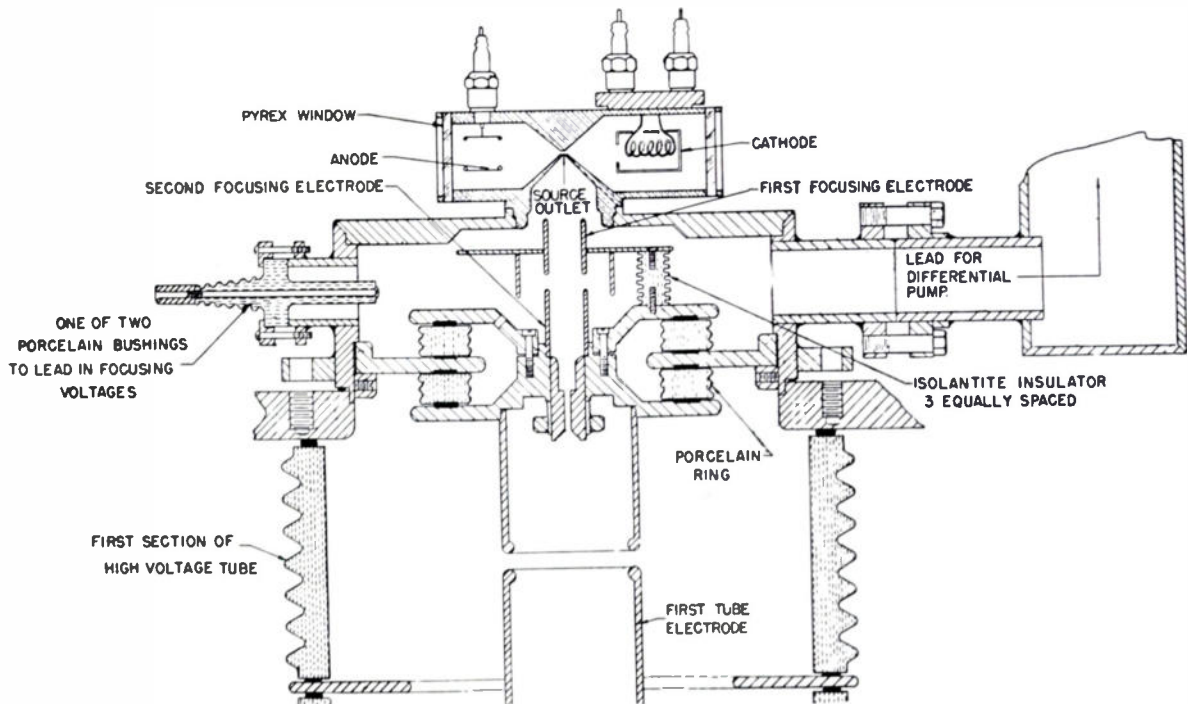

Fig. 6—A capillary-type ion source.

of which is to use a glass capillary for the discharge chamber. The percentage of protons over particles of other masses can be increased in this manner, although at the cost of some serious engineering difficulties in both the construction and use of the ion source. One modification of this source is to be used in the new MIT 12-million volt electrostatic generator.

RADIO-FREQUENCY ION SOURCES

Ion production by an electrodeless discharge⁹ is interesting for two reasons. It eliminates the filament (see Fig. 7) and its attendant troubles, short life and difficulty in replacement. Such an electrodeless discharge can be operated readily in a glass or quartz discharge chamber which inhibits the recombination of protons to heavier molecular ions at the walls. The rf ion source described here was designed by R. N. Hall at the California Institute of Technology, and is powered by a 60-watt 400-Mc oscillator. The arc chamber is a small pyrex cylinder which is part of a tuned rf cavity of the coaxial type. An adjustable shorting plunger in this cavity tunes it to the frequency of the oscillator. An axial magnetic field supplied by an external magnet coil effectively lengthens the paths of the electrons oscillating in the arc discharge chamber under the influence of the rf field by making the electrons take spiral paths. This effectively lowers the gas pressure at which the ion source will operate. The ions are allowed to drift out of the discharge chamber, and are focused by a probe potential in a manner similar to that used in the MIT capillary ion source. The ion source shown in Fig. 7 is a test source only, and requires further engineering before it could be used in a pressure generator.

ION SOURCES CONCLUSION

The advantages of the various types of ion sources previously described are all in the direction of larger proton currents with less gas flow into the main accelerating tube. The development of the differential pumping system is by far the most outstanding improvement in the last few years.

Many ion sources have one characteristic in common—they operate amazingly well on an ion source test bench with a short accelerating tube and very poorly when installed in an electrostatic generator with a long acceleration tube. Numerous papers have been published on test bench performances of ion sources but very few have discussed the application of the same ion source to an electrostatic generator. It would seem self-evident that if a beam starts out in the direction of a distant target and is well focused, it should all get to the target. This does not appear to be borne out in practice. The proton current from most generators is very low (of the order of one μa) while the ion sources have been reported to give 20 to 1,000 μa . One empirical fact has been noticed; generators with short acceleration tubes like the "short tank" generator at Los Alamos can produce very sizeable ion beams of the order of 50 μa or more. The very long

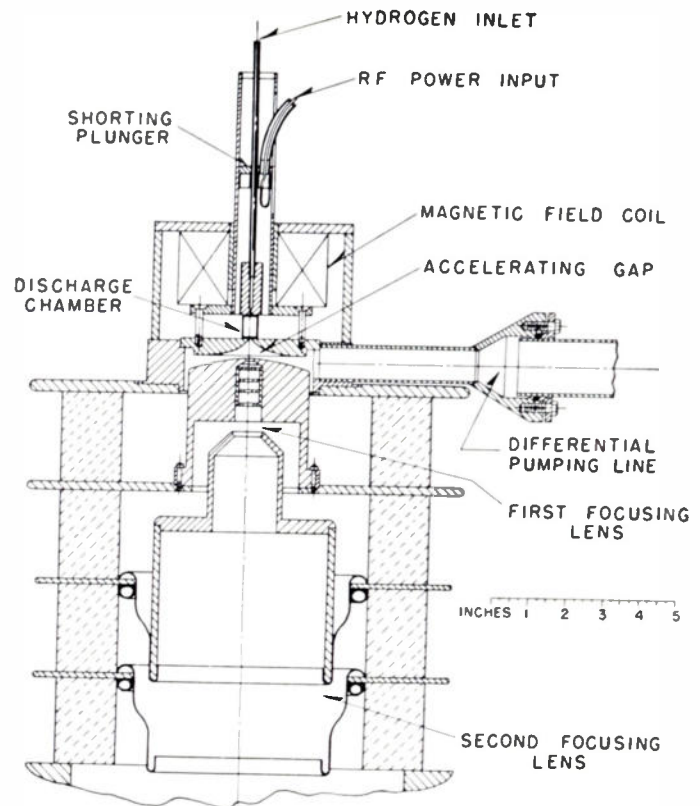

Fig. 7—Rf ion source.

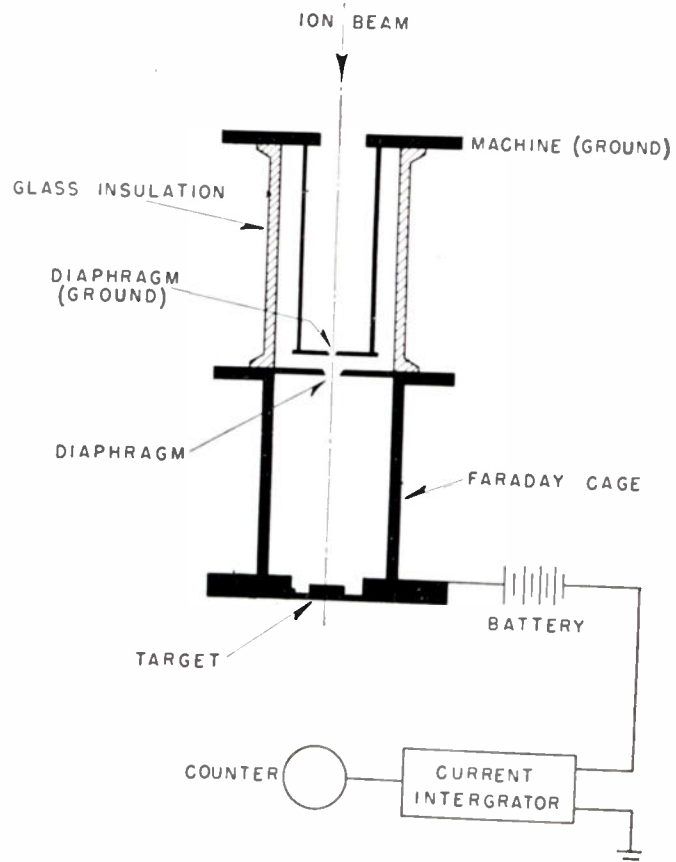

Fig. 8—A beam current collection and measurement.

⁹ Robert N. Hall, "High frequency proton source," *Rev. Sci. Instr.*, vol. 19, p. 905; December, 1948.

tube machines like the generators at the Westinghouse Research Laboratories and the Carnegie Institute of Terrestrial Magnetism operate generally at levels of $1 \mu\text{a}$. The ion current carried by the tube seems to be limited by the tube length, but it is not easy to understand why. The fact that a longer tube has a slow pumping speed and hence less favorable vacuum conditions does not completely explain this phenomena. Further work should be done on this part of the design problem.

ION CURRENT MEASUREMENT

The ion beam originating in the ion source is accelerated through the vacuum tube by the potential developed in the generator. The beam, consisting of protons, and atomic and molecular ions must be analyzed into its various mass components so that only a homogeneous proton beam is retained. This is done by a magnetic field so that ions with the least momentum are bent through the greatest angle and sent into the target chamber. One further problem remains in this field, and that is to measure the ion current striking the target.

It is desirable in most nuclear experiments to know the total number of ions striking the target during a length of time as long as many hundreds of seconds. For this reason an electronic current integration circuit is desirable, instead of a microammeter or galvanometer. The current integrator is usually nothing more than a condenser, charged by the beam current. As current flows into the condenser, the voltage across it rises until at some predetermined fixed voltage the condenser is discharged, and the cycle starts over again. A simple gas triode can be used to discharge the condenser or, in some of the later type circuits, it is done with a multivibrator system. It is only necessary to count the number of times the condenser is charged during the operating interval to know how much current has struck the target. This is done simply by counting the condenser discharges with some type of an electronic circuit like a scaler.

The proton current from the generator is usually collected in an enclosed Faraday cage, shown in Fig. 8. A Faraday cage is a totally enclosed hollow conductor, so that all charges appearing on the inside run to the outside surface. It is not a bad approximation of a true Faraday cage to have a hole small compared to its dimensions through which the focused ion beam may enter. The charges carried by the ion beam, therefore, flow to the surface where they can be removed by a wire connected to the current integrating circuit. A second and very important reason for the use of such a cage is that the ions produce many secondary electrons when they strike a target. If these electrons could get out of the cage, their charge would be measured by the current integrating equipment as if it were from protons coming in. As there may be many electrons produced per single proton, large errors can be made in this way. It has been found, in fact, that even a fairly long Faraday cage is not enough to eliminate this error, so a small electric field is established between the cage and ground to push the electrons back into the cage where they were formed. A potential of about 300 volts is

usually enough for most applications, but where high precision is necessary an additional magnetic field across the cage can be used to deflect the electrons into the walls of the chamber.

GENERATOR VOLTAGE MEASUREMENT

It has been shown that the measurement of the voltage at which some nuclear process, such as a threshold or resonance level, occurs is of greatest importance. In practice, such a measurement is made by counting the number of particles resulting from the target bombardment for a considerable period of time at one voltage and repeating this for many other voltages to obtain a curve of yield versus energy. This experimental procedure places two requirements on the design of the voltage measuring and control equipment. It must be able to hold the generator operating voltage to the required value for long periods of time and permit this voltage to be easily and quickly changed. For these reasons voltage stabilizing feedback circuits are used, with the voltage measuring equipment as the source of error signal for some type of voltage control mechanism.

This routine voltage measuring equipment is only used for *relative* voltage measurements, comparing the voltage of the nuclear process in question with some secondary standard and assuming linearity of the measuring equipment.

The equipment used for the *absolute* voltage measurement of these secondary standards will be described first. The calibrated electrostatic analyzer and the radio-frequency ion velocity gauge are in this class. The uncalibrated electrostatic analyzer and the generating voltmeter are used for *relative* voltage measurement and error signal sources for stability control. Finally, the methods of generator voltage control from these error signals will be described.

ABSOLUTE VOLTAGE MEASUREMENTS

No method has as yet been devised for directly measuring electrical potentials of the order of millions of volts with an accuracy of better than about 10 per cent. We have, however, simple instruments which are capable of making *relative* measurements of such high potentials to a much better accuracy so that the practice has been to select a few secondary voltage standards and interpolate voltages from these. Such a secondary voltage standard must be easy to set up in any laboratory having an electrostatic generator and be easily reproducible. Nuclear physicists have turned to well-known nuclear processes for such a standard, and the most important one used today is the threshold of the production of neutrons when lithium is bombarded with protons which occurs at $1.882 \pm (0.002)$ Mev. This reaction is very sharp, experimentally easy to do, and can be used in any laboratory for voltage calibration. There are several other voltage standards, such as the $\text{Al}(p, \gamma)$ resonance at 0.9933 Mev, and the $\text{F}(p, \gamma)$ resonance at 0.8735 Mev, but these are not as widely used. At present the only absolute voltage measurements that have been made were on these secondary standards. All nuclear physics measurements are made relative to one or the other of these calibrated points. The only methods of absolute volt-

age calibration available at present are based on the properties of the ion beam after it has been accelerated by the generator potential. Two methods have been applied to the measurement of the $\text{Li}(p, n)$ threshold: that by deflection of the ion beam in an electrostatic field and by measurement of the velocity of the beam after acceleration by radio-frequency means.

It is interesting to point out that although electrostatic generators throughout the country which are used to accelerate protons have an accurate voltage scale, the electron generators do not. So far there is no direct correlation between the voltage scales used by the two types of generators, except a remote one through various nuclear processes of questionable accuracy. This correlation between the two scales is very important and merits further investigation.

The ion beam, being made up of charged particles with a well-known e/m ratio, can be deflected by electric or magnetic fields or both. If the field strengths are accurately known, the radius of curvature of the path of the ions of any given velocity or voltage may be calculated. Slit systems can be used to establish any desired radius of curvature so that the ion beam voltage can be determined if the field strength is known. At present the production of magnetic fields, constant and known over a large area, to better than 0.1 per cent is so difficult that this method has not been used. However, many of the necessary techniques have been developed by the designers of cyclotron magnets so that magnetic analyzers may soon take their place in the precision voltage measurement field. Electrostatic analyzers, however, have been used with high accuracy. The electric and magnetic analyzers have a great advantage in that by using slit systems they can select only ions of a certain voltage having a known voltage distribution.

A particle of charge e and mass m has an energy E and a velocity v after being accelerated by a potential V given by the equation:

$$E = 1/2mv^2 = eV. \quad (1)$$

In precise calculations a correction term must be added to this equation for the relativistic change in mass with velocity, but we may neglect it in this simple description of an electrostatic analyzer. If a small parallel beam of particles of energy E is passed between two plates, Fig. 9, of length L and separation d and at a potential difference v , it will be deflected an amount S . The field ϵ between the plates will be:

$$\epsilon = \frac{v}{d}. \quad (2)$$

And the force on the particles in the beam due to this field:

$$f = \frac{ev}{d} = ma, \quad (3)$$

where a is the acceleration. It will be accelerated for a time t given by:

$$t = \frac{L}{v}. \quad (4)$$

The deflection S at the end of the analyzer plates due to this acceleration will be:

$$S = 1/2at^2 = \frac{1}{4} \frac{e}{d} \frac{L^2 v}{E}.$$

The deflection S is proportional to the inverse of the energy of the particle and by placing a slit of width ΔS in the correct position only particles of an energy distribution ΔE can come through and fall on the target.

It is difficult with a parallel plate analyzer to get sufficient energy resolution to make the instrument practical because the space d must be large enough to allow for the curvature of the beam. The field, Fig. 10, between plates curved to form a section of a cylinder of radius R_1 and R_2 will bend a beam of ions of constant energy in a circle of radius R between R_1 and R_2 . Much higher resolution may be obtained from this type of an analyzer because of the greater deflection angle. The radius of the ion beam may be established by a slit system at each end of the analyzer plates and the analyzer voltage adjusted to allow ions of a certain energy to go through.

This type of electrostatic analyzer,^{10,11} was used by Herb, Snowdon, and Sala in the precision voltage measurement of the nuclear reactions generally used as secondary voltage standards. The plates of the analyzer are about 1.5 meters long and separated by about 1 cm. These plates were very carefully made the variations in plate separation are not over 0.0005 inch.

The potential applied to the analyzer plates must be known to a very high precision. The voltage required for the measurement of the $\text{Li}(p,n)$ threshold was about 30 kv with one-half of this potential on each plate and was provided by two 15 kv stacks of dry batteries composed of several fixed battery boxes with an adjustable box at the low potential end. The voltage of one of the battery boxes was measured by precision dc methods, (voltage divider and type K potentiometer and standard cell) and adjusted to precisely 500 volts. This box, now a secondary voltage standard, can be compared with another 500-volt box by adjusting the voltage of the second box until no circulating currents were found when they were connected together. The two known 500-volt boxes were added together and a 1,000-volt box set for zero circulating current against the sum of two 500-volt boxes. This was repeated until both stacks were adjusted to exactly 15 kv. Small voltage variations were made in one of the 500-volt boxes and measured in the usual dc manner. It was felt that the total voltages of these battery stacks were known to an accuracy of 0.03 per cent.

It is interesting to note that electronic controlled power supplies were not used because of voltage instability. However, an electronic power supply controlled by a galvanometer and photocell system has proved to be more stable than the battery boxes.

Knowing the analyzer potential, the radius of curvature of the beam path as established by the slit system, the plate separation, and making the necessary corrections for relativity and other minor second-order effects the voltage of the generator may be

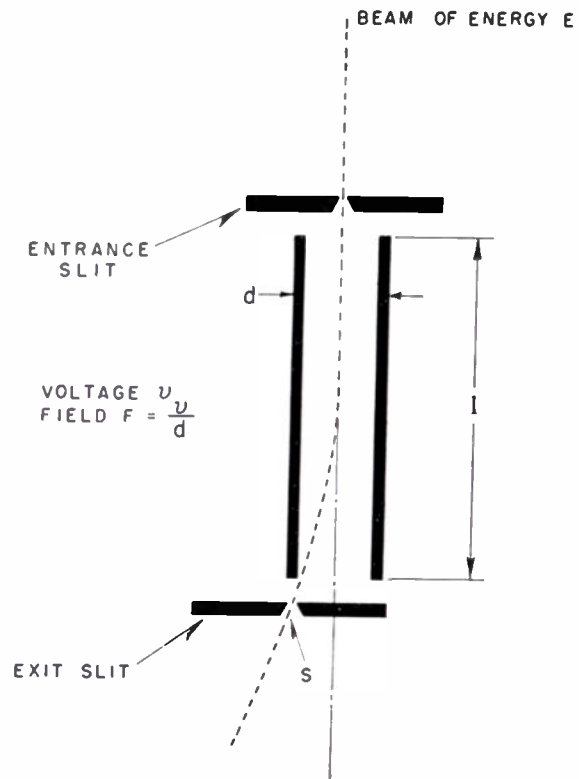

Fig. 9—A parallel plate electrostatic analyzer.

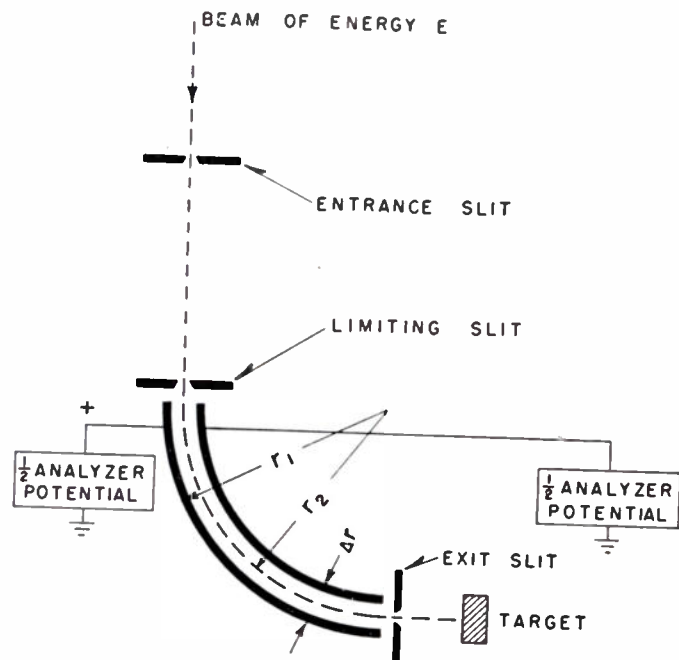

Fig. 10—A curved plate electrostatic analyzer.

obtained. As the analyzer plate voltage is now a measure of the voltage of the ion beam which will come through the analyzer system, it may be used as a primary voltage scale. The measurement of a secondary voltage standard such as the $\text{Li}^7(p,n)$ threshold involves the recording of the number of neutrons produced by the target as a function of beam voltage at various voltages close to the threshold value. The threshold can be

determined by selecting the highest voltage at which no neutrons appear. This was found to be 1.8820 ± 0.002 Mev.

ABSOLUTE VOLTAGE MEASUREMENT BY THE RADIO-FREQUENCY ION VELOCITY GAUGE

This method, which also makes use of the known constants of a beam of ions, permits

¹⁰ R. G. Herb, S. C. Snowdon, and O. Sala, "Absolute voltage determination of three nuclear reactions," *Phys. Rev.*, vol. 75, p. 246; January, 1949.

¹¹ R. E. Warren, J. L. Powell, and R. G. Herb, "Electrostatic analyzer for selection of homogeneous on beam," *Rev. Sci. Instr.*, vol. 18, p. 559; August, 1947.

one to establish a number of voltage calibration points along the nuclear voltage scale.^{12,13} It is absolute in the sense that the kinetic energy of the particle is determined in terms of its known mass and charge and the directly and accurately measurable parameters-length and frequency. The ion beam from the electrostatic generator is intensity modulated by a beam defocusing electrode placed just below the ion source and supplied by a 70-Mc crystal-controlled oscillator mounted in the high voltage electrode. This beam of modulated ions is accelerated by the generator potential and analyzed into its mass components by a momentum analyzer. The desired beam is then sent through two gaps in an rf cavity as shown in Fig. 11. This cavity (Fig. 12) is of the coaxial type, with the inside of the center conductor used as a field free drift tube. The cavity can be tuned to resonate at the beam modulation frequency by the gap condensers. The ion beam, as it passes through the first gap in the rf cavity, induces a 70-Mc voltage in the cavity because of its intensity modulation. As the rf cavity has a high *Q*, the two gaps are closely coupled and an rf measuring instrument will indicate the sum or difference voltage of the two gaps. The addition or subtraction of the voltage from these two gaps will depend on the phase difference of the 70-Mc modulation cycle between the two gaps. If the transit angle $\Delta\theta$ is equal to $n\pi$ (where *n* is an odd integer) the excitation from the first gap will be cancelled by that from the second and a minimum in rf signal will result. Whence

$$\Delta\theta = n\pi = 2\pi f\Delta t \quad (5)$$

$$\Delta t = n/2f = L/v, \quad (6)$$

where Δt is the transit time of any group of ions of velocity *v* through length *L* between the gaps, and *f* is the modulation frequency. The velocity of the ions will therefore be

$$v = \frac{2fL}{n} \quad (7)$$

and the voltage *V* of a beam of particles of velocity *v* and mass to charge ratio M_0/e will be

$$V = \frac{2M_0f^2L^2}{en^2} \quad (8)$$

In practice it is necessary to include the relativity correction for the change in mass of the ion with velocity so that the final result becomes:

$$V = \frac{2Mf^2L^2}{en^2} \left(1 + \frac{3f^2L^2}{n^2C^2} \right)$$

where *C* is the velocity of light.

With a fixed modulation frequency *f* and distance *L* between the gaps, it is possible to find several minima along the nuclear voltage scale with a precision of about 0.1 per cent by using various values of the order number *n*.

To make the measurement of the rf signal from the cavity easier, the 70-Mc modu-

¹² W. Altar and M. Garbuny and J. W. Coltman, "A speed gauge for high voltage ion beams," *Phys. Rev.*, vol. 72, p. 528, September, 1947.

¹³ W. Altar, and M. Garbuny, "Absolute speed gauge for high voltage particles," *Phys. Rev.*, vol. 76, p. 496, August, 1949.

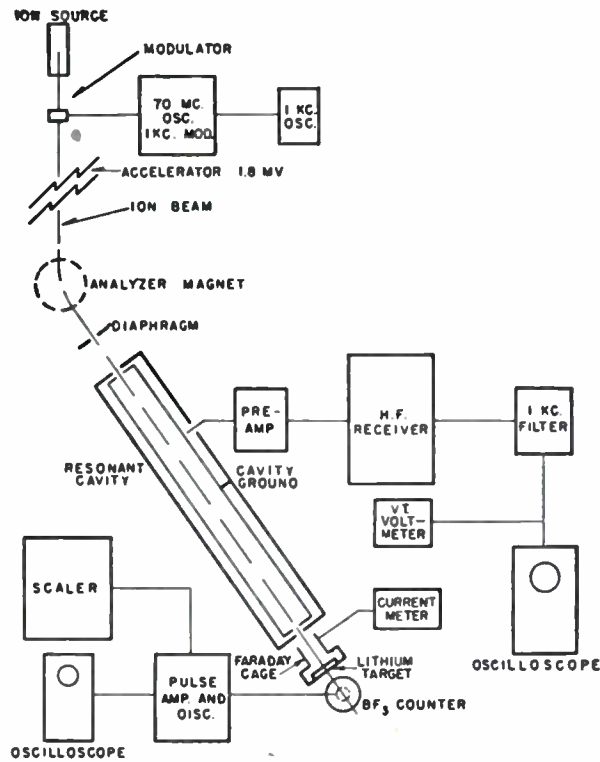

Fig. 11—Rf ion speed gauge assembly. The magnetic analyzer permits rapid switching from the proton beam used for threshold measurement to the mass 2 beam used for the speed measurement, the mechanical geometry remaining fixed.

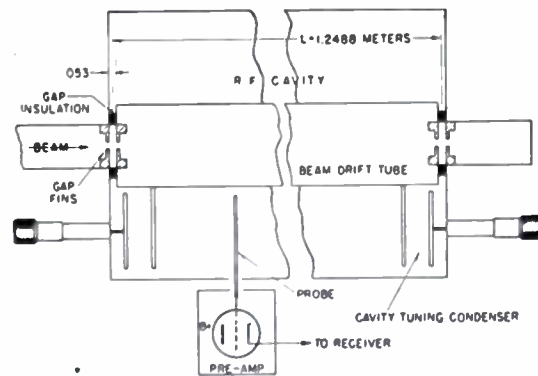

Fig. 12—An schematic section of the speed gauge cavity, giving essential dimensions.

lation voltage in the electrode is further modulated by a 1,000-cycle signal to allow audio amplifiers to be used after the 70-Mc detection circuits. The signal from the cavity is picked up by a voltage probe and fed to a preamplifier and impedance matching tube adjacent to the probe. It is amplified and detected by a communications receiver with a 1,000-cycle narrow-band filter in its output, which reduces the receiver bandwidth to the order of 100 cycles thus considerably increasing the signal-to-noise ratio. The output signal can be read on a scope or a meter. The magnitude of the rf signal from the cavity is recorded as a function of an arbitrary voltage scale as determined by a compensating generating voltmeter. A measurement of

the lithium¹⁴ threshold is made on the same arbitrary scale. Knowing the constants of the cavity, the length between the gaps, and the modulation frequency it is possible to calculate the absolute voltage at which the minimum in the rf signal occurs. From the experimental points recorded a minimum in the rf signal can be selected which calibrates the arbitrary voltage scale in absolute volts. A linear extrapolation of this point can be made to the $Li(p,n)$ threshold. The value found in this manner was 1.8812 ± 0.002 Mev which may be compared with $1.8820 \pm .0002$

¹⁴ W. E. Shoupp, R. Jennings, and W. Jones, "An absolute calibration of the $Li(p,n)$ threshold voltage," *Phys. Rev.*, vol. 76, p. 502, August, 1949.

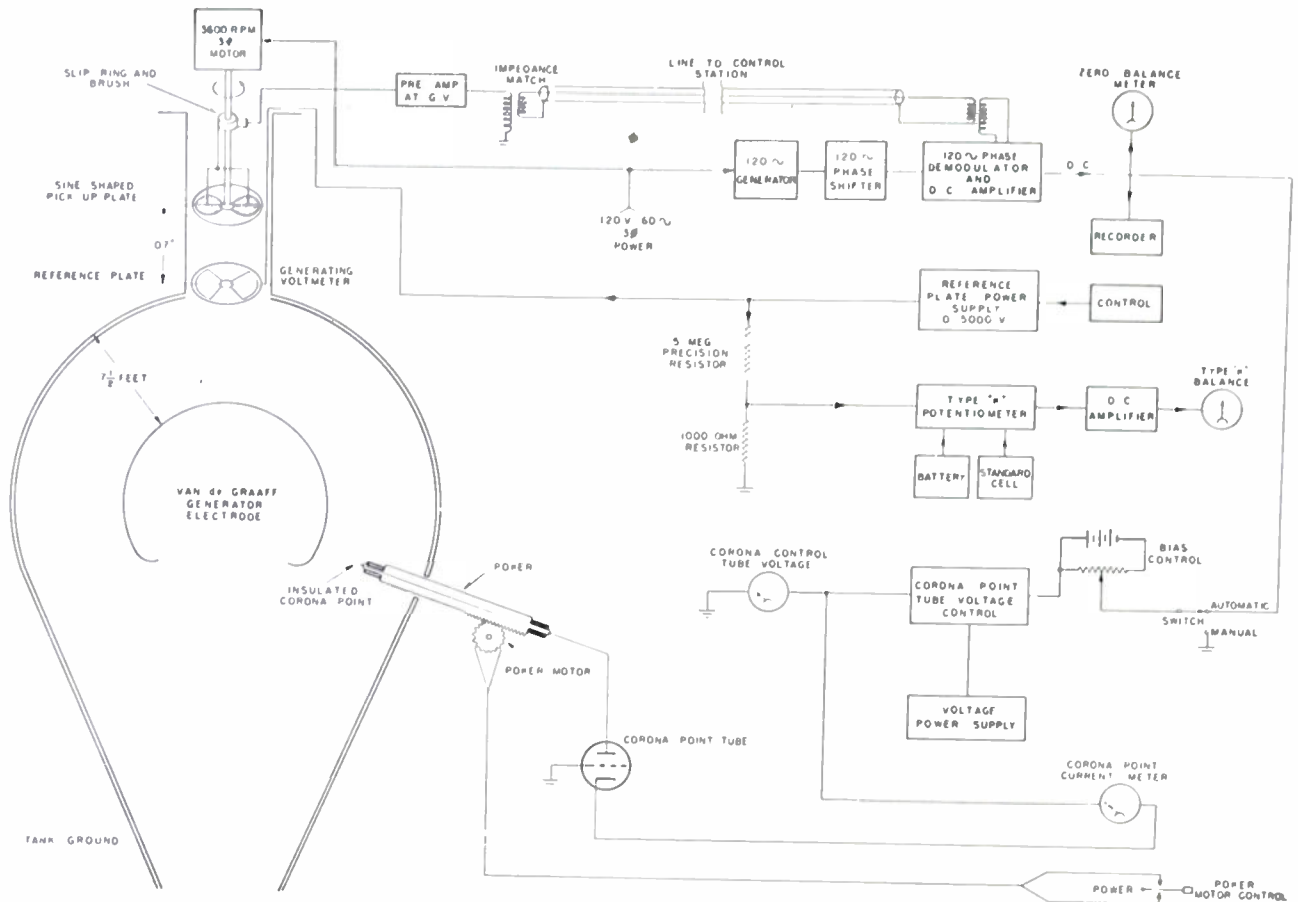

Fig. 13—A Westinghouse Van de Graaff generator generating voltmeter comparison and control circuits.

Mev, as determined with an electrostatic analyzer.

GENERATING VOLTMETER

The previously described instruments can be used for absolute calibration of the nuclear voltage scale. The generating voltmeter can be used for relative measurements only. This instrument is a field measuring device which determines the field strength due to the high potential electrode at the surface of the tank. Several types of generating voltmeters have been used, the simplest form consisting of an insulated segmented plate exposed to the field of the electrode. A mechanical rotating shutter at ground potential alternately exposes this plate to the field of the electrode and to ground so that a resistor between this insulated plate and ground has a small ac potential developed across it, whose peak value is a measure of the electrode field strength. This peak ac voltage as read by some form of vacuum-tube voltmeter therefore becomes a measure of the electrode voltage. However, this instrument is not capable of extremely high accuracy because of variation in generated wave shape.

Since a direct reading generator voltmeter involves the problem of accurately measuring an ac voltage of very poor wave shape, a null-type instrument would be advantageous. This is done in the compensat-

ing-type voltmeter which is capable of somewhat better precision than the direct reading instrument. As all these instruments (see Fig. 13) are of the electrostatic ac generator type, it must also have a rotating element or armature. This rotating element, in the more advanced design voltmeters, consists of a pair of sine-wave shaped insulated pickup plates connected through a slip ring and a low impedance matching transformer to ground. An insulated stationary plate cut so as to leave open two 90° sectors is placed a short distance in front of the pickup plate. The whole is placed in the electrostatic generator so that it is exposed to the high potential field from the electrode. The rotating pickup plate continuously explores the field distribution behind the reference plate, being alternately exposed to the electric field from the electrode and to that of the insulated reference plate. If the insulated reference plate is charged with a dc potential of the same sign as the electrode, there will be some potential at which it will be on an equipotential plane and the field intensity from it will be the same as that from the electrode. When these fields are balanced, the rotating pickup plate will be in a homogeneous field and the ac generated will be, to a first approximation, zero. This null can be used to indicate that the dc reference plate potential is some unknown but constant fraction of the electrode voltage. Although the absolute value of this ratio is dependent on the rela-

tive spacing of the various components, the geometry is so complex that the ratio cannot be theoretically determined with any accuracy. However, it has been experimentally shown that the relationship is linear over very wide ranges of voltages to an accuracy of about a tenth of one per cent.

The signal generated by the pickup plate when the reference plate voltage and the electrode voltage are not in the correct ratio is an ac of twice the frequency of the mechanical driving motor and there is a 180° shift of this ac signal at the balance or null point. This is fortunate, as it allows the generating voltmeter to be used as a source of error signal for voltage stabilization circuits. For voltage measurement only, it is enough to present the output of the pickup plate on a high gain scope and adjust the voltage for minimum ac signal. The dc reference plate voltage can be measured to any degree of accuracy necessary by standard low-voltage dc measurement techniques, which is one of the major improvements in this type of voltmeter over the ac type. The limit of accuracy of this type of instrument is, of course, in the second-order effects. In the first place, the field from the electrode does not completely match that of the reference plate, due perhaps to edge effects of the plate itself and to mechanical inaccuracy in the equipment. This "noise" is of higher harmonics than the true ac generated, but it obscures the voltage minimum. This is not a limita-

tion, as one can always use the same wave pattern as a balance criteria, either by observation on a scope or by electronic means. However, it has been found that the wave shape of this noise does not remain constant, and this fact definitely limits the accuracy of the instrument.

METHODS OF GENERATOR VOLTAGE CONTROL AND STABILIZATION

The voltage of an electrostatic generator, even with the belt speed, charging current, and other input conditions held as constant as is practical, is still subject to considerable variation. There is a fast voltage change probably associated with the surface conditions of the charging belts and with the local corona conditions on the electrode and down the support members. There is also usually a slow drift in voltage which is due to an integrated change in all these conditions. The fast voltage variation may not amount to more than a few tenths of one per cent, but the slow drift may be as great as one per cent or more during a long period of operation.

The voltage at which an electrostatic generator operates is governed by current taken up the charging belt and that lost by all paths down to ground. To control the generator voltage, one must be able to regulate one or both of these currents. It has been found that controlling the electrostatic generator voltage by means of the belt spray current is not satisfactory except as a slow control, because there is considerable time delay in conveying the charge to the electrode on the relatively slow belt.

If a sharp point or group of points is inserted through the ground wall of the electrostatic generator tank (Fig. 14) it will become a source of corona current to the electrode. The corona current can be controlled either by mechanically adjusting the distance between the point and the electrode, or by changing the potential of the corona point with respect to the tank wall. Forcing this corona point to go several tens of kilovolts above ground has the effect of redistributing the field lines from the electrode so that the field strength at the discharge point is very much less. If the corona point is insulated from ground and connected to the plate of a high-voltage triode vacuum tube whose cathode is grounded, the grid of this tube can be biased to control the current to the corona point, and hence its voltage. In this simple manner a fine, relatively fast control of the current lost from the electrode, and hence the electrode voltage may be obtained.

Another method of controlling the loss of current from the electrode is by the process of shooting a stream of electrons (Fig. 15) from ground to the electrode and controlling the magnitude of the electron current. This method, although very fast, usually requires a second vacuum tube to be installed in the generator for the electron stream. Also the very high voltage X rays produced when these electrons are stopped at the top of the tube can be hazardous from a health standpoint.

A third method which has been used on the electron generator at Notre Dame is that of capacitance control. The inside of the electrostatic generator tank (see Fig. 1)

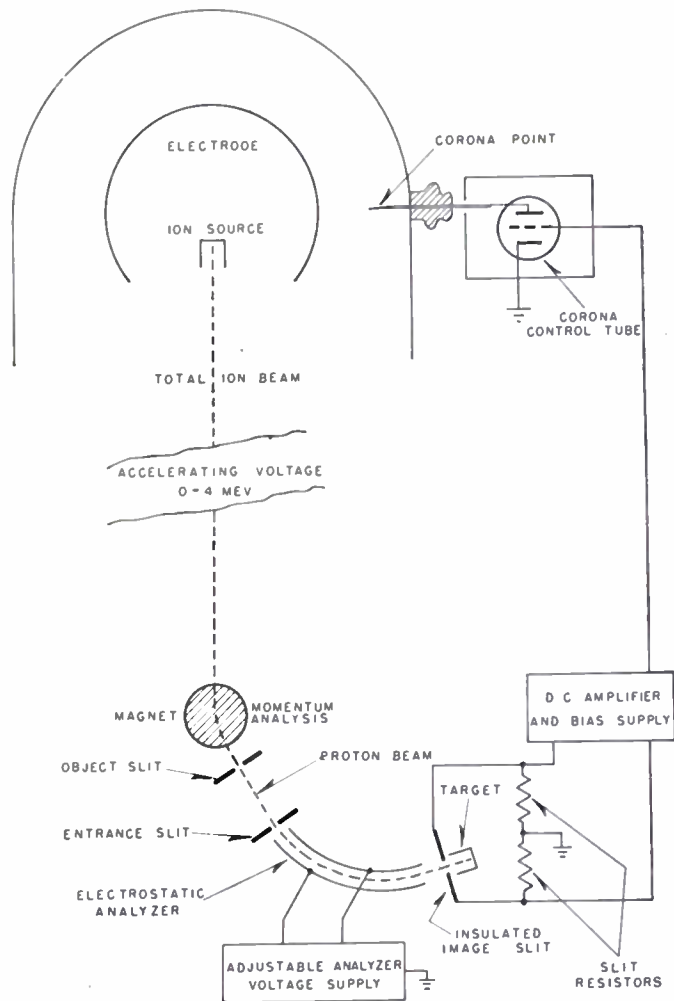

Fig. 14—A corona point voltage control using electrostatic analyzer.

has a metal lining insulated from ground for about 100 kv. The potential of the generator electrode is now with respect to the lining and not ground, although the ion beam is accelerated by the potential from the electrode to ground. If the potential of the tank lining is raised above ground, the electrode potential with respect to ground will be increased. This method is limited by the fact that it cannot compensate for long slow drifts in machine voltage, but these can be taken care of by one of the other slower control methods. Its response to a voltage error signal is fast, being limited only by the power of the liner voltage control amplifiers in changing the voltage of the liner. This method has also been proposed for the new 12-Mev generator at Los Alamos.

ERROR SOURCE FOR VOLTAGE STABILIZATION

If the two exit slits described in the section on electrostatic analyzers and shown in Fig. 14 are insulated from ground and from each other, the potential developed across a resistor from each slit to ground will be a measure of the ion current striking it. If the ion beam velocity or voltage changes a small amount from that for which the electrostatic analyzer voltage is set, more of the

ion beam will strike one slit than the other and a difference in the slit resistor voltage drops will appear. These voltage differences can be amplified by dc electronic amplifiers and used to bias the grid control tubes in either of the previously described voltage stabilizing circuits. This forms a feedback loop or servo system in which analyzer voltage is the standard and slit resistor voltages are the error signals operating the generator voltage control mechanism. This mechanism, by changing the generator voltage in the direction to reduce the error signal, completes the loop. To change the operating voltage of the electrostatic generator, at least within the rather narrow limits of the control mechanism, it is only necessary to change the electrostatic analyzer plate voltage and the servo system will cause the generator voltage to follow.

GENERATING VOLTMETER VOLTAGE STABILIZATION METHODS

The compensated generating voltmeter as described in the section of voltage measurement (Fig. 13), produces a minimum in the generated ac error signal when the reference plate potential is on an equipotential plane of the electrode. When the voltage of the electrode changes, a 120-cycle ac is produced

whose phase shifts 180°, dependent on whether the electrode voltage is higher or lower than the balance voltage. This phase shift can be made use of in voltage stabilization of the electrostatic generator.

While it would be very simple to convert this ac voltage to dc by a simple rotating commutator as it is done in a two-pole dc machine, it is better to amplify it to a much higher level while it is still capable of being handled by ac electronic amplifiers. In this amplification process the signal can be cleaned up by narrow-band 120-cycle filters while it is still in the ac form. Although these filters introduce some signal phase shift of their own, this is not serious when one remembers that the rate of change of generator voltage is limited (except at spark over) by the fact that the current drawn from the electrode by any control system is very small and the time to reduce the generator voltage to 1/e of its former value may be as great as 10 seconds.

The amplified ac null signal can then be demodulated against a reference ac whose phase is known and controlled from the rotation of the pickup plate. This ac can come either from a small ac generator rotating on the same shaft as the pickup plate or from the ac power driving the synchronous motor. An ordinary demodulator or synchronous amplifier can be used to derive a dc voltage whose sign is either positive or negative, depending on the relative voltages of the electrode and the reference plate. Amplification of this dc and additions of a constant bias voltage can be used to control the grid of a heavy transmitting tube in series with the corona point voltage control. At the same time the output dc from the demodulator serves as an indicator to the operator that the average voltage of the electrode has not changed and that his reference plate potential is still a measure of the electrode voltage. It must be emphasized that all the voltage measurements made in this manner are *not* absolute, and the instrument must be calibrated in some manner.

MISCELLANEOUS USES OF ELECTRONICS

There are a few minor uses of electronic circuits in connection with an electrostatic generator, such as ionization gauges, for measuring the ion tube vacuum. As the vacuum conditions found in an electrostatic generator ion tube are not extreme, conventional circuits can be used with the ionization gauge and are not of special interest. Relay systems are also used with the output of the ion gauge, so that if the vacuum does go bad for some reason, the gauges and pumps will be automatically turned off. These safety systems, although of great importance to the operation of the machine, are

again as simple and direct as they can be made to reduce accidental troubles and maintenance.

Some electrostatic generators have been designed with complicated telemetering systems involving either radio or light links between the electrode and ground for making measurements of the various voltages associated with the ion source. It is doubtful if

microamperes of protons with energies up to about 4 Mev. With great care, voltage accuracies of about 0.1 per cent are available. Even within this limited range, this generator can and has been used for many important nuclear investigations. The electrostatic generator is as close to the ideal design of generator for most nuclear experiments as can be conceived. For this reason its limita-

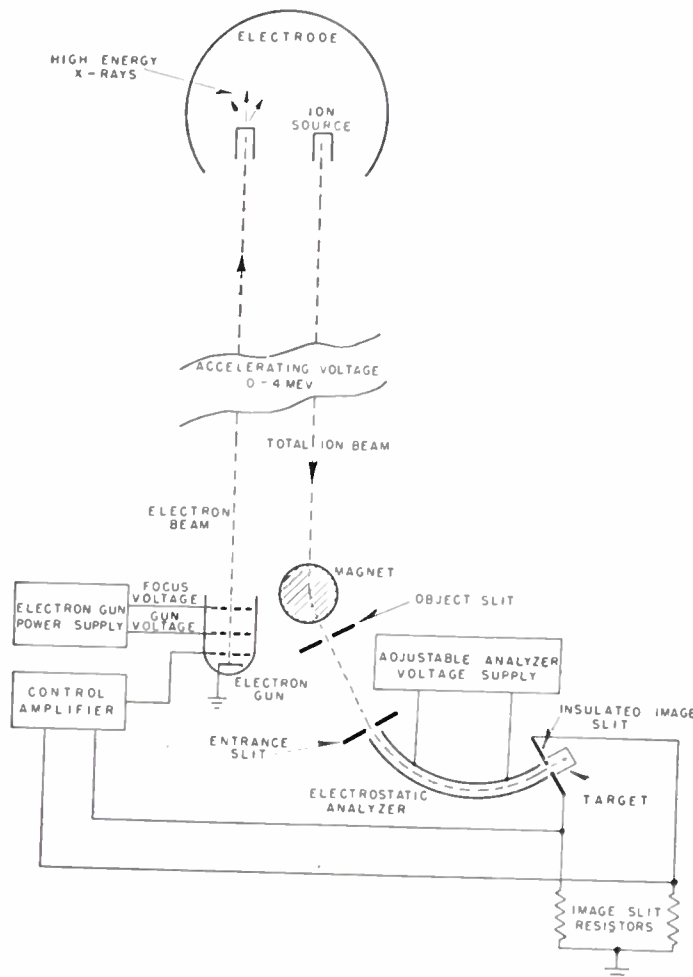

Fig. 15—A electron beam voltage control using electrostatic analyzer.

such systems can compete with the simple process of looking at meters in the electrode with a telescope.

CONCLUSIONS

The electrostatic generator, at the present stage of design, can produce a very few

tions, the small ion current, low top voltages, and poor voltage stability should be carefully studied.

The high voltage engineering groups at MIT and Los Alamos are engaged in just this task and their development of the proposed 12-Mev machines is of great interest.



New Techniques for Electronic Miniaturization*

ROBERT L. HENRY†, ASSOCIATE, IRE, ROBERT K-F SCAL†, MEMBER, IRE,
AND GUSTAVE SHAPIRO†, ASSOCIATE, IRE

Summary—The general approach to the problems of miniaturization is outlined with special emphasis on problems caused by the high operating temperatures. In addition to the general techniques, both conventional and printed circuit, three models of miniature wide-band, high-gain radar-type intermediate-frequency amplifiers (having similar characteristics) are described. A discussion of production methods and techniques is also included.

INTRODUCTION

THE RECENT phenomenal increase in the application of electronics in the fields of ordnance, aeronautics, and instrumentation has emphasized the need for reduction in size and weight of equipment. Furthermore, high-level performance under ambient conditions of increased severity has also been required.

To investigate the possibilities of electronic miniaturization, a program was instituted within the Engineering Electronics Section of the National Bureau of Standards sponsored by the Navy Bureau of Aeronautics with some contribution toward the later work by the Navy Bureau of Ordnance. This program had as its objective the development of new techniques and methods aimed toward miniaturization and toward development of mass-production methods. The embodiment of the results of some of these developments into certain specific electronic assemblies was also undertaken, and three of these assemblies are described. All are intermediate-frequency amplifiers of the same general type. The developments in this family of equipment illustrate some of the most promising techniques for miniaturizing electronic assemblies.

Early electronic miniaturization efforts were aimed only at utilizing standard components in as compact an assembly as possible. The method undertaken at the National Bureau of Standards has been to go farther and develop smaller components and standardized techniques which facilitate the production of component assemblies whose characteristics and circuitry may be conveniently varied for specific applications. The design of miniature equipment must satisfy not only the usual requirements associated more specifically with component design but also the conditions of practicality in terms of manufacturing, testing, and repairing difficulties. These problems require the attention and cooperative efforts of the chemist and mechanical engineer as well as the electronics engineer.

The question of how far miniaturization efforts should go is quite appropriate. The program of miniaturization of intermediate-frequency amplifiers at the National Bureau of Standards has demonstrated that the process can be carried to a point where the complete device is

only slightly larger than the volume occupied by the subminiature type tubes. However, such a degree of miniaturization is purchased at the price of greater difficulty in construction, and the miniaturization aspects of design must be adjusted to the requirements of the application if they are to be attained economically. There is, of course, the possibility that mass-production methods may make it economical to use the smallest components for all installations. This might be viewed as the ultimate goal of the "miniaturization" engineer.

A factor of great concern in the miniaturization of electronic equipment is the high internal temperature caused by packaging heat-dissipating components into small volumes. This problem is intensified by the recent tendency of military agencies to specify operation at much higher ambients than in the past. Some specifications already call for 100°C operation, and there is some indication of a desire to extend this to 200°C operation in the case of certain airborne equipment. These are formidable requirements. For example, conventional components are limited by their composition to operation in ambients of only 85°C or in some cases of 125°C. Yet measurements made within miniature intermediate-frequency amplifiers indicate that components sometimes operate in 200°C ambients when the amplifier is subjected to temperatures of only 85°C. The engineering of the miniature intermediate-frequency amplifiers has thus been greatly influenced by the desire to permit operation of the equipment in ambients approaching 85°C.

With these temperature problems in mind, the Model II amplifier, which was originally designed to use conventional resistors, was modified to permit utilization either of these or of special resistors for high-temperature operation. This latter resistor type was used exclusively in the Model V amplifier. It consists of a steatite rod on which a cracked carbon film is deposited and which is equipped with axial leads. For the printed circuit unit, a special high-temperature film-type resistor was developed in the National Bureau of Standards Laboratories.

High temperature also required the use of special solder having a melting point of about 220°C and the inclusion of sufficient silver to prevent alloying of fired-on silver from printed circuits to which connections were being soldered. This solder was used with the same general equipment and techniques, and with only slightly more difficulty than ordinary solder.

CIRCUITRY

The selection of the high-frequency, wide-band intermediate-frequency amplifier as a vehicle for the evalua-

* Decimal classification: R380X R363.4. Original manuscript received by the Institute, April 6, 1950.

† National Bureau of Standards, Washington, D. C.

tion of miniaturization techniques in the early stages of the program was predicated upon a number of considerations. Principal among these were: (1) an immediate need for such equipment by some government agencies, (2) the diversity of problems imposed by this type of equipment, and (3) the probability that the general solutions arrived at would have wide applicability in other types of equipment. The selection of specific circuitry for the intermediate-frequency amplifiers requires that all factors bearing on miniaturization, including the effect of high temperatures on components, must be considered and that prime emphasis must be placed on attainment of electrical requirements rather than extremes in miniaturization.

After consideration of various types of intermediate-frequency circuitry, it was decided that a stagger-tuned interstage coupling system using bifilar unity-coupled inductors was most adaptable to a miniature design. Such a system eliminates the need for coupling capacitors and provides excellent isolation of the various intermediate-frequency ground-return circuits. The use of staggered pairs rather than triples or quadruples provides less critical circuitry. Chain decoupling of power supplies was selected for Models II and PC-IV because of greater efficiency even though this requires the use of chokes rather than resistors in the decoupling filters. The above selections, together with the basic specifications for performance, defined the circuitry as shown in Fig. 1.

The pentode amplifiers are subminiature equivalents of the type 6AK5 miniature tube. Each of the models has been built with both the Sylvania type SN973B and the Raytheon type 5702 tubes. Although the former is a button-base type and the latter a press-base type, the physical layout of each design permits the use of either type without modification. The same tube types were used in the intermediate-frequency, video-amplifier, and cathode-follower stages; the duo-diode used in Models II and PC-IV is a National Union type 1106; and the single diode used in Model V is a Raytheon type 5704.

MODEL II

The Model II intermediate-frequency amplifier was designed so that it could be produced by electronic equipment manufacturers without radical changes in their manufacturing methods. It was also designed to be sufficiently flexible so that modifications of circuitry and operating frequency could be made easily. Another objective was an extremely rugged and rigid design.

This amplifier has a 10-Mc bandwidth centered at 60 Mc. As shown in the schematic diagram, Fig. 1, it

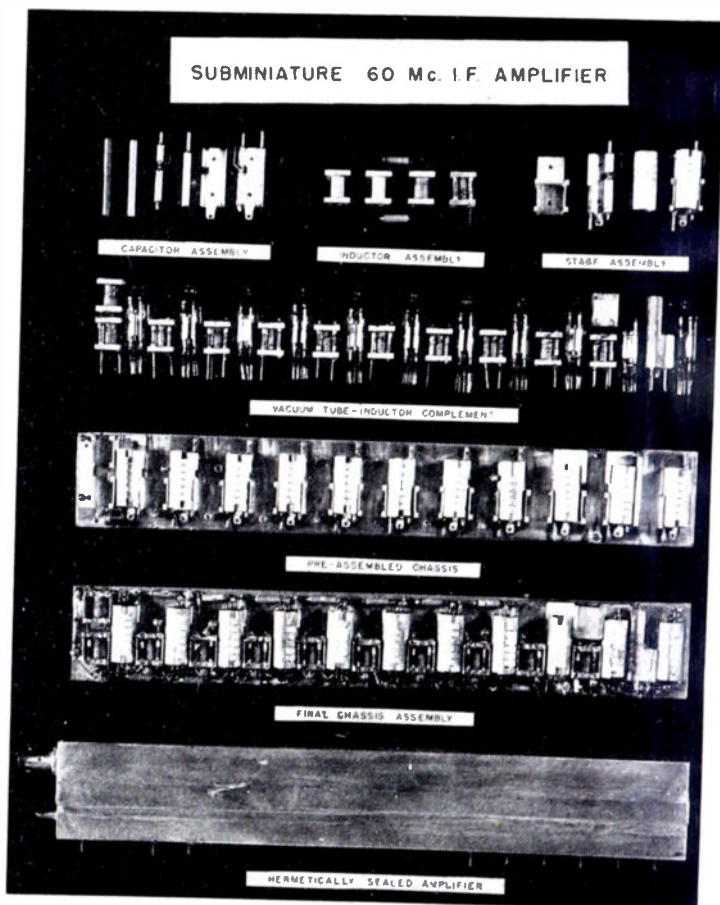

Fig. 2—Model II miniature subminiature amplifier.

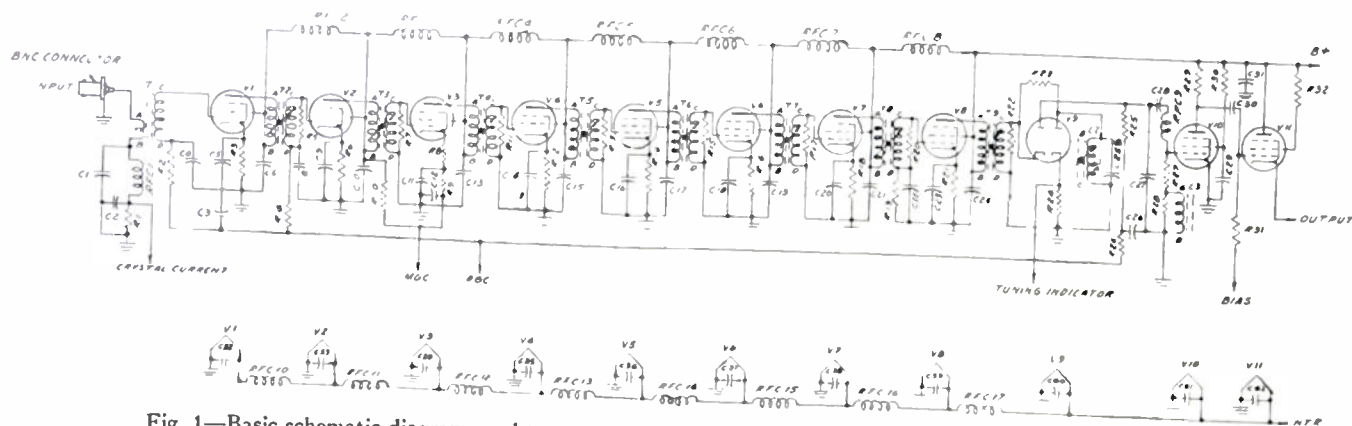

Fig. 1—Basic schematic diagram used to construct miniature wide-band amplifiers. Note—All transformers except T1 are bifilar wound. C25 is temperature compensating.

consists of an eight-stage stagger-tuned intermediate-frequency amplifier, diode detector, video amplifier, and cathode follower—eleven vacuum tubes in all. The gain-bandwidth factor approximates that of an amplifier using type 6AK5 tubes.

The amplifier is housed in a hermetically sealed plug-in container (see Fig. 2). Sealing is accomplished with the aid of a soldered-down metal strip that may be removed, in the event that the amplifier must be repaired.

The original intent was to pot this amplifier in a casting resin. However, there are some very serious objections to potting this unit. First, most of the existing casting resins cannot stand high temperatures. Second, the sealing provided by casting resins is not generally as satisfactory as that provided by a hermetically sealed container; there is a tendency for moisture creepage to occur along wires emerging from potted assemblies exposed to humid atmospheres for long periods. Third, dielectric constants of even the best casting resins being in the order of 2.5, the interstage capacity might be increased seriously and the over-all performance deteriorated by casting. In order to provide good metallic bonding to assist in heat transfer to the outer surface of the assembly and to provide low inductance grounds for many of the components, a mechanical structure was provided which proved to be sufficiently rugged that little additional rigidity resulted from the use of a casting resin.

Because miniature assemblies can require a great deal of skill on the part of the wiremen, interconnections made with hook-up wire were almost completely eliminated in the Model II design. Component leads and printed wiring were used for interconnections. The only other wires used were a shielded automatic-gain-control line and a 2-inch long B+ lead. Most of the wire connections were less than $\frac{1}{4}$ inch long.

Intermediate-frequency amplifiers of this general type contain more by-pass capacitors than any other component. These capacitors must be located to permit efficient by-passing action for the intermediate-frequency portions of the circuit. The physical shape of the capacitor, therefore, plays a very important part in the determination of the intermediate-frequency layout. It is not necessary that a capacitor used for by-passing have a particularly good power factor as long as the total impedance at the operating frequency is low. In high-gain designs, low-loss by-pass capacitors often cause trouble by creating a condition conducive to parasitic oscillation. Since low- Q by-pass capacitors are acceptable in this amplifier, it is possible to use some of the higher- K barium titanates with high dissipation factors. Because the temperature characteristics of high- K ceramic make it impossible to use resonant by-pass capacitors, high-capacity by-pass structures with low self-inductance were used. These took the form of $\frac{1}{8}$ -inch-diameter thin-wall tubing silvered inside and outside.

The Model II chassis is a single metal plate to which the components are secured. The tubes lie parallel to each other and the coupling networks lie between the tubes. The tube mounting also functions as a tube and interstage shield and as a heat-transfer medium that bonds the vacuum tube to the outer wall of the shield case. The tube shields are provided with fingers that short out the waveguide formed by the amplifier enclosure, thereby reducing the tendency toward instability due to propagation of energy down the length of the enclosure.

The B+ and heater by-pass capacitor assemblies mount under the tube shields with the tubular capacitors beneath the vacuum tubes (see Fig. 3). The inductor forms are secured to the chassis by phosphor-bronze stampings which are soldered to silvered areas on the edges of the inductor forms. The same screws that secure the tube shields to the chassis simultaneously secure the capacitor assemblies and inductor clamps.

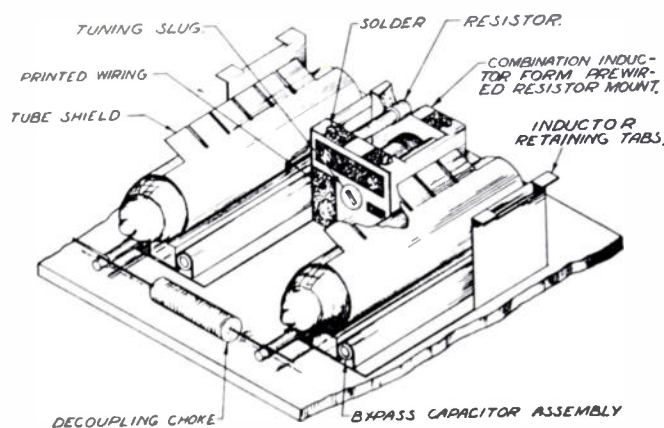

Fig. 3—Stage assembly of the Model II intermediate-frequency amplifier.

The inductors were wound with teflon-ceramic insulated wire and impregnated with silicone resin. Because this amplifier was sealed in a dry nitrogen atmosphere, no breakdown due to electrolytic action between the primaries and secondaries of these inductors is anticipated. The powdered-iron cores used to tune these inductors were adjusted from the inductors' low-potential ends. The physical properties, losses, and permeability of these cores change slightly after continuous operation at high temperatures, but the Q of the loaded network is sufficiently low so that variations in the loss and permeability of the slugs do not materially affect the bandwidth or tuning.

The use of ceramic for inductor forms made it possible to metallize a wiring pattern on their ends. Holes were provided in the ends of the inductor forms so that resistors could be inserted into these holes and soldered to the metallized wiring pattern (see Fig. 3).

The radio-frequency chokes were made from $\frac{1}{8}$ -inch-diameter steatite tubing cut into $\frac{7}{16}$ -inch lengths. The ends were nicked and silvered. After firing, axial

leads were soldered into the ends and ceramic-insulated wire wound on each form.

The interstage components between the video amplifier and the cathode follower were mounted in a ceramic block. The ends of the ceramic block were silvered so that the components had only to be inserted into their respective holes and soldered into place to complete the circuit connections. The majority of the resistors in this amplifier were not required to dissipate any appreciable power. Several resistors that must dissipate considerable power were housed in the ceramic block to increase their power-dissipating capabilities. The resistors that have the most critical stability requirements are those used to load the tuned circuits. That these resistors are not called upon to dissipate appreciable power is a favorable factor.

Pretinned metal inserts were sweated into the center of each capacitor tube, making a very rigid structure. These metal inserts function as insulated tie-points for the heater and B+ chain decoupling chokes. The cathode and automatic-gain-control by-pass capacitors have tapped metal inserts so that they may be screwed vertically to the chassis with the inner metallized surface functioning as the grounded terminal. The heater and B+ by-pass capacitors have their outer metallized surface grounded. Since there is always the possibility that extreme stresses might cause the silver to separate from the ceramic base material, these capacitors were mechanically held in place by light-gauge metal stampings into which they were snapped before soldering. The stampings also function as grounding lugs.

All of the ceramic parts have been designed so that they may be extruded. Where formed and stamped metal pieces were required, these were inexpensively made of 0.005-inch sheet with the exception of the chassis plate. The chassis is die-stamped or perforated in a drill jig.

The interstage inductors are wound and the resistors inserted into the inductor forms in a preassembly operation. All hardware, preassembled interstage networks, by-pass capacitors, and tubes are mounted on the chassis, which is then set on edge in a cradle with the tube leads projecting upwards. It then progresses down a wiring line with the heater and B+ decoupling chokes mounted as a final wiring operation.

The basic layout of Model II permits many circuit modifications to be made without requiring radical modifications. There is sufficient room for larger inductors (for lower-frequency operation) to be incorporated without increasing the size of the amplifier. Because the by-pass capacitors have more capacity than is required for 60 Mc, they too will function quite satisfactorily at lower frequencies.

PRINTED CIRCUIT INTERMEDIATE-FREQUENCY AMPLIFIER

The printed-circuit-type intermediate-frequency amplifier is closely related in circuit and performance to

the model just described. The printed assemblies are contained in a hermetically sealed, rectangular metal case approximately $6\frac{1}{2}$ inches long, $2\frac{1}{4}$ inches wide, and $\frac{5}{8}$ inch thick.

The design is based on a unit assembly of the principal parts associated with each electron tube. Each standard unit (see Fig. 4) is a tubular structure 2 inches long and $\frac{1}{2}$ inch in diameter, enclosing a subminiature



Fig. 4—Model PC-IV, printed intermediate-frequency amplifier design based on unit construction of a single-stage unit. Unit printed assembly contains subminiature electron tube and principal circuit components associated with each stage, including inductor assembly. Three basic parts form the stage unit: (a) high-K ceramic tube, (b) steatite inductor form, and (c) high-K ceramic tube.

tube and an inductor assembly. As shown in Fig. 5, eleven of these cylindrical units are assembled to per-

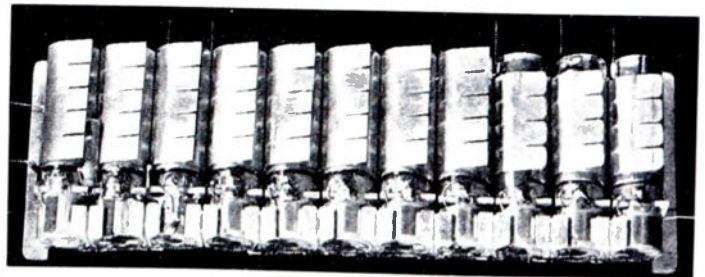

Fig. 5—Front view of the complete assembly of the printed, miniature intermediate-frequency amplifier, Model PC-IV.

form the functions required in the intermediate-frequency amplifier. Eight of the units perform as tuned amplifiers and are stagger-tuned in pairs to give a band-

width of 10 Mc centered on 60 Mc. Supplementing these are a detector stage, a video amplifier, and a cathode-follower output stage.

All stages are similar in appearance and general construction with a common design evolved from a basic assembly of three ceramic parts and a subminiature vacuum tube. This assembly may be supplemented by the addition of decoupling chokes when necessary, as in the case of intermediate-frequency stages. Changes in the primary function of the assembly are accomplished by changing the pattern of the printed circuit and by using electron tubes of desired characteristics. Standardization of the construction of the assemblies was adopted. Such items as uniformity of tube connections and power-supply lead location facilitate construction, repair, and diversity of application of this type of assembly. In the amplifier as constructed, each stage unit is slipped into a silver-plated spring clip, which in turn is soldered to a single metal support. Individual units may be removed from or inserted into such an assembly by disconnecting the five interstage connections. It is believed that this feature, repair by stage replacement, may eliminate some previous objections to printed circuit devices where long service was mandatory.

The construction of the printed intermediate-frequency amplifier employs basic metallizing techniques for conductors and makes extensive use of ceramic materials, as is characteristic of the commercial printed-circuit activities of this country. Conductive patterns are made by imprinting the ceramic materials with a special silver-pigmented paint, using the screen-stencil processes. This simple mechanism of reproduction is readily adapted to the manufacture of printed circuit assemblies. The conductive paint is fired at temperatures of the order of 700°C to give it the required properties of good electrical conductivity, good adherence, and ability to accept solder.

The basic stage assembly is described in detail as follows: The first element is a high-K titanate tube approximately 1½ inches in length and 0.4-inch inside diameter so as to slip over the T-3 size subminiature tube. Assembled to one end of this long ceramic tube and the base of the subminiature tube is a steatite inductor form with a bifilar wound inductor. Over this inductor form is slipped the second tubular ceramic element which may be used to provide inductor shielding, additional by-passing capacity, or a circuit area for printed wiring of low distributed capacity by suitable selection of ceramic material and printed conductive pattern. Fig. 6 is a cutaway view of a typical stage showing the general construction of the parts and the details of the assembly. This figure also illustrates the multiple-layer construction of the long titanate tube. Metallized on the inside and with multiple capacitor plates printed on the outside, such a unit becomes a capacitor assembly with the capacitors produced *in situ* and by a single printing operation. In order to shield this assembly, a coating of

vitreous enamel is applied to the outside area of the tube and an all-over metallizing coat is then fired on top of the vitreous enamel.

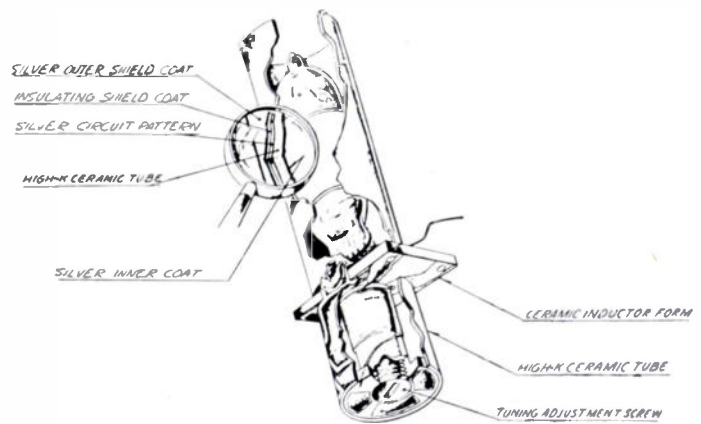

Fig. 6—Cutaway view of a typical stage of the Model PC-IV, printed-circuit amplifier.

An inductor assembly using wire-wound inductors was selected, for at the time of the conception of this design it was believed printed inductors could not compete with wire-wound inductors in extreme reduction of size. A special steatite spool was designed to function as an inductor form. The core is drilled and tapped with standard 8-32 screw threads. The inductor is thus made tunable by the use of either a powdered-iron screw or other standard metallic screw. Printed wiring on the rectangular flange on one end of this steatite form brings two internal connections outside of the stage assembly, making them easily accessible. In addition, the flange furnishes a convenient area for the location of a loading resistor with a minimum of distributed capacity. It also carries regularly spaced projections on its top surface, which serve to align the electron tube and its leads, and the long tubular capacitor assembly surrounding the electron tube. Another flange on the opposite end of the spool provides for termination of the "cold" end of the inductor windings and permits external connections to be readily made. This round flange is of a diameter which will permit the ½-inch-long titanate tube to slip over it up to the rectangular flange and the point of juncture with the 1½-inch-long tube. When printing the short tubes, it has been found expedient to reverse the order of ground connections used on the long tubes; the electrodes on the external surface, instead of the internal electrodes, are connected to ground. This arrangement makes it unnecessary to provide an additional shield coat, with its accompanying vitreous enamel layer, on the short tube.

The end of the 1½-inch tube that joins the inductor assembly has eight small notches cut in its periphery, permitting the tube leads of the totally enclosed electron tube to be brought out of the assembly and appropriate connections made. The tube leads are preformed in a radial pattern, with the exception of the grid connection which joins directly to the inductor assembly as a very

short connection ($\frac{1}{8}$ inch). The radial tube leads are aligned with the projections of the inductor form and protrude through the appropriate notches in the end of the $1\frac{1}{2}$ -inch tube. The leads are then soldered directly to the proper capacitor or other connection. It is to be noted that there are only two internal connections in the stage unit and that these are made and verified before final assembly of the stage. All other connections are external, facilitating assembly, inspection, testing, disassembly, and repair. This system uses combination electrical and mechanical connections so that the operation of soldering joins the elements electrically and mechanically.

Orienting the circuit components around the circumference of the associated electron tube has been found to be very adaptable to variation in circuit requirements. For example, it almost always permits the optimum location, particularly with respect to lead length, of the major circuit element connected with a particular electron tube element. In the design of the intermediate-frequency amplifier, this adaptability permitted the standardization of the location of major circuit elements and connections.

In this basic design, leads as such are practically eliminated. As already pointed out, by-pass capacitors make up a large part of the total circuit elements. They are so located as to require short direct connections to the tube leads. Resistors usually do not require separate electrodes, but naturally fall so that they can use capacitor electrodes or existing "ground" patterns as their point of circuit contact. Heater and plate chokes do not require separate leads and are made to join directly to applicable circuit elements. As an example, the heater source is fed through a chain of chokes, each of which connects to the extreme ends of the printed heater by-pass capacitor electrodes which therefore also serve as conductors to supply the heaters with their normal voltage.

In addition to the elimination of many separate leads and connections, it can be seen that the design is also a step in the direction of the elimination of lumped constants. The design approaches a system of distributed constants contributing to operating efficiency and stability in some cases and, in particular, permitting the realization of economy in manufacture and fabrication as well as increasing the versatility of the basic concept in adapting it to many electronic circuits.

MODEL V

In the course of development of the Models II and PC-IV amplifiers, a request was made for a still smaller amplifier for a similar application. In order to obtain the desired shape, the configuration used in the printed-circuit model, with the inductors directly below the tubes, was selected. The mechanical design is one of several which were worked out to give the smallest possible size with available subminiature tube types. The particular advantage of this design is that it is built

up of stages mounted on individual chassis plates so that it lends itself to application in amplifiers having diverse electrical characteristics. Fig. 7 shows the stage detail

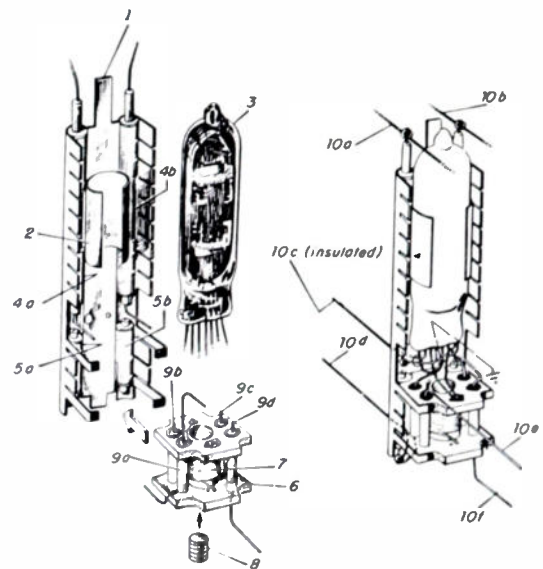

Fig. 7—Detail of stage construction used in the Model V amplifier. (1) Chassis plate. (2) Tube clip. (3) Tube. (4) Decoupling filter. (5) By-pass capacitors. (6) Inductor form. (7) Bifilar inductor. (8) Tuning core. (9) Resistors. (10) Interstage connections.

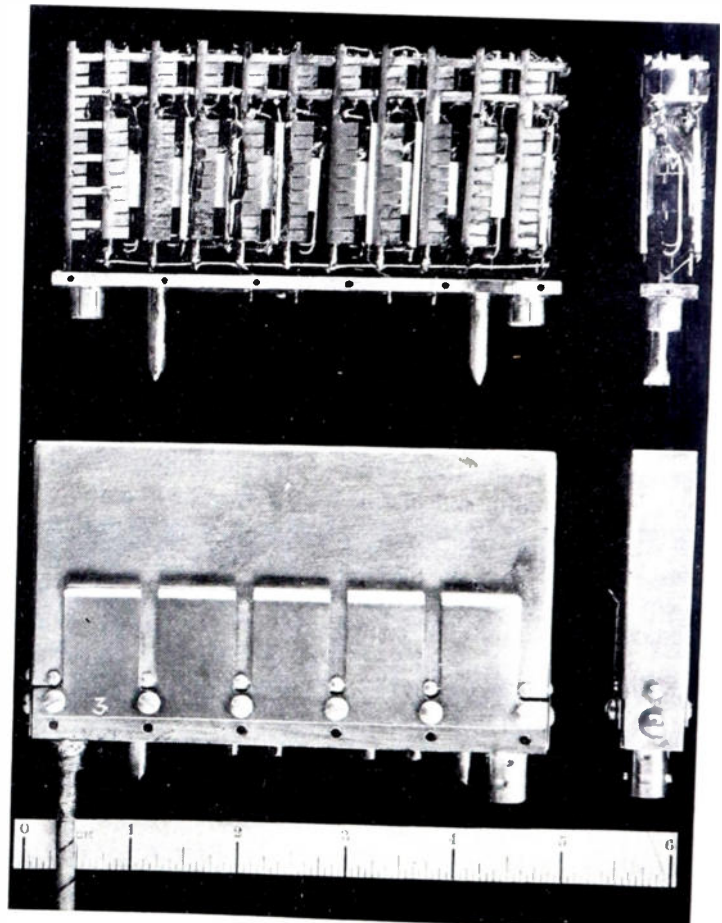

Fig. 8—Model V miniature intermediate-frequency amplifier. (Top) Side and end views of final assembly. (Bottom) Side and end views of encased amplifier in socket.

construction used in the Model V amplifier. While this stage is a grounded-grid amplifier used in the low-noise input circuit, its construction is typical of stages with other circuitry. It is shown to emphasize the fact that various types of circuitry may be used with this construction, although great attention to detail is required to utilize this advantage.

The assembly method consists of soldering the tubular capacitors, decoupling filters, and tube clip onto the chassis plate, then mounting the inductor form (already wound and with resistors in place) and the tube on the chassis plate. Connections between tube and inductor assembly are then made, after which the stages are assembled and interconnected. The various components shown in Fig. 7 are essentially the same as those used in the Model II, with modifications as required by the special design and circuitry.

A complete design was evolved to embody the identical circuitry of Fig. 1, as well as one for the special application. Fig. 8 shows the latter amplifier (ten tubes on separate chassis plates, plus one chassis plate con-

taining the input coupling unit) and the plug-in-type case with the socket assembly used for this amplifier. This assembly provides coaxial connections between amplifier and socket for input and output, complete shielding of all connections, and by-passing (1,000 μmf in socket) for power and gain-control leads.

A small production of the Model II has been completed and others are under way for the PC-IV and projected for the Model V. Some of the production models are being subjected to life tests at this time while others are intended for various other tests or installation application.

ACKNOWLEDGMENT

The authors wish to extend their appreciation to Benjamin L. Davis and P. V. Horton for their printed-resistor developments, and to Welfred M. Redler, Melvin E. Lutton, and Clinton O. Lindseth all of the Engineering Electronics Section, National Bureau of Standards, for their support in the development work on the various models.

Interference Caused by More Than One Signal*

RAYMOND M. WILMOTTE†, FELLOW, IRE

Summary—This paper covers a theoretical survey of the factors involved in establishing the effect on a desired signal of several interfering signals, including noise. It makes some suggestions toward the solution of the problems involved, and discusses the related problem of defining service area for broadcasting in the very-high and ultra-high frequencies.

I. FACTORS AFFECTING THE MEASUREMENT OF INTERFERENCE

WHEN THERE IS more than one signal causing interference, the interfering signals will add to cause greater interference than is caused by any single one. The method by which they can be added depends on the following factors:

- A. The estimate of the median intensity of each signal;
- B. The time distribution of each signal;
- C. The correlation (if any) between the distributions of the several interfering signals;
- D. The probability distribution of the departure from the estimate of the median intensity;
- E. The type of interference (such as cochannel, adjacent channel, carrier beats, cross modulation, noise, and the like);

- F. The minimum acceptable ratio of desired to undesired signal for each type of interference;
- G. The threshold ratio of desired to undesired signal at which each type of interference becomes noticeable;
- H. The rate of change of objectionableness with signal intensity;
- I. The noise level and its distribution.

The factors will generally vary with the location so that in addition to time considerations a statistical analysis by location should be included.

A discussion on the estimate and effect of these factors follows.

A. and B. The Estimate of Median Intensity and Time Distribution

The true time distribution of each signal should be obtained by measurements over a long period; short time distributions are not satisfactory because the intensity-variations are often caused by the combination of signals arriving over different paths. During a short interval of time, the variation in intensity is often largely controlled by the variation in the phase of two or more interfering signals. It is usually only over long periods that correct information can be obtained regarding the variations in the intensity. Such long periods are needed to take care of diurnal and seasonal variations, and, in some cases, variations from year to year.

* Decimal classification: R171X R430.11. Original manuscript received by the Institute, November 28, 1949; revised manuscript received, June 29, 1950.

† Raymond M. Wilmotte, Inc., Washington, D. C.

A factor which is very difficult to translate into quantitative terms is the nature of the time distribution of the interference. An interference that occurs 10 per cent of the time only may generally be considered acceptable. On the other hand, if it occurs one second out of every ten, it will not be acceptable, but if it occurs for one month out of every ten it will be. There is need for a factor representing the period between objectionable interferences. This might possibly be achieved by counting as five minutes of continuous interference any five-minute period in which objectionable interference occurs more than a specified number of times.

C. Correlation Between Signal Distributions

Signals from two separate sources may be combined if their time distributions are known. Such estimates should strictly be divided into two parts, considering separately:

1. The parts of the time distributions which have no correlation with each other;
2. The parts of the time distributions which have some common relationship.

An example of what is being considered in this separation can be given from measurements of tropospheric waves. If measurements are made from two stations, there generally does not appear to be any correlation between the two, yet when each is analyzed separately there are found definite common diurnal and seasonal trends. These two trends should be removed from the time distribution, leaving only the uncorrelated time distribution. These can then be combined and the correlated trends reinstated to the combination to give the complete resultant time distribution. It is only when the correlation is considerable that it will become apparent in the final result.

D. The Distribution of the Departure from the Median Values.

Over a period of time signals may vary from their median values so that when the median values of two signals are added together the procedure for obtaining the median value of the resultant is not the same as if the two signals were constant in value. The median value of the resultant depends on the distribution of the value of each of the signals and the law for calculating the resultant of several signals of fixed value. If this law is a simple addition (as in the case when the peak value of the resultant is the controlling function of interference) then the median value of the resultant is equal to the sum of the median values of the individual signals. If, however, the law is an rss (root-sum-square) law (as in the case when the total power is the controlling function of interference), then the times when a signal is strong is more than proportionately influential in affecting the value of the resultant, so that the median

value of the resultant will be greater than the rss of medians of the component signals.¹

E. Type of Interference

When several interfering signals on the same frequency which are not fading are received simultaneously, it is clear that, if they all carry the same modulation, the interference will be a function of the resultant of the signals. If the component signals are of constant intensity the resultant will vary depending on the phases of the components. The median amount of desired interference will be equal to that produced by a signal having an intensity equal to the median value of the resultant of the signals. That is equal to the root-sum-square of the rms intensities of the component signals.

This may be written in the form of the equation

$$R_{med}^2 = \sum_{r=1}^{r=n} E_r^2$$

where R_{med} is the median value of the equivalent single signal causing the same interference as the sum of the signals of intensity E_1, E_2, \dots, E_n .

This solution will not be accurate if the component signals carry different programs or in any way cause different types of interference. In television, for instance, there are several easily recognizable types of interference. Two synchronous signals carrying the same program will add correctly according to this formula if they arrive at the receiver without any substantial time delay.² However, it is possible to receive besides the desired signal a number of interfering signals; one may produce "Venetian blinds," another a background of an undesired program, and another the interference due to noncoincidence of the synchronizing pulses. Two or more of these types of interference to-

¹ This statement can be given in mathematical terms as follows: When the rss rule is applicable, it can be applied to a distribution curve only at the point corresponding to the rms (root-mean-square) value. Then

$$E_{rms}^2 = \sum_{r=1}^{r=n} E_{rms,r}^2.$$

For percentages of time T shorter than that corresponding to the rms value

$$E_T^2 < \sum_{r=1}^{r=n} E_{T,r}^2$$

and for percentages of time longer than that corresponding to the rms value

$$E_T^2 > \sum_{r=1}^{r=n} E_{T,r}^2.$$

In the case of log normal distribution, it has been shown in the F.C.C. TID Report 4.2.1, "The Log-Normal Distribution" by Harry Fine, that for two equal signals

$$E_{rms} = F_{rms} + 0.00532F^2$$

where E is in db and $F = E_1/E_{99}$ db, E_1 and E_{99} being the signals exceeded 1 per cent and 99 per cent of the time, respectively. Figs. 1 and 2 show the trend of the probability curves when such equal signals as 2, 4, 8, and the like combine.

² If there is an appreciable time delay between them, they may act as though they produced quite different types of interference, so that in this case the above formula may not hold.

gether are more objectionable than one alone, but how much more? There is no experimental evidence providing an answer to this question. The problem seems similar to that of how to add oranges to elephants. It has been assumed commonly that the equivalent single signal producing the same degree of interference as several signals producing different types of interferences was equal to the root-sum-square of the product of the component signal and the minimum ratio of desired to undesired signal producing objectionable interference. This assumption is no more than a guess. It is unsupported by any experimental evidence, and, in fact, is unlikely to be correct, though in some cases it may be an adequate approximation.

In order to make correct estimates of interference, there is need of a unit for measuring objectionability. Such a unit, termed an "interference unit," is discussed below.

The lack of knowledge on the degree to which interference is objectionable, as far as allocation problems are concerned, does not exclude the possibility of making an estimate of the minimum percentage of time that

the interference is objectionable. Two broad concepts are of assistance. First, when the interferences are very strong the dominant interference is probably the only one that matters to the observer. Whether that is so or not, however, is not of interest for allocation purposes because under such conditions the reception is definitely unacceptable. The case of importance is the one in which the interference is on the borderline of being objectionable. Second, when interference from each component signal is weak, each being objectionable for only a small percentage of time ($T_1, T_2 \dots$) two or more of them will seldom be objectionable at the same time unless there is a high degree of correlation between them. If there is no correlation, the total percentage of time T_0 that at least one interfering signal produces objectionable interference is given by

$$T_0 = 100 - 100 \left(1 - \frac{T_1}{100}\right) \left(1 - \frac{T_2}{100}\right) \dots \left(1 - \frac{T_n}{100}\right)$$

$$\approx \sum_{r=1}^n T_r$$

The percentage of time T_0 is lower than the total percentage of time that the interference is objectionable by an amount T_0' during which each component interfering signal is individually too low to be objectionable, yet when combined with the others becomes objectionable.

In our present state of knowledge, it is difficult to guess to what degree of accuracy T_0 represents the percentage of time of objectionable interference, but in many practical cases it is likely to be a good approximation. The error T_0' is made up of periods when two or more signals are individually close to causing objectionable interference, for it is only then that combining several such interferences together may become objectionable. T_0' is therefore small when the percentage of time that a signal is close to being objectionable is small. That is likely to occur when the fading of the desired or undesired signals or both covers a wide range of intensity. It is less likely to occur, however, if a large change in signal intensity is required to produce a noticeable change in the objectionableness of the interference. While no quantitative values are available, it seems probable that some types of interference fall in this latter category.

When dealing with allocation, it is not so much the interference at one location that matters, but the interference at many locations, or more specifically the probability of interference with location. In this case, where probability with location is a consideration, T_0' will tend to be small if the signal intensity varies over a wide range from one location to another.

F. and G. The Minimum Acceptable and Threshold Ratio of Desired to Undesired Signals

Subjective tests, while they have not been carried out in detail seem to indicate that observers agree relatively closely on the value of the threshold point where

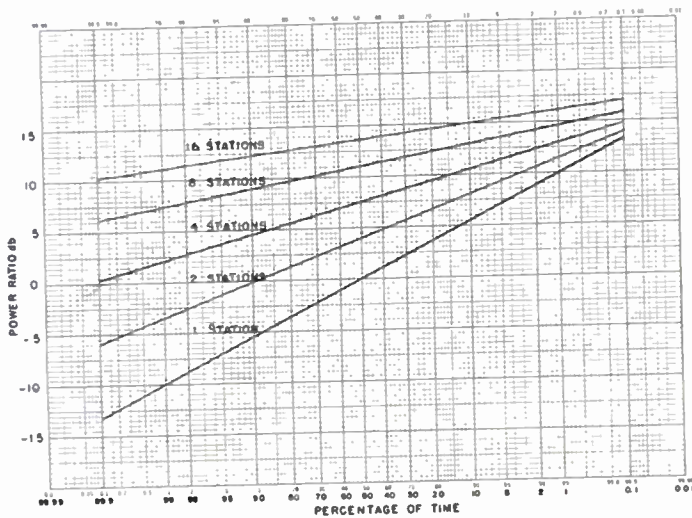

Fig. 1—Signal from several equal stations each having log normal distribution fading ratio 20 db.

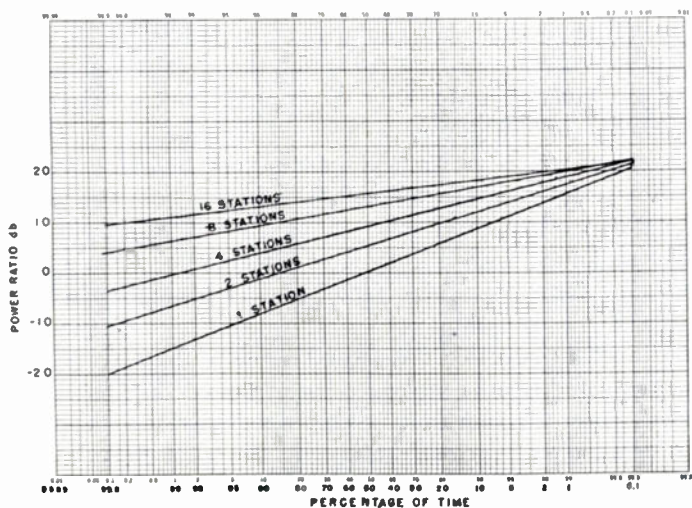

Fig. 2—Signal from several equal stations each having log normal distribution fading ratio 30 db.

interference just begins to be noticeable. The fact that they do indicates strongly that the threshold point is an important psychological quantity and justifies its use in formulas developed for evaluating total interference.

The value of the minimum acceptable ratio appears to vary over a wide range for different observers, and is therefore more difficult to estimate. It is, in part, subject to environment. A person who can only receive poor-quality signals will accept more interference than one who is accustomed to high-quality reception.

II. The Rate of Change of Objectionableness with Signal Intensity

The degree with which a type of interference varies with the desired- to undesired-signal ratio varies with the type of interference. Also, because of receiving-set characteristics as well as psychological effects, the signal intensity of the desired signal has some effect, but generally that is much less influential than the effect of the desired to undesired ratio.

I. Noise Level

Noise has usually been treated as a special kind of interference and in allocation problems it has usually been assumed that services may be rendered satisfactorily provided the signal is above a certain strength. This minimum signal strength has been estimated on the basis of the combination of the set noise, man-made noise, static noise, cosmic noise, and so forth. Actually, all these types of noise are subject to different treatment. For instance, set noise varies with each set and man-made noise varies with each location. The sum of various types of noises is therefore a statistical problem. There is no single figure which would be suitable for all locations, for all times, and for all sets. Noise should therefore be treated in the same way that other forms of interference are treated and the interference it causes added to other types of interference by the same kind of process.

It is incorrect to treat noise differently, as may be seen by considering the case of the interference caused by noise and an interfering signal from an undesired station. The combination of the two will produce more interference than each one separately. That result will be shown in the calculations if noise is treated as another interference, but it will not if it is treated, as has been customary, by merely requiring a certain minimum signal intensity to overcome it, and considering other interferences independently.

II. THE INTERFERENCE UNIT

A. Need for Unit

In order to ascertain whether the degree to which an interference is objectionable varies over a wide range as the signal intensity varies, and how different types of interferences combine in terms of objectionableness, three things are necessary: first, to establish a unit, which might conveniently be called an "interference

unit"; second, to find how the interference varies with the ratio of desired to undesired signal and for different types of interference; third, how interference units for different types of interference may be added together.

A satisfactory definition of interference unit must be one which will provide a simple relationship between interference and signal intensity and which will also provide a simple formula for adding different types of interference. A suitable definition should make it possible to state that with a given ratio of desired to undesired signal of a certain type of interference the objectionableness is (x) interference units. If another interfering signal of a different type exists which alone would produce (y) interference units, then the total objectionableness would be a simple function of x and y , preferably ($x+y$) interference units. A prime requirement is that the same degree to which an interference is objectionable should be experienced with any type of interfering signal producing the same number of interference units.

The establishment of an interference unit would require subjective tests to establish the correlation between "objectionableness" and the ratio of desired to undesired signals of different types.

B. Suggestions for Subjective Tests

To carry out subjective tests in order to establish a formula for measuring the degree to which an interference is objectionable, it is desirable to establish a certain type of interference as a standard and compare other types with it. A convenient standard is an unmodulated carrier having a specified frequency difference with the carrier of the desired signal.

Having established a type standard, two identical receivers should be used. Both receivers carry the same program with one carrying a specified amount of the standard interference and the other carrying the interference under test. The program used should be of sufficient interest that the audience (which is now the detecting instrument) has a substantial degree of enjoyment in hearing or viewing it. Arrangements should be provided so that each member of the audience may select at will the reception for which the interference seems to him least objectionable. After a reasonable time each member of the audience will automatically select the program which he finds is least objectionable as far as the interference is concerned. The intensity of the interference is then changed in steps until fifty per cent of the audience finds one type of interference more satisfactory than the other. This test will provide information of the undesired to desired ratio of signal strength required to produce the same degree of interference as is produced by the standard interference. The interference under test can then be combined with the standard interference in various ratios, and the total disturbance compared with the standard. The result of this and similar tests will provide information on how interferences add together.

C. Possible Definition of Interference Unit

Without a background of quantitative subjective tests it is probably futile to try to imagine what will be a suitable definition of an interference unit which meets the requirements of accuracy and simplicity. The suggestion made here for a definition is not to suggest the adoption of this unit, but to assist in the concept of it and thereby possibly help in the planning of subjective tests. The following train of reasoning leads to the definition given below.

It can readily be shown that the degree to which a signal is objectionable is not directly proportional to the ratio of undesired to desired signal. It can also be shown that for a certain ratio, a certain type of interference may be more objectionable than another, while for another ratio it may be less objectionable. The definition given below meets at least these qualitative requirements, but is given only as an example to explain the application of the use of an interference unit.

An interference which is below threshold is not noticeable. Hence, to add such an interference to one of another type already existing is not likely to increase the degree of interference. (Subjective tests may prove this to be incorrect when there are many different types of interference just below threshold.) This argument, if it is correct, leads to the suggestion that interference should use the threshold value as zero and be measured from that point up. Since most physiological reactions are logarithmic in character, it is therefore possible (again subject to tests so proving) that the degree to which an interference is objectionable may be measured as the quotient of two ratios; first, the ratio of desired to undesired signals, and second, that same ratio at the threshold point. This conclusion may be written mathematically as follows:

$$I = k(p - \sigma)$$

where I interference units are the "objectionableness" of the interference; p db is the ratio of the desired to undesired signal; σ db is the ratio of the desired to undesired signals at threshold and is dependent on the type of interference; and k is a constant dependent on the type of interference. If p_A is the minimum acceptable ratio of desired to undesired signal, then the minimum acceptable interference I_A is given by

$$I_A = k(p_A - \sigma).$$

For the standard type of interference, $k = 1$. If σ_s is the ratio of desired to undesired signal at the threshold for the standard, and p_A , the minimum acceptable ratio, then, if the above assumptions should prove to be sufficiently correct,

$$k = \frac{p_A - \sigma_s}{p_A - \sigma}.$$

Under those conditions the key values for any particular type of interference would therefore be p_A and σ to-

gether with the corresponding values for the standard type of interference.

III. THE EFFECT OF ADDING INTERFERENCE ON THE AREA OR ON THE NUMBER OF PERSONS RECEIVING A SATISFACTORY SIGNAL

In many places in the United States, the service area of a station will be limited principally by the interference from other stations. The estimate of its service will depend greatly, therefore, on the estimate of the interference caused by several signals causing different types of interference. Their effect on the service area will also depend greatly on the definition of service area. In fact the definition of service area may have a great influence on the service rendered, particularly in areas saturated with stations.

The field-strength contour which is free from objectionable interference for a specified percentage of the time (90 per cent) has been taken in the Standards of Good Engineering Practice of the Federal Communications Commission as the limiting service contour of a station in the regular broadcast band. In the vhf and uhf bands there is no such contour, for on both sides of a contour there are persons receiving good signals for more than 90 per cent of the time. There are also on both sides persons receiving interference-free signals for less than 90 per cent of the time who find such signals acceptable. On both sides also there are persons receiving interference-free signals 80 per cent, possibly even 50 per cent, of the time and who find them acceptable.

It has been suggested that a contour be established as the limiting service contour where a specified percentage of the receiving locations (say 50 per cent) receive interference-free service not less than a specified percentage of the time (say 90 per cent). Any such definition of service tends to conceal some of the real facts. It tends to conceal the fact, for instance, explained in reference II to the Ad Hoc Committee Report, that the service deterioration is much more rapid when the service is limited by adjacent-channel interference than when it is limited by cochannel interference.³ If a new station is installed causing interference, the number of persons affected is therefore not equal to the number of persons lying between lines representing the old and the new calculated service contours, for it will affect considerably many persons within the new service contour while some outside of it will not be affected as much. Actually, the number of persons affected will depend greatly on the type of interference.

It seems desirable, therefore, to be able to estimate the service area in terms of the number of persons or

³ A graphical representation applicable to television is shown in Figs. 3 and 4 taken from reference II by R. M. Wilmotte and Harry Fine of the Ad Hoc Committee report. From the curves at any desired distance, the total percentage of locations receiving a specific grade of service or better can be read directly. Comparing Fig. 3, which refers to cochannel interference, and Fig. 4, which refers to adjacent-channel interference, shows clearly that in the case of adjacent-channel interference the service deteriorates with distance much more rapidly than in the case of cochannel interference.

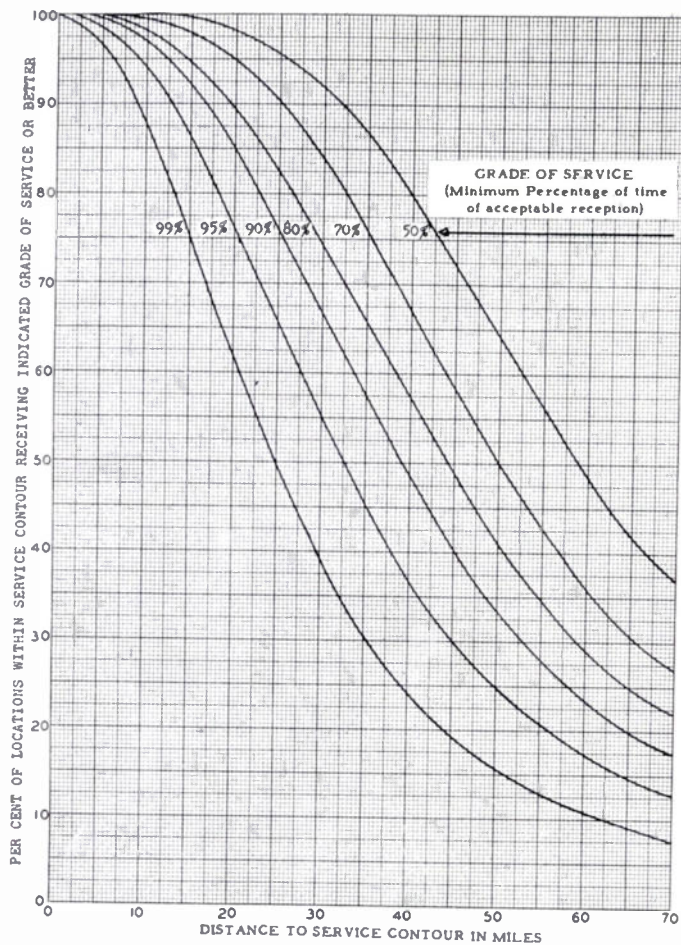

Fig. 3—Cochannel interference. Distance to service contour along radial between desired station and interfering station versus percentage of locations within service contour for various minimum grades of service. Frequency, 82 Mc; transmitting antenna heights, 500 feet; receiving antenna heights, 30 feet; equal power for both stations; station spacing, 150 miles; interference ratio, 40 db; type of area, rural.

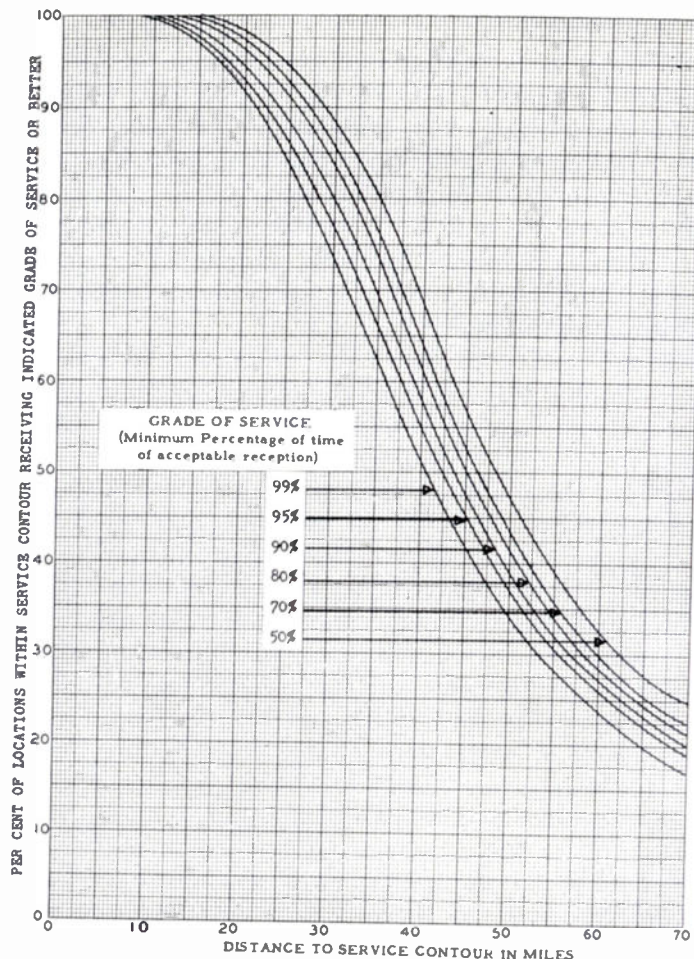

Fig. 4—Adjacent channel interference. Distance to service contour along radial between desired station and interfering station versus percentage of locations within service contour for various minimum grades of service. Frequency, 82 Mc; transmitting antenna heights, 500 feet; receiving antenna heights, 30 feet; equal power for both stations; station spacing, 75 miles; interference ratio, 6 db; type of area, rural.

receiving locations having a specified grade of service. The deterioration of the service due to a new source of interference could then be properly evaluated.

It would not be proper to find simply the total potential man hours of reception of interference-free signals, for clearly a person receiving a good signal only ten per cent of the time could hardly be considered as receiving a service at all. Ten-thousand such would not represent one-thousand man hours, they would represent more closely zero useful hours of reception.

It is suggested, therefore, that, in order to evaluate at least approximately the effect of an interfering signal, several grades of radio service be defined based only on the percentage of time of reception free from objectionable interference. (For instance, Grade A, 90 per cent or more of the time; Grade B, 70 per cent or more; and Grade C, 50 per cent or more. A minor modification of this may be considered as an alternative; namely, to

consider Grade A service as a service between 90 per cent and 100 per cent of the time; Grade B as service between 70 per cent and 90 per cent, and Grade C as service between 50 per cent and 70 per cent.) Inside a specified area served by vhf or uhf there will be persons receiving Grades A, B, or C service, or worse, depending on their location. The complete description of a service would then include the total area and the total number of persons expected to receive each grade of service.

ACKNOWLEDGMENTS

This paper in substantially this form was prepared for a subcommittee of the Ad Hoc Committee of the Federal Communications Commission. The author wishes to thank the members of the subcommittee, William Boese, Kenneth Norton, and Harry Fine, for helpful suggestions, particularly the latter who spent much time reading critically the original report.

The *p*-Germanium Transistor*

W. G. PFANN† AND J. H. SCAFF‡

Summary—The transistor effect in *p*-type germanium is discussed and some properties are given for *p*-germanium transistors made in the laboratory. These exhibit higher cutoff frequency and somewhat lower current multiplication than their *n*-germanium counterparts. Under certain conditions a negative resistance “snap” effect is observed which is apparently peculiar to *p*-type germanium. Both types of transistor are governed by the same physical principles but they differ in the signs of the emitted carriers and of the bias voltages.

IN THE TRANSISTOR described by Bardeen and Brattain^{1,2} two adjacent metallic points make rectifying contact to one surface of a small block of germanium. A third large-area contact comprises the base electrode. The point electrodes are designated emitter and collector and form the input and output terminals, respectively, of the transistor when connected as an amplifier. The basic material of the transistor described by Bardeen and Brattain is the electronic semiconductor, *n*-germanium.

The transistor effect has also been produced in the semiconductor *p*-germanium and a number of experimental *p*-germanium transistors have been made in the laboratory.³ The preparation and properties of such *p*-germanium transistors are described herein, following a brief description of some characteristics of the semiconductors, *n*- and *p*-germanium.⁴

Germanium is an electronic semiconductor. Its electrical conductivity lies between those of metals and insulators. The conductivity can be increased by the addition of certain elements to the germanium. Such addition elements produce carriers of electrical charge which contribute directly to the conductivity. Addition elements fall into one of two classes, depending on the type of conductivity which they produce. Elements in Group V of the Periodic System donate conduction electrons to the germanium, thereby producing *n*-type (*n* for negative) conductivity. Elements of Group III accept an electron from the germanium lattice, leaving therein a net positive charge, or “hole,” which can move freely through the lattice, producing *p*-type (*p* for positive) conductivity.⁵ The existence of negative or positive carriers in semiconductors such as germanium can be demonstrated experimentally by measurement of the

Hall voltage, which is a transverse electromotive force produced by a magnetic field in a current-carrying conductor, the sign of the Hall voltage depending upon the sign of the moving carriers.

In actual practice, relatively pure *n*- or *p*-germanium, of resistivity on the order of 10 ohm-centimeters, has been used. Residual impurities may produce sufficient *n*-type conductivity for the requirements of transistors and high back-voltage rectifiers. Furthermore it has been shown by Scaff and Theuerer that such *n*-germanium can be thermally converted to *p*-germanium by heating at about 600°C or higher followed by quenching.^{6,7} Such *p*-germanium, as well as *p*-germanium produced by additions of aluminum, have been used for the *p*-type transistors discussed herein.

While a good rectifying junction can be made between a metallic point and either *n*- or *p*-germanium, it should be noted that the polarity of the rectifying junction depends on the conductivity type of the semiconductor. Table I shows the polarity of the point with respect to the semiconductor in the two cases.

TABLE I

Conductivity Type of the Semiconductor	Polarity of Point	
	Forward Direction	Reverse Direction
<i>n</i> type	+	-
<i>p</i> type	-	+

In either type of transistor the collector is biased in the reverse direction and the emitter is usually biased in the forward direction. Operation of the *n*-germanium transistor may be explained on the basis that the current which passes through the emitter consists largely of holes, i.e., of carriers of opposite sign to those normally in excess in the body of the germanium. The holes are attracted to the negatively biased collector, so that a large part of the emitter current, introduced at low impedance, flows into the collector circuit and through a high impedance load, as may be seen in Fig. 1.

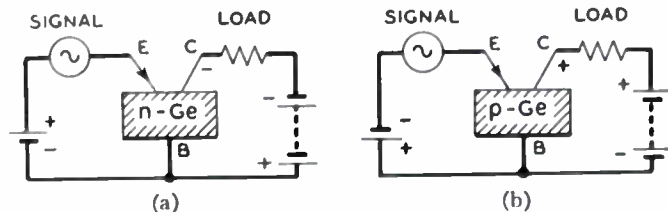

Fig. 1—Schematics showing operation of (a) *n*-germanium transistor, and (b) *p*-germanium transistor.

* Decimal classification: R282.12. Original manuscript received by the Institute, May 25, 1950.

† Bell Telephone Laboratories, Inc., Murray Hill, N. J.
¹ J. Bardeen and W. H. Brattain, “The transistor, a semiconductor triode,” *Phys. Rev.*, vol. 74, p. 230; July 15, 1948.

² J. Bardeen and W. H. Brattain, “Physical principles involved in transistor action,” *Phys. Rev.*, vol. 75, pp. 1208-1225; April 15, 1949. And *Bell Sys. Tech. Jour.*, vol. 28, pp. 239-277; April, 1949.

³ W. G. Pfann and J. H. Scaff, “The *p*-germanium transistor,” *Phys. Rev.*, vol. 76, p. 459; August, 1949.

⁴ For further information on electronic conduction in germanium, see footnote reference 2.

⁵ J. H. Scaff, H. C. Theuerer, and E. E. Schumacher, “*P*-type and *N*-type silicon and the formation of the photovoltaic barrier in silicon ingots,” *Jour. Met.*, vol. 185, pp. 383-388; June, 1949.

⁶ J. H. Scaff and H. C. Theuerer, “Preparation of High Back Voltage Germanium Rectifiers,” National Defense Research Council, NDRC 14-555, October 24, 1945.

⁷ H. C. Torrey and C. A. Whitmer, “Crystal Rectifiers,” McGraw-Hill Book Co., New York, N. Y., chap. 12; 1948.

The result is a voltage gain and a power gain of an input signal. There may be an amplification of current as well.

In the *p*-germanium transistor a large part of the emitter current consists of electrons, which enter the germanium and are drawn to the positively biased collector. Voltage gain and current gain occur, just as in the *n*-type transistor.

The characteristics of the two types of transistor are such that in both, the output voltage is in phase with the input voltage for the grounded-base connection shown in Fig. 1. The input and output currents, however, are 180° out of phase in both types.

A transistor construction which has been found useful for laboratory studies is shown in Fig. 2. The germanium wafer assembly and the contact spring assembly are force-fitted into a metallic sleeve which serves also as the base electrode. The germanium surface is etched as has been described^{6,7} for high back-voltage rectifiers, the etchant not being particularly critical. The con-

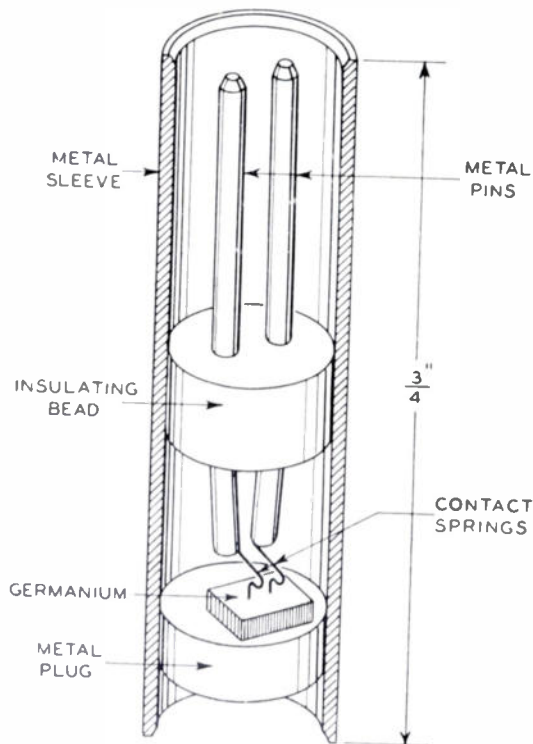

Fig. 2—Transistor construction used for laboratory studies.

tact springs are mounted on supporting pins which have previously been molded in a bakelite compound. The contact springs are phosphor bronze wires, 0.002 inch in diameter. Their tips are usually several mils apart; the wider spacing shown in Fig. 2 was used for clarity of illustration.

The ability of the emitter to inject electrons into *p*-germanium is greatly increased by an electrical forming treatment.⁸ If desired, both point electrodes may

⁸ J. Bardeen and W. G. Pfann, "Effects of electrical forming on the rectifying barriers of *n*- and *p*-germanium transistors," *Phys. Rev.*, vol. 77, pp. 401-402; December, 1950.

be pulsed, thereby enabling either point to be used as an emitter.⁹

The ac small signal performance of the *p*-germanium transistor at relatively low frequencies may be described with the help of the equivalent circuit of Fig. 3. The impedance associated with the emitter contact is r_e , and because the emitter junction is usually biased in the forward direction, r_e is small, of the order of hun-

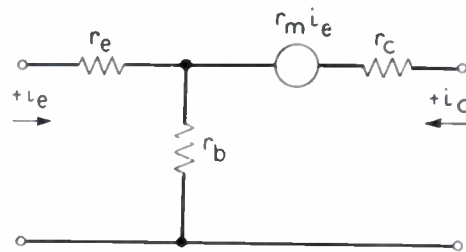

Fig. 3—Equivalent circuit representation of the transistor.

dreds of ohms. The impedance associated with the collector junction r_c is relatively high because the collector is biased in the reverse direction. The impedance in the semiconductor common to emitter and collector currents, r_b , represents a positive feedback. The transfer impedance r_m represents the active properties of the network. This network corresponds to the grounded-base connection.

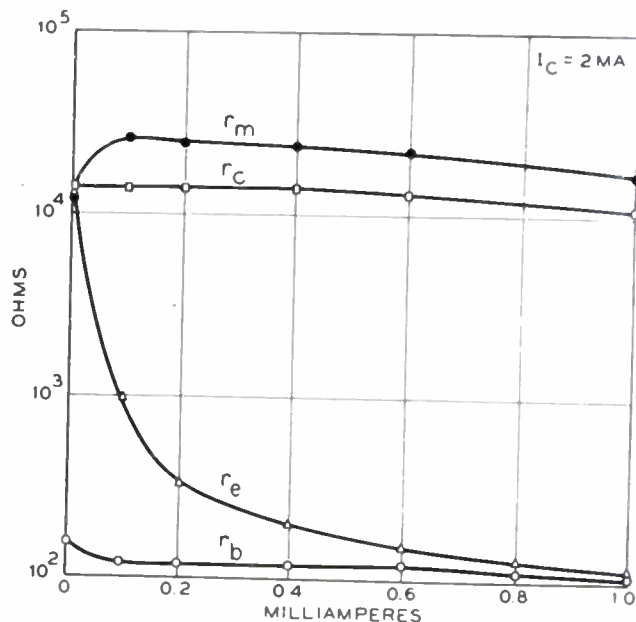

Fig. 4—Small-signal self- and transfer-impedances of a representative *p*-germanium transistor.

Some properties of a representative *p*-germanium transistor are shown in Fig. 4 in terms of these impedances. The r 's are plotted as functions of emitter current for a constant collector current of +2.0 milliamperes. At values of emitter current above a few tenths of a milliampere the impedances have the following approximate values:

$$\begin{aligned} r_e &\sim 200 \text{ ohms} & r_c &\sim 12,500 \text{ ohms} \\ r_b &\sim 100 \text{ ohms} & r_m &\sim 22,000 \text{ ohms} \end{aligned}$$

⁹ W. G. Pfann, correspondence, "The transistor as a reversible amplifier," *PROC. I.R.E.*, this issue, p. 1222.

The ratio r_m/r_c is approximately equal to α , the current multiplication factor and as may be seen, α is greater than 1, usually being from about 1.5 to 2. The significance of $\alpha > 1$ in terms of the physical operation of the transistor is that a given change in emitter current causes a larger change in the current through the collector.

As in the case of *n*-germanium, the gain of the *p*-germanium transistor falls off at frequencies in the megacycle range. Although we do not have an entirely complete comparison of the *n* and *p* devices, in which all quantities except frequency response are held constant, it does appear that the *p*-germanium transistor will operate at higher frequencies. Cutoff frequencies above 15 megacycles are common. (The cutoff frequency is that at which α is down 6 db.) Measurements of cutoff frequency have been made by Rack and are plotted against distance between emitter and collector for both types of transistor in Fig. 5.

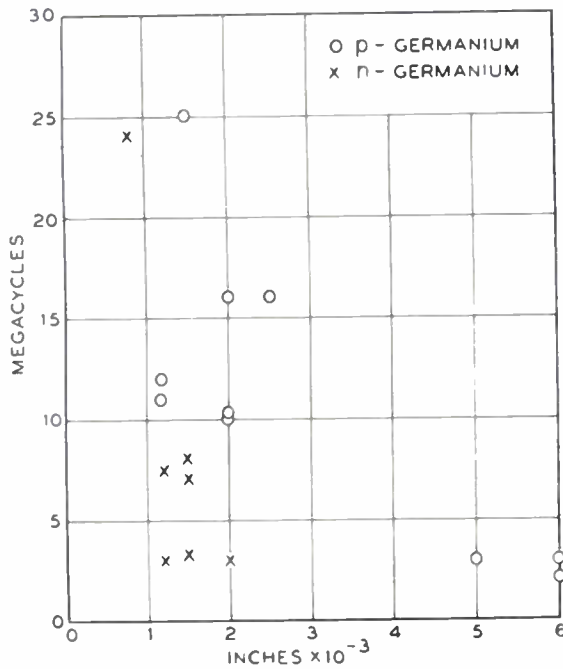

Fig. 5—Cutoff frequency of *n*-germanium and *p*-germanium transistors as a function of distance between emitter and collector.

An inherent feature of the *p*-germanium transistor may be at least partly responsible for its superiority in frequency response. It has been shown by recent measurements¹⁰ that the mobility of electrons in germanium exceeds that of holes by a factor of about 1.5. Since the emitted carriers in the *p*-germanium transistor are electrons, and since it is dispersion in transit times of emitted carriers which limits the operating frequency, the observed superiority of the *p*-germanium transistor is at least partly to be expected.

The *p*-germanium transistor has a peculiarity which is found when the germanium is of particularly high resistivity. In such instances the forward current-volt-

age characteristic of the emitter has a negative resistance region of the voltage-maximum type, the peak voltage being on the order of several tenths of a volt. When the emitter bias exceeds this peak voltage, and if the series resistance in the emitter circuit is low, a sudden increase in I_e occurs which causes a corresponding change in the collector circuit. This action has been called the snap effect and may be seen in Fig. 6, which is a photograph of an oscilloscope trace in which the current-voltage characteristic of the collector junction is traced out at a frequency of 60 cycles per second, the voltage axis being horizontal, current axis vertical. The nearly horizontal portion of the trace represents the

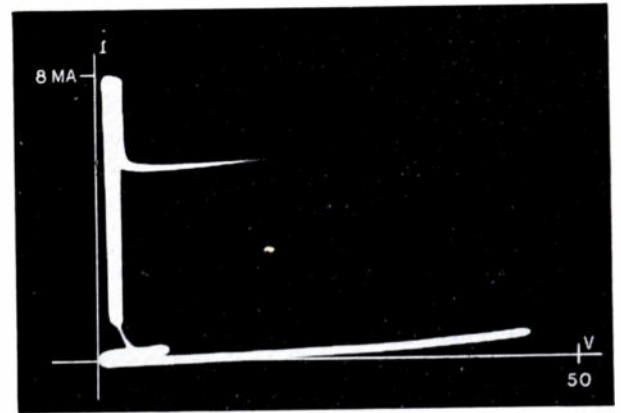

Fig. 6—Oscillograph pattern showing "snap" effect in *p*-germanium transistor.

reverse current through the collector for an emitter bias which is barely below the voltage maximum. At the extreme tip of the characteristic a small amount of positive feedback due to increase in collector current has caused the emitter bias to just exceed the voltage maximum. As a result the collector trace snaps suddenly to the high-current position as indicated by the vertical trace. The return trace remains in the low resistance position until the current falls to a small value, whereupon the characteristic again "snaps" back to the high-resistance position.

It is emphasized that the negative resistance in the forward current-voltage characteristic of the emitter is a diode effect, which can occur in a single point contact to *p*-germanium. It should not be confused with a similar effect which can be produced in an ordinary transistor by placing positive feedback resistance in the common base lead. However, the finite value of r_b does enter into the explanation of Fig. 6.

On the basis of a limited number of measurements there does not appear to be a significant difference in noise performance of *n*- and *p*-germanium transistors. Noise figures for *n*-germanium transistors are given in the literature.¹¹

¹⁰ W. Shockley, G. L. Pearson, and J. R. Haynes, "Hole injection in germanium," *Bell Sys. Tech. Jour.*, vol. 28, pp. 344-366; July, 1949.

¹¹ R. M. Ryder and R. J. Kircher, "Some circuit aspects of the transistor," *Bell Sys. Tech. Jour.*, vol. 28, pp. 367-400; July, 1949.

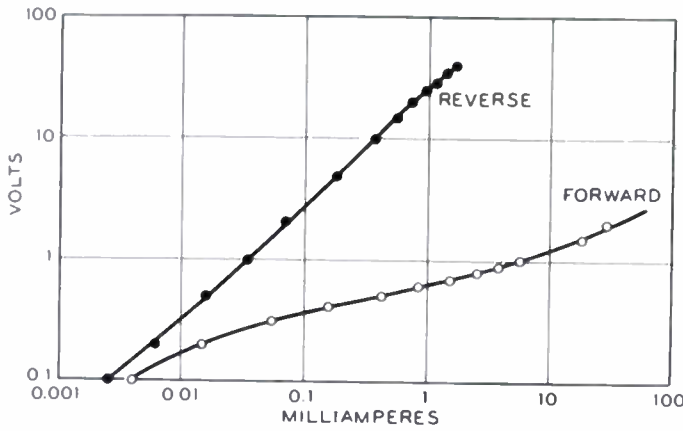

Fig. 7—Current-voltage characteristic of collector junction in a representative *p*-germanium transistor.

While it does not appear to have been recognized generally,^{12,13} useful point contact rectifiers can be made with *p*-germanium. We have found that rectifier properties approaching those of high back-voltage *n*-germanium can be obtained by pulsing high-resistivity, thermally-converted *p*-germanium. The forward resistance before pulsing is high, on the order of thousands of ohms at one volt, but is greatly decreased by pulsing, to values on the order of 100 ohms or less. The reverse re-

¹² See p. 63 of footnote reference 7.

¹³ W. C. Dunlap, Jr., and E. F. Hennelly, "Non-rectifying," *Phys. Rev.*, vol. 74, p. 976; October, 1948.

sistance is essentially unaffected by pulsing, and peak reverse voltages above 100 volts are common. A theoretical interpretation of electrical forming effects in *n*- and *p*-germanium has been made by Bardeen and Pfann.⁸

In Fig. 7 are shown the current-voltage characteristics of the collector junction in a representative *p*-germanium transistor at zero emitter current. Here, the reverse impedance is lower than the highest which can be obtained for it has been found, in common with the *n*-germanium transistor, that too high a reverse impedance is incompatible with best collector performance.

The attainment of transistor action in both *n*- and *p*-germanium provides further illustration of the dual nature of conduction processes in semiconductors such as germanium. In the *n*-type transistor, positive holes are injected into a semiconductor normally having an excess of electrons; in the *p*-type transistor, electrons are injected and the semiconductor normally has an excess of holes. In general, the properties of the *n*- and *p*-germanium transistors are similar, although in devices made up to the present time the *n*-germanium device appears to be superior in α and inferior in frequency response to the *p*-germanium transistor. The present differences may be as much a result of the early status of transistor technology as of fundamental differences between the semiconductors themselves.

Asymmetrically Driven Antennas and the Sleeve Dipole*

RONOLD KING†, SENIOR MEMBER, IRE

Summary—The problem of determining the distribution of current in and the impedance of a cylindrical antenna asymmetrically driven by a discontinuity in scalar potential is formulated. An integral equation is derived and solved by the method of successive approximations to obtain general expressions for the current and the impedance. A simple approximate expression for the impedance of the asymmetrically driven antenna involving a series combination of the known impedances of symmetrically driven antennas is obtained. The impedance and the distribution of current for a cylindrical

antenna of length $3\lambda_0/4$ driven $\lambda_0/4$ from one end are evaluated. The broad-band properties are discussed.

Since the sleeve dipole with its image is equivalent to a superposition of two asymmetrically driven antennas, expressions for the impedance and distribution of current are obtained readily from the current distribution of the asymmetrically driven antenna. Both impedance and current distribution are determined for a sleeve dipole of over-all length $3\lambda_0/4$ over a conducting plane driven $\lambda_0/4$ from the plane. It is shown that this antenna has broad-band properties very superior to those of a conventional dipole.

I. CURRENT AND IMPEDANCE FOR ASYMMETRICALLY DRIVEN CYLINDRICAL ANTENNAS

SINCE THE CENTER-DRIVEN cylindrical antenna is symmetrical with respect to its center, the currents in the halves are the same, $I(-z) = I(z)$,

and a single integral equation is involved. If the antenna is not center-driven, numerous complications arise. Most important is the fact that a transmission line feeding the antenna as in Fig. 1 is not in a neutral plane and is unbalanced by the different lengths of conductor attached to its ends. As a result, the transmission line is an important part of the radiating system since the co-directional components of current contribute significantly to the far-zone electromagnetic field. A radiating system which includes the transmission line as a radiating element is always undesirable. Obviously, the length and the location of the line should not play a part

* Decimal classification: R326.611. Original manuscript received by the Institute, February 21, 1950.

The research reported in this paper was made possible through support extended Cruft Laboratory, Harvard University, jointly by the Navy Department (Office of Naval Research), the Signal Corps of the U. S. Army, and the U. S. Air Force, under ONR Contract N5ori-76, T. O. 1.

† Cruft Laboratory, Harvard University, Cambridge, Mass.

in determining the field characteristics of an antenna system.

The only manner in which an asymmetrical antenna can be driven without introducing a radiating transmission line is by a generator completely within the

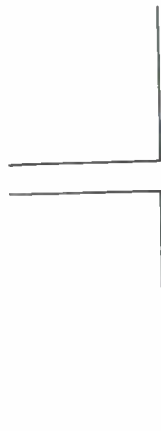

Fig. 1—Asymmetrical antenna driven by two-wire line.

metal surfaces of the antenna. Possible arrangements are those shown in Fig. 2. Except for projectiles, an-

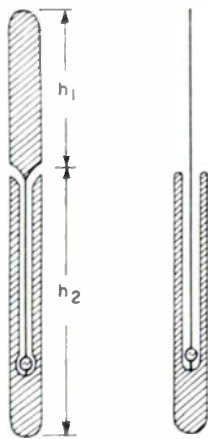

Fig. 2—Asymmetrical antenna internally driven.

tennas of this type are not practically important. However, a very useful antenna, the sleeve dipole, in which the radiating currents are equivalent to the superposition of the current in two asymmetrical driven antennas, is discussed later. Moreover, one step in the analysis of the collinear antenna¹ involves the determination of the current in an asymmetrical antenna center-driven by a discontinuity in scalar potential, i.e., by a slice generator.

The antenna to be analyzed is the thin cylindrical antenna drive off-center by a discontinuity in scalar potential at $z=0$ as shown in Fig. 3. As in the analysis of the center-driven antenna, it is assumed that currents and charges are confined to the cylindrical envelope of radius a . Account may be taken of other surfaces at the

driving point if they exist just as for the center-driven cylinder. At the extremities, hemispherical ends approximate the idealized cylinder which has no chargeable surfaces other than on the cylinder itself. For simplicity, terms involving the surface impedance per unit length z' are omitted so that the analysis applies strictly to a perfect conductor.

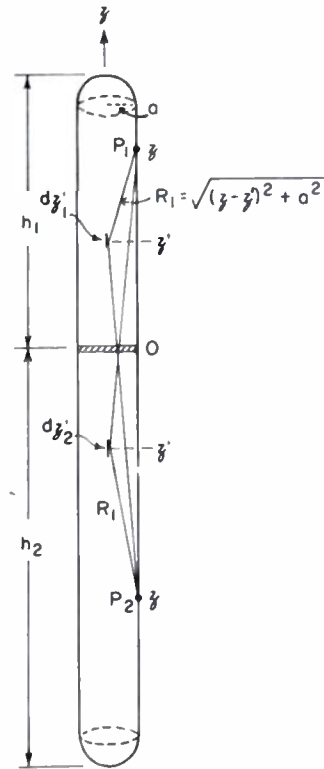

Fig. 3—Asymmetrically driven antenna to illustrate the notation.

Since the two parts of the antenna are not equal in length the distributions of current on them are necessarily different. This means that two currents, I_{1z} for $(0 \leq z \leq h_1)$ and I_{2z} for $(-h_2 \leq z \leq 0)$, must be determined subject to the condition that they join smoothly at $z=0$; that is

$$I_{10} = I_{20} = I_0. \tag{1}$$

The currents I_{1z} and I_{2z} are the unknowns in a pair of simultaneous integral equations. The equations are obtained, just as for the center-driven antenna,² by equating the Helmholtz integral for the vector potential to the solution of the differential equation for the vector potential. They are

$$\begin{aligned} 4\pi\nu_0 I_{1z} &= \int_0^{h_1} I_{1z'} K_1(z, z') dz' + \int_{-h_2}^0 I_{2z'} K_1(z, z') dz' \\ &= \frac{-j4\pi}{\xi_0} [C_1 \cos \beta_0 z + C_2 \sin \beta_0 z]; \end{aligned} \tag{2a}$$

¹ R. King, "Theory of Collinear Antennas," Cruft Laboratory Technical Report No. 91, October 3, 1949. To be published in *Jour. Appl. Phys.*

² R. King and D. Middleton, "The cylindrical antenna: current and impedance," *Quart. Appl. Math.*, vol. 3, p. 302; January, 1946.

$$4\pi\nu_0 I_{2z} = \int_a^{h_1} I_{1z'} K_1(z, z') dz' + \int_{h_2}^a I_{2z'} K_1(z, z') dz' + \int_{h_2}^a [I_{2z'} - I_{1z} g_{12}(z, z')] K_1(z, z') dz' \quad (13a)$$

$$= \frac{-j4\pi}{\zeta_0} [C_3 \cos \beta_0 z + C_4 \sin \beta_0 z]; \quad \Pi_2(z) \equiv \int_a^{h_1} [I_{1z'} - I_2 g_{21}(z, z')] K_1(z, z') dz' + \int_{h_2}^a [I_{2z'} - I_2 g_{22}(z, z')] K_1(z, z') dz' \quad (13b)$$

$$(-h \leq z \leq 0) \quad (2b)$$

where $\beta_0 = 2\pi/\lambda_0$, $\zeta_0 = 376.7$ ohms, and

$$K_1(z, z') \equiv \frac{e^{-j\beta_0 R_1}}{R_1}; \quad R_1 \equiv \sqrt{(z' - z)^2 + a^2} \quad (3)$$

These two equations must be solved for I_{1z} and I_{2z} subject to (1) and the conditions

$$I_{1z} = 0, \quad z = h_1; \quad I_{2z} = 0, \quad z = -h_2 \quad (4)$$

$$V_0 = \lim_{\delta \rightarrow 0} [\phi_1(\delta) - \phi_2(-\delta)] = \phi_1(0) - \phi_2(0). \quad (5)$$

The scalar potential ϕ is obtained as follows:

$$\phi_1(z) = \frac{j\omega}{\beta_0^2} \frac{\partial I_{1z}}{\partial z} = -C_1 \sin \beta_0 z + C_2 \cos \beta_0 z \quad (6)$$

$$\phi_2(z) = \frac{j\omega}{\beta_0^2} \frac{\partial I_{2z}}{\partial z} = -C_3 \sin \beta_0 z + C_4 \cos \beta_0 z. \quad (7)$$

Let

$$V_{10} \equiv \lim_{\delta \rightarrow 0} [\phi_1(\delta) - 0] = C_2; \quad V_{20} \equiv \lim_{\delta \rightarrow 0} [0 - \phi_2(-\delta)] = -C_4. \quad (8)$$

With (5)

$$V_0 = \lim_{\delta \rightarrow 0} [\phi_1(\delta) - \phi_2(-\delta)] = V_{10} + V_{20} = C_2 - C_4. \quad (9)$$

The distribution functions for the currents may be introduced as follows:

$$f_1(z) \equiv I_{1z}/I_0; \quad f_2(z) = I_{2z}/I_0 \quad (10)$$

$$g_{11}(z, z') = f_1(z')/f_1(z); \quad g_{22}(z, z') = f_2(z')/f_2(z) \quad (11a)$$

$$g_{12}(z, z') = f_2(z')/f_1(z); \quad g_{21}(z, z') = f_1(z')/f_2(z). \quad (11b)$$

Let the following functions be defined:

$$\Psi_1(z) \equiv \int_a^{h_1} g_{11}(z, z') K_1(z, z') dz' + \int_{-h_2}^a g_{12}(z, z') K_1(z, z') dz'; \quad (0 \leq z \leq h_1) \quad (12a)$$

$$\Psi_2(z) \equiv \int_a^{h_1} g_{21}(z, z') K_1(z, z') dz' + \int_{-h_2}^a g_{22}(z, z') K_1(z, z') dz'; \quad (-h_2 \leq z \leq 0) \quad (12b)$$

$$\Pi_1(z) \equiv \int_a^{h_1} [I_{1z'} - I_{1z} g_{11}(z, z')] K_1(z, z') dz'$$

The functions $\Psi_1(z)$ and $\Psi_2(z)$ are the ratios of vector potential to current at points z on the two parts of the antenna if $f_1(z)$ and $f_2(z)$ are the true distributions of current. These ratios are predominantly real and sensibly constant over each of the two parts of the antenna.² Therefore, let

$$\Psi_1(z) = \Psi_1 + \gamma_1(z); \quad \Psi_2(z) = \Psi_2 + \gamma_2(z) \quad (14)$$

where

$$\Psi_1 = |\Psi_1(z_r)|; \quad \Psi_2 = |\Psi_2(z_r)| \quad (15)$$

and z_r is a reference point on each part at which the magnitude of $\Psi(z)$ approximates the mean constant value of $|\Psi(z)|$. The complex functions $\gamma_1(z)$ and $\gamma_2(z)$ are very small except near the respective ends at $z = h_1$, $z = -h_2$ where they become infinite, but $I_2 \gamma(z)$ vanishes.

With (10) to (15) and (9), (2) becomes

$$I_{1z} [\Psi_1 + \gamma_1(z)] + \Pi_1(z) = \frac{-j4\pi}{\zeta_0} [C_1 \cos \beta_0 z + V_{10} \sin \beta_0 z]; \quad (0 \leq z \leq h_1) \quad (16a)$$

$$I_{2z} [\Psi_2 + \gamma_2(z)] + \Pi_2(z) = \frac{-j4\pi}{\zeta_0} [C_3 \cos \beta_0 z - V_{20} \sin \beta_0 z]; \quad (-h_2 \leq z \leq 0). \quad (16b)$$

If the functions $f_1(z)$ and $f_2(z)$ were the true distributions of current, the difference integrals $\Pi_1(z)$ and $\Pi_2(z)$ necessarily would be zero. Since the true distributions are actually the unknowns, approximate distributions must be used, in which case $\Pi_1(z)$ and $\Pi_2(z)$ are the smaller the more closely the assumed distribution functions represent the true currents. It follows that the principal terms on the left are $I_{1z} \Psi_1$ and $I_{2z} \Psi_2$. Hence

$$I_{1z} = \frac{-j4\pi}{\zeta_0 \Psi_1} [C_1 \cos \beta_0 z + V_{10} \sin \beta_0 z - \frac{1}{\Psi_1} [\gamma_1(z) + \Pi_1(z)]]; \quad (0 \leq z \leq h_1) \quad (17a)$$

$$I_{2z} = \frac{-j4\pi}{\zeta_0 \Psi_2} [C_3 \cos \beta_0 z - V_{20} \sin \beta_0 z - \frac{1}{\Psi_2} [\gamma_2(z) + \Pi_2(z)]]; \quad (-h_2 \leq z \leq 0). \quad (17b)$$

The simultaneous integral equations (17a) and (17b) involve no approximations not already contained in (2). They represent merely a rearrangement of the terms. However, the unknown currents I_{1z} and I_{2z} in (17a) and

(7b) occur in two types of terms, namely, the principal terms on the left and the difference integrals $\Pi_1(z)$ and $\mathbf{I}(z)$ on the right which are small if well-chosen distribution functions $f_1(z)$ and $f_2(z)$ are used. These equations may be solved by the same method of iteration used for the center-driven antenna.² The final formulas are as follows:

$$I_{1z} = \frac{j4\pi V_{10}}{\zeta_0 \Psi_1} \left\{ \frac{\sin \beta_0(h_1 - z) + M_1(h_1, z)/\Psi_1 + M_2(h_1, z)/\Psi_1^2 + \dots}{\cos \beta_0 h_1 + A_1(h_1)/\Psi_1 + A_2(h_1)/\Psi_1^2 + \dots} \right\} \quad (0 \leq z \leq h_1), \quad (18)$$

the variable x is defined as follows:

$$x = -z, \quad (19)$$

the current I_{2z} in the lower part of the antenna has exactly the same form as (18) with appropriate changes of subscripts. Thus

$$I_{2z} = -I_{2x} = \frac{j4\pi V_{20}}{\zeta_0 \Psi_2} \left\{ \frac{\sin \beta_0(h_2 - x) + M_1(h_2, x)/\Psi_2 + M_2(h_2, x)/\Psi_2^2 + \dots}{\cos \beta_0 h_2 + A_1(h_2)/\Psi_2 + A_2(h_2)/\Psi_2^2 + \dots} \right\} \quad (0 \leq x \leq h_2). \quad (20)$$

$$Z_1 = \frac{V_1}{I_{10}} = \frac{V_{10}}{I_0} = \frac{-j\zeta_0 \Psi_1}{4\pi} \left\{ \frac{\cos \beta_0 h_1 + A_1(h_1)/\Psi_1 + A_2(h_1)/\Psi_1^2 + \dots}{\sin \beta_0 h_1 + B_1(h_1)/\Psi_1 + B_2(h_1)/\Psi_1^2 + \dots} \right\} \quad (25a)$$

$$Z_2 = \frac{V_2}{I_{20}} = \frac{V_{20}}{I_0} = \frac{-j\zeta_0 \Psi_2}{4\pi} \left\{ \frac{\cos \beta_0 h_2 + A_1(h_2)/\Psi_2 + A_2(h_2)/\Psi_2^2 + \dots}{\sin \beta_0 h_2 + B_1(h_2)/\Psi_2 + B_2(h_2)/\Psi_2^2 + \dots} \right\} \quad (25b)$$

Note that from (8)

$$V_{20} = \lim_{z \rightarrow 0} [0 - \phi_2(-z)] = \lim_{x \rightarrow 0} [0 - \phi_2(x)]. \quad (21)$$

referred to $x = -z$ this is the negative of V_1 referred to

Since a solution of (18) in terms of z and h_1 automatically gives a solution of (20) in terms x and h_2 , it is necessary only to solve (18). In (18) the functions F_1 and A_1 are defined as follows:

$$F_1(h_1, z) = F_1(h_1, z) \sin \beta_0 h_1 - G_1(h_1, z) \cos \beta_0 h_1 + G_1(h_1, h_1) \cos \beta_0 z - F_1(h_1, h_1) \sin \beta_0 z \quad (22a)$$

$$A_1(h_1) = F_1(h_1, h_1). \quad (22b)$$

The functions F_1 and G_1 in (22a) and (22b) are defined as follows:

$$F_1(h_1, z) = F_{oz}(h_1)\Psi_1 - \int_n^{h_1} F_{oz'}(h_1)K_1(z, z')dz' - \int_{-h_2}^n F_{oz'}(h_2)K_1(z, z')dz' \quad (23a)$$

$$G_1(h_1, z) = G_{oz}(h_1)\Psi_1 - \int_0^h G_{oz'}(h_1)K_1(z, z')dz' - \int_{-h}^n G_{oz'}(h_2)K_1(z, z')dz'. \quad (23b)$$

The functions $F_1(h_1, h_1)$ and $G_1(h_1, h_1)$ are obtained from (23a) and (23b) with $z = h_1$. The zeroth-order function are

$$F_{oz}(h_1) = \cos \beta_0 z - \cos \beta_0 h_1; \quad G_{oz}(h_1) = \sin \beta_0 z - \sin \beta_0 h_1; \quad (0 \leq z \leq h_1) \quad (24a)$$

$$F_{oz}(h_2) = \cos \beta_0 z - \cos \beta_0 h_2; \quad G_{oz}(h_2) = -\sin \beta_0 z - \sin \beta_0 h_2; \quad (-h_2 \leq z \leq 0). \quad (24b)$$

The impedance of the asymmetrically driven antenna is obtained using (1) and (9), namely, $I_{20} = I_{10} = I_0$; $V_0 = V_1 + V_2$, in conjunction with (18) with $z = 0$ and (20) with $x = 0$. Thus, retaining terms through the second order, it follows from (18) and (20) that

where

$$B(h) \equiv M(h, 0). \quad (25c)$$

However, from (9) and (25a) and (25b)

$$V_0 = V_{10} + V_{20} = I_0(Z_1 + Z_2). \quad (26)$$

Since the impedance Z_0 of the antenna is by definition $Z_0 \equiv V_0/I_0$, it follows, with (26), that

$$Z_0 \equiv V_0/I_0 = Z_1 + Z_2 \quad (27)$$

where Z_1 and Z_2 are given by (25a) and (25b). Therefore, the impedance of the asymmetrical antenna is a series combination of the impedances Z_1 and Z_2 characteristic of the individual parts when in each other's presence.

With Z_0 , Z_1 , and Z_2 defined in (25) through (27) it is possible to express the partial voltages V_{10} and V_{20} as follows:

$$V_{10} = V_0 \frac{Z_1}{Z_0}; \quad V_{20} = V_0 \frac{Z_2}{Z_0}. \quad (28)$$

Substitution of (28) in (18) and (19) gives the final expressions for current in terms of the driving discontinuity in scalar potential.

$$I_{1z} = \frac{j4\pi V_0}{\zeta_0 \Psi_1} \frac{Z_1}{Z_0} \left\{ \frac{\sin \beta_0(h_1 - z) + \sum_{i=1}^N M_i(h_1, z) / \Psi_1'}{\cos \beta_0 h_1 + \sum_{i=1}^N A_i(h_1) / \Psi_1'} \right\} \quad (0 \leq z \leq h_1) \quad (29a)$$

$$I_{2z} = \frac{j4\pi V_0}{\zeta_0 \Psi_2} \frac{Z_2}{Z_0} \left\{ \frac{\sin \beta_0(h_2 + z) + \sum_{i=1}^N M_i(h_2, -z) \Psi_2}{\cos \beta_0 h_2 + \sum_{i=1}^N A_i(h_2) \Psi_2'} \right\} \quad (-h_2 \leq z \leq 0) \quad (29b)$$

$$Z_0 = Z_1 + Z_2 = \frac{-j\zeta_0}{4\pi} \left\{ \frac{\Psi_1 \left[\cos \beta_0 h_1 + \sum_{i=1}^N A_i(h_1) \Psi_1' \right]}{\sin \beta_0 h_1 + \sum_{i=1}^N B_i(h_1) \Psi_1'} + \frac{\Psi_2 \left[\cos \beta_0 h_2 + \sum_{i=1}^N A_i(h_2) \Psi_2' \right]}{\sin \beta_0 h_2 + \sum_{i=1}^N B_i(h_2) \Psi_2'} \right\} \quad (30)$$

This completes the general analysis of the asymmetrically driven antenna. It remains to express the solutions in terms of tabulated functions.

II. FUNCTIONS AND PARAMETERS FOR ASYMMETRICALLY DRIVEN ANTENNAS

In order to evaluate the several integrals involved in the expressions (29) and (30) for the current in and impedance of an asymmetrically driven antenna, it is convenient to introduce the integrals

$$C_{11}(h, z) \equiv \int_0^z \cos \beta_0 z' K_1(z, z') dz' \quad (31a)$$

$$S_{11}(h, z) \equiv \int_0^z \sin \beta_0 z' K_1(z, z') dz' \quad (31b)$$

$$E_{11}(h, z) \equiv \int_0^z K_1(z, z') dz' \quad (31c)$$

where

$$K_1(z, z') \equiv \frac{e^{-\beta_0 R_1}}{R_1}; \quad R_1 = \sqrt{(z - z')^2 + a^2} \quad (32)$$

These integrals may be expressed in terms of the tabulated generalized sine and cosine integrals.³

Since

$$K_1(z, -z') = K_1(-z, z'), \quad (33)$$

it follows that

$$\int_{-h}^0 \cos \beta_0 z' K_1(z, z') dz'$$

³ Staff of Computation Laboratory, "Tables of Generalized Sine and Cosine Integral Functions," vols. I and II, Harvard University Press, Cambridge, Mass.; 1949.

$$= \int_0^h \cos \beta_0 z' K_1(-z, z') dz' = C_{11}(h, -z) \quad (34a)$$

$$- \int_h^0 \sin \beta_0 z' K_1(z, z') dz' = \int_0^h \sin \beta_0 z' K_1(-z, z') dz' = S_{11}(h, -z) \quad (34b)$$

$$\int_{-h}^0 K_1(z, z') dz' = \int_0^h K_1(-z, z') dz' = E_{11}(h, -z) \quad (34c)$$

Note that

$$C_{11}(h, z) + C_{11}(h, -z) = C_a(h, z) \quad (35a)$$

$$S_{11}(h, z) + S_{11}(h, -z) = S_a(h, z) \quad (35b)$$

where $C_a(h, z)$ and $S_a(h, z)$ are the functions occurring in the formulas for the center-driven antenna.²

With the notations (31) and (34), (23) becomes

$$F_1(h_1, z) = (\cos \beta_0 z - \cos \beta_0 h_1) \Psi_1 - C_{11}(h_1, z) + \cos \beta_0 h_1 E_{11}(h_1, z) - C_{11}(h_2, -z) + \cos \beta_0 h_2 E_{11}(h_2, -z); \quad (0 \leq z \leq h_1) \quad (36a)$$

$$F_1(h_1, h_1) = -C_{11}(h_1, h_1) + \cos \beta_0 h_1 E_{11}(h_1, h_1) - C_{11}(h_2, -h_1) + \cos \beta_0 h_2 E_{11}(h_2, -h_1) \quad (36b)$$

$$G_1(h_1, z) = (\sin \beta_0 z - \sin \beta_0 h_1) \Psi_1 - S_{11}(h_1, z) + \sin \beta_0 h_1 E_{11}(h_1, z) - S_{11}(h_2, -z) + \sin \beta_0 h_2 E_{11}(h_2, -z); \quad (0 \leq z \leq h_1) \quad (37a)$$

$$G_1(h_1, h_1) = -S_{11}(h_1, h_1) + \sin \beta_0 h_1 E_{11}(h_1, h_1) - S_{11}(h_2, -h_1) + \sin \beta_0 h_2 E_{11}(h_2, -h_1) \quad (37b)$$

In order to evaluate the expansion parameters Ψ_1 and Ψ_2 it is necessary to choose distribution functions for the currents in the two parts of the antenna. For this purpose the zeroth-order currents are good approximations. Therefore, let

$$f_1(z) \sim \sin \beta_0(h_1 - z); \quad f_2(z) \sim \sin \beta_0(h_2 + z) \quad (38a)$$

$$g_{11}(z) = \frac{\sin \beta_0(h_1 - z')}{\sin \beta_0(h_1 - z)}; \quad g_{22}(z) = \frac{\sin \beta_0(h_2 + z')}{\sin \beta_0(h_2 + z)} \quad (38b)$$

$$g_{12}(z) = \frac{\sin \beta_0(h_2 + z')}{\sin \beta_0(h_1 - z)}; \quad g_{21}(z) = \frac{\sin \beta_0(h_1 - z')}{\sin \beta_0(h_2 + z)} \quad (38c)$$

With (38), (12a) becomes

$$\Psi_1(z) \sin \beta_0(h_1 - z) = \int_0^{h_1} \sin \beta_0(h_1 - z') K_1(z, z') dz' + \int_{-h_2}^0 \sin \beta_0(h_2 + z') K_1(z, z') dz' \quad (39a)$$

$$= \sin \beta_0 h_1 C_{11}(h_1, z) - \cos \beta_0 h_1 S_{11}(h, z) + \sin \beta_0 h_2 C_{11}(h_2, -z) - \cos \beta_0 h_2 S_{11}(h_2, -z); \quad (0 \leq z \leq h_1) \quad (39b)$$

The definition of $\Psi_1 \equiv |\Psi_1(z_r)|$ involves the choice of a reference point z_r such that Ψ_1 will be a good representation of $|\Psi_1(z)|$ over its principal, essentially constant range. Since the contributions to $\Psi_1(z)$ are predominantly from currents near the point z , it follows that currents in the lower part of the antenna, i.e., where $-h_2 \leq z \leq 0$, contribute negligibly to $\Psi_1(z)$ defined at $z = a$ on the upper part, $0 \leq z \leq h_1$, except in a small range near and at $z = 0$. The continuity of current at $z = 0$, namely, $I_{20} = I_{10} = I_0$, assures that significant contributions to $\Psi_1(z)$ with z near zero by currents in the nearest section of the lower part of the antenna cannot differ appreciably from what they would be if h_2 were equal to h_1 . Therefore, the general distribution of $\Psi_1(z)$ for the symmetrically driven antenna must be essentially similar to $\Psi_{K1}(z)$ for the center-driven antenna. Hence the same location of the reference point z_r must be appropriate. That is,

$$\Psi_1 = \begin{cases} |\Psi_1(0)| \sin \beta_0 h & \text{for } \beta_0 h_1 \leq \pi/2 \\ |\Psi_1(h_1 - \lambda_0/4)| & \text{for } \beta_0 h_1 > \pi/2 \end{cases} \quad (40)$$

where $\Psi_1(z)$ is given by (12a).

The parameter Ψ_2 for the lower part of the antenna ($-h_2 \leq z \leq 0$) is defined by (40) with subscripts 1 replaced by 2, and h_1 by h_2 on h and Ψ , and $-z$ is substituted for z .

With the functions F_1 and G_1 and the expansion parameters Ψ_1 and Ψ_2 reduced to forms involving only tabulated functions, a complete first-order solution for the current at all points in, and the driving-point impedance of, a cylindrical antenna of small cross section symmetrically driven by a discontinuity in scalar potential is made available.

III. APPROXIMATE IMPEDANCE OF ASYMMETRICALLY DRIVEN ANTENNA

The actual numerical evaluation of the general formulas for current and impedance given in Section II has not been carried out, since good approximations are readily obtained directly from the solution of the center-driven antenna for which numerical values are available.² The argument is straightforward.

The determination of the current in the upper part ($0 \leq z \leq h_1$) of a cylindrical antenna driven at $z = 0$ involves the vector potential at all points on the surface of this part. Contributions to the vector potential arise from current in the entire antenna, but as has been pointed out before, these are significant only from currents very near the point z ($0 \leq z \leq h$). Since z is confined to the upper part of the antenna in determining the current in this part, contributions by currents in the lower part are significant only in a small range when z is near zero. The actual magnitude of this range can be obtained directly from computations made by Winternitz⁴

to determine the significance of a gap of length 2δ at the center. In Winternitz's Figs. 9A to 9H, for example, is plotted $|\Psi(z)| = |C^b(z)|$, which is a magnitude proportional to the vector potential at $r = a$ on the surface of the antenna and in the gap 2δ . Since the antenna is symmetrical, the value at $z = 0$, the bottom of the dip, is due equally to currents in both halves of the antenna. Therefore the vector potential at $z = 0$ due to the lower half only is only one half the magnitude of this dip. Note that this is a value proportional to the vector potential due to the currents in the entire lower half at a distance δ from the point of maximum current at $z = -\delta$. In Fig. 4 is a plot of the approximate variation of $|\Psi(z)|$ (which is proportional to the vector potential) beyond the end of a section of conductor carrying a maximum current at that end due only to the current in that section. The insert shows $|\Psi(z)|$ for half of an antenna and, framed on the right, the section beyond the end represented in the main diagram. The rate of decrease

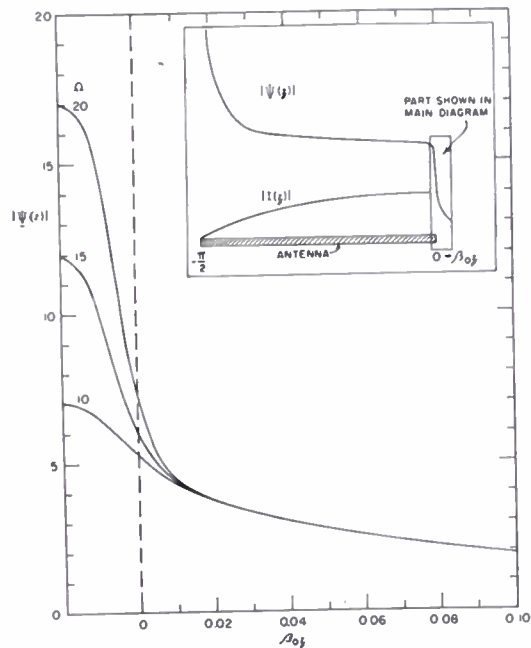

Fig. 4— $|\Psi(z)|$ as a function of $\beta_0 z$ with Ω as the parameter.

of $|\Psi(z)|$ is such that at angular distances as small as 0.1 radians the magnitude is reduced to from 10 to 30 per cent, depending on the magnitude of $\beta_0 a$ as specified by the value of Ω . For small values of $\beta_0 a$ the decrease is more rapid. Note that $\beta_0 z = 0.1$ corresponding to $z = 0.0159\lambda_0$. Thus, the contribution to the vector potential even at $z = 0$ on an antenna by currents in the lower part ($z < 0$) is confined to currents at distances not exceeding a tenth of a wavelength. Since rapid variations in the magnitude of the current in an antenna do not occur in such short distances, the requirement $I_{10} = I_{20} = I_0$ is sufficient to assure that contributions to the vector potential at all points on the upper part of an

⁴ T. W. Winternitz, "The Cylindrical Antenna Center-Driven by a Two-Wire Open Transmission Line," Cruft Laboratory Technical Report No. 56, August 15, 1948.

asymmetrically driven antenna, including $z=0$, by the actual currents in the lower part, do not differ effectively from what they would be if the distribution of current were the same in the lower part as in the upper, as when $h_2=h_1$. Evidently, currents in the lower part that are near enough to contribute to the vector potential in the upper part, i.e., near $z=0$, cannot differ appreciably from the currents in the adjacent upper part since $I_{10}=I_{20}$.

This means that in determining the distributions of current in the two parts, each may be analyzed separately as if each were a base-driven antenna over an infinite, perfectly conducting plane. That is, I_{1z} in (18) will be changed negligibly if h_2 is set equal to h_1 wherever it occurs in Ψ and in the F and G functions that contribute to the M and A functions. Similarly, I_{2z} may be determined from (20) by setting h_1 equal to h_2 in the corresponding integrals. Each of these problems is equivalent to the center-driven antenna.² The current I_{1z} in the upper part is the same as in the upper part of a center-driven antenna of half-length h_1 ; the impedance $Z_1=V_{10}/I_{10}$ is one half that of the center-driven antenna. Similarly, I_{2z} in the lower part is the same as that in the lower part of a center-driven antenna of half-length h_2 , and the impedance $Z_2=V_{20}/I_{20}$ is one half that of the center-driven antenna. The impedance Z_0 of the asymmetrical array is the series combination of Z_1 and Z_2 .

$$Z_0 = Z_1 + Z_2. \quad (41)$$

The currents in the two isolated antennas of half-length h_1 and h_2 , respectively, are related to each other and to the asymmetrical antenna they are to represent by setting

$$V_{10} = V_0 Z_1 / Z_0; \quad V_{20} = V_0 Z_2 / Z_0. \quad (42)$$

Hence, with $Y=1/Z$,

I_{1z} (upper part of asymmetrical antenna)

$$= \frac{Y_0}{Y_1} I_1 \text{ (upper half of symmetrical antenna of half-length } h_1) \quad (43a)$$

I_{2z} (lower part of asymmetrical antenna)

$$= \frac{Y_0}{Y_2} I_2 \text{ (lower half of symmetrical antenna of half-length } h_2) \quad (43b)$$

where

$$Y_1 = 2(Y_0 \text{ of symmetrical antenna of half-length } h_1) \quad (44)$$

$$Y_2 = 2(Y_0 \text{ of symmetrical antenna of half-length } h_2) \quad (45)$$

$$Y_0 = \frac{Y_1 Y_2}{Y_1 + Y_2}. \quad (46)$$

As a numerical example consider the asymmetrical antenna defined as follows:

$$\beta_0 h_1 = \pi/2; \quad \beta_0 h_2 = \pi \quad (47a)$$

$$\Omega_1 = 2 \ln(2h_1/a_1) = 10; \quad \Omega_2 = 2 \ln(2h_2/a_2) = 10. \quad (47b)$$

Since $h_2=2h_1$, $a_2=2a_1$. The second-order King-Middleton² admittances are

$$\begin{aligned} \beta_0 h_1 = \pi/2: Y_1 &= 2(9.56 - j4.62) \times 10^{-3} \\ &= (19.12 - j9.24) \times 10^{-3} \\ &= 23 \times 10^{-3} / -23.2^\circ \text{ mhos} \end{aligned} \quad (48a)$$

$$\begin{aligned} \beta_0 h_2 = \pi: Y_2 &= 2(1.0 + j1.8) \times 10^{-3} \\ &= (2 + j3.6) \times 10^{-3} \\ &= 4.12 \times 10^{-3} / 61^\circ \text{ mhos.} \end{aligned} \quad (48b)$$

The input admittance of the asymmetrical antenna is

$$Y_0 = (2.51 + j3.1) \times 10^{-3} = 3.98 \times 10^{-3} / 51^\circ \text{ mhos.} \quad (48c)$$

The input impedance is

$$Z_0 = 158 - j195 = 251 / -51^\circ \text{ ohms.} \quad (48d)$$

The input current of the asymmetrical antenna is

$$\begin{aligned} \frac{I_0}{V_0} &= 2.51 + j3.1 \\ &= 3.98 / 51^\circ \text{ milliamperes per volt.} \end{aligned} \quad (49)$$

The distribution of current along the individual parts is the same as if this part were half of a center-driven antenna, but multiplied for part 1 ($\beta_0 h_1 = \pi/2$) by Y_0/Y_1 , for part 2 ($\beta_0 h_2 = \pi$) by Y_0/Y_2 . Numerical values for the special case under consideration are

$$\frac{2Y_0}{Y_1} = 0.346 / 74.2^\circ; \quad \frac{2Y_0}{Y_2} = 1.936 / -10^\circ. \quad (50)$$

The factor 2 before Y_0 is necessary for comparison with the center-driven antennas which have admittance $Y_1/2$ and $Y_2/2$, respectively. Accordingly, the distributions of the magnitudes and phases of the currents per unit driving voltage are

$$\begin{aligned} \left| \frac{I_{1z}}{V_0} \right| &= 0.346 \left| \frac{I_z}{V_0} \right|_{\beta_0 h_1 = \pi/2}; \\ \theta_{1z} &= \theta_{I, \beta_0 h_1 = \pi/2} + 74.2^\circ \end{aligned} \quad (51a)$$

$$\begin{aligned} \left| \frac{I_{2z}}{V_0} \right| &= 1.936 \left| \frac{I_z}{V_0} \right|_{\beta_0 h_2 = \pi}; \\ \theta_{2z} &= \theta_{I, \beta_0 h_2 = \pi} - 10^\circ. \end{aligned} \quad (51b)$$

Curves showing the distributions of the magnitude and phase of the current referred to the driving voltage for the asymmetrical antenna with $h_1 = \lambda_0/4$, $h_2 = \lambda_0/2$ are in Fig. 5. These were obtained from approximate second-order curves of the King-Middleton distribution of current.⁵

⁵ The second-order current curves will be included in a subsequent technical report. First-order curves are given in footnote reference 2.

Since the input impedance of the asymmetrical antenna is approximately equal to the sum of the impedances of two antennas of different and quite arbitrary lengths, it is interesting to consider the possibility of selecting these lengths so that the sum of the two im-

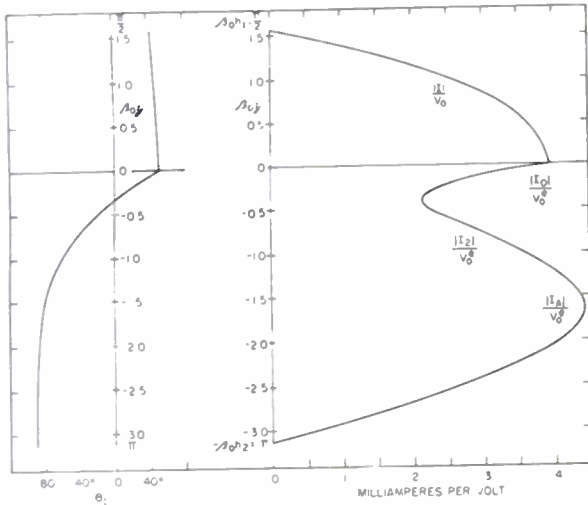

Fig. 5—Current distribution on asymmetrical antenna.

pedances is less sensitive to changes in $\beta_0 h = \omega h / v_0$ than either one separately; that is, it is possible to select h_1 and h_2 so that the asymmetrical antenna has desirable broad-band characteristics? The answer is in the affirmative if it is possible to design the two parts 1 and 2 of the asymmetrical antenna so that for a given range in frequency from $\omega_0 - \Delta\omega$ to $\omega_0 + \Delta\omega$ the resulting change in R_1 and X_1 is compensated by a nearly equal and opposite change in R_2 and X_2 . For frequency change from ω to $\omega + \Delta\omega$, $\beta_0 h_1 = \omega h_1 / v_0$ increases to $(\omega + \Delta\omega) h_1 / v_0$, and $\beta_0 h_2 = \omega h_2 / v_0$ increases to $(\omega + \Delta\omega) h_2 / v_0$. Thus, the change in $\beta_0 h$ is $\Delta\omega h_1 / v_0$, and the change in $\beta_0 h_2$ is $\Delta\omega h_2 / v_0$. Evidently, the increase in $\beta_0 h_2$ is greater than that in $\beta_0 h_1$ if h_2 is greater than h_1 , so that the slope of the R_2, X_2 curves should be smaller than, and of opposite sign to, the slope of R_1, X_1 curves. Since for all moderately thin antennas the regions of negative slope for X are always much steeper than regions of positive slope, it is difficult to satisfy these conditions without using sections that are several half wavelengths long. If both h_1 and h_2 are to be under a wavelength and Ω_1 and Ω_2 are not to differ greatly, a reasonably broad-band antenna can be constructed by choosing h_1 to maximize X_1 and h_2 to minimize X_2 at $\omega = \omega_0$. For $\Omega_1 = \Omega_2 = 10$, $h_1 = 2.2v_0/\omega_0$ and $h_2 = 2.9v_0/\omega_0$ where $v_0 = 3 \times 10^8$ m per second. A range of ω defined by

$$0.9\omega_0 \leq \omega \leq 1.1\omega_0 \tag{52a}$$

corresponds to

$$1.98 \leq \beta_0 h_1 \leq 2.42; \quad 2.61 \leq \beta_0 h_2 \leq 3.19. \tag{52b}$$

Curves showing the variation of R_1 and X_1, R_2 and $X_2, R_0 = R_1 + R_2$, and $X_0 = X_1 + X_2$ are shown in Fig. 6 as a function of ω in the range from $0.9\omega_0$ to $1.1\omega_0$. It is seen that over this 20-per cent frequency change, R_0 and X_0 are reasonably constant. It is to be noted that with a corresponding choice of h_1 and h_2 for thicker antennas for which Ω_1 and Ω_2 are smaller than 10, a considerable extension of this approximately constant range is possible.

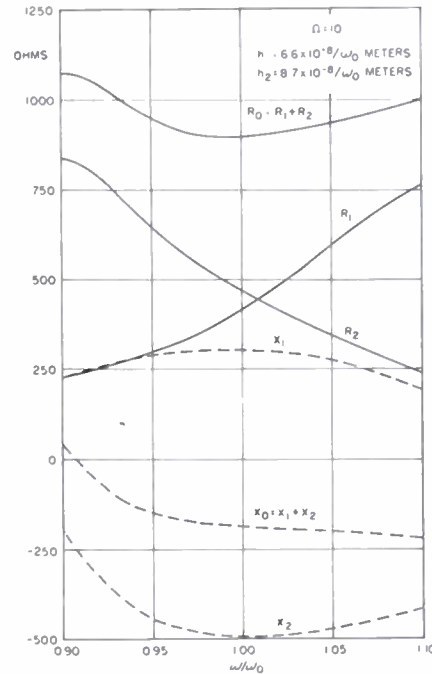

Fig. 6—Broad-band characteristics of asymmetrical antenna.

IV. THEORY OF THE SLEEVE DIPOLE

An antenna of considerable importance because of its broad-band properties is the *sleeve dipole* shown in Figs. 7(a) and 7(b). It consists essentially of the vertically extended inner conductor and outer conductor of a

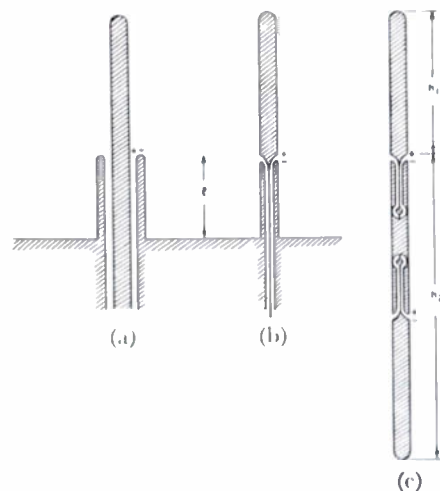

Fig. 7—Sleeve dipole driven by a coaxial line over an image plane and its equivalent symmetrical structure.

coaxial line over a horizontal conducting plane. It differs from the conventional base-driven half-dipole over a conducting plane in that the sheath of the coaxial line does not end at this plane but extends above it a distance l . This is equivalent to moving the gap across which a voltage is maintained by the feeding transmission line upward from $z=0$ at the conducting plane to $z=l$. Application of the theorem of images to obtain an equivalent symmetrical structure yields the internally driven antenna of Fig. 7(c) in which two generators maintain equal voltage respectively across two gaps at $z=\pm l$.

Owing to the linearity of the Maxwell equations, the principle of superposition is applicable, so that the current at any point along the antenna in Fig. 7(c) is the algebraic sum of the currents maintained independently by the generators. This is illustrated schematically in Fig. 8.

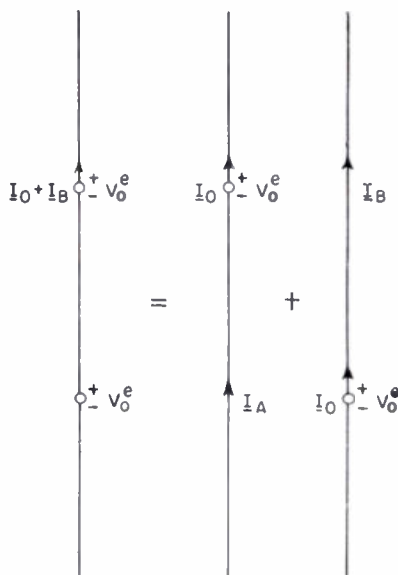

Fig. 8—Decomposition of the symmetrically driven antenna into two asymmetrically driven antennas.

The determination of the currents due to the upper generator in the symmetrical antenna on the left in Fig. 8 reduces to the analysis of the current in the middle antenna in Fig. 8. Since this is the asymmetrically driven antenna already analyzed, this part of the problem is solved. The current in the antenna on the right in Fig. 8 may be obtained directly from that in the middle antenna by interchanging ends. Finally, the resultant current in the antenna on the left is the algebraic sum of the currents in the other two.

The impedance at the terminals of the upper generator in the antenna on the left in Fig. 8 is given by the driving voltage V_0^e divided by the total current in the terminals. Thus,

$$Z_{in} = V_0^e / (I_0 + I_B) = V_0^e / (I_0 + I_A). \quad (53a)$$

The admittance is

$$Y_{in} = (I_0 + I_A) / V_0^e. \quad (53b)$$

The numerical evaluation of the impedance and the distribution of current in a sleeve dipole is complicated by several factors. Consider first the simplest case of the symmetrical antenna in Fig. 9(a) where the driving voltages are maintained by discontinuities in scalar potential. To permit numerical evaluation, let $\beta_0 h_1 = \pi/2$, $\beta_0 h_2 = \pi$, as shown. Also let $h_2/a_2 = 75$ so that $\Omega = 2 \ln(2h_2/a_2) = 10$. Since $h_2 = 2h_1$, it follows that with $a_2 = a_1$, $\Omega_1 = 2 \ln(2h_1/a_1) = 9.3$. Since the impedance of an antenna of half length $h_1 = \lambda_0/4$ varies only slowly with Ω , an error of only a few per cent is made if it is assumed for simplicity that $\Omega_1 = 10$. This value corre-

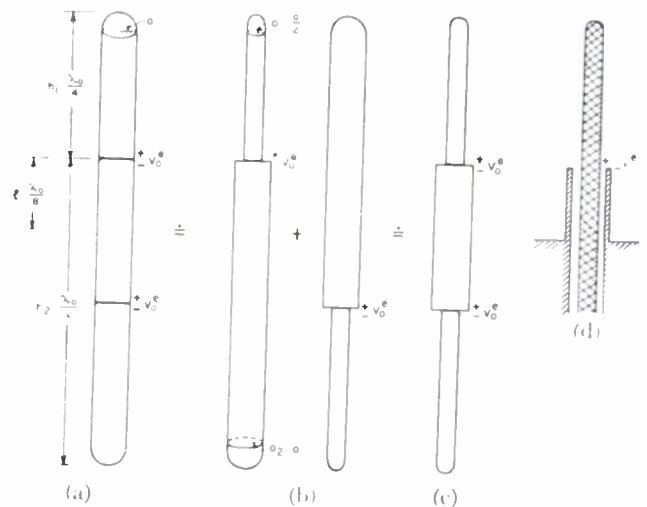

Fig. 9—Method of analysis of the sleeve dipole.

sponds to $a_1 = a_2/2$. Physically the condition $\Omega_1 = \Omega_2 = 10$ has a meaning for the asymmetrical antenna with $h_2 = 2h_1$; $a_2 = 2a_1$, but not for the antenna symmetrically driven by two equal generators. Thus, each of the two asymmetrically driven antennas in Fig. 9(b) may be analyzed, but the superposition of their solutions does not correspond *exactly* to any physically realizable structure since the outer thirds of each antenna cannot simultaneously have different radii. It is clear that the antenna of Fig. 9(d) also is approximated by a superposition of the two antennas in Fig. 9(b) except for the added complication of the shoulders at the driving points, of which no account is taken in the theory. In the following, the currents in the two antennas in Fig. 9(b) will be superimposed with the understanding that the results apply approximately to both Figs. 9(a) and 9(c), if a correction is made to take account of the shoulders in the latter.

The currents I_0 and I_A in the central asymmetrical antenna in Fig. 8 with $\Omega_1 = \Omega_2 = 10$ are obtained directly from Fig. 5. They are

$$\frac{I_o}{V_o^e} = 3.98/51^\circ$$

$$= 2.51 + j3.1 \text{ milliamperes per volt} \quad (54a)$$

$$\frac{I_A}{V_o^e} = 4.4 - 81^\circ$$

$$= 0.68 - j4.34 \text{ milliamperes per volt.} \quad (54b)$$

Substitution in (53b) gives the following driving-point admittance at the terminals of each slice generator in the symmetrical two-generator antenna or at the terminals of the single-slice generator of half of the symmetrical structure erected vertically on an infinite conducting plane:

$$Y_{in} = (I_o + I_A) / V_o^e = (3.18 - j1.24) \times 10^{-3} \text{ mhos.} \quad (55a)$$

The corresponding input impedance is

$$Z_{in} = 273 + j106 \text{ ohms.} \quad (55b)$$

The distribution of current on the symmetrical two-generator antenna is obtained by superposition. It is

$$I(z) \text{ symmetrical antenna} = [I(z) + I(-z)] \text{ asymmetrical antenna} \quad (56)$$

Since the current in the lower part of the middle unit in Fig. 8 is equal to the current in the upper part in the right-hand unit. The magnitude and phase of the current in the symmetrical two-generator antenna are given by

$$I = \sqrt{(I_t \cos \theta_t + I_b \cos \theta_b)^2 + (I_t \sin \theta_t + I_b \sin \theta_b)^2} \quad (57a)$$

$$\phi = \tan^{-1} [(I_t \sin \theta_t + I_b \sin \theta_b) / (I_t \cos \theta_t + I_b \cos \theta_b)] \quad (57b)$$

where

$$I_t = I_t e^{j\theta_t} \equiv I(z); \quad I_b = I_b e^{j\theta_b} \equiv I(-z). \quad (58)$$

The magnitude I and the phase-angle θ_I referred to V_o^e are plotted in Fig. 10 for $\beta_o h_1 = \pi/2$, $\beta_o h_2 = \pi$, and $\Omega = 10$. The current in the central part of the antenna between the two generators is seen to be relatively great and to differ in phase from the currents in the outer parts by 25° on the average.

The admittance and impedance of a base-driven antenna of electrical length $\beta_o h = 3\pi/4$; $\Omega = 10$, base-driven over a perfectly conducting half space are

Y_o = (2.8 - j1.1) × 10⁻³ mhos; Z_o = 310 + j122 ohms. (59)

These do not differ greatly from values (55a) and (55b) for the same antenna when driven at a height λ_o/8 from the conducting plane.

The degree in which the impedance (55b) and the current in the upper half of Fig. 10 approximate the apparent terminal impedance of and the current on the sleeve dipole in Fig. 9(d) depends upon the size and the nature of the junction region where the coaxial line ends and the driving voltage is applied to the antenna. Usually, more-or-less extensive surfaces exist in the form of flat or curved surfaces with or without sharp edges on which charge can accumulate. Since these surfaces and transmission-line end effects are not considered in the analysis of the cylindrical antenna, it is to be expected that the measured apparent impedance of a sleeve dipole will differ considerably from the theoretical impedance. The additional chargeable surfaces are equivalent to a lumped capacitance in parallel with the theoretical impedance. The effect of a positive capacitance in parallel with a center-driven antenna is to decrease the magnitude of resistance and reactance and shift the curves toward shorter lengths. In particular, the positive reactance is reduced relatively much more than the negative reactance.

For example, suppose a susceptance $B = \omega C = 3.2 \times 10^{-3}$ mhos is connected in parallel with a sleeve dipole for which the theoretical admittance and impedance are given by (55a) and (55b). The apparent admittance is

$$Y_{ina} = (3.18 + j1.96) \times 10^{-3} \text{ mhos.} \quad (60a)$$

The apparent impedance is

$$Z_{ina} = 228 - j141 \text{ ohms.} \quad (60b)$$

The broad-band properties of the sleeve dipole can not be investigated in general without extensive numerical computations of the input impedance for a variety of sleeve lengths and antenna lengths. However, the behavior as a function of frequency of the input impedance of the particular antenna for which the currents in Fig. 10 were determined may be carried out using available current and impedance data.

Suppose the frequency for which $\beta_o h_1 = \pi/2$, $\beta_o h_2 = \pi$, $\beta_o l = \pi/4$ is f_o , and the associated angular velocity is ω_o . For a variation in frequency from $\omega_o - \Delta\omega$ to $\omega_o + \Delta\omega$, where $\Delta\omega = \omega_o/4$, the electrical lengths have the following ranges:

$$\left. \begin{aligned} \frac{3\pi}{8} &\leq \beta_o h_1 \leq \frac{5\pi}{8} \\ \frac{3\pi}{4} &\leq \beta_o h_2 \leq \frac{5\pi}{4} \\ \frac{3\pi}{16} &\leq \beta_o l \leq \frac{5\pi}{16} \end{aligned} \right\} \quad \frac{3}{4} \omega_o \leq \omega \leq \frac{5}{4} \omega_o \quad (61)$$

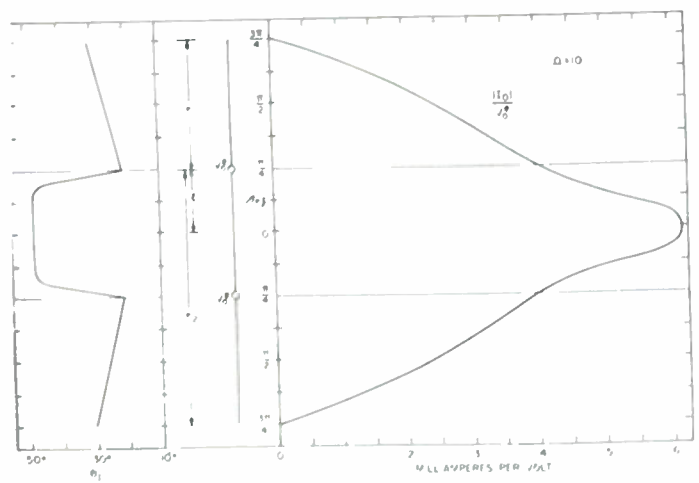

Fig. 10 - Current distribution on the sleeve dipole.

asymmetrically driven antenna, including $z=0$, by the actual currents in the lower part, do not differ effectively from what they would be if the distribution of current were the same in the lower part as in the upper, as when $h_2=h_1$. Evidently, currents in the lower part that are near enough to contribute to the vector potential in the upper part, i.e., near $z=0$, cannot differ appreciably from the currents in the adjacent upper part since $I_{10}=I_{20}$.

This means that in determining the distributions of current in the two parts, each may be analyzed separately as if each were a base-driven antenna over an infinite, perfectly conducting plane. That is, I_{1z} in (18) will be changed negligibly if h_2 is set equal to h_1 wherever it occurs in Ψ and in the F and G functions that contribute to the M and A functions. Similarly, I_{2z} may be determined from (20) by setting h_1 equal to h_2 in the corresponding integrals. Each of these problems is equivalent to the center-driven antenna.² The current I_{1z} in the upper part is the same as in the upper part of a center-driven antenna of half-length h_1 ; the impedance $Z_1=V_{10}/I_{10}$ is one half that of the center-driven antenna. Similarly, I_{2z} in the lower part is the same as that in the lower part of a center-driven antenna of half-length h_2 , and the impedance $Z_2=V_{20}/I_{20}$ is one half that of the center-driven antenna. *The impedance Z_0 of the asymmetrical array is the series combination of Z_1 and Z_2 .*

$$Z_0 = Z_1 + Z_2. \tag{41}$$

The currents in the two isolated antennas of half-length h_1 and h_2 , respectively, are related to each other and to the asymmetrical antenna they are to represent by setting

$$V_{10} = V_0 Z_1 / Z_0; \quad V_{20} = V_0 Z_2 / Z_0. \tag{42}$$

Hence, with $Y=1/Z$,

I_{1z} (upper part of asymmetrical antenna)

$$= \frac{Y_0}{Y_1} I_{1z}(\text{upper half of symmetrical antenna of half-length } h_1) \tag{43a}$$

I_{2z} (lower part of asymmetrical antenna)

$$= \frac{Y_0}{Y_2} I_{2z}(\text{lower half of symmetrical antenna of half-length } h_2) \tag{43b}$$

where

$$Y_1 = 2(Y_0 \text{ of symmetrical antenna of half-length } h_1) \tag{44}$$

$$Y_2 = 2(Y_0 \text{ of symmetrical antenna of half-length } h_2) \tag{45}$$

$$Y_0 = \frac{Y_1 Y_2}{Y_1 + Y_2}. \tag{46}$$

As a numerical example consider the asymmetrical antenna defined as follows:

$$\beta_0 h_1 = \pi/2; \quad \beta_0 h_2 = \pi \tag{47a}$$

$$\Omega_1 = 2 \ln(2h_1/a_1) = 10; \quad \Omega_2 = 2 \ln(2h_2/a_2) = 10. \tag{47b}$$

Since $h_2=2h_1$, $a_2=2a_1$. The second-order King-Middleton² admittances are

$$\begin{aligned} \beta_0 h_1 = \pi/2: \quad Y_1 &= 2(9.56 - j4.62) \times 10^{-3} \\ &= (19.12 - j9.24) \times 10^{-3} \\ &= 23 \times 10^{-3} / -23.2^\circ \text{ mhos} \end{aligned} \tag{48a}$$

$$\begin{aligned} \beta_0 h_2 = \pi: \quad Y_2 &= 2(1.0 + j1.8) \times 10^{-3} \\ &= (2 + j3.6) \times 10^{-3} \\ &= 4.12 \times 10^{-3} / 61^\circ \text{ mhos.} \end{aligned} \tag{48b}$$

The input admittance of the asymmetrical antenna is

$$Y_0 = (2.51 + j3.1) \times 10^{-3} = 3.98 \times 10^{-3} / 51^\circ \text{ mhos.} \tag{48c}$$

The input impedance is

$$Z_0 = 158 - j195 = 251 / -51^\circ \text{ ohms.} \tag{48d}$$

The input current of the asymmetrical antenna is

$$\begin{aligned} \frac{I_0}{V_0} &= 2.51 + j3.1 \\ &= 3.98 / 51^\circ \text{ milliamperes per volt.} \end{aligned} \tag{49}$$

The distribution of current along the individual parts is the same as if this part were half of a center-driven antenna, but multiplied for part 1 ($\beta_0 h_1 = \pi/2$) by I_0/Y_1 , for part 2 ($\beta_0 h_2 = \pi$) by I_0/Y_2 . Numerical values for the special case under consideration are

$$\frac{2I_0}{Y_1} = 0.346 / 74.2^\circ; \quad \frac{2I_0}{Y_2} = 1.936 / -10^\circ. \tag{50}$$

The factor 2 before I is necessary for comparison with the center-driven antennas which have admittance $Y_1/2$ and $Y_2/2$, respectively. Accordingly, the distributions of the magnitudes and phases of the currents per unit driving voltage are

$$\begin{aligned} \frac{I_1}{V_0} &= 0.346 \left| \frac{I_z}{V_0} \right|_{\beta_0 h = \pi/2}; \\ \theta_{1z} &= \theta_{I, \beta_0 h = \pi/2} + 74.2^\circ \end{aligned} \tag{51a}$$

$$\begin{aligned} \frac{I_2}{V_0} &= 1.936 \left| \frac{I_z}{V_0} \right|_{\beta_0 h = \pi}; \\ \theta_{2z} &= \theta_{I, \beta_0 h = \pi} - 10^\circ. \end{aligned} \tag{51b}$$

Curves showing the distributions of the magnitude and phase of the current referred to the driving voltage for the asymmetrical antenna with $h_1 = \lambda_0/4$, $h_2 = \lambda_0/2$ are in Fig. 5. These were obtained from approximate second-order curves of the King-Middleton distribution of current.⁵

⁵ The second order current curves will be included in a subsequent technical report. First order curves are given in footnote reference 2.

Since the input impedance of the asymmetrical antenna is approximately equal to the sum of the impedances of two antennas of different and quite arbitrary lengths, it is interesting to consider the possibility of selecting these lengths so that the sum of the two im-

pedances is less sensitive to changes in $\beta_0 h = \omega h / v_0$ than either one separately; that is, is it possible to select h_1 and h_2 so that the asymmetrically driven antenna has desirable broad-band characteristics? The answer is in the affirmative if it is possible to design the two parts 1 and 2 of the asymmetrical antenna so that for a given change in frequency from $\omega_0 - \Delta\omega$ to $\omega_0 + \Delta\omega$ the resulting change in R_1 and X_1 is compensated by a nearly equal and opposite change in R_2 and X_2 . For frequency change from ω to $\omega + \Delta\omega$, $\beta_0 h_1 = \omega h_1 / v_0$ increases to $(\omega + \Delta\omega) h_1 / v_0$, and $\beta_0 h_2 = \omega h_2 / v_0$ increases to $(\omega + \Delta\omega) h_2 / v_0$. Thus, the change in $\beta_0 h$ is $\Delta\omega h_1 / v_0$, and the change in $\beta_0 h_2$ is $\Delta\omega h_2 / v_0$. Evidently, the increase in $\beta_0 h_2$ is greater than that in $\beta_0 h_1$ if h_2 is greater than h_1 , so that the slope of the R_2, X_2 curves should be smaller than, and of opposite sign to, the slope of R_1, X_1 curves. Since for all moderately thin antennas the regions of negative slope for X are always much steeper than regions of positive slope, it is difficult to satisfy these conditions without using sections that are several half wavelengths long. If both h_1 and h_2 are to be under a wavelength and Ω_1 and Ω_2 are not to differ greatly, a reasonably broad-band antenna can be constructed by choosing h_1 to maximize X_1 and h_2 to minimize X_2 at $\omega = \omega_0$. For $\Omega_1 = \Omega_2 = 10$, $h_1 = 2.2v_0/\omega_0$ and $h_2 = 2.9v_0/\omega_0$ where $v_0 = 3 \times 10^8$ m per second. A range of ω defined by

$$0.9\omega_0 \leq \omega \leq 1.1\omega_0 \quad (52a)$$

corresponds to

$$1.98 \leq \beta_0 h_1 \leq 2.42; \quad 2.61 \leq \beta_0 h_2 \leq 3.19. \quad (52b)$$

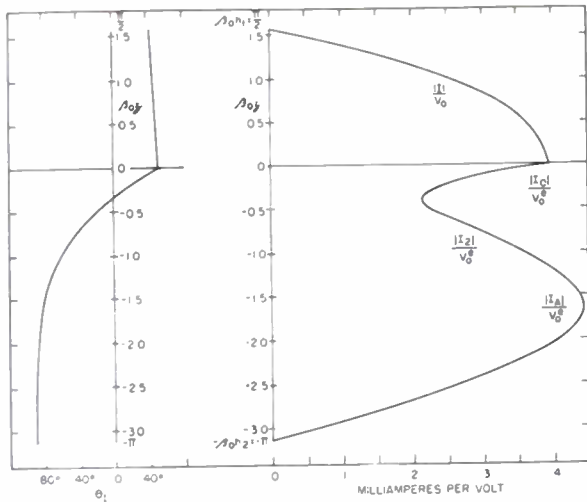

Fig. 5—Current distribution on asymmetrical antenna.

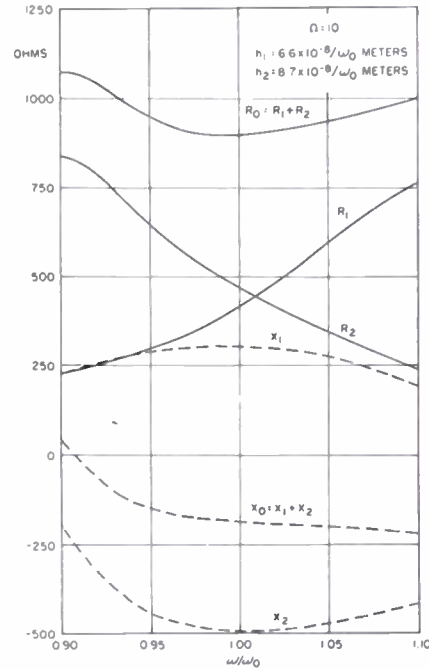

Fig. 6—Broad-band characteristics of asymmetrical antenna.

IV. THEORY OF THE SLEEVE DIPOLE

An antenna of considerable importance because of its broad-band properties is the *sleeve dipole* shown in Figs. 7(a) and 7(b). It consists essentially of the vertically extended inner conductor and outer conductor of a

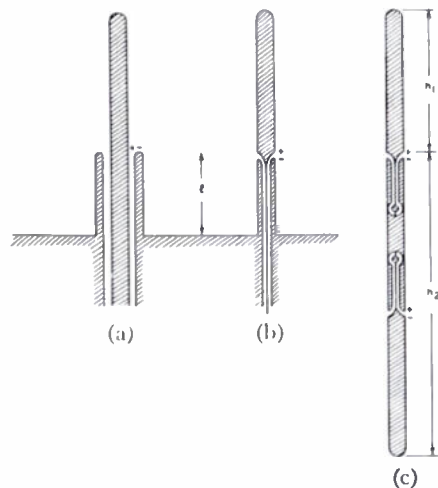

Fig. 7—Sleeve dipole driven by a coaxial line over an image plane and its equivalent symmetrical structure.

asymmetrically driven antenna, including $z=0$, by the actual currents in the lower part, do not differ effectively from what they would be if the distribution of current were the same in the lower part as in the upper, as when $h_2=h_1$. Evidently, currents in the lower part that are near enough to contribute to the vector potential in the upper part, i.e., near $z=0$, cannot differ appreciably from the currents in the adjacent upper part since $I_{10}=I_{20}$.

This means that in determining the distributions of current in the two parts, each may be analyzed separately as if each were a base-driven antenna over an infinite, perfectly conducting plane. That is, I_{1z} in (18) will be changed negligibly if h_2 is set equal to h_1 wherever it occurs in Ψ and in the F and G functions that contribute to the M and A functions. Similarly, I_{2z} may be determined from (20) by setting h_1 equal to h_2 in the corresponding integrals. Each of these problems is equivalent to the center-driven antenna.² The current I_{1z} in the upper part is the same as in the upper part of a center-driven antenna of half-length h_1 ; the impedance $Z_1=V_{10}/I_{10}$ is one half that of the center-driven antenna. Similarly, I_{2z} in the lower part is the same as that in the lower part of a center-driven antenna of half-length h_2 , and the impedance $Z_2=V_{20}/I_{20}$ is one half that of the center-driven antenna. *The impedance Z_0 of the asymmetrical array is the series combination of Z_1 and Z_2 .*

$$Z_0 = Z_1 + Z_2. \tag{41}$$

The currents in the two isolated antennas of half-length h_1 and h_2 , respectively, are related to each other and to the asymmetrical antenna they are to represent by setting

$$I_{10} = I_0 Z_1 / Z_0; \quad I_{20} = I_0 Z_2 / Z_0. \tag{42}$$

Hence, with $Y=1/Z$,

I_{1z} (upper part of asymmetrical antenna)

$$= \frac{Y_0}{Y_1} I_{1z}(\text{upper half of symmetrical antenna of half-length } h_1) \tag{43a}$$

I_{2z} (lower part of asymmetrical antenna)

$$= \frac{Y_0}{Y_2} I_{2z}(\text{lower half of symmetrical antenna of half-length } h_2) \tag{43b}$$

where

$$Y_1 = 2(Y_0 \text{ of symmetrical antenna of half-length } h_1) \tag{44}$$

$$Y_2 = 2(Y_0 \text{ of symmetrical antenna of half-length } h_2) \tag{45}$$

$$Y_0 = \frac{Y_1 Y_2}{Y_1 + Y_2}. \tag{46}$$

As a numerical example consider the asymmetrical antenna defined as follows:

$$\beta_0 h_1 = \pi/2; \quad \beta_0 h_2 = \pi \tag{47a}$$

$$\Omega_1 = 2 \ln(2h_1/a_1) = 10; \quad \Omega_2 = 2 \ln(2h_2/a_2) = 10. \tag{47b}$$

Since $h_2=2h_1$, $a_2=2a_1$. The second-order King-Middleton² admittances are

$$\begin{aligned} \beta_0 h_1 = \pi/2: Y_1 &= 2(9.56 - j4.62) \times 10^{-3} \\ &= (19.12 - j9.24) \times 10^{-3} \\ &= 23 \times 10^{-3} / -23.2^\circ \text{ mhos} \end{aligned} \tag{48a}$$

$$\begin{aligned} \beta_0 h_2 = \pi: Y_2 &= 2(1.0 + j1.8) \times 10^{-3} \\ &= (2 + j3.6) \times 10^{-3} \\ &= 4.12 \times 10^{-3} / 61^\circ \text{ mhos.} \end{aligned} \tag{48b}$$

The input admittance of the asymmetrical antenna is

$$Y_0 = (2.51 + j3.1) \times 10^{-3} = 3.98 \times 10^{-3} / 51^\circ \text{ mhos.} \tag{48c}$$

The input impedance is

$$Z_0 = 158 - j195 = 251 / -51^\circ \text{ ohms.} \tag{48d}$$

The input current of the asymmetrical antenna is

$$\begin{aligned} \frac{I_0}{V_0} &= 2.51 + j3.1 \\ &= 3.98 / 51^\circ \text{ milliamperes per volt.} \end{aligned} \tag{49}$$

The distribution of current along the individual parts is the same as if this part were half of a center-driven antenna, but multiplied for part 1 ($\beta_0 h_1 = \pi/2$) by Y_0/Y_1 , for part 2 ($\beta_0 h_2 = \pi$) by Y_0/Y_2 . Numerical values for the special case under consideration are

$$\frac{2I_0}{I_1} = 0.346 / 74.2^\circ; \quad \frac{2I_0}{I_2} = 1.936 / -10^\circ. \tag{50}$$

The factor 2 before I_0 is necessary for comparison with the center-driven antennas which have admittance $Y_1/2$ and $Y_2/2$, respectively. Accordingly, the distributions of the magnitudes and phases of the currents per unit driving voltage are

$$\begin{aligned} \frac{I_{1z}}{I_0} &= 0.346 \left[\frac{I_{1z}}{I_0} \right]_{\beta_0 h_1 = \pi/2}; \\ \theta_{1z} &= \theta_{I, \beta_0 h_1 = \pi/2} + 74.2^\circ \end{aligned} \tag{51a}$$

$$\begin{aligned} \frac{I_{2z}}{I_0} &= 1.936 \left[\frac{I_{2z}}{I_0} \right]_{\beta_0 h_2 = \pi}; \\ \theta_{2z} &= \theta_{I, \beta_0 h_2 = \pi} - 10^\circ. \end{aligned} \tag{51b}$$

Curves showing the distributions of the magnitude and phase of the current referred to the driving voltage for the asymmetrical antenna with $h_1 = \lambda_n/4$, $h_2 = \lambda_n/2$ are in Fig. 5. These were obtained from approximate second-order curves of the King-Middleton distribution of current.⁵

⁵ The second order current curves will be included in a subsequent technical report. First order curves are given in footnote reference 2.

Since the input impedance of the asymmetrical antenna is approximately equal to the sum of the impedances of two antennas of different and quite arbitrary lengths, it is interesting to consider the possibility of selecting these lengths so that the sum of the two im-

Curves showing the variation of R_1 and X_1 , R_2 and X_2 , $R_0 = R_1 + R_2$, and $X_0 = X_1 + X_2$ are shown in Fig. 6 as a function of ω in the range from $0.9\omega_0$ to $1.1\omega_0$. It is seen that over this 20-per cent frequency change, R_0 and X_0 are reasonably constant. It is to be noted that with a corresponding choice of h_1 and h_2 for thicker antennas for which Ω_1 and Ω_2 are smaller than 10, a considerable extension of this approximately constant range is possible.

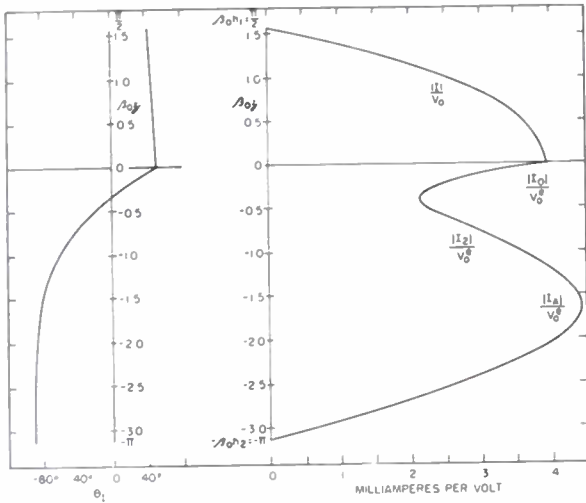

Fig. 5—Current distribution on asymmetrical antenna.

pedances is less sensitive to changes in $\beta_0 h = \omega h/v_0$ than either one separately; that is, is it possible to select h_1 and h_2 so that the asymmetrically driven antenna has desirable broad-band characteristics? The answer is in the affirmative if it is possible to design the two parts 1 and 2 of the asymmetrical antenna so that for a given change in frequency from $\omega_0 - \Delta\omega$ to $\omega_0 + \Delta\omega$ the resulting change in R_1 and X_1 is compensated by a nearly equal and opposite change in R_2 and X_2 . For frequency change from ω to $\omega + \Delta\omega$, $\beta_0 h_1 = \omega h_1/v_0$ increases to $(\omega + \Delta\omega)h_1/v_0$, and $\beta_0 h_2 = \omega h_2/v_0$ increases to $(\omega + \Delta\omega)h_2/v_0$. Thus, the change in $\beta_0 h$ is $\Delta\omega h_1/v_0$, and the change in $\beta_0 h_2$ is $\Delta\omega h_2/v_0$. Evidently, the increase in $\beta_0 h_2$ is greater than that in $\beta_0 h_1$ if h_2 is greater than h_1 , so that the slope of the R_2 , X_2 curves should be smaller than, and of sign opposite to, the slope of R_1 , X_1 curves. Since for all moderately thin antennas the regions of negative slope for X are always much steeper than regions of positive slope, it is difficult to satisfy these conditions without using sections that are several half wavelengths long. If both h_1 and h_2 are to be under a wavelength and Ω_1 and Ω_2 are not to differ greatly, a reasonably broad-band antenna can be constructed by choosing h_1 to maximize X_1 and h_2 to minimize X_2 at $\omega = \omega_0$. For $\Omega_1 = \Omega_2 = 10$, $h_1 = 2.2v_0/\omega_0$ and $h_2 = 2.9v_0/\omega_0$ where $v_0 = 3 \times 10^8$ m per second. A range of ω defined by

$$0.9\omega_0 \leq \omega \leq 1.1\omega_0 \tag{52a}$$

corresponds to

$$1.98 \leq \beta_0 h_1 \leq 2.42; \quad 2.61 \leq \beta_0 h_2 \leq 3.19. \tag{52b}$$

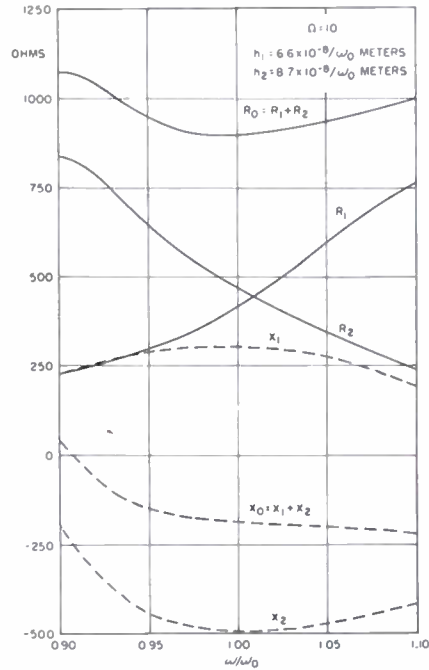

Fig. 6—Broad-band characteristics of asymmetrical antenna.

IV. THEORY OF THE SLEEVE DIPOLE

An antenna of considerable importance because of its broad-band properties is the *sleeve dipole* shown in Figs. 7(a) and 7(b). It consists essentially of the vertically extended inner conductor and outer conductor of a

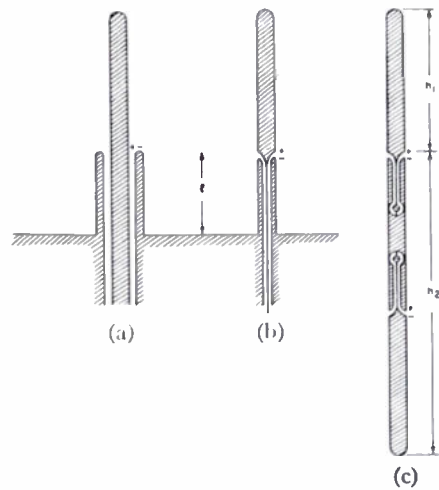

Fig. 7—Sleeve dipole driven by a coaxial line over an image plane and its equivalent symmetrical structure.

coaxial line over a horizontal conducting plane. It differs from the conventional base-driven half-dipole over a conducting plane in that the sheath of the coaxial line does not end at this plane but extends above it a distance l . This is equivalent to moving the gap across which a voltage is maintained by the feeding transmission line upward from $z=0$ at the conducting plane to $z=l$. Application of the theorem of images to obtain an equivalent symmetrical structure yields the internally driven antenna of Fig. 7(c) in which two generators maintain equal voltage respectively across two gaps at $z = \pm l$.

Owing to the linearity of the Maxwell equations, the principle of superposition is applicable, so that the current at any point along the antenna in Fig. 7(c) is the algebraic sum of the currents maintained independently by the generators. This is illustrated schematically in Fig. 8.

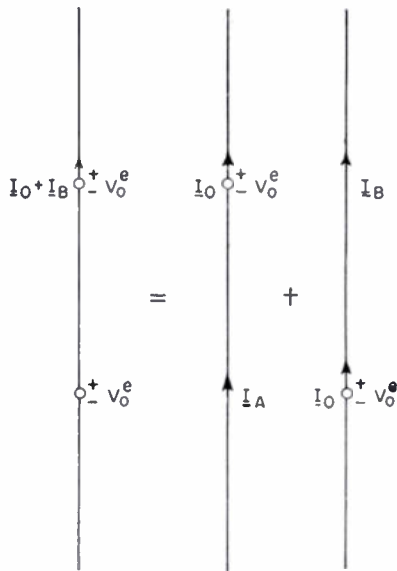

Fig. 8—Decomposition of the symmetrically driven antenna into two asymmetrically driven antennas.

The determination of the currents due to the upper generator in the symmetrical antenna on the left in Fig. 8 reduces to the analysis of the current in the middle antenna in Fig. 8. Since this is the asymmetrically driven antenna already analyzed, this part of the problem is solved. The current in the antenna on the right in Fig. 8 may be obtained directly from that in the middle antenna by interchanging ends. Finally, the resultant current in the antenna on the left is the algebraic sum of the currents in the other two.

The impedance at the terminals of the upper generator in the antenna on the left in Fig. 8 is given by the driving voltage V_0^e divided by the total current in the terminals. Thus,

$$Z_{in} = V_0^e / (I_0 + I_B) = V_0^e / (I_0 + I_A). \quad (53a)$$

The admittance is

$$Y_{in} = (I_0 + I_A) / V_0^e. \quad (53b)$$

The numerical evaluation of the impedance and the distribution of current in a sleeve dipole is complicated by several factors. Consider first the simplest case of the symmetrical antenna in Fig. 9(a) where the driving voltages are maintained by discontinuities in scalar potential. To permit numerical evaluation, let $\beta_0 h_1 = \pi/2$, $\beta_0 h_2 = \pi$, as shown. Also let $h_2/a_2 = 75$ so that $\Omega_2 = 2 \ln(2h_2/a_2) = 10$. Since $h_2 = 2h_1$, it follows that with $a_2 = a_1$, $\Omega_1 = 2 \ln(2h_1/a_1) = 9.3$. Since the impedance of an antenna of half length $h_1 = \lambda_0/4$ varies only slowly with Ω , an error of only a few per cent is made if it is assumed for simplicity that $\Omega_1 = 10$. This value corre-

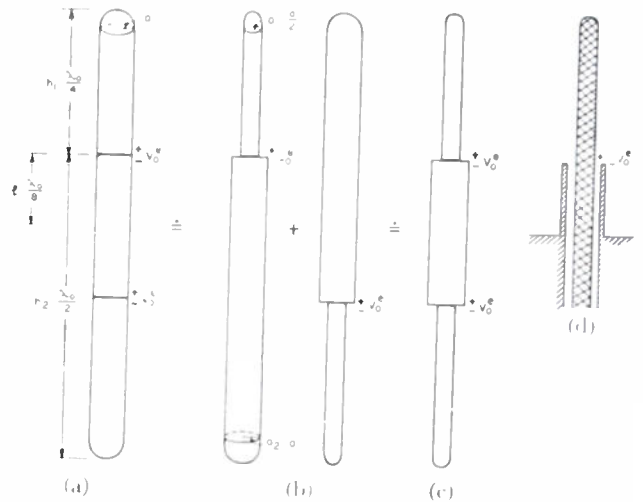

Fig. 9—Method of analysis of the sleeve dipole.

sponds to $a_1 = a_2/2$. Physically the condition $\Omega_1 = \Omega_2 = 10$ has a meaning for the asymmetrical antenna with $h_2 = 2h_1$; $a_2 = 2a_1$, but not for the antenna symmetrically driven by two equal generators. Thus, each of the two asymmetrical antennas in Fig. 9(b) may be analyzed, but the superposition of their solutions does not correspond *exactly* to any physically realizable structure since the outer thirds of each antenna cannot simultaneously have different radii. It is clear that the antenna of Fig. 9(d) also is approximated by a superposition of the two antennas in Fig. 9(b) except for the added complication of the shoulders at the driving points, of which no account is taken in the theory. In the following, the currents in the two antennas in Fig. 9(b) will be superimposed with the understanding that the results apply approximately to both Figs. 9(a) and 9(c), if a correction is made to take account of the shoulders in the latter.

The currents I_0 and I_A in the central asymmetrical antenna in Fig. 8 with $\Omega_1 = \Omega_2 = 10$ are obtained directly from Fig. 5. They are

$$\begin{aligned} \frac{I_o}{V_o^e} &= 3.98/51^\circ \\ &= 2.51 + j3.1 \text{ milliamperes per volt} \end{aligned} \quad (54a)$$

$$\begin{aligned} \frac{I_A}{V_o^e} &= 4.4/-81^\circ \\ &= 0.68 - j4.34 \text{ milliamperes per volt.} \end{aligned} \quad (54b)$$

substitution in (53b) gives the following driving-point admittance at the terminals of each slice generator in the symmetrical two-generator antenna or at the terminals of the single-slice generator of half of the symmetrical structure erected vertically on an infinite conducting plane:

$$Z_{in} = (I_o + I_A) / V_o^e = (3.18 - j1.24) \times 10^{-3} \text{ mhos.} \quad (55a)$$

The corresponding input impedance is

$$Z_{in} = 273 + j106 \text{ ohms.} \quad (55b)$$

The distribution of current on the symmetrical two-generator antenna is obtained by superposition. It is

$$[I(z)]_{\text{symmetrical antenna}} = [I(z) + I(-z)]_{\text{asymmetrical antenna}} \quad (56)$$

since the current in the lower part of the middle unit in Fig. 8 is equal to the current in the upper part in the right-hand unit. The magnitude and phase of the current in the symmetrical two-generator antenna are given by

$$I = \sqrt{(I_t \cos \theta_t + I_b \cos \theta_b)^2 + (I_t \sin \theta_t + I_b \sin \theta_b)^2} \quad (57a)$$

$$\theta_t = \tan^{-1} [(I_t \sin \theta_t + I_b \sin \theta_b) / (I_t \cos \theta_t + I_b \cos \theta_b)] \quad (57b)$$

where

$$I_t = I_0 e^{j\theta_t} \equiv I(z); \quad I_b = I_0 e^{j\theta_b} \equiv I(-z). \quad (58)$$

The magnitude I and the phase-angle θ_t referred to V_o^e are plotted in Fig. 10 for $\beta_o h_1 = \pi/2$, $\beta_o h_2 = \pi$, and $\Omega_1 \doteq \Omega_2 \doteq 10$. The current in the central part of the antenna between the two generators is seen to be relatively great and to differ in phase from the currents in the outer parts by 25° on the average.

The admittance and impedance of a base-driven antenna of electrical length $\beta_o h = 3\pi/4$; $\Omega = 10$, base-driven over a perfectly conducting half space are

These do not differ greatly from values (55a) and (55b) for the same antenna when driven at a height $\lambda_o/8$ from the conducting plane.

$$Y_o = (2.8 - j1.1) \times 10^{-3} \text{ mhos; } Z_o = 310 + j122 \text{ ohms.} \quad (59)$$

The degree in which the impedance (55b) and the current in the upper half of Fig. 10 approximate the apparent terminal impedance of and the current on the sleeve dipole in Fig. 9(d) depends upon the size and the nature of the junction region where the coaxial line ends and the driving voltage is applied to the antenna. Usually, more-or-less extensive surfaces exist in the form of flat or curved surfaces with or without sharp edges on which charge can accumulate. Since these surfaces and transmission-line end effects are not considered in the analysis of the cylindrical antenna, it is to be expected that the measured apparent impedance of a sleeve dipole will differ considerably from the theoretical impedance. The additional chargeable surfaces are equivalent to a lumped capacitance in parallel with the theoretical impedance. The effect of a positive capacitance in parallel with a center-driven antenna is to decrease the magnitude of resistance and reactance and shift the curves toward shorter lengths. In particular, the positive reactance is reduced relatively much more than the negative reactance.

For example, suppose a susceptance $B = \omega C = 3.2 \times 10^{-3}$ mhos is connected in parallel with a sleeve dipole for which the theoretical admittance and impedance are given by (55a) and (55b). The apparent admittance is

$$Y_{in} = (3.18 + j1.96) \times 10^{-3} \text{ mhos.} \quad (60a)$$

The apparent impedance is

$$Z_{in} = 228 - j141 \text{ ohms.} \quad (60b)$$

The broad-band properties of the sleeve dipole can not be investigated in general without extensive numerical computations of the input impedance for a variety of sleeve lengths and antenna lengths. However, the behavior as a function of frequency of the input impedance of the particular antenna for which the currents in Fig. 10 were determined may be carried out using available current and impedance data.

Suppose the frequency for which $\beta_o h_1 = \pi/2$, $\beta_o h_2 = \pi$, $\beta_o l = \pi/4$ is ω_o , and the associated angular velocity is ω_o . For a variation in frequency from $\omega_o - \Delta\omega$ to $\omega_o + \Delta\omega$, where $\Delta\omega = \omega_o/4$, the electrical lengths have the following ranges:

$$\left. \begin{aligned} \frac{3\pi}{8} &\leq \beta_o h_1 \leq \frac{5\pi}{8} \\ \frac{3\pi}{4} &\leq \beta_o h_2 \leq \frac{5\pi}{4} \\ \frac{3\pi}{16} &\leq \beta_o l \leq \frac{5\pi}{16} \end{aligned} \right\} \quad \frac{3}{4} \omega_o \leq \omega \leq \frac{5}{4} \omega_o \quad (61)$$

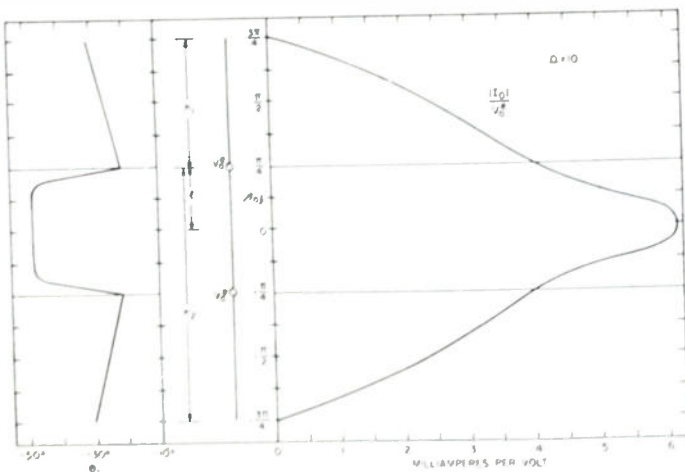

Fig. 10—Current distribution on the sleeve dipole.

The input impedance and admittance seen by the generator at $z=l$ are given by (53a) and (53b). In order to determine the admittance or impedance over this range, it is necessary to know the currents I_o at the driving point $z=l$ where the impedance is to be evaluated and I_A at $z=-l$ in the asymmetrical antenna. These currents are available^b for $\beta_o h = \pi/2, 3\pi/4, \pi,$ and $5\pi/4$. It follows that in the range (61) the required currents may be determined for both extremes, $\beta_o h_2 = 3\pi/4$ and $5\pi/4$, and for the middle value $\beta_o h_2 = \pi$. The current in the lower part 2 of the asymmetrically driven antenna is obtained from the current in the lower half of a symmetrical, center-driven antenna by multiplying by $Z_2/(Z_1 + Z_2)$ where Z_1 is the impedance of a symmetrical center-driven antenna of half length h_1 and Z_2 is the impedance of a symmetrical center-driven antenna of half length h_2 . These values of impedance, as well as $I_o/V_o = Y_2$ for the symmetrical antenna, may be determined over the entire range of variation, namely, $3\pi/8 \leq \beta_o h_1 \leq 5\pi/8; 3\pi/4 \leq \beta_o h_2 \leq 5\pi/4$ using the second-order impedance and admittance curves.^c The current I_A/V_o can be obtained from the second-order distribution curves^b for $\beta_o h = 3\pi/4, \pi,$ and $5\pi/4$. A reasonable estimate of the variation of I_A/V_o is obtainable by plotting curves of the magnitude and phase and of the real and imaginary parts of I_A as functions of $\beta_o h$. Using interpolated values from these curves the approximate input impedance Z_{in} of the sleeve dipole may be determined over the specified frequency range using the formula

$$\frac{1}{Z_{in}} = Y_{in} = 2 \left(\frac{I_o + I_A}{V_o} \right) \left(\frac{Z_2}{Z_1 + Z_2} \right). \quad (62)$$

Note that I_o and I_A in (62) are the values obtained in terms of a single generator with voltage V_o . Since the generator voltage at $z=l$ in the sleeve dipole is V_o , the limiting case with $l=0$ gives a generator of voltage $2V_o$ at the center. Therefore, the factor 2 in (62) is required.

Curves showing the input impedance $Z_{in} = R_{in} + jX_{in} = Ze^{j\theta_{in}}$ are in Fig. 11 as a function of $\beta_o h_2$ and as a function of ω/ω_o . For purposes of comparison the variation in $Z_1 = R_1 + jX_1$ and $Z_2 = R_2 + jX_2$ for symmetrical center-driven antennas of electrical half lengths in the ranges $3\pi/8 \leq \beta_o h_1 \leq 5\pi/8$ and $3\pi/4 \leq \beta_o h_2 \leq 5\pi/4$ are shown in Fig. 12. It is seen that the reactance of the sleeve dipole is remarkably constant near 110 ohms over the greater part of the range whereas X_1 and X_2 for the center-driven dipoles vary widely over positive and negative values. R_{in} for the sleeve dipole varies within 50 per cent of a mean value near 200 ohms whereas R_2 ranges between 80 and 850 ohms, and R_1 varies over a range of

nearly 100 per cent from a mean value of about 110 ohms. Clearly, the frequency response of the sleeve dipole is very much better from the point of view of

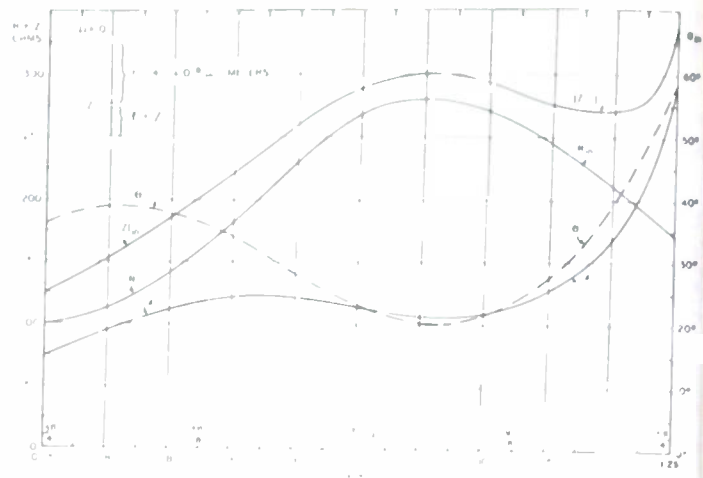

Fig. 11 Impedance behavior of the sleeve dipole

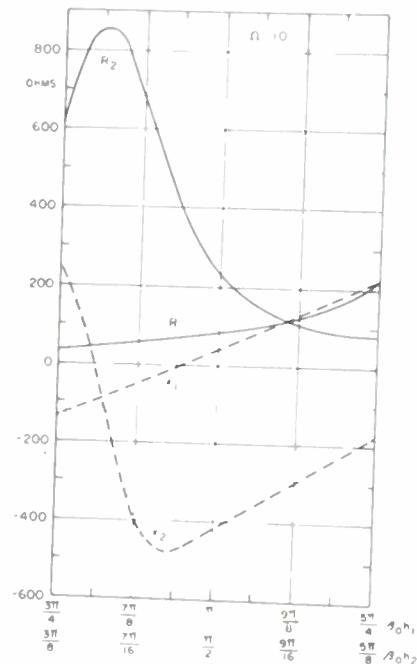

Fig. 12 Impedance behavior of the symmetrical center-driven antenna.

broad-band operation than the response of either a half-wave or a full-wave dipole. With an appropriately designed reactive matching network the standing-wave ratio on a line terminated in the sleeve dipole could be made to remain reasonably constant and small over a wide frequency range.

Application of Correlation Analysis to the Detection of Periodic Signals in Noise*

Y. W. LEE†, T. P. CHEATHAM, JR.†, AND J. B. WIESNER†, SENIOR MEMBER, IRE

Summary—The first part of this paper is a resumé of correlation analysis. An interpretation of the correlation function of a continuous random process is given in terms of the sum of the products obtained by representing the process as a discrete time series. An electronic correlator capable of performing the necessary mathematical operations to obtain correlation functions is described. The theory of detection of a periodic signal in random noise by the correlation method and a description of the application of the correlator to the theory are presented.

PRACTICAL APPLICATION of the recent developments in communication theory based upon the statistical concept of information has necessitated the study of characteristic functions of actual messages and noise as random processes and the development of techniques for their experimental determination. A statistical characteristic of messages or noise which has shown considerable effectiveness as a tool in the analysis of some communication problems is the correlation function.

As an application of the statistical approach to communication problems this paper presents the theory of detection of periodic signals in random noise by the method of correlation. The theory is supported by experimental results which have been obtained from an electronic correlator. The principles of the correlator are briefly presented. In order to provide sufficient background material, the first part of the paper contains a resumé of correlation analysis.

I. CORRELATION ANALYSIS

A. Autocorrelation of Random Processes

For a function belonging to a stationary random process^{1,2} such as, for example, the fluctuations of shot noise or thermal noise with time as the independent variable, a characteristic known as the autocorrelation function has some interesting and important properties. If $f_1(t)$ represents a member function of a stationary random process the autocorrelation function is defined as

$$\phi_{11}(\tau) = \lim_{T \rightarrow \infty} \frac{1}{2T} \int_{-T}^T f_1(t)f_1(t + \tau)dt. \quad (1)$$

* Decimal classification: R361.211. Original manuscript received by the Institute, December 19, 1949; revised manuscript received, July 7, 1950. Presented, 1949 IRE National Convention, New York, N. Y., March 10, 1949.

This work has been supported in part by the Signal Corps, the Air Materiel Command, and ONR.

† Research Laboratory of Electronics, Massachusetts Institute of Technology, Cambridge, Mass.

¹ M. C. Wang and G. E. Uhlenbeck, "On the theory of the Brownian motion," *Rev. Mod. Phys.*, vol. 17, pp. 323-342; April-July, 1945.

² H. M. James, N. B. Nichols, and R. S. Phillips, "Theory of Servomechanisms," McGraw-Hill Book Co., New York, N. Y., chaps. 6-8; 1947.

The function $f_1(t)$, which shall be called a random function, may or may not have a hidden periodic component. However, when it represents a shot noise or thermal noise, such a component does not exist. Although correlation functions may be defined for discrete random series, the functions concerned in this paper are continuous so that attention is confined to continuous random functions only. Because of the fact that expression (1) requires an averaging process with time as the independent variable, it is called a *time average* for $\phi_{11}(\tau)$.

It is known that an autocorrelation function is a continuous, even function with a maximum value at the origin which no other value of the function may exceed in magnitude. In the absence of a hidden periodic component, the function is asymptotic to the square of the mean of the random function. Consequently, if the mean is zero, the autocorrelation function tends to zero as the displacement τ tends to infinity. Based upon these general properties a representative autocorrelation curve for a random phenomenon without hidden periodicity is roughly sketched in Fig. 1. If the random function is a voltage or current and a pure resistive load is assumed, then $\phi_{11}(0)$ represents the total mean power, $\phi_{11}(\infty)$ the dc power, and the difference, the power due to the fluctuating or random portion of the function.

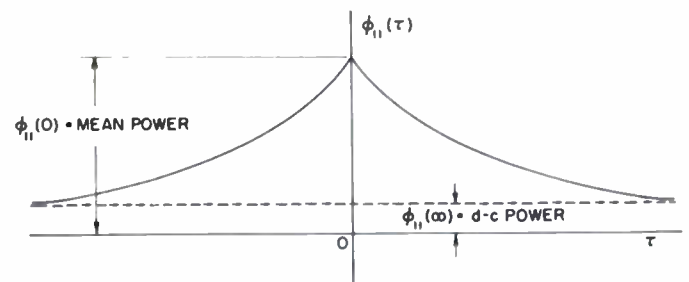

Fig. 1—Sketch of an autocorrelation function.

B. Crosscorrelation of Random Processes

For two member functions $f_1(t)$ and $f_2(t)$ belonging to different stationary random processes but which are in some manner related to each other, a crosscorrelation function is defined by the expression

$$\phi_{12}(\tau) = \lim_{T \rightarrow \infty} \frac{1}{2T} \int_{-T}^T f_1(t)f_2(t + \tau)dt. \quad (2)$$

If the displacement τ is given to $f_1(t)$ instead of $f_2(t)$, then

$$\phi_{21}(\tau) = \lim_{T \rightarrow \infty} \frac{1}{2T} \int_{-T}^T f_2(t)f_1(t + \tau)dt. \quad (3)$$

Crosscorrelation is a measure of coherence between two random functions. For two random functions which are independently generated, crosscorrelation produces a constant which is the product of the individual mean values of the functions. Under this condition the functions are said to be incoherent; and in the particular case of either one having a zero mean, the crosscorrelation function is zero everywhere.

C. Correlation of Periodic Functions

Correlation need not be confined to random phenomena. When the phenomenon under consideration is purely periodic, its autocorrelation function is defined by the same expression (1) in which $f_1(t)$ is now the periodic function. Thus if $f_1(t)$ has the general periodic form

$$f_1(t) = \frac{a_0}{2} + \sum_{n=1}^{\infty} a_n \cos (n\omega t + \theta_n), \quad (4)$$

the autocorrelation function is, by application of (1),

$$\phi_{11}(\tau) = \frac{a_0^2}{4} + \frac{1}{2} \sum_{n=1}^{\infty} a_n^2 \cos n\omega\tau. \quad (5)$$

This result brings out the interesting fact that the autocorrelation function of a periodic function is periodic, retains the fundamental and the harmonics, but drops all phase angles.

The crosscorrelation of periodic functions is defined by (2) and (3) in which $f_1(t)$ and $f_2(t)$ now represent the periodic functions. The crosscorrelation function of two periodic functions of the same fundamental frequency retains the fundamental and only those harmonics which are present in both, together with their phase differences.

D. Ensemble Averages and the Ergodic Hypothesis

Instead of taking the time average of a member function of a stationary random process for the correlation function as it is done up to this point, the same result may be obtained by considering the process as a whole. The process consists of an infinite ensemble of functions which are generated by mechanisms of similar character. In this ensemble, let y_1 be the random variable representing the values of the member functions observed at an arbitrary time t_1 , y_2 those observed at time τ later, and $P(y_1, y_2; \tau)dy_1dy_2$ the joint probability that y_1 lies in the range (y_1, y_1+dy_1) and y_2 in the range (y_2, y_2+dy_2) . Because the process is stationary, the joint probability distribution is independent of t_1 . A characteristic of the ensemble of particular interest is the mean product of the variables y_1 and y_2 as a function of the displacement τ . This function is expressed as

$$\int_{-\infty}^{\infty} \int_{-\infty}^{\infty} y_1 y_2 P(y_1, y_2; \tau) dy_1 dy_2. \quad (6)$$

An important hypothesis in the theory of stationary random processes, known as the ergodic hypothesis,

states that the time average (4) is equivalent to the ensemble average (6). This hypothesis makes it possible to write

$$\phi_{11}(\tau) = \int \int y_1 y_2 P(y_1, y_2; \tau) dy_1 dy_2. \quad (7)$$

as the ensemble average for the autocorrelation function. Crosscorrelation functions obtained from ensemble consideration are expressed in a similar manner.

E. Wiener's Theorem

The central theorem in the harmonic analysis of stationary random processes is Wiener's theorem³ for autocorrelation. The theorem asserts that the autocorrelation function $\phi_{11}(\tau)$ and the power density spectrum $\Phi_{11}(\omega)$ of the random process are determinable one from the other by the integrals

$$\phi_{11}(\tau) = \int_{-\infty}^{\infty} \Phi_{11}(\omega) \cos \omega\tau d\omega \quad (8)$$

and

$$\Phi_{11}(\omega) = \frac{1}{2\pi} \int_{-\infty}^{\infty} \phi_{11}(\tau) \cos \omega\tau d\tau. \quad (9)$$

In other words $\phi_{11}(\tau)$ and $\Phi_{11}(\omega)$ are Fourier cosine transforms of each other.

II. AN ELECTRONIC METHOD FOR COMPUTING CORRELATION FUNCTIONS

A. Theory

According to the definition of $\phi_{11}(\tau)$ given in (1) a graphical method for its computation would consist of the following steps: (1) to displace $f_1(t)$ by a small interval τ_1 resulting in $f_1(t+\tau_1)$ as shown in Fig. 2; (2) to multiply these two functions continuously; (3) to inte-

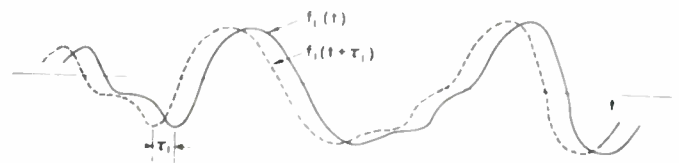

Fig. 2—Graphical method of obtaining an autocorrelation function. Integrate the product over a long duration; and (4) to take the average value of the integral over the duration thus obtaining the points $\phi_{11}(\tau_1)$ on the autocorrelation curve as illustrated in Fig. 3. Repetition of this procedure for

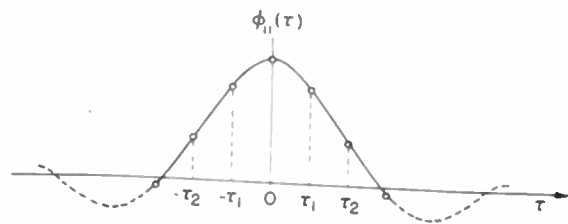

Fig. 3—Autocorrelation function obtained by graphical method.

³ N. Wiener, "Generalized harmonic analysis," *Acta. Math.*, vol. 55, pp. 117-258, 1930.

different values of τ determines as many points on the curve as necessary. To carry out this interpretation of autocorrelation by an electronic method would require means for delaying and storing the random function of a long duration. A satisfactory electronic device for continuous multiplication is also necessary. Unfortunately these essential requirements are difficult to meet at the present stage of development of electronic techniques.

However, a simpler electronic method which avoids these difficulties may be developed through the ensemble interpretation of the autocorrelation function. For the explanation of the method consider the random function $f_1(t)$ in Fig. 4, which, for the time being, is as-

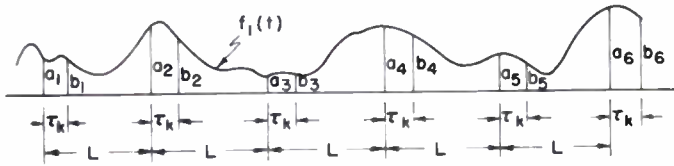

Fig. 4—Portion of a random function showing graphical representation of (12).

sumed to have no periodic component. Let the function be divided into sections each of duration L , and let it be assumed that the duration is so long that the set of values a_1, a_2, a_3, \dots of the function at the junction points are independent of one another. Under this condition the sections of the function may be considered as belonging to the member functions of a stationary random process. Now if b_1, b_2, b_3, \dots are the values of the sections at time τ_k following the correspondingly numbered values in the first set, then the mean of the product of the two sets of values for n sections is

$$\frac{1}{n} \sum_{j=1}^n a_j b_j \tag{10}$$

As the number of sections increases to infinity, the average quantity (10) tends to the value of the autocorrelation function of the random process for $\tau = \tau_k$. This interpretation of autocorrelation in the case of a physical situation is in agreement with the meaning of the ensemble average (7). Hence it is permissible to write

$$\phi_{11}(\tau_l) = \lim_{n \rightarrow \infty} \frac{1}{n} \sum_{j=1}^n a_j b_j \tag{11}$$

In actual observation the number n can be made large, but it remains finite so that the autocorrelation curve at $\tau = \tau_k$ has the approximate value

$$\phi_{11}(\tau_l) \cong \frac{1}{n} \sum_{j=1}^n a_j b_j \tag{12}$$

Clearly the error in approximation depends upon the number n . The calculation of this error is discussed in a later section when correlation analysis is applied to the problem of signal detection.

If a former restriction on $f_1(t)$ is removed so that it now has an additive periodic component but the sections still have a fixed duration L , then the values

a_1, a_2, a_3, \dots are no longer independent of one another. However, from a practical point of view, if the ratio of the period of the periodic component wave and the duration L is not such that the junction points of the sections always occur at only a few fixed locations on each period of the wave, the expression (12) should hold for a random function with a periodic component.

When the duration L is so short that the values a_1, a_2, a_3, \dots are in some manner related to one another even in the absence of a periodic component, the formula (12) may be shown to remain valid on the basis of time averaging for the correlation function carried out in accordance with the principles of sampling. The remarks just made in regard to the presence of periodicity applies in the present case.

Keeping the section duration L a constant is a great convenience in actual computation by electronic means. But if it were made a random variable the approximate expression (12) may still be applied in the point-by-point determination of the correlation curve.

Although the expression (12) is applicable in the several different situations discussed, it does not necessarily give the same value in all cases for the same number n . The calculation of error in each case depends upon the manner in which the values a_j and b_j are obtained.

B. Electronic Techniques

The electronic method embodying the principles discussed for the computation of correlation functions is indicated in the diagram of Fig. 5 and a brief description follows. The irregular continuous wave form (a) repre-

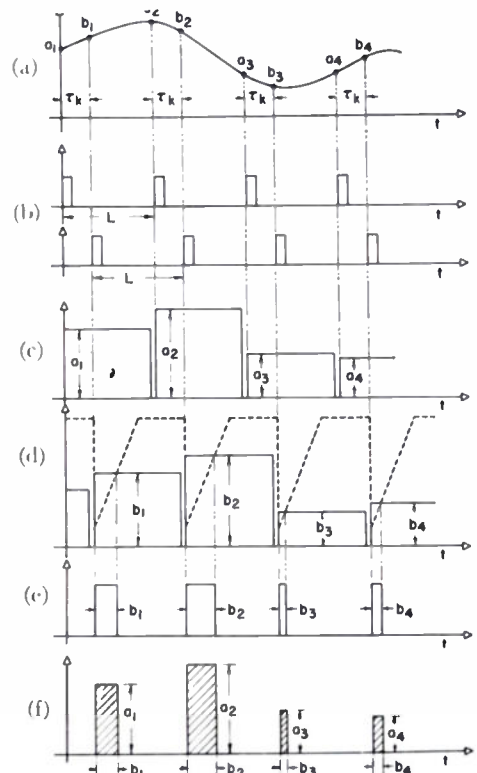

Fig. 5—Characteristic wave forms of electronic correlator.

sents a portion of the random function for which the autocorrelation curve is to be computed. Two sets of periodic timing pulses (b) both with the period L , are derived from a sine-wave master oscillator. The second set of timing pulses is displaced by a delay network from the first set by the adjustable duration τ_k . By means of the first set of timing pulses, the values $a_1, a_2, a_3 \dots$ are obtained. A boxcar wave form (c) is then generated in such a way that its discretely varying amplitudes are proportional to these values. Similarly another boxcar wave form (d) is formed from the set $b_1, b_2, b_3 \dots$. A sawtooth sampling wave converts the amplitudes of the second boxcar wave into a series of duration-modulated pulses (e). Clearly these pulses represent the b series. By means of a gating circuit the wave forms (c) and (e) are multiplied giving wave form (f) which is a series of pulses whose amplitudes represent the a series and durations the b series. The integration of wave form (f) by an integrating circuit for a large number of samples n results in a value which is proportional to the value $\phi_{11}(\tau_k)$ as expressed by (12).

An electronic correlator⁴ based upon the theory and techniques discussed has been developed at the Research Laboratory of Electronics, Massachusetts Institute of Technology. A photograph of the correlator is shown in Fig. 6. The displacement τ_k is automatically adjusted in discrete steps as the correlation curve is computed point by point each for the same number of samples. The results are presented graphically by a recording meter. The machine has been designed for crosscorrelation as well as autocorrelation.

III. DETECTION OF SINUSOIDAL SIGNAL IN RANDOM NOISE

A. Principles of Detection by Autocorrelation

Consider an additive mixture of a sinusoidal signal $S(t)$ and a random noise $N(t)$. Let the mixture be written as

$$f_1(t) = S(t) + N(t). \quad (13)$$

By application of the defining equation (1) the autocorrelation function of $f_1(t)$ is

$$\begin{aligned} \phi_{11}(\tau) &= \lim_{T \rightarrow \infty} \frac{1}{2T} \int_{-T}^T [S(t) + N(t)][S(t+\tau) + N(t+\tau)] dt \\ &= \phi_{SS}(\tau) + \phi_{NN}(\tau) + \phi_{SN}(\tau) + \phi_{NS}(\tau). \end{aligned} \quad (14)$$

The first two terms of the result are the autocorrelation functions of the sinusoid and the noise, respectively, and the last two terms are their crosscorrelation functions. As a matter of convenience, let the means of both $S(t)$ and $N(t)$ be zero. If $S(t)$ has the form

$$S(t) = E_m \cos(\omega t + \theta), \quad (15)$$

⁴ Further details are given in Technical Report No. 122, T. P. Cheatham, "Experimental Determination of Correlation Functions and Their Application in the Statistical Theory of Communications," Research Laboratory of Electronics, MIT (to be published).

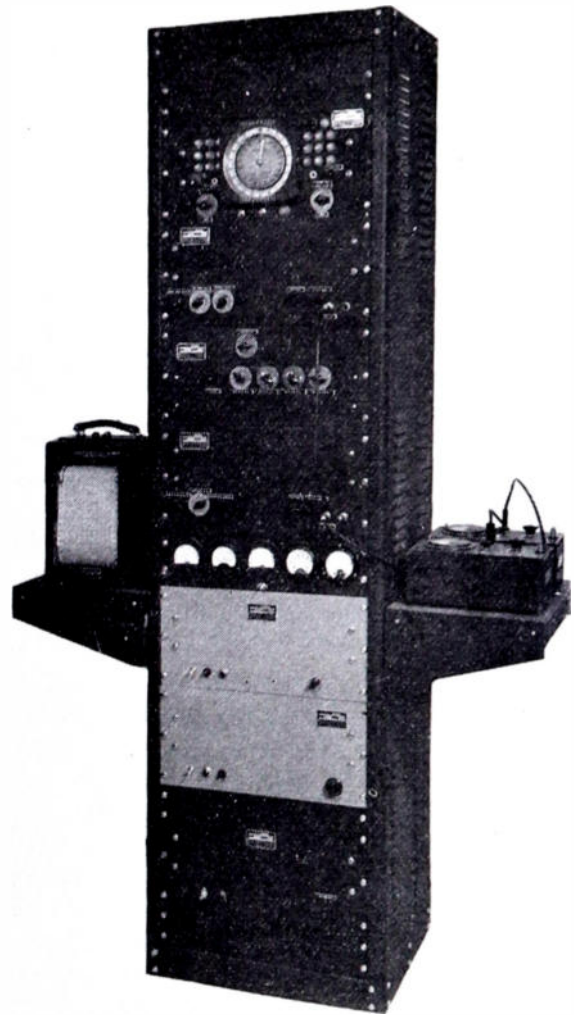

Fig. 6—MIT electronic correlator.

then according to the general expression (5)

$$\phi_{SS}(\tau) = E^2 \cos \omega \tau \quad (16)$$

where E is the rms value of the sinusoid. The function $\phi_{NN}(\tau)$ is nonperiodic and tends to zero as τ tends to infinity. Because of incoherence between signal and noise the crosscorrelation terms vanish in view of a previous discussion. From these considerations the general appearance of the autocorrelation function (14) may be sketched as in Fig. 7.

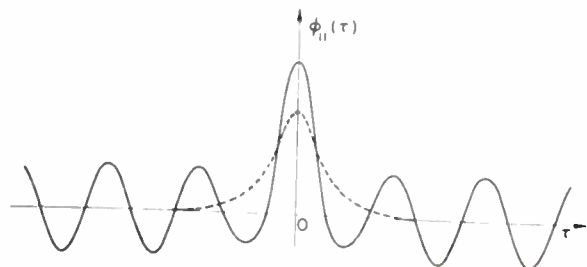

Fig. 7—Autocorrelation function of sine wave plus random noise. Dotted curve is component due to random noise.

The fact that the autocorrelation of random noise approaches zero as the displacement becomes large

whereas that of a periodic function persists as a periodic function, suggests that in the region of τ where noise autocorrelation is essentially zero, the presence of a periodic wave in the input of the correlator should be evidenced by a periodic variation in its output. Theoretical considerations show that a periodic signal masked by random noise can be detected by autocorrelation however small the signal may be. However, the theoretical possibility requires, among other things, an infinite time for observation.

Nature of Correlator Output

In view of the fact that the correlator operates according to sampling theory and in view of the finite time of observation in a practical situation, it is important to determine to what extent a periodic signal may be detected by this method. When the input of the correlator is a sine wave plus random noise its output graph for displacement τ sufficiently beyond the coherent range of noise is as shown in Fig. 8. Let it be assumed

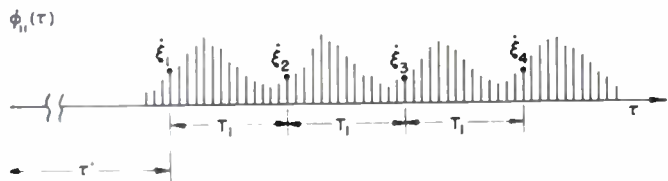

Fig. 8—Output graph of electronic correlator for large values of τ .

that there are sufficient number of points in each cycle of the output curve for the identification of a set of n points $\xi_1, \xi_2, \xi_3, \dots$, as indicated, which are located at a corresponding position in each cycle. Other sets of points may be formed in a similar manner. Let each point be the average of n sample products. The random variable from which the sample mean ξ_1 of size n is drawn is the variable

$$\begin{aligned} \xi &= [S(t) + N(t)][S(t + \tau') + N(t + \tau')] \\ &= S(t)S(t + \tau') + N(t)N(t + \tau') \\ &\quad + S(t)N(t + \tau') + N(t)S(t + \tau') \end{aligned} \tag{17}$$

where τ' is the time displacement from the origin to the point ξ_1 . The random variables from which the other sample means ξ_2, ξ_3, \dots are drawn are similarly written with τ' increased by integral multiples of the period of the sinusoid. These random variables have the same distribution because of incoherence between $N(t)$ and $N(t + \tau)$ for $\tau > \tau'$ and of the particular values of successive displacements.

To simplify the discussion, assume for the moment that the sampling process in the correlator is random. Actually, of course, the samples are taken at periodic intervals. Under the temporary assumption, the sample means $\xi_1, \xi_2, \xi_3, \dots$ are independent and are drawn from variables with the same distribution. It is known in statistical theory that in such circumstances the sample mean, as a random variable, has the mean of the vari-

able ξ of (17) and the variance that of ξ divided by the sample size n .

C. Correlator Output Noise

In determining the gain in signal-to-noise ratio it is necessary to discuss the nature of the output noise. Whereas the input noise is a continuous fluctuation, the output "noise" consists of the dispersion of a set of discrete points about a mean. The variance of the random sample means such as the set $\xi = \xi_1, \xi_2, \xi_3, \dots$ is a measure of the output noise. Clearly the input and output of the correlator cannot be compared on an instantaneous time basis as is possible in the case of a wave filter. The correlator output is a function of the displacement τ , not the independent variable time, for each value of which an average product is taken over a long duration.

If E is the rms value of the sinusoidal signal and σ is the standard deviation of the random noise (variance = σ^2), and if both signal and noise have a zero mean, it may be shown that the variance of the sample mean ξ as a random variable has the expression

$$\sigma_{\xi}^2 = \frac{1}{n} \left(\frac{1}{2} E^4 + 2E^2\sigma^2 + \sigma^4 \right). \tag{18}$$

This result has been obtained in accordance with the known properties of a sample mean already stated. One important property of the variance (18) is its independence of the displacement τ in the region under consideration.

D. Gain in Autocorrelation

Let the rms noise-to-signal ratio at the input be ρ_i so that

$$\rho_i = \frac{\sigma}{E}. \tag{19}$$

In decibel units, the input signal-to-noise ratio is

$$R_i = 20 \log_{10} \frac{1}{\rho_i} \text{ db.} \tag{20}$$

According to (15) and (16) the ideal output signal, as a function of τ , has the rms value

$$S_o = \frac{E^2}{\sqrt{2}}. \tag{21}$$

The output noise N_o in rms value of the sample means about the ideal mean is the square root of the variance given in (18). Therefore

$$N_o \equiv \sigma_{\xi} = \sqrt{\frac{1}{n} \left(\frac{1}{2} E^4 + 2E^2\sigma^2 + \sigma^4 \right)} \tag{22}$$

and the correlator output rms signal-to-noise ratio becomes

$$\frac{S_o}{N_o} = \frac{\sqrt{n} E^2}{\sqrt{E^4 + 4E^2\sigma^2 + 2\sigma^4}}. \tag{23}$$

In decibel units the ratio is

$$R_{on} = 20 \log_{10} \frac{S_o}{N_n} \text{ db}$$

$$= 10 \log_{10} \frac{n}{1 + 4\rho_i^2 + 2\rho_i^4} \text{ db.} \quad (24)$$

A curve of this expression for $n = 60,000$ is given in Fig. 9.

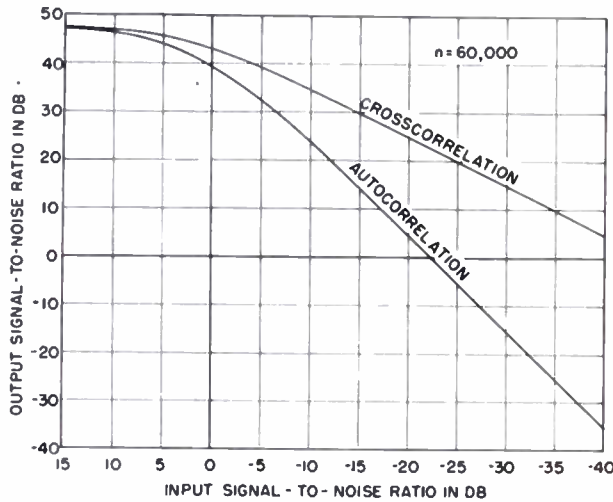

Fig. 9—Improvement in signal-to-noise ratio through autocorrelation and crosscorrelation for sinusoid in random noise.

E. Periodic Sampling

Analysis shows that, except when the sampling period happens to be such that samples are selected at points corresponding to only a small fraction of a cycle of the sinusoid or at points restricted to a few locations in a cycle, periodic sampling reduces the variance (18) by decreasing its first term. This quantity originates from the purely periodic component, that is, the first term of the variable (17). For a large sample size in periodic sampling the first term of (18) is negligible. On the other hand, if it may be assumed that there is sufficient variation in the duration of switching time in the correlator for each change of τ , so that the starting phase of the sinusoid for each point of the output curve is random, the second term of (18) remains the same as before. The last term of (18) is independent of the manner of sampling.

Under these conditions the correlator output signal-to-noise ratio is

$$R_{on}' = 10 \log_{10} \frac{n}{2\rho_i^2(2 + \rho_i^2)} \text{ db.} \quad (25)$$

For large values of ρ_i there is practically no difference between random sampling and periodic sampling as far as the ratio is concerned.

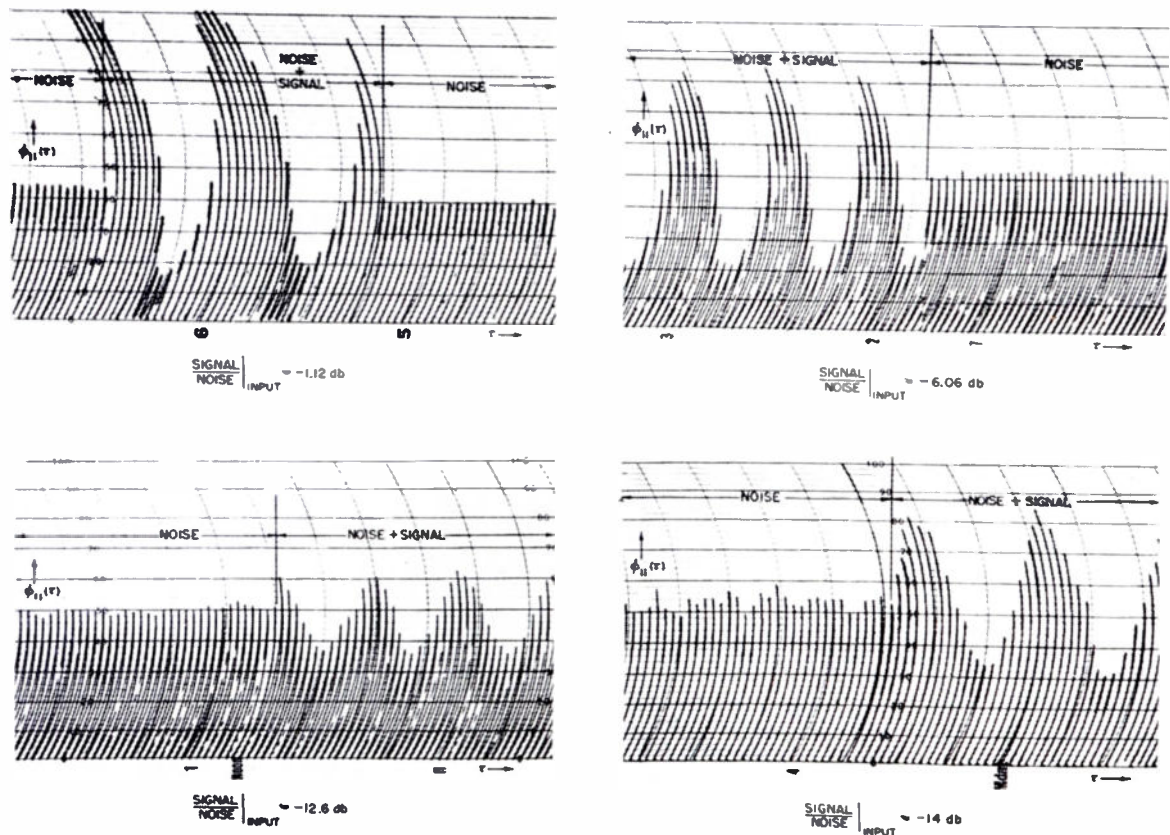

Fig. 10—Experimental results from electronic correlator showing gain in output signal-to-noise ratio for input of sinusoid plus random noise at several ratios.

7. Experimental Results

To verify the analytical results in 8-kc sine wave plus random noise derived from a Type-884 gas tube was applied to the electronic correlator. The correlator output curves as presented by the recorder for input signal-to-noise ratios of -1.12 db, -6.06 db, -12.6 db, and -14 db are shown in Fig. 10. The comparatively flat portions of the curves represent the autocorrelation of noise alone while the other portions indicate clearly the presence of a sine wave. In this experiment the sampling rate was 500 sample products per second and the sample size was 60,000.

7. Gain in Crosscorrelation

If the frequency of the sinusoidal signal is known, advantage may be taken of this information for attaining a further gain in signal-to-noise ratio. Instead of autocorrelation, a local sinusoidal wave of the known frequency is generated for cross correlating with the incoming corrupted signal. The advantage of crosscorrelation over autocorrelation may be seen from an examination of the random variable from which the correlator output is obtained. For crosscorrelation the input function is

$$f_1(t) = S_1(t) + N_1(t) \quad (26)$$

and the local wave is

$$f_2(t) = S_2(t) \quad (27)$$

so that the variable from which samples are drawn is

$$\begin{aligned} \eta &= [S_1(t) + N_1(t)]S_2(t + \tau) \\ &= S_1(t)S_2(t + \tau) + N_1(t)S_2(t + \tau). \end{aligned} \quad (28)$$

Comparison of this variable and the variable in (17) shows that because of the reduction of the number of terms from four to two the noise in crosscorrelation should be much less. In fact, the principal contribution to the variance, which is the measure of output noise, is accounted for by the pure noise term $N(t)N(t + \tau')$ in (17) so that its absence in (28) permits a substantial gain.

By calculations similar to those for autocorrelation, the output signal-to-noise ratio in crosscorrelation by random sampling may be shown to have the expression

$$R_{oc} = 10 \log_{10} \frac{n}{1 + 2\rho_i^2} \text{ db.} \quad (29)$$

A curve for this equation when $n = 60,000$ is given in Fig. 9.

A comparison of (24) and (29) shows clearly that for the same sample size, crosscorrelation has a gain over autocorrelation of the amount

$$G = 10 \log_{10} \frac{1 + 4\rho_i^2 + 2\rho_i^4}{1 + 2\rho_i^2} \text{ db.} \quad (30)$$

Fig. 11 contains a curve of this expression.

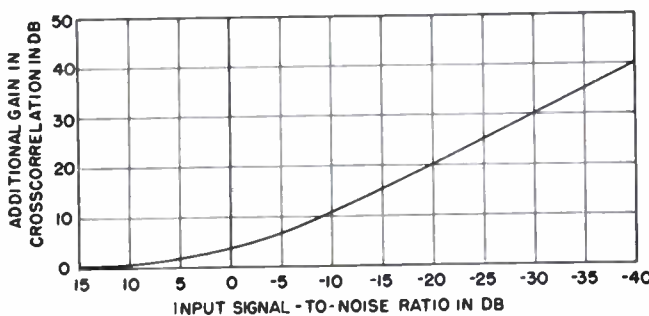

Fig. 11—Additional gain in signal-to-noise ratio through crosscorrelation as compared with autocorrelation (difference of the two curves in Fig. 9.)

Under conditions of Section III, Part E, periodic sampling reduces (29) to

$$R_{oc}' = 10 \log_{10} \frac{n}{2\rho_i^2} \text{ db} \quad (31)$$

and (30) to

$$G' = 10 \log_{10} (2 + \rho_i^2) \text{ db.} \quad (32)$$

IV. REMARKS

The method and technique of detecting a periodic wave in random noise presented here may be regarded as a type of filtering in the time domain. It is well to emphasize that theoretically no claim can be made that the method of correlation is superior to conventional filtering in the frequency domain in the sense of accomplishing in the time domain what is impossible in the frequency domain. Such a claim would be false, since it has already been stated that the correlation function and power-density spectrum of a stationary random process are uniquely related by a Fourier transformation, and since it is well known that a similar relationship holds for a periodic phenomenon. Nevertheless, from an engineering point of view, many equivalent operations may be more practicable and feasible in the time domain. For instance, a "zero" bandwidth filter in the frequency domain corresponds to an extremely stable oscillator in the time domain. At the present time it is much easier to build a stable oscillator than to build a network having zero bandwidth.

ACKNOWLEDGMENTS

The writers wish to express their appreciation for the valuable suggestions and assistance given by M. Cerillo, E. R. Kretzmer, C. A. Stutt, and M. Loewenthal.

The Traveling-Wave Cathode-Ray Tube*

K. OWAKI†, S. TERAHATA†, T. HADA†, AND T. NAKAMURA†

Summary—We have constructed cathode-ray tubes utilizing traveling waves, whose deflection sensitivity can be made independent of frequency by equalizing the phase velocity of the wave and the electron velocity. According to the theoretical analysis, the sensitivity of this tube is increased to 10^{-3} mm/v at 30 kMc without any difficulty. The results of the theoretical analysis are proved experimentally by the inversion spectrums.

As examples of its application, measurements of amplitude modulation degree and observations of uhf voltage wave form are described in this paper.

INTRODUCTION

SEVERAL PAPERS have hitherto been published about cathode-ray tubes or oscillographs for measurement in the region of uhf. For instance, Hollmann^{1,2} together with Von Ardenne, has studied the Lissajous figures in uhf region using a specially designed oscillograph, in which a very fine electron beam was focussed electrostatically and was deflected by a pair of extremely small deflecting plates. Recently, Lee³ has succeeded in taking photographs of voltage waves at 10,000 Mc using an oscillograph of three elements with a magnetic lens, operated similarly to that of Hollmann.

These cathode-ray tubes or oscillographs adopt either electron beams of extremely high velocity or deflecting plates of very small size in order to render it possible to neglect the transit-time effect (transit-time effect of the first kind) under the deflecting plates.

On the other hand, in 1943 the authors of this paper proposed a new method of electron deflection based upon the principle of velocity modulation. In this cathode-ray tube, the variation in velocity of the electron beam, which is proportional to the instantaneous uhf voltage, is transformed into the transverse deflection of the beam.

Recently we have developed a traveling-wave cathode-ray tube which makes use of a pair of parallel wires folded repeatedly instead of the usual deflecting plates. The electron beam is passed between these wires and is deflected by the electric field between the parallel wires.

A similar idea is seen in Haeff's patent⁴ and J. R. Pierce's paper,⁵ in which the former utilizes distributed constant circuits and the latter lumped constant circuits for the realization of deflecting system.

* Decimal classification: R138.31×R339.2. Original manuscript received by the Institute, November 30, 1949; revised manuscript received, July 6, 1950.

† Kobe Kogyo Corporation, Kobe, Japan.

¹ H. E. Hollmann, "Mikrowellen-Oszillographie," *Hoch. Frequenz. Tech.*, vol. 54, pp. 188-190; December, 1939.

² H. E. Hollmann, "Ultra-high-frequency oscillography," *Proc. I.R.E.*, vol. 28, pp. 213-219; May, 1940.

³ G. M. Lee, "A three-beam oscillograph for recording at frequencies up to 10,000 megacycles," *Proc. I.R.E.*, vol. 34, pp. 121W-127W; March, 1946.

⁴ A. Haeff, U. S. Patent No. 2,064,469.

⁵ J. R. Pierce, "Traveling-wave oscilloscope," *Electronics*, vol. 22, p. 97; November, 1949.

CONSTRUCTION

The construction of this tube is similar to that of conventional types, except for the deflecting device. As is shown in Fig. 1, two pairs of deflecting devices are constructed with parallel wires folded repeatedly, the respective fields of deflection being so arranged as to be at right angles to each other.

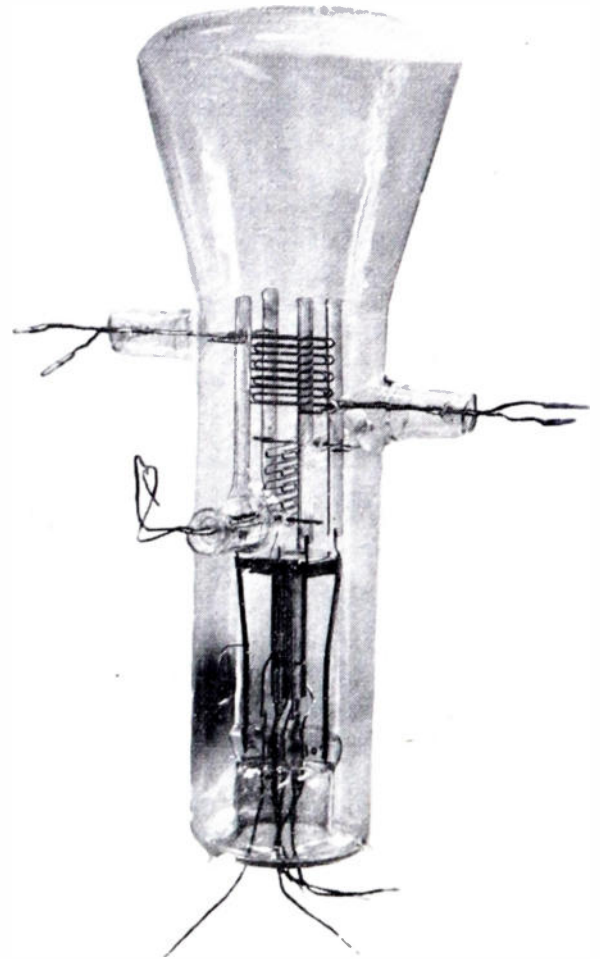

Fig. 1—Construction of the traveling-wave cathode-ray tube.

PRINCIPLES

The electron travels along the axis of the deflecting device from *A* to *B* between the two parallel wires, as shown in Fig. 2. The electromagnetic wave, $V_m \sin \omega t$, is made to travel from *P* to *Q* along the parallel wires. Because of the folded nature of the transmission wires which constitute the deflecting device, the phase velocity *u* of the electromagnetic wave along the axis *AB* becomes smaller than that on the parallel wires,

and is given by

$$u = \frac{a}{l} \times c \tag{1}$$

where

- a = spacing between adjacent parallel wires
- l = folded length of the wire between adjacent points on the axis
- (0-1; 1-2 ··· n-1-n; refer to Fig. 2)
- c = light velocity.

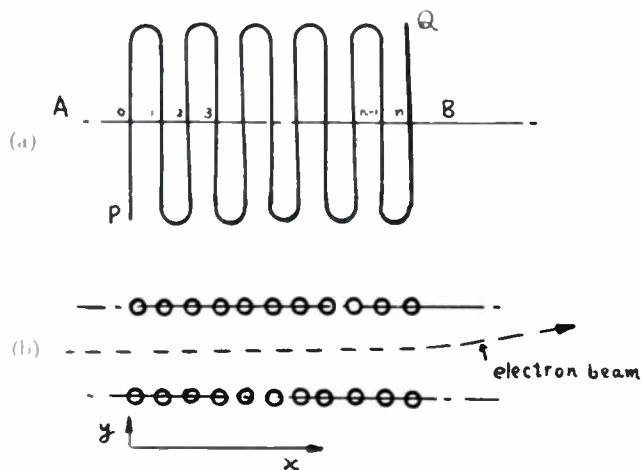

Fig. 2—Diagrammatic illustration of deflecting system. (a) View of the folded parallel transmission lines from above. (b) Side view.

Suppose that the velocity v_0 of the electron along the axis (x axis) is constant, and let $u = v_0$. Under this condition, electrons passing through the deflecting device are subject to a constant accelerating field in direction, and magnitude, if the attenuation of the wave is neglected. This is because the transit time of the electron from A to B is equal to the propagating time of the electromagnetic wave.

We shall proceed to a mathematical analysis of the deflection of the electron. As is shown in Fig. 2, the x -axis is taken along the axis of the deflecting device, and the y axis is taken to coincide with the direction of the deflecting force which is perpendicular to the x axis. The electron, traveling with the velocity v_0 along the x axis, is deflected in the direction of the y axis by the electric field due to the voltage on the deflecting device. If the deflecting device consists of a pair of plate electrodes, the electric field in the y direction at any point on the x axis will be a function of time only. But in this case, the electric field is a function of both t and x .

Here, we investigated the potential distribution along the deflecting device by using an electrolytic bath. First, the equipotential curves on a plane perpendicular to the parallel wires which contain the x axis of the device were obtained. Then, an approximate transverse field distribution along the x axis was deduced from the potential difference between two points having an infinitesimal distance separation on both sides of the x axis.

Fig. 3 shows an example of equipotential curves at a phase difference of 40° between the adjacent parallel wires, in which 18 circles represent the electrodes and the number in the circles denote their respective applied voltage referred to the maximum value of uhf voltage taken as 100. Fig. 4 (a), (b), (c), (d), and (e) show distributions of transverse potential gradients along the x axis obtained from the equipotential curves corresponding to phase differences of 40° , 60° , 120° , 180° , and 240° between adjacent parallel wires, respectively. Full lines and dotted lines represent results of experiments and sinusoidal curves, respectively. These curves are almost identical with the exception of the end disturbances. However, in these results the potential variation along the parallel wires is left out of consideration, so that the results are applicable only when l is very small compared with the wavelength.

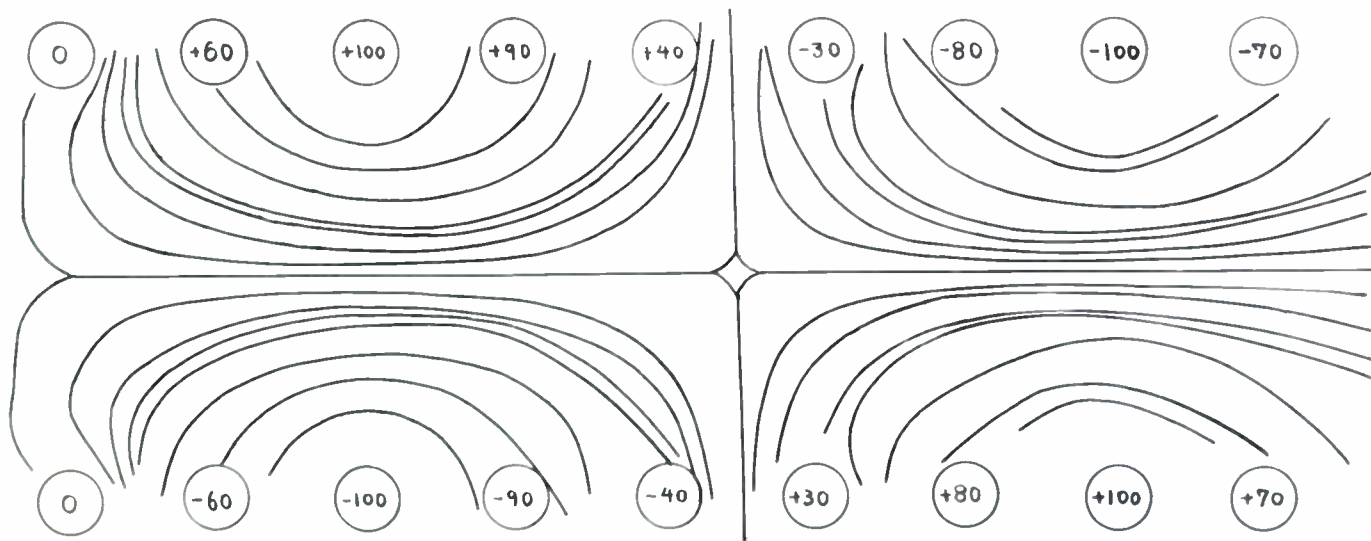

Fig. 3—Equipotential curves on the plane perpendicular to parallel wires which contain the x axis of the deflecting device. This figure corresponds to (b) of Fig. 2. The circles indicate the cross section of wires, and the numerical figure in these circles show the voltage of the wires for phase difference of 40° between adjacent parallel wires.

Now, from the above results, it may safely be assumed that the voltage waves along the axis of the deflecting device is expressed by a cosinusoidal form. Also, the wave propagating along the parallel wires from *P* to *Q* will, in general, be partially reflected at *Q*; hence at a point on the axis of the deflecting device the electric field will be composed of the incident and reflected waves, leading to the resultant potential difference between the parallel wires at a point *x* on the axis to be represented as follows:

$$V_{(x,t)} = V_m \cos \omega \left(t - \frac{x}{u} \right) + (1 - \beta) V_m \cos \left[\omega \left\{ t - (2an - x) \frac{1}{u} \right\} - \phi \right] \quad (2)$$

where

- V_m = maximum value of uhf voltage
- u = velocity of propagation of the electromagnetic wave along the axis of the deflecting device as described above, i.e., phase velocity
- β, ϕ = attenuation coefficient and the phase angle or the electromagnetic wave at *B* when reflection occurs at *Q*.

The transverse electric field *E* on the *x* axis may be obtained as follows:

$$E_{(x,t)} = \frac{k}{D} \left\{ V_m \cos \omega \left(t - \frac{x}{u} \right) + (1 - \beta) V_m \cos \left[\omega \left(t - (2an - x) \frac{1}{u} \right) - \phi \right] \right\} \quad (3)$$

where

- D = distance between two parallel wires
- k = ratio of the electric field between the two parallel wires and that between two imaginary parallel plates extended infinitely.

The questions of motion of electron are expressed as follows:

$$\frac{d^2x}{dt^2} = 0 \quad (4)$$

$$\frac{d^2y}{dt^2} = \frac{e}{m} \frac{kV_m}{D} \left\{ \cos \omega \left(t - \frac{x}{u} \right) + (1 - \beta) \cos \left[\omega \left\{ t - (2an - x) \frac{1}{u} \right\} - \phi \right] \right\} \quad (5)$$

From (4) we obtain

$$\frac{dx}{dt} = v_0(\text{const}). \quad (6)$$

Substituting $x = (t - t_0)v_0$ in (5), and integrating

$$\frac{dy}{dt} = \frac{2e}{m} \frac{kV_m}{D} \frac{u}{\omega} \left[\frac{1}{(u - v_0)} \sin \frac{\omega}{u} \left(1 - \frac{v_0}{u} \right) (t - t_0) \cdot \cos \frac{\omega}{2} \left\{ t - \frac{v_0}{u} (t - t_0) + t_0 \right\} \right]$$

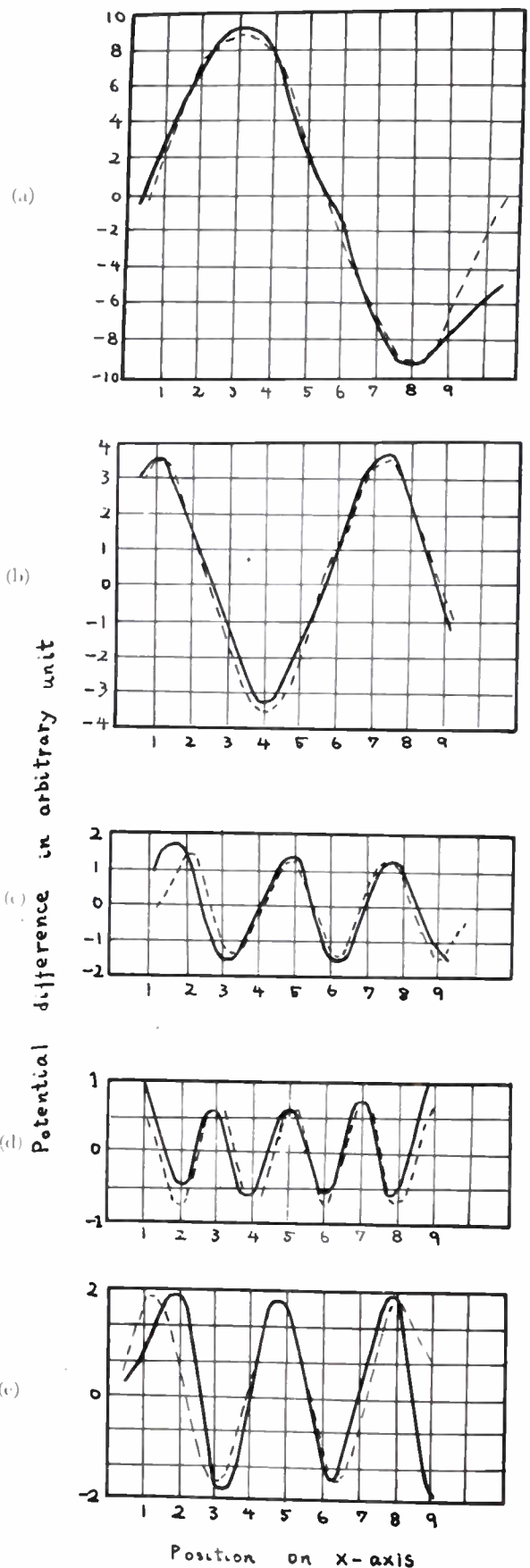

Fig. 4—Distribution of transversal potential gradient along the *x* axis for various phase difference of voltage between adjacent parallel wires. (a) Phase difference of adjacent parallel wires, 40 degrees. (b) 60 degrees. (c) 120 degrees. (d) 180 degrees. (e) 240 degrees.

$$\begin{aligned}
 & + (1 - \beta) \left\{ \frac{1}{(u + v_0)} \sin \frac{\omega}{2} \left(1 + \frac{v_0}{u} \right) (t - t_0) \right. \\
 & \cdot \cos \frac{1}{2} \left[\omega \left\{ \left(\frac{v_0}{u} - 1 \right) (t - t_0) \right. \right. \\
 & \left. \left. + 2t - \frac{4an}{u} \right\} - 2\phi \right] \left. \right\} \quad (7)
 \end{aligned}$$

where, t_0 = time of departure of the electron at A . Substituting $c = (t - t_0)v_0 = an$ in (7), the transverse velocity at the end of deflecting device can be obtained as follows,

$$\begin{aligned}
 \frac{dy}{dt(x=an)} &= \frac{2e}{m} \frac{kV_m}{D} \frac{u}{\omega} \left[\frac{1}{(u - v_0)} \sin \frac{an\omega(u - v_0)}{2uv_0} \right. \\
 & \cdot \cos \left\{ \omega t - \frac{an\omega(u + v_0)}{2uv_0} \right\} \\
 & + \frac{(1 - \beta)}{(u + v_0)} \sin \frac{an(u + v_0)}{2uv_0} \\
 & \left. \cdot \cos \left\{ \omega t - \frac{an\omega(u + 3v_0)}{2uv_0} - \phi \right\} \right]. \quad (8)
 \end{aligned}$$

This equations can be rewritten thus:

$$\frac{dy}{dt(x=an)} = K \cdot \cos(\omega t - \theta), \quad (9)$$

where

$$\begin{aligned}
 K &= \frac{2ekV_m}{mD\omega} \left\{ \frac{1}{(u - v_0)} \sin^2 \frac{an\omega(u - v_0)}{2uv_0} \right. \\
 & + \frac{(1 - \beta)^2}{(u + v_0)^2} \sin^2 \frac{an\omega(u + v_0)}{2uv_0} \\
 & + \frac{2(1 - \beta)}{(u^2 - v_0^2)} \sin \frac{an\omega(u - v_0)}{2uv_0} \\
 & \left. \cdot \sin \frac{an\omega(u + v_0)}{2uv_0} \cos \left(\frac{an\omega}{u} + \phi \right) \right\}^{1/2}, \quad (10)
 \end{aligned}$$

$$\theta = \tan^{-1} \frac{\frac{1}{(u - v_0)} \sin \frac{an\omega(u - v_0)}{2uv_0} \cdot \sin \frac{an\omega(u + v_0)}{2uv_0} + \frac{(1 - \beta)}{(u + v_0)} \sin \frac{an\omega(u - v_0)}{2uv_0} \cdot \sin \frac{an\omega(u + v_0)}{2uv_0}}{\frac{1}{(u - v_0)} \sin \frac{an\omega(u - v_0)}{2uv_0} \cdot \cos \frac{an\omega(u + v_0)}{2uv_0} + \frac{(1 - \beta)}{(u + v_0)} \sin \frac{an\omega(u - v_0)}{2uv_0} \cdot \cos \frac{an\omega(u + v_0)}{2uv_0}}. \quad (11)$$

The angle of deflection is expressed as α . It is evident from these equations that the sensitivity is

$$\tan \alpha = \frac{dy}{dx(x=an)} = \frac{dy}{dt} \frac{dt}{dx} = \frac{1}{v_0} \frac{dy}{dt(x=an)}. \quad (12)$$

The displacement Y of the spot on the screen is

$$Y = L \cdot \tan \alpha, \quad (13)$$

where L = distance from the deflecting device to the screen.

Further considerations on the deflecting angle for special cases will be discussed in the following. When the wave is not reflected at Q , the deflecting angle α , can be written as follows by taking the first term of (8); i.e.,

$$\begin{aligned}
 \tan \alpha_1 &= \frac{2ekV_m u}{mDv_0\omega} \frac{1}{(u - v_0)} \sin \frac{an\omega(u - v_0)}{2uv_0} \\
 & \cdot \cos \left\{ \omega t - \frac{an\omega(u + v_0)}{2uv_0} \right\}. \quad (14)
 \end{aligned}$$

If $u = v_0$

$$\tan \alpha_2 = \frac{ekV_m an}{mDv_0^2} \cos \left(\omega t - \frac{an\omega}{v_0} \right). \quad (15)$$

It is evident from these equations that the sensitivity is independent of the frequency and is constant over a wide range of frequency.

When $u \gg v_0$:

$$\tan \alpha_3 = \frac{2ekV_m}{mD\omega v_0} \sin \frac{an\omega}{2v_0} \cdot \cos \left(\omega t - \frac{an\omega}{2v_0} \right). \quad (16)$$

This equation has the same meaning as the general theoretical formula for the conventional cathode-ray tube. It leads to the same result obtained theoretically by Hollmann.⁶

CONSIDERATIONS ON DEFLECTING SENSITIVITY AND EXPERIMENTAL RESULTS

1. Calculated Results of Relationship Between Frequency and Sensitivity when the Electromagnetic Field and Electron Travel in the Same Direction.

Relations between frequency and sensitivity when the electromagnetic field and electron travel in the same direction when reflection does not occur, may be calculated by using (14). In this case, it is assumed that the cosine term which involves the time variable is equal to 1. The phase velocity was chosen to be equal to 2.93×10^9 centimeters per second to be in accord with operating conditions.

Fig. 5, curve (a) shows an example when the accelerating voltage is 900 volts (i.e., $v_0 = 1.78 \times 10^9$ cm/sec). Sensitivity begins to decrease at a frequency of 400 Mc, and reaches an extremely small value at 2,000 Mc. In the case of $u > v_0$, the electron transit time under the deflecting device increases, resulting in the shift of the

⁶ H. E. Hollmann, "Die Braunshe Rohre bei sehr hohen Frequenzen," *Hochfrequenz- und Elektroakust.*, vol. 40, pp. 97-103; September, 1932.

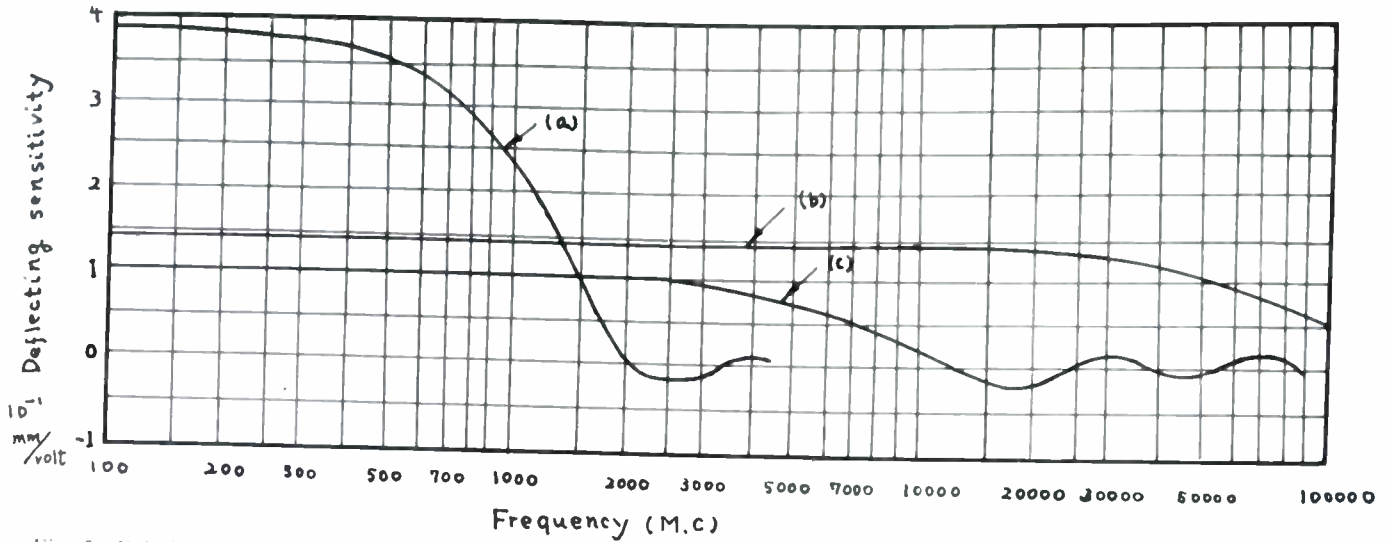

Fig. 5—Relation between frequency and sensitivity when electromagnetic wave and electron travel in same direction. (a) Accelerating voltage, 900 volts; (b) 2,500 volts; (c) 3,025 volts.

falling point of the sensitivity curves to a lower frequency which makes it difficult for application in the uhf range.

Fig. 5, curve (b) shows an example when the accelerating voltage is 2,500 volts (i.e., $v_0 = 2.95 \times 10^9$ cm/sec.). Comparing with the former case (a), sensitivity is seen to be lower but the frequency range becomes extremely wide. At 100 kMc ($\lambda = 3$ mm), sensitivity decreases to 30 per cent. When the phase velocity u is very nearly equal to v_0 , sensitivity becomes independent of frequency, therefore, uniform measurement from low frequency to uhf is possible in this case. But, it is neglected that the potential distribution along the axis of deflection devices becomes to be departed from cosine distribution when $l \neq \lambda$ (l of the present tube is 28 mm).

Fig. 5, curve (c) shows an example when the accelerating voltage is 3,025 volts (i.e., $v_0 = 3.245 \times 10^9$ cm/sec.). In this case, electron velocity exceeds the phase velocity u , and the sensitivity decreases.

2. Calculated Results of Relationship Between Accelerating Voltage and Sensitivity

Calculations are made on the following two cases: (a) When the electron and electromagnetic wave travel in the same direction without reflection of the wave; and (b) when the wave is reflected at the end of the device and forms a standing wave along the deflecting devices.

Fig. 6 shows the relation between accelerating voltage and sensitivity at frequencies of 500, 1,000, 1,500, and 3,000 Mc in the first case (a). The accelerating voltage at which inversion of deflection occurs will increase with the increase of frequency.

Fig. 7 shows an example at 100 Mc for $\beta = 0.5$ and $\phi = \pi/2$, by using (8) in the second case. In this case, sensitivity decreases to a minimum, different from zero, at 500 volts. When reflection occurs at the end, sensitivity generally does not become zero at any voltage.

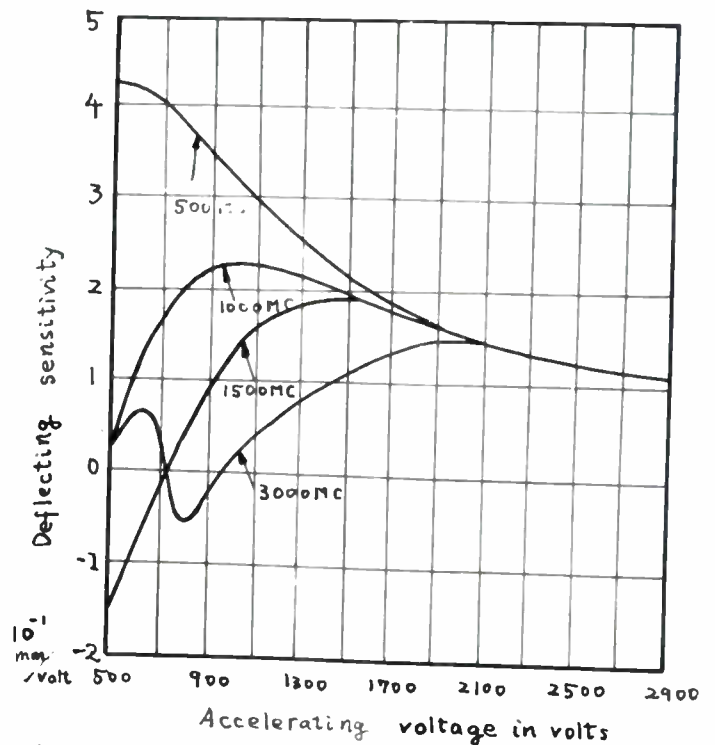

Fig. 6—Relation between accelerating voltage and sensitivity at frequencies of 500, 1,000, 1,500, and 3,000 Mc when electromagnetic wave and electron travel in the same direction.

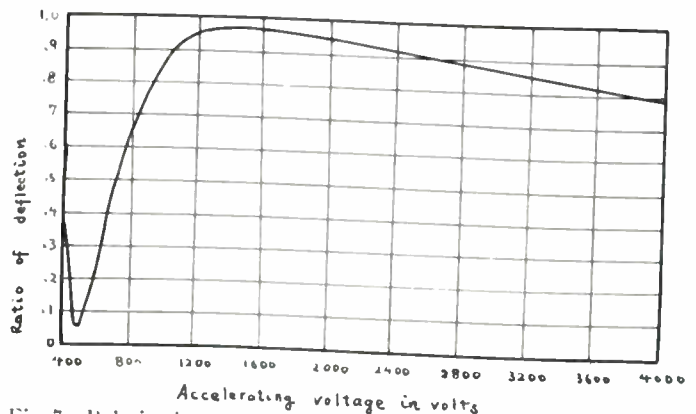

Fig. 7—Relation between accelerating voltage and ratio of sensitivity when the wave is reflected at the end.

3. Experiments on the Accelerating Voltage and Sensitivity (By Inversion Spectrum Method)

In order to make clear the relation between the accelerating voltage and sensitivity, Hollmann's method on inversion spectrum has been applied. According to this method, an alternating voltage of 60 cycles is superimposed on the dc accelerating voltage, changing the electron velocity periodically. The alternating voltage of 60 cycles is also supplied to the horizontal deflecting device. An ultra-high-frequency voltage produced by a magnetron oscillator is made to travel along the perpendicular deflecting device. An electron image describing a horizontal line on the screen consists of electron beams of different velocities, in other words, of different accelerating voltages, hence, an inversion spectrum of sensitivity corresponding to each accelerating voltage is obtained on the screen.

Fig. 8 shows the inversion spectrums when the ac rms voltage superimposed on the dc accelerating voltage of 1,040 volts is 370 volts, and a voltage wave of 1,000

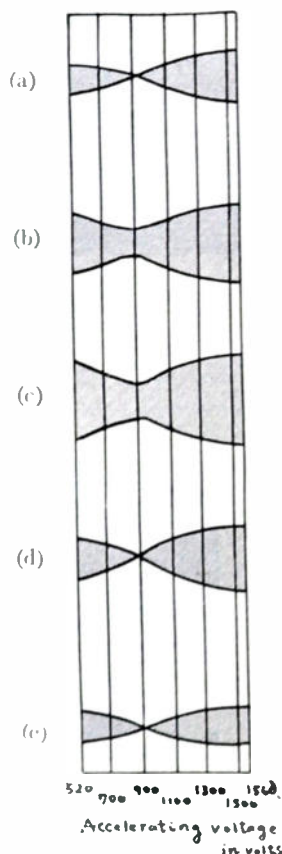

Fig. 8—Inversion spectrum for various terminated conditions. Sections (a) and (e) are cases when the waves are very small. Sections (b), (c), and (d) are cases when reflection occurred.

Mc is propagated along the perpendicular deflecting device. Sections (a), (b), and (c) correspond to the variation of impedance at the end of the perpendicular deflecting device. As is clearly seen, the point of minimum sensitivity and its magnitude varies according to the varia-

tion of the terminating impedance, which is in fair accord with the theoretical deduction previously obtained. The terminal construction of the deflecting device is shown in Fig. 9 in which the terminal impedance may be changed by shifting the tunable stub *A*.

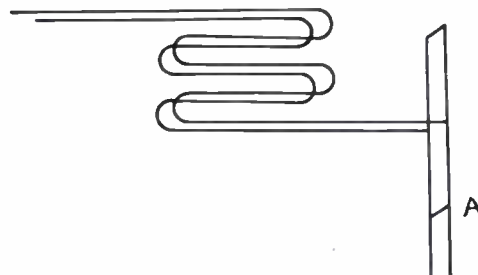

Fig. 9—Illustrated diagram of the deflecting device.

APPLICATION

1. Observation of Voltage Wave Form

Many difficulties are encountered in the uhf region in obtaining a time axis to observe voltage wave forms. So far, it is impossible to use saw-tooth sweeps in the uhf range, as is done in the low frequencies. As a result, many propositions have been made, among which the the outstanding methods are the following:

- (i) To record the voltage wave by a photograph by using a single sweep time axis.
- (ii) To use the linear portion of a sinusoidal voltage as a time axis.
- (iii) To describe an ultra-dynamical Lissajous figure.

The (i) method requires an extremely rapid sweep in order to make its period equal to the time corresponding to several cycles of the uhf voltage. So rapid is the required velocity of the electron beam across the screen, that its beam density as well as its accelerating voltage must be made large to secure sufficient photographic sensitivity.

But this would result in a decrease of deflection sensitivity. This also requires a long drift space for the electron beam.

The (ii) method implies difficulty in obtaining frequency stability for both the observed voltage and the time axis, whereby, either one of the two should be synchronized with the other to produce a stationary figure on the screen.

The last method (iii) is similar to the usual method of Lissajous figure, wherein, the only difference is that the phase difference between the waves at the horizontal and the vertical deflecting electrodes is controlled by the transit time of the electron beam between the two electrodes.

When the wave involves an n th harmonic component, the phase difference of the vertical and horizontal voltage affected by the transit time τ of the electron is equal to $\omega \tau$ for the fundamental wave and $n\omega \tau$ for the n th harmonic component.

Therefore, the direction of rotation of the fundamental and harmonic vectors has various combinations according to values of n and τ . The most important factor affecting the Lissajous figure is the combination of the direction of the respective vectors incidental to the fundamental and the harmonic component, whether they are unidirectional or antidiagonal. It is sufficient to take into account only these two cases, since the other combinations may be obtained as symmetrical figures of these.

Therefore, the case where the vectors incidental to the fundamental and harmonic wave rotating in the same direction will be considered first. In this example, the direction of rotation of the harmonic vector is coincident with the direction of the movement of the center of the ellipse described by the harmonic vector. This aspect is shown in Fig. 10, where the cycloidal curve has

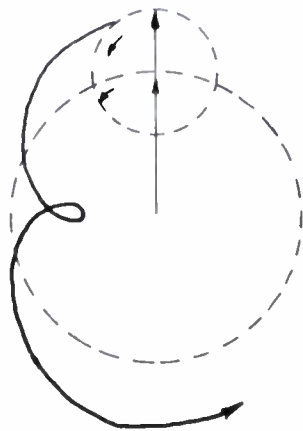

Fig. 10—Lissajous figure when vectors incidental to fundamental and harmonic wave are rotating in the same direction.

a larger radius of curvature around the outer part than the inner. In general, the inner curve describes a little loop, which will be called a "petal" for convenience. This petal sometimes degenerates into a cusp according to the relative magnitude of the amplitude of the fundamental and the harmonic wave. When the petals are directed toward the interior, as shown in Fig. 10, the figure will be called an "inward figure." Since the harmonic vector rotates n times while the fundamental describes a single ellipse, the direction of the harmonic ellipse also describes a single rotation resulting in the decrease of the number of the cycloidal loops, which becomes $(n-1)$. The photographs shown in Fig. 11 illus-

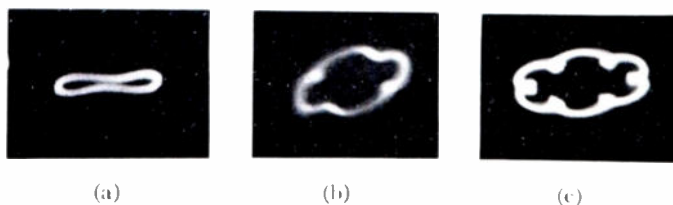

Fig. 11—Photographs of ultradynamic Lissajous figure of distorted waves, involving third (a), fifth (b), and seventh harmonics (c).

trate examples of inward petals of distorted waves involving the third, fifth, and seventh harmonics, respectively.

In cases where the fundamental and harmonic waves rotate in opposite directions, the cycloids are described externally with petals or cusps on the outer sides. This is shown in Fig. 12. The number of petals in this case is

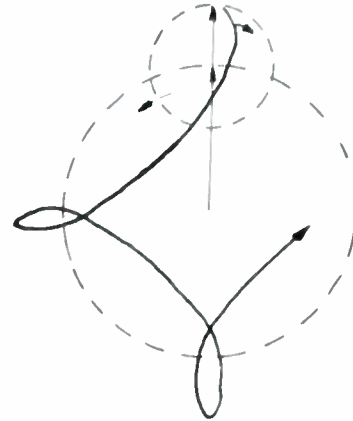

Fig. 12—Lissajous figure when vectors incidental to fundamental and harmonic wave are rotating in opposite direction.

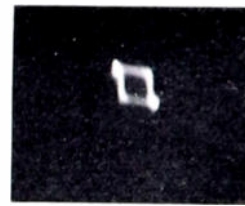

Fig. 13—Photograph of ultradynamic Lissajous figure of distorted wave involving the third harmonic.

equal to $(n+1)$. Fig. 13 shows examples of such a case when the distorted wave consists of the third harmonic component.

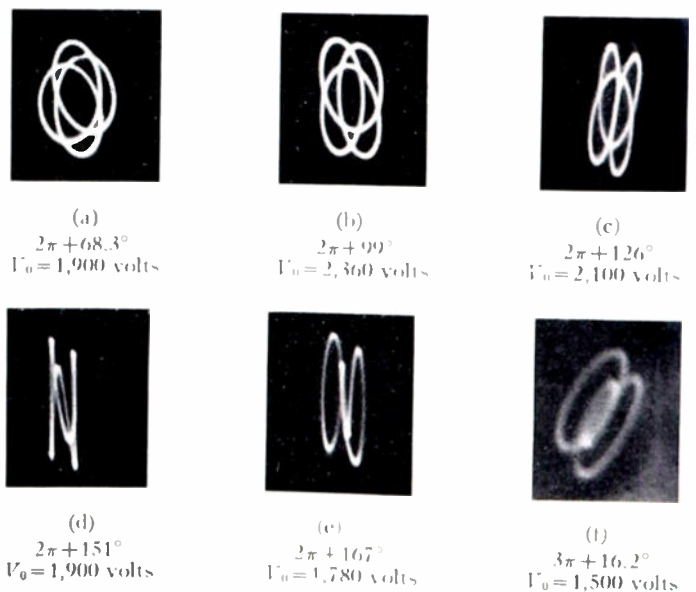

Fig. 14—Photographs of ultradynamic Lissajous figure of distorted wave involving the third harmonic having various phase differences between fundamental and harmonic wave. V_0 = Accelerating voltage of electron beam.

The direction of rotation of the fundamental and the harmonic vector thus varies according to $\omega\tau$ and $n\omega\tau$, which necessarily leads to a frequent variation of the direction of the harmonic vector by the same amount of change in the transit time τ . Since it is necessary to consider only the case of unidirectional or antidi-
rectional rotation, it is sufficient to take into account the variation rotation of the harmonic wave upon a certain fundamental rotation.

Fig. 14 shows actual examples of such cases, which are the ultradynamic Lissajous figure having the third harmonic at a fundamental wavelength of about 100 cm. Here (a), (b) and (c) are cases of outward petals, (e) and (f) are cases of inward petals. The phase difference of the third harmonic between (a) and (f) is about 0.7π .

In the case of the amplitude of the fundamental wave being so small as to be hardly perceptible in the figure, the second, third, or other higher harmonics are apt to be taken as the fundamental, whereby the preceding analysis leads sometimes to harmonics having orders other than numbers. In such a case, the figure is not completed with a single cycle of the apparent funda-

mental, but after several cycles. An example of such procedure is shown in Fig. 15. The order of the harmonics, in such cases, may be determined by the following method.

- (i) Count the number (N) of petals.
- (ii) Count the number of petals lying between two successive petals and add one to this number. This is equal to the number of rotation P of the apparent fundamental wave to return to its original position.
- (iii) The rigorous order of harmonics is equal to:

$$m = \frac{N + P}{P} = n \pm 1,$$

where the negative and the positive signs correspond to the case of outward and inward petals.

An example of such a case is shown in Fig. 16, which is approximately 2.5 times larger than the actual figure. Here,

$$N = 15, \quad P = 4$$

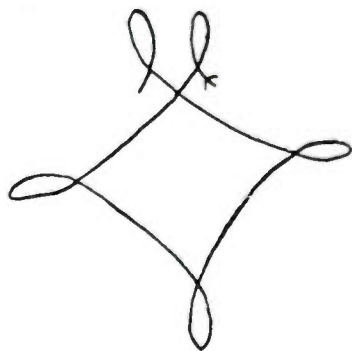

Fig. 15—Lissajous figure involving fractional harmonic.

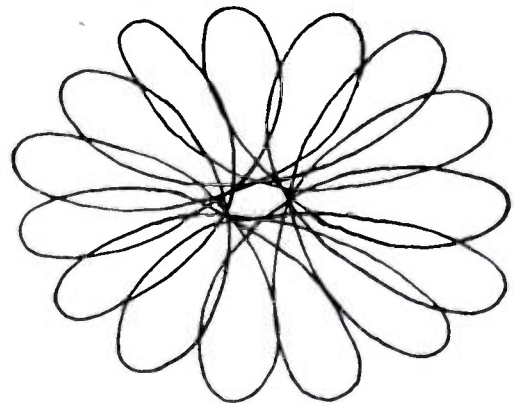
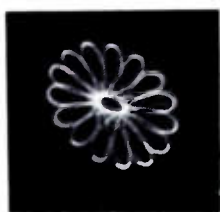
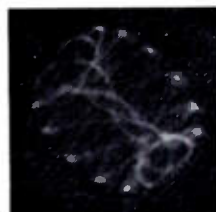

Fig. 16—Ultradynamic Lissajous figure involving fraction harmonic



$$A \sin 4\omega t + B \sin 11\omega t.$$



$$A \sin 4\omega t + B \sin 11\omega t.$$

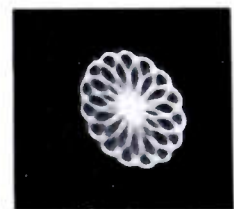

$$A \sin 4\omega t + B \sin 11\omega t.$$

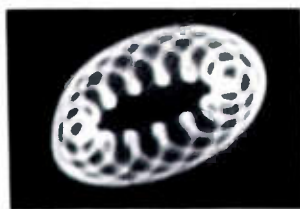

$$A \sin 3\omega t + B \sin 14\omega t.$$

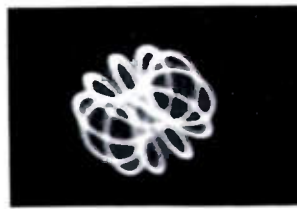

$$A \sin 3\omega t + B \sin 8\omega t.$$

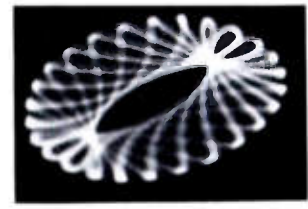

$$A \sin 4\omega t + B \sin 19\omega t.$$

Fig. 17—Photographs of ultradynamic Lissajous figures involving fractional harmonics.

hence,

$$m = \frac{15 - 4}{4} = \frac{11}{4} = 2.75,$$

The original wave may be represented as, (i) $\sin \omega t + 0.8 \sin 2.75 \omega t$ or (ii)

$$\sum_{n=1}^{\infty} A_n \sin n\omega t, \quad A_n = 0 \text{ except, } A_1 = 1, A_{11} = 0.8.$$

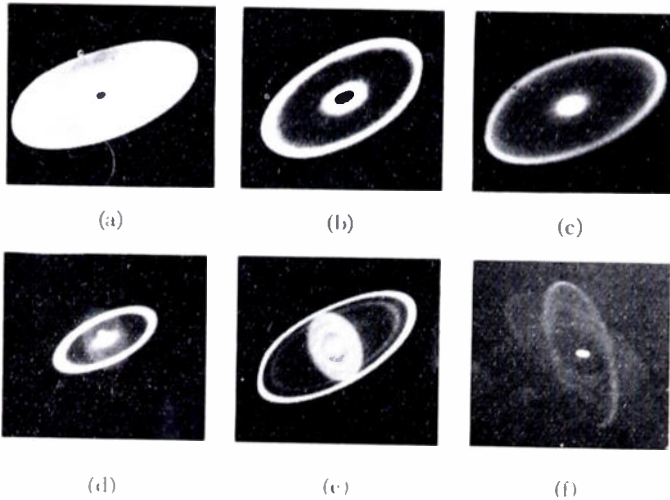

Fig. 18—Photographs of double ellipse obtained with magnetron oscillations.

Fig. 17 shows photographs of ultradynamical Lissajous figure containing the fractional harmonics.

2. Measurement of the Degree of Amplitude Modulation

For the measurement of the degree of amplitude modulation using the cathode-ray tube, the trapezoidal or elliptical methods are adopted, in general. The latter is adaptable with the present traveling-wave-type tube.

Fig. 18 shows examples of this method obtained with magnetron oscillations. In Fig. 18(a) is shown the double ellipsoid when the degree of amplitude modulation is about 90 per cent. In this case, the modulation character is nearly linear. In (b) and (c) are shown, respectively, cases of distortion and over modulation. Fig. 18(d), (e) and (f) all show examples of over modulation, but these cases differ from (b), in that oscillations of two different frequencies are represented.

ACKNOWLEDGMENT

The authors are much indebted to Professors Okabe, Sonoda, and Moto of the Osaka University for their kind advice, and sincere gratitude is due to Messrs. Sakamoto and Otsubo for their valuable assistance in carrying out the experiment. The presentation of this paper is due to H. M. Sarasohn, to whom the authors' special gratitude is expressed.



Corrections and Additions to

Speed of Electronic Switching Circuits*

The authors of the above-mentioned paper have called to the attention of the editors several typographical errors in certain of the equations. The last term of the first equation on page 66 should read as follows:

$$\left[\frac{1}{R_1 R_2} - g_m^2 \right].$$

The equation (2) gives m^2 , rather than m .

Equation (4) should read

$$e_2 = \frac{g_m}{2mC_2(m - \alpha)} \left[\frac{de_1}{dt} \right]_{t=0} e^{(\beta - \alpha)t}.$$

Since this paper deals with an analysis of multivibrators, a footnote reference should be added, calling attention to the work of R. Benjamin,¹ which analyzes blocking oscillators, and in which much the same conclusions are derived.

* E. M. Williams, D. F. Aldrich, and J. B. Woodford, "Speed of electronic switching circuits," *Proc. I.R.E.*, vol. 38, pp. 65-69; January, 1950.

¹ R. Benjamin, "Blocking oscillators," *Jour. IEE*, vol. 93, Part IIIA, no. 7; 1946.

Conductivity Measurements at Microwave Frequencies*

A. C. BECK†, SENIOR MEMBER, IRE, AND R. W. DAWSON†

Summary—Because of the skin effect, the surface condition of conductors becomes very important in determining attenuation at microwave frequencies. This has been investigated by measuring small wire samples at a frequency of about 9,000 megacycles. A sample of the wire to be measured is inserted in a metal tube to form the center conductor of an open-ended coaxial line. The ratio of the peak frequency to the half-power bandwidth of this coaxial-line resonator, measured with the aid of an oscillographic display of its amplitude-versus-frequency characteristic, gives its loaded Q . The amplitude characteristic of the frequency-modulated signal generator, on which a wavemeter marker appears, is viewed simultaneously and used as a reference. By correcting the result to obtain the unloaded Q of the center conductor alone, the effective conductivity of the sample is obtained.

Results of measurements on a number of samples of different conductors having various surface conditions, treatments, and platings are given. These results are of value in the design of microwave components of all types where loss is a factor of importance.

I. INTRODUCTION

AT FREQUENCIES in the microwave range, the skin effect limits current penetration in conductors to a small fraction of a mil. Therefore the nature and condition of the current-carrying surfaces of microwave equipment have a very important bearing on the attenuation. In order to get quantitative data, equipment was set up to measure the effective conductivity of short pieces of small wire at frequencies in the order of 9,000 megacycles. Various metals, alloys, and plated specimens can be investigated easily and quickly when such small samples are used for the measurements, and it is a simple matter to produce and study the effects of surface roughness, contamination, and corrosion, as well as methods of protection against these conditions.

The equipment described herein was designed to determine the loaded Q of an open-circuited coaxial line having as a center conductor the sample being measured. This is done by displaying the resonance curve of the coaxial line on an oscilloscope, measuring its peak frequency and half-power bandwidth, and taking their ratio. Effective conductivity is obtained by correcting this result to obtain the unloaded Q of the center conductor alone.

II. MEASURING EQUIPMENT

Fig. 1 shows the specimen holder and exciting waveguides used. Small wire specimens, 15 to 20 mils in diameter and less than 5 inches long, are supported in a coaxial line at voltage nulls by polyfoam beads whose dielectric loss is negligible. The ends of the specimen-holder tube are open to permit quick insertion and removal of the samples. This tube is made sufficiently

longer than the sample so that no appreciable radiation losses occur at the open ends, and the ratio of its diameter to that of the wire is large so that its loss is small compared to the loss in the wire. This coaxial line is excited through an orifice from a terminated waveguide by a frequency-modulated signal generator. The output is taken into a second terminated waveguide through an opposite orifice in the coaxial line, and connected to a superheterodyne receiver.

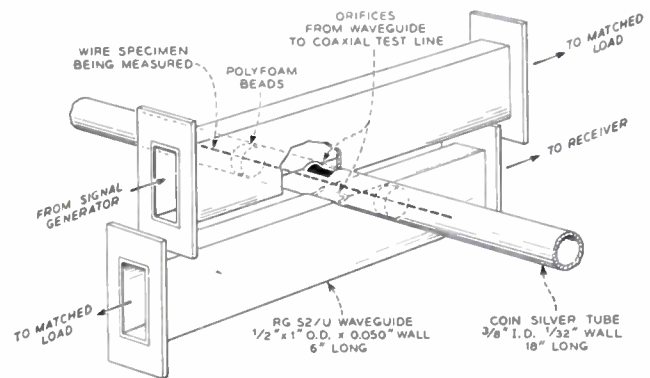

Fig. 1—Specimen holder for wire conductivity measurements.

A block diagram of the measuring equipment is given in Fig. 2, and Figs. 3 and 4 are photographs of the waveguide circuits and the complete equipment. The signal generator, shown at the left center of Fig. 2, and at the extreme left of the photographs, is frequency modulated by placing a fraction of the 60-cycle supply voltage on the repeller in addition to its usual dc voltage. The signal generator output waveguide is connected through a matching and level adjusting attenuator to monitoring directional coupler #1. The forward take-off of this coupler is connected through an adjustable attenuator to a de-biased crystal detector. The output of this detector is displayed on the oscilloscope, which has a 60-cycle sine-wave sweep of the same phase as the voltage on the oscillator repellers, when the video switching relay is connected on one side. This relay is driven by a 30-cycle oscillator synchronized at the proper phase with the 60-cycle line. A plot of the amplitude-versus-frequency characteristic of the signal generator is shown on the oscilloscope during this time interval. A typical display of this characteristic is shown in Fig. 5(a). The base line is produced when the 30-cycle video switching relay is on the other side, which at this time had no signal.

Following that monitoring branch is directional coupler #2, whose forward take-off is connected through an adjustable attenuator and a cavity wavemeter to another de-biased crystal detector. The calibration and

* Decimal classification: R208×R282.1. Original manuscript received by the Institute, January 20, 1950.

† Bell Telephone Laboratories, Inc., Holmdel, N. J.

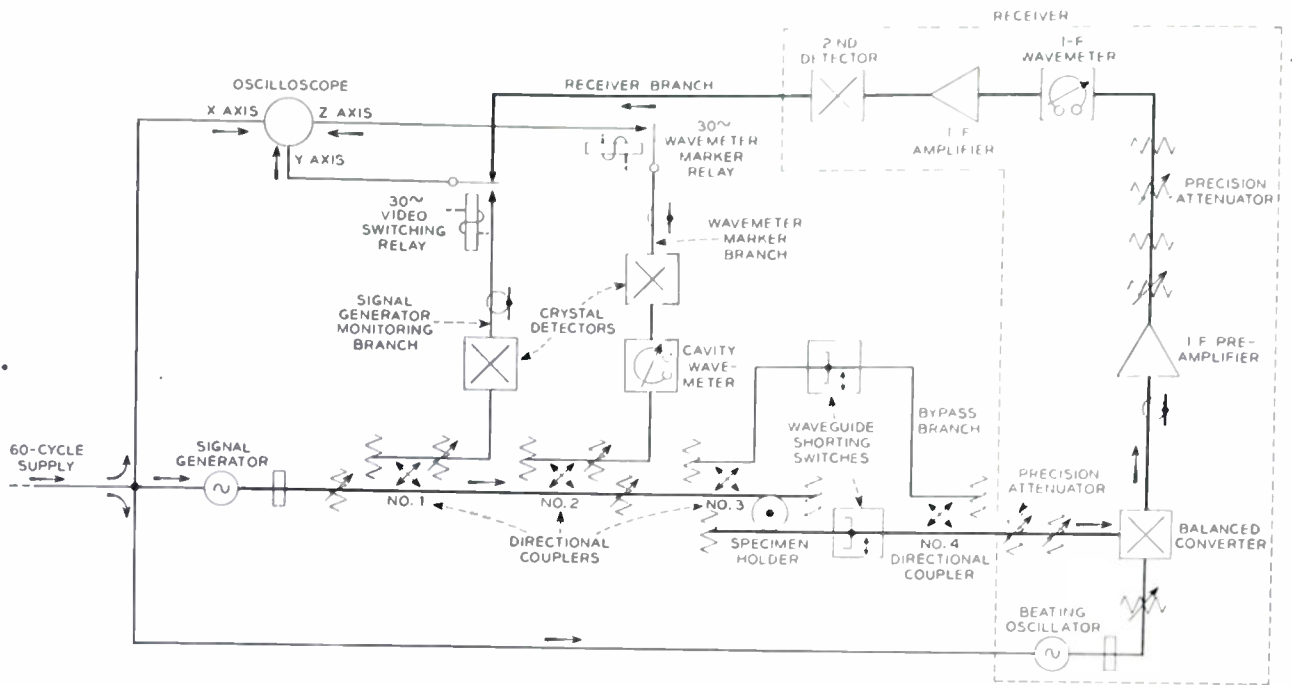

Fig. 2—Block diagram of wire-conductivity measuring equipment.

use of this wavemeter will be discussed later. The output of the detector goes through another 30-cycle relay running in synchronism with the video switching relay to the Z-axis blanking amplifier of the oscilloscope, producing a small gap in the signal-generator monitoring trace corresponding to the frequency at which the cavity wavemeter is set. This gap moves across the face of the oscilloscope as the wavemeter or signal-generator

frequency settings are changed. The appearance of the oscilloscope with the signal generator monitoring detector trace and the frequency marker is shown in Fig. 5(b).

Continuing with Fig. 2, the main signal follows the heavy line through a level adjusting attenuator to directional coupler #3, and then to the specimen holder which has been described and shown in Fig. 1. This is followed by a waveguide shorting switch and directional coupler #4. Between directional couplers #3 and #4 is a separate by-pass waveguide branch paralleling the specimen-holder branch. If the waveguide shorting switch in this by-pass branch is open, and the one in the specimen-holder branch is set to close its waveguide, the

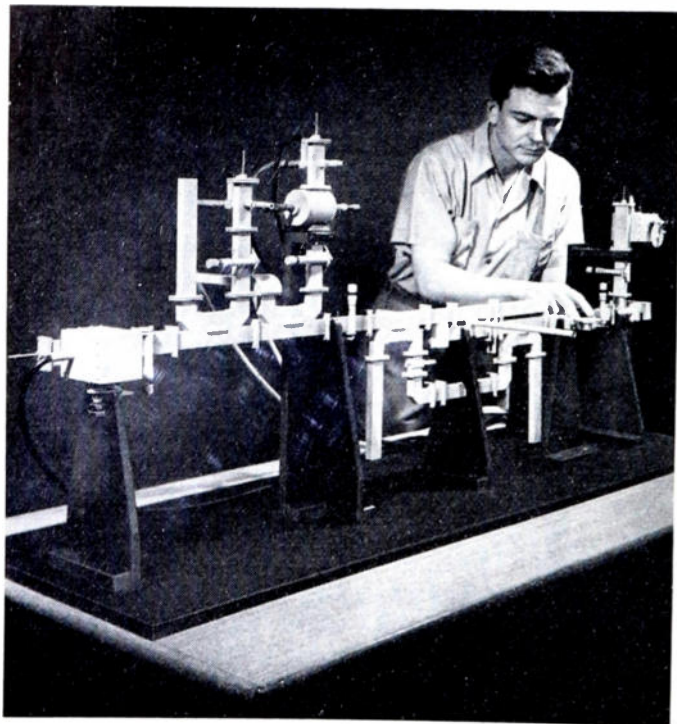

Fig. 3—The waveguide component assembly used for wire-conductivity measurements.

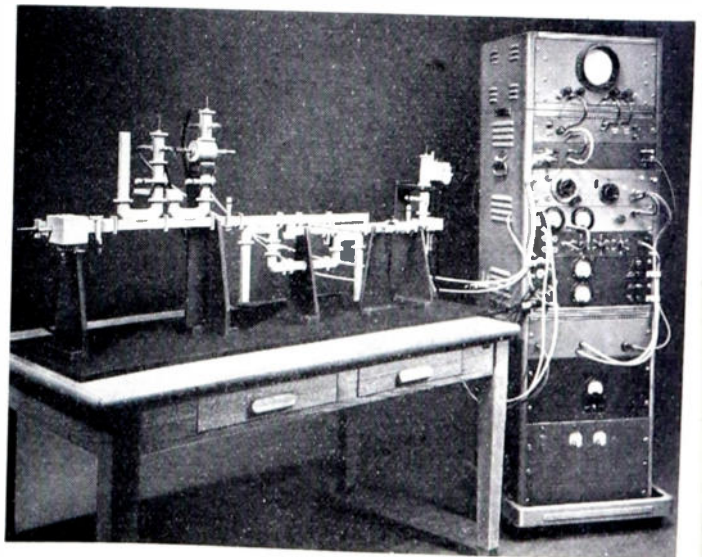

Fig. 4—The complete conductivity-measuring apparatus.

signal goes to the receiver through directional couplers #3 and #4 and the by-pass branch without any frequency-restricting circuits. This switch setting is used for tuning, and as a reference condition for measuring the loss through the specimen holder. When the switch

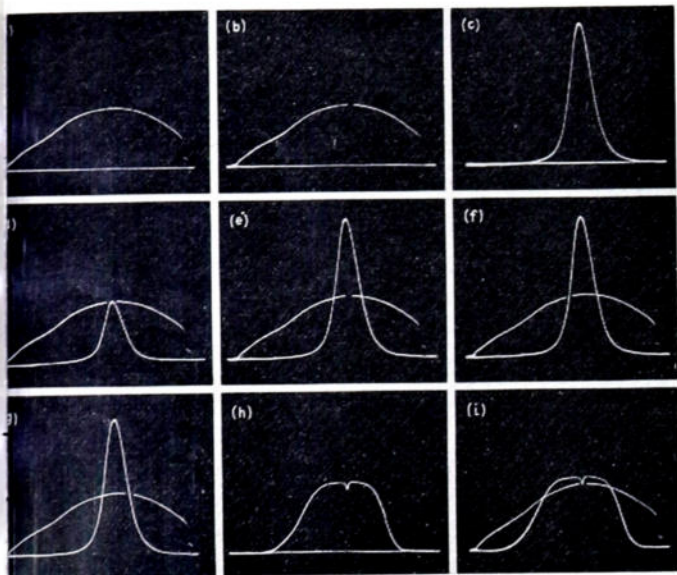

Fig. 5—Photographs of representative oscilloscope traces.

in this by-pass branch is set to block its waveguide path, and the switch in the specimen-holder branch is open, the signal goes to the receiver through the specimen holder, and the resonance characteristic of its coaxial line is displayed so that Q measurements can be made.

Again referring to Fig. 2, the receiver section is shown in the dashed-line box at the right. After passing through a precision attenuator used for calibration and check purposes, and a level adjusting and terminating attenuator, the signal reaches a balanced crystal converter whose output is the difference between the signal and beating oscillator frequencies. Since the signal is frequency modulated, the beating oscillator is also frequency modulated in synchronism with it, and tuned to a frequency 65 megacycles away from the signal generator frequency. This difference is thus maintained over the frequency-modulation range. The intermediate-frequency output goes to a preamplifier, then to an adjustable calibrated attenuator for measuring the loss in the system, and to the precision attenuator (used for setting the half-power level), which is padded on both sides to maintain a good match. This attenuator is arranged to switch between two positions giving about 3- and 11-db attenuation, respectively, and so adjusted and calibrated that the 3.01-db difference is accurately established. Next is the intermediate-frequency wavemeter, which is an absorption-type instrument with a Cardwell precision capacitor having a 5,000-division scale. It produces a frequency marker pip on the oscilloscope that is used for calibration of the cavity wave-

meter, as will be described later. The main intermediate-frequency amplifier is next, with a gain of about 45 db. This unit, together with the preamplifier, gives an intermediate-frequency amplifier system having a gain of about 85 db, a center frequency of 65 megacycles, a bandwidth of about 20 megacycles one db down, and a low over-all noise figure.

The output of the superheterodyne receiver is displayed on the oscilloscope when the 30-cycle video switching relay is on the opposite side from that used for monitoring the signal generator. A typical trace of this receiver branch signal, with a sample of copper wire in the specimen holder, and no signal on the monitoring branch side of the video switching relay, is shown in Fig. 5(c). A 60-cycle blanking relay is used to produce, from a dc supply, the rectangular wave which is applied to the oscilloscope Z-axis amplifier to blank the return trace, at the ends of the sinusoidal sweep, where the spot is moving slowly. This relay, and the two 30-cycle ones, are Western Electric vibrating-reed mercury-contact relays.

A wave-form timing and phasing diagram is shown in Fig. 6. The 60-cycle oscilloscope blanking relay turns

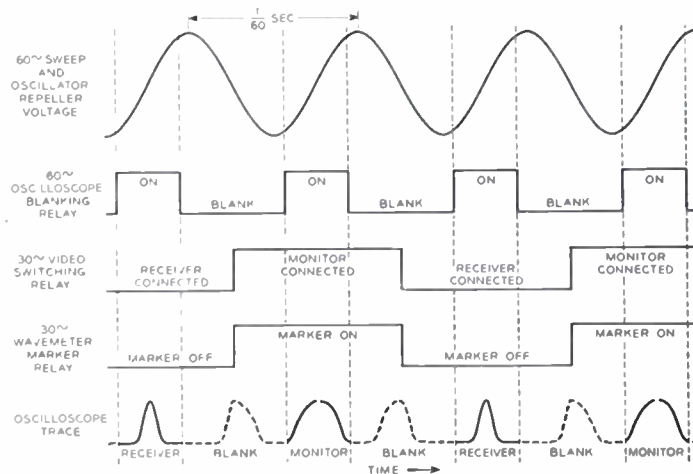

Fig. 6—Wave-form timing and phasing diagram.

on the scope trace during the nearly linear rising voltage part of the 60-cycle line voltage used for sweeping the oscilloscope and oscillators. During this interval the oscilloscope spot moves across the face of the tube from left to right and the frequency of the oscillators goes through its range. The 30-cycle video switching relay alternately connects the scope Y axis to the monitor branch and to the receiver branch, and the cavity wavemeter detector is connected to the oscilloscope Z axis by its relay only when viewing the signal-generator monitor trace. These successive monitor and receiver traces are both seen on the oscilloscope, due to persistence of vision, giving patterns as shown in Fig. 4 ((d), (e), (f), and (g)), which will be explained in more detail later.

III. AMPLITUDE MEASURING SYSTEM

In order to measure the half-power bandwidth of a

resonant element, means must be provided for accurately determining a 3.01-db difference in signal level. For convenience in use, a special precision attenuator, which was described in Section II, is included in the intermediate-frequency system of the receiver. This attenuator was adjusted to its correct setting with the precision waveguide attenuator, and checked also by direct comparison with intermediate-frequency standard pads that were obtained from Western Electric and checked against standards maintained in these laboratories. The precision waveguide attenuator, in this case a guillotine-type instrument, has a very low standing-wave ratio. It has a total attenuation of about 4 db, and a long scale dial indicator to measure this range. It can be accurately calibrated on a double detection-measuring receiver against precision intermediate-frequency attenuator pads by measuring the input standing-wave ratio with its output shorted. This method gives a change in intermediate-frequency attenuation several times as large as the change in radio-frequency attenuation, which increases the accuracy of calibration. In addition, in use it is the 3.01-db difference between two settings that is required, and not the absolute value of attenuation at either setting. Differences can be determined more accurately than the absolute values. Using this attenuator to calibrate the intermediate-frequency attenuator also checks the linearity of the equipment between them.

Since the measurement of levels 3.01 db down from the peak of the resonance curve is made at different signal generator frequencies, the change due to its output level variation as a function of frequency must be corrected. This is the reason for displaying on the oscilloscope both the resonance curve of the specimen holder and the amplitude-versus-frequency curve of the signal generator so they are viewed together. Using the latter as the reference line compensates for this change in signal generator output level. There is no parallax difficulty, since these curves are in the same plane. This is, however, only true if the response of the signal-generator monitoring branch and the receiver branch are identical. To make them identical, the monitoring detector and receiver second detector use crystals of the same type that have been selected for matched performance.

At first, even when the receiver was tuned, using the by-pass branch between directional couplers #3 and #4, so that its oscilloscope trace was superimposed on the signal-generator monitor trace, Q measurements were found to be in error. This error was caused by a change in match and law of response of the receiver second detector with signals having different dc components, which is the case when switching from the by-pass branch for tuning to the specimen-holder branch for making measurements. This difficulty was overcome by using a large dc bias on the second detector to maintain a constant input impedance and to swamp out the

small dc component changes with the different signals. To keep the detector characteristics alike, and to obtain a good match, dc bias is also used on the monitoring detectors. To maintain alignment of the base lines when these different signals are displayed, direct coupled video amplification is used in the vertical deflection system of the oscilloscope. Initial alignment of the base lines is obtained by small adjustments in the detector bias voltages.

IV. FREQUENCY MEASURING SYSTEM

The TE_{011} cavity-type double orifice coupled wavemeter mentioned before produces the frequency marker used for measuring the absolute frequency and the half-power bandwidth. It has a high enough Q to give a sharp marker, as can be seen in Fig. 5. Frequency readings are obtained from the calibration of the micrometer which drives the piston, and for measuring bandwidth, a fine control was added at the opposite end of the instrument, as can be seen from the photographs, Figs. 3 and 4. This consists of a movable silver rod of small diameter extending into the cavity. A dial spread of about forty divisions per megacycle is obtained on the micrometer driving this rod.

Since the calibration of this fine-control micrometer is not linear, and also is a function of the setting of the main piston, it is calibrated each time it is used. The first step in this calibration is to remove the frequency modulation from the receiver beating oscillator by disconnecting the 60-cycle voltage on its repeller. Since the signal generator is still frequency modulated, the frequency response curve of the receiver, modified by the signal-generator amplitude characteristic, is now traced out on the oscilloscope. The precision intermediate-frequency absorption wavemeter is used to put a downward pip on this trace, as shown on Fig. 5(h). This intermediate-frequency wavemeter has about 200 divisions per megacycle, and has been accurately calibrated with a heterodyne frequency meter which is checked with station WWV. Settings of the high-frequency cavity wavemeter are transferred to this wavemeter by aligning the intermediate-frequency wavemeter pip on the receiver trace with the frequency marker on the monitor trace, as shown in Fig. 5(i). After doing this for the two settings of the cavity wavemeter obtained at the half-power points on the resonance curve, the bandwidth is obtained by subtracting the two frequency readings of the intermediate-frequency wavemeter.

This method of transferring the readings to the intermediate-frequency wavemeter can be in error if there is any residual or pickup frequency modulation on the beating oscillator of the receiver. To avoid this possibility, dc is used on the heater of the oscillator tube, all leads are well shielded, and the repeller is grounded for ac by a large capacitor when frequency modulation is removed for this calibration. To make sure that this was effective, an electron-coupled video-frequency oscil-

lator known to have no frequency modulation was connected to drive the crystal in the detector of the cavity wavemeter branch. This modulated the high-frequency signal, so the cavity wavemeter appears to give three markers instead of one. The middle one occurs when the signal generator sweeps across the resonant frequency of the cavity wavemeter, and the others are the sidebands due to its amplitude modulation, so the spacing between the two outside markers is twice the checking video oscillator frequency. To check for beating-oscillator frequency stability, the spacing of these markers was measured with the intermediate-frequency wavemeter. The results showed that beating-oscillator frequency modulation was negligible when calibrating the cavity wavemeter with this equipment.

V. MEASUREMENT PROCEDURE

The waveguide switches are set for the signal to pass through the specimen holder. After inserting a sample several half wavelengths long, the signal generator and receiver are tuned approximately to locate a resonance. The sample wire is adjusted in lengthwise position to give maximum signal transmission. Then the waveguide shorting switches are reversed so that the signal goes to the receiver through the by-pass branch, and the beating-oscillator frequency and sweep magnitude are carefully adjusted to superimpose the receiver and monitor traces on the oscilloscope. The receiver is then connected through the specimen holder again by means of the waveguide shorting switches, and adjusted to a level which gives trace alignment as shown in Fig. 5(d). The power transmission ratio through the specimen holder at resonance is measured with the intermediate-frequency attenuator by comparing these last two conditions, and correcting for the fixed loss through the directional coupler path, which has been previously determined. The frequency of the resonance peak is measured with the cavity wavemeter marker using the main dial, with the fine frequency micrometer set at its fixed reference position. The attenuator next to the signal generator is varied to check that the peak of the resonance-curve trace stays superimposed on the monitor trace as the level changes. This is important, as it is a check on the linearity of the system. Then the precision intermediate-frequency attenuator is changed to its 3.01-db lower setting, which changes the pattern to the one shown in Fig. 5(e). Using an optical magnifier on the oscilloscope, the half-power bandwidth is measured with the cavity-wavemeter fine frequency dial by putting the marker on each side as shown in (f) and (g) Fig. 4. Calibration of these readings with the intermediate-frequency wavemeter as previously described gives the frequency bandwidth. One half wavelength is then cut off the sample and the new length is measured. This process is repeated for several multiples of a half wavelength.

VI. CORRECTIONS AND CALCULATIONS

The measured loaded Q for each multiple half wavelength of line is obtained by taking the ratio of the resonant frequency to the half-power bandwidth. Different sample lengths are usually measured at slightly different resonant frequencies, because in practice it is difficult to cut exact half wavelengths off the specimen. For this reason, the Q values for each length are converted to values at a convenient common frequency by use of the relation that Q is inversely proportional to the square root of wavelength. These values still include the effects of losses through the orifices of the coaxial test line into the waveguide system, the end effects due to fringing fields, and the outer conductor losses.

The unloaded Q values, which would have been measured if there had been no losses through the coupling orifices, can be obtained from the loaded Q values by using the measured power-transmission ratio through the specimen holder at resonance. Denoting the unloaded Q by Q_0 , the loaded Q by Q_l , and the power-transmission ratio at resonance by T , this correction is made by using the relation

$$Q_0 = \frac{Q_l}{1 - 2\sqrt{T}} \quad (1)$$

which is derived in the appendix. Although each wire is inserted as near as possible to the position giving greatest transmitted power at resonance, exact location is difficult, but since the measurements are made for a fixed wire position, this correction compensates for small misalignments of the specimen with respect to the orifices. With the specimen holder used in this work, the measured power-transmission ratio at resonance is between 30 and 40 db, so this amounts to a correction of two to six per cent of the Q values. Smaller orifices would mean a smaller correction, but also less power transmitted, so noise on the receiver trace would be more of a problem. The present design seems to represent a good compromise in this respect. With no center conductor wire in the specimen holder, the output is about 90 db below the input, so no correction is necessary for leakage power.

Measurements are made on several multiple half wavelengths of wire in order to increase the accuracy by averaging a number of readings, to correct for end effects, and to find nonhomogeneous samples. From the wire lengths and the frequencies, the number n of half wavelengths of each measured piece of the sample is determined. A plot of $n\lambda/2Q_0$ for each length versus $n\lambda/2$ is then made. An example of such a plot is shown in Fig. 7. This should be a straight-line relation, so departures from linearity check sample homogeneity and random errors of measurement. End effects in the coaxial resonator are eliminated by taking the slope of this plot. From the slope of a straight line drawn as carefully as possible through the plotted points, the

total unloaded Q of the coaxial line is determined, as shown in Fig. 7, and denoted by Q_t .

The effect of losses in the outer conductor must be taken out, since we are interested in the losses due to the center conductor alone. The formulas for the Q of a coaxial line, which can be obtained from numerous sources,¹ show how these can be separated. It is possible to write

$$\frac{1}{Q_t} = \frac{1}{Q_a} + \frac{1}{Q_b} \quad (2)$$

where Q_t is the total unloaded Q of the coaxial line, and Q_a and Q_b are defined as Q values corresponding to the inner conductor and the outer conductor, respectively. For the specimen holder used in this work the outer conductor loss is only two to five per cent of the total loss, so the required accuracy of determining outer conductor loss is not very high. It was determined by assuming its value in the first place, then measuring a specimen wire of the same material with as near as possible the same surface conditions, and using the first assumption in correcting its measurement. Using the more accurate figure obtained by this measurement for the material, instead of the assumed one, the outer conductor correction was again made, and a new result obtained. Such a procedure converges rapidly to a result of more than the required accuracy. For correcting all the measurements obtained with this equipment, Q_b is obtained from this result and the relation that it is inversely proportional to the square root of wavelength. Q_a is then obtained from Q_t by means of (2).

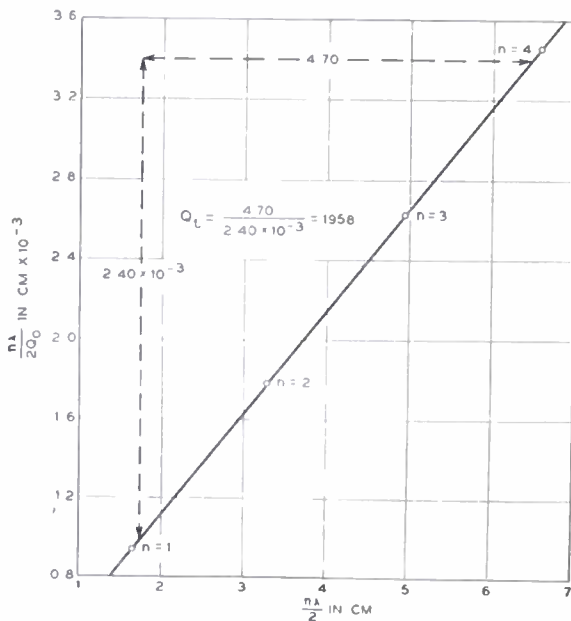

Fig. 7.—A sample plot of measurements on a specimen of vacuum annealed copper wire, showing how Q_t is obtained from the slope of the line.

¹ For example, S. A. Schelkunoff, "Electromagnetic Waves," D. Van Nostrand Co., Inc., New York, N. Y., Sections 4.9, 7.22 and 8.8; 1943.

The results of measurements with this equipment are usually given in terms of Q_a , or its ratio to theoretical values, or to values for other materials or conditions. Such quantities are given in Table I. A measurement of Q_a with this equipment by this method takes about two hours to make. Q_a is inversely proportional to the attenuation of microwave components using the same material in the same condition. However, formulas for computing the attenuation of most components, particularly coaxial lines or waveguides, are usually given in terms of the conductivity of the material of which they are made. The formula relating Q_a to the effective conductivity is given by Schelkunoff¹ in terms of the "intrinsic resistance" R as follows:

$$Q_a = \frac{4\pi^2 K}{R\lambda/a} \quad (3)$$

where

- K = surge impedance of line = $138.155 \log_{10} b/a$
- a = outer radius of center conductor in centimeters
- b = inner radius of outer conductor in centimeters
- λ = free-space wavelength in centimeters.

This intrinsic resistance is related to the conductivity by the formula

$$R = \frac{344.144\sqrt{\mu}}{\sqrt{g}\sqrt{\lambda}} \quad (4)$$

where

- μ = permeability relative to free space
- λ = free-space wavelength in centimeters
- g = conductivity in mhos per meter.

The intrinsic resistance and the effective conductivity of any sample can be obtained from Q_a by means of (3) and (4).

In order to relate the measurements to calculated values, the theoretical Q_a can be calculated from the measured dc resistance of the sample wires. In making this measurement of dc resistance, a long piece of the sample wire was used when possible in the Wheatstone Bridge, and its length and temperature were also recorded. Its dc resistance at 20° C was obtained by means of the usual relation

$$r_{20} = \frac{r_t}{1 + \alpha(t - 20)} \quad (5)$$

where

- r_t = total measured dc resistance of the wire
- α = temperature coefficient of resistance
- t = temperature of wire in degrees C.

From this, the relative conductivity C , with respect to the International Annealed Copper Standard, is calculated from the formula

$$C = \frac{0.15328L}{88900.1r_{20}} \quad (6)$$

TABLE I

Material	C	Diameter (Mils)	λ cm	Q_a'	Q_a''	Q_o	Q_o/Q_a''	Q_o/Q_a'	Remarks
Silver	1.0629	19.8	3.272	2202	2145	1927	0.90	0.87	Commercial wires
Copper	1.0293	19.6	3.280	2144	2113	1880	0.89	0.88	
24K Gold	0.7634	20.0	3.283	1881	2155	1794	0.83	0.95	
Aluminum	0.6106	19.4	3.277	1651	2113	1469	0.69	0.89	
Tungsten	0.3128	19.8	3.259	1201	2148	1011	0.47	0.84	
Molybdenum	0.3095	20.5	3.284	1219	2188	1160	0.53	0.95	
Platinum	0.1581	20.0	3.286	896	2155	898	0.42	1.00	
Coin Silver	0.8418	20.0	3.280	1977	2155	1705	0.79	0.86	Commercial alloys
Soft Brass	0.2700	19.8	3.287	1116	2139	1069	0.50	0.96	
Phosphor Bronze	0.1498	20.0	3.267	832	2160	811	0.38	0.97	
Silver	1.0832	20.0	3.264	2248	2160	1894	0.88	0.84	Vacuum-annealed metals and alloys
Copper	1.0490	19.5	3.296	2164	2103	2038	0.97	0.94	
24K Gold	0.7560	19.5	3.281	1842	2108	1707	0.81	0.93	
Aluminum	0.6214	19.6	3.265	1680	2118	1611	0.76	0.96	
Molybdenum	0.3095	19.5	3.270	1180	2112	1133	0.54	0.96	
Spring Brass	0.2246	19.6	3.300	997	2097	1006	0.48	1.01	
Phosphor Bronze	0.1347	19.6	3.264	828	2118	809	0.38	0.98	
Iron	0.1873	15.3	3.264	788	1802	297	0.16	0.38	Commercial annealed
Silver	1.0629	19.0	3.272	2145	2090	1987	0.95	0.93	Commercial wires hand-polished with #3 alumina, rubbed lengthwise only; 100 strokes
Copper	1.0293	19.2	3.284	2127	2096	2009	0.96	0.95	
24K Gold	0.7634	20.0	3.268	1883	2160	1875	0.87	1.00	
Aluminum	0.6106	19.0	3.273	1630	2090	1492	0.71	0.92	
Molybdenum	0.3095	20.5	3.274	1220	2191	1198	0.55	0.98	
Phosphor Bronze	0.1498	20.0	3.270	832	2159	840	0.39	1.01	
Soft Brass	0.2700	19.5	3.286	1099	2107	1086	0.52	0.99	
Copper ¹	1.0293	19.9	3.282	2178	2147	844	0.39	0.39	Threaded 220 threads per inch
Soft Brass ¹	0.2700	18.8	3.290	1073	2063	1025	0.50	0.96	Electropolished
Copper ¹	1.0293	19.2	3.277	2129	2098	1928	0.92	0.91	Electropolished
Copper ¹	1.0293	19.2	3.280	2127	2096	2068	0.99	0.97	Smooth electropolished
Copper ¹	1.0293	19.2	3.284	2127	2096	2088	1.00	1.00	Very smooth electropolished
Copper ²	1.0293	19.2	3.277	2129	2098	1928	0.92	0.91	Immediately after electropolishing
Copper ²	1.0293	19.3	3.266	2139	2108	1940	0.92	0.90	2 hours after lacquering
Copper ²	1.0293	19.8	3.288	2170	2139	1982	0.93	0.91	12 days after electropolishing
Copper ²	1.0293	19.4	3.271	2145	2114	1983	0.94	0.92	12 days after lacquering
Copper ²	1.0293	19.0	3.265	2121	2091	1843	0.88	0.87	33 days after electropolishing
Copper ²	1.0293	19.1	3.2810	2120	2090	1897	0.91	0.89	33 days after lacquering
Copper ²	1.0293	19.4	3.2638	2148	2117	1879	0.89	0.87	64 days after electropolishing
Copper ²	1.0293	19.8	3.2783	2173	2142	1973	0.92	0.91	64 days after lacquering
Copper ²	1.0293	19.2	3.2737	2130	2097	1990	0.91	0.93	3 months after lacquering
Copper ²	1.0293	20.0	3.2697	2190	2158	1932	0.89	0.88	5 months after electropolishing
Copper ³	1.0293	18.8	3.273	2100	2070	1955	0.94	0.94	20 lengthwise strokes #4/0 emery; grooves 1 micron wide, 1 micron deep
Copper ³	1.0293	18.7	3.298	2083	2052	1830	0.89	0.88	20 lengthwise strokes #2/0 emery; grooves 2.6 microns wide, 2 microns deep
Copper ³	1.0293	18.5	3.293	2074	2044	1578	0.77	0.76	20 lengthwise strokes #1 emery; grooves 5.4 microns wide, 4.5 microns deep
Copper ³	1.0293	18.6	3.289	2080	2050	1218	0.59	0.59	Rolled between ground steel plates producing circumferential grooves, 4 microns wide, 3.5 microns deep
Copper ³	1.0293	19.2	3.284	2127	2096	2088	1.00	0.98	Immediately after electropolishing
Copper ³	1.0293	19.0	3.284	2115	2085	2033	0.97	0.96	3 days after electropolishing
Copper ³	1.0293	19.2	3.297	2123	2093	2012	0.96	0.95	10 days after electropolishing
Copper ³	1.0293	18.9	3.274	2104	2074	2010	0.97	0.95	13 days after electropolishing
Copper ³	1.0293	18.5	3.257	2086	2060	1938	0.94	0.93	21 days after electropolishing
Copper ³	1.0293	19.0	3.270	2116	2088	2029	0.97	0.95	41 days after electropolishing
Copper ³	1.0293	19.0	3.262	2115	2087	1891	0.91	0.89	18 weeks after electropolishing
Copper ³	1.0293	20.0	3.281	2185	2155	1561	0.72	0.71	Aged out of doors, 4½ months
Copper ⁴	1.0	20.8	3.298	2204	2204	1814	0.82	0.82	Acid bath 20 minutes at 200 ma
Copper ⁴	1.0	20.1	3.294	2158	2158	1787	0.83	0.83	Acid bath 20 minutes at 200 ma, then hand-polished 100 strokes #3 alumina, lengthwise, only
Copper ⁴	1.0	20.0	3.291	2152	2152	1683	0.78	0.78	Acid bath 30 minutes at 100 ma
Copper ⁴	1.0	20.8	3.265	2215	2215	2100	0.95	0.95	Acid bath 20 minutes at 200 ma, then re-electropolished with same process that produced 1.0 Q_o/Q_a''
Copper ⁴	1.0	20.8	3.263	2215	2215	1874	0.85	0.85	5 months exposure to air; same treatment as previous sample

TABLE I—(continued)

Material	C	Diameter (Mils)	λ cm	Q_a'	Q_a''	Q_a	Q_a/Q_a''	Q_a/Q_a'	Remarks
Silver ⁶	1.0843*	20.9	3.275	2311	2229	1019	0.46	0.44	Cyanide 15 minutes at 80 ma
Silver ⁶	1.0843*	19.8	3.272	2238	2143	1268	0.59	0.57	Cyanide 6 minutes at 100 ma
Silver ⁶	1.0843*	19.8	3.278	2236	2141	1628	0.76	0.73	Cyanide 25 minutes at 25 ma
Silver ⁶	1.0843*	19.8	3.265	2239	2143	1498	0.70	0.67	Cyanide 25 minutes at 25 ma, hand-polished #3 alumina; 100 strokes lengthwise

* Assumed relative conductivity of silver.

¹ Commercial wires.

² Electropolished copper wire of 0.92 Q_a/Q_a'' .

³ Electropolished copper wire of 1.0 Q_a/Q_a'' .

⁴ Copper-electroplated on electropolished copper of 1.0 Q_a/Q_a'' .

⁵ Silver-electroplated on electropolished copper of 1.0 Q_a/Q_a'' .

where

L = wire length in centimeters

A = wire area in square centimeters.

The conductivity g , in mhos per meter, is given by the relation

$$g = 5.8005 \times 10^7 \times C. \quad (7)$$

This can be used in (4) to get the theoretical intrinsic resistance, and, from this, (3) gives the theoretical value of Q_a calculated from the measured dc resistance.

VII. RESULTS

Table I gives results of measurements with this equipment for a number of specimen wires. The first column lists the material under test. The second column, headed "C," gives the relative conductivity of the sample as calculated by (5) and (6) from dc resistance measurements. Next are listed the diameter of the sample and the wavelength of the measurement. The column headed Q_a' gives the theoretical Q_a value calculated from this dc conductivity, diameter, and wavelength, as explained in the previous section. The column headed Q_a'' gives the theoretical Q_a calculated for copper of unit relative conductivity, and the given diameter and wavelength. The column headed Q_a gives the value measured¹ at the given wavelength with this equipment. The next column gives the ratio Q_a/Q_a'' , a quantity which is useful in comparing the attenuation of microwave systems made of this material with the theoretical attenuation using standard copper. The increase in attenuation is obtained by dividing by this number, since attenuation is inversely proportional to Q . The last column gives the ratio Q_a/Q_a' , which indicates the relation between the measured results and calculated values based on the dc-resistance measurements of the same samples.

As a check on the accuracy of measurement with this equipment, it will be seen that very smooth samples of platinum, phosphor bronze, brass, molybdenum, 24K gold, and copper gave results within 2 per cent of the Q

calculated from measurements of their dc resistance. These metals have Q_a values in the range from about 800 to 2,100 when used in this specimen holder.

The data of Table I show quantitatively the importance of a smooth surface, especially for high conductivity samples, at these frequencies where the current skin depth is in the order of one thirtieth of a mil for copper. Microscopic examination showed that the hand-polished samples were still not very smooth. Lengthwise grooves or scratches do not reduce the effective conductivity as much as circumferential ones, as would be expected. Theoretically a smooth 60° V thread on the surface should reduce the Q to one half its value for a smooth sample,² but the measurement of a rough thread shows a reduction to about 40 per cent of the smooth sample value.

It will be noted that electropolishing is somewhat variable, but that good results can be obtained. Microscopic examination of the surface always showed good correlation between smoothness and measured high conductivity. The effective conductivity of freshly electropolished copper is seen to drop in value due to aging in the laboratory, and to drop further if aged outdoors, as would be expected. To protect a freshly polished copper surface, DuPont clear lacquer was selected, because it was considered to be good for this purpose, and was found to cause a negligible increase in loss at these frequencies.

Fragmentary measurements on electroplated samples gave rather poor results. Since plated metal is usually more rough and porous than solid metal, this would be expected. It will be noted that copper-plated samples could not be electropolished to as high a conductivity as solid samples, probably because of the lower density of the plating due to its porosity. Silver plated on very smooth electropolished copper samples from a cyanide bath gave very poor results, with the lowest values for rough porous platings at high current densities.

² S. P. Morgan, Jr., "Effect of surface roughness on eddy current losses at microwave frequencies," *Jour. Appl. Phys.*, vol. 20, pp. 352-362; April, 1949.

VIII. ACKNOWLEDGMENTS AND CONCLUSIONS

We have received suggestions and encouragement from many of our colleagues, particularly H. T. Friis and A. E. Bowen, under whose supervision this work was done, and W. A. Tyrrell, who in addition helped with the plating, chemical treatment, and microscopic examination of specimens. Assistance in the measurements was given by G. D. Mandeville.

The information obtained with this measuring equipment has been found useful in the design and treatment of microwave components of all types where loss is a factor of importance. The values obtained in this study of small wires agree very well with the results of waveguide attenuation measurements made by other methods for several materials. The versatility, rapidity, and accuracy of measurements by this method have made this a valuable tool in microwave work.

APPENDIX

Derivation of the Relation between the Unloaded Q and the Loaded Q of the Coaxial Line in Terms of the Transmission of Energy through the Specimen Holder

Fig. 8 gives a representation of the equivalent circuit of the specimen holder. The orifices between the coaxial line and the waveguides are depicted by ideal trans-

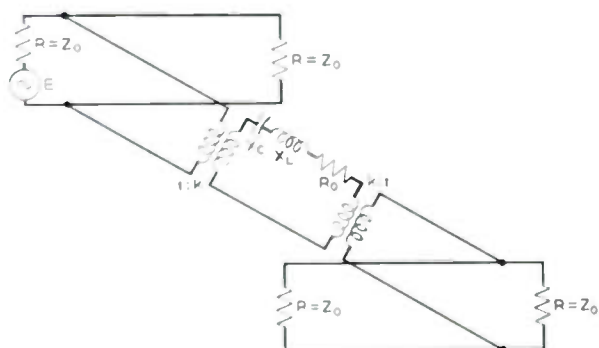

Fig. 8—A representation of the equivalent circuit of the specimen holder shown in Fig. 1.

formers, here assumed to be identical. Fig. 9 shows this circuit transformed into the upper mesh. The measuring method determines the loaded Q , here called Q_t , of this circuit. This is the ratio of inductive reactance to total equivalent series resistance in the circuit. Hence

$$Q_t = \frac{X_L/k^2}{R/2 + R_0/k^2 + R/2} = \frac{X_L}{k^2R + R_0} \quad (8)$$

We need to know the unloaded Q of the coaxial line itself, the value it would have if there were no losses

through the orifices into the rest of the circuit. We denote this by Q_0 . This is the ratio of inductive reactance to the equivalent series resistance of the coaxial line itself. Hence

$$Q_0 = \frac{X_L/k^2}{R_0/k^2} = \frac{X_L}{R_0} \quad (9)$$

Taking the ratio of (9) to (8)

$$\frac{Q_0}{Q_t} = \frac{k^2R + R_0}{R_0} \quad (10)$$

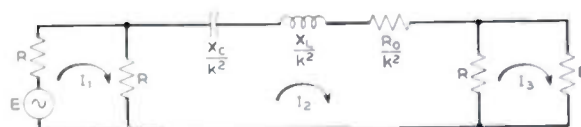

Fig. 9—The circuit of Fig. 8 transformed into the upper mesh.

In order to determine this ratio, the power transmission through the specimen holder at resonance is measured. This is the ratio of the power output from the specimen holder to the power available at its input, in both cases between matched loads at the generator and receiver. Accordingly, as defined above, denoting the power transmission by T , the output power by P_0 , and the available power by P_A

$$T = P_0/P_A \quad (11)$$

From Fig. 9

$$P_0 = I_3^2R \quad (12)$$

and

$$P_A = E^2/4R \quad (13)$$

Solving the network of Fig. 9 at resonance for I_3 in terms of E gives

$$I_3 = \frac{k^2E}{4(k^2R + R_0)} \quad (14)$$

Putting (14) into (12), and that result and (13) into (11) gives

$$T = \frac{k^4R^2}{4(k^2R + R_0)^2} \quad (15)$$

Combining (10) and (15) gives

$$\frac{Q_0}{Q_t} = \frac{1}{1 - 2\sqrt{T}} \quad (16)$$

which is the desired relation.

Cascade-Connected Attenuators*

R. W. BEATTY†, MEMBER, IRE

TWO OR MORE calibrated attenuators are often connected in series (cascade), as in Fig. 1, in order to obtain a desired reduction in power level. The



Fig. 1—Cascade-connected attenuators.

total attenuation of the combination is usually obtained by adding the attenuation of each unit. In general, this will not give the correct result because of reflections due to mismatch at the attenuator junctions.

The correct value of attenuation can be obtained in terms of reflection coefficient measurements at the attenuator junctions.

For two units, the total attenuation A_T is

$$A_T = A' + A'' + 20 \log_{10} |1 - \Gamma_2' \Gamma_1''|, \quad (1)$$

where

* Decimal classification: R396. Original manuscript received by the Institute December 28, 1949, abstract received May 25, 1950. This is an abstract of a paper published in *Jour. Res. Nat. Bur. Stand.* RP2129, vol. 45, September, 1950.

† Central Radio Propagation Laboratory, National Bureau of Standards, Washington, D. C.

- A' = attenuation of first unit
- A'' = attenuation of second unit
- Γ_2' = reflection coefficient at junction looking toward first unit with input matched
- Γ_1'' = reflection coefficient at junction looking toward second unit with output matched.

The last term in equation (1) is the error (ϵ_2) resulting when the individual attenuations are added to obtain the total attenuation of the combination. If the voltage standing-wave ratios corresponding to Γ_2' and Γ_1'' are measured, ϵ_2 will lie between two limits, depending upon the phases of Γ_2' and Γ_1'' . A nomogram which gives the limits of error appears in Fig. 2.

If more than two cascade-connected attenuators are considered, the total attenuation may be obtained by successive use of (1), starting from one end of the chain. When the attenuation of the first two attenuators has been determined, they are treated as the first unit and the third attenuator becomes the second unit in (1). If the attenuators are numbered from the end, the following equation is obtained for any number (n) of cascade-connected attenuators:

$$A_T = \sum_{K=1}^n A^{(K)} + \sum_{K=2}^n 20 \log_{10} |1 - \Gamma_2^{(K-1)} \Gamma_1^{(K)}|, \quad (2)$$

where

- (K) = a superscript denoting the number of the attenuator
- $A^{(K)}$ = attenuation of K^{th} attenuator
- $\Gamma_2^{(K-1)}$ = reflection coefficient measured at the output terminals of the $(K-1)^{\text{th}}$ attenuator looking toward the input with the end of the chain matched
- $\Gamma_1^{(K)}$ = reflection coefficient measured at the input terminals of the K^{th} attenuator with its output matched.

As shown in Fig. 1, each attenuator in the chain has its output terminals connected to the input terminals of the following attenuator.

These results may be applied to attenuators which are not used in a transmission-line system if expressions of the form $Z - Z_0$, $Z + Z_0$ are substituted for the appropriate reflection coefficients, and the same reference impedance (Z_0) is used throughout.

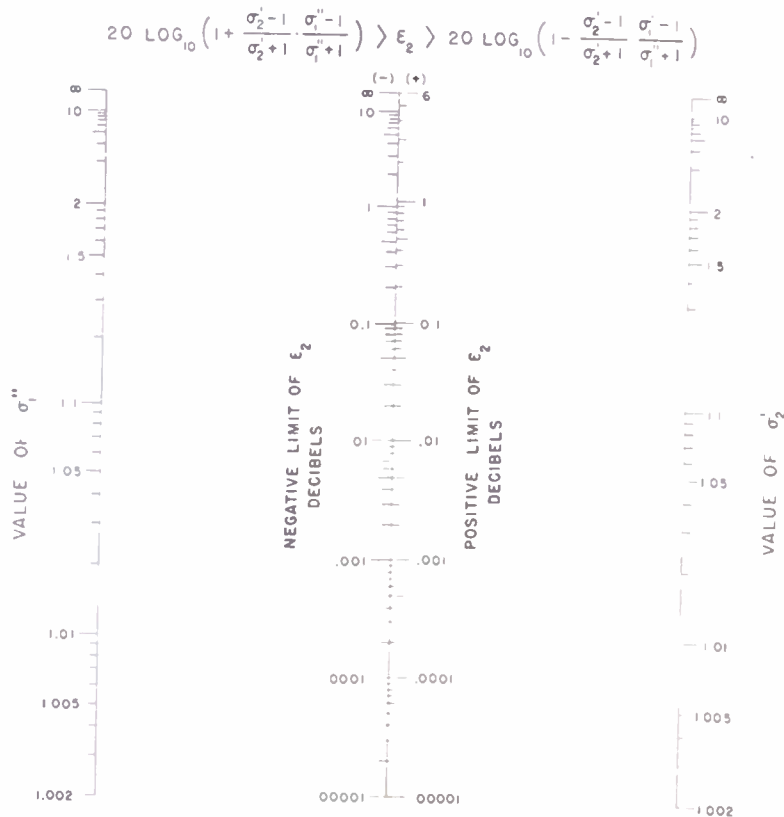

Fig. 2—Nomogram of mismatch error for two cascade connected attenuators.

The Design of Frequency-Compensating Matching Sections*

V. H. RUMSEY†

Summary—Frequency-compensating networks have been employed to improve the impedance bandwidth of antennas and other radio-frequency components. The general problem considered here is that of transforming an impedance which changes with frequency to a specified resistance which is, as nearly as possible, constant with frequency. A simple procedure for solving the general problem is established, and formulas for the design of the appropriate matching section are worked out. The formulas give the parameters of the matching section in terms of the impedance of the load at selected frequencies. The technique is mainly applicable where the half bandwidth is small compared with the center frequency. For the purpose of illustration, the method is described in terms of its application to coaxial lines, although it is equally applicable to any form of transmission line whose characteristic impedance is known.

INTRODUCTION

THE TECHNIQUE of compensating for the change of impedance with frequency of a load, such as an antenna, was first brought to the attention of the author in 1942, by Westcott at TRE Great Malvern, England. Techniques of frequency compensation have been widely used in the meantime, although there are relatively few open publications on the subject.¹⁻⁵ These consist largely of particular examples which illustrate the mechanism of frequency compensation but do not give an explicit solution of the general problem. In this paper a more general approach is attempted. A procedure and design formulas are established from which an optimum matching section can be constructed without recourse to methods of trial and error. For the purpose of illustration, the method is described in terms of its application to coaxial lines, although it is equally applicable to any form of transmission line whose characteristic impedance is known.

The problem is to design a matching section which, as nearly as possible, transforms the load impedance into

a constant resistance Z_0 at all frequencies in the band. The design of the optimum matching section is based on the impedance curve obtained by plotting the variation of load impedance with frequency on the Smith Chart. While the technique of frequency compensation can be used to give considerable improvement, there is no substitute for a good impedance curve in the first place. In practice it is often possible to make adjustments to the load itself, yielding a variety of curves. The first step is therefore to select the best curve. This may be done by plotting the impedance curve with respect to a complex characteristic impedance equal to the impedance at the mean frequency. As a general rule, the best curve is the shortest curve so obtained.

TWO-ELEMENT MATCHING SECTIONS

It is assumed that the simplest and smallest matching section is required in all cases. This means that a better match could be obtained in some cases by using a more complicated section, but it is seldom worth the trouble.

In order to set up a systematic procedure, it is convenient to restrict ourselves to quarter-wave stubs and transformers. This results in practically no loss of generality, though in some cases it may not give the most elegant solution. Fortunately these cases are uncommon in practice.

Fig. 1 shows the five types of matching section in co-

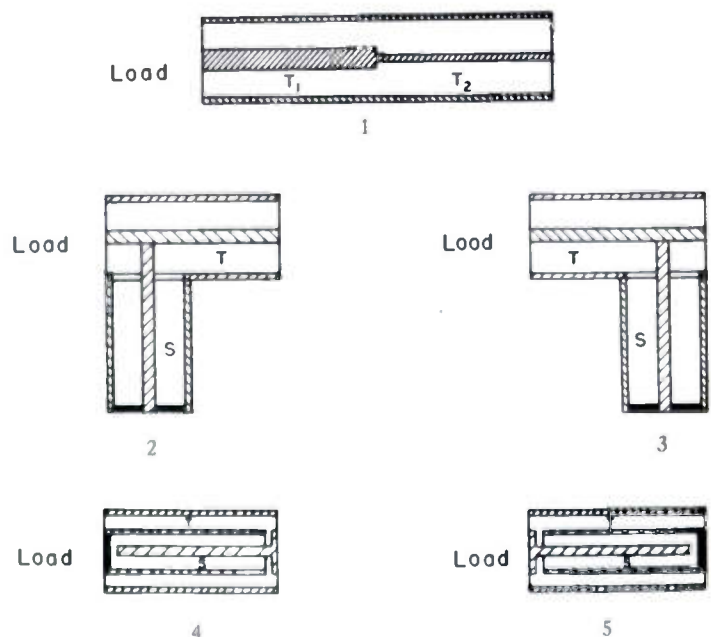

Fig. 1—Two element frequency-compensating matching sections.

* Decimal classification: R117.12. Original manuscript received by the Institute, July 6, 1949; revised manuscript received, April 17, 1950. Presented, 1949 IRE National Convention, New York, N. Y., March 8, 1949.

The work described in the paper was done while the author was employed by the British Air Commission, Washington, D. C., at the Naval Research Laboratory, Washington, D. C. It was originally published in report CRG 89, Naval Research Laboratory, Washington, D. C., September, 1945.

† Ohio State University, Columbus, Ohio.

¹ L. H. Dawson and N. M. Rust, "A wide band linear array aerial," *Jour. IEE* (London), part IIIa, vol. 93; 1946.

² E. G. Fubini and P. S. Sutro, "A wide-band transformer from an unbalanced to a balanced line," *Proc. I.R.E.*, vol. 35, p. 1153; October, 1947.

³ R. G. Fellers and R. T. Weidner, "Broad-band waveguide admittance matching by use of irises," *Proc. I.R.E.*, vol. 35, p. 1080; October, 1947.

⁴ C. H. Westcott and F. K. Goward, "The design of broadband aerial elements for 500-600 Mc ground radar," *Jour. IEE* (London), part III, vol. 96; 1949.

⁵ Harvard Radio Research Laboratories, "Very High Frequency Techniques," McGraw-Hill Book Co., New York, N. Y., vol. 1, chap. 3; 1947.

axial form although the analysis which follows applies, in general, to balanced or unbalanced lines. Each consists of two quarter-wave elements. Referring to Fig. 1, T_1 and T_2 denote the characteristic impedances of the two quarter-wave transformers in 1; S and T denote the characteristic impedance of the quarter-wave stubs and transformers in 2, 3, 4 and 5. It is required to determine the values of T_1 and T_2 or S and T which give the best match to a given resistance Z_0 over the frequency band.

We first note the limitations imposed by the use of quarter-wave elements. Since the final result is required to be a pure resistance, it follows that the impedance curve applied to the beginning of the matching section must be resistive at the mean frequency and perpendicular to the line of zero reactance. In general, the curve does not satisfy these requirements, but can be made to without significantly affecting the bandwidth. Fig. 2

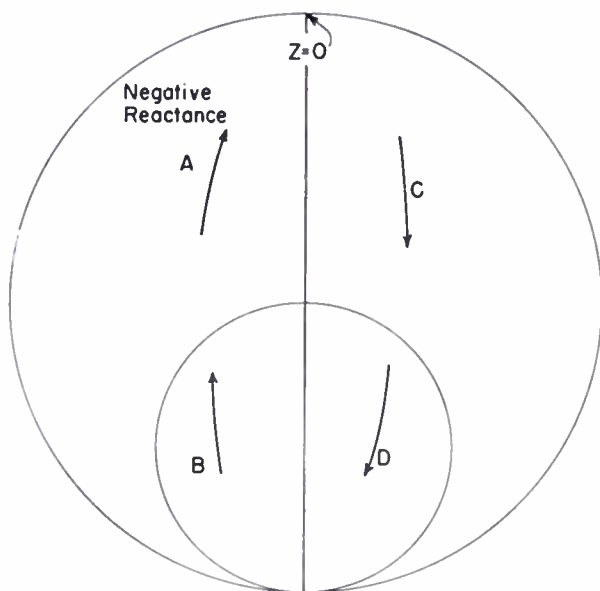

Fig. 2—Representative positions of the impedance curve on the Smith chart.

shows four typical positions of the curve. If it falls in the position A or B , then a short length of high-impedance line (effectively an inductance) will transform the midband impedance to a pure resistance, B requiring a higher impedance than A . If the curve falls in the position C or D , a short length of low-impedance line (a capacity) will transform the midband impedance to a pure resistance. In either case, since the matching section is short, the bandwidth will not be changed appreciably. We thus obtain a curve which cuts the line of zero reactance at the midband point, but not necessarily at right angles. In order to obtain the desired orientation, we must apply an appropriate length of line whose characteristic impedance is equal to the midband impedance (in order to minimize any change of bandwidth).

Hence, the compensating matching sections of Fig. 1 are preceded by two short sections, the first of which translates the curve to the real axis and the second of

which rotates it to the perpendicular position. It remains to decide which of the matching sections in Fig. 1 should be used, and to determine the values of the two characteristic impedances in it. This is accomplished by means of a series of formulas which are given below. Before giving the procedure, the method of obtaining the formulas will be described briefly. A detailed analysis is given in the Appendix.

DERIVATION OF THE DESIGN FORMULAS

To derive the formulas, the conditions for an exact match at the ends and the middle of the band are worked out on the assumption that the frequency band is small enough that third-order terms in the relative frequency difference (ratio of half bandwidth to mean frequency) may be ignored in comparison with first- and second-order terms. This means that the formulas cannot be used for bandwidths which exceed about 50 per cent (total). The values of, say, T_1 and T_2 (see Fig. 1), which give an exact match at one end of the band, also give an exact match at the other end if the curve is symmetrical about the line of zero reactance. If these values of T_1 and T_2 were used, the final curve would resemble curve A in Fig. 3. The nearest values of T_1 and T_2 which give an exact match at the midband produce a result like curve B in Fig. 3. The optimum value of, say, T_1 ,

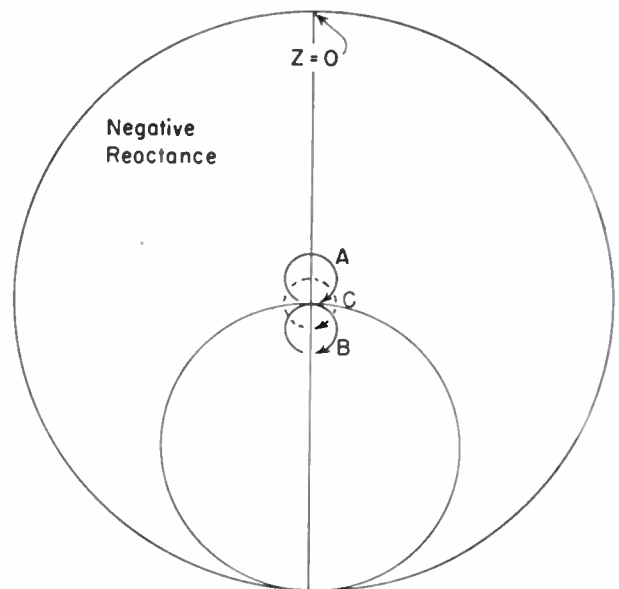

Fig. 3—Illustrating performance of optimum matching section.

is then the geometric mean of the two values which give the curves A and B ; similarly for T_2 . When these mean values are used, the final curve resembles curve C in Fig. 3, for which the mismatch is roughly the same at all frequencies in the band. The value of this mismatch is easily deduced, and is given in the formulas as a voltage standing-wave ratio, which may be either greater than or less than one. The optimum values of

S and T in the other matching sections are similarly determined.

The curve may not be exactly symmetrical about the zero reactance line. In order to take this into account, let $r_L + jx_L$, $r_H - jx_H$ represent the impedance points at the lowest and highest frequencies. Then in the formulas we use

$$r = \frac{1}{2}(r_L + r_H) \quad \text{and} \quad x = \frac{1}{2}(x_L + x_H)$$

and assume that $r \pm jx$ represents the impedance at the lowest and highest frequencies; i.e., we assume that an asymmetrical curve would give about the same result as the symmetrical curve which most nearly coincides with it.

THE DESIGN FORMULAS

The formulas apply to the frequency band between $f - Df$ and $f + Df$, f representing the mean frequency and Df the half bandwidth. The values of the characteristic impedances in the matching sections are given relative to Z_0 , the resistance to which a match is required. The numbers 1, 2, 3, 4, and 5, associated with the formulas, apply to the corresponding matching sections given in Fig. 1.

Frequency	Impedance $\div Z_0$	Admittance $\times Z_0$
$f - Df$	$r_L + jx_L$	$g_L + jb_L$
f	r_1	g_1
$f + Df$	$r_H - jx_H$	$g_H - jb_H$

$$d = \tan \frac{\pi Df}{2f}$$

$$M = \text{VSWR mismatch}$$

$$2r = r_H + r_L$$

$$2g = g_H + g_L$$

$$2x = x_H + x_L$$

$$2b = b_H + b_L$$

1. For $x > 0$

$$h = \sqrt{r} - d^2(r + \sqrt{r})$$

$$M = \frac{\sqrt{r_1}}{h}$$

$$a = \frac{x(1 - d^2h)}{2dh(1 + h)}$$

$$t_2 = \frac{h^{1.4}}{r_1^{1/8}} \left(a + \sqrt{a^2 + \frac{r}{h}} \right)$$

$$t_1 = t_2 \sqrt{h} \sqrt{r_1}$$

1. For $b > 0$, replace r_1 , r , x , t_1 , and t_2 by g_1 , g , b , $1/t_1$, and $1/t_2$, respectively.

$$2. M = \sqrt{\frac{g}{g_1}}$$

$$t^2 = \frac{1}{\sqrt{gg_1}}$$

$$\frac{1}{s} = \sqrt{g}(g - 1) + \frac{b}{d}$$

$$3. M = \frac{\sqrt{r} - dx}{\sqrt{r_1}}$$

$$t^2 = \sqrt{r_1}(\sqrt{r} - dx)$$

$$\frac{1}{s} = \frac{1}{\sqrt{r}} \left[r - 1 + \frac{x}{dt} \right]$$

4. Replace r , r_1 , x , s , and t in 3 by g , g_1 , b , $1/s$, and $1/t$, respectively.
5. Replace g , g_1 , b , $1/s$, and $1/t$ in 2 by r , r_1 , x , s , and t , respectively.

PROCEDURE

Summarizing the foregoing discussion, we obtain the following procedure for matching a given load over a band of frequencies $f \pm Df$ to a resistance Z_0 :

1. All possible adjustments are made to load in order to obtain the best curve in the first place.
2. The curve is transformed using methods which do not reduce the bandwidth until
 - (a) the midband impedance is a pure resistance,
 - (b) the curve cuts the line of zero reactance at right angles.
3. The curve so obtained is plotted with respect to Z_0 and values of the parameters required in the formulas are noted.
4. The best matching section is determined by substitution in the formulas for mismatch.
5. The design of the best matching section is determined from the formulas.

AN EXAMPLE

Suppose that the best curve obtained was curve A in Fig. 4, plotted with respect to Z_0 over a ± 10 per cent

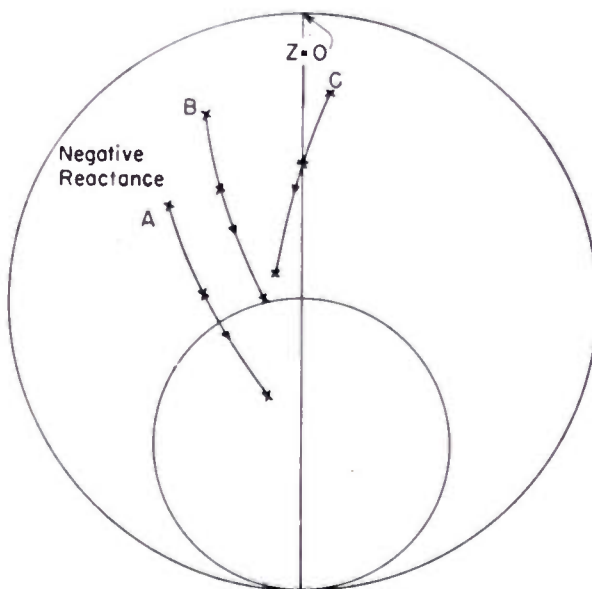

Fig. 4—Transformation of initial curve A to real axis. (Frequency increases in direction of arrow.)

band. Referring to the procedure, step 2(a) is accomplished by a short length of high-impedance line. Suppose that $2Z_0$ is the highest convenient value. Replotting A with respect to $2Z_0$ we obtain curve B . In order to make the impedance at the mean frequency f a pure resistance, it is necessary to transform B through a length of 0.05λ (at frequency f), of characteristic impedance $2Z_0$. After this transformation we obtain curve C in Fig. 4, which gives an impedance at frequency f of $0.7Z_0$. To accomplish step 2(b), we therefore transform through an appropriate length of line of characteristic impedance equal to $0.7Z_0$. Replotting curve C in Fig. 4 with respect to $0.7Z_0$ gives curve D in Fig. 5. Curve D shows

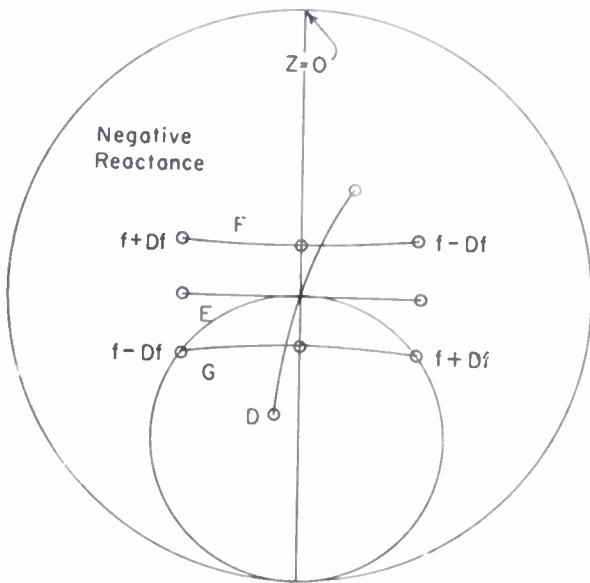

Fig. 5—Transformation of curve C , Fig. 4, to orientation perpendicular to real axis.

that a line of length 0.1λ (at frequency f) of characteristic impedance $0.7Z_0$ transforms the curve so that it cuts the line of zero reactance at right angles, giving curve E in Fig. 5. Proceeding to step 3, curve E is plotted with respect to Z_0 , giving curve F , from which we plot the admittance curve G in Fig. 5. Curves F and G are the impedance and admittance curves which are used in the formulas. Hence, before using one of the matching sections shown in Fig. 1, we apply 0.05λ of $2Z_0$ line followed by 0.1λ of $0.7Z_0$ line.

The values of r_L , r_H , x_L , x_H , and r_1 are read from curve F , Fig. 5, and the values of g_L , g_H , b_L , b_H , and g_1 are read from curve G , Fig. 5. Applying step 4 to formulas 1, 3, and 5 we obtain 1.2, 1.33, and 1.18, respectively, for the mismatch (when expressed as a fraction greater than 1). Matching sections 2 and 5 give a negative value of S and are therefore not applicable. Using the formulas, we obtain the values $T=0.77Z_0$ and $S=2.77Z_0$ as the characteristic impedances of the elements in the matching section 5. The complete matching section constructed in coaxial line thus takes the form shown in Fig. 6.

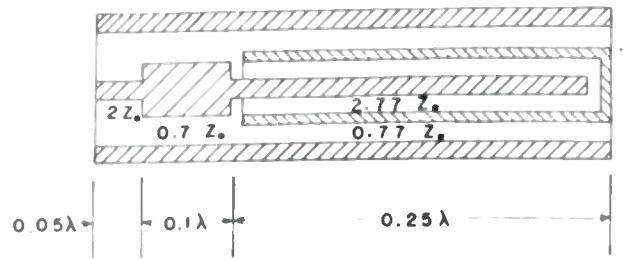

Fig. 6—Coaxial line form of optimum matching section for curve A , Fig. 4.

In order to illustrate the action of the matching sections, the transformations have been plotted with respect to Z_0 for matching section 5 in Fig. 7. The initial curve is represented by A , curve B represents the impedance after the addition of the series stub, and curve C represents the final impedance. Curve C in Fig. 7 is slightly overcompensated, indicating that a smaller value of S could have been used in matching section 5.

It should be remembered that there is an inevitable error in any impedance measurement. Also, that a change of physical dimensions in a transforming section gives rise to a small reflection, which is not taken into account in the formulas. In general, the accuracy of the formulas given here is about the same as the accuracy of measurement.

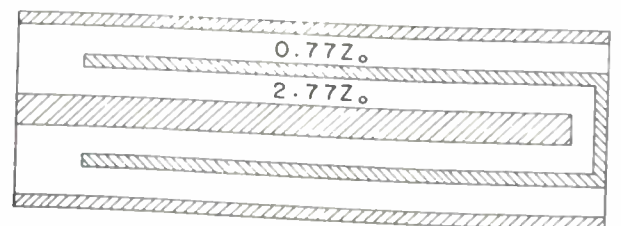
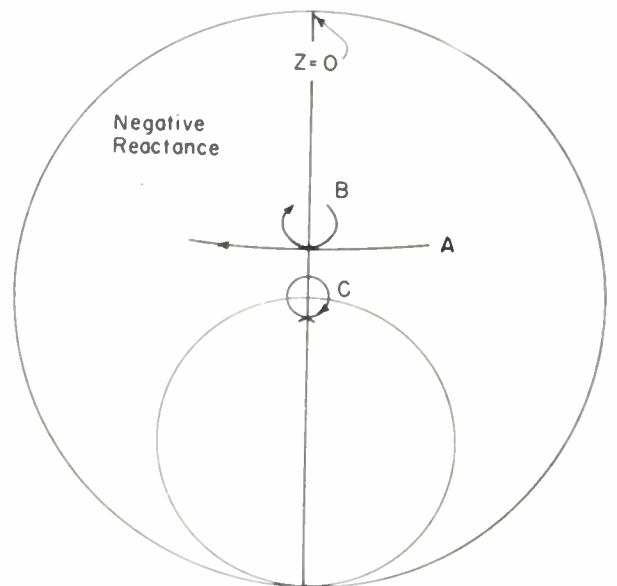

Fig. 7—Transformations due to frequency-compensating matching section.

APPENDIX

The Derivation of the Formulas

Referring to Fig. 1, let the load be connected to the transformer of characteristic impedance T_1 in matching section 1. The impedance of the load is $R + jX$ at the lowest frequency, R_1 at the mean frequency, and $R - jX$ at the highest frequency.

Let

$$d = \tan \frac{Df}{f} 90^\circ \tag{1}$$

where $f \pm Df$ are the highest and lowest frequencies.

Let

$$z = \frac{Z}{Z_0}, \quad r = \frac{R}{Z_0}, \quad x = \frac{X}{Z_0}, \quad t_1 = \frac{T_1}{Z_0}, \quad t_2 = \frac{T_2}{Z_0}, \text{ and so forth,}$$

where Z_0 is the characteristic impedance to which a match is required. Then the impedance seen through the first quarter-wave transformer of characteristic impedance T_1 at the frequency $f - Df$ is given by Z' where

$$\frac{z'}{t_1} = \frac{zd + jt_1}{t_1d + jz} \tag{2}$$

Similarly the final impedance is given by

$$\frac{z''}{t_2} = \frac{z'd + jt_2}{t_2d + jz'} \tag{3}$$

The condition that $Z'' = Z_0$ or $z'' = 1$ results in the equations

$$t_1^2 - rt_2^2 + dx(t_1 + t_2) + d^2t_1t_2(r - 1) = 0 \tag{4}$$

and

$$t_2^2x + d(t_1 + t_2)(r - t_1t_2) - d^2t_1t_2x = 0. \tag{5}$$

Let

$$h = \frac{t_1}{t_2} \tag{6}$$

Then from (4) we have

$$t_2 = \frac{-dx(1 + h)}{h^2 - r + d^2h(r - 1)} \tag{7}$$

Elimination of t_1 and t_2 from (5), (6), and (7) gives

$$(h^2 - r)(u^2 - g) + 2d^2[gh(1 - r) + ru(1 - g) + 1 - rg] + d^4(r - 1)(g - 1) = 0 \tag{8}$$

where

$$uh = 1 \tag{9}$$

$$g = GZ_0 = \frac{r}{r^2 + x^2} = \text{normalized conductance.} \tag{10}$$

Equation (8) is unaltered if we interchange h and u , and r and g . This means that if we find a solution in terms of

impedances we may immediately write down an alternative solution in terms of admittances by making the above interchange.

We now make use of the fact that d is small. For a ± 10 -per cent band, $d = 0.16$, $d^2 = 0.0256$, and so forth. An approximate solution is therefore obtained by assuming $d = 0$. This gives

$$h^2 = r \quad \text{or} \quad u^2 = g,$$

i.e.,

$$h^2 = r \quad \text{or} \quad h^2 = \frac{1}{g} = \frac{r^2 + x^2}{r} \tag{11}$$

Now these are two different solutions if $x \neq 0$. To determine which is correct we substitute in (7).

Suppose $x > 0$ and $h^2 = r$.

Then

$$t_2 = \frac{\text{negative quantity}}{d^2h(r - 1)}$$

Therefore t_2 exists only if $r < 1$

(12)

Suppose $x > 0$ and

$$h^2 = r + \frac{x^2}{r}$$

Then

$$t_2 = \frac{\text{negative quantity}}{\frac{x^2}{r} + d^2h(r - 1)}$$

Therefore, t_2 exists only if

$$d^2h(1 - r) > \frac{x^2}{r} \tag{13}$$

Since we have assumed $x \neq 0$, but $d = 0$, the inequality (13) is plainly inadmissible. The inequality (12) which restricts the values of r arises because the original approximation was poor, not because the assumption that $h^2 = r$ is fundamentally incorrect.

Suppose $x < 0$ and $h^2 = r$.

Then

$$t_2 = \frac{\text{positive quantity}}{d^2h(r - 1)}$$

Therefore, t_2 exists only if $r > 1$.

(14)

Suppose

$$x < 0 \quad \text{and} \quad h^2 = r + \frac{x^2}{r}$$

Then

$$t_2 = \frac{\text{positive quantity}}{\frac{x^2}{r} + d^2h(r - 1)}$$

Therefore, t_2 exists only if

$$\frac{x^2}{r} > d^2h(1-r). \quad (15)$$

Since d is small, the inequality (15) is less restrictive than the inequality (14). We conclude therefore that the correct solution to the first approximation is

$$h^2 = r \text{ if } x > 0 \text{ and } u^2 = g \text{ if } x < 0.$$

To proceed with the solution, we return to (8). Assuming $x > 0$, we substitute the first approximation $h^2 = r$ in the coefficient of d^2 , ignoring d^4 , giving

$$(h^2 - r)(u^2 - g) = 2d^2(\sqrt{r} + 1)(gr - 1).$$

Solving for h gives to the same order of approximation

$$h = \sqrt{r} - d^2(r + \sqrt{r}). \quad (16)$$

This approximation is sufficiently accurate for most practical purposes, since the next approximation involves terms in d^4 which is very small.

We can now solve for t_2 from either (4) or (5). Equation (4) gives a poor approximation when x is small. We therefore use (5), which may be written

$$t_2^2 - 2at_2 - \frac{r}{h} = 0 \quad (17)$$

where

$$a = \frac{x(1 - d^2h)}{2dh(1 + h)}. \quad (18)$$

Therefore, when $x > 0$,

$$t_2 = a + \sqrt{a^2 + \frac{r}{h}}. \quad (19)$$

We do not consider the negative square root because this would make t_2 negative. t_1 is then given by

$$t_1 = ht_2. \quad (20)$$

If the impedance at the highest frequency is $R - jX$, we obtain identical equations. Hence, the conditions for an exact match at the ends of the band are identical and are given by the above equations. The condition for an exact match at the midband frequency is simply

$$t_1 = t_2\sqrt{r_1} \quad (21)$$

where $R_1 + j0$ is the impedance at the midband frequency.

Summarizing the results, the condition for a match at the ends of the band when $x > 0$ is

$$t_1 = i \quad (22)$$

$$t_2 = k \quad (23)$$

where i and k are given by (20) and (19).

The condition for a perfect match at the middle of the band is

$$\frac{t_1}{t_2} = L \quad (24)$$

where L is given by (21).

The values of t_1 and t_2 which satisfy (24) and deviate least from those given by (22) and (23) are given by

$$\frac{t_1}{t_2} = L \quad t_1 t_2 = ik \quad (25)$$

whence

$$t_1^2 = Lik \quad (26)$$

$$t_2^2 = \frac{ik}{L} \quad (27)$$

are the values of t_1 and t_2 which give an exact match at the midband and have the smallest relative deviation from the values which give an exact match at the ends of the band. The values of t_1 and t_2 which most nearly satisfy (22), (23), (26), and (27) are given by

$$t_1^2 = i\sqrt{L}ik = i^{3/2}k^{1/2}L^{1/2} \quad (28)$$

$$t_2^2 = k\sqrt{\frac{ik}{L}} = i^{1/2}k^{3/2}L^{-1/2}. \quad (29)$$

Substituting the values of i , k , and L we have

$$t_1 = h^{3/4} \left[a + \sqrt{a^2 + \frac{r}{h}} \right] r_1^{1/8} \quad (30)$$

$$t_2 = h^{1/4} \left[a + \sqrt{a^2 + \frac{r}{h}} \right] r_1^{-1/8}. \quad (31)$$

When t_1 and t_2 are given by (30) and (31) the mismatch is very nearly the same at all frequencies. We may therefore find its value by evaluating at the midband. The impedance obtained from (30) and (31) at the midband is

$$N = R_1 \frac{t_2^2}{t_1^2} = \frac{R_1}{h\sqrt{r_1}}. \quad (32)$$

This represents a mismatch M on a line of characteristic impedance Z_0 where

$$M = \frac{N}{Z_0} = \frac{R_1}{Z_0}, \quad \frac{1}{h\sqrt{r_1}} = \frac{\sqrt{r_1}}{h} = \frac{r_1 t_2^2}{t_1^2}. \quad (33)$$

Hence the complete solution for $x > 0$ is given by (16), (18), (30), (31), and (33). For $x < 0$ the solution is obtained by interchanging impedance and admittance.

The formulas for the other matching sections are similarly derived.

Signal-to-Noise Improvement Through Integration in a Storage Tube*

J. V. HARRINGTON†, ASSOCIATE, IRE, AND T. F. ROGERS†, MEMBER, IRE

Summary—Random noise places a fundamental physical limitation on the precision with which a signal may be observed or measured. In the case where signal energy arrives piecemeal in a repetitive manner, this energy may be integrated over a period of time to provide an increase in signal-to-noise ratio, thereby reducing this limitation. Several techniques have been suggested for performing this integration process; recent work with an electronic barrier-grid storage tube has shown that such a device exhibits many desirable features when used as an integrating device. An introduction to integrator theory in general and an analysis of the storage tube operating as an integrator are given. Calculations are made of the expected improvement in signal-to-noise ratio as a function of tube parameters and number of integrations. Evidence is presented to show that the improvement achieved experimentally is nearly equal to the calculated value.

I. INTRODUCTION

THE BENEFITS to be obtained by applying an integration, or addition, process to periodic signals in noise have been appreciated for some time. Various practical integrators have been tried in attempts to obtain some of these benefits, since, especially in the field of radar, where signals are essentially repetitive over a number of intervals, an improvement in signal-to-noise ratio represents an improvement in the entire target detection process.¹ Long-persistence cathode-ray tubes and photographic integration techniques have been used; narrow band-pass filters constructed around the pulse-repetition frequency have also come into prominence; delay lines also are now being used. Each of these methods, while possessing certain advantages, also presents more or less distinct limitations.

Regardless of the method used in any particular integration scheme, a fundamental requirement which they all have in common is that of a suitable "memory." This memory must possess the faculty of accepting and remembering with reasonable accuracy a number of mixed signals, that is, a mixture of signals and the contaminating noise. When a number of such sequences have been added in storage, their sum may be extracted and examined. With the knowledge that the noise, in general, will build up at a slower rate than will the coherent signal, an increasingly better judgment may be made on the composite signal as to which is the signal and which is the noise.

* Decimal classification: R361.211×R339. Original manuscript received by the Institute, December 8, 1949; revised manuscript received, June 2, 1950. Presented, 1949 IRE National Convention, New York, N. Y., March 10, 1949.

† Air Force Cambridge Research Laboratories, Cambridge, Mass.

¹ S. Goldman, "Some Fundamental Considerations Concerning Noise Reduction and Range in Radar and Communications," M.I.T. Technical Report No. 32, Dec. 15, 1947. Also published, *Proc. I.R.E.*, vol. 36, pp. 584-594, May, 1948.

Certain types of storage tubes possess characteristics which indicate that they might serve as memory and general comparative devices. The STE-A barrier grid storage tube² is one such device and this paper will deal with its theory and performance as a practical signal integrator, as well as with the theory of signal-to-noise ratio improvement in general.

II. THEORETICAL ANALYSIS OF POST-DETECTOR INTEGRATION

While there are many factors which limit the benefits to be obtained by the addition or integration of coherent video signals in noise, the two which appear to predominate in importance are (1) the small signal suppression effect attributable to the inherent characteristics of the second detector; and (2) the effect of a nonideal integrator law, i.e., one in which the component signals are not equally weighted in forming the sum or total integrated signal.

The first of these effects has been discussed many times as part of the general problem of analyzing the passage of signal-plus-noise through a nonlinear circuit. This general problem has been attacked by several authors but, in the main, they have been concerned with calculating the power spectrum of the detector output. As Rice³ has pointed out, there also exists the question of determining the probability distribution function in the output of a nonlinear device given the statistical nature of the input. It is with this aspect of the problem that we shall be concerned, since the probability distribution is, in general, of greater interest in analyzing the effect of integration on the detected mixed signal.

Specifically, this analysis will deal with the calculation of the resultant distribution function where a sine wave (carrier) plus noise is (a) processed by a nonlinear detector, and (b) further processed by a nonideal integrator. The usual assumptions are made: that the noise in the intermediate-frequency amplifier preceding the second detector is normally distributed, that the power spectrum of the noise is confined to a small band compared to the carrier frequency, and that the detector (and video amplifier) filter doesn't seriously affect the spectrum of the low-frequency portion of the detected mixed signal. Under these conditions the output of the

² A. S. Jensen, J. P. Smith, M. H. Mesner, and L. E. Flory, "Barrier grid storage tube and its operation," *RCA Rev.*, vol. 9, p. 3; March, 1948.

³ S. O. Rice, "Mathematical analysis of random noise," *Bell Sys. Tech. Jour.*, vol. 25, p. 151; January, 1945.

detector may be obtained from the envelope of the mixed signal at the input and, in fact, the detector may then be alternately described as "an envelope tracer" as suggested by North.⁴ The envelope of a sine wave plus noise has the probability distribution

$$P(R)dR = \frac{R}{\psi_0} e^{-(R^2 + P^2/2\psi_0)} I_0\left(\frac{RP}{\psi_0}\right) dR. \quad (1)$$

The moments of this distribution are given by Rice³ as

$$\bar{R}^n = (2\psi_0)^{n/2} \Gamma(1 + n/2) {}_1F_1(-n/2; 1; -P^2/2\psi_0). \quad (2)$$

The notation is made somewhat simpler if we normalize with respect to the root-mean-square noise by letting

$$v = R(\psi_0)^{-1/2}; \quad a = P(\psi_0)^{-1/2}; \quad x = a^2/2. \quad (3)$$

Then

$$\bar{v}^n = 2^{n/2} \Gamma(1 + n/2) {}_1F_1(-n/2; 1; -x). \quad (4)$$

For a half-wave *k*th law detector the normalized output amplitude *Z* is defined as

$$Z = Bv^k \quad \text{for } v > 0. \quad (5)$$

For this type of detector, which is perhaps the most common of all, (that is, neither biased nor saturated) the output distribution is very simply described in terms of its moments since

$$\bar{Z}^n = B^n \bar{v}^{nk}. \quad (6)$$

Hence, the *n*th moment of the distribution of the output of a *k*th law detector is the same as the *kn*th moment of the output of a linear detector and is given by

$$\bar{Z}^n = B^n 2^{nk/2} \Gamma(1 + nk/2) {}_1F_1(-nk/2; 1; -x). \quad (7)$$

The distribution function *p*(*Z*) may then be expressed as an Edgeworth⁵ series since the various coefficients involved in the series are defined by the moments. The predominant terms in this series are

$$p(y)dy = \left[\phi(y) - \frac{\alpha_3}{3!} \phi^3(y) + \frac{(\alpha_4 - 3)}{4!} \phi^4(y) + \frac{10}{6!} \alpha_3^2 \phi^6(y) \right] dy \quad (8)$$

where

$$y = \frac{Z - m}{\sigma}; \quad m = \bar{Z}; \quad \sigma^2 = \bar{Z}^2 - m^2,$$

$$\phi(y) = (2\pi)^{-1/2} e^{-y^2/2},$$

and

$$\phi^n(y) = (d^n/dy^n)\phi(y) = (-1)^n (2\pi)^{-1/2} e^{-y^2/2} H_n(y).$$

The factors α_3 and α_4 are, respectively, the third and fourth standard central moments and are measures of the skewness and peakedness of the distribution or, more exactly, one can define⁶

$$\begin{aligned} \zeta_3 &= \alpha_3 = \mu_3/\sigma^3 \\ &= \text{coefficient of skewness} \\ \zeta_4 &= [\alpha_4 - 3] = \mu_4/\sigma^4 - 3 \\ &= \text{coefficient of excess or kurtosis.} \end{aligned} \quad (9)$$

If now *n* signals each having the amplitude distribution given by (8) are added with the same weight being given to each signal, it may be shown that

$$p_n(y)dy = dy \left[\phi(y) - \frac{\zeta_3}{3! \sqrt{n}} \phi^3(y) + \frac{\zeta_4}{4! n} \phi^4(y) + \dots \right] \quad (10)$$

where, now, $y = (Z - nm)/n^{-1/2}\sigma$, and we observe that one effect of integration is to diminish the skewness and peakedness of the distribution, forcing it to approach a normal distribution specified by the number *n* and the first two moments of the original distribution. This leads us to the definition of signal-to-noise ratio as the mean value of the mixed signal divided by its root-mean-square value where the reference axis chosen in specifying this mean is the average value of the detected noise alone. The reason for the shift of axis can be seen from Fig. 1. A similar definition of signal-to-noise ratio has

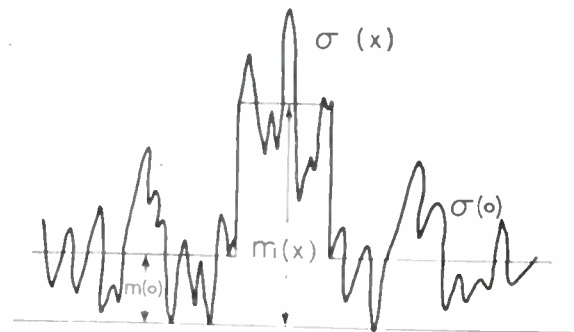

Fig. 1—The shift in reference axis for low signal-to-noise ratios.

been used by Van Vleck and Middleton.⁶ In terms of the moments previously calculated (8), the signal-to-noise ratio at the output of a *k*th law detector is therefore

$$\begin{aligned} \frac{\bar{m}}{\sigma_z} &= \frac{m(x) - m(0)}{\sigma(x)} \\ &= \frac{{}_1F_1(-k/2; 1; -x) - 1}{\left[\frac{\Gamma(k+1)}{\Gamma^2(1+k/2)} {}_1F_1(-k; 1; -x) - {}_1F_1^2(-k/2; 1; -x) \right]^{1/2}} \end{aligned} \quad (11)$$

⁶ J. H. Van Vleck and D. Middleton, "A theoretical comparison of the visual, aural and meter reception of pulsed signals in the presence of noise," *Jour. Appl. Phys.*, vol. 17, p. 940; November, 1946.

⁴ D. O. North, "An Analysis of the Factors Which Determine Signal-Noise Discrimination in Pulsed Carrier Systems," RCA Laboratories Report PTR-6-C, June, 1943.

⁵ H. Cramer, "Mathematical Methods of Statistics," Princeton University Press, Princeton, N. J., p. 229; 1946.

While this is a rather cumbersome expression to analyze, it is possible to make approximations for very large and very small values of x from which the consequences of small signal detection can be deduced. Thus, for $x \ll 1$ we take the first two terms of the series expansion for the confluent hypergeometric function

$${}_1F_1(-k; 1; -x) \cong (1 + kx). \quad (12)$$

Using this, for small signal-to-noise ratios (11) becomes

$$\bar{m}/\sigma_x \cong Kx = Ka^2/2 \quad (13)$$

where

$$K = (k/2)([\Gamma(k+1)/\Gamma^2(1+k/2)] - 1)^{-1/2}.$$

The factor K is a function only of the power of the detector law and may be considered a sort of dynamic amplification factor which has the maximum value unity for the square law detector and falls off for all others; its reciprocal has been calculated by North in some unpublished work.⁴ From (13) one draws the now well-known conclusion⁷ that for detection of small signals, all detectors (except for the scale factor K) act like the square-law detector. If a linear integrator is used to bring the signal-to-noise ratio up to a given level by n additions, then the output signal-to-noise ratio in terms of the input S/N ratio is given by

$$n^{1/2}\bar{m}/\sigma_x = K(n)^{1/2}a^2/2 = (K/2)(n^{1/4}a)^2. \quad (14)$$

A rather serious consequence of this small signal suppression effect is to cause the S/N improvement factor to go up as the 1/4 power of the number of additions for $x \ll 1$ instead of the 1/2-power law predictable for predetector integration.⁸ (In predetector integration, $S/N \cong a$.)

For very large input signal-to-noise ratios ($x \ll 1$) we use the first few terms of the asymptotic expansion³

$${}_1F_1(-k; 1; -x) \cong \frac{x^k}{\Gamma(k+1)} \left[1 + \frac{k^2}{1!x} + \frac{k^2(k-1)^2}{2!x^2} + \dots \right]. \quad (15)$$

This leads to the relationship

$$\bar{m}/\sigma_x \cong k(2x)^{1/2} = a/k; \quad \text{for } x \gg 1. \quad (16)$$

Thus, for large signal-to-noise ratios, a linear relationship exists between the input and detector output which yields an integration improvement factor varying as the half power of n . In between these two limiting cases for very small and very large x one would expect a transition region to exist in which the improvement factor varies smoothly from a 1/2-power law to a 1/4-power law going from large to small input signal-to-noise ratios.

⁷ D. Middleton, "Rectification of a sinusoidally modulated carrier in the presence of noise," *Proc. I.R.E.*, vol. 36, p. 1467; December, 1948.

⁸ See page 24 of footnote reference 1.

III. PRACTICAL INTEGRATORS

The discussion thus far has been based on the existence of a perfect integrator in which the weight a signal is given in forming the sum or total signal is independent of its time of arrival. In general, such devices are not practically realizable; consequently, our purpose now is to analyze the operation of a nonideal integrator, and to see how the results of the previous section are to be modified by the actual integrator law. In this regard it is instructive to note the general law by which signals are added in some simple integration networks prior to consideration of storage-tube integration. It may be shown, for instance, that if a succession of impulses are applied at intervals (Δt) to a single RC network, then the response at the time the n th signal is applied is

$$h(t) = [1/RC][E_n + E_{n-1}\epsilon^{-\Delta t/RC} + \dots + E_1\epsilon^{-(n-1)(\Delta t/RC)}]. \quad (17)$$

The law of addition here is evidently a "weighted linear one" in which the effect of each signal is exponentially weighted. Also, the narrow-band RLC circuit, whose mechanical analogue has been used very successfully in extracting weak signals from noise,⁹ has a resultant response after n additions of

$$h(t) = [1/C][E_n + E_{n-1}\epsilon^{-(L/C)^{1/2}\pi/R} + \dots + E_1\epsilon^{-(n-1)(L/C)^{1/2}\pi/R}] \quad (18)$$

which again involves exponential weighting. Again, integration networks, for periodic signals, may also be designed around delay lines where the delay is made equal to the repetition interval of the signal. Here, a feedback loop exists and, for stability, the loop gain must be less than unity; the summation again follows the law

$$E_r = [E_n + E_{n-1}\epsilon^{-\alpha} + \dots + E_1\epsilon^{-(n-1)\alpha}] \quad (19)$$

where α is the attenuation around the loop in nepers and is greater than zero.

The STE-A barrier grid storage tube,² the integrating device to be considered here, consists of an electron gun and electrostatic beam deflection system, a dielectric surface on which the signal is stored as a charge distribution, a backing plate to which the input signal is applied, and a secondary beam collector from which the reading signal is obtained (see Fig. 2). In operation, the dielectric surface will be charged in the absence of a signal to some potential at which the effective secondary-emission ratio is unity and equilibrium exists. Thereafter, when a signal is applied to the back plate the emission ratio is changed, resulting in a charge, which is different from the equilibrium charge, being deposited on the dielectric at the point of beam impingement. Thus, for a linear beam motion, a signal varying in time would be

⁹ F. R. Dickey, A. G. Emslie, and H. Stockman, "Extraction of Weak Signals from Noise by Integration," Cambridge Research Laboratories Report, E5038, September, 1948.

stored as a charge distribution varying in distance along a line of the dielectric surface. In reading, when no signal is applied to the back plate, the beam in sweeping over this same line acts to restore the charge distribution to the equilibrium value and, in so doing, the secondary-emission current as observed at the collector will regenerate essentially a counterpart of the stored signal.

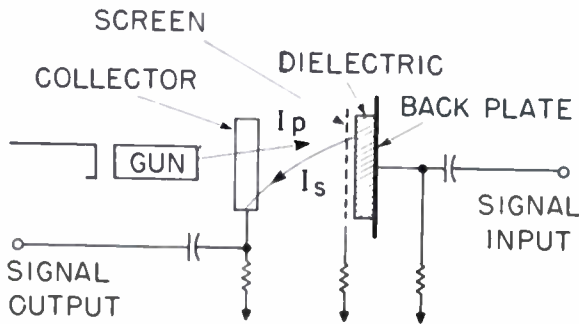

Fig. 2—Simplified schematic of barrier-grid storage tube.

While such a device is difficult to analyze in a rigorous manner, it is possible to derive certain very useful relationships descriptive of the tube's external behavior.¹⁰ Such an approximate analysis, incidentally, agrees reasonably well with observed tube performance and hence, to some degree we are justified in using its results to further our present analysis. It may be shown that for storage of a succession of pulses of amplitude E_1, E_2, \dots, E_n , the maximum amplitude of the corresponding voltage distribution built up along a scan line of the dielectric surface is

$$E_r = (1 - \epsilon^{-\gamma}) [E_n + E_{n-1}\epsilon^{-\gamma} + \dots + E_1\epsilon^{-(n-1)\gamma}] \quad (20)$$

where $\gamma = [KI_b/CV]$ is a factor of basic importance in describing tube operation.¹¹ A reading operation following this series of writing operations would give an output signal resembling the net charge distribution along the scan line, and would leave a resulting charge distribution, when the reading operation is completed, given by

$$E_r = \epsilon^{-\gamma}(1 - \epsilon^{-\gamma}) [E_n + E_{n-1}\epsilon^{-\gamma} + \dots + E_1\epsilon^{-(n-1)\gamma}]. \quad (21)$$

Thus, the reading operation is also an erasing operation in which the stored signal is reduced by an amount $\epsilon^{-\gamma}$.

It may be noted that many of the basic integrating devices, the RC network, narrow-band filter, and regenerative delay-line loop, all have the same general law of addition that the storage tube possesses, i.e.,

$$E_{out} = \sum_{q=1}^n E_{i,q} \epsilon^{-(n-q)\gamma}. \quad (22)$$

¹⁰ J. V. Harrington, "Storage of small signals on a dielectric surface," to be published in *Jour. Appl. Phys.*, October, 1950.

¹¹ A quantity having similar significance and called the tube-discharge factor by Jensen, et al (see footnote reference 2) is equal to $(1 - \epsilon^{-\gamma})$.

It is of primary interest to calculate the output distribution when n mixed signals are added in accordance with this law¹² and not the ideal linear law previously assumed (10). If n independent variables are to be added, it may be shown that the semi-invariants of their sum are simply given by

$$X_k' = \sum_{n=1}^n X_{k,n} \quad (23)$$

where the first few semi-invariants in terms of the central moments are

$$\begin{aligned} X_1 &= \mu & X_3 &= \mu_3 \\ X_2 &= \sigma^2 & X_4 &= \mu_4 - 3\sigma^4. \end{aligned}$$

For addition in accordance with (22) where the scale factors¹³ are constantly reduced in powers of $\epsilon^{-\gamma}$ we obtain

$$\begin{aligned} X_k' &= X_k [1 + \epsilon^{-k\gamma} + \dots + \epsilon^{-k(n-1)\gamma}] \\ &= X_k [(1 - \epsilon^{-kn\gamma}) / (1 - \epsilon^{-k\gamma})]. \end{aligned} \quad (24)$$

The coefficients of the Edgeworth series may be expressed in terms of these semi-invariants normalized with respect to X_2 . Thus the resulting signal-to-noise ratio, coefficient of skewness, and coefficient of excess are given by

$$\begin{aligned} \frac{m'}{\sigma} &= \frac{X_1'}{X_2'^{1/2}} = \rho_1(n, \gamma) \cdot \frac{m}{\sigma} \\ \zeta_3' &= \frac{X_3'}{X_2'^{3/2}} = \rho_3(n, \gamma) \cdot \zeta_3 \\ \zeta_4' &= \frac{X_4'}{X_2'^2} = \rho_4(n, \gamma) \cdot \zeta_4. \end{aligned} \quad (25)$$

From (24) and (25), it is seen that the general form of the improvement factor ρ is

$$\rho_k(n, \gamma) = \left[\frac{\sinh n\gamma k/2}{\sinh \gamma k/2} \right] \left[\frac{\sinh \gamma}{\sinh n\gamma} \right]^{k/2}. \quad (26)$$

For the first few values of ρ , and the practical assumption of $\gamma \ll 1$, this reduces to the more useful forms

$$\begin{aligned} \rho_1(n, \gamma) &= (n)^{1/2} \left[\frac{\tanh n\gamma/2}{n\gamma/2} \right]^{1/2} \\ \rho_3(n, \gamma) &\cong (n)^{-1/2} (n\gamma/\tanh n\gamma)^{1/2} \\ \rho_4(n, \gamma) &= (1/n)(n\gamma/\tanh n\gamma). \end{aligned} \quad (27)$$

We conclude from this that to describe properly the effects of integration we must define not only a signal-to-noise improvement factor, but also reduction factors representing the reduction in the higher-order coefficients of the Edgeworth series. Thus, ρ_1 can be termed the signal-to-noise improvement factor and ρ_3 and ρ_4

¹² It should be noted that a treatment of integrators with poor memories first appeared in the work of North. See footnote reference 4.

¹³ See page 187 of footnote reference 5.

can be called the skewness and kurtosis reduction factors.

It is seen from Fig. 3 and from the limiting values in Table I that the best results are obtained for small values of γ , that is, where the integrator approaches the ideal linear one. A value of $\gamma = 0$, while attractive from

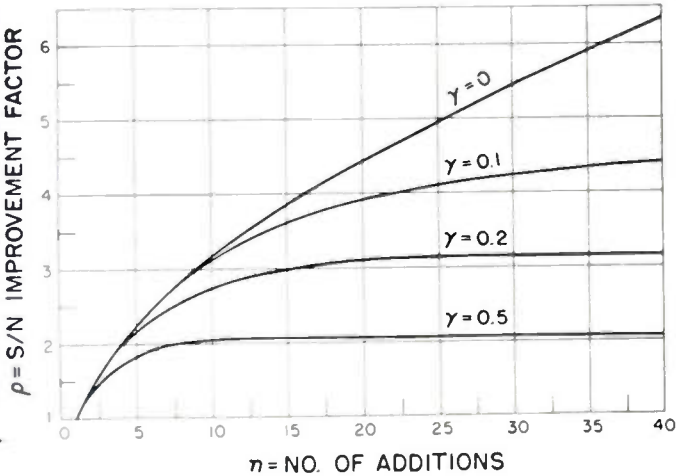

Fig. 3—Signal-to-noise improvement factor, ρ versus number of additions n for the nonideal integrator case.

the viewpoint of improvement factor, is manifestly impossible since, in the case of the resonant circuit and delay-line integrators, instability occurs, and in the case of the RC integrator and storage tube the output would

TABLE I
LIMITING VALUES

	$\gamma \rightarrow 0$	$\gamma \rightarrow \infty$	$n \rightarrow \infty; \gamma \leq 1/4$
ρ_1	$(n)^{1/2}$	1	$(2/\gamma)^{1/2}$
ρ_2	$(n)^{-1/2}$	1	$0.943(\gamma)^{1/2}$
ρ_4	$1/n$	1	γ

become vanishingly small, with a $\gamma = 0$ in the latter case normally signifying a zero current (see (20) et seq.). However, for a given number of signal additions, finite values of γ exist which give results close to those obtained from direct linear addition. For example, from Fig. 3, for $n = 10$, $\gamma = 0.1$ gives $\rho = 3.04$ as compared to the 3.16 value ideally obtainable.

To find out just how nonideal an integrator can be and still be worthwhile using, it is helpful to define some quantities equivalent to efficiency factors for comparing the actual to the ideal integrator. For a value of $\gamma \leq 1/4$ which is the only condition of any great interest to us we find

$$\eta_1(n\gamma) = \rho_1(n, \gamma) / \rho_1(n, 0) = [(\tanh n\gamma/2) / (n\gamma/2)]^{1/2}$$

$$\eta_3(n\gamma) = \rho_3(n, \gamma) / \rho_3(n, 0) \cong (n\gamma / \tanh n\gamma)^{1/2} \quad (28)$$

$$\eta_4(n\gamma) = \rho_4(n, \gamma) / \rho_4(n, 0) = n\gamma / \tanh n\gamma.$$

These are rather useful quantities in determining what the permissible value for γ is for a given number of additions. It can be seen that a reciprocal relationship between n and γ , (i.e., $n\gamma = 1$) leads to an integrator giving a signal-to-noise improvement ratio 96 per cent of the

maximum attainable and yielding an output probability density with a 14-per cent greater coefficient of skewness and 31-per cent greater excess. Since ζ_3 and ζ_4 are, in general, small anyway, these values are quite acceptable for most cases and we can say that, if $n\gamma = 1$, we have an integrator which is very nearly an ideal one.

While the foregoing results apply to a variety of practical integrators, they are particularly useful in arriving at the proper operating point in storage-tube integrators. In this instance, γ can be directly measured as the natural logarithmic decrement of the successive-reading signal amplitudes (see Fig. 4).

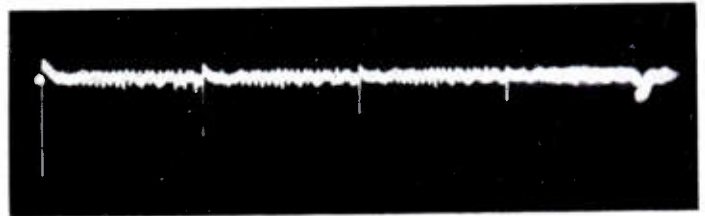

Fig. 4—Picture of storage-tube "read-out" sequence showing exponential decay.

IV. STORAGE-TUBE EXPERIMENTAL RESULTS

A block diagram showing the arrangement of the experimental equipment appears as Fig. 5, in which the major circuitry components are displayed.

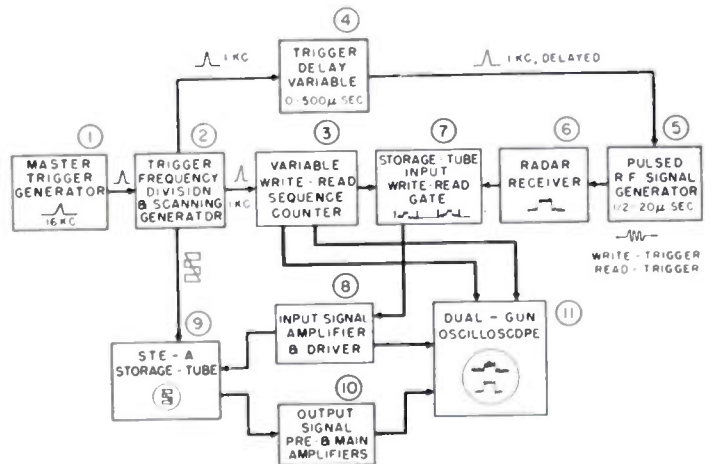

Fig. 5—Block diagram of storage-tube-integrator experimental equipment arrangement.

A master trigger at approximately 16 kc is derived from a sine wave generator, 1.¹⁴ This trigger is used to set the line frequency of the storage tube deflection scan, 2, each line, of which there are sixteen, being 62.5 microseconds in length. The master triggers are also counted down by sixteen to 1 kc, the scanning frame rate. These 1-kc triggers are used to time the variable write-read sequence counter, 3, which provides the proper number of triggers for the number of signals desired to be "written in" to the storage tube, and the proper delay "read-

¹⁴ The numbers refer to the corresponding block of the diagram in Fig. 5.

out" time, after the write interval, during which the signals are taken from the storage tube and the dielectric returned to equilibrium.

The 1-kc trigger is also led through a variable delay, 4, and used to trigger a pulsed 10-centimeter signal generator, 5, whose output pulse may be varied in duration from 0.5 to 20 microseconds. This pulse signal is fed into a radar receiver type APG-5, 6, at which point, by varying the signal generator output power and the radar receiver gain, a $0 \leq S/N \leq 100$ can be obtained with the input circuits of the receiver furnishing the noise power. The repetitive signals and the accompanying noise are then gated, 7, into the variable bandwidth input amplifier to the STE-A storage tube's back plate an arbitrary number of times and then prevented from reaching the back plate by gating them off during the "read" interval. This signal-plus-noise is also displayed on one channel of a dual-gun oscilloscope, 11; this channel receives a "write" trigger from the write-read sequence counter, 3.

After the desired number of signal-plus-noise sweeps have been placed into storage, the composite signal is gated off the back plate and "read" signals appear at the collector output of the storage tube where they are amplified, 10, and displayed on the second channel of the dual gun oscilloscope; this channel is triggered by the "read" trigger from 3. On the dual-gun oscilloscope, then, there appears on separate sweeps both the composite picture of the signal plus noise before being placed into storage, and the storage tube output; the improvement in signal-to-noise ratio may, therefore, be viewed directly. It should be pointed out that with this experimental procedure erroneous conclusions can be reached regarding the attained S/N improvement, if the n reading operations do not give essentially complete erasure, and a value of n must be chosen such as to erase the dielectric during the read sequence.

With this experimental procedure, improvements in S/N (for original $S/N \geq 1$) have been investigated as a function of n , the number of signal-plus-noise additions, and γ , the exponential weighting factor. The range of γ 's explored was between 0.1 and 2, and $2 \leq n \leq 16$. Fig. 6 illustrates the theoretical improvement ρ in S/N for linear integration ($\rho = [n]^{1/2}$), the theoretical improvement for various values of γ , and the actual improvements measured after storage-tube integration with these values. Fig. 7 is a picture of the improvement for $n=9$. Measurements made within the practical limitations of tube operability have borne out the analytical work very well, the improvements predicted have been achieved, and the noise distribution shifts expected have been observed.

The improvement of S/N in the STE-A storage tube departs in practice from the theory developed in earlier sections because of any or all of the following characteristics of tube operation:

(a) The change in δ , the secondary-emission ratio of the dielectric, as a function of excursion from the equi-

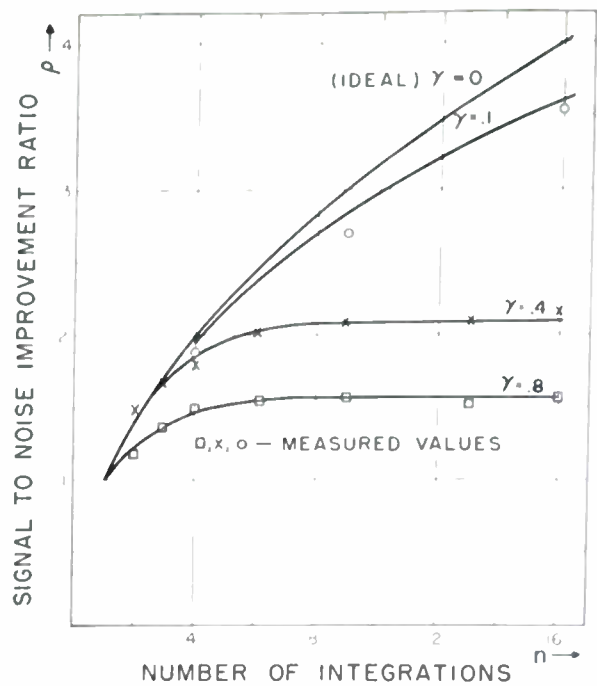

Fig. 6—Measured signal-to-noise improvement ρ as a function of the number of additions n .

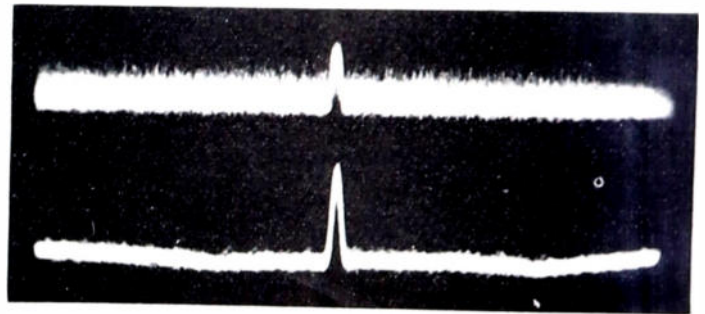

Fig. 7—Pictures of actual signal-to-noise improvement for a 1-microsecond pulse, $\gamma=0.1$ and $n=9$ additions.

librium potential is approximately linear over only a relatively small range of voltage changes applied to the back plate. As a consequence of using only small input voltages to the back plate in order to stay within this linear region, the dielectric cannot assume full charge and the output signal is small; for these small output signals, noise in the first stage of the wide-band output amplifier will diminish the expected improvement in S/N .

(b) For maximum improvement a vanishingly small value of γ is desirable. From the definition of γ ((20) et seq.), however, it is seen that K and C cannot be varied without making changes internal to the tube, and since V is fixed once the signal repetition interval has been defined, the only parameter capable of being varied is I_b . Inasmuch as $\gamma \propto I_b$, a small I_b is called for; this results in the same condition as (a) above, however, in that as I_b is reduced, the output signal becomes smaller and output amplifier noise becomes a limiting factor to S/N improvement. Additional circuitry (a positive gat-

ng voltage applied to the grid) might be employed to increase the beam current during the read interval, however, thus reducing this limitation somewhat.

(c) Even under static equilibrium conditions, when there is no signal being placed into or taken from storage, a periodic "disturbance" appears at the output as the electron beam is swept across the dielectric. (See, for instance, Fig. 4.) This disturbance has line and frame frequency components and arises, for the most part, from the change in collection efficiency as a function of angular departure of the primary beam current from the normal to the dielectric. With the limitations on input signal voltage mentioned in (a) above, this disturbance sets an upper limit of about 10 to 15 (depending upon the particular tube) on the signal-to-disturbance ratio viewed at the output of the tube.

V. CONCLUSIONS

The theory of the ideal (linear) and nonideal integrator has been developed, relating improvement in signal-to-noise ratio to such parameters as original signal-to-noise ratio, detector function, number of additions and the degree of integrator nonlinearity. The improvements expected have been verified experimentally by using a storage tube as the integrating device. At least where the number of integrations is small ($n \leq$ about 25) and the output S/N does not need to be higher than about 10 to 15, the STE-A barrier-grid storage tube is shown to possess practical utility as a repetitive signal integrator.

ACKNOWLEDGEMENT

The author wish to acknowledge the helpful advice and criticism received from A. S. Jensen of the RCA Princeton Laboratories, E. W. Samson, the chief of the Communications and Relay Laboratory in which the work was carried on, and many members of the Air Force Cambridge Research Laboratories.

GLOSSARY

(Terms not constants or not defined explicitly in the text appear here.)

- C = capacitance
- ${}_1F_1$ = confluent hypergeometric function
- H_n = n th Hermite polynomial
- I_0 = modified Bessel function of the first kind and zero order
- I_b = beam current
- I_N = noise current
- L = inductance
- n = an integer; also, number of integrated signals
- P = sine wave amplitude
- R = envelope of sine wave plus noise; also, resistance
- \bar{R}^n = n th moment of a distribution R
- S = generalized frequency
- V = beam-scanning velocity
- X = a general variable
- Γ = the gamma function
- μ_k = the k th moment of a distribution
- $\omega = 2\pi f$
- ψ_0 = noise power.

Distortion—Band-Pass Considerations in Angular Modulation*

ALBERT A. GERLACH†, ASSOCIATE, IRE

Summary—The distortion introduced into an angular modulated signal transmitted through a network or medium is analyzed using the sideband approach. An exact open-form solution of the output signal is derived; however, the usefulness of this equation is limited by the ability to perform the indicated integrations. It is shown that exact solutions may readily be found for transfer functions which are linear exponential functions of frequency, and since over a given frequency interval, any transfer function may be expanded in an orthogonal set of linear exponential functions of frequency, a solution is always obtainable. A few examples of possible transfer functions are treated, illustrating the distortion tendencies for both the

amplitude and phase characteristics. A rule-of-thumb formula is derived to determine the maximum undistorted modulation frequency which may be transmitted through a network of a given band-pass characteristic. It is concluded that linear phase characteristics are a more important design objective than flat amplitude characteristics in minimizing distortion.

INTRODUCTION

WITH THE INCREASING USE of frequency modulation for instrumentation purposes, more concern is being focused on the nature and quantity of distortion introduced in the intelligence during transmission. A topic of much study has been to determine accurately the output intelligence of an angular

* Decimal classification: R148.2. Original manuscript received by the Institute, August 15, 1949; revised manuscript received, March 31, 1950. Presented, 1950 IRE National Convention, New York, N. Y., March 7, 1950.

† Armour Research Foundation of Illinois Institute of Technology, Technology Center, Chicago, Ill.

modulated signal which is transmitted through a medium of a given sinusoidal-frequency transfer characteristic. (A transfer function is that expression which relates an output quantity to an input quantity as a function of the sinusoidal frequencies of the two quantities.) Unfortunately, this problem is a very complex one and it becomes exceedingly difficult to solve the problem for the general transfer function. As a matter of fact, no closed mathematical expression has been derived which exactly relates the output signal to the input signal for the general transfer function. What has been done is to express the output signal as a function of the input signal and the general transfer function in the form of a differential equation, a definite integral, or an infinite series; or to approximate the output signal in the form of a finite series of terms. The versatility of this latter method is, of course, restricted by the approximations made.

HISTORICAL REVIEW

There have been two general methods of attacking the problem although there are many variations of these methods. These methods are the instantaneous signal approach, keeping the signals in their exact form as a function of time and using the transfer function as a differential operator to derive the output signal, and the spectrum analysis approach where the input signal is transformed into a sinusoidal frequency spectrum and the output signal is then the sum of the products of the individual components and the transfer function at that frequency.

Carson and Fry¹ have expressed the output signal as an infinite series, the first term of which has been called the quasi-steady-state result and is valid only within a restricted range of the deviation, modulation frequency and bandwidth of the network. Jaffe,² Van der Pol,³ Gladwin,⁴ and others have made use of, or arrived at the same results by other methods. On the other hand, Frantz⁵ and Gold⁶ have exploited the sideband or spectrum analysis method to arrive at formulas for a general result, limited again by a more well-defined approximation than the quasi-steady-state method.

All of the methods of analysis to date have followed the more or less logical procedure of requiring the analysis to be a slave to the transfer function which is carried along in as general a condition as is possible. In the analysis to follow, the reverse procedure has been em-

ployed; that is, a search has been made for those transfer characteristics which would result in a manageable and exact solution of the output quantity. Ordinarily this approach to the problem would lead to pure abstract relations which would have little bearing on a practical solution; however, as shall be shown, the results obtained are quite useful in predicting the distortion effects on the signal intelligence for most practical transfer characteristics.

SOME BASIC EQUATIONS

In the following paragraphs will be derived some basic equations for the solution of an output quantity when an input quantity or signal is applied to a medium or network of known transfer function.

The general angular modulated signal may be expressed as

$$e(t) = E \sin [\omega_0 t + \theta(t)] \quad (1)$$

where ω_0 is the carrier frequency about which the signal intelligence function varies. (In a phase-modulation system the intelligence will be directly proportional to $\theta(t)$, and in a frequency-modulation system the intelligence will be proportional to the time derivative of $\theta(t)$.)

Keeping in mind that it is the imaginary part that is of interest, (1) may be written

$$e(t) = E e^{i[\omega_0 t + \theta(t)]} = E e^{i\omega_0 t} e^{i\theta(t)}. \quad (2)$$

If the function $\theta(t)$ is periodic of period T it may be expanded in a Fourier series in terms of the orthogonal set of functions $e^{in\rho t}$ as follows:⁷

$$e^{i\theta(t)} = \sum_{-\infty}^{\infty} C_n e^{in\rho t} \quad (3)$$

where

$$\rho = 2\pi/T$$

and

$$C_n = \frac{1}{2\pi} \int_{-\pi}^{\pi} e^{i\theta} e^{-in\rho t} d\rho t = \frac{1}{2\pi} \int_{-\pi}^{\pi} e^{i(\theta - n\rho t)} d\rho t. \quad (4)$$

(If θ is a sinusoidal function of frequency, (4) may be recognized as the Bessel integral form of the Bessel function of the first kind of order n .) Equation (2) may then be expressed as

⁷ It is assumed here that the function concerned possesses the necessary properties for the Fourier series or Fourier integral, as the case may be, to converge to the mean value of the function over the necessary interval. This does not impose too stringent a restriction on the function since sufficient conditions for the Fourier series representation are that the function be periodic, be sectionally continuous over the fundamental period, and possess right- and left-hand derivatives at all points of the independent variable. Sufficient conditions for the Fourier integral representation are that the function be sectionally continuous in every finite interval, possess right- and left-hand derivatives at all points of the independent variable, and that over the limits minus infinity to plus infinity the integral of the function with respect to its independent variable converges.

¹ J. R. Carson and T. C. Fry, "Variable electric circuit theory," *Bell Sys. Tech. Jour.*, vol. 16, p. 513; October, 1937.

² D. L. Jaffe, "A theoretical and experimental investigation of tuned circuit distortion in frequency-modulation systems," *PROC. I.R.E.*, vol. 33, pp. 318-334; May, 1945.

³ B. Van der Pol, "Fundamental principle of frequency modulation," *Jour. IEE*, Part III, vol. 93, pp. 153-158; May, 1946.

⁴ A. S. Gladwin, "The distortion of frequency-modulated waves by transmission networks," *PROC. I.R.E.*, vol. 35, pp. 1436-1445; December, 1947.

⁵ W. J. Frantz, "The transmission of a frequency-modulated wave through a network," *PROC. I.R.E.*, vol. 34, pp. 114P-125P; March, 1946.

⁶ B. Gold, "The solution of steady-state problems in FM," *PROC. I.R.E.*, vol. 37, pp. 1264-1269; November, 1949.

$$e(t) = E\epsilon^{i\omega_0 t} \sum_{-\infty}^{\infty} C_n \epsilon^{in\rho t} \tag{5}$$

If now this quantity is impressed on a medium or network with transfer function $Z(\omega)$ (see Fig. 1), the output response may be written as

$$e_0(t) = E\epsilon^{i\omega_0 t} \sum_{-\infty}^{\infty} C_n \epsilon^{in\rho t} Z(\omega_0 + n\rho) \tag{6}$$

The procedure up to this point has been to express a complex function of time into an infinite series of sinusoidal components. Each component then is multiplied by the appropriate transfer impedance at that particular frequency and the resultant sum of all of these products is then the output response as indicated by (6) above. Now it is possible by the Fourier transform to express the transfer function $Z(\omega)$ in a definite integral form as⁷

$$Z(\omega) = \int_{-\infty}^{\infty} F(\tau) \epsilon^{-i\omega\tau} d\tau \tag{7}$$

where

$$F(\tau) = \frac{1}{2\pi} \int_{-\infty}^{\infty} Z(\omega) \epsilon^{i\omega\tau} d\omega \tag{8}$$

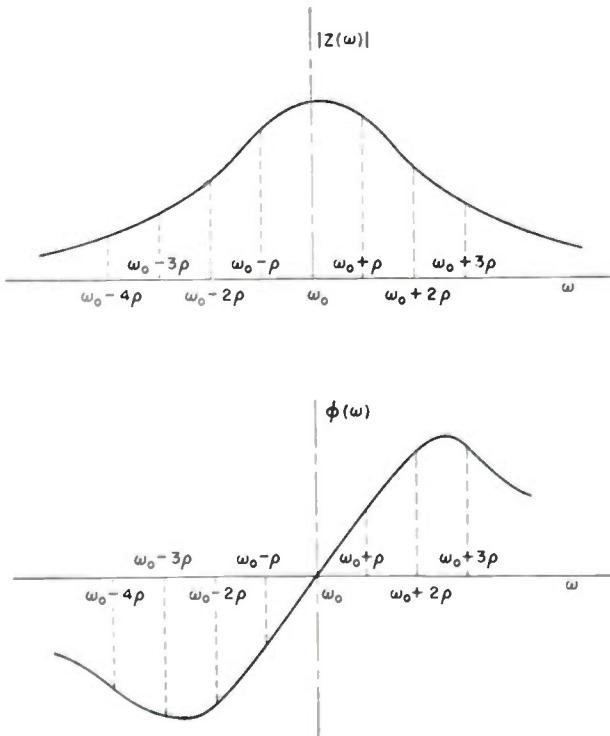

Fig. 1

Equation (6) may then be written

$$\begin{aligned} e_0(t) &= E\epsilon^{i\omega_0 t} \int_{-\infty}^{\infty} F(\tau) \epsilon^{-i\omega_0\tau} \sum_{-\infty}^{\infty} C_n \epsilon^{in\rho(t-\tau)} d\tau \\ &= \int_{-\infty}^{\infty} F(\tau) e(t-\tau) d\tau \\ &= \frac{1}{2\pi} \int_{-\infty}^{\infty} e(t-\tau) \int_{-\infty}^{\infty} Z(\omega) \epsilon^{i\omega\tau} d\omega d\tau, \end{aligned} \tag{9}$$

when $\theta(t)$ is a sinusoidal function; that is, let

$$\theta(t) = m \sin \rho t. \tag{10}$$

Equation (9) may be expressed as

$$e_0(t) = E\epsilon^{i\omega_0 t} Y(\omega_0, t) \tag{11}$$

where

$$Y(\omega_0, t) = \frac{1}{2\pi} \int_{-\infty}^{\infty} \epsilon^{im \sin \rho(t-\tau)} \int_{-\infty}^{\infty} Z(\omega) \epsilon^{i(\omega-\omega_0)\tau} d\omega d\tau. \tag{12}$$

It is the argument of the above expression which contains the output intelligence, however, the magnitude of $Y(\omega_0, t)$ is also of some interest since it will indicate the degree of limiting necessary to eliminate the undesirable amplitude variations.

It is of interest to note that if the periodicity of $\theta(t)$ is not assumed, an equally general solution for e_0 may be obtained by making use of the Fourier transforms. This expression may readily be shown to be

$$e_0(t) = \frac{E}{2\pi} \int_{-\infty}^{\infty} Z(\omega) \int_{-\infty}^{\infty} \epsilon^{i[\omega_0\tau + \theta(\tau)]} \epsilon^{i(\omega-\omega_0)\tau} d\tau d\omega. \tag{13}$$

The procedure will now be to determine the nature of the transfer functions which will allow the output quantity to be expressed in a closed mathematical form and to determine what conclusions may be drawn from these functions about the general case.

Rather than investigate possible solutions of the integral in (9) directly, it will be simpler and more instructive to work from (6). It may be noticed from this equation that transfer functions which are linear exponential functions of frequency may be combined with the Fourier series so that this series is directly transformable into its original closed form with the time variable shifted by a constant factor dependent on the nature of the exponent of the transfer function. This property was utilized in (9) in the derivation of the general output quantity. Let

$$Z(\omega) = \epsilon^{\alpha + \beta\omega} \tag{14}$$

From (6) then the output response may be written

$$\begin{aligned} e_0(t) &= E\epsilon^{\alpha + i\omega_0(t-i\beta)} \sum_{-\infty}^{\infty} C_n \epsilon^{in\rho(t-i\beta)} \\ &= \epsilon^\alpha e(t - i\beta). \end{aligned} \tag{15}$$

It will be of considerable interest to note that the entire result may be generalized for any function⁷ of time $e(t)$ regardless of whether or not the function is periodic or of the form indicated by (1). The procedure is as follows:

$$e_0(t) = \frac{1}{2\pi} \int_{-\infty}^{\infty} \epsilon^{\alpha + \beta\omega} G(\omega) \epsilon^{i\omega t} d\omega \tag{16}$$

where

$$G(\omega) = \int_{-\infty}^{\infty} e(t) \epsilon^{-i\omega t} dt. \tag{17}$$

Therefore

$$e_0(t) = \frac{\epsilon^\alpha}{2\pi} \int_{-\infty}^{\infty} G(\omega) \epsilon^{i\omega(t-i\beta)} d\omega = \epsilon^\alpha e(t - i\beta). \quad (18)$$

Now, over the range of frequencies where the spectral energy of $e(t)$ is appreciable (see (17)), any transfer function⁷ may be represented by a Fourier series. The series will generally not represent the transfer function elsewhere; however, this is of little consequence since no appreciable signal energy exists elsewhere. Let B be the bandwidth in cycles containing the appreciable spectral energy and ω_0 be the angular frequency of the center of the spectral range, then over the range $\omega - B/2 \leq \omega \leq \omega + B/2$, $Z(\omega)$ may be represented by⁷

$$Z(\omega) \sim \sum_{-\infty}^{\infty} a_n \epsilon^{in(\omega/B)} \quad (19)$$

where

$$a_n = \frac{1}{2\pi B} \int_{\omega_0 - B/2}^{\omega_0 + B/2} Z(\omega) \epsilon^{-in(\omega/B)} d\omega. \quad (20)$$

Equation (19) has the form of (14) if one recognizes the fact that

$$\alpha_n = \log a_n \quad \text{and} \quad \beta_n = i \frac{n}{B}. \quad (21)$$

The output signal may then be written directly from (15) or (18) as

$$e_0(t) = \sum_{-\infty}^{\infty} a_n e\left(t + \frac{n}{B}\right). \quad (22)$$

By extension of the above analysis using the Fourier transforms it may be shown that the following relation between the input and output functions is valid (under rather moderate restrictions):

$$e_0(t) = \frac{1}{2\pi} \int_{-\infty}^{\infty} e(t - \tau) \int_{-\infty}^{\infty} Z(\omega) \epsilon^{i\omega\tau} d\omega d\tau. \quad (23)$$

Equation (23) should prove to be a useful formula in solving $e_0(t)$ for any desired transfer function $Z(\omega)$. It is quite interesting in that it provides a direct solution of the output voltage as a function of time in terms of the input voltage as a function of time and the transfer function as a function of frequency. Equation (23) may still be useful if the first integral does not converge provided one considers $Z(\omega)$ to extend over finite limits sufficient to include the appreciable spectral energy of $e(t)$ and to be zero for all other values of the variable ω .

A FEW EXAMPLES

As a first example of the use of (18) and (22) consider the case of flat-amplitude transfer characteristics and linear-phase transfer characteristics. In this case, α may be complex and β will be pure imaginary and, therefore,

the signal intelligence $\theta(t)$ will just experience a time delay through the transmission medium.

Consider next that the phase transfer characteristics are linear, and that over the portion of the frequency spectrum where the spectral components of the angular modulated signal are appreciable, the amplitude obeys the following function:

$$|Z(\omega)| = \cosh \lambda(\omega - \omega_0) = \frac{1}{2} [\epsilon^{\lambda(\omega - \omega_0)} + \epsilon^{-\lambda(\omega - \omega_0)}]. \quad (24)$$

(See Fig. 2.) From (2) and (18) then

$$e_0(t) = \frac{1}{2} E \epsilon^{i\omega_0 t} [\epsilon^{i\theta(t-i\lambda)} + \epsilon^{i\theta(t+i\lambda)}]. \quad (25)$$

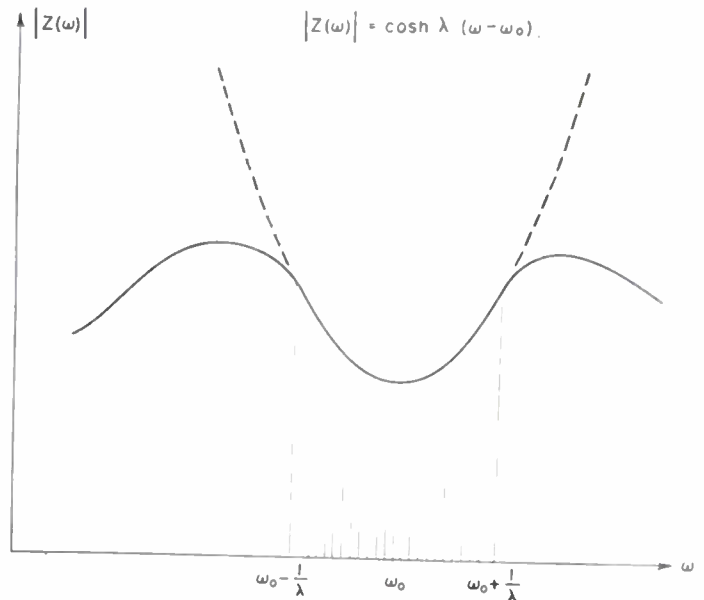

Fig. 2

If $\theta(t)$ is a sinusoidal function (see (10)), (25) becomes

$$e_0(t) = E \cosh [(m \sinh \rho\lambda) \cos \rho t] \epsilon^{i[\omega_0 t + (m \cosh \rho\lambda) \sin \rho t]}. \quad (26)$$

Equation (26) illustrates the rather interesting result that the signal intelligence suffers no nonlinear distortion and, additionally, that the higher signal frequency components are exalted by an amount $\cosh \rho\lambda$. It therefore becomes conceivable that this property may be used advantageously in a frequency-modulation system to enhance the higher frequency components. The chief limitation of this property is that the greater the signal variation of $e_0(t)$ requiring, therefore, increased limiting of the output signal.

As a third example, consider the case where the phase characteristics are again either zero or essentially linear over the pertinent portion of the frequency spectrum and that the amplitude characteristics obey the function

$$|Z(\omega)| = \cos(\lambda\omega + \Omega) = \frac{1}{2} [\epsilon^{i(\lambda\omega + \Omega)} + \epsilon^{-i(\lambda\omega + \Omega)}]. \quad (27)$$

(See Fig. 3.) From (2) and (18) then

$$e_0(t) = \frac{1}{2} E \epsilon^{i\omega_0 t} \left\{ \epsilon^{i[(\Omega + \omega_0\lambda) + \theta(t+\lambda)]} + \epsilon^{-i[(\Omega + \omega_0\lambda) - \theta(t-\lambda)]} \right\}, \quad (28)$$

If now $\theta(t)$ is a sinusoidal function (see (10)), (28) becomes

$$e_0(t) = E \cos \left[(m \sin \rho\lambda) \cos \rho t + (\Omega + \omega_0\lambda) \right] \epsilon^{i[\omega_0 t + (m \cos \rho\lambda) \sin \rho t]}. \quad (29)$$

Equation (29) again illustrates that the intelligence suffers no nonlinear distortion; however, in this case the higher frequency signals are depressed to an amount equal to $\cos \rho\lambda$ of the original amplitude. This fact is of primary interest in the application of angular modulation techniques to magnetic recording since, to a first approximation, the amplitude playback characteristics of a tape or wire recorder is a sine wave.

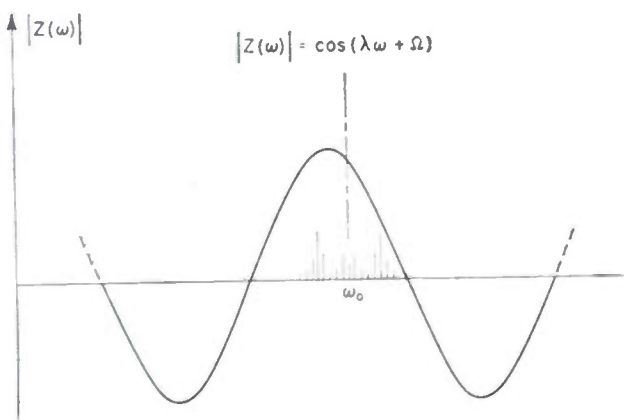

Fig. 3

Consider now that B is the band pass in cycles of the 3-db down points of the cosine transfer function and let δ be the maximum amount of signal depression that can be tolerated; then it may readily be shown that the relationship between B and the maximum signal intelligence frequency that may be transmitted is

$$f_s = \frac{2B}{\pi} \cos^{-1} (1 - \delta). \quad (30)$$

For small values of δ this may be approximated as

$$f_s = 0.9B\sqrt{\delta}. \quad (31)$$

The sinusoidal-amplitude transfer characteristic therefore imposes quite a fundamental limitation on the maximum modulation frequency which may be transmitted, based solely on the shape of the transfer characteristic and completely independent of the deviation frequency. For example if δ is two per cent, the required band-pass B should be about eight times the maximum modulation frequency.

CONCLUSIONS

The output of an angular modulated signal transmitted through a network or medium (under certain restrictions⁷) may be expressed as a double definite integral (see (9), (11), (13), and (23)). The usefulness of these open-form equations is limited by the ability to perform the indicated integrations. It was found, however, that transfer functions which are linear exponential functions of frequency readily lend themselves to a closed mathematical solution of the output signal. Since any transfer function⁷ may be expanded in a Fourier series of linear exponential functions of frequency over a desired range of frequencies, the output signal may always be expressed in a finite number of terms, the number of terms being the number of terms of the Fourier expansion necessary to approximate the transfer function over the range of frequencies where the spectral components of the input signal are appreciable. Equations (18), (22), and (23) are more inclusive formulas in that they express an output function of time in terms of a general input function of time and the transfer function relating the output and input as a function of frequency.

A few particular cases were investigated in order to study the effects of the amplitude and phase characteristics of the transfer function on the output intelligence. It was found that for linear phase characteristics, the output intelligence will suffer no distortion but will be shifted along the time axis by an amount depending on the slope of the phase characteristic. If the amplitude characteristics are a hyperbolic cosine function of frequency the output intelligence will suffer no nonlinear distortion, but the amplitude of the signal intelligence will be an increasing function of frequency. On the other hand, if the amplitude transfer characteristics are a sinusoidal function of frequency there will again be no nonlinear distortion in the output intelligence; however, in this case, the amplitude of the intelligence will be a decreasing function of frequency. This amplitude characteristic imposes a fundamental limitation on the maximum frequency response of the intelligence signals as is indicated by (30). By extension of the analysis it may be shown that, generally speaking, amplitude transfer characteristics which rise on either side of the carrier frequency enhance the higher modulation frequencies, while those which fall on either side of the carrier frequency depress the higher modulation frequencies. In this latter case, (30) may be used as a rule-of-thumb formula to determine the maximum modulation frequency which may be transmitted without appreciable distortion.

This analysis again supports the contention and conclusions of other writers on the subject that linear-phase transfer characteristics are a more important design objective than are perfectly flat-amplitude transfer characteristics.

Pulse Transients in Exponential Transmission Lines*

EDWARD R. SCHATZ†, ASSOCIATE, IRE, AND EVERARD M. WILLIAMS†, SENIOR MEMBER, IRE

Summary—The pulse response of exponential transmission lines is analyzed and it is suggested that such lines may be used advantageously as pulse transformers with short, rapidly rising pulses, particularly where large amounts of power are involved. A subsequent paper will discuss design problems and experimental results.

THE EXPONENTIAL transmission line shows promise as a pulse transformer for use with very short, rapidly rising pulses, particularly where large amounts of power are involved. The design and effective use of exponential transmission-line sections as pulse transformers require a fairly precise knowledge of the general transient characteristics of such lines. It is the purpose of this paper to discuss some of these general characteristics. A subsequent paper will treat design problems and describe some typical exponential-line pulse transformers.

Requirements exist for pulse-transforming devices capable of handling large amounts of power in pulse durations of the order of hundredths of microseconds; examples of such requirements are to be found, for instance, in the "electrostatic" ion deflectors for large nuclear particle accelerators. Such requirements are not readily satisfied by conventional two-winding iron-core transformers and, in a search for an alternative wide-band impedance-transforming device, the authors were led to consider the exponential transmission line. The steady-state characteristics of exponential transmission lines have been widely discussed in the literature¹⁻³ and it is known that their behavior is equivalent to that of combinations of high-pass filters and ideal impedance transformers. The high-pass characteristic is an ideal one for the transformation of steep edges of pulses but necessarily distorts their flat-topped portions. It seemed probable, however, that the parameters of an exponential transmission line could be so chosen as to reduce this distortion to any desired extent. The analytical study described in this paper was, therefore, undertaken to investigate the transient properties of the exponential transmission line.

An exponential line is defined as a transmission line in which spacing between conductors is tapered so that the

inductance and capacitance per unit length l_x and c_x vary exponentially with the distance along the line from the sending end according to the relations

$$l_x = L_0 e^{\gamma x}$$

$$c_x = C_0 e^{-\gamma x}.$$

The flare coefficient γ may be either positive or negative; the analysis of this paper, however, considers positive values of γ only. The differential equations for V_x and i_x are, by an analysis similar to that for uniform lines,

$$\frac{\partial^2 V_x}{\partial x^2} - \gamma \frac{\partial V_x}{\partial x} = L_0 C_0 \frac{\partial^2 V_x}{\partial t^2} \quad (1)$$

$$\frac{\partial^2 i_x}{\partial x^2} + \gamma \frac{\partial i_x}{\partial x} = L_0 C_0 \frac{\partial^2 i_x}{\partial t^2} \quad (2)$$

A method of solution using Laplace transform analysis was employed; the general steps in this solution are illustrated briefly for (1).

The Laplace transform $F(x, s)$ of a function $f(x, t)$ is defined as

$$F(x, s) = \int_0^{\infty} e^{-st} f(x, t) dt$$

and the operation of taking the Laplace transform is indicated as

$$F(x, s) = Lf(x, t).$$

The notations $V(x, s)$ and $I(x, s)$ will be used for the transforms of $v(x, t)$ and $i(x, t)$. Taking the Laplace transforms of each term in (1) we obtain

$$L \frac{\partial^2 v(x, t)}{\partial x^2} - \gamma L \frac{\partial v(x, t)}{\partial x} = L_0 C_0 L \frac{\partial^2 v(x, t)}{\partial t^2}$$

which for the conditions of this analysis can be shown to become

$$\frac{\partial^2 V(x, s)}{\partial x^2} - \gamma \frac{\partial V(x, s)}{\partial x} = L_0 C_0 s^2 V(x, s).$$

The solution of this is

$$V = e^{\gamma x/2} [A e^{-\sqrt{(\gamma^2/4) + s^2 L_0 C_0} x} + B e^{\sqrt{(\gamma^2/4) + s^2 L_0 C_0} x}] \quad (3)$$

in which A and B are functions of s and independent of x .

The first and second terms of (3) represent traveling waves in the x and $-x$ directions, respectively. The parameter $\sqrt{1/L_0 C_0}$, hereafter designated as c , is the velocity of propagation of electromagnetic waves in the space between conductors. The solution is completed by using boundary conditions to solve for the terms A and B . This procedure yields $V(x, s)$. The desired voltage $v(x, t)$ is obtained from the inverse transform of $V(x, s)$.

* Decimal classification: R117.1. Original manuscript received by the Institute, January 3, 1949; revised manuscript received, April 24, 1950. This paper is part of a dissertation submitted by Edward R. Schatz in partial fulfillment of the requirements for the degree of Doctor of Science at Carnegie Institute of Technology. Also presented, in part, under the title "The exponential line pulse transformer," 1950 IRE National Convention, New York, N. Y., March 9, 1950.

This work was supported in part by the joint ONR-AEC program. † Department of Electrical Engineering, Carnegie Institute of Technology, Pittsburgh, Pa.

¹ H. A. Wheeler, "Transmission lines with exponential taper," Proc. I.R.E., vol. 27, pp. 65-71; January, 1939.

² C. R. Burrows, "The exponential transmission line," Bell Sys. Tech. Jour., vol. 17, pp. 555-573; October, 1938.

³ P. J. Selgin, "Electrical Transmission in the Steady State," McGraw-Hill Book Co., New York, N. Y., 1946.

This operation of finding the inverse transform is extremely complicated in the case of a general arbitrary termination; the authors have obtained solutions for the cases summarized in Table I.

The first case is the infinite line. The integrals appearing in this case have been computed for the conditions shown in the curves of Figs. 1 and 2. Fig. 3 is a sketch of the voltage and current distribution on an infinite line, excited by a short rectangular pulse, for four instants of time at which the leading edge of the pulse has reached the positions $x_1, x_2, x_3,$ and $x_4,$ respectively.

Sending end current as a function of time is given in the second case. Fig. 4 shows a curve of this function, useful in determining the sending end resistance and in efficiency calculations.

The third case is that of the short-circuited line. The last case is that of the voltage at a receiving end load

$$R_{z_1} = \sqrt{\frac{l_{z_1}}{c_{z_1}}} = \sqrt{\frac{L_0}{C_0}} e^{\gamma z_1}$$

This resistance is equal to the characteristic impedance at infinite frequency and will be termed the "impedance level" at the output terminals of the length x_1 of line. With this termination there is no reflection from a step-impulse wave front but reflections occur immediately

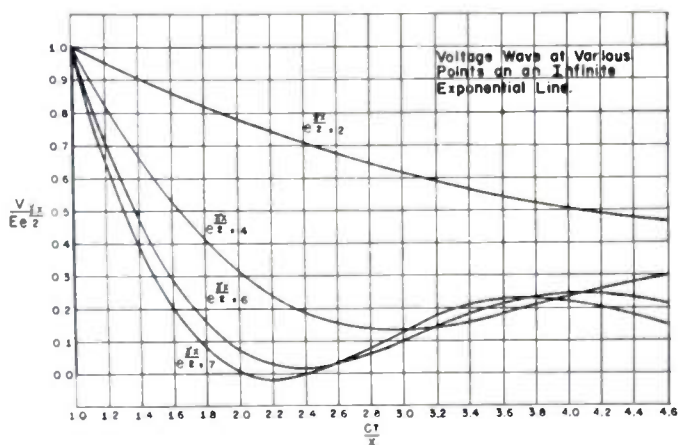

Fig. 1—Voltages at the end of step-up sections of exponential transmission line of length x (terminated in an indefinite continuation of the same line) as functions of a time parameter ct/x when the lines are excited with a step input voltage E at time $t=0$. Curves are drawn for sections with voltage ratios of one to two, four, six, and seven, and voltage is expressed as a ratio of actual voltage to the input voltage multiplied by the voltage ratio in each case.

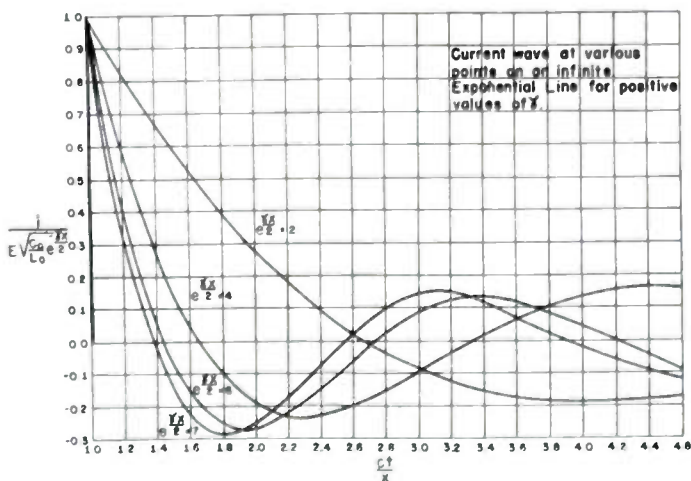

Fig. 2—Currents at the end of voltage step-up sections of exponential transmission line of length x (terminated in an indefinite continuation of the same line) as functions of the time parameter ct/x . Curves are drawn for sections with voltage ratios corresponding to those in Fig. 1, and current is expressed as a ratio of actual current to the input current divided by the voltage ratio in each case.

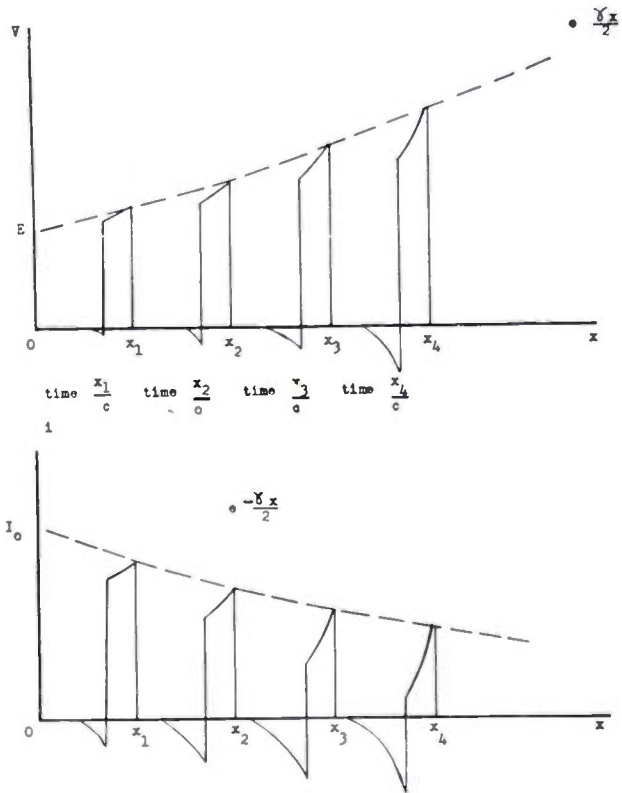

Fig. 3—Sketches of voltage and current distribution on an infinite line, excited by a short rectangular voltage pulse, for several instants of time at which the leading edge of the pulse has reached the positions $x_1, x_2, x_3,$ and x_4 . The distortion is exaggerated and corresponds to that occurring with very great taper.

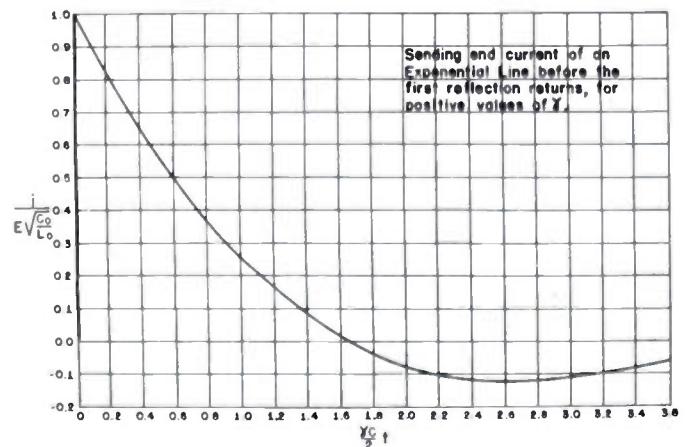

Fig. 4—Current at the sending end of an exponential transmission line when the line is excited at this point by a step voltage function. This current is applicable not only in the case of the line of infinite extent but also to any line section prior to the arrival of reflections from the receiving (load) end.

TABLE I

Voltage v and current i as functions of time t and distance x along exponential transmission lines excited with a step function of voltage E at $x=0$ and $t=0$. Solutions are for positive flare coefficient γ only. J_0, J_1 are Bessel functions of the first kind and H_0, H_1 are Struve functions. The notations $f_1(\tau)$ and $f_1(t)$ are used for $\sqrt{\tau^2 - x^2/c^2}$ and $\sqrt{t^2 - x^2/c^2}$; and $N(t-x/c)$ is a function with the value 0 for $t < x/c$ and unity for $t > x/c$.

Case	Voltage transform V or current transform I	Solution for voltage or current
Infinite line Voltage and Current at any point x	$V(x, s) = \frac{E}{s} e^{\gamma x/2} \left[e^{-\sqrt{(s^2/c^2) + (\gamma^2/4)x}} \right]$ $I(x, s) = \frac{-E}{L_0} e^{-\gamma x/2} \left[\frac{\gamma}{2s^2} - \sqrt{\frac{1}{c^2 s^2} + \frac{\gamma^2}{4s^4}} \right] e^{-\sqrt{(s^2/c^2) + (\gamma^2/4)x}}$	$V(x, t) = E e^{\gamma x/2} \left[1 - \frac{\gamma x}{2} \int_{x/c}^t \frac{J_1 \left[\frac{\gamma c}{2} f_1(\tau) \right] d\tau}{f_1(\tau)} \right] N \left[t - \frac{x}{c} \right]$ $i(x, t) = \frac{E}{\sqrt{\frac{L_0}{C_0}}} e^{-\gamma x/2} \left[\frac{\gamma^2 c x}{4} \int_{x/c}^t (t-\tau) \frac{J_1 \left[\frac{\gamma c}{2} f_1(\tau) \right] d\tau}{f_1(\tau)} - \frac{\gamma c}{2} \left(t - \frac{x}{c} \right) + J_0 \left[\frac{\gamma c}{2} f_1(t) \right] \right. \\ \left. + \frac{\gamma^2 c^2 t}{4} \int_{x/c}^t J_0 \left[\frac{\gamma c}{2} f_1(\tau) \right] d\tau - \frac{\gamma c}{2} f_1(t) J_1 \left[\frac{\gamma c}{2} f_1(t) \right] \right] N \left(t - \frac{x}{c} \right)$
Sending end current (for any case) before first reflection returns	$I(0, s) = \frac{-E}{L_0} \left[\frac{\gamma}{2s^2} - \sqrt{\frac{1}{s^2 c^2} + \frac{\gamma^2}{4s^4}} \right]$	$i(0, t) = \frac{E}{\sqrt{\frac{L_0}{C_0}}} \left[\left(1 + \frac{\gamma^2 c^2 t^2}{4} \right) J_0 \left(\frac{\gamma c t}{2} \right) + \pi \left(\frac{\gamma^2 c^2 t^2}{8} \right) \left[J_1 \left(\frac{\gamma c t}{2} \right) H_0 \left(\frac{\gamma c t}{2} \right) - J_0 \left(\frac{\gamma c t}{2} \right) H_1 \left(\frac{\gamma c t}{2} \right) \right] - \frac{\gamma c t}{2} J_1 \left(\frac{\gamma c t}{2} \right) - \frac{\gamma c t}{2} \right]$
Open-circuited line of length x_1 (Receiving end voltage before reflections from sending end)	$V(x_1, s) = E e^{\gamma x_1/2} \left[\frac{2 e^{-\sqrt{(s^2/c^2) + (\gamma^2/4)x_1}}}{s} \right] \left[\frac{\sqrt{\frac{s^2}{c^2} + \frac{\gamma^2}{4}}}{\frac{\gamma}{2} + \sqrt{\frac{s^2}{c^2} + \frac{\gamma^2}{4}}} \right]$	$V(x_1, t) = E e^{\gamma x_1/2} \left[2 - \gamma x_1 \int_{x_1/c}^t \frac{J_1 \left[\frac{\gamma c}{2} f_1(\tau) \right] d\tau}{f_1(\tau)} + \frac{\gamma^2 c^2}{4} \left(t - \frac{x_1}{c} \right)^2 - \frac{\gamma^2 c^2 x_1}{8} \int_{x_1/c}^t (t-\tau)^2 \frac{J_1 \left[\frac{\gamma c}{2} f_1(\tau) \right] d\tau}{f_1(\tau)} - \gamma c \int_{x_1/c}^t J_0 \left[\frac{\gamma c}{2} f_1(\tau) \right] d\tau - \frac{\gamma^2 c^2}{8} \int_{x_1/c}^t (t-\tau)^2 J_0 \left[\frac{\gamma c}{2} f_1(\tau) \right] d\tau \right] N \left(t - \frac{x_1}{c} \right)$ <p>Note: $f_1(\tau) = \sqrt{\tau^2 - \frac{x_1^2}{c^2}}$ for this and following cases</p>
Short-circuited line of length x_1 (Receiving end current before reflections from sending end)	$I(x_1, s) = \frac{2E e^{-\gamma x_1/2}}{L_0 s^2} \left[\sqrt{\frac{s^2}{c^2} + \frac{\gamma^2}{4}} e^{-\sqrt{(s^2/c^2) + (\gamma^2/4)x_1}} \right]$	$i(x_1, t) = \frac{2E}{\sqrt{\frac{L_0}{C_0}}} e^{-\gamma x_1/2} \left[\frac{\gamma^2 c^2 t}{4} \int_{x_1/c}^t J_0 \left[\frac{\gamma c}{2} f_1(\tau) \right] d\tau + J_0 \left[\frac{\gamma c}{2} f_1(t) \right] - \frac{\gamma c}{2} f_1(t) J_1 \left[\frac{\gamma c}{2} f_1(t) \right] \right] N \left(t - \frac{x_1}{c} \right)$
Line terminated in resistance R equal to impedance level at $x=x_1$ (Receiving end voltage before reflections from sending end)	$V(x_1, s) = \frac{E}{s} e^{\gamma x_1/2} \left[e^{-\sqrt{(s^2/c^2) + (\gamma^2/4)x_1}} \right] \left[\frac{2 \sqrt{\frac{s^2}{c^2} + \frac{\gamma^2}{4}} R}{I_{x_1} s + R \left(\frac{\gamma}{2} + \sqrt{\frac{s^2}{c^2} + \frac{\gamma^2}{4}} \right)} \right]$	$V(x_1, t) = E e^{\gamma x_1/2} \left[\frac{\gamma^2 c x_1}{4} \int_{x_1/c}^t (t-\tau) \frac{J_1 \left[\frac{\gamma c}{2} f_1(\tau) \right] d\tau}{f_1(\tau)} - \frac{\gamma c}{2} \left(t - \frac{x_1}{c} \right) - \frac{\left(t - \frac{x_1}{c} \right) J_1 \left[\frac{\gamma c}{2} f_1(t) \right]}{f_1(t)} \right. \\ \left. + J_0 \left[\frac{\gamma c}{2} f_1(t) \right] + \left(\frac{\gamma^2 c^2 t}{4} + \frac{\gamma c}{2} \right) \int_{x_1/c}^t J_0 \left[\frac{\gamma c}{2} f_1(\tau) \right] d\tau - \frac{\gamma c}{2} f_1(t) J_1 \left[\frac{\gamma c}{2} f_1(t) \right] \right] N \left(t - \frac{x_1}{c} \right)$

$$R = \sqrt{\frac{L_x}{C_x}} = \sqrt{\frac{L_0}{C_0}} e^{\gamma x_1}$$

thereafter, increasing in magnitude with time. Fig. 5 shows a curve of the resulting receiving end voltage. Although data on voltage with loads different from the "impedance level" would be of some interest, the transforms involved have proved complex and, to date, uneconomical to evaluate.

The distortion undergone by an ideal rectangular pulse transformed by a section of exponential line may be determined by superposition of two step-voltage responses of opposite polarity with delay between steps equal to the pulse duration. It is apparent from Fig. 5 that distortion may be reduced to any desired extent by reducing the abscissa ct/x to as low a value as necessary. This may be done, for instance, by choosing a sufficiently low value of the flare coefficient. Flare coefficient is also important, however, in connection with efficiency.

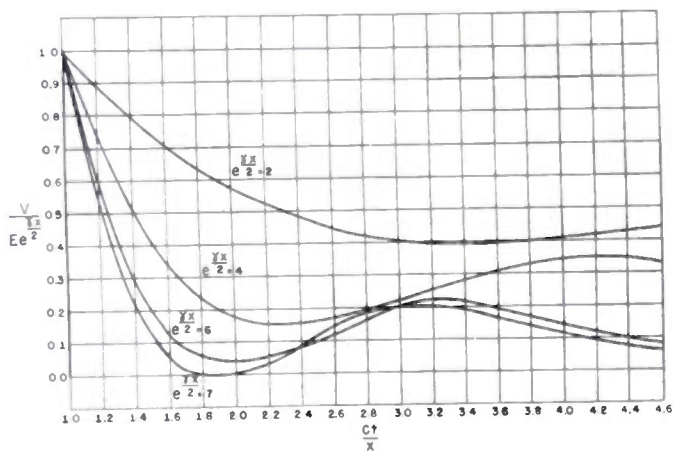

Fig. 5—Receiving voltage as a function of time in terminated exponential transmission-line sections excited with a step input voltage for step-up ratios of one to two, four, six, and seven. The line is terminated in a load resistance equal to its impedance level. Voltage is expressed as the ratio of actual voltage to input voltage multiplied by step-up ratio.

The magnitude of the flare coefficient affects efficiency (a) through its influence on ratio of useful energy delivered to that stored and reflected, and (b) through its effect on dissipation. The first of these effects is significant even when dissipation is negligible. Although all the energy in a dissipationless line is eventually delivered to the load or returned to the generator, the useful load energy is generally only that delivered during the pulse duration. Furthermore, pulse-generator capacity at the sending end is determined by the peak power and energy delivered in a pulse and it is of little advantage to return some of this energy at a later time. It is, therefore, convenient to evaluate a "nominal" efficiency n , defined as

$$n = \frac{\text{energy delivered to load during duration of initial pulse}}{\text{energy supplied to line at sending end during initial pulse}}$$

Typical nominal efficiency curves are shown in Fig. 6.

The flare coefficient affects dissipation because choice of very low flare coefficient values results in such great

lengths of line to obtain a specified impedance ratio that dissipation may be appreciable. The precise evaluation of dissipation effects on efficiency and pulse shape requires a rigorous transient solution for the exponential line with finite losses; this solution, however, offers extraordinary analytical difficulties. An approximate analysis is readily applicable, however, when losses are not negligible but low.

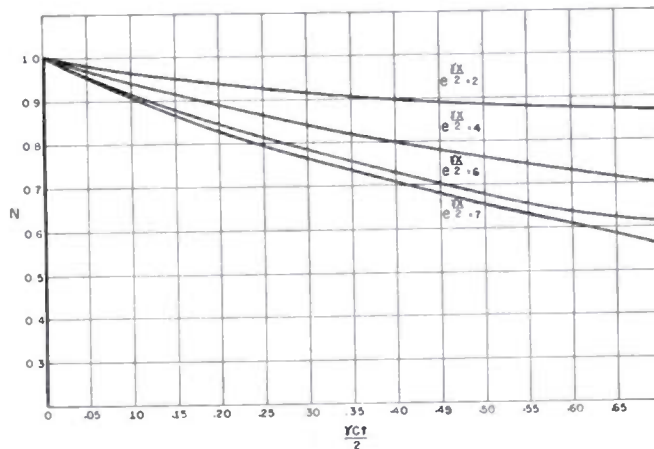

Fig. 6—Nominal efficiency of the exponential-line sections of Fig. 5.

In an analysis of approximate attenuation in uniform lines with losses Ramo and Whinnery⁴ have described a method based on the assumption that losses, when small, can be calculated by allowing voltages and currents as computed for a lossless line to encounter the known resistances and conductances. The voltage on a uniform line with losses is of the form

$$V = e^{-\alpha x} f(x, t)$$

in which $f(x, t)$ is the expression determined for a lossless line. α is shown to be

$$\alpha = \frac{r}{2Z_0} + \frac{gZ_0}{2}$$

in which r , g , and Z_0 are series resistance per unit length, shunt conductance per unit length, and characteristic impedance, respectively. This expression can be shown to be applicable to exponential lines in a form in which the attenuation per unit length is a function of the parameters associated with that unit length, r_x , g_x , and steady-state characteristic impedance Z_{0x} at some frequency f , in terms of which $\alpha_x = ((r_x/2Z_{0x}) + (g_x Z_{0x}/2))$. Although α_x is an attenuation referred to steady-state phenomena, this expression may readily be used to determine the attenuation undergone by the individual frequency components of transient impulses. The components of particular interest are generally the highest frequency components, the attenuation of which is responsible for deterioration of steep leading and trailing

⁴ S. Ramo and J. R. Whinnery, "Fields and Waves in Modern Radio," John Wiley and Sons, Inc., New York, N. Y., p. 32; 1944.

edges. The frequencies of such components are remote from the steady-state cutoff frequency of a transformer section and the characteristic impedance Z_{0x} becomes the impedance level R_x . Burrows² has given, in the steady-state case for frequencies remote from cutoff,

$$\alpha_x = \frac{r_x}{2} \sqrt{\frac{C_0}{L_0}} \epsilon^{-\gamma x} + \frac{g_x}{2} \sqrt{\frac{L_0}{C_0}} \epsilon^{\gamma x}.$$

In exponential-line pulse transformers the resistance r_x is readily held at negligible levels. The conductance g is likely to be of importance since it is usually convenient to limit the physical length required for a particular minimum pulse distortion by the use of solid or

liquid dielectric material in which there are unavoidable losses. In such cases, the conductance g_x is an exponential function of length and the attenuation constant independent of x . For ordinary dielectrics α is given with sufficient accuracy by

$$\alpha = \frac{\omega}{2} \sqrt{L_0 C_0} \sqrt{\frac{\delta^2}{1 - \delta^2}} = \frac{\omega}{2c'} \sqrt{\frac{\delta^2}{1 - \delta^2}}$$

in which δ is the power factor of the dielectric at the frequency f and c' the propagation velocity in the dielectric, neglecting losses. Phase distortion owing to changes of velocity with frequency of pulse components is usually of negligible proportions.

Discussion on

“On the Energy-Spectrum of an Almost Periodic Succession of Pulses”*

G. G. MACFARLANE

T. S. George:¹ There is an alternate approach to the problem of calculating the power spectra of fluctuating pulses which I have found in general to be more facile than the one employed by Mr. MacFarlane. I am sure that this method is familiar to Mr. MacFarlane, but may not be to other readers. This is the method of first calculating the autocorrelation function, and then transforming to the power spectrum by the Wiener-Khinchine theorem.²

Consider, as an example, the first case calculated by Mr. MacFarlane, that is, the case of periodic pulses of shape $f(t)$ whose amplitude fluctuates in a random fashion described by a probability density function $P(y)dy$.

First of all, one may assume that the amplitude of the fluctuating pulses consists of a constant or dc term plus a part which fluctuates about an average value zero. Thus for this part, we have a sequence of periodic pulses with constant amplitude

$$A = \int_{-\infty}^{\infty} yP(y)dy.$$

One may proceed directly to the power spectrum through the Fourier series of the pulses. The Fourier series is

$$\sum_{-\infty}^{\infty} c_n e^{j2\pi n t/T},$$

The power spectrum then is

$$2\pi \sum_{-\infty}^{\infty} |c_n|^2 \delta\left(\omega - \frac{2\pi n}{T}\right)$$

where

$$c_n = \frac{\bar{A}}{T} \int_0^T f(t) e^{-2\pi n t/T} dt = \frac{A}{T} G\left(\frac{2\pi n}{T}\right)$$

and $G(\omega)$ is the continuous spectrum of a single pulse of unit amplitude. $\delta(\omega)$ is the Dirac delta function, and is defined here as

$$\delta(\omega) = \frac{1}{2\pi} \int_{-\infty}^{\infty} e^{-j\omega t} dt.$$

This accounts for the second part of Mr. MacFarlane's result.

For the fluctuating part, we calculate the autocorrelation $\rho(\tau) = \overline{f(t)f(t+\tau)}$. It is observed first that if t is within one pulse and $t+\tau$ in any other pulse

$$\overline{f(t)f(t+\tau)} = \overline{f(t)} \overline{f(t+\tau)} = 0,$$

since the separate pulses are assumed to fluctuate independently (tacitly assumed by Mr. MacFarlane). Thus permissible values of τ lie between $-T$ and T and it is obvious that this part of the spectrum will be continuous. Now it is convenient to consider the fluctuating pulse to consist of $f(t)$ itself, multiplied by an infinite line parallel to the t axis and which fluctuates about zero with probability determined by $P(y)dy$.

The autocorrelation function of the line is \bar{I}^2 , say,

* Proc. I.R.E., vol. 37, pp. 1139-1144; October, 1949.

¹ Philco Corporation, Philadelphia, Pa.

² H. M. James, N. B. Nichols, R. S. Philips, "Theory of Servomechanisms," Radiation Laboratory Series No. 25, p. 283, McGraw-Hill Book Co., New York, N. Y.; 1947.

where I is the instantaneous departure of the line from zero. This is, of course,

$$\overline{(A - A)^2}$$

The power spectrum of this line is obtained from $\rho(\tau)$ by the Wiener-Khinchine theorem which for unnormalized $\rho(\tau)$ may be written

$$F_1(\omega) = \int_{-\infty}^{\infty} \rho(\tau) \cos \omega\tau d\tau.$$

Thus for the line,

$$F_1(\omega) = 2\pi(A - \bar{A})^2\delta(\omega).$$

The average power spectrum of the pulse itself is

$$\frac{|G(\omega)|^2}{T}.$$

Now when one has the product of two time functions, whose spectra are $F_1(\omega)$ and $F_2(\omega)$, respectively, the complex convolution integral gives the spectrum of the product, thus

$$F(\omega) = \frac{1}{2\pi} \int_{-\infty}^{\infty} F_1(\omega - s)F_2(s)ds.$$

Thus the continuous power spectrum is

$$F(\omega) = \frac{2\pi(A - \bar{A})^2}{2\pi} \int_{-\infty}^{\infty} \frac{|G(\omega - s)|^2}{T} \delta(s)ds$$

$$= \frac{|G(\omega)|^2}{T} \overline{(A - \bar{A})^2}.$$

This is the other part of Mr. MacFarlane's result.

Several steps are involved in this method, but each is easy to carry out. The same procedure may be applied to the problem of pulses varying statistically in width or position.

G. G. Macfarlane:³ I agree with Mr. George that the results given in equations (21) and (33) can be more neatly derived with the aid of Khinchine's theorem. Moreover, the forms of the autocorrelation functions are themselves of interest. Nevertheless, the method given in the paper was adopted because it seems to the author to be more elementary.

³ Ministry of Supply, Great Malvern, Worcs., England.

Measurement of the Electrical Characteristics of Quartz Crystal Units by Use of a Bridged-Tee Network*

CHARLES H. ROTHAUGE†, ASSOCIATE, IRE, AND FERDINAND HAMBURGER, JR.‡, SENIOR MEMBER, IRE

Summary—A bridged-tee null network has been used to measure the equivalent resistance and the equivalent reactance of a quartz crystal plate.

This measuring circuit has the advantages that shielding is relatively simple (both the source and the detector have a common grounded terminal) and that corrections for all stray capacitances that affect the measurements may be included in the calibrations of the capacitors of the tee.

The precision of the measurements is estimated to be 0.3 per cent for the determination of the equivalent reactance and 2.3 per cent for the determination of the equivalent resistance.

INTRODUCTION

WITH THE EXTENDED USE of quartz crystal plates in the past several years there has been an increasing demand for the accurate measurement of the electrical properties of the crystals. In the past, the expression of the dynamic impedance of the crystal has been made in an arbitrary and indirect man-

ner.^{1,2} However, the electrical characteristics (the impedance, the equivalent reactance, and the equivalent resistance) of a quartz crystal plate may be measured at any frequency of operation without reference to the external circuit in which the unit is to be used.³⁻⁷ These electrical quantities permit the prediction of the performance of the crystal unit in any particular external circuit whose characteristics are known. Such a method of specification of crystal units using their impedance,

¹ G. M. Thurston, "A crystal test set," *Bell Lab. Rec.*, vol. 22, pp. 477-480; August, 1944.

² W. E. McNatt, "Test set for quartz crystals," *Electronics*, vol. 18, pp. 113-115; April, 1945.

³ C. W. Harrison, "The measurement of the performance index of quartz plates," *Bell Sys. Tech. Jour.*, vol. 24, pp. 217-252; April, 1945.

⁴ A. J. Biggs and G. M. Wells, "The measurement of the activity of quartz oscillator crystals," Part III, *Jour. IEE (London)*, vol. 93, pp. 29-36; January, 1946.

⁵ K. S. Van Dyke and A. M. Thorndyke, "The three-crystal method of quartz resonator measurement," *Phys. Rev.*, vol. 57, p. 560; March, 1940.

⁶ C. J. Miller, Jr., "Long Range Planning for Quartz Crystal Units," Signal Corps Engineering Laboratories; October, 1945.

⁷ W. D. George, M. C. Selby, and R. Scolnik, "Precision measurement of the electrical characteristics of quartz crystal units," *Proc. I.R.E.*, vol. 36, pp. 1122-1131; September, 1948.

* Decimal classification: R214.211. Original manuscript received by the Institute, November 26, 1949; revised manuscript received, April 21, 1950.

† U. S. Naval Postgraduate School, Annapolis, Md.

‡ The Johns Hopkins University, Baltimore, Md.

equivalent reactance, and resistance has many advantages,^{3,8} not the least of which is the availability to the engineer of data which will be most useful in design procedures.

This paper will present a method of measurement of these electrical characteristics of a quartz crystal unit using a "bridged-tee" null network.

EQUIVALENT CIRCUIT OF A PIEZOELECTRIC CRYSTAL

A piezoelectric crystal vibrating near its resonant frequency may be represented by an equivalent electric circuit.⁹ This equivalent circuit, composed of a series branch of resistance, inductance, and capacitance in parallel with a capacitance, may be reduced to a series arrangement of an effective inductance and an effective resistance when the frequency of operation of the crystal is between its series resonant and antiresonant frequencies. The values of the series resistance and inductance vary rapidly as the frequency is changed from series to parallel resonance. This simplified circuit is the one that will be used to represent a crystal in this paper and implies that the crystal resonators under consideration are to be operated into capacitive loads.

THE BRIDGED-TEE NULL NETWORK

A tee configuration of two equal capacitances and a resistance will form a null network when bridged by an inductance in series with a resistance.¹⁰ This arrangement is shown in Fig. 1.

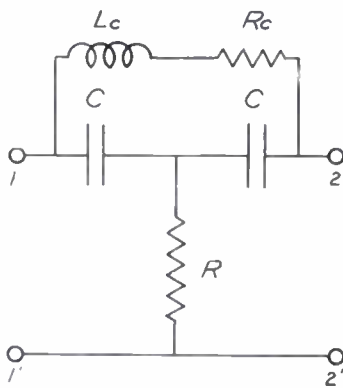

Fig. 1—Bridged-tee null network.

This circuit may be used to measure the effective inductance and resistance of a crystal at its operating frequency, when the crystal is one designed to operate into a capacitive load.

The balance conditions for such a network (i.e., conditions for zero transmission) are

$$X_c = \frac{2}{\omega C} \quad (1)$$

⁸ K. S. Van Dyke, "The standardization of quartz crystal units," *Proc. I.R.E.*, vol. 33, pp. 15-20; January, 1945.

⁹ K. S. Van Dyke, "The electrical network equivalent of a piezoelectric resonator," *Phys. Rev.*, vol. 25, p. 895; June, 1925.

¹⁰ W. N. Tuttle, "Bridged-T and parallel-T null circuits for measurements at radio frequencies," *Proc. I.R.E.*, vol. 28, pp. 23-29; January, 1940.

$$R_c = \frac{1}{\omega^2 C^2} \quad (2)$$

Such an arrangement has several advantages which are readily apparent. First, stray capacitances between the terminals 1 and 1' and terminals 2 and 2' do not affect the measurement. Effectively such capacitances are across the source and the detector. Second, the source and detector have a common grounded terminal. Shielding is thus simplified since no shielded transformers or Wagner ground connections are needed.

Stray capacitance from the junction point of the tee to ground will introduce errors. The conditions for zero transmission with such a stray capacitance C_1 become

$$R_c = \frac{1}{\omega^2 C^2} \quad (3)$$

$$X_c = \frac{2}{\omega C} \left(\frac{C_1}{2C} + 1 \right) \quad (4)$$

CIRCUIT ARRANGEMENTS AND COMPONENTS

The circuit arrangement consists of the source, two buffer amplifiers, the bridged tee, and a detector. These units and the shielding are shown in the schematic diagram of Fig. 2 and will be briefly described.

The circuit was driven by a crystal controlled triode oscillator (source). This oscillator is controlled by a crystal having approximately the same frequency as the crystal being measured. An adequate range of frequencies was obtained by use of a small variable air capacitor placed across the crystal. Additional range may be obtained by the use of a series inductance and by a suitable selection of crystals with slightly different natural resonant frequencies. The frequency stability of the oscillator was better than one part in 10^7 for the periods during which measurements were taken.

It was found necessary to isolate the bridged tee from the remainder of the circuit in order to prevent coupling between the source and the detector. Isolation was accomplished by use of two buffer amplifier stages, a triode amplifier coupled inductively to the source and capacitively to the tee and a miniature pentode amplifier coupled capacitively to the output of the tee.

The triode amplifier is of conventional resistance-coupled design using a 6AC5 high- μ power amplifier triode. The gain of this stage is approximately 12 to 15 for the frequency range of 7 megacycles per second to 1 megacycle per second. The buffer amplifier using a 6AK5 pentode was designed with a tuned plate circuit and an input of the highest possible impedance. Its gain was approximately 25 at 7 megacycles per second. The high input impedance increases the sensitivity of the bridged-tee network.

A radio receiver was used as a detector for the measurements. The output of the buffer amplifier was connected directly to the antenna input of the receiver, and the input signal strength determined by measuring the

automatic-volume-control voltage. An equally satisfactory method used in some of the measurements was to view the audio output of the receiver with a cathode-ray oscilloscope. The receiver in this latter case was operated with the beat frequency oscillator on.

A twin capacitor, each unit with a range of 30 to 450 micromicrofarads, was used in the bridged tee. This twin capacitor was of a standard commercial type with both rotors mounted on a single shaft. The calibration of this capacitor included the effect of stray capacitance from the junction of the tee to ground.

A variable noninductive resistor is of the utmost importance to the accuracy of the measurements. Such a resistor was constructed giving values of resistance from zero to 15,210 ohms in steps of ten ohms. The resistance values were found to remain within 5 per cent of their direct-current values at frequencies up to 7 megacycles per second with an equivalent capacitance to ground of 23.5 ± 0.3 micromicrofarads for all values of resistance.

At any setting of this resistor, only three resistance elements are in use. This principle is similar to that used by Behr and Tarpley of Leeds and Northrup in the construction of shielded resistance boxes.¹¹ However, the individual elements of the Leeds and Northrup box are wire-wound resistors which limit the use of the box to applications at relatively low frequencies. The useful frequency range of a box constructed by this principle may be appreciably extended by use of deposited carbon resistors manufactured by the Western Electric Company. These resistors are characterized by small reactance and constancy of effective resistance which arise largely from their inherently small inductance and capacitance.

The elements are mounted on three drums arranged in tandem on concentric shafts. Each drum may be rotated separately. The drums contain, respectively, the tens, hundreds, and thousands units. The resistance values of the elements on each drum are 1, 2, 3, 4, . . . , and so forth, units. Thus, any value of resistance within the limits of the box may be obtained with only three resistors in series. Capacitance to ground is kept con-

stant by making the arrangement of the elements as symmetrical as possible. To further this symmetry the zero resistance elements are silver-plated brass replicas of the deposited carbon resistors. This resistor is shown in Fig. 3.

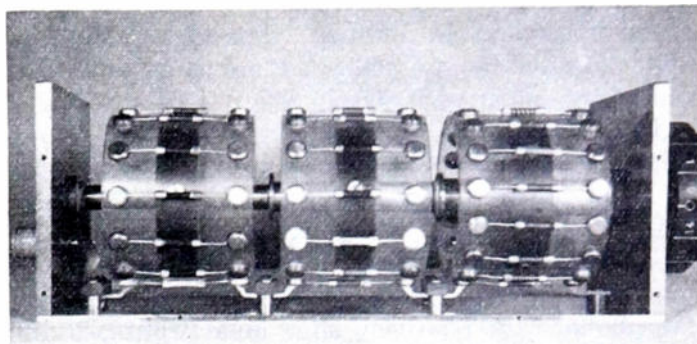

Fig. 3—Closeup of the placement of the individual resistance elements in the resistor box.

The shielding is conventional. The source and its buffer amplifier are included in one shield and the predetector buffer amplifier in another. In order to facilitate construction the bridged tee was separated into two parts. The crystal under test and the twin capacitor were placed in one shield, and the resistor R in another. A double shield is necessary for the capacitor to eliminate the effects of hand capacitance, since both plates are operated above ground potential. All connections between units are made with shielded single conductor cable. No special shielding was used for the receiver or vacuum tube voltmeter used to measure its automatic-volume-control voltage.

MEASUREMENTS

The method of measurement is direct. The crystal to be measured is inserted in the bridged-tee network and the frequency of the source is adjusted to the desired value. The tuned plate circuit of the predetector amplifier and the receiver are then adjusted for this value. First, the reactive balance of the bridged tee is obtained by varying the setting of the twin capacitor until a

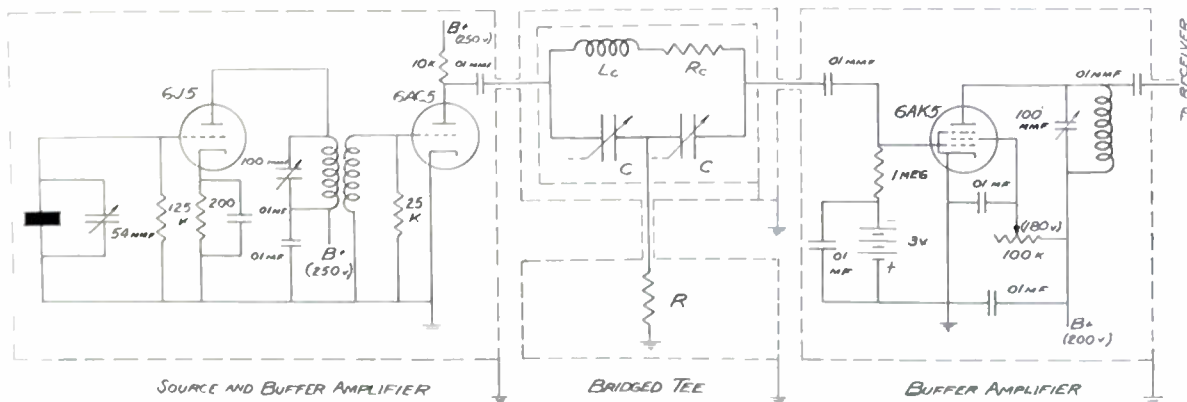

Fig. 2—Schematic diagram of measuring circuit.

¹¹ L. Behr and R. E. Tarpley, "Design of resistors for precise high-frequency measurements," PROC. I.R.E., vol. 20, pp. 1101-1116; July, 1932.

minimum output is obtained; then the resistive balance is made with the resistor R .

Inspection of the balance conditions (3) and (4) reveals why this order of operation is essential. Both the reactive and resistive balance depend upon the value of capacitance, while the variation of R affects only the resistive balance. In addition, variations of detector voltage caused by variations of C are many times that caused by similar variations in R .

Thus, after an approximate reactive balance is obtained, the gain of the detector may be increased to secure the desired sensitivity to determine the resistive balance and the final fine adjustment of capacity and resistance. The gain of the detector must not be placed too high until after a coarse reactive balance is obtained, since the relatively large input will mask any indication of a minimum signal.

The limits of the bridged tee are dependent upon frequency. With the values of C used in the circuit reported in this paper, inductive reactances of 100 to about 1,520 ohms may be measured at a frequency of 7 megacycles per second, reactances of 700 to 10,600 ohms at one megacycle per second. These limits may be extended but it is to be noted that a practical limit is reached for the larger values of reactance when the stray capacitance becomes appreciable in relation to the value of C . No difficulty is encountered in lowering the limits.

The limits of the value of resistance that may be determined are dependent not only on the value of R but also upon the reactive balance. If the inductive reactance of a series combination of resistance and reactance is 100 ohms at a frequency of 7 megacycles per second, the resistance value that can be determined is between 0.15 and 300 ohms; at the same frequency, with an inductive reactance of 1,520 ohms, resistances of 40 to 55,000 ohms may be determined. Similarly, at one megacycle per second, resistance values of 8 to 12,000 ohms may be measured when associated with an inductive reactance of 700 ohms, with corresponding values of resistances with an inductive reactance of 10,600 ohms.

Several series of crystals have been measured. The detailed data will not be given in this paper. However, representative results are given in Table I. The nominal frequency of all crystals in a series was the same, and the measurements reported were made at the same frequency for each series.

Values of X_c were measured from about 218 ohms

to 747 ohms, and values of R_c ranged from approximately 10 ohms to 33 ohms.

TABLE I
CRYSTAL TYPE DC-11-A¹

Crystal No.	X_c (ohms)	R_c (ohms)
1	522.0	32.19
2	415.0	30.50

CRYSTAL TYPE DC-31-C.P.R.²

Crystal No.	X_c (ohms)	R_c (ohms)
1	662.0	12.22
2	650.2	18.46
4	707.0	13.72
8	591.0	22.80

¹ Measurements made at a frequency of 7,102,115 cycles per second.

² Measurements made at a frequency of 4,540,362 cycles per second.

The precision of these measurements is estimated to ± 0.3 per cent for the determination of X_c and ± 2.3 per cent for the determination of R_c . This estimate was made from a series of ten measurements made at the same frequency on the same crystal. The average value of X_c was 532.9 ohms with an average deviation from the mean of ± 1.8 ohms or ± 0.3 per cent. The average value of R_c was 13.03 ohms with an average deviation from the mean of ± 0.30 ohms or ± 2.3 per cent. The measurements were made at a frequency of 4,950,340 cycles per second.

CONCLUSIONS

A method of measurement is presented for the determination of the equivalent series reactance and the equivalent series resistance of a quartz crystal plate at its operating frequency. This method utilizes a bridged-tee null network.

The determination of the equivalent series reactance is made with a precision of ± 0.3 per cent. The equivalent series resistance is determined with a precision of ± 2.3 per cent.

A design of a variable resistance box is presented. The box has values of resistance of 10 to 15,210 ohms in steps of 10 ohms. The resistance values of the box remain within 5 per cent of their direct-current values up to frequencies of 7 megacycles per second with an equivalent capacitance to its shield of 23.5 ± 0.3 micromicrofarads for all values of resistance.

CORRECTION

George Sinclair, author of the paper, "The transmission and reception of elliptically polarized waves," which appeared on pages 148-151 of the February, 1950, issue of the PROCEEDINGS OF THE I.R.E., has brought the following error to the attention of the editors.

On page 149, the vector N in equations (2) and (3) should read N_t , where N_t is the component of N transverse to the direction of propagation.

Contributors to Proceedings of the I.R.E.

Alfred C. Beck (A'30-SM'46) was born on July 26, 1905, at Granville, N. Y. He received the E.E. degree from Rensselaer Polytechnic Institute in 1927. After two summers in the test department of the New York Edison Company and a year as instructor in mathematics at Rensselaer, he became a member of the technical staff of Bell Telephone Laboratories, Inc., in 1928. Since then he has been in the radio research department, working on antennas, waveguides, and various short-wave, radar, and microwave projects. He is a New York State licensed professional engineer and a member of Sigma Xi.



A. C. BECK

Thomas P. Cheatham, Jr., was born on January 30, 1923, in Washington, D. C. After receiving the B.S. degree and a commission as ensign from the United States Coast Guard Academy in June, 1943, he served three years of active duty, leaving the service with the rank of lieutenant. He entered Massachusetts Institute of Technology in June, 1946, to pursue graduate study and research, and received the M.S. degree in electrical engineering in September, 1947. He was a research associate in the Research Laboratory of Electronics from 1946 to 1949.

Mr. Cheatham is a member of Sigma Xi. He is now associated with the Optical Research Laboratory and physics department of Boston University.



T. CHEATHAM, JR.

Takeo Hada was born on November 7, 1920, at Osaka, Japan. He was graduated from the electrical engineering department of the Osaka High Technical School in 1939, and then entered the Kawanishi Machine Works.

Mr. Hada is now associated with the Kobe Kogyo Corporation, in Kobe, Japan, engaged in research.

He is a member of the Institute of Electrical Engineering and Electrical Communication in Japan.



TAKEO HADA

Robert W. Dawson was born in Spring Lake, N. J., on May 26, 1922. He joined the radio research department of the Bell Telephone Laboratories, Inc., in 1941, after attending Newark College of Engineering. Mr. Dawson enlisted in the U. S. Army Signal Corps in 1942. He received training as a wire chief at Ft. Monmouth, and was then selected to attend the Army Specialized Training Program at Rutgers University, where he completed the course in communications engineering in 1944. Assignment was then made to the Manhattan District at Los Alamos, N. Mex., where he remained until his discharge, except for a few months overseas with the Atom Bomb group from Los Alamos. A special citation was received from Rear Admiral Purnell USN, for this overseas work.



R. W. DAWSON

After discharge from the Army early in 1946, employment was resumed with the Bell Telephone Laboratories at Holmdel, N. J., where Mr. Dawson now works on various microwave projects.

Albert A. Gerlach (S'42-A'46) was born on May 22, 1920, in Columbus, Ohio. He received the B.S. degree in electrical engineering from the Ohio State University in June, 1942, and the M.S. degree in electrical engineering from the Illinois Institute of Technology in January, 1949.



A. A. GERLACH

From 1942 to 1946, as a radar officer in the U. S. Army Signal Corps, he instructed and supervised the instruction of military personnel in the theory, operation, and maintenance of radar equipments, wrote technical manuals on radar and radio equipments, and made siting surveys on the West Coast for purposes of radar air-warning installations. In 1946, he became senior project engineer and, subsequently, laboratory director at the Rowe Engineering Corporation in Chicago and, since 1948, he has been a research engineer at the Armour Research Foundation of the Illinois Institute of Technology.

Mr. Gerlach is the vice-chairman of the Procedures Committee of the Chicago Section of the IRE, an associate member of AIEE and Sigma Xi, and a member of Eta Kappa Nu and Tau Beta Pi. He is a registered professional engineer in the State of Illinois.

F. Hamburger, Jr., (A'32-M'39-SM'43) was born in Baltimore, Md., on July 5, 1904. He received the B.E. degree in electrical engineering from The Johns Hopkins University in 1924. After participating in a program of dielectric research for several years, he earned the degree of Doctor of Engineering from that University in 1931.



F. HAMBURGER, JR.

Since 1931, Dr. Hamburger has been on the staff of the electrical engineering department of The Johns Hopkins University where he was appointed professor of electrical engineering in 1947. He served as chief test engineer for Bendix Radio Division from 1942 to 1945 while on partial leave of absence from the University, as consultant for the National Defense Research Council, Section 17-2, during 1944-1945, and as consultant to the Research and Standards Section, Bureau of Ships, Navy Department, during 1945-1946. At the present time he is associate director in charge of engineering of the systems research contract between The Johns Hopkins University and Special Devices Center, Office of Naval Research.

Dr. Hamburger has served as chairman of the Baltimore Section of the IRE in 1940-1941 and is now regional director. He is also a fellow of the American Institute of Electrical Engineers, a member of Sigma Xi and Tau Beta Pi, and a director of The Engineers Club of Baltimore.

John V. Harrington (A'47) was born in New York, N. Y., on May 9, 1919. He received the B.E.E. degree from Cooper Union Institute of Technology in 1940 and the M.E.E. degree from Polytechnic Institute of Brooklyn in 1948. At the present time he is a special graduate student at the Massachusetts Institute of Technology.



J. V. HARRINGTON

Upon completion of his undergraduate work, he spent two years in the power engineering field, first as a student engineer with the Consolidated Edison Company of New York and then as an assistant engineer with the American Gas and Electric Service Corporation. At the beginning of the war he spent several months as a research associate working on search receivers at the Radio Research Laboratory of Harvard University, and then accepted a commission in the Navy.

While a member of the Armed Forces, Mr. Harrington served as an electronic specialist in both the United States and the Pacific theatres. Following separation in 1946, he joined the staff of the Air Force Cambridge Research Laboratories where he is a member of the Communications and Relay Laboratory and has been engaged in research in the fields of microwave relay, data transmission, and storage systems.

Mr. Harrington is a member of Tau Beta Pi and Sigma Xi.

❖

Robert L. Henry (A'50) was born on March 13, 1918, in Rutledge, Tenn. He received the B.S. degree in mechanical engineering in 1939 from Clemson College.



ROBERT L. HENRY

After two years of employment in machine design and production engineering positions, he was called to active duty as a captain with the Army Ordnance Department. The last two years of army service were with the Office of the Chief of Ordnance in connection with the proximity-fuze program.

Upon discharge from the service in 1946 he joined the Ordnance Development Division of the National Bureau of Standards, where he soon became associated with the Bureau's activity in the field of printed electronic circuits. Mr. Henry is at present employed in the Electronics Division of the National Bureau of Standards, conducting research on materials and techniques associated with special production processes and the mechanization of the production of electronics equipment. He is a member of Tau Beta Pi.

❖

Y. W. Lee was born on April 14, 1904, at Macao, China. He received the Sc.D. degree in electrical engineering in 1930 from the Massachusetts Institute of Technology.



Y. W. LEE

Dr. Lee was a professor of electrical engineering at National Tsing Hua University, Peiping, China from 1934 to 1937, at St. John's University from 1942 to 1946, and at Ta Tung University, in Shanghai, China, during the same period.

At present, he is an associate professor of electrical engineering at Massachusetts Institute of Technology.

B. Jennings (S'38) was born on September 13, 1910, at Baltimore, Md. He attended The Johns Hopkins University as a graduate student, specializing in nuclear physics up to the beginning of the war, and received the M.A. degree in 1947.



B. JENNINGS

During the war he became a test equipment design engineer at Western Electric Company at Baltimore, Md. In 1946 he joined the electronics and nuclear physics department of the Westinghouse Research Laboratories and was engaged in radar design. He became one of the members of the nuclear physics group in 1947 which was being reformed after the war, and in 1949 was made section manager in charge of nuclear research at the Westinghouse Research Laboratories, his present position.

❖

Tadashi Nakamura was born on December 23, 1923, at Ujiyamada, Japan. He was graduated from the electrical engineering department of Nagoya Technical College in 1943, and joined the technical staff of the Kawanishi Machine Works.



T. NAKAMURA

At present Mr. Nakamura is affiliated with the Kobe Kogyo Corporation, in Kobe, Japan.

He is a member of the Institute of Electrical Engineering and Electrical Communication in Japan.

❖

Ken-ichi Owaki was born on August 25, 1910, at Kochi, Japan. He was graduated from the electrical engineering department of Nagoya Technical College in 1934, and received the Ph.D. degree from Osaka University in 1948.



KEN-ICHI OWAKI

From 1935 to 1937 Dr. Owaki was an assistant in the science department of Osaka University, until he entered the Kawanishi Machine Works in 1937.

He is a member of the Institute of Electrical Engineering and Electrical Communication in Japan. He is now associated with the Kobe Kogyo Corporation in Kobe, Japan.

❖

Ronold King (A'30-SM'43) was born on September 19, 1905, at Williamstown, Mass. He received the B.A. degree in 1927 and the M.S. degree in 1929 from the University of Rochester, and the Ph.D. degree from the University of Wisconsin in 1932.

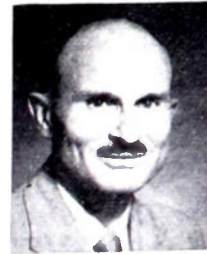

RONOLD KING

He was an American-German exchange student at Munich from 1928 to 1929; a White Fellow in physics at Cornell University from 1929 to 1930; and a Fellow in electrical engineering at the University of Wisconsin from 1930 to 1932. He continued at Wisconsin as a research assistant from 1932 to 1934. From 1934 to 1936 he was an instructor in physics at Lafayette College, serving as an assistant professor in 1937.

During 1937 and 1938, Dr. King was a Guggenheim Fellow at Berlin. In 1938 he became instructor in physics and communication engineering at Harvard University, advancing to assistant professor in 1939 and to associate professor in 1942. He was appointed Gordon McKay professor of applied physics at Harvard University in 1946.

Dr. King is a Fellow in the American Physical Society, the American Association for the Advancement of Science, and the American Academy of Arts and Sciences. He is a member of Phi Beta Kappa and Sigma Xi.

❖

William G. Pfann was born in New York, N. Y., on October 25, 1917. He received the B.Ch.E. degree from Cooper Union in 1940. He is now a research metallurgist on the technical staff of the Bell Telephone Laboratories, Inc., where he has been employed since 1935.



W. G. PFANN

Mr. Pfann has been engaged principally in research on semiconductors for crystal rectifiers and transistors.

He is a member of Tau Beta Pi, the American Physical Society, and the American Institute of Mining and Metallurgical Engineers.

❖

Thomas F. Rogers (M'50) was born in Providence, R. I., on August 11, 1923. He received the B.S. degree in physics from Providence College in January, 1945, and the M.A. degree, also in physics, from Boston University in August, 1949.

From January, 1945, until the end of the

var, he was on the staff of the Radio Research Laboratory of Harvard University, where, as a research associate, he was engaged in radar-countermasures work. For the next year he performed circuit design on projection-type television receivers at the Bell and Howell Company in Chicago, Ill. During much of this time he was also a radio instructor at the Chicago Technical College.



T. F. ROGERS

Mr. Rogers joined the staff of the Air Force Cambridge Research Laboratories in Cambridge, Mass., in August, 1946, and has since been associated with this organization. As a member of the Communications and Relay Laboratory at Cambridge he has engaged in research work in the fields of broad-band microwave relaying, microwave propagation, memory devices, and magneto-acoustic effects. He is a member of the Research and Development Board Subpanel on Special Tubes.

❖

Charles H. Rothauge was born on September 8, 1919, in Baltimore, Md. He received the B.E. degree from The Johns Hopkins University, in 1940, and the Doctor of Engineering degree from the same University in 1949.



C. H. ROTHAUGE

From August, 1941, to April, 1946, he served with the Ordnance Department of the United States Army at Aberdeen Proving Grounds, Md. During this time he conducted tests on aircraft armament. In the spring of 1944, he headed a special test group which conducted high-altitude tests of ordnance material in the Chilean Andes. He was separated from active duty with the rank of major.

During the period from April, 1946, to June, 1949, he was an instructor of electrical engineering at The Johns Hopkins University, and in the summer of 1949 he joined the faculty of the United States Naval Postgraduate School as assistant professor of electrical engineering. Dr. Rothauge is a member of Sigma Xi and Tau Beta Pi.

❖

V. H. Rumsey was born in 1919, in Devizes, England. He graduated from Cambridge in 1941 with an honors degree with distinction in Part III of mathematical tripos. In the United Kingdom civil service, he was a third-class assistant in 1941, a junior scientific officer in 1942, and a scientific officer in 1943 at TRE, Great Malvern, England. From 1943 to 1945 he was the head of the antenna section of the Combined Research Group at the Naval Research Laboratories in Washington, D. C. As a senior scientific officer in the

United Kingdom civil service from 1945 to 1948, he worked as a theoretical physicist at the Canadian atomic energy project. Since 1948, Mr. Rumsey has been supervisor of the Antenna Laboratory at Ohio State University.



V. H. RUMSEY

Mr. Rumsey is a member of the IRE Committee on Antennas and Waveguides, chairman of the Antenna Instrumentation Subpanel of the Research Development Board panel on antennas and propagation, and a member of the URSI #1 Commission on Radio Standards and Measurements.

❖

J. H. Scaff was born in Jackson, Tenn., on October 1, 1908. He received the B.S. degree in chemical engineering from the University of Michigan in 1929. Since then he has been associated with Bell Telephone Laboratories, Inc., as a member of their metallurgical research group.



J. H. SCAFF

Mr. Scaff's work has been principally in the field of semi-conductors for use in rectifiers and transistors and magnetic materials. He is an active participant in the affairs of the Institute of Metals Division of AIME as a member of their Executive Committee and as Chairman of their Membership Committee.

❖

Robert K-F Scal (S'41-A'45-M'47) was born on December 8, 1919, in New York, N. Y. After receiving the B.A. degree in chemistry from Stanford University in 1941, he began graduate work in electrical engineering. These studies were interrupted in 1942, when he accepted a commission in the United States Army Signal Corps.



ROBERT K-F SCAL

Following ES-MWT radar courses at Harvard and the Massachusetts Institute of Technology, Mr. Scal transferred to the Army Air Force Air Materiel Command in 1943. Here he was primarily concerned with electronic maintenance, research, and development.

In 1946 Mr. Scal returned to Stanford University to continue his studies. While at Stanford he designed and built new control circuits for the Stanford ionosphere equipment. He received the M.A. degree in electrical engineering in 1946, and the professional degree of Electrical Engineer in 1947.

Since 1947 Mr. Scal has been associated with the Electronics Division of the National Bureau of Standards, where he has been working on miniaturization of electronic equipment and components, and on development of new techniques and materials for production of such equipment.

❖

Edward R. Schatz (A'44) was born in St. Marys, Pa., in 1921. He received the B.S. degree in 1942 and the M.S. degree in 1943, both from the Carnegie Institute of Technology.



EDWARD R. SCHATZ

From 1943 to 1946 he was employed by the Manhattan District Project at the University of Chicago and Los Alamos Scientific Laboratory. He returned to Carnegie Tech in 1946 as an instructor in electrical engineering, and completed the work for the Doctor of Science degree in 1949.

Dr. Schatz is now assistant professor of electrical engineering and industrial administration at Carnegie Tech. He is a member of Eta Kappa Nu, Tau Beta Pi, and Sigma Xi.

❖

Gustave Shapiro (A'43) was born in New York, N. Y., on July 6, 1917. He attended George Washington University. Following



GUSTAVE SHAPIRO

two years of employment in test and development work, he became a project engineer at the Eatontown Signal Laboratory in 1942. In 1945 he joined the Evans Signal Laboratory, where he worked on direction-finding antenna and miniaturization problems. From 1946 to 1947 he was engaged in the development of intermediate-frequency amplifiers for moon radar equipment at the Coles Signal Laboratory.

Since 1947 Mr. Shapiro has been on the staff of the Electronics Division of the National Bureau of Standards, where he works on the development of unclassified miniaturization techniques. He is a member of the Research and Development Board Subpanel on Miniature Components and Packaged Sub-Assemblies.

Shigeo Terahata was born on July 14, 1917, at Tokyo, Japan. He received the B.E. degree in 1941 from Tokyo University, and then entered the Kawanishi Machine Works. Mr. Terahata is now employed by the Kobe Kogyo Corporation in Kobe, Japan.



SHIGEO TERAHATA

He is a member of the Institute of Electrical Engineering and Electrical Communication in Japan.



Lester C. Van Atta (M'42-SM'43) was born in Portland, Ore., on April 18, 1905. He received the B.A. degree in 1927 from Reed



L. C. VAN ATTA

College; the M.S. degree in 1929, and the Ph.D. degree in physics in 1931 from Washington University in St. Louis, Mo. Dr. Van Atta conducted research at Washington University, Princeton University, and also at the Radiation Laboratory and in the physics department of the Massachusetts Institute of Technology. He was head of the Antenna Research Branch of the Naval Research Laboratory, from 1945 to 1950. His present position is head of the Antenna Laboratory and member of the Advisory Council of the Hughes Aircraft Company Research and Development Laboratories in Culver City, Calif.

Dr. Van Atta is past Chairman of the Panel on Antennas and Propagation of the Research and Development Board. He served on the following IRE committees: Research, 1946-1947, 1949-1950; Antennas and Wave Guides, Chairman 1949-1950; and the Standards, 1949-1950. He has also served as Chairman of the Administrative Committee of the IRE Professional Group on Antennas and Propagation. He is currently Chairman of the United States Commission 6 of the International Scientific Radio Union. Dr. Van Atta is a Fellow of the Physical Society.

His special fields of interest have included high resistors, electron scattering in gases, high-voltage generation, nuclear reactions by bombardment, and the microwave antenna theory and design.

Jerome B. Wiesner (S'36-A'40-SM'48) was born in Detroit, Mich., on May 30, 1915. He received the B.S. degree in 1937, the M.S. degree in 1940, and the Ph.D. degree in May, 1950, all from the University of Michigan.



J. B. WIESNER

He was chief engineer of the Acoustical and Record Laboratory of the Library of Congress from 1940 to 1942, at which time he became a member of the staff of the Radiation Laboratory at the Massachusetts Institute of Technology. In 1945, Dr. Wiesner went to the Los Alamos Laboratory in New Mexico as a member of the staff, returning to MIT in 1946. He has been assistant director of the Research Laboratory of Electronics at MIT for the past three years and is now associate director. In addition to his work in the laboratory, he is professor of electrical engineering at MIT.

Dr. Wiesner is a member of the Acoustical Society of America, the Federation of American Scientists, and the American Association for the Advancement of Science. He is also a member of Eta Kappa Nu, Sigma Xi, and Phi Kappa Phi.



Everard M. Williams (S'36-A'41-SM'44) was born in New Haven, Conn., in 1915. He received the B.E. degree in 1936



E. M. WILLIAMS

and the Ph.D. degree in 1939, both from Yale University. During the summer of 1937 he was employed by the General Electric Company, and during the academic year 1938-1939, he was the recipient of a Charles A. Coffin Fellowship from this company. From 1939 to 1942, he was an instructor in electrical engineering at the Pennsylvania State College. From 1942 to 1945, he served as the chief engineer of the development branch, Special Projects Laboratory, Radio and Radar Subdivision, ATSC, Wright Field, Ohio. He subsequently

received the President's Certificate of Merit for outstanding service in this post.

In 1945, Dr. Williams was appointed associate professor of electrical engineering at the Carnegie Institute of Technology, in Pittsburgh, Pa., where he is now a professor. He is also serving as expert consultant to the Research and Development Board of the National Military Establishment.

Dr. Williams was the recipient of the 1946 Eta Kappa Nu award. During 1947-1948 he served as Chairman of the IRE Pittsburgh Section.



Raymond M. Wilmotte was born in Paris, France, on August 13, 1901. He took first class honors in Mechanical Science (Engineering) at Cambridge University, England, in 1920, when he received the M.A. degree.



R. M. WILMOTTE

Until 1929 he was engaged at the National Physical Laboratory in research on radio measurements, direction finding, wave propagation, and theory and design of antennas.

In 1929 Mr. Wilmotte came to the United States and worked until 1931 at Boonton Aircraft Corporation on research and development on aircraft equipment, including antennas and blind landing systems. He opened a consulting practice in 1931 on being requested by Commander Craven to solve the problem of a client of his, Station WFLA, which interfered with Station WTMJ. This led him to design, install, and test the first directional antenna used for this purpose. He has appeared in patent cases and before the Federal Communications Commission. During the war he carried out design and development contracts for the Signal Corps, the Navy, and NDRC. At the request of the latter he established a small manufacturing facility for specialized production where one of the projects was the modification of radar units to meet the Japanese Kamikaze menace. For this work he was awarded the Bureau of Ordnance Development Award.

Mr. Wilmotte invented the antifading broadcast antenna recently used in Germany. Recently he has demonstrated the possibility of receiving a weak FM signal in the presence of a strong one in the same frequency band. He was one of the original members of the "Ad Hoc" Committee of the Federal Communications Commission.



Correspondence

Propagation of UHF and SHF Waves Beyond the Horizon*

Calculations of ground-wave propagation beyond the horizon by the usual methods are severely limited at frequencies above 200-500 megacycles by the uncertainty in the choice of effective antenna heights, and the clearance or lack of clearance over some intervening obstacle is frequently more important than the antenna heights at the terminals. It now appears that a useful parameter is the actual clearance divided by the height of the first Fresnel zone. The diffraction loss over a perfect sphere, as well as diffraction over a knife edge and reflection from a plane surface, can be expressed in terms of this ratio, and the results are illustrated on Fig. 1.

The plane earth reflection theory shows the familiar series of maxima and minima as the clearance is increased, but this theory fails at grazing angles and in the region of the nulls because the earth's surface is not plane. The diffraction loss over a knife-edge obstruction results in relatively minor oscillations around the free-space field as the clearance is increased, but shows a 6-db loss at grazing angles; this theory, in effect, assumes

unlimited antenna heights and a zero reflection coefficient.

On the other hand, the received field beyond the horizon of a perfectly smooth sphere decreases exponentially (linearly in decibels) and depends to some extent on the antenna heights. The dashed lines connecting these data on the figure with the curve for reflection from a plane surface show the region where neither of the three theoretical approaches is quite applicable and some interpolation is necessary. It will be noted that the smooth-sphere solution tends to approach the solution for knife-edge diffraction as the antenna heights increase.

The exponential decrease in field intensity beyond the line of sight in the smooth-sphere solution is caused by phase cancellation, and the net result is critically dependent on the smoothness of the sphere in much the same way as the results of the plane earth theory are critically dependent on the flatness of the plane. More exactly, the particular phase distribution that is produced by the smooth sphere in the region above the earth can be changed significantly either by the lack of a smooth surface or by the lack of a homogeneous atmosphere, but only the former effect is considered in this note. Variations in the terrain tend to upset this critical phase balance with the result that the field intensity is usually increased. Within the

line of sight a rough surface diffuses the reflected "ray," and thereby reduces the effective reflection coefficient and prevents deep cancellations; beyond the line of sight a rough surface has a similar effect, but it is more difficult to visualize because of the failure of the ray concept.

When the deviations from a perfectly smooth surface are very small compared with the first Fresnel zone, the smooth earth theory is expected to be applicable, but when the variations are comparable to or greater than the first Fresnel zone, the effective reflection coefficient approaches zero and, in the limit, the mean field intensity is expected to approach the value indicated by the knife edge or "rough sphere" diffraction theory.

Some experimental results in the 4,000- to 4,600-Mc range are shown on the figure. The circles were obtained on a very smooth path (Utah Salt Flats) by varying the antenna heights at both ends simultaneously. The crosses were measured on a "rough" path by varying only the antenna height at the New York end of the circuit. A profile of the latter path is shown in a recent paper by Durkee.¹ Mean values of ground wave

¹ A. L. Durkee, "Results of microwave propagation tests," Proc. I.R.E., vol. 36, pp. 197-205; February, 1948.

* Received by the Institute, February 28, 1950.

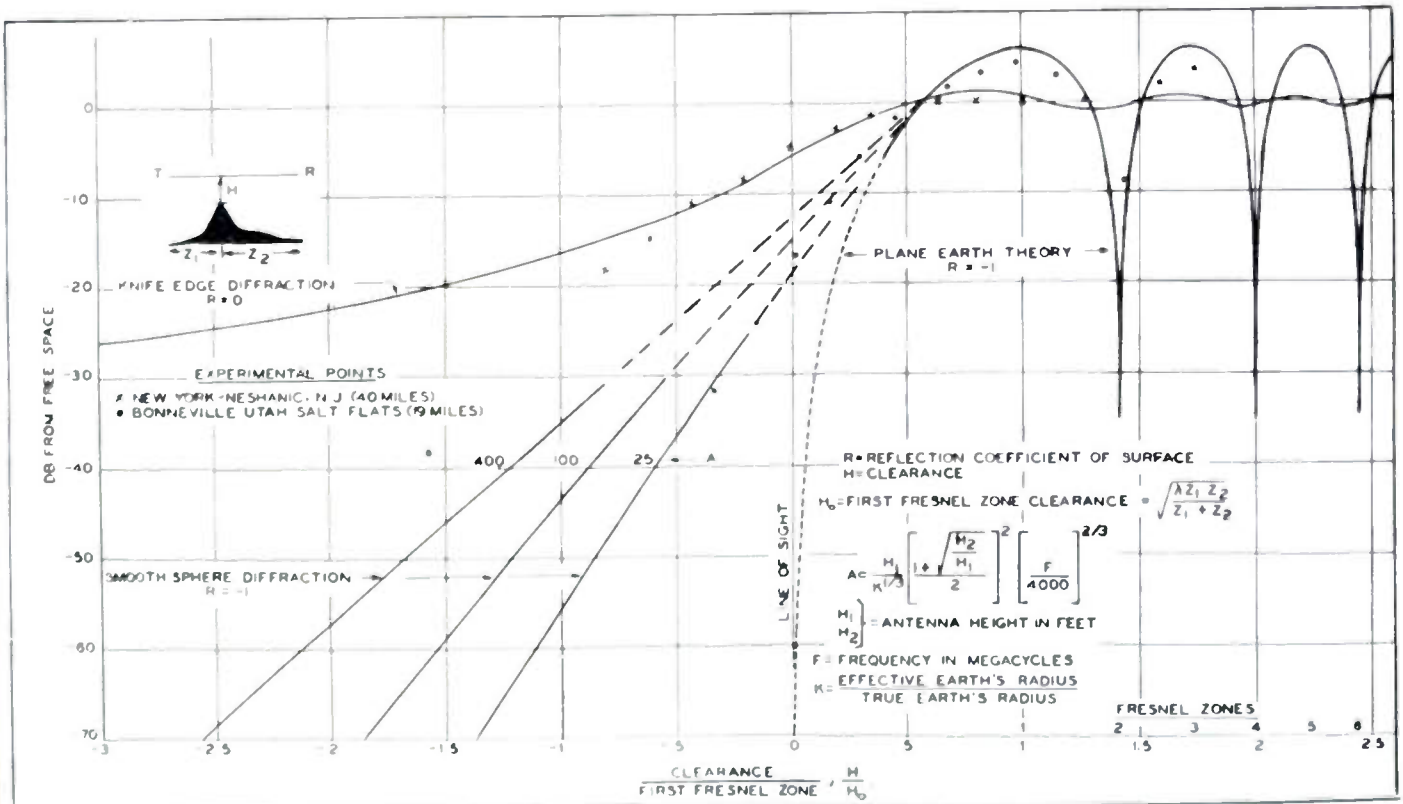

Fig. 1—Effect of clearance on radio transmission.

field intensity that are greatly in excess of those predicted by the smooth sphere theory have also been observed at much lower frequencies, notably in the 40- to 50-Mc range.²

This method of presenting radio propagation theory emphasizes both the importance of clearance and the great range of values of field intensity that can be obtained beyond the horizon. It presents an explanation of the enhancement of field intensity beyond the horizon to values greatly in excess of those calculated on the assumption that the surface of the earth is perfectly smooth. In addition, the rough sphere concept suggests that microwave transmission at distances far beyond the horizon may have sufficient strength and reliability to be useful for communication purposes, when reasonable increases in transmitter power become available. The Bell Telephone Laboratories plans to test this possibility.

KENNETH BULLINGTON
Bell Telephone Labs.
New York, N. Y.

² K. Bullington, "Radio propagation variations at vhf and uhf," Proc. I.R.E., vol. 38, pp. 27-32; January, 1950.

Suggestions to Technical Writers*

Robert Hamlett's article on "Suggestions for the Preparation of Technical Papers" in the March, 1950, issue of the PROCEEDINGS OF THE I.R.E. is very well done.

There are, however, some minor facets of his presentation that might be better illuminated; for example, that paragraph which refers to personal pronouns.

It just so happens that the article in the February issue of *Physics Today* on "Physicists and the English Language," by William Fuller Brown, Jr., provides these very well-illuminated facets of this subject. Paper-writing engineers would do well to read it also, because it recommends a much less stuffy and pedantic style.

Engineers would make their papers much more readable and more easily digestible if they restrained their natural inclinations to exhibit their own profundity by omitting long-winded mathematical approaches where they can tell their stories in physical terms.

Who among us takes the time to check the involved mathematical presentations of most IRE papers, even if they be squarely in our own special field of interest? We are not carving out the ten commandments in indestructible stone tablets for the guidance of all eternity! We are merely trying to explain to our fellow engineers what we have found in some particular crevice of nature's secrets, so why not be a little more natural and direct when we set this down on paper? Besides, if our paper-publication object is to disclose and disseminate new information widely, we will never accomplish this by involved, abstract mathematics, where the language of physics will do the same thing better.

* Received by the Institute, March 25, 1950.

If we are falling into the mathematical footsteps of the nuclear physicists, let us not forget that, beginning in the cob webbed cubicles of the ancient alchemists, it has taken two thousand years to transmute the elements! Immanuel Velikovsky's Preface to his learned and provocative "Worlds in Collision" aptly says: "This book is written for the instructed and uninstructed alike. No formula and no hieroglyphic will stand in the way of those who set out to read it," and "If . . . evidence does not square with formulated laws, it should be remembered that a law is but a deduction from experience or experiment, and therefore laws must conform with facts, not facts with laws."

BENJAMIN MIESSNER
Miessner Inventions, Inc.
Morristown, N. J.

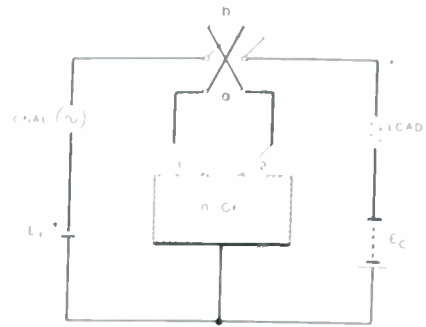

Fig. 1.—Circuit demonstrating reversible properties of an *n* germanium transistor amplifier. When switch is in position *a*, electrode 1 is emitter, 2 is collector. When switch is in position *b*, 2 is emitter, 1 is collector.

Representative properties of such a transistor appear in Fig. 2. It may be seen that transmission is substantially the same in each direction at comparable values of emitter bias current.

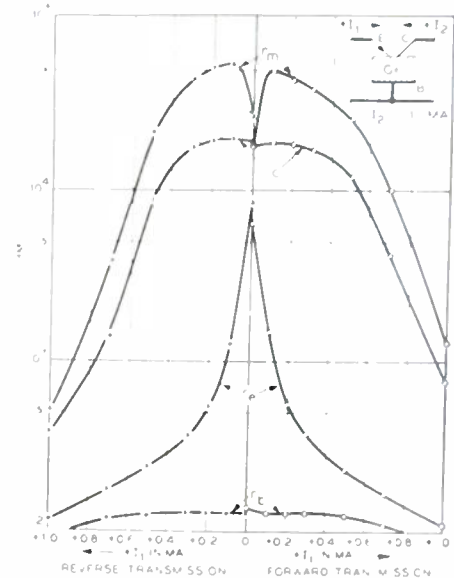

Fig. 2.—Small signal impedances of a reversible *n*-germanium transistor. See footnote reference 4 for definitions of symbols.

In the *p*-germanium transistor the emitter is formed⁴ and in this case also it is feasible to produce reversible transistor amplifiers.

The term "reversible" rather than "bilateral" has been used herein because at any given instant the device is unilateral, even though the amplifying direction can be reversed by changing the electrode biases.

W. G. PFANN
Bell Telephone Laboratories, Inc.
Murray Hill, N. J.

The Transistor as a Reversible Amplifier*

In the transistor described by Bardeen and Brattain two closely spaced electrodes of the point-contact type rest on the surface of a block of *n* germanium which has a large-area base electrode.^{1,2} The point electrodes have been designated emitter and collector and, in conjunction with the base, they comprise the input and output terminals, respectively, of the transistor.

An interesting feature of the transistor, especially as compared with a triode vacuum tube, is the dual nature of the point electrodes. Either can be used as emitter or as collector, provided it is properly biased. For an electrode to function as a collector it is usually biased in the reverse, or high-impedance, direction, while to act as an emitter it is biased in the forward, or low-impedance, direction.

An electrical treatment known as "forming" has been described for the *n*-germanium transistor which increases the effectiveness of an electrode as a collector.^{2,3} Such forming need not seriously impair the operation of an electrode as an emitter. Hence, it is feasible to form both rectifying junctions and to obtain thereby an improved, reversible transistor amplifier. By proper control of the forming operations, the properties of the device can be made substantially the same in both directions. A number of such transistors have been made in the laboratory.

The operation of a reversible *n*-germanium transistor is illustrated by the circuit of Fig. 1, which, however, is not intended to represent an actual application.

* Received by the Institute, May 25, 1950.

¹ J. Bardeen and W. H. Brattain, "The transistor, a semi-conductor triode," *Phys. Rev.*, vol. 74, p. 230; July 15, 1948.

² J. Bardeen and W. H. Brattain, "Physical principles involved in transistor action," *Phys. Rev.*, vol. 75, pp. 1208-1225; April 15, 1949. Also *Bell Sys. Tech. Jour.*, vol. 28, pp. 239-277; April, 1949.

³ J. Bardeen and W. G. Pfann, "Electrical forming of *n*- and *p*-germanium transistors," *Phys. Rev.*, 1950.

⁴ W. G. Pfann and J. H. Scaff, "The *p*-germanium transistor," Proc. I.R.E., this issue, pp. 1151-1154. Also *Phys. Rev.*, vol. 76, p. 459; August, 1949.

Institute News and Radio Notes

TECHNICAL COMMITTEE AND PROFESSIONAL GROUP NOTES

The Standards Committee, under the Chairmanship of J. G. Brainerd, held a meeting on July 20. Arthur Van Dyck, IRE Representative on ASA Section Committee Z-17 (Preferred Numbers), will write a paper on Preferred Numbers for publication in the PROCEEDINGS OF THE I.R.E. A Subcommittee of the Standards Committee has been formed for the purpose of defining terms of a general nature not in the field of any one technical committee. The list of terms collected will be submitted to the Standards Committee and given to the various technical committees for defining. If, upon presentation of these terms to the Standards Committee, it is found that no particular committee wishes to define them, they will then be defined by this Subcommittee. The Standards Committee approved the following standards: "Proposed Standards on Wave Propagation, Definitions of Terms, 1950," and "Standards on Television, Methods of Measurement of Time of Rise, Pulse Width and Pulse Timing of Video Pulses in Television." Both of these standards are scheduled for publication in the November issue of the PROCEEDINGS OF THE I.R.E. A supplement to the "Standard on Television: Methods of Measurement of Television Receivers, 1948," was also approved. This supplement covers intercarrier sound receivers. It will not be published separately but a mimeographed copy will be included with each copy of the 1948 Standards. "Definitions in Network Topology," prepared by the Circuits Committee, received approval of the Standards Committee. The publication date for these definitions has not been scheduled. The IRE will participate in a Joint IRE/AIEE/RDB Conference on Electron Tubes for Computers which is expected to be held in the Fall. Complete details will be announced. A new committee, to be known as the Joint IRS Committee for Television, has been formed by IRE, RTMA, and SMPTE, to avoid duplication of effort in the preparation of standards in the fields associated with television. The initials "IRS" represent the first letter of each sponsor's title. Axel G. Jensen, Millard W. Baldwin, Jr., and R. L. Garman were appointed as the IRE Representatives to the Committee. . . . A Joint IRE/AIEE Committee on Noise Definitions has also been organized with the specific task of critically reviewing all existing noise definitions and adding any such new definitions as might be required. The IRE personnel on this Committee is as follows: Stanford Goldman, Syracuse University; Jerry Minter, Measurements Corporation; A. W. Friend, RCA; Ray Moffett, NBC; Claude Shannon, BTL; and R. M. Ryder, BTL. . . . The Third Annual Joint IRE/AIEE Conference on Electronic Instrumentation in Nucleonics and Medicine will be held on October 23, 24, and 25, at the Hotel Park Sheraton, New York, N. Y. For details on the Conference, see page 1224. . . . The re-

cently organized IRE Professional Group on Radio Telemetry will now be known as the IRE Professional Group on Radio Telemetry and Remote Control. . . . The IRE Professional Group on Vehicular and Railroad Radio Communications has also changed its title to the IRE Professional Group on Vehicular Communications. . . . The Joint Technical Advisory Committee held a meeting on August 3 under the Chairmanship of J. V. L. Hogan. Table #1, which appears in Volume 4 of JTAC, has been revised.

NOTICE

Effective January 1, 1951, the Student dues will be \$5.00 per year. Payments at the old rate of \$3.00 will be accepted through December 31, 1950. All payments received thereafter will be at the new rate.

Signal Corps Center Recruits Civilian Technical Personnel

The U. S. Signal Corps Center Headquarters at Fort Monmouth, N. J., has announced position vacancies for communication and electronic engineers, teachers, and technical writers in grades ranging from GS-5 to GS-12. Civilian technical personnel with extensive professional experience who can qualify for the higher grades in these categories are particularly needed.

For further information and for making application, write to the Civilian Personnel Branch, Building T-530, Fort Monmouth, N. J.

Applicants should submit a completed Standard Form 57, "Application for Federal Employment," for review before coming to Fort Monmouth for a personal interview. Standard Form 57 can be obtained at a first or second class post office.

3-DAY PROGRAM ANNOUNCED FOR RADIO FALL MEETING

The three-day Radio Fall Meeting, sponsored jointly by the RTMA and IRE, will convene on Monday, October 30, at the Hotel Syracuse, Syracuse, N. Y. The tentative program, announced by Virgil M. Graham, chairman, is as follows:

Monday, October 30, 1950

9:30 A.M.—General Session, R. R. Batcher, Presiding. Welcome by Chairman of Syracuse IRE Section; "A Broad Range Oscillator for Television Testing," by H. A. Finke and J. Ebert, Polytechnic

Research and Development Corp.; "Wide-Band Impedance Matching Between a Resonant Antenna and a Line," by H. A. Wheeler, Wheeler Laboratories, Inc.; "High-Frequency Crystal Calibrator Design," by J. B. Minter, Measurements Corporation; "The Determination of Amplifier Sensitivity With the Aid of the Noise Diode," by W. K. Squires, Sylvania Electric Products Inc.

2:00 P.M.—Quality Control Session, J. R. Steen, Presiding. (Sponsored by IRE Professional Group on Quality Control.) "Application of Statistical Quality Control in Manufacture of Electronic Products," by E. R. Ott, Rutgers University, and George Scheel, Sonotone Corp.; "The Quality Control Indicator," by C. J. Falk, General Electric Co.; "The Control of Averages in Radio Tube Manufacture," by A. K. Wright, Tung-Sol Lamp Works, Inc.; "The Human Aspect of Engineering Quality into the Product," by Carl Gartner, Allen B. DuMont Labs., Inc.

8:00 P.M.—Joint Session with Technology Club of Syracuse.

Tuesday, October 31, 1950

9:00 A.M.—Television Session, R. A. Hackbusch, Presiding. (Sponsored by the IRE Professional Group on Broadcast and Television Receivers). "A Study of Permanent Magnet Focusing Devices for Television Picture Tubes," by Kenneth James and R. T. Capodanno, Emerson Radio & Phonograph Corp.; "The Application of a New Low-Noise Double Triode as an RF and IF Amplifier in Television Receivers," by R. M. Cohen, RCA; "Consideration of Optimum Use of Picture Tubes," by W. B. Whalley, Sylvania Electric Products Inc.; "Evaluation of Performance Characteristics of Cathode-Ray Tubes for Use in Television Receivers," by K. A. Hoagland, Allen B. DuMont Labs., Inc.

2:00 P.M.—Television Session, D. D. Israel, Presiding. (Sponsored by IRE Professional Group on Broadcast and Television Receivers). "The Technical Aspects of Phonevision," by E. M. Roschke, Zenith Radio Corp.; "An Analysis of Color Television," by A. V. Loughren, Hazeltine Electronics Corp.

6:45 P.M.—Radio Fall Meeting Dinner. Toastmaster, W. R. G. Baker; Speaker, R. C. Sprague, President of RTMA.

Wednesday, November 1, 1950

9:00 A.M.—Audio Session, O. L. Angevine, Jr., Presiding. (Sponsored by the IRE Professional Group on Audio). "The Mechanics of the Phonograph Pickup," by T. E. Lynch, Brush Development Co.; "Lightweight Pickup and Tone Arm," by C. R. Johnson and L. J. Anderson, RCA; "Sound Pickup in High Ambient Noise," by Wayne Beaverson, Electro-Voice, Inc.; "RTMA Standards For Sound Equipment," O. L. Angevine.

Institute News and Radio Notes

NUCLEAR-MEDICAL INSTRUMENT CONFERENCE PROGRAM ANNOUNCED

Over 800 persons are expected to attend the Third Annual Joint AIEE/IRE Conference on Electronic Instrumentation in Nucleonics and Medicine to be held on October 23, 24, and 25, 1950. The location of this meeting, which will feature technical papers and discussions on current problems and advances in the vital fields of nuclear and medical science, is the Park Sheraton Hotel, New York, N. Y.

During the last two days of the conference, many interesting and informative exhibits of instruments and related products will be displayed by leading companies in the field. Those attending the meeting will have an opportunity to see many of the devices, some in actual operation, which will be discussed in the technical papers.

Highlighting the conference will be a special evening round-table discussion during which a number of prominent authorities will discuss "The Effects of Atomic Weapons," a government publication containing recently declassified information on this vital and timely subject.

The registration fee for the conference is \$3.50 per person. All papers and discussions presented during the meeting will be published in a proceedings of the Conference, available at a later date for \$4.00 per copy.

The tentative program of the Conference has been announced as follows:

Monday, October 23, 1950

- 10 A.M.—"The Needs of Physiology and Medicine for Better Instrumentation for the Measurement of Respiratory Gases," O. Fenn, University of Rochester, Rochester, N. Y.; "Analysis of Respiratory Gases with Mass Spectrometer," A. Hitchcock, Ohio State University, Columbus, Ohio; "The Application of the Infrared Spectrophotometer to the Analysis of Respiratory Gases," E. D. Palmes, New York University, Bellevue Medical Center, New York, N. Y.; "The Measurement of Oxygen in Gases by Paramagnetism," O. Beckman, South Pasadena, Calif.
- 2 P.M.—"The Delineation of Intracranial Structure with the Aid of Ultrasonic Waves," R. H. Bolt, H. T. Ballantine, G. R. Ludwig, and I. E. Hueter, MIT, Cambridge, Mass.; "The Localization of Brain Tumors with Radioactive Isotopes," Theodore Fields, Veterans' Hospital, Hines, Ill.; "The Use of Isotopes in the Measurement of Body Fluids," J. L. Nickerson, Columbia University, New York, N. Y.; "Developing of Sectioning Techniques for Electron Microscopy," (to be read by S. G. Ellis), James Hillier, RCA Laboratories, Princeton, N. J.

Tuesday, October 24, 1950

- 10 A.M.—"General Survey of Health Physics Instrumentation Problems," H. M. Parker, General Electric Co., Hanford Works, Richland, Wash. "Calibration of Radiation Detection Instruments," L.

D. Marinelli, Argonne National Laboratory, Chicago, Ill.; "A Calorimetric Method of Measuring High X Ray Intensities," W. T. Ham, Jr., Medical College of Virginia, Richmond, Va.; "Consideration of Radiation from High Voltage Cathode Ray Tubes," O. W. Pike, General Electric Co., Schenectady, N. Y.

- 2 P.M.—"Fast Neutron Dosimetry and Related Problems," G. S. Hurst and R. H. Ritchie, Oak Ridge National Laboratory, Oak Ridge, Tenn.; "New Medical Applications of Tracers," A. H. Holland, Armour Research Foundation, Chicago, Ill.; "Electronics and Nucleonics Applied to Enzymes and Viruses," E. C. Pollard, Yale University, New Haven, Conn.

Following the afternoon session will be the Annual meeting of the IRE Professional Group on Nuclear Science.

- 8 P.M.—"Round Table Discussion on 'The Effects of Atomic Weapons'." Speakers to include Brig. Gen. J. P. Cooney, AEC; H. D. Bowman, Drexel Institute and Consultant to AEC; and Herbert Scoville, Armed Forces Special Weapons Project.

Wednesday, October 25, 1950

- 10 A.M.—"Manufacture and Quality Control of Geiger Tubes," D. L. Collins, Victoreen Instrument Co., Cleveland, Ohio, and D. Atchley, Tracerlab, Boston, Mass.; "Boron-Lined Neutron Proportional Counters," W. W. Schultz, General Electric Co., Schenectady, N. Y.; "Design of a Commercial Scintillation Counter," E. W. Jervis, Jr., W. S. MacDonald Co., Cambridge, Mass.; "Testing Photomultipliers for Scintillation Counting," R. W. Engstrom, RCA Laboratories, Princeton, N. J.

- 2 P.M.—"Scintillation Counter Instrumentation," G. Cowper, Chalk River, Ont., Canada; "Recent Advances in Electron Techniques in Canada," N. F. Moody, Chalk River, Ont., Canada; "Fast Counting," Martin Deutsch, MIT, Cambridge, Mass.; "New Developments in Mass Spectrometry," John Hipple, National Bureau of Standards, Washington, D. C.

GENERAL ELECTRIC COMPANY DEVICES NEW TYPE COUNTER

A new instrument for the detection and counting of alpha, beta, and gamma particles has been announced by General Electric's special products division. Called a Universal scintillation counter, the device provides low background alpha counting and high-efficiency beta and gamma counting, according to engineers of the company's General Engineering and Consulting Laboratory who worked on its development.

It is intended for use in counting samples and smears in health physics work, for analytical determination of disintegration rate, and in counting radiation of ore samples. The sampling chamber can accommodate specimens up to two inches in diameter.

Calendar of COMING EVENTS

National Academy of Sciences Meeting, G. E. Research Laboratory, Schenectady, N. Y., October 9-11

SMPTTE Semiannual Convention, Lake Placid, N. Y., October 16-20

IRE-AIEE Conference on Electronic Instrumentation in Nucleonics and Medicine, Hotel Sheraton, New York, N. Y., October 23-25

Audio Fair, Sponsored by Audio Society of America, Hotel New Yorker, New York, N. Y., October 26-28

Optical Society of America Meeting, Hotel Statler, Cleveland, Ohio, October 26-28

Radio Fall Meeting, Syracuse, N. Y., October 30, 31, November 1

National Conference of the IRE Professional Group on Vehicular Communications, Detroit, Mich., November 3

IRE-AIEE Conference on Electron Tubes for Computers, Washington, D. C., December 14-15

AAAS Annual Meeting, Cleveland, Ohio, December 26-30

1951 IRE National Convention, Waldorf-Astoria Hotel, New York, N. Y., March 19-22

IRE Southwestern Conference, Dallas, Texas, April 20-21, 1951

SECOND CALL!

AUTHORS FOR IRE NATIONAL CONVENTION!

E. Weber, Chairman of the Technical Program Committee for the 1951 IRE National Convention, requests that prospective authors submit the following information:

1. Name and address of author
2. Title of paper
3. A 100 word abstract and additional information up to 500 words (both in triplicate) to permit an accurate evaluation of the paper for inclusion in the Technical Program.

Please address all material to E. Weber, Microwave Research Institute, Polytechnic Institute of Brooklyn, 55 Johnson Street, Brooklyn 1, N. Y. The deadline for acceptance is November 20, 1950. Your prompt submissions will be appreciated.

IRE People

Frederick A. Kolster (A'12-M'13-F'16-L'49), who had been engaged as a consulting engineer at



F. A. KOLSTER

San Francisco, Calif., of later years, and who was an early and prominent member of the Institute, passed away in July. A pioneer specialist in the fields of radio engineering and radio physics, Mr. Kolster earned recognition for his contributions to the development of radio.

Born on January 13, 1883, at Geneva, Switzerland, Mr. Kolster was educated in New England public schools and was graduated from Harvard University in 1908.

He was an assistant to John Stone Stone and Lee de Forest in the early days of radio, and an assistant to Fritz Lowenstein in 1911 and 1912. Until 1921 Mr. Kolster was chief of the radio section of the National Bureau of Standards, Washington, D. C., and later served as Consultant at the Bureau of Ships, Electronics Division, with the Navy Department in Washington.

Joining the Federal Telegraph Company in Palo Alto, Calif., in 1921 as a research engineer, he remained there until 1931 when he went to the International Telephone and Telegraph Corporation. He also was affiliated with the Radio Navigational Instrument Corporation.

Mr. Kolster was responsible for numerous radio devices, ranging from precision-measuring instruments to special forms of television antennas.

He was a Director of the Institute during 1933 and 1935, and was active on the following IRE Committees: Admissions, 1935-1936; Membership, 1930-1932; Nominations, 1933; Papers, 1913; Sections, 1933; Standardization, 1914-1921, 1925, 1927-1931; Subcommittee on Marine and Direction-Finding Receivers, Chairman, 1930-1931; Wave-length Regulation, 1916; and Wave Propagation, 1937-1938.

Eric Walker (M'47) became executive secretary of the Research and Development Board on August 1, and is on leave from Pennsylvania State College, where he is director of the Ordnance Research Laboratory and the head of the electrical engineering department.

Dr. Walker has been associated with the board during the past year as a consultant to its committee on electronics. He recently took a leave from the college to serve as deputy chairman of a weapons panel in the National Research Council. He has been with Pennsylvania State College since July, 1945, and during that time he inaugurated a series of annual conferences on the administration of research. These were attended by administrators of university and industrial research organizations.

During the war Dr. Walker was assistant director of the Underwater Sound Laboratory at Harvard University and served with the Office of Scientific Research and Development. From 1940 to 1942 he was head of the Electrical Engineering Department of the University of Connecticut and served in the same capacity at Tufts College, Medford, Mass., from 1934 to 1940.

While with the University of Connecticut he was in charge of research for the electrical division of the Colt's Patent Firearms Manufacturing Company, and while at Tufts College was consulting engineer for the Doble Engineering Company as well as technical assistant to the president.

Dr. Walker serves as consultant to the Koppers Company, Pullman-Standard Car Manufacturing Company, and the Mine Safety Appliances Company, and is a licensed professional engineer in the States of Pennsylvania and Connecticut. He has invented a polar vector indicator and a gallstone detector, and is the author of several books and papers in technical magazines.

He was born in Long Eaton, England. Dr. Walker holds the Doctor of Science degree from Harvard University. He is a Fellow in the AIEE, the Acoustical Society of America, and the American Physical Society; and is a member of the American Society for Engineering Education and the American Institute of Physics. In 1948 he was awarded the President's Certificate of Merit for outstanding service for the Armed Forces during World War II.



Donald E. Smith (A'37), formerly an engineer for the electronics division of Sylvania Electric Products Inc., Boston, Mass.,



DONALD E. SMITH

has been transferred to the renewal tube sales department of the radio tube division. He will serve as a sales representative operating out of Emporium, Pa., but will be located at St. Louis, Mo.

Mr. Smith joined the Sylvania engineering staff at the Product Development Laboratories, Kew Gardens, L. I., N. Y., in October, 1948, and was transferred to the engineering staff of the electronics division at Boston in January, 1949.

He received the B.S. degree in electrical engineering from Purdue University, where he was graduated with distinction. Mr. Smith is a member of Tau Beta Pi and Eta Kappa Nu.

John F. Bates (A'36-SM'45), instructor in physics at the University of Illinois, died recently. He was a native of Philadelphia, Pa., and was born on November 24, 1892.

He was graduated from the U. S. Naval Academy in 1915 with the B.S. degree, and attended Harvard University. From 1930 through 1932 he was an instructor in radio engineering, crypt analysis, and communications, at the postgraduate school at Annapolis, and for the following two years was on service at the Underwater Sound Research on the U.S.S. *Eagle*. From 1935 to 1936 he was electronics assistant to the director of the Naval Research Laboratory at Anacostia, Washington, D. C. He then was an inspector of electronics materials at RCA in Camden, N. J., and electronics director of all radio contractors in the Chicago area.

Ralph A. Hackbusch (A'26-M'30-F'37), president and managing director of Stromberg-Carlson Co. Ltd., Canada, was elected



R. A. HACKBUSCH

president of the Radio Manufacturers Association of Canada at the twenty-first annual meeting held in June. The Manufacturers also elected A. B. Hunt (A'43-SM'43), manager of communications equipment division of the Northern Electric Company Ltd., Montreal, as vice-president of the association, and re-appointed S. D. Brownlee as executive secretary.

Mr. Hackbusch has been associated with development of the radio industry in Canada for many years, and was elected vice-president of the Radio Manufacturers Association two years ago.

From October, 1940, to 1943, Mr. Hackbusch was vice-president and director of the Radio Division of the Canadian Government Research Enterprises Ltd. Mr. Hackbusch returned to Stromberg-Carlson Company Ltd., as vice-president and managing director in November, 1943, and was elected president in 1949. Mr. Hackbusch is also president of the Canadian R.T.P.B., a member of the Radio Club of America, and a member of the Association of Professional Engineers of Ontario. He was vice-president of the IRE in 1944.

Nicholas M. Oboukhoff (M'23-SM'43), research professor emeritus of electrical engineering and professor emeritus of mathematical physics at Oklahoma Agricultural and Mechanical College, died recently at Stillwater, Okla. He was 77.

Mr. Oboukhoff received the physics and mathematics degree from the University of Moscow, Russia, and the degree of engineer technologist, from the Technological Institute of Kharkov, Russia. He earned the Ingenieur Electricien Diplome E.S.E., Ecole Superieure d'Electricite de Paris, France, and the Ph.D. cum laude from the California Institute of Technology. He was a special student in philosophy at the University of Chicago.

He was a designer with the Locomotive Building Works of Kharkov, Russia, during 1904 and 1906, and then went on a technical inspection and study tour through France, Switzerland, England, Belgium, Italy, Austria, Germany, and Egypt. He inspected irrigation and Nile navigation control, as well as irrigation problems in Palestine.

During the years 1911 through 1941, he taught in a trade school in Paris and then became a research engineer. He was associated with several concerns in Petrograd (now Leningrad), among them Siemens and Halske Co. He was Commissioner of Labor in Donetz District and Ural District, Russia, under the Provisional Government during 1918 and 1919. Mr. Oboukhoff was then put in charge of the Irkut River Project (the hydroelectric development of the river). He held patents in France, the United States, and England, dealing chiefly with medium and high-frequency alternators. He was also the author of numerous technical papers published in different languages.

Mr. Oboukhoff was a member of the Sigma Xi and Eta Kappa Nu, and a Fellow of the American Association for the Advancement of Science, the American Geographical Society and the Oklahoma Academy of Science. He was also an accomplished musician.

❖

Homer M. Sarasohn (A'41-M'48) has returned to the United States after spending more than three years at General MacArthur's headquarters in Japan. During his stay, he has assisted and advised the Supreme Commander on communication matters through the Civil Communications Section, and has also assisted the Japanese through that section, as well as helping them in the solution of their industrial engineering problems. His special mission has been rehabilitation and reorientation of the Japanese

communications equipment manufacturing industry.

At the time of Sarasohn's arrival with the Occupation Force, he found that 85 per cent of this industry had been destroyed during the war. This, together with the relatively inadequate level of engineering in Japan at that time, and the feudalistic management practices being used, was a severe obstacle to the re-establishment of a completely stable nation.

He directed his efforts towards the reorganization of the industry and introduced the modern concepts and practices of statistical quality control. His activity was also related to the Japanese Government. He assisted the Ministry of Telecommunications, which owns and operates the telephone and telegraph systems of Japan, the Broadcasting Corporation of Japan, which is government-supported, and the National Rural Police in the revision and modernization of their communications equipment, and also of their procurement specifications and procedures.

Formerly, Mr. Sarasohn was engaged by the Raytheon Manufacturing Company, Waltham, Mass., in its microwave research activity.

❖

E. H. Ulm (M'46), formerly sales engineer for the electronics division, Sylvania Electric Products Inc., has been appointed merchandising manager of the company. He joined the staff of the electronics division of Sylvania Electric in 1945 as a sales engineer.



E. H. ULM

Prior to that time he was associated with the field engineering force of radio division of the Western Electric Company, where he served as an instructor in radar and sonar. During 1943 he served as an antisubmarine warfare field engineer for the Division of War Research, Columbia University.

Mr. Ulm, who is a native of Fort Dodge, Iowa, was graduated from Carleton College in 1938 and later did postgraduate work at Carleton College, the University of Iowa, and Northwestern University. He is also a member of the AIEE and the Radio Club of America.

❖

Robert E. Martin (S'49), who received the master of science degree and the bachelor of electrical engineering degree from Ohio State University at the recent Spring Commencement, has been appointed to the staff of Batelle Institute, Columbus, Ohio. He will be engaged in research in electrical engineering.

❖

James Winston Woody, Jr. (S'49) who recently received the E.E. degree from the University of Kentucky, has joined the staff of the instrument department, Engineering Division, of the Oak Ridge National Laboratory, Oak Ridge, Tenn.

Norman R. Beers (SM'50), who formerly had been in charge of the meteorology group at the Brookhaven National Laboratory, Upton, L. I., N. Y., and was the editor of *Nucleonics*, a McGraw-Hill publication, until his resignation owing to ill health, died recently at Fort Hamilton Veterans' Hospital. Mr. Beers was 38 years old.

A native of Missouri, he attended the University of Missouri, and from 1934 to 1937 he was a Rhodes Scholar at Oxford University, specializing in astrophysics. He was associated with the college textbook department of McGraw-Hill until 1941, when he joined the Navy. He was on active duty for five years. Mr. Beers was in charge of the basic-phase Aviation Machinist Mate School at the Naval Air Station, Jacksonville, Fla., and was later in the Bureau of Aeronautics, in Washington, and on the faculty of the postgraduate school of the United States Naval Academy, at Annapolis, Md. He was a lieutenant commander at the time of his discharge from the service.

He remained on the Annapolis staff as associate professor of aerological engineering until 1947, when he joined the Brookhaven atomic project.

In 1949 he became editor of *Nucleonics* and continued as a consultant for the Brookhaven laboratory. Mr. Beers was co-author of the McGraw-Hill "Handbook of Meteorology," and had published a number of papers in technical journals.

Rawson Bennett (A 36-M'43-SM'43-F'50), who has been commanding officer and director of the U. S. Navy Electronics Laboratory, San Diego, Calif., for four years, reported in August to the Armed Services Industrial College in Washington, D. C. Captain Bennett was named director of the Laboratory in 1946.



RAWSON BENNETT

Prior to his assignment as director of the Navy's electronics research and development installation on Point Loma, Captain Bennett was head of the design branch, electronics division, of the Bureau of Ships. He holds the Navy Department's Legion of Merit Award for his contributions to varied developments in the military field of submarine detection.

Graduated from the Naval Academy in 1927, Captain Bennett received the Master of Science degree in engineering from the University of California at Berkeley in 1937. In March, 1950, he was elected a Fellow of the Institute, becoming the fifth officer of the regular armed services to receive that honor in the history of the IRE.

Industrial Engineering Notes¹

TELEVISION NEWS

Sales of cathode-ray tubes to television receiver manufacturers in May increased 20 per cent over the preceding month as the trend to larger screens in home receivers was further emphasized, according to RTMA member-company reports. More than 64 per cent of all TV receiver-type tubes sold to manufacturers during the month were 14 inches and over in size. The previous dominant tube size—12 through 13.9 inches—represented only 35 per cent of the total picture tubes sold to manufacturers in May. . . . **The Hazeltine Electronics Corp.**, in conclusions on color television offered to the FCC, declared that none of the proposed color television systems "currently is really ready" for standardization. The FCC did not formally accept the company's conclusions as part of the color record, as Hazeltine was not a party to the hearing and its proposals did not conform to FCC procedure. Hazeltine asked the FCC to take two steps in arriving at its color decision. First, the company suggested the FCC make a broad policy decision and then follow this action with close co-operation with industry in order to get detailed standards. . . . **Television receiver production** during the first half of 1950 equalled that of the entire year of 1949, attaining a new industry record of almost 3,100,000 sets up to July 1, according to RTMA estimates based on reports by member companies. Radio receiver production also was up, about 50 per cent higher than during the corresponding six-month period last year. . . . **The General Electric Company** has advised the FCC that it had developed a **new color television system** which has "very important advantages both technically and economically." W. R. G. Baker, vice-president, wrote Chairman Wayne Coy that the new system, **identified as frequency interlace**, "appears to have such outstanding potential advantages as to justify serious consideration even at such a late date." In a detailed description of the new system, General Electric said: "Among the apparent technical advantages are compatibility with existing monochrome standards and freedom from twinkle, crawl, flicker, color fringing, and transient color shifts."

MOBILIZATION

Military procurement of electronic equipment and components during the current fiscal year are expected by key defense officials to exceed \$1 billion and may run as high as \$1.5 billion or more, according to information obtained by RTMA. While an accurate breakdown of military requirements

from the radio-television industry is not yet available, officials point out the following: Regular military appropriations measure of more than \$13 billion carries funds for electronic procurement of between \$500 and \$600 million; electronic procurement in the special \$10 billion budgetary request will add another \$500 million to \$1 billion; military orders for electronic items already let under the past fiscal year's appropriations add another \$300 to \$400 million; and an additional appropriation for further rearmament of American allies, as forecast by the President, unquestionably will include additional funds for electronic procurement. This over-all appropriation, according to some estimates, may run as high as \$10 billion. . . . While the FCC was continuing its day-to-day deliberations preparatory to issuing a decision in the color TV proceedings, there was speculation in Washington as to what effect the international situation may have on the Commission's findings both in this case and the forthcoming uhf allocation inquiry and the lifting of the TV "freeze." Observers point out that the **FCC's color decision may become "academic" or have to be shelved until the present rearmament program is completed**, in view of the anticipated military demands on the production capacity and engineering talent of the radio-television industry. There appeared to be general anticipation in Government circles that production of TV receivers will be sharply cut back within the next few months by the mere impact of military procurement and industrial controls on vital materials and priorities, regardless of whether TV and radio receiver production is reduced by actual limitation orders. Curbs on consumer credit are expected to slow down TV set buying concurrent with reduced production. It is also pointed out that Administration policies designed to halt "expansion" of consumer industries may result in a practical continuation on the "freeze" on new TV station construction regardless of the action of the FCC. On the other hand, however, some officials believe that expansion of TV reception, even in wartime, would be desirable from the Government's standpoint because of the value of the medium in transmitting important information to the public.

SECRET GENERAL MANAGER OF RTMA AS GEDDES RETIRES AFTER 23 YEARS

James D. Secrest, who for several years has been Director of Public Relations for the Radio-Television Manufacturers Association, assumed the duties of secretary and general manager of RTMA on August 1, succeeding Bond Geddes, who retired as executive vice-president after 23 years of service with the association. Mr. Geddes continues to serve as a consultant under an arrangement with the Board of Directors.

A long-time newspaper man in Washington, D. C., Mr. Secrest was associated with newspapers in Cincinnati, Ohio, and Asheville, N. C., before coming to Washington in 1929. From then until 1941 he was on the staff of the *Washington Post*, during which time he was also a member of the Capitol staff. He also reported radio industry news.

Early in 1941 he joined the Information Division of the Office of Emergency Management which subsequently became the Office of War Information. He helped to organize and directed the OWI domestic field service comprising sixty offices throughout the United States.

Before joining RTMA in March, 1945, Mr. Secrest was in charge of publicity and advertising for the wartime pulpwood production campaign conducted by the War Activities Committee of the Pulpwood Consuming Industries, with headquarters in New York, N. Y.

NBS DEVELOPS NEW OSCILLATOR

The National Bureau of Standards has announced the development of a resistance-capacitance oscillator "with many immediate applications in radio and electrical work." The new oscillator covers, in five steps, the frequency range from 20 cycles to 2 megacycles. In the new RC oscillator, a single amplifier driving a cathode follower, provides wide-band operation with small phase shift, low output impedance, and constant output voltage. Complete details of the new development are to be published in "*The Technical News Bulletin*," a monthly publication of the National Bureau of Standards.

KAAR WILL REPRESENT RTMA AT SESSIONS OF CCIR STUDY GROUP

I. J. Kaar of General Electric Company, who is chairman of the Committee on Television, Receiver Section, RTMA Engineering Department, represented RTMA and the industry at a meeting of the CCIR Study Group 11 in Geneva, Switzerland, at the designation of Director W. R. G. Baker. He was appointed upon the recommendation of Donald S. Parris of the U. S. Department of Commerce, who was one of the American delegates to the CCIR sessions held recently in London, at which Donald G. Fink represented RTMA.

The RTMA Export Committee, at its recent meeting in Chicago, adopted a resolution recommending to the Board of Directors that RTMA be represented at all pertinent international meetings on radio and TV problems. The Geneva session is scheduled to give further consideration to FM versus AM for TV sound, positive or negative modulation, and other standards not agreed on at the London CCIR meeting.

NEW NAME OF RTMA IS OFFICIAL; INSIGNIA FOLLOWS RMA DESIGN

The official name of the former Radio Manufacturers Association has now become the Radio-Television Manufacturers Association. Judge John W. Van Allen, RTMA General Counsel, has advised RTMA headquarters that the articles of amendment to the RTMA charter, as approved by the membership at the June meeting, have been filed with the State of Illinois and become effective immediately.

¹ The data on which these NOTES are based were selected by permission from *Industry Reports*, issues of July 7, July 14, July 21, and July 28, published by the Radio-Television Manufacturers Association, whose helpful attitude is gladly acknowledged.

ATOMIC ENERGY COMMISSION WILL PUBLISH REPORTS TWICE MONTHLY

The Atomic Energy Commission and the Department of Commerce recently jointly announced that business firms will have easier access to nonsecret atomic energy technical reports under a new distribution plan. Under the plan, the Office of Technical Services of the Department of Commerce will become the sales agency and reference source for nonsecret AEC technical reports.

"Nuclear Science Abstracts," a magazine issued twice monthly, is the principal medium through which business firms may learn about reports relating to atomic energy research. The magazine, which provides titles and abstracts of publicly and privately published reports in these fields, sells for \$6 per year. Subscriptions should be addressed to the Office of Technical Services, U. S. Department of Commerce, Washington 25, D. C.

SKIATRON CORPORATION DEVELOPS "SUBSCRIBER VISION" TV SYSTEM

The Skiatron Corporation of New York, N.Y., has informed the Federal Communications Commission that it expects to demonstrate this fall a "Subscriber Vision" television system by which paying subscribers would be enabled to view movies on their receivers.

"We are proceeding energetically on a pilot model," the New York concern wrote the FCC, "and following its completion, we intend to apply to the FCC for the same type of experimental public test privilege in New York City as the Zenith Radio Corporation has obtained in Chicago."

The firm claims to own the only "practical, patented system for providing a special television service to paying subscribers." Skiatron says its method provides for the broadcasting pictures over the air "without the necessity for any intervening telephone

connection." It said further that Skiatron intends to offer other manufacturers in the television industry licensing arrangements under its proposed system.

J. V. L. HOGAN IS NAMED CHAIRMAN OF JTAC TO SUCCEED DONALD FINK

John V. L. Hogan has succeeded Donald G. Fink as Chairman of the Joint Technical Advisory Committee of RTMA and IRE. The group was organized by RTMA and IRE to advise the government on technical matters as a successor to the former Radio Technical Planning Board.

I. J. Kaar succeeds Mr. Hogan as vice-chairman of the committee. Other JTAC members are: Donald G. Fink, Ralph Brown, T. T. Goldsmith, Jr., Haraden Pratt, Philip F. Siling, and David B. Smith.

Books

The World's Radio Tubes (Brans, Vademecum), 1950 International Edition

Published (1950) by P. H. Brans, Ltd., Antwerp. Distributed by Editors and Engineers, Ltd., 1300 Kenwood Road, Santa Barbara, Calif. 508 pages +xxii +xx pages, 8X11 $\frac{1}{2}$.

This is the eighth edition of the late P. H. Brans' handbook giving the principal rated characteristics of electron tubes manufactured throughout the world. Introductions, abbreviations, and instructions for using the book are given in most of the common European languages except Russian.

Tubes are listed by type number first, together with manufacturer's name, cathode heater or filament voltage, basing index and reference to a second table which gives rated electrode voltages, currents, and dynamic characteristics. Listed also are the type numbers of tubes having equivalent characteristics to facilitate substitution when the original tube cannot be duplicated; base connections are also given for the equivalent types.

Coverage, at least so far as American tubes are concerned, is rather complete and includes transmitting, cathode-ray, and special-purpose tubes, in addition to receiving tubes. In most cases a single manufacturer is listed, and one suspects that the editors have overlooked the fact that most American tubes having a type number assigned by RMA are made by several manufacturers and are listed in the catalogues of most of the larger concerns. This handbook will probably be of interest to persons in the United States who are interested in foreign tube types and in exporting. It is easily understandable that it would be especially useful in countries where most of the tubes used are imported.

GEORGE D. O'NEILL
Sylvania Electric Products Inc.
P.O. Box 6
Bayside, L. I., N. Y.

New Publications

The Table of Complex Numbers by **Herbert E. Salzer**, National Bureau of Standards Applied Mathematics Series AMS8, 44 large pages, is available from the Superintendent of Documents, U. S. Government Printing Office, Washington 25, D. C., for 25 cents a copy. Remittances from foreign countries should be in United States exchange and should include an additional sum of one-third the publication price to cover the cost of mailing.

The booklet has been published to meet the needs of engineers, mathematicians, and scientists who are working on problems in fields as diverse as alternating-current circuits, number theory, and exterior ballistics. The Table is especially useful in the treatment of Taylor series involving complex variables. It is the first extensive table of powers of complex numbers ever published.

In this Table, exact values of powers of complex numbers are given in Cartesian form for powers from 1 through 25 and for arguments with real and imaginary parts ranging separately from 0 to 10 in unit steps. The Table is arranged essentially in order of magnitude of the distances of the argument values from the origin in the complex plane.

Colorimetry, Circular C478, by Deane B. Judd, is a publication issued by the National Bureau of Standards and available from the Superintendent of Documents, U. S. Government Printing Office, Washington 25, D. C., at 30 cents a copy. The circular contains 56 large double-column pages and is illustrated.

Scientists and technicians concerned with color measurement will find much helpful information. For the past 20 years, the National Bureau of Standards has played a

leading part in establishing practical working standards on color and in setting up and administering color tolerances. As a result, conformity to a color requirement can now be determined with the same assurance as mechanical properties.

The booklet describes the standards and measurements methods developed by the Bureau in this field, giving the basis for each technique and showing clearly how one method supplements the other. Chapters cover the following topics: the standard observer; illuminants and co-ordinate system; small difference colorimetry; material standards of color; one dimensional color scales; and general methods.

Radiological Laboratory is a new four-page folder available from New York University College of Engineering. It describes problems of using radioactive isotopes and discusses hazards, special equipment required, how atomic wastes are handled, and gives data on the design and operation of such a laboratory. Copies of the illustrated folder may be obtained for 10 cents from V. W. Phalen, Bureau of Public Information, New York University, New York 53, N. Y.

Audio Anthology has been published recently by Radio Magazines, Inc., 342 Madison Ave., New York 17, N.Y., 124 pages. Paper-bound edition is priced at \$2.00 and hard-cover edition at \$3.00.

A compilation of material, designed for the high-fidelity enthusiast, the volume is published to satisfy the demand for articles which appeared in early issues of *Audio Engineering*. Since *Audio Engineering* first made its appearance in 1947, those interested in audio as a hobby, or professionally, have found in it many articles of interest.

Traveling-Wave Tubes by J. R. Pierce

Published (1950) by D. Van Nostrand Co., Inc. 250 Fourth Ave., New York, N. Y. 223 pages+34-page appendices.+2-page index+xii pages. 137 figures. 6 1/2 X 9 1/4. \$4.50.

All radio engineers interested in learning of progress towards full utilization of microwaves will welcome the appearance of this book on "Traveling-Wave Tubes" written by John Pierce, so well known for his many important contributions to the art of electron dynamics. This book is the first on traveling-wave tubes and develops the theory of operation of such tubes in considerable detail. It is a "must" for every tube engineer concerned with problems of design and development of traveling-wave and related tubes.

The author points out in the introduction (Chapter I) that in addition to high gain (over 30 db) and the operating frequency range from 200 to 40,000 Mc, the most important characteristic of the traveling-wave tube is its extraordinary bandwidth (3 to 1). This makes the traveling-wave tube (TWT) a most welcome addition to the microwave tube family, since it promises to utilize fully the possibilities of broad-band service where multichannel distortionless transmission is required.

As indicated by the author in the preface to his book, "the emphasis is on general aspects of various wave circuits and their coupling to and interaction with electron flow." After a brief description of the basic form of the TWT (single helix), Chapter II is devoted to the small-signal theory in which the excitation of the circuit by the electron beam and its effect on the circuit are analyzed and the characteristic equation determining the propagation constant is derived. Concepts of gain parameter and beam impedance are introduced and the tube gain is expressed in these terms. Chapter III is devoted to the analysis of wave propagation on a helix and the theory of coupled helices. Detailed mathematical treatment for this and other chapters is contained in the appendices. Chapter IV deals with filter-type circuits where field solutions are derived for simple geometries and more complex circuits are treated as lumped-circuit analogues to which filter network analysis applies.

In Chapter V the effectiveness of circuit interaction with electron beams is analyzed and the desired properties of circuits, such as high impedance, are expressed in terms of stored energy, phase and group velocities, etc. Chapter VI is devoted to a general treatment of waveguiding circuits where their wave propagating properties are described in terms of normal modes. Chapter VII makes use of the generalized circuit representation and derives the characteristic equation for the propagation constant in a more general way, taking into account forces due to space-charge fields. Effects of circuit attenuation and of space-charge forces on tube gain, obtained from solutions of the characteristic equation for special cases, are discussed in Chapter VIII.

In Chapter IX initial boundary conditions and the effect of discontinuities in waveguiding structure are discussed in such a manner that the over-all tube gain can be evaluated. In Chapter X the effect of noise

resulting from random fluctuation in the electron stream of the TWT is analyzed, making use of solutions for the one dimensional case of space-charge flow. Partition noise and noise due to transverse motions of electrons are also considered. In Chapter XI it is shown that backward waves do not produce effective gain, but only wave interference effects. Chapter XII discusses high-level operation and gives estimates of efficiency which are expressed in terms of parameters used in the small signal theory. In Chapter XIII transverse motions of electrons are considered and the gain formula is derived for the transverse type of TWT. Chapter XIV deals with field solutions where the effect of variation of the rf fields over the cross section of the electron beam is considered. The two final Chapters (XV and XVI) are devoted to the introduction to the theory of magnetron and double-stream amplifier tubes.

The reviewer believes that John Pierce's book on "Traveling-Wave Tubes" represents a most competent treatment of the TWT theory, containing the generally accepted basic theory which will serve as a very useful guide to tube designers, and some material of more controversial nature which will inspire many fruitful discussions and will stimulate creative thought.

ANDREW HAEFF
Naval Research Laboratory,
Washington, D. C.

Advances in Electronics, Vol. II, Edited by L. Marton

Published (1950) by Academic Press, Inc. 125 E. 23 St., New York, N. Y. 362 pages+15-page index+x pages. 160 figures. 9 X 6. \$7.00.

This second volume, like Volume I published in 1948, consists of survey articles on a variety of topics in the general field of electronics, each article written by a different expert. Volume I contained 10 such articles; the present volume contains 8, ranging between 30 and 60 pages in length. Additional volumes are to be published to provide the electronics specialist with yearbooks resembling, in some respects, those published in another field under the title, "Reports on Progress in Physics" (Physical Society of London).

It is inevitable that the general approach, literary style, scope, and method of treatment in such a collection will have as many variations as the book has articles. There is also a danger that such a book may have a selection of topics so diverse that, in this day of extreme specialization, it will be rare for one individual to be greatly interested in more than a few of the topics. In this respect, Volume II is markedly better than Volume I; the topics are largely in the field of physical electronics and, in the main, are more closely related than were those of Volume I.

The general utility of a collection of partially unrelated survey papers in a bound volume would be subject to question if existing technical journals were already covering the field competently. It may safely be said that, in the electronics and radio engineering sphere, we have not had the careful and periodic selection and preparation of survey papers comparable to those of the *Reviews of Modern Physics*. For this

reason, "Advances in Electronics" fulfills a definite need. On the other hand, in comparing with publication in journal form, the latter assumes adequate attention by the abstracting and bibliographical services, and at the same time, achieves wider initial circulation. It may be that important and carefully worked out papers, when published in book form, will be overlooked by future workers because the content is not clearly established by the title of the book. The remedy is to include articles from these compendia in the standard abstract lists but, to this reviewer's knowledge, it is not being done.

The first four articles of Volume II are related to the cathode-ray art. Dr. Hilary Moss, of Electronic Tubes, Ltd., Reading, England, opens the book with "Cathode Ray Tube Progress in the Past Decade With Special Reference to Manufacture and Design." The title is a reasonably accurate description but, it should be added, the emphasis is on British practice. The treatment appears to be intended for the practical but well-informed engineer and knowledge of the terminology is presupposed. The author is never hesitant to express a definite opinion on controversial points and the paper is largely based on his own experiences. For example, there are 29 references (which is certainly not a large number for a survey) and 10 are to the author's own work. The design information is largely empirical rather than basic, and is a little too limited to a particular type of gun design to survey many years of design changes. The article by Professor Grivet of the University of Paris, "Electron Lenses," is of quite different character. It is basic in nature and intended for the man interested in fundamentals; it is well documented by 100 references, and emphasizes high-performance lenses, as is quite fitting today. This article will be of value to the cathode-ray tube designer, but even more so to the electron microscope worker and the research man using electron optical principles in other devices. Dr. G. Liebmann, of Associated Electrical Industries, Ltd., Berkshire, England, has contributed another well-written basic article on field plotting and electron-ray tracing which, with its 129 bibliographical references, is an excellent complement to the lens papers. These two, together, cover the field of electron optics perhaps as well as could possibly be done in the allotted space. The fourth of the surveys devoted to the cathode-ray art is by Dr. G. F. Garlick of the University of Birmingham, England, and is entitled, "Cathodoluminescence." This review of the physical properties of phosphors which are useful in cathode-ray tubes is one of the shorter items in the book, but is a concise minimal treatment of cathodoluminescent materials, their characteristics and theoretical interpretations, written from the point of view of a physicist interested in the fundamentals.

The remaining four contributions are not so directly related to each other. Professors Frohlich and Simpson of the University of Liverpool have written "Intrinsic Dielectric Breakdown in Solids." This is a good summary of the experimental phenomena and the underlying theoretical hypotheses; one should not expect, and the author does not

include, lists of materials and their breakdown points, since this type of material is better suited to standard handbooks. Professor Gunnar Hok, of the University of Michigan (up to this point the first author with a U. S. affiliation) has written "The Microwave Magnetron," which is the shortest, and the least complete, survey of the present book. It is not documented in detail and suffers by comparison with the classic and much more elegant 1946 paper of Fisk, Hagstrum, and Hartman. On the other hand, it adds a feature to the book under review which, though it will not alone sell the book, may have value to some who are primarily interested in the other electron tube material. In a less well-known field, Dr. George T. Rado, of the U. S. Naval Research Laboratory, discusses "Ferromagnetic Phenomena at Microwave Frequencies"; this is a thorough and up-to-date treatise which will serve many as an excellent introduction, particularly to current research. The final paper is a good review of microwave absorption by gases, under the title, "Microwave Spectroscopy," and was written by Donald K. Coles of the Westinghouse Research Laboratories. The paper includes a long bibliography and a comprehensive presentation of the important topics in the field.

To sum up the entire book, it is a compilation of selected subjects which will be of particular value to the research worker and to the man outside the realm of research who wishes to keep up with fundamental progress in physical electronics.

E. W. HEROLD
Radio Corporation of America
Princeton, N. J.

Radio and Television Mathematics by Bernhard Fischer

Published (1949) by the Macmillan Company, 60 Fifth Ave., New York, N. Y. 440 pages + 12-page index + 2-page mathematical index + xviii pages + 147 figures. 5½ × 8. \$6.00.

This is the first edition of a handbook on problems and solutions intended "to serve as a guide and reference book for the practical man, as a collection of problems for instructors, and as a review for those who want to acquire a rapid practical skill in solving problems in preparation for radio license examinations given by the United States Federal Communications Commission." In the opinion of the reviewer, this is a book which would be of no value to the practicing engineer or to the engineering student, and that the author does not intend it to be.

The mathematical prerequisite is a working knowledge of algebra and trigonometry. The author states in the preface, "There is no danger of telling the beginner too much. Electronics has become too universal a field, universal in its all-embracing application and universal in the type of persons working in it. No longer can teachers afford to forget that the obvious may be inconceivable to one unfamiliar with the tools of mathematics." In following this idea, the book consists mostly of the statement of the problem and the formula to be used; then the numerical substitution, and the various steps of computation are given. No statement is

made as to whether the formula can be used generally or, if not, what the limitations of it are. The derivations of only a few formulas are given, and some of the problems are solved using network theory.

The text is made up of four sections. The first and most important section covers the following topics: Circuit Components; Direct-Current Circuits; Alternating-Current Circuits; Vacuum-Tube Fundamentals; Amplifiers; Oscillators; Transmitters; Receivers; Power Supplies; Antenna and Transmission Lines; Television; Measurements; and Industrial and Control Circuits. The second section deals with problems for further practice and consists of 312 problems (and answers) of the type worked out in detail in the first section. Some important tools for radio mathematics are the subject of the third section, in which the uses of the powers of 10 in calculating, the *j*-operator, and polar vectors are explained. There is also a brief discussion of the slide rule. The final section is made up of formulas used in the preceding detailed problems, and miscellaneous tables.

From the viewpoint of the practical radioman the information given under each topic is reasonably complete, except in the following cases. Radio-frequency and intermediate-frequency amplifiers, and FM detectors are not dealt with in the topic on Receivers. In the case of Power Supplies, no discussion was given on three-phase supplies, voltage doubling circuits, the various high-voltage supplies used in television, and bridge rectifiers; regulated supplies were not discussed except for single VR tube supplies. Again, in dealing with the subject of Television no mention is made of sweep generators, blocking oscillators, phase discriminators, automatic-gain-control circuits, and multivibrators. In covering video amplifiers, no calculation of the phase response of the amplifier is made. Also, in using the method applied to the amplifiers it would be difficult to calculate an unknown circuit component, as no general formulas are given for the video amplifier.

Practically all of the calculations required for the Study Guide of the Federal Communications Commission are covered in the text. Only two problems, the calculation of the effective height of an antenna and the speed of an induction motor, are not included.

The book, in general, is easily readable, but some errors were noted which might cause confusion. Under the topic of direct-current circuits some alternating-current calculations are made. In the case of conversion calculation for beam-power tubes the answers obtained are correct, but the statement is made that "the current conversion factor can be found by using the fundamental law of vacuum tubes that $I_p \propto E_p^{3/2}$ " This statement is not correct and probably causes considerable confusion. In a beam-power tube, the plate current is practically independent of the plate voltage over a considerable range. The reason the conversion factor is correct in the problem is:

$$I_{\text{space current}} = K \left(E_0 + \frac{E_{sc}}{\mu_{sc}} \right)^{3/2},$$

and the plate current and the screen current are each a certain fraction of the total space

current; therefore,

$$I_p + K_1 \left(E_0 + \frac{E_{sc}}{\mu_{sc}} \right)^{3/2}$$

and

$$I_{sc} = K_2 \left(E_0 + \frac{E_{sc}}{\mu_{sc}} \right)^{3/2}.$$

The new screen and grid voltages are $E'_{sc} = F_s E_{sc}$ and $E'_0 = E_s E_0$, where F_s is the conversion factor. Substituting these voltages in the equation for plate current,

$$\begin{aligned} I_p' &= K_1 \left(F_s E_{sc} + \frac{F_s E_{sc}}{\mu_{sc}} \right)^{3/2} \\ &= \left[K_1 \left(E_0 + \frac{E_{sc}}{\mu_{sc}} \right) \right] F_s^{3/2} \\ &= I_p F_s^{3/2}. \end{aligned}$$

The same procedure would apply for the screen current. There are a few other problems which are incorrect.

On the whole the extent of the material covered in this book is quite impressive. It would probably be useful to the beginner and to the practical radioman who does not know how to make quantitative calculations.

WILLIAM L. BEHREND
RCA Laboratories
Princeton, N. J.

Television for Radiomen by Edward M. Noll

Published (1949) by the Macmillan Company, 60 Fifth Avenue, New York, N. Y. 573 pages + 7-page index + xii pages. 456 figures. 9½ × 6. \$7.00.

This book starts with excellent instructions on how to study a book with the objective of a home study course in mind. It is not so much an equipment designers text as it is a review of present-day television system details. It includes very little abstract theory and design engineering, but (assuming an understanding of ordinary radio circuits) explains in practical terms the principles of television transmission and reception equipment. It uses enough of the essential mathematics to enable a technician working with such apparatus to make necessary adjustments.

A modern television receiver is handled part by part, showing the particular applications of the theory to understand, operate, adjust, or repair these items. The information on commercial equipment is up-to-date, and is well arranged for classroom teaching, home study work, as a text in trade and technical schools, and as a reference book on present-day techniques in TV receivers. The book can thus serve as a basis for those who desire to advance into transmitter operation or into the engineering end of the art. It opens the door for the ambitious radioman to become adept in servicing, giving him the detailed knowledge that permits him to diagnose receiver difficulties. All examples are taken from typical commercial receivers, and all circuit arrangements found in practice seem to be covered. Finally, the book provides "easy reading" for those who do not have an instructor at hand to interpret the meanings.

RALPH R. BATCHER
Douglaston, L. I.,
N. Y.

Institute Committees—1950

EXECUTIVE

R. F. Guy, *Chairman*
D. B. Sinclair, *Vice-Chairman*
Haraden Pratt, *Secretary*
S. L. Bailey A. N. Goldsmith
W. R. G. Baker J. W. McRae

BOARD OF EDITORS

A. N. Goldsmith, *Chairman*

F. W. Albertson	S. S. Mackeown
J. S. Allen	Nathan Marchand
William Bachman	E. D. McArthur
G. M. K. Baker	Knox McIlwain
W. L. Barrow	J. W. McRae
R. R. Batcher	L. A. Meacham
B. B. Bauer	G. F. Metcalf
R. M. Bowie	R. A. Miller
Ralph Bown	E. L. Nelson
R. S. Burnap	D. O. North
O. H. Caldwell	H. F. Olson
C. W. Carnahan	R. M. Page
C. C. Chambers	H. O. Peterson
L. M. Clement	G. W. Pickard
J. D. Cobine	Haraden Pratt
M. G. Crosby	C. A. Priest
R. B. Dome	J. R. Ragazzini
W. G. Dow	Simon Ramo
E. W. Engstrom	H. J. Reich
W. L. Everitt	J. D. Reid
W. G. H. Finch	F. X. Rettenmeyer
D. G. Fink	P. C. Sandretto
H. C. Forbes	H. H. Scott
I. A. Getting	S. W. Seeley
A. W. Graf	V. W. Sherman
F. W. Grover	L. C. Smeby
D. B. Harris	C. E. Smith
L. B. Headrick	J. A. Stratton
E. W. Herold	W. C. Tinus
J. K. Hilliard	K. S. Van Dyke
J. A. Hutcheson	E. K. Van Tassel
J. K. Johnson	H. A. Wheeler
L. F. Jones	J. R. Whinnery
H. S. Knowles	W. C. White
J. D. Kraus	L. E. Whittemore
J. B. H. Kuper	Jerome Wiesner
J. L. Lawson	G. W. Willard
D. G. Little	I. G. Wolf
F. B. Llewellyn	V. K. Zworykin

AWARDS

M. G. Crosby, *Chairman*

S. L. Bailey	A. V. Loughren
D. E. Chambers	J. W. McRae
Keith Henney	B. E. Shackelford
F. S. Howes	Karl Spangenberg

EDUCATION

H. J. Reich, *Chairman*

R. G. Anthes	J. M. Pettit
R. E. Beam	W. H. Pickering
L. J. Black	Albert Preisman
C. C. Chambers	L. R. Quarles
R. M. Fano	J. R. Ragazzini
G. H. Fett	J. D. Ryder
R. A. Galbraith	R. P. Siskind
A. W. Graf	W. R. Smith
A. E. Harrison	Karl Spangenberg
R. W. Hickman	F. R. Stansel
G. B. Hoadley	F. E. Terman
G. L. Hollander	L. A. Ware
A. H. Howell	Ernst Weber
A. W. Melloh	L. E. Williams
P. H. Nelson	A. H. Wing, Jr.

Irving Wolff

CONSTITUTION AND LAWS

I. S. Coggeshall, *Chairman*

R. D. Chipp	F. B. Llewellyn
R. A. Heising	Haraden Pratt
H. R. Zeamans	

PROFESSIONAL GROUPS

W. R. G. Baker, *Chairman*

S. L. Bailey	R. A. Heising
I. S. Coggeshall	J. V. L. Hogan
W. H. Doherty	J. D. Reid
W. L. Everitt	B. E. Shackelford

(Professional Group Chairmen
Ex-Officio)

TELLERS

J. L. Callahan, *Chairman*

E. J. Isbister	A. A. McKenzie
----------------	----------------

ADMISSIONS

P. S. Christaldi, *Chairman*

H. S. Bennett	C. A. Hachemeister
C. M. Burrill	L. N. Hatfield
A. G. Clavier	R. E. Mathes
H. P. Corwith	H. S. Moncton
F. M. Deerhake	J. H. Moore
T. M. Ferrill, Jr.	G. B. Riley
H. C. Vance	

POLICY DEVELOPMENT

Haraden Pratt, *Chairman*

K. C. Black	T. A. Hunter
A. V. Eastman	F. B. Llewellyn
W. L. Everitt	J. D. Reid
W. R. Hewlett	B. E. Shackelford
J. V. L. Hogan	J. A. Stratton
W. N. Tuttle	

SECTIONS

J. F. Jordan, *Chairman*

Robert Broding	George Rappaport
R. A. Heising	J. E. Shepherd
T. A. Hunter	E. T. Sherwood
H. I. Metz	L. C. Sigmon
C. A. Norris	R. N. White

(Section Chairmen Ex-Officio)

NOMINATIONS

R. A. Heising, *Chairman*

Ralph Bown	W. L. Everitt
Robert Broding	Keith Henney
Melville Eastham	W. R. Hewlett
F. H. R. Pounsett	

MEMBERSHIP

T. H. Clark, *Chairman*

F. W. Albertson	E. C. Jordan
J. E. Brown	W. A. Knoop
A. B. Chamberlain	O. I. Lewis
J. B. Coleman	F. B. Llewellyn
H. C. Forbes	F. L. Marx
G. W. Fyler	W. P. Short
V. M. Graham	D. B. Smith
R. N. Harmon	F. E. Terman
G. L. Hollander	W. C. White

(Chairmen of Section Membership
Committees Ex-Officio)

PUBLIC RELATIONS

R. R. Batcher, *Chairman*

S. L. Bailey	W. L. Everitt
W. R. G. Baker	E. K. Gannett
E. L. Bragdon	R. A. Hackbusch
O. H. Caldwell	Keith Henney
W. C. Copp	T. R. Kennedy
O. E. Dunlap, Jr.	M. B. Sleeper
Lewis Winner	

FINANCE

W. R. G. Baker, *Chairman*

S. L. Bailey	I. S. Coggeshall
D. B. Sinclair, ex-officio	

PAPERS REVIEW

G. F. Metcalf, *Chairman*

H. A. Affel	M. T. Lebenbaum
P. H. Betts	C. V. Litton
F. J. Bingley	W. P. Mason
D. S. Bond	R. E. Mathes
Kenneth Bullington	H. F. Mayer
H. A. Chinn	L. L. Merrill
J. K. Clapp	H. R. Mimno
S. B. Cohn	F. L. Moseley
J. M. Constable	G. G. Muller
M. G. Crosby	A. F. Murray
F. W. Cunningham	J. R. Nelson
A. R. D'heedene	K. A. Norton
M. J. DiToro	Ernest Pappenfus
H. D. Doolittle	H. W. Parker
O. S. Duffendack	L. J. Peters
R. D. Duncan, Jr.	A. P. G. Peterson
E. H. Felix	W. H. Pickering
V. H. Fraenckel	A. F. Pomeroy
R. L. Freeman	Albert Preisman
Paul Fritschel	T. H. Rogers
E. G. Fubini	H. E. Roys
Stanford Goldman	J. D. Ryder
W. M. Goodall	M. W. Scheldorf
G. L. Haller	Samuel Seely
O. B. Hanson	Harner Selvidge
A. E. Harrison	R. E. Shelly
T. J. Henry	J. E. Smith
C. N. Hoyle	R. L. Snyder
P. K. Hudson	E. E. Spitzer
D. L. Jaffe	J. R. Steen
Hans Jaffe	G. C. Sziklai
Henry Jasik	H. P. Thomas
D. C. Kallifell	Bertram Trevor
A. G. Kandoian	W. N. Tuttle
Martin Katzin	Dayton Ulrey
J. G. Kreer, Jr.	S. N. Van Voorhis
Emile Labin	J. R. Weiner
J. J. Lamb	M. S. Wheeler
V. D. Landon	R. M. Wilmotte
H. R. Zeamans	

Technical Committees, May 1, 1950-May 1, 1951

ANNUAL REVIEW

R. R. Batcher, *Chairman*
R. T. Hamlett, *Vice-Chairman*

H. E. Allen	P. C. Sandretto
George M. Brown	P. F. Shea
Donald H. Castle	R. E. Shelby
Trevor Clark	H. E. Singleton
John Crawford	W. N. Tuttle
E. L. Harder	G. L. Van Deusen
J. V. L. Hogan	K. S. Van Dyke
E. C. Jordan	D. E. Watts
R. M. Mitchell	Ernst Weber
W. J. Poch	H. P. Westman
A. F. Pomeroy	I. R. Weir
George Rappaport	H. W. Wells
Nathaniel Rochester	L. E. Whittemore
A. L. Samuel	R. E. Zenner

ANTENNAS AND WAVE GUIDES

A. G. Fox, *Chairman*
Sidney Frankel, *Vice-Chairman*

T. M. Bloomer	D. C. Ports
P. S. Carter	H. J. Riblet
L. J. Chu	V. H. Rumsey
W. S. Duttera	M. W. Scheldorf
J. E. Eaton	S. A. Schelkunoff
Henry Jasik	S. Scnsiper
E. C. Jordan	J. P. Shauklin
M. L. Kales	George Sinclair
O. E. Kienow	P. H. Smith
W. E. Kock	R. N. Sorea
	L. C. Van Atta

AUDIO TECHNIQUES COMMITTEE

R. A. Miller, *Chairman*
H. H. Scott, *Vice-Chairman*

O. L. Angevine, Jr.	W. W. Dean
H. W. Augustadt	J. A. Green
L. L. Beranek	H. D. Harris
W. L. Black	J. K. Hilliard
H. Burris-Meyer	F. L. Hopper
C. A. Cady	D. E. Maxwell
D. H. Castle	Ralph Schlegel
E. J. Content	W. E. Stewart
A. N. Curtis	R. T. Van Niman

CIRCUITS

W. N. Tuttle, *Chairman*
C. H. Page, *Vice-Chairman*

W. R. Bennett	E. A. Guillemin
J. G. Brainerd	W. H. Huggins
Cledo Brunetti	Herbert Krauss
A. R. D'heedene	John Linvill
R. L. Dietzold	P. F. Ordung
W. L. Everitt	E. H. Perkins
R. M. Foster	Wolcott Smith
Stanford Goldman	Ernst Weber
	J. R. Weiner

ELECTROACOUSTICS

E. S. Seeley, *Chairman*
B. B. Bauer, *Vice-Chairman*

H. E. Allen	F. V. Hunt
Eginhard Dietze	W. F. Meeker
M. J. Di Toro	H. F. Olson
Martin Greenspan	Vincent Salmon
E. C. Gregg	P. S. Veneklasen
H. F. Hopkins	John Volkman

ELECTRON TUBES AND SOLID-STATE DEVICES

L. S. Nergaard, *Chairman*
A. L. Samuel, *Vice-Chairman*

R. S. Burnap	W. G. Dow
J. W. Clark	C. E. Fav

A. M. Glover	J. A. Morton
J. E. Gorham	I. E. Mouromtseff
J. W. Greer	G. D. O'Neill
L. B. Headrick	O. W. Pike
L. A. Hendricks	P. A. Redhead
E. C. Homer	H. J. Reich
S. B. Ingram	A. C. Rockwood
R. B. Janes	R. M. Ryder
S. J. Koch	R. W. Slinkman
R. L. McCreary	H. L. Thorson
	C. M. Wheeler

ELECTRONIC COMPUTERS

J. W. Forrester, *Chairman*
Nathaniel Rochester, *Vice-Chairman*

D. R. Brown	G. W. Patterson
R. B. Elbourne	J. A. Rajchman
E. L. Harder	Robert Serrell
John Howard	R. L. Snyder
E. Lakatos	J. R. Weiner
B. R. Lester	C. F. West
G. D. McCann	W. D. Woo

FACSIMILE

J. V. L. Hogan, *Chairman*
C. J. Young, *Vice-Chairman*

James Barnes	F. A. Hester
Henry Burkhard	Pierre Mertz
J. J. Callahan	N. A. Nelson
A. G. Cooley	Hugh C. Ressler
	R. J. Wise

INDUSTRIAL ELECTRONICS

D. E. Watts, *Chairman*
John Dalke, *Vice-Chairman*

G. P. Bosomworth	H. W. Parker
J. M. Cage	S. I. Rambo
E. W. Chapin	Walther Richter
J. E. Eiselein	W. C. Rudd
C. W. Frick	C. F. Spitzer
G. W. Klingaman	E. H. Schulz
H. R. Meahl	W. R. Thurston
Eugene Mittelmann	R. S. Tucker
P. E. Ohmart	M. P. Vore
	Julius Weinberger

MEASUREMENTS AND INSTRUMENTATION

Ernst Weber, *Chairman*
F. J. Gaffney, *Vice-Chairman*

Wilson Aull	W. J. Mayo-Wells
Carl C. Chambers	G. A. Morton
P. S. Christaldi	C. D. Owens
John Dalke	A. P. G. Peterson
G. L. Fredendall	J. G. Reid, Jr.
C. W. Frick	J. R. Steen
W. D. George	N. H. Taylor
E. J. Green	R. S. Tucker

MOBILE COMMUNICATIONS

F. T. Budelman, *Chairman*
Alexander Whitney, *Vice-Chairman*

G. M. Brown	D. E. Noble
D. B. Harris	J. C. O'Brien
C. M. Heiden	David Talley
C. N. Kimball, Jr.	George Teomney
	R. W. Tuttle

MODULATION SYSTEMS

Bertram Trevor, *Chairman*
W. G. Tuller, *Vice-Chairman*

F. L. Burroughs	J. G. Kreer, Jr.
W. J. Cunningham	E. R. Kretzmer
L. A. W. East	V. D. Landon
A. C. Goodnow	L. A. Meacham
D. D. Grieg	Dale Pollack
D. M. Hill	H. E. Singleton

NAVIGATION AIDS

P. C. Sandretto, *Chairman*
H. R. Mimno, *Vice-Chairman*
C. J. Hirsch, *Vice-Chairman*

W. B. Burgess	Wayne Mason
Henri Busignies	K. A. Norton
G. C. Comstock	W. M. Richardson
Harry Davis	L. M. Sherer
D. G. Fink	Ben Thompson
	R. R. Welsh

PIEZOELECTRIC CRYSTALS

K. S. Van Dyke, *Chairman*
R. A. Sykes, *Vice-Chairman*

C. F. Baldwin	Clifford Frondel
W. L. Bond	B. S. George
W. G. Cady	Edward Gerber
J. K. Clapp	Hans Jaffe
W. A. Edson	W. P. Mason
	P. L. Smith

RADIO TRANSMITTERS

H. Tanck, *Chairman*
A. E. Kerwien, *Vice-Chairman*

E. L. Adams	J. B. Heffelfinger
T. J. Boerner	J. B. Knox
Paul Breen	L. A. Looney
M. R. Briggs	J. F. McDonald
H. R. Butler	John Ruston
L. T. Findley	Berthold Sheffield
Harold Goldberg	Harry Smith
	I. R. Weir

RECEIVERS

R. F. Shea, *Chairman*
J. D. Reid, *Vice-Chairman*

J. Avins	I. E. Lempert
G. L. Beers	C. R. Miner
J. E. Brown	Garrard Mountjoy
W. F. Cotter	J. F. Myers
R. T. Cox	J. M. Pettit
A. R. Hodges	F. H. R. Pounsett
K. W. Jarvis	S. W. Seeley
J. K. Johnson	S. C. Spielman
	W. O. Swinyard

SOUND RECORDING AND REPRODUCING

H. E. Roys, *Chairman*
A. W. Friend, *Vice-Chairman*

S. J. Regun	Everett Miller
M. S. Corrington	A. R. Morgan
George Graham	A. P. G. Peterson
G. P. Hixenbaugh	Harry Schecter
F. L. Hopper	R. A. Schlegel
E. W. Kellogg	Ward Shepard, Jr.
R. A. Lynn	Lincoln Thompson
J. Z. Menard	C. F. West
	R. E. Zenner

STANDARDS

J. G. Brainerd, *Chairman*
L. G. Cumming, *Vice-Chairman*
A. G. Jensen, *Vice-Chairman*

M. W. Baldwin, Jr.	A. F. Pomeroy
R. R. Batcher	George Rappaport
H. G. Booker	H. E. Roys
F. T. Budelman	P. C. Sandretto
W. G. Cady	E. S. Seeley
P. S. Carter	R. F. Shea
J. W. Forrester	J. R. Steen
A. G. Fox	H. Tanck
R. A. Hackbusch	Bertram Trevor
J. V. L. Hogan	W. N. Tuttle
J. E. Keister	L. C. Van Atta
E. A. Laport	K. S. Van Dyke
Wayne Mason	D. E. Watts
R. A. Miller	Ernst Weber
L. S. Nergaard	L. E. Whittemore

SYMBOLS

A. F. Pomeroy, *Chairman*
A. G. Clavier, *Vice-Chairman*

K. E. Aspach	C. D. Mitchell
C. R. Burrows	C. Neitzert
H. F. Dart	M. B. Reed
E. T. Dickey	Duane Roller
W. J. Everts	A. L. Samuel
W. A. Ford	E. W. Schafer
R. T. Haviland	M. S. Smith
O. T. Laube	W. F. Snyder

H. P. Westman

TELEVISION SYSTEMS

A. G. Jensen, *Chairman*
R. E. Shelby, *Vice-Chairman*

W. F. Bailey	A. H. Brolly
M. W. Baldwin, Jr.	J. E. Brown
R. M. Bowie	K. A. Chittick

C. G. Fick
D. G. Fink
C. J. Franks
P. C. Goldmark
R. N. Harmon
J. L. Hollis
I. J. Karr
R. D. Kell
P. J. Larsen
H. T. Lyman

Leonard Mautner
J. Minter
J. H. Mulligan, Jr.
A. F. Murray
J. A. Ouimet
D. W. Pugsley
David Smith
M. E. Strieby
A. Talamini
Norman Young, Jr.

L. W. Morrison, Jr.
R. S. O'Brien

C. G. Pierce
J. F. Wiggin

WAVE PROPAGATION

H. G. Booker, *Chairman*
H. W. Wells, *Vice-Chairman*

E. W. Allen, Jr.	D. E. Kerr
S. L. Bailey	J. E. Keto
J. E. Boyd	Morris Kline
C. R. Burrows	M. S. Morgan
F. J. Carroll	K. A. Norton
A. B. Crawford	H. O. Peterson
A. E. Cullum, Jr.	George Sinclair
W. S. Duttera	Newbern Smith
E. G. Fubini	A. W. Straiton
I. H. Gerks	A. H. Waynick
M. C. Gray	J. W. Wright
	R. L. Smith-Rose

VIDEO TECHNIQUES

J. E. Keister, *Chairman*
W. J. Poch, *Vice-Chairman*

M. W. Baldwin, Jr.	V. J. Duke
A. J. Baracket	G. L. Fredendall
P. F. Brown	R. L. Garman
R. H. Daugherty, Jr.	L. L. Lewis

Special Committees

PROFESSIONAL RECOGNITION

G. B. Hoadley, *Chairman*

C. C. Chambers	W. E. Donovan
Harry Dart	C. M. Edwards

EDITORIAL ADMINISTRATIVE

A. N. Goldsmith, *Editor, Chairman*

G. M. K. Baker	Haraden Pratt
H. S. Black	J. R. Ragazzini
R. S. Burnap	F. X. Rettenmeyer
E. F. Carter	(alternate)
R. L. Dietzold	Newbern Smith
(alternate)	G. C. Sziklai
A. V. Haeff	(alternate)
E. W. Herold	Ernst Weber
F. B. Llewellyn	H. A. Wheeler
Knox McIlwain	L. E. Whittemore
Donald McNicol	Harold Zahl
K. A. Norton	
(alternate)	

ARMED FORCES LIAISON
COMMITTEE

G. W. Bailey, *Chairman*

INSTITUTE REPRESENTATIVES IN COLLEGES—1950*

*Agricultural and Mechanical College of Texas: Tom Prickett, Jr.
*Akron, University of: P. C. Smith
*Alabama Polytechnic Institute: G. H. Saunders
*Alberta, University of: J. W. Porteous
*Arizona, University of: H. E. Stewart
*Arkansas, University of: G. H. Scott
British Columbia, University of: H. J. MacLeod
*Brooklyn, Polytechnic Institute of: A. B. Giordano
*Bucknell, University of: R. C. Walker
*California Institute of Technology: W. H. Pickering
*California State Polytechnic College: Clarence Radius
*California, University of: I. J. Black
California, University of at Los Angeles: F. F. King
Carleton College: G. R. Love

*Carnegie Institute of Technology: E. M. Williams
*Case Institute of Technology: J. D. Johannesen
Cincinnati, University of: A. B. Bereskin
*Clarkson College of Technology: F. A. Record
*Colorado, University of: H. W. Boehmer
*Columbia University: J. R. Ragazzini
*Connecticut, University of: C. W. Schultz
*Cooper Union: J. B. Sherman
*Cornell University: True McLean
Dartmouth College: M. G. Morgan
*Dayton, University of: Appointment later
*Delaware, University of: H. S. Bueche
Denver University of: Herbert Reno
*Detroit, University of: Appointment later
Drexel Institute of Technology: R. T. Zern
Duke University: W. J. Seely
Evansville College: J. F. Sears
*Fenn College: K. S. Sherman
*Florida, University of: H. A. Owen
*George Washington University: W. S. Carley

*Georgia Institute of Technology: M. A. Honnell
Harvard University: E. L. Chaffee
Idaho, University of: appointment later
*Illinois Institute of Technology: G. F. Levy
*Illinois, University of: E. C. Jordan
*Iowa, State University of: L. A. Ware
*Iowa State College: G. A. Richardson
*John Carroll University: J. L. Hunter
Johns Hopkins University: Ferdinand Ham-burger, Jr.
*Kansas State College: J. E. Wolfe
Kansas, University of: D. G. Wilson
*Kentucky, University of: H. W. Farris
*Lafayette College: F. W. Smith
Lawrence Institute of Technology: H. L. Byerlay
*Lehigh University: D. E. Mode
Louisiana State University: Appointment later
*Louisville, University of: Appointment later
*Maine, University of: W. J. Creamer, Jr.
*Manhattan College: T. P. Canavan

* Colleges with approved Student Branches

- Manitoba, University of: R. G. Anthes
 *Marquette University: G. A. Frater
 *Maryland, University of: George Corcoran
 *Massachusetts Institute of Technology: E. A. Guillemin, W. H. Radford
 McGill University: F. S. Howes
 *Miami, University of: Appointment later
 *Michigan College of Mining and Technology: R. J. Jones
 *Michigan State College: M. D. Rogers
 *Michigan, University of: L. N. Holland
 *Minnesota, University of: O. A. Becklund
 *Mississippi State College: Appointment later
 *Missouri School of Mines and Metallurgy: G. G. Skitek
 *Missouri, University of: G. V. Lago
 *Nebraska, University of: Charles Rook
 Nevada, University of: I. J. Sandorf
 *Newark College of Engineering: M. E. Zaret
 New Hampshire, University of: A. L. Winn
 *New Mexico College of Agriculture and Mechanic Arts: H. A. Brown
 *New Mexico, University of: Tom Martin
 *New York, College of the City of: Harold Wolf
 *New York University: Philip Greenstein
 *North Carolina State College: G. B. Hoadley
 *North Dakota, University of: Clifford Thomforde
 *Northeastern University: G. E. Pihl
 Northwestern University: A. H. Wing, Jr.
 Notre Dame, University of: H. E. Ellithorn
 *Ohio State University: E. M. Boone
 *Oklahoma Agricultural and Mechanical College: H. T. Fristoe
 Oklahoma, University of: C. L. Farrar
 *Oregon State College: A. L. Albert
 *Pennsylvania State College: C. R. Ammerman
 *Pennsylvania, University of: C. C. Chambers
 *Pittsburgh, University of: J. F. Pierce
 *Pratt Institute: David Vitrogran
 *Princeton University: N. W. Mather
 *Purdue University: R. P. Siskind
 Queens University: H. H. Stewart
 *Rensselaer Polytechnic Institute: H. D. Harris
 *Rhode Island State College: J. L. Hummer
 Rice Institute: C. R. Wischnmeyer
 Rose Polytechnic Institute: H. A. Moench
 *Rutgers University: J. L. Potter
 *San Diego State College: D. C. Kalbfell
 Santa Clara, University of: W. J. Warren
 *San Jose State College: Harry Engwicht
 *Seattle University: Appointment later
 *South Carolina University of: L. R. Wever
 *South Dakota School of Mines and Technology: Appointment later
 *Southern California, University of: G. W. Reynolds
 *Southern Methodist University: E. J. O'Brien
 *Stanford University: J. M. Pettit
 *St. Louis University: G. E. Dreifke
 *Stevens Institute of Technology: A. C. Gilmore, Jr.
 *Syracuse University: R. P. Lett
 *Tennessee, University of: E. D. Shipley
 Texas Technological College: Appointment later
 *Texas, University of: C. M. Crain
 *Toledo, University of: R. E. Weeber
 *Toronto, University of: George Sinclair
 *Tafts College: A. H. Howell
 *Tulane University: M. E. Forsman
 Union College (N.Y.): R. B. Russ
 Union College (Nebr.): M. D. Hare
 United States Military Academy: F. K. Nichols
 United States Naval Post Graduate School: G. R. Giet
 *Utah State Agricultural College: Clayton Clark
 *Utah, University of: O. C. Haycock
 *Virginia Polytechnic Institute: R. R. Wright
 *Virginia, University of: J. C. Mace
 Washington, State College of: appointment later
 *Washington, University of: V. L. Palmer
 Washington University: S. H. Van Wambeck
 *Wayne University: M. B. Scherba
 Western Ontario, University of: E. H. Tull
 West Virginia University: R. C. Colwell
 *Wisconsin, University of: Glenn Koehler
 Witwatersrand, University of: G. R. Bozzoli
 *Worcester Polytechnic Institute: H. H. Newell
 *Wyoming, University of: W. M. Mallory
 *Yale University: H. J. Reich

INSTITUTE REPRESENTATIVES ON OTHER BODIES—1950

- American Association for the Advancement of Science: J. C. Jensen
 American Documentation Institute: J. H. Dellinger
 ASA Standards Council: J. G. Brainerd, L. G. Cumming (alternate)
 ASA Conference of Staff Executives: G. W. Bailey, L. G. Cumming (alternate)
 ASA Electrical Standards Committee: L. G. Cumming, F. B. Llewellyn, E. A. LaPort
 ASA Sectional Committee (C16) on Radio: V. M. Graham (Chairman), J. G. Brainerd, L. G. Cumming, J. J. Farrell
 ASA Sectional Committee (C18) on Specifications for Dry Cells and Batteries: H. M. Turner
 ASA Sectional Committee (C39) on Electrical Measuring Instruments: Wilson Aull, Jr.
 ASA Sectional Committee (C42) on Definitions of Electrical Terms: J. G. Brainerd, A. G. Jensen, Haraden Pratt, H. A. Wheeler
 ASA Subcommittee (C42.1) on General Terms: J. C. Jensen
 ASA Subcommittee (C42.6) on Electrical Instruments: J. H. Miller
 ASA Subcommittee (C42.13) on Communications: J. C. Schelleng
 ASA Subcommittee (C42.14) on Electronics: R. S. Burnap
 ASA Sectional Committee (C60) on Standardization of Electron Tubes: L. S. Nergaard, C. E. Fay
 ASA Sectional Committee (C61) on Electric and Magnetic Magnitudes and Units: J. H. Dellinger
 ASA Sectional Committee (C63) on Radio-Electrical Co-ordination: C. C. Chambers
 ASA Sectional Committee (C67) on Standardization of Voltages—Preferred Voltages—100 Volts and Under: A. F. Van Dyck
 ASA Sectional Committee (Z10) on Letter Symbols and Abbreviations for Science and Engineering: H. M. Turner, A. F. Pomeroy (alternate)
 ASA Sectional Committee (Z14) on Standards for Drawings and Drafting Room Practices: Austin Bailey
 ASA Sectional Committee (Z17) on Preferred Numbers: A. F. Van Dyck
 ASA Sectional Committee (Z24) on Acoustical Measurements and Terminology: Eginhard Dietze, H. F. Olson
 ASA Sectional Committee (Z32) on Graphical Symbols and Abbreviations for Use on Drawings: Austin Bailey, A. F. Pomeroy (alternate)
 ASA Subcommittee (Z32.9) on Communication Symbols: H. M. Turner
 ASA Sectional Committee (Z57) on Standards for Sound Recording: S. J. Begun
 ASA Subcommittee (Z57.1) on Magnetic Recording: W. J. Morlock
 ASA Sectional Committee (Z58) on Standardization of Optics: E. D. Goodale, L. G. Cumming (alternate)
 ASME Glossary Review Board: W. R. G. Baker
 IRE, AIEE Committee on Noise Definitions: Stanford Goldman, Jerry Minter, Claude Shannon
 IRE, RMA Problem No. 2: S. L. Bailey
 Joint EEI, NEMA, RMA Co-ordination Committee on Radio Reception: C. E. Brigham
 Joint IRE, ASA C42 Definitions Co-ordinating Committee: C. L. Dawes, A. G. Jensen, J. C. Schelleng
 Joint IRE, AIEE, NEMA Co-ordination Committee on Commercial Induction and Dielectric Heating Apparatus: D. E. Watts
 Joint RMA-IRE Co-ordination Committee: R. F. Guy, Keith Henny
 Joint Technical Advisory Committee: R. F. Guy
 National Electronics Conference Board of Directors: J. D. Reid
 National Research Council, Division of Engineering and Research: F. B. Llewellyn
 URSI (International Scientific Radio Union) Executive Committee: C. M. Jansky, Jr.
 U. S. National Committee, Advisers on Electrical Measuring Instruments: Melville Eastham, H. L. Olesen
 U. S. National Committee, Advisers on Symbols: L. E. Whitmore, J. W. Horton
 U. S. National Committee of the International Electrotechnical Commission: L. G. Cumming, E. A. LaPort, F. B. Llewellyn

Abstracts and References

Prepared by the National Physical Laboratory, Teddington, England, Published by Arrangement with the Department of Scientific and Industrial Research, England, and *Wireless Engineer*, London, England

NOTE: The Institute of Radio Engineers does not have available copies of the publications mentioned in these pages, nor does it have reprints of the articles abstracted. Correspondence regarding these articles and requests for their procurement should be addressed to the individual publications, and not to the IRE.

Acoustics and Audio Frequencies.....	1235
Antennas and Transmission Lines.....	1236
Circuits and Circuit Elements.....	1236
General Physics.....	1238
Geophysical and Extraterrestrial Phenomena.....	1239
Location and Aids to Navigation.....	1240
Materials and Subsidiary Techniques.....	1240
Measurement and Test Gear.....	1243
Other Applications of Radio and Electronics.....	1244
Propagation of Waves.....	1245
Reception.....	1245
Stations and Communication Systems.....	1245
Subsidiary Apparatus.....	1246
Television and Phototelegraphy.....	1246
Transmission.....	1247
Tubes and Thermionics.....	1247
Miscellaneous.....	1248

The Annual Index to these Abstracts and References, covering those published in the PROC. I.R.E. from February, 1949, through January, 1950, may be obtained for 2s. 8d. postage included from the *Wireless Engineer*, Dorset House, Stamford St., London S. E., England. This index includes a list of the journals abstracted together with the addresses of their publishers.

The number in heavy type at the upper left of each Abstract is its Universal Decimal Classification number and is not to be confused with the Decimal Classification used by the United States National Bureau of Standards. The number in heavy type at the top right is the serial number of the Abstract. DC numbers marked with a dagger (†) must be regarded as provisional.

ACOUSTICS AND AUDIO FREQUENCIES

- 534.232 **2112**
The Production of Edge Tones by Circular Gas Jets and Plane Laminae—H. von Gierke. (*Z. Angew. Phys.*, vol. 2, pp. 97–106; March, 1950.) An experimental investigation and discussion of the theory of the production of edge tones at a hole or slit in a lamina directly above a jet of gas. Stroboscopic observations of the jets under such conditions indicate that the tones are due to the periodic whirls of the issuing gas. Frequency measurements were made for different lamina spacings and different velocities and diameters of jet. The properties of edge-tone devices as radiators of sound energy are considered.
- 534.26+535.421 **2113**
The Diffraction of a Plane Wave through a Grating—Miles. (*See* 2179.)
- 534.26 **2114**
On Two Complementary Diffraction Problems—A. Storruste and H. Wergeland. (*Phys. Rev.*, vol. 73, pp. 1397–1398; June 1, 1948.) Spheroidal coordinates are introduced for obtaining exact solutions for the diffraction of sound waves by a circular disk and by a hole in an infinite plane screen. The electromagnetic case is to be dealt with later.
- 534.321.9:534.133-14 **2115**
Theoretical and Experimental Investigations of the Oscillations and the Radiation Resistance of an Ultrasonic Quartz Crystal—G. Bolz. (*Z. Angew. Phys.*, vol. 2, pp. 119–127; March, 1950.) The differential equations are derived for the 3-dimensional motion of a quartz crystal oscillating in a liquid. An approximate solution is given, assuming plane oscillations, and expressions are derived for radiation re-

sistance, amplitude of oscillations, decrement and equivalent circuit values near resonance. The mean value of radiation resistance found by measuring the damping effect on an oscillatory circuit agrees with the theoretical expression. Deviation (generally <10 per cent) of the measured value from the mean is attributed to an unknown form factor, the assumption of plane oscillations being only an approximation to the actual conditions. Values given for equivalent L and C are valid for a crystal oscillating in air or in vacuo.

534.321.9:[534.373+534.22] **2116**

A New Frequency-Modulation Method for Measuring Ultrasonic Absorption in Liquids—E. Ribchester. (*Nature* (London), vol. 165, p. 970; June 17, 1950.) The output from a rf oscillator, modulated by a sinusoidal af voltage, is applied to a quartz transducer. The af voltage is also passed through a variable-phase-shift network and modulates a second oscillator on a different radio frequency. The output from this oscillator is injected into a frequency changer together with the signal from the receiving transducer in the liquid cell, and the phase-shift network is adjusted for maximum output from the frequency-changer, corresponding to absence of frequency modulation. Results of measurements of absorption in water, using a frequency of 10 Mc, are in close agreement with those obtained by pulse techniques.

534.6:621.395.632.11 **2117**

Acoustical Study of Telephone Bells of the French P.T.T. Administration—In 1325 of July please insert as authors P. Chavasse and R. Lehmann.

534.86 **2118**

Listeners' Sound-Level Preferences: Part 2—T. Somerville and S. F. Brownless. (*BBC Quart.*, vol. 5, pp. 57–64; Spring, 1950.) A description of tests on listeners' preferences for changes in sound level between the end of one program and the beginning of the next. The results are summarized for various program changes; a reduction of 4–5 db is preferred for speech following music, and an increase of about 2 db for music following speech. Part 1: 1266 of 1949.

621.395.61+621.395.623.7]:597.08 **2119**

Underwater Sound Technique in the Service of Modern Research—H. Gemperle. (*Radio Tech.* (Vienna), vol. 26, pp. 235–239; May, 1950.) Description and theory of pressurized transmitter and microphone units for depths up to 30 m. The frequency range 30 cps–20 kc is covered with good efficiency.

621.395.623.7 **2120**

Study of Different Acoustic Baffles for Loudspeakers—T. S. Korn. (*Toute la Radio*, vol. 17, pp. 183–186; June, 1950.) Analysis of general theory of sound radiation from loud speakers and discussion of different basic types of baffle. The simplest effective construction for even response is the base reflex baffle consisting of a closed cabinet lined with absorbent material, with an orifice beneath the loudspeaker. The labyrinth type baffle gives a similar response curve.

621.395.625.3:621.3.018.78† **2121**

Over-all Frequency Characteristic in Magnetic Recording—P. E. Axon. (*BBC Quart.*, vol. 5, pp. 46–53; Spring, 1950.) Frequency distortion in magnetic recording is discussed and illustrated by calculated and measured characteristic curves. The frequency characteristic of the record on the tape can be determined independently of the reproducing-head characteristic by using a reproducing head with a wide gap. The magnitude of self-demagnetization in commercial tapes can be evaluated by this method, and the results obtained can be used in conjunction with the calculated characteristic of a normal reproducing head to predict the response of magnetic recording equipment.

621.395.665.1 **2122**

The Electrodynamical Volume Expander—(*Radio Tech. Dig.* (Franc), vol. 4, pp. 116–124 and 177–181; April and June, 1950.) Based on an article in Italian by Zanarini. The principles of a simple and economical expansion circuit are described in which the moving-coil loudspeaker serves as the expander, the current through the field coil being controlled in accordance with the amplitude of the af signal applied to the moving coil. No distortion is introduced by this method and the amplifier chain needs no modification. The basic circuit consists of a transformer with primary across the moving coil; the output from the secondary is rectified and applied across a parallel RC circuit to the grid and cathode of a pentode which has the field coil in its anode circuit. Developments of the circuit are discussed and practical considerations are summarized.

621.396.645.029.3 **2123**

A.F. Amplifiers—R. Besson. (*Toute la Radio*, vol. 17, pp. 167–171 and 187–191, 199; May and June, 1950.) Three classes of amplifier are considered: (a) high-quality; (b) a compromise of quality and cost; and (c) the cheapest with satisfactory performance. Design considerations and details of ancillary circuits are discussed. A 4.5-w and 10-w amplifier of class (b) are treated as examples and simple calculations made to determine their design specifications.

Complete circuit diagrams and notes on construction and testing are included.

ANTENNAS AND TRANSMISSION LINES

- 621.315.212:621.317.336 2124
Study of the Impedance Irregularities of Coaxial Cables by Oscillographic Observation of Pulse Echoes—P. Herreng and J. Ville. (*Ann. Télécommun.*, vol. 3, pp. 317-331; October, 1948.) See 2162 of 1948 and 142 of 1949 (Coutant and Herreng).
- 621.392 2125
Phase Distortion in Feeders: Effect of Mismatching on Long Lines—L. Lewin, J. J. Muller, and R. Basard. (*Wireless Eng.*, vol. 27, pp. 143-145; May, 1950.) A fresh approach to the problem of transmitting FM signals along feeder lines is made by considering the system as supporting a series of progressive waves of various instantaneous frequencies and reflected within the confines of the feeder. The production of phase distortion and harmonics is analyzed and an example of transmission along a waveguide is worked out.
- 621.392 2126
Study of a System of Two Parallel Wires by the Method of Hallén—V. Belevitch. (*HP* (Brussels), no. 6, pp. 163-168; 1950.) An integral equation, analogous to that of Hallén for an antenna, is established for a bifilar line. The first-approximation solution of this equation corresponds with the results given by the classic theory of transmission lines. The second approximation takes account of end effects and of radiation. The expression obtained for the radiated power coincides with that derived by C. Manneback by another method.
- 621.392.26† 2127
The Field Generated by an Arbitrary Current Distribution within a Waveguide—J. J. Freeman. (*Bur. Stand. Jour. Res.*, vol. 44, pp. 193-198; February, 1950.) Formulas are derived for waveguides of rectangular, circular, and coaxial cross section by extending expressions previously obtained for cavities (2762 of 1948) to the case of infinite length. As a check on the formulas it is shown that the value given for the field from an axially directed dipole within a circular guide reduces to the free-space value when the radius becomes infinite.
- 621.392.26† 2128
Reflection Cancellation in Waveguides—L. Lewin. (*Elec. Commun.*, vol. 27, pp. 48-55; March, 1950.) Reprint. See 3037 of 1949.
- 621.392.26†:621.396.67 2129
Slotted Waveguides and Their Applications as Aerials: Part 1—J. Ortusi and G. Boissinot. (*Ann. Radioélec.*, vol. 5, pp. 94-108; April, 1950.) Theory is given based on the elementary concept of the reflection and transmission coefficients of a slot. From consideration of a single slot in (a) an infinite conducting plane, and (b) a waveguide wall, general formulas are derived for the radiation from a waveguide having n equal and equidistant slots. The relations are applied to waveguides with $\lambda/2$ and with $\lambda/4$ spacing of slots, which radiate respectively with constant amplitude and with exponentially decreasing amplitude. Formulas which determine the conditions of use of slotted waveguides and their operating bandwidth are deduced.
- 621.392.5 2130
Note on Artificial Delay Lines—G. Martin. (*Compt. Rend. Acad. Sci. (Paris)*, vol. 230, pp. 1645-1647; May 8, 1950.) A method of calculation more exact than hitherto used is developed for a line consisting of a helically wound wire on an insulated cylindrical metal core, by considering the planar transformation in which the system is cut lengthwise and opened out. The method applies particularly to the case when the dielectric layer is thin and the pitch of the winding and the core curvature are small, and permits evaluation and correction of non-uniformity effects at the end of the line. Measurements by various methods agree with the calculated results to within a few per cent.
- 621.396.67 2131
The Principle of Conservation of Energy and Kottler's Formulae—J. Ortusi and J. C. Simon. (*Ann. Radioélec.*, vol. 5, pp. 67-73; April, 1950.) Application of Kottler's formulas to the radiation from a waveguide aperture shows that, considering a waveguide of infinite length, the law of energy conservation and Maxwell's equations are satisfied simultaneously only by an existing field. For an arbitrary field to satisfy the energy condition, the reflected wave must be introduced. In a waveguide of rectangular cross section the reflected wave tends to a zero value as the frequency is increased without limit. A rigorous proof of this is given.
- 621.396.67 2132
An All-Band Mobile Antenna System—S. S. Perry. (*QST*, vol. 34, pp. 16-18; June, 1950.) Details of a combination covering the wavelength range 2-160 m. For wavelengths of 2, 6, and 10 m a $\lambda/4$ whip antenna mounted high on the vehicle is used. For longer waves an antenna center-loaded with a multitapped coil is substituted. This serves as a $\lambda/4$ antenna for 10.7-m wavelength when all the coil is short-circuited, and resonates at 3.5 Mc (85.7 m) when about 160 turns of the coil are in use. For wavelengths up to 160 m a second loading coil is added in series.
- 621.396.671 2133
Indoor Measurement of Microwave Antenna Radiation Patterns by Means of a Metal Lens—G. A. Wootton, R. B. Borts, and J. A. Carruthers. (*Jour. Appl. Phys.*, vol. 21, pp. 428-430; May, 1950.) Laboratory measurements were made using a metal lens to render the spherical wave-front plane, the method being similar to that used in optical diffraction measurements. Comparison of results with those obtained by standard field methods showed little loss of accuracy for angles between -15° and $+15^\circ$ for horns of aperture width 32 cm, using a lens of aperture 119 cm and a wavelength of 3.2 cm. A stepped lens was found unsatisfactory, probably because of diffraction caused by the steps.
- 621.396.671 2134
Input Impedance of Horizontal Dipole Aerials at Low Heights above the Ground—R. F. Proctor. (*Proc. IEE* (London), vol. 97, pp. 188-190; May, 1950.) "The large increase in the radiation resistance of a horizontal dipole at low heights above the ground, predicted by the mathematical analysis of Sommerfeld and Renner, is confirmed by actual measurement for the case of an essentially pure dielectric ground. Measurements carried out above a series of conducting mats of increasing mesh size corroborate the supposition that the large increase in the radiation resistance at low heights is caused by a corresponding increase in the energy radiated downwards into the dielectric ground."
- 621.396.671 2135
Gain of Aerial Systems—P. M. Woodward and J. D. Lawson. (*Wireless Eng.*, vol. 27, p. 166; May, 1950.) Comment on 3057 of 1949 and 820 of May (Bell).
- 621.396.671.011.2 2136
Mutual Impedance and Self-Impedance of Coupled Parallel Aerials—B. J. Starkey and E. Fitch. (*Proc. IEE* (London), vol. 97, pp. 129-137; May, 1950.) Existing formulas for the mutual impedance of parallel antennas are ap-

proximate or based on simplifying assumptions. To check these formulas, the authors measured the front/back ratios of the radiation patterns of 2-element arrays, confirming and extending the observations of McPetrie & Saxton (1450 of 1946). The use of "intrinsic impedance," based on a simple transmission-line calculation, for the self-impedance of each antenna resulted in poor agreement between theory and observation. By introducing resistive losses and end-capacitance in the lines, quite good agreement was obtained.

CIRCUITS AND CIRCUIT ELEMENTS

- 621.3.011.2 [negative] 2137
Negative-Resistance Characteristics—A. W. Keen. (*Wireless Eng.*, vol. 27, pp. 175-179; June, 1950.) Negative resistance characteristics as encountered in practice are qualitatively surveyed, and the distinction between the characteristics resulting respectively from voltage and current control of feedback is emphasized. A method of building up a particular characteristic by synthesis of positive and negative elements is described, the basic positive element being represented very closely by the characteristic of a hard diode. The concept of a "negative diode" is introduced, and an equivalent circuit composed of positive and negative diodes is shown for a triode and discussed also for a tetrode.

- 621.314.2:621.396.645.2 2138
Bifilar I.F. Coils—S. R. Schweiner. (*Electronics*, vol. 23, pp. 104-107; June, 1950.) The use of transformers with the two coils wound together for coupling the various stages of stagger-tuned IF amplifiers renders coupling capacitors unnecessary. The low time constant of the grid circuit gives improved signal-to-noise ratio and the rf choke normally used to feed the anode of the final IF tube can be omitted. Detailed analysis of circuits including bifilar transformers is presented and their advantages and limitations are discussed.

- 621.314.3† 2139
Magnetic Amplifiers of the Balance-Detector Type—W. A. Geyger. (*Elec. Eng.*, vol. 69, p. 459; May, 1950.) Summary of 1950 AIEE Winter General Meeting paper.

- 621.316.726.078.3:538.569.4.029.64 2140
Servo Theory Applied to Frequency Stabilization with Spectral Lines—W. D. Hershberger and L. E. Norton. (*Jour. Frank. Inst.*, vol. 249, pp. 359-366; May, 1950.) Comparison between the frequency of a gas-absorption line and the frequency to be stabilized, or a frequency simply related to it, is made by a sweep-oscillator technique. A pulse is generated each time the resonance frequency is passed through. The resulting voltages are applied to a suitable discriminator, the output from which is fed to a servo system controlling the frequency. The limitations and performance of the circuits involved are discussed. A long-term frequency stability within 1 part in 10^7 has been realized.

- 621.316.8:621.396.822 2141
Noise in Current-Carrying Ohmic Conductors—B. Meltzer. (*Phil. Mag.*, vol. 41, pp. 393-398; April, 1950.) The mean-square noise current in a conductor which is in temperature equilibrium and carries a current I , is calculated on the assumption that the current is due to elementary carriers of charge e . The value obtained for the spectral density is $\{2kT/R + [(2kT/R)^2 + (2eI)^2]\}^2$ where R , T , k are respectively resistance, absolute temperature, and Boltzmann's constant. The interpretation of this result is that, over and above the ordinary thermal Nyquist noise, there is present an additional noise, of which the spectral density varies in square-law fashion according to $(e^2R/kT)^2$ for small values of I , and in linear

fashion according to $\{(-2kT/R) + 2eI\}$ for large values of I . These predictions are compared with Bernamont's experimental results for thin metallic conductors, and the discrepancies are discussed.

621.316.86 2142
Thermistors: Part 1. Static Characteristics
 —O. J. M. Smith. (*Rev. Sci. Instr.*, vol. 21, pp. 344–350; April, 1950.) "The fundamental Thermistor equations are presented as functions only of electrical quantities and constants, and independent of temperature measurements. The universal curves allow one to predict the static characteristics of thermistors as circuit elements. The two most significant characteristics are the power coefficient of resistance, and the negative incremental resistance. These can be computed, or read from the universal curves, at the resistance and four parametric constants are known. These five values can be determined from six convenient measurements: the resistance and change of resistance with current at very low current, at the maximum voltage point, and at maximum current." Part 2: 2143 below.

621.316.86 2143
Thermistors: Part 2. Dynamic Characteristics
 —O. J. M. Smith. (*Rev. Sci. Instr.*, vol. 21, pp. 351–356; April, 1950.) The thermistor sinusoidal and transient response characteristics are presented as functions of the dissipation constant and incremental resistance. Equations are given for time constant, critical frequency, equivalent inductance, and Q . The construction of a low frequency oscillator is discussed, as well as possible nonlinear filter applications. Part 2: 2142 above.

621.318.572 2144
Decade Pulse Counter for Geiger-Müller Tubes
 —B. Åström. (*Rev. Sci. Instr.*, vol. 21, pp. 324–326; April, 1950.) Full circuit details of a counter with the following features:—direct indication; easily reset to zero; all resistors and capacitors with 10 per cent tolerances; very reliable and insensitive to power line fluctuations; highly sensitive; components easily accessible; high-voltage supply for G-M tube capable of supplying enough current for a quenching circuit of the Neher-Pickering type.

621.318.572 2145
Pentode Counting or Control Ring
 —B. L. Moore. (*Rev. Sci. Instr.*, vol. 21, pp. 337–338; April, 1950.) Ten pentodes, Type 6AS6, are used in a very stable counting or control ring whose operation is essentially independent of the incoming pulses, and which does not require careful selection of tubes.

621.392 2146
A Useful Network Procedure
 —S. C. Dunn. (*Wireless Eng.*, vol. 27, pp. 171–175; June, 1950.) The method establishes a relation between the parallel and the star connection of quadripoles. Any number of networks in parallel, with common generator and load, can be replaced by a set in star connecting, having a common central load, but each having an independent generator. The method is applied to study the steady-state and transient responses of a parallel-T RC network. The use of the method for obtaining the input impedance of multichannel networks is demonstrated, and an example is given of a prism-like system of resistor wires which may be reduced to a network of the separate-generator type.

621.392.4 2147
Transformation of a Lumped-Constant Two-Pole Network to a Dissipative Transmission Line
 —A. Millán. (*Rev. Telecomunicación* (Madrid), vol. 4, pp. 2–14; March, 1949.) The short-circuited dissipative transmission line whose admittance simulates, over a particular frequency band, the input admittance of a

given lumped-parameter circuit, is determined by developing the appropriate irrational function in terms of Mittag-Leffler partial fractions. The graph of the resultant approximately rational function is compared with that of the rational function for the given network, and the transmission-line parameters deduced. Alternatively the lumped-parameter circuit is simulated by a lossless line terminated by a dissipative rod. An illustrative example is calculated.

621.392.43 2148
Matching of Amplifiers and Centimetre-Wave Autooscillators over a Wide Band of Frequencies
 —M. Denis. (*Ann. Radioélec.*, vol. 5, pp. 74–88; April, 1950. *Onde Elec.*, vol. 30, pp. 271–284; June, 1950.) Typical examples are given of maximum amplifier efficiency and minimum distortion occurring at different frequencies. The advantages of ideal matching in this sense are discussed with particular reference to the klystron amplifier. Matching circuits are described which are derived from band-pass filters or from natural or artificial delay lines. The phase-changing element necessary for an asymmetrical quadripole matching device is analogous to the circuits used in the microwave field. The extension of these principles to self-oscillators and amplifier chains is discussed, the resulting improvement in efficiency and reduction of the number of stages making the sacrifice of simplicity worth while.

621.392.43 2149
Method of Matching a Feeder Line for a Given Frequency
 —J. Paris. (*Radio Franç.*, no. 6, pp. 4–8; June, 1950.) Formulas are derived for finding the positions of the Sterba clip and its short-circuiting link for matching a 2-wire feeder of negligible loss to an antenna or other terminating load. The use of the Sterba diagram and of a cartesian diagram is illustrated by numerical examples.

621.392.43 2150
Graphical Methods for Impedance Matching
 —A. F. Huerta. (*Rev. Telecomunicación* (Madrid), vol. 4, pp. 15–22; March, 1949.) With special reference to stub matching.

621.392.5 2151
A Graphical Approach to the Synthesis of General Insertion Attenuation Functions
 —J. M. Linke. (*Proc. IEE* (London), vol. 97, pp. 179–187; May, 1950.) An investigation of methods of constructing the insertion transfer function of a network as a rational function meeting prescribed requirements. The insertion modulus function has been determined approximately by earlier methods of limited usefulness. A new semigraphical method is described, using template curves on log-log paper. These are selected to fit the required zeros and poles of the numerator and denominator polynomials and are added graphically to give the approximate attenuation curve shape. The method is unsuitable for networks having sharp cutoff regions.

621.392.5:621.315.212:621.397.743 2152
Equalization of Coaxial Lines
 —K. E. Gould. (*Elec. Eng.*, vol. 69, p. 390; May, 1950.) Summary of 1949 AIEE Fall General Meeting paper. Arrangements used for television service are discussed; the measured gain and delay-distortion characteristics for the Washington/Chicago circuit are shown graphically.

621.392.52 2153
Design of Dissipative Band-Pass Filters Producing Desired Exact Amplitude-Frequency Characteristics
 —M. Dishal. (*Elec. Commun.*, vol. 27, pp. 56–81; March, 1950.) Reprint. See 3369 of 1949.

621.392.52 2154
Calculation of Transients in Electrical

Filters—T. Laurent. (*Rev. Telecomunicación* (Madrid), vol. 4, pp. 17–28; December, 1948.) Application of the frequency-transformation method noted in 1339 of 1938 to obtain expressions for transients in low-pass and band-pass filters. Translated from *Tekniska Meddelander från Kungl. Telegrafstyrelsen*, no. 2, August, 1947.

621.392.52:539.2 2155
Physical Basis of the Wave Filter—Salt-peter. (See 2197.)

621.392.52:621.397.82 2156
The Latest Techniques for the Elimination of Ham TVI—P. S. Rand. (*CQ*, vol. 6, pp. 9–12, 61; June, 1950.) Description of the construction and correct method of fitting low-pass filters in antenna leads for harmonic suppression, together with methods of interference suppression for ignition systems.

621.395.665.1 2157
The Electrodynamical [volume] Expander—(See 2122.)

621.395+621.396].813 2158
621.3.018.78†
Distortion—Please note that, in this and subsequent issues, the UDC number used will be 621.3.018.78† instead of 621.395.813 and 621.396.813 used hitherto.

621.396.6'061.4 2159
Trends in Components—(*Wireless World*, vol. 56, pp. 229–235; June, 1950.) Short account of selected exhibits at the private exhibition organized by the Radio and Electronic Component Manufacturers' Federation and held in London, April 17–19, 1950. A list of the names and addresses of exhibitors is appended.

621.396.611.1:517.942.932 2160
Relaxation Oscillations—LaSalle. (See 2261.)

621.396.611.21 2161
Loading Quartz Crystals to Improve Performance—(*Tech. Bull. Nat. Bur. Stand.*, vol. 34, pp. 59–62; May, 1950.) Experimental investigation by L. T. Sogn. Examination by means of a probe electrode of the frequency and activity distribution at the surface of a crystal plate led to the detection of differences in thickness of $<20 \mu$. Variations in surface activity and frequency for various plates, loaded and unloaded, and during temperature runs from -60°C to $+90^\circ\text{C}$ are described. In many cases loading has proved very beneficial.

621.396.611.21.012.8 2162
X-Cut Quartz Crystal—F. M. Leslie. (*Wireless Eng.*, vol. 27, pp. 180–181; June, 1950.) "A new equivalent circuit for a crystal driving a mechanical load is devised in terms of an electrical transmission line instead of the usual lumped components of inductance and capacitance."

621.396.615.11 2163
The Calculation of RC Oscillators—G. Isay. (*Bull. Schweiz. Elektrotech. Ver.*, vol. 40, pp. 509–517; August 6, 1949. In German.) The basic design principles of RC oscillators are outlined and illustrated by an example in which the calculation for a negative-feedback amplifier is based on that for two simple amplifier stages with negative current feedback, the first stage having a relatively low value of cathode resistance so that feedback to the second stage is reduced. The sharp resonance of the amplifier using a Wien-bridge type of feedback circuit, and two methods of amplitude limiting by means of thermistors, are discussed. Phase-shift oscillators are briefly considered, with particular application to the design of a 3-phase generator.

621.396.615.142.2.018.424 2164

A Wide Range 600-7000 Mc/s Local Oscillator—P. Janis. (*Tele-Tech*, vol. 9, pp. 22-24; April, 1950.) The frequency range 600-7000 Mc is covered on cw by two reflex klystrons, Types 6BL6 and 6BM6, used in conjunction with an adjustable cavity resonator consisting of a short-circuited coaxial line. Design and construction details are given. For pulsed outputs, Types SD-1103 and SD-1104 reflex klystrons have been developed; these have similar operating characteristics to the cw tubes, but have a low-voltage control electrode for taking the input pulses.

621.396.615.17/.18 2165

A Tuned Plate Multivibrator—A. E. Johanson. (*Bell Lab. Rec.*, vol. 28, pp. 208-212; May, 1950.) The difficulty of obtaining short-duration pulses with the conventional multivibrator circuit is overcome by replacing the anode resistors by parallel combinations of variator rectifiers and tuned circuits, whose resonance frequency then controls the timing. Pulses of duration estimated at 0.02 μ s have been produced. A further modification is described for frequency division at high frequencies, e.g., from 18.432 Mc to 8 kc in four steps.

621.396.615.18 2166

Frequency Division with Phase-Shift Oscillators—C. R. Schmidt. (*Electronics*, vol. 23, pp. 111-113; June, 1950.) Divisions by factors as high as 7 are easily obtainable by means of single-tube RC oscillators using standard components requiring only initial adjustment. Dividers operating from crystal- or tuning-fork-controlled oscillators have been constructed to give accurate 60-cps outputs. Divisions by 5, 6, and 7 were used in these designs, the locking range for these factors being adequate to ensure reliable operation. Initial adjustment of single-stage scale-of-ten circuits requires more care because of the restricted locking range.

621.396.619.23 2167

Non-Linear Distortion in a Cowan Modulator—V. Belevitch. (*Wireless Eng.*, vol. 27, pp. 164-165; May, 1950.) Author's reply to 1552 of July (Tucker and Jeynes).

621.396.645 2168

A New Amplifier, the "Cathode Repeater"—V. J. Cooper. (*Marconi Rev.*, vol. 13, pp. 72-80; 1950.) The use of a triode with the cathode as the signal input terminal has certain advantages for wide-band amplifiers. Under different conditions its input impedance may be purely resistive or may have a positive or negative susceptance. The circuit described can amplify from a low-impedance input into a low-impedance output, with considerable control of the values of input and output impedance.

621.396.645 2169

Differential Amplifiers—D. L. Johnston. (*Wireless Eng.*, vol. 27, p. 194; June, 1950.) Comment on 1636 of August (Parnum).

621.396.645 2170

Amplifier with Negative-Resistance Load—D. M. Tombs and M. F. McKenna. (*Wireless Eng.*, vol. 27, pp. 189-193; June, 1950.) Stage gains up to 2.5 μ (where μ is the tube amplification factor) have been obtained with a triode amplifier loaded with a negative-resistance element. The restrictions imposed on the operation of this type of amplifier by considerations of stability, and the limitation of the gain due to the capacitance of the load are discussed.

621.396.645+621.396.621]:621.385 2171

Electronic Valves: Books II-IV. [Book Review]—(See 2388.)

621.396.645:621.3.015.3]:012 2172

Transient Response Calculation—J. E. Flood. (*Wireless Eng.*, vol. 27 pp. 182-188; June, 1950.) The response of various types of

n -stage amplifier circuits may be expressed in terms of the Poisson exponential probability summation. Values of this function are already available in tables and charts. Examples are given of its use in analysis of single-stage amplifiers with resistance or LC coupling, and of multi-stage amplifiers with RC or filter coupling or with critically damped inductance compensation.

621.396.645.018.424 2173

Stagger Gain Calculator—E. R. Jenkins. (*Tele-Tech*, vol. 9, p. 29; April, 1950.) Graphs are presented for determining the optimum number of stages required in a wide-band amplifier of specified characteristics.

621.396.645.35 2174

A D. C. Amplifier for Biological Application—P. O. Bishop and E. J. Harris. (*Rev. Sci. Instr.*, vol. 21, pp. 366-377; April, 1950.) A four-channel high-gain direct-coupled amplifier is described, with an input impedance >100 M Ω at 10 kc. The frequency response is flat from zero to over 10 kc. Alternative capacitor coupling is provided so that large-amplitude very-low-frequency noise may be eliminated. When direct-coupled, the zero shift is of the order of 100 μ v peak to peak over a period of 30 minutes.

621.396.645.37:621.526 2175

Feedback Amplifiers and Servo Systems—E. E. Ward. (*Wireless Eng.*, vol. 27, pp. 146-153; May, 1950.) The pattern of poles and zeros of the response function is considered as a basis for classifying and studying these devices; this avoids discrimination between the frequency and transient responses, and the Laplace transform is used to develop a broad theory which includes both as special cases. The analysis is restricted to linear systems having lumped constants and one closed loop. A tentative classification of response functions on this basis is tabulated.

621.396.645.371 2176

Some Considerations in the Design of Negative-Feedback Amplifiers—W. T. Duerdoh. (*Proc. IEE* (London), vol. 97, pp. 138-155; May, 1950. Discussion, pp. 155-158.) "A brief survey is made of the application of a phase-amplitude theorem, due to Bode, to the design of feedback amplifiers with constant-phase margins, and a graphical method of estimating the phase change at any frequency from a knowledge of the amplitude characteristic is described. The use of constant-phase margin as a design criterion is criticized, and justification is given for a new criterion termed 'stability margin.' Using this criterion, a technique is developed for employing several feedback paths, thus enabling an increased amount of feedback to be connected to circuits of increased complexity. A brief account of a miniature audio amplifier with two feedback paths is included, and a 100-watt amplifier covering 300 cps-108 kc with some 35 db of feedback is described which, although it is 'conditionally' stable, is suitable for use in a multichannel telephony system."

621.392.52 2177

An Introduction to the Theory and Design of Electric Wave Filters [Book Review]—F. Scowen. Publisher: Chapman and Hall, London, 2nd edn., 1950, 188 pp. 18s. (*Jour. Brit. I.R.E.*, vol. 10, p. vi; May, 1950.) First published in 1945, this book "has already established itself as a work of major importance" in its field. A new section now added describes Darlington's insertion-loss method of filter design.

GENERAL PHYSICS

53 2178

Heaviside's Unpublished Notes—(*Electrician*, vol. 144, p. 1749; May 26, 1950.) Re-

port of a paper "Some Unpublished Notes of Oliver Heaviside," by H. J. Josephs, given at one of the I.E.E. Heaviside Centenary Commemorative Meetings, May, 1950. The documents in the possession of the IEE show that the fourth volume of "Electromagnetic Theory" was to contain an account of his ideas concerning the transformation of matter and energy on the atomic scale, together with his integration of the electrodynamics of Clerk Maxwell with the thermodynamics of Willard Gibbs. He extended his conception of "energy-tubes" to include their condensation into electronic particles. Other notes deal with the particle-like structure of electromagnetic pulses and the correlation of electromagnetism with gravitation.

534.26+535.421 2179

The Diffraction of a Plane Wave through a Grating—J. W. Milks. (*Quart. Appl. Math.*, vol. 7, pp. 45-64; April, 1949.) The problem of diffraction and scattering of a normally incident plane wave of sound by an infinite plane grating consisting of infinitely thin, coplanar, equally spaced strips with parallel edges is solved. The solution is extended to deal with cm waves incident on a grating the elements of which are perfectly conducting at rf or perfectly reflecting at optical frequencies. The case when the screen elements are of finite thickness t is also considered and an approximate solution is obtained including only first-order terms in t/λ .

534.26+535.42]:517.564.4 2180

The Oblate Spheroidal Wave Functions—Leitner and Spence. (See 2259.)

535.37:548.0 2181

On the Mechanism of Phosphorescence in Crystals—I. Curie. (*Jour. Phys. Radium*, vol. 11, pp. 179-185; April, 1950.) Study of the decay of phosphorescence of long persistence. If the return of electrons to the emission centers is bimolecular their recapture is favored and the decay of phosphorescence is retarded. In certain cases however the general law of decay still holds.

535.42 2182

Diffraction at a Circular Disk—W. Braunk. (*Z. Phys.* vol. 127, pp. 405-415; March 17, 1950.) The method previously described (2183 below) is applied to the case of a circular disk and to related problems. For the near field at points on the axis a very simple expression is obtained which agrees with the rigorous solution better than the Kirchhoff approximation. Simple formulas are also derived for the distant field. For the transmission coefficient on account of mathematical difficulties no improvement on the Kirchhoff approximation is obtained.

535.42 2183

New Approximation Method for Diffraction at a Plane Screen—W. Braunk. (*Z. Phys.*, vol. 127, pp. 381-390; March 17, 1950.) Various approximation methods for diffraction of a scalar wave have been proposed, but none give accurate results for small wavelengths (large ka), since their series converge very slowly when ka is large. a being a linear dimension of the disk or aperture and k the coefficient in the scalar wave equation $\Delta u + k^2 u = 0$. A new approximation method has been developed specially for the case where $ka \gg 1$. Numerical comparison with the rigorous solution for a particular case shows that the new method gives considerably better results than the Kirchhoff approximation down to $ka \approx 1$.

535.42:538.56 2184

A More Exact Fresnel-Field Diffraction Relation—G. A. Wootton. (*Canad. Jour. Res.*, vol. 28, pp. 120-126; March, 1950.) The field close to a radiating aperture is often of interest in radio-optical measurements, but the usual

- approximations in the Fresnel-field evaluation are generally invalid in this region. The distant field is given with good accuracy by the Fraunhofer relation, and from it the near Fresnel field is obtained by the Fourier-transform method. The analysis applies to rectangular apertures for which the field distribution can be expressed as the product of separate distributions in the two directions. The result is an integral which has not been evaluated in closed form, but which reduces to Fresnel's integral when the appropriate approximations are made.
- 535.42:538.56** **2185**
On the Diffraction of an Electromagnetic Wave through a Plane Screen—J. W. Miles. (*Jour. Appl. Phys.*, vol. 21, p. 468; May, 1950.) Corrections to paper abstracted in 202 of February.
- 537.217** **2186**
Vibration Pressure Hypothesis for Electric Repulsion—H. B. Dwight. (*Elec. Eng.*, vol. 69, pp. 397-398; May, 1950.) Similarity between the equation for the net repulsion between moving charges and the equation for the pressure exerted on one moving body by sound emitted from another is adduced in support of Mackay's theory that es repulsion is a manifestation of radiation pressure.
- 537.224** **2187**
Electrets—W. F. G. Swann. (*Phys. Rev.*, vol. 78, p. 811; June 15, 1950.) An expression is derived for the potential of an electret assuming that it consists of (a) a distribution of semi-permanent polarization which decays with time, and (b) a distribution of surface and volume charge which leaks away and has no relation to the decay of the polarization. Complete mathematical details will be published later.
- 537.226** **2188**
The Lorentz Correction in Barium Titanate—J. C. Slater. (*Phys. Rev.*, vol. 78, pp. 748-761; June 15, 1950.) It is assumed that the ferroelectric behavior of BaTiO₃ arises because the Lorentz correction leads to a vanishing term in the denominator of the expression for the dielectric constant. The Lorentz correction is computed for the actual crystal structure and it is found that the local field near the Ti ions is much greater than previously believed, so that even a small ionic polarization of the Ti ions will lead to ferroelectric effects.
- 537.311.3** **2189**
The Electrical Conductivity of Thin Wires—R. B. Dingle. (*Proc. Roy. Soc. A*, vol. 201, pp. 545-560; May 23, 1950.) Simple approximate methods are first given for evaluating the conductivity of films and wires of a size comparable with the mean free path of the conduction electrons. Rigorous theory for a thin wire is then developed to cover both inelastic and elastic collisions of the electrons at the metal surface. Finally Andrew's recent experimental results for a thin mercury wire are fitted to the theoretical curves obtained, and the mean free path evaluated.
- 537.311.5:621.396.671** **2190**
Currents on the Surface of an Infinite Cylinder Excited by an Axial Slot—C. H. Papas and R. King. (*Quart. Appl. Math.*, vol. 7, pp. 175-182; July, 1949.) "The distribution of surface-current density is determined on an axially infinite, perfectly conducting cylinder. A constant distribution of electric field across a narrow axial slot is assumed given."
- 537.525.029.6** **2191**
Electron Diffusion in a Spherical Cavity—A. D. MacDonald and S. C. Brown. (*Canad. Jour. Res.*, vol. 28, pp. 168-174; March, 1950.) The diffusion equation for electrons in a non-uniform field is solved in terms of the confluent hypergeometric function, and the condition for breakdown is derived. Measurements of breakdown fields for uniform electric fields enable the effective characteristic diffusion length to be found. Hence theoretical breakdown curves for nonuniform fields are predicted; these are in agreement with experimental results.
- 537.562:538.561** **2192**
Radio Emission of Purely Thermal Origin in Ionized Media—J. F. Denisse. (*Jour. Phys. Radium*, vol. 11, pp. 164-171; Aприл, 1950.) Radiation due to "hyperbolic" transitions similar to those occurring in the X-ray and γ -ray bands is studied theoretically by an analysis simplified from that of Kramers. By combining classical and quantum theory, a general expression is obtained for the radiation coefficient which is valid in all cases. The corresponding absorption calculated by application of Kirchhoff's theorem agrees with the value obtained from Lorentz's formula, and hence the influence of the refractive index of the medium on the radiation can be studied. Gyromagnetic radiation is briefly discussed.
- 537.71** **2193**
The M.K.S. or Giorgi System of Units—L. H. A. Carr. (*Beama Jour.*, vol. 57, pp. 101-106 and 145-147; April and May, 1950.) A paper given at the IEE, in March, 1950, putting the case for the adoption of this system. Rationalization is discussed as a separate subject in an appendix.
- 538.3** **2194**
Electromagnetic Theory—(*Electrician*, vol. 144, p. 1750; May 26, 1950. Report of a paper "An Appreciation of Heaviside's Contribution to Electromagnetic Theory," by W. Jackson, given at one of the IEE Heaviside Centenary Commemorative Meetings, May, 1950. Heaviside's development of a comprehensive theory of line transmission is not easy to discern from his published work, partly because of repetitions and partly on account of the style, though many of his writings are very clear and the chapter on em waves in vol. 1 of "Electromagnetic Theory" is probably the best physical discussion of em wave propagation along telephone lines yet written. Recognition is given to his work in interpreting and extending Maxwell's theory. A partial treatment (published in 1888) of E_m-mode propagation within a cylindrical conducting tube is also noted.
- 539.172.4:537.311.33** **2195**
Transmutation-Produced Germanium Semiconductors—J. W. Cleland, K. Lark-Horovitz, and J. C. Pigg. (*Phys. Rev.*, vol. 78, pp. 814-815; June 15, 1950.) Ge exposed to neutron bombardment becomes a p-type semiconductor due to lattice displacements and to transmutations. The former can be removed by heat treatment and good agreement is then observed for the number of carriers per cm³ as calculated from cross sections and as measured by the Hall effect.
- 539.172.4:537.311.33** **2196**
Fast Neutron Bombardment Effects in Germanium—J. H. Crawford, Jr. and K. Lark-Horovitz. (*Phys. Rev.*, vol. 78, pp. 815-816; June 15, 1950.)
- 539.2:621.392.52** **2197**
Physical Basis of the Wave Filter—J. L. Salpeter. (*Philips Tech. Commun.* (Australia), no. 1, pp. 3-10; 1950.) A simple explanation is given of the action of periodic lumped-reactance filters, and the analogy with the behavior of a row of particles such as atoms in a crystal lattice when irradiated by X rays is demonstrated, the existence of cut-off frequency and stop- or pass-bands being due to the structural discontinuity in both cases. A brief discussion of the 'zone' theory of solids is included. The exponential electrical line is an instance where the existence of a cutoff frequency is not an indication of discontinuous structure.
- 501:512.9** **2198**
Calcolo Tensoriale e Applicazioni [Book Review]—Finzi and Pastori. (See 2268.)
- 537.226** **2199**
Time Dependence of Electronic Processes in Dielectrics. Technical Report Reference L/T219 [Book Review]—H. Fröhlich and J. O'Dwyer. Publisher: British Electrical and Allied Industries Research Association, London, 1949, 8 pp., 4s. 6d. (*Beama Jour.*, vol. 57, p. 151; May, 1950.)
- 537.71** **2200**
The M.K.S. System of Electrical and Magnetic Units. British Standard No. 1637 [Book Review]—Publisher: British Standards Institution, London, 1950, 8 pp., 2s. (*Wireless Eng.*, vol. 27, pp. 167-168; May, 1950.) A summarized record of decisions taken by the International Electrotechnical Commission, expressing no opinions either for or against the system. The question of rationalization is not discussed.
- 538.1** **2201**
Die Maxwellsche Theorie in Veränderter Formulierung [Book Review]—L. Kneissler. Publisher: Springer Verlag, Vienna, 51 pp. (*Wireless Eng.*, vol. 27, p. 167; May, 1950.) A suggested modification of Maxwell's theory. "By eliminating magnetism and replacing it by the currents that produce it within the material. . . Maxwell's theory is brought into agreement with the electron theory in its macroscopic form." The book is a development of articles published in *Archiv für Elektrotechnik* in 1940-2.
- 538.1** **2202**
Magnetism [Book Review]—D. Shoenberg. Publisher: Sigma Books, London, 1949, 216 pp., 10s. 6d. (*Nature* (London), vol. 166, p. 5; July 1, 1950.) "None of the essential theory of elementary magnetism is omitted, but it appears in a guise less formidable and more convincing than usual." "The book is of a more advanced character than most of the Sigma series and it should be useful to the serious student as well as to the general reader."
- GEOPHYSICAL AND EXTRATERRESTRIAL PHENOMENA**
- 521.15:538.12** **2203**
A 4-Dimensional Generalization of Wilson's Hypothesis—A. Papapetrou. (*Phil. Mag.*, vol. 41, pp. 399-404; April, 1950.) "Wilson's hypothesis of electric currents accompanying the rotation of electrically neutral matter (in order to explain the origin of the geomagnetic field) is generalized in a 4-dimensional language. The main consequences of the generalized formulation are discussed."
- 521.15:538.12** **2204**
Magnetism and the Rotation of Celestial Bodies—A. E. Benfield. (*Nature* (London), vol. 166, p. 31; July 1, 1950.) The difference between (a) the predictions based on Fermi-Dirac statistics and (b) the requirements of the charge-separation theory of Berlage (1139 of June) is so great that it is hard to see how terrestrial magnetism can be due to this effect to any appreciable extent.
- 521.15:538.12** **2205**
The External Gravitational and Electromagnetic Fields of Rotating Bodies—G. L. Clark. (*Proc. Roy. Soc. A*, vol. 201, pp. 488-509; May 23, 1950.) An electromagnetic field of the form proposed by Blackett is shown to be possible, but the analysis does not rule out the possibility that alternative fields may also satisfy the conditions.

- 523.74 2206
A Particularly Intense Solar Flare—R. Müller. (*Naturwissenschaften*, vol. 37, p. 137; March, 1950.) Details of observations at Wendelstein Observatory on November 19, 1949.
- 523.746 2207
Origin of Sunspots—D. H. Menzel. (*Nature* (London), vol. 166, pp. 31-32; July 1, 1950.) A new theory is suggested, based on the assumption of a solar general magnetic field of polar intensity several gauss, i.e., 10-20 times less than usual estimates. Ionized gas ejected from the poles returns to the surface near the equator, producing intensification of the magnetic field. Collapse occurs when the gravitational acceleration exceeds the buoyancy effect of the magnetic field; sunspots may then result. Details of the theory are to be given later.
- 523.746 2208
On the Interpretation of the Sunspot Cycle—W. Grotrian. (*Naturwissenschaften*, vol. 37, p. 163; April, 1950.) Extension of Schwarzschild's calculation of the period of a star to the case of the sun gives values of 9 and 18 years for the solar cycle, when the general field strength is taken as 3,000 gauss. A combination of the Alfvén-Walén (3469 and 3470 of 1945) and Schwarzschild theories offers a conclusive explanation of the sunspot cycle as the period of electromagnetic-hydrodynamic or plasma oscillation of the sun's disk.
- 550.381 2209
The Effect of the Compressibility of the Earth on Its Magnetic Field—C. Truesdell. (*Phys. Rev.*, vol. 78, p. 823; June 15, 1950.)
- 551.51 2210
The Stratification of the Atmosphere—H. Flohn and R. Penndorf. (*Bull. Amer. Met. Soc.*, vol. 31, pp. 71-77 and 126-130; March and April, 1950.) Suggestions are made for a new classification of atmospheric layers, based on thermal data.
- 551.510.535 2211
Theory of the Production of an Ionized Layer in a Non-Isothermal Atmosphere, Neglecting the Earth's Curvature, and Its Application to Experimental Results—J. A. Gledhill and M. E. Szendrei. (*Proc. Phys. Soc.*, vol. 63, pp. 427-445; June 1, 1950.) "A new theory of ionospheric layer formation is developed, in which the temperature is assumed to vary linearly with height. The equations are compared at each step with those obtained by Chapman in his theory of layer formation in an isothermal atmosphere. The equations for the maximum of electron density and its height are also given. The effect of the parameters on the shape of the layer is shown in graphical form. The equations are somewhat complex in form, but an ingenious graphical method has been devised suitable for the application of the theory to results given in the form of a Booker and Seaton parabolic distribution of electronic density with height. By application of the theory to mean hourly values for four summer months in South Africa, values are obtained for the temperature gradient, the temperature at 200 km, and its variation over the middle part of the day. The results obtained are in accordance with previous estimates and offer numerical confirmation of the theory that the atmosphere expands bodily upwards during the middle part of a summer day."
- 551.510.535:621.396.11 2212
The Air Force Interest in Sporadic-E Ionization—N. C. Gerson. (*CQ*, vol. 6, pp. 17-19) June, 1950.) An account of cooperation between a band of 425 amateurs in 15 countries and the U. S. Air Force in the study of sporadic-E ionization, particularly regarding the movement of sporadic-E reflection points. The data obtained may be used to advance theories on the mechanism of sporadic-E effects and to form some conception of diurnal, seasonal, and annual variations.
- 551.515.4:621.396.9 2213
Radar Measurements of the Initial Growth of Thunderstorm Precipitation Cells—Hilst and MacDowell. (See 2200.)
- 551.524.7 2214
The Temperature Distribution of the Upper Atmosphere over New Mexico—A. Nazarek. (*Bull. Amer. Met. Soc.*, vol. 31, pp. 44-50; February, 1950.) The vertical distribution of temperature was derived, by use of the hydrostatic equation, from pressure data obtained in rocket experiments. The results indicate a steady increase from 210°K at 15 km to 308°K at 55 km, followed by a rapid decrease to 180°K at 85 km and a subsequent increase to 266°K at 120 km. An irregularity occurs at about 100 km, where the temperature decreases slightly, probably owing to dissociation of molecular into atomic oxygen. Seasonal and latitudinal effects are discussed.
- 551.578.11 2215
The Size Distribution of Raindrops—A. C. Best. (*Quart. Jour. R. Met. Soc.*, vol. 76, pp. 16-36; January, 1950.) Existing experimental data are examined, together with recent measurements in England and Wales, and the results are presented in a common form. Drop-size distribution is regarded as a function of rate of rainfall only, for simplification, and in many cases the distribution is in agreement with simple formulas. Tables based on these formulas are included showing values of the amount of liquid water per unit volume and of the number and total volume of drops, between certain diameter limits, for various rates of rainfall.
- 551.594.6+621.315.59 2216
University Research in Physics—J. A. Teegan. (*Beama Jour.*, vol. 57, pp. 133-138; May, 1950.) A brief survey of work done and in progress at London University on the nature of atmospherics and on the electrical properties of semiconductors.
- 551.51 2217
Oscillations of the Earth's Atmosphere [Book Review]—M. V. Wilkes. Publisher: Cambridge University Press, 1949, 74 pp., 12s 6d. (*Proc. Phys. Soc.*, vol. 63, pp. 459-460; June 1, 1950.) "This excellent little volume . . . deals with the oscillations produced daily in the atmosphere by the sun and the moon, as revealed mainly by the . . . daily variations of barometric pressure."
- 551.510.535:621.396.11 2218
Short-Wave Radio and the Ionosphere [Book Review]—T. W. Bennington. Publisher: Hiffe and Sons, London, 2nd edn., 138 pp., 10s. 6d. (*Wireless Eng.*, vol. 27, p. 168; May, 1950.) "This book presents the available information on the ionosphere in simple form so that it is usable by nonspecialists in the subject. The approach is nonmathematical."
- LOCATION AND AIDS TO NAVIGATION**
- 621.396.9 2219
'La Pipologie': the Art of Interpreting the 'Pips' on a Radar Screen—Vienne and Scotto. (*Radio Tech. Dig.* (Franc), vol. 4, pp. 67-81; April, 1950.) An article on the technique of radar operating, reproduced from a French Service document.
- 621.396.9:551.515.4 2220
Radar Measurements of the Initial Growth of Thunderstorm Precipitation Cells—G. R. Hilst and G. P. MacDowell. (*Bull. Amer. Met. Soc.*, vol. 31, pp. 95-99; March, 1950.) Sequence photographs of PPI and RHI (range height indicator) radar presentations are used for measurement of the vertical and horizontal growth of the storm. Vertical growth is rapid and horizontal growth is uniform.
- 621.396.9:551.578.1/4 2221
The Bright Band—A Phenomenon Associated with Radar Echoes from Falling Rain—J. E. N. Hooper and A. A. Kippax. (*Quart. Jour. R. Met. Soc.*, vol. 76, pp. 125-132; April, 1950.) The echoes obtained with vertical transmission are characterized by an intense echo from a layer at a height slightly below the freezing level. This is more pronounced in frontal rain than in instability showers, and is about 5 to 9 times more intense than the echo from the rain below, allowing for difference in range. Experiments are described which establish the height and thickness of the "bright band" layer. Measurements of the terminal velocity of snowflakes support Ryde's suggestion that the reduction in echo intensity below the bright band is due to the acceleration of water droplets from their velocity as snowflakes to the terminal velocity of raindrops.
- 621.396.9:551.578.1/4 2222
Radar Echoes from Meteorological Precipitation—J. E. N. Hooper and A. A. Kippax. (*Proc. IRE* (London), vol. 97, pp. 89-95; May, 1950. Discussion, pp. 95-97.) A more detailed account of the work referred to in 2221 above.
- 621.396.9:621.385.832:535.371.07 2223
Visibility on Cathode-Ray Tube Screens: Positive vs Negative Signals on an Intensity Modulated Scope—Harriman and Williams. (See 2386.)
- 621.396.933 2224
How the C.A.A. Flight Tests V.O.R. Ranges—A. E. Jenks. (*Tele-Tech*, vol. 9, pp. 22-24, 56; May, 1950.) The horizon profile as viewed from the antenna is plotted and course distortion in the shadow area forecast. The station error is obtained by the theodolite check, in which a circular course, with the station as center, is navigated and plotted. The line-of-sight cutoff point can be deduced by analysis of course-line records obtained by flying aircraft over known test points and courses. Errors in course indication due to instability of the supply voltage frequency, to the presence of vertical polarization in the transmitted signal and to heading effect are measured.
- 621.396.933 2225
Notes on Radiocommunication Systems for Civil Aviation—(*Rev. Telecomunicación* (Madrid), vol. 4, pp. 47-64; March, 1949.) An account of navigational aids considered at the third [British] Commonwealth and Empire Conference on Radio for Civil Aviation.
- MATERIALS AND SUBSIDIARY TECHNIQUES**
- 533.5 2226
On Certain Phenomena of Gaseous Emission Observed during the Evacuation of Low-Voltage Incandescent Lamps—L. Dunoyer. (*Le Vide*, vol. 5, pp. 793-806; May, 1950.) Ignition of the filament of 2-v lamps while still connected to the vacuum plant causes an emission of gas which is more rapid and of greater amount, within limits, the longer the time interval between the heating/degassing process and this ignition. This emission was studied with a special thermal micromanometer. It is attributed to adsorbed layers on the walls of the bulb. Immediate sealing after evacuation limits the possibility of subsequent gassing.
- 535.37 2227
X-Rays in the Development of Inorganic Phosphors—H. P. Rooksby and A. H. McKeag. (*GEC Jour.*, vol. 17, pp. 89-95; April, 1950.) Greater knowledge of the crystal chemistry of

luminescent materials is required both to explain the phenomena of luminescence and to effect improvements in the materials. Identification, crystalline perfection, the effect of changed matrix composition on fluorescence color, and the role of impurity activators are among the aspects considered in this survey of the ways in which X-ray analysis has been used in the investigation of phosphor characteristics.

- 535.37 2228
Trivalent Cations in Fluorescent Zinc Sulphide—F. A. Kröger and J. Dickhoff. (*Physica's Grav.*, vol. 16, pp. 297–316; March, 1950. In English.) Incorporation of monovalent cations in a lattice consisting of divalent ions is only possible to an appreciable extent when the lack of positive charge resulting from the substitution of a monovalent cation for a divalent one is compensated. This compensation can be effected by a simultaneous incorporation of monovalent anions or of cations of a valency higher than two. An explanation can thus be given of the activation of ZnS by monovalent Ag, Cu, Au and Zn when halogens or trivalent cations are present. Some of the trivalent ions incorporated in this way are found to cause effects of their own (electron traps fluorescence and killing of fluorescence due to the other centers). An atomic model of the centers of fluorescence is described.
- 535.37 2229
The Physical Chemistry of the Formation of Fluorescence Centres in ZnS-Cu—F. A. Kröger and N. W. Smit. (*Physica's Grav.*, vol. 16, pp. 317–328; March, 1950. In English.)
- 538.114 2230
Magnetic After-Effect Revealed by Means of a Blow—L. Liboutry. (*Compt. Rend. Acad. Sci.* (Paris), vol. 230, pp. 1586–1587; May 3, 1950.) A light blow may be used instead of a small variation of magnetic field for demonstrating this effect in a steel. See also 1660 of August.
- 538.22 2231
The a/H Law of Approach [to saturation] and a New Theory of Magnetic Hardness—L. Néel. (*Jour. Phys. Radium*, vol. 9, pp. 184–192; May, 1948.)
- 538.221 2232
Relation between the Anisotropic Constant and the Law of Approach to Saturation of Ferromagnetic Materials—L. Néel. (*Jour. Phys. Radium*, vol. 9, pp. 193–199; June, 1948.)
- 538.221 2233
The Effect of Annealing on the Residual Magnetization of Ferromagnetics—J. C. Barbier. (*Compt. Rend. Acad. Sci.* (Paris), vol. 230, pp. 1643–1645; May 8, 1950.)
- 538.221 2234
Factors Affecting Magnetic Quality—R. M. Bozorth. (*Bell Sys. Tech. Jour.*, vol. 29, pp. 251–286; April, 1950.) The substance of Chapter 2 of a forthcoming book entitled "Ferromagnetism." The effects of chemical composition and methods of production and treatment on the final properties of magnetic materials are discussed. Details of relevant manufacturing processes are included, and lists are given of useful materials and their magnetic properties.
- 538.221 2235
Thermal Variation of the Coercive Field of Powdered Cobalt—L. Weil, S. Marfouré, and F. Bertaut. (*Jour. Phys. Radium*, vol. 9, pp. 203–207; June, 1948.)
- 538.221 2236
Antiferromagnetism and Intermittent Activation in Chromium—Iron and Vanadium—Iron Alloys—R. Forrer. (*Compt. Rend. Acad. Sci.* (Paris), vol. 230, pp. 1584–1585; May 3, 1950.)

538.221 2237
On the Conditions for the Occurrence of Ferromagnetism in Metal Compounds—J. H. Gisolf. (*Physica's Grav.*, vol. 15, pp. 677–678; September, 1949. In English.) Discussion leading to the conclusion that in ferrites (which possess both octahedron holes and tetrahedron holes) only the metal ions in tetrahedron holes can contribute to the ferromagnetism.

538.221 2238
On the Ferromagnetism of Ferrites, or Ferromagnetism—L. Néel. (*Physica's Grav.*, vol. 16, pp. 350–352; March, 1950. In French.) Various experimental results are quoted which indicate that Gisolf's interpretation of the magnetic properties of ferrites (2237 above) is not correct. Néel's theory, on the contrary, is supported by much experimental evidence. See also 1166, 1170 and 1171 of June, and 3159 of 1949.

538.221 2239
Magnetic Properties of a Ferrite of Manganese in Weak Fields—C. Guillaud and A. Barbezat. (*Jour. Rech. Centre. Nat. Rech. Sci.*, no. 11, pp. 83–100; 1950.) Description of the method of measurement of different characteristics, particularly lf and hf losses. Results are presented in tables and graphs.

538.221:537.311.33 2240
Experimental Study of the Resistance of Some Semiconducting Ferrites—C. Guillaud and R. Bertrand. (*Jour. Rech. Centre Nat. Rech. Sci.*, no. 11, pp. 73–82; 1950.) Description of method and results of an investigation of Ni, Mn, Mg, and complex ferrites between -253° and 800°C . No exceptional characteristics were observed near the Curie point.

538.221:621.318.22 2241
Preferred Domain Orientation in Permanent-Magnet Alloys—M. McCaig. (*Nature* (London), vol. 165, p. 969; June 17, 1950.) Discussion of possible explanations of the improvement in the magnetic properties of alloys such as alcomax due to preferred domain orientation. See also 3453 of 1949 (Hoselitz and McCaig).

546.57:539.23]:537.311.31 2242
Current/Voltage Characteristic of Very Thin Films of Silver at High Values of Electric Field—A. Blanc-Lapierre and M. Perrot. (*Compt. Rend. Acad. Sci.* (Paris), vol. 230, pp. 1641–1643; May 8, 1950.) Measurements were made at ordinary temperatures with field strengths up to 10 kv/cm, on films of equivalent thickness $< 10 \mu$ vaporized on to glass; marked deviations from Ohm's law were observed. The curvature of the characteristic is mainly due to the lacunal structure of the film, heating effects playing only a minor part. Similar characteristics have been observed for semiconductors and for imperfect metal-point contacts.

548.0:535/539 2243
Optical Properties and the Electro-Optic and Photoelastic Effects in Crystals Expressed in Tensor Form—W. P. Mason. (*Bell Sys. Tech. Jour.*, vol. 29, pp. 161–188; April, 1950.) The Fresnel ellipsoid is first derived from Maxwell's equations. The electrooptic and photoelastic effects are then expressed in terms of thermodynamic potentials; methods of measuring them by determining the birefringence in various directions are discussed, and constants are listed for various classes of crystal. The application of the photoelectric effect for measuring strains in isotropic media is considered.

620.197 2244
Tropicalization of Some Materials and Assemblies Used in the Construction of Valves—

G. Trébuchon (*Le Vide*, vol. 5, pp. 814–818; May, 1950.) Conclusion of paper noted in 1432 of July.

621.315.33 2245
Insulated Sleeving and Covered Wires Used on Service Electronic Equipment—V. G. Hopftruff and G. J. R. Rosevear. (*Proc. IEE* (London), vol. 97, pp. 191–198; May, 1950.) The mechanical and electrical properties desirable on wire-covering material and sleeving are reviewed and standardization is discussed. Summaries are given of interservice specifications. The manufacture and properties of present-day materials are described and their limitations considered. More exacting future requirements are suggested. A table is appended of materials suitable for various temperature and voltage ranges.

621.315.59+551.594.6 2246
University Research in Physics—Teegan. (See 2216.)

621.315.59 2247
Semiconductive Colloidal Suspensions with Non-Linear Properties—H. E. Hollmann. (*Jour. Appl. Phys.*, vol. 21, pp. 402–413; May, 1950.) The conductivity and dielectric constant of these mixtures (e.g., a fine dielectric powder in oil) depend on the applied electric field; a physical explanation of their properties is given, which is relevant to the general theory of semiconductors. Oscillograms illustrating the nonlinear characteristics of such resistors are shown, and applications are mentioned; the wide range of voltage sensitivity and power dissipation is particularly noted.

621.315.59 2248
On Electrical Conduction in Semiconductors—F. Stöckmann. (*Naturwissenschaften*, vol. 37, pp. 85–89 and 105–111; February and March, 1950.) Discussion of conduction processes inside semiconductors, the barrier layer between semiconductors and metals, and photoconductivity.

621.315.59:546.412.64 2249
Study of the Semiconductor Properties of a Natural Calcium Carbonate—P. Vidal. (*Ann. Phys.* (Paris), no. 5, pp. 257–309; May and June, 1950.) Experimental and theoretical study of deep-quarried chalk at normal temperatures. Unlike chalk from surface layers, it is relatively pure, has a high resistivity and is a normal semiconductor. Under constant voltage gradient above about 10 v per cm, current intensity decreases with time, tending to a practically constant limit, under which conditions a fall of potential occurs at the cathode. Two methods of determining ion mobility are applied. The rectifying property of the substance and the complex radiation of soft X rays which occurs when a mesh-type cathode is used are discussed.

621.315.612.4 2250
Deoain Structure and Dielectric Response of Barium Titanate Single Crystals—B. Matthias and A. von Hippel. (*Phys. Rev.*, vol. 73, pp. 1378–1384; June 1, 1948.)

621.318.22 2251
The Performance and Stability of Permanent Magnets—A. J. Tyrrell. (*Jour. Brit. I.R.E.*, vol. 10, pp. 182–191; May, 1950.) The characteristics which contribute to the long-term magnetic stability of a permanent-magnet alloy are considered; present-day anisotropic alloys (e.g., ticonal) embody improvements in all these characteristics. Tests over a period of ten years have proved ticonal magnets to be more stable than materials previously obtainable; they are giving satisfactory service in watt-hour meters, which make high demands on stability. Tables are included giving the performance of numerous British and American commercial alloys.

621.357.8:533.5 2252

Electrolytic Polishing and Vacuum Technique—P. Nineuil. (*Le Vide*, vol. 5, pp. 807-813; May, 1950.) Review and discussion of the technique. Its advantages in eliminating surface impurities and reducing gas liberation and "cold" emission, particularly in X-ray tubes, are stressed.

666.1.037.5 2253

The Physical Aspect of Glass-to-Metal Sealing in the Electronic Valve Industry: Part I—G. Reébuchon and J. Kieffer. (*Ann. Radio-élec.*, vol. 5, pp. 125-149; April, 1950.) From a detailed examination of laboratory results together with experience gained in actual manufacture, specifications are drawn up for quality of seal, annealing cycles and finished-work inspection. Physical and chemical aspects of the sealing process are discussed and a critical survey of methods of test is made.

669.725.3 2254

Beryllium Copper—J. T. Richards. (*Materials and Methods* vol. 31, pp. 75-90; April, 1950.) The properties, characteristics, and available forms of the alloy are described, design considerations and methods of treatment discussed, and applications listed.

535.37 2255

Luminescent Materials [Book Review]—G. F. J. Garlick. Publisher: Clarendon Press, Oxford, 1949, 254 pp., \$5.50. (*Rev. Sci. Instr.*, vol. 21, pp. 386-387; April, 1950.) "... a book which will give a reader with prior knowledge of solid-state physics an opportunity to become acquainted with some of the main characteristics of luminescence in solid materials together with associated descriptive theory in a minimum of time."

666.1.037.5 2256

Glass-to-Metal Seals [Book Review]—J. H. Partridge. Publisher: Society of Glass Technology, Sheffield, 238 pp., 35s. (*Jour. Sci. Instr.*, vol. 27, p. 175; June, 1950.) "A valuable addition to technical literature."

517.432.1 2257

The Operational Calculus—a Historical Survey of Heaviside's Methods—(*Electrician*, vol. 144, p. 1751; May 26, 1950.) Report of a paper given by B. van der Pol at one of the IEE Heaviside Centenary Commemorative Meetings, May, 1950. The wide divergence of contemporary estimates of Heaviside's achievements is attributed to the fact that he never gave an exposition of his operational calculus as such; knowledge of it had to be gained by studying the many scattered practical applications in his writings. Modern developments are mentioned, in particular Carson's work in justifying Heaviside's methods by the Laplace transform; Heaviside was aware of this basis to his calculus.

517.432.1:621.39 2258

Oliver Heaviside's Operational Calculus—W. Jackson. (*Electrician*, vol. 144, pp. 1663-1667; May 19, 1950.) Heaviside's early experiments on problems in telegraphy, and the development of his mathematical methods, are described.

517.564.4:534.26+535.42 2259

The Oblate Spheroidal Wave Functions—A. Leitner and R. D. Spence. (*Jour. Frank. Inst.*, vol. 249, pp. 299-321; April, 1950.) These functions arise in problems such as the diffraction of sound and em waves by circular disks and apertures. Tables published previously by other workers are here extended.

517.942.9 2260

Separation of Laplace's Equation—N. Levinson, B. Bogert, and R. M. Redheffer. (*Quart. Appl. Math.*, vol. 7, pp. 241-262; October,

1949.) To use the separation-of-variable method in solving partial differential equations, the surface over which boundary values are specified must coincide with one of the coordinate surfaces, and hence any restriction on the coordinates which can be used is also a restriction on the physical situations to which the method can be applied. The paper is concerned with determining all coordinate systems which are, in this sense, permissible.

517.942.932:621.396.611.1 2261

Relaxation Oscillations—J. LaSalle. (*Quart. Appl. Math.*, vol. 7, pp. 1-19; April, 1949.) A class of relaxation oscillations related to the equation $d^2x/dt^2 + \mu f(x) dx/dt + x = 0$ is studied, in which $f(x)$ is not necessarily even. Regions $E(\mu)$ of the phase plane are constructed, each of which contains a single periodic solution. An introductory example deals with the case of an LCR circuit in which R is nonlinear and nonpassive. The use of a series linear resistance to produce mode separation is mentioned.

519.283:621.39.001.11 2262

Correlation Functions and Communication Applications—Y. W. Lee and J. B. Wiesner. (*Electronics*, vol. 23, pp. 86-92; June, 1950.) The difference in the forms of the correlation functions for a stationary random process and for a periodic process may be used as a means of separation of the one from the other. The correlation curves are obtained by means of an electronic computer. Among the examples given is the separation of a sinusoidal signal from random noise when an input signal-to-noise ratio of -15 db is changed to an output signal-to-noise ratio of +15 db.

681.142 2263

High-Speed Digital Calculating Machines—J. Bennett. (*Distrib. Elec.*, vol. 22, pp. 251-255 and 276-280; March and May, 1950.) A simple account of the historical development and of the operation and capabilities of these machines illustrated by reference to the EDSAC (see also 3458 and 3459 of 1949). The use of acoustic delay lines, special cr tubes and magnetic recording devices for storage has helped to make present-day high speeds possible. Costs are examined and applications, both actual and potential, in research and commerce are mentioned.

681.142 2264

Linear Equation Solvers—F. J. Murray. (*Quart. Appl. Math.*, vol. 7, pp. 263-274; October, 1949.) The set of equations to be solved is of the form

$$\sum_{j=1}^n a_{ij} x_j = b_i$$

where $i=1, 2, \dots, n$. In the type of machine considered, the x_j unknowns are not driven to their correct values by power supplied from the constant inputs, but reach an equilibrium state corresponding to the solution by a process of adjustment. The operating conditions for such a machine are examined for the case in which the adjusting process is determined by a linear operator with constant coefficients.

681.142 2265

Pulse Packing in Magnetic Recording Wire—I. L. Cooter. (*Bur. Stand. Jour. Res.*, vol. 44, pp. 163-174; February, 1950.) An oscillographic method is described for determining the number of magnets per unit length of the recording wire; a powder-pattern method for observing the fields of the individual magnets in a section of wire is also described, with photographs. A comparison was made of the resolution of recorded pulses obtainable with stainless-steel and plated Co-Ni wires. A parameter termed "interference ratio" is defined and used as a criterion of performance. Application is to high-speed digital computers.

681.142:533.6 2266

Analogue Computer for Flight Simulator—A. C. Hall. (*Elec. Eng.*, vol. 69, p. 433; May, 1950.) Summary of 1950 AIEE Winter General Meeting paper.

681.142:621-526 2267

The Electronic Servomechanism Simulator—C. M. Edwards and E. C. Johnson, Jr. (*Elec. Eng.*, vol. 69, p. 411; May, 1950.) Summary of 1950 AIEE Winter General Meeting paper. The apparatus discussed forms part of a large-scale analogue computer, under development at the MIT, for solving the equations of motion of aircraft. See also above.

512.9:501 2268

Calcolo Tensoriale e Applicazioni [Book Review]—B. Finzi and M. Pastori. Publisher: N. Zanichelli, Bologna, 1949, 427 pp., 2,000 lire. (*Quart. Appl. Math.*, vol. 7, p. 352; October, 1949.) The concepts and principal methods of the tensor calculus are presented in order to facilitate its application by mathematicians, physicists, and engineers. The last three chapters deal with applications to (a) the mechanics of deformable continua, (b) electromagnetic theory, and (c) relativity theory.

512.972 2269

Éléments de Calcul Tensoriel [Book Review]—A. Lichnerowicz. Publisher: Armand Colin, Paris, 1950, 216 pp., 180 fr. (*Jour. Frank. Inst.*, vol. 249, p. 426; May, 1950.) "The first part comprises an elementary but rigorous presentation of the basic theory both of tensor algebra and tensor analysis. The second part discusses some of the various applications in classical dynamics, electrodynamics, and the theory of relativity."

517.53:501 2270

Introduction to Complex Variables and Applications [Book Review]—R. V. Churchill. Publishers: McGraw-Hill, New York and London, 1948, 216 pp., \$3.50. (*Quart. Appl. Math.*, vol. 7, p. 240; July, 1949.) "The book should be of interest to those concerned with the use of function theory in engineering problems and similar applications."

517.75:621.3.015.3 2271

Transformation Calculus and Electrical Transients [Book Review]—S. Goldman. Publisher: Constable and Co., London, 1949, 440 pp., 30s. (*Beama Jour.*, vol. 57, p. 150; May, 1950.) The book is written for students, but will also be useful for research workers. Stress is laid upon physical interpretations, and detailed solutions are given of many important examples.

517.9:501 2272

Introduction to the Differential Equations of Physics [Book Review]—L. Hoop. Publishers: Dover Publications, New York, 1948, 154 pp., \$1.95. (*Quart. Appl. Math.*, vol. 7, pp. 239-240; July, 1949.) "The exposition is clear and concise, and one might like the treatment to go further than it does. The text should be very useful to seniors and beginning graduate students in physics and chemistry."

681.142 2273

Giant Brains, or Machines that Think [Book Review]—E. C. Berkeley. Publishers: J. Wiley, New York, and Chapman and Hall, London, 1949, 270 pp., \$4.00. (*Rev. Sci. Instr.*, vol. 21, pp. 385-386; April, 1950.) A primer dealing with a wide variety of computing mechanisms. "A strong anthropomorphic flavor pervades the book. . . . It contains a useful bibliography, its descriptions of existing machines probably include some facts unknown to any reader, and the discussions of future possibilities, though incomplete, may be suggestive."

MEASUREMENT AND TEST GEAR

- 531.764.5 2274
Crystal-Controlled Clock—(Bell Lab. Rec., vol. 28, p. 213; May, 1950.) This instrument was developed as an alternative to the chronometer for use where a portable, accurate standard of time is required. The output of an 1,800-cps crystal-controlled oscillator is used, after frequency division and amplification, to drive a 60-cps clock. Correct time was maintained to within 0.22 sec per day over an 8-day period without temperature control; with temperature control the limit of error could be reduced to 0.09 sec per day.
- 531.764.5 2275
The Performance of the P.T.R. Quartz Clocks and the Yearly Variation of the Length of the Astronomical Day—A. Scheibe and U. Adelsberger. (*Z. Phys.*, vol. 127, pp. 416-428; March 17, 1950.) Results of time comparisons made from 1934 to 1945, using different types of quartz clock are shown and discussed. Mean daily deviations of the measured time during certain periods are plotted for the different clocks. Observations from 1937, when improved models were brought into operation, confirm the earlier view that the mean daily variation of ± 0.0015 sec, which has a yearly period, is due to a variation in astronomical standard time, probably corresponding to an actual change in the rotational velocity of the earth. At summer and winter solstices the variation is zero. In summer the mean measured value is up to 0.12 sec in advance of astronomical time.
- 538.71 2276
A Saturated-Core Recording Magnetometer—D. C. Rose and J. N. Bloom. (*Canad. Jour. Res.*, vol. 28, pp. 153-163; March, 1950.) The magnetometer operates on the saturated-core inductor principle, the sensitive element being a strip of high-permeability alloy. An inverse-feedback system supplies a current to neutralize, within 2 or 3 gammas, the field being measured. This current is measured by a recording milliammeter which gives the field directly.
- 621.317.335.3†+621.317.372 2277
Measuring Dissipation and Dielectric Constants—C. F. Miller and F. G. Whelan. (*Elec. Eng.*, vol. 69, p. 512; June, 1950.) Summary of A.I.E.E. Winter Meeting paper, giving a description of apparatus used in the susceptance-variation method of measuring dissipation factor due to Hartshorn & Ward (351 of 1937). A constant-speed motor-driven capacitor is used to tune the circuit through resonance. A recording milliammeter operated from a tube voltmeter traces the voltage resonance curves. In 5 runs at 24-hour intervals on each of 35 specimens with dielectric constants in the range 3.0-7.3, the deviation from the mean was <0.05 in most cases. For the dissipation factor the deviations were generally <2 per cent.
- 621.317.336:621.315.212 2278
Study of the Impedance Irregularities of Coaxial Cables by Oscillographic Observation of Pulse Echoes—P. Herreng and J. Ville. (*Ann. Télécommun.*, vol. 3, pp. 317-331; October, 1948.) See 2162 of 1948 and 142 of 1949 (Couanault and Herreng).
- 621.317.336.1 2279
Impedance Measurement—H. J. Round. (*Wireless Eng.*, vol. 27, pp. 154-158; May, 1950.) A substitution method is described in which the voltages across the unknown impedance and across a known adjustable resistance R are in turn applied to a cro. A "swamping" series resistance maintains constant current without introducing unduly high errors. Impedances of 2-300 Ω can be measured over the frequency range 1-150 kc. The vector angle is found by connecting a known capacitance in series with the unknown and obtaining a new value of R .
- 621.317.351 2280
Various Applications of our Low-Frequency Analyser—R. Aschen and R. Gaillard. (*TSE Pour Tous*, vol. 26, pp. 170-174; May, 1950.) Oscillograph tracings effected with the instrument described in 2002 of 1948 illustrate the measurement of harmonic distortion, analysis of sawtooth and square-wave signals and their modifications after passing through an amplifier, and analysis of musical sounds.
- 621.317.444 2281
An Electrostatic Fluxmeter of Short Response-Time for Use in Studies of Transient Field-Changes—D. J. Malan and B. F. J. Schonland. (*Proc. Phys. Soc.*, vol. 63, pp. 402-408; June 1, 1950.) A conducting system of small capacitance is alternately exposed to and screened from the electric field, 1,200 times a second, by a rotating earthed shield and produces an alternating emf of period 0.83 ms. This output is amplified and displayed on a cro screen and can be recorded photographically. An automatic indication of the sense of the field is provided every 7.5 ms. At maximum sensitivity the instrument gives a deflection of 1 cm in a field of 20 v/m with a background noise level of 3 v/m and has a response time of one half-period (0.42 ms).
- 621.396.821:621.317.7.087:551.594.6 2282
On the Recording of the Mean Level of Atmospherics—F. Carbenay. (*Comp. Rend. Acad. Sci.* (Paris), vol. 230, pp. 1648-1649; May 8, 1950.) A receiver-recorder has been developed for operation on 27 kc. The receiver has a tuned amplifier stage and a diode detector, and the recorder uses a sensitive highly-damped galvanometer. The mean ordinate of the recorded curve is proportional to the product of the amplitude of the impulses and their repetition rate, i.e., the mean field intensity, while the fluctuations about the mean ordinate are proportional to the individual flux impulses. See also 2902 and 3504 of 1948.
- 621.317.715 2283
An Electromechanism: the Galvanometer—A. Kaufmann and P. Mériaux. (*Radio Tech. Dig.* (France), vol. 4, pp. 51-61 and 83-89; February and April, 1950.) A mathematical treatment of the theory of the galvanometer, making use of the operational calculus and of electromechanical/electrical analogies. No new properties are shown, but the introduction of complex or operational electromechanical impedances may be useful for the study of new types of galvanometer.
- 621.317.72.088.2 2284
Influence of the Ground on the Calibration and Use of V.H.P. Field-Intensity Meters—F. M. Greene. (*Bur. Stand. Jour. Res.*, vol. 44, pp. 123-130; February, 1950.) The input impedance of receiving antennas varies with height and changing ground conditions. An approximate method is described for calculating this impedance in the case of horizontal dipole antennas over earth having finite values of dielectric constant and conductivity. The effect of changes in ground conditions and antenna terminating impedance on the error of the field-intensity meter is calculated as a function of antenna height. Measured error values are in reasonably good agreement with the theoretical values.
- 621.317.725.029.45/5 2285
A Millivoltmeter for the Frequency Range From 1,000 to 30×10^6 c/s—H. J. Lindenhovius, G. Arbelet, and J. C. van der Breggen. (*Philips Tech. Rev.*, vol. 11, pp. 206-214; January, 1950.) Six inductance-compensated RC amplifying stages between the input stage and a moving-coil meter with series crystal rectifier give an over-all amplification of about 1,500 throughout the frequency range. Compensation for mains fluctuation and tube aging is provided. Voltage ranges are 1 mv, 10 mv, and thence by successive factors of $\sqrt{10}$ to 1 kv, the range being selected by adjustment of a capacitive attenuator.
- 621.317.73 2286
A Direct-Reading Instrument for Measuring Unbalanced Impedances at Decimetric Wavelengths—W. H. Ward. (*Proc. IEE* (London), vol. 97, pp. 199-205; May, 1950.) The instrument is based on the reactance-variation method, the circuit elements being lengths of concentric line. Direct voltage measurement is eliminated and replaced by the reading of a piston attenuator. By enclosing the oscillator in the moving part of the attenuator, the use of flexible hf cable is avoided. The mechanical drive may, if required, be transmitted from a distance. The instrument measures capacitance from -10 pF to +10 pF and resistance from 10 to 10,000 Ω at frequencies up to at least 1,000 Mc, with an accuracy within about 1 per cent. Both scales are direct-reading.
- 621.317.734:621.319.4 2287
A Direct Reading Instrument for the Measurement of the Series-Resistance of Capacitors—F. Gutmann. (*Jour. Sci. Instr.*, vol. 27, pp. 169-170; June, 1950.) A thermocouple ammeter measures the rf tank current of a 1.6-Mc oscillator, whose output is adjusted to produce full-scale deflection. The capacitor under test is then inserted in series with the tank capacitor. The resultant decrease of tank current is a measure of the series resistance of the tested capacitor. Capacitors from 0.01 μ f upwards may be tested.
- 621.317.755:621.385.012 2288
Curve Generator for Electron Tubes—(*Tech. Bull. Nat. Bur. Stand.*, vol. 34, p. 62; May, 1950.) Equipment developed by M. L. Kuder. I_a/V_a or I_a/V_g families of characteristics are displayed simultaneously on a cro to an over-all accuracy within ± 5 per cent on voltage and current readings. Measurement is by a standard co-ordinate rectangle. Marker dots indicate the load-line for the conditions selected. Special circuits are included in the equipment for observation of the step-function signal at the grid of the tube under test and for identifying the curves obtained with positive grid bias.
- 621.317.772 2289
Direct-Reading Phasemeter—L. H. O'Neill and J. L. West. (*Rev. Sci. Instr.*, vol. 21, pp. 271-273; April, 1950.) The amplitude of the sum or difference of two sinusoidal voltages of equal amplitude depends on the phase difference between them; this is the basis of the simple phase meter here described. The method of adjusting the individual amplitudes and mixing the two voltages, and of determining the sign of the phase difference, are discussed. The over-all accuracy is within $\pm 1^\circ$ over the frequency range 7 cps to 100 kc.
- 621.317.79.001.4:621.397.6 2290
Television Monitors—J. E. B. Jacob. (*Wireless World*, vol. 56, pp. 206-210; June, 1950.) Equipment of higher quality than that of the average home set is required. The special features that are necessary in the design of the magnetic lens, focus-correction system, synchronizing-signal separator and black-level control circuit are described.
- 621.385.18.001.4 2291
Measurement of Tube Voltage Drop in Hot-Cathode Gas Tubes—E. K. Smith. (*Elec. Eng.*, vol. 69, pp. 419-422; May, 1950.) 1950 AIEE Winter General Meeting paper. Increase of the voltage drop is one of the commonest preliminary indications of failure in gas-filled tubes. Various methods are described for observing this drop while the tubes are in use, typical results are charted, and their significance discussed.

- 621.396.615:621.317.7.001.4 2292
VOR Signal Generator—J. H. Battison, (*Tele-Tech*, vol. 9, pp. 37–39, 57; May, 1950.) Operation of the VOR is based on the phase difference between two 30-cps signals, one with a rotating antenna pattern and the other an omnidirectional reference. The apparatus described generates such signals at a strength sufficient for testing the receiving equipment of aircraft in a nearby field or hangar. The generator can also be used to test runway localizers in which the reference signal is in phase with the variable signal on one side of the runway and 180° out of phase on the other.
- 621.396.615.029.42 2293
A Low-Frequency Sinusoidal-Voltage Source—L. A. Rosenthal. (*Rev. Sci. Instr.*, vol. 21, pp. 302–303; April, 1950.) Frequencies extending from 20 cps nearly to zero can be obtained by a method in which a variable-frequency audio oscillator is heterodyned with a stable frequency derived from ac mains. A mathematical explanation of the mixing operation is given. Application to the testing of a voltage regulator is mentioned.
- 621.396.615.14.029.63 2294
U. H. F. Sweep-Frequency Oscillator—J. E. Ebert and H. A. Finke. (*Electronics*, vol. 23, pp. 79–81; June, 1950.) A variable capacitor, with vane rotated at the high-impedance end of a cavity resonator by a synchronous motor, provides a maximum sweep of 30 Mc on the fundamental frequency of an enclosed coaxial-line type of oscillator covering a range of 470–890 Mc. The sweep can be varied by altering the capacitor plate spacing. The output voltage is continuously variable from 2 v across 50 Ω to a value 90 db below this. Details of the equipment are given, together with performance curves and a dimensioned sketch of the oscillator.
- 621.396.822:621.316.8 2295
Resistor Noise—(*Radio Tech. Dig.* (Franç), vol. 4, pp. 91–107; April, 1950.) French version of 1465 of July (Paolini and Canegallo).
- 621.397.645:621.316.761.2 2296
How to Adjust Frequency Response in Video Amplifiers for TV—J. H. Roe. (*Broadcast News*, no. 58, pp. 54–65; March and April, 1950.) Methods of adjusting video amplifier circuits to obtain satisfactory frequency response characteristics, and methods of measuring their performance, are described with practical details of the necessary equipment. Typical results are illustrated by numerous oscillograms showing the effects of correct alignment and of misadjustment of a particular circuit commonly used for hf and lf compensation.
- 621.317 2297
Electrical Measurements in Theory and Application [Book Review]—A. W. Smith. Publisher: McGraw-Hill, London, 1948, 371 pp., 25s. 6d. (*Beama Jour.*, vol. 57, pp. 150–151; May, 1950.) Though mainly addressed to students, the book is recommended to laboratory and test-room workers in general. New methods of measuring capacitance and inductance are included in this edition.
- 621.317.755 2298
Cathode-Ray Tube Traces [Book Review]—H. Moss. Publisher: Electronic Engineering, London, 66 pp., 10s. 6d. (*Jour. Sci. Instr.*, vol. 27, p. 175; June, 1950.) "In putting the main emphasis on the geometrical theory of cathode-ray-tube patterns, Dr. Moss has produced a monograph which will be valuable both to the advanced student and to the qualified engineer."
- 621.396.001.4 2299
Radio Servicing Equipment [Book Review]
- E. J. G. Lewis. Publisher: Chapman and Hall, London, 371 pp., 25s. (*Jour. Sci. Instr.*, vol. 27, p. 175; June, 1950.) "Describes in plain and simple language the construction and operation of most of the types of test and measuring equipment used by the radio service engineer."
- OTHER APPLICATIONS OF RADIO AND ELECTRONICS**
- 529.781 2300
Carrier Frequency for Remote Timing Control—J. L. Wagner and W. Webb. (*Elec. Mfg.*, vol. 43, pp. 104–107, 198; April, 1949.) The requirements for a timing-control system operating on power distribution lines are enumerated. A detailed description is given of commercial equipment in which the master clock operates keying relays in the transmitter, providing three separate channel frequencies in the range 2–6 kc, one for time correction of slave clocks and the others for applying pulses at 1-minute intervals to attendance recorders, for ringing bells, etc.
- 534.321.9:615 2301
Ultrasonics in Therapy—P. Hémardinquer. (*Rev. Belge Électronique*, vol. 1, pp. 14–21; February, 1950.) A review of the technique, and description of typical generating apparatus.
- 535.322.1:539.165 2302
On an Improvement in Lens-Type β-Ray Spectrographs—P. Grivet. (*Compt. Rend. Acad. Sci.* (Paris), vol. 230, pp. 1652–1654; May 8, 1950.)
- 539.16.08 2303
621.387†
Radiation Counters—Please note that, in this and subsequent issues, the UDC number used will be 621.387† and subdivisions, instead of 539.16.08 used hitherto.
- 621.317.083.7 2304
Present-Day Telemetry Technique—G. Swoboda. (*Elektrotech. u. Maschinenb.*, vol. 67, pp. 129–136; May, 1950.) Review of current methods and description of a pulse system and of one using rotary selector switches.
- 621.317.087.9:621.317.083.7 2305
The Metrotype System of Digital Recording and Telemetry—G. E. Foster. (*Elec. Eng.*, vol. 69, pp. 427–430; May, 1950.) 1950 AIEE Winter General Meeting paper. The system enables electrical quantities to be automatically measured and recorded in numerals, at predetermined intervals. Readings may be transmitted to any distance, a single channel of telegraph quality being adequate. The processes of measuring, transmitting, and printing the readings are described.
- 621.317.39 2306
Electrical Methods of Measuring Mechanical Quantities—(*Engineering* (London), vol. 169, pp. 483–484; April 28, 1950.) Report of a paper given at the IEE by F. J. Woodcock.
- 621.365.55†:674.23 2307
High-Frequency Generators: Application in the Wood Industry—M. Diopère. (*Rev. Belge Électronique*, vol. 1, pp. 22–28; February, 1950.) Description of different manufacturing processes, e.g., bending, sticking, etc., in which hf heating is applied to materials under pressure.
- 621.38.001.8:543/545 2308
Electronic Instrumentation for Chemical Laboratories—F. Gutmann. (*Jour. Brit. I.R.E.*, vol. 10, pp. 194–212; May, 1950.) Reprint. See 710 of April.
- 621.384.611.2† 2309
The Proton Synchrotron—E. J. Loifgren. (*Science*, vol. 111, p. 295–300; March 24, 1950.) Brief survey of development of particle accelerators and description of the proton synchrotron now under construction at Berkeley, which will be ultimately capable of producing protons of about 6×10^3 Mev.
- 621.384.612.1† 2310
Omegatron—a Miniature Cyclotron—(*Electronics*, vol. 23, pp. 122, 124; June, 1950.) The omegatron operates on the same fundamental principle as the cyclotron and can be used as a mass analyzer. In addition to the constant uniform magnetic field a rf electric field is applied at right angles. When the rf equals the cyclotron frequency the ions spiral outwards and can be collected. Measurement of the frequency corresponding to maximum ion current and a measurement of the magnetic field enable the mass of the particles to be determined.
- 621.385:621.318.572 2311
An Electron-Beam Decimal-Counter Tube—Hollway. (See 2374.)
- 621.385.833 2312
On Magnetic Cylindrical Lenses with Image-Distortion Correction—H. Hintenberger. (*Z. Naturf.*, vol. 3a, pp. 125–127; February, 1948.) The conditions for exact focusing are determined and also for first- and second-order approximations.
- 621.385.833 2313
The Calculation of Magnetic-Lens Fields by Relaxation Methods—M. B. Hesse. (*Proc. Phys. Soc.*, vol. 63, pp. 386–401; June 1, 1950.) "The field and lens constants are calculated for two typical magnetic lenses as used in electron microscopes, using the relaxation method developed by Southwell for the solution of potential problems."
- 621.385.833 2314
The Independent Electrostatic Lens under 'Transgaussian' Conditions—É. Regenström. (*Compt. Rend. Acad. Sci.* (Paris), vol. 230, pp. 1650–1652; May 8, 1950.) A study of the paths of rays termed transgaussian which are initially parallel to the axis but for which r_0/z_0 is negligible.
- 621.385.833:621.396.615.141.2 2315
Electron-Optical Mapping of the Space-Charge Field in a Magnetron—(*Tech. Bull. Nat. Bur. Stand.*, vol. 34, pp. 57–59; May, 1950.) Method devised by D. L. Reverdin. Space-charge distribution is related to the distorting effect of the electric field in an elementary steady-stage magnetron on the shadow pattern formed by two wire screens in the path of a focused nondisturbing axial electron beam. The method may be extended to oscillating magnetrons and to the indication of noise. Results differ widely from predictions based on theory.
- 621.395.625.3.001.8 2316
Various Applications of Magnetic Recording—P. Hémardinquer. (*Radio Franç.*, no. 6, pp. 8–16; June, 1950.) Description of the principles and basic circuits of magnetic recorders for secret transmission phototelegraphy, time measurement, etc.
- 629.13.014.57 2317
The Electronic Automatic Pilot—M. Nerinckx. (*Rev. Belge Électronique*, vol. 1, pp. 5–13; March and April, 1950.) Description of the Sperry automatic pilot Type A-12.
- 621.38.001.8 2318
Industrial Electronics [Book Review]—A. W. Kramer. Publisher: Pitman Publishing Co., New York, 1949, 311 pp., \$6.00. (*Electronics*, vol. 23, pp. 136, 140; June, 1950.) "... intended for readers who have a good knowledge of general physics and engineering but who have had very little training or experience in electronics."

- 21.387 2319
Counting Tubes [Book Review]—S. C. Curran and J. D. Craggs. Publisher: Butterworths Scientific Publications, London, 238 p., 35s. (*Jour. Sci. Instr.*, vol. 27, p. 175; June, 1950.)

PROPAGATION OF WAVES

- 38.56:535.42 2320
On the Diffraction of an Electromagnetic Wave through a Plane Screen—J. W. Miles. (*Jour. Appl. Phys.*, vol. 21, p. 468; May, 1950.) Corrections to paper abstracted in 202 of February.
- 21.396.11 2321
The First Ionospheric-Storm-Warning Service 1941-45—J. S. Kojan and G. A. Isted. (*Marconi Rev.*, vol. 13, pp. 53-71; 1950.) The development of this service at Baddow is traced from its origin during the War, and an account is given of the factors upon which the forecasts are based. The efficiency of the storm warnings is reviewed and new developments are discussed in connection with future storm-warning services; an "idealized" warning system might include: solar-corona observations; solar-noise observations; monitoring of radio circuits having great-circle paths in (or near) the auroral zones; geomagnetic measurements; sunspot observations.
- 521.396.11:551.510.535 2322
The Air Force Interest in Sporadic E Ionization—Gerson. (See 2212.)
- 621.396.81 2323
Reception [at Madrid] of [s.w.] Transmissions from Great Britain, the Vatican and U.S.A.—R. G. Sacasa. (*Rev. Telecomunicación* (Madrid), vol. 4, pp. 10-16; December, 1948.) Graphs show receiver output power variations during March, 1948, at various times of the day for transmissions in the range from 16.85 m to 50.26 m. Average values are compared with those for signals from Spanish and Australian stations.
- 621.396.81 2324
Washington and Madrid [radio] Propagation Forecasts—R. G. Sacasa. (*Rev. Telecomunicación* (Madrid), vol. 4, pp. 20-29; June, 1949.) A comparison is made between NBS forecast charts and the author's, based on experimental observations, for reception of wavelengths in the range 13-31 m. Agreement for January and February, 1949, was better than for 1942, but there were still appreciable discrepancies.
- 621.396.81 2325
Back-Scatter Observations by the Central Radio Propagation Laboratory—August 1947 to March 1948—W. L. Hartsfield, S. M. Ostrow, and R. Silberstein. (*Bur. Stand. Jour. Res.*, vol. 44, pp. 199-214; February, 1950.) A high-power pulsed transmitter, the circuit diagram of which is given, and westwardly beamed antenna system were used, transmissions being made from Sterling, Virginia, at a frequency of 13.66 Mc. Back-scatter observations are presented graphically and photographs are shown of different types of echo pattern received. Back-scatter from both the ground and the E region was identified, ground scatter usually predominating. Comparisons of results are made with transponder signals and skip distance maps drawn from concurrent ionospheric data. Curves of calculated transmission and echo delays are also given.
- 621.396.81 2326
Effect of a Sudden Ionospheric Disturbance on Long Radio Waves Reflected Obliquely from the Ionosphere—K. Weckes. (*Nature* (London), vol. 165, pp. 935-936; June 10, 1950.) The behavior of radio waves reflected at oblique or at steep incidence during periods of

sudden ionospheric disturbance is outlined. Signal-strength measurements on the Danish transmissions for the Decca navigation system suggest that for frequencies of about 100 kc, transmitted over about 900 km, the reflected wave amplitude is increased during a sudden ionospheric disturbance, corresponding to an effective reflection coefficient of 0.25, which is about five times the normal value. When waves of the same frequency are reflected at steep incidence, a decrease in amplitude is observed. In either case, the associated phase change corresponds to a decrease in the height of reflection.

On frequencies above 2 Mc a decrease in amplitude occurs both for vertical and oblique incidence, whereas frequencies in the region of 16 kc show little amplitude change at steep incidence but an increase at oblique incidence. The above results confirm and extend the recent observations of Smith-Rose (1228 of June).

- 621.396.812 2327
A Survey of Ionospheric Cross-Modulation—L. G. H. Huxley and J. A. Ratcliffe. (*Proc. IEE* (London) vol. 97, p. 165; May, 1950.) Discussion on 211 of February.

621.396.82 2328
Contribution to the Study of Gyromagnetic Frequency by means of Gyro-Interaction of Radio Waves in the Ionosphere—M. Cutolo. (*Nuovo Cim.*, vol. 5, pp. 475-488; October 1, 1948.) A full account of experiments carried out in 1947 and briefly reported in 2055 of 1948. The results confirm the previous observation that there is a regular rise in the value of the resonance frequency during the course of the night.

621.396.812 2329
Low-Level Atmospheric Ducts—R. F. Jones. (*Nature* (London), vol. 165, p. 971; June 17, 1950.) The variations in signal strength over paths in the Cardigan Bay area in conditions of strong wind can be related to the origin and subsequent track of the air over that area at the time. In particular, the drying effect on the lowest layers due to recent travel over land is important. See also 2033 of 1949.

- 551.510.535:621.396.11 2330
Short-Wave Radio and the Ionosphere [Book Review]—Bennington. (See 2218.)

RECEPTION

621.396.621 2331
The Transmission-Line Discriminator—P. Magne. (*Ann. Radioélec.*, vol. 5, pp. 89-93; April, 1950.) The principle is described by which discrimination is effected with an open-ended and a closed coaxial line across a common fm source. Calculation is made of the length of line required and of the amount of third harmonic. A harmonic-filter circuit including two tubes Type 6AK5 is described for a discriminator for use in a 20-Mc band centered at 105 Mc. The response curve is flat over the whole band and distortion is of the order of 0.1 per cent.

621.396.621.5 2332
A Crystal Tetrode used as a Frequency Changer—R. W. Haegle. (*Onde Élec.*, vol. 30, pp. 239-241; May, 1950.) Preliminary experimental study showing the conversion characteristics as functions of the collector current, local oscillator voltage, etc. The crystals were of the type normally used in Ge diodes Type IN34, the points of contact of the three electrodes at the crystal surface forming an equilateral triangle of side about 0.05 mm. Signal frequencies up to at least 200 Mc may be used; there is little interaction between the input circuits; conversion gain is high. The maximum if appears to be sensibly equal to the maximum

frequency of amplifying crystal triodes, so that the input signals may have much higher frequencies.

- 621.396.821:621.317.7.087:551.594.6 2333
On the Recording of the Mean Level of Atmospherics—Carbenay. (See 2282.)

621.396.822 2334
Thermal Noise at High Frequencies—A. van der Ziel. (*Jour. Appl. Phys.*, vol. 21, pp. 399-401; May, 1950.) "Spence's discussion of thermal noise from the point of view of the electron theory leads to a result which differs from Nyquist's original formula at frequencies ν such that $h\nu/kT \geq 1$. This discrepancy is due to the assumptions which Spence made in his analysis."

621.396.822:621.396.619.13 2335
The Spectrum of Frequency-Modulated Waves after Reception in Random Noise: Parts 1 & 2—D. Middleton. (*Quart. Appl. Math.*, vol. 7, pp. 129-174; July, 1949; and vol. 8, pp. 59-80; April, 1950.) Mathematical analysis. The wave emerging from the if amplifier and entering the limiter is assumed to be of the narrow-band type, the limiter providing an output voltage proportional to the instantaneous amplitude of the wave for amplitudes less than a certain threshold value, and a constant output for larger amplitudes. The discriminator is "ideal" and provides an output voltage directly proportional to the instantaneous difference in frequency between the input wave and the central if.

The spectrum of the signal and of the noise emerging from the discriminator is analyzed generally. The results of the analysis for no limiting and extreme limiting, for different input signal-to-noise ratios and for carrier mistuning, are presented graphically. Part 2 extends the theory given above to the general case of an arbitrary degree of limiting, the postulated conditions being the same as before. The spread of the spectrum of the noise due to the clipping produced by the limiter is evaluated. The results for various degrees of limiting are presented for the two special cases of no carrier (noise alone) and strong carrier.

621.396.621+621.396.61 2336
Radio Receivers and Transmitters [Book Review]—S. W. Amos and F. W. Kellaway. Publisher: Chapman and Hall, London, 2nd edn. revised 1948, 356 pp., 25s. (*Beama Jour.*, vol. 57, pp. 117-118; April, 1950.) Deals mainly with receivers, only one of the ten chapters being devoted to transmitters. "... this book contains much useful information, and where proofs are lacking references are indicated."

- 621.396.621+621.396.645]:621.385 2337
Electronic Valves: Books II-IV [Book Review]—(See 2388.)

STATIONS AND COMMUNICATION SYSTEMS

621.39.001.11 2338
On the Maximum Transmission Capacity of a Channel in the Presence of Noise—J. Laplume. (*Onde Élec.*, vol. 30, pp. 235-238; May, 1950.) Paper presented at the Congrès d'Électronique et de Radioléctricité, January, 1950. Random noise is the only essential factor limiting the capacity of a channel. A formula is derived showing the number of signals which may be transmitted in a given time interval. In the ideal case this number is an exponential function of the bandwidth. In the case of AM or FM the number is proportional to the pass-band. With PCM the theoretical limit may be reached. Quantization of a continuous message is possible only if the channel bandwidth is greater than that necessary for ssb AM transmission, the bandwidth being increased at the expense of transmission power. See also 1649 of 1949 (Shannon) and 2319 of 1949 (Tuller).

- 621.39.001.11:519.283 2339
Correlation Functions and Communication Applications—Lee and Wiesner (See 2262.)
- 621.394/.396 2340
Telecommunications and Heaviside—(Electrician, vol. 144, p. 1752; May 26, 1950.) Report of a paper "Fifty Years' Development in Telephone and Telegraph Transmission in Relation to the Work of Heaviside," by W. G. Radley, given at one of the IEE Heaviside Centenary Commemorative Meetings, May, 1950. Heaviside in 1876 first realized the need for an inductance term and, subsequently, for a leakage-conductance term in the basic equations for line transmission; the use of loading coils as standard practice followed from his theory. Modern improvements of these coils are mentioned. Heaviside's work on em waves in space is considered and an account is given of systems developed to overcome the effects of ionospheric irregularities on long-distance radio communication.
- 621.395 2341
The Telephone and the Laboratory: Part 1—H. M. Trainor. (Trans. S. Afr. Inst. Elec. Eng., vol. 40, pp. 251-274; November 11, 1949. Discussion, pp. 275-280.) The organization of telecommunications research in the Bell System, U.S.A., the British Post Office, and the Australian Post Office is reviewed, and an account is given of work done in South Africa. This has consisted largely in the quality testing of equipment and the investigation of problems arising from the special conditions of use existing in South Africa. Laboratory facilities of the Post Office and other services are described and various laboratory and field investigations are discussed. Part 2: 2342 below.
- 621.395 2342
The Telephone and the Laboratory: Part 2—H. M. Trainor. (Trans. S. Afr. Inst. Elec. Eng., vol. 41, pp. 57-79; March, 1950. Discussion, pp. 80-86.) Relevant theories of speech, hearing, and noise are reviewed and a detailed discussion is given of the transmission aspects of the telephone instrument, which is a source of distortion in a telephone system. The development of the modern instrument has been based on a detailed knowledge of speech characteristics and the various noise components affecting reproduction. The carbon-type transmitter and the importance of improved magnetic materials in reduction of frequency distortion in receivers are discussed. Side tone can be reduced by modification of the matching induction-coil circuit. Tests of sensitivity, frequency response, nonlinear and amplitude distortion and articulation, are important measures of the efficiency of a system. The over-all effective transmission or repetition rating, as determined in practice, is the final criterion of efficiency. Part 1: 2341 above.
- 621.396.1 2343
Technical Repercussions of the Copenhagen Plan—J. Garcin. (Toute la Radio, vol. 17, pp. 152-154; May, 1950.) Comment on the practical effects of the redistribution of wavelengths for French broadcasting, and suggested receiver adjustments to minimize interference.
- 621.396.619.16 2344
Pulse-Time and Pulse-Width Modulation—P. Bréant. (Ann. Télécommun., vol. 3, pp. 309-316; October, 1948.) Theoretical study made in 1946. The systems are defined and a rapid method for determining the modulation spectrum is described. In the case of PTM, demodulation cannot be effected with a simple low-pass filter. In PWM this demodulation method is effective only if (a) modulation depth is small; (b) the sides of the pulses displaced by the modulation are steep; and (c) only one side of the pulse is displaced. Demodulation by simple filtering is thus of little practical use for PM signals.
- 621.396.619.16 2345
Narrow-Band Pulse Communication—T. Roddam. (Wireless World, vol. 56, pp. 202-205; June, 1950.) Short square-wave amplitude-modulated pulses are converted to Gaussian pulses; the most efficient method is to use an amplifier with several "maximal flatness" stages [3013 of 1941 (London)] and one plain RC stage. After the Gaussian pulses have traveled along telephone cables provided with suitable intermediate repeaters, the shape is preserved but there is overlapping of the pulse signals. The overlapping increases as the bandwidth is decreased, causing cross-modulation, but a corrector circuit can be used to eliminate this effect.
- 621.396.65 2346
Carrier Power Requirements for Long-Distance Communication by Microwaves—A. G. Clavier. (Elec. Commun., vol. 27, pp. 39-47; March, 1950.) A general expression is given for the path attenuation of a radio link in terms of wavelength, distance, and effective areas of transmitting and receiving antennas; abacs are presented for finding values of the free-space attenuation between (a) nondirectional and (b) parabolic antennas. Conditions for PCM and FM transmission are compared; the rf power required for a PCM system is 17 db less than for a corresponding FM system, suitable allowances being made for fading and for receiver noise, but under conditions of deep fading the FM system is the better.
- 621.396.65 2347
A Simple Microwave Relay Communication System—M. G. Staton. (Tele-Tech, vol. 9, pp. 40-42, 44; April, 1950.) This equipment operates in the 952-960-Mc band and uses conventional tubes and circuits. The carrier frequency is derived by repeated multiplication from a p.h.m. crystal-controlled oscillator operating at about 1 Mc, and the transmitter output is ≤ 3 W. The receiver is a superheterodyne with self-contained power supply. Dipole antennas with 42-in. parabolic reflectors are used for both transmitter and receiver. Unattended repeater stations are provided with automatic monitoring arrangements.
- 621.396.65 2348
V. H. F. Links at Manila Airport—E. J. Rudisuhle and P. B. Patton. (Electronics, vol. 23, pp. 82-85; June, 1950.) Line-of-sight FM links in the 160-Mc band provide over 150 speech, telegraphy, printer, and control circuits between the control station and remote transmitting and receiving stations. Details are given of some of the special circuits used.
- 621.396.823:621.395.44 2349
On Radiation from Overhead Transmission Lines—M. Jensen. (Proc. IEE (London), vol. 97, pp. 166-178; May, 1950.) An analysis is made of the fields of single and multiple lines over imperfectly conducting earth. Field strengths measured along profiles transverse to a 3-phase line in a valley agreed quite well with theoretical values, for different connections of the lines. Single phase-to-earth connection in power-line carrier systems is undesirable if interference is to be minimized. It is suggested that horizontal antennas may be useful for low-power broadcasting transmission in valleys.
- 621.396.931 2350
The Introduction in Switzerland of the Public Telephone Service to Vehicles—II. Kappeler. (Bull. Schweiz. Elektrotech. Ver., vol. 40, pp. 433-439; July 9, 1949. In French, with German summary.) By the service introduced at Zürich in June, 1949, 2-way telephone connection via a radio link may be made with any suitable equipped vehicle plying within about 10 km of a fixed transmitting/receiving station. Details are given of the automatic calling and selection system and of the radio-telephone equipment. Phase modulation is used, with carrier frequencies between 31 and 41 Mc.
- 621.396.932:621.396.5.029.62 2351
Thames Radio Service—(Wireless World, vol. 56, pp. 215-216; June, 1950.) For an abstract of another account see 999 of May (Neale and Burr).

SUBSIDIARY APPARATUS

621-526:621.396.645.37 2352
Feedback Amplifiers and Servo Systems—Ward. (See 2175.)

621-526:621.398 2353
Synco Units for Remote Indication and Control—S. N. Mead and G. E. Day. (Elec. Mfg., vol. 43, pp. 74-79, 204; April, 1949.) Operating characteristics are given of many types of ac self-synchronous transmitter and indicator units commercially available, together with design details useful in selecting equipment for particular practical applications.

621.3.077.2/.3]:621.3.016.35 2354
On the Application of Stability Criteria to an Amplidyne Control Circuit—F. van Geerttruyden. (IEE (Brussels), no. 6, pp. 169-176; 1950.) The amplidyne, a dynamoelectric amplifier, plays a part in control circuits very similar to that of an electronic amplifier. The mathematical study of such amplifiers, particularly with reference to stability, has been extended to the amplidyne. Two stability criteria are examined: that of Leonhard, which is mathematically tractable, and the generalized Nyquist criterion, which is particularly suitable for use in the experimental study of a control circuit. The formulation of the equation for a control circuit is simple in operational notation. Transients superposed on the steady state are specially studied. An account is given of a complete numerical investigation, both theoretical and experimental, of the stability in two types of alternator-voltage regulation. In one case the amplidyne supplies the alternator excitation directly and in the other case feeds a separate exciter.

621.316.726:621.314.3† 2355
A Magnetic-Amplifier Frequency Control—L. J. Johnson and H. G. Schafer. (Elec. Eng., vol. 69, p. 445; May, 1950.) Summary of 1950 AIEE Winter General Meeting paper. A circuit is described for stabilizing the 60-cps output frequency of a small motor-driven alternator. A magnetic amplifier is controlled by the output of a pair of balanced tuned circuits fed from a pilot generator attached to the dynamotor shaft, and its output in turn regulates the field of the dynamotor. Temperature stability is obtained by the use of permalloy cores in the tuned circuits. Frequency regulation of the order of 1 part in 5,000 at normal temperatures is claimed.

621.396.682 2356
Design, Construction and Test of a Stabilized Anode Voltage [supply unit]—L. Chrétien. (TSF Pour Tous, vol. 26, pp. 177-180; May, 1950.) Details and performance of equipment using the circuit noted in 1532 of July.

621.398 2357
Radio Synchro-Motor [Selsyn]—In 1258 of June please change J. R. Duthil to J. R. Dutilh.

TELEVISION AND PHOTOTELEGRAPHY

621.397.6 2358
Line-by-Line Black-Level Control of Television Signals—N. N. Parker Smith. (Marconi Rev., vol. 13, pp. 81-85; 1950.) The gain of a receiver or the carrier level of a transmitter is controlled by a voltage derived during part of

the 5- μ s black-level period at the commencement of each line. This control voltage, proportional in amplitude to the black-level signal, remains steady over the line period of approximately 100 μ s, and yet follows any changes which occur between successive lines. The description of the control arrangement is illustrated by circuit and waveform diagrams.

521.397.6 2359
Simplified Television for Industry—R. C. Webb and J. M. Morgan. (*Electronics*, vol. 23, pp. 70-73; June, 1950.) Equipment using the vidicon camera tube (2040 of September).

521.317.79.001.4:621.397.6 2360
Television Monitors—Jacob. (See 2290.)

521.397.611.21.002.2 2361
Producing the 5820 Image Orthicon—R. B. Janes, R. E. Johnson, and R. R. Handel. (*Electronics*, vol. 23, pp. 93-95; June, 1950.) Short illustrated account of the special techniques used.

621.397.62 2362
Magnetic Deflector Coils—(*Radio Tech. Dig.* (Frang), vol. 4, pp. 131-156; June, 1950.) An article based primarily on 2043 of September (Cocking), with added bibliography.

621.397.621.2 2363
R.C.A. Color Kinescope Demonstrated—(*Tele-Tech*, vol. 9, pp. 20-21, 63; May, 1950.) In the two laboratory-produced tubes described the screen is composed of 351,000 color-emitting dots arranged in triangular groups of 3, corresponding to the three primary colors of the picture. An apertured mask is interposed between the electron beam source and the screen so that one color only is emitted by each group as it is scanned. (a) Three-gun tube. Each gun is operated in the time sequence corresponding to the sampling process at the transmitter. Each gun excites one color only on the tube face. (b) Single-gun tube. Two sets of coils fed with quadrature currents at the sampling frequency generate a rotating field producing circular deflection of the beam. The phase of the field determines which color is excited on the tube face.

621.397.645:621.316.761.2 2364
How to Adjust Frequency Response in Video Amplifiers for TV—Roe. (See 2296.)

621.397.743:621.392.5:621.315.212 2365
Equalization of Coaxial Lines—Gould. (See 2152.)

621.397.82:621.392.52 2366
The Latest Techniques for the Elimination of Ham TVI—Rand. (See 2156.)

621.397.5 2367
Television Explained [Book Review]—W. E. Miller. Publisher: The Trader Publishing Co., London, 3rd edn., 104 pp., 5s. (*Jour. Brit. I.R.E.*, vol. 10, p. vi; May, 1950.) A number of sections have been revised and additional information is included. "The treatment is non-mathematical . . . The student, the radio service engineer, and the amateur will find this book an excellent investment . . ."

TRANSMISSION

621.394.61 2368
Low-Frequency Radiotelegraph Transmitter for Arctic Use—H. P. Miller, Jr. (*Elec. Commun.*, vol. 27, pp. 11-20; March, 1950.) A conventional 10-kw equipment for operation in the frequency range 80-200 kc or, in later models, 200-300 kc. Single-frequency operation with on-off keying is normally used, but provision is also made for modulated cw operation. Arctic conditions necessitate air cooling of the F.892R final amplifier tube and preheating of the Hg-vapor rectifiers. Unit construction is

employed, to facilitate the transportation of the equipment by air.

621.396.61:621.396.97 2369
Contribution to the Study of High-Efficiency Broadcasting Transmitters—J. Polonsky. (*Ann. Radioelec.*, vol. 5, pp. 109-124; April, 1950.) The simplified theory of the grid-modulated amplifier is criticized and a more rigorous theory put forward. The disadvantages of the Doherty-Terman circuit (4020 of 1936 and 4300 of 1938) are practically eliminated in the experimental SIF transmitter at Boutigny by (a) locating the impedance inverter at the rf exciter input; (b) mounting the two modulator tubes in a cathodyne connection; and (c) incorporating an over-all degenerative and a local regenerative feedback loop. Useful carrier power of this transmitter is 18 kw; plate efficiency of the final stage 73 per cent; over-all efficiency 43 per cent. Other characteristics are shown. The advantages of such equipment compared with those using anode modulation of the last hf stage are stressed.

621.396.615.142.2:621.396.619.13 2370
Experiments on the Modulation of a Reflex Klystron—J. van Mulders. (*IIF* (Brussels), no. 6, pp. 153-163; 1950.) Theory of the relation between the oscillation frequency of a reflex klystron and the reflector voltage is reviewed and measurements of the modulation index of an American klystron, Type 707B, are described. The modulation index was determined from photographs of the modulation spectrum displayed on a cro. The modulation distortion can at once be found from the modulation index when the static characteristic of the klystron (frequency as a function of reflector voltage) is known.

621.396.619.23 2371
Rectifier Modulators with Frequency-Selective Terminations—D. G. Tucker. (*Proc. IEE* (London) vol. 97, pp. 205-207; May, 1950.) Discussion on 260 of February.

621.396.619.23 2372
Non-Linear Distortion in a Cowan Modulator—Belevitch. (*Wireless Eng.*, vol. 27, pp. 164-165; May, 1950. Author's reply to 1552 of July (Tucker and Jaynes).

621.396.61+621.396.621 2373
Radio Receivers and Transmitters [Book Review]—Amos and Kellaway. (See 2336.)

TUBES AND THERMIONICS

621.385:621.318.572 2374
An Electron-Beam Decimal-Counter Tube—D. L. Hollway. (*Nature* (London), vol. 165, pp. 856-857; May 27, 1950.) The tube described is 2.9 cm in diameter and 15 cm long, and operates at the relatively low anode voltage of 500 v with a beam current of 300 μ a and a frequency range 0-68 kc. The beam is caused to move in a path comprising alternate radial and circumferential steps by means of a special 5-plate deflector system with appropriate connections to a 5-segment slotted collector electrode. Visual indication of the count is given by projection on to the fluorescent screen of numbers cut in the back segments of the collector electrode.

621.385.029.63/64 2375
Wave Propagation in a Slipping Stream of Electrons: Small Amplitude Theory—G. G. Macfarlane and H. G. Hay. (*Proc. Phys. Soc.*, vol. 63, pp. 409-427; June 1, 1950.) Amplifying waves are found to travel along a slipping stream of electrons for all frequencies, a slipping stream being defined as one in which the electrons move in parallel paths with velocities varying with distance transverse to their motion. A slipping-stream tube may have the properties of a two-beam tube or a traveling-wave tube. The characteristics of one or the

other are displayed according to whether $(V_a - V_{-a}) / (V_a + V_{-a}) \leq 0.42$ the velocity of the electrons varying linearly from V_{-a} to V_a across the stream. A slipping stream inside a waveguide, capable of guiding a TM wave of slow phase-velocity in the absence of the electrons, acts very much as a traveling-wave tube with a uniform electron beam.

621.385.029.63/64 2376
Experimental Investigation of a Long Electron Beam in an Axial Magnetic Field—J. S. A. Tomner. (*Chalmers Tekn. Högsk. Handl.*, no. 92, 16 pp; 1950. In English.) An extension of an experimental investigation (561 of 1949) of the effect of the focusing magnetic field on the amplification of a traveling-wave tube. The form of the magnetic field produced by two helical focusing coils is studied and the collector current measured as a function of the number of turns of the coils. To avoid helix current due to space-charge effect for a helix of length 35 cm and diameter 3 mm, using a beam current of 1.5 ma and an accelerating voltage of 2,200 v, a field of 400 gauss or more is necessary.

621.385.029.63/64 2377
Traveling-Wave Tubes: Part 2—J. R. Pierce. (*Bell Sys. Tech. Jour.*, vol. 29, pp. 189-250; April, 1950.) The second installment (Chapters 4, 5, and 6) of a forthcoming book. Chapter discusses the two methods of analyzing iterated waveguide structures used in traveling-wave tubes, involving field theory and lumped-circuit analogues respectively. These methods are illustrated by analysis of typical simple structures. Chapter 5 is a discussion of group and phase velocities, gain and bandwidth, and the criteria by which the quality of a circuit should be judged. The helix and various resonator circuits are compared. In Chapter 6 the circuits are described in terms of normal modes of em wave propagation. Part 1: 1810 of August.

621.385.029.63/64 2378
1000-Watt Traveling-Wave Tube—S. E. Webber. (*Electronics*, vol. 23, pp. 100-103; June, 1950.) An article based on a 1949 National Electronics Conference paper. An illustrated description and construction details are given of a water-cooled tube which as a power amplifier produces a power gain of about 25 at 450 Mc. The efficiency is 20 per cent when operated with a beam voltage of 5,000 and beam current of 1 amp. Unwanted oscillations are suppressed by an attenuator consisting of a conducting coating on the outside of the tube. The inherent bandwidth is more than adequate for most commercial applications where a wide transmission band is required. See also *Proc. NEC*, vol. 5, pp. 493-499; 1949.

621.385.032.213.2 2379
Change of Mutual Conductance with Frequency—W. Raudorf. (*Wireless Eng.*, vol. 27, p. 164; May, 1950.) Author's reply to 1812 of August (Eisenstein). See also 1301 of June.

621.385.032.216 2380
Contribution to the Study of Oxide Cathodes—F. Violet and J. Riethmuller. (*Le Vide*, vol. 4, pp. 687-720; November, 1949.) Reprint. See 2956 of 1949.

621.385.15 2381
Secondary-Emission Valve—G. Diemer and J. L. H. Jonker. (*Wireless Eng.*, vol. 27, pp. 137-143; May, 1950. Correction, *ibid.*, vol. 27, p. 194; June, 1950.) "An experimental secondary-emission tube is described. The high figure of merit ($gm/C = 3.0 \text{ ma/v-pF}$) that is obtained by adding one stage of secondary emission to an earthed-grid triode of rather conventional construction makes the tube useful as a wideband amplifier for those cases where a very low noise figure is not required; typical figures are: at 1 m wavelength 30 db gain G with a bandwidth B of 3.5 Mc, at 50 cm $G = 15 \text{ db}$

with $B=20$ Mc, at 30 cm $G=10$ db with $B=10$ Mc. The maximum power output is for $\lambda > 1$ m about 1.5 watts. At 7 m wavelength the noise figure amounts to 12 db; this rather high value is due to secondary emission. It is shown that for this secondary-emission noise a kind of space-charge smoothing effect exists."

621.385.18.001.4 2382
Measurement of Tube Voltage Drop in Hot-Cathode Gas Tubes—Smith. (See 2291.)

621.385.2 2383
Space Charge in Planar Diodes—C. S. Bull. (*Proc. IEE* (London), vol. 97, pp. 159-165; May, 1950.) Following Langmuir's assumptions, the author considers five variables: total emissivity i_s , anode current i , anode voltage V , the value V_m of Langmuir's "potential minimum" and the cathode-anode separation x . Of these only three are independent. From them are formed thirty partial differential coefficients which are tabulated. By using these, quantities not accessible to direct measurement can be calculated. Particular attention is paid to the "motional transconductance" $(\partial i/\partial x) V_i$, which is related to scale changes in tubes and to their microphonic properties; a method for determining this quantity is described

621.385.3:621.396.615.14 2384
Electron Transit Time—M. R. Gavin. (*Wireless Eng.*, vol. 27, p. 164; May, 1950.) Comment on 1820 of August (Chatterjee and Sreekantan).

621.385.832 2385
Improved Production Methods for Television C.R. Tubes—(*Engineer* (London), vol. 189, pp. 482-483; April 21, 1950.) Description of an automatic machine installed at the Mulard factory for joining the necks and heads of cr tubes; the continuous production rate is 60 bulbs per hour.

621.385.832:535.371.07:621.396.9 2386
Visibility on Cathode-Ray Tube Screens: Positive vs Negative Signals on an Intensity Modulated Scope—M. W. Harriman and S. B. Williams. (*Jour. Opt. Soc. Amer.*, vol. 40, pp. 102-104; February, 1950.)

621.396.615.141.2:621.385.833 2387
Electron-Optical Mapping of the Space-Charge Field in a Magnetron—(See 2315.)

621.385:[621.396.621+621.396.645 2388
Electronic Valves: Books II IV [Book Review]—Cleaver-Hume Press, London and N. V. Philips, Eindhoven, Holland.

Book II. Data and Circuits of Receiver and Amplifier Valves. 409 pp., 21s.

Book III. First supplement to Book II. 213 pp., 12s. 6d.

Book IV. Application of the Electronic Valve in Radio Receivers and Amplifiers. 416 pp., 35s. (*Wireless Eng.*, vol. 27, pp. 193-194; June, 1950.) Book I was noted in 519 of March. Books II and III chiefly consist of details of the characteristics of Philips' tubes, one dealing mainly with the E, C, and K series and the other with the more recent E20, U20, D20, and U series and their applications. Book IV is in the nature of a wireless receiver textbook and is of general application. "The treatment throughout is very thorough but . . . almost entirely from the viewpoint of the designer of broadcast receivers."

621.385.83 2389

The Theory and Design of Electron Beams [Book Review]—J. R. Pierce. Publisher: D. Van Nostrand, New York, 1949, 197 pp., \$3.50. (*Wireless Eng.*, vol. 27, p. 166; May, 1950; *Electronics*, vol. 23, pp. 134-136; June, 1950.) "Written on the graduate level, [the book] discusses that material on electron beams which lends itself most readily to mathematical analysis, although some attention is also given to experimental techniques . . . [It] is clearly intended for those concerned with the formation and focusing of electron beams for use in such devices as low-frequency amplifiers, oscillators, and, especially, microwave tubes. . . . Comparisons between theory and practice are frequent. All chapters are followed by excellent problems. . . ."

MISCELLANEOUS

6:061.4 2390
British Scientific Instruments exhibited at Olympia—(*Metallurgia* (Manchester), vol. 41,

pp. 401-413; May, 1950.) Short descriptions of equipment shown on the stand of the Scientific Instrument Manufacturers' Association at the 1950 British Industries Fair, including a wide range of electronic apparatus, magnetic and electrical instruments, electromechanical equipment, temperature measurement and control apparatus, optical equipment and vacuum plant.

621.39 Heaviside 2391

The Heaviside Centenary—(*Electrician*, vol. 144, pp. 1747-1748; May 26, 1950.) Report of Heaviside Centenary Commemorative Meetings, May 1950. The opening paper, "Heaviside, the Man," by G. Lee, was followed by short tributes from leading scientists. Abstracts of papers on particular aspects of Heaviside's work will be found in the relevant sections.

621.39 Heaviside 2392

Oliver Heaviside and his Layer—E. V. Appleton. (*Wireless World*, vol. 56, pp. 187-188; May, 1950.) A short appreciation of "Heaviside's work" with special reference to his suggestion concerning the possible existence of a conducting layer in the upper atmosphere. See also 2391 above.

621.3 2393

Leitfaden der Elektrotechnik. Vol. 1: Grundlagen der Elektrotechnik [Book Review]—Möller and Wolff. Publisher: B. G. Teubner Verlagsgesellschaft, Leipzig, 4th edn., 358 pp. (*Wireless Eng.*, vol. 27, p. 193; June, 1950.) This textbook is unreservedly recommended to both students and teachers with a knowledge of German; the foundations of electrical engineering are laid with great thoroughness. A new chapter is included on the calculation of single-phase and three-phase transmission lines.

621.38/.39 2394

Electronic Engineering Master Index for 1947-1948 [Book Review]—Publisher: Electronics Research Publishing Co., New York, 1950, 339 pp., \$19.50. (*Jour. Frank. Inst.*, vol. 249, p. 340; April, 1950.) The second supplement of this reference work, which covers all aspects of the subject, and indexes material from about 250 scientific periodicals.

Books (continued)

Applications of the Electronic Valve in Radio Receivers and Amplifiers. By H. G. Dammers, Ing. J. Haantjes, J. Otte, In. H. Van Suchtelen.

Published (1950) by Philips Technical Library, Eindhoven, Holland. 410 pages+7-page index+256 figures. 9×6½.

This book is one of a series of three from the Philips organization of Holland, one of the world's leading technical centers in lamps and electronics. These three volumes will bear the same title and the chapters will be numbered consecutively. Only this first volume has been printed, the other two being in preparation. This book contains chapters on rf and if amplification, mixing and oscillator circuits, capacitor tracking, parasitic effects, and distortion with the final chapter on detection. With this rather limited scope, it is apparent that in a large book, such as this one (over 400 pages), the subjects are covered in considerable detail. The treatment of each subject is from a fundamental, and, in most cases, mathematical viewpoint, with little or no mention of specific tube types.

It will probably be of limited interest to engineers in the U.S.A. engaged in the design of radio receivers, because there is no inclusion of material on FM circuits nor the circuits used in modern television receivers. This would appear to be true also of the two additional volumes in preparation.

The material in each chapter is well organized under subheadings, but the general index is quite limited in its coverage. There are references at the end of each chapter.

Engineers needing the basic mathematical relationship for the subjects covered will find this volume an excellent one for reference. The three volumes are to be made available also in the Dutch, German, and French languages.

W. C. WHITE

General Electric Research Laboratory
Schenectady, N. Y.

NEW PUBLICATIONS

The Geiger-Muller Counter, National Bureau of Standards Circular 490, 25 large double-column pages, illustrated, is avail-

ble from the Superintendent of Documents, U. S. Government Printing Office, Washington 25, D. C., at 20 cents a copy. Remittances from foreign countries should be in United States exchange, and should include an additional sum of one-third the publication price to cover the cost of mailing.

The nature, construction, and use of the Geiger-Muller counter, one of the most important of present-day detectors of radioactive radiation, is concisely presented on an elementary level in this new booklet just published by the National Bureau of Standards.

In addition to the treatment of the Geiger-Muller counter itself, the booklet discusses methods of detecting counter pulses, applications of counters to quantitative measurements, proportional counters, and the preparation and filling of Geiger-Muller counters. Also included are a number of examples of special forms of counters which have been developed and a discussion of some of the electronic circuits commonly used to obtain an indication of the response of the counter to radiation. A bibliography of scientific papers is presented.

Centralab Model 2 Radiohm

A 1951 CONTROL FOR 1951 DESIGNS



Today's Finest Control!

14 Good Reasons Why CRL'S Model 2 Radiohm is the Control for You!

1. **Switch** — with positive detent in both on and off positions. **Terminals** — with surfaces elevated to eliminate danger of shorting to cover legs . . . $\frac{1}{8}$ " hole diameter for simplified wiring . . . hot tin dipped for easy soldering . . . mechanical lock to prevent loosening in soldering operations.
2. Cadmium plated steel **cover** completely shields resistor.
3. **Insulator's** high dielectric strength permits breakdown test at 1000 volts R. M. S. Dust and dirt can't get in.
4. **Stop**, of cup design, provides superior switch shielding . . . gives you excellent torque strength without distortion.
5. High grade laminated phenolic **shoe** maintains high insulation resistance under humidity conditions.
6. **Contact Spring** gives you double wiping contacts on both resistor and center terminal ring . . . is accurately formed to maintain uniform pressures and minimize noise.
7. Electro tin-plated **terminals** provide soldering ease. Tightly crimped terminals give you direct contact to re-

- sistor . . . assure constant contact under humidity and soldering conditions.
8. **Resistor** is made of special resistance material bonded to high quality phenolic for smooth operation, low noise level, outstanding humidity characteristics.
9. Cadmium-tipped **center terminal** provides easy soldering . . . good shelf life without oxidation. Adequately lubricated for good rotation life, center terminal is finished to give you smooth take-off . . . minimum noise.
10. Laminated phenolic **bate** maintains high insulation resistance under humidity conditions.
11. Cadmium-plated steel **ground plate** assures positive grounded cover.
12. Cadmium-plated steel **bushing** is accurately finished and fit to shaft for smooth rotation.
13. **Retaining ring**.
14. **Shaft**. Unlimited variations available to meet your specifications.

*Switch Type, Tapped. Exploded View: Switch Type, Unmapped.

Centralab — DEVELOPMENTS THAT CAN HELP YOU

Division of GLOBE-UNION INC. • Milwaukee

Centralab Components

AND ALL OTHER ELEC

YOU'LL FIND CENTRALAB a good source of supply for a wide range of controls, switches, ceramic capacitors, and printed Electronic Circuits in standard or custom-built models, sizes and values — for all type electronic devices — military and commercial.



IMAGINE the large variety of uses for peak-quality controls that are only $15/16$ " in diameter, yet rated at $1/2$ watt. That's Centralab's great new line of Model 2 Radiohms. Designed for television and radio sets, sound and test equipment, the versatile Model 2 is just what you need for many other electronic uses where a combination of small size and finest performance is essential. CRL Model 2 Controls are precision built of the finest materials to give you lower noise level . . . longer life. Their clinched terminals insure rigid contact to the resistance element under humidity and soldering conditions. What's more, Model 2's complete line of 3 basic switches — 5, 8, and 1 amp. — provide 24 switch combinations for real flexibility in application and design. For all the facts, see your CRL representative or write direct.



New Centralab Model 2 Radiohm Control. Left, single unit plain type, untapped; right, twin unit plain type, untapped. Both with single shafts.

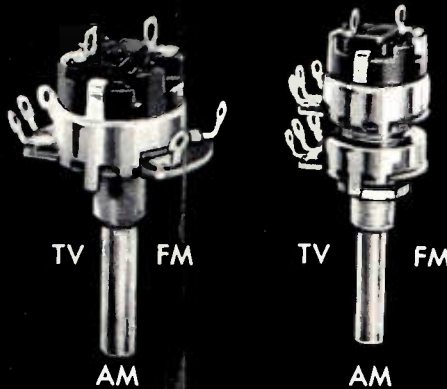

New Centralab Model 2 Radiohm Controls. At left single unit switch type, tapped with single shaft. Right — twin unit switch type, untapped with single shaft.



New Centralab Model 2 Radiohm Control. Left, twin unit plain type, front section tapped; right, twin unit switch type, rear section tapped. Both units have concentric shafts.

...for TV-AM-FM TRONIC DEVICES

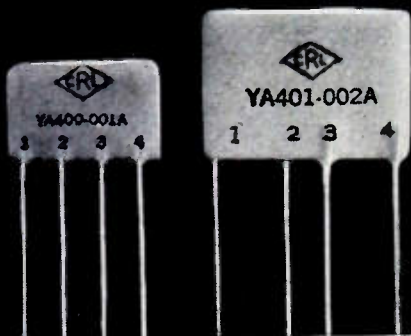

Centrallab Triode Couplates save space and weight. They actually replace 5 components normally used in audio circuits. Triode Couplates are complete assemblies of 3 capacitors and 2 resistors bonded to a dielectric ceramic plate. Available in a variety of resistor and capacitor values.

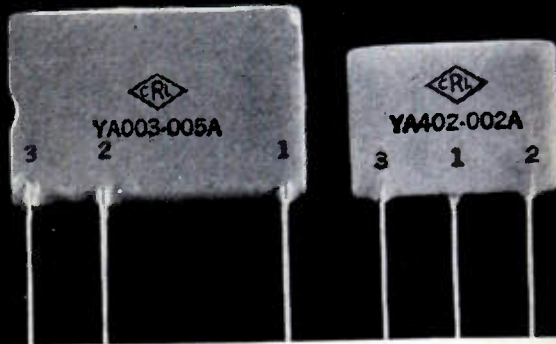

Centrallab Vertical Integrators give you big savings in assembly costs, particularly in TV vertical integrator networks. One type consists of 4 resistors and 4 capacitors brought out to 3 leads . . . reducing the formerly required 16 soldered connections to only 3! There's a big saving in the number of parts handled, too!

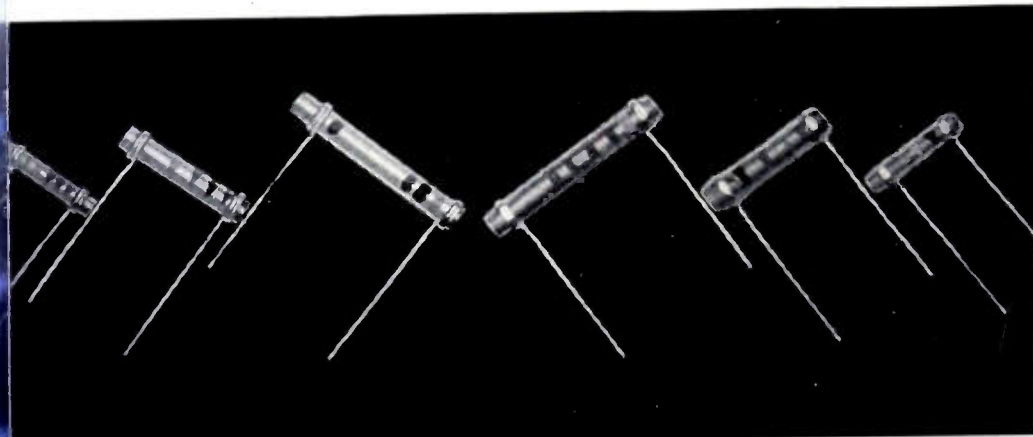

Centrallab's TC (Temperature Compensating) Tubular Hi-Kaps, left, are the most stable capacitors available. With TC Hi-Kaps, there's practically no variation due to aging or changes in temperature or humidity. For applications where temperature compensation is unimportant, use Tubular BC Hi-Kaps, right.

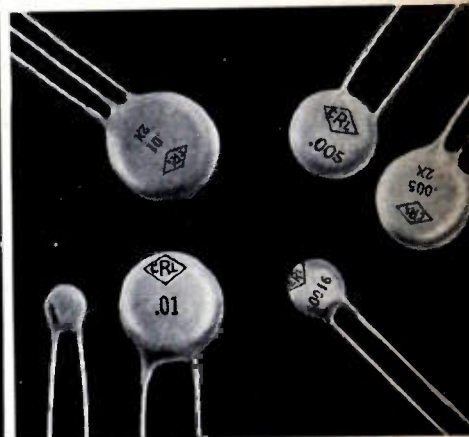

Disc: The original miniature ceramic disc capacitors combining utmost reliability with small size and low mass weight. Diameter $\frac{3}{16}$ ", $\frac{1}{8}$ ", $\frac{3}{32}$ " and $\frac{1}{4}$ ". Single shielded and non-shielded units available.

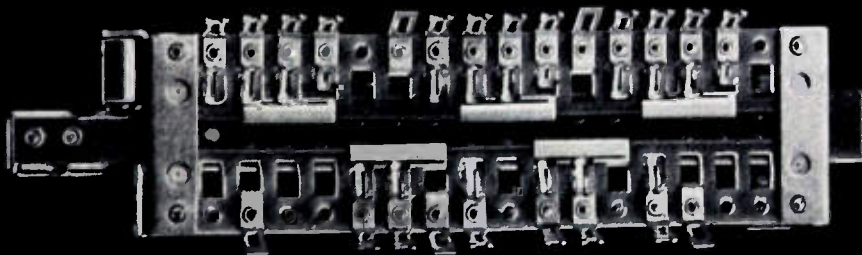

Centrallab's development of a revolutionary, new Slide Switch gives you improved AM and FM performance! Flat, horizontal design saves valuable space, allows short leads, convenient location to coils, reduced lead inductances for increased efficiency in low and high frequencies. CRL Slide Switches are rugged and dependable.

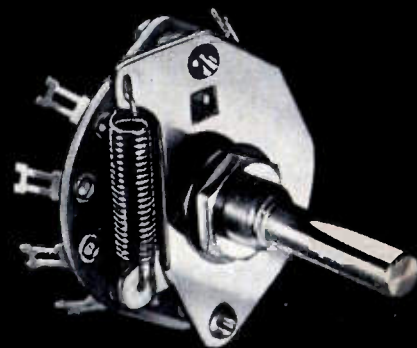

Great step forward in switching is CRL's New Rotary Coil and Cam Index Switch. Its coil spring gives you smoother action, longer life.

IMPORTANT BULLETINS FOR YOUR TECHNICAL LIBRARY!

They're factual!



THEY'RE FREE!

Choose From This List!

Centralab Printed Electronic Circuits

- 973 — AMPEC — three-tube P. E. C. amplifier.
- 42-6 — COUPLATE — P. E. C. interstage coupling plate.
- 42-22 — VERTICAL INTEGRATOR — for TV application.
- 42-24 — CERAMIC PLATE COMPONENTS — for use in low-power miniature electronic equipment.
- 42-27 — MODEL 2 COUPLATE — for small or portable set applications.
- 999 — PENTODE COUPLATE — specialized P. E. C. coupling plate.
- 42-9 — FILPEC — Printed Electronic Circuit filter.

Centralab Capacitors

- 42-3 — BC TUBULAR HI-KAPS — capacitors for use where temperature compensation is unimportant.
- 42-4R — BC DISC HI-KAPS — miniature ceramic BC capacitors.
- 42-10 — HI-VO-KAPS — high voltage capacitors for TV application.
- 42-59 — CERAMIC TUBULAR TRIMMERS — designed for TV and VHF application.
- 695 — CERAMIC TRIMMERS — CRL trimmer catalog.

- 981 — HI-VO-KAPS — capacitors for TV application. For jobbers.
- 42-18 — TC CAPACITORS — temperature compensating capacitors.
- 814 — CAPACITORS — high-voltage capacitors.
- 975 — FT HI-KAPS — feed-thru capacitors.

Centralab Switches

- 953 — SLIDE SWITCH — applies to AM and FM switching circuits.
- 970 — LEVER SWITCH — shows indexing combinations.
- 995 — ROTARY SWITCH — schematic application diagrams.
- 722 — SWITCH CATALOG — facts on CRL'S complete line of switches.

Centralab Controls

- 42-19 — MODEL "1" RADIOHM — world's smallest commercially produced control.
- 42-85 — MODEL "2" RADIOHM — CRL's new line of 1/16" diam. controls for TV — AM — FM.

Centralab Ceramics

- 967 — CERAMIC CAPACITOR DIELECTRIC MATERIALS.
- 720 — CERAMIC CATALOG — CRL steatite, ceramic products.

Look to CENTRALAB in 1950! First in component research that means lower costs for the electronic industry. If you're planning new equipment, let Centralab's sales and engineering service work with you. For complete information on all CRL products, get in touch with your Centralab Representative. Or write direct.

CENTRALAB
Division of Globe-Union Inc.
920 East Keefe Avenue, Milwaukee, Wisconsin

Yes—I would like to have the CRL bulletins, checked below, for my technical library!

- | | | | | | | |
|--------------------------------|--------------------------------|--------------------------------|--------------------------------|--------------------------------|------------------------------|--------------------------------|
| <input type="checkbox"/> 973 | <input type="checkbox"/> 42-24 | <input type="checkbox"/> 42-9 | <input type="checkbox"/> 42-10 | <input type="checkbox"/> 981 | <input type="checkbox"/> 953 | <input type="checkbox"/> 42-19 |
| <input type="checkbox"/> 42-6 | <input type="checkbox"/> 42-27 | <input type="checkbox"/> 42-3 | <input type="checkbox"/> 42-59 | <input type="checkbox"/> 42-18 | <input type="checkbox"/> 970 | <input type="checkbox"/> 42-85 |
| <input type="checkbox"/> 42-22 | <input type="checkbox"/> 999 | <input type="checkbox"/> 42-4R | <input type="checkbox"/> 695 | <input type="checkbox"/> 814 | <input type="checkbox"/> 995 | <input type="checkbox"/> 967 |
| | | | | <input type="checkbox"/> 975 | <input type="checkbox"/> 722 | <input type="checkbox"/> 720 |

Name.....

Address.....

City..... State.....

TEAR OUT COUPON

for the Bulletins you want

Centralab
Division of GLOBE-UNION INC. • Milwaukee

SECTIONAL VIEW
of solid molded
resistor element.

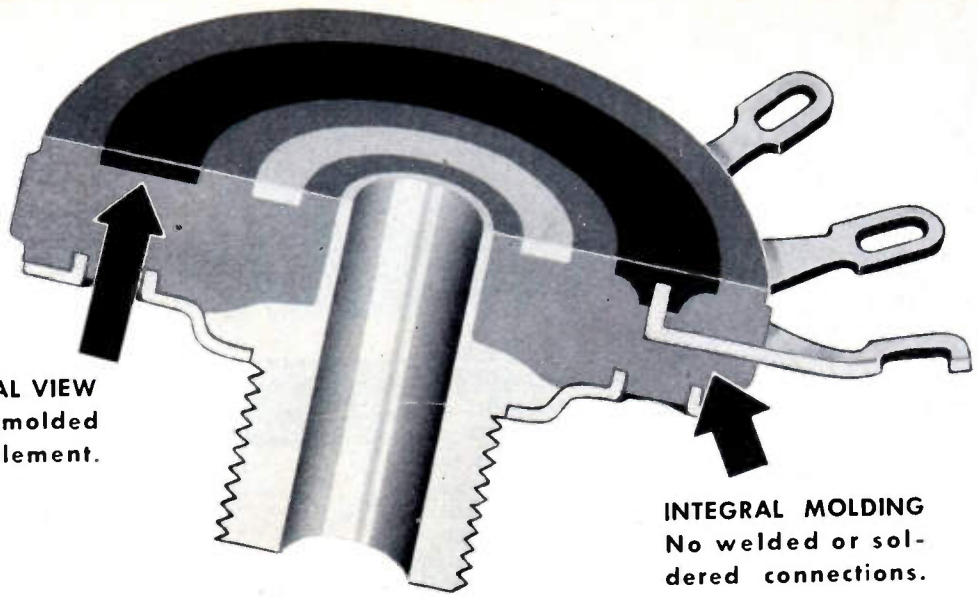

INTEGRAL MOLDING
No welded or soldered connections.

Any Resistance-Rotation Curve

can be permanently molded
into the Type J Bradleyometer

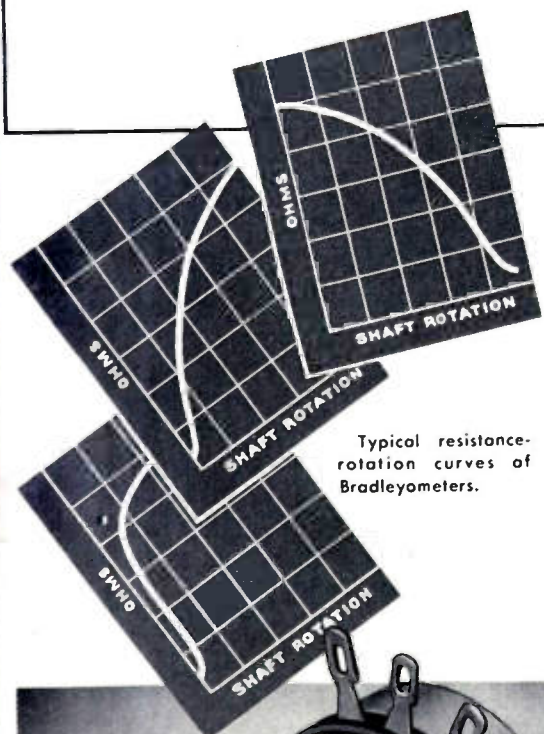

Typical resistance-rotation curves of Bradleyometers.

The Type J Bradleyometer can be built to produce any resistance-rotation curve because, during manufacture, the solid molded resistor can be varied in resistance throughout the circumference of the ring.

It is not a film or paint type resistor. The resistor unit is molded as one piece with terminals, face plate, and threaded bushing imbedded in the molded piece. After molding, the resistor material is no longer affected by heat, cold, moisture, or age. The contact brush actually improves with age.

Type J Bradleyometers can be supplied in single, dual, or triple unit construction for rheostat or potentiometer applications. A built-in line switch is an optional feature on single and dual models. Specifications sent upon application.

Allen-Bradley Co.
114 W. Greenfield Ave., Milwaukee 4, Wis.

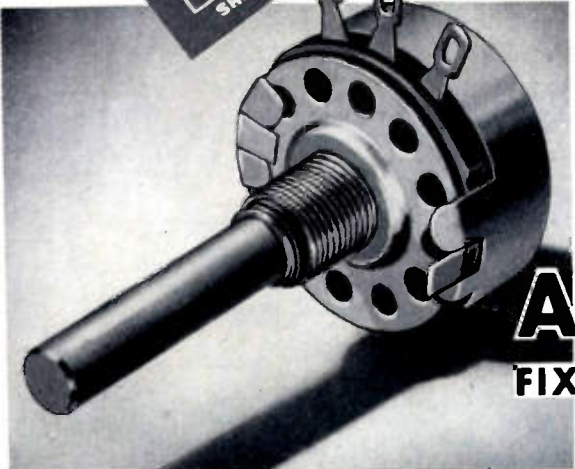

ALLEN-BRADLEY
FIXED & ADJUSTABLE RADIO RESISTORS
Sold exclusively to manufacturers of radio and electronic equipment
QUALITY

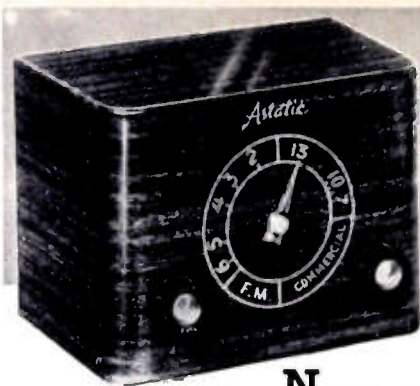

**ASTATIC BOOSTER
MODEL BT-1
LIST PRICE \$29.95**



**ASTATIC BOOSTER
MODEL BT-2
LIST PRICE \$32.50**

NEVER BEFORE such quality features in a low-priced booster. Choice of conventional styling in a metal cabinet with rich mahogany woodgrain finish or modern design in dark brown plastic. Simplified controls—single tuning knob with continuous tuning through both TV and FM bands.

ASTATIC LEADS

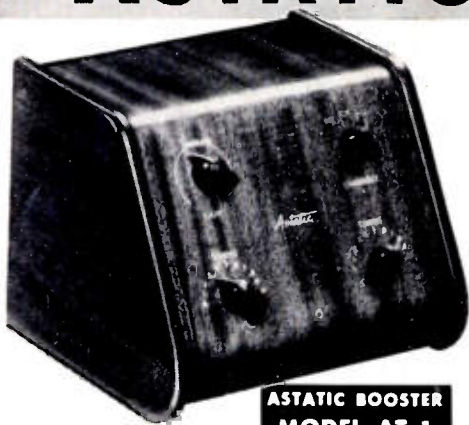

**ASTATIC BOOSTER
MODEL AT-1
LIST PRICE \$49.50**

ASTATIC four-tube deluxe models—no other booster can do so much in improving TV picture contrast and clarity, in improving sound, in eliminating interference. Feature exclusive variable gain control and dual-tuning. Model AT-1 in fine furniture finish mahogany, model AT-1B in blond wood cabinet.



**ASTATIC BOOSTER
MODEL AT-1B
LIST PRICE \$51.50**

THE TV AND FM BOOSTER FIELD IN THESE THREE IMPORTANT WAYS

1

COMPLETE LINE—Four models from which to choose, with variety of handsome cabinet styling.

2

UNEQUALLED PERFORMANCE—Astatic engineering leadership assures superior booster performance... unequalled improvement of TV and FM reception.

3

WIDEST PRICE RANGE—A price to fit every purse, assuring top volume sales.

Write for New, Full-Color Folder giving Complete Details on Astatic Boosters

THE Astatic CORPORATION
CONNEAUT, OHIO
IN CANADA: CANADIAN ASTATIC LTD., TORONTO, ONTARIO

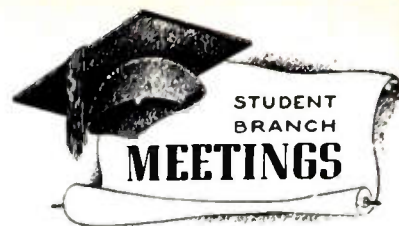

STUDENT BRANCH MEETINGS

MARQUETTE UNIVERSITY, IRE-AIEE BRANCH
Field Trip through General Electric X-Ray Corporation of West Allis, Wisconsin; June 6, 1950.
Business Meeting; Election of Officers; June 29, 1950.
Business Meeting; July 13, 1950.



SECTION MEETINGS

AKRON
"Military Aircraft Communication Systems," by L. B. Hallman, Wright-Patterson Air Base; April 18, 1950.
"Automatic Flight Control," by James Anast, Air Materiel Flight Command; Election of Officers; May 16, 1950.

BUENOS AIRES
Film, "Atomical Physics," by H. T. Magno; June 16, 1950.

"Modern Developments of the Impulse Governed Oscillator's Technique," by H. B. R. Boosman; July 7, 1950.

"Some Mathematics Aspects of the Communication's Theory," by A. G. Dominquez; July 21, 1950.

"Facsimile," by M. V. Sarli; August 4, 1950.

CLEVELAND

"Battery-Capacitor Pulse Power Supplies," by W. H. Fritz, National Carbon Company; February 23, 1950.

"Large Scale Operational Research in Industry as Illustrated by the Great Lakes Radar Studies," by C. M. Jansky, Jr., and S. L. Bailey, Jansky & Bailey; March 23, 1950.

"Discussion of Color Television Systems," by Students from John Carroll University, Case Institute and Fenn College; April 27, 1950.

Inspection Trip through WXEL Television Station; May 11, 1950.

"Television Studio Equipment," by H. B. Fancher, General Electric Company; May 26, 1950.

COLUMBUS

"The T. V. Freeze and The Status of Color Television," by S. L. Bailey, Jansky and Bailey; March 22, 1950.

"High Voltage Power Transmission," by W. J. Sheets, Student, Battelle Memorial Institute; "The Magnetron Oscillator," by J. F. Braeunig, Student, Battelle Memorial Institute; "Two-Phase Symmetrical Components," by H. W. Wilber, Student, Battelle Memorial Institute; "Sonar Systems" by R. A. Orth, Student, Battelle Memorial Institute; April 13, 1950.

Tour of WLW-C Studios and Transmitter; May 31, 1950.

"Cybernetics," by David Huffman, Instructor, Ohio State University; June 22, 1950. Election of Officers; June 22, 1950.

EMPORIUM

"Color Television," by R. M. Bowie, Sylvania Electric Products Inc.; August 18, 1950.

(Continued on page 40A)

DID YOU EVER LOOK INSIDE AN

OHMITE

Type AB POTENTIOMETER?

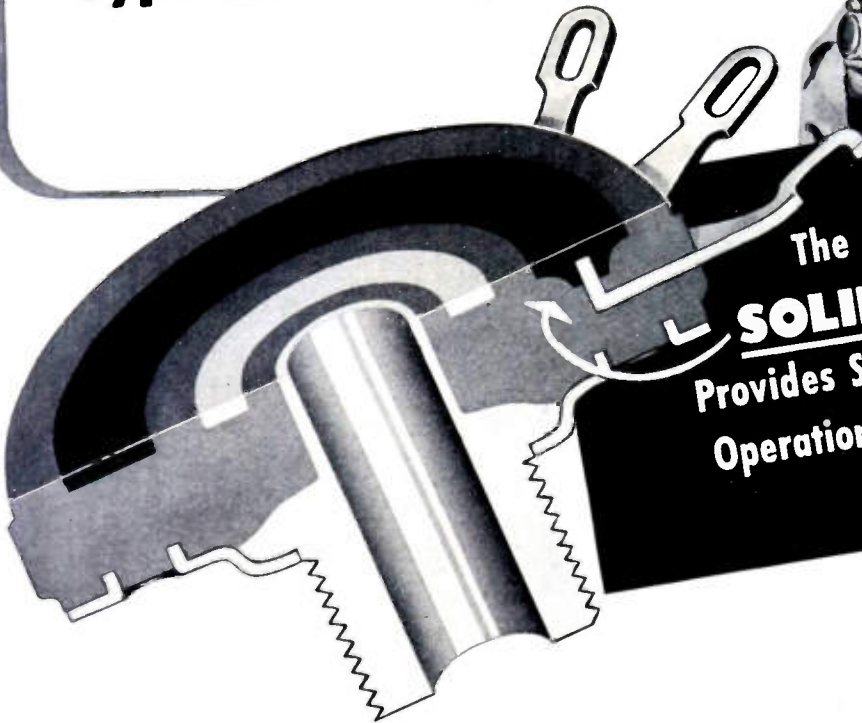

The resistance element is **SOLID MOLDED**—
Provides Smoother, Quieter
Operation, and Longer Life

AVAILABLE FROM
STOCK IN TWO
STANDARD SHAFTS

2" DIMENSION
ROUND SHAFT

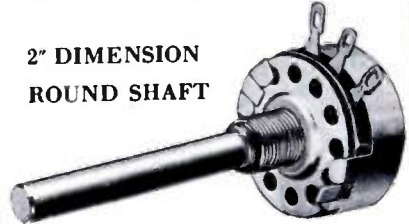

SCREWDRIVER
SHAFT WITH
LOCKING NUT



If you were to cut an OHMITE Type AB Potentiometer in half, you would see where these rugged little two-watt units get their reputation for reliability, long life, and smooth, quiet operation. The secret lies in their *unique design*.

The resistance element, for instance, is a thick, solid ring, molded under heat and pressure—not a sprayed film or paint type element. Because of this, the unit is unaffected by heat, cold, moisture, and length of service—and, the low noise level often becomes *less* with use! Furthermore, terminals are *imbedded* in the element, and all parts are corrosion resistant.

Use these fine components where reliability is important. Available in a wide variety of resistance values, and in three tapers—linear, clockwise logarithmic, and counter-clockwise logarithmic.

AVAILABLE AT ALL OHMITE DISTRIBUTORS

Write for **BULLETIN 131A**

OHMITE MANUFACTURING CO.
4860 Flournoy St., Chicago 44, Illinois

Be Right with **OHMITE**
Reg. U. S. Pat. Off.

RHEOSTATS • RESISTORS • TAP SWITCHES

Q-max

TRADE MARK REGISTERED



7 Service-Proven Types OF FINE Insulating Compositions and Finishes

- CLEAR RF LACQUER NO. A-27
- CLEAR AIR DRYING FINISHING LACQUER NO. 28
- BLACK AIR DRYING VARNISH NO. 30
- CLEAR BAKING VARNISH NO. 43
- BLACK BAKING VARNISH NO. 45
- HITEMP CLEAR BAKING VARNISH NO. 41
- INDUSTRIAL BAKING ADHESIVE NO. 49



Here's what Q-Max does:

Q-Max reduces corrosion, tropicalizes (when solutions permit the use of tropicalizing agents), repels moisture, increases volume and surface resistivity, promotes electrical stability, protects, reinforces and bonds. Q-Max has

proven its worth in actual service under all climatic and operating conditions—the reason why radio engineers and operations men, everywhere, specify Q-Max for utmost protection.

These are its many applications: Q-Max, developed by C-P engineers to provide better performance for installations in RF service, is highly efficient when applied to a wide variety of materials and surfaces. Applications include the treatment of wood, steatite, porcelain, glass, plastics, organic and inorganic fabrics, paper, vulcanized fibre and metals. A reputation for positive action and permanence has made Q-Max the accepted standard for RF service.

WRITE FOR YOUR COPY OF THE NEW Q-MAX CATALOG

Q-MAX CHEMICALS DIVISION

Communication Products Company, Inc.

KEYPORT  NEW JERSEY



(Continued from page 38A)

"Electrical Application of Glass," by E. M. Guyer, Corning Glass Co.; "Standardization Program of the RTMA," by V. M. Graham, Sylvania Electric Products Inc.; August 19, 1950.

HOUSTON

"Some Problems in the Miniaturization of Components," by Leon Podolsky, Sprague Electric Company; May 16, 1950.

"The FM Logging System," by W. J. Greer, Halliburton Oil Well Cementing Company; June 21, 1950.

MONTREAL

Tour of Canadian Broadcasting Corporation Studio; Election of Officers; May 10, 1950.

NEW MEXICO

Election of Officers; June 23, 1950.

"Recent Applications of Electron Multiplier Tubes," by J. A. Allen; July 21, 1950.

SAN ANTONIO

"Ground Controlled Approach," by W. P. Lord, U. S. Air Force; "G. C. A. and the Berlin Air Lift," by J. R. Guthrie, U. S. Air Force; July 27, 1950.

SAN DIEGO

"Network Analysis, Simplified," by D. C. Kalbfell, Faculty, San Diego State College; August 1, 1950.

TOLEDO

"Control Problems of Atomic Power Generators," by M. A. Schultz, Westinghouse Corporation; June 20, 1950.



The following transfers and admissions were approved and will be effective as of October 1, 1950:

Transfer to Senior Member

Bibbero, R. J., 773 Potomac Ave., Buffalo 9, N. Y.
Braun, W. L., 555 Long Ave., Harrisonburg, Va.
Denius, H. R., Woodbridge, Va.

Doersam, P. D., Research & Development Laboratories, Hughes Aircraft Co., Culver City, Calif.

Dwork, L. E., 125 E. Clinton Ave., Bergenfield, N. J.

Fisk, N. C., 3005 W. Chicago, Detroit 6, Mich.

Gerlach, A. A., 4020 Overhill Ave., Chicago 34, Ill.

Hamilton, G. E., 37 Weston St., Nutley, N. J.

Haner, L. P., 75 Koenig Rd., Tonawanda, N. Y.

Horrell, M. W., 4855 Fourth Ave., Detroit 1, Mich.

Jenkins, J., 7209 Fait Ave., Baltimore 24, Md.

Levens, L. M., 2000 Anthony Ave., New York 57, N. Y.

Morrison, L. H., 134 Upland Rd., Waban 68, Mass.

Robinson, E. F. V., Radio and Electrical Engineering, National Research Council, Ottawa, Ont., Canada

Skellett, A. M., 10 Midwood Ter., Madison, N. J.

Sperling, P., 4501-B Ridgeway Dr., Los Alamos, N. Mex.

Wallace, F. C., 260 Linden Ave., Belleville 9, N. J.

Zaret, M. E., 15 Cedar St., Nutley, N. J.

Admission to Senior Member

Curry, G. T., 618 Maple, Emporium, Pa.

(Continued on page 42A)

STANDARD RI-FI* METERS

14kc to 1000mc!

DEVELOPED BY **STODDART**
FOR THE ARMED FORCES.
AVAILABLE COMMERCIALY.



VHF!
15 MC
to
400 MC
NMA - 5

Commercial equivalent of TS-587/U.
Sensitivity as two-terminal voltmeter, (95 ohms balanced)
2 microvolts 15-125 MC; 5 microvolts 88-400 MC. Field
intensity measurements using calibrated dipole. Frequency
range includes FM and TV Bands.



VLF!
14 KC
to
250 KC
NM - 10A

Commercial equivalent of AN/URM-6.
A new achievement in sensitivity! Field intensity measure-
ments, 1 microvolt-per-meter using rod; 10 microvolts-per-
meter using shielded directive loop. As two-terminal volt-
meter, 1 microvolt.

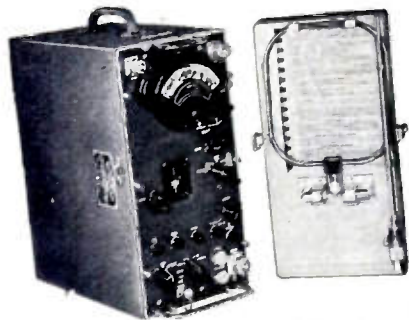

HF!
150 KC
to
25 MC
NM - 20A

Commercial equivalent of AN/PRM-1.
Self-contained batteries. A.C. supply optional. Sensitivity as
two-terminal voltmeter, 1 microvolt. Field intensity with 1/2
meter rad antenna, 2 microvolts-per-meter; rotatable loop
supplied. Includes standard broadcast band, radio range,
WWV, and communications frequencies.



UHF!
375 MC
to
1000 MC
NM - 50A

Commercial equivalent of AN/URM-17.
Sensitivity as two-terminal voltmeter, (50-ohm coaxial input)
10 microvolts. Field intensity measurements using calibrated
dipole. Frequency range includes Citizens Band and UHF
color TV Band.

Since 1944 Stoddart RI-FI* instruments have established the
standard for superior quality and unexcelled performance.
These instruments fully comply with test equipment require-
ments of such radio interference specifications as JAN-I-225,
ASA C63.2, 16E4(SHIPS), AN-I-24a, AN-I-42, AN-I-27a, AN-I-40
and others. Many of these specifications were written or re-
vised to the standards of performance demonstrated in
Stoddart equipment.

The rugged and reliable instruments illustrated above serve
equally well in field or laboratory. Individually calibrated
for consistent results using internal standard of reference.
Meter scales marked in microvolts and DB above one microvolt.
Function selector enables measurement of sinusoidal or complex
waveforms, giving average, peak or quasi-peak values.
Accessories provide means for measuring either conducted
or radiated r.f. voltages. Graphic recorder available.

*Radio Interference and Field Intensity.

STODDART AIRCRAFT RADIO CO.

6644 SANTA MONICA BLVD., HOLLYWOOD 38, CALIF.
Hillside 9294

Precision Attenuation for UHF!

Less than 1.2 VSWR to 3000 MC.
Turret Attenuator:
0, 10, 20, 30, 40, 50 DB.
Accuracy \pm .5 DB.

Patents applied for.



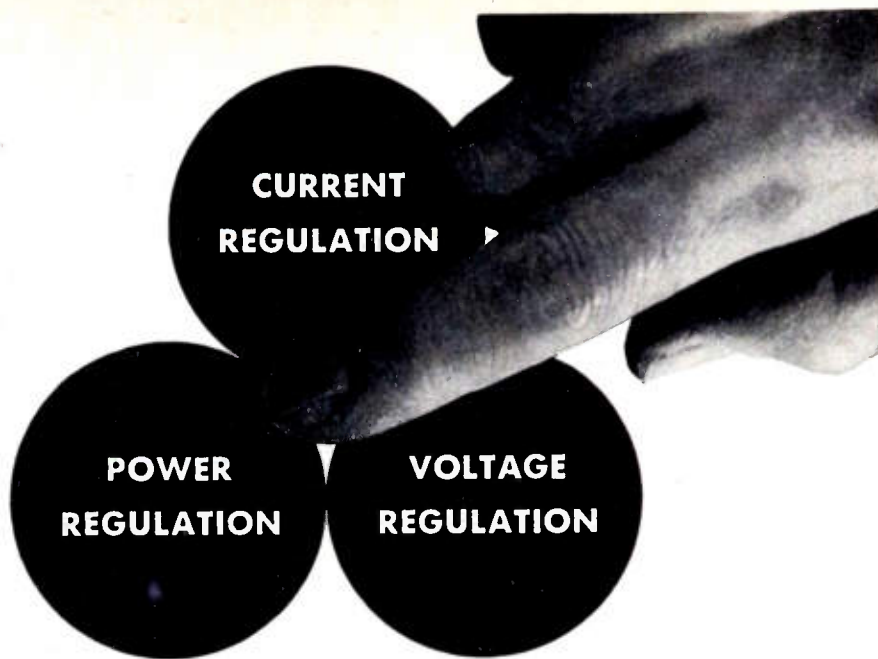

*can you put your Finger
on the TROUBLE?*

If you can, a SORENSEN Electronically controlled, magnetic amplifier regulating circuit can solve it!

Sorensen's new line of Electronic AC Voltage Regulators is the most accurate and most economical line of Electronic Voltage Regulators on the market today. Standard specifications offer Accuracy to within $\pm 0.1\%$ and Distortion as low as 2%. Load range from zero to full load. All models are temperature Compensated and can be supplied hermetically sealed or fosterited. And the Sorensen line uses less tubes than other electronic type regulators.

Sorensen Engineers are always at your service to solve unusual problems and give you the benefits of years of experience. Describe your needs and let a Sorensen Engineer suggest a solution. It will save you time and money to try Sorensen first.

CATALOG A1049 DESCRIBES
COMPLETE LINE



Sorensen and company, inc.
375 FAIRFIELD AVE. • STAMFORD, CONN.
MANUFACTURERS OF AC LINE REGULATORS, 60 AND 400 CYCLES, REGULATED DC POWER SOURCES, ELECTRONIC INVERTERS, VOLTAGE REFERENCE STANDARD, CUSTOM BUILT TRANSFORMERS, SATURABLE CORE REACTORS

TYPICAL AC REGULATORS



Model 5000-25—high power
Input 95 to 130; distortion 3%; load 0-5000 VA;
Accuracy $\pm 0.1\%$ against line or load; 50-60 cycles



Model 3000S—medium power
Input 95 to 130; distortion 3%; load 0-3000 VA;
Accuracy $\pm 0.1\%$ against line or load; 50-60 cycles



Model 500S—low power
Input 95 to 130; distortion 3%; load 0-500 VA;
Accuracy $\pm 0.1\%$ against line or load; 50-60 cycles



(Continued from page 40A)

Hayworth, D. F., 305 S. Blanchard Ave., Wheaton, Ill.
Maxwell, J. W., 1502 E. 80 St., Indianapolis, Ind.
Olsen, R. K., 8042 Brecksville Rd., Brecksville, Ohio
Safford, F. J., 6 Dougal Ave., Livingston, N. J.
Wooldridge, D. E., Research & Development Laboratories, Hughes Aircraft Co., Culver City, Calif.

Transfer to Member

Baruch, J. J., 1 Westgate, Cambridge, Mass.
Boyle, B. H., 6019 Primrose, Indianapolis 20, Ind.
Crandall, W. R., CNAAT (Staff), Bldg. 1, NAS, Corpus Christi, Tex.
Gangopadhyaya, I., c/o Area Installation Engineer, Eastern Court, New Delhi 1, India
Hughes, W. A., 2329 Thayer St., Evanston, Ill.
Neely, N. B., 7422 Melrose Ave., Los Angeles 46, Calif.
Packard, R. H., 14 Gleason Rd., Lexington 73, Mass.
Parker, H. W., Box 575, Oxnard, Calif.
Phlegar, C. L., Jr., Radio Station WHBU, 640 Citizens Bank Bldg., Anderson, Ind.
Price, G. W., 226 Park Ct., S.E., Cedar Rapids Iowa
Stubbins, W. F., 1582 Glen Parker Ave., Cincinnati 23, Ohio
Vergason, D. L., Sylvania Electric Products Inc., Emporium, Pa.
Wight, V. H., 1411 Nemaha, Lincoln 2, Neb.

Admission to Member

Albrecht, J. C., 1612 Saunders, St. Paul 5, Minn.
Bakura, J., 65 Edward Rd., Watertown, Mass.
Ball, R. M., Jr., c/o Mehrabad Airport, Department Civil Aviation, Teheran, Iran
Basil, V. P., D-6, Airport Lane, Willingdon Aerodrome, New Delhi, India
Beckers, A. E., 447 Prospect St., Apt. 28 East Orange, N. J.
Disser, C. J., Suite 302, 1425 La Salle Avenue, S., Minneapolis 3, Minn.
Hyden, I. F., 3637 Hillcrest Dr., Los Angeles 16, Calif.
Kersey, L. R., Department of Electrical Engineering, University of British Columbia, Vancouver, B. C., Canada
Larkin, J. P., 208 E. 18 St., New York 3, N. Y.
Lac, C. B., 202 Carolina Pl., North Charleston, S. C.
McCready, K. F., General Electric Co., Receiving Tube Division, Owensboro, Ky.
Soderstrom, H. W., 3009 Cottage Grove Ave., S.E., Cedar Rapids, Iowa
Patremio, S. R., 253 Azalea Dr., New Milford, N. J.
Stacy, R. A., 3142 Werk Rd., Apt. 2, Cincinnati 11, Ohio
Tourville, G. A., 2315 Anniels Dr., Dallas 11, Tex.
Walrabenstein, E. M., Boeing Airplane Co., Seattle Wash.
Wolfe, B., 3513 Lucille Ave., Baltimore 15, Md.

The following elections to Associate grade were approved and will be effective as of September 1, 1950:

Apgar, R. R., Jr., 3 Maple Ter., Charleston 1, W. Va.
Bleasdale, J., 118 Blackburn Rd., Acorington, Lancs., England
Bloyd, J. E., 1630 Landerdale Ave., Lakewood, Ohio
Burkhalter, B. L., Jr., 1841 N. Prospect Ave., Milwaukee 2, Wis.
Cohen, B. E., 2700 Hazelwood, Detroit 6, Mich.
Collins, J. D., 1323 Ave. D, Beaumont, Tex.

(Continued on page 44A)

NOTICE to **MYCALEX** USERS

and all recipients of the **1950 IRE DIRECTORY**

The complete Mycalex 1950-51 Catalog-Engineer's Handbook is bound in your new IRE DIRECTORY. It contains complete characteristics of all types of Mycalex glass-bonded mica, information concerning comparative properties of various dielectrics, the proper design criteria for molded and machined insulators, and a great deal of other engineering data which will prove most useful in solving your insulation problems.

An error was made in reproducing the graph on the bottom of page 15 in the Mycalex Catalog-Engineer's Handbook (which appears in alphabetical order in the Product Directory Section of the IRE Yearbook). Below is the corrected graph and it is suggested that you cut it out as indicated and paste, or affix it with scotch tape, over the graph now shown at the bottom of page 15 of the Catalog.

Mycalex 400 is a grade L-4A insulation in accordance with JAN-I-10. It has a power factor at 1 meg. of 0.0018 and loss factor of only 0.013 at 1 meg. after 48 hours emersion in water.

Our application Engineering Dept. is at your disposal to help you solve your insulation engineering problems.

Additional copies of the Mycalex 1950-51 Catalog-Engineer's Handbook are available on request.

Mycalex 400 - variation of power factor and dielectric constant with frequency

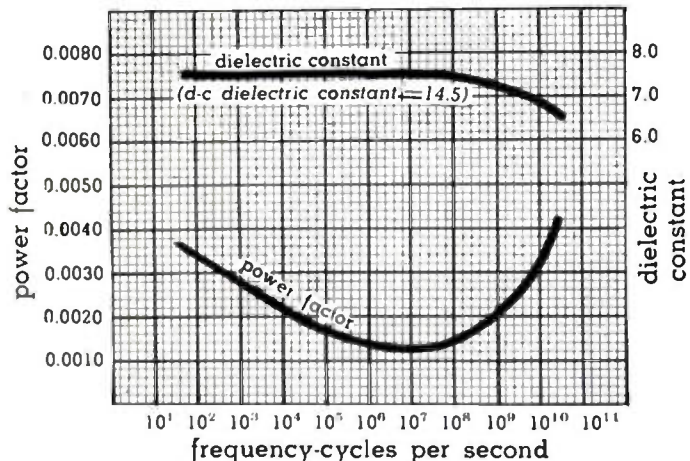

CUT ON DOTTED LINE AND INSERT ON PAGE 15 OF CATALOG



MYCALEX CORP. OF AMERICA

"Owners of 'MYCALEX' Patents"

Executive Offices: 30 Rockefeller Plaza, New York 20, N. Y.

Plant and General Offices: Clifton, N. J.

MORE GEO. STEVENS COIL WINDING EQUIPMENT IS IN USE THAN ALL OTHER MAKES COMBINED!

- **MORE OUTPUT . . . LOWER COSTS . . .** from **EXCLUSIVE SPEED FEATURE.** Universal motors permit variable speeds without changing belts and pulleys. Coil design permitting, speeds as high as 7500 RPM are not uncommon.
- **PORTABILITY.** Conveniently carried from place to place. Machines come mounted on bases to constitute one complete unit.
- **MUCH LOWER ORIGINAL COST.** The same investment buys more GEO. STEVENS machines than any other coil winding machines.
- **LONG LIFE.** Most of the original

GEO. STEVENS machines bought 14 years ago are still operating daily at full capacity.

- **MUCH FASTER CHANGING OF SET-UPS** than any other general purpose coil winding machine. Quickly changed gears and cams save time between jobs.
- **VERY LOW MAINTENANCE.** Replacement parts are inexpensive, can be replaced in minutes, and are stocked for "same day" shipment, thus saving valuable production time.
- **EASIEST TO OPERATE.** In one hour, any girl can learn to operate a GEO. STEVENS machine.

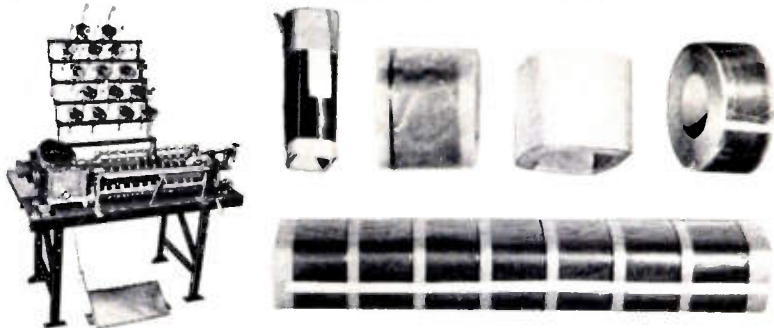

Transformer winder Model 37S multiple winds power, audio, automotive, fluorescent ballast and similar types of coils. Winds wire from No. 18 B&S to 46 B&S up to 9" O.D. Maximum economy is possible by using mandrels up to 30" long. Thirty or more coils may be wound at one time. All turns are accurately registered by Model 50 or 51 6" full vision clock face Dial Counter. Set-ups can be changed in less than 5 minutes. A gear chart is furnished to quickly determine wire spacing.

No loss of turns (an **exclusive** feature) and accurate margins are assured by a screw feed traverse and an electrically controlled clutch. Highly polished wire guide rollers are ball-bearing mounted for free running. Traverse is quickly adjusted from 1/16" to 6".

Paper feed:—A tilting table for pre-cut paper is furnished making paper feed simple and fast, or a new roll paper feed for extra economy is available at a small additional cost.

Motor equipment:—Variable speed, uniform torque 1/2 H.P. motor with foot treadle control.

Tension equipment:—12 T-1 tensions and spool rack. Tensions will handle 6" spools.

Mounting:—Ground steel channel base ensures rigidity and permanent alignment. Machine is shipped mounted on bench ready for use.

There is a GEO. STEVENS machine for every coil winding need. Machines that wind ANY kind of coil are available for laboratory or production line. . . . Send in a sample of your coil or a print to determine which model best fits your needs. Special designs can be made for special applications. Write for further information today.

World's Largest Manufacturer of Coil Winding Machines

REPRESENTATIVES

Frank Tatro
6022 No. Rogers Ave., Chicago 30, Illinois
Ralph K. Reid
1911 W. 9th St., Los Angeles 6, California
R. F. Staff & Co.
1213 W. 3rd St., Cleveland 13, Ohio

GEO. STEVENS
MFG. CO., INC.
Pulaski Road at Peterson
Chicago 30, Illinois



(Continued from page 42A)

- Coombs, S. H., 76 Mountain Ave., Maplewood, N. J.
Cope, J. L., 408 Maple St., Yankton, S. Dak.
Crenca, G., 4117 Illinois Ave., N.W., Washington, D. C.
Crozier, R. W., 17139 Chatfield Ave., Cleveland 11, Ohio
Culicetto, P. J., 417 Bement Ave., S. I. 10, N. Y.
Davis, R. J., 4911 S.W. Charming Way, Portland, Ore.
Digrundakis, J., 526 West Ave., Bridgeport 4, Conn.
Fine, H., 86 Forrester St., S.W., Washington, D. C.
Fournier, L. W., 139-A Hornet, China Lake, Calif.
Gagne, F. W., 830 1/2 S. Front St., Sunbury, Pa.
Gawel, E. W., 8220 Brandon Ave., Chicago 17, Ill.
Gleason, M. H., 1094 85 St., Niagara Falls, N. Y.
Goun, P. L., Weston College, Weston 93, Mass.
Graubeger, W. E., 3570 W. 46 St., Cleveland 2, Ohio
Hannan, C. V., III, 102 Richards Rd., Rm. 205, Kansas City, Mo.
Harris, J. E., Jr., c/o Melpar, Inc., 452 Swann Ave., Alexandria, Va.
Huffman, J. C., 2513 Miller Park Cir., Winston-Salem, N. C.
Johnston, R. H., Radio Station WILL, University of Illinois, Urbana, Ill.
Kemic, C. S., Setauket Ave., E. Setauket, L. I., N. Y.
Kissinger, R. G., 4206 W. Adams St., Chicago 24, Ill.
Kuzma, P., Jr., 4632 N. Winchester St., Chicago 40, Ill.
Lauffenburger, H. A., 269 Douglas Ave., Elgin, Ill.
Levinson, S., 2969 Upton St., N.W., Washington, D. C.
Lima, E. J. T., 2603 Westwood Dr., Waynesdale, Fort Wayne 6, Ind.
Lincoln, J. P., 926 1/2 E. Commerce St., San Antonio 3, Tex.
Lockwood, G. C., 37 S. Jersey St., Dayton 3, Ohio
Lucero, W. H., 71 Rest Beach, Key West, Fla.
Madrick, S. A., 76-20 271 St., New Hyde Park, N. Y.
Magdeburger, P. E., 40 Newman Ave., Nutley 10, N. J.
McCallum, C. A., Rawson 2682, Olivos FCNGBM, Buenos Aires, Argentina
Mitchell, P. R., 320 W. Montecito Dr., El Monte, Calif.
Nelson, J. B., 29 West 39 St., Anderson, Ind.
Nelson, V. A., 737 South Lyman, Oak Park, Ill.
Paracchini, G. B., c/o Mr. Berizzi, 607 Fifth Ave., New York, N. Y.
Preisig, J. O., 1625 Overing St., New York, N. Y.
Reynolds, B. G., 2200 Nichol Ave., Anderson, Ind.
Schlaepfer, E. D., Box 2902, Rio De Janeiro, Brazil
St. Villers, D. R., 4316 Greenlee Ave., St. Bernard 17, Ohio
Stanley, E. R., 1138 Wadsworth St., Syracuse, N. Y.
Subrahmanyam, T., Delhi Zone Transmitters, Civil Lines 2, Delhi, India
Tarowsky, H., 45 E. Moshulu Pkwy., Bronx 67, N. Y.
Thayer, J. W., 4553 West 150 St., Cleveland 11, Ohio
Thompson, M. A., 2610 San Jacinto, Beaumont, Tex.
Van S. Bennett, J. H., Box 376, Mt. Pleasant, S. C.
Von Ohlsen, L. H., Jr., 3035 Greenleaf St., Allentown, Pa.
von Trentini, G., 1790 Calle Rosetti, Fla. FCNGBM, Buenos Aires, Argentina
Walling, K. L., 4537 S.E. 46 Ave., Portland 6, Ore.
Whitman, J. A., 23 Hillside Ave., Melrose 76, Mass.
Wilkins, F. W., 2 Arlington Park, Buffalo 1, N. Y.
Wilkinson, J. E., 1830 S. 54 Ave., Chicago, Ill.
Wilson, R. M., 174 James Ave., Oxnard, Calif.
Wilson, V. C., 7034 South Park Ave., Chicago, Ill.
Wopat, J. W., Jr., 88 West 197 St., New York 63, N. Y.
Yates, T., 701 N. Colorado St., Midland, Tex.

Airborne Instruments Laboratory Specifies

CLARE SEALED **RELAYS**

**For Aircraft, Ship and
Submarine Control Equipment**

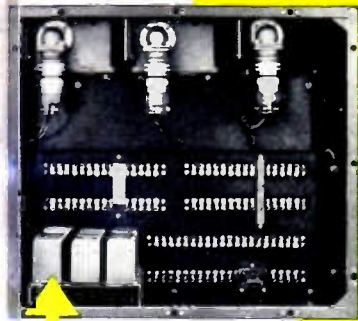

Front view of Airborne Instruments Laboratory control panel, with cover removed, showing group of eight CLARE hermetically sealed relays which perform important circuit control functions.

Cutaway view of typical CLARE Type "K" d-c Relay which is hermetically sealed in a permanent atmosphere of dry, inert gas to give maximum performance under the most extreme conditions of dust, moisture, air pressure and combustible gases.

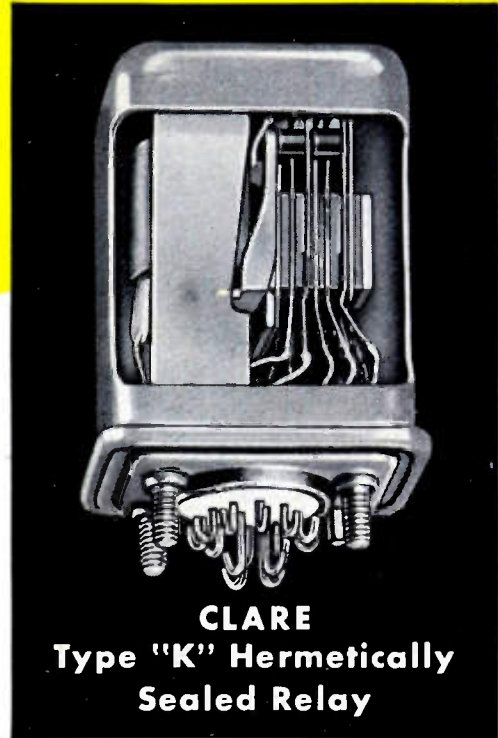

**CLARE
Type "K" Hermetically
Sealed Relay**

Close-up view of the CLARE relay installation which demonstrates the economical use of space which use of CLARE sealed relays makes possible.

● Airborne Instruments Laboratory of Mineola, N. Y. uses CLARE Type "J" and Type "K" sealed relays as components of ruggedly designed but delicately operated control equipment for aircraft, ship and submarine.

These small, compact, space-saving relays are used in circuit applications that cover the broad field of low and high current, a-c and d-c switching and video switching. CLARE Type "J" and Type "K" Relays were selected for their outstanding speed of operation, dependable performance, resistance to vibration and very small size. Hermetically sealed in dry, inert gas, they are immune to changes in atmospheric pressure, humidity, dust or dirt . . . will operate as required over a long period.

CLARE relays have long been first choice of manufacturers whose products must not fail. Selection of highest quality materials, precise manufacture and ability to "custom-build" just the relay for a specific requirement have made CLARE relays first choice with engineers who insist on . . . and get . . . the best.

Sales engineers are located in principal cities to cooperate with you in the development of a CLARE "custom-built" relay that will meet your most difficult relay need. Look in your classified telephone directory or write: C. P. Clare & Co., 4719 West Sunnyside Ave., Chicago 30, Illinois. In Canada: Canadian Line Materials Ltd., Toronto 13, Ontario. Cable Address: CLARELAY.

CLARE RELAYS... ..

First in the Industrial Field

save work . . .
 increase
 precision . . .
 measure
 phase difference
DIRECTLY

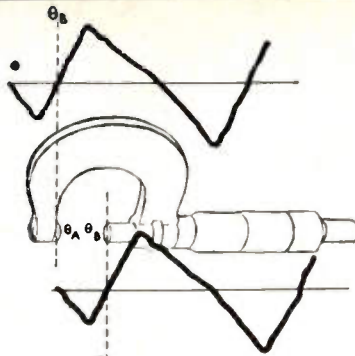

with the new **TIC** Phase Meter



TIC's New 320-A Phase Meter is the first commercially available instrument for the direct measurement of the phase difference between two recurrent mechanical motions or two electrical signals independent of amplitude, frequency, and wave shape.

Phase measurements are made instantly and accurately—no balances, adjustments or corrections are involved. Phase angle readings at audio and ultrasonic frequencies are indicated directly on a large wide-scale meter with ranges of 360°, 180°, 90° and 36°. Useful frequency range 2 cps. to 100 k.c.

In audio facilities, ultrasonics, servomechanisms, geophysics, vibration, acoustics, aerial navigation, electric power transformation or signaling . . . in mechanical applications such as printing register, torque measurement, dynamic balancing, textile and packaging machinery and other uses where an accurate measure of the relative position of moving parts is required . . . the Phase Meter is a long needed measuring instrument never before available—a new tool for a heretofore neglected field of measurement.

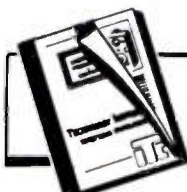

Technical Catalog — yours for the asking. Contains detailed information on all TIC Instruments, Potentiometers and other equipment. Get your copy without obligation — write today.

TIC TECHNOLOGY INSTRUMENT CORP.
 1058 Main Street, Waltham 54, Massachusetts
 Engineering Representatives Cleveland, Ohio PProspect 1-6171

Chicago, Ill.—Uptown 8-1141 Dallas, Tex.—LOgan 6-5097 Rochester, N.Y.—Charlotte 3193-J
 Cambridge, Mass.—ELiot 4-1751 Canaan, Conn.—Canaan 649 Hollywood, Cal.—Hollywood 9-6305

News—New Products

These manufacturers have invited PROCEEDINGS readers to write for literature and further technical information. Please mention your I.R.E. affiliation.

Octal Base Connector With Built-in Resistor

Designed for use with a 6AL7-GT electron-ray tuning indicator tube, a new octal base connector with an insulated, built-in resistor is announced by Alden Products Co., 117 N. Main St., Brockton 64, Mass.



Ready for immediate connection, the 208FERC, with a fully insulated, 3,300-ohm resistor built in the molding and complete with leads, enables television manufacturers to incorporate a 6AL7-GT tuning indicator tube in their set design, and thus obtain precision tuning for optimum audio quality at a minimum effort and cost.

Available in production quantities, the connector can be supplied with either 5 or 6 leads to any length as specified ready for internal connections.

TV Sweep Generator

The Kay Electric Co., 24 Maple Ave., Pine Brook, N. J., announces the Switcha-Sweep, an entirely new all-electronic TV sweep generator with fundamental outputs on all channels, as well as output in the if range. A rotary switch selects the desired channel, which is swept through a range of 15 Mc by an all-electronic system. The instrument also produces a true zero level reference baseline on the oscilloscope display.

Sawtooth sweep eliminates phasing problems. Amplitude modulation of the sweep signal is less than 1 per cent per Mc. Both switched and continuously variable output attenuation is provided, with maximum outputs of about 0.5 volt on the 70-ohm unbalanced output and 1.0 volt on the 300-ohm balanced output. The Switcha-Sweep contains no internal marks, and is intended for use with external marker generators such as the Kay Megaligner, Mega-Marker, etc. A regulated power supply is provided to allow operation of the instrument under very poor power line condition. The many features of this instrument contribute to reduced costs of operation and maintenance, as compared to the more conventional mechanically-driven sweep generators.

(Continued on page 48A)

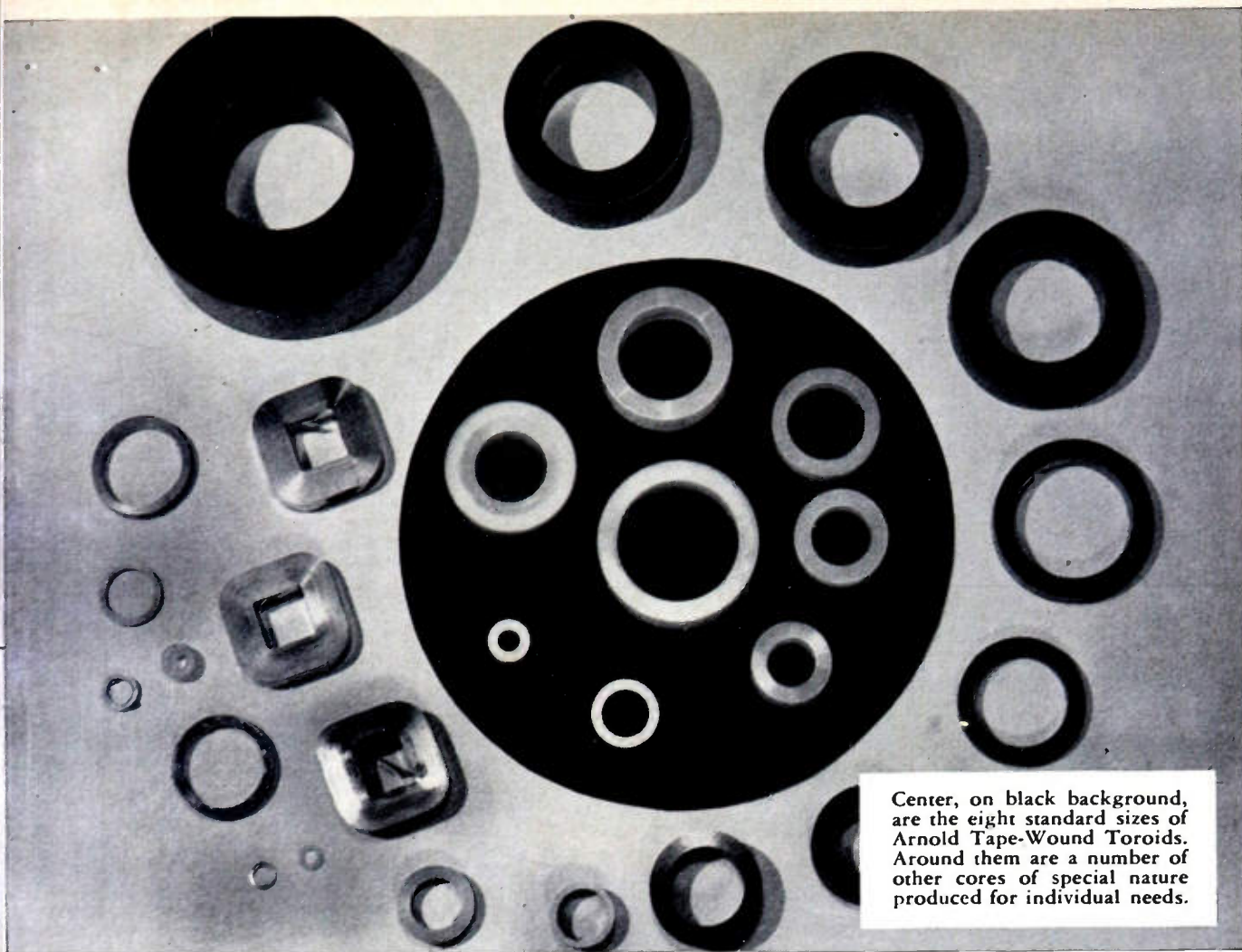

Center, on black background, are the eight standard sizes of Arnold Tape-Wound Toroids. Around them are a number of other cores of special nature produced for individual needs.

ARNOLD TAPE-WOUND TOROIDAL CORES

of DELTAMAX

4-79 MO-PERMALLOY
SUPERMALLOY*

In addition to the standard toroids described at left, Arnold Tape-Wound Cores are available in special sizes manufactured to meet your requirements—toroidal, rectangular or square. Toroidal cores are supplied in protective cases.

* Manufactured under licensing arrangements with Western Electric Company.

W&D 3182

APPLICATIONS

MAGNETIC AMPLIFIERS
PULSE TRANSFORMERS
NON-LINEAR RETARD COILS
and TRANSFORMERS
PEAKING STRIPS, and many other
specialized applications.

RANGE OF SIZES

Arnold Tape-Wound Toroids are available in eight sizes of standard cores—all furnished encased in molded nylon containers, and ranging in size from 1/2" to 2 1/2" I.D., 3/4" to 3" O.D., and 1/8" to 1/2" high.

RANGE OF TYPES

These standard core sizes are available in each of the three magnetic materials named, made from either .004", .002" or .001" tape, as required.

THE ARNOLD ENGINEERING COMPANY



SUBSIDIARY OF ALLEGHENY LUDLUM STEEL CORPORATION

General Office & Plant: Marengo, Illinois

HE PREFERS

Magnecorder

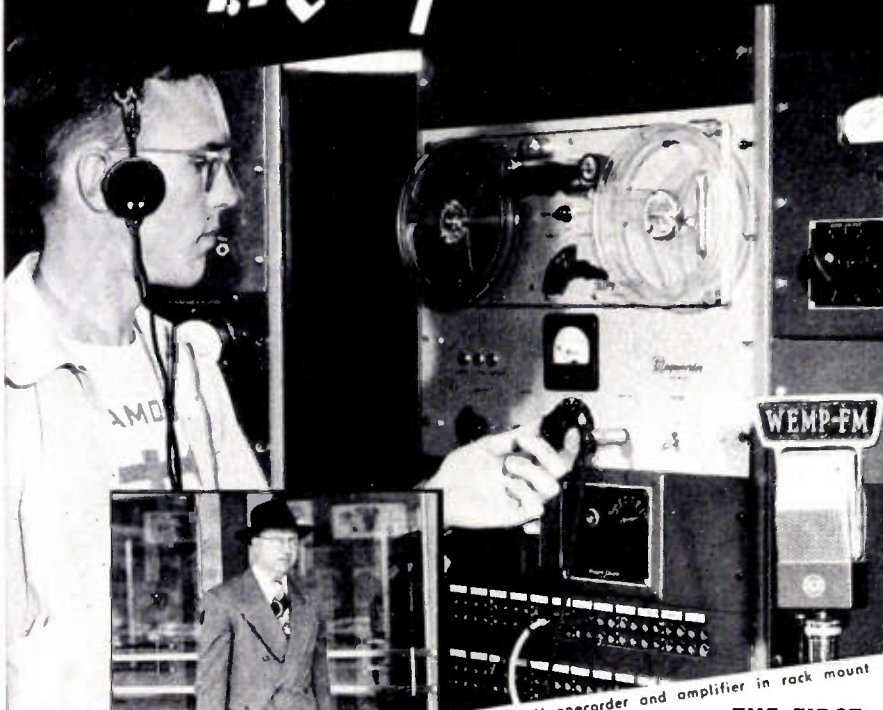

Magnecorders are portable, perfect for remotes.

THE FIRST CHOICE OF RADIO ENGINEERS

HIGH FIDELITY, LOW COST

Only Magnecord offers you such high fidelity at such low cost. Magnecorder frequency response: 50-15 kc \pm 2 db. Signal-noise ratio: 50 db. Harmonic distortion less than 2%. Meets N.A.B. standards. More radio engineers use Magnecorders than all other professional tape recorders combined!

GREATEST FLEXIBILITY

Mount a Magnecorder in a rack or console cabinet for delayed studio or network shows. Slip it into its really portable cases for remotes.

Add to your Magnecord equipment as you need it — combine and carry Magnecorders to suit every purpose.

MORE FEATURES

Your Magnecorder, new or old, now can have 3 heads (separate erase, record, and playback) to permit monitoring from tape. Three speeds (15"-7½"-3¾" — up to an hour on a 7" reel) available on both PT6 and PT63 equipment. Dual track heads also available if desired.

MAGNECORDER

For every purpose . . . every purse!



PT6 SERIES
Most widely used professional tape recorder in the world.



PT63 SERIES
Three heads to erase, record, and monitor from the tape.



PT7 SERIES
A complete console for only \$950.00. Outstanding features and flexibility. Models for portable or rack mount also available.

Write for NEW CATALOG

MAGNECORD, Inc., Dept. P. 10,
360 N. Michigan Ave., Chicago 1, Ill.
Send me latest catalog of Magnecord equipment

Name.....

Company.....

Address.....

City.....Zone.....State.....

News—New Products

These manufacturers have invited PROCEEDINGS readers to write for literature and further technical information. Please mention your I.R.E. affiliation.

(Continued from page 47A)

VHF Impedance Bridge



General Radio Co., 275 Massachusetts Ave., Cambridge 39, Mass., announces the Type 1601-A VHF bridge which extends the frequency range of conventional bridge techniques up to 165 Mc. Similar in basic circuit to the GR Type 916-A rf bridge, in wide use at lower frequencies, the new instrument measures the impedance of antennas, lines, networks, and components between the frequencies of 10 and 165 Mc. Over-all accuracy is \pm 2 per cent for resistance and \pm 5 per cent for reactance. Terminals are GR Type 874 coaxial connectors.

Derivative-Integral Servo Design Filter

A new test instrument for the servo-mechanisms field has been recently announced by the Krohn-Hite Instrument Co., 580 Massachusetts Ave., Cambridge 39, Mass.

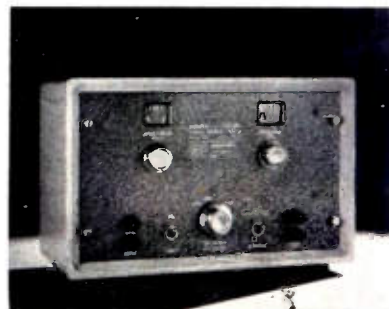

The Model 340-A derivative-integral servo design filter is designed primarily to aid the servo engineer in experimental determination of optimum filter characteristics for any feedback control system.

When used in the dc path of a servo loop, the Model 340-A represents a compensating function which approximates either proportional-plus-derivative or proportional-plus-integral correction. Mathematically, the compensating function is the ratio of two first-order polynomials. By means of the frequency and attenuation controls the filter may be adjusted for operation anywhere in the frequency range between 0.01 to 100 cps, with attenuation ratios ranging between 2 and 50. Both attenuation ratio and frequency are read directly on the two dials provided. A switch selects between the two types of compensation available.

(Continued on page 62A)

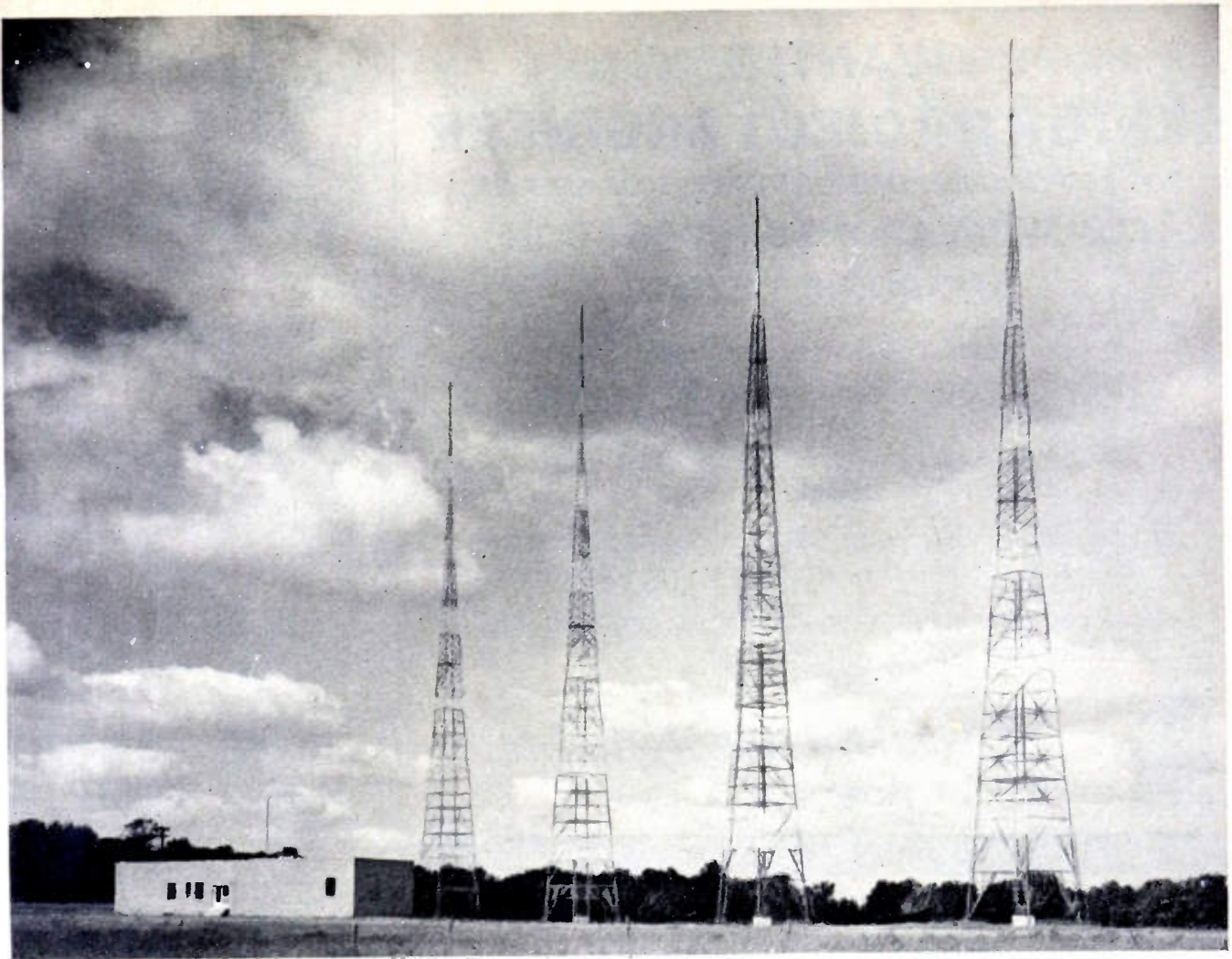

IT'S
ALL
THERE!

You can't see Blaw-Knox engineering—but *it's there!* You can't see Blaw-Knox experience in tower-building—but *it's there.* You can't see efficiency and strength and durability—but they're all there—when the towers are built by Blaw-Knox.

... A quotation will prove that there's no premium on Blaw-Knox quality.

BLAW-KNOX DIVISION

OF BLAW-KNOX COMPANY

2037 Farmers Bank Building, Pittsburgh, Pa.



BLAW-KNOX ANTENNA TOWERS

WANTED: SENIOR PROJECT ENGINEER

FOR RESPONSIBLE POSITIONS IN DEVELOPMENT OF
COMMUNICATIONS & NAVIGATION
ELECTRONIC SYSTEMS

- Graduate or practical engineer.
- 5 or 6 years experience in development of electronic systems.
- Direct own project and supervise engineering personnel.

If you can qualify, send us a resume of your education, experience, age and salary requirements.

Or, if you prefer, telephone us for an appointment
... Matawan 1-2600.



Lavoie Laboratories, Inc.

MORGANVILLE, N. J.

Specialists in the Development and Manufacture of UHF Equipment

ELECTRONIC ENGINEERS

BENDIX RADIO DIVISION
Bendix Aviation Corporation

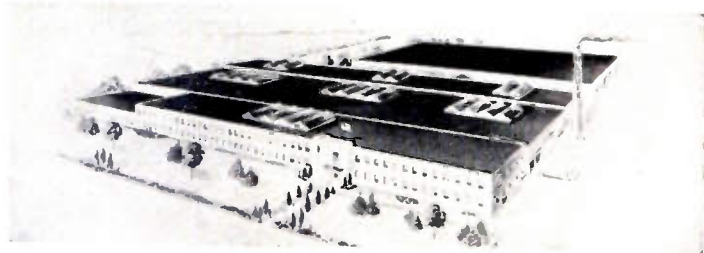

PRODUCTION DESIGN RESEARCH

Bendix Radio Division, a leader in the field of high quality radar and communications equipment, has positions for engineers experienced in the design and development, for production, of radio and radar equipment or electronic research.

Positions are available at all salary levels.

Good advancement opportunities, air-conditioned plant in suburban location, excellently equipped laboratories, technical library, large experimental engineering model shop.

Housing and rentals in Baltimore are plentiful.

Interviews will be held in Baltimore, Chicago and New York.

Please send resume of experience promptly to:

MR. W. L. WEBB, Director Engineering and Research
BENDIX RADIO DIVISION
Bendix Aviation Corporation • Baltimore 4, Maryland



The following positions of interest to I.R.E. members have been reported as open. Apply in writing, addressing reply to company mentioned or to Box No.

The Institute reserves the right to refuse any announcement without giving a reason for the refusal.

PROCEEDINGS of the I.R.E.
1 East 79th St., New York 21, N.Y.

PROJECT RADIO ENGINEER

To take responsible charge of design of radio communications systems between Hawaiian Islands. Experience in VHF and microwave links design desirable. College training or equivalent necessary. Live in Honolulu. Contact Mutual Telephone Co. Box 2200, Honolulu, T. H.

ENGINEER

Chief systems test engineer with practical experience in electro-mechanical and hydraulic systems to direct systems testing on guided missiles. Familiarity with production testing techniques and test equipment in above fields is desirable. Excellent opportunity for someone who can organize a rapidly expanding facility. Direct inquiries to Manager, Engineering Personnel, Bell Aircraft Corp., P. O. Box 1, Buffalo, New York.

SPECIFICATION WRITERS

Specification writers capable of clear, concise technical description of the design, construction and testing of missile and electronic equipment. Knowledge of military specifications and familiarity with aircraft and electronic components is essential. Direct inquiries to Manager, Engineering Personnel, Bell Aircraft Corporation, P. O. Box 1, Buffalo 5, New York.

ENGINEER

Engineer, electrolytic capacitor, at least 5 years experience in design and development. Write resume of experience and salary expected. Box 620.

RADIO ENGINEER

Radio engineer wanted by prominent Chicago manufacturer to design and supervise manufacture of full line of commercial amplifiers. Must have engineering degree or equivalent and minimum of 2 years design experience in commercial P.A. systems. Give details including age, education, experience, reference, availability and salary expected. Box 621.

ENGINEER

Excellent opportunity for engineer to apply microwave measurements and techniques to development and manufacture of magnetrons and klystrons. Pulse circuit knowledge also valuable. B.S. degree and experience or advanced degree with heavy concentration on above required. State salary expected and qualifications. Location New York City. Box 622.

CIRCUITS ENGINEER

Rapidly expanding company in instrumentation field has opening for senior en-

(Continued on page 51A)

Graduate ENGINEERS

Good Opportunities for ELECTRONICS Engineers or Physicists

M.S. or Ph.D. in Physics, Physical Chemistry, E.E., M.E., or Ch.E. for industrial electronics research. Must be outstanding technically with at least a few years research experience, and interested in the development of instruments and physical techniques.

Give experience, education, age, references, personal history, salary received and salary expected. Please be complete and specific.

All inquiries will be considered promptly and kept confidential.

E. I. du Pont de Nemours & Co. (Inc.)
Engineering Department Personnel
Wilmington 98, Delaware

ELECTRONIC ENGINEERS

Excellent opportunities are offered by one of the leading concerns in the electronic computer field to engineers with development or design experience in video and pulse circuitry or test and maintenance experience in the radar, television, or computer fields.

Send complete resumes and salary requirements to:

Personnel Department

ECKERT-MAUCHLY COM- PUTER CORPORATION

3747 Ridge Avenue
Philadelphia 32, Pa.

Subsidiary of Remington Rand, Inc.



(Continued from page 50A)

gineer. Prefer man with masters degree and 4 or more years of experience in design of pulsing circuits, VHF and UHF. Excellent opportunity for man who can meet requirements. Location Brooklyn. Send complete resume to Box 623.

PHYSICIST

Physicist for fundamental electron tube research. Should be familiar with techniques of producing photo-electric, secondary emissive and fluorescent screens, experience with electron-optics, physical optics and solid state physics an advantage. Box 624.

SALESMAN

Salesman to organize and promote sales of high quality radio resistors now being produced by a company well established in radio and electrical component industry. Give summary of experience and availability in reply. Box 625.

ASSISTANT PROFESSOR AND INSTRUCTOR

Strong eastern college has opening for Assistant Professor and Instructor in electrical engineering. Master of Science in electrical engineering is required, and industrial experience is desirable. Send resume of qualifications, references and salary required. Box 626.

PHYSICISTS AND ENGINEERS

Cornell Aeronautical Laboratory, an affiliate of Cornell University, has permanent positions open in fields of pure and applied physics for men of project engineer caliber with advanced degrees and experience in physics, applied mathematics, electronics, and mechanical instrument design. The position of our laboratory is between those of universities and commercial research institutes, and combines, we believe, many of the traditional advantages of both. Inquiries confidential; address Mr. Nathaniel Stimson, Dept. R, Cornell Aeronautical Lab. P. O. Box 235, Buffalo 21, New York.

ELECTRONIC PHYSICIST

Electronic physicist for research and development work on instrumentation problems with major petroleum refiner. Degree in physics essential, M.S. or Ph.D. preferred. Must have a minimum of 5 years' research experience on a variety of electronic problems and demonstrated ability to develop new and ingenious electronic devices. Age 28-40. Location Chicago. Salary dependent upon training and experience. Reply in confidence giving full details to Box 627.

ENGINEER

Well known German radio manufacturer has immediate opening for engineer with design and development experience in FM-TV equipment. Factory situated in mountainous part of southern Germany (U.S. zone) with pleasant living conditions (summer and winter sports). German language desirable. Please write to Z.G. 931-Annoncen-Expedition Carl Gabler, GMBH, Munich, Germany.

(Continued on page 52A)

ELECTRONICS TECHNICIANS WANTED

The RCA Service Company, Inc., a Radio Corporation of America subsidiary, needs qualified electronics technicians for U. S. and overseas assignments. Candidates must be of good character and qualified in the installation or maintenance of RADAR or COMMUNICATIONS equipment or TELEVISION receivers. No age limits, but must have at least three years of practical experience.

RCA Service Company offers comprehensive Company-paid hospitalization, accident and life insurance programs; paid vacations and holidays; periodic review for salary increases; and opportunity to obtain permanent position in our national and international service organization, engaged in the installation and maintenance of AM, FM, and TV transmitters, electronic inspection devices, electron microscopes, theatre and home television, r-f heating equipment, mobile and microwave communications systems, and similar electronic equipment.

Base pay, overseas bonus, payments for actual living and other expenses, and benefits mentioned above add up to \$7,000 per year to start for overseas assignments, with period review of base salary thereafter. Openings also available at proportionately higher salaries for specially qualified technicians with supervisory ability.

Qualified technicians seeking an advantageous connection with a well-established company, having a broad-based, permanent peacetime and wartime service program, write to:

Mr. G. H. Metz,
Personnel Manager,
RCA Service Company, Inc.,
Camden 2, New Jersey.

RESEARCH ENGINEERS ELECTRICAL ENGINEERS AND PHYSICISTS

THE FRANKLIN INSTITUTE LABORATORIES FOR RE- SEARCH AND DEVEL- OPMENT

Have opening for personnel with 2-10 years experience. Advanced degrees are desirable in certain of the positions. Fields of interest covered are: Mathematical Analysis of Physical Problems, Statistical Theory of Communications, Electromagnetic Theory, Circuit Analysis, Servomechanism Theory, Electrical Computing, Advanced and Fundamental Circuit Development, Radar and Pulse Circuits, Supervision of Operation of G.C.A. or Tracking Radar, Air Traffic Control, Air Navigation, Automatic Controls, Industrial or Marine Power Drives, and Electrical Machinery.

Send resume of education and experience, salary requirements and a photograph to:

Personnel Department
THE FRANKLIN INSTITUTE
Philadelphia 3, Pennsylvania

★ important personal and professional opportunities for experienced ELECTRONICS ENGINEERS

A broad program of research, design and development in new electronic fields with vast commercial applications by the manufacturer of Freed-Eisemann radio phonographs and television receivers provides an opportunity for gaining valuable experience in new electronic concepts and techniques under the direction of scientists of international repute. Adequate facilities, pleasant conditions and attractive salaries make this an opportunity for personal as well as professional advancement. Many openings for experienced electronic engineers . . . including:

■ **Project Physicist** for fundamental electron tube research. Ph.D. or M.S. degree and extensive technical experience in the field of photo-electric, secondary emission, solid state, electron and physical optics.

■ **Senior Electronics Engineer and Juniors:** B.S. or M.S. degree. Three to five years experience in television, radar, and display circuits.

■ **Project Engineer:** Capable of designing low-power transmitters and receivers, AM, FM and UHF.

Furnish complete resume of education and experience, salary required to Director of Research.

FREED RADIO CORPORATION

200 Hudson St. • New York 13, N.Y.



(Continued from page 51A)

MANUFACTURER'S REPRESENTATIVE

Must be sales engineer. To handle growing line of electronic test instruments which now includes oscillators, DC amplifiers, transducers, electronic potentiometers, electronic DC and AC voltmeters, megohmmeters, bridges and others. Some good territories are still open. Send qualifications to Southwestern Industrial Electronic Co., P. O. Box 13058, Houston 19, Texas.

PROJECT ENGINEERS

Five years or more experience in charge of design and development of radio and communication equipment. Must be a graduate of a credited engineering school. Well equipped laboratory in modern radio and television plant, with excellent opportunities for advancement. Send resume of qualifications to Mr. S. F. Cascio, Personnel Director, Hallicrafters Company, 4401 West Fifth Ave., Chicago 24, Illinois.

ENGINEERS

A very large vacuum tube and cathode ray tube manufacturer has attractive openings for experienced vacuum tube engineers. It will be to your benefit to investigate these possibilities. Please write to Box 628.

(Continued on page 51A)

ENGINEERING OPPORTUNITIES MODERN LABORATORIES IN LOS ANGELES AREA

Unusual opportunity for Senior men with degree and a background of proven accomplishment.

ELECTRONIC ENGINEERS
PHYSICISTS-CIRCUITRY
PHYSICISTS-ANALYSIS
PHYSICISTS-OPTICS

SERVOMECHANISMS
ENGINEERS
ELECTRO MECHANICAL
DESIGNERS
MECHANICAL DESIGNERS

Long term program of research and development.

Please do not answer unless you meet the above requirements.

RESEARCH AND DEVELOPMENT LABORATORIES

Hughes Aircraft Company
CULVER CITY, CALIFORNIA

Engineers Physicists

- What do you want in a position?
- What are your aims and ambitions?

SENIORS

The W. L. Maxson Corporation offers special opportunities if you are heavily experienced in research and development on radar, computers and associated equipment.

Please address your job requirements and résumé to A. Hoffsommer for individual attention.

THE W. L. MAXSON CORPORATION
460 W. 34th Street
New York 1, N.Y.

SENIOR ELECTRONIC ENGINEERS

Prominent New England Company needs a number of top-flight engineers, skilled on pulse circuits, microwave circuits, R. F. techniques and design and development of circuits for use in high speed electronic digital computers. Minimum of at least 6 to 8 years experience. Attractive salary—group insurance—pension plan—paid vacation. Please write, giving complete resume of education, experience and salary expected.

Box 629

The Institute of Radio Engineers,
Inc.
1 East 79th Street, New York 21,
N.Y.

Controlling the Nation's TV AND RADIO!

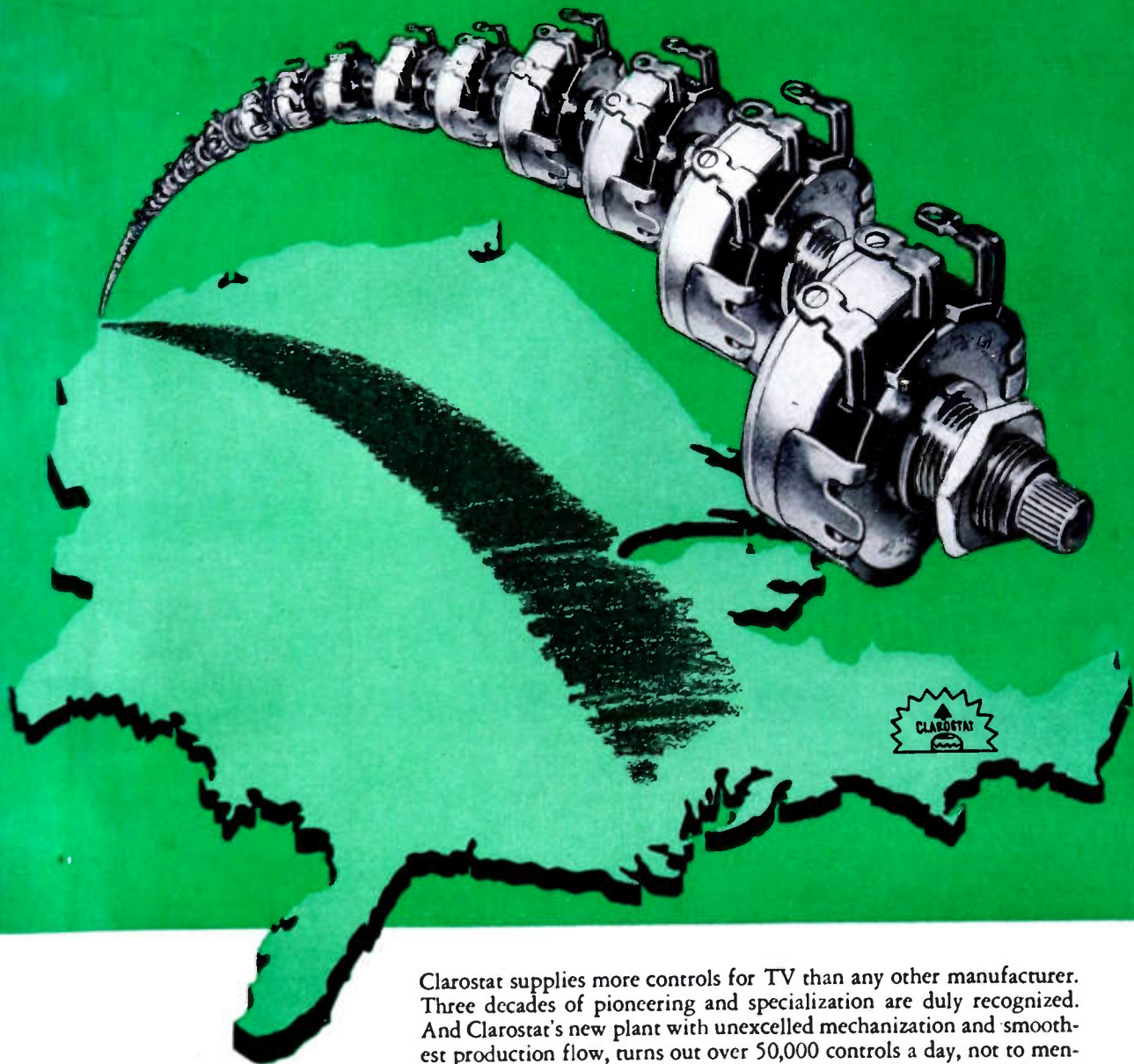

Clarostat supplies more controls for TV than any other manufacturer. Three decades of pioneering and specialization are duly recognized. And Clarostat's new plant with unexcelled mechanization and smoothest production flow, turns out over 50,000 controls a day, not to mention resistors of many different types, in meeting the major portion of today's TV and radio requirements. Obviously, for quality, uniformity, dependability, economy, it's CLAROSTAT.

Write for Engineering Bulletins on resistors, controls and resistance devices. Let us collaborate on your control and resistance problems and needs.



Controls and Resistors

CLAROSTAT MFG. CO., INC. • DOVER, NEW HAMPSHIRE
IN CANADA: CANADIAN MARCONI CO. LTD., MONTREAL, P. Q., AND BRANCHES

PHYSICISTS AND ENGINEERS

You can find plenty of positions where you will work on minor improvements on radar, telemetering systems, and other conventional devices. However, you will find very few positions where you can break ground in new fields having tremendous significance. This you can do at the **JACOBS INSTRUMENT COMPANY**, whose entire effort is devoted to pioneering activities in new fields that it has opened up itself. One of these fields, for example, is that of ultra-high speed, ultra-compact digital computers and controllers. This company's **JAINCOMP** family of computers dominates this field. Other equally important fields are being developed. Engineers and physicists with sound backgrounds and experience in the design of advanced electronic circuits or precision mechanical instruments may qualify, also individuals with good backgrounds in applied physics. A few openings exist for outstanding Junior E. E.'s and physicists, also experienced technicians; applicants for these positions must apply in person.

JACOBS INSTRUMENT CO.

4718 Bethesda Ave.
Bethesda 14, Maryland

Positions available for

SENIOR ELECTRONIC ENGINEERS

with

Development & Design
Experience

in

MICROWAVE RECEIVERS
PULSED CIRCUITS
SONAR EQUIPMENTS
MICROWAVE
COMMUNICATIONS
SYSTEMS

Opportunity For Advancement
Limited only by Individual
Ability

Send complete Resume to:
Personnel Department

MELPAR, INC.
452 Swann Ave.
Alexandria, Virginia



(Continued from page 52A)

SENIOR ELECTRONIC ENGINEER

Opportunity with manufacturer of electronic electro-mechanical and radiation Instruments. Requirements: 5 years experience in design and development of pulse circuits, computers, nuclear instrumentation or video circuits required. Manufacturing or production experience desirable. Send complete resumes and salary requirements to: Berkeley Scientific Company, P. O. Box 1826, Richmond, California.

PRODUCTION ENGINEER

Opportunity with manufacturer of electronic, electro-mechanical and radiation instruments. Requirements: 5-10 years experience as electronic and mechanical instrument production engineer in small lot production. Thorough electronic theory grounding. Send complete resume and salary requirements to Berkeley Scientific Co., P. O. Box 1826, Richmond, California.

ELECTRICAL ENGINEER

Graduate with experience in design and product technique of specialized electronic tubes other than high production transmitting and receiving types. Bendix Aviation Corp., Kansas City Division, P.O. Box 1159, Kansas City, Missouri.

ELECTRONIC ENGINEERS

Excellent opportunities are offered by one of the leading concerns in the electronic computer field to engineers with development or design experience in video and pulse circuitry or test and maintenance experience in the radar television or computer fields. Send complete information to Personnel Department, Eckert-Mauchly Computer Corporation, 3747 Ridge Avenue, Philadelphia 32, Pa.



NATIONAL UNION RESEARCH DIVISION

Electrical Engineers and Physicists are needed for research on Cathode Ray, Subminiature, Secondary Emission and other types of Vacuum Tubes.

Permanent interesting positions are available in the following fields:

Tube design & development
Tube processing
High vacuum systems
Solid state physics
Electron optics
Phosphorescence

Men qualified in any of the above are invited to send their resumes to:

Divisional Personnel Manager
National Union Research Division
350 Scotland Rd., Orange, N.J.

PHYSICISTS AND SENIOR RESEARCH ENGINEERS

POSITIONS NOW OPEN

Senior Engineers and Physicists having outstanding academic background and experience in the fields of:

- Microwave Techniques
- Moving Target Indication
- Servomechanisms
- Applied Physics
- Gyroscopic Equipment
- Optical Equipment
- Computers
- Pulse Techniques
- Radar
- Fire Control
- Circuit Analysis
- Autopilot Design
- Applied Mathematics
- Electronic Subminiaturization
- Instrument Design
- Automatic Production Equipment
- Test Equipment
- Electronic Design
- Flight Test Instrumentation

are offered excellent working conditions and opportunities for advancement in our Aerophysics Laboratory. Salaries are commensurate with ability, experience and background. Send information as to age, education, experience and work preference to:

NORTH AMERICAN AVIATION, INC.
Aerophysics Laboratory
Box No. N-4, 12214 South Lakewood Blvd.
Downey, California

THE MUSHROOM-LIKE OBJECT directly below is the completed assembly of the radio volume control shaft made by P. R. Mallory & Co., Inc., Indianapolis, Ind., (actual size). Photo below it shows the plastic part attached by a staking operation. This staking is shown in detail in photo of part enlarged 7 times, at right. Photo at bottom shows control shaft after machining and before staking. Shaft is made from Revere Alloy 247 . . . $\frac{1}{4}$ " round free cutting brass rod.

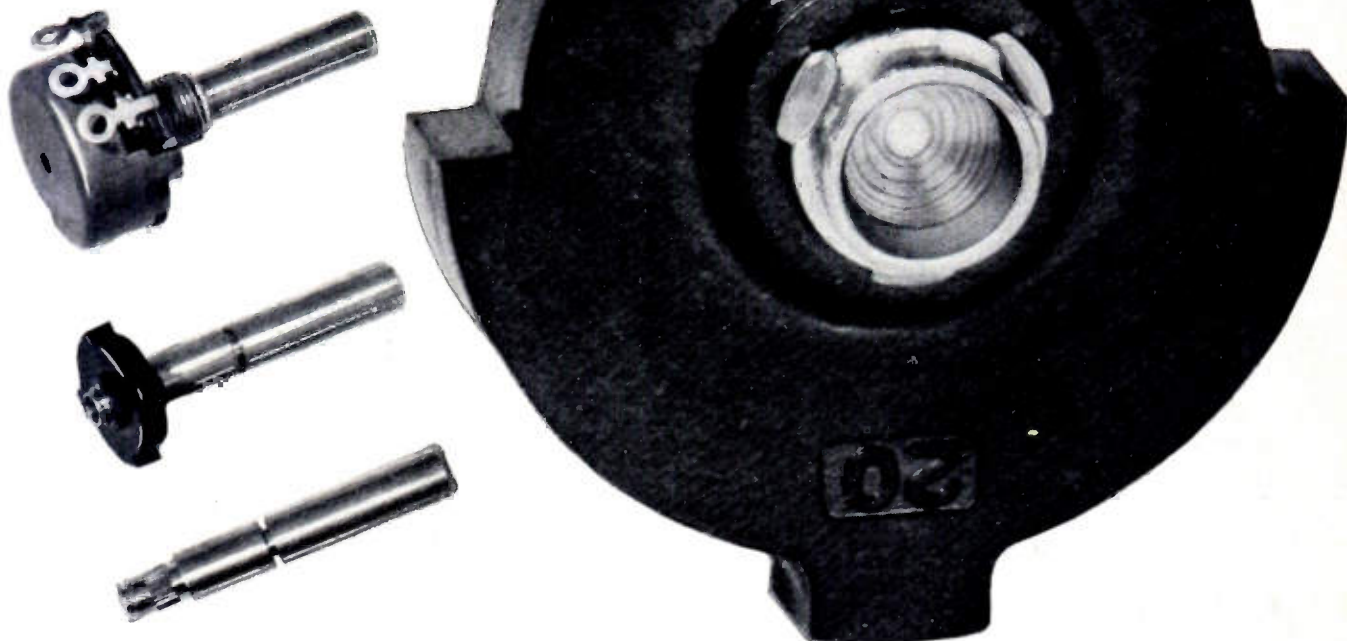

BY SWITCHING TO REVERE FREE CUTTING
BRASS ROD P. R. MALLORY & CO., INC.,

SAVES ON 2 COUNTS!

Staking operation on radio volume control shaft performed without fracture . . . annealing operation eliminated.

The solution to the Mallory Company's problem was not as easy as it might appear. It was not simply a case of Revere Technical Advisory Service recommending $\frac{1}{4}$ " round, free cutting brass rod. That rod had to possess the machinability to match Mallory's existing production machine set-up and at the same time be sufficiently workable so that annealing, prior to staking, could be eliminated; and that staking be accomplished without fracturing the metal.

After consulting with the Mallory Engineers, and discussing the tests which Mallory would subsequently conduct, Revere recommended a $\frac{1}{4}$ " round, half hard riveting and turning rod mixture 247. Working tests made by Mallory showed this rod to possess all the necessary requirements.

As a result of those tests, P. R. Mallory & Company

is now using this Revere free cutting brass rod to its complete satisfaction for the radio volume control shafts it manufactures. Not just any $\frac{1}{4}$ " brass rod, but the *right* rod made it possible for them to save on 2 counts.

Perhaps Revere has a brass, a copper or some special alloy to help you in the development or improvement of your product . . . in cutting your production costs. So why not tell Revere *your* metal problems? Call the Revere Sales Office nearest you today.

REVERE

COPPER & BRASS INCORPORATED

Founded by Paul Revere in 1801

230 Park Avenue, New York 17, New York

*Mills: Baltimore, Md.; Chicago and Clinton, Ill.; Detroit, Mich.; Los Angeles and Riverside, Calif.; New Bedford, Mass.; Rome, N. Y.
Sales Offices in Principal Cities, Distributors Everywhere.*

ENGINEERING OPPORTUNITIES IN Westinghouse

Wanted:

**Design Engineers
Field Engineers
Technical Writers**

Must have at least one year's experience.

For work on airborne radar, shipborne radar, radio communications equip., microwave relay, or micro-wave communications.

Good pay, excellent working conditions; advancement on individual merit; location Baltimore.

Send resume of experience and education to: Manager of Industrial Relations, Westinghouse Electric Corp., 2519 Wilkens Ave., Baltimore 3, Maryland.

PROJECT ENGINEERS

Real opportunities exist for Graduate Engineers with design and development experience in any of the following: Servo-mechanisms, radar, microwave techniques, microwave antenna design, communications equipment, electron optics, pulse transformers, fractional h.p. motors.

SEND COMPLETE RESUME TO EMPLOYMENT OFFICE.

SPERRY GYROSCOPE CO.

DIVISION OF
THE SPERRY CORP.
GREAT NECK, LONG ISLAND



Positions Wanted By Armed Forces Veterans

In order to give a reasonably equal opportunity to all applicants, and to avoid overcrowding of the corresponding column, the following rules have been adopted:

The Institute publishes free of charge notices of positions wanted by I.R.E. members who are now in the Service or have received an honorable discharge. Such notices should not have more than five lines. They may be inserted only after a lapse of one month or more following a previous insertion and the maximum number of insertions is three per year. The Institute necessarily reserves the right to decline any announcement without assignment of reason.

ELECTRICAL ENGINEER

Electrical engineer. Graduate of Iowa State College, June 1950, communication option. 6 months acetylene and electric welding experience. 14 months machinist apprentice training. Class A Amateur Radio Operators license. Age 24, married. Location immaterial. Box 452 W.

ENGINEER

B.E.E. Pratt Institute, June 1950, top fifth of class. Desires start in electronic control and/or servomechanism. 2 years experience in testing. Salary secondary. Box 454 W.

ENGINEER

B.E.E. Cornell, June 1950. Tau Beta Pi, Eta Kappa Nu. Some experience as laboratory assistant and in radio manufacture. Seeking position in communications or electronics development, design or research. Age 25. New York City or eastern U.S. location preferred. Starting salary secondary. Resume on request. Box 456 W.

ELECTRONICS ENGINEER

B.E.E. City College of New York, June 1950. Age 25, married. 1 year assistant in development of new oscilloscope. 1 year as electronic equipment specialist with Navy catalog office. 1 year as radio serviceman. AETM 1/c in Navy. Desires work in electronics or communications. Will relocate if necessary. Box 457 W.

ELECTRICAL ENGINEER

Electrical engineer, age 43, single. B.S.E.E. 1½ years design and development of transformers and coils for electronic equipment through manufacture. 2½ years electrical design; 1½ years Chief Electrical Engineer; 2 years engineer-draftsman; 1 year construction and inspection—power and light engineering and telephone conduit installation. Desires responsible position with electronic transformer manufacturer or research. Wish to locate southwest. Box 463 W.

(Continued on page 58A)

RCA VICTOR Camden, N. J. Requires Experienced Electronics Engineers

RCA's steady growth in the field of electronics results in attractive opportunities for electrical and mechanical engineers and physicists. Experienced engineers are finding the "right position" in the wide scope of RCA's activities. Equipment is being developed for the following applications: communications and navigational equipment for the aviation industry, mobile transmitters, microwave relay links, radar systems and components, and ultra high frequency test equipment.

These requirements represent permanent expansion in RCA Victor's Engineering Division at Camden, which will provide excellent opportunities for men of high caliber with appropriate training and experience.

If you meet these specifications, and if you are looking for a career which will open wide the door to the complete expression of your talents in the fields of electronics, write, giving full details to:

National Recruiting Division
Box 960, RCA Victor of America
Radio Corporation of America
Camden, New Jersey

ELECTRICAL ENGINEER

Nationally known electronics firm has need in its Long Island laboratories for engineer with BS or MS to work with group on circuit & miniaturization problems, relating to electronics equipment & techniques. Must be capable of job planning & project control. Minimum 5 years experience in both audio & TV circuits and in tube component design or equipment production. Prefer engineering physicist or electrical engineer with some mechanical design experience and major interest in circuits. Send complete resume to Box IRE 1684, 221 W 41 St NYC

Potter INSTRUMENT COMPANY

ANNOUNCES

INCREASED MANUFACTURING & DEVELOPMENT FACILITIES

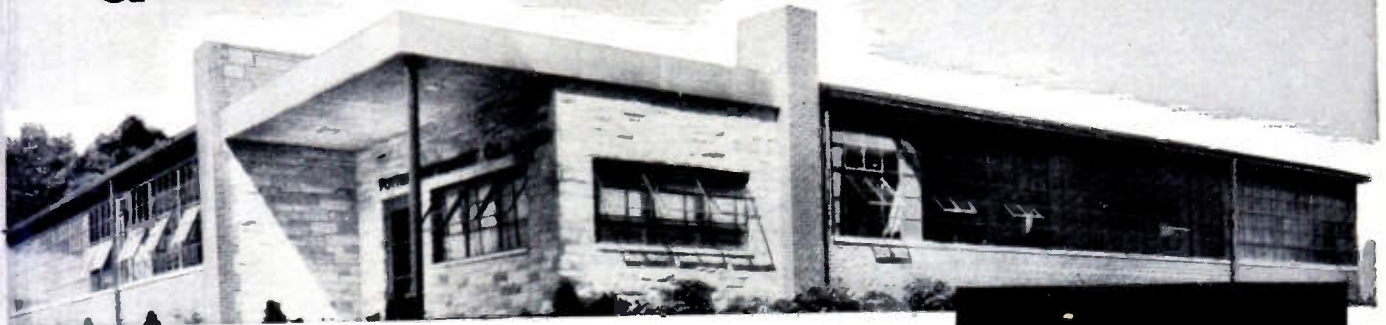

YOU, OUR CUSTOMERS, have been presenting us with problems which require skill not only in electronic circuitry but in unique mechanical design as well.

In solving many of your problems, we have found it necessary to think in terms of the most compatible combination of electronics and mechanics. Many companies are expert in one or the other of these fields, but a company which is skilled in both is rather rare. Realizing this fact, we have made a greater effort to mold our organization and facilities accordingly. Our latest step in this direction has been to construct a new plant with complete machine shop facilities and increased manufacturing space. Another goal for which we have been striving is circuit simplification. Our philosophy for the last eight years has been to design equipment with the fewest number of tubes and components without compromising on dependability. The result of this philosophy is evident in the basic 4-lamp Potter Decade and in new equipment designs yet to be announced. These include simplified and economic arithmetic units, multi-purpose shift registers, storage devices, photoelectric readers, tape handlers and a radically new high speed line-at-a-time printer. If you are concerned with problems in these fields write to Dept. 5-B for additional information.

- High Speed Electronic Counters and Scalers
- Precision Chronograph and Timing Instruments
- Frequency Measurement Counters
- Electronic Digital Computers and Memory Devices
- High Speed Printer Units and Data Handling Equipment



POTTER INSTRUMENT COMPANY

INCORPORATED

115 CUTTER MILL ROAD, GREAT NECK, NEW YORK



PREDETERMINED COUNTERS feature counting rates to 60,000 per minute, absolute accuracy, instantaneous automatic reset, simple dial selection of count.



DECADE COUNTER provides direct decimal read-out with the simplest most reliable decade circuit made. Finest components, superb construction.



TIME STUDY COMPUTER—custom designed to compute operation waiting time for payroll applications, etc.; also computes most efficient combination of man and machines.



1.6 MC COUNTER CHRONOGRAPH with high resolution and accuracy (1/1,600,000 second). Indicates intervals up to 1 second. Dependable, stable, no adjustments required.

you get MORE PERFORMANCE for LESS MONEY with the NEW Browning OSCILLOSYNCHROSCOPE

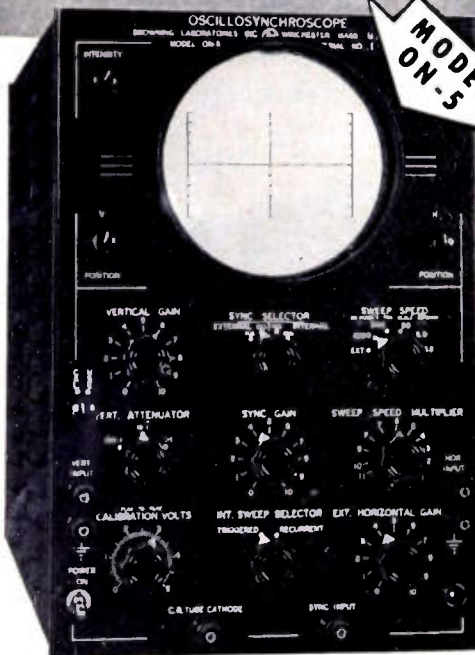

For only
\$485.00

this new five-inch Browning 'scope gives you the basic laboratory equipment for pulse work — in a single, compact unit with:

- Triggered sweep rate continuously variable from 1.0 to 25,000 microseconds per inch.
- Sawtooth sweep rate 10 cycles to 100 KC.
- Sweep calibration (triggered and sawtooth) in microseconds per screen division accurate to $\pm 10\%$.
- Vertical amplifier flat within 3 db. from 5 cycles to 5 megacycles.
- Sensitivity 0.075 volts RMS per inch.
- Horizontal amplifier d.c. to 500 KC, sensitivity 2 volts per inch.
- Self-calibrating on both X and Y axis.
- Readily portable . . . weighs but 50 pounds.

plus these ELECTRICAL and MECHANICAL features

- 5UP1 cathode-ray tube operates at accelerating potential of 2600 volts
- Sweep starting time is approximately 0.1 microsecond
- Sweep may be triggered or synchronized by positive or negative sine-wave or pulse signals of 0.5 volts (external) or 0.75 inches deflection (from vertical amplifier)
- Three-step attenuator — 100:1, 10:1, and 1:1, plus continuous adjustability over entire range
- Peak-to-peak vertical calibration voltages of 0.2-20-200 at accuracy of $\pm 10\%$
- Cathode connection, brought out to front panel, allows external blanking and marker connection
- All deflection plates are available for direct connection
- Steel cabinet finished in black wrinkle
- Steel panel finished in black leatherette
- Copper-plated steel chassis with lacquer finish
- Controls grouped by function for operating convenience
- Free-view screen has graduated X- and Y-axis scales
- Size: 10" wide, 14½" high, 16¾" deep
- Instrument draws 180 volt-amperes at 115 volts 60 cycles.

NET PRICE, F.O.B. Winchester, Mass.....\$485.00

FREE BULLETIN gives further data on this new, low-cost, versatile oscillosynchroscope. Ask for data sheet ON-54E.

In Canada, address Measurement Engineering Ltd., Arnprior, Ontario

Export Sales
9 Rockefeller Plaza
Room 1422
New York 20



BROWNING
Laboratories, Inc.
Winchester, Mass.
ENGINEERED FOR ENGINEERS

Positions Wanted

(Continued from page 56A)

ELECTRONIC ENGINEER

B.S.E.E. Oklahoma Institute of Technology 1950. Communications major. 9 hours towards Masters degree. 3 years Naval Airborne radio and radar maintenance. 5½ years 1st class machinist with Sperry. Age 31, single. Desires position with future in research, development, medical electronics, communications or electronic work. Anywhere in U.S. Box 464 W.

ELECTRONIC ENGINEER

B.S.E.E. communications, Oklahoma A. and M. College, June 1950. Eta Kappa Nu. 18 hours advanced graduate work. Age 24, single. Infantry 2 years. Informal varied experience in field of electronics. Desires position in research, design or development in any phase of electronics, preferably microwaves. Location immaterial. Box 465 W.

ELECTRONIC ENGINEER

B.E.E., M.E.E. 2 years design and development work in servomechanisms, measurement equipment, electronics; 1½ years laboratory instruction in electrical engineering; 1½ years radar technician U.S. Navy. High scholastic record. Box 475 W.

COMMUNICATIONS ENGINEER

B.S.E.E. Sept. 1950, Ohio State University. Married, age 25. 6 years AM and FM broadcasting experience. Chief Engineer overseas Armed Forces radio station 8 months. 1st class radio-telephone license. Desires production or design. Box 476 W.

ELECTRICAL ENGINEER

B.S.E.E. Kansas State College, January 1950. Eta Kappa Nu, I.R.E. Age 29, married. Aircraft electrician, Army radar. Interested in sales, design or development of electronic equipment. Location and salary secondary. Box 478 W.

ELECTRONICS INSTRUCTOR

9 years servicing civilian and government RXs, TXs and PA systems; 6 years teaching AM, FM and TV mathematics, theory and laboratory; 2 years Navy radar training. Last positions: organized school technically and held chief instructors status 3 years. Box 479 W.

ELECTRONIC ENGINEER—PHYSICIST

6 years of physics, electrical engineering and electronics in Fordham, University of Rochester, Harvard, Mass. Institute of Technology and Brooklyn Polytechnical Institute; B.S. in physics, June 1949. 1½ years servomechanism development plus 3 years as Naval electronics officer. Age 27. Married. 2 children. Desires position in electrical engineering, technical or sales anywhere in U.S. or overseas. Box 480 W.

(Continued on page 60A)

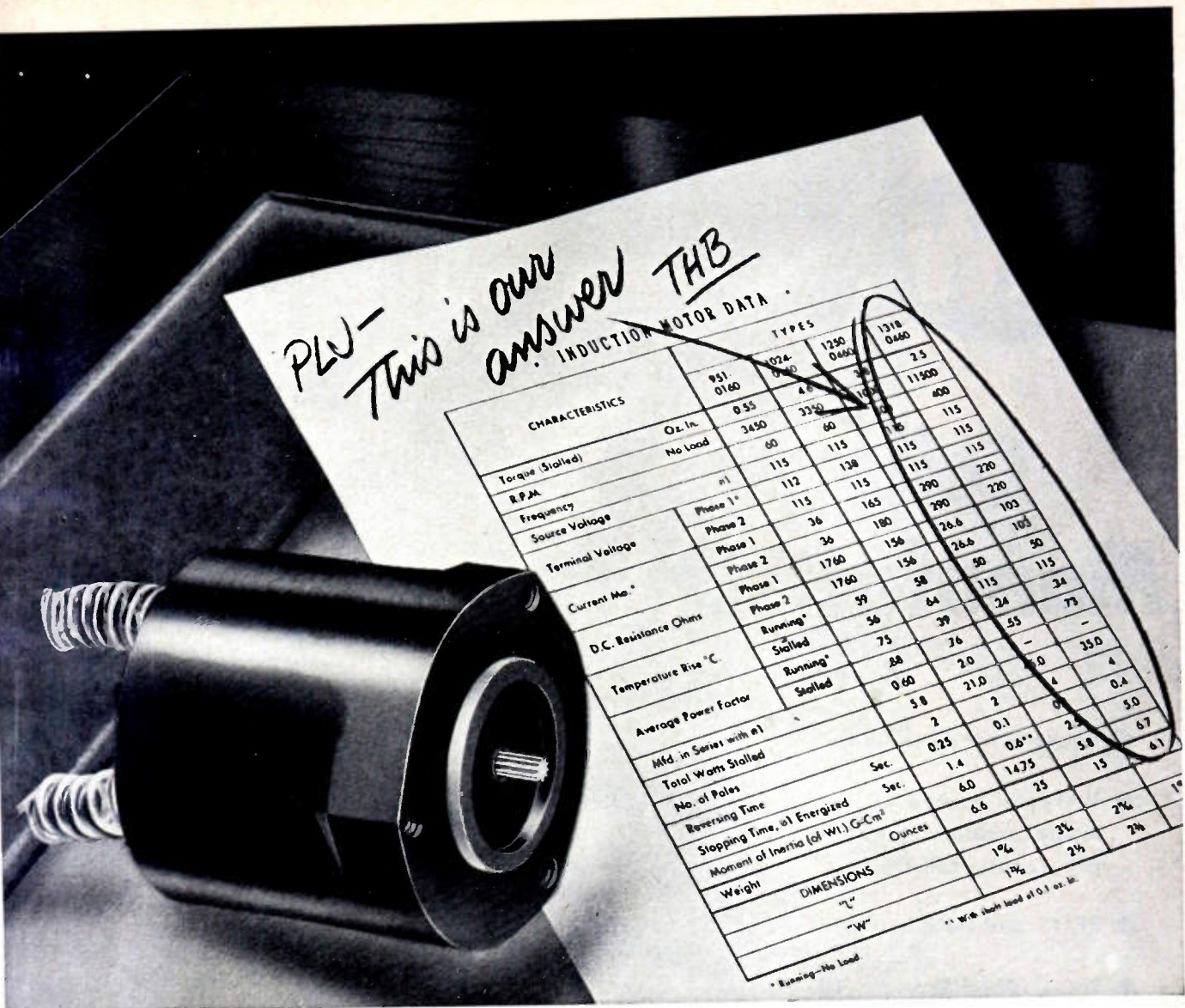

PLW - This is our answer THB

CHARACTERISTICS	TYPES			
	951-0160	024-0400	1250-0660	1318-0660
Torque (Stalled)	0.55	3750	400	11500
B.P.A.	3450	60	115	115
Frequency	60	115	115	115
Source Voltage	Phase 1 ^a	115	138	115
Terminal Voltage	Phase 2	115	115	115
	Phase 1	36	165	290
Current Ma. ^a	Phase 2	36	180	220
	Phase 1	1760	156	28.6
D.C. Resistance Ohms	Phase 2	1760	156	28.6
	Phase 1	1760	50	105
Temperature Rise °C	Running ^a	59	64	115
	Stalled	56	39	24
Average Power Factor	Running ^a	75	26	55
	Stalled	88	20	—
Mtd. in Series with #1	0.60	2.0	—	35.0
Total Wms Stalled	5.8	21.0	—	4
No. of Poles	2	2	4	4
Reversing Time	0.25	0.1	0.1	0.1
Stopping Time, (at Energized)	1.4	0.6	2.5	5.0
Moment of Inertia (of Wl.) G-Cm ²	6.0	14.75	5.8	6.7
Weight	6.6	25	15	15
DIMENSIONS				
"L"	1%	3%	2%	2%
"W"	1%	2%	2%	2%

^a Running-No Load

^a With shaft load of 0.1 oz. in.

Your answer, too, for extreme precision in remote indication and control systems

Instant responsiveness, complete smoothness of operation and a high torque/rotor inertia ratio make Kollsman Induction Motors ideally suited for use as servo or follow-up motors in control mechanisms. These miniature two-phase units have fast starting, stopping and reversing characteristics and deliver maximum torque at stall. Designed with distributed wound stators and

squirrel-cage type rotors, they perform smoothly from zero to maximum r.p.m., with no "cogging" action in the low speed ranges. They may be energized by two-phase AC or by single-phase, using a phase-splitting condenser in series with one winding.

The Induction Motors constitute one series in a complete line of special purpose AC motors designed and manufactured by Kollsman, leader in the field of precision aircraft instrumentation and control. Among those available, you may find the exact answer to your control problem. If not, the skill and experience of Kollsman engineers may be relied upon to produce a unit that fulfills your particular specifications. For further information regarding these motors, address: Kollsman Instrument Division, Square D Company, 80-08 45th Avenue, Elmhurst, New York.

KOLLSMAN INSTRUMENT DIVISION



SQUARE D COMPANY

ELMHURST, NEW YORK

GLENDALE, CALIFORNIA

B&W

Coil Manufactures*

- Single layer solenoid coils
- Universal wound coils of single, multiple pie, and progressive construction
- RF, IF, and Oscillator Coils
- Traps, Discriminators, Filters, RF and Delay Line Chokes

These are but a few of the many types of coils designed and built by B&W to answer your specific needs.

Whether your problems concern research, design, development, or production . . . in electronics, television, radio broadcasting, or radio communications . . . for long or short production runs—to exacting commercial or military specifications—you'll find the complete facilities of B&W able to answer your coil problems.

For detailed information on coils that are recognized the world over for their consistent dependability, write today to B&W, Dept. PR-100.

*Manufactures=manufacturing facts

BARKER & WILLIAMSON, Inc.

237 Fairfield Avenue

Upper Darby, Pa.

Positions Wanted

(Continued from page 58A)

ELECTRICAL ENGINEER

Recent electrical engineering graduate. Some experience. Special interest in design of VHF communications equipment, propagation studies or field surveys, and evaluation of overall system performance. Desires position continental U.S.A. Box 481W.

ELECTRONIC ENGINEER

B.E.E. June 1949, University of Delaware. Age 25, married. 3½ years Navy AETM. 1 year in nucleonic instrument maintenance, calibration, and modification. Desires research or development position in New York or Phila. area. Box 482 W.

ANTENNA ENGINEER

B.S. and M.S. in E.E., extra graduate credit. 2 years Navy electronics, 1 year part time teaching, over 2 years aircraft antenna research and development work. Age 27, married. Eta Kappa Nu, Tau Beta Pi, Sigma Xi, A.I.E.E., I.R.E. Desires research and development in VHF, UHF or microwave antennas. Box 483 W.

COMMUNICATIONS ENGINEER

B.E.E. Clarkson College, June 1950. Single, age 26. Formerly A.A.F. radar technician. Metropolitan New York area preferred. Box 484 W.

TELEVISION ENGINEER

Presently employed, 28 months equipment design and advanced development; video, pulse and special associated circuits. Seeking permanent connection with future away from metropolitan New York area. Systems engineering preferred, but will consider research or development. Present salary \$5400. Credentials on request. Box 485 W.

ELECTRONIC ENGINEER

M.S.E.E. electronics, University of Illinois 1949. Age 31, married. 4 years A.A.F. radar officer, instructor. 1 year radio manufacturing. Last year and a half in geophysics, still employed. Prefer mid-west or southwest. Box 486 W.

ELECTRONIC ENGINEER

B.E.E. June 1949. Communications option. Rensselaer Polytechnic Institute. 3 years electronic technician 1/cl. U.S. Navy. 1½ years experience test and development fire and control equipment; 1 year M.B.A. at N.Y.U. major management. Position desired: test and development or project engineering with communication or electronic instruments. New York—Long Island area. Resume on request. Box 487 W.

ELECTRONIC ENGINEER

B.E.E. University of Minnesota 1948. 28, married, 2 children. Laboratory experience in pulse communication systems. Desires permanent position in west. Box 488 W.

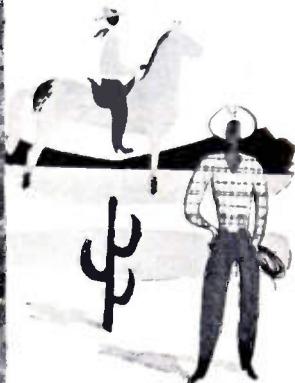
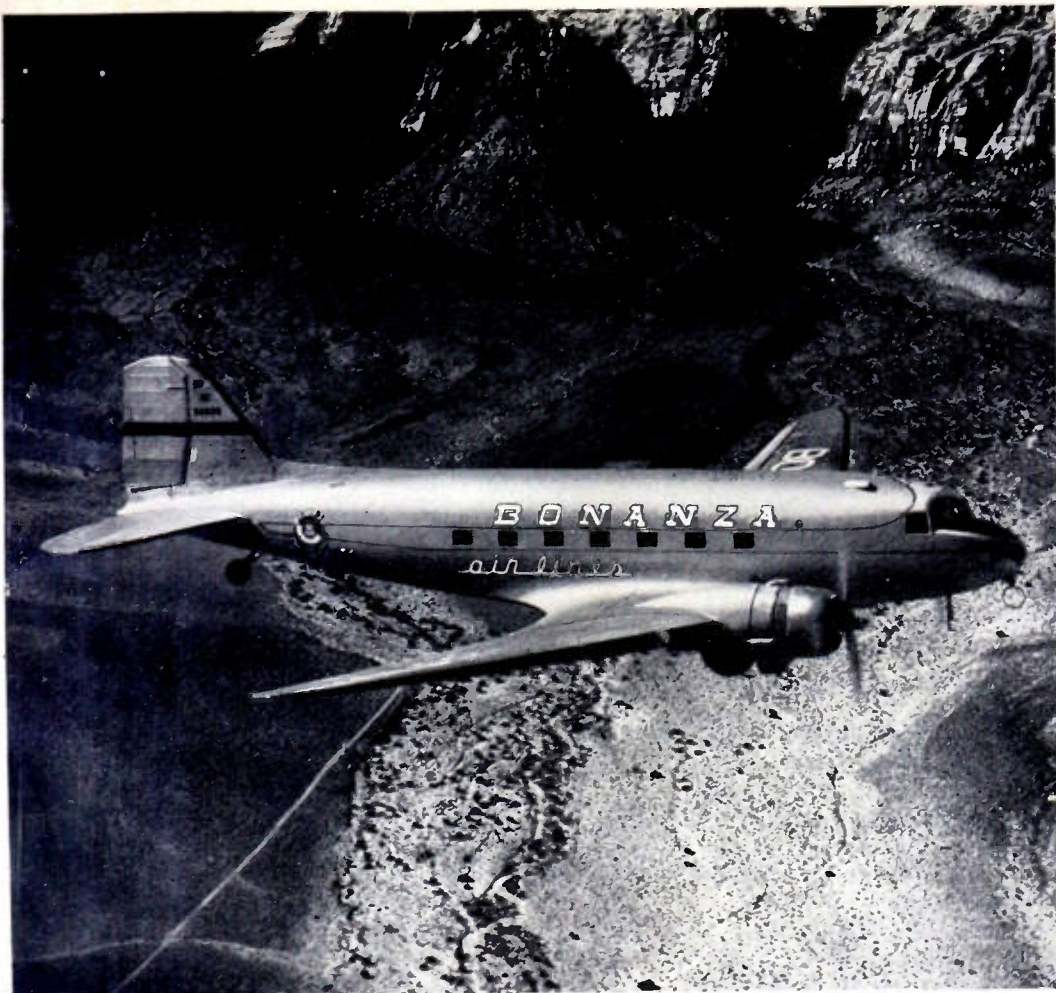

WILCOX

...First Choice of



**BONANZA AIR LINES SELECTS WILCOX TYPE 428
FACTORY PACKAGED VHF STATION For All Ground Stations**

A WILCOX Factory Packaged Station offers you:

1. OPERATING CONVENIENCE

Conveniently grouped controls, telephone handset, typewriter, filing cabinet, and writing desk assure efficient operation.

2. INSTALLATION ECONOMY

The 72-inch-high standard relay rack is completely wired at the factory. Just install the antenna, plug the station into any standard electrical outlet, and it's ready for operation.

3. MAINTENANCE EFFICIENCY

All adjustments are made from front panels. Plug and receptacle connections permit instant removal of all components. Simple circuits

minimize the number and types of tubes, require no special training or test equipment.

**DEPENDABLE COMMUNICATIONS
FOR THE WORLD'S AIR LINES**

In recent months many of the world's foremost air lines, UNITED, EASTERN, TWA, MID-CONTINENT, BRANIFF, PIONEER, ROBINSON, HAWAIIAN, SOUTHERN, and WISCONSIN CENTRAL, have placed volume orders for Wilcox equipment. No greater compliment could be paid to the performance, dependability, and economy of Wilcox equipment than to be "FIRST CHOICE" of this distinguished group.

Write Today... for complete information on the Wilcox Type 428 Packaged VHF Ground Station.

WILCOX ELECTRIC COMPANY

KANSAS CITY 1,



MISSOURI, U. S. A.

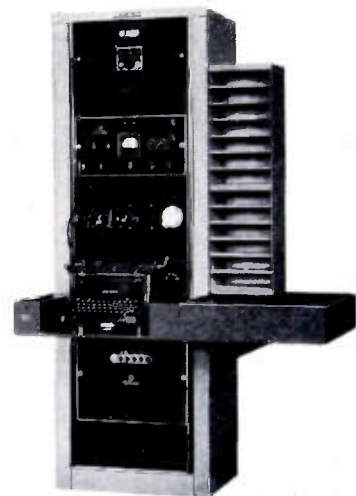

The Type 428 Packaged VHF Ground Station includes 50 watt Transmitter, Receiver, Power Supply, and Antenna.

NEW!

THE HIGHEST GAIN COMMUNICATIONS ANTENNA EVER BUILT!

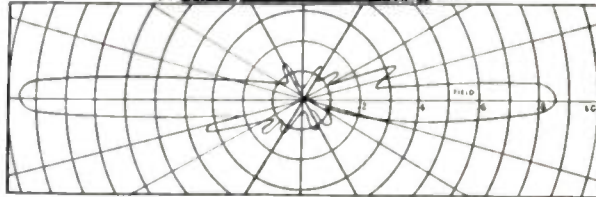

VERTICAL RADIATION PATTERN OF TYPE 3000 ANTENNA

Actually delivers 6 db increases your power 4 times!

Now, for the first time, you can operate in areas previously far out of your reach. This vast extra service area is yours at no additional operating cost because the 6 db actually delivered by this new ANDREW antenna is equivalent to increasing your power 4 TIMES! Think of the economy! This tremendous extra power also fills in any dead spots.

It's another pace-setting ANDREW "first".

Uniformity of performance is assured regardless of supporting structure height through a NEW EXCLUSIVE ANDREW METHOD of electrically isolating the radiating elements from the support structure.

Lightning protection and quieter reception during electrical storms are achieved by a DC path which conducts static charges from the elements to ground.

SPECIFICATIONS 148-174 MC

TYPE NO.	3000	3001	3002
Gain	6 db	6 db	3 db
Height above top of tower	27½ ft.	27½ ft.	13½ ft.
Length of support mast extending into tower	5 ft.	5 ft.	5 ft.
Weight	625 lbs.	375 lbs.	175 lbs.
Moment of tower top*	9300 ft. lb.	6150 ft. lb.	1600 ft. lb.

*Based on 100 mph wind loading and ½" radial ice. Moments include loading added by 300 mm beacon for Type 3000 and double obstruction light for Type 3001.

Type 3000 is designed to support a 300 mm code beacon, and includes a suitable mounting plate. Type 3001 is designed to support a double obstruction light.

All models are designed for connection to ANDREW Type 737 transmission line, and are provided with climbing steps.

All orders filled chronologically. Deliveries begin September 1. Write, wire or phone (ask for Mr. Bickel) today.

Andrew
CORPORATION

363 EAST 75th STREET · CHICAGO 19

WORLD'S LARGEST ANTENNA EQUIPMENT SPECIALISTS

TRANSMISSION LINES FOR AM-FM-TV · ANTENNAS · DIRECTIONAL ANTENNA EQUIPMENT
ANTENNA TUNING UNITS · TOWER LIGHTING EQUIPMENT · CONSULTING ENGINEERING SERVICES

News—New Products

These manufacturers have invited PROCEEDINGS readers to write for literature and further technical information. Please mention your I.R.E. affiliation.

(Continued from page 48A)

Tape Recording Head

Shure Bothers Inc., 225 W. Huron St., Chicago, Ill., announce the development of the Model TR 5 tape recording head—they state that it is the only tape head in the field that is engineered for mass production. It combines the functions of record, playback, and erase in one versatile unit.

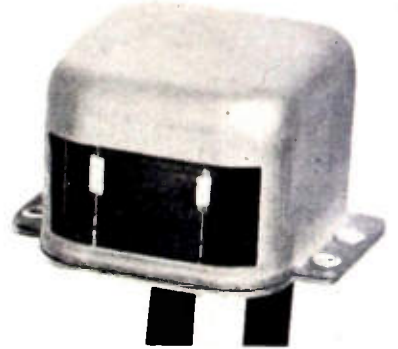

The TR 5 has a unique design that insures production control of gap dimension and alignment. Another special feature of the Shure tape head is the fact that it employs an effective deep-drawn, mu-metal shield for optimum hum reduction.

The TR 5 is designed for ease in assembly to equipment as well as for excellent frequency response and output level. Of special interest to manufacturers of tape transport mechanisms is the low cost of the Model TR 5 and its compactness.

Specific technical data: record and playback coil impedance—1,650 ohms at 1,000 cps; erase coil impedance—1,000 ohms at 40 kc; output level—5 db above 1 mv at 1,000 cps (at tape speed of 3.75 inches per second); over-all dimensions—0.685 inch maximum height × 1.240 width × 1.031 depth.

Pneumatic Electrode Dresser

To meet the need for redressing round electrodes of single- or multiple-point weld-ind machines, Keller Tool Co., Grand Haven, Mich., announces development of a new air-powered electrode dresser.



(Continued on page 64A)

The New ML-2C39A*...

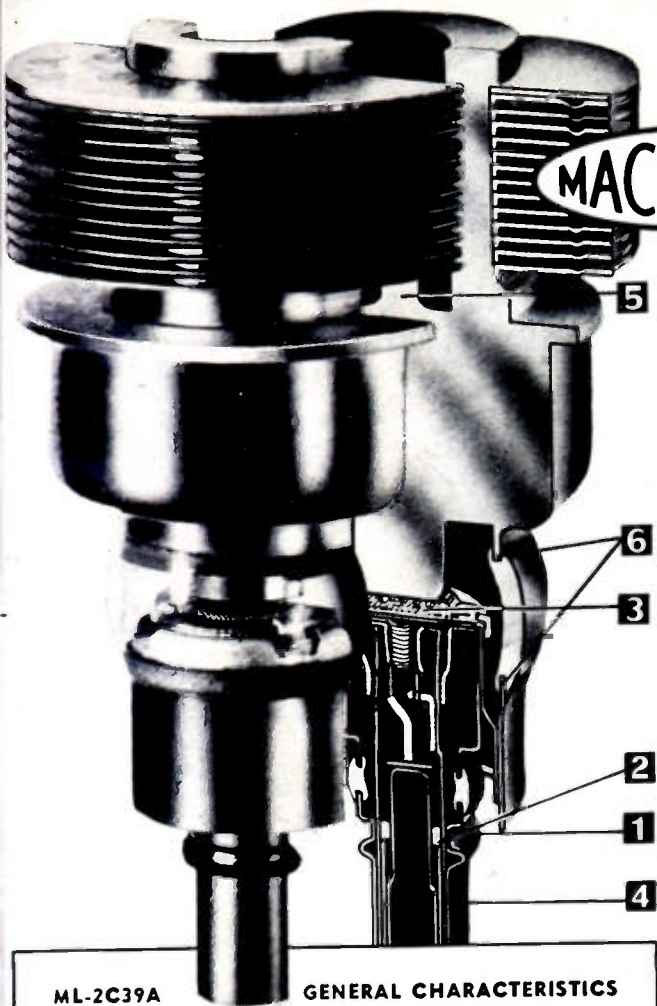

Proving once again that

MACHLETT ..makes the Difference

1. Design of cathode lead for positive adjustment and control of transconductance; limits are 20,000-23,000 μmhos or only 25% of permissible specified range.
2. High temperature ceramic in hot cathode end eliminates danger of gas evolution from glass at high temperatures. Assures better protection under overload conditions.
3. Uniquely processed mesh grid assures greater frequency stability with variation in grid dissipation.
4. Gold over silver plating to maintain optimum surface conductivity even in corrosive atmospheres.
5. Machlett's high vacuum processing for good cathode activation and freedom from gasiness.
6. Stronger glass-metal seals. Less breakage inserting and removing tubes.

* Conforms with recently issued JAN specifications.

ML-2C39A GENERAL CHARACTERISTICS

Electrical

Cathode: Coated Unipotential	
Heater Voltage	6.3 volts
Heater Current	1.0 amperes
Amplification Factor (Average)	100
Direct Interelectrode Capacitances (Average)	
Grid Plate	1.95 $\mu\text{mfd.}$
Grid Cathode	6.50 $\mu\text{mfd.}$
Plate Cathode	0.035 $\mu\text{mfd.}$

Transconductance
($i_b = 70 \text{ ma.}$, $E_b = 600 \text{ v.}$) (Average). 23,000 μmhos

Radio Frequency Power Amplifier

Class-C FM Telephony or Telegraphy
(key-down conditions, 1 tube)

Maximum Ratings	
D-C Plate Voltage	1000 max. volts
D-C Cathode Current	125 max. ma.
D-C Grid Voltage	-150 max. volts
Peak Positive R-F Grid Voltage	30 max. volts
Peak Negative R-F Grid Voltage	-400 max. volts
Plate Dissipation	100 max. watts
Grid Dissipation	2 max. watts

ML-381 FOR PULSED APPLICATIONS

Maximum Ratings (Tentative)

e_p , peak	3500 volts
i_p , peak	4.5 amps
i_g , peak	2.0 amps
i_p , ave	30 MA
i_g , ave	15 MA
T, pulse length	5 $\mu\text{sec.}$
duty	1%
E_f	5.5 volts \pm 5%

In all other respects the ML-381 is electrically and mechanically interchangeable with the 2C39A.

"Look to the Tube Specialist"

Long experience in the development and manufacture of the 2C39A electron tube has given Machlett Laboratories a comprehensive understanding of the operating problems encountered in a wide variety of applications of this tube type.

For assistance on your specific problem, write to Machlett Laboratories

or contact your local Graybar office.



MACHLETT

OVER 50 YEARS OF ELECTRON TUBE EXPERIENCE

Specify BREEZE "Monobloc" Waterproof and Pressure Sealed CONNECTORS



The only APPROVED Monobloc System for Advanced Radar, Communications, and Electronic Equipment

Breeze "Monoblocs", with single piece plastic inserts, offer outstanding advantages in assembly, wiring, mounting and service in the field.

Single piece inserts make a tighter unit, eliminate the air spaces within conventional multiple-piece inserts, greatly reduce the opportunity for moisture shorts.

Removable contact pins make possible bench soldering of leads, quick, error free assembly of Breeze Waterproof Connectors and panel-type "Monobloc Miniatures."

Single-Hole Panel Mounting is all that is required for either Waterproof or Pressure Sealed types.

Pressure Sealed types are available for values up to and including 75 psi, or they can be specially engineered for greater pressures. They meet specified requirements of shock, vibration, salt spray, humidity and temperature cycling from -65° to $+185^{\circ}$ F.

Breeze "Monobloc" Waterproof and Pressure Sealed Connectors are engineered to your requirements in aluminum, brass or steel—in all sizes and capacities. They are fully tested and approved... cost no more than ordinary types.

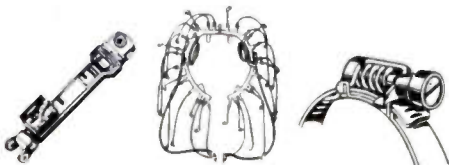

Other Breeze Precision Products

ACTUATORS:
All types, sizes. Complete control systems engineered to requirements. Above: Landing gear actuator Fairchild Packet.

RADIO SHIELDING: For any type of high or low tension system. New type "unit leads" or re-wirable leads. Flexible shielded conduit.

"AERO-SEAL"
Worm-Drive Hose Clamps. Vibration proof, uniform clamping, use again and again. All clamps have stainless steel bands.

Write for Details

If you have a tough connector problem, ask BREEZE for the answer!

BREEZE

CORPORATIONS, INC.

41-G South Sixth Street, Newark 7, N.J.

News—New Products

These manufacturers have invited PROCEEDINGS readers to write for literature and further technical information. Please mention your I.R.E. affiliation.

(Continued from page 62A)

The new tool, which combines the functions of both angle- and thin-type dressers, is designed to quickly restore electrodes to original shape without their removal from the welding machine.

The cutter attachment of $\frac{3}{8}$ -inch thickness readily accommodates close-clearance jobs. Both Porter- and severance-type cutters can be used, the changing of cutters being made easily. Fast cutting action is provided by a free speed of 1,750 rpm.

"The new dresser," Keller engineers state, "assures uniformly dressed electrode points, eliminates hand filing methods, and reduces the usual shut-down time for servicing multiple-spindle machines."

Over-all length of the dresser is 12 $\frac{1}{2}$ inches, net weight, 4 $\frac{1}{2}$ pounds.

Radiation Monitor

A new ac-operated radiation monitor, Model K-900, which makes it possible for the isotope laboratory worker to determine simply and quickly the contamination of laboratory accessories, benches and hands, is announced by the Instrument Div., The Kelley-Koett Mfg. Co., 147 E. Sixth St., Covington, Ky., manufacturers of instruments for radiation detection and measurement.



This versatile count rate meter serves as a continuous monitor in "hot" labs. Flashing neon light and variable volume speaker respond immediately to any increases in radio-active levels in area. When provided with a contact-making meter and relay-alarm, the K-900 unit gives instantaneous, audible indication of increases in background over any predetermined level.

A large easy-to-read meter indicates either radiation rates or high voltage applied to the tube. A range and high-voltage switch on front panel selects either one of two ranges: 10,000 ($\times 10$) or 1,000 ($\times 1$) counts per minutes, full scale. The tube voltage is adjustable from 500 to 1,000 volts. When set on "calibration," an internal pulse generator synchronizes with the line frequency. Selection of 15 or 45 second time constants is permitted for the accuracy of meter reading desired.

(Continued on page 66A)



ALL RANGES WITH THIS ONE CONTROL

Just *one* knob—extra large—easy to turn—flush with the panel, controls all ranges. This one knob saves your time—minimizes the chances of “burn-outs” because you don’t have to remember to set another control. You can work fast with Model 630 with your eyes as well as your hands. Look at that scale—wide open—easy to read, accurately. Yes, this is a *smooth TV* tester. Fast, safe, no projecting knobs, or jacks, or meter case. Get your hand on that single control and you’ll see why thousands of “Model 630’s” are already in use in almost every kind of electrical testing

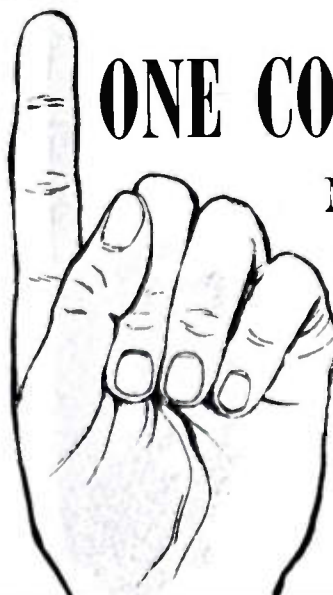

**Model
630**

ONLY \$39.50 AT YOUR DISTRIBUTOR

In Canada: Triplet Instruments of Canada, Georgetown, Ontario

FOR THE MAN WHO TAKES PRIDE IN HIS WORK

Triplet

TRIPLET ELECTRICAL INSTRUMENT COMPANY - BLUFFTON, OHIO, U.S.A.

Here's why those in the know

-demand

CANNON PLUGS

Ribbed for excellent grip.

Boss prevents movement.

With special anodized or lacquered finishes, threads are masked to maintain shielding or bonding.

Interchangeable pin and socket inserts... fit all Cannon shells of same diameter.

No section of plug exceeds end bell diameter.

Contacts, precision-machined from solid bar stock, electroplated with silver or gold.

90° end bell can be set at 60° interval.

Type AN Connectors are made in 6 styles; straight and 90° cord plugs; box, wall, and extension cord receptacles; and special quick disconnect plugs. Fifteen diameters for inserts with contact arrangements from single to 100 contacts. Contact capacities from 5 to 200 amps. Peak voltages from 70 to 9,000 volts.

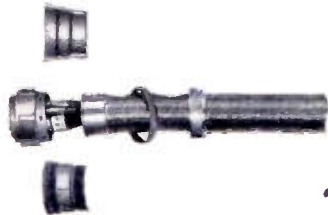

Cannon split-shell design advantages

no assembly tools needed
end bells are interchangeable
no slack in lines
test without disengaging plug
easy inspection and circuit changes

See that your circuit requirements are met. See that all control, communication and power circuits have firm positive contact, low dielectric loss... and see that each circuit is protected by the design advantages found only in Cannon Plugs. AN Connector Series is just one of the many Cannon types—world's most complete line. Request bulletins by required type or describe the connector service you need.

CANNON ELECTRIC

Since 1915

LOS ANGELES 31, CALIFORNIA
REPRESENTATIVES IN PRINCIPAL CITIES

News—New Products

These manufacturers have invited PROCEEDINGS readers to write for literature and further technical information. Please mention your I.R.E. affiliation.

(Continued from page 64A)

TV Receiver Calibrator

The RCA television calibrator, WR-39B, a new test instrument which is of basic usefulness in TV, providing the facilities of six important instruments for the accurate calibration of television receivers, has been announced by the Tube Dept., Radio Corp. of America, 415 S. Fifth St., Harrison, N. J.



Combining the accuracy of crystal control with the versatility of the variable-frequency oscillator, the company stated, the new calibrator includes in one compact, portable unit (1) a crystal-calibrated television marker generator with dual markers for all TV frequencies; (2) a bar-pattern generator for making linearity adjustments; (3) a miniature re-broadcast transmitter for checking all 12 TV channels; (4) a heterodyne frequency meter including amplifier and speaker; (5) a signal generator operating on fundamentals in all TV bands; and (6) a dual crystal standard with three crystals supplied.

Nuclear Laboratory Monitor

A new laboratory monitor for alpha-beta-gamma detection has just been announced by Nuclear Instrument and Chemical Corp., 229 W. Erie St., Chicago 10, Ill. This new Model 1615 "Radiation Sentinel" is a general purpose count rate instrument. It may be used for checking clothing, benches, glassware, hands, or fingertips for contamination, or for continuous monitoring of background air contamination or isotope decay. It may also be



(Continued on page 68A)

Shooting a bird...

IN THE AIR AGE

THIS IS "shooting a bird" at the U. S. Naval Air Missile Test Center, Point Mugu, California.

The "shoot" is the launching of a missile, while the "bird," in this particular case, is the Fairchild CTV-N-9a guided missile.

In a matter of seconds the missile is hurled high into the atmosphere with a deafening roar, propelled by its reaction type motors and auxiliary booster. Separation of the booster occurs as the missile speeds higher and higher into space, stabilized and controlled by the "intelligence" of its electronic guidance systems.

Soon the launching crews and ground observers no longer see the missile... but its path is being carefully plotted as it hurls toward its target... now under its own homing control.

This "shooting a bird" is but one phase of the Lark project. It is an operation requiring split-hair timing and perfect coordination. It is the result of teamwork between the Bureau of Aeronautics, Navy Department, the Naval Research Laboratory and Fairchild engineers and represents a combination of the best in aerodynamic design, electronic controls and precision manufacturing.

Here is another example of a Fairchild first and of "shooting a bird"... in the Air Age.



DEPT OF DEFENSE PHOTOS



ENGINE AND AIRPLANE CORPORATION

FAIRCHILD

Guided Missiles Division

Farmingdale, N.Y.

Other Divisions: Fairchild-NEPA Division, Oak Ridge, Tenn. • Fairchild Aircraft Division, Hagerstown, Md.
Fairchild Engine Division • Al-Fin Division and Stratos Corporation, Farmingdale, N.Y.

These manufacturers have invited PROCEEDINGS readers to write for literature and further technical information. Please mention your I.R.E. affiliation.

(Continued from page 66A)

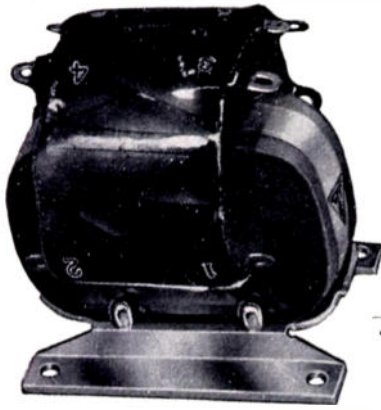

CHECK THESE FEATURES OF THE HORNET

- ✓ **SIZE AND WEIGHT** Because they are designed for high operating temperatures, Hornet Transformers and Reactors have only about one-fourth the size and weight of Class A units of comparable rating.
- ✓ **VOLTAGE RATINGS** Designs are available for RMS test voltages up to 10,000 volts at sea level, and up to 5,000 volts at 50,000 feet altitude. Power ratings from 2VA to 5KVA.
- ✓ **POWER FREQUENCIES** These units are designed to operate on 380/1600 cps aircraft power supplies, 60 cps power supplies, and any other required power frequency.
- ✓ **AMBIENT TEMPERATURES** Hornet Units can be designed for ambient temperatures up to 200 deg. C. Size for any given rating depends upon ambient temperature and required life.
- ✓ **LIFE EXPECTANCY** Extensive tests indicate that the life expectancy of Hornet units at continuous winding temperatures of 200 deg. C. is over 50,000 hours.
- ✓ **MOISTURE RESISTANCE** Since Hornet Transformers and Reactors contain only inorganic insulation, they are far more moisture resistant than conventional Class A insulated units.
- ✓ **EFFICIENCY** Regulation and efficiency of Hornet Transformers compare favorably with Class A units.
- ✓ **SPECIFICATIONS** Hornet Transformers meet the requirements of Government specifications covering this type of equipment.



Bulletin B300, containing full electrical and dimensional data on Hornet units, is now available. Write for it, or tell us your specifications for special units.



**NEW YORK
TRANSFORMER CO., INC.**
ALPHA NEW JERSEY

used to count samples with activities between 100 and 50,000 counts per minute where accuracy of measurement need not be better than 3 per cent standard error. A chart-type recorder may be attached for maintaining a permanent written record.

The dc outputs may be used separately, in parallel, in series, and bucking. The dc parallel operation 200 to 500 volts, 0 to 400 ma. The dc series operation 200 to 1,000 volts, 0 to 200 ma. The dc bucking operation 0 to 300 volts, 0 to 200 ma. The ac parallel operation 6.3 volts, 12 amperes. The ac series operation 12.6 volts, 6 amperes.

A choice of five different ranges, from 500 to 50,000 counts per minute full scale, is provided. Suitable time constants in each range, in conjunction with a switch permitting choice of standard error allow either 3 or 20 per cent error to be read on any range if desired. The instrument also incorporates a loudspeaker with controllable volume and a high voltage supply which is controlled from the front of the panel.

Electrolytic Capacitor

Type FW 10005, an electrolytic photo-flash capacitor with an unusual number of applications, is now available from Cornell-Dubilier Electric Corp., 1000 Hamilton Ave., South Plainfield, N. J.



This unit is designed for use with photo-flash lamps of 900 to 1,000 volts ratings. When four units are used in series-parallel, they can deliver 100 watt-second energy. The FW-type units are in a molded bakelite case, and therefore are especially suitable for operation where good insulation due to series connection is necessary. The etched cathode construction will prevent the capacity from dropping with frequent discharges through the tube.

This capacitor has a capacity of 200 μ fd and a voltage rating of 500 v. Maximum ambient temperature 100° F. Dimensions of the container are $2\frac{1}{8} \times 4\frac{1}{8}$ inches. It can be mounted with No. 20301 mounting rings.

(Continued on page 70A)



Here are some of the many reasons why there are more Simpson 260 high sensitivity volt-ohm-milliammeters in use today than all others combined. The Simpson 260 has earned world-wide acceptance because it was the first tester of its kind with all these "Firsts":

Simpson 260 SET TESTER

WORLD FAMOUS FOR ALL THESE "FIRSTS"

- First high sensitivity instrument to use a metal armature frame.
- First to use fully enclosed dust proof rotary switch with all contacts molded in place accurately and firmly.
- First to do away with harness wiring.
- First to provide separate molded recesses for resistors, batteries, etc.
- First to cover all resistors to prevent shorts and accidental damage and to protect against dust and dirt.
- First with a sturdy movement adapted to the rugged requirements of a wide range of service work or laboratory testing.
- First to provide easy means of replacing batteries.
- First to use all bakelite case and panels in volt-ohm-milliammeters.
- First volt-ohm-milliammeter at 20,000 ohms per volt with large 4 1/2" meter supplied in compact case (size 5 1/4" x 7" x 3 1/8").
- First and only one available with Simpson patented Roll Top Case.
- First to provide convenient compartment for test leads (Roll Top case).
- First to offer choice of colors.

RANGES

20,000 Ohms per Volt DC, 1,000 Ohms per Volt AC
VOLTS: AC & DC—2.5, 10, 50, 250, 1,000, 5,000
OUTPUT: 2.5, 10, 50, 250, 1000
MILLIAMPERES, DC: 10, 100, 500
MICROAMPERES, DC: 100
AMPERES, DC: 10
DECIBELS: (5 ranges)—12 to +55 DB
OHMS: 0-2,000 (12 ohms center), 0-200,000 (1200 ohms center), 0-20 megohms (120,000 ohms center).

Prices: \$38.95 dealers net; Roll Top \$45.95 dealers net.



The Model 260 also is available in the famous patented Roll Top safety case with built-in lead compartment. This sturdy, molded, bakelite case with Roll Top provides maximum protection for your 260 when used for servicing in the field or shop.

25,000 volt DC Probe for television servicing, complete, for use with 260, \$12.85

SIMPSON ELECTRIC COMPANY • 5200-18 W. Kinzie St., Chicago 44, Ill. • In Canada: Boch-Simpson, Ltd., London, Ont.

PRESTO...most carefully made recording discs in the world

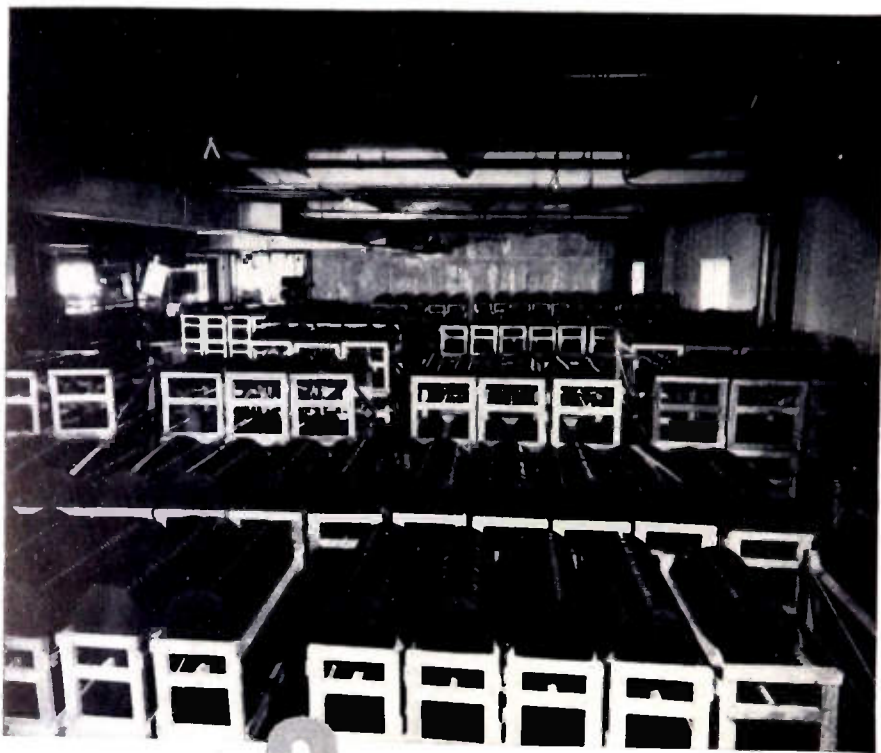

step **3** -the "Curing" process

Like fine wine, recording discs must be correctly and naturally aged. Without aging, lacquer surfaces will not engrave properly, and will result in muddy, low fidelity reproduction.

At the PRESTO disc plant, thousands of discs are allowed to "cure" under constant temperature in a dust-free atmosphere. Not one disc is allowed to leave the plant until it has been fully matured for a specified period. At PRESTO, this process is never hurried by baking or forced methods.

Careful, unhurried curing is another reason for the superiority of PRESTO discs... known throughout the world as the most carefully-made, most permanent, best performing discs available.

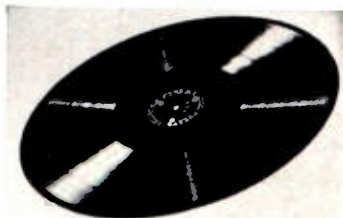

The famous PRESTO "Green Label"
... world's finest recording disc.

PRESTO
RECORDING CORPORATION

Paramus, New Jersey
Mailing Address:
Box 500, Hackensack, New Jersey

In Canada:
Walter P. Downs, Ltd.
Dominion Sq. Bldg.
Montreal, Canada

Overseas:
M. Simans & Son Co., Inc.
25 Warren Street
New York, New York

News—New Products

These manufacturers have invited PROCEEDINGS readers to write for literature and further technical information. Please mention your I.R.E. affiliation.

(Continued from page 68A)

UHF Impulse Generator

A new uhf impulse generator, producing impulses of extremely short duration, has been announced by Empire Devices, Inc., 38-25 Bell Blvd., Bayside, L. I., N. Y.



The IG-102 impulse generator produces a spectrum, flat within $\pm \frac{1}{2}$ db, over the entire frequency range from 10 kc to 1,000 Mc, corresponding to a pulse width of less than 0.001 microsecond (10^{-9} seconds). The output of the instrument is 70,000 microvolts per Mc, adjustable over a 60-db range by means of a continuously variable 10-db attenuator and a resistive step attenuator.

Pulse polarity is indicated on the front panel of the instrument and automatically reverses every ten seconds.

Continuously adjustable repetition rate from 2.5 to 2,500 cps is provided. In addition, single impulses may be obtained by manual keying.

The output impedance of the instrument is 50 ohms, the VSWR being better than 1.2 at all frequencies.

This impulse generator may be used for studying transient phenomena, ignition noise, switch and relay noise, and noise produced by rotating machinery. In addition, it may be employed for receiver alignment and bandwidth determination.

Voltage-Regulated Power Supply

The Model 510 which features two completely independent voltage regulated power supplied with excellent regulation, low ripple content, low output impedance, fuses on input and output circuits, and output current and voltage meters has been designed and developed by Kepco Laboratories, Inc., 149-14 41st Ave., Flushing, L. I., N. Y.



(Continued on page 71A)

News—New Products

These manufacturers have invited PROCEEDINGS readers to write for literature and further technical information. Please mention your I.R.E. affiliation.

(Continued from page 70A)

Each dc output voltage is continuously variable from 200 to 500 volts, 0 to 200 ma. For all output voltages, the output voltage variation is less than $\frac{1}{2}$ per cent for both line fluctuation from 105 to 125 volts and load variation from minimum to maximum current. Ripple voltage is less than 5 mv. Each ac output is 6.3 volts, 6 amperes, center-tapped, unregulated. Power requirements 600 watts.

New PA Amplifier

Rauland-Borg Corp., 3523 Addison St., Chicago 18, Ill., has released the first of a new series of PA amplifiers, known as the "Green Gem" line.



(Continued on page 72A)

The nonmelting SILICONE insulating and waterproofing compound that is stable at temperatures from -70°F. to $+400^{\circ}\text{F.}$



↑ for AIRCRAFT ignition and electrical control systems

↑ for ELECTRONIC EQUIPMENT

MEETS ALL THE REQUIREMENTS OF AN-C-128a

Marc water repellent than paraffin, Dow Corning 4 Compound is highly resistant to oxygen, ozone and to deterioration caused by corona discharge.

POWER FACTOR, up to 10 megacycles . . . 0.001
VOLUME RESISTIVITY, ohm centimeters . . . 10^{11}
DIELECTRIC STRENGTH, volts/mil 500

Write Today!

for your copy of our new booklet on Dow Corning 4 Compound Address Dept. D.

Dow Corning
FIRST IN SILICONES

DOW CORNING CORPORATION, Midland, Michigan

Just Published!

An up-to-date, thorough book which supplies the need for an authoritative treatment of the fundamental physics of semiconductors in a form accessible and useful to everyone interested in the field of transistor electronics.

ELECTRONS AND HOLES IN SEMICONDUCTORS

With Applications to Transistor Electronics

By William Shockley

Member of the Technical Staff, Bell Telephone Laboratories

Author of Numerous Publications on Solid Physics and Transistors

Reflecting the point of view that led to the invention of the transistor, this book develops the subject from the broadest theoretical and practical standpoints. It shows how—with the advent of the transistor—the concept of the positive hole and that of its negative counterpart, the excess electron, have assumed new technological significance and a very much greater degree of operational reality.

BASED ON EXTENSIVE LABORATORY EXPERIMENTATION

New experiments growing out of the transistor program have resulted in the direct observation of most of the important properties of electronic conduction in germanium. Experimental evidence is here used to show how electronic conduction in semiconductors occurs, both by the excess electron or negative carrier process and by the defect electron or positive hole process.

Conveniently divided into three parts: Introduction to Transistor Electronics; Descriptive Theory of Semiconductors; Quantum-Mechanical Foundations.

Scope of the material treated is suggested by this review of chapter headings: Bulk Properties of Semiconductors; The Transistor as a Circuit Element; Quantitative Studies of Hole Injection; Physical Theory of Transistors; Quantum States, Energy Bands and Brillouin Zones; Velocities and Currents for Electrons in Crystals; Electrons and Holes in Magnetic Fields; Introductory Theory of Conductivity and Hall Effect; Distribution of Quantum States in Energy; Fermi-Dirac Statistics for Semiconductors; Mathematical Theory of Conductivity and Hall Effect; Elementary Quantum Mechanics with Circuit Theory Analogues; Theory of Electron and Hole Velocities and Accelerations; Statistical Mechanics for Semiconductors; Theory of Transition Probabilities for Holes and Electrons. Clarified by numerous illustrations.

EXAMINE THIS BOOK FREE

Use the convenient order form below to obtain an examination copy of this important new work.

PLEASE CUT OUT AND MAIL

D. Van Nostrand Company, Inc. PIRE-1050
250 Fourth Avenue, New York 3, N.Y.

Please send me a copy of "Electrons and Holes in Semiconductors." Within ten days I will either return the book or send you its price, plus a few cents postage.

Name
Address
City Zone State

EMSCO ENGINEERED
RADIO TOWERS

FOR AM, FM,
UHF, VHF,
MICROWAVE,
TELEVISION
AND RADAR

Emsco Towers are available for all types of broadcast and communication service. Backed by years of fabricating experience, Emsco towers are engineered for safety, performance and economy. Bolted construction and hot dip galvanizing insure long life, low maintenance cost and maximum electrical conductivity. Self-supporting triangular and square towers and guyed triangular towers are available in heights up to 1,000 feet with wind loadings up to 60 lbs. RMA design.

There is an Emsco Engineered Tower to meet your needs. Write our Houston plant for bulletin.

EMSCO
TOWERS OF
STRENGTH

EMSCO DERRICK
& EQUIPMENT
COMPANY
Houston, Texas
LOS ANGELES,
CALIFORNIA
Garland, Texas

Shown here is an Emsco 20 $\frac{1}{2}$ " face, 160', type 1 RT Radio Tower with 30 lb. wind loading rating.

News—New Products

These manufacturers have invited PROCEEDINGS readers to write for literature and further technical information. Please mention your I.R.E. affiliation.

(Continued from page 71A)

The initial amplifier is the Rauland Model 1916, rated 16 watts at 5 per cent or less harmonic distortion (measured at 100, 400 and 5,000 cps); 20-watts peak output.

The Model 1916 provides: 2 microphone inputs (either convertible for use with a low-impedance mike by means of a plug-in transformer); 1 phono input; true electronic mixing and fading on all 3 inputs; tone control. Frequency response is plus or minus 1 db, 40 to 20,000 cps. Output impedances are 4-, 8-, 16-, 250-, 333- (70 volts), 500-ohms. Gain characteristics are: Mike—130 db (2 Mc); 117 db (100,000 ohms); 117 db (150 ohms). Phono—85 db ($\frac{1}{2}$ Mc). Voltage required for rated output: High impedance input—0.0015; low impedance—0.0001; phono—0.1 volt.

Impulse-Test Cathode-Ray Oscillograph

The Instrument Div., Allen B. Du Mont Laboratories, Inc., Clifton, N. J., announces the new Type 293 C-R oscillograph as an important contribution to the field of impulse-testing of high-voltage transformers, insulators, lightning arrestors, and other equipment designed to withstand surge potentials of great amplitude.



Employing a sealed-off high-vacuum cathode-ray tube and means for convenient external photographic recording, the Type 293 may be used with any standard impulse-test installation, and can be triggered by a sample of the test impulse. It also contains a pulse generator to trigger external circuits.

(Continued on page 73A)

AVOID LOSSES FROM
"NICKING"
Not being an extruded plastic,
absolute uniformity of diameter
can be guaranteed. Therefore:—
NO NICKING OF CONDUCTORS
NO CONSTANT RESETTING OF BLADES

specify



"NOFLAME-COR"

the TELEVISION hookup wire

APPROVED BY
UNDERWRITERS
LABORATORIES AT

90° CENTIGRADE **600** VOLTS

Proven BEST, and specified regularly, by leading manufacturers of television, F-M, quality radio and all exacting electronic equipment. For maximum output and minimum rejects. Available in all sizes, solid and stranded. Over 200 color combinations.

PRODUCTION ENGINEERS: Specify "NOFLAME-COR" for absolute uniformity of diameter, permitting clean stripping of insulation without damage to the copper conductor...

NO NICKING OF CONDUCTORS
NO CONSTANT RESETTING OF BLADES

AVOID LOSSES FROM
"BLOBBING"
Not being an extruded plastic,
eliminates the costly "blobbing" of
insulations under soldering heat

- Flame Resistant
- High Insulation Resistance
- Heat Resistant
- Facilitates Positive Soldering
- High Dielectric
- Easy Stripping
- Also unaffected by the heat of impregnation — therefore, ideal for coil and transformer leads

COMPLETE DATA AND SAMPLES ON REQUEST

"made by engineers for engineers"

CORNISH WIRE COMPANY, Inc.

605 North Michigan Avenue,
Chicago 11

15 Park Row, New York 7, N. Y.

1237 Public Ledger Bldg.,
Philadelphia 6

MANUFACTURERS OF QUALITY WIRES AND CABLES FOR THE ELECTRICAL AND ELECTRONIC INDUSTRIES

perfect
for 3 speed playing

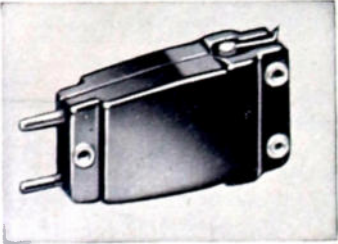

WEBSTER ELECTRIC
MODEL "A" CARTRIDGE
with TWIST
MECHANISM

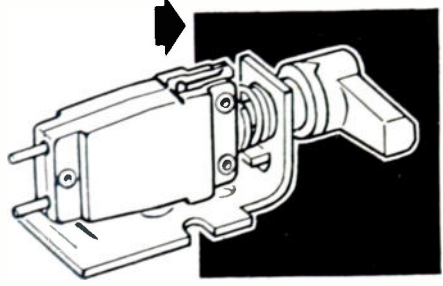

- ✓ Outstanding performance... small streamline design that fits modern tone arms.
- ✓ No chance to damage leads or play in incorrect position.
- ✓ Easy installation.

The Model "A" cartridge and twist mechanism are assembled at factory ready for installation in tone arm... no adjustment or modification necessary. Completely assembled it gives positive tracking at all playing speeds. High vertical and lateral compliance eliminates "skating." Positive indexing eliminates the possibility of twisting and damaging leads. The cartridge rotates through a 180 degree arc for playing either 33 $\frac{1}{3}$, 45 or 78 R.P.M. records. There are no parts to get out of order. Write for data sheet and prices. Webster Electric Co., Racine, Wisconsin. Established 1909.

WEBSTER ELECTRIC
RACINE • WISCONSIN
*Where Quality is a Responsibility and Fair Dealing an Obligation

News—New Products

These manufacturers have invited PROCEEDINGS readers to write for literature and further technical information. Please mention your I.R.E. affiliation.

(Continued from page 72A)

Driven, logarithmic sweeps may be initiated from an external signal, internal signal, by manual push-button, or from any point in the cycle of the 60-cps line voltage. Sweep duration is adjustable in steps from 0.5 to 1,000 microseconds. Delay of the sweep, with respect to the trigger output of the instrument, is continuously variable from 0.5 to 15 microseconds, permitting detailed display of any portion of the impulse wave form.

Bandwidth of both the X and Y axes is essentially uniform from dc to 25 Mc, assuring excellent reproduction of pulses with high-frequency components. There is no distortion of pulses having a rise time of 0.01 microseconds or greater.

Interesting Abstract

To aid individual consumers, as well as industrial and professional groups, Harvey Radio Co., Inc., 103 W. 43rd St., New York 18, N. Y., has constructed an "Auditorium." All equipment on display is permanently connected to a central control panel to facilitate selection of any of the many possible audio component combinations.

(Continued on page 74A)

don't fail
to see the
AMPEREX
advertisement
next month
announcing the
NEW
AMPEREX
TUBES

*You'll find the details on the
inside front cover next month
... be sure to see them.*

AMPEREX ELECTRONIC CORP.
25 WASHINGTON STREET, BROOKLYN 1, N. Y.
In Canada and Newfoundland: Rogers Majestic Limited
11-19 Brantcliffe Road, Leaside, Toronto, Ontario, Canada

**Check these 2 NEW
McGRAW-HILL BOOKS**

Just Published
**HIGH SPEED
COMPUTING
DEVICES**



Gives a clear picture of the various mathematical methods and physical mechanisms which have been developed for use in automatic computation. HIGH-SPEED COMPUTING DEVICES explains the general character of computing machines... outlines the arithmetic techniques employed in their operation... and describes basic circuits used to perform computing machine functions. The different uses to which large-scale machines can be put are pointed out, and several computers are described. **By the staff of Engineering Research Associates, Inc., 440 pages, 90 illustrations, \$6.50.**

Just Published
**RADIO ENGINEERING
HANDBOOK**
New 4th Edition

Here are quick answers to routine and special assignments in communications, broadcasting, aircraft radio, television, and related fields. Includes data on every field and aspect of radio engineering—from inductance, power-supply systems, and electron tubes... to receiving systems and code reception—all arranged in concise, quick-reference form. Brings you 1197 pages of carefully selected design data—charts, tables, circuits, diagrams, and formulas. **Written by 26 specialists. Keith Henney, Editor-in-Chief, Consulting Editor of Electronics, 1197 pages, 1038 illustrations, \$10.00.**

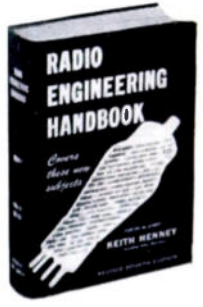

SEE THESE BOOKS 10 DAYS FREE

McGraw-Hill Book Co., Inc.
330 W. 42nd St., New York 18

Send me book(s) checked below for 10 days' examination on approval. In 10 days I will remit for book(s) I keep, plus few cents for delivery, and return unwanted book(s) postpaid. (We pay for delivery if you remit with this coupon; same return privilege.)

ERA—High-Speed Computing Devices—\$6.50

HENNEY—Radio Engineering Handbook—\$10.00

Name

Address

City

Zone

State

Company

Position

IRE-10 50

This offer applies to U. S. only.

NEW

CONTINENTAL NOBLELOY

METAL FILM

NF RESISTOR



- Low Temperature Coefficient
- Range; 1 Ohm to 1 Megohm
- Axial Leads; 1/2 Watt
- Small Size 1/2" long x .150" Dia.
- Tolerance; + - 1% & 5%

Continental type NF "Nobleloy" resistors were designed to meet the needs of miniature, stable, precision resistors in critical applications.

Write for further details.

CONTINENTAL CARBON INC. CLEVELAND 11, OHIO

ONE OF OUR PRECISION PRODUCTS

SPECIAL MICROMETER HEAD

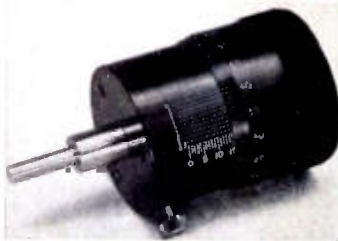

- Invar nut and spindle (Hard chrome plated)
- Anti-back lash screw thread
- Readable in either direction of rotation to .00005

MANUFACTURERS THREAD GRINDING, INC.

P. O. Box 66

EATONTOWN, N. J.

ASBURY PARK 1-1019

TWO NEW TWIN POWER SUPPLIES



MODEL 610-F

- Precise Electronic Regulation.
- 2 Independent Sources of Power.
- 0-325 V.D.C. at 0-100 Milliamperes. Continuously Adjustable.
- 0-325 V.D.C. at 0-200 Mils if the Sources are Combined.
- Both D.C. Outputs Metered for Voltage or Current.
- 6.3 and 12.6 V.A.C. Outputs Provided.
- A.C. Ripple Less than 10 Millivolts.

MODEL 1210

- Precise Electronic Regulation.
- 2 Independent Sources of Power.
- 0-500 V.D.C. at 0-150 Milliamperes. Continuously Adjustable.
- 0-500 V.D.C. at 0-300 Mils if the 2 Sources are Combined.
- Both D.C. Outputs Metered for Voltage or Current.
- 6.3 or 12.6 V.A.C. Outputs Provided.
- A.C. Ripple Less Than 10 Millivolts.

Also available with regulated bias output.

Furst Twin Power Supplies double the usefulness of a single unit at considerable saving in space and cost. Write for complete specifications on these and other Furst Twin Power Supply Models.



FURST ELECTRONICS

10 S. Jefferson St., Chicago 6, Ill.

News—New Products

These manufacturers have invited PROCEEDINGS readers to write for literature and further technical information. Please mention your I.R.E. affiliation.

(Continued from page 73A)

Stainless Steel Cathode G-M Tubes

The development of a new process which makes it possible to evaporate stainless steel on the inside of the glass walls of Geiger-Mueller tubes and on the mica windows is announced by Tracerlab, Inc., 130 High St., Boston 10, Mass.



This has enabled the substitution of a stainless steel cathode coating for the previously used aquadag coating. As a consequence, the tubes have improved operating characteristics.

The life of the mica window-type tubes has been extended by a factor of 10 over the old aquadag type, and they now have a useful life of about 10⁹ counts. The all-glass tubes also have a greatly increased life.

The background of these stainless steel cathode tubes is at least 30 per cent lower than that of the previous aquadag cathode tubes, and since stainless steel has a very small coefficient of electron emission by positive ion and photon bombardment, spurious counts are minimized. Furthermore, the use of stainless steel eliminates outgassing and thus decreases changes in the tube characteristics with aging.

Plant Expansion

Coral Designs, Div. Henry G. Dietz Co., formerly located in Forest Hills, New York, N. Y., is now operating in its new expanded quarters located at 12-16 Astoria Blvd., Long Island City 2, L. I., N. Y., Telephone: Ravenswood 6-3347. The facilities will be devoted to production of its standard line of electronic, electrical, and mechanical controls. It is also equipped to handle development work in the electronic field on a contract basis. Its facilities include all of the necessary equipment to produce phototypes and small-scale production of specialized electronic equipment.

(Continued on page 75A)

We will be grateful if you will mention PROCEEDINGS of the I.R.E. when writing to our advertisers.

**FOR SUPERIOR
PAPER-DIELECTRIC
CAPACITORS**

Permanol

G-H "Custom-manufactured" capacitors treated with this highly effective impregnant insure

Utmost protection against voltage breakdown . . .

Maximum stability under adverse climatic conditions

Low power-factor change with frequency . . .

Permanent, non-ageing characteristics . . .



can supply you with PERMANOL treated capacitors to your own specifications. Any reasonable capacity, tolerance or working voltage . . . any size or type of container . . . small or production quantities.

One of the best equipped capacitor manufacturing plants on the Pacific Coast

GIRARD-HOPKINS
1000 40th Avenue, Oakland 1, Calif.

News—New Products

These manufacturers have invited PROCEEDINGS readers to write for literature and further technical information. Please mention your I.R.E. affiliation. (Continued from page 74A)

Stabilized Crystal Unit

Of interest to broadcast stations is a new and improved broadcast stabilized unit, the JK57MT, recently announced by The James Knights Co., Sandwich, Ill.



This new crystal features a unique and more positive method of varying the gap. Unlike conventional crystals, in which the entire electrode turns to change the frequency, the JK57M variable electrode moves only up and down in guides like a piston. This completely eliminates any danger of damaging the crystal.

The JK57MT has a frequency range from 400 to 1,750 kc. Nominal temperature $60^{\circ} \pm 1^{\circ}$. Adjustable frequency in your equipment. 6.3 volt 1 ampere heater. Completely insulated, it will hold temperature to -20°C and it can be supplied with octal base (JK87MT) with or without thermometer, or factory set for operation at specific temperatures.

High-Voltage Resistors for TV

New high-voltage carbon-coated steatite-base resistors are in production at Resistance Products Co., 714 Race St., Harrisburg, Pa.



Type T resistors are offered in a range of resistance values covering the requirements of TV power supply circuits, with a tolerance of ± 20 per cent. Where closer tolerances are required, Type B should be specified.

The terminals are solder-type of tinned brass, fastened to the resistor by machine screws. If required, they can be furnished without terminals, to be mounted into special assemblies.

(Continued on page 76A)

**ELECTRONICALLY REGULATED
LABORATORY
POWER SUPPLIES**



BENCH MODEL 25

STABLE
DEPENDABLE
MODERATELY PRICED

- **INPUT:** 105 to 125 VAC, 50-60 cy
- **OUTPUT #1:** 200 to 325 Volts DC at 100 ma regulated
- **OUTPUT #2:** 6.3 Volts AC CT at 3A unregulated
- **RIPPLE OUTPUT:** Less than 10 millivolts rms

For complete information write for Bulletin G

WIDTH 14"
DEPTH 6"
HEIGHT 8"
WT: 17 LBS.

 **LAMBDA ELECTRONICS CORPORATION**
CORONA NEW YORK

Gold Plated
TUNGSTEN
and
MOLYBDENUM
GRID WIRE

SIGMUND COHN
NEW YORK

Made to meet your specifications . . . for gold content, diameter and other requirements.

Write for details and list of products

SINCE 1901

SIGMUND COHN CORP.
44 GOLD ST. NEW YORK

FOR BETTER PERFORMANCE



Output characteristics of television transformers must match the circuit exactly.

Acme Electric transformers are custom engineered to your specifications.

(illustrated) Television Power Transformer with copper shorting band.

BETTER BUY

Acme **ACME** Electric

TRANSFORMERS

ACME ELECTRIC CORPORATION • 4410 Water St., Cuba, N.Y., U.S.A.

Acme **ACME** Electric
TRANSFORMERS



don't crystal gaze

**SELECT JK CRYSTALS
AND BE SURE . . .**

There's no guess work involved when you use JK stabilized crystals. Every JK crystal is manufactured with such care—and pride—that you can take it for granted there is none more dependable anywhere.

Next time you need crystals, specify JK crystals—and be sure!



JK STABILIZER HEAT JK02

JK stabilized heat—JK02 will accommodate two stabilized H17 crystals (HC6 type). Has standard octal base, 6.3 volt heater at less than 1 amp. Temperature stability $\pm 2^\circ\text{C}$. Oven is normally set at $+75^\circ\text{C}$. Can be supplied set at other temperatures on special order.



The James Knights Company
SANDWICH, ILLINOIS

News New—Products

These manufacturers have invited PROCEEDINGS readers to write for literature and further technical information. Please mention your I.R.E. affiliation.
(Continued from page 75A)

32-Watt Amplifier

Rauland-Borg Corporation, 3523 Addison St., Chicago 18, Ill., has just released the second of a new series of Green Gem P/A amplifiers. The Model 1932 is rated 32 watts at 5 per cent or less harmonic distortion (measured at 100, 400 and 5,000 cps); 48 watts peak output.



This Model features 3 microphone inputs (each convertible for use with a low-impedance mike by means of a plug-in transformer); 2 phono inputs with dual fader; true electronic mixing and fading on all 5 inputs; and separate bass and treble tone controls. Frequency response is ± 1 db, 40 to 20,000 cps. Output impedances are 4, 8, 16, 166; (70 volts), 250-, 500-ohms. Gain characteristics are: Mike—128 db (2 Mc); 115 db (100,000 ohms); 115 db (150 ohms). Phono—82 db (1/2 Mc). Voltage required for rated output: High impedance input—0.005; low impedance—0.0004; phono—0.3 volts.

(Continued on page 77A)

All-Metal...

All-Weather

MOUNTS

COMPLETE and BALANCED PROTECTION

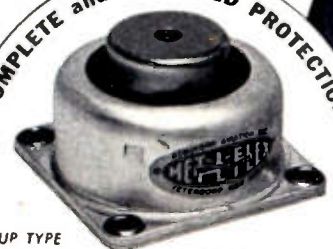

(CUP TYPE
MODEL #7002)

MET-L-FLEX

Unit mounts and mounting systems with MET-L-FLEX provide vibration isolation and true shock absorption through the widest range of operating conditions.

All-metal • no organic materials • stable characteristics from -90°C . to $+175^\circ\text{C}$. • wide load tolerance • built-in damping for stability and reduced amplification at resonance.

For electronic or delicate equipment mounting, write Dept. 814 MET-L-FLEX Data Sheets available.

ROBINSON AVIATION INC.
TEBESBORO, NEW JERSEY
Vibration Control Engineers

News—New Products

These manufacturers have invited PROCEEDINGS readers to write for literature and further technical information. Please mention your I.R.E. affiliation.

(Continued from page 76A)

Small SWR Bridge

A new and extremely compact standing-wave ratio bridge has just been designed by the James Millen Mfg. Co., 150 Exchange St., Malden, Mass. The case of the new bridge measures only $4\frac{1}{2} \times 2\frac{1}{2} \times 1\frac{1}{2}$ inches.



The bridge (catalog number 90671) is of the resistance type, and is intended for use with coaxial lines of either 52 or 75 ohm type. The compact size of the bridge makes its use convenient in most any location. It will work with any low range dc instrument such as a 0-1 milliammeter, and thus makes possible an inexpensive means for making measurements of a type so necessary with all modern transmitter installations.

Horizontal-Deflection-Output and High-Voltage Transformer

The new horizontal-deflection-output and high-voltage transformer, RCA-223T1, and the new deflecting yoke, RCA-209D1, each utilizing a ferrite core for superior performance, are available from the Tube Dept., Radio Corp. of America, 415 S. Fifth St., Harrison, N. J. These components were designed for use with the 16GP4 and similar picture tubes having a deflection angle of about 70° and operating at an anode potential up to 14 kv.

The 223T1 is designed for use with a single, horizontal-deflection amplifier tube, such as the 6AU5-GT, and a single, high-voltage rectifier tube 1B3-GT. Because of its ferrite core, the 223T1 makes possible the design of a horizontal-deflection system which operates efficiently with a dc power supply of only 300 to 320 volts, and which provides full deflection of a 16GP4 kinescope.

The 209D1 deflecting yoke is co-ordinated in design to operate efficiently with the 223T1, and has good deflection sensitivity.

(Continued on page 78A)

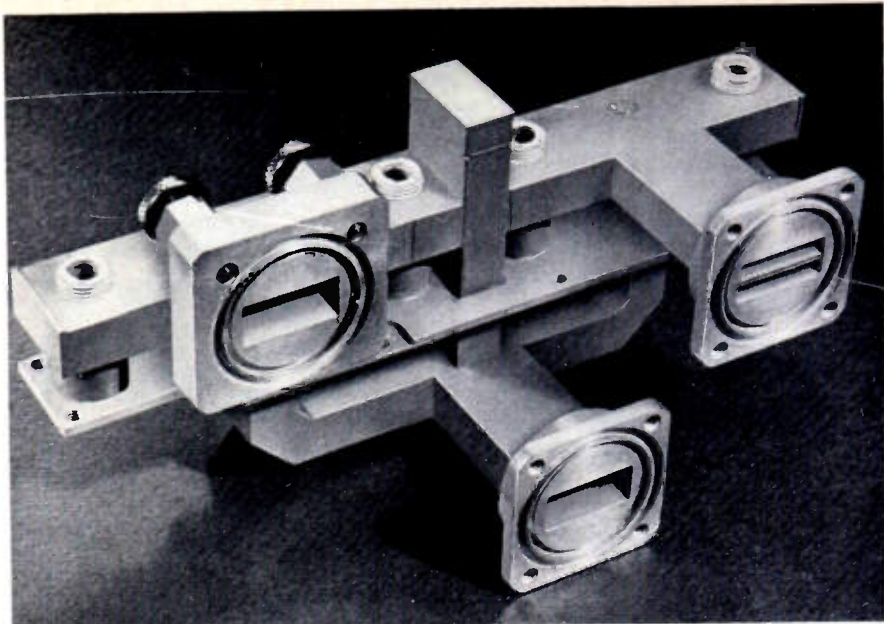

Need help with microwave transmission lines?...call TERPENING

The microwave mixer shown above was designed and produced on special order, in quantity, in our plant. Though made up from a number of different sections brazed together, special jigs, fixtures, and skilled techniques made it possible to hold tolerances between the outer flange center lines to $\pm .001''$.

Whether it's a special component, such as the mixer shown, or complete microwave transmission systems, we're set up to produce them with a high degree of precision from blueprints or performance specs. Although our engineering staff, laboratories, and fully equipped shop are usually busy on government contracts, our unusual facilities may permit us to work with you on special components for military or other microwave systems. We shall be happy to talk with you about your present and/or future needs.



L. H. TERPENING COMPANY

DESIGN • RESEARCH • PRODUCTION

Microwave Transmission Lines and Associated Components

16 West 61st St. • New York 23, N. Y. • Circle 6-4760

SAFE AT THE PLATE!



AND SO IS **Seletron**

SELETRON "Safe Center" plates in miniature rectifiers eliminate the danger of arc-over, short circuits and excessive heating due to high leakage current at the center contact point. Assembly pressure, or pressure applied in mounting the rectifier cannot affect its performance. This SELETRON feature is accomplished by deactivating the area of the plate under the contact washer.



There are millions of SELETRON Selenium Rectifiers in service in radio and TV; millions more in other electronic circuits. That is why you can specify SELETRON and be safe!

Look for Howard W. Sam's Red Book Supplement listing SELETRON replacements . . . and write for your copy of our new Bulletin No. RE-5

SELETRON DIVISION/
RADIO RECEPTOR COMPANY, Inc. 
Since 1922 in Radio and Electronics
 Factory: 84 North 9th St., Brooklyn 11, N. Y. • Sales Department: 251 West 19th St., New York 11, N. Y.

CHECK small inductors

...Quickly and
 Accurately—
 with this TYPE 110-B
QX-CHECKER

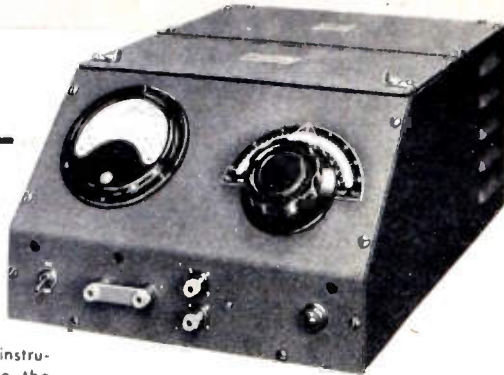

The QX-Checker is a production type test instrument specifically designed to compare the reactance and relative Q of small RF inductors with approved standards. The two factors, reactance and relative Q, are separately indicated, one on the meter and the other on a condenser dial, so that the deviation of either from established tolerances is immediately shown. Built to laboratory standards, the QX-Checker is a sturdy, foolproof instrument for use in production work by factory personnel.

SPECIFICATIONS

OSCILLATOR FREQUENCY RANGE: 1.5 to 25 mc. in 3 ranges using accessory plug-in-coils (two coils furnished with each instrument).

ACCURACY OF COIL CHECKS: Inductance values between 5 and 35 microhenries may be checked to an accuracy of $\pm 0.5\%$. Smaller values down to 0.1 microhenries may be checked with decreasing accuracy.

INDICATING SYSTEM: Q indicating meter with well expanded $3\frac{1}{4}''$ scale shows departure of Q from nominal value. Vernier condenser scale calibrated directly in terms of percent departure from known standard over range of -15% to $+20\%$. Capacitance scale is also provided reading changes of -50 mmf. to $+50$ mmf. from nominal circuit capacitance of 300 mmf.

POWER SUPPLY: 110-125 volts, 50-60 cycles, also 200-250 volts, 50 cycles.

DIMENSIONS: Width $12\frac{1}{4}''$, Depth $18''$, Height $8''$.

WEIGHT: 26 lbs. **PRICE:** \$415.00 f.o.b. Boonton, N. J.

Write for Catalog

BOONTON RADIO



BOONTON-N.J.-U.S.A.

Corporation

DESIGNERS AND MANUFACTURERS OF THE "Q" METER . . . QX-CHECKER . . . FREQUENCY MODULATED SIGNAL GENERATOR . . . BEAT FREQUENCY GENERATOR . . . AND OTHER DIRECT READING TEST INSTRUMENTS

News—New Products

These manufacturers have invited PROCEEDINGS readers to write for literature and further technical information. Please mention your I.R.E. affiliation.

(Continued from page 77A)

New Oscilloscope

Manufactured by Jackson Electrical Instrument Co., 18 S. Patterson Blvd., Dayton 1, Ohio, this new oscilloscope has a wide-band vertical amplifier response uniform from 20 cps to 4.5 Mc. It has a high sensitivity of 0.018 rms volts per inch, with response uniform to 100 kc.

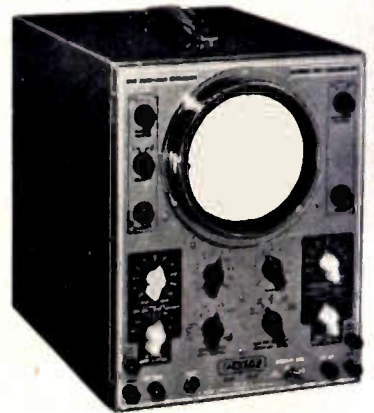

A sweep oscillator provides saw-tooth wave, 20 cps to 50 kc in five steps. A sine wave sweep of 60 cps is also available. Intensity modulation, either external or internal, is 60 cps. The calibration screen is removable, and a demodulation probe is also available to use for signal tracing.

Re-Designed Frequency Response Recorder

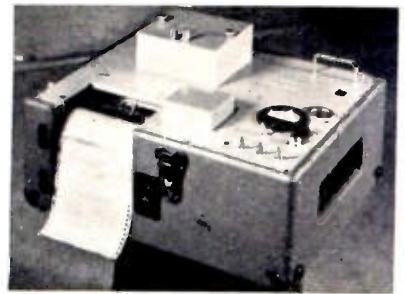

Sound Apparatus Co., Stirling, N. J., has re-designed their frequency response recorder, Model FR. The new features are: an additional synchronous motor to operate the chart and a connection to auxiliary apparatus, such as oscillator, analyzer, etc.; a switching arrangement whereby a signal source (oscillator, analyzer) can be electrically remotely controlled from the recorder, in addition to the conventional mechanical link unit; ac and dc voltages can be recorded; the electronic circuit, an integral part of the instrument, can be easily interchanged. The new design also includes improvement of the mechanical construction, such as sturdier writing mechanism and sturdier construction of subassemblies.

(Continued on page 79A)

News—New Products

These manufacturers have invited PROCEEDINGS readers to write for literature and further technical information. Please mention your I.R.E. affiliation.

(Continued from page 78A)

New Potentiometer

An ultra-low-torque potentiometer incorporating design characteristics new to the precision instrument field has been announced by Electro-Mec Laboratory, 225 Broadway, New York 7, N. Y. The new instrument, following laboratory and field tests, is now in commercial production.



(Continued on page 80A)

The New STAVER MINI-SHIELD

TRADE MARK REG. AND PAT. PEND.

The shield that fits all Miniature Tubes



A flexible shield that snugly fits all miniature tubes because it compensates for all variations in tube dimensions. Mini-Shields are made for both T5 1/2 and T6 1/2 bulb tubes. Send for catalog sheet.

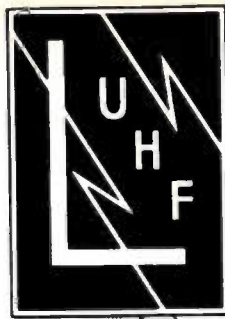

complete facilities for

**DESIGN
DEVELOPMENT
PRODUCTION**

OF
**U·H·F
EQUIPMENT**

- ... If UHF design or development is a major problem with you, or ...
- ... If low-unit manufacturing cost is essential to satisfactorily meet competition, or ...
- ... If trustworthy, confidential collaboration is a highly necessary factor ...

THEN Lavoie Laboratories can be of invaluable, practical assistance. We have the Engineering Staff ... the shop techniques ... a competent understanding of government contract procedures ... and the reputation to satisfactorily meet all those requirements.

Lavoie Laboratories, Inc.
MORGANVILLE, N. J.

Specialists in the Development and Manufacture of UHF Equipment

SMALL
PARTS
Cost less when made by
MULTI-SWAGE

The economy way to get a million small parts similar to these —

Examine the tubular metal parts shown here twice size. If you use anything similar ... in quantities of over a million ... important savings can be yours. Send us the part and specs. Our quotation will show why the Bead Chain Company's MULTI-SWAGE Process has long been known as the most economical method of making electronic contact pins, terminals, jacks and sleeves. And, why more and more users of mechanical parts (up to 1/4" dia. and to 2" length) employ our facilities. WRITE for Data Bulletin.

B THE BEAD CHAIN MANUFACTURING CO.,
Tr. Mark 60 MOUNTAIN GROVE ST., BRIDGEPORT 5, CONN.

E-I HERMETIC SEALING COMPONENTS

Easy to Install — High Dielectric GASKET TYPE BUSHINGS



For heavier equipment requiring larger terminals, E-I Gasket Type Bushings are recommended. They offer high dielectric strength, high resistance to mechanical and thermal shock, complete hermetic sealing, easy installation. Specially processed gland penetrates deeply into the L-5 Steatite insulator, seals against the mounting surface, resists oil and pitch and is unaffected by high heat. Hot-tinned brass studs provide excellent electrical conductivity. E-I Bushings meet all government specifications for sealed transformers and condensers (Jan T-27, Jan C-25) Glands available in Neoprene (-65° to +227°F) Hycar (-90° to +350°F) Silastic (-100° to +500°F)

Write for quotations and descriptive Bulletin 851 for complete details and specifications — no obligation.



ELECTRICAL INDUSTRIES
INCORPORATED
44 SUMMER AVENUE • NEWARK 4, N. J.

News—New Products

These manufacturers have invited PROCEEDINGS readers to write for literature and further technical information. Please mention your I.R.E. affiliation.

(Continued from page 79A)

Primarily designed as an industrial or aircraft instrument component, this potentiometer can be operated by the minute hand of a wrist watch or the pointer of an aneroid barometer, and is currently offered with a shaft torque as low as 0.003-inch ounces.

Designs of the new ultra-low-torque potentiometers are available to carry currents as high as 0.1 ampere and with outputs sufficient to operate indicating, recording, or controlling devices, without amplification. Resistance values between 50 and 200,000 ohms are provided for.

Accuracies as high as 0.05 per cent are available, and satisfactory operation under vibration at frequencies up to 200 cps have been demonstrated in actual use.

New DC Millivoltmeter and Microammeter

The new Model MV-17b dc millivoltmeter has been electronically and physically redesigned by Millivac Instruments, P.O. Box 3027, New Haven, Conn., so as to give performance and accuracy with a variation in calibration of less than 1 per cent for 20 per cent line voltage change.

Electronic PEAK to PEAK

VOLTMETER

Designed for PULSE AMPLITUDE MEASUREMENTS

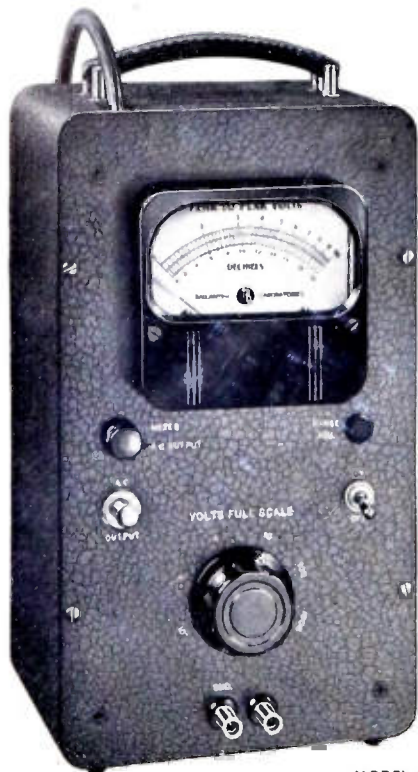

MODEL 305

The outstanding characteristic of the Model 305 Electronic Voltmeter is its ability to provide absolute indication of transient or pulse voltages of short duration. Reliable indication of pulses a few microseconds wide repeated only 20 times per second is readily obtained with this instrument. The Voltmeter is pre-calibrated, compact, easy to operate and observe. Positive and negative peaks are registered over the ranges of .001 volt to 1000 volts, peak to peak. Decade ranges and a logarithmic scale output meter are characteristic features, along with a separately available high gain, wide-band amplifier.

For further information on this and other Ballantine Voltmeters, write for catalog

BALLANTINE LABORATORIES, INC.



102 FANNY ROAD, BOONTON, N. J.



The first stage of the carrier amplifier has an unusually high gain of over 1,000, and is directly coupled to the second stage. Internal hum pickup and tube noise are reduced by exceptionally heavy feedback of more than 1,000 to 1. All tubes are under-heated, making burn-outs a rare occurrence. The instrument has a sensitivity of 1 mv full scale with 6 megohms input impedance (165×10^{15} watts) and ranges up to 1,000 volts dc at 60 megohms. It may also be used as a micromicroammeter (250×10^{12} amperes full scale) with a separate shunt box, type MV-171.

(Continued on page 81A)

News—New Products

These manufacturers have invited PROCEEDINGS readers to write for literature and further technical information. Please mention your I.R.E. affiliation.

(Continued from page 80A)

Vectron Spectrum Analyzer

Vectron, Inc., 235 High St., Waltham 54, Mass., announces the entirely new Vectron spectrum analyzer, covering the S and X bands.



(Continued on page 82A)

NOW!
SPEED UP ALL SOLDERING WITH
UNGAR
FEATHER-LIGHT SOLDERING PENCILS WITH
HI-HEAT
INCREASED WATTAGE
TIPS



For use with No. 776 Handle & Cord Set

Stop wrestling with big irons. Now HI-HEAT TIPS in your Ungar Electric Soldering Pencil produce a really versatile tool that'll perform on a par with the big, bulky 100-150 watt irons. If you can't get immediate delivery, please be patient, for production hasn't yet caught up with demand. Ask your supplier for No. 1236 Pyramid or No. 1239 Chisel. List price, \$1.25 each.

Ungar
ELECTRIC TOOL CO., Inc.
LOS ANGELES 54, CALIFORNIA

FROM THE SMALLEST TO THE LARGEST YOU'LL DO BETTER WITH BUD

MINIBOXES



There are thousands of uses in the fields of radio and electronics for these new boxes. They are made from heavy gauge aluminum. The design of the box permits installation of more components than would be possible in the conventionally designed box of the same size. It is of two piece construction, each half forming three sides. The flange type construction assures adequate shielding. Available in etched aluminum finish and gray hammerloid finish.

Catalog Number	Gray Etched	Length	Width	Height	Gray Etched	Dealer Cost
CU-2100	CU-3000	2 1/2"	2 1/2"	1 1/2"	\$.57	\$.51
CU-2101	CU-3001	3 1/2"	2 1/2"	1 1/2"	.57	.51
CU-2102	CU-3002	4"	2 1/2"	1 1/2"	.60	.54
CU-2103	CU-3003	4"	2 1/2"	1 1/2"	.78	.72
CU-2104	CU-3004	5"	2 1/2"	2 1/4"	.81	.75
CU-2105	CU-3005	5"	4"	3"	.90	.84
CU-2106	CU-3006	5 1/2"	3"	2 1/8"	.87	.81
CU-2107	CU-3007	6"	5"	4"	1.21	1.02
CU-2108	CU-3008	7"	5"	3"	1.26	1.14
CU-2109	CU-3009	8"	6"	3 1/2"	1.83	1.71
CU-2110	CU-3010	10"	6"	3 1/2"	2.25	1.89
CU-2111	CU-3011	12"	7"	4"	2.67	2.40
CU-2112	CU-3012	17"	5"	4"	3.15	2.79
CU-2113	CU-3013	10"	2"	1 1/2"	.90	.84
CU-2114	CU-3014	12"	2 1/2"	2 1/4"	1.23	1.05
CU-2115	CU-3015	4"	2"	2 1/4"	.75	.69
CU-2116	CU-3016	3 1/4"	2 1/4"	1 1/2"	.78	.72

Prices 10% higher west of the Mississippi River

ADD-A-RACK SERIES



It has always been necessary to buy special racks without louvers on one side to obtain a maximum of panel space with a minimum of floor space. Now, you no longer need to buy a whole new cabinet when you want additional panel space. Through our new and exclusive Add-a-Rack series, BUD not only offers additional racks at a lower cost, but provides you with a sturdier, better looking assembly.

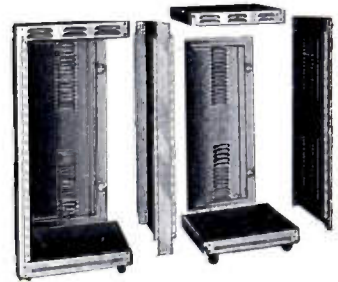

The illustration above at left shows two Add-a-Rack cabinets assembled together. The illustration above at right shows the unique and ingenious method of adding a unit to your present equipment. Instead of buying an entire new outfit, you purchase only four parts: (1) a door, (2) a top, (3) a bottom and (4) an Add-a-Rack coupling unit. The right (or left) hand side of your present relay rack is removed and replaced by the Add-a-Rack coupling unit; next, a top and bottom is fastened into place, and the side taken from the first rack is fastened onto the second rack which has been added. Place the additional door into position and you have two racks properly and efficiently coupled together.

In the same simple way, more racks can be added at any time and every one will be in a CONTINUOUS ONE-PIECE assembly.

This series is available in two ways: (1) a double unit consisting of two racks and the Add-a-Rack coupling unit, (2) Add-a-Rack unit, consisting of a door, a top, a bottom and an Add-a-Rack coupling unit. These units are furnished with all necessary assembling and panel mounting hardware.

BUD RC-7756 Casters will fit this unit. Casters are not included in price of cabinet.

Add-a-Rack Unit	To Add-a-Rack to	Overall Height	Panel Space	Dealer Cost
AR-1778	CR-1774	46 1/16"	36 3/4"	\$28.85
AR-1775	CR-1771	47 5/16"	42"	35.00
AR-1776	CR-1772	66 9/16"	61 1/4"	42.00
AR-1777	CR-1773	82 5/16"	77"	52.00

Complete unit, consisting of the knocked-down parts necessary for two relay racks coupled together.

CR-1779 two coupled relay racks same size as CR-1774	Dealer Cost
CR-1779 two coupled relay racks same size as CR-1774	\$60.20
CR-1780 two coupled relay racks same size as CR-1771	70.45
CR-1786 two coupled relay racks same size as CR-1772	87.00
CR-1799 two coupled relay racks same size as CR-1773	107.00

Prices are 10% higher west of the Mississippi River.

The above are only a few of our standard items. Send for catalog for complete information. We welcome the opportunity of quoting from your blue prints on special steel or aluminum housings.



BUD RADIO, INC.

2110 EAST 55TH STREET

CLEVELAND 3, OHIO

Pioneer in Radio Engineering Instruction Since 1927

CAPITOL RADIO

ENGINEERING INSTITUTE

An Accredited Technical Institute

ADVANCED HOME STUDY AND RESIDENCE COURSES IN PRACTICAL RADIO-ELECTRONICS AND TELEVISION ENGINEERING

Request your free home study or resident school catalog by writing to:

DEPT. 2610B
16th and PARK ROAD, N.W.
WASHINGTON 10, D.C.

Approved for Veteran Training

IT'S KINGS FOR CONNECTORS

News—New Products

Pictured here are some of the more widely used R. F. co-axial, U. H. F. and Pulse connectors. They are all Precision-made and Pressurized when required. Over 300 types available, most of them in stock.

Backed by the name **KINGS**—the leader in the manufacture of co-axial connectors. Write for illustrated catalogs. Department "T"

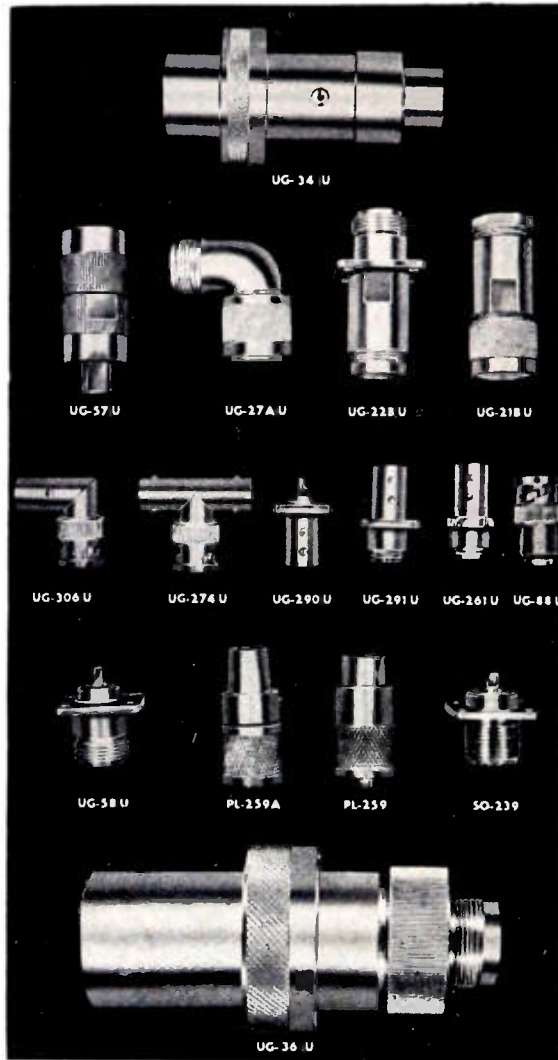

Manufacturers of Radar, Whip, and Aircraft antennas
Microphone Plugs and Jacks.
Radar Assemblies, Cable Assemblies, Microwave and
Special Electronic Equipment

These manufacturers have invited PROCEEDINGS readers to write for literature and further technical information. Please mention your I.R.E. affiliation.

(Continued from page 81A)

This analyzer has been engineered carefully to avoid obsolescence, by making provisions for rapid interchange of rf heads that will provide coverage of the microwave spectrum to 30,000 Mc. The unit features a functionally designed housing incorporating a 5-inch cathode-ray tube indicator, with a mounting that permits convenient use of a 35-mm camera for recording information from the cathode-ray tube.

New Clipper-Filter

The SA-403-A, a device for clipping and filtering speech before modulation in a radiotelephone transmitter, has been introduced by the **Standard Transformer Corp.**, 3580 Elston Ave., Chicago 18, Ill.

Measuring $1\frac{1}{2} \times 1\frac{1}{2} \times 4\frac{1}{2}$ inches, the SA-403-A clipper-filter requires no outboard wiring, and is designed to plug into the octal socket vacated by removing a tube in the speech amplifier circuit.



Highly effective circuits in the SA-403-A involve four triodes (two 6J6's). A control sets the peak level of amplitude modulation or frequency deviation, as the case may be.

The use of this clipper-filter for radiotelephonic transmission safeguards against overmodulation or overdeviation, and increases the effectiveness of the transmission. A higher average level of modulation is attainable. Narrow channel-width results as unnecessary high and low audio frequencies are eliminated and all modulating power is concentrated to produce the most useful sideband frequencies.

More complete details can be obtained by writing for Bulletin 360.

(Continued on page 84A)

THE RADIO ENGINEERING SHOW



Dates: March 19-22, 1951
Monday through Thursday
Place: Grand Central Palace,
New York City
at Lexington Ave. and 46th St.

Plan to Come!

252 Exhibits—17,689 Attended in 1950

for your

Raytheon Tube Requirements in the Metropolitan New York Area

It's

DALIS

Phone

Algonquin

5-3000

*Serving the trade for
over a quarter century*

**H.L.
DALIS INC.**
*Wholesale Distributors
Electronic Parts*

175 VARICK ST.,
NEW YORK 14, N.Y.

Wire or Write Dept. IND

ON THE JOB AT THE FAMOUS BELL "LABS"



In this modern home of telephone research—the Bell Telephone Laboratories, Murray Hill, N. J.,—Ace Screen Rooms play an important part in assuring maximum shielding efficiency for numerous test and research procedures.

Better Attenuation

... AT NO GREATER COST!

Designed to exacting wartime laboratory standards, supplied in ready-built "knock-down" form for installation in a few hours, Ace Screen Rooms provide a minimum of 100 db. attenuation from 0.15 to 1000 mc. Total cost is no greater than that of "homemade" screen rooms of far lower efficiency. Numerous sizes are available and rooms can readily be moved or enlarged as required. Write, wire, or 'phone for details.

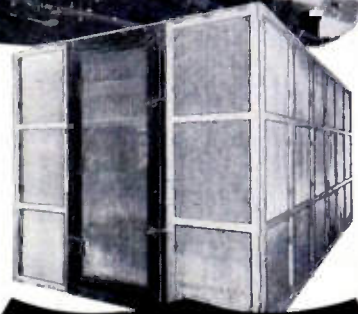

ACE
READY-BUILT "UNIT CELL"
SCREEN ROOMS

ACE ENGINEERING & MACHINE CO.
3642 N. Lawrence St.
Philadelphia 40, Pa. REgent 9-1019

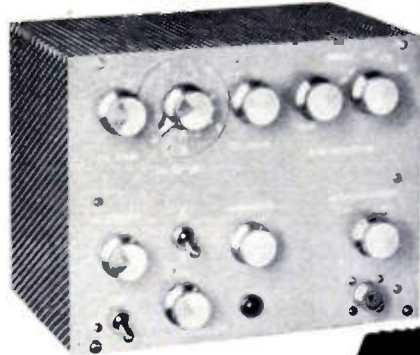

THE *Berkeley*
MODEL 902

DOUBLE PULSE GENERATOR

TYPICAL PULSE COMBINATIONS

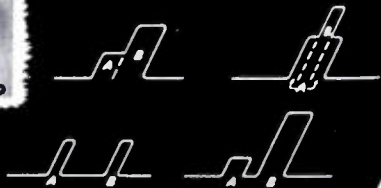

BRIEF SPECIFICATIONS

PULSE DURATION individually adjustable from 0.15 to 1.5 microseconds; RISE TIME is .05. DECAY TIME 0.10 microseconds. SPACING between pulses variable from -0.5 to +10 microseconds. REPETITION RATE adjustable in 3 ranges, 1 to 10, 10 to 100 and 100 to 1000 cycles; can be externally triggered. OUTPUT IMPEDANCE approximately 400 ohms, maximum output voltage, -200 v. CONTROL CALIBRATION ACCURACY $\pm 5\%$ over entire range.

The Berkeley Double Pulse Generator produces two pulses individually controllable in width, amplitude and time relation to each other. Pulse amplitude is individually adjustable without cross effect from 0 to +50 v. and 0 to -200 v. A fine control, plus a 10 to 1 step attenuator permits varying the amplitude of both pulses after mixing.

TYPICAL APPLICATIONS... Resolution tests of high speed scaling circuits, response simulation of scintillation and proportional counters, evaluation of electronic gate and switch response, TV equipment testing, characteristic checks of wide band amplifiers, etc.

COMPLETE INFORMATION is yours for the asking; please request Bulletin IRE-902.

Berkeley Scientific Company

SIXTH & NEVIN AVENUE • RICHMOND, CALIFORNIA

These manufacturers have invited PROCEEDINGS readers to write for literature and further technical information. Please mention your I.R.E. affiliation.

(Continued from page 82A)

New Oscillosynchroscope

Browning Laboratories, Inc., 750 Main St., Winchester, Mass., announces the Model OJ-17 oscillosynchroscope, designed for use in those laboratories where the maximum oscillographic facilities is required. The high-gain vertical amplifier has a response flat from 5 cps to 16 Mc, extending beyond 30 Mc, including the use of a 0.2-microsecond signal delay line. Two completely separate sweep systems permit display of repetitive phenomena with recurrence rates as high as 10 Mc, or transient and recurrent pulses as short as 0.05 microseconds.

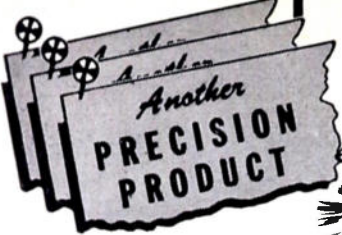

FOLLOW THE PARADE TO THE *New* Burlington Hermetically Sealed INSTRUMENT

JUST PLAIN RUGGED
 ... yet an instrument of highest **QUALITY**
 ... **PRECISION**
 ... **ACCURACY**

The Burlington "Hermetically Sealed" Instrument was designed and is manufactured to conform to JAN specifications for sealed instruments.

- Steel case with heavy copper-cadmium plate and black finish.
- Excellent shielding due to case material and construction.
- Double strength clear glass.
- Black satin onodized aluminum bezel.
- Glass to metal seal under controlled humidity and temperature conditions.
- D'Arsonval permanent magnet type movement for DC applications.
- Designed to enhance panel appearance.
- Available in 2 1/2" and 3 1/2" round case types.
- Guaranteed for one year against workmanship and materials.

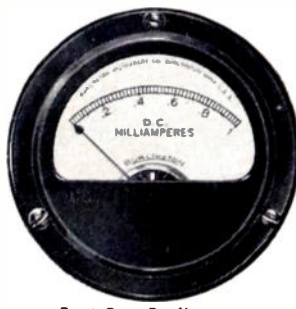

Best Buy Burlington

BURLINGTON INSTRUMENT COMPANY
 DEPT. I-100, BURLINGTON, IOWA

Test Equipment FOR **RADAR and PULSE APPLICATIONS**

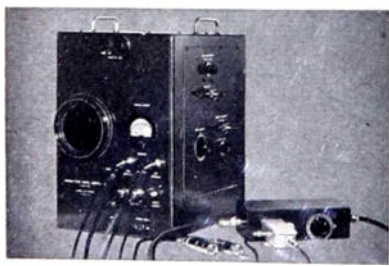

MODEL 705 WOBBULATOR

Swept signal output with center frequency adjustable from 2 to 500 mc.
 Continuous swept output adjustable from 0 to 100 mc./sec. with 0.1 volt output at 50 ohms.
 Internally synchronized scope with detectors and amplifiers.
 High and low impedance shielded traveling detectors.
 Output designed for making response measurements at 3000 mc., IF frequencies, and Video.

MODEL 708 SPECTRUM ANALYZER

Frequency range—8500 mc to 9600 mc.
 Receiver—Double conversion superheterodyne.
 IF bandwidth—approximately 10 kc.
 Sweep frequency—10 cps to 25 cps.
 Minimum frequency dispersion—1 mc/inch.
 Maximum frequency dispersion—10 mc/inch.
 Signal input attenuator—100 db linear.
 Power—115V or 230V, 50 cps to 800 cps.

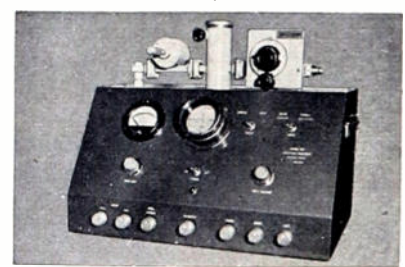

Built-in trigger and delay generators are provided for synchroscopic applications such as those encountered in radar circuits.

Accurate time measurements may be made by use of 0.1-, 1.0-, 10-, and 100-microsecond timing markers. Vertical signal amplitude measurements are likewise possible using a direct-reading deflection calibration system.

The high-voltage cathode-ray tube employed provides a trace sufficiently bright to be photographed even under high writing rate, single sweep conditions.

The OJ-17 consists of five separate chassis units assembled in a rack cabinet mounted on casters. A compartment is provided for permanent installation of an oscillo-record camera.

New Marine Radios

Standard Electronics Corp., Carlisle, Pa., has entered the marine radio telephone manufacturing field, with the production of four types of marine radios.

(Continued on page 85A)

Write for complete technical data | **Canoga Corporation**
 14315 Bessemer St., Van Nuys, Calif. • Box 361

News—New Products

These manufacturers have invited PROCEEDINGS readers to write for literature and further technical information. Please mention your I.R.E. affiliation.

(Continued from page 84A)

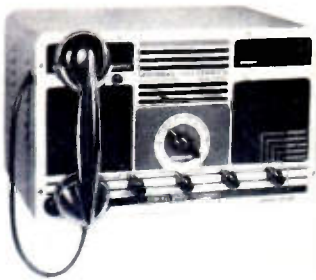

The sets, which range in power from 12 to 80 watts and are designed to cover pleasure and commercial craft requirement, will be made available in a few weeks through Graybar Electric Co.

Among the four marine radios is a compact, high-powered 12-watt unit at low cost for small boats and includes a standard broadcast band that can pick up all radio broadcasts available from shore. Another model, 15 inches wide by 9 inches deep, operating at 35 watts and having five channels, is considered the most efficiently designed marine radio telephone of comparable output yet developed, the company claims.

The two larger units operate at 50 watts and 80 watts, respectively, both having six transmitting and receiving channels.

(Continued on page 86A)

HIGHEST QUALITY ELECTRONIC COMPONENTS

Large Quantities in Stock for Immediate Delivery

- RELAYS
- TUBES
- TRANSFORMERS
- CHOKES
- VOLUME CONTROLS
- RECTIFIERS
- WIRE & CABLE
- TUBE SOCKETS
- RESISTORS (WIRE WOUND, CARBON, etc.)
- CONDENSERS (MOLDED, CERAMIC, OIL FILLED, etc.)
- SWITCHES (TOGGLE, MINIATURE, WAFER, etc.)

All standard brands, inspected and guaranteed by Wells Sales.

Manufacturers: Write for complete Electronic Catalog and prices. Dept. P



320 N. LA SALLE ST. CHICAGO 10, ILL.

COSSOR for QUALITY

WHEN TIMING COUNTS
you can count on
Cossor Twin Beam Scopes

UNIQUE twin beam flat face tube permits EXACT time comparison of two waveforms without phase or frequency error. Beams are independent vertically and locked in horizontal direction, can be separated, superimposed or crossed for any comparative test . . . and . . .

Model 1035 TWIN BEAM SCOPE (illustrated) offers these additional features: DIRECT time measurement on calibrated controls from 150 millise. to 1 microsec. DIRECT voltage measurement on each beam from 500 volts to 1 millivolt.

Recurrent or triggered sweeps from 150 millise. to 5 microsec. High gain, wide-band amplifier, -3 db. at 7 Mc.

Write for details on Model 1428 Scope Camera for still or moving film records.

All instruments and spares in stock New York.

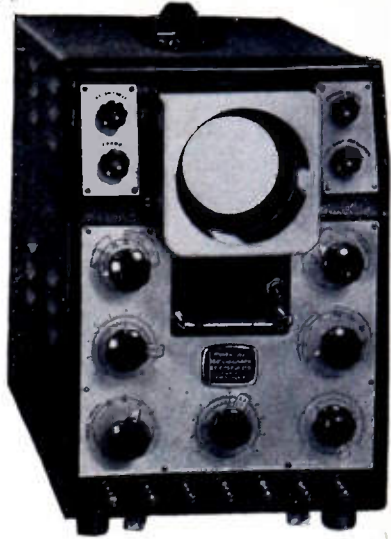

\$465 fob Halifax
\$650 fob New York

COSSOR (CANADA) LIMITED
301-303 Windsor Street, Halifax, N. S.
BEAM INSTRUMENTS CORPORATION
Room 907, 511 5th Avenue, New York 17, N. Y.

JOHNSON a famous name in Radio



SINGLE



BUTTERFLY



DIFFERENTIAL

SMALLEST AIR VARIABLES EVER PRODUCED

Variables in Miniature

JOHNSON miniature air variable condensers save space both behind and in front of the panel. The ceramic plate measures only 3/8" wide by 3/4" high. In spite of their size, these diminutive capacitors, accurately produced to close tolerances result in a completely dependable unit. Split sleeve bearings (available in plain or locking type) and soldered plate construction insure perfect alignment even in rigorous portable mobile service. A beryllium copper contact-tension spring guarantees permanent peak performance.

Three types of miniature variables are currently being produced: Single and Differential to 19.7 mmf. per section maximum capacity and Butterfly to 11.0 mmf. maximum capacity per section. Minimum capacity is held to low values. Plate spacing is .017"; peak breakdown voltage is 1250 volts.

As with all JOHNSON condensers, low loss ceramic insulation is used. Small plates and design with low inherent inductance enable the miniatures to be used efficiently at extremely high frequencies.

Write for JOHNSON Catalog 701 describing the miniature line as well as other JOHNSON variable condensers.



JOHNSON . . . a famous name in Radio!
E. F. JOHNSON CO., WASECA, MINNESOTA

KENYON

Fits Your

Production To A "T"

KENYON "T's"—high quality, uniform transformers, are your best bet for development, production and experimental work. For over 20 years, the KENYON "K" has been a sign of skillful engineering, progressive design and sound construction.

Now—reduce inventory problems, improve deliveries, maintain your quality—specify KENYON "T's," the finest transformer line for all high quality equipment applications.

New Catalog Edition! Write Today!

KENYON new modified edition tells the complete story about specific ratings on all transformers. Our standard line saves you time and expense.

Send for your copy of our latest catalog edition now!



KENYON TRANSFORMER CO., Inc.
840 BARRY STREET · NEW YORK 59, N. Y.

Tuning Forks for precision frequency control

Philamon Laboratories manufactures a complete line of tuning fork resonators to meet your frequency control requirements.

Temperature-compensated and hermetically sealed, the resonators are available in accuracies from 1 part in 3,000 to 1 part in 100,000, for operation over wide temperature ranges.

The resonators may be obtained individually—as a part of compact sub-assemblies—or in completely engineered equipment.

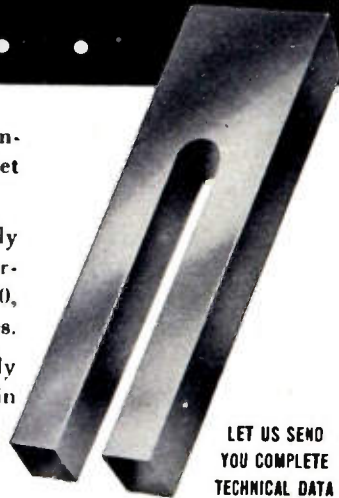

LET US SEND
YOU COMPLETE
TECHNICAL DATA



PHILAMON LABORATORIES
5717 Third Avenue, Brooklyn 20, N. Y.

News—New Products

These manufacturers have invited PROCEEDINGS readers to write for literature and further technical information. Please mention your I.R.E. affiliation.

(Continued from page 85A)

Subminiature Photoelectric Devices

Laboratory development of a tiny, inexpensive photocell which utilized the photosensitivity of germanium has been announced by R. M. Bowie, Physics Laboratories, Sylvania Electric Products Inc., Bayside, L. I., N. Y.

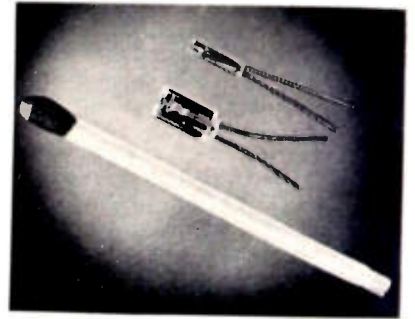

These new subminiature photoelectric devices are sufficiently sensitive so that useful current changes are obtained with relatively small changes in light intensity. It is anticipated that they will find wide use in such applications as decoding punched tape, electronic computing and sorting, and in the direct operation of relays such as opening and closing doors. Compactness and high sensitivity should make them well suited for many applications where cost, complexity of circuitry, and space limitation are important factors.

The new photoelectric device is essentially a germanium diode especially designed to permit use of the photoelectric properties of germanium and similar semiconductors. Experimental models have been made in which a tiny piece of germanium in contact with a fine wire or "whisker" is sealed in a solid piece of plastic about half an inch long and smaller diameter than a kitchen match. The transparent plastic, in addition to serving as a rugged sealed housing, provides an effective light path to the point at which the whisker makes contact with the germanium.

These new devices are still in the laboratory stage and have not been completed for quantity production.

Frequency Standards and Dividers

A new type frequency divider is being employed in the frequency standards of Analysis Instrument Co., P.O. Box 231, East Paterson, N.J. The divider, when used in conjunction with crystal or tuning fork standard oscillators, makes possible a more compact arrangement for supplying motor drive frequencies for facsimile, watchtiming, and similar applications than were formerly available, the company claims.

(Continued on page 87A)

News—New Products

These manufacturers have invited PROCEEDINGS readers to write for literature and further technical information. Please mention your I.R.E. affiliation.

(Continued from page 86A)

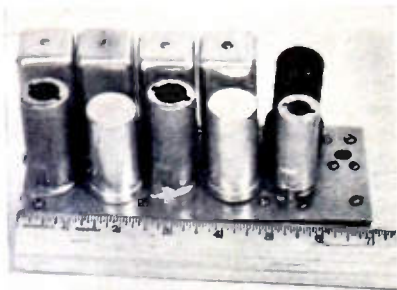

The picture shows a complete frequency standard for delivering 60 cps from a 90.72-kc crystal controlled oscillator; its over-all dimensions are: length, 7 inches; depth, 3 inches; and height, 3 $\frac{3}{4}$ inches; weighing 1 pound 3 ounces.

The frequency divider gives stable operation over wide supply voltage and ambient temperature variations. The divider can be supplied to specifications with or without frequency standards.

(Continued on page 88A)

S.S. White MOLDED RESISTORS

The All-Weather Resistors



ARE USED IN THIS ULTRA SENSITIVE ELECTRONIC PHOTOMETER

In this instrument—designed for measurement of very low light values—S.S. White Resistors serve as the grid resistance in the all-important high-gain D.C. amplifier circuit. The manufacturer, Photovolt Corp., New York, N.Y., reports that the resistors "work very satisfactorily"—which checks with the experience of the many other electronic equipment manufacturers who use S.S. White resistors.

WRITE FOR BULLETIN 4906

It gives essential data about S.S. White Resistors, including construction, characteristics, dimensions, etc. Copy with price list on request.

Photo courtesy of
Photovolt Corp., New York, N.Y.



S.S. WHITE RESISTORS
are of particular interest to all who need resistors with inherent low noise level and good stability in all climates.
HIGH VALUE RANGE
10 to 10,000,000 MEGOHMS
STANDARD RANGE
1000 OHMS to 9 MEGOHMS

THE S.S. White INDUSTRIAL DIVISION
DENTAL MFG. CO. Dept. G-R 10 East 40th St.
NEW YORK 16, N. Y.



**ONLY \$215* FOR
THE GREEN
ENGRAVER**
... yet it's fast, versatile
and rugged enough
for die steel

The Green Engraver offers great speed and convenience. Quickly cuts up to four lines of letters from 3/64" to 1" on curved or flat surfaces whether made of metal, plastics or wood... operates by merely tracing master copy — anyone can do an expert job. Special attachments and engineering service available for production work. Just the thing for radio, electronic apparatus and instrument manufacturers.

For quality engraving on

• Panels • Name Plates • Scales
• Dials • Molds • Lenses • Instruments
... also does routing, profiling and three dimensional modeling.

*Price does not include master type and special work holding fixtures.

GREEN INSTRUMENT CO.

GREEN

361 Putnam Ave.
Cambridge, Mass.

WIDE BAND DIRECT COUPLED OSCILLOSCOPE

Tektronix Type 514-D

Bandwidth: DC—10 mc

Sensitivity: AC—.03 v/cm
DC—.3 v/cm

Sweep Range: .1 usec/cm—.01 sec/cm
continuously variable

Voltage Calibrator: Square wave,
0—50v in 6 ranges

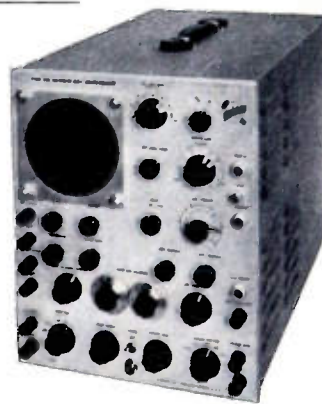

The advantages of the direct coupled oscilloscope are now available in the region of 10 mc. Not only is it possible to measure the duration and amplitude of a waveform, but also the D.C. level at which it occurs.

- Distributed type push-pull output amplifiers.
- .25 usec signal delay network.
- All DC voltages electronically regulated.
- Better than 5% accuracy of timing and amplitude.
- Triggered, recurrent or single sweeps.

Write or wire for complete specifications.

\$950.00

f. o. b. Portland,
Oregon



Circle 1, TEKTRONIX

712 S. E. HAWTHORNE BLVD. PORTLAND 14, OREGON

News—New Products

These manufacturers have invited PROCEEDINGS readers to write for literature and further technical information. Please mention your I.R.E. affiliation.

(Continued from page 87A)

Impedance Measurement Equipment

The FTL-42A Impedometer is a device for the measurement of impedance in the frequency range from below 50 Mc to above 500 Mc. Below 500 Mc its accuracy is ± 5 per cent. Designed by Federal Telecommunication Laboratories, Inc., 500 Washington Ave., Nutley 10, N. J., the meter consists of a short length of standard $1\frac{1}{2}$ -inch 52-ohm coaxial line on which are mounted two directional couplers, a voltage probe, and a capacitance plunger. On the panel, besides the capacitance button, is a switch for selecting either of the two directional couplers or the voltage probe; also a plug connected to the output of the switch. Two step adapters are furnished, $1\frac{1}{2}$ inch line to type N. Adapters for other sizes of lines and cables can be supplied.



To use the Impedometer, a signal generator is connected to one end of the line and the load to be measured is connected to the other end. A crystal detector and amplifier, or a radio receiver, is connected to the output plug on the panel. Then the switch is set consecutively to its three positions and the relative output voltage measured for the incident and reflected waves and the total voltage on the line. A simple diagram or a Smith Chart gives the impedance at the voltage probe, which can be readily transformed to the impedance at the load.

The Impedometer can also be used as a simple reflectometer for the measurement of reflection coefficient and SWR.

Dynamic Micro-Miker

The new Dynamic Micro-Miker should be an invaluable tool for television engineers and others concerned with wide-band amplifiers. Designed by Kalbfell Labs., Inc., 1076 Morena Blvd., San Diego 10, Calif., this equipment measures the small interelectrode and wiring capacities present in video amplifiers under operating conditions, including Miller effect. It also measures the inductance of peaking coils. Thus, for the first time, it is possible to make a significant measurement of capacity for designing a peaking coil and to check the coil with one instrument.

(Continued on page 89A)



Patents Regd Trade Mark

THE LOWEST EVER CAPACITANCE OR ATTENUATION

We are specially organised to give SPOT DELIVERIES TO U.S.A. Cable your rush order for shipment by air freight. Settlement by your own check

TRANSRADIO LTD

CONTRACTORS TO H.M. GOVERNMENT
43 BA CROMWELL ROAD-LONDON SW7 ENGLAND
CABLES: TRANSRAD. LONDON.

LOW ATTEM TYPES	IMPED OHMS	ATTEN db/100ft	LOADING M_w of 100 Mc/s	OD"
A 1	74	1.7	0.11	0.36
A 2	74	1.3	0.24	0.44
A 34	73	0.6	1.5	0.88
LOW CAPAC TYPES	CAPAC mmf/ft	IMPED OHMS	ATTEN db/100ft	OD"
C 1	7.3	150	2.5	0.36
PC 1	10.2	132	3.1	0.36
C 11	6.3	173	3.2	0.36
C 2	6.3	171	2.15	0.44
C 22	5.5	184	2.8	0.44
C 3	5.4	197	1.9	0.64
C 33	4.8	220	2.4	0.64
C 44	4.1	252	2.1	1.03

HIGH POWER FLEXIBLE

PHOTOCELL CABLE

V. L. C. ★

★ Very Low Capacitance cable.

SYNTHESIS
IS A HIGH CLASS WORD
FOR DESIGNING
SERVO MECHANISMS



... SERVOSCOPE IS A HIGH CLASS INSTRUMENT FOR SERVO SYNTHESIS!



Write for Information

MEASURES amplitude & phase vs. frequency
CARRIERS accepted, 50 to 800 cps
MODULATES chosen carrier, 0.1 to 20 cps
ANALYZES D.C. or A.C. automatic controls
SUB-AUDIO sine generator, 0.1 to 20 cps
SQUARE WAVE generator, 0.1 to 20 cps
PHASE READING to 1° accuracy, 2 methods
LINEAR SWEEP for external use, 0.1 to 20 cps

SERVO CORP. OF AMERICA
NEW HYDE PARK, N. Y.

New Miniature Insulated Terminals

to help your miniaturization program

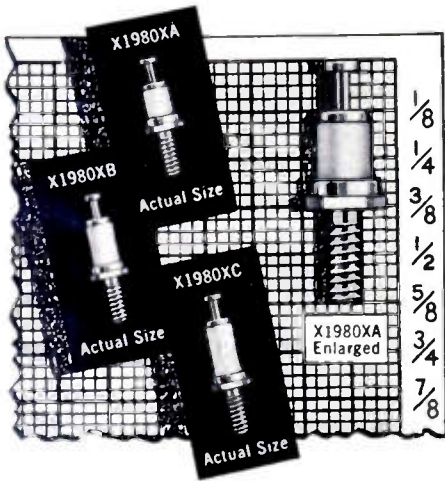

Featuring extremely small size combined with excellent dielectric properties, three new miniature insulated terminals are now available from CTC.

Designed to meet the requirements of the miniaturization programs now being carried out by manufacturers of electrical and electronic equipment, the terminals come in three lengths of dielectric and with voltage breakdown ratings up to 5800 volts. In addition, they have an extremely low capacitance to ground.

The X1980XA is the smallest terminal, having an over-all height of only three-eighths of an inch including lug. Insulators are grade L-5 ceramic, silicone impregnated for maximum resistance to moisture and fungi.

All terminals have hex-type mounting studs with 3/48 thread or .141" OD rivet style mounting. Mounting studs are cadmium plated, terminals are of bright-alloy plated brass.

Write for additional data.

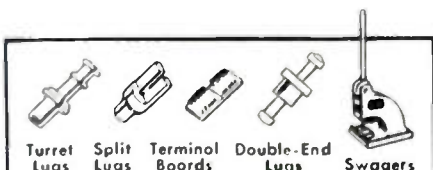

custom or standard the guaranteed components

CAMBRIDGE THERMIONIC CORP.
456 Concord Ave., Cambridge 38, Mass.
West Coast Stock Maintained By: E. V. Roberts,
5014 Venice Blvd., Los Angeles, California

News—New Products

These manufacturers have invited PROCEEDINGS readers to write for literature and further technical information. Please mention your I.R.E. affiliation.

(Continued from page 89A)



Capacities from 0.1 μf up to 0.005 μf are measured in three ranges and the inductance range extends from 1 microhenry to 250 microhenries. The instrument is direct reading and unusually simple to operate.

12-Channel Television Transmitter

The Tel-Instrument Co., Inc., 50 Paterson Ave., East Rutherford, N. J., Type 2111 television transmitter, is designed to provide a rapid method of production testing TV receivers on all 12 TV channels. When modulated by a composite video signal such as produced by a microscope chain, it will provide a standard rf picture signal suitable for use as a final air check of receivers. The picture signal has an associated FM sound carrier which may be modulated at 400 cps or with music from an external source.



The Type 2111 consists of a 12-channel crystal controlled oscillator, frequency multiplier, and amplifier turret which produces the rf picture carrier on each TV channel. The rf output amplifier is suppressor grid double sideband modulated by means of a video amplifier having adequate frequency response to fully reproduce at least a 375-line signal. The video signal is obtained from an external source.

The FM sound carrier has two components 4.5 Mc above and below the picture carrier, and the TV receiver selects the upper side band while rejecting the lower. Modulation of the sound carrier is accomplished by means of the internal audio oscillator operating at 400 cps or by an external signal such as music. A standard 75-microsecond pre-emphasis network is incorporated, and 40-kc deviation may be obtained. The deviation is continuously variable by means of a panel control.

(Continued on page 90A)



In only 1 SECOND! COMPLETE AUDIO WAVEFORM ANALYSIS with the AP-1 PANORAMIC SONIC ANALYZER

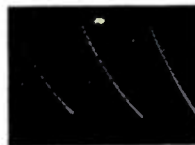

Oscilloscope of waveform to be analyzed

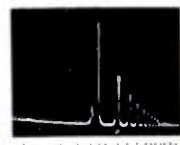

Panoramic Sonic Analysis of the same wave

Provides the very utmost in speed, simplicity and directness of complex waveform analysis. In only one second the AP-1 automatically separates and measures the frequency and amplitude of wave components between 40 and 20,000 cps. Optimum frequency resolution is maintained throughout the entire frequency range. Measures components down to 0.1%.

- Direct Reading
- Logarithmic Frequency Scale
- Linear and Two Decade Log Voltage Scales
- Input voltage range 10,000,000:1

AP-1 is THE answer for practical investigations of waveforms which vary in a random manner or while operating or design constants are changed. If your problem is measurement of harmonics, high frequency vibration, noise, intermodulation, acoustics or other sonic phenomena. Investigate the overall advantages offered by AP-1.

Write NOW for complete specifications, price and delivery.

See us in Room 626 at the Audio Fair, Hotel New Yorker, October 26, 27, 28, 1950.



A TRUE ELECTROSTATIC VOLTMETER

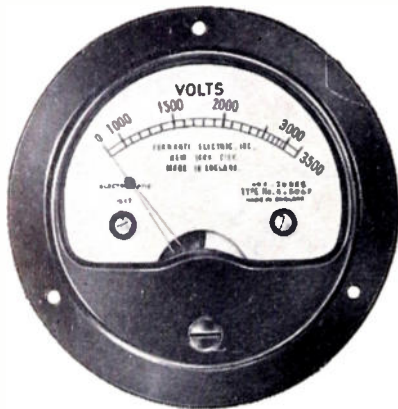

This instrument permits voltage readings on AC or DC circuits of very high resistance. The only current drawn is the very small leakage current and a very low capacitance current on AC circuits. Very useful for the many high voltage—low current circuits employed in nuclear research. Available with full scale voltages ranging between 300 and 3500 volts. Special laboratory instrument available with full scale reading of 150 volts. Full scale capacitance ranges from 8 mmfds for the 3500 volt model to 100 mmfds for the 150 volt instrument. Magnetic damping. 2½" dia. Write for complete specifications.

FERRANTI

FERRANTI ELECTRIC, INC.
30 Rockefeller Plaza • New York 20, N. Y.
FERRANTI, LTD., HOLLINWOOD, ENGLAND
FERRANTI ELECTRIC, LTD., TORONTO, CANADA

News—New Products

These manufacturers have invited PROCEEDINGS readers to write for literature and further technical information. Please mention your I.R.E. affiliation.

(Continued from page 89A)

Double Pulse Generator

Producing two pulses individually controllable in width, amplitude, and time relation to each other, a new instrument designated as the Model 902 double pulse generator is now in production by Berkeley Scientific Co., Sixth & Nevin Sts., Richmond, Calif.



Pulse amplitude is individually adjustable, without cross effect, from 0 to +50 and 0 to -200 volts. Amplitude of both pulses after mixing can be varied by means of a continuous fine control plus a 10-to-1 step attenuator. Pulse rise time is 0.05 microsecond, decay time 0.10 microsecond; duration is individually adjustable from 0.15 to 1.5 microseconds. Spacing between the two pulses is continuously variable in two ranges, -0.5 to +3 microseconds. Repetition rate is adjustable in 3 ranges: 1 to 10, 10 to 100, and 100 to 1,000 cps, and can be externally triggered. Output impedance is approximately 400 ohms; maximum output voltage is -200 v. Overall accuracy of control calibrations is ±5 per cent over the entire range.

Interesting Abstract

Available to the industry at no charge from **Magnetic Recording Div., Armour Research Foundation**, 35 W. 33 St., Chicago 16, Ill., is a comprehensive bibliography on magnetic recording. Beginning with a reprint from *The Electrical World* entitled "Some Possible Forms of Phonograph," (September 8, 1888), by Oberlin Smith, and listing 370 references through April, 1950, this booklet should be helpful to those interested in all stages of development of magnetic recording equipment.

(Continued on page 91A)

We will be grateful if you will mention PROCEEDINGS of the I.R.E. when writing to our advertisers.

Dependable
PERFORMANCE
at
LOWER COST



TOWER LIGHTING EQUIPMENT

H & P lighting equipment, consistently specified by outstanding radio engineers, is furnished as standard equipment by most leading tower manufacturers.

300 MM CODE BEACON

Patented ventilator dome circulates the air, assures cooler operation, longer lamp life. Concave base with drainage port at lowest point. Glass-to-glass color screen supports virtually eliminate color screen breakage. Neoprene gaskets throughout. CAA approved



MERCURY CODE FLASHER

Lifetime-lubricated ball bearings. No contact points to wear out. Highest quality bronze gears. Adjustable, 14 to 52 flashes per minute



SINGLE and DOUBLE OBSTRUCTION LIGHTS

Designed for standard A-21 traffic signal lamps. Prismatic globes meet CAA specifications.



"PECA" SERIES PHOTO-ELECTRIC CONTROL

Turns lights on at 35 f.c.; off at 58 f.c., as recommended by CAA. High-wattage industrial type resistors. Low-loss circuit insulation.



ALSO COMPLETE LIGHT KITS
FOR A-2, A-3, A-4 and A-5 TOWERS

PROMPT SERVICE and DELIVERY

First-day shipments out of stock. Immediate attention to specifications and unusual requirements

WRITE OR WIRE FOR CATALOG
AND DETAILED INFORMATION

HUGHEY & PHILLIPS

TOWER LIGHTING DIVISION

326 N. LA CIENEGA BLVD.
LOS ANGELES 48, CALIF.
60 E. 42ND ST. NEW YORK 17, N. Y.

News—New Products

These manufacturers have invited PROCEEDINGS readers to write for literature and further technical information. Please mention your I.R.E. affiliation.

(Continued from page 90A)

Three New Microphones

Stephens Manufacturing Corp., 8538 Warner Dr., Culver City, Calif., announces the introduction of a group of three microphone systems for swivel, stand, and lapel applications. Each system employs

heads of extremely small size. During the testing period, production models were used as standard equipment in recording, motion picture, broadcast, and television work.



Each system employs heads of extremely small size. During the testing period, production models were used as standard equipment in recording, motion picture, broadcast, and television work. Claimed to be essentially nondirectional throughout the entire audio range, this "Tru-Sonic Microphone" is claimed to be the only microphone on the market today utilizing the advantages of the condenser-type diaphragm in a circuit which does not require vacuum-tube circuits mounted adjacent to the head.

This microphone eliminates conventional pre-amplifiers. The efficiency claimed for the unit necessitates no other amplification than the one-tube amplifier circuit incorporated in the oscillator/demodulator unit to achieve an output of -15dbm when operated in the usual sound field of 10 dynes/cm². This level is said to be equivalent to a ribbon microphone with a 40 db pre-amplifier.

Recent Catalog

A new catalog, #500, presenting the complete line of transformers for broadcast, amateur, laboratory, and replacement purposes, is available to the industry from United Transformer Co., 150 Varick St., New York 13, N. Y.

NOTICE

Information for our News and New Products section is warmly welcomed. News releases should be addressed to Industry Research Division, Proceedings of I.R.E., Room 707, 303 West 42nd St., New York 18, N. Y. Photographs, and electrotypes if not over 2" wide, are helpful. Stories should pertain to products of interest specifically to radio engineers.

VARIAN MICROWAVE ENGINEERING

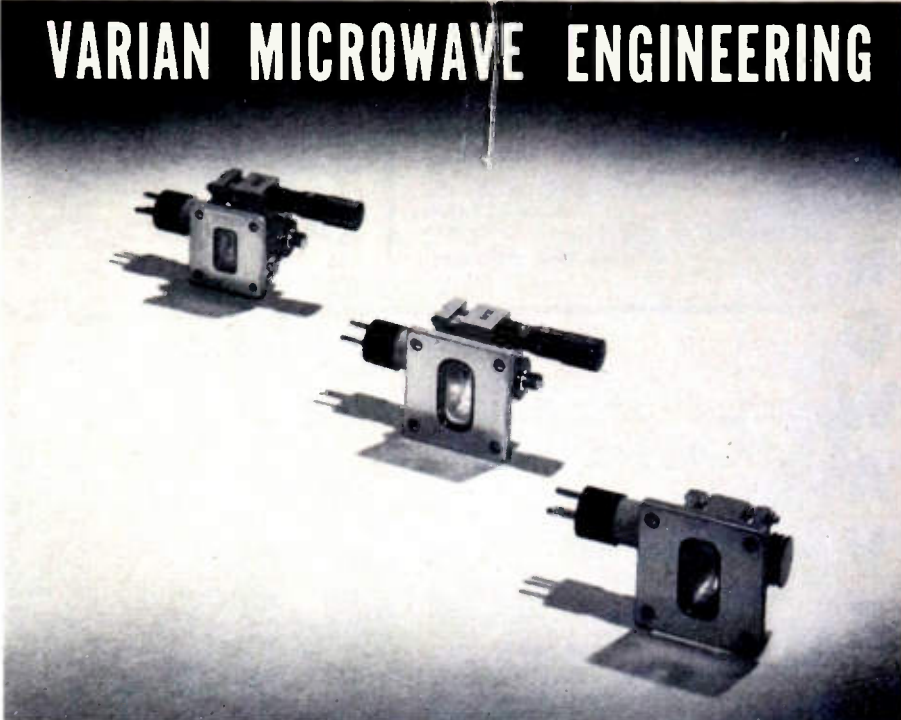

... adds a new broadband waveguide-output klystron

Designed for high-power laboratory and antenna measurements as well as for use as a stable transmitter tube in fixed and mobile service, the new Varian X-21 Klystron covers the frequency range 9100 to 11,000 mc. It is illustrated at right above. The two resonant cavities are integral and have self-contained feedback. Output mates with standard UG/39U flange for 1/2 by 1 by 0.050-in. waveguide. Low microphonic construction. Weight, 4 1/2 oz.

Typical Operation: Frequency, 10,000 mc; beam voltage, 1270 v; beam current, 98 ma; power output, 5.9 w; load VSWR, less than 1.1.

Two tunable waveguide-output reflex klystrons for the frequency range 8100 to 17,500 mc, the Varian X-12 and X-13, left and center in the illustration. Widely used for transmitter service and as local and bench oscillators as measurement power sources. Single screw tuners cover entire frequency ranges.

Typical Operation:	X-12	X-13
Frequency, mc	16,000	10,000
Beam Voltage	600	400
Beam Current, ma	50	48
Reflector Voltage	280	575
Power Output, mw	25	230
Load VSWR, max	1.1	1.1
Modulation Bandwidth, mc	50	30
Temperature Coefficient, mc per deg C, max	0.25	0.25

Now in production, two new klystrons for television service. Varian X-17 covers the range from 1990 to 2100 mc with 5 watts minimum power output. Varian X-26 Klystron group covers 5850 to 8200 mc with 0.5 watts minimum power output.

VARIAN
associates

99 washington st.
san carlos, calif.

MICROWAVE TEST EQUIPMENT

PULSE EQUIPMENT

G.E.K.—2745 \$39.80
 G.E.K.—2744-A. 11.5 KV Ithab Voltage, 3.2 KV Low Voltage @ 200 KV over. (270 KV max.) 1 microsec. or ¼ microsec. @ 600 PPS \$39.50
 G.E. K2450A. Will receive 13 KV 4 micro-second pulse on pri. secondary delivers 14KV. Peak power out 100KW G.E. \$34.50
 TP810 Modulator X Band \$350.00
 SO-4 Thyatron Modulator \$600.00
 SCR-208 Keyer units \$95.00
 715B Tubes \$12.00
 705A Tubes \$2.80
 705 Sockets \$7.70

Complete line of high voltage pulse transformers, networks and dual lines.

23,000 TO 27,000 MC. BENCH TEST PLUMBING

½" x ¼" WAVEGUIDE

PRECISION SLOTTED LINE. DeMornay Budd type 337, complete with adjustable probe and crystal output, Square flanges. \$400.00
PRECISION SLOTTED LINE. Adjustable probe. Humble Oil type CPK-2111H \$200.00
DIRECTIONAL COUPLER-WAVEMETER MOUNT. 12DB \$60.00
PRECISION VARIABLE ATTENUATOR. mfg. Bernard Rice \$90.00
TUNABLE CRYSTAL MOUNT. DB423 less tuning plunger \$30.00
FLAP ATTENUATOR. DB405 10DB attenuation \$25.00
LOW POWER LOAD \$20.00
SCHREW TUNER \$25.00
SHUNT TEE \$35.00
WAVEGUIDE LENGTHS. 2" to 6" long, gold-plated with circular flanges and coupling nuts \$2.25 per inch
 APS-34 Rotating Joint \$49.50
 Right Angle Bend E or H Plane, speedy com-

binlation of couplings desired \$12.00
 45° Bend E or H Plane, Choke to cover \$12.00
 Directional coupler CU-103/APS32 \$49.50
 Mitered Elbow cover to cover \$4.00
 TR-ATR Section, choke to cover \$4.00
 Flexible Section 1" choke to choke \$3.00
 "B" Curve Choke to cover \$5.00
 Adaptor, round to square cover \$4.00
 Feedback to Parabola Horn with pressurized window \$27.50
 Low Power Load, less cards \$18.50
 K Band Mixer Block \$48.00
 WAVEGUIDE ½" x ¼" \$1.00 per ft.
 Circular Flanges \$3.50
 Flange Coupling Nuts \$3.50
 Slotted line, DeMornay Budd 337, new \$450.00
 90° Twist \$10.00
 "K" Band Directional Coupler CU104/APS-34 20 DB \$49.50 ea.
 K BAND 2K33 w/cav \$115.00
 3131 Magnetrans \$55.00

8500 Mc. to 9600 Mc. Bench Test Plumbing

1" x 1½" WAVEGUIDE

SLOTTED LINE. Complete with adjustable probe, crystal output, precision vernier adjust. Humble Oil type \$220.00
KLYSTRON MOUNTS. DeMornay Budd type DB380 for 2K25 etc. includes tunable termination \$70.00
VARIABLE ATTENUATOR. DeMornay Budd type DB383. Maximum attenuation 35DB \$120.00
VARIABLE STUB TUNER. DB536, 180 degree phase shifting capability \$70.00
FLAP ATTENUATOR. DB385, Maximum Attenuation 10DB \$25.00
MAGIC TEE. DB539 \$42.00
WAVE GUIDE TO TYPE "N" ADAPTOR. DB377 \$15.00
LOW POWER TERMINATION. DB381 \$18.50
UNI-DIRECTIONAL COUPLER. DB390, 23DB type "N" output \$18.50
PICK UP HORN. Type "N" output \$4.50
WAVEMETER. 8500 to 9400 mcs. with calibration, Micrometer adjust head. Reaction type \$85.00
WAVEGUIDE LENGTHS. Plated and fitted with couplings available in 6", 12", 24", 30", 60" sections \$2.00 per ft.
 90 DEGREE ELBOWS, E or H plane, 2½" radius \$12.50
 MITERED ELBOWS, E or H plane \$10.00
 45 DEGREE OFFSET ELBOWS, E or H plane \$10.00
 90 DEGREE TWIST, 6" long \$8.00
 BULKHEAD FEED—THRU ASSEMBLY \$15.00
 PRESSURE GAUGE SECTION, 15lb. gauge and pressure nipple \$10.00
 PRESSURE GAUGE, 15 lbs. \$2.50
 CRYSTAL MOUNT, IN23 type crystal holder \$17.50

DUAL OSCILLATOR-BEACON MOUNT. P/O APS10 Radar for mounting two 723A/B klystrons with crystal mts, matching slugs, shields \$42.50
DUAL OSCILLATOR MOUNTS. (Back to back) with crystal mount, tunable termination, attenuating slugs \$18.50
 Directional Coupler, UG-40/U Take off 20 DB \$17.50
 Directional coupler, APS-6 type "N" take off 20 DB calibrated \$17.50
 Flexible Section 18" long \$12.00
 Rotary Joint Choke to Choke \$10.00
 2K25/723 AB Receiver local oscillator Klystron Mount, complete with crystal mount, iris coupling and choke coupling to TR \$22.50
 TR-ATR Duplexer section for above \$8.50

1¼" x ¾" WAVEGUIDE

SLOTTED LINE. Complete with adjustable probe, crystal output, precision vernier adjust. Humble Oil type \$225.00
TUNABLE TERMINATION. Precision adjust. \$65.00
LOW POWER TERMINATION \$25.00
MAGIC TEE \$45.00
TRANSITION. 1¼" x ¾" to 1" x ½" \$19.50
OSCILLATOR MOUNT. for four 723AB klystron \$38.50
 90 DEGREE ELBOWS, E or H plane \$12.50
WAVEGUIDE LENGTHS. Cut to size and supplied with I choke, 1 cover, per length \$2.00 per ft.
WAVEMETER: Absorption type. Precision micrometer adjust. Very high Q \$150.00

MAGNETRON MAGNETS

Gauss	Pole Diam.	Spacing	Price
4850	¾ in.	¾ in.	\$12.50
5200	11/32 in.	¾ in.	\$17.50
1300	1 ½ in.	1 5/16 in.	\$12.50
1860	1 ½ in.	1 ½ in.	\$11.50

Electromagnets for magnetrons \$24.50 ea.
 GE Magnets type M776115, G1 Distance Between pole faces variable, 2 1/16" (1900 Gauss) to 1 ½" (2200 Gauss) Pole Dia. 1 ½", New Part of SCR 684 \$34.50



MAGNETRONS

	QK 61 2J32	2J61	720CY
QK 60 2J37	2J62	725-A	730-A
2J21	2J38	3J31	728
2J22	2J39	5J30	728
QK 915 2J26	2J40	714A	700
QK 62 2J27	2J49	718DY	706
QK 59 2J31	2J34	720BY	

Klystrons 723A, 707B, 417A, 2K41

Write or phone for Price and Quantity Brand New Orig. Packed J.A.N.

THERMISTORS	VARISTORS
D-167332 (tube) 1.50	D-170225 1.50
D-170396 (head) 1.50	D-167176 1.50
D-167613 (button) 1.50	D-168687 1.50
D-164699 for MTG in "X" band Guide 2.50	D-171812 1.50
D-167018 (tube) 1.50	D-171528 1.50
	D-168442 \$3.00
	D-165593 \$1.25
	D-98836 \$2.00
	D-161871A \$2.85
	D-171121 \$1.50
	D-99836 \$1.50
	D-162356 (308A) \$1.50
	D-163357 \$2.00
	D-99946 \$2.95

WRITE FOR C.E.C. MICRO-WAVE CATALOG NOW AVAILABLE

COUPLINGS—UG CONNECTORS

UG 15U \$ 75	UG 117 Choke \$2.50
UG206U 90	UG 51 Cover 1.00
UG87U 1.25	UG 52 Choke 1.35
UG27U 1.69	UG 210 Cover 1.85
UG167U89	UG 212 Choke 2.40
UG29U 2.25	¾ Coax Female Ring50
UG167U89	¾ Coax Male Fitting95
UG251U 1.69	¾ X Band Circ. Choke50
UG86U 1.40	Flange Flat Contact50
UG342U 3.25	X Band Flat Contact25
UG85U 1.45	Flange ½ Thk.25
UG9U60	Contact Ring ¼" Thk. 1 ½ dia. hole25
UG102U45	UG 53 U. Cover 4.00
UG103U45	UG 54 U. Cover 4.75
UG255U 1.65	UG 55 U. Cover 4.00
UG 40 U. Spec. for Mixer Assy.75	UG 56 U. Choke 3.00
UG 40A 1.10	UG 65 U. Contact 6.50
UG 343 Cover 2.35	UG 149 U. Cover 3.00
UG 344 Choke 3.00	UG 148 U. Choke 4.00
UG 425 Contact 2.00	UG 150 U. Contact 3.00
UG 116 Cover & Conn Ring 1.95	UG 40 U. Choke60

Write us your needs.

6000 Mc. to 8500 Mc. Bench Test Plumbing

1½" x ¾" WAVEGUIDE

KLYSTRON MOUNT. DB356 complete with shield and tunable termination \$125.00
FLAP ATTENUATOR. DB361 \$45.00
PRECISION WAVEMETER. DB358, Micrometer adjust head \$190.00
VARIABLE STUB TUNER \$90.00
WAVEGUIDE TO TYPE "N" ADAPTER \$18.50
WAVEMETER TEE. DB352 \$32.50
SLOTTED LINE. DB354 Precision vernier adjust, less probe \$320.00
MAGIC TEE \$80.00
DIRECTIONAL COUPLER. Two hole 25DB coupling, type "N" output \$25.00
PRECISION CRYSTAL MOUNT. Equipped with tuning slugs and tunable termination \$125.00
TUNABLE TERMINATION. Precision adjust \$70.00
LOW POWER LOAD \$35.00

4000 to 6000 mcs. Bench Test Plumbing

2" x 1" WAVEGUIDE

SLOTTED LINE. DeMornay type 332 complete with probe, etc. \$600.00
FLAP ATTENUATOR. \$48.00
VARIABLE STUB TUNER AND LOW POWER TERMINATION \$48.00
WAVEMETER TEE \$48.00
ADAPTERS: Choke to choke \$18.00
 Cover to cover \$14.00
 Choke to cover \$16.00
WAVEGUIDE TO TYPE "N" ADAPTER. \$45.00
DIRECTIONAL COUPLER. Two hole type, type "N" output \$48.00
KLYSTRON MOUNT. Equipped with tunable termination and micrometer adjust. klystron antenna tuning \$110.00
CRYSTAL MOUNT. Equipped with tunable termination and micrometer adjust crystal tuning \$125.00
TUNABLE TERMINATION. Precision adjust \$90.00

3000 MC BENCH TEST PLUMBING

TEST EQUIPMENT

10 CM Wavemeter WE type B435400 Transmission type. Type N fittings, Vee-Rod Micrometer dial. Gold Plated W/Cable, Chart P/O Freq. Meter N66104A, New \$99.50
 AS14A/AP-10 CM Pick up Dipole with "N" Cables \$4.50
 LITR LIGHTHOUSE ASSEMBLY. Part of RT-39 APG 5 & APG 15. Receiver and Trans Cavities w/assoc. Tr. Cavity and Type N CPLG. To Resp. Uses 2C40, 2C43, 1B27. Tunable APX 2400-2700 MCS. Silver Plated \$49.50
 Beacon Lighthouse cavity 10 cm with miniature 28 volt DC FM motor. Mfg. Bernard Rice \$47.50 ea.

S. BAND

90° Twist, circular cover to circular cover \$25.00
 Magnetron to Wavguide Coupler with 721A Duplexer cavity, gold-plated \$45.00
 721A TR Box complete with tube and tuning plungers \$12.50
 McNally Klystron Cavities for 707B or 2K28. Three types available \$4.00
 F-29/SPR-2 Filters, Type "N" input and output \$12.50

ARMY-NAVY TEST SETS

TS-45/APM—3 cm Signal Generator.
 TS-226A/AP Power Meter.
 TS67/AP 3 centimeter precision echo box.
 TS36/AP 3 centimeter Thermistor Bridge—Power Meter.
 TS89/AP Voltage divider.
 TS268/U Crystal checker for IN23 type crystals etc.
 CW-60ABM 10 Centimeter Wavemeter. Coaxial type

726 Klystron Mount. Tunable, to type "N" complete, with socket and mounting bracket \$12.50

WAVEGUIDE TO ¾" RIGID COAX "DOOR-NOB" ADAPTER, CHOKE FLANGE, SILVER PLATED BROAD BAND \$32.50
WAVEGUIDE DIRECTIONAL COUPLER. 27 db. Navy type CABV-47AAN, with 4 in. slotted section. \$32.50
SQ. FLANGE to rd choke adapter, 18 in. long OA 1 ½ in. x 3 in. guide, type "N" output and sampling probe \$27.50
AN/APR54 10 cm antenna equipment consisting of two 10 cm waveguide sections, each polarized, 45 degrees \$75.00 per set
POWER SPLITTER 726 Klystron input dual "N" output \$5.00

¾" RIGID COAX

10 CM FEEDBACK DIPOLE ANTENNA, in lucite ball, for use with parabola ¾" Rigid Coax Input \$8.00
 721A TR cavities, heavy silver plated \$2.00 ea.
 Magnetron Coupling with TR Loop \$7.50
 Sperry Rotating Bend, pressurized \$22.50
 5 Ft. Lengths Stub Supported, gold-plated, per length \$7.50
 Short Right Angle Bends (for above) \$2.50

micrometer adjust cavity, Resonance Indicating meter, carrying case (similar to TS117/GP)
 TS235/UP High Power Load, "N" band (1000 mcs.)
 LU-1 Freq. Meter and Test OSC. Type CRV-60ACL TVN-9HU Power Supply, M.I.T. Rad. Lab.
 TVN-85E Klystron Power Supply, M.I.T. Rad. Lab.
 CS60ABW Watt Meter—Wavemeter, 3 centimeter.
 APR5 Receiver—1000 to 6000 mcs.
 AN/CPN-8—10 centimeter 40 kw. output RF pack-

GENERAL TEST EQUIPMENT

Multi Frequency Generator, American Time Product type SC-16, Frequency 10 to 190. Precision Standard "Watch-Master"
 UHF Signal Generator R.C.A. type 710A 370 to 560 mcs.
 Wheatstone Bridge, Industrial Instruments type IN-1
 FM Signal Generator, Boonton Radio type 165A Freq. Range 1 to 10 mcs., 38 to 60 mcs.
 Condenser Weld Power, Cap. 56 mfd. max., max. cha. 1500 Volts
 Frequency Meter, Lavelle Model 105-300 to 600 mcs.
 Megohm Bridge, Industrial Instruments type MB.
 Visual Alignment Signal Generator, General Electric—0 to 60 mcs.

NEW TEST EQUIPMENT IN STOCK

I-185A Oscillator
 I-233 Range Calibrator
 I-233 Range Calibrator
 BC 438 Freq. Meter
 RF Preamp.
 G.R. Capacity Brdg. #216
 G.R. Uni Galvo Shunt #229
 G.R. 1000 Aud. Osc. #213
 TS226A/AP Pwr. Mtr. Q-1000 W.
 Sig. Gen. 2804 8-330 MC

WRITE OR PHONE FOR DATA AND PRICE

age, includes magnetron oscillator, complete modulator, complete receiver, complete signal and power analyzer with 5" scope, 115V AC input. Dehydrator Unit CPD 10137 Automatic cycling. Line New
 SO-3 Receiver, 30 mc. IF, 6 stages, 6 C7 10 MC. Band width inpt. 5.1 mc B.W. per atk. 9.6 vlt gain per stage as desc in ch. 13 vol. 23 M.I.T. Rad. Lab. Series \$99.50

All merch. guar. Mail orders promptly filled. All prices, F.O.B., N.Y.C. Send Money Order or Check. Only shipping charges sent C.O.D. Rated Concerns send P.O.

COMMUNICATIONS EQUIPMENT COMPANY

131 LIBERTY STREET, NEW YORK, N.Y. DEPT. 1-10 P. J. PLSHNER PHONE: DIGBY-9-4124

QCQ2 SONAR

ECHO RANGING AND LISTENING EQUIPMENT

Use: Medium ASW ships.
Keying interval, 1,000, 2,000, 4,000, 8,000 yards, and manual.
Projector. Magnetostrictive, permanent magnet polarization, resonant frequency about 25 kc.
Transmitting system. The electron tube driver oscillator and two amplifier stages are contained in the receiver chassis; the variable tuning condenser being ganged with the receiver tuning condensers in order to give uni-control of receiver and driver tuning. In another chassis are located the output tubes and the high voltage rectifier. Sweep frequency modulation is provided, giving a shift from 400 cycles below to 600 cycles above the operating frequency during the transmission.
Receiving system. The receiver is of the tuned-radio-frequency type. It includes time varied gain, to reduce the volume of reverberations immediately following the transmission, and has a "Flat-Peak" audio filter, and an adjustable BFO to give an audible note above or below 800 cycles.
Keying and indicating system. Keying is mechanical; cams in the indicator unit determine the pulse length and keying interval. Ranges are indicated by the flash of a neon lamp.
Complete sets available less hoist. Also stacks alone.

QBF and QJA SONAR

ECHO RANGING AND LISTENING EQUIPMENT

Use. Large ASW ships.
QBF may be converted by field modifications, to QJA available.
Keying interval, 1,000, 2,000, 3,000, 4,000, 5,000, 10,000 yards and manual.
The electrical train system consists of a handwheel on the stack which selects, by commutation, three voltages from the secondary of a transformer-like device called a Commutator Transmitter.
Projector. The projector is of the Itocelle salt crystal type with a single element used for both listening and ranging. The frequency is 22 to 28 kc.
Transmitting system. The receiver-driver oscillator unit contains two electron tube oscillators, one tuned at about 150 kc and one tunable over the range from 160 to 180 kc. The outputs of the two are mixed, producing a difference frequency, which is then fed to the driver-amplifier unit and thus to the projector.
Receiving system. The receiver is a superheterodyne type covering the range from 10 to 30 kc.
Keying and indicating system. Ranges are indicated by the flash of a neon lamp which revolves at a constant speed, driven by a synchronous motor.

QCU, QCU-1 SONAR

ECHO RANGING AND LISTENING EQUIPMENT

Use. Small ASW Ships.
Intended to be used as a replacement for the obsolete WEA-1 equipment the old hoist.
Keying interval, 1,000, 2,000, 4,000, 8,000 yards and manual.
Training is electrical, controlled by a hand crank at the remote station.
Projector. Magnetostrictive, permanent magnet polarization, resonant frequency about 25 kc, split for HDI.
Transmitting system. The electron tube driver oscillator and two amplifier stages are contained in the receiver chassis; the variable tuning condenser being ganged with the receiver tuning condensers in order to give uni-control of receiver and driver tuning. In another chassis are located two type 811 output tubes and two type 836 high voltage rectifier tubes. Sweep frequency modulation is provided, giving a shift from 400 cycles below to 600 cycles above the operating frequency during the transmission.
Receiving system. The receiver is of the tuned radio frequency type. It includes time varied gain, to reduce the volume of reverberations immediately following the transmission, and has a "Flat-Peak" audio filter, and an adjustable BFO to give an audible note, above or below 800 cycles.

QCS, QCS-1, QCT-1 SONAR

ECHO RANGING AND LISTENING EQUIPMENT

Use. ASW ships.
Keying interval (original)—1,000, 2,000, 5,000, 10,000 yards and manual. (field modification added 3,000 and 4,000 yards)
Transmitting system. The driver-rectifier unit contains an electron-tube oscillator tunable over the range of 17 to 25.5 kc, and electron-tube amplifier and a rectifier power supply.
Receiving system. The superheterodyne receiver covers the range from 13 to 37 kc and may be connected by a selector switch to either the "QCQ" or the "JK" face of the projector. It has separate audio amplifiers for the range indicator lamp and for the loudspeaker. The audible note may be adjusted over the range from 0 to 1600 cycles. Three degrees of 1-f selectivity and two of audio are provided by selector switches connected to filters.
Keying and indicating system. Keying is mechanical; cams driven by the range indicator disc shaft determine the pulse strength and keying interval.

THE MUST OF THE MONTH

Complete 3 CM Radar System Equipment

40 KW peak transmitter, pulse modulator, receiver, using 723AB, power supply operating from 115V 800 Cycle, antenna system. Complete radar set neatly packaged in less than 16 cubic feet. All tubes, in use but excellent condition—\$350.00. This price for laboratories, schools, and experimental purposes only.

High Voltage Power Supply

15 KV at 30 Ma DC, Bridge Rectifier\$125.00

RADIO SYSTEMS

White Radio Telephone Model 2WRM55—ship to ship—shore to ship—small airports—minors—inter-island—ranches. 10 channel fix tuned rec. & xmitter. Xmitter. over output in excess of 100W unmodulated into antenna of 18 & 100 MMF. Freq. range 2-12 MC. Can be modified to increase range. Xtal controlled. 110V 60 cy or 220V 60 or 25 cy. Meas. 24" H x 19" W x 14" D. 125 lbs. Write or phone for data.

TAJ 500 Watt Low Frequency Transmitter 150-550KC CW-MCW.
TBK 500 Watt High Frequency Transmitter 2-18 MC. A1, A2, A3. Emission Mfg. by RCA.

FM STATION

Kilowatt Amplifier
Model 4BT2A1 Type BT2A Serial RC25
250 Watt Exciter
Model 4BT1A1 Type 3T1A Serial CC833
Station Monitor
Model 4BM1A1 Type BM1A Serial WC268
Power Supply
Model BP241 Type BFA Serial WC547
Transmitter Console
Model 4BC3A1 Type BC3A Serial WC5
Type BX-2A Two Bay Circular Antenna with Mast, Transmission Line, Elevators and Matchers.
100 Feet of 1 1/2 coax, transmission line including 90° elbows.
Dehydrator for transmission line.
Desk and Chair for transmitter console.
Write or Phone for Data and Price



APS-2 10 cm. airborne radar set designed for navigation and high altitude bombing. The antenna rotates through 360 degrees. Presentation is PPI and A Scope. The following units of the set are supplied: Antenna, transmitter-receiver, modulator, indicator, 24VDC input power unit. New with all tubes, incl. 714AY magnetron, 417A klystron.

APS-3 3 cm. airborne radar set designed for intercept of enemy aircraft and nominal navigation. Antenna is sector scan. Presentation is PPI and A Scope. The following units are supplied: Antenna, transmitter-receiver, modulator, indicator, 24VDC input power unit. New with all tubes incl. magnetron and 723AB klystrons. Both new and used condition.

APS-4 3 cm. airborne radar set designed for sector scan surface search, mapping and navigation, weather forecasting intercept of enemy aircraft. Entirely enclosed in a streamlined housing for optional mounting on aircraft bomb rack, or on power of large bombers. Complete sets with indicator equipment, and power unit ready for installation.

APS-6 3 cm. Night Fighter radar with pencil beam antenna. Transmitter-receiver packages and antennas available in equal to new condition.

APS-6A 3 cm. airborne radar RF package. 45kw. using 725A magnetron. IF strip using 6AK5's, 723AB beacon and local oscillator.

APS-10 3 cm. airborne radar using 2J42 magnetron. Modulator decks and low voltage power supply, only, available, less tubes. Beacon—local oscillator klystron mounts are available.

APQ-13 3 cm. airborne radar complete RF package in excellent condition including all tubes.

APS-15 3 cm. airborne radar designed for high altitude bombing, navigation, intercept of enemy aircraft, weather forecasting. Antenna rotates 360 degrees. Presentation is PPI and A Scope. The following units are supplied: Antenna, transmitter-receiver, modulator, indicator, slant-range computer, 24VDC input power unit. New with all tubes including 45kw 725A magnetron, 723AB local oscillator-beacon.

CPN-6 3 cm. Navigation Beacon ground station. Complete installation. High power coded beacon of latest JAN design. 115VAC input.

CPN-8 10 cm. Navigation Beacon ground station. Complete and partial installations available. High power beacon of long range capability. Complete power, frequency, operation analyzer (5" scope) included.

CXBR 10 cm. M.I.T. navigation beacon equipment, complete, in excellent condition.

FD MARK IV 800 mc. gunlaying radar mfg. and designed by Western Electric for battleships. Complete consoles available with all tubes including 700A magnetron and modulator thyratron.

MARK 10 10 cm. gunlaying radar, complete, for automatic firing of guns as antenna tracks target. 250 KW.

RT73/UPN-2 10 cm. portable beacon equipment.

SA 200 cm. Air Search radar especially designed for shipboard or mobile installation. Ideal for ground intercept and control of aircraft. PPI 7" indicator. Long range.

SD 200 cm. radar similar to SA but designed for installation on submarines. New.

SE 10 cm. shipboard Surface Search radar, using thyratron modulator. Complete installation available including spare parts. "A" scope presentation. 250 KW.

SF-1 10 cm. shipboard Surface Search radar with PPI and A scope. Used for navigation and target range information on naval vessels. 250 KW.

SG 10 cm. shipboard Surface Search radar with PPI and A scope. Heavy, rugged equipment designed for large naval and merchant vessels. 250 KW.

SJ-1 10 cm. radar designed for installation on Submarines. Equipped with PPI and A scope. Complete installations.

SL 10 cm. radar designed for Surface Search on shipboard. PPI indicator console.

SN 10 cm. portable radar. Lightweight, easily transportable complete radar installation using lighthouse tubes with a 25 mile maximum range. 115 VAC operation.

SO-1 10 cm. shipboard radar for navigation on all types of vessels. 4, 20, and 80 mile range. PPI indicator, Large antenna. 115 VDC input.

SO-8 Same as SO-1 but with a lightweight antenna.

SO-13 Same as SO-1 but with a lightweight antenna. 28 VDC input. Designed for PT boat installation.

SCR-518 Radar altimeter using pulse-echo-time principle. 400 mc. 28 VDC input. CR tube altitude indication.

SCR-520 Airborne radar RF package, 10 cm., complete with pulser, hard tube, 714AY magnetron.

SCR-533 IFF/Air Search trailer, complete, 500mc operation, A scope.

SCR-663 Specially searchlight training, aircraft tracking ground installation. Used condition.

SQ 10 cm. portable radar designed for use on landing barges and beachheads. PPI, B, A indication on 3" scope. 115 VAC operation.

TPS-2 1000 mc. portable early warning system. Bedspring antenna. Complete with portable generator.

MORE TEST EQUIPMENT Phone or write for information

TN 26, 110AP, 35, 62, 108, 102, 111, 34, 104, 45, 102, 33, 107, 10

All merch. guar. Mail orders promptly filled. All prices F.O.B. N.Y.C. Send MO or Chk. Only shipping chgs. sent C.O.D. Rated concerns send P.O.

COMMUNICATIONS EQUIPMENT CO.

131 Liberty Street, New York, N.Y.

Dept. E-10

P. J. Pilshner

Phone Digby-9-1124

RADAR
RADAR
RADAR
RADAR

R

A

D

A

R

SONAR
SONAR
SONAR
SONAR

PROFESSIONAL CARDS

LESTER W. BAILEY
Registered Patent Agent
Senior Member IRE
PATENT OFFICE PRACTICE specializing in
ELECTRONICS RADIO MECHANICS
LINCOLN-LIBERTY BUILDING
PHILADELPHIA 7
Broad & Chestnut Streets Rittenhouse 6-3267

ALFRED W. BARBER LABORATORIES
Specializing in the Communications Field and
in Laboratory Equipment
Offices, Laboratory and Model Shop at:
32-44 Francis Lewis Blvd., Flushing, L.I., N.Y.
Telephone: Independence 3-3306

HAROLD J. BROWN
Vibrators
Vibrator Power Supplies
Electrical Contact Systems
Mattapoisett, Mass.

W. J. BROWN
International Electronics Consultant
AT PRESENT IN GREAT BRITAIN
Will undertake assignments for American or
British Clients. Please address inquiries to 11
Public Square, Cleveland 13, Ohio.
TO 1-6498 FA-1-0030

EDWARD J. CONTENT
Acoustical Consultant
Functional Studio-Theater Design
FM — Television — AM
Audio Systems Engineering
Hoxbury Road Stamford 3-7157
Stamford, Conn.

CROSBY LABORATORIES, INC.
Murray G. Crosby & Staff
Radio-Electronic Engineering,
Research & Development
FM, Communications, TV
Test Equipment
Offices, Laboratory & Model Shop at:
126 Herricks Rd., Mineola, N.Y.
Garden City 7-0284

Richard B. Schulz
Electro-Search
Radio-Interference Reduction;
Development of
Interference-Free Equipment,
Filters, Shielded Rooms
515 W. Wyoming Ave., Philadelphia 40, Pa.
Gladstone 5-5353

ELK ELECTRONIC LABORATORIES
Jack Rosenbaum
Specializing in the design and
development of
Test Equipment for the communications,
radar and allied fields.
333 West 52nd St. Telephone:
New York 19, N.Y. PLAZA 7-0520

WILLIAM L. FOSS, INC.
927 15th St., N.W. REpublic 3883
WASHINGTON, D.C.

PAUL GODLEY CO.
Consulting Radio Engineers
P.O. Box J. Upper Montclair, N.J.
Offs & Lab.: Great Notch, N.J.
Phone: Montclair 3-3000
Established 1926

HERMAN LEWIS GORDON
Registered Patent Attorney
Patent Investigations and Opinions
Warner Building 100 Normandy Drive
Washington 4, D.C. Silver Spring, Md
National 2497 Shepherd 2433

Eugene Mittelman, E.E., Ph.D.
Consulting Engineer & Physicist
High Frequency Heating—Industrial Electronics
Applied Physics and Mathematics
549 W. Washington Blvd. Chicago 6, Ill.
State 2-8021

MEASUREMENTS CORP.
RESEARCH & MANUFACTURING
ENGINEERS
Harry W. Houck Jerry B. Minter
John M. van Beuren
Specialists in the Design and
Development of Electronic Test Instruments
BOONTON, N.J.

PICKARD AND BURNS, INC.
Consulting
Electronic Engineers
240 HIGHLAND AVE.
NEEDHAM, MASS.

PAUL ROSENBERG ASSOCIATES
Consulting Physicists
Main office: Woolworth Building,
New York 7, N.Y.
Cable Address Telephone
PHYSICIST WOrth 2-1937
Laboratory: 21 Park Place, New York 7, N.Y.

SERVO CORPORATION OF AMERICA
Henry Blackstone, President
Consultants on
Electronic Control Problems
for Industry
New Hyde Park Long Island, N.Y.

TECHNICAL MATERIEL CORPORATION
COMMUNICATIONS CONSULTANTS
RADIOTELETYPE - FREQUENCY SHIFT
INK SLIP RECORDING - TELETYPE NETWORKS
121 Spencer Place, Mamaroneck, N.Y.

WHEELER LABORATORIES, INC.
Radio and Electronics
Consulting — Research — Development
R-F Circuits — Lines — Antennas
Microwave Components — Test Equipment
Harold A. Wheeler and Engineering Staff
Great Neck, N.Y. Great Neck 2-7806

INDEX AND DISPLAY ADVERTISERS

Section Meetings	38A
Student Branch Meetings	38A
Membership	40A
Positions Open	50A
Positions Wanted	56A
News-New Products	46A

DISPLAY ADVERTISERS

Ace Eng. & Machine Co., Inc.	83A
Acme Electric Corp.	76A
Allen-Bradley Co.	37A
American Lava Corp.	17A
Amperex Electronic Corp.	73A
Andrew Corp.	62A
Antara Products, Div. of General Aniline & Film Corp.	30A & 31A
Arnold Engineering Co.	47A
Astatic Corp.	38A
Lester W. Bailey	94A
Ballantine Laboratories, Inc.	80A
Alfred W. Barber Labs.	94A
Barker & Williamson	60A
Bead Chain Mfg. Co.	79A
Bell Telephone Labs.	2A
Bendix Aviation (Radio Div.)	50A
Berkeley Scientific Co.	83A
Blaw-Knox	49A
Bliley Electric Co.	28A
Boonton Radio Corp.	78A
Breeze Corporation	64A
Harold J. Brown	94A
W. J. Brown	94A
Browning Laboratories	58A
Bud Radio, Inc.	81A
Burlington Instrument Co.	84A
Cambridge Thermionic Corp.	89A
Cannon Electric Development Co.	66A
Canoga Corp.	84A
Capitol Radio Engineering Inst.	81A
Centralab	33A, 34A, 35A, 36A
C. P. Clare & Co.	45A
Clarostat Mfg. Co.	53A
Cleveland Container Co.	9A
Sigmund Cohn Corp.	75A
Communication Products Co.	40A
Communications Equipment Co.	92A & 39A

(Continued on page 4)

HOGAN LABORATORIES, INC.
John V. L. Hogan, Pres.
APPLIED RESEARCH, DEVELOPMENT,
ENGINEERING
Est. 1929. Exceptionally competent staff. Elec-
tronics, Optics, Mechanisms, Facsimile Com-
munication, Electro-sensitive recording media,
Instrumentation.
155 Perry Street, New York 14 Chelsea 2-7855

INDEX AND DISPLAY ADVERTISERS—Continued

E. J. Content	94A	Manufacturers Thread Grinding Inc.	74A
Continental Carbon, Inc.	74A	W. L. Maxson	52A
Cornell-Dubilier Electric Corp.	Cover III	McGraw-Hill Book Co.	73A
Cornish Wire Co.	72A	Measurements Corp.	24A, 94A
Cossor, Ltd.	85A	Melpar, Inc.	54A
Crosby Labs.	94A	Metal Textile	95A
H. L. Dalis, Inc.	83A	Eugene Mittelman	94A
Daven Co.	27A	Mycalex Corp. of America	43A
Dow Corning Corp.	71A	National Union Radio Corp.	54A
Allen B. DuMont Labs., Inc.	5A and Facing 16A & 17A	New York Transformer Co.	68A
E. I. DuPont de Nemours & Co.	51A	J. M. Ney	28A
Eckert-Mauchly Computer Co.	51A	North American Aviation	54A
Eitel-McCullough, Inc.	6A	Ohmite Mfg. Co.	39A
Electrical Industries	80A	Panoramic Radio Products, Inc.	89A
Electrical Reactance Corp.	25A	Philamon Labs.	86A
Electro-Motive Mfg. Co.	21A	Pickard & Burns	94A
Electro Search	94A	Potter Instrument Co.	57A
Elk Electronic Laboratories	94A	Presto Recording Corp.	70A
Emsco Derrick & Equipment Co.	71A	Radio Corp. of America	32A, 56A, 96A
Erie Resistor Co.	16A	RCA Service Co.	51A
Fairchild Engine & Airplane Corp.	67A	Radio Receptor Inc.	78A
Ferranti Electric	90A	Revere Copper & Brass Inc.	55A
W. L. Foss	94A	Robinson Aviation, Inc.	76A
Franklin Institute	52A	Paul Rosenberg	94A
Freed Radio Corp.	52A	Servo Corp. of America	88A, 94A
Furst Electronics	74A	Shallcross Mfg. Co.	18A & 19A
Fusite Corp.	22A	Sheldon Electric Co.	26A
General Electric Co.	10A & 11A, 15A	Simpson Electric Co.	69A
General Precision Laboratory, Inc.	29A	Sorensen & Co., Inc.	42A
General Radio Co.	Cover IV	Spencer-Kennedy Labs.	28A
Girard Hopkins	75A	Sperry Gyroscope Co.	56A
Paul Godley	94A	Sprague Electric Co.	4A
H. L. Gordon	94A	Stackpole Carbon Co.	14A
Green Instrument Co.	87A	Staver Co.	79A
Guardian Electric Co.	23A	Geo. Stevens Mfg. Co., Inc.	44A
Helipot Corp.	7A	Stoddart Aircraft Radio Co.	41A
Hewlett-Packard Co.	3A	Technical Materiel Corp.	94A
Hughes Aircraft Co.	52A	Technology Instrument Corp.	46A
Hughes & Phillips	90A	Tektronix Inc.	87A
International Resistance Co.	12A & 13A	L. H. Terpeling Co.	77A
Jacobs Instrument Co.	54A	Transradio Ltd.	88A
E. F. Johnson Co.	85A	Triplett Electrical Inst. Co.	65A
Kenyon Transformer Co.	86A	Truscon Steel Co.	8A
Kings Electronics	82A	Ungar Electric Tool Inc.	81A
James Knights Co.	76A	United Transformer Co.	Cover II
Kollsman Inst. Div.	59A	D. Van Nostrand Co.	71A
Lambda Electronics	75A	Varian Associates	91A
Lavoie Laboratories	50A, 79A	Webster Electric Co.	73A
Machlett Labs.	63A	Wells Sales Inc.	85A
Magnecord, Inc.	48A	Westinghouse Electric Corp.	56A
P. R. Mallory & Co., Inc.	20A	H. A. Wheeler Labs.	94A
		S. S. White Dental Mfg. Co.	87A
		Wilcox Electric Co.	61A

**"We have found
Metex Electronic Gaskets
excellent for HF currents
inexpensive to assemble."
Sylvania Electric Products Inc.**

Sylvania has been using Metex gaskets for over a year as conductive shields for their TR tubes used in radar and micro-wave ranging equipment.

To quote their experience: "We have found Metal Textile knitted wire gaskets excellent for conducting high frequency currents without boundary arcing. The gaskets are resilient, and yet do not deform too readily. Best of all, the material is inexpensive to assemble through soft soldering techniques."

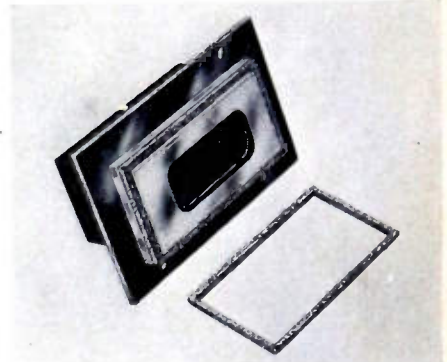

A Sylvania Electric TR tube showing Metex gasket loose and in position

The properties—electrical and physical—which make Metex Electronic Gaskets effective in this, and other demanding HF and UHF applications are due to their being made from *knitted* (not woven) wire mesh. The hinge-like action of the knitted mesh permits controlled resiliency of the finished gaskets. These can be die-formed to close dimensional tolerances, when required. There is practically no limit to the metal or alloy which can be used.

If the equipment you are manufacturing or designing requires a resilient conductive or shielding material, our engineers will welcome the opportunity of working with you. A letter, addressed to Mr. R. L. Hartwell, Executive Vice President and outlining your requirements, will receive immediate attention.

METAL TEXTILE CORPORATION
637 EAST FIRST AVE., ROSELLE, N. J.



Compact industrial television system—developed at RCA Laboratories—lets us see the unseeable in safety!

Eye-witness reports from a fiery furnace!

Something's gone wrong in a big blast furnace, and heat is too high for engineers to approach. Focus the Vidicon camera of an RCA Industrial Television System on the flames and the fiery furnace can be studied in comfort on a television receiver.

This is only one suggested use, for RCA's compact industrial television system is as flexible as its user's ingenuity. "Eye" of the tiny camera—small enough to be held in one hand—is the sensitive Vidicon tube. Extremely simple, the only other equipment

needed is the Vidicon camera's suitcase-size control cabinet, which operates anywhere on ordinary household current.

The Vidicon camera could be lowered under water where divers might be endangered—or stand watch on atomic reactions, secure from deadly radiations. And it is practical to arrange the RCA Industrial Television system in such a way that observers can see a 3-dimensional picture . . . sharp, clear and real as life!

See the latest wonders of radio, television, and electronics in action at RCA Exhibition Hall, 36 West 49th St., N. Y. Admission is free. Radio Corporation of America, Radio City, New York.



Here's RCA's Vidicon system at work beside a steaming vat. Note how the television camera is getting a safe "close-up" of the action.



RADIO CORPORATION of AMERICA

World Leader in Radio — First in Television

they

may

look

alike,

but:

there

is

only

one

C-D

THE STANDARD IN THE FIELD OF HIGH POWER OSCILLATORS



type 50 series

C-D HIGH POWER MICA TRANSMITTER CAPACITORS

Typical of the many C-D firsts are the type 50 mica capacitors. Only C-D micas can point to a record of dependable service of over forty years. Here's why:

Series mica stack—C-D first to use and patent this construction. Affords uniform voltage gradient!

India-ruby mica—Sheets individually tested for uniform thickness and dielectric strength!

Special exclusive high melting point low loss filler—Reduces stray field losses; protects against humidity!

Vacuum impregnated assembly—Assures high insulation resistance; low losses; eliminates air voids!

High pressure maintained on stacks—Results in high Q; good capacity stability.

Cast-aluminum end caps—Low-resistance, wide-

path, positive-contact terminals for series, parallel or series-parallel connection. Speedy, space-conserving installations!

Every unit tested under long, continuous overload—Assures maximum reliable service.

Type 50 capacitors are available in all commercial capacity and voltage ratings. For complete description of these and Faradon type transmitter capacitors, write for catalog, CORNELL-DUBILIER ELECTRIC CORPORATION, Dept. M-100 South Plainfield, New Jersey. Other plants in New Bedford, Brookline and Worcester, Mass.; Providence, R. I.; Indianapolis, Ind., and subsidiary, The Radiart Corp., Cleveland, Ohio.

C-D Best by Field Test!



CONSISTENTLY DEPENDABLE

CORNELL-DUBILIER

CAPACITORS • VIBRATORS • ANTENNAS • CONVERTERS



This **GENERAL-PURPOSE** STANDARD-SIGNAL GENERATOR

FEATURES

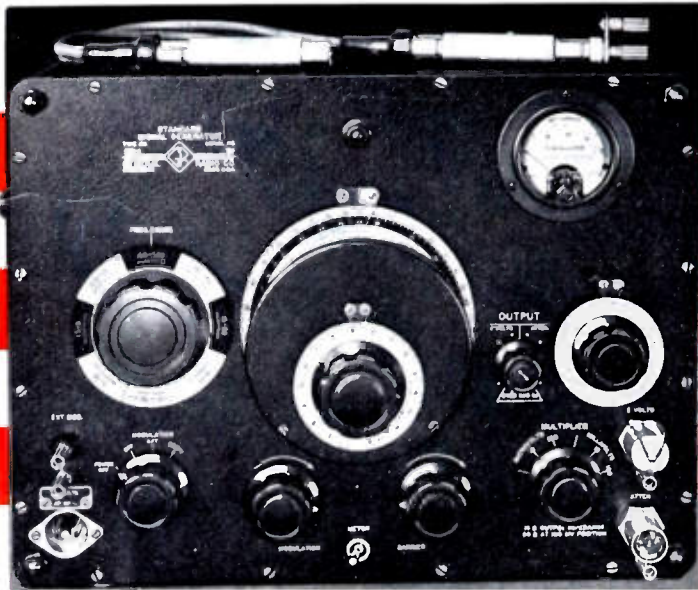

• MODERATE COST

• VERY LOW LEAKAGE

• SIMPLIFIED DESIGN



Type 1001-A Standard-Signal Generator.

SPECIFICATIONS

CARRIER-FREQUENCY RANGE: 5 kc to 50 Mc in eight logarithmic, direct-reading ranges

FREQUENCY CALIBRATION accurate to $\pm 1\%$

INCREMENTAL-FREQUENCY DIAL indicates increments of 0.1 per cent of frequency per division up to 15 Mc

OUTPUT VOLTAGE: open-circuit voltage adjustable from less than 0.1 microvolt to 200 millivolts. Two-volt output available from second jack

AMPLITUDE MODULATION adjustable from 0 to 80% either with 400-cycle built-in source, or over 20 to 15,000 cycles from an external source

LEAKAGE: stray fields are substantially less than 1 microvolt-per-meter two feet from generator

INCIDENTAL FREQUENCY MODULATION: varies from 10 to 100 parts per million, at 80% a-m, over each range except 15-50 Mc where it may be three times this amount

ENVELOPE DISTORTION: about 6% at 80% modulation

NOISE LEVEL: carrier noise level corresponds to about 0.1% modulation

TYPE 1001-A STANDARD-SIGNAL GENERATOR \$650.00

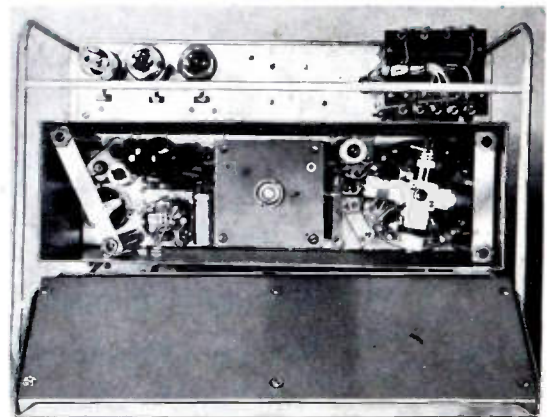

Cover removed from oscillator compartment. Note two-piece construction of cover, each being insulated from the other and making contact with both surfaces of the metal box housing the oscillator. All leads to this box are carefully filtered to prevent leakage.

The complete oscillator plugs in and out of the metal box, making testing and servicing particularly easy. The oscillator can be operated when removed from its shielding box.



GENERAL RADIO COMPANY

Cambridge 39,
Massachusetts

90 West St., New York 6 920 S. Michigan Ave., Chicago 5 1000 N. Seward St., Los Angeles 38