

Proceedings



of the I · R · E

A Journal of Communications and Electronic Engineering

March, 1950

Volume 38

Number 3



General Electric Co.

AN INDUSTRIAL UNIVERSITY

At Electronics Park, Syracuse, N.Y., there has been established a plant and its laboratories bearing a striking and significant resemblance to an institution of higher learning—a fitting similarity in this age of electronic progress.

PROCEEDINGS OF THE I.R.E.

- Preparation of Technical Papers
- Disk Recording for Broadcasting Purposes
- Calibration of Disk Reproducing Pickups
- New Type of Slotted Line Section
- Radiation Characteristics of Conical Horn Antennas
- Interference Characteristics of Pulse-Time Modulation
- Echoes in Land-to-Car Transmission at 450 Mc
- Variable and Nonlinear Circuit Analysis
- Resistor-Capacitor Networks
- Asynchronous Multiplexing
- Methods for Obtaining VSWR Independently of Detector Characteristics
- Flat-Plate Aircraft Antennas
- Volume Scanning with Conical Beams
- Frequency Analysis of Variable Networks
- Impedance of an Open-Line Cylindrical Antenna
- Radio-Wave Reflection from a Rough Sea
- Coaxial Bethe-Hole Directional Couplers
- n -Mesh RC Filter Network
- Abstracts and References

TABLE OF CONTENTS, INDICATED BY BLACK-AND-WHITE MARGIN, FOLLOWS PAGE 32A

The Institute of Radio Engineers

NEW AMPEREX tubes

Specifically designed for grid-control operation at peak anode voltages as high as **21,000 v.** for heavy duty INDUSTRIAL uses and high power TRANSMITTERS with outputs to **150 KW.** (3 phase full wave)



	AGR-9951/5870		AGR-9950/5869	
CATHODE Directly Heated, Oxide Coated				
MAXIMUM PEAK ANODE VOLTAGE				
Inverse	21,000	10,000	13,000	10,000
Forward	21,000	10,000	13,000	10,000
CONDENSED MERCURY TEMPERATURE LIMITS (centigrade)	+30° to +45° +25° to +60°		+25° to +55° +25° to +60°	
MAXIMUM PLATE CURRENT (Amperes)				
Peak	10		4	
Average	2.5		1	
FREQUENCY RANGE (cps)	25 to 150		25 to 150	
FILAMENT VOLTAGE	5.0		5.0	
FILAMENT CURRENT (amperes)	15		6.5	
TUBE VOLTAGE DROP (volts, approx.)	14		15	
	(1b = 10 amperes)		(1b = 4 amperes)	

PROVEN LIFE

AGR-9951/5870

\$90.

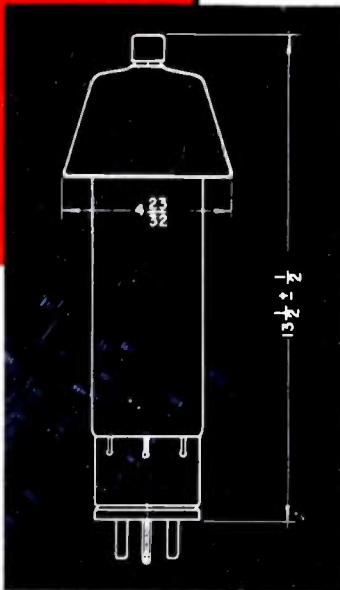

Re-tube with AMPEREX

THREE-ELECTRODE, MERCURY VAPOR RECTIFYING TUBES
with NEGATIVE CONTROL characteristics

GENERAL CONTROL CHARACTERISTICS

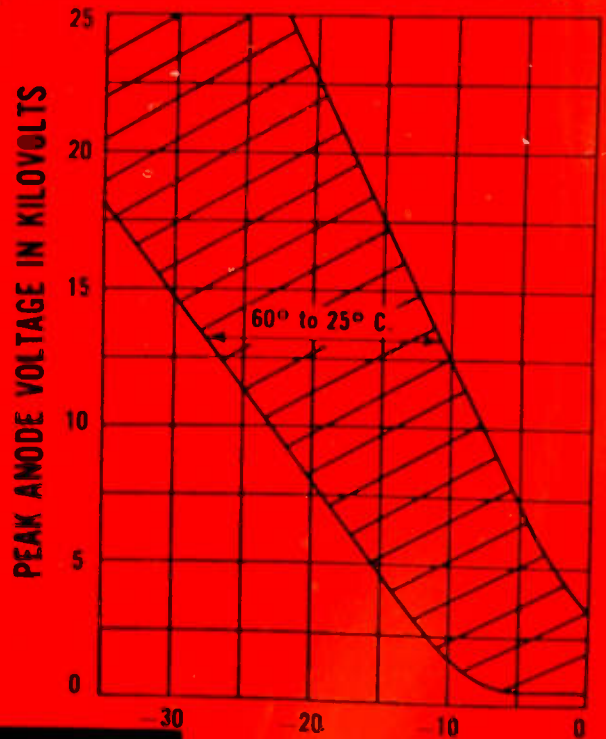

AGR-9951/5870

D-C CONTROL-GRID VOLTAGE IN VOLTS

Data sheets and charts available on request



AMPEREX ELECTRONIC CORP.

25 WASHINGTON STREET, BROOKLYN 1, N. Y.

In Canada and Newfoundland: Rogers Majestic Limited
11-19 Brentcliffe Road, Leaside, Toronto, Ontario, Canada



The Newspaper that the "Savannah" delivered

The first steamship to cross the Atlantic, it is said, brought back a newspaper containing the report of a famous European scientist "proving" that practical marine propulsion by steam was impossible.

That, of course, was in the knee-pants days of the Scientific Age. Today, it would be a rash scientist who would apply any such label to a proposed development. "Unknown" or "yet to be proved" perhaps, but not "impossible." Imagination is as much a part of modern

research and engineering background as physics or mathematics.

In electronics alone, a generation of progress was crowded into a few hectic war years. Products not known — for jobs that had never been done — became commonplace. Yet all of this represents only a fresh beginning . . . not an end. As in the past, Sprague research continues on the assumption that even the best of today's components are only test models for tomorrow's even more difficult assignments.

SPRAGUE

PIONEERS

SPRAGUE ELECTRIC COMPANY
North Adams, Massachusetts

IN ELECTRIC AND ELECTRONIC DEVELOPMENT

GLASS-TO-METAL SEALS, pioneered by Sprague, have paved the way to new and higher standards of protection and efficiency in thousands of capacitor and resistor types.



SUBMINIATURE Sprague molded Prokar® capacitors, rated for -50°C . to $+125^{\circ}\text{C}$. operation, are playing a big part in revolutionizing the engineering of ultra-small equipment.

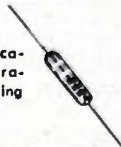

SPRAGUE KOOLOHM® RESISTORS, wound with ceramic insulated wire, doubly protected by outer ceramic shells, have answered one difficult resistor problem after another.



• T. M. REG.

PROCEEDINGS OF THE I.R.E. March, 1950, Vol. 38, No. 3. Published monthly by The Institute of Radio Engineers, Inc., at 1 East 79 Street, New York 21, N.Y. Price \$2.25 per copy. Subscriptions: United States and Canada, \$18.00 a year; foreign countries \$19.00 a year. Entered as second class matter, October 26, 1927, at the post office at Menasha, Wisconsin, under the act of March 3, 1879. Acceptance for mailing at a special rate of postage is provided for in the act of February 28, 1925, embodied in Paragraph 4, Section 412, P. L. and R., authorized October 26, 1927.

Table of Contents will be found following page 32A

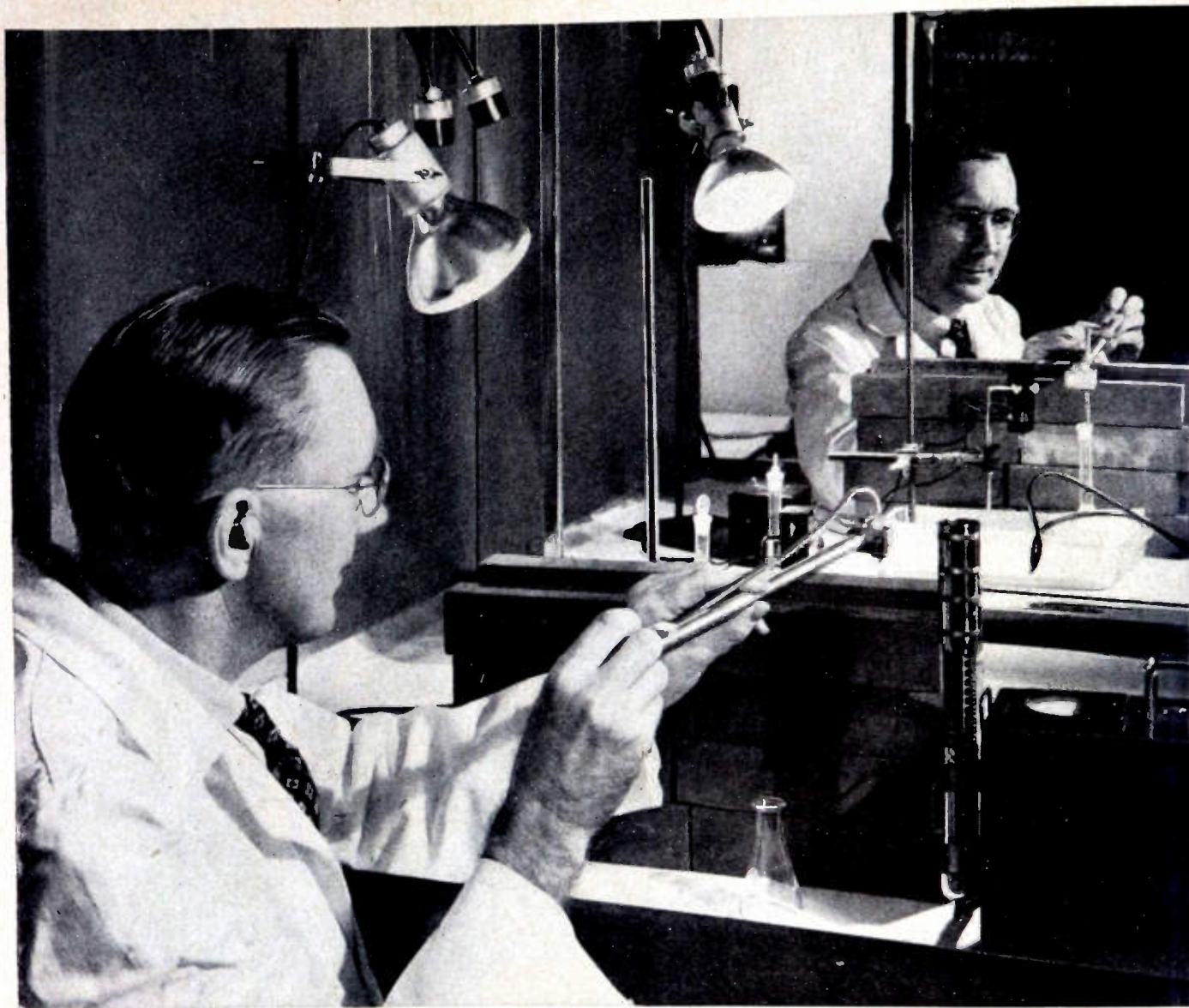

IT'S **DONE WITH MIRRORS!**

Protected by a wall of lead bricks and using a mirror to guide his instruments, this Bell Laboratories scientist is preparing a solution of a radioactive isotope, for use as a tracer to study materials for your telephone system.

Bombardment by neutrons turns some atoms of many chemical elements into their "radioactive isotopes"; these are unstable and give off radiation which can be detected by a Geiger counter. Chemically a "radioactive isotope" behaves exactly like the original element. Mix the two in a solution or an alloy and they will stay together; when the Geiger counter shows up an isotope, its inactive brother will be there too. Minute amounts beyond the reach of ordinary chemical methods can be detected—often as little as one part in a billion.

The method is used to study the effect of composition on the performance of newly developed germanium transistors—tiny amplifiers which may one day perform many functions which now require vacuum tubes.

It enables Bell scientists to observe the behavior of microscopic impurities which affect the emission of electrons from vacuum tube cathodes. It is of great help in observing wear on relay contacts. And it may develop into a useful tool for measuring the distribution and penetration of preservatives in wood.

Thus, one of science's newest techniques is adopted by Bell Laboratories to make your telephone serve you better today and better still tomorrow.



BELL TELEPHONE LABORATORIES

EXPLORING AND INVENTING, DEVISING AND PERFECTING, FOR CONTINUED IMPROVEMENTS AND ECONOMIES IN TELEPHONE SERVICE.

NEW GENERAL PURPOSE PULSE GENERATOR



-hp- MODEL 212A

TYPICAL 1 MICROSECOND PULSE INTO 50-OHM LOAD

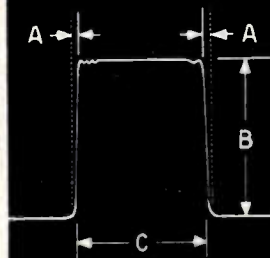

- A. 0.02 μ sec rise and decay time. Minimum overshoot.
- B. 50 watt peak power. (50 v. to 50 Ω load.)
- C. Pulse length variable 0.07 to 10 μ sec.

SPECIFICATIONS

PULSE LENGTH:

Continuously variable, 0.07 to 10 μ sec.
Direct reading panel control.

PULSE AMPLITUDE:

50 v. into 50 Ω load. Pos. & neg. pulses.
100 v. open circuit.

AMPLITUDE CONTROL:

Continuous control throughout range. 50 db in 10 db steps. 10 db fine adjustment.

INTERNAL IMPEDANCE:

50 Ω or less.

PULSE SHAPE:

Rise and decay time approx. 0.02 μ sec.
(10% to 90% amplitude.)

REPETITION RATE:

50 pps to 5,000 pps. Internally or externally controlled.

SYNC IN:

May be triggered by pos. or neg. pulse at 5 v. at rates up to 5,000 pps.

SYNC OUT:

50 v. into 200 Ω load. Approx. 2 μ sec long. Approx. 0.25 μ sec rise time.

PULSE DELAY:

Main pulse delayable 0 to 100 μ sec from sync output pulse.

PULSE ADVANCE:

Main pulse can be advanced 0 to 10 μ sec from sync output pulse.

POWER SUPPLY:

110/220 v; 50/60 cps.

SIZE:

Panel 10 1/2" high, 19" wide. Depth 12".

PRICE:

\$550.00 f.a.b. Palo Alto.

Data Subject to Change Without Notice

CONTINUOUSLY VARIABLE, HIGH POWER PULSES OF SUPERIOR WAVE FORM!

THIS NEW -hp- 212A PULSE GENERATOR saves you time and work testing "fast" circuits as well as making everyday laboratory checks of other generators, rf circuits, peak-measuring equipment, etc. It is the first commercial pulse generator to successfully combine broad laboratory usefulness with the fast rise time, high power, variable pulsing and other features demanded in radar, television and nuclear work.

ACCURATE PULSES AT END OF LONG TRANSMISSION LINE

The pulse length is continuously variable from 0.07 μ sec to 10 μ sec, and is varied by a direct reading panel control. Extremely fast rise and decay time, together with freedom from ringing or overshoot

provide a virtually distortion-free pulse. A low internal impedance (50 ohms or less) insures a pulse shape virtually independent of load. This low impedance also makes it possible to deliver accurate pulses at a distance from the instrument, if the transmission lines are correctly terminated.

The Model 212A's repetition rate is continuously variable from 50 to 5,000 pps. It can be controlled internally, or from an external synchronizing source. Synchronizing pulses are available from the instrument either in advance of or following the output pulse. An amplifier-attenuator output system gives a low source impedance, and makes possible continuously variable pulse amplitude, positive or negative.

Brief specifications of this new -hp- instrument are shown in the adjoining column. For complete details... see your local -hp- representative... or write to the factory.

HEWLETT-PACKARD COMPANY

2040D Page Mill Road • Palo Alto, California

Export: FRAZAR & HANSEN, Ltd., 301 Clay St., San Francisco, Calif., U. S. A. Offices: New York, N. Y. and Los Angeles, Calif.

3040

 **laboratory instruments**
FOR SPEED AND ACCURACY



**CAST ALNICO V and VI THIN WALL RINGS
FOR MAGNETIC FOCUSING ASSEMBLIES**

Quality and Quantity - NO PROBLEM!

In TELEVISION SETS, magnetic focusing eliminates blur; gives clear, sharp reception even during warm-up, or line voltage fluctuations; and the *first* focusing adjustment is the *last*. The thin ring-type permanent magnets of Alnico V and VI produced by Arnold for this use (several sizes are pictured here) are *cast*, not sintered, in order to save on first cost. It's a difficult job, but Arnold's advanced methods produce these rings in the desired quality and any quantity, *without trouble*. —No matter what the application, in any grade of Alnico or other materials, you can depend on Arnold Permanent Magnets. We'll welcome your inquiries.

THE ARNOLD ENGINEERING COMPANY



Subsidiary of
ALLEGHENY LUDLUM STEEL CORPORATION
147 East Ontario Street, Chicago 11, Illinois

Specialists and Leaders in the Design, Engineering and Manufacture of PERMANENT MAGNETS

PRODUCED BY THE MILLIONS

The Hi-Q Ceramic Laboratory

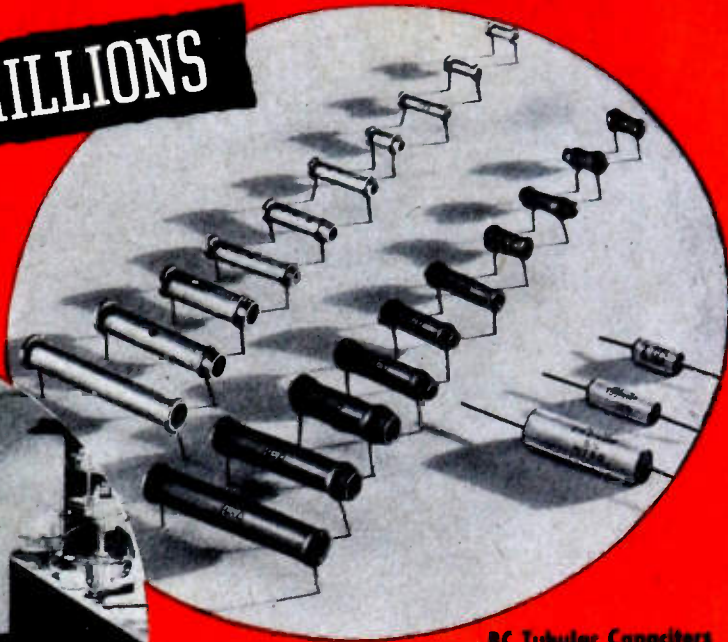

BC Tubular Capacitors

- by the top specialists in the ceramic field

Hi-Q COMPONENTS

Capacitors
Trimmers • Choke Coils
Wire Wound Resistors

BETTER 4 WAYS

- ✓ PRECISION
- ✓ UNIFORMITY
- ✓ DEPENDABILITY
- ✓ MINIATURIZATION

• Hi-Q BC Tubular Ceramic Capacitors for bypassing, coupling and filtering are available with any of three types of insulations:—clear non-hydroscopic styrene coating (CN) . . . Durez impregnated with low loss microcrystalline wax (SI) . . . or a ceramic (steatite) cover tube sealed with a specially developed end seal (CI). The Hi-Q trade mark is your assurance that like all Hi-Q Components, they rigidly meet specifications and are uniformly dependable in every respect. As leading specialists in the ceramic field, Hi-Q has come to be regarded by producers of radio, television, communications and electronic equipment as their best source of technical assistance in developing components to meet the needs of any circuit.

JOBBERS — Address: 740 Belleville Ave., New Bedford, Mass.

Hi-Q

Electrical Reactance Corp.

FRANKLINVILLE, N. Y.

SALES OFFICES: New York, Philadelphia, Detroit, Chicago, Los Angeles

PLANTS: Franklin, N.Y., Jessup, Pa., Myrtle Beach, S.C.

EXPORT DEPARTMENT: 41 East 42nd St., New York 17, N.Y., U.S.A.

*A page
from the
note-book
of Sylvania
Research*

Automatic bulb sealing equipment speeds production of Sylvania Television Picture Tubes

It's a far cry from the slow and laborious "hand-work" methods of producing television picture tubes, to this automatic machine method now in operation at Sylvania's Ottawa, Ohio, plant.

On the machine shown here, the glass tube necks are perfectly sealed and bonded to the metal cones.

This process is but one important step in a completely conveyORIZED plant . . . where raw materials emerge as finished units. As a result of highly specialized mass production techniques and the application of the latest materials, Sylvania picture tube production increased by 30 percent during the past year.

Today, backed by continuing product research and development, plus exhaustive scientific, electrical, and mechanical tests, Sylvania is producing larger and higher quality television picture tubes . . . at lower prices.

This means better product performance for you . . . better values for television set owners everywhere.

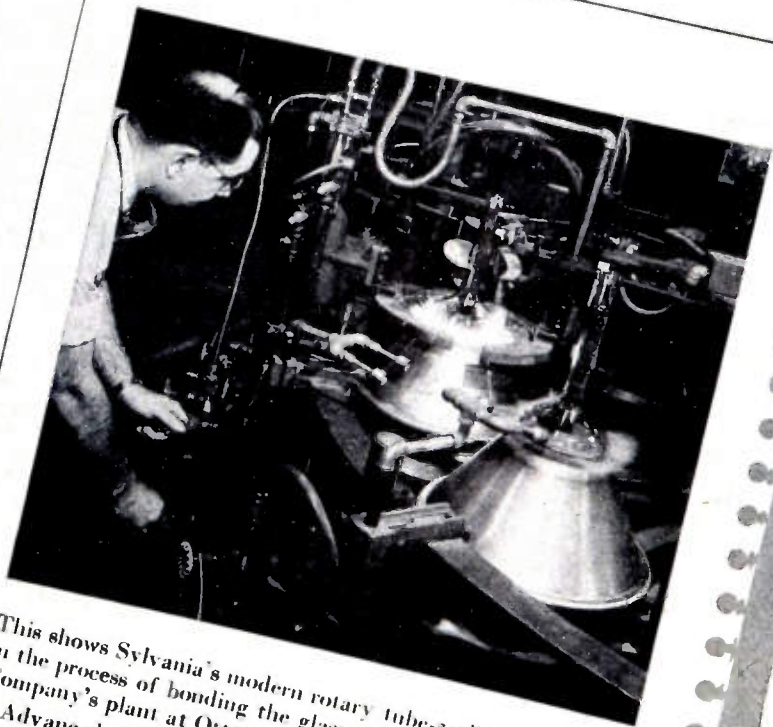

This shows Sylvania's modern rotary tube-sealing equipment in the process of bonding the glass necks to the tubes in the Company's plant at Ottawa, Ohio.

Advanced production engineering, scientific quality control, and precision fabrication of parts are factors behind the development of this automatic machine . . . a machine which is only one step in the efficient, mass production methods responsible for the manufacture of more, better and larger Sylvania television picture tubes.

SYLVANIA ELECTRIC

RADIO TUBES; CATHODE RAY TUBES; ELECTRONIC DEVICES; FLUORESCENT LAMPS, FIXTURES, WIRING DEVICES, SIGN TUBING; LIGHT BULBS; PHOTOLAMPS

DELIVERS

as

SPECIFIED

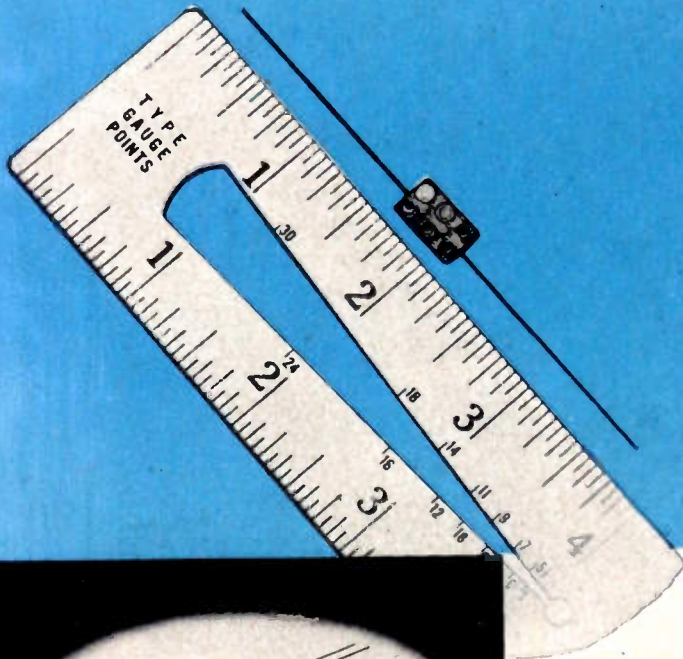

EL-MENCO CAPACITORS

EL-MENCO is the standard of dependability in capacitors. Each tiny El-Menco Capacitor delivers at maximum in any climate under the most critical operating conditions. Before leaving the factory, they are tested for dielectric strength at *double* working voltage; for insulation resistance and capacity value. Each tiny El-Menco Capacitor meets and beats strict Army-Navy standards. Put them in *your* product and get real performance.

A COMPLETE LINE OF CAPACITORS TO MEET EVERY REQUIREMENT

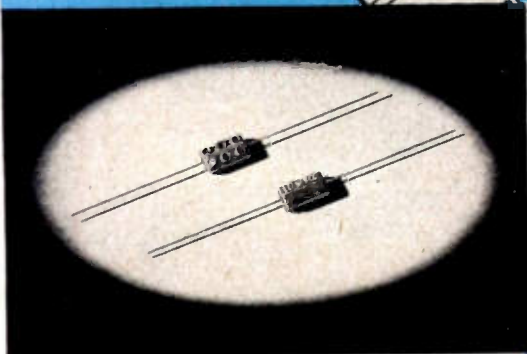

CM 15 MINIATURE CAPACITOR

Actual Size: 9/32" x 1/2" x 3/16"
For Television, Radio and other Electronic Applications

- 2 — 420 mmf. cap. at 500v DC w
 - 2 — 525 mmf. cap. at 300v DC w
- Temp. Co-efficient ± 50 parts per million per degree C for most capacity values. 6-dot color coded.



THE
ELECTRO MOTIVE MFG. CO., Inc.
WILLIMANTIC CONNECTICUT

Write on your firm letterhead for Catalog and Samples

MOLDED MICA

EL-MENCO CAPACITORS

MICA TRIMMER

FOREIGN RADIO AND ELECTRONIC MANUFACTURERS COMMUNICATE DIRECT WITH OUR EXPORT DEPT. AT WILLIMANTIC, CONN. FOR INFORMATION.
ARCO ELECTRONICS, INC. 135 Liberty St., New York, N. Y.—Sole Agent for Jobbers and Distributors in U.S. and Canada

ANNOUNCING

EIMAC TUBE TYPE

4X150G

Another Engineering Achievement by Eimac



The 4X150G is a new coaxially constructed UHF tetrode, a modification of the popular Eimac 4X150A. The new design has resulted in lower lead inductance, reduced the UHF grid driving-power requirements, and increased upper frequency limits of efficient performance.

The 4X150G can be operated as either a conventional radio-frequency amplifier or oscillator over a wide range of plate voltages at frequencies up to 1000 Mc. In pulse service efficient performance is obtained up to 1500 Mc.

Operating as a class-C amplifier in the 750 Mc. region, the Eimac 4X150G will provide a power-gain of 8. (100 watts output, 12½ watts driving power.) In pulse oscillator service at 1250 Mc., tests indicate peak output-powers of over 20 kw per tube.

Maximum ratings and other operational characteristics for this new tetrode are available from the Eimac Field Engineering Department.

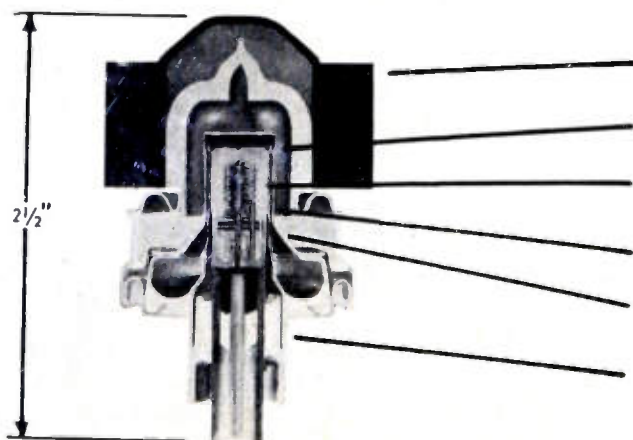

- External Anode
150 watts dissipation
- Processed Non-emitting Grids
- Unipotential Cathode
2.5 volt heater
- Precision Aligned Elements
for Optimum Tetrode Characteristics
- Well Shielded Input-Output Circuits
- Concentric Grid-Cathode Terminals
Allow Cavity Use.

EITEL-McCULLOUGH, INC.
San Bruno, California

Export Agents: Frazar & Hansen, 301 Clay St., San Francisco, California

Follow the Leaders to

Eimac
TUBES

The Power for R-F

244

You can use a machete to make it fit...

"I'M THROUGH
KIDDIN'
AROUND —"



BUT it's simpler
to design the
radio around
the battery!



● The right starting point for designing a new portable radio is its batteries. The set will need them sooner or later, and it's a little embarrassing to have to use a shoe horn to get them in, or whack off excess with a machete. Obviously, the easy way is to pick good, reliable, long-lasting batteries and design the set around them.

"Eveready" brand radio batteries qualify on all counts. They are well known for long life and they come in a range of types and sizes to fit virtually every conceivable design. They are available everywhere for easy replacement by the user. Write to our Battery Engineering Department for free and complete technical data.

"Eveready" No. 950 "A" batteries and the No. 467 "B" battery make an ideal combination for small portable receivers.

"Eveready", "Mint-Max", "Nine Lives" and Cat Symbol are trade-marks of
NATIONAL CARBON DIVISION of
UNION CARBIDE AND CARBON CORPORATION

UCC

30 East 42nd Street, New York 17, N. Y.

District Sales Offices: Atlanta, Chicago, Dallas, Kansas City, New York, Pittsburgh, San Francisco

EVEREADY
TRADE-MARK
RADIO BATTERIES



Designers

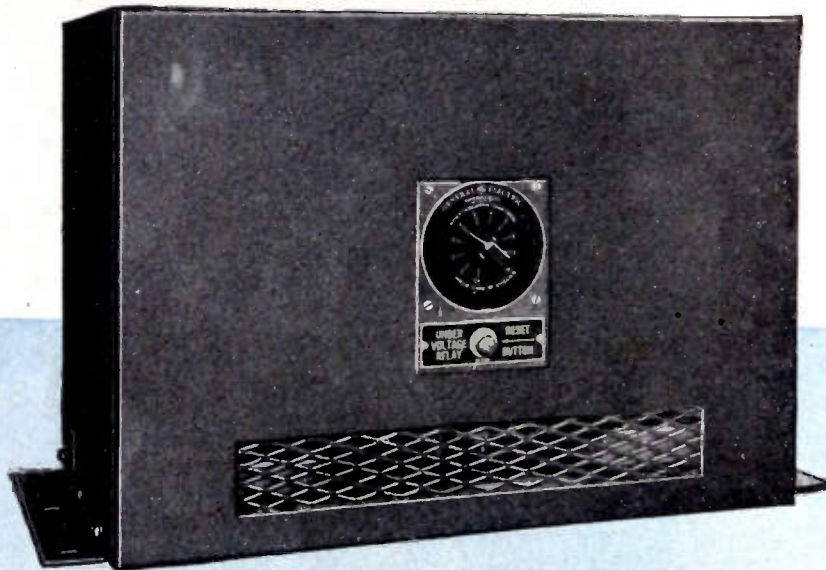

low-cost welding speeds up production

General Electric engineers have developed a new low-cost method of precision-control resistance welding for use in many expensive assembly operations in the manufacture of electronic equipment.

This new welding method makes it possible for a single operator to weld 15 grounding ribbons and one resistor lead to the chassis of a television set in two minutes.

The control panel shown above provides for welding-current adjustment to control the amount of heat produced in the welds. Once set, this control will keep successive welding currents constant to insure accurate and consistent welding of connections. Write for complete data in Bulletin GEA-4175.

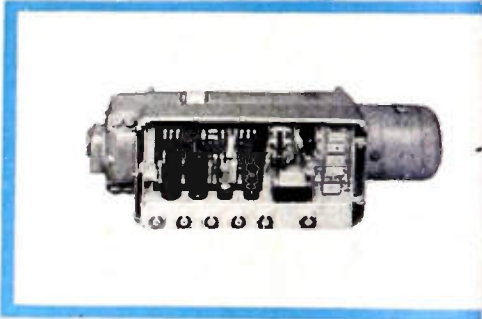

one package— Amplidyne plus Amplifier

The G-E electronic amplidyne consists of a motor-amplidyne set, a high-gain d-c balanced amplifier, and a reference voltage supply. It is similar to equipments used in drive systems for radar antennas, searchlights, and ship and aircraft gun mounts. Commercially, it can be used in many kinds of motor control systems for close regulation of current, voltage and speed—to limit torque, hold tension, speed up acceleration, and position accurately.

The electronic amplifier makes the amplidyne respond quickly to sudden changes in the control signal, and gives it high sensitivity to small gradual changes. These and other features make it readily adaptable to automatic programming and closed-cycle processing control.

Applications range from power supply for $\frac{1}{4}$ to $1\frac{1}{2}$ horsepower motors to field excitation for large adjustable voltage drives up to 200 horsepower. For information, see Bulletin GEA-4889.

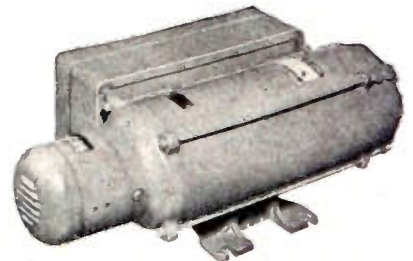

GENERAL  **ELECTRIC**

Digest

TIMELY HIGHLIGHTS ON G-E COMPONENTS

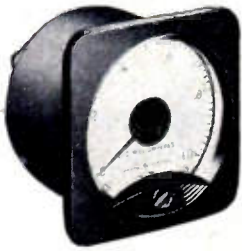

250 degrees of meter scale

General Electric's new long-scale panel instruments are designed for applications where space is limited, but ease and accuracy of reading are required. These 3 1/2-inch instruments have a 4.92-inch scale which covers 250 degrees.

The sturdy, attractive, molded Textolite cases (round or square) harmonize with other G-E panel instruments. The mechanism is the internal-pivot type—a reliable unit construction which permits minimum behind-the-panel depth. Accuracy is within 5% of full scale on the rectifier type, 2% on all others. For full details, write for Bulletin GEA-5425.

If you need it—
± one degree accuracy



Electronic engineers are well aware of the usefulness of selsyns. Whether used for indicating or control, they have proved themselves a reliable, accurate, and rapid means of communication.

G.E. produces a complete line of selsyns—the high-accuracy type with an accuracy of ± one degree, and the general-purpose type with a ± five-degree accuracy. All units have high operating torque and are totally enclosed with no exposed terminals. Indicators and transmitters are also available in several models. See Bulletin GEA-2176.

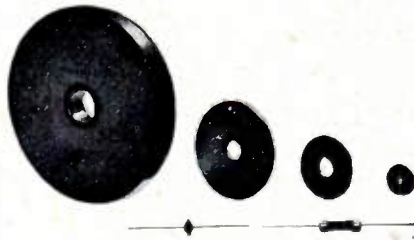

R varies inversely as E⁴

Thyrite® resistance material is inorganic and has the unique electrical property of varying inversely in resistance as the fourth power (or even higher) of an applied voltage. It has stable electrical characteristics over a wide range of operating conditions and can be used with a-c, d-c, or short-duration pulses. Because of this, it has solved many problems for the electronic design engineer.

Its most widely known applications are in the limiting of voltage surges, the stabilization of rectifier output voltages, the controlling of voltage-selective circuits, and the potentiometer division of voltages.

It is usually supplied in disk form in diameters from 0.25 to 6.00 inches, with or without mounting holes. Smaller sizes are furnished with wire leads. Complete information is contained in Bulletin GEA-4138.



Cast glass bushings
make possible new designs

Originally developed by General Electric for use in vital communication equipment, these unique bushings are now successfully used on such apparatus as power capacitors, transformers (filament, modulator or pulse), and rectifiers. They're made of cast glass with sealed-in nickel-steel hardware and can be readily welded, soldered or brazed directly to the apparatus. This eliminates the need for gaskets and provides a permanent hermetic seal.

Because they are small and compact, as well as vibration and weather resistant, glass bushings make possible new designs, especially where apparatus is to be airborne or where high humidity or fungus growth are special problems. Glass bushings will not puncture or shatter under excess potentials—either 60 cycle or impulse. For more data, including sizes and ratings, see Bulletin GEA-5093.

General Electric Company, Section B 667-4
Apparatus Department, Schenectady 5, N. Y.

Please send me the following bulletins:

- | | |
|--|--|
| <input type="checkbox"/> GEA-2176 Selsyns | <input type="checkbox"/> GEA-4889 Electronic Amplidyne |
| <input type="checkbox"/> GEA-4138 Thyrite Material | <input type="checkbox"/> GEA-5093 Glass Bushings |
| <input type="checkbox"/> GEA-4175 Welding Control | <input type="checkbox"/> GEA-5425 Panel Instruments |

NAME

COMPANY

ADDRESS

CITY STATE

New DU MONT FEATURES

DC

10

100

1000

OSCILLOGRAPHY THROUGHOUT THE SPECTRUM

Once again, DuMont paces the modern art of oscillography by extending the operation of oscillographs over the entire frequency spectrum from d-c to over 100 megacycles, for the study of new and broader fields of industry and research. In a group of new instruments covering this entire range, superior circuit design has been expertly integrated to give each instrument optimum performance in its particular category of applications.



5 CPS. TO 100,000 CPS.



DC TO 200,000 CPS.

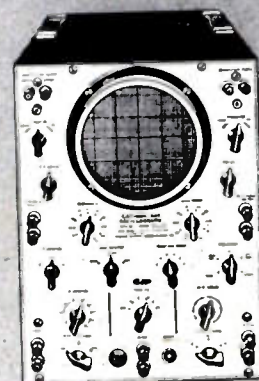

DC TO 500,000 CPS.

Type 292—Outstanding development in portable oscillographs employing a new three-inch tube, the Du Mont Type 3RP-A. Type 292 provides, good sensitivity, balanced deflection, and other performance features usually found only in instruments employing a five-inch tube.

Type 304-H—A new standard of performance in moderately priced oscillographs. Offers such advances as many times full screen expansion of sweep and vertical signal; complete positioning; high sensitivity at 3,000 volts accelerating potential high-gain a-c and d-c amplifiers; both driven and recurrent sweeps, sync limiting.

Type 250-AH—High-voltage operation and high light output for study of transient signals. New, extremely stable sweep circuit provides good linearity over its entire range of sweep-time intervals from 5 seconds to 10 microseconds. Contains built-in voltage calibrator and a variety of input connections.

at THE I.R.E. SHOW

100,000

1MC

10MC

100MC

OUTSTANDING DEVELOPMENTS IN CATHODE-RAY TUBES



Type 5XP— Multi-band intensifier tube providing high sensitivity and high light output at operating potentials up to 29 kv. Flat face insures maximum useful screen diameter with minimum distortion of signals. Writing rates of the Type 5XP— are extended in a modification incorporating metalized screen.

Type 3RP-A— New, flat-face three-inch tube permitting operation from balanced deflection circuits. High sensitivity is provided despite extremely short overall length of 9½ inches. Specially designed deflection plates minimize pattern distortions.

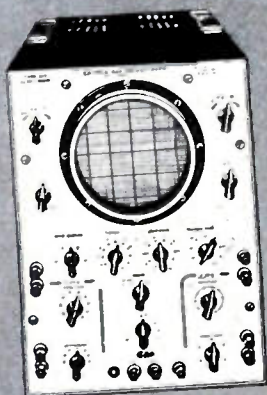

5 CPS. TO 10 MEGACYCLES



5 CPS. TO 15 MEGACYCLES

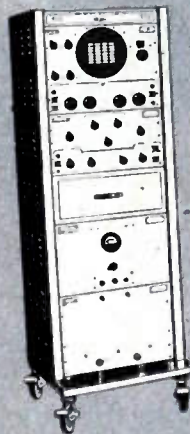

DC TO OVER 100 MEGACYCLES

Type 303— This new instrument employs a five-inch cathode-ray tube operated at 3,000 volts accelerating potential and provides over three inches of undistorted deflection at a sensitivity of 0.1 volt per inch. Both sensitivity and frequency response ratings of the Y-axis amplifier include the performance of a built-in signal delay line.

Type 294— New high-frequency oscillograph employing the sensitive Type 5XP— Cathode-ray Tube. Selection may be made at the rear panel for accelerating potential of either 7 kv. or 12 kv. Sensitivity at 12 kv. — 0.15 rms volt per inch. Built-in signal delay line permits full display of steep wavefronts. Built-in calibrator.

Special Type— A specially constructed cathode-ray oscillograph illustrating the possible applications of a newly-developed high-gain, wide-band amplifier having a frequency response, within 3db, from d-c to over 100 megacycles. Sweep speeds as fast as 100 inches per microsecond will be observed on the Type 5XP— Cathode-ray Tube.

© ALLEN B. DUMONT LABORATORIES, INC.

DUMONT

for Oscillography

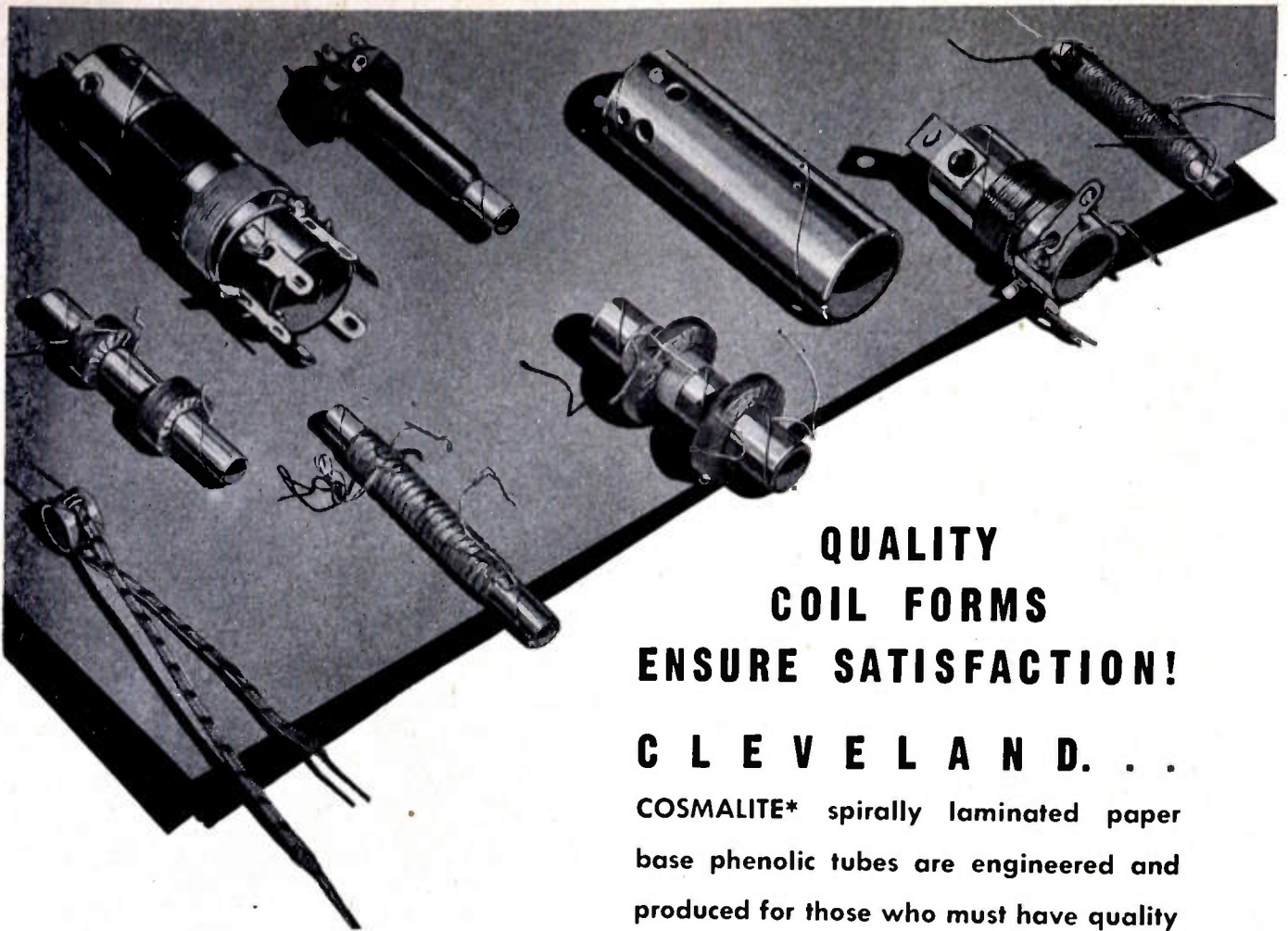

**QUALITY
COIL FORMS
ENSURE SATISFACTION!**

C L E V E L A N D . . .
 COSMALITE* spirally laminated paper base phenolic tubes are engineered and produced for those who must have quality performance with attractive prices and quick deliveries.

The outstanding choice in the industry for coil forms in all standard broadcast receiving sets and for permeability tuners . . . Cleveland Cosmalite is backed by over 25 years experience.

Consult us about our kindred products for both new and established needs in the electronic and electrical fields. For the best . . . "Call Cleveland!"

* Reg. U.S. Pat. Off.

See our Exhibit No. 207
 at the I. R. E. Radio
 Engineering Show.

The **CLEVELAND CONTAINER Co.**
 6201 BARBERTON AVE. CLEVELAND 2, OHIO

PLANTS AND SALES OFFICES at Plymouth, Wisc., Chicago, Detroit, Ogdensburg, N.Y., Jamesburg, N.J.
 ABRASIVE DIVISION at Cleveland, Ohio
 CANADIAN PLANT: The Cleveland Container, Canada, Ltd., Prescott, Ontario

REPRESENTATIVES

CANADA	WM. T. BARRON, EIGHTH LINE, RR #1, OAKVILLE, ONTARIO
METROPOLITAN NEW YORK	R. T. MURRAY, 614 CENTRAL AVE., EAST ORANGE, N.J.
NEW ENGLAND	E. P. PACK AND ASSOCIATES, 968 FARMINGTON AVE. WEST HARTFORD, CONN.



Microline

* CROSS-GUIDE DIRECTIONAL COUPLERS

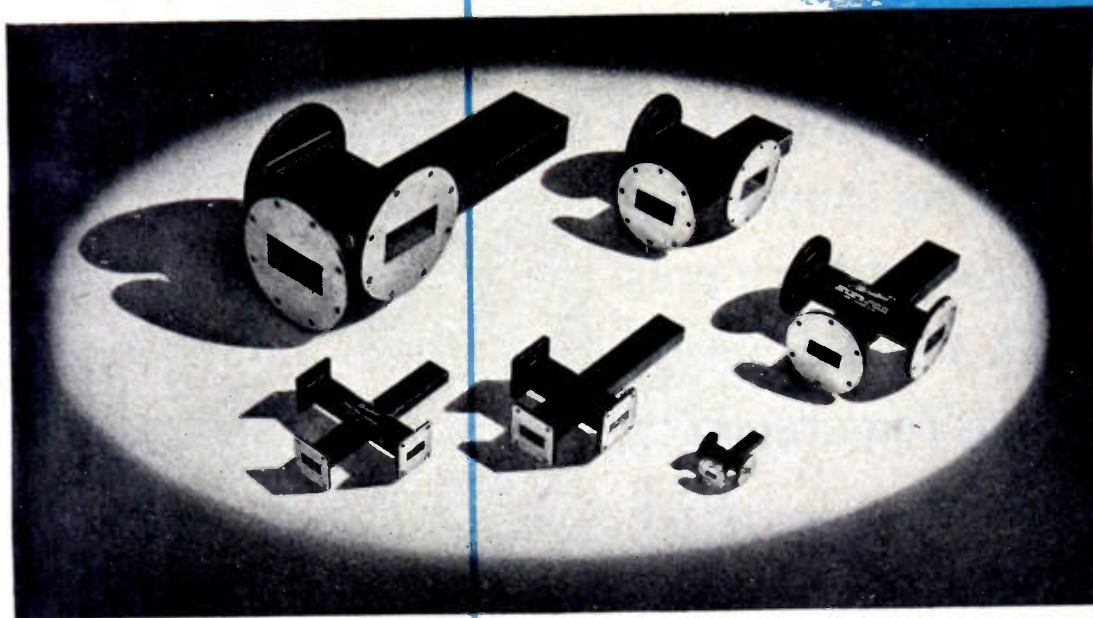

■ Sperry has a complete line of Cross-Guide Directional Couplers for all frequencies ranging from 2600 to 40,000 mc. These couplers are superior to other types of directional couplers in high directivity and unusually uniform coupling characteristics.

■ The coupling varies less than 3 db over the entire useful frequency band of the waveguide transmission line, whereas other types of couplers have attenuation which varies rapidly with frequency. Calibration accuracy on these instruments is ± 0.5 db through the quoted range. Operating temperature range is from -40° to $+55^{\circ}$ C and humidity effects are negligible.

■ Cross-Guide Directional Couplers, part of Sperry's MICROLINE*, are versatile, precision instruments well adapted for general laboratory and pro-

duction test work. They differ in appearance only in their external dimensions. Each consists of two rectangular waveguides, a primary and secondary guide, joined perpendicularly to each other. Coupling is provided by slots cut in the common wall between the waveguides. One end of the secondary waveguide is terminated in a matched load.

■ In addition to the superior electrical properties of the Cross-Guide Directional Couplers, they are also physically constructed for convenient assembly into a waveguide system. Our Industrial Department will be glad to give you additional information on these as well as other MICROLINE instruments.

ELECTRICAL CHARACTERISTICS			LINE AND CONNECTOR TYPES		
Model No.	Frequency Range (Kmc)	Nominal Coupling (Db)	Waveguide		Connectors Both Arms AN Type
			AN Type	Size (in.-O.D.)	
306	2.6-4.0	30	RG-58/U	3x1½x.080	UG-214/U
233	4.0-6.0	24	RG-49/U	2x1x.064	UG-149A/U
321	4.0-6.0	30			
322	4.0-6.0	40			
209	5.3-8.1	24	RG-50/U	1½x¾x.064	UG-344/U
237	5.3-8.1	30			
235	8.1-12.4	20	RG-52/U	1x½x.050	UG-39/U
236	8.1-12.4	24			
234	8.1-12.4	40			
388	12.4-17.0	20	RG-91/U	.702x.391x.040	UG-419/U
413	18.0-26.5	20	RG-53/U	½x¼x.040	UG-425/U
415	18.0-26.5	40			
405	26.5-36.0	20	RG-96/U	.360x.220x.040	UG-381/U

*TRADE MARK

SPERRY

GYROSCOPE COMPANY

DIVISION OF THE SPERRY CORPORATION, GREAT NECK, NEW YORK · NEW YORK · CLEVELAND · NEW ORLEANS · LOS ANGELES · SAN FRANCISCO · SEATTLE

MYCALEX 410

COMMUTATORS IN CONTINUOUS OPERATION For 600 HOURS

Sets astonishing high operational record for telemetering commutator used on aeronautical research projects . . . MYCALEX 410 only insulation to fill exacting requirements.

To December 2, 1949 more than 600 hours of maintenance free, high speed, clean signal telemetering commutator performance has been logged on MYCALEX 410 Units . . . Experience indicated four hours was optimistic . . . specifications hoped for ten hours . . . and the challenging problem was solved by MYCALEX 410 molded insulation.

SPECIFICATIONS TO BE MET IN PRODUCING MYCALEX 410 MOLDED INSULATION COMMUTATORS FOR TELEMETERING

O.D. 2.996" + .000 - .002 • Location of 3 slip rings and the 3 contact arrays from the center has a total tolerance of $\pm .001$. • Contact spacing 6° apart ± 1 minute. • Parting line thicknesses on insulation body are + .002 - .000. • Concentricity between ball bearing bushing and O.D. .0015. • Assembly height from face of slip rings and contacts to Mycalex 410 has tolerance of + .002 - .000. • Every contact must be tested from its neighbor contact for infinity on a 500 volt megger • Plate ambient - 20° C. to + 100° C. • Plate to operate at 95% humidity must not warp, crack, change in dielectric constant or resistivity • Contacts to resist high temperatures and must not loosen when repeatedly heated by soldering • Soldering required to withstand and operate under a 50 G acceleration.

SPECIFY MYCALEX 410 for Low Dielectric loss. . . . High Dielectric strength. . . . High Arc Resistance. . . . Stability over wide Humidity and Temperature Changes. . . . Resistance to High Temperatures. . . . Mechanical Precision. . . . Mechanical Strength. . . . Metal Inserts Molded in Place. . . . Minimum Service Expense. . . . Cooperation of MYCALEX Engineering Staff.

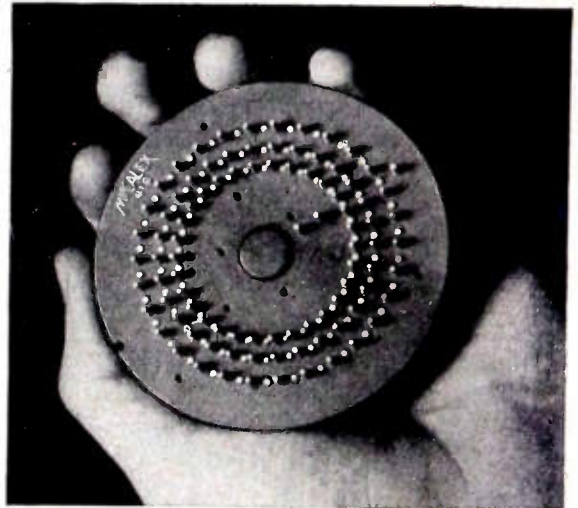

Illustrated are top and bottom views of the MYCALEX 410 molded insulation commutators manufactured to the specifications of Raymond Rosen Engineering Products, Inc., for Air Material Command, Navy telemetering projects, and other government agencies. These commutators are precision injection molded with 108 or 180 contacts and 3 slip rings all of coin silver.

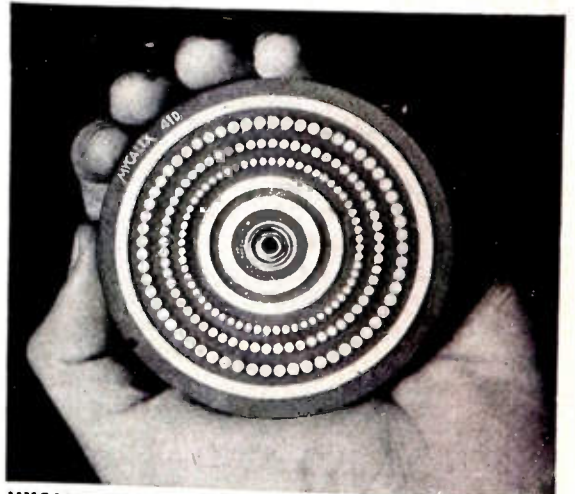

MYCALEX 410 molded insulation is designed to meet the most exacting requirements of all types of high frequency circuits. Difficult, involved and less complicated insulation problems are being solved by MYCALEX 410 molded insulation . . . the exclusive formulation of MYCALEX CORP. OF AMERICA . . . our engineering staff is at your service.



MYCALEX CORP. OF AMERICA

"Owners of 'MYCALEX' Patents"

Plant and General Offices, CLIFTON, N. J.

Executive Offices, 30 ROCKEFELLER PLAZA, NEW YORK 20, N. Y.

*Here's Why
You Get*



**UNFAILING
DEPENDABILITY**

with

OHMITE

RHEOSTATS

Years of field experience emphasize the underlying soundness of Ohmite rheostat design. These rheostats are constructed entirely of ceramic and metal—contain nothing to char, burn, shrink, or deteriorate. Ceramic parts insulate the shaft and mounting. The resistance winding is permanently locked in place by vitreous enamel. Every turn is contacted by the smoothly gliding metal-graphite brush, assuring smooth, gradual, close control.

OHMITE MANUFACTURING CO.
4862 Flournoy St.
Chicago 44, Ill.

Be Right with

OHMITE

Reg. U. S. Pat. Off.

RHEOSTATS • RESISTORS • TAP SWITCHES

UNIFORM CONTACT PRESSURE

Spring steel contact arm forms a long spring which assures uniform contact pressure at all times.

METAL-GRAPHITE BRUSH

Assures perfect contact with negligible wear on the wire.

UNIFORM SLIP-RING PRESSURE

Compression spring maintains uniform pressure and electrical contact between slip ring and center lead. Pressure here is independent of that at the contact brush.

SHAFT INSULATED FROM LIVE PARTS

High-strength ceramic hub insulates shaft and bushing from all live parts.

STOP PREVENTS STRAIN ON CONTACT ARM

Stop, keyed to the shaft, limits the rotation of the arm. No torsional strain is imposed on the arm in stopping.

THREE TERMINALS

Ohmite rheostats are provided with three terminals, so they can be used as potentiometers (voltage dividers), or to permit alternate rheostat connections.

WEAR-RESISTANT BEARING

Brass bushing for the steel shaft provides a wear-resistant, wobble-free bearing.

LOCKED-IN WINDING

Special alloy resistance wire is wound over a porcelain core. Each turn is firmly locked in vitreous enamel.

VITREOUS ENAMEL BOND

Vitreous enamel bonds the ceramic core and base together into one integral unit.

BEND-UP LOCK WASHER

Bend-up lock washer provides positive assurance against loosening of the assembly nut.



Write on Company Letterhead for Catalog and Engineering Manual #40.

25th Anniversary

1933-1958

**Value
Beyond
Expectation!**

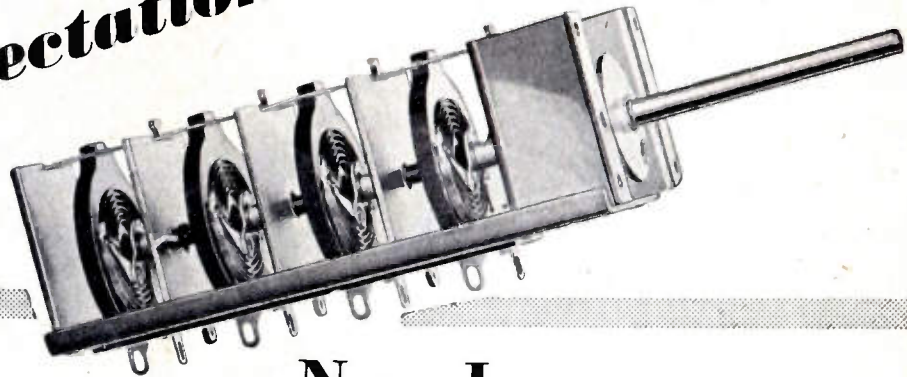

New Improvements in Mallory Inductuner* for Television Receivers

Outstanding Advantages of the new

Mallory Spiral Inductuner:

1. A single control for easy selection and fine tuning of any television or FM channel.
2. Easily adapted to UHF converter use.
3. Excellent stability eliminates frequency drift.
4. Supplied in three- or four-section designs.
5. Far more quiet operation; permits high signal-to-noise ratio in front end designs.
6. Free from microphonics.
7. Greater selectivity on high frequency channels.
8. Eliminates "bunching" of high band channels.
9. Simplifies front end design and production.
10. Reduces assembly costs.

*Reg. trade mark of P. R. Mallory & Co., Inc. for inductance tuning devices covered by Mallory-Ware patents.

Now there are important new reasons why the Mallory Inductuner should be first choice for your TV receiver. Each one offers more convenience to the set owner, new economy for you, without any sacrifice in the performance advantages of the continuous tuning principle . . .

Improved Inductuner eliminates "dead zone" from continuous tuning; covers entire TV range from 54 to 216 megacycles, including FM, in only 4 revolutions!

Improved Inductuner covers entire TV spectrum in only 3 revolutions, if FM is not required!

Improved Inductuner can be channel-indexed for touch-tuning without dial watching . . . still provides fine-tuning adjustment!

Finally, the Improved Inductuner is available at low cost and will make important savings for you in assembly and alignment operations.

That's Value Beyond Expectation!

Write for technical details. Also inquire about the surprisingly low cost and superior performance of the suggested front end designs which Mallory engineers have developed around the Inductuner.

Television Tuners, Special Switches, Controls and Resistors

SERVING INDUSTRY WITH

Capacitors	Contacts
Controls	Resistors
Rectifiers	Vibrators
Special	Power
Switches	Supplies
Resistance	Welding Materials

P. R. MALLORY & CO., Inc.
MALLORY

P. R. MALLORY & CO., Inc., INDIANAPOLIS 6, INDIANA

Simpson

INSTRUMENTS THAT STAY ACCURATE

Presents

the

New!

MODEL 303

VACUUM TUBE VOLT-OHMMETER

A Worthy Companion
of the 260

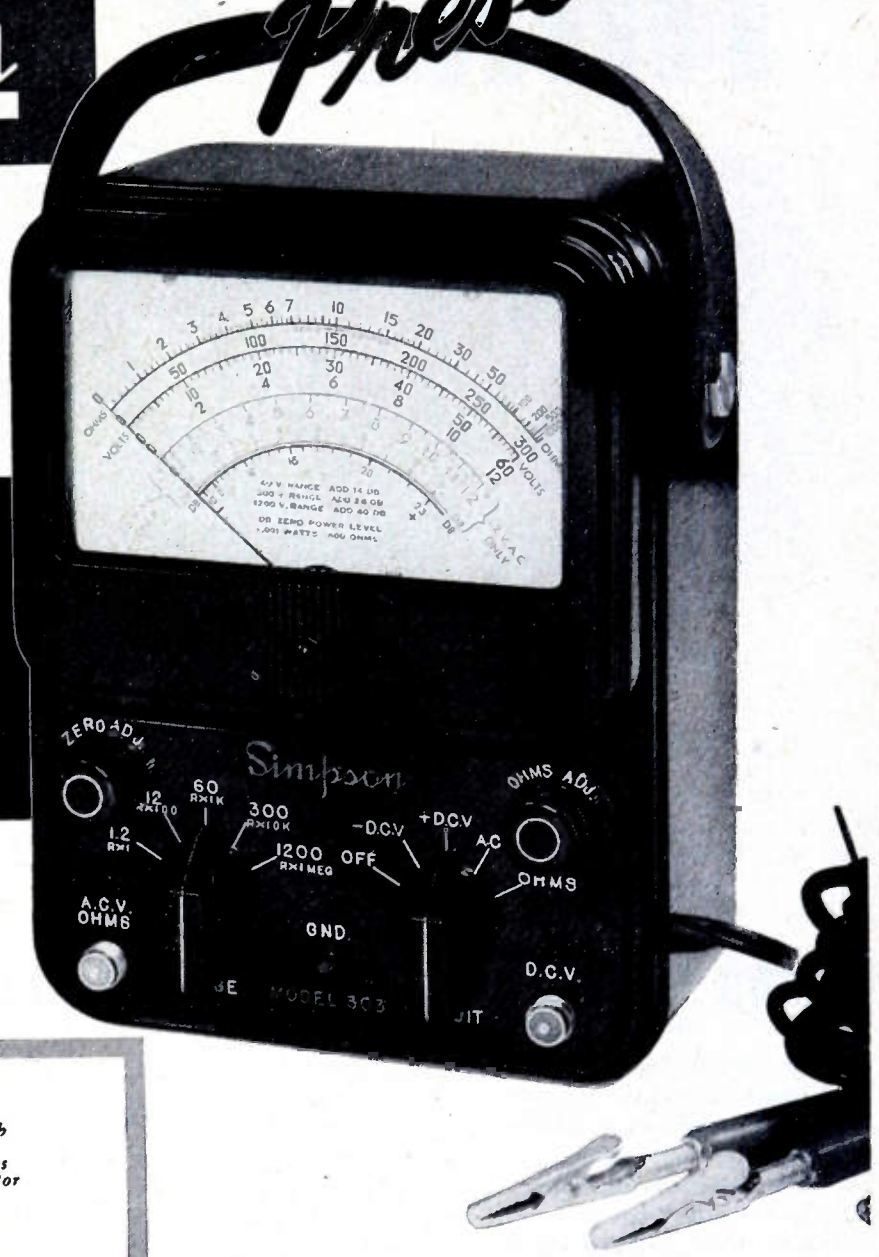

SPECIFICATIONS

DC Voltage

Ranges—1.2, 12, 60, 300, 1200 (30,000 with Accessory High Voltage Probe)
Input Resistance—10 megohms for all ranges
DC Probe—with one megohm isolating resistor
Polarity reversing switch

Ohms

Ranges—1000 (10 ohms center)
100,000 (1000 ohms center)
1 megohm (10,000 ohms center)
10 megohms (100,000 ohms center)
1000 megohms (10 megohms center)

AC Voltage

Ranges—1.2, 12, 60, 300, 1200
Impedance (with cable) approx. 200 mmf shunted by 275,000 ohms

AF Voltage

Ranges—1.2, 12, 60
Frequency Response—Flat to 100,000 cycles

Decibels

Ranges—-20 to +3, -10 to +23, +4 to +37,
+18 to +51, +30 to +63
Zero Power Level—1 M. W., 600 ohms

Galvanometer

Zero center for FM discriminator alignment and other galvanometer applications

R. F. Voltage

(Signal tracing with Accessory High Frequency Crystal Probe)

Range—20 volts maximum
Frequency—Flat 20 KC to 100 M.C.
105-125 V. 60 cycles

Size 5 1/4" x 7" x 3 1/4" (bakelite case). Weight: 4 lbs.
Shipping Wt.: 6 1/2 lbs.

Dealer's Net Price Model 303, including DCV Probe, ACV—Ohms probe and Ground Lead—\$58.75; Accessory High Frequency Probe, \$7.50
Accessory High Voltage Probe, \$14.85

Also available with roll top case, Model 303RT—\$64.75

Smaller and Handier for Greater Portability

A worthy companion of the world-famous Model 260 is this brand new addition to the Simpson line—the Model 303!

Skilled Simpson engineers spent months of painstaking research in the laboratory to produce the Model 303, which is one of the most versatile instruments ever made for TV servicing. This ruggedly constructed instrument offers the maximum in portability because it is approximately 60% smaller than other vacuum tube volt-ohmmeters. However, no sacrifice has been made in readability. The 303 has a large 4 1/2" meter, despite its handy compactness.

One of the many features of the 303 is its low current consumption. The AC voltage range is wider than on any other similar instrument—from 1.2 volts minimum to 1,200 maximum. Like all other instruments bearing the Simpson name, the Model 303 is an instrument of highest quality at an amazingly low price.

SIMPSON ELECTRIC COMPANY

5200-5218 West Kinzie Street, Chicago 44, Illinois
In Canada: Boch-Simpson, Ltd., London, Ontario

"THIRSTY WATER"

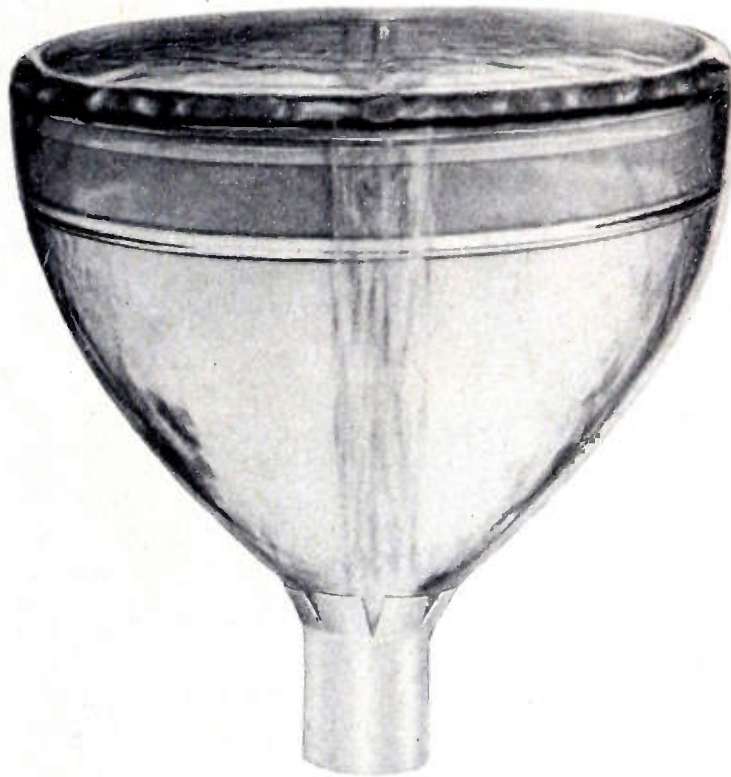

Makes PERFECT Sheldon Picture Tube Screens!

First, the inside face of the glass blank gets an acid wash; then it is rinsed with water. Next, the inside face is given a caustic wash and rinsed with water. *As the final step*, the inside face is given a rinse with a high pressure stream of "thirsty water" for several minutes.

"Thirsty water" is water from which all MINERALS and FOREIGN SUBSTANCES have been removed by special equipment and techniques in our plant. It is so pure that it becomes "hungry" or "thirsty" to re-absorb these foreign substances. The use of "thirsty water" leaves the inside surface of the glass blank bacteriolog-

ically clean and medically sterile. The inside surface is now PRIMED to receive the phosphor-coating.

This clean, sterile surface when coated with the phosphor coating, produces a uniformly perfect screen without blemishes.

During the coating process, every known precaution is taken against contamination. The rooms in which the tubes are coated are temperature-controlled, air-conditioned and kept dust-free . . . this assures the consistently perfect screens of Sheldon "Telegenic" Picture Tubes.

Sheldon
NATURAL IMAGE



SOFT GLOW
Picture Tube

WRITE for Descriptive Literature on these NEW All-Glass Tubes: 10", 12½" and 16" Velour Black . . . 16" 52° Deflection Angle, interchangeable with glass-metal 16AP4 . . . 16" Rectangular . 16YP4 70° Deflection Angle, interchangeable with glass-metal 16GP4 . Short 16" 70° Deflection Angle, 17½" overall . . . 19" 70° Deflection Angle . NEW Rectangular 14BP4 . . . NEW 19AP4 and 19AP4A Glass-Metal .

SHELDON ELECTRIC CO.

Division of Allied Electric Products Inc.

68-98 Coit Street, Irvington 11, N. J.

Branch Offices & Warehouses: CHICAGO 7, ILL., 426 S. Clinton St. LOS ANGELES 6, CAL., 2559 W. Pico Blvd.

SHELDON TELEVISION PICTURE TUBES • CATHODE RAY TUBES • FLUORESCENT STARTERS AND LAMP HOLDERS • SHELDON REFLECTOR & INFRA-RED LAMPS
PHOTOFLOOD & PHOTOSPOT LAMPS • SPRING-ACTION PLUGS • TAPMASTER EXTENSION CORD SETS & CUBE TAPS • RECTIFIER BULBS

→ VISIT THE SHELDON BOOTH NO. 201, PARTS DISTRIBUTOR SHOW, MAY 22-25, STEVENS HOTEL, CHICAGO ←



Robinson

Airlines



Choice of the Elite!

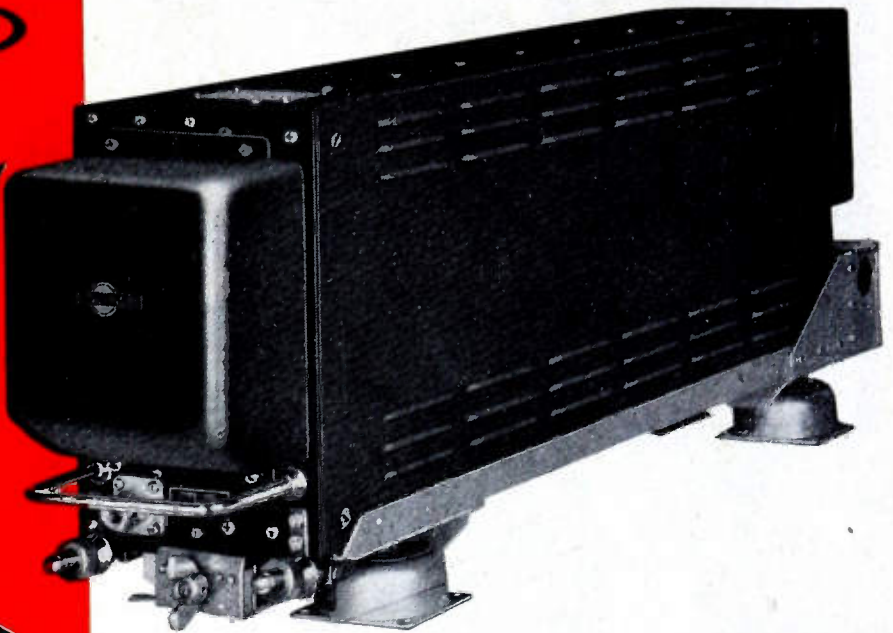

• After comprehensive examinations and tests, the most outstanding men in airline operations and communications have almost without exception specified the Collins 51R aircraft receiver for navigational use of the omnidirectional range.

By their choice, nearly all major United States airlines have installed or soon will install this efficient, trustworthy receiver and accessory instrumentation, to take full advantage of the new VHF radio facilities with which most of America's airways are now equipped.

The Collins 51R equipment and its companion VHF airborne transmitter, the Collins 17L, are also providing up-to-the-minute navigation and communications in an increasing number of private and business planes. Write us today for descriptive bulletins.

COLLINS 51R SPECIFIED FOR:

- American Airlines
- Capital Airlines
- Chicago and Southern Air Lines
- Colonial Airlines
- Continental Air Lines
- Eastern Air Lines
- National Airlines
- Northwest Airlines
- Pan American World Airways System
- Robinson Airlines
- Transcontinental & Western Air
- United Air Lines

IN AVIATION RADIO, IT'S...



COLLINS RADIO COMPANY, Cedar Rapids, Iowa

11 West 42nd Street
NEW YORK 18

2700 West Olive Avenue
BURBANK

ATOM SMASHING

with AEROVOX CAPACITORS

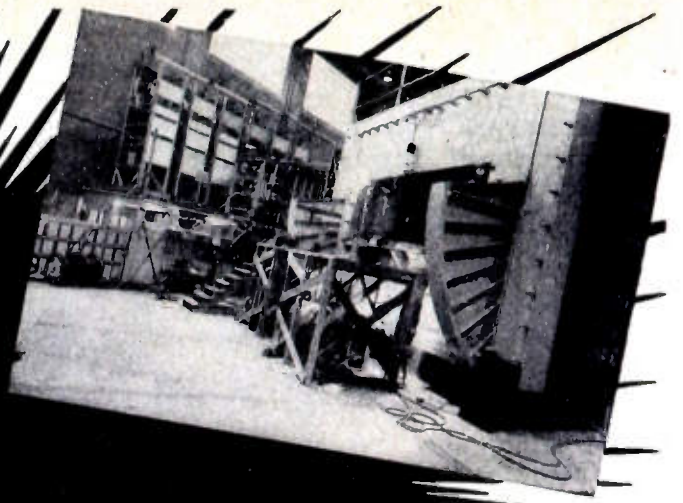

● This Atomic Age calls for huge capacitor banks in atom-smashing installations. Typical is the betatron installation at the University of Illinois, Urbana, Ill., with a capacitor bank totaling 12,960 mfd. made up of 648 units each rated at 20 mfd. 6000 volts D.C. Sufficient energy is stored in this capacitor bank to lift a 3000 lb. car 57 ft.!

Aerovox engineering and experience were important factors in the special design and processing required for the manufacture of these capacitors. Such skill is applied to all Aerovox production, regardless of type or size. Every design is given

individualized attention.

Because of outstanding experience with oil-filled capacitors, together with production facilities difficult to duplicate elsewhere, Aerovox is meeting the rigid requirements of atom-smashing installations.

Likewise for other high-voltage needs such as deep-penetration X-ray, radio transmitting, high-voltage testing, carrier-current coupling, and electronic laboratory equipment, Aerovox offers the widest choice of tried-tested-proven capacitors backed by application engineering second to none.

Aerovox Series '26 oil-filled stack-mounting capacitors. One or more units can be conveniently banked in series or parallel. Voltage ratings up to 150,000 D.C. Max. per unit.

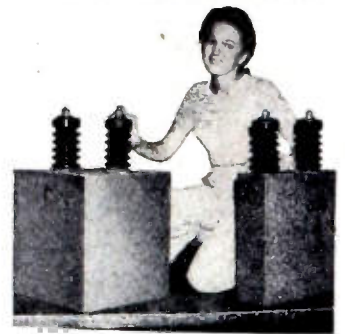

Aerovox Series '20 steel-case oil-filled capacitors. Voltage ratings up to 50,000 D.C.W. Also dual units of 25,000 v. (12,500-12,500) for voltage doubler circuits.

● Try Aerovox first! Our engineers will gladly share their high-voltage capacitance "know-how" with you in solving your particular problem.



FOR RADIO-ELECTRONIC AND INDUSTRIAL APPLICATIONS

AEROVOX CORPORATION, NEW BEDFORD, MASS., U.S.A.

SALES OFFICES IN ALL PRINCIPAL CITIES • Export: 13 E. 40th ST., NEW YORK 16, N. Y.

Cable: 'ARLAB' • In Canada: AEROVOX CANADA LTD., HAMILTON, ONT.

Q-max

TRADE MARK REGISTERED



7 Service-Proven Types
OF FINE
Insulating Compositions
and **Finishes**



- CLEAR RF LACQUER NO. A-27
- CLEAR AIR DRYING FINISHING LACQUER NO. 28
- BLACK AIR DRYING VARNISH NO. 30
- CLEAR BAKING VARNISH NO. 43
- BLACK BAKING VARNISH NO. 45
- HITEMP CLEAR BAKING VARNISH NO. 41
- INDUSTRIAL BAKING ADHESIVE NO. 49

Here's what Q-Max does:

Q-Max reduces corrosion, tropicalizes (when solutions permit the use of tropicalizing agents), repels moisture, increases volume and surface resistivity, promotes electrical stability, protects, reinforces and bonds. Q-Max has

proven its worth in actual service under all climatic and operating conditions—the reason why radio engineers and operations men, everywhere, specify Q-Max for utmost protection.

These are its many applications

Q-Max, developed by C-P engineers to provide better performance for installations in RF service, is highly efficient when applied to a wide variety of materials and surfaces. Applications include the treatment of wood, steatite, porce-

lain, glass, plastics, organic and inorganic fabrics, papers, vulcanized fibre and metals. A reputation for positive action and permanence has made Q-Max the accepted standard for RF service.

CALL OR WRITE FOR YOUR COPY OF THE NEW Q-MAX CATALOG TODAY

Q-MAX CHEMICALS DIVISION

Communication Products Company, Inc.

KEYPORT

NEW JERSEY



COAXIAL TRANSMISSION LINE
DIPOLE ANTENNAS • SWITCHES

TOWER HARDWARE • DEHYDRATORS
Q-MAX LACQUER • CUSTOM SPECIALTIES

These Stackpole Specialties SIMPLIFY DESIGN *and* CONSTRUCTION

TINY "GA" CAPACITORS

...that cost no more than "gimmicks"

These sturdy little capacitors cost no more than flimsy, twisted wire "gimmicks," are non-inductive and assure greater stability, higher Q, better insulation resistance and higher break-down voltage. Standard capacities include .5— .68—1.0—1.5—2.2—3.3 and 4.7 mmfd. types.



INEXPENSIVE SUPPORTS FOR WINDINGS

Handy Stackpole molded Bakelite coil forms take less space and require one-third fewer soldered connections. Standard forms are available for universal, solenoid, tapped universal and multiple windings. Molded iron center sections can also be provided.

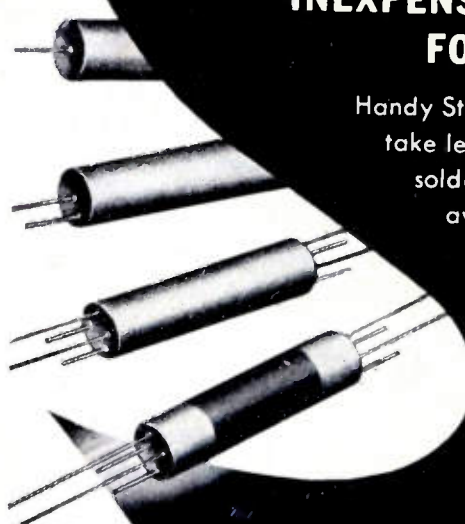

WRITE FOR CATALOG RC7

Stackpole fixed and variable resistors—iron cores for practically any need—in-expensive line and slide switches.

DEPENDABLE, LOW COST SLIDE SWITCHES

for 3 ampere, 125V. A. C. use

The new Stackpole Type SS-26 Switch is just the thing for electrical appliances and equipment of all sorts! Construction is exceptionally durable and the switches are readily adaptable to various mounting arrangements. Underwriters approved and conservatively rated for 3 amperes at 125 volts A.C. (or 1 ampere at 125 volts D.C.). Single-pole single-throw and single-pole double-throw types available.

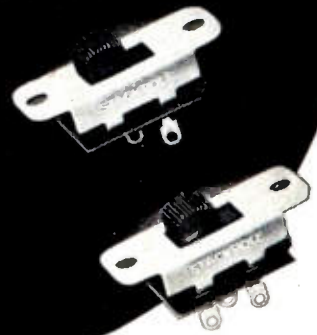

The Stackpole Minute Man—your assurance of prompt, dependable service

STACKPOLE

Electronic Components Division

STACKPOLE CARBON COMPANY • ST. MARYS, PENNA.

Exceeding Expectations!

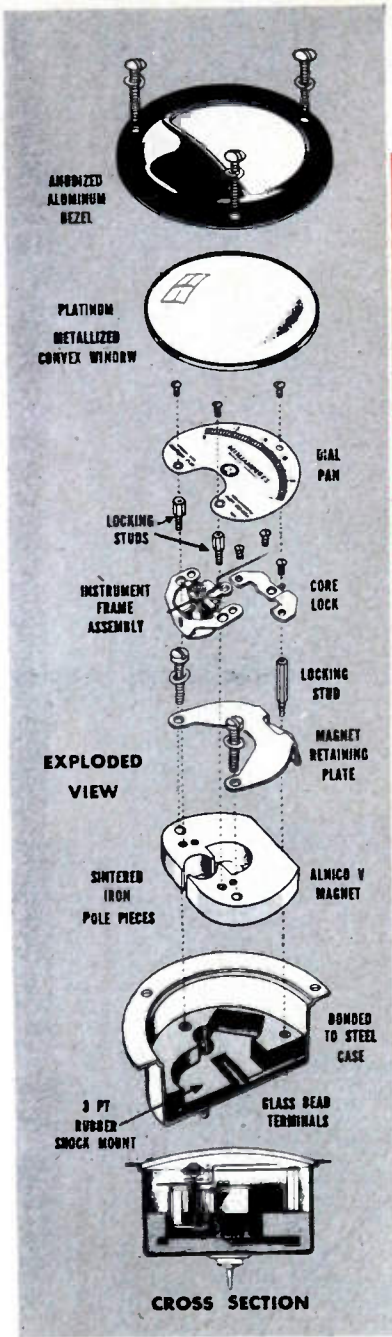

NEW marion ruggedized meter

Marion Ruggedized Meters introduce a brand new family of panel instruments produced to give outstanding performance under *extreme* conditions of Shock . . . Vibration . . . Mechanical Stress or Strain. Hermetically sealed, they are impervious to the weather conditions of *any* climate.

Marion Ruggedized Instruments give you new freedom of application. They are extremely accurate, highly sensitive meters that may be used in places where no one has ever before *dared* use "delicate instruments." Count on them to exceed your greatest expectations in *any* application.

Send for your free copy of our booklet on the new Marion Ruggedized Meters today. See how Ruggedized Meters meet the dimensional requirements of JAN-I-6 and are interchangeable with existing standard JAN 2 1/2" and 3 1/2" types. Learn why their electrical and mechanical performance far *exceeds* existing JAN requirements. Discover for yourself some of the developments that made the ruggedized meter possible.



MADE BY THE MAKER WHOSE NAME MEANS THE MOST IN METERS

Manufacturers of
Hermetically Sealed
Meters Since 1944



MARION ELECTRICAL INSTRUMENT COMPANY
MANCHESTER, NEW HAMPSHIRE
Export Division, 458 Broadway, New York 13, U. S. A., Cables MORHANEX
In Canada: The Astral Electric Company, 44 Danforth Rd., Toronto, Ontario

Another successful start with **DU MONT**

KPHO-TV

PHOENIX, ARIZONA

Channel 5

EFFECTIVE POWER:

17.5 KW Visual

8.7 KW Aural

◆ Commencing commercial operation on December 4, 1949, KPHO-TV has joined the ever-increasing ranks of Du Mont-equipped television stations. With its Du Mont equipment, this station is assured of lowest operating costs, finest transmission, and the all-important advantage of being able to expand its facilities in perfect step with its economic progress. Welcome KPHO-TV of Phoenix, Ariz.!

◆ *When you are ready for TV broadcasting, investigate Du Mont first! Then compare!*

©ALLEN B. DU MONT LABORATORIES, INC.



DU MONT *First with the Finest in Television*

ALLEN B. DU MONT LABORATORIES, INC., TELEVISION TRANSMITTER DIVISION, CLIFTON, N. J.

PRECIOUS METAL LAMINATED RINGS



Where electrical contact is required to a moving part, laminated precious metal rings offer unusual operating characteristics at a real saving in cost over solid precious metal rings. Silver or Gold, or Platinum, or Palladium, or their alloys, bonded to the required base metal, such as copper or bronze alloys, make possible

- **Uniform contact resistance**
- **Low noise level**
- **Selected temper for essential wearing quality**
- **Mechanical strength**
- **Corrosion resistance**

These rings are now being used in special electric motors, calculators, and computers, Radar, and fire control instruments, potentiometers, and other electro mechanical devices. Our engineers will be pleased to make recommendations to meet your requirements. We would also be pleased to submit quotations to cover your specifications.

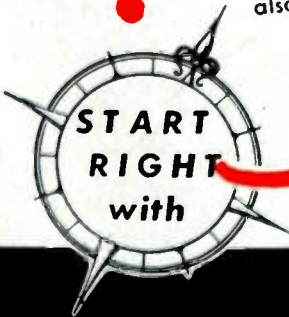

Makepeace PRODUCTS

LAMINATED AND SOLID SILVER WAVE GUIDE TUBING • SILVERCLAD WIRE, SHEET AND TUBING
SILVER SOLDERS • FABRICATED PARTS AND ASSEMBLIES

D. E. MAKEPEACE COMPANY
MAIN OFFICE AND PLANT • ATTLEBORO, MASS.

New York Office, 30 Church Street

Chicago Office, 55 East Washington Street

WEMP Serves the Milwaukee Empire with a Truscon Steel Radio Tower

● Millions of people are concentrated in the rich industrial and agricultural area that comprises the Milwaukee empire.

Adequate coverage of this intensive listener audience made a radio tower of the most modern design a paramount requirement.

WEMP radio personnel enlisted the services of Truscon radio engineers, long skilled in designing radio towers to meet specific conditions all over America.

Promptly and efficiently, Truscon engineered and erected the 456 feet high over-all, self-supporting tower shown here, with its Western Electric 6-unit cloverleaf FM antenna.

Another
TRUSCON
TOWER OF STRENGTH
456 FT.
HIGH

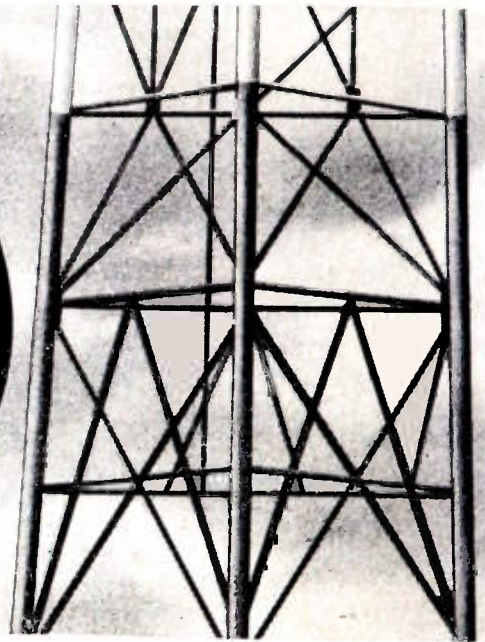

Truscon offers a world-wide background of experience to call upon in fitting Radio Towers to specific needs. Whether your own plans call for new or enlarged AM, FM, or TV transmission, Truscon will assume all responsibility for tower design and erection . . . tall or small . . . guyed or self-supporting . . . tapered or uniform in cross-section. Your phone call or letter to our home office in Youngstown, Ohio—or to any convenient Truscon District Sales Office—will rate immediate, interested attention . . . and action. There is no obligation on your part, of course.

TRUSCON STEEL COMPANY

YOUNGSTOWN 1, OHIO
Subsidiary of Republic Steel Corporation

TRUSCON 
SELF-SUPPORTING
AND UNIFORM
CROSS SECTION GUYED **TOWERS**

TRUSCON COPPER MESH GROUND SCREEN



High Fidelity Components

*Linear Standard... Hipermalloy...
Ultracompact... Ouncer. Four
great lines for every quality
application.*



Hermetic Seal Components

*Largest producers during the war.
Largest producers today.*



High Q Components

*Dust Core Toroids... Variable
Inductors... Complete filters...
for every application.*

United Transformer Corp.

150 VARICK STREET NEW YORK 13, N. Y.
EXPORT DIVISION: 13 EAST 40th STREET, NEW YORK 16, N. Y. CABLES: "ARLAB"

"His receiver or equipment will have a Dependable Stout Heart"

The core is the heart of the circuit — in radio, TV, short wave, FM, radar and in many forms of telephonic apparatus. The dependable, stout heart can only be built with the finest materials available.

Stackpole Carbon Company has unparalleled experience in the manufacture of quality powdered iron cores. They know — and the firms they serve know — the all-importance of minimizing fading and drifting. They know that a core made with a G A & F Carbonyl Iron Powder represents the one surest safeguard.

Stackpole Carbon Company knows — and the firms they serve know — that the *gains* thus made are all but

doubled by the *savings* which also occur — automatically. If you can cut down the space and the weight in your receiver or equipment, if you can make a substantial savings in wire, why specify any core material except G A & F Carbonyl Iron Powders?

We invite you to send for the free booklet described below. We invite you to call upon our highly specialized research facilities for any help we can logically render. We also invite you to ask your core maker, your coil winder, your industrial designer, how G A & F Carbonyl Iron Powders can improve the performance of the equipment you manufacture. It will cost you nothing to get all the facts.



THIS FREE BOOK — fully illustrated, with performance charts and application data — will help any radio engineer or electronics manufacturer to step up quality, while saving real money. Kindly address your request to Dept. 15.

These unique properties tell why G A & F Carbonyl Iron Powders are superior:

PROPERTY	ADVANTAGE
Spherical structure	Facilitates insulation and compacting
Concentric shell structure (some types only)	Low eddy current losses
High iron content	Exceptional permeability and compressibility
Absence of non-ferrous metals	Absence of corresponding disturbing influences
Relative absence of internal stress; regular crystal structure	Low hysteresis loss
Spheres of small size	Low eddy current losses; usable for high frequencies
Variations of sphere size	Extremely close packing

ANTARA® PRODUCTS

**GENERAL
GA** NILINE & FILM CORPORATION

444 MADISON AVENUE

NEW YORK 22, N. Y.

G A & F® Carbonyl

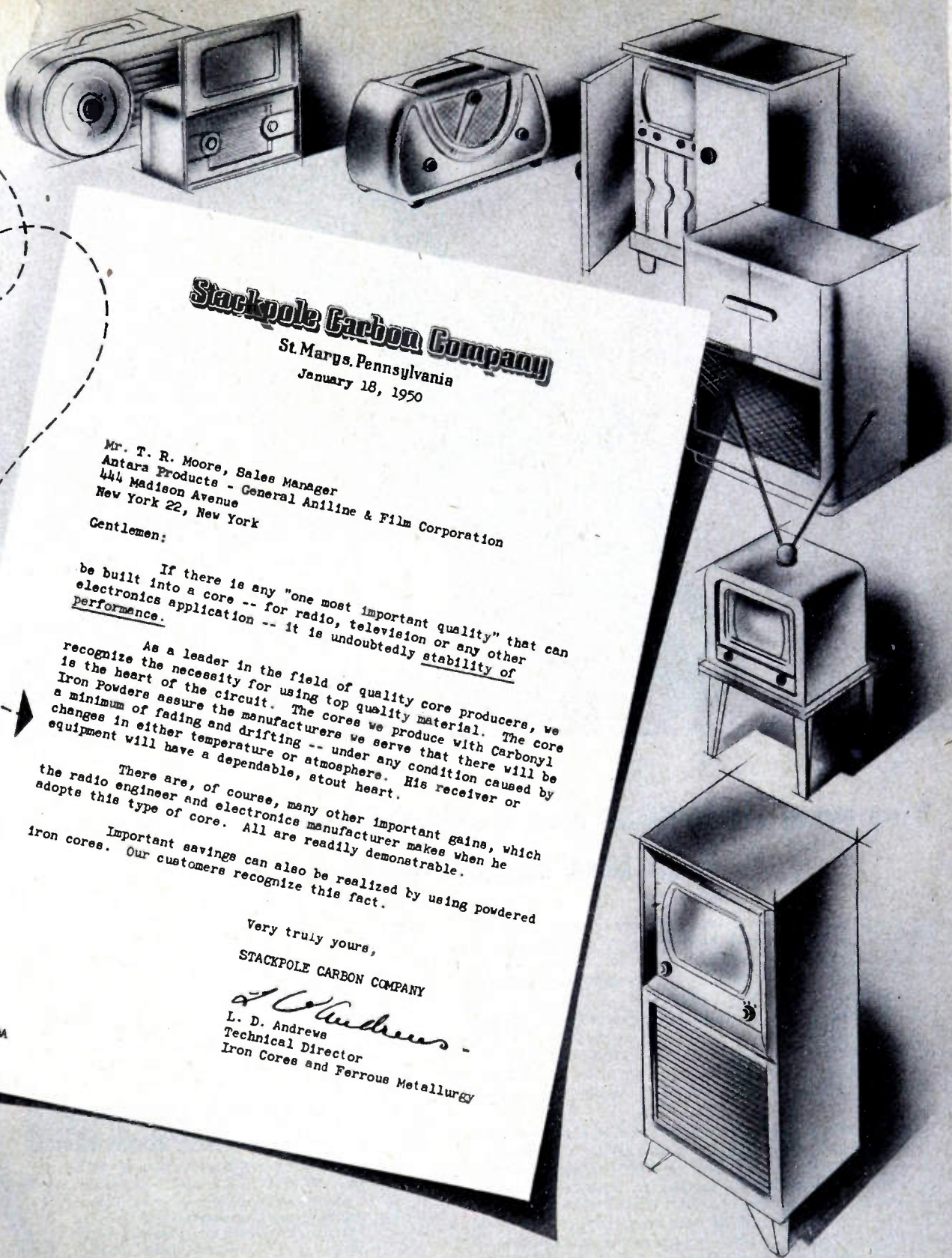

Stackpole Carbon Company

St. Marys, Pennsylvania
January 18, 1950

Mr. T. R. Moore, Sales Manager
Antara Products - General Aniline & Film Corporation
444 Madison Avenue
New York 22, New York

Gentlemen:

If there is any "one most important quality" that can be built into a core -- for radio, television or any other electronics application -- it is undoubtedly stability of performance.

As a leader in the field of quality core producers, we recognize the necessity for using top quality material. The core is the heart of the circuit. The cores we produce with Carbonyl Iron Powders assure the manufacturers we serve that there will be a minimum of fading and drifting -- under any condition caused by changes in either temperature or atmosphere. His receiver or equipment will have a dependable, stout heart.

There are, of course, many other important gains, which the radio engineer and electronics manufacturer makes when he adopts this type of core. All are readily demonstrable.

Important savings can also be realized by using powdered iron cores. Our customers recognize this fact.

Very truly yours,

STACKPOLE CARBON COMPANY

L. D. Andrews
L. D. Andrews
Technical Director
Iron Cores and Ferrous Metallurgy

LDA

Iron Powders . . .



Another

RCA FIRST!



SUPER-POWER Beam Triode

Tested at one million watts input

The Fountainhead of Modern Tube Development is RCA

The new RCA-5831 has a conservative 500-kw output* with less than 2-kw grid drive!

IMAGINE A TUBE just a shade over 38 inches long and 9 inches in diameter that handles with high efficiency an input of 650 kilowatts* in continuous commercial service . . . that, then, is the new and revolutionary RCA-5831 super-power *beam triode*—tipping the scales at a mere 135 pounds!

This new tube can be operated with maximum rated plate voltage and plate input at frequencies up through the AM broadcast band and much higher. The limitations for operation at the higher frequencies have not yet been determined, but we will welcome requests for information on specific applications.

The RCA-5831 is unique in that it features a symmetrical array of unit electron-optical systems embodying a mechanical structure which permits close spacing and accurate alignment of the electrodes to a degree unusual in high power tubes. Ducts for water-cooling the plate and beam-forming cylinder are built-in and have simplified hose connections. The grid-terminal flange employs a water-cooled connector. Because of the electron-optical principles incorporated in its design, the

5831 has low grid current and hence requires unusually low driving power.

Other features of the RCA-5831 include a multi-strand, thoriated-tungsten filament for economical operation as well as high emission capability, and low-inductance rf leads and flange terminals.

A technical bulletin covering the RCA-5831 in more detail, is available from RCA Commercial Engineering, Section C47R, Harrison, N. J. *Unmodulated class C service

ANOTHER new RCA tube . . .

. . . the RCA-5675 "Pencil-Type" Triode for UHF applications: RCA-5675 is a new medium-mu triode employing a double-ended coaxial-electrode structure, for use in grounded-grid circuits. As a local oscillator, it will deliver a power output of 475 milliwatts at 1700 Mc. and about 50 milliwatts at 3000 Mc.



See the new RCA-5831 at the RCA Exhibit, I.R.E.
National Convention, Grand Central Palace, N.Y.C., March 6-9.



RADIO CORPORATION of AMERICA

ELECTRON TUBES

HARRISON, N. J.

PROCEEDINGS OF THE I.R.E.

Published Monthly by

The Institute of Radio Engineers, Inc.

BOARD OF DIRECTORS, 1950

Raymond F. Guy
President

R. A. Watson-Watt
Vice-President

D. B. Sinclair
Treasurer

Haraden Pratt
Secretary

Alfred N. Goldsmith
Editor

B. E. Shackelford
Senior Past President

Stuart L. Bailey
Junior Past President

1950

Ben Akerman
W. R. G. Baker
T. H. Clark
J. V. L. Hogan
T. A. Hunter
H. E. Kranz
F. H. R. Pounsett
J. E. Shepherd
J. A. Stratton

1950-1951

A. V. Eastman
W. L. Everitt
D. G. Fink
F. Hamburger, Jr.
H. J. Reich
J. D. Reid

1950-1952

W. R. Hewlett
J. W. McRae

Harold R. Zeamans
General Counsel

George W. Bailey
Executive Secretary

Laurence G. Cumming
Technical Secretary

Changes of address (with advance notice of fifteen days) and communications regarding subscriptions and payments should be mailed to the Secretary of the Institute, at 450 Ahnaip St., Menasha, Wisconsin, or 1 East 79 Street, New York 21, N. Y.

All rights of republication, including translation into foreign languages, are reserved by the Institute. Abstracts of papers, with mention of their source, may be printed. Requests for republication privileges should be addressed to The Institute of Radio Engineers.

VOLUME 38

March, 1950

NUMBER 3

PROCEEDINGS OF THE I.R.E.

Austin V. Eastman, Regional Director, 1950-1951.....	226
The Engineer as Government Advisor..... Donald G. Fink	227
3572. Suggestions for the Preparation of Technical Papers..... R. T. Hamlett	228
3573. Some Problems of Disk Recording for Broadcasting Purposes..... F. O. Viol	233
3574. A Variable Speed Turntable and Its Use in the Calibration of Disk Reproducing Pickups..... H. E. Haynes and H. E. Roys	239
3575. A New Type of Slotted Line Section..... W. Bruce Wholey and W. Noel Eldred	244
3576. The Radiation Characteristics of Conical Horn Antennas..... A. P. King	249
3577. Interference Characteristics of Pulse-Time Modulation..... Ernest R. Kretzmer	252
3578. Echoes in Transmission at 450 Megacycles From Land-to-Car Radio Units..... W. R. Young, Jr. and L. Y. Lacy	255
3579. A General Review of Linear Varying Parameter and Nonlinear Circuit Analysis..... W. R. Bennett	259
3580. The Synthesis of Resistor-Capacitor Networks..... J. L. Bower and P. F. Ordung	263
3581. Theoretical Aspects of Asynchronous Multiplexing..... W. D. White	270
3582. Methods for Obtaining the Voltage Standing-Wave Ratio on Transmission Lines Independently of the Detector Characteristics..... A. M. Winzemer	275
3583. Shunt-Excited Flat-Plate Antennas with Applications to Aircraft Structures..... J. V. N. Granger	280
3584. Volume Scanning with Conical Beams..... Daniel Levine	287
3585. Frequency Analysis of Variable Networks..... Lotfi A. Zadeh	291
3586. Input Impedance of a Two-Wire Open-Line and Cylindrical-Center Driven Antenna..... T. W. Winternitz	299
3587. Reflection of Radio Waves from a Rough Sea..... Lamont V. Blake	301
3511. Correction to "Fluctuation Phenomena Arising in the Quantum Interaction of Electrons with H-F Fields"..... D. K. C. MacDonald and R. Kompfner	304
3588. A Note on Coaxial Bethe-Hole Directional Couplers..... Edward L. Ginzton and Paul S. Goodwin	305
3589. Admittance and Transfer Function for an <i>n</i> -Mesh RC Filter Network..... E. W. Tschudi	309
Contributors to Proceedings of the I.R.E.....	311

CORRESPONDENCE

3590. Increase in Q-Value and Reduction of Aging of Quartz-Crystal Blanks..... A. C. Prichard, M. A. A. Druesne, and D. G. McCaa	314
3316. Calculation of Ground-Wave Field Strength..... K. Venkataraman	314

INSTITUTE NEWS AND RADIO NOTES SECTION

Technical Committee Notes.....	315
Industrial Engineering Notes.....	317
I.R.E. People.....	319
Sections.....	321
Books:	
3591. "Transformation Calculus and Electrical Transients" by Stanford Goldman..... Reviewed by Lloyd T. DeVore	322
3592. "Fourier Transforms" by S. Bochner and K. Chandrasekharan..... Reviewed by Gordon L. Fredendall	322
3593. Abstracts and References.....	323
Section Meetings..... 37A	Positions Open..... 50A
Students Branch Meetings..... 42A	Positions Wanted..... 52A
Membership..... 45A	News—New Products..... 60A
Advertising Index.....	67A

EDITORIAL DEPARTMENT

Alfred N. Goldsmith
Editor

E. K. Gannett
Technical Editor

Mary L. Potter
Assistant Editor

ADVERTISING DEPARTMENT

William C. Copp
Advertising Manager

Lillian Petranek
Assistant Advertising Manager

BOARD OF EDITORS

Alfred N. Goldsmith
Chairman

PAPERS REVIEW COMMITTEE

George F. Metcalf
Chairman

Responsibility for the contents of papers published in the PROCEEDINGS OF THE I.R.E. rests upon the authors. Statements made in papers are not binding on the Institute or its members.





Austin V. Eastman

REGIONAL DIRECTOR, 1950-1951

Austin V. Eastman, Regional Director of the Pacific Region, was born on May 16, 1902, at Seattle, Wash. He received the Bachelor of Science degree in electrical engineering from the University of Washington in 1922, and then spent two years with the General Electric Company at Schenectady, New York, in the radio engineering department. During the second year he was in charge of developmental work on carrier current control equipment for use on high-voltage power lines.

In 1924, he returned to the University of Washington as instructor in electrical engineering, receiving the Master of Science degree in electrical engineering from that institution in 1929. He was elevated to the rank of Assistant Professor that year, became Associate Professor in 1937, and Professor and Executive Officer of the Department of Electrical Engineering in 1942.

During the war he was appointed to the Seattle Transportation Commission, a board of three men responsible for the operation of the Seattle Transit System, where his engineering training proved of value in meeting some of the wartime problems.

Professor Eastman is the author of several technical articles and of the book, "Fundamentals of Vacuum Tubes." He became an Associate Member of The Institute of Radio Engineers in 1923, a Member in 1932, and a Fellow in 1941. He has served as a member of the Papers Procurement, Membership, Regular Papers, and Policy Development Committees. Professor Eastman was Section Chairman of the Seattle Section of the IRE in 1929 and 1930, and was Institute Representative of the University of Washington from 1941 until 1947. He is also a Fellow of the AIEE.

Modern governmental regulatory bodies should meet the harsh specifications that they shall know more and more about more and more. Dealing with fields of ever-increasing technical complexity and public and industrial importance, their responsibility is indeed heavy. Unless their findings are based on sound technical, social, and industrial data, tinged with an irreducible minimum of political flavor, confusion, retarding, or even stoppage of progress may result.

For these reasons, skilled and impartial advisers to government groups are needed. Fortunately such are to some extent available. The more seriously the advisers and their recommendations are regarded by the governmental bodies, the more will these advisers be moved to enthusiastic and productive effort. There is clearly a reciprocal obligation between the adviser and the advisee.

These subjects have been well analyzed in the following guest editorial by the Chairman of the Joint Technical Advisory Committee (established by The Institute of Radio Engineers and the Radio Manufacturers Association), who is also a Director of the IRE, and the Editor of *Electronics*.—*The Editor*.

The Engineer as Government Advisor

DONALD G. FINK

Government agencies concerned with the regulation of radio facilities, notably the FCC, the CAA, and the Department of Defense, are faced with technical problems of ever-increasing complexity. Propagation data are required over a spectrum spanning more than 25 octaves. The current performance data of hundreds of different types of transmitters, receivers, and antennas must be established, and extrapolated into the future. The conflicting interests of manifold agencies, services, and commercial organizations must be resolved to promote efficient and equitable use of the spectrum.

No government agency possesses a sufficient staff or facilities to uncover, to measure, or to evaluate all the pertinent data in such a vast array of interrelated factors and interests. Recognizing this limitation, the FCC has made use of three channels of information, linked to engineers outside the government service: the Engineering Conference, the Ad Hoc Committee, and the Committee of Knowledgeable Men from the Industry and the Profession.

The first two perform official functions of the Commission. The Engineering Conference is called by the Commission to describe a particular problem, to lay out plans for assembling information, and to perform a preliminary evaluation prior to a public hearing. The Ad Hoc Committee is a comparatively recent device; it is appointed by the Commission to study a particular problem and render a report within a stated time limit.

The third group, the COKMIP, has a long and honorable tradition, comprising such organizations as the National Television System Committee, the Radio Technical Planning Board, and the Joint Technical Advisory Committee. To serve a useful function, the COKMIP must have several qualifications. It must be expert, in itself and in all its sources of technical data. It must respond to all those who would contribute usefully to its findings, whether or not the contributor is an established member of the industry or the profession. It must, by reputation and by its actions, command respect as an objective and impartial organ, devoted to an unbiased evaluation of the facts.

The responsibility of the COKMIP is great, particularly when its findings are adopted as the basis of public policy. The danger of being caught between conflicting interests, since it takes side with neither, is ever present. All those connected with such a group—whether as member, as consultant, or as member of a supporting committee—may, on occasion, wonder whether the job is worth the candle. But there can be no doubt that the jobs assigned to the COKMIP must be done. The only question is how best to do them.

The Committee of Knowledgeable Men must have its collective face turned in two directions: to the professional and industrial sources of information on the one hand, and to the regulatory agencies who must understand, and must act upon, that information on the other. It should be ready to collect information, to supervise tests, to evaluate data on request from either group. It should take careful note of gaps and duplications, of overemphases and underemphases, in programs of technical investigation. It should notify all concerned, industry and government, when such discrepancies arise. Above all, the COKMIP must have the good will and support of all concerned, if it is to participate in the important task of collecting and evaluating pertinent technical evidence in the wide reaches of the radio art.

Suggestions for the Preparation of Technical Papers*

ROBERT T. HAMLETT†, SENIOR MEMBER, IRE

Summary—The value and purpose of technical papers is presented, followed by generalized suggestions for their preparation. Separate sections deal with the *introduction, main body, and conclusion*. Throughout is interspersed information on illustrations, value of good logic and grammatical correctness, along with other data for the writing of a paper from its conception through ultimate delivery and publication.

I. INTRODUCTION

THE ENGINEER rarely faces a more clean-cut opportunity for accomplishment than that presented to him when he is chosen to prepare a technical paper. The direct benefits of successful accomplishment are threefold: the author's professional prestige is enhanced, the reputation of the organization he represents is maintained or improved, and last but by no means unimportant, the standing of the engineering profession in general is raised. With these inviting benefits, it is unfortunate that they are only occasionally realized because of poor preparation and even poorer presentation of the technical paper.

The engineer has always labored under the stigma that "Engineers cannot write." It is questionable whether engineers as a class write any more poorly than doctors or lawyers or salesmen. Perhaps the subjects we write about are more complex and require more specific knowledge of the reader. Whether this poor reputation is justified or not, the only logical course for engineers is one of continual self-improvement until this undesirable *class distinction* disappears.

Courses in technical writing are given in many of the better schools but unfortunately the student seldom appreciates at that time the importance of effective writing, and even worse he retains little of what he learned because in the years immediately following graduation there are few opportunities for him to prepare a technical paper. His knowledge of ordinary rules of grammar, rhetoric, and logical presentation become rusty from inactivity, and he finds that writing clearly and keeping in mind these rules is like reading a foreign language taken in high school; the rules tend to confuse rather than simplify his task.

To attempt to lay down in this article a complete and final set of rules for preparation of the perfect technical paper would be an impossible task. There are many variables entering into the preparation of a particular technical paper to be presented under certain circumstances at a specific meeting. Further, the complete skills involved in preparation of a paper encompass the entire

education and experience of the engineer. However, there are certain accepted qualities which any successful technical paper must possess. It is the purpose of this article to refresh the engineer's mind on some of these fundamentals and to stress other factors which can make his paper more effective.

The material for this article is derived from the author's avid interest and attendance at technical meetings, from the instruction pamphlets of prominent technical societies, from a number of excellent textbooks on technical writing (see bibliography), and from the helpful suggestions of fellow engineers.

II. THE PRINCIPAL ELEMENTS

A. The Outline

It is well to recognize at the beginning that writing a technical paper is hard, and sometimes very boring, work. There is certainly no royal road to perfect technical exposition. One must be willing to write and re-write many times. The successful writer often tears up his copy and starts over again when he finds that the logical development of the paper is blocked by the existing approach.

Most authorities agree that the best way to start is by setting down an outline of the paper, i.e., writing down the principal topics to be covered. Carry the outline as far as possible the first time, let it rest for a few days and then try again. Missing blocks in the outline will begin to appear with increasing ease. The major and minor topics will form a basis for the start of actual writing. Do not worry about organization of the paper until a large portion of the text matter has been written. Preparing an outline, a first draft, and a final copy may appear to involve an unnecessary amount of work, but it is usually true that such a routine actually saves time.

When the basic technical material has been developed it is time to look at the paper from the reader's viewpoint. The reader's requirements are simple but definite: he must be carefully introduced to the subject of the paper, the subject must be adequately covered, and finally the subject must be concluded. It is alarming how often technical papers violate these three simple rules.

The development of a good technical paper may be compared to the preparation of a good dinner. First there must be an appetizer (introduction) which whets the reader's interest in what is to follow, second the main course (body of text) must be well balanced and full of meat, and third the dessert (conclusion) must be satisfying and should leave a pleasant effect on the reader. While many other courses (soup, salad or spinach!) may be added to round out the technical meal,

* Decimal classification: R050. This paper is reprinted essentially from the *Sperry Engineering Review*, May-June, 1949.

† Sperry Gyroscope Company, Great Neck, L. I., N. Y.

these three basic elements remain the same for any paper, and must be blended together carefully to accomplish the writer's purpose.

I am indebted to one of my Navy Publication friends for an apt phrase in this connection. He says every effective piece of technical writing requires "that first you tell them what you are going to tell them; then you tell them; and then you tell them what you have told them"; this simplified expression repeats again the basic requirement in any technical paper for *introduction*, *main body* of information, and *conclusion*.

B. The Introduction

Without question the *introduction* is the most important part of the paper—from the reader's viewpoint. Whether the reader will continue with the paper at all depends largely upon the impression created by the *introduction*. Because of the tremendous growth in variety and complexity of technical subjects, there is an increasing demand from readers that the first page or two of a technical paper should provide a comprehensive idea of the whole paper. The average writer is likely to write too long an introduction or none at all.

It should be recognized that while the *introduction* is read first, it should be written last—after the main body and conclusion are completed, for it must include in an abbreviated form some of the material from each. Do not hesitate to spend a large amount of time in the preparation of the *introduction* for it will pay attractive dividends in number of readers.

C. The Main Body of Text

This portion of the paper contains the technical facts which justify the paper itself. This part of the paper offers the least difficulty to the engineer. He is on more familiar ground where technical grasp of the subject is the primary requisite. If an outline has been prepared, the writing should proceed satisfactorily. The first rough draft should be written rapidly without regard for literary style. Too much attention at this time to grammar and spelling will slow down the development of basic material.

A search of contemporary literature on the subject should be made so that the material to be presented will not unknowingly duplicate or contradict existing literature. If the paper does differ in important conclusions with any previously accepted literature, the differences should be pointed out and substantiated by the author. The author should make use of the facilities offered by his engineering library for a search of contemporary literature on his subject. The preparation of a satisfactory bibliography is covered in another portion of this article.

Accuracy of data in the paper hardly needs mentioning. The engineer by nature and training is careful in the weighing and analyzing of data and is seldom tempted to distort facts to gain a temporary advantage.

However, he cannot exercise too much care in being correct and honest in all of his statements.

Be constructive and positive in presenting the material, never antagonistic, pessimistic, or negative. Tearing down some other engineer's reputation will seldom add to the author's professional standing. Direct criticism of competitor companies by name is particularly unwise. In fact the shortest route to the listener's good graces is by paying tribute to others, whether they are competitors or associates.

While it is essential that the text cover the subject adequately, it is also important that it be neither too detailed nor too complex for the intended reader. After the main body is prepared, go over it several times to cut out material not absolutely necessary for clarity. Almost any technical paper can be boiled down considerably with little loss to the reader. It is an old story around Sperry that our former president, Mr. Reginald Gillmor, was a stickler not only for good written material but also for concise writing. Many times he would return copy to the writer with a notation "cut it in half." After sweating it out the writer would make the required reduction, but then get another shock when he received a second note from Mr. Gillmor "to cut it in half" again. While this method cannot be applied generally, many technical papers could be cut in half and be more interesting and just as informative.

The writing in technical papers should be impersonal; do not use *I* if it can be avoided; try to keep the language in the third person. It is permissible, however, to use *we* occasionally, if its meaning is clear. For example, following several references to a project in the author's company, it may be more diplomatic to use *we* instead of repeating the company name and be criticized for too much "name advertising."

Sentence length is important in the technical paper. When the draft copy has been completed, it is advisable to go over the sentences again and separate the longer ones into lengths that will not burden the reader's power of concentration. If the paper is to be delivered, short sentences will help the speaker in his breathing; 13 words maximum is a good rule to follow. This is a point often overlooked by the engineer who is not a regular speaker.

Carelessness in spelling, grammar, or speaking by the engineer may bespeak carelessness in other elements of the paper and may well lead the audience to question the accuracy of the technical statements. Do not split infinitives when you can avoid doing so. The prejudice against split infinitives is deep-seated and persistent. Usually it is just as easy to write effectively as it is to effectively write. However, if there is real gain in emphasis or clearness through splitting the infinitive, you can do so and be in the company of many excellent writers—but you are likely to be misjudged by some readers.

The use of headings and subheadings is often neglected by the technical author. The more complex a

subject becomes, the more necessary it is to break it up into a number of parts which the reader can visualize. More than three degrees of subheadings are not recommended for a paper. For instance, a good example of main and subheadings would be:

- I. General description of xx radar set
 - A. Transmitting system
 1. Purpose and general description
 2. Detailed circuit analysis
 - a. Modulator
 - b. Pulse forming network
 - c. Clipper circuit
 - d. _____
 - e. _____
 - B. Receiving system
 1. Purpose and general description
 2. Detailed circuit analysis
 - a. Local oscillator
 - b. Receiver mixer circuit
 - c. I-F section
 - d. _____
 - e. _____

Avoid the use of unfamiliar terms unless you have time to define them. This is particularly important in the delivered paper. If necessary, a list of symbols or complicated derivations should be placed in an appendix, rather than in the main body of the text. Use footnotes sparingly; from the reader's standpoint it is much better to integrate such material with the text. Bibliographical references are an exception; they are usually carried as footnotes on the same page of the matter to which they apply.

D. The Conclusion

The *conclusion* is another challenge to the writing ability of the engineer. It should sum up the major points made in the text and leave the reader with a feeling that the conclusions are fully justified by the data presented. The normal purpose of the technical paper is to inform and not to sell or arouse to action, but it is difficult to visualize a good paper which does not accomplish these latter purposes to some degree. The *conclusion*, like the *introduction*, requires careful writing and rewriting before it will accomplish the author's purpose. One simple warning: do not state that certain conclusions are "obvious"—nothing irritates the average reader more than the assumption by the writer that his own logic requires no substantiation.

E. Illustrations and Lantern Slides

Illustrations can add much to the readability and conciseness of technical papers. As Lord Kelvin pointed out "a single curve, drawn in the manner of the curve of prices of cotton, describes all that the ear can possibly hear as the result of the most complicated musical performance. . . ." The judicious use of illustrations will

improve the paper in many ways. It is well to review the completed text for instances where illustrations can shorten or supplement the written material. Do not try to show too much on *one* illustration; a simple illustration will be instantly valuable to the average reader who may not be inclined to concentrate on more complicated diagrams.

If the technical paper is to be delivered, lantern slides can be used advantageously and here it is particularly important not to include so much on the slide that it is unreadable by all in the audience. For examples of good and bad slides see Figs. 1-3. The usual lantern slide

(a)

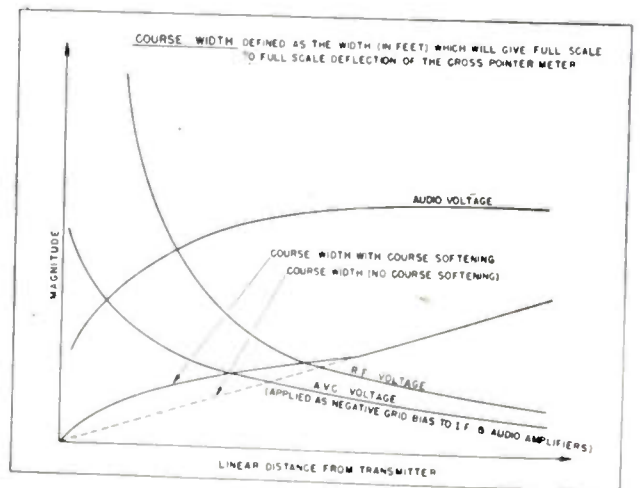

(b)

Fig. 1—(a) This chart is almost unreadable. It is ineffective as a lantern slide, and appropriate for a publication only if a large space could be devoted to it. (b) This illustration is an excellent example of a good slide or a good diagram for a published paper.

size is $3\frac{1}{4} \times 4$ "; the original illustration should be about three times this size. Lettering on the original should not be less than $\frac{1}{4}$ " in height; this assures readability in the rear seat of the average-size lecture room.

F. Bibliography

Every good technical paper should have a bibliography of literature related to the subject. This is necessary not only to guide the reader if he has desire to

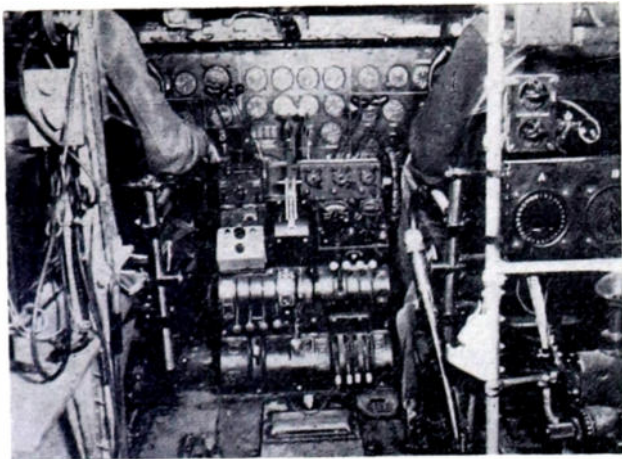

(a)

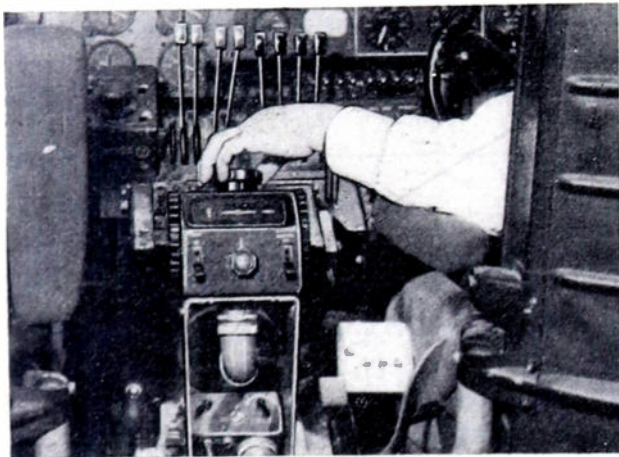

(b)

Fig. 2—Generally, only illustrative material directly concerned with the component under discussion should be included in a lantern slide. Too much background matter often ruins the effect. (a) This photograph (slide) is effective to illustrate the complexity of a cockpit, but too detailed to permit the pedestal controller of the A-12 Gyropilot* to be noticed. (b) This slide, with the co-pilot's hand directed to the controller, is far more effective for this purpose.

* Reg. trademark.

pursue the subject further, but it also indicates that the author is acquainted with the literature in his field and has made use of others' knowledge in the preparation of his paper.

Engineers in preparing their papers frequently and inadvertently offend their readers by using incomplete bibliographical references. In the case of books, the reader may wish to procure for his personal library one or more of those listed. It is appropriate then to include the publisher's name. Page references also are valuable, and page references usually are erroneous unless the edition number of the book also is given. In the case of periodicals, it is helpful to list the volume number as well as the month and year along with page references. Libraries bind their periodicals into volumes and it is helpful both to the reader and the librarian when this number is known. Bibliographies are usually carried as footnotes on appropriate pages of the prepared copy but may be included as a separate section after the *conclusions* section.

The form of bibliographical references may vary but the following are typical and adequate:

For a book:

¹ J. H. Morecroft, "Principles of Radio Communication," John Wiley and Sons, Inc., New York, N. Y., 3rd Edition, p. 402; 1933.

For a periodical:

¹ P. H. Trickey, "Field harmonics in induction motors," *Elec. Eng.*, vol. 50, pp. 937-939; December, 1931.

III. DELIVERY

No matter how excellent the technical paper may be, it loses much of its effectiveness when poorly delivered. One does not have to be a Dale Carnegie graduate to make a creditable appearance before a technical society, but one does have to obey some of the common rules of listener psychology if he hopes to walk off the platform with a feeling of accomplishment instead of confusion and ineffectiveness.

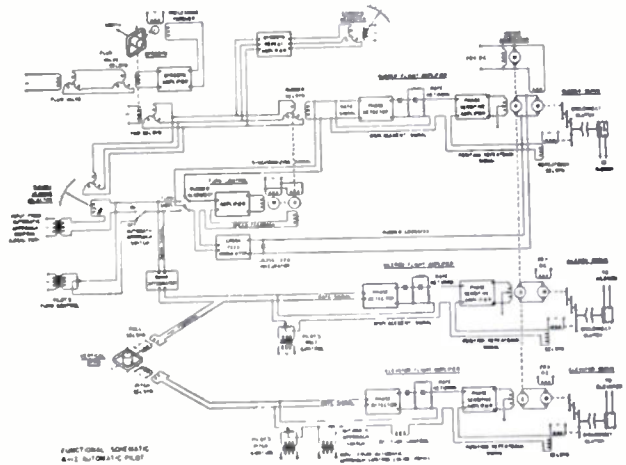

(a)

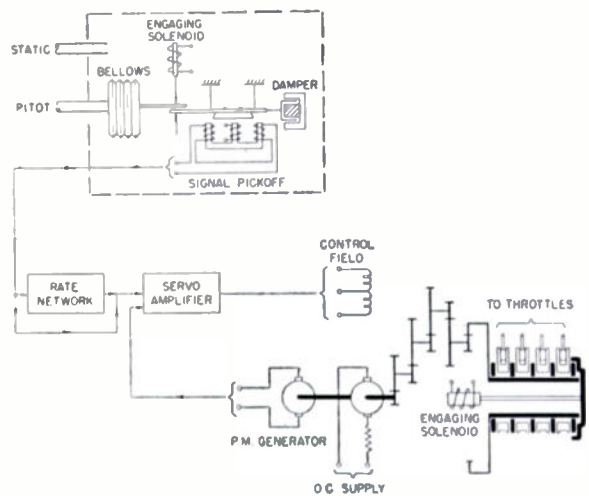

AIRSPEED CONTROL SYSTEM

(b)

Fig. 3—An audience cannot grasp a mass of detail in the moments that a lantern slide is shown on the screen. (a) This diagram has far too much detail. It might be acceptable for a printed paper if a half page could be allotted. (b) This diagram is well arranged and of the correct content for either a slide or a figure in a paper.

After the paper has been completed, read it out loud several times to get the feel of it. If some of the sentences or paragraphs are too long, cut them into shorter sections which can be read without making the talker puff like a steam engine. If particular words in the text are hard to pronounce, substitute synonyms that are easier to enunciate. Determine the correct reading speed for yourself and stick to it. The average technical lecturer reads about 150 words per minute; if he is speaking without notes this will drop to approximately 100 words per minute. Using the accepted average of 300 words (double-spaced) on the standard sized typewritten sheet, a 10-page article should take about 20 minutes to read or 30 minutes to deliver without notes. Accurate timing of the technical speech will add much to its effectiveness, and will save embarrassment for the author, particularly if the material is so long that important conclusions have to be cut short.

Nearly all technical papers are read verbatim by the

authors, but there is a growing feeling that engineers should overcome their reticence and not read their papers in a monotonous tone that lulls the audience to sleep. In the opinion of this writer, the most effective technical presentation is partially read, and partially spoken without apparent reference to the written text. The successful talker refers to his notes when necessary, and reads in detail such portions as require exact statements; this dual method gives an atmosphere of authority which is effective and convincing. There is increasing support for the practice of preparing a simplified version of a written paper for oral presentation. Techniques are covered by W. J. Temple in his paper "Preparing the Oral Version of a Technical Paper," published in the March, 1948, issue of PROCEEDINGS OF THE I.R.E.

Above all else, *rehearse* the technical paper several times before its actual delivery. Rehearse it first in front of fellow engineers who are familiar with the subject

Check List

For the Preparation and Delivery of a Technical Paper

Do—

Recognize the personal and professional opportunities presented in the preparation of a good technical paper.

Prepare an outline before beginning actual writing.

Be willing to write and rewrite every part of the paper.

Be extremely careful with the accuracy of your material.

Consider reader's viewpoint carefully.

Be sure the paper has clearly defined *introduction*, *main body*, and *conclusion*.

Write the *main body* first, the *conclusion* second, and the *introduction* last.

Keep the main text as concise as possible.

Put long equations and derivations in an appendix.

Use headings and subheadings for complex material.

Prepare a *conclusion* that sums up the main points made in the body of the text.

Use adequate and suitable illustrations.

Use lantern slides if paper is delivered.

Prepare an adequate bibliography of literature directly related to the subject.

Read paper out loud several times if it is to be delivered orally.

Time your talk so that it fits into allotted period in meeting.

Rehearse talk in front of technical associates.

Rehearse talk in front of nontechnical friend.

Try to deliver some portions of the paper without apparent reference to your written material.

Give proper credit to any individuals who inspired or contributed substantially to the paper.

Don't—

Use first person; third person is preferable.

Make mistakes in spelling or grammar.

Split infinitives—unless you are sure it helps!

Employ long and complicated sentences or paragraphs.

Use unfamiliar symbols—if they must be included, define them.

Include too many footnotes; integrate them with the text.

Assume your conclusions are obvious to the reader.

Hesitate to write and rewrite the paper several times.

Use illustrations that have too much in them. Lantern slides should be readable by all in the audience.

Read entire paper in a monotone without once looking at the audience.

Expect your audience to be interested in your paper if you haven't been careful to prepare it with their interests in mind.

and who can criticize any apparent technical errors. Rehearse it again in front of someone who is not familiar with your subject (the "better half" is a constructive critic!). This is a tough assignment but it is worth the effort.

IV. CONCLUSION

The preparation of a good technical paper is a real challenge to the engineer. Into its preparation can go the complete range of his abilities—education, experience, and knowledge of human behavior. The technical paper sticks out all over with its good and bad points. No amount of patience and concentration is too great to apply to the task, and the rewards always justify the effort.

The accompanying check list may serve as a "silent" critic of a technical paper.

Good organization, accurate and complete technical material, correct grammar and spelling, suitable illustrations, and effective delivery—these basic points

should be kept in mind as the principal factors which will make the technical paper command the interest of its audience, which after all is the only justification for writing it.

V. BIBLIOGRAPHY

1. A. C. Howell, "A Handbook of English in Engineering Usage," John Wiley & Sons, Inc., New York, N. Y., 2nd edition; 1942.
2. Thomas R. Agg and W. L. Foster, "The Preparation of Engineering Reports," McGraw-Hill Book Co., New York, N. Y.; 1935.
3. J. R. Wilson, "Writing the Technical Report," McGraw-Hill Book Co., New York, N. Y.; 1940.
4. Leslie M. Oliver, "Technical Exposition," McGraw-Hill Book Co., New York, N. Y.; 1940.
5. "An A.S.M.E. Paper—Its Preparation, Submission and Publication, and Presentation," American Society of Mechanical Engineers, New York, N. Y.; 1947.
6. Herbert B. Michaelson, "Techniques of editorial research," *Jour. Frank. Inst.*, vol. 247, pp. 245-253; March, 1949.
7. M. D. Hassialis, "What constitutes an acceptable technical paper," *Mining and Metals Mag.*, vol. 29, pp. 495-496; September, 1948.
8. W. J. Temple, "Preparing the oral version of a technical paper," *Proc. I.R.E.*, vol. 36, pp. 388-389; March, 1948.
9. "A Manual of Style," University of Chicago Press, Chicago, Ill. 10th edition, 11th impression; 1947.

Some Problems of Disk Recording for Broadcasting Purposes*

F. O. VIOL†

Summary—The first part of the paper outlines briefly the advantages of disk as compared with other systems of recording. Groove spacing, groove velocity, and direction of cut as applied to 16-inch disks are discussed, and a conclusion is reached regarding the best compromise which can be used. Recording characteristics are considered in detail and a characteristic is recommended which could be used generally. The use of automatic equalizers to improve the frequency response at low groove velocities is also recommended. The more essential requirements of recording heads and gramophone pickups suitable for the cutting and playing of cellulose nitrate disks are discussed.

INTRODUCTION

ALTHOUGH DISK recording, which permits direct playback, was introduced into broadcasting about fourteen years ago, its technical advancement has been comparatively slow and certainly not as spectacular as the development of its use for program purposes, particularly during the war years. Even now the demand for this type of service is still increasing in spite of the introduction of other methods of sound recording and, judged by present-day practices, it is doubtful if disk recording for broadcasting use will be completely displaced by these new techniques.

* Decimal classification: 621.385.971×681.843. Paper received by the Institute, July 29, 1949. Presented, Melbourne Division of the Institution of Radio Engineers, Australia, October 21, 1948. Reprinted from the *Proceedings of the Institution of Radio Engineers, Australia*, vol. 10, pp. 42-47; February, 1949.

† Formerly, Radio and Broadcasting Section, Chief Engineer's Branch P.M.G.'s Dept., Melbourne; now, Department of Civil Aviation, Melbourne.

The newer methods include magnetic tape, magnetic wire, and engraved film (Philips Miller) and each has, or will have, a place in the broadcasting system. However, it is not proposed to consider these, but rather to discuss some problems of the lateral method of recording on a cellulose nitrate lacquer coated disk which can be played back immediately after recording.

This method of sound recording is favored for three important reasons. Firstly, the recording is distributed over a flat disk so that all parts are available simultaneously, and any part can be selected instantly. Thus a series of extracts may be played in any order, in quick succession, with the omission of unwanted sections. This rapid editing cannot be obtained with wire or tape on spools. Secondly, gramophone machines are required for the playing of commercial records and it is possible, at a relatively small cost, to make them suitable for the playing of the direct playback type of disk. Thus, there is available throughout the broadcast system, replay equipment in quantity capable of playing both types of disks. The present cost of other systems prevents the widespread installation of replay equipment. Thirdly, by the same process which is used to press commercial records, copies in quantity having the same life can be obtained relatively cheaply. In addition, the metal matrices which are made during the process are of value for records which are of national interest and which are kept for historic purposes.

Before proceeding with the lateral method of disk recording it is necessary to consider briefly the vertical or "hill and dale" method. As far as is known by the author, this method is not used for recording in Australia and has limited use in America for the reasons that, firstly, special replay equipment is required: and secondly, there is not the cancellation of the even harmonics of "tracing distortion" during replay. As tracing distortion will be considered more fully in later paragraphs it will not receive further attention here.

GROOVE SPACING AND VELOCITY

As the 16-inch disk cut at $33\frac{1}{3}$ rpm is the one most favored, it is proposed to deal with this type in detail.

It is generally recognized that, to maintain a satisfactory standard of quality, it is undesirable to permit the groove velocity to fall below 75 feet per minute, otherwise the frequency response will be adversely affected and excessive harmonic distortion will be introduced, both during recording and during replay. During recording, when the modulation includes high frequency waves of high amplitude the rear edge of the cutting sapphire will contact the groove walls. As shown in Fig. 1, the face ADB should be the only part in contact

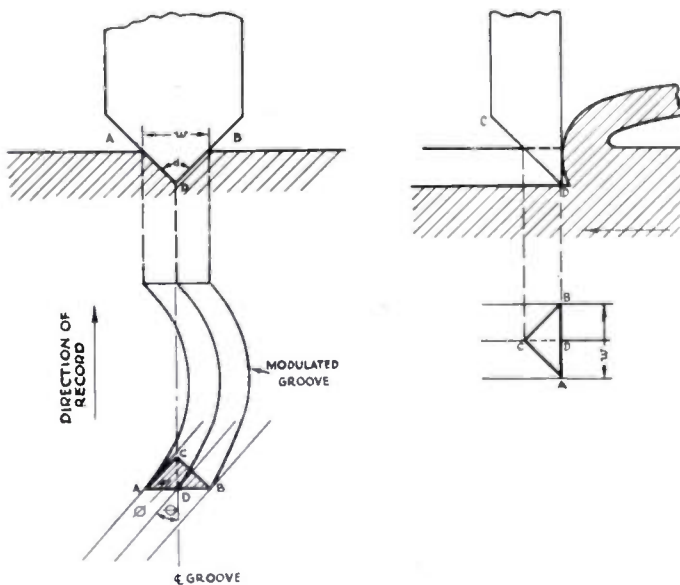

Fig. 1—Profile of sapphire cutting stylus and limits determining maximum velocity.

with the lacquer, and the maximum instantaneous velocity of the cutter is reached when the angle θ between the tangent to the bottom of the groove and the direction of the motion of the record reaches the value $90^\circ - \phi$ or, at this instant, the rear edge of the cutter will be in contact with the walls of the groove just cut. In these circumstances, since the lacquer is of an elastic nature, the material will be deformed under the lateral pressure of the sapphire and will restore itself immediately after the cutter has passed. The resulting wave shape cannot, due to the finite dimension of the replay stylus, be replayed without the introduction of further distortion.

To record a 15-minute program, which is the unit most commonly used, it will be necessary, if the groove velocity is not to fall below 75 feet per minute, to record at 145 lines per inch, starting at an inner radius of 4.3 inches. This spacing is not practicable owing to the reduced width " w " of the groove made necessary by the fine pitch, and in any case, the signal-to-noise ratio would not be satisfactory because of the restricted amplitude dictated by the close groove spacing. In fact, 120 lines per inch appears to be the desirable figure, but this, in turn, means that the groove velocity would fall to 62 feet per minute with an inner groove radius of 3.6 inches. There are three methods by which the effects of low groove velocity can be minimized:

(a) Record all programs on a 16-inch disk from "outside to in" rather than "inside to out" which is now the general practice. This would mean that full advantage could be taken of that part of the disk with the high groove velocity. The maximum time, which can be recorded without the groove velocity falling below 75 feet per minute is $12\frac{1}{2}$ minutes and, as it is fair to assume that many programs do not exceed this time, then the quality of a high percentage would be satisfactory throughout. To record "outside to in" requires air suction equipment which, at present, is not generally installed, nor readily available. As this type of plant is also required to remove the swarf which would otherwise foul the gramophone pickup while the record is being monitored, it is probable that there is sufficient demand for such equipment to encourage its manufacture.

(b) Use $17\frac{1}{4}$ -inch disks generally instead of confining their use to process work only. This would mean that the groove velocity would not fall below 75 feet per minute, and the quality would be satisfactory for the full 15 minutes. However, this advantage would only apply for the case of recordings made for direct playback, since limitations imposed by the plating and stripping process for the production of pressings restrict the diameter of the outermost recording groove to that applying in the case of 16-inch disks, hence the quality of the pressings made from these disks would not be improved. As the number of pressings made in Australia is probably greater than the number of disks recorded for direct playback, the use of $17\frac{1}{4}$ -inch disks generally would not solve the problem of low groove velocity.

(c) Automatic equalizers could be used to maintain the frequency response to the inner radius. The relative merits or otherwise of automatic equalizers will be discussed later.

A method used in America to mask the loss in frequency response when the program exceeds 15 minutes is to record the first disk "inside to out," the next "outside to in," and so on. This, so far as the listener is concerned, prevents the abrupt change in quality which would otherwise be evident if all the disks were cut, say "inside to out," but this practice does not offer a solution to the general problem.

Summing up, it appears that 120 lines per inch cut on a 16-inch disk represents the best compromise, and that recording "outside to in" and the use of automatic equalizers would give an appreciable improvement to the over-all quality.

RECORDING CHARACTERISTICS

If a sinusoidal constant voltage of varying frequency is applied to an ideal cutting head of the moving iron type, the stylus will vibrate with a sinusoidal motion of amplitude A with a peak velocity of $2\pi fA$ at frequency f . Under these conditions the maximum velocity is the same for all frequencies, and the amplitude of the recorded wave forms varies inversely as the frequency. If such a recording be replayed with an ideal moving iron pickup, a constant voltage output will be obtained. The signal level that has been recorded on the disc can be defined, at a given frequency, in terms of amplitude or velocity and, under the ideal conditions stated above, a flat velocity-frequency characteristic is obtained. The velocity is usually regarded as corresponding to voltage and the ratio of the rms velocities can be stated in decibels.

It is not practicable to record the lower frequencies with constant velocity as the amplitude obtained would be excessive. Instead, constant amplitude is used and the requirement is obtained by recording head design or electrical networks. At the higher frequencies, a network may be used in the recording chain to obtain pre-emphasis such that the amplitudes of the recorded wave forms approach constant amplitude. In all cases it is usual to state the recording characteristic in terms of the ratio of the rms velocities expressed in decibels.

Although the problem of applying a common recording characteristic to all disk recordings may yet be

overcome, the position at present is far from satisfactory, and it is proposed to examine in detail two characteristics which are most commonly used.

For the recording of disks to be used for the production of commercial pressings, the recommended recording characteristic is shown in Fig. 2. The most important point to note is the 250 cps crossover with the constant velocity characteristic above that frequency. Also shown is the National Association of Broadcasters standard characteristics with a 500 cps crossover and pre-emphasis above that frequency. This characteristic is almost the same as that used for the original "Orthocoustic" recordings.

These latter characteristics have been developed to improve the signal-to-noise ratio of recordings for the reasons that the noise on a disk is of a high-frequency nature, and that the constant amplitude to 500 cps permits a higher level of program to be recorded than can be attained with a 250 cps crossover.

If the peak incremental curves for speech and music of Fig. 3 be examined, it will be found that a maximum value occurs at about 400 cps while at 5,000 cps the

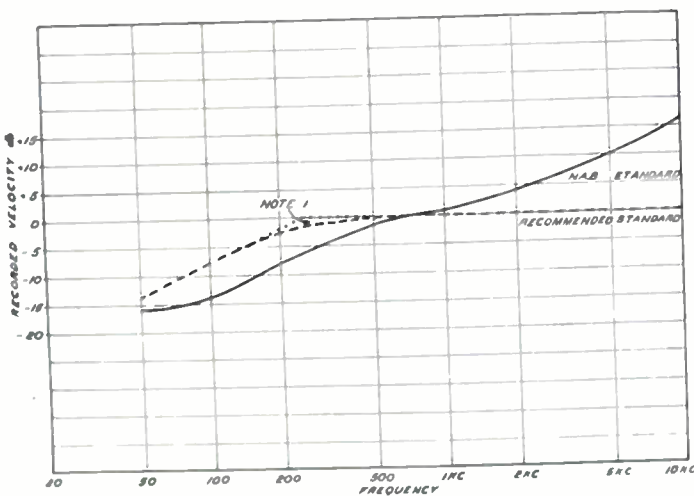

Fig. 2—Recording characteristics for constant input voltage applied to the recording system.

Note: The crossover frequency is defined as the point of intersection of the asymptotes to the constant-amplitude and constant velocity portions of the response curve and the response at the crossover frequency is not more than 3 db below the level of this intersection point.

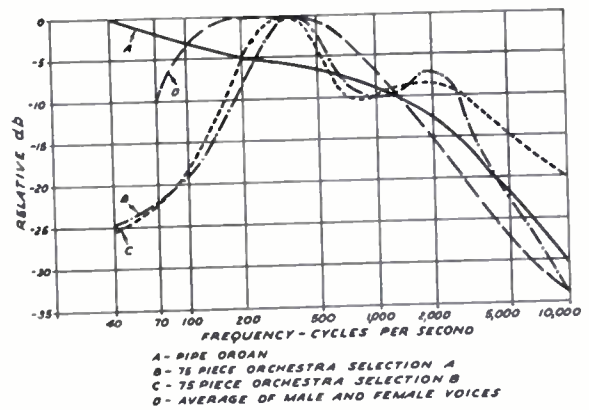

Fig. 3—Speech and music—peak energy per increment of frequency.

energy is reduced by 15 db and at 10,000 cps at least 20 db. This explains why a 500 cps in lieu of 250 cps crossover permits a higher level to be recorded and, also, why it is possible to use pre-emphasis. An equalizer with an inverted characteristic is used to restore the frequency response to normal during replay.

In disk recording, it is important to avoid high velocity high amplitude signals because as previously explained, the cutting stylus is unable to record such signals faithfully, with the result that excessive distortion is introduced. Likewise, it has been shown by Pierce and Hunt¹ and again by Sepsmeier² that such signals produce excessive distortion when replayed, i.e., "tracing distortion."

¹ J. A. Pierce and F. Hunt, "On distortion in sound recording from phonograph records," *Jour. Acous. Soc. Amer.*, vol. 10, pp. 14-29; July, 1938.

² Ludwig W. Sepsmeier, "Tracing distortion in reproduction of constant amplitude recordings," *Jour. Acous. Soc. Amer.*, vol. 13, pp. 276-280; January, 1942.

To demonstrate the impracticability, in the extreme case, of the constant amplitude characteristic, Fig. 4 has been prepared. If a square wave be fed to an ideal recording system using such a characteristic, it is not possible to cut a groove of the required wave shape because of the limitations imposed by the cutter, as shown in Fig. 1. If now the same signal be applied to an ideal recording system which has the constant velocity characteristic, the recording requirement is not so severe for the reason that the harmonics which make the wave square are attenuated at the rate of 6 db per octave, which gives a wave shape within the capabilities of the cutter.

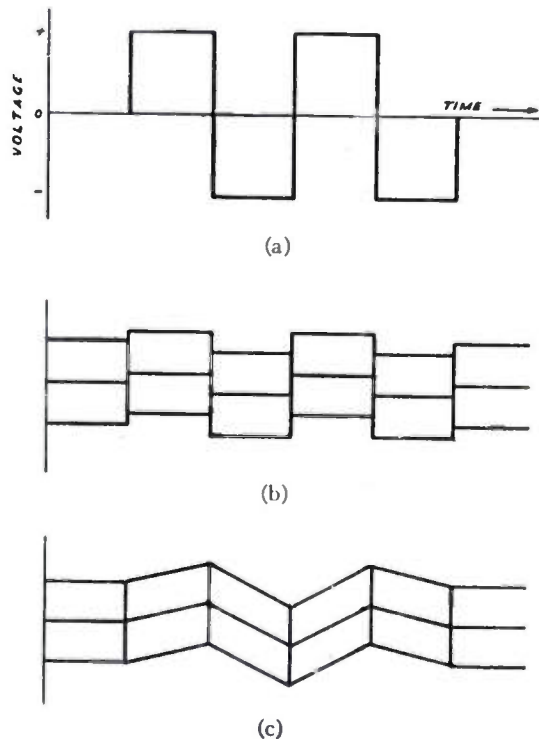

Fig. 4—Square wave as recorded by constant amplitude and constant velocity system (ideal recorder). (a) Input wave to system; (b) recorded groove required, constant amplitude; and (c) recorded groove required, constant velocity.

An examination of Fig. 2 will show that, for the NAB characteristic, the rate of pre-emphasis is 4 db per octave, which approaches the 6 db per octave of the constant amplitude recording system and, when compared with the constant velocity system, the harmonic distortion is greater. It will be seen from the above that the NAB standard unduly weights the importance of the signal-to-noise ratio and, in so doing, produces the undesirable condition of signals having high velocity with high amplitude, which is not undesirable only during recording but also during replay.

As far as nonlinear distortion in the cutting head is concerned, constant velocity recording has some disadvantages compared with the constant amplitude system. The nonlinear distortion can be due to saturation of the armature and pole pieces or nonlinearity

of the control stiffness. These will give rise to odd harmonics which, in the stiffness controlled frequency range, i.e., the lower frequencies, are a function of amplitude. Assume the fundamental frequency is 500 cps and that 1 per cent of third harmonic distortion, i.e., 1,500 cps, is produced within the head. On replay, with the constant velocity system, the fundamental frequency will be reproduced with 4 per cent, i.e., an increase of 12 db, in harmonic distortion. This is best seen by an examination of Fig. 5 which is the recommended characteristic of Fig. 2, shown as recorded amplitude instead of recorded velocity. While the constant amplitude system, which the NAB characteristic approaches, tends to reduce the importance of harmonic generation as such, it likewise causes a multiplying of intermodulation products but, in this case, they are the difference products. These products can be produced

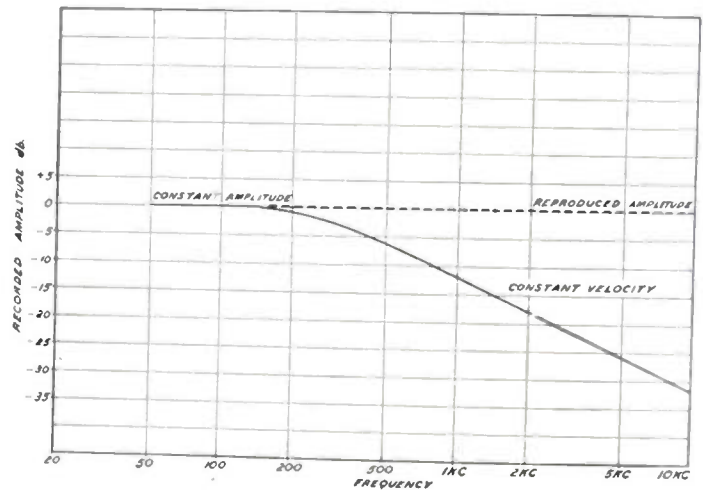

Fig. 5—Recommended recording characteristics in terms of recorded amplitude instead of recorded velocity.

in those stages of the recording amplifier following the pre-emphasis network and in the recording reproducing process. It is realized that, generally speaking, the power capability of the recording amplifier needs to be much greater in the constant amplitude system than in the constant velocity system.

To summarize the above, it will be seen that the NAB standard characteristic has inherent disadvantages, and rather than continue its use it would be better to obtain the improvement in signal-to-noise ratio by an improvement in the lacquer-coated disk. This would permit the use of the constant velocity characteristic, provided the cutting heads used were of a type which did not introduce undue distortion and intermodulation. As far as the low frequencies are concerned, the 500 cps crossover has the disadvantage that, due to the amount of record equalization required on replay, gramophone machines need to be maintained in a first-class condition, otherwise low-frequency noise will be experienced. It appears then that the recording characteristic recom-

mended by Mittell³ in England and Southey in Australia⁴ for domestic disks is to be commended. This characteristic, which has been used for a number of years by the P.M.G.'s Department for the National Broadcasting Service, is shown in Fig. 2.

There is also the important point that process disks to the recommended characteristic can be played on any gramophone machine suitable for commercial pressings. It is not known how many process disks are made in Australia, but it would appear that the quantity is large; therefore, as the proposed standard for domestic discs appears to be acceptable to the recording companies, it is logical that lacquer-coated disks and the process copies should have the same characteristic.

The use of automatic equalizers was mentioned earlier. Actually they pre-emphasize by a varying amount, depending on the position of the recording head in relation to the disks radius, i.e., the maximum emphasis is obtained when the cutting head is recording on the inner radius. The same arguments as applied to the use of pre-emphasis for the NAB standard are applicable here and, although their use is undesirable, it will be appreciated that the maximum pre-emphasis is only used for that part of the disk where the groove velocity is less than 75 feet per minute. As it is usual to compensate for the over-all loss, recording as well as replay, the use of suitable gramophone pickups for the playing of lacquer-coated disks reduces the translation losses, and the actual amount of equalization required is not so great.

From the above it will be seen that the use of automatic equalizers has been considered only in relation to the recommended recording characteristic and not to the NAB characteristic. As discussed earlier, the peak incremental curves for speech and music allow only for the use of automatic equalizers or the NAB characteristic, but not both simultaneously. To use both would result in wave shapes far exceeding the capabilities of the recording cutter and the replay stylus, with consequent distortion greater than that already considered. Therefore, this practice is not to be commended.

The use of a compromise recording characteristic which would enable records to be played equally well with gramophone equipment suitable for the recommended characteristic or the NAB characteristic has been suggested, and, in fact, is used by the BBC.⁵ This characteristic is shown in Fig. 6, with the others already considered for comparison. It will be seen that partial pre-emphasis is used for the higher frequencies, while the lower frequencies fall between the two already discussed. The compromise characteristic has some merit under

existing conditions, but it will be realized that, for the reasons already discussed, it has definite disadvantages and the better approach would be to adopt one common characteristic acceptable to all interested parties.

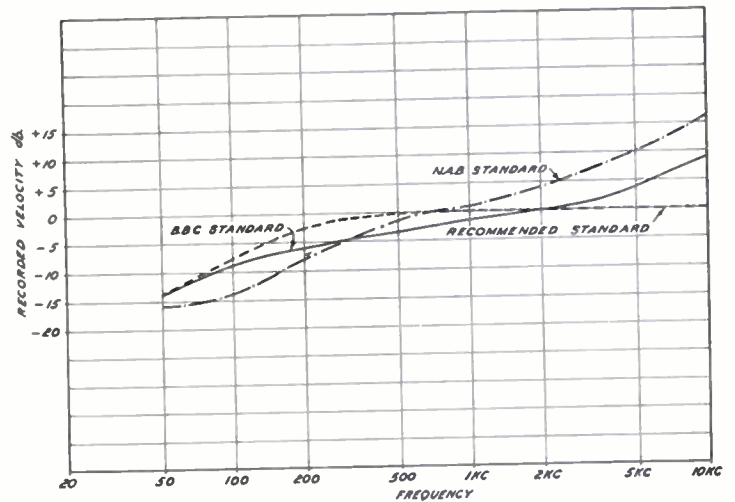

Fig. 6—Recording characteristics: BBC recording characteristic compared with the NAB and recommended standard.

It has been suggested⁶ that a compromise replay characteristic could be used to replay records cut to the various known characteristics. Probably, this would be a satisfactory solution to the problem if there were numerous characteristics in use whereas, in fact, as far as Australia is concerned, there are only two in general use, the two already discussed. Again, if all recording characteristics had equal merit, such an approach may be acceptable, but it has already been shown that, of the two examined, one has definite advantages.

Regarding commercial pressings, Mittell³ and Southey⁴ have already shown that reproducing equipment suitable for records cut to the recommended characteristic will also play satisfactorily recordings made generally to this characteristic over a period of 40 years, and will also play such records made in a number of different countries. This, in effect, means that the NAB and the new interim Decca characteristics are the two which cannot be played satisfactorily with such equipment.

We see then that, if the recommended characteristic is adopted generally by the manufacturers of commercial pressings, it would require only a small and inexpensive alteration on the part of broadcast stations to change from the NAB to the recommended characteristic for recording, and existing replay equalizers, as used for commercial discs, could then be used at all times. In addition, it would be possible to lay down standards of performance similar to those specified for the majority of equipment items used in the broadcast chain.

³ B. E. G. Mittell, "Commercial disk recording and processing," Informal Lecture to the Radio Section, The Institution of Electrical Engineers, December 9, 1947. E.M.I. Publication.

⁴ R. V. Southey, "Modern practices in disk recording and processing," Lecture to the Sydney Division, Institution of Radio Engineers (Aust.), *Proc. I.R.E. (Aust.)*, November, 1948.

⁵ H. Davics, "The design of a high fidelity disk recording equipment," *Jour. IEE (London)*, vol. 94, pt. III, pp. 275-300; July, 1947.

⁶ L. N. Schultz, Correspondence Section, *Proc. I.R.E. (Aust.)*, vol. 9, p. 19; September, 1948.

RECORDING HEADS

From earlier remarks, it will be appreciated that the recording head should be as free as practicable from harmonic distortion and intermodulation effects, but there are other requirements equally as important:

(a) The characteristics of head should be independent of time and temperature. This is rather a severe requirement, but when it is realized that the majority of recording rooms in Australia are not temperature-controlled, and that the recording heads are used as far south as Hobart and as far north as Port Moresby, it will be seen that they are required to operate over a wide range of temperatures.

From the time aspect, the majority of heads at present used in Australia are unsatisfactory in that the damping medium ages and needs replacing at regular intervals.

(b) The heads should be of a design that requires the minimum of maintenance and should not have critical adjustments. Again the heads being used are unsatisfactory in both these respects.

(c) The heads should have a satisfactory sensitivity. It will be appreciated that a 3-db improvement in sensitivity permits a 50 per cent reduction in the power capability of the recording amplifier.

(d) The impedance characteristics of the head should be reasonably constant over the frequency range. The amplifiers being used at present have a power capability ranging from 40 to 75 watts, and much could be done to avoid these high figures if the sensitivity and impedance characteristics were improved.

GRAMOPHONE PICKUPS FOR LACQUER-COATED DISKS

For the playing of cellulose nitrate disks, it is recognized that the vertical force measured at the stylus point should not exceed $\frac{3}{4}$ ounce, otherwise the grooves will be deformed due to the elastic nature of the surface material. This requirement, however, also means that the armature movement should have a satisfactory compliance, otherwise the grooves will be unduly damaged, and, in the extreme case, the pickup may not stay in the grooves.

The frequency response should extend from 50 to at least 10,000 cps, which appears to be the practical limit to the high-frequency response with the recording equipment in use at present. The frequency response should be reasonably flat and should not have excessive peaks even above the highest frequency to be used, otherwise harmonic products may be accentuated.

It would appear that a pickup to meet these requirements would be of the moving armature type. In the case of moving coil pickups, it is difficult to reduce the mass of the coil assembly sufficiently to prevent the resonance of the mass, and the compliance occurring below 10,000 cps. The coil can be reduced to a single turn and the stylus need only be a mere sapphire tip to

overcome this difficulty; but with this arrangement the electrical impedance is extremely low and is difficult to match to the load. If the moving armature type is employed, the use of a small sapphire stylus would ensure that the resonance would fall outside of the desired frequency range. With this type it is possible to avoid the problem of armature centring by using an inefficient magnetic circuit, but this reduces the electrical output appreciably. While the low output voltage of these types is not a real disadvantage, it does increase the over-all cost of the gramophone equipment.

One important factor sometimes overlooked is the necessity for a satisfactory vertical compliance of the stylus to reduce tracing distortion primarily caused by "pinch effect." This is due to the varying width of the modulated groove which causes the stylus to be "pinched" twice in the tracing of a sine wave. If there is no vertical compliance, the stylus gouges out the walls of the groove. One method of providing the vertical compliance is to fit a sapphire stylus in a cantilever movement in which the compliance is provided in the lever, but there are other methods of obtaining a satisfactory compliance.

It is desirable for the pickups to be reasonably robust, but the use of small sapphire styli which are fitted permanently, i.e., not readily replaceable, requires that the reproducer head be of the plug-in type to permit a ready means of changing should the sapphire be damaged.

At present there are no pickups available in Australia which will meet all of the requirements discussed above, and it is felt that unless manufacturers have a clearer understanding of the basic requirements, little progress in design will be made.

CONCLUSION

The problems discussed can be grouped into two classes, namely, practices and equipment. The former may not be readily solved except within an organization such as the National Broadcasting Service, where the records cut by the Postmaster-General's Department are played, for the greater part, within that organization. So far as equipment problems are concerned, the picture is much brighter, as progress is being made and at least two recently developed cutting heads of improved types have been described elsewhere.^{3,5} The trend in design in England shows that consideration is being given to pickups suitable for the playing of lacquer-coated disks. This excludes, for various reasons, the light-weight pickups supplied for the playing of commercial pressings.

ACKNOWLEDGMENT

Acknowledgment is given to the Acting Chief Engineer, N. Hayes, of the Postmaster-General's Department, for granting permission to publish this paper.

A Variable Speed Turntable and Its Use in the Calibration of Disk Reproducing Pickups*

H. E. HAYNES†, MEMBER, IRE, AND H. E. ROYST‡, SENIOR MEMBER, IRE

Summary—The frequency response of a disk reproducing pickup, when measured by means of a conventional variable-frequency test disk is a function of the dimensional and physical properties of the disk, as well as of the pickup itself. This is because the effects of elastic deformation of the record material and of finite stylus tip size vary with the physical wavelength of the undulations of the recorded groove, and hence with frequency. If variations of test frequency are instead produced by variations of the rotational speed of a constant frequency disk, the above-mentioned effects are constant and do not affect the response characteristic of the pickup. A test procedure embodying this latter method is discussed, along with experimental results which have been obtained.

A variable speed turntable well suited to this method of calibration is described. It covers a very wide continuous range of speeds, with excellent speed stability and low flutter.

I. PICKUP CALIBRATION

Introduction

CALIBRATION, or determination of the frequency response characteristic of a pickup, by playing a constant recorded tone and changing the speed of the turntable in order to vary the reproduced frequency, is a method that has been in existence for some time.¹ It has never been widely publicized or accepted, due probably to the variable-speed requirements and the complicated test procedure.

The method, however, has the advantage that the resulting characteristic is independent of record calibration, yield of material, and such dimensional factors as recorded diameter and turntable speed. For this reason it is believed to be useful for basic pickup response measurements.

Principle of Operation

The measurement procedure requires that a record containing a constant-frequency recording be played back at different speeds in order to vary the reproduced frequency. If the band is short so that little change in wavelength occurs throughout the recorded portion, certain losses that manifest themselves during playback, due to yield of the record material and the size of the stylus tip, remain constant and do not appear in the response characteristic. Pickup impedance, which de-

pends not only upon the design constants of the pickup but also upon the stiffness of the record material, does appear, however, in the normal manner and so is taken into account as it should be.

The effect of the elastic properties of the record material on reproduction has been considered theoretically by Kornei. In his paper on playback loss,² the following equation for the approximate loss is given:

$$L = 20 \log \left[1 + \frac{2\sqrt{2K}}{3} \left(\frac{W^2}{E^2R} \right)^{1/3} \left(\frac{R\omega^2}{4\sqrt{2} V^2} - \frac{m(\omega^2 - \omega_0^2)}{W} \right) \right] \text{db}, \quad (1)$$

where

- L = loss in db
- K = a constant
- W = steady vertical pickup force
- E = Young's modulus of record material
- R = radius of spherical tip of pickup stylus
- V = record groove velocity (not modulation velocity)
- $\omega = 2\pi f$ where f is the reproduced frequency
- $\omega_0 = 2\pi f_0$ where f_0 is the lateral resonance frequency of the stylus system
- m = mass of the stylus system as effective in the center of the stylus tip for lateral motion.

For the case under consideration, where a variable frequency is obtained by changing the turntable speed while reproducing grooves of a fixed recorded frequency, (of essentially constant wavelength if the recorded band is of short duration):

where

$$\begin{aligned} \lambda &= \text{recorded wavelength} \\ V &= \lambda f. \end{aligned} \quad (2)$$

Substituting this expression for V in Kornei's equation (1) in the term where groove velocity V is involved,

$$\text{term} \frac{R\omega^2}{4\sqrt{2} V^2} = \frac{4\pi^2 R f^2}{4\sqrt{2} \lambda^2 f^2} = \frac{\pi^2 R}{\sqrt{2} \lambda^2}, \quad (3)$$

and since λ is a constant for our particular case, this term becomes constant when R is fixed. Thus we can express (1) for our particular method of test as follows:

$$L = 20 \log \left[1 + K_1 \left(K^2 - \frac{m(\omega^2 - \omega_0^2)}{W} \right) \right] \text{db}. \quad (4)$$

* Decimal classification: R391.11XR391.12. Original manuscript received by the Institute, June 7, 1949; revised manuscript received, November 15, 1949. Presented, Fifth Annual National Electronics Conference, Chicago, Ill., September 26-28, 1949. The complete text of the paper will appear in volume 5 of the *Proceedings of the National Electronics Conference*.

† Radio Corporation of America, RCA Victor Division, Camden, N. J.

‡ J. M. Kendall and A. D. Burt designed equipment for such use in 1929 while with the General Electric Co. The equipment was transferred to Camden in 1930, and was used for many years in the development and test of RCA phonograph pickups.

² O. Kornei, "On the playback loss in the reproduction of phonograph records," *Jour. Soc. Mot. Pict. Eng.*, vol. 37, pp. 569-590; December, 1941.

For fixed values of E , R , and W , the losses due to yield of material and tip size remain constant while the effect of mechanical impedance of the pickup exists in the normal manner. Thus we see that the variable-speed method of calibration permits us to make response measurements that directly show the capabilities of the pickup.

Equipment

The equipment of a typical arrangement is illustrated in Fig. 1.

A voltmeter is necessary for measuring the output voltage, and it is preferable that the input impedance

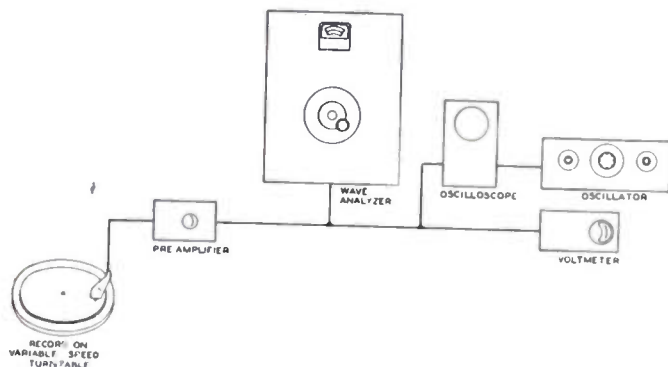

Fig. 1—Typical arrangement for variable-speed measurements using an oscillator and oscilloscope for frequency measurements and a wide-band analyzer for frequency selective voltage measurements.

be high so that the pickup is not loaded and the voltages are "open circuit" values. If the pickup output voltage is low, a decade or preliminary amplifier may be necessary, as illustrated.

An oscillator of good frequency stability and an oscilloscope are useful for determining the reproduced frequency and setting the turntable speed, where extreme accuracy is wanted. By connecting one pair of plates to the oscillator and the other pair to the pickup and observing the Lissajous' figures, the reproduced frequency can be determined. The wave analyzer, if stable and accurate, may be used instead of the oscillator and oscilloscope.

In addition to the variable speed turntable which in itself is a major item, a frequency record is needed. One cut at $33\frac{1}{3}$ rpm with short recorded bands of frequencies from 10,000 to 50 cps has been found adequate.

Methods of Measurement

The number of measurement steps required to cover a wide frequency range, from 20 to 20,000 cps for example, depends upon the speed variation of the turntable. With a turntable having a speed ratio of 10 to 1 or better, it is possible to cover the above frequency range in four overlapping steps using the 10,000, 2,000, 400 and 100 cps recorded bands. As shown by equation (4), the loss due to yield of the record material and tip size remains constant throughout each band, even though the rotational speed is varied in order to change the

frequency. Thus, whenever playback loss is encountered, the curve will still be a true representation of the pickup characteristic, but will be lower in level by the amount of the loss. A substantial overlap in frequency range is therefore desirable so that the different response characteristics can be shifted into alignment in order to form a continuous curve. Typical results are shown in Fig. 2 and it will be noted that the overlapping portion of the 2,000- to 20,000-cycle band is some 7 db lower in level, due to playback loss, than the 400- to 4,000-cycle band.

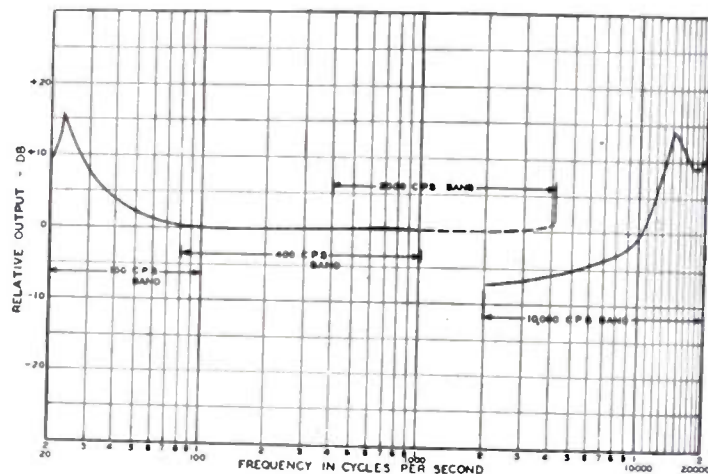

Fig. 2—Response characteristic obtained by the variable-speed method. The 2,000 to 20,000 cps band is low due to losses and should be shifted upwards into alignment with the other curves.

In our tests magnetic pickups were used, so it became necessary to correct for the change in output voltage as the speed of the turntable was varied in order to keep the results on a velocity basis. The output of a magnetic pickup is proportional to rate of change of the flux linking the coil or essentially to stylus velocity. Since amplitude of motion for any recorded band is constant, any change in turntable speed results in a proportional change in output voltage. In order to correct for this each output voltage was multiplied by the ratio of the reference to the reproduced frequency, and expressed in db relative to the reference frequency voltage. For example, the output voltage at 5,000 cps obtained by reproducing the 10,000-cycle band at half normal speed was multiplied by 2 and expressed in db with respect to the 10,000 cps voltage measured at normal speed.

Discussion of Results

A light-weight magnetic pickup of conventional design, with a diamond stylus 2.3 mils in radius, was tested and the results are shown in Fig. 3. These were obtained by the variable-speed method and also by reproducing in the normal manner two frequency pressings, one at $33\frac{1}{3}$ and the other at 78 rpm.

We immediately see that the variable-speed method offers an advantage in that the location of the transition frequency, where the recording characteristic changes from constant velocity to constant amplitude, is of little consequence.

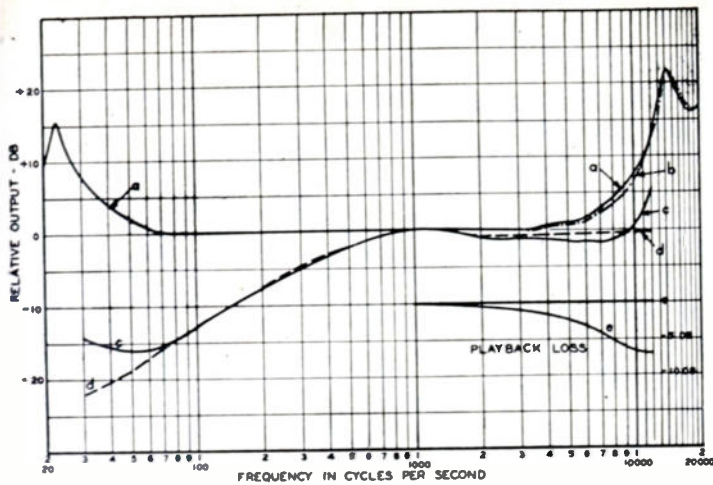

Fig. 3—Response measurements for the variable speed and direct-record playback methods: (a) variable speed, (b) direct playback at 78 rpm, (c) direct playback at 33½ rpm, (d) calibration of 33½ rpm record, (e) playback loss or difference between (a) and (c).

The peak at the high-frequency end is due to a resonance condition in which the compliance of the record material, the stiffness, and mass of the stylus assembly and moving system are all factors.

The peak at the low-frequency end is due to tone arm resonance, a function of pickup stiffness, and inertia of pickup and the suspension arm.

Playback Loss

Reproduction of the 33½ and 78 rpm frequency pressings, in the normal manner, gave widely different results. Both records were 12 inches in diameter with the highest frequencies recorded at the outside. The 33½ rpm record contained frequency bands from 12,000 to 30 cps and its calibration, which has been obtained by several different methods, is included in Fig. 3.

The record for 78 rpm reproduction contained bands of frequencies ranging from 20,000 to 1,000 cps, and its recording characteristic is constant velocity throughout.

The 78 rpm pressing gave essentially the same results as obtained by the variable-speed method and hence showed no appreciable playback loss for the pickup tested. Reproduction of the 33½ rpm pressing showed considerable playback loss for frequencies above 2,000 cps. It is interesting to note that the loss in this particular case was almost completely equalized by the rise in pickup response, due to resonance, and the net result was a flat response up 10,000 cycles, and in good agreement with the recorded characteristic. These results serve as a good illustration why the direct-record playback method of calibration should be considered as a special case. Records of the same material and the same recording characteristics, but cut at different speeds and diameters, produce different results.

Hardness of Record Material

Variation in response at the high frequencies due to hardness of record material, is illustrated by Fig. 4 in which characteristics obtained by the variable speed

method for a lacquer, a vinyl pressing, and a metal mold are shown. Note the shift of the resonance peak towards a higher frequency as a harder material was used. No difference in frequency of tone-arm resonance at the low-frequency end, or height of the peak was found between lacquer and vinyl. (Metal mold was not used for low-frequency measurements.) The upper resonance depends to a great extent upon the stylus fit and hardness of record material, but the tone-arm resonance depends upon pickup stiffness. The grooves in all cases had a bottom radius much smaller than the playback tip, and a good "fit" between stylus and groove existed.

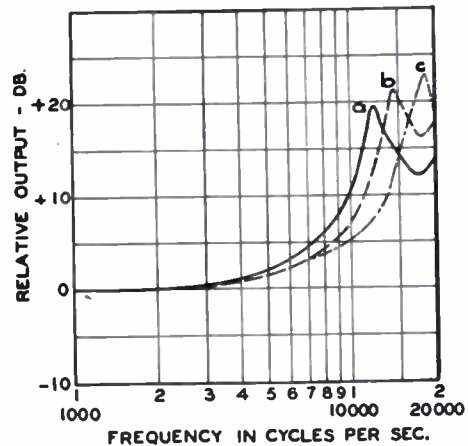

Fig. 4—Variable-speed response measurements using records of different hardness: (a) lacquer recording, (b) vinyl pressing, (c) metal mold.

Vertical Force and Groove Fit

If the groove is worn or the bottom radius large so that contact between stylus and groove is not along the side walls, or if the vertical force is inadequate, the high-frequency peak may appear to be flat-topped. This may lead to an erroneous conclusion that a sharp peak does not exist, whereas what is probably happening is that the stylus is tending to climb up the side walls and out of the groove, and a loose mechanical fit between stylus and groove exists. Increasing the vertical force will correct this condition and result in a more accurate response characteristic, as illustrated in Fig. 5(a).

The same climbing condition can exist at tone-arm resonance, and in some cases the tip may even skip out of the groove, also indicating that too little vertical force is being used. The variable-speed method with a fine-speed adjustment affords an excellent means of studying pickup and tone-arm resonance.

Effect of Wave-Form Distortion on Response

The use of a frequency-selective voltmeter was mentioned when discussing equipment requirements. Where we are making open-circuit measurements of a pickup, without any filter or compensator, a high-frequency peak may result in considerable wave-form distortion at submultiples of the peak frequency. Fig. 5(b) represents an exceptional illustration of this condition. The high-frequency peak when making variable-speed meas-

measurements while using the metal mold was between 18,000 and 19,000 cps. At 6,000 cps, or $\frac{1}{3}$ of 18,000 cps, bad wave form was observed and a peak was measured with the voltmeter; between 8,000 and 9,000 cps, or one-half the resonance frequency, another peak was also found, but neither of these subharmonic peaks was observed when using the wave analyzer as a frequency-selective voltmeter. The difference pictured in Fig. 5(b) between a selective and nonselective voltmeter while using a metal mold is the greatest that has been observed. Fortunately, results obtained with pressings only differed by a db or two, but Fig. 5(b) is given to illustrate what may happen under certain conditions.

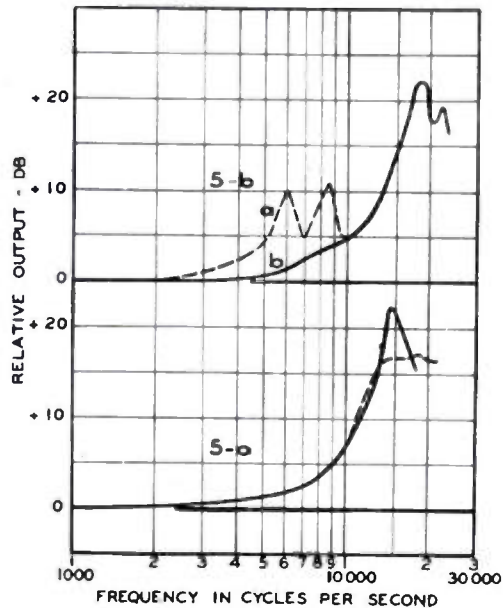

Fig. 5—Variable speed response measurements: (a) hump or reduced peak due to lack of adequate vertical force while reproducing a vinyl pressing, (b) with metal master using an ordinary tube voltmeter and wide-band wave analyzer as frequency selective voltmeter. Note the peaks at subharmonic frequencies obtained with the nonselective voltmeter.

High-Frequency Peak

Harmful effects of the high-frequency peaks, such as increased distortion, have not been observed either when making measurements or during listening tests, providing suitable playback compensation is used to overcome the response increase due to the peaks, or adequate frequency cutoff is used. Observations do indicate, however, that the response characteristic well above the intended range should be known and considered when designing the playback compensator.

Tests at Different Amplitudes

Tests were made using frequencies recorded at different amplitudes. In general, when sufficient vertical force was used to maintain good contact between stylus and groove side walls, the agreement was good. When insufficient vertical force was used, considerable variation was noted at the higher frequencies. It is believed that the increased amplitude and hence increased accelerating force caused the stylus to climb up the side

walls of the groove, which of course would cause erratic results. This effect was particularly noticeable at the pickup resonance frequency where the mechanical impedance is high.

Dynamic Yield

Varying the turntable speed in order to change the reproduced frequency means, of course, that the recorded band is not being reproduced at its normal speed. However, changes in yield due to different linear velocities of the record groove have not appeared to greatly alter the calibration results for the speed ranges we have used.

II. VARIABLE SPEED TURNTABLE

Calibration of pickups by the method described is naturally most satisfactorily accomplished with a variable speed turntable having high-quality performance, particularly in the following respects:

(1) *Speed range.* As has been indicated, in studying the frequency response of a pickup by means of a fixed-frequency recording reproduced at different speeds, a large speed range permits a greater frequency range to be covered; thus fewer "overlaps" between recorded frequencies are necessary to cover the audio-frequency spectrum.

(2) *Accuracy of speed indication.* This is desirable for operating convenience.

(3) *Flutter.* If measurements are to be representative of conditions existing at a single frequency, rapid or "instantaneous" speed fluctuations should be minimized.

(4) *Long-term speed constancy.* When a desired speed has been set, it should be maintained within close limits without the necessity of further adjustment, in order to facilitate taking measurements.

A reproducing turntable having excellent properties in these respects was developed as one part of a high-fidelity disk recording and reproducing equipment. The specifications called for a continuous speed range of five to 80 rpm, together with a high order of accuracy of speed indication and a flutter value comparable to the best obtainable in conventional two-speed studio-type reproducing turntables.

A servo-type motor drive, shown in block diagram form in Fig. 6, is used, in which the entire speed range

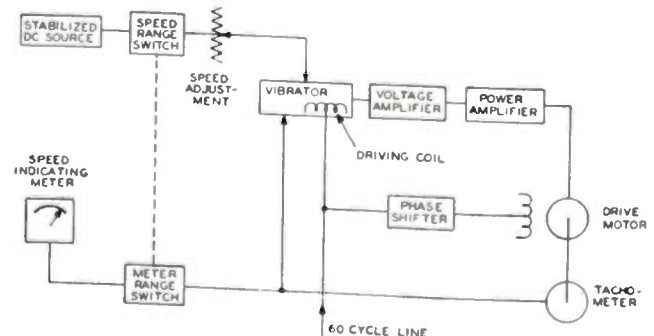

Fig. 6—Block diagram.

is covered by the motor itself, obviating the need for multiple speed ratios. The system operates so as to minimize a velocity error, rather than the more familiar position error, and employs an ac commutator type motor with integrally mounted dc tachometer for velocity measurement. Velocity voltage generated by the tachometer is compared with a stabilized adjustable dc voltage, which constitutes the speed standard, and the difference commutated at a 60-cycle rate by a vibrating contactor, amplified, and supplied to the armature of the drive motor. Constant amplitude 60-cycle current of correct phase is supplied to the motor field.

Speed indication takes the form of a large four-range voltmeter connected across the tachometer. Although motor speed rather than turntable speed itself is thus actually measured, the rubber-idler rim drive employed has been found to introduce negligible error in speed measurements. By using four meter ranges, it is never necessary to use the lower half of the scale; hence a meter of 0.3 per cent accuracy cannot introduce more than 0.6 per cent error in speed.

By having a large amount of loop gain in the system, excellent stability of speed with time and with changing loads is obtained. In addition, at low operating speeds where turntable inertia provides very little filtering effect, a large amount of feedback is essential for reducing flutter. By having the motor and tachometer rigidly coupled, so as to minimize mechanical phase shifts, feed-

back factors of about 500 at maximum speed and 80 at minimum speed are feasible.

The operating convenience and performance quality of this turntable are well adapted to pickup testing. Its speed range of 16 to one is ample, permitting investigation of four octaves of pickup performance with a single recorded frequency. Accuracy of speed indication is within one per cent of actual speed throughout the entire range, and stability is such that speed does not drift as much as one-half per cent over relatively long intervals. Performance with regard to flutter is excellent, even at relatively low speeds, as shown by the oscillograms of Fig. 7. Those for 20 and $33\frac{1}{3}$ rpm were made by reproducing a disk recorded on a high-quality machine at $33\frac{1}{3}$ rpm, the former at 1,667 cycles, the latter at 1,000 cycles, so that the reproduced frequency was 1,000 cycles in both cases, and hence suited to the flutter measuring equipment used. Similarly, those for 60 and 78 rpm were recorded at 78 rpm, the former at 1,300 and the latter at 1,000 cycles. The rms flutter values (which include the recorder) are seen to be approximately 0.10 per cent at 78 rpm, 0.085 per cent at 60 rpm, and 0.12 per cent at $33\frac{1}{3}$ and 20 rpm. It is interesting to note that the oscillograms for $33\frac{1}{3}$ and 78 rpm show greater once-around components than the others, undoubtedly due to the addition of the speed fluctuations during recording and those during reproduction, the two processes having been carried out at the same speed.

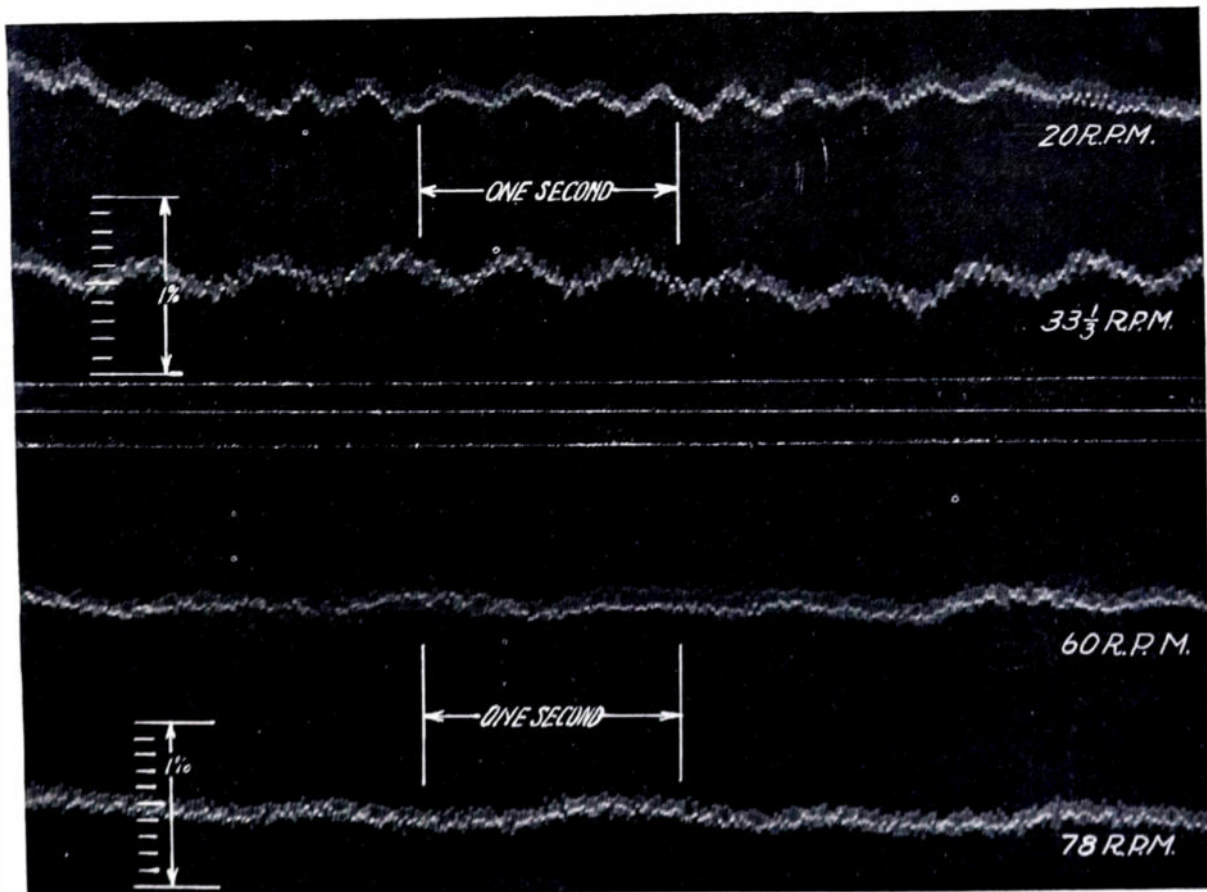

Fig. 7—Flutter oscillograms of variable-speed turntable.

A New Type of Slotted Line Section*

W. BRUCE WHOLEY†, MEMBER, IRE, AND W. NOEL ELDRED‡, SENIOR MEMBER, IRE

Summary—Conventional slotted lines require very close machining tolerances and care in construction if accurate measurements of VSWR (voltage standing-wave ratio) are to be obtained. A much less critical slotted line may be obtained by use of the transformation $w = \tan z$. The concentric line is converted to two parallel semi-infinite planes with a slightly elliptical center conductor. Simple modifications of this configuration will permit the construction of a slotted line section that is far less critical, with respect to mechanical dimensions, than its coaxial equivalent and will exhibit considerably less external energy radiation. Lines embodying this principle have been constructed, and were found to have excellent electrical properties with only moderate mechanical accuracies used in their construction. In a line covering the frequency range 500 to 4,000 Mc, a VSWR of only 1.006 was obtained for the basic slotted section and the necessary transition section to coaxial line.

INTRODUCTION

SLOTTED SECTIONS are a fundamental measuring tool in the microwave frequency range. They are useful in obtaining basic data concerning the impedances in any ultra-high-frequency system, and hence are of considerable value and interest to the microwave engineer.

The slotted sections now available are not completely satisfactory. The coaxial section is difficult to machine, requiring very close tolerances, and under even the very best conditions its accuracy leaves something to be desired. Because of the difficulty of machining these sections, their cost is high. This paper reports on an investigation that was made of slotted sections. An effort was made to develop a section requiring less rigid mechanical tolerances; a slotted section which would have a simple mechanical structure and at the same time would be more economical to produce. Before discussing this new section, let us review some of the inherent errors in a coaxial slotted line system.

BASIC ERRORS IN COAXIAL SLOTTED SECTIONS

Some of the errors introduced by slotted sections can be listed as follows:

1. Eccentricity of the center conductor with respect to the outer conductor will change the characteristic impedance of the line.¹ This is equivalent to having discontinuities in the section which will set up undesired standing waves. Eccentricity which is not uniform

throughout the section will, in general, cause the distance between the center conductor and the probe to vary throughout the length of the line. Such an error is commonly known as slope error and is indicated by different readings of successive maxima and minima of a standing wave pattern.

2. Change in the depth of penetration or change in the impedance between the probe and ground will affect the power transfer between the probe and detector, and thus cause a change in the output reading. These changes are a function of the mechanical tolerances. In coaxial structures, the dimensions affecting these variations are small, and great accuracy of the mechanical structure is required to keep these variations small.

3. Radiation from the slot is inherent in all slotted sections. The radiation is, in reality, a distributed loading, and its effects will be made apparent in two ways. First, this distributed loading will cause a reactive component to appear in the characteristic impedance of the slotted section. This effect, while it may not set up a residual standing wave, will lead to errors when calculations are made upon the assumption that the characteristic impedance is purely resistive. Second, there will be a loss in power down the line which will result in a slope error. The best way to minimize these errors is to make the radiation from the slot as small as possible.

From the above discussion of errors it is apparent that, in order to obtain an accurate line which does not require the small mechanical tolerances of coaxial lines, a different configuration must be found. Many possible configurations have been studied, and a line has been chosen which overcomes the common coaxial slotted line problems. It has been named the "slab line."

EQUIVALENT SLAB LINE

A very powerful method for obtaining transmission systems with a common characteristic impedance, but with different physical configurations, is available through the use of conformal transformations. Conformal transformations are based upon the properties of complex functions. Consider, for instance, the following equation

$$w = f(z)$$

where w and z are complex numbers ($u + jv$) and ($x + jy$), respectively. Now, based upon the method of plotting complex numbers, w and z can be taken to represent two planes, namely the w plane and the z plane, respectively. By use of the above equation, points in the w plane can be transformed into corresponding points in the z plane. Furthermore, if $f(z)$ satisfies certain other requirements, then it can be shown that the orthogonal curvilinear squares in the w plane will be mapped into

* Decimal classification: R244.211. Original manuscript received by the Institute, February 25, 1949; revised manuscript received, October 31, 1949. Presented, National Electronics Conference, November, 1948, Chicago, Ill.

The work described in this paper was carried out at the Hewlett-Packard Company as part of the United States Navy Bureau of Ships research development program, Contract Number NO bsr-30202, Task Order #2.

† Hewlett-Packard Company, Palo Alto, Calif.

‡ Theodore Moreno, "Microwave Transmission Design Data," Sperry Gyroscope Company.

corresponding orthogonal curvilinear squares in the z plane. An example of the use of conformal transformation is in mapping, where it is desired to show various parts of a spherical surface upon a flat surface.

The transformation² used in obtaining the slab line was

$$w = \tan z.$$

In applying this transformation, a cross section of the coaxial line is considered to be in the w plane, and the transformed section is shown in the z plane. The application of this transformation can be considered as a systematic warping of the conductors of the coaxial line. The outer conductor of the coaxial line is cut at two points diametrically opposite. These points are then pulled upward and outward until the outer conductor degenerates into two semi-infinite planes. As a result of this warping of the outer conductor, the inner conductor is also warped, and it becomes a slightly elliptically shaped rod located symmetrically between these planes. The resultant transformed line is shown in Fig. 1.

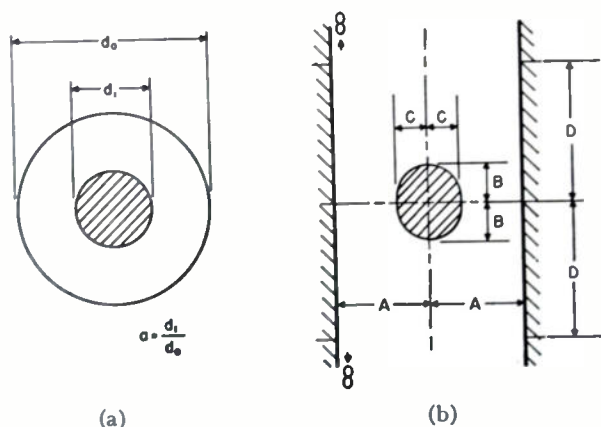

Fig. 1—(a) Section of coaxial line. (b) Section of slab line.

The dimensions A , B , and C are related to the coaxial section as follows:

$$\frac{A}{B} = \frac{\pi}{4 \operatorname{arctanh} a}$$

$$\frac{A}{C} = \frac{\pi}{4 \operatorname{arctan} a}$$

$$a = \frac{\text{outer diameter of inner conductor of coaxial}}{\text{inner diameter of outer conductor of coaxial}}$$

The development of these and the following relations are shown in the Appendix.

The shape of the flux lines and lines of equal potential in the coaxial section and the slab section are

shown in Fig. 2. From an examination of this figure it can be readily seen that, in the neighborhood of the probe, the lines of equipotential are farther apart in the slab line and also have less curvature. Thus, it is to be expected that the slab line would be much less sensitive to small variations in the vertical probe position than the coaxial line. Likewise, moving the probe to the right or left of the mid-position between the planes will have a smaller effect on the voltage pickup in the slab line.

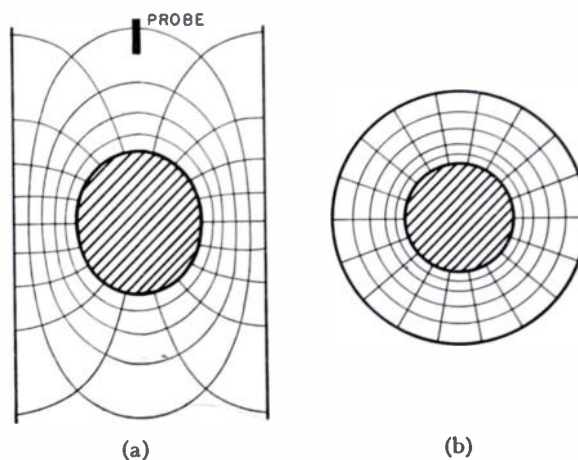

Fig. 2—Field plot. (a) Slab line. (b) Coaxial line.

Because of the need for semi-infinite planes and a slightly elliptically shaped center conductor, it would appear that this line would be difficult to construct. Nevertheless, it is possible to modify this configuration so as to permit practical construction without changing the electrical characteristics appreciably.

First, the semi-infinite planes are modified into planes of finite extent. This modification is possible because the fields are rapidly attenuated with distance from the center conductor. This change is equivalent to making two slots in the coaxial line. The relation between the equivalent slot width ω (radians) in the coaxial line and the width $2D$ of the slab line is shown below:

$$D = \frac{2A}{\pi} \operatorname{arcsinh} \frac{4}{\omega}$$

or

$$\omega = \frac{4}{\sinh \frac{\pi D}{2A}}$$

For a practical slab line with the relation $D/A = 5.6$, the effective slot referred to a coaxial section is computed to be 0.0012 radian. This is equivalent to a slot 0.0006 inch wide in a 1-inch diameter line.

The second modification is applied to the center conductor to provide a conveniently fabricated shape. The basic requirement in making this modification is to keep the characteristic impedance of the modified conductor the same as the elliptical conductor. The center con-

² Method suggested by E. L. Ginzton, Physics Department, Stanford University.

ductor may be of any shape, but a circular one was chosen for its ease of fabrication. The method which was used to make this modification was to consider that, for small changes in the center conductor, one can write $Z_0 = K/C$, where Z_0 = characteristic impedance; K = a constant; C = capacitance per unit length of line. Hence in changing the shape of the center conductor, if the capacity C remains constant, the Z_0 will remain constant. In this approach, the field associated with the circular center conductor was matched to that of the original center conductor at four points. This gives a match which has proved in practice to be adequate. The relation between R/A and characteristic impedance is shown in Fig. 3.

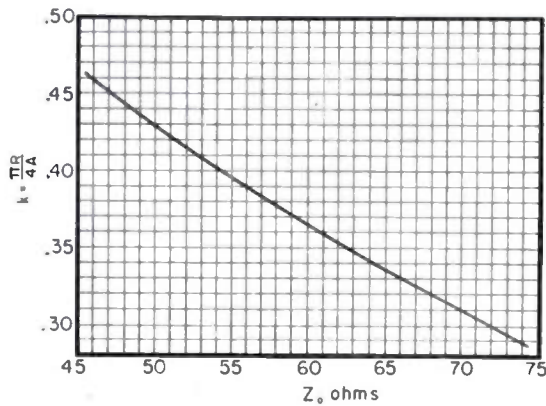

Fig. 3—Design curve for computing characteristic impedance.

The probe of the slab line is less sensitive to small changes in depth of penetration. This improvement over the coaxial line can be expressed as follows:

$$S_P/S_C = b(2 - b)$$

$$b = \frac{\text{depth of probe penetration in coaxial line}}{\text{radius of outer conductor of coaxial line}}$$

S_P = sensitivity of parallel plane line to small changes in the distance between the probe and the center conductor

S_C = sensitivity of the coaxial line to small changes in distance between the probe and the center conductor.

For example, if b is $\frac{1}{6}$, the ratio S_P/S_C is 0.121, and the slab line is approximately 8 times less sensitive to changes of probe penetration.

TRANSITION SECTION

Connections to the slab line must normally be accomplished through the use of coaxial line structures. Even though the slab line will have the same impedance as the coaxial end section, there is a change in configuration when going from one section to the other. This change in configuration has been shown to be equivalent to introducing a shunt capacitance discontinuity in a uni-

form line.³ It may be compensated by introducing at the discontinuity a section of line the impedance of which is higher than that of the normal line. Such a section is easily obtained by displacing the steps in the inner and outer conductor by a small amount. This section becomes, in essence, a low pass filter whose constants can be adjusted to give a very low reflection over very broad bands of frequency.

It has been found easier to use displaced steps than tapered sections for transition sections in slotted lines. The displaced steps can be made as good electrically as tapered sections, and they are, in general, very much simpler from a mechanical standpoint.

The center conductor was supported on beads that were compensated to give a low residual reflection. This was accomplished by making the beads electrically short compared to a quarter wavelength, and by making the bead section of a higher impedance than the rest of the line. By controlling the length of the bead and the impedance of the bead, it is possible to compensate for its discontinuity in a manner similar to that employed in making transition sections between systems having different configurations.

EXPERIMENTAL WORK AND RESULTS

Slotted sections based upon the slab line theory have been constructed for two frequency ranges, 500 to 4,000 Mc, and 3,000 to 10,000 Mc. A photograph of the 500- to 4,000-Mc line is shown in Fig. 4. Both of these lines

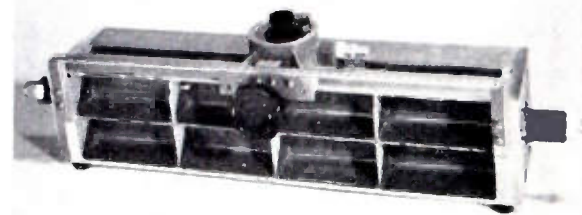

Fig. 4—Slotted line: 500 to 4,000 Mc.

consist of parallel-plane slotted sections with coaxial transition sections and Type *N* connectors on each end. The center conductor is supported at each end by means of a compensated bead. A female connector is employed at one end and a male connector at the other. Both ends are built to have low residual reflections, so that either end may be used for the output or input as desired.

The discontinuities were isolated and their residual reflection reduced by experimental procedure. A null-shift method was used to measure the residual reflection.^{4,5}

³ J. R. Whinnery, H. W. Jamieson, and T. H. Robbins, "Coaxial line discontinuities," *Proc. I.R.E.*, vol. 32, pp. 695-709; November, 1944.

⁴ E. Feenberg, "The relation between nodal position and standing wave ratio in a composite transmission system," *Jour. Appl. Phys.*, vol. 17, pp. 530-532; June, 1946.

⁵ Nathan Marcuvitz, "On the representation and measurement of waveguide discontinuities," *Proc. I.R.E.*, vol. 36, pp. 728-736; June, 1948.

Residual reflection coefficients in the 500- to 4,000-Mc line were as follows: Transformer between the slab and coaxial line was reduced to less than 0.003, bead and transformer together were reduced to less than 0.007, and, finally, the total reflection including the adapters to type N connectors was reduced to less than 0.01. The above figures hold for the complete frequency range. In the 3,000- to 10,000-Mc line, the over-all residual reflection through connectors was less than 0.025.

APPENDIX

Detailed Development of Slab in Theory

The transformation used for mapping the coaxial line in the w plane into the parallel plane line in the z plane (See Fig. 5)

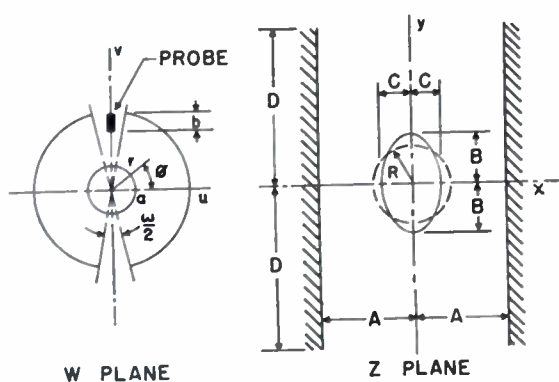

Fig. 5—Transformation of coaxial line to slab line.

was

$$w = \tan z$$

expanding and separating into real and imaginary components

$$u = \frac{\tan x - \tan x \cdot \tanh^2 y}{1 + \tan^2 x \cdot \tanh^2 y}$$

$$v = \frac{\tanh y + \tanh y \cdot \tan^2 x}{1 + \tan^2 x \cdot \tanh^2 y}$$

In the w and z plane surfaces of constant r are given respectively by

$$r^2 = u^2 + v^2 = \frac{\tan^2 x + \tanh^2 y}{1 + \tan^2 x \cdot \tanh^2 y}$$

At the outer conductor where $r=1$, and when

$$y = 0 \quad \text{then} \quad x = \pm \frac{\pi}{4}$$

when

$$x = 0 \quad \text{then} \quad y = \pm \infty.$$

Thus the outer conductor is transformed into two semi-infinite planes located at $x = \pm (\pi/4)$ in the z plane.

At the inner conductor $r=a$ and when

$$y = 0 \quad \text{then} \quad x = \pm \arctan a$$

when

$$x = 0 \quad \text{then} \quad y = \pm \operatorname{arctanh} a.$$

The following equations can now be written

$$\frac{C}{A} = \frac{4 \arctan a}{\pi}$$

$$\frac{B}{A} = \frac{4 \operatorname{arctanh} a}{\pi}.$$

From an angular consideration it can be shown that

$$\tan \phi = \frac{v}{u} = \frac{\sinh 2y}{\sin 2x}$$

which at

$$x = \pm \frac{\pi}{4} \quad \text{and} \quad y = \pm D$$

reduces to

$$\tan \phi = \pm \sinh (\pm 2D) = \tan \left(\frac{\pi}{2} - \frac{\omega}{4} \right),$$

and since ω is small

$$D = \frac{\operatorname{arcsinh} \frac{4}{\omega}}{2}$$

and

$$\omega = \frac{4}{\sinh \frac{\pi D}{2A}}.$$

Transformation of the Center Conductor

The above theory leads to an elliptical shaped center conductor which is undesirable from several standpoints, and it hence became desirable to calculate the characteristic impedance using a cylindrical center conductor.

If the reverse transformation

$$z = \tan^{-1} w$$

is applied to the slab line with a circular center conductor of radius R , then a coaxial structure with an elliptically shaped center conductor, as shown in Fig. 6 is obtained.

Here

$$k = \frac{\pi R}{4A}.$$

A solution of Laplace's equation in cylindrical coordinates gives

$$V = K \ln r + Mr^2 \cos 2\theta + \frac{N}{r^2} \cos 2\theta.$$

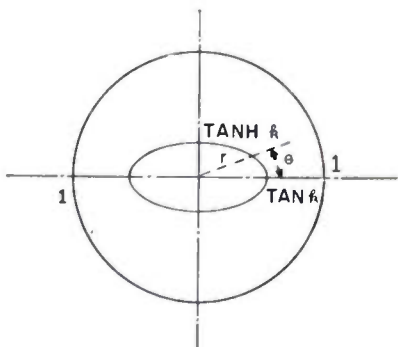

Fig. 6—Transformed slab line with circular center conductor.

The boundary condition to be satisfied are:
when

$$r = 1 \quad V = 0$$

when

$$r = \tan k \quad \text{and} \quad \theta = 0 \quad V = V_1$$

when

$$r = \tanh k \quad \text{and} \quad \theta = \frac{\pi}{2} \quad V = V_1.$$

Applying these boundary conditions to eliminate the constants M and N and rearranging the equation

$$K = V_1 \frac{s + t}{s \ln \tan k + t \ln \tanh k}$$

where

$$s = \tanh^2 k - \frac{1}{\tanh^2 k}$$

$$t = \tan^2 k - \frac{1}{\tan^2 k}.$$

But in normal coaxial lines,

$$K = \frac{V_1}{\ln a}.$$

Hence

$$\ln a = \frac{s}{s + t} \ln \tan k + \frac{t}{s + t} \ln \tanh k.$$

But the characteristic impedance Z is

$$Z = 60 \ln \frac{1}{a}$$

then

$$Z = 60 \left(\frac{s}{s + t} \ln \frac{1}{\tan k} + \frac{t}{s + t} \ln \frac{1}{\tanh k} \right).$$

Since this equation does not give k explicitly, it is necessary to solve it by approximations. A plot of the function of Z versus k is shown in Fig. 3.

Effect of Probe Penetration

To evaluate the effect of small changes in distance between the probe and the center conductor, two quantities will be defined. These are:

S_p = sensitivity of the parallel plane line to small changes in the spacing between the probe and center conductor

S_c = same as S_p , except for coaxial lines.

The ratio of these sensitivities can be obtained by comparing the appropriate gradients of electric field existing in the two lines, and at a point of equal potential in the two lines.

$$S_p/S_c = \frac{dE}{dy} \frac{dr}{dE} = \frac{dr}{dy} = 1 - r^2;$$

if

$$b = \frac{\text{depth of probe penetration in the coaxial line}}{\text{radius of outer conductor of the coaxial line}},$$

then $S_p/S_c = b(2 - b)$.

ACKNOWLEDGMENT

The authors are indebted to John Woodyard of the Radiation Laboratory, University of California, who suggested the slab line, and to E. L. Ginzton of the physics department at Stanford University, who suggested the method of transformation; also to Karl Spangenberg, of Stanford University, who suggested the method of calculating the impedance of a central circular conductor in the slab line. We also express appreciation to William R. Hewlett for his advice and direction; and to Arthur Fong, who developed and constructed the high-frequency model of the slab line.



The Radiation Characteristics of Conical Horn Antennas*

A. P. KING†, SENIOR MEMBER, IRE

Summary—This paper reports the measured radiation characteristics of conical horns employing waveguide excitation. The experimentally derived gains are in excellent agreement with the theoretical results (unpublished) obtained by Gray and Schelkunoff.

The gain and effective area is given for conical horns of arbitrary proportions and the radiation patterns are included for horns of optimum design. All dimensional data has been normalized in terms of wavelength, and are presented in convenient nomographic form.

I. INTRODUCTION

THIS PAPER reports the experimental results obtained with conical horn antennas having a linear rate of flare and employing waveguide excitation which is limited to the dominant mode. Some earlier experiments made in this field have been reported.¹ This study was conducted at the Holmdel Laboratory of the Bell Telephone Laboratories.

Conical horns probably comprise the most simple antenna structure, and in the range of moderate antenna gains, in the vicinity of 20 db, they are quite compact in size. Since the length of a conical horn increases directly with the power gain, the length of the horn may become objectionably long at high gains. In this respect, and in general, conical horns exhibit gain and directional characteristics which are quite similar to those of rectangular or pyramidal horns. Since the axial gain can readily be calculated from their physical dimensions, conical horns are especially useful as antenna gain standards.

Most of the conical horn measurements were made at a wavelength around 10 cm; a few in the 3-cm range. The measurement of antenna gain is in terms of absolute gain, i.e., relative to an isotropic radiator and the general measuring procedures closely follow the techniques reported in an earlier paper.² Since the radiation characteristics of a conical horn are determined by its dimensions in wavelengths, it has been convenient to normalize all dimensional data in terms of wavelength.

II. GENERAL

A conical horn is a section of a right circular cone and is usually connected to a cylindrical waveguide as shown in Fig. 1. An alternate form of excitation may

comprise a rectangular waveguide which is gradually flared into the circular waveguide or into the horn directly. For either dominant wave (TE_{10}) excitation in rectangular waveguide or TE_{11} wave excitation in circular waveguide, the conical horn has been found to exhibit substantially the same behavior.

The performance of this class of antenna can be determined by specifying two dimensions. These are the axial length L and the diameter of the horn aperture d_m , as indicated in Fig. 1.

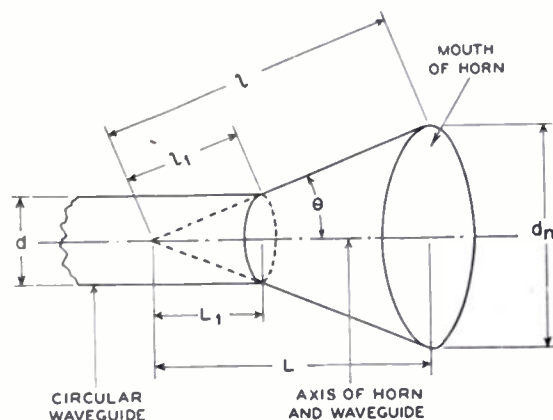

Fig. 1—Conical horn.

The absolute gain of a conical horn of arbitrary dimensions is given by the theoretical curves of Fig. 2 which were derived by Gray and Schelkunoff.³ A number of horns measured over a wide range of values show excellent agreement with the calculated values of Fig. 2. Conical horns of a fixed length and varying aperture size exhibit a gain variation characteristic which is analogous to that of rectangular horns. For a conical horn whose axial length L is fixed, the axial gain increases as the aperture diameter d_m increases up to a certain optimum value. For all other values of d_m the gain will be less. The dimensions which correspond to a maximum gain for a given length are horns of optimum design. These proportions are indicated by the dashed line of Fig. 2. However, for the case of conical horns whose aperture (d_m) is fixed and the axial length is allowed to vary the gain varies in a different manner, the maximum gain now occurs when the length is infinite. The latter is, of course, equivalent to a circular waveguide radiator whose diameter is d_m .

The measured values of 6 conical horns, whose proportions vary over a wide range, are indicated by the points a, b, \dots, f in Fig. 2. Of these, horns a and b are

* Decimal classification: R325.8×R120. Original manuscript received by the Institute, June 8, 1949; revised manuscript received, October 11, 1949.

† Bell Telephone Laboratories, Inc., Holmdel, N. J.

¹ G. C. Southworth and A. P. King, "Metal horns as directive receivers of ultra-short waves," *PROC. I.R.E.*, vol. 27, pp. 95-102, February, 1939.

² C. C. Cutler, A. P. King, and W. E. Kock, "Microwave antenna measurements," *PROC. I.R.E.*, vol. 35, pp. 1462-1471; December, 1947.

³ M. C. Gray and S. A. Schelkunoff, Bell Telephone Laboratories, from unpublished data.

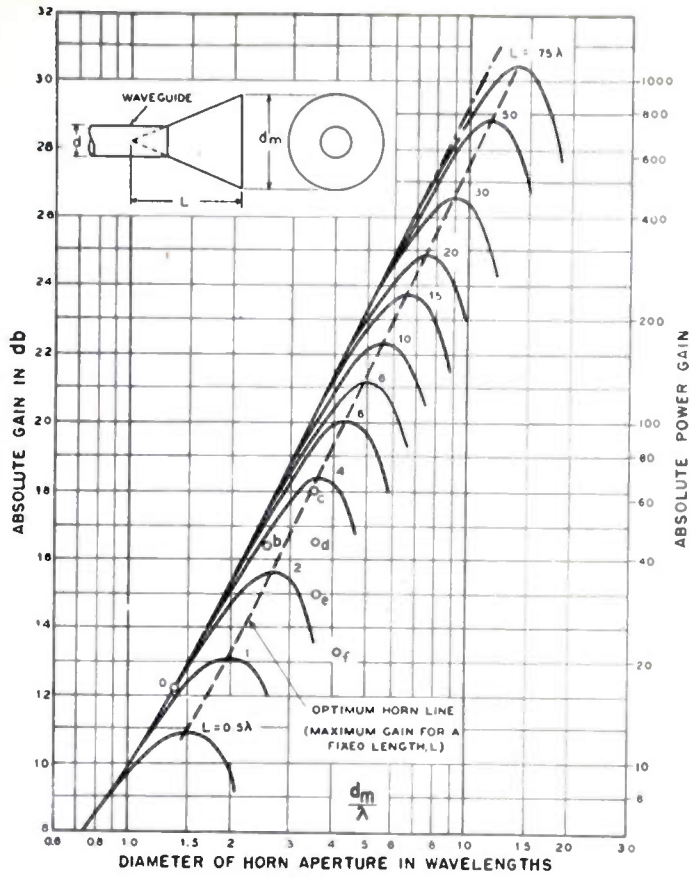

Fig. 2—The absolute gain of a conical horn as a function of aperture diameter (d_m/λ) for a series of axial lengths, L .

for values of aperture diameter d_m , less than optimum, point c corresponds very closely to optimum, and horns d, e, f are for horns whose diameter (d_m) exceeds optimum. The radiation characteristics of these particular horns are plotted in Fig. 3. These patterns indicate a typical behavior over this range of horn proportions, in that the magnetic plane patterns have a single major

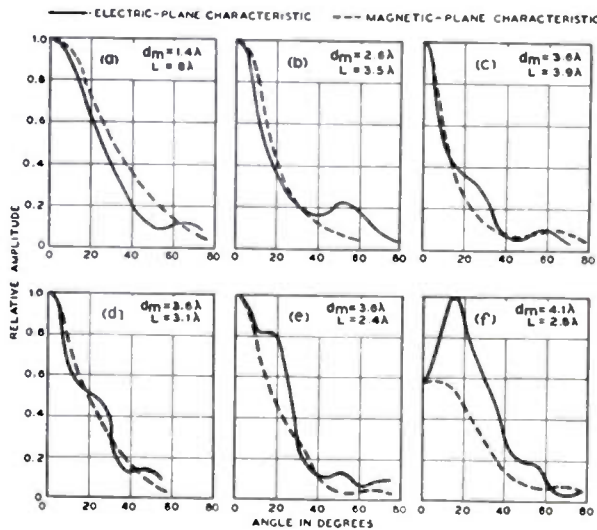

Fig. 3—Directional characteristics are shown of a series of conical horns of varying proportions. In Figs. (a) and (b) the apertures for horn length L are of less than optimum value, in (c) of optimum value, and in (d), (e), (f) of greater than optimum value.

lobe and are relatively free from minor lobes. In the electric plane, the minor lobe is separated from the major lobe for (a) and (b) where the values of d_m are appreciably less than optimum. However, as the value of d_m approaches the optimum value, the minor lobe moves toward the axis of the beam and merges with the major lobe, as shown in Fig. 3(c). As d_m increases beyond the optimum, the minor lobe continues to rise higher on the side of the major lobe as indicated in Fig. 3 by patterns (d) and (e). A still further increase in d_m to the proportions indicated in Fig. 3(f), produces a splitting of the major lobe with the result that radiation is no longer a maximum along the axis. To obtain good major lobe characteristics which are moderately free from minor lobe effects, it is preferable to operate in the range where the aperture diameter, d_m , does not exceed the optimum value.

III. OPTIMUM HORNS

The optimum horns considered throughout this paper are restricted to conical horns so proportioned that for a given axial length L , the antenna gain is a maximum. Optimum horns are generally most useful since they comprise the most compact antenna for a given gain.

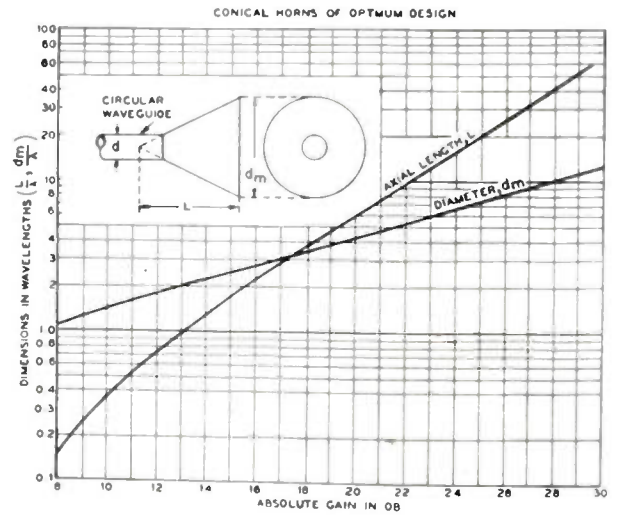

Fig. 4—Shows diameter d_m and axial length L as a function of axial gain for conical horns of optimum design.

The gain-dimensional data for optimum horns is given in Fig. 4. The geometrical relationships are

$$\frac{l}{\lambda} - \frac{L}{\lambda} = 0.3 \tag{1}$$

$$\frac{L}{\lambda} \approx 0.3 \left(\frac{d_m}{\lambda} \right)^2 \tag{2}$$

where l , the radial length, is indicated in Fig. 1. A typical measured radiation pattern for an optimum conical horn, whose absolute gain is 17.7 db, is shown in Fig. 5. Additional experimental data are presented in nomographic form in Fig. 6 for plotting the directional characteristics of optimum horns whose aper-

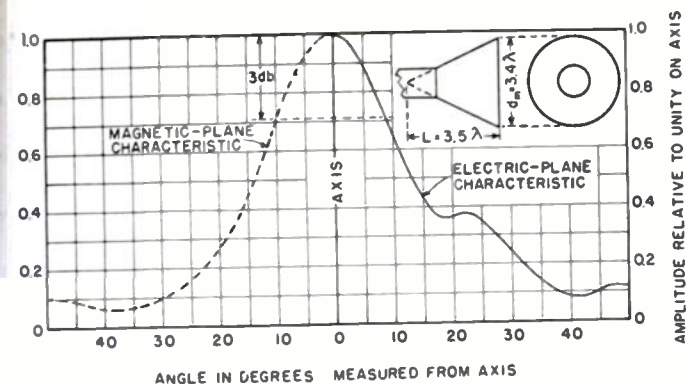

Fig. 5—Radiation pattern of a 17.7-db gain conical horn of optimum design.

ure diameter d_m/λ lies in the range of 1.5–15λ. In this nomogram the amplitude, relative to unity in the direction of maximum radiation intensity, is represented by the slant lines, the abscissa the value of aperture d_m/λ , and the ordinate gives the radiation angle relative to the axis of the beam. The beam angle ϕ , between points 3 db below the maximum radiation intensity, is

$$\phi_M \approx \frac{70}{\left(\frac{d_m}{\lambda}\right)} \text{ degrees (beam angle in the magnetic plane)} \quad (3)$$

$$\phi_E \approx \frac{60}{\left(\frac{d_m}{\lambda}\right)} \text{ degrees (beam angle in the electric plane).} \quad (4)$$

As indicated in (3) and (4) above, the beam angle is somewhat sharper in the electric plane than in the magnetic plane. These two beam angles can be made equal

(at points 3 db below maximum radiation intensity) by deforming the circular aperture to an ellipse whose major to minor axis ratio is approximately 1.2, the minor axis being parallel to the electric plane.

IV. EFFECTIVE AREA OF CONICAL HORNS

The effective area A_{eff} of an antenna is

$$A_{eff} = \frac{g\lambda^2}{4\pi}, \quad (5)$$

where g is the absolute power gain and λ the free-space wavelength. For an antenna whose intensity distribution, polarization and phase are uniform across its aperture, the effective area is equivalent to the actual aperture area A . While it is difficult to realize this degree of perfection in practice, it serves as a criterion to indicate how closely the performance of an antenna approaches the ideal. Usually the effective area of an antenna is expressed relative to the actual area, as a ratio A_{eff}/A . The aperture area of a conical horn is

$$A = \frac{\pi}{4} d_m^2 \quad (6)$$

and the ratio

$$\frac{A_{eff}}{A} = \frac{g}{\pi^2 \left(\frac{d_m}{\lambda}\right)^2} \quad (7)$$

where g is the absolute power gain. The effective area for a conical horn of arbitrary proportions may be calculated from the values of g (after converting to power gain) and the corresponding values d_m/λ in Fig. 2. For a horn whose dimensions correspond to optimum design, the effective area is 0.52 or 52 per cent that of the actual area. When the aperture (d_m) of a conical horn is fixed, its effective area increases with the axial length (L) and reaches a maximum value of $A_{eff}/A = 0.84$ (84 per cent) for very long horns. The effective area as a function of the axial length, relative to the length at optimum, is shown in Table I.

TABLE I
EFFECTIVE AREA OF CONICAL HORNS

Length relative to optimum	Effective area A_{eff}/A
0.5	20%
0.75	39%
1.0	52%
1.5	69%
2.0	75%
3.0	80%
4.0	82%
∞	84%

As is indicated in this table, only a small increase in effective area or axial gain is realized by increasing the axial length beyond 2 or 3 times the value corresponding to optimum.

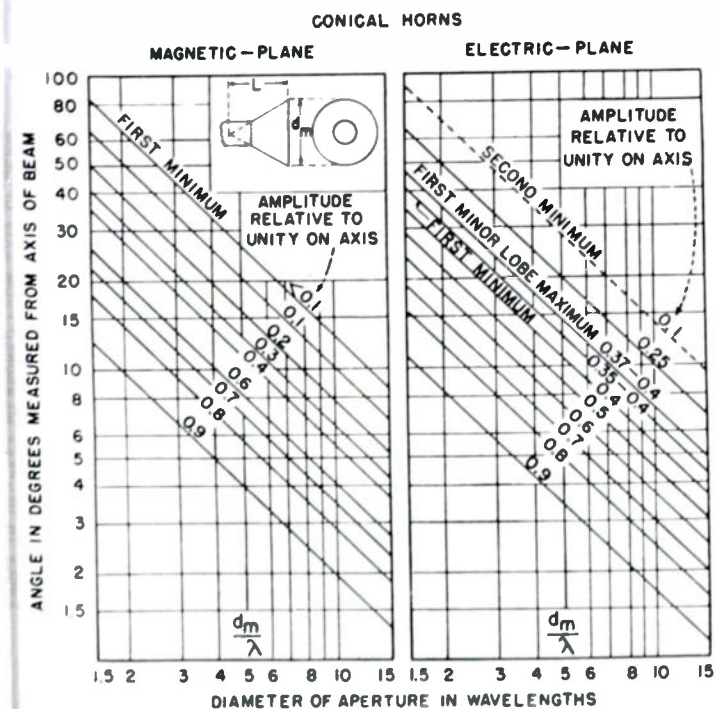

Fig. 6—Nomogram for plotting the radiation characteristic for conical horns of optimum design.

Interference Characteristics of Pulse-Time Modulation*

ERNEST R. KRETZMER†, ASSOCIATE, IRE

Summary—The interference characteristics of pulse-time modulation are analyzed mathematically and experimentally; particular forms examined are pulse-duration and pulse-position modulation. Both two-station and two-path interference are considered. Two-station interference is found to be characterized by virtually complete predominance of the stronger signal, and by noise of random character. Two-path interference, in the case of single-channel pulse-duration modulation, generally permits fairly good reception of speech and music signals.

I. INTRODUCTION

AMONG the most important characteristics of a modulation system is its susceptibility to noise and to interference caused by other communication services or multipath transmission. Different systems may exhibit totally different behavior under identical conditions of interference. Pulse-time modulation (PTM), of which pulse-duration modulation (PDM) and pulse-position modulation (PPM) are particular forms, has been in use for point-to-point communication for the past ten years. While much has been written about its properties with regard to fluctuation noise,^{1,2} little attention has been paid to its characteristics with regard to two-path or two-station interference.

II. TERMINOLOGY AND NOTATION

The two signals involved are referred to as the desired and interfering signals, respectively. The desired signal consists of rf pulses having unity amplitude, while the interfering signal may be pulsed or continuous and has an amplitude a . The quantity a is therefore the interference level as well as the interference ratio. The following notation is used in the remainder of this paper:

- a = interference level or interference ratio ($a < 1$)
- s = slicing level
- ϕ = rf phase difference
- δ = rise or decay time of pulse edge
- Δt = time shift caused by interfering signal
- T = pulse-repetition period of desired signal
- E = peak voltage of pulses at slicer output
- V_n = effective noise voltage, based on low-pass audio characteristic having zero db gain and an equivalent noise bandwidth equal to $1/2T$

* Decimal classification: R148.6XR170. Original manuscript received by the Institute, July 27, 1949; revised manuscript received, December 5, 1949. Presented, 1949 IRE National Convention, New York, N. Y., March 7, 1949.

This work has been supported in part by the Signal Corps, the Air Materiel Command, and the Office of Naval Research.

† Formerly, Massachusetts Institute of Technology, Cambridge, Mass., now, Bell Telephone Laboratories, Inc., Murray Hill, N. J.

¹ E. M. Deloraine and E. Labin, "Pulse time modulation," *Electronics*, vol. 18, pp. 100-104; January, 1945.

² Z. Jelonek, "Noise problems in pulse communication," *Jour. IEE*, part IIIA, vol. 94, no. 13, pp. 533-545; 1947.

V_s = peak signal voltage, based on an audio characteristic having zero db gain at the signal frequency or frequencies

d_1 = average duration of desired pulses

D_2 = duty factor of interfering pulses

Δf = difference between the radio frequencies of the desired and interfering signals

F = probability that the resultant of two overlapping pulses fails to reach the slicing level.

III. HOW INTERFERENCE AFFECTS PTM SYSTEMS

In a PTM system all information is conveyed by the timing of pulse edges, regardless of whether the duration or the position of the pulses is modulated. A step which is essential in the detection of time-modulated pulses is the so-called slicing process, illustrated in Fig. 1(a). Before being sliced, the pulses have rise and decay times determined by the system bandwidth; at the instant at which a pulse edge passes the slicing level, a new, much steeper pulse edge appears at the slicer output. Fig. 1(b) shows the effects of three bursts of inter-

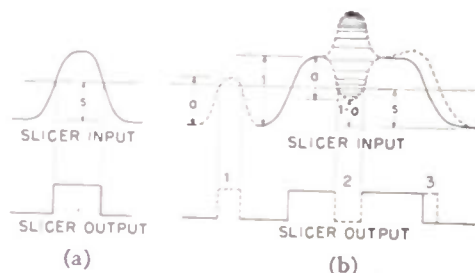

Fig. 1—(a) Illustration of slicing process. (b) Three ways in which interference may enter PTM systems.

ference, each reaching the slicer output in a different manner: the first pierces the slicing level directly ($a > s$), the second cancels part of the desired pulse ($1 - a < s$), and the third shifts the trailing edge of the desired pulse. The type and magnitude of the disturbance caused by the interference depends very much on s ; in practice s is easily adjusted.

IV. CHOICE OF SLICING LEVEL

Both theory and experiment lead to definite conclusions as to optimum slicing level. The optimum value is generally $s = 0.5$ for small interference ratios, since the pulse edges are steepest at one-half the peak value, and the spurious time shifts of the edges are consequently minimized. For interference ratios exceeding one-half ($a > 0.5$), the optimum value of s depends on the type of interference. In the case of two-station interference, it is always desirable to prevent the modulation of the interfering signal from reaching the receiver output;

consequently, the best position of the slicing level is just above the interference level ($s = a +$). On the other hand, in the case of two-path interference, the modulation of the interfering signal is the same as that of the desired signal, except for a small delay; as a result, the optimum slicing level is well below the interference level ($s < a$ and $s < 1 - a$), though only for single-channel PDM systems.

V. THE TIME-SHIFT EFFECT—TWO-STATION INTERFERENCE

Although spurious time shifts of the pulse edges are the most common way in which interference from another station enters the system, the resulting disturbance is generally not of serious consequence. The maximum possible time shift (see Fig. 2) is given by

$$\Delta t_{\max} = a\delta, \quad a < 0.5, \quad (1)$$

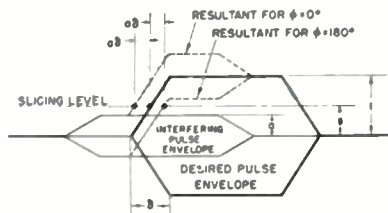

Fig. 2—Illustration of time-shift effect: an interfering pulse overlaps the leading edge of a desired pulse, thereby advancing or retarding the time at which the pulse edge passes the slicing level.

if linearly rising and falling pulse edges are assumed. This relation serves as a good guide in appraising the time-shift magnitudes, although the exponential shape of the edges used in practice modifies the relation considerably. Not all pulse edges overlapped by interference are shifted by the maximum amount, Δt_{\max} ; the maximum shifts occur only if the rf carriers of the overlapping pulses are exactly in phase or out of phase, i.e., for $\phi = 0^\circ$ or 180° (see Fig. 2). Intermediate values of the rf phase difference ϕ will cause intermediate time shifts. In general, ϕ is different each time an interfering pulse overlaps part of a desired pulse. Furthermore, with the type of pulse transmitter used in practice, the change in ϕ from pulse to pulse is essentially random; that is, successive values of ϕ ,—and hence of Δt ,—are substantially independent of each other, all values of ϕ being equally likely.³ Thus, unlike the intentional time modulation of the pulse edges, the time shifts caused by interference are random and consequently give rise to random noise in the receiver output. Such "random time-shift noise" is encountered in both PDM and PPM systems, with $a < 0.5$ and $s \approx 0.5$, regardless of whether the interfering signal is pulsed or continuous.

³ It is possible to construct pulse transmitters which produce coherent oscillations in such a way that the behavior of ϕ is completely nonrandom.

The pulse-edge time shifts have a probability distribution which depends on the relation between Δt and ϕ . The probability distribution in turn determines the mean effective value of Δt , which turns out to be approximately $0.7 \Delta t_{\max}$.⁴ Accordingly, the resulting noise voltage would be given by

$$V_n \approx 0.7 \frac{E}{T} \Delta t_{\max}, \quad (2)$$

if one edge of each pulse were overlapped by interference and if the audio system had an equivalent noise bandwidth equal to $1/2T$. With continuous interference, both edges of each pulse are overlapped and undergo shifts which may add in phase or may partially cancel each other, depending on the value of Δf . In the case of pulsed interference, only a fraction D_2 of all pulse edges are overlapped, or an average of $2D_2$ edges are shifted per pulse. Therefore, excepting certain special cases, the effective noise voltage is given by

$$V_n \approx 0.7 \frac{E}{T} \sqrt{2D_2} \Delta t_{\max} \approx \frac{E}{T} a\delta \sqrt{D_2} \quad (a < 0.5). \quad (3)$$

In order to make this noise voltage more meaningful, one may compare it to the signal voltage. The peak signal in a fully modulated PDM system cannot exceed

$$V_s = \frac{E}{T} d_1, \quad (4)$$

so that the maximum possible ratio of peak signal voltage to rms noise voltage is roughly equal to $d_1/a\delta\sqrt{D_2}$. In a typical case, the values may be $d_1 = 5 \mu\text{sec}$, $D_2 = 0.1$, $\delta = 0.5 \mu\text{sec}$,⁵ $a = 0.3$, so that the ratio is approximately 100. This relatively high ratio explains why, for interference ratios below one-half ($a < 0.5$), the interference (manifesting itself purely as random noise through the time-shift effect) need not be of serious consequence. In a typical PPM system under similar conditions, the output signal-to-noise ratio would be still higher as a result of a smaller duty factor.

VI. PARTIAL CANCELLATION OF PULSES—TWO-STATION INTERFERENCE

The cancellation effect (see Fig. 1(b)) is encountered for $0.5 < a < 1.0$, $s \geq a$. This condition occurs, particularly, in the case of two-station interference with the desired and interfering signals of almost equal strength. Like the time-shift effect, the cancellation effect is random in nature because of the random variation of the rf phase difference ϕ . Consequently, some pulses or portions of pulses fail to reach the slicer output at random.

⁴ The subject of random time shifts has been analyzed in detail by the author by means of the auto-correlation method. (Technical Report No. 92, Research Laboratory of Electronics, M.I.T.) It is hoped to publish the results.

⁵ This implies a system bandwidth in the order of magnitude of 1 Mc.

Fig. 3 shows the possible resultants of two overlapping pulses, the gradation being indicative of the probability distribution of the resultant. It can be shown that any

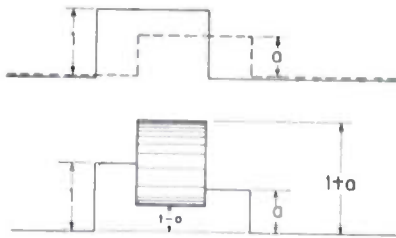

Fig. 3—Possible resultants of overlapping pulses. The resultant may fall below the slicing level for $s = a +$ but will always exceed the slicing level for $s < 1 - a$.

desired pulse which is overlapped by interference has a probability F of failing to reach the slicer output, where

$$F = \frac{1}{\pi} \left| \cos^{-1} (1/2a) \right|. \quad (5)$$

The main result of the "randomly missing pulses" is random noise, generally more severe than that caused by the time-shift effect. In the case of PPM, the magnitude of the noise is very much dependent on the type of demodulator used. In the case of PDM, where the demodulator usually consists only of a low-pass filter, the noise spectrum and voltage are readily determined by means of auto-correlation analysis. The noise voltage is given, within a few per cent, by

$$V_n \approx \frac{E}{T} d_1 \sqrt{F - F^2} \quad (6)$$

if the interference is continuous. With pulsed interference having a duty factor D_2 , the noise voltage is approximately equal to (6) multiplied by D_2 . Reference to (4) shows the maximum ratio of peak signal voltage to rms noise voltage to be about $1/D_2 \sqrt{F - F^2}$. For a nearly equal to one, and $D_2 = 0.1$, this ratio is almost 30, but larger interference duty factors rapidly reduce the ratio to unacceptable values. Those pulses not lost through cancellation are still subject to the time-shift effect which contributes some additional noise. The variation in noise with interference ratio is small for $0.6 < a < 1.0$, since $\sqrt{F - F^2}$ is a slowly varying function of a . Even for interference ratios as high as 0.95, the modulation of the "taller" desired pulses is marred only by the random noise discussed above; the modulation of the interfering pulses is not audible, that is, a strong "capture effect" prevails.

VII. TWO-PATH INTERFERENCE

As indicated in section IV, two-path interference, in the case of single-channel PDM systems, is handled quite differently than two-station interference. In other systems, it is treated like two-station interference

($s > a$), and the same effects are therefore encountered. However, the two pulse trains have identical repetition rates, so that their degree of overlap depends critically on the time delay between them.

The noise produced by the time-shift and cancellation effects can be avoided by meeting the conditions $s < a$ and $s < 1 - a$. Fig. 3 is helpful in showing that a sufficiently low slicing level means not only avoidance of the cancellation effect but also mixing of the desired and interfering pulse trains. This technique is permissible in single-channel PDM systems modulated with speech or music, since the receiver output then suffers essentially only from one defect which is usually tolerable and frequently unnoticeable: the output consists of the sum (or sometimes half the sum)⁶ of the modulation signal and its delayed replica. Since the time delays encountered in practice are below the resolving time of the ear (rarely more than a few milliseconds at 30 Mc and much less in the microwave band), the result is merely a modification of the audio-frequency characteristic. The original characteristic is multiplied by a function having the shape of a full-wave rectified sinusoid. Perfect nulls occur at all frequencies which are odd integral multiples of half the reciprocal of the time delay, while response maxima are at zero frequency and all frequencies which are integral multiples of the reciprocal of the delay. With a time delay of 10 μ sec, the first null is at 50 kc, and the effect on the audio characteristic is negligible. A time delay of 0.5 msec results in nulls at 1, 3, 5, \dots , kc, and even this is scarcely noticeable for speech or music unless $A-B$ tests are made. Nonlinear distortion occurs under certain conditions of overlap between the two pulse trains, but these conditions are critical and the probability of their occurring is low. Good reception is obtained for interference ratios as high as $a = 0.98$, provided that the background-noise level is sufficiently low to permit the condition $s < 0.02$.

VIII. CONCLUSIONS

The most definite and surprising conclusions appear in the case of single-channel PDM. Interference from a second PDM station causes only random noise, and under most conditions the stronger signal remains intelligible until the interference ratio exceeds 0.95. If the interfering pulses become "taller" than the desired pulses, reception switches very abruptly from the desired to the interfering signal modulation. The required condition $s = a +$ is easily maintained automatically over limited signal-amplitude ranges. As for two-path interference, fairly good reception is usually obtainable, even with nearly equal path attenuations. Experimental simulation of the various interference conditions shows that, so far as receiver design is concerned, the

⁶ Depending on the exact type of duration modulation and the degree of overlap between the two pulse trains, the output may even be unimpaired.

above findings hinge on one important but easily fulfilled requirement: the all-important slicer must remove a slice whose thickness should not exceed a few per cent of the pulse height, and whose level can readily be varied over the entire pulse-amplitude range. Comparing single-channel PDM with conventional wide-band FM, one finds that, while the characteristics of the ideal FM system are quite superior to those of the PDM system, they are so difficult to realize that PDM may well compete with FM in applications permitting relatively large bandwidths (1 Mc).

The interference characteristics of time-division multiplex PDM systems differ from those of simplex PDM systems in two important respects. First, the larger duty factor associated with multiplex systems causes the random interference noise to be more severe, making reception poor or impossible for $a > 0.5$. Second, two-path interference cannot be handled by the technique described in section VII, since cross talk between channels would result; instead, it must be handled in the same way as two-station interference ($s > a$), so that reception is generally acceptable only for $a < 0.5$.

PPM systems differ from PDM systems chiefly in

that they have a smaller duty factor for the same bandwidth. The pulse duration, instead of varying between a minimum and a maximum, is constant at the minimum permitted by the system bandwidth. Apart from the resulting saving in power, the smaller duty factor makes the interference noise less severe. As a result, PPM multichannel systems are distinctly preferable to PDM multichannel systems, the former being capable of intelligible reception even for $a > 0.5$ (though not generally in the case of two-path interference). Single-channel PPM systems, although in some respects potentially superior to single-channel PDM systems, are hardly superior in practice unless one resorts to elaborate demodulation and synchronization schemes. Consequently, in single-channel pulse applications, the use of PDM would seem to be preferable, especially if simplicity is a factor.

ACKNOWLEDGMENT

The author is indebted to J. B. Wiesner for his valuable suggestions, and to the Massachusetts Institute of Technology Research Laboratory of Electronics for its services and facilities.

Echoes in Transmission at 450 Megacycles From Land-to-Car Radio Units*

W. R. YOUNG, JR. †, ASSOCIATE, IRE, AND L. Y. LACY †, SENIOR MEMBER, IRE

Summary—By the use of short pulses of 450-megacycle carrier, the echoes which appear in transmitting from a land station to a moving car in New York City have been investigated. The results show the multiple-path nature of transmission. Sample pictures of the received pulses are given, and, in addition, a statistical analysis of the multiple-path situation is presented. These results are of use in considering the possibilities of systems employing a wide modulation band.

INTRODUCTION

ECHOES MAY CONSTITUTE a serious limitation on the performance of radio transmission systems employing a wide modulation band. As a part of a program to study the possibilities of multi-channel mobile telephone systems occupying a relatively wide band, a test was arranged which would show the echoes encountered in transmission between a land station and a car. The test was conducted at 450 Mc since this general region of the spectrum appears to be a spot

where such a wide band might be assigned. The tests cover the lower part of Manhattan, in New York City.

Radio echoes result when some components of the signal travel by indirect routes involving reflection from buildings and other prominent structures. Because these transmission paths are longer than the direct path, the corresponding components of the signal will be delayed compared to that obtained over the direct path. In addition, the amplitudes of the echoes may be either greater or less than that of the direct signal. Reception may be impaired in certain kinds of systems if the received signal is the sum of several signals which are identical except for differences in attenuation and delay.

The effect of multiple-path transmission may be viewed in several different ways. Thus, for example, if the signal is simply a continuous-wave carrier, the received signal will be the vector sum of the carriers which arrive by way of the direct and echo paths. It will be apparent that the resultant signal may be made large or small and may have its phase varied by the exact manner in which these components combine. For any given echo situation the amplitude and phase characteristics

* Decimal classification: R113.617.7×R113.307. Original manuscript received by the Institute, May 3, 1949; revised manuscript received, December 6, 1949. Presented, 1949 IRE National Convention, New York, N. Y., March 8, 1949.

† Bell Telephone Laboratories, Inc., New York, N. Y.

of the net transmission path may be expected to vary with frequency. This is one manifestation of echoes.

Echoes are perhaps more easily visualized if the signal is a short pulse of rf power. When such a signal is sent out from a land transmitter, several pulses of signal may be received at a car at different instants according to the delay of the several paths. This is illustrated for the case of one echo in Fig. 1. The difference in time of arrival of

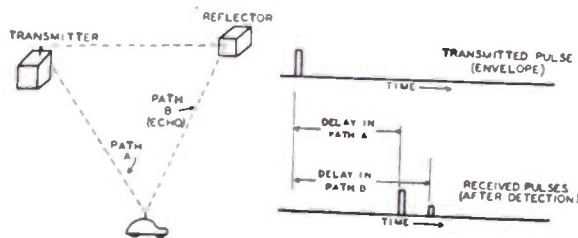

Fig. 1—Illustration of direct and echo transmission.

the two pulses is related to the differences in path distance. For example, if the second pulse arrives 5 microseconds after the first, it would mean that one path is about one mile longer than the other.

METHOD OF TESTING FOR ECHOES

The presence of echoes could have been detected, therefore, by measuring the transmission characteristic over a frequency range, using a continuous carrier, or by inspecting the received signal when the transmitted signal was a pulse of power. The latter method was chosen for the purposes of these tests because it seemed the simpler and because the echo situation is then presented in a form which can be easily visualized.

A 100-watt pulse of rf power $\frac{1}{2}$ -microsecond long was radiated from a transmitter located at the top of the telephone building at 32 Avenue of the Americas. A vertically polarized antenna having 6 db of gain was used. A schematic of the receiving equipment in the test car is shown in Fig. 2. The test car was equipped with an os-

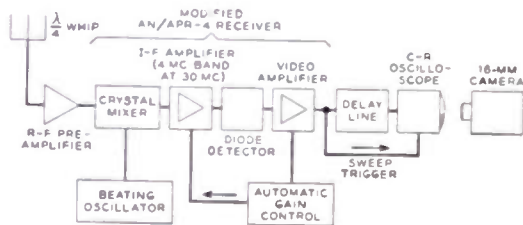

Fig. 2—Test equipment for 450-Mc echo measurements (mobile unit).

cilloscope which presented a picture of the received pulses plotted against time. After the echoes had had time to die away, another pulse was radiated from the transmitter and another train of pulses and echoes was registered on top of the first train on the oscilloscope. The transmitted pulse was repeated every 100 microsec-

onds. To one viewing the oscilloscope, the echo situation thus appeared as a continuous presentation.

The time sweep for the oscilloscope was operated on a start-stop basis, arranged to trigger at the instant that the first of a train of pulses arrived. The triggering pulse was therefore the one which arrived by the direct or at least the most direct path. In order that the sweep would have time to get under way before the start of the vertical deflections corresponding to the pulses, the received signal was passed through a 5-microsecond delay line on its way to the vertical deflection circuit of the oscilloscope while the pulse train was passed directly to the sweep-trigger circuit with no delay. The time sweep covered about 25 microseconds.

A special automatic gain control, operated by the largest pulses being received, depressed receiver gain by the amount required to give these pulses a predetermined constant value. Other pulses, of course, were correspondingly smaller. This action took place even though the largest pulse was an echo rather than a direct pulse.

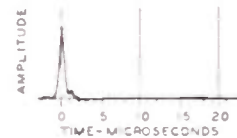

Fig. 3—Sample of pulse transmission without echoes (on Fifth Avenue at 95th Street).

Fig. 3 shows the picture obtained on the oscilloscope when there were no echoes. It thus illustrates the transmission of a pulse through the entire system. Certain small imperfections, which are due to the 5-microsecond delay line, will be noted. These are small enough that they do not affect the results.

PULSE AND ECHO PICTURES

The pattern of received echoes differed from one general location to another. In fact, it changed as the car moved over short distances.¹ A record was obtained of the echo pattern by photographing the oscilloscope with a moving picture camera. In order to obtain a fair sampling of locations, pictures were taken at the points on an imaginary grid of $\frac{1}{2}$ -mile spacing in the area of Manhattan from 39th Street south. Pictures were obtained at certain other locations as well.

Fig. 3 is a tracing of a picture taken on Fifth Avenue at 95th Street. This is typical of Fifth Avenue, except at its southern end. Reference to a map shows that Fifth Avenue points directly at the transmitter location.

The pictures given in Fig. 4 are tracings made from single frames of the motion picture film. They are intended to illustrate the different types of echo patterns which have been observed. As will be noted, they vary

¹ The pattern was also observed to change when the test car was stationary and other vehicles in the vicinity were in motion.

from the simple picture which contains few echoes to those which are filled with echoes in about the first 10 microseconds.

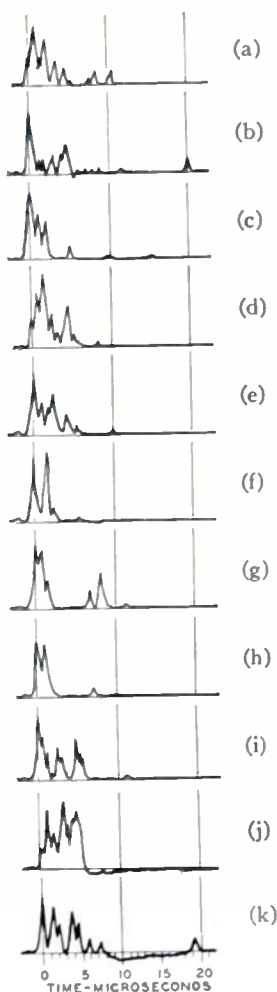

Fig. 4—Sample pulse patterns received at various locations: (a) 30th Street at Avenue of the Americas; (b) First Avenue at 31st Street; (c) 14th Street between Eighth and Ninth Avenues; (d) 14th Street at Union Square; (e) West Side Highway near Horatio Street; (f) Hudson Street at Desbrosses Street; (g) Greenwich Street at Cortlandt Street; (h) Wall Street at Broadway; (i) South Street at Rutgers Street; (j) Monroe and Jefferson Streets; (k) East River Drive at Delancey Street.

As mentioned above, the patterns changed as the car moved at most of the locations tested. For lack of space it is not possible to include enough pictures here to show this factor at all of the locations given in Fig. 4. However, for two locations, Fig. 5(a) and (b) shows a succession of motion picture frames which were taken at the rate of 16 per second. Since the car was moving 10 to 15 miles per hour the successive pictures represent locations which are in the order of one foot apart.

The rapid changing of echo sizes noted in the foregoing pictures and in the original films may be explained as follows. In many cases what appears to be a single echo is actually two or more pulses which arrive at very nearly the same time, say, within $\frac{1}{4}$ microsecond. The resulting pulses on the oscilloscope overlap in time and appear as one pulse. The resultant amplitude then depends upon the relative phases of the individual com-

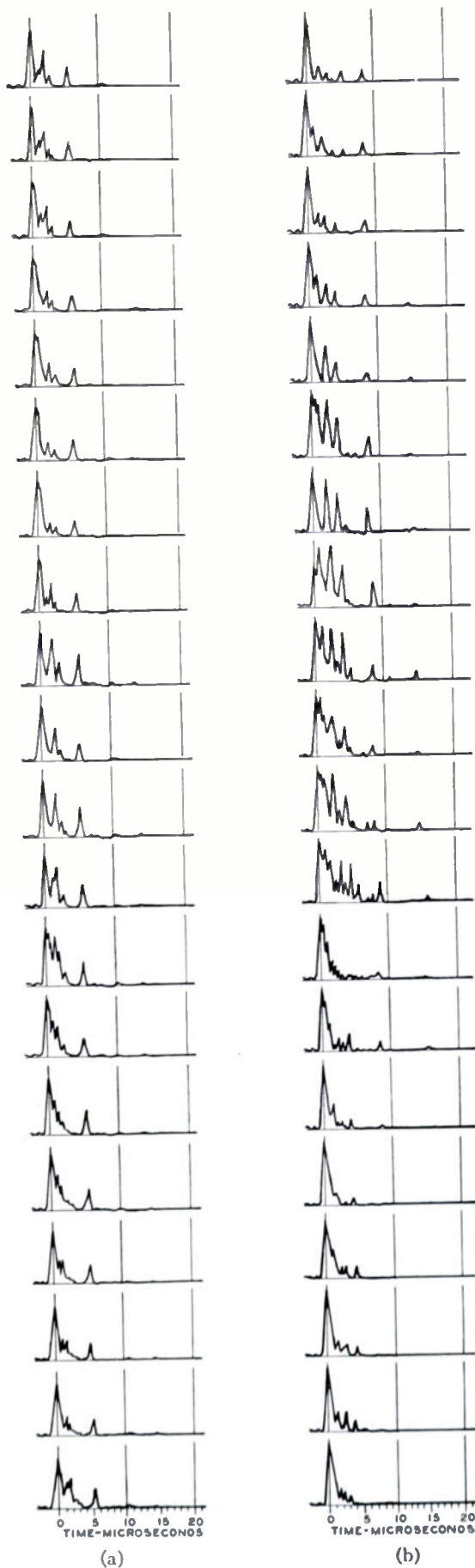

Fig. 5—Sequence of motion picture frames recording pulse patterns: (a) on Fifth Avenue at 10th Street; and (b) on 14th Street at Avenue of the Americas.

ponents. These change as the car moves, with the result that at one moment they aid and at another tend to cancel each other. This variation can complete a cycle in as little as one foot of motion of the car in a particular direction, or further in other directions.

STATISTICAL RESULTS

While the foregoing pictures give a rough over-all view of the echo situation throughout the area covered by the test transmitter, a better quantitative view has been obtained by a statistical analysis. For each location the strongest signal component is taken as the reference, and all other components are related in both loss and delay to this standard. It is desirable to assume the reference path in this way because, in general, the disturbance caused to transmission will be dependent on the relative loss and delay of the minor paths.

In applying these results to the engineering of wide-band systems, it will be useful to have the data in the form of probability that minor paths will appear within specified intervals of relative delay. For this discussion, two classes of minor paths are distinguished. One class comprises those minor paths whose loss is between 0 and 6 db more than the main path, and the second class comprises those whose loss is between 0 and 12 db.

The statistical analysis is shown in two different forms in Figs. 6 and 7. These data were derived from the moving picture film by analyzing five frames at random for each of 40 test locations. Thus, a total of 200 frames were analyzed. In order that the data would be as random and representative as possible, the test locations included in this analysis were at the points of an imaginary one-half mile grid.

Fig. 6 shows how the minor paths are distributed in various time delay intervals for the two classes of path loss. It shows, for example, that in the delay interval from 4 to 5 microseconds, there is a probability of 18.5 per cent that a minor path will exist whose transmission is within 12 db of the major path. On the other hand, there is a probability of 5 per cent that minor paths within 6 db of the reference path will be present.

The ordinates shown for negative values of time represent those cases where paths exist for which the

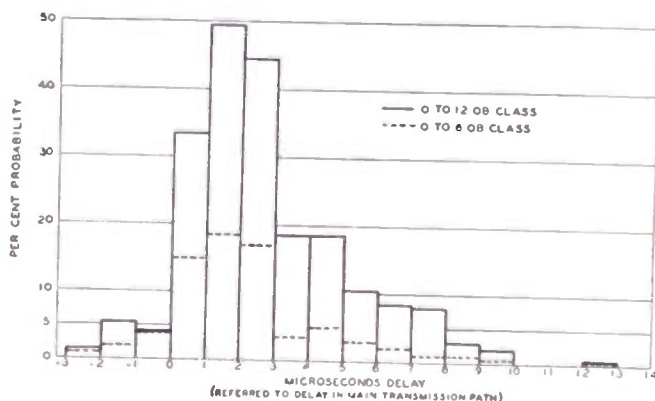

Fig. 6—Probability of minor paths occurring within specified delay intervals.

delays are less than that of the reference path. This is because the reference is taken as the one with the least attenuation, which is not always the one with the least delay.

Fig. 7 is derived from the same data as Fig. 6, replotted in cumulative fashion. It shows the average number of minor paths which appear at relative delays greater than any specified value. One pair of curves applies to paths having positive delay (greater than reference) for the two size classes. Another pair is for negative paths (delay less than reference), and this includes the direct path occasionally. A third pair is the sum of the first two, thus treating positive and negative delay without distinction.

The meaning of these curves is best illustrated by showing how a typical point was computed. For example, one curve shows that the average number of paths in the 0-to-12 db class which occur with positive delays of 6 microseconds and longer is 0.22. This figure results because 44 such paths were found in the total of 200 sample moving picture frames.

It is expected that the foregoing pictures and statistical data will furnish at least a rough basis for determining the maximum bandwidth or shortest time intervals that may be satisfactorily used in certain kinds of multichannel communication systems. While it will also be of some interest to those concerned with television transmission, it is not expected to be of much real value in this connection because the transmission paths tested in this investigation were all from a stationary land transmitter to a moving car. The situation might be considerably different as between two fixed antennas, both elevated above the street.

ACKNOWLEDGMENT

The authors wish to acknowledge the help rendered by A. J. Aikens, who performed the tests in the car with the assistance of J. M. MacMaster. The authors are also indebted to D. Mitchell and others of the Bell Telephone Laboratories who have participated in laying out the tests and have given valuable comments during preparation of this paper.

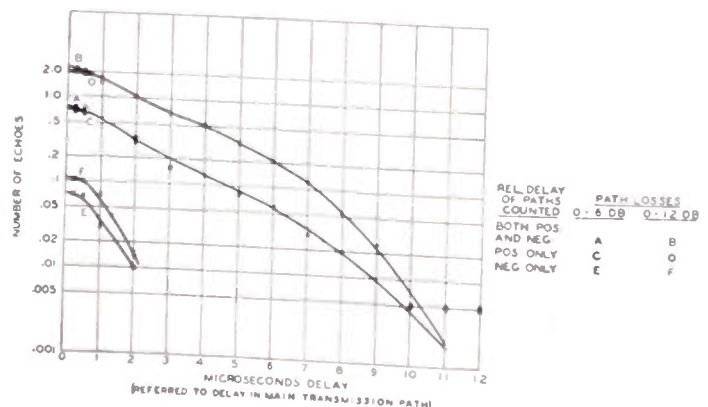

Fig. 7—Average number of minor paths per location with greater than a specified delay.

A General Review of Linear Varying Parameter and Nonlinear Circuit Analysis*

W. R. BENNETT†, SENIOR MEMBER, IRE

Summary—Variable and nonlinear systems are classified from the standpoint of their significance in communication problems. Methods of solution are reviewed and appropriate references are cited. The paper is a synopsis of a talk given at the Symposium on Network Theory of the 1949 National IRE Convention.

INTRODUCTION

THE SUBJECTS of linear variable and truly nonlinear systems have been linked together as the subject of this paper. It is proper from the viewpoint of the communication engineer that this should be so, although a mathematician would rate them as of quite different species. The linear variable systems, in which parameters are functions of independent variables only—in our case almost always one independent variable, the time—are really much simpler than the nonlinear ones, in which parameters change with the dependent variables—in our case with current, voltage, charge, flux, and the like. The linear variable case has the advantage of a considerable amount of elegant applicable theory. As in the more familiar systems with constant coefficients, the principle of superposition holds and the various resolutions such as Fourier's, which express responses to complicated waves as sums of responses to simple components can be used. We also have highly developed specialized theories¹⁻³ such as that of Mathieu's and Hill's equations, the Floquet theory of differential equations with periodic coefficients, the corresponding theory of Bloch when more than one independent variable appears, the Sturm-Liouville theory for expansion in series of orthogonal functions, and many other complete doctrines.

In the nonlinear case, the conditions required for the linear theories disintegrate and use of the results is clouded by suspicion, even in cases where there is a germ of validity. We can not superpose solutions without getting cross products or coupling terms which do not satisfy the equation. The singularities, or values of the variables at which peculiar behavior occurs, are not predictable from the equation directly but become functions of the constants of integration and hence of starting conditions.

* Decimal classification: R140XR355.91. Original manuscript received by the Institute, August 26, 1949; revised manuscript received, December 13, 1949. Presented, 1949 IRE National Convention, New York, N. Y., March 7, 1949.

† Bell Telephone Laboratories, Inc., Murray Hill, N. J.
¹ E. T. Whittaker and G. N. Watson, "Modern Analysis," Cambridge Press, 4th ed.; 1940.

² L. Brillouin, "A practical method for solving Hill's equation," *Quart. Appl. Math.*, vol. 6, pp. 167-178; 1948. Also "Wave Propagation in Periodic Structures," McGraw-Hill Book Co., New York, N. Y., 1946.

³ E. L. Ince, "Ordinary Differential Equations," Dover Publications, New York, N. Y.; 1944.

But as far as behavior of the systems as parts of communication circuits is concerned, the two types have much in common. They are both generators of new frequencies. In the nonlinear case, it is clear from trigonometry that if we square or cube a current containing sinusoidal components, we obtain new frequencies which are harmonics and cross products of the original frequencies. Likewise, in the variable linear case, a coefficient changing sinusoidally and multiplying a sinusoidal current produces sums and differences of the two frequencies involved. Both types of systems therefore have a common useful property for the communication engineer—that of producing two or more new frequencies for every one that grew before. This is one thing that the linear system with constant parameters will not do for us, and it is an indispensable operation for communication, even though it does complicate analysis.

We shall divide the subject into four headings with respect to functions performed in communication. The first is the oscillator, or generator of independent frequencies. We apply a battery, which is a source of frequency zero cycles per second, and obtain in the output a frequency f cycles per second, with the value of f an intrinsic property of the oscillating system. This is essentially a nonconstant parameter problem. It is true that linear constant-parameter theory may enable us to predict transient oscillations which grow in amplitude indefinitely as time progresses, but this is not a satisfactory description of steady-state oscillations. We know that physical apparatus can not deliver indefinitely large amplitudes, and hence for a useful result some property of the system must limit the size. This property is either a departure from linearity or a change in parameters, and it is only from a study of the way in which the system departs from linearity or changes its parameters that we can predict the final amplitude of the oscillation, its frequency, and wave form.

The second grouping is headed modulator. This device is a frequency shifter. Its general function is to translate the spectrum of a signal from one part of the frequency scale to another. It should do this in a linear manner; that is, the shifted band should consist of components with amplitudes linearly related to the amplitudes of the corresponding components of the original signal band. This may be accomplished in either a nonlinear or variable system, provided that the interaction between the signal components and the frequency shifting function, which we call the carrier wave, is expressible by first-order terms. The system may be highly nonlinear to the carrier wave and produce strong harmonics.

This does not matter if the signal acts as a relatively small perturbation on the response to carrier alone to give first order sidebands on the carrier or its harmonics with terms proportional to the second- and higher-powers of the signal either negligible or outside the frequency band of the output circuit. The linear non-variable relationship between sideband and signal amplitudes enables much of the conventional constant-parameter network theory to be taken over bodily to the modulator problem.

The third item is headed distortion. Here we deal with the imperfections in a communication system which cause the final received signal to be different from the one originally transmitted. We ordinarily think of distortion as a small departure subject to calculation by the usual methods of expansion in power series or successive approximation, but in some practical cases the distortion is too large for such methods. Communication systems exist in which the information is badly mutilated but still useful.

The fourth entry includes devices which have become of increasing importance in recent years as the radio engineer has expanded his field of operation. We shall use the heading control mechanisms. Many of the problems thus labeled have come out of military applications such as gun directors and guided missiles. Older examples include signal range compressors and expanders, variable equalizers, automatic volume control, automatic-frequency control, and gain regulation. One could also include here the various electronic switching circuits, which are also closely allied with modulators and oscillators.

1. Oscillators

Our starting point on this topic is the work of Poincaré⁴ on the curves defined by differential equations. Here is a thorough discussion of the properties of the solution of the general first order differential equation:

$$F(x, y, dy/dx) = 0. \quad (1)$$

If our equation can be expressed in this form, Poincaré's work leaves little more to be asked; the various singular points are classified and, in particular, the limiting cycles which show the existence and nature of steady-state oscillations are explained.

We point out that the approach of Poincaré abandons as impractical an attempt to solve nonlinear differential equations in terms of standard functions with tabulated values. The point of view is that the differential equation itself gives the necessary information and means for abstracting this information can be developed. We can see how this might be so, for instance, if we can write the equation in the form

$$dy/dx = G(x, y), \quad (2)$$

for this would enable us to calculate the slope at every point of the plane. If these slopes are plotted as small arrows of the proper inclination at a sufficient number of points we can draw smooth curves through them which have the right slopes and hence represent possible solutions. Such graphical constructions are not a necessary adjunct to the reasoning required in determining properties of solutions, but are a help in visualizing relations.

Unfortunately our oscillatory circuits are likely to give us at least second-order differential equations rather than first. Now if we replace (1) by

$$F(x, y, dy/dx, d^2y/dx^2) = 0 \quad (3)$$

the Poincaré method becomes more complicated. One approach is to introduce a new variable z for dy/dx . Then (3) can be replaced by two first-order equations,

$$\begin{cases} F(x, y, z, dz/dx) = 0 \\ z - dy/dx = 0 \end{cases} \quad (4)$$

These can be treated in three-dimensional space in a manner analogous to the first-order treatment in two-dimensional space. Poincaré, in fact, does treat the case of two simultaneous first-order equations and the corresponding properties of the three-dimensional curves so defined, but of course the results are more difficult to visualize and we would prefer a two-dimensional formulation. For this reason it is natural that much work based on Poincaré's method has sought to reduce by hook or crook to a first-order equation. It should not be essential that such a reduction should be made, and perhaps developments in topology may show us, or may already have shown us, how to deal with any order, but these matters seem at present to be rather obscure.

One case where there is an easy reduction of a second-order equation to first is that in which the time does not appear explicitly in the equation of the oscillating system. If our equation is of form:

$$F(I, dI/dt, d^2I/dt^2) = 0, \quad (5)$$

where I is the current and t is the time, then, as one learns early in the study of differential equations, we can set dI/dt equal to a new variable z , whereupon

$$\frac{d^2I}{dt^2} = \frac{dz}{dt} = \frac{dz}{dI} \frac{dI}{dt} = z \frac{dz}{dI} \quad (6)$$

Our equation then becomes

$$F(I, z, zdz/dI) = 0, \quad (7)$$

which is of the general first-order type. This reduction is possible for the second-order oscillating circuit when a battery is the only applied electromotive force. It does not work in the so-called entrainment problem in which an oscillator is pulled into synchronism with an externally applied wave. Here t appears explicitly in the specification of the applied driving function and exact reduction is no longer possible. Even without an externally applied wave varying with time, we may find

⁴ H. Poincaré, "Oeuvres," tome 1, Gauthier-Villars et Cie, Paris, France, 1928; pp. 1-222.

exact reduction to first order impossible because the complete oscillating system includes derivatives of higher order than the second.

Reduction to first order in many such cases is however accomplished in effect by finding a good approximation. For example, the linear part of the equation may give a good clue to the frequency of the oscillation. If we then assume, as did Appleton and van der Pol⁶⁻⁷, a solution in the form

$$a(t) \cos \omega_0 t + b(t) \sin \omega_0 t,$$

or if we prefer

$$A(t) \cos [\omega_0 t + \phi(t)],$$

where ω_0 is the frequency given by the linear theory, we can resolve the equation into two simultaneous ones in $a(t)$, $b(t)$ or in $A(t)$, $\phi(t)$. Then if these functions vary slowly with time, higher derivatives of them may be neglected, and it may be possible to get a single first-order equation relating a and b or A and ϕ . Poincaré's theory is then applicable. The general principle is that approximate methods are easiest to handle when we make a good guess on the first try. The difficulty is often one of proving just how good our approximation is. We do not need to say much more about these principles as they have been well covered in the literature.⁸⁻¹⁹

2. The Modulator

Considering now the modulator problem, we suppose that a large carrier wave swings the nonlinear elements through most of their operating range. The problem of how the system responds to the carrier itself may be dis-

posed of in various ways; for example, by assuming that we swing between simple limiting conditions with the transition regions having negligible importance. The main feature is that a small superposed signal sees a linear system with varying parameters determined by the carrier wave. For example, a varistor does not follow Ohm's Law but at each instance of the carrier cycle there is a definite value of dE/dI applicable to a small superposed signal, which accordingly encounters a linear resistance varying periodically with time. Solutions for the signal and its sidebands may therefore be carried out by the theory of linear differential equations with periodic coefficients. If we use Fourier series to represent the periodic coefficients, we are led to an infinite system of linear equations in which the different signal and sideband frequencies play the role of mesh currents in constant parameter systems. The work is likely to be unbearably burdensome, however, unless we can make further simplifications.

One simplifying artifice which has been found useful is that of terminating nonlinear elements in an idealized impedance which is a pure resistance in the signal or sideband range, and either zero or infinite at all other frequencies. This reduces the number of meshes in the equivalent constant parameter circuit because current components flowing through a short circuit produce no voltage drops, and likewise voltage components impressed across an open circuit produce no currents. An example of this method of attack is the paper by Peterson and Hussey.²⁰⁻²² The reduction to an ordinary network representation makes available a highly developed art, including impedance matching, conditions for stability, and the various other powerful auxiliary theorems and concepts employed in network design.

New light may be thrown on otherwise obscure properties. For example, the sideband power delivered may exceed the signal power; the magnetic amplifier is based on this principle. Or we may find that the impedance facing a particular sideband has a negative resistance component. In ordinary network theory this implies the possibility of self-excited oscillations, and in modulation theory it means that a sideband frequency could be present even when no signal is applied. This gives a clue to a set of phenomena related to oscillator theory sometimes described under the heading of subharmonic production, frequency demultiplication, or quasi-free oscillations. As in the theory of the more familiar battery-driven oscillator, the negative resistance behavior merely indicates the existence of free oscillations, and not their final magnitude. We must depart from the small signal case toward the region where the simplified assumptions break down in order to get a complete solu-

⁶ B. van der Pol, "On relaxation oscillations," *Phil. Mag.*, vol. 2, series 7, pp. 978-992; 1926.

⁷ E. V. Appleton and B. van der Pol, "On a type of oscillation-hysteresis in a simple triode generator," *Phil. Mag.*, series 6, vol. 43, pp. 177-193; 1922.

⁸ W. M. H. Greaves, "On the stability of the periodic states of the triode oscillator," *Cambridge Phil. Soc. Proc.*, vol. 22, pp. 16-23; 1924.

⁹ J. W. S. Rayleigh, "Theory of Sound," Second Edition, Macmillan, London, England, vol. 1, pp. 76-85; 1894.

¹⁰ H. Bateman, "Partial Differential Equations of Mathematical Physics," Dover Publications, New York, N. Y., chap. 12; 1944.

¹¹ H. Jeffreys, "Approximate solutions of linear differential equations of second order," *Proc. London Math. Soc.*, vol. 23, p. 428; 1924.

¹² P. LeCorbeiller, "The nonlinear theory of the maintenance of oscillations," *Jour. IEE (London)*, vol. 79, pp. 361-378; September, 1936.

¹³ N. W. McLachlan, "Theory and Applications of Mathieu Functions," Oxford Univ. Press, New York, N. Y.; 1947.

¹⁴ M. L. Cartwright, "Nonlinear vibrations," *Science*, vol. 21, pp. 64-75; April, 1949.

¹⁵ S. A. Schelkunoff, "Solution of linear and slightly nonlinear differential equations," *Quart. Appl. Math.*, vol. 3, pp. 348-355; 1946.

¹⁶ N. Kryloff and N. Bogoliuboff, "Introduction to Nonlinear Mechanics," English translation by S. Lefshetz, Princeton Univ. Press, Princeton, N. J.; 1943.

¹⁷ A. Andronow and S. Chaikin, "Theory of Oscillations," Princeton Univ. Press, Princeton, N. J.; 1949.

¹⁸ N. Minorsky, "Introduction to Nonlinear Mechanics," J. W. Edwards, Ann Arbor, Mich.; 1947.

¹⁹ K. O. Friedrichs, P. LeCorbeiller, N. Levinson, and J. Stoker, "Nonlinear Mechanics," Brown University, Winter Semester, 1942-1943.

²⁰ M. A. Liapounoff, "Probleme General de la Stabilité du Movement," Princeton Univ. Press, Princeton, N. J.; 1947.

²¹ E. Peterson and L. W. Hussey, "Equivalent modulator circuits," *Bell Sys. Tech. Jour.*, vol. 18, pp. 32-48; January, 1939.

²² Sigurd Kruse, "Theory of Rectifier Modulators," Thesis for Doctorate, K. Tekniska Hogskolan, May 26, 1939.

²³ L. C. Peterson and F. B. Llewellyn, "The performance and measurement of mixers in terms of linear-network theory," *Proc. I.R.E.*, vol. 33, pp. 458-475; July, 1945.

tion. An instructive example of these principles is furnished by Miller's frequency divider,²³ which consists of a modulator followed by an amplifier with positive feedback to the modulator input. In nonlinear magnetic circuits a similar regenerative modulation process may occur within the iron. The effects may be self-starting in some cases, while in others they may require some sort of initial impact, or they may appear only above certain definite threshold levels of input. The frequencies generated need not be related to the applied frequency by ratios of integers, but may be combination tones of the applied frequency with resonant frequencies of the system. A comprehensive treatment of these effects has been given by Peterson and Manley.²⁴

Similar phenomena are associated with nonlinear capacitors, and with nonlinear electromechanical systems.^{25,26} A resemblance of some of the results to effects observed in spectroscopy led Hartley in 1928 to propose a molecular model based on a nonlinear circuit analogy to explain the Raman Effect—a scattering of infrared radiation accompanied by a change in wavelength, with the amount of wavelength change a function of the molecular properties of the scattering substance. The theoretical physicists were remarkably non-enthusiastic. Why should they change to a difficult nonlinear model when they could linearize their problem by seeking a probability density function instead of coordinate values? Maybe we could learn something from them. It seems that we know too much about our electrical circuits; we know that they are nonlinear and so far, while solutions of the nonlinear problem may be hard to get, they do not fail to agree with experiment when found.

3. Distortion

The distortion problem²⁷ from the communication point of view is usually expressed in terms of what happens to sinusoidal signals impressed on nonlinear or variable systems. When one sine wave is applied we ask about the relative size of the harmonics which appear, and when more than one sine wave is applied, the sizes of the combination tones are important. Harmonic data may not be enough, for in some cases the harmonics fall outside the signal band. In such cases no extraneous components appear until two tones are applied. Since distortion is usually of interest when we try to meet moderately severe fidelity requirements, the case in

which the distortion terms are relatively small is the most common. Power series expansions based on MacLaurin's and Taylor's theorems have therefore occupied a dominant role. There was a time when we leaned on Taylor's series as a sort of universal property of physical systems. Our household words amplification factor, transconductance, and plate resistance stem from the Taylor's series concept of evaluating partial derivatives at an operating point. We are likely to think of the existence of these derivatives as obvious from the engineering axiom that physical data always yield smooth curves.

Taylor's series was actually extended to cases where the smoothness was not so evident. For example, E. Peterson²⁸ used a Taylor's series in two variables to evaluate harmonic production caused by hysteresis, a multiple valued response function. Here the response to sine waves could be represented by a family of hysteresis loops with the choice of loop depending on the peak of the sine wave, and Peterson matched these conditions with a double power series in instantaneous and peak signals. The individual loops themselves were not very smooth looking, but their form varied smoothly with peak signal.

When it came to such things as an ideal rectifying characteristic in which the slope is discontinuous at one point, mathematicians gagged at any mention of Taylor's series. It was unnecessary to bring in the idea of derivatives, we were told, because Weierstrass proved an all-important theorem²⁹ on the possibility of approximating continuous functions over a finite interval to within any assigned degree of error by polynomials. In the practical case polynomials are what we use, and we do not have to evaluate all the higher derivatives or write down infinite power series.

Freeing ourselves from the bounds imposed by differentiable functions is a step forward; it reminds us that it might be profitable to use other representations than power series. Peterson and Keith³⁰ used a Fourier series to represent a rectifying characteristic in 1928. The actual characteristic, of course, did not repeat itself periodically along the voltage axis, but the repetition period was made larger than any voltage applied. It then did not make any difference what mathematical function was used outside the operating range. It is a short step from series representations to various integral representations, and much sophisticated calculating machinery can thereby be brought to bear on distortion problems.

In nonlinear theory one early resigns himself to limited generality. If we can get a good solution for a single-frequency input, it does not follow that we can solve a

²³ R. L. Miller, "Fractional-frequency generators utilizing regenerative modulation," *PROC. I.R.E.*, vol. 27, pp. 446-457; July, 1939.

²⁴ E. Peterson and J. M. Manley, "Negative resistance effects in saturable reactor circuits," *Trans. AIEE*, vol. 65, pp. 870-881; 1946.

²⁵ R. V. L. Hartley, "Oscillations in systems with nonlinear reactance," *Bell Sys. Tech. Jour.*, vol. 15, pp. 424-440; July, 1936.

²⁶ L. W. Hussey and L. R. Wrathall, "Oscillations in an electromechanical system," *Bell Sys. Tech. Jour.*, vol. 15, pp. 441-445; July, 1936.

²⁷ So-called linear distortion which results only in change of amplitude and phase shift of single-frequency terms, and which is subject to correction by constant parameter networks, is not the type of interest to us here.

²⁸ E. Peterson, "Harmonic production in ferromagnetic materials at low frequencies and low flux densities," *Bell Sys. Tech. Jour.*, vol. 7, pp. 762-796; October, 1929.

²⁹ E. Goursat, "Mathematical Analysis," English translation by E. R. Hedrick, vol. 1, p. 422; Ginn and Co., Cambridge, Mass., 1904.

³⁰ E. Peterson and C. R. Keith, "Grid current modulation," *Bell Sys. Tech. Jour.*, vol. 7, pp. 106-139; January, 1928.

two-frequency case for the same system with the same methods, and of course three or more frequencies in the input confront us with increasingly more woe. One principle of value is to generalize the problem by studying the properties of periodic functions of several independent variable x, y, z, \dots with a view toward applying any results obtained to the special case in which $x=pt+\theta, y=qt+\phi, z=rt+\psi, \dots$.³¹⁻³³ Single- and two-frequency inputs were sufficient for the early needs of communication engineers, but with the advent of multi-channel carrier, larger numbers of input components had to be considered. It was eventually realized that the case of many applied frequencies approached that of a random noise input. This equivalence had a two-fold significance. Random noise could be used as a test signal for multichannel carrier systems, and multifrequency modulation calculations could be applied to noise problems. Passage to the limit of an infinite number of components actually resulted in a simplification compared to the case of several components. New mathematical methods, some of them borrowed from the field of statistics, were put to work.³⁴⁻⁴⁰

4. Control Mechanisms

We shall not say very much about the last topic, not because it is unimportant, but because of shortages in

space and knowledge. There are chapters on nonlinear and variable cases in MacColl's book⁴¹ on servomechanisms, and there are some scattered references in the periodicals. There has been effective use of the analog computer for solution of problems in this field. Here we take advantage of the fact that the circuit itself knows what to do, so that if we build a scale model we too can get the right answers. A change in time scale is particularly valuable because it enables us to predict a result without waiting for the original system to act.

CONCLUSION

We close on a note of optimism and express a hope that not only the analog, but the digital type of computer as well, may be of increasingly more help as we learn to work with them. Perhaps the knowledge that a quick, accurate, and nontiring mechanism is available to perform calculations will change our point of view. If all we need to do is to formulate the laws governing the physical system and then let the machine answer all further questions, we should extend the scope of our knowledge rapidly. However, the analyst must remain the master and make sure he is studying the properties of the nonlinear circuit, rather than those of the computing machine.

- ³¹ W. R. Bennett, "New results in the calculation of modulation products," *Bell Sys. Tech. Jour.*, vol. 12, pp. 228-243; April, 1933.
³² W. R. Bennett, "Response of a linear rectifier to signal and noise," *Jour. Acous. Soc. Amer.*, vol. 15, pp. 164-172; January, 1944.
³³ W. R. Bennett, "The biased ideal rectifier," *Bell Sys. Tech. Jour.*, vol. 26, pp. 139-169; January, 1947.
³⁴ N. Wiener, "Generalized harmonic analysis," *Acta Math.*, vol. 55, pp. 117-258; 1930. Also "The harmonic analysis of irregular motion," *Jour. Math. and Phys.*, vol. 5, pp. 99-189; 1926.
³⁵ G. I. Taylor, "Diffusion by continuous movements," *Proc. London Math. Soc.*, series 2, vol. 20, pp. 196-212, 1920.
³⁶ S. O. Rice, "Mathematical analysis of random noise," *Bell Sys. Tech. Jour.*, vol. 23, pp. 282-332; July, 1944; vol. 24, pp. 46-156; January, 1945.

³⁷ David Middleton, "Rectification of a sinusoidally modulated carrier in the presence of noise," *Proc. I.R.E.*, vol. 36, pp. 1467-1477; December, 1948.

³⁸ M. Kac, "On the notion of recurrence in discrete stochastic processes," *Bull. Amer. Math. Soc.*, vol. 10, pp. 1002-1010; October, 1947.

³⁹ J. H. Van Vleck and David Middleton, "A theoretical comparison of the visual, aural, and meter reception of pulsed signals in the presence of noise," *Jour. Appl. Phys.*, vol. 17, pp. 940-971; November, 1946.

⁴⁰ W. R. Bennett, "Spectra of quantized signals," *Bell Sys. Tech. Jour.*, vol. 27, pp. 446-473; July, 1948.

⁴¹ L. A. MacColl, "Fundamental Theory of Servomechanisms," D. Van Nostrand Co., Inc., New York, N. Y.; 1945.

The Synthesis of Resistor-Capacitor Networks*

J. L. BOWER†, SENIOR MEMBER, IRE, AND PHILIP F. ORDUNG†, SENIOR MEMBER, IRE

Summary—This paper develops a general method of synthesis of a prescribed ratio of output-to-input voltage in the form of a resistor-capacitor lattice.

The method is described for both the cases where the output terminals are unloaded and where a resistor-capacitor load is specified. The methods of transformation of the lattice to unbalanced structure are outlined. Illustrative examples are given for each of the cases discussed in the paper.

THE IMPORTANCE of the resistor-capacitor network in low-frequency work is well established. This paper offers a method of synthesis through use of the lattice structure. Although other methods may yield simpler results in specific cases, the lattice provides an approach which is usable in every realizable case.

I. OUTPUT-TO-INPUT VOLTAGE RATIO REALIZED AS AN UNLOADED LATTICE

A symmetrical lattice used as a two-terminal-pair network that couples a voltage source to a load is shown

* Decimal classification: R143. Original manuscript received by the Institute, March 28, 1949; revised manuscript received November 23, 1949. Presented, 1949 IRE National Convention, New York, N. Y., March 8, 1949.

† Yale University, New Haven, Conn.

in Fig. 1(a).^{1,2} The voltage source and the load can each be made symmetrical to a ground plane by replacing each with its respective equivalent consisting of two series-connected generators and loads as shown in Fig. 1(b). Since points *a* and *b* are at the same potential,

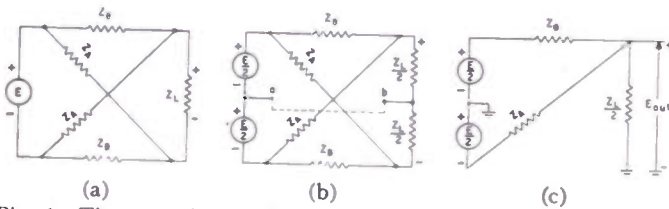

Fig. 1—The steps in the degeneration of the symmetrical lattice.

they can be interconnected as shown by the dotted line in Fig. 1(b). Then the structure can be decomposed into the form shown in Fig. 1(c). The degenerate form is simple to synthesize; particularly so if the load impedance is sufficiently great in comparison to the network impedances that it may be neglected. Providing the load is negligible, the output voltage from the network in Fig. 1 may be expressed as

$$E_{out} = \frac{E}{2} \left(\frac{Z_A}{Z_A + Z_B} - \frac{Z_B}{Z_A + Z_B} \right) \quad (1)$$

Since Z_A and Z_B are driving-point impedances constructed with resistors and capacitors, $Z_A + Z_B$ is also such a driving-point impedance.

Suppose that the output-to-input voltage ratio or "transfer ratio" to be realized is

$$A = \frac{E_{out}}{E} = \frac{f(p)}{F(p)} = \frac{a_0 + a_1 p + \dots + a_r p^r}{b_0 + b_1 p + \dots + b_s p^s}, \quad s \geq r. \quad (2)$$

To be realizable as a network of the form of Fig. 1, the denominator in (2) must be identifiable as one of the polynomials that defines the driving point impedance $Z_A + Z_B$. That is, the denominator of (2) must have roots which are real, simple, and negative.³ Since the output voltage for a given input voltage cannot increase indefinitely as a function of frequency, the greatest power of p in the denominator must be equal to or greater than the greatest power of p in the numerator. Furthermore, $b_0 \neq 0$, in order to limit the gain at zero

¹ R. B. Blackman, H. W. Bode, and C. E. Shannon, "Monograph on Data Smoothing and Prediction in Fire Control Systems," Nat. Military Est. Research and Development Board, February, 1946. Chap. 6 pertains to the design of R - C networks. The method described in the monograph does not allow the liberty in choice of roots of $F_1(p)$ that is permitted in the above method. It does, however, always give a maximum-gain network.

² E. A. Guillemin, "R-C coupling networks," MIT Rad. Lab. Report No. 43. Guillemin has offered an alternative method based on the synthesis of a transfer impedance and conversion of the resulting network into one that obtains the desired transfer ratio by the application of the Thevenin's theorem. However, it does not show how to adjust the design for maximum gain.

³ The general form of an R - C driving point impedance function is

$$Z(p) = K \frac{(p + \lambda_1)(p + \lambda_2) \dots (p + \lambda_m)}{(p + \rho_1)(p + \rho_2) \dots (p + \rho_n)}$$

with $0 \leq \rho_1 < \lambda_1 < \rho_2 < \lambda_2 < \dots < \lambda_m < \rho_n$, where $n = m$ or, $n = m + 1$. See E. A. Guillemin, "Communication Networks," vol. 2, John Wiley and Sons, Inc., New York, N. Y., pp. 211-217; 1935.

frequency. The transfer ratio function (2), therefore can be expressed in factored form

$$A = \frac{h(p + \alpha_1)(p + \alpha_2) \dots (p + \alpha_r)}{(p + \beta_1)(p + \beta_2) \dots (p + \beta_s)} \quad (3)$$

in which the α 's need only be paired complex conjugates or reals. The β 's are real, simple, negative, and non-zero. The constant h is directly proportional to the maximum value of the transfer ratio, or "gain" as it will be called subsequently.

To realize $Z_A + Z_B$, a polynomial $F_1(p)$,

$$F_1(p) = (p + \gamma_1)(p + \gamma_2) \dots (p + \gamma_t) \quad (4)$$

$$t = s \quad \text{or} \quad t = s + 1$$

is selected such that

$$0 < \gamma_1 < \beta_1 < \gamma_2 < \beta_2 < \dots, \quad (5)$$

in accordance with the form of R - C impedances. The choice of $s + 1$ as the number of roots of $F_1(p)$ introduces one more capacitor in each of the impedances than does the choice of s . How to choose the γ roots within the intervals defined by (5) in order to secure the maximum gain of the R - C network is discussed in a later paragraph. Divide the numerator and the denominator of (2) by $F_1(p)$ as follows:

$$A = \frac{\frac{f(p)}{F_1(p)}}{\frac{F(p)}{F_1(p)}} \quad (6)$$

The denominator $F(p)/F_1(p)$, since it satisfies all requirements for realization as a driving-point impedance constructed with resistors and capacitors,³ can be identified as $Z_A + Z_B$. Therefore, the numerator of (6) may be identified as $Z_A - Z_B$.

To effect the separation of Z_A and Z_B , expand the numerator as well as the denominator by partial fractions. This gives

$$\frac{f(p)}{F_1(p)} = Z_A - Z_B = h \left[\frac{k_1^{(n)}}{p + \gamma_1} + \frac{k_2^{(n)}}{p + \gamma_2} + \dots + \frac{k_t^{(n)}}{p + \gamma_t} + k_0^{(n)} \right]$$

$$\frac{F(p)}{F_1(p)} = Z_A + Z_B = \frac{k_1^{(d)}}{p + \gamma_1} + \frac{k_2^{(d)}}{p + \gamma_2} + \dots + \frac{k_t^{(d)}}{p + \gamma_t} + k_0^{(d)} \quad (7)$$

in which the superscript (n) denotes the numerator of (6), and in which the superscript (d) denotes the denominator of (6). The gain parameter h , which is defined in (3) is regarded for the partial fraction expansion and for the subsequent discussion as part of the polynomial $f(p)$. The residues of the partial fraction expansion of the denominator of (6) must all be positive, whereas the residues of the partial fraction expansion of the

numerator may be positive or negative. If $(Z_A - Z_B)$ and $(Z_A + Z_B)$ in (7) are also expanded by partial fractions, the residues of like terms on each side of an equation may be equated as follows

$$\begin{aligned} k_\nu^{(A)} - k_\nu^{(B)} &= h k_\nu^{(n)} \\ k_\nu^{(A)} + k_\nu^{(B)} &= k_\nu^{(d)} \quad \nu = 1, 2, 3, \dots, l. \end{aligned} \quad (8)$$

The subscript denotes the particular fraction of (7) to which the residue belongs, and superscript indicates the impedance function (Z_A or Z_B) from which the residue was obtained. The residues on the right hand side of (8) are known quantities. The residues on the left hand side are to be evaluated by solution of the simultaneous equations. Once obtained, the residues $k_\nu^{(A)}$ and $k_\nu^{(B)}$ may be used to define

$$\begin{aligned} Z_A &= \frac{k_1^{(A)}}{p + \gamma_1} + \frac{k_2^{(A)}}{p + \gamma_2} + \dots + \frac{k_\nu^{(A)}}{p + \gamma_\nu} + \dots \\ &\quad + \frac{k_t^{(A)}}{p + \gamma_t} + k_0^{(A)} \\ Z_B &= \frac{k_1^{(B)}}{p + \gamma_1} + \frac{k_2^{(B)}}{p + \gamma_2} + \dots + \frac{k_\nu^{(B)}}{p + \gamma_\nu} + \dots \\ &\quad + \frac{k_t^{(B)}}{p + \gamma_t} + k_0^{(B)}. \end{aligned} \quad (9)$$

However, the constants $k_\nu^{(A)}$ and $k_\nu^{(B)}$ must necessarily be positive, real numbers in order to be residues of $R-C$ driving-point impedance functions. To insure satisfaction of this requirement on the residues, in the solution of (8),⁴

$$-1 \leq \frac{h k_\nu^{(n)}}{k_\nu^{(d)}} \leq 1. \quad (10)$$

The gain parameter h , which first appeared in connection with (3), must be chosen sufficiently small that all l residues satisfy (10). This can always be done. For maximum gain, on the other hand, h should be chosen as large as possible. However, the maximum gain must depend upon the choice of the roots of $F_1(p)$ within the intervals defined by (4), because $|k_\nu^{(n)}/k_\nu^{(d)}|$ is a function of the γ roots. Since

$$\frac{k_\nu^{(n)}}{k_\nu^{(d)}} = \frac{f(p)}{F(p)} \Big|_{p=\gamma_\nu} = A \Big|_{p=\gamma_\nu} \quad (11)$$

the minima of $|k_\nu^{(n)}/k_\nu^{(d)}|$ can be easily ascertained from a plot of $A(p)$ for negative real values of p . Such a plot for the example of the second section is shown in Fig. 2. The largest of the minima of $A(p)$ including $|A(0)|$ and $|A(\infty)|$ as "minima," determines through (10) the largest possible value of h . The location of the root within the interval defined by (5) in which the largest minimum of $A(p)$ occurs is evidently critical. To realize the maximum possible gain, this root should be located pre-

cisely at the value of p for which the largest minimum of $|A(p)|$ occurs.⁵ The remaining roots of $F_1(p)$ may be chosen arbitrarily within those portions of their respective intervals defined by inequality (5) where the corresponding values $|A(p)|$ do not exceed that for the critical root. At this point the procedures described by Guillemin³ may be used to realize the expressions for Z_A and Z_B in one of the canonical forms for two-terminal $R-C$ networks.

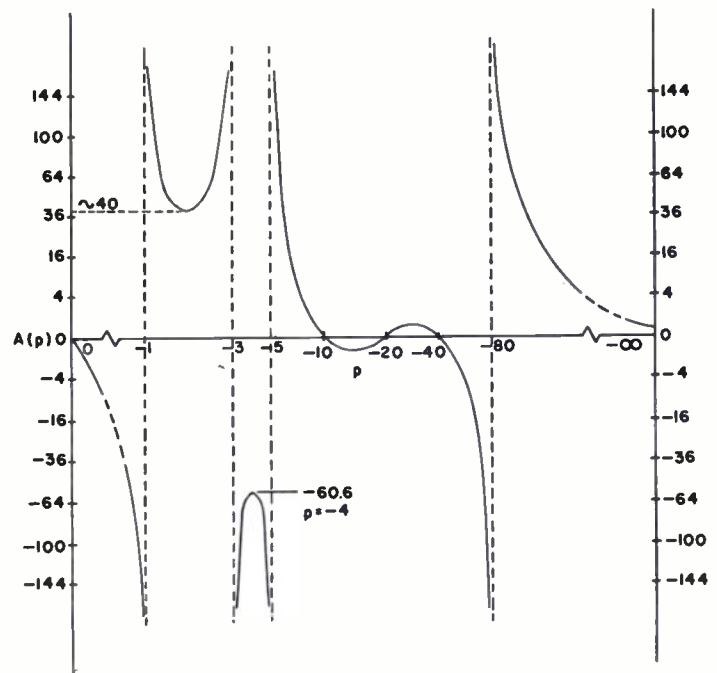

Fig. 2— $A(p)$ for example of unloaded lattice.

II. EXAMPLE

To exemplify the foregoing method, let us take the transfer ratio

$$\begin{aligned} A &= \frac{p^4 + 70p^3 + 1400p^2 + 8000p}{p^4 + 89p^3 + 743p^2 + 1855p + 1200} \\ &= \frac{p(p+10)(p+20)(p+40)}{(p+1)(p+3)(p+5)(p+80)}. \end{aligned}$$

From Fig. 2, it is evident that for maximum gain $h = 1/60.6$ and the critical root is at $p = -4$. In order to make the impedances Z_A and Z_B as nearly alike as possible, roots of $F_1(p)$ were chosen at $p = 0$ and $p = -20$. The fourth root was selected arbitrarily at $p = -2$. Hence

$$F_1(p) = p(p+2)(p+4)(p+20).$$

The impedances Z_A and Z_B can now be obtained as

$$\begin{aligned} Z_A &= 0.508 + \frac{3.75}{p} + \frac{2.87}{p+2} + \frac{25.2}{p+20} \\ Z_B &= 0.492 + \frac{3.75}{p} + \frac{0.375}{p+2} + \frac{1.78}{p+4} + \frac{25.2}{p+20}. \end{aligned}$$

⁴ This entire theory applies with few modifications to a realization on the admittance basis. In particular, (10) and (11) apply without change for this case.

⁵ An infinite root yields the constant terms (7) and (9).

This realizes as shown in Fig. 3(a).

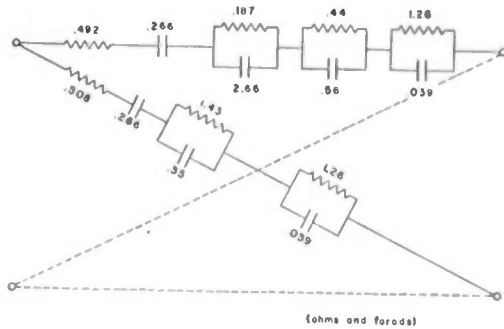

Fig. 3(a)

III. SYNTHESIS OF THE LATTICE STRUCTURE WITH A SPECIFIED R-C LOAD

The loaded lattice structure can be synthesized most easily on an admittance basis. According to Norton's theorem, the voltage across the load of the lattice per volt of driving signal can be expressed as

$$A = E_{out}/E = \frac{Y_{12}}{Y_{22} + Y_L} = \frac{f(p)}{F(p)} \tag{12}$$

in which Y_L is the specified load admittance.⁶ It can be readily shown for the circuit of Fig. 1(a) that

$$\begin{aligned} Y_{12} &= \frac{1}{2}(Y_B - Y_A) \\ Y_{22} &= \frac{1}{2}(Y_B + Y_A). \end{aligned} \tag{13}$$

The synthesis procedure for the loaded lattice is similar to that for the unloaded case in that a rational fraction $G(p)$ is chosen to multiply numerator and denominator of $A(p)$ in order to convert them into realizable fractions in p . The additional feature of the present method results from the identification of the resulting denominator fraction $G(p) \cdot F(p)$ as the sum of the two admittances, Y_{22} and Y_L . The form of $G(p)$ must be

$$G(p) = b \frac{(p + \sigma_1)(p + \sigma_2)(p + \sigma_3) \cdots}{(p + \gamma_1)(p + \gamma_2)(p + \gamma_3) \cdots (p + \gamma_t)} \tag{14}$$

where $b, \sigma_1, \sigma_2, \dots, \gamma_1, \gamma_2, \dots, \gamma_t$ are positive real numbers. The poles of $G(p)$ are chosen to include the poles of Y_L ; additional poles, and the zeros are then added until the product $G(p) \cdot F(p)$ satisfies the alternation principle defined in footnote 3. The poles γ_r are located for maximum gain factor in a manner somewhat similar to that for the unloaded lattice. The zeros of $G(p)$ may be placed halfway between their respective adjacent poles as a first try. These locations will be discussed more fully later.

As in (7) the partial-fraction expansions of the numerator and denominator fractions may be written

$$f(p) \cdot G(p) = \frac{1}{2}(Y_B - Y_A)$$

⁶ The possibility of identical poles in $A(p)$ and $Y_L(p)$ is ruled out, since this would produce a multiple pole in the transfer admittance between input voltage and load current.

$$= bh \left[\frac{pk_1^{(n)}}{p + \gamma_1} + \cdots + \frac{pk_r^{(n)}}{p + \gamma_r} + \cdots + \frac{pk_t^{(n)}}{p + \gamma_t} + pk_0^{(n)} \right] \tag{15}$$

$$\begin{aligned} F(p) \cdot G(p) &= \frac{1}{2}(Y_B + Y_A) + Y_L \\ &= b \left[\frac{pk_1^{(d)}}{p + \gamma_1} + \cdots + \frac{pk_r^{(d)}}{p + \gamma_r} + \cdots + \frac{pk_t^{(d)}}{p + \gamma_t} + pk_0^{(d)} \right]. \end{aligned} \tag{16}$$

The admittance of the specified load can be written

$$\begin{aligned} Y_L &= \frac{pk_1^{(L)}}{p + \gamma_1} + \cdots + \frac{pk_r^{(L)}}{p + \gamma_r} + \cdots \\ &\quad + \frac{pk_t^{(L)}}{p + \gamma_t} + pk_0^{(L)}. \end{aligned} \tag{17}$$

Before realizing Y_A and Y_B , Y_L must be subtracted from the right-hand member of (16). In order to insure that each residue of Y_A and Y_B will be positive, by reasoning in a manner similar to that in connection with (8), (9), and (10), both b and h must be chosen so as to satisfy

$$-1 \leq \frac{bhk_r^{(n)}}{bk_r^{(d)} - k_r^{(L)}} \leq +1 \tag{18}$$

and

$$bk_r^{(d)} - k_r^{(L)} \geq 0 \tag{19}$$

for all ν . Inequality (19) follows from the requirement of positive residues in $Y_A + Y_B$, and provides a lower limit on the possible values of b . As $b \rightarrow \infty$, the solution approaches that for the unloaded lattice, and consequently h has for its upper limit the value for the unloaded case. Large values of b permit the selection of large values of h , the upper limit on b being determined generally by system considerations on the level of input admittance for the entire network. Conversely, as smaller values of b are selected, the gain h must be reduced.

Just as in the theory of the unloaded lattice, the plot of $A(p)$ is an important guide to the location of the free poles of $G(p)$ for maximum gain h . Where b is very large, (18) reduces to (10), and (11) applies directly. As smaller values of b are taken, the residue constants of Y_L play a more important part in locating the free poles.

The procedure for the synthesis of the loaded lattice can be outlined as follows:

- (a) Determine the locations of free poles as for the unloaded lattice.
- (b) Select the poles and zeros of $G(p)$, including the poles of $Y_L(p)$, so as to satisfy the alternation principle in the product $G(p) \cdot F(p)$, and place the zeros midway between adjacent poles.
- (c) Make partial-fraction expansions of $f(p) \cdot G(p)$, $F(p) \cdot G(p)$, and $Y_L(p)$.
- (d) Choose b to satisfy (19) for all poles.

- (e) Choose h to satisfy (18).
- (f) Review the selection of free-pole locations with a view to improvement in gain factor h .
- (g) Review the locations of zeros of $G(p)$ to obtain a larger h , taking note that the zeros nearest the pole where h is determined generally have the largest influence, and that placing a zero very near a pole calls for impractical element values.
- (h) Examine the economy of the design in regard to balance between h and the input admittance of the entire network; if indicated, redesign with different value of b .
- (i) Solve for the residues of Y_A and Y_B and obtain their two-terminal R - C representations.

IV. AN EXAMPLE OF THE SYNTHESIS OF THE LATTICE STRUCTURE WITH A SPECIFIED R - C LOAD

An example has been chosen to illustrate a typical situation that can arise in the determination of b and h .

$$A(p) = \frac{f(p)}{F(p)} = \frac{p^2 + 4p + 40}{p^2 + 6p + 8} \\ = \frac{(p + 2 + j6)(p + 2 - j6)}{(p + 2)(p + 4)}$$

and

$$Y_L = 0.451 + \frac{0.17p}{p + 5} + \frac{p}{p + 7}$$

To satisfy the alternation principle, $G(p)$ must have a pole between $p = -2$ and -4 , as well as the ones at -5 and -7 . After examination of the plot shown in Fig. 4, this pole is chosen at $p = -3$. An additional zero required in $G(p)$ is chosen at $p = -6$, midway between $p = -5$ and -7 in accordance with the suggested procedure. Hence,

$$G(p) = \frac{b(p + 6)}{(p + 3)(p + 5)(p + 7)}$$

The partial-fraction expansions are as follows:

$$f(p) \cdot G(p) = 1/2(Y_B - Y_A) \\ = bh \left[2.2860 - \frac{4.625p}{p + 3} + \frac{2.250p}{p + 5} + \frac{1.089p}{p + 7} \right]$$

and

$$F(p) \cdot G(p) = 1/2(Y_B + Y_A) + Y_L \\ = b \left[0.4572 + \frac{0.1250p}{p + 3} + \frac{0.1500p}{p + 5} + \frac{0.2679p}{p + 7} \right]$$

Evidently for $h > 0$, $b > (1/0.2679) = 3.734$. For the preliminary design, let $b = 4$. Then

$$1/2(Y_B - Y_A) = h \left[9.144 - \frac{18.50p}{p + 3} + \frac{9.000p}{p + 5} + \frac{4.356p}{p + 7} \right]$$

and

$$1/2(Y_B + Y_A) = \left[1.378 + \frac{0.50p}{p + 3} + \frac{0.430p}{p + 5} + \frac{0.0717p}{p + 7} \right]$$

For this case $h_{\max} = (0.0717/4.356) = 0.01646$, and the critical pole is at $p = -7$. The location of the zero in $G(p)$ has a considerable effect on the gain. In this particular case, a shift of the zero of $G(p)$ towards the $(p + 5)$ pole improves the gain because it increases $(bk_7^{(d)} - k_7^{(L)})$ more rapidly than it does $bhk_7^{(n)}$. For example, putting the zero of $G(p)$ at $p = -5.5$ while retaining $b = 4$ gives

$$1/2(Y_B - Y_A) = h \left[8.381 - \frac{15.42p}{p + 3} + \frac{4.50p}{p + 5} + \frac{6.536p}{p + 7} \right]$$

and

$$1/2(Y_B + Y_A) = \left[1.225 + \frac{0.4168p}{p + 3} + \frac{0.13p}{p + 5} + \frac{0.607p}{p + 7} \right]$$

Now $h_{\max} = (0.416/15.4) = 0.0270 = 1/37$, and the critical root has changed from $p = -7$ to $p = -3$. The slight shift of the zero of $G(p)$ increased the gain nearly 65 per cent—up to the gain of the unloaded lattice. The same thing could have been achieved by a slight increase in b .

The design, completed for

$$G(p) = \frac{4(p + 5.5)}{(p + 3)(p + 5)(p + 7)}$$

and $h = 1/37$, is

$$Y_A = 0.998 + \frac{0.834p}{p + 3} + \frac{0.0084p}{p + 5} + \frac{0.430p}{p + 7},$$

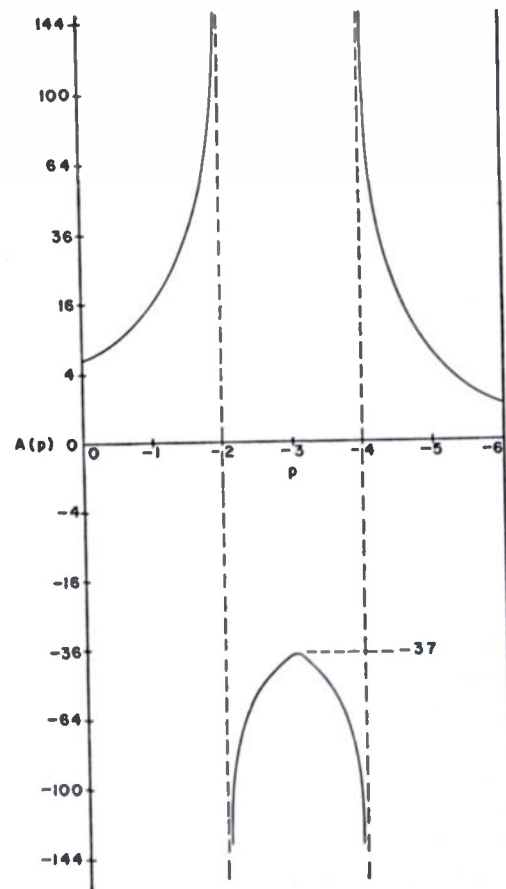

Fig. 4

$$Y_B = 1.452 + \frac{0.252p}{p+5} + \frac{0.783p}{p+7},$$

and

$$Y_L = 0.451 + \frac{0.17p}{p+5} + \frac{p}{p+7}.$$

The network is shown in Fig. 5.

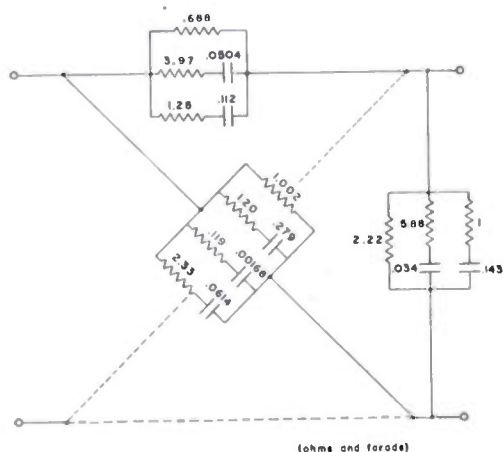

Fig. 5

V. THE SYNTHESIS OF A SPECIFIED TRANSFER IMPEDANCE (RATIO OF OUTPUT VOLTAGE TO A DRIVING CURRENT)

The transfer impedance can be synthesized as a lattice structure of the form of Fig. 6.

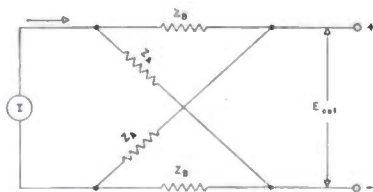

Fig. 6

Providing the load is negligible, the transfer impedance of this structure can be written as

$$E_{out} = \frac{I}{2} (Z_A - Z_B). \tag{20}$$

Suppose that the transfer impedance function to be realized is

$$Z_{12} = \frac{1}{2} (Z_A - Z_B) = \frac{f(p)}{F(p)} = \frac{a_0 + a_1p + \dots}{b_1 + b_1p + \dots} \tag{21}$$

Because the output voltage for a given driving current cannot be infinite at infinite frequency, the greatest power of p in the numerator cannot exceed the greatest power of p in the denominator. On the other hand, the voltage across a condenser through which a finite current is transmitted is infinite at zero frequency; hence $F(p)$ can admit a root at $p=0$.

Provided that the coefficients $a_0, a_1, \dots, b_1, b_2, \dots$ be real and provided that the roots of $F(p)$ be real, simple, and negative, Z_A and Z_B can each be realized by ob-

taining a partial-fraction expansion of (21). The impedance $Z_A/2$ is constructed by collecting the terms from the partial fraction expansion which have positive residues into a group. Likewise $Z_B/2$ is constructed by grouping the terms from the partial fraction expansion which have negative residues. Once the terms representing Z_A have been collected and the terms representing Z_B assembled, the two corresponding impedances can be realized in a straightforward fashion.

VI. TRANSFORMATION OF A LATTICE PROTOTYPE TO AN UNBALANCED STRUCTURE^{1,2}

There are five steps which may be taken to transform a lattice into an unbalanced form. The steps are based upon a rule derived from Bartlett's bisection theorem: the transfer and driving characteristics of a symmetrical two-terminal pair network are not affected by any alterations that preserve the symmetry, as well as the impedances obtained at one of the terminal pairs, both when the other terminal pair is open-circuited and when it is short-circuited. Evidently such steps may be taken in any order and as often as desired. However, not all networks are transformable.

The steps which can be used to obtain an unbalanced configuration from the symmetrical lattice prototype will now be described and illustrated.

1. A shunt impedance may be extracted from each of the branches of the lattice and placed in parallel with each of the terminal pairs. (See Fig. 7.)
2. A shunt impedance may be extracted from the line network and regarded as bridging the resultant lattice. The ideal transformer⁷ may be eliminated when the resultant lattice has been reduced to unbalanced form. (See Fig. 8.)
3. A series impedance may be extracted from each of the branches of the lattice and placed in series with each of the terminal pairs. (See Fig. 9.)

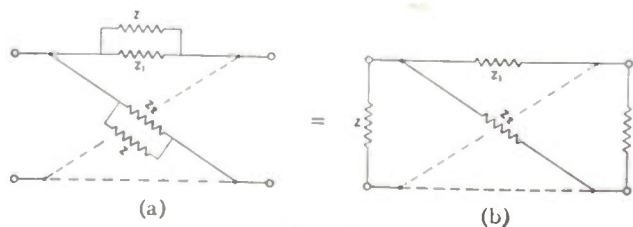

Fig. 7

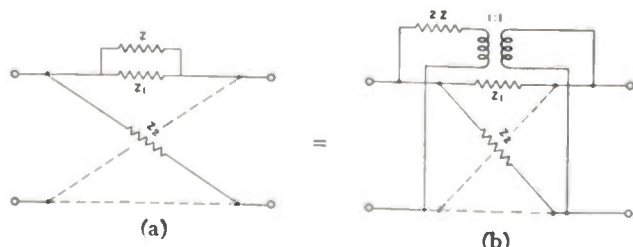

Fig. 8

⁷ The ideal transformer has its upper terminals in phase in voltage, while a current flowing into one upper terminal produces a current flowing out of the other.

4. A series impedance may be extracted from the cross branch and eventually becomes the middle leg of a T-section. Until the resultant lattice is reduced to unbalanced form, this also requires an ideal transformer. (See Fig. 10.)
5. A lattice may be replaced by a group of parallel lattices. (See Fig. 11.)

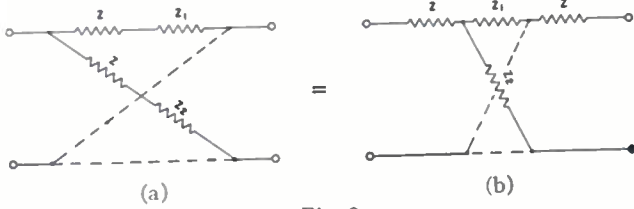

Fig. 9

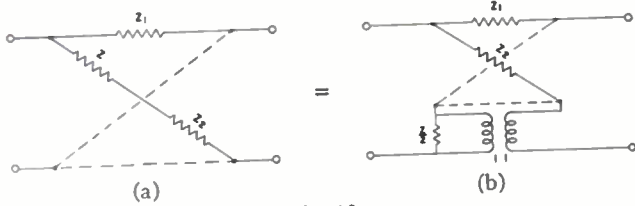

Fig. 10

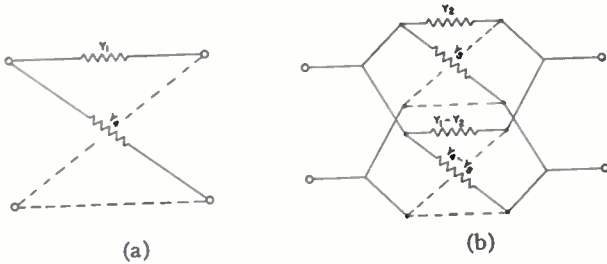

Fig. 11

In a particular case, the application of these steps requires a considerable amount of ingenuity.

VII. EXAMPLE

This example is the lattice which realizes the gain function in paragraph 2. The original lattice is shown in Fig. 3(a).

1. The common series impedance can be removed to yield Fig. 3(b).
2. The series resistance is extracted from the cross branch to yield the circuit of Fig. 3(c).
3. The lattice in Fig. 3(c) can be regarded as two parallel lattices, one containing resistances only and the other containing capacitances only. The resistance lattice reduces to a tee by extracting series resistance. Likewise the capacitance reduces to a tee by removing series capacitances. The transformer shown can then be removed to give Fig. 3(d).

Since this lattice structure is not loaded, the series impedances on the output end of the structure may be omitted.

VIII. CONCLUSIONS

The following conclusions may be drawn regarding the method for the synthesis of network functions realizable in R-C form:

1. Any transfer ratio, transfer impedance, or transfer admittance can be realized in lattice form by a straightforward process. Many of these solutions are reducible to unbalanced equivalents.
2. The maximum gain factor in the case of a transfer ratio can be ascertained without designing the network, merely by making a rough plot of the prescribed transfer ratio function.
3. The lattice method can be employed to synthesize a given transfer ratio (or load-to-input-current ratio) when the network is to work into a prescribed R-C load.

ACKNOWLEDGMENT

This paper is a portion of a larger report on the synthesis of resistor-capacitor networks prepared for the General Electric Company. The authors wish to acknowledge the courtesy of E. A. Guillemin, who made available to them his notes on a previously unpublished method.

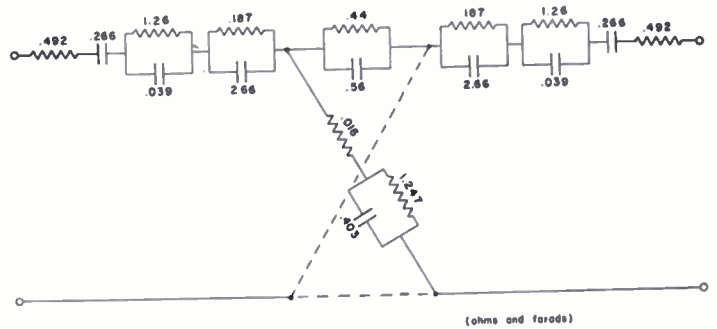

Fig. 3(b)

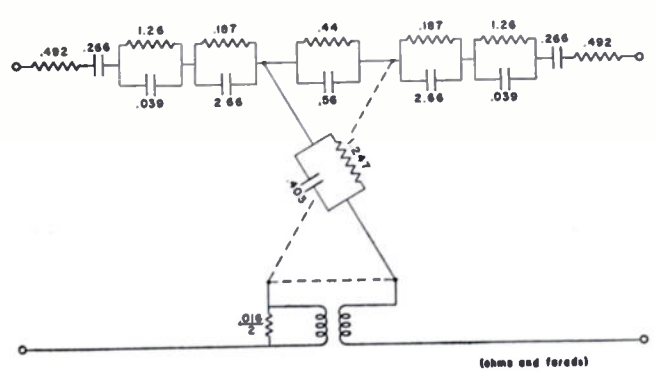

Fig. 3(c)

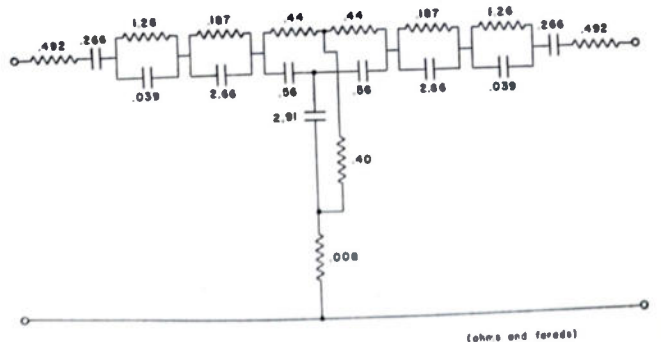

Fig. 3(d)

Reduction of the lattice of Section II.

Theoretical Aspects of Asynchronous Multiplexing*

W. D. WHITE†, SENIOR MEMBER, IRE

Summary—Various forms of multiplexing, in which information from several sources is systematically combined and transmitted over a single channel, have been described in the literature. Recent advances in communication theory make possible an examination of the case where isolated transmitters share a common channel without synchronization. This case is important in applications where the transmitters are so separated that synchronization cannot be accomplished directly, but where multiplex operation is nevertheless desired.

Under these conditions, it is possible to add redundant information at the output of each transmitter and at the receiver to separate the signals in much the same manner as a desired signal is separated from random noise. Some simple systems are discussed, and general observations on the efficiency of asynchronous multiplex systems are presented.

INTRODUCTION

IN MANY applications, it is more economical to multiplex several information sources on a common rf channel than to provide separate channels for each source. The conventional technique usually consists of bringing the several sources to a common point, where a systematic multiplex operation can be performed either on a time-division or on a frequency-division basis. In some applications, however, this type of multiplex is difficult or impossible since the information sources are widely scattered. In this case, if multiplex operation is to be obtained, it must be done without the benefit of the lines linking the various sources to a common point. This paper is a study of asynchronous multiplex systems in which each source is provided with its own independent transmitter. Coding techniques are used to separate the signals.

Perhaps the first important case in which the use of an asynchronous multiplex system proved profitable was the loran hyperbolic navigation system.^{1,2} Because the success of this system depended on the accurate measurement of a time difference between the arrival of the two pulses, it was essential that the rise time of the pulses be as short as possible. In consequence, the bandwidth of the channel had to be as wide as the spectrum assignments would permit (about 25 kc). To avoid an exorbitant demand for rf spectrum, an asynchronous multiplex system was used whereby 8 to 12 pairs of stations could be operated on the same rf channel. Al-

though the two stations of a pair were, of course, synchronized, no synchronization was required between pairs, and the signals were separated on the basis of slight differences in pulse repetition frequency.³

There are also a number of interrogator-responder type navigation systems which use an asynchronous multiplex. In these systems, several interrogators simultaneously trigger the same transponder and each interrogator identifies its own reply pulses by the fact that the extraneous pulses are unsynchronized. This is an asynchronous multiplex system in which one channel is provided for each interrogator. One of these systems, the airborne distance-measuring equipment, also makes use of a pulse code multiplex to assist in identifying the pulses from a particular transponder out of several operating on the same frequency. However, none of the systems mentioned above makes use of a very large part of the maximum information capacity of the rf channel.

INFORMATION CAPACITY FOR ASYNCHRONOUS MULTIPLEX

It is worth-while to determine whether the use of asynchronous multiplex is limited to cases where the information rate is extremely low, or whether it is also possible to employ asynchronous principles in cases where the resulting spectrum efficiency is moderately high. Fortunately, recent advances in the theory of communication⁴⁻⁶ make it possible to do this.

Let us consider a single-channel pulse communication system. All of the transmitted pulses are of uniform height and width and communication is accomplished by the presence or absence of a pulse. In the absence of noise, the information capacity is one bit of information per pulse-width of time, provided that the duty cycle is unlimited. This maximum information capacity occurs at a duty cycle of 0.5, and the capacity falls off for other duty cycles, reaching zero at duty cycles of zero and unity.⁷ In the presence of noise, it is possible for noise

* It would have been possible, of course, to employ a completely synchronous multiplex system in which all the stations on a common frequency were locked to the same prf. In the gee system, as a matter of fact, it was standard practice to operate three- and four-station synchronized chains. It appears, however, that the asynchronous type of operation is preferable when large numbers of stations are to be multiplexed. This is true because it not only avoids the necessity of maintaining long synchronized chains, which would fail upon the failure of a single link, but also because it provides a convenient method of identifying the pulses from a particular station without requiring additional length of time base.

† C. E. Shannon, "A mathematical theory of communication," *Bell Sys. Tech. Jour.*, pp. 379-423, July, 1948; and pp. 623-656, October, 1948.

‡ C. E. Shannon, "Communication in the presence of noise," *PROC. I.R.E.*, vol. 37, p. 10, January, 1949.

§ Norbert Wiener, "Cybernetics," John Wiley and Sons, Inc., New York, N. Y.; 1948.

¶ See Fig. 7 of footnote reference 4.

* Decimal classification: R460. Original manuscript received by the Institute, July 8, 1949; revised manuscript received, November 14, 1949. Presented, 1949 National IRE Convention, New York, N. Y., March 10, 1949.

† Airborne Instruments Laboratory, Inc., Mineola, L. I., N. Y.

‡ J. A. Pierce, A. A. McKenzie, and R. H. Woodward, "Loran," vol. 4, MIT Radiation Laboratory Series, McGraw-Hill Book Co., New York, N. Y.; 1948.

§ J. A. Pierce, "An introduction to loran," *PROC. I.R.E.*, vol. 34, p. 216; May, 1946.

peaks to give rise to spurious pulses or to cancel some of the genuine pulses so that at the receiver we may never be certain about the exact transmitted message.

The effect of noise on the system can be represented in terms of the probabilities that a spurious pulse will be received or that a genuine pulse will be lost (Fig. 1). At any given instant $P_x(1)$ is the probability that the pulse is being transmitted. For a stationary process $P_x(1)$ is the duty cycle and, of course, $P_x(0)$ is the complement of the duty cycle. If a pulse is transmitted, there is a probability $P_1(0)$ that because of the presence of noise or interference, it is lost in transmission, and the complement of $P_1(0)$ is $P_1(1)$. If no pulse is transmitted, there is another probability $P_0(1)$ that a spuri-

ous pulse is received, and $P_0(0)$ is its complement.

$$R = H(x) - H_y(x) = H(x) + H(y) - H(x, y).$$

Shannon has shown that, given these probabilities, it is possible to calculate a definite information capacity for the circuit, despite the fact that we may never be exactly certain that the received message is correct. Before applying Shannon's formulas, we first express the combined effect of the source and the disturbance in terms of a new set of bivariate probabilities

It will be noted that these formulas do not depend on any characteristic of the noise other than the frequency with which it causes spurious pulses to be received or genuine pulses to be lost. Except as it affects the probabilities involved, it is immaterial whether we are dealing with impulse noise, fluctuation noise, or some other form of interference. The only requirement is that we be able to represent the effect as a set of random probabilities. Some caution is necessary because Shannon's formulas are based on the assumption that the equivocation is due to an independent random source. If the spurious effects had strong correlations, either correlations with the signal or auto-correlations within themselves, the formulas would not be strictly valid.

It is possible with some restriction to consider the interference from other transmitters operating on the same channel as though it were due to random noise. A pulse communication system of the type we are considering will, when operating in the most efficient manner, radiate pulses essentially at random and will produce a result indistinguishable (except for the probabilities involved) from that caused by random noise.

Fig. 2 shows an example of how the information rate and the equivocation vary with the probability of receiving spurious pulses. In plotting it, we have assumed a pulse code communication system operating at 50 per cent duty cycle; $P_x(1) = 0.5$. The interference is assumed to be spurious pulses indistinguishable from the genuine pulses. Although none of the transmitted pulses are lost, some extraneous pulses are received.⁸

Fig. 2 shows that in the absence of spurious pulses or when $P_0(1)$ is zero, the equivocation is zero, and the

⁸ It will be noted that it is theoretically possible for an undesired pulse to arrive in phase opposition and cancel a pulse from the desired transmitter. In practice, however, such an occurrence would be very rare. This is due not only to the fact that the phases (and to some extent the frequencies) are random, but also to the fact that, in general, the signals from the various transmitters will be unequal in amplitude. If the threshold of the receiver is set to receive the weakest signal that will be encountered, then over the greater part of the coverage area, complete cancellation of pulses is not possible.

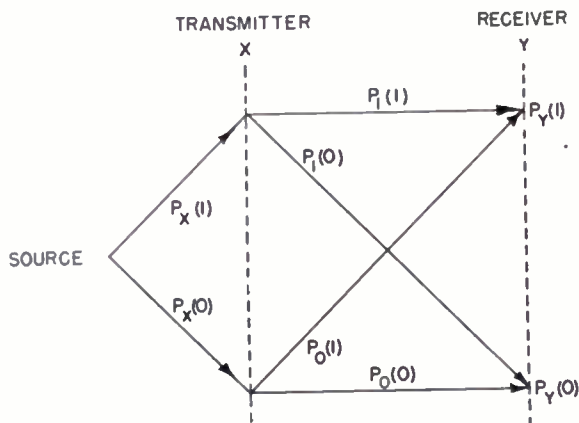

Fig. 1—Effect of noise on signal transmission.

$P(1, 1)$ is the probability that a pulse is transmitted and received as intended. $P(1, 0)$ is the probability that a pulse is transmitted but lost in transmission. $P(0, 1)$ is the probability that no pulse is transmitted but that a spurious pulse is received, and $P(0, 0)$ is the probability that no pulse is transmitted and none is received. Having defined this new set of probabilities, we may calculate a set of entropies using Shannon's formulas

$$H(x) = - \sum_{i,j} P(i, j) \log_2 \sum_j P(i, j)$$

$$H(y) = - \sum_{i,j} P(i, j) \log_2 \sum_i P(i, j)$$

$$H(x, y) = - \sum_{i,j} P(i, j) \log_2 P(i, j)$$

$$H_y(x) = H(x, y) - H(y)$$

transmission rate is one bit of information per pulse-width. As the frequency of spurious pulses is increased, the transmission rate falls off sharply at first and then more slowly. When $P_0(1)$ is unity, corresponding to a receiver completely blocked by interference, no more communication is possible and the transmission rate is zero.

Fig. 3 shows the same information for the case where the signal duty cycle is only 5 per cent; $P_x(1) = 0.05$. Because of the restricted duty cycle, the maximum information rate, even in the absence of interference, is only 0.286 bit per pulse width. As before, the information rate falls to zero for a completely blocked receiver.

Suppose that we have a multiplex system in which four transmitters are operating on the same rf channel. Let us further suppose that each transmitter is emitting

pulses independently of the others with an average duty cycle of 5 per cent. At any given receiver, then, the probability of receiving a pulse from the desired transmitter at any instant is 0.05, whereas if no pulse is sent from the desired transmitter, the probability that a pulse will be received from at least one of the three undesired transmitters is $P_0(1) = 1 - (1 - 0.05)^3 = 0.143$. This means (Fig. 3) that the transmission rate R has dropped to about 0.13 bit per pulse width for a single information source. Counting all four sources, we have a total informational capacity for the channel of 0.52 bit per pulse width of time. A synchronous multiplex system of the same over-all average power (20 per cent duty cycle) would have been able to transmit about 0.73 bit per pulse width.

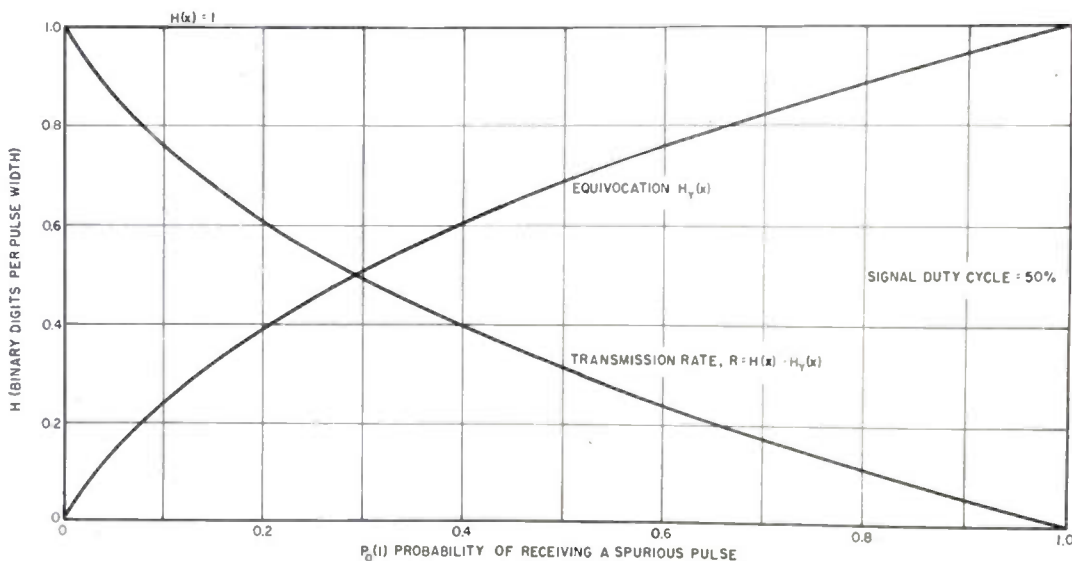

Fig. 2—Effects of spurious pulses on transmission rate.

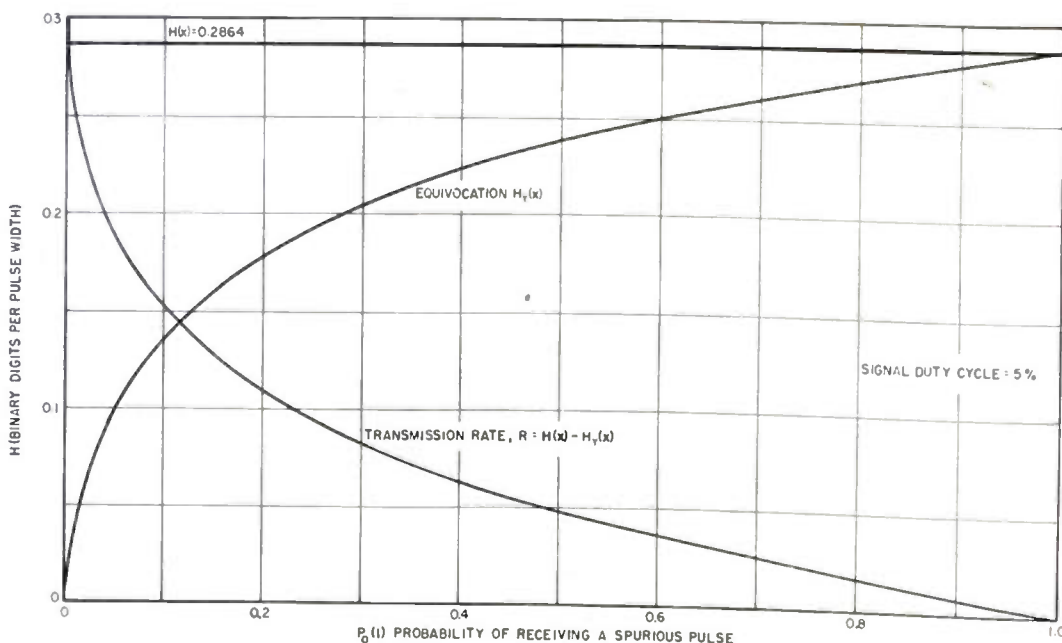

Fig 3—Effects of spurious pulses on transmission rate.

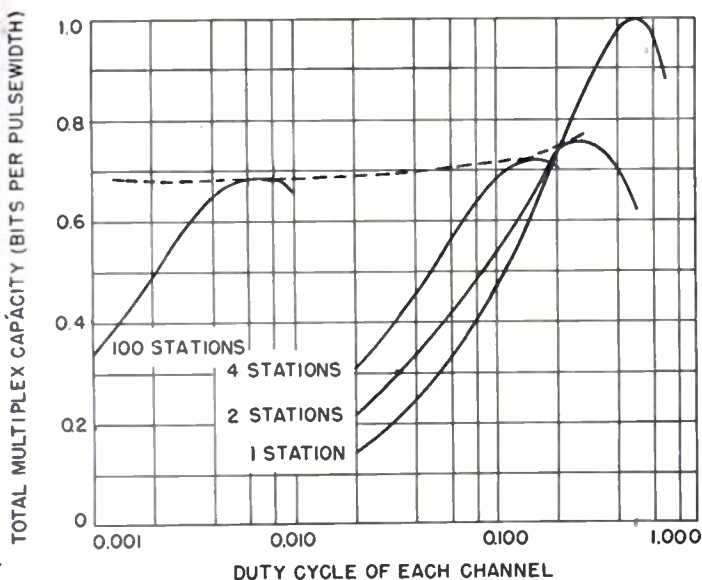

Fig. 4—Information capacity, simple asynchronous system.

Fig. 4 gives the result of similar calculations of the total information capacity of asynchronous multiplex systems as a function of duty cycle. Curves are shown for two-station multiplexing, four-station multiplexing, and hundred-station multiplexing. Shown for comparison is the single-station case, which, in addition, represents what can be done with a synchronous multiplex system. It will be noted that, though the type of operation postulated (interfering signals treated as though they were caused by noise) may not be the ideal, the loss in information capacity is only of the order of 25 to 30 per cent as compared with a single-channel pulse code system or a synchronous multiplex.

PRACTICAL CODES

It is seen that, at least in theory, it is possible to devise an asynchronous multiplex system which provides several channels on the same frequency without a prohibitive loss in efficiency due to the asynchronous feature. It is perhaps pertinent to inquire whether it is feasible to devise such a system that would not be intolerably complex. We have seen that, because the actual rate of transmission is less than the entropy of the transmitted signal, the transmitted signal must contain redundant information if we are to reconstruct the original message despite the loss in transmission. Fortunately, some types of messages inherently contain a good deal of redundancy and, consequently, can stand a fair amount of deterioration without impairing their usefulness.

Consider conventional facsimile transmission of a black-and-white page containing printed characters, lines, and similar material but no halftones. In transmitting such information by conventional facsimile methods, we are providing a facility that is equally capable of transmitting any conceivable combination of black area and white area within the resolution limits of the system. We are by no means using the full capability of the system, however, because by far the majority of

the possible signals that could be transmitted are completely meaningless. In the transmission of an image such as an outline map with fairly broad expanses of white area, a few spurious black specks would not be confusing, provided they did not combine into a pattern that could be mistaken as part of the map. It would be possible, therefore, to multiplex facsimile transmissions of this type on an asynchronous basis merely by using different or random scanning rates for each channel. Each receiver would receive all of the pulses from all of the channels, but only one of the channels would have the correct scanning rate to result in a recognizable pattern, whereas the others would result in a more or less random scattering of black dots. The result would be a spotty picture but, if the amount of interference from the other channels were not excessive, one could recover nearly all of the information contained in the original message. In this case, we are relying on the human observer to act as the decoder.

There are cases where it is undesirable to employ a human operator to do the decoding operation. We would prefer that the original message be reconstructed by an inanimate device. In other cases, our original message material may not have the required degree of redundancy. Fig. 5 shows a simple system where redun-

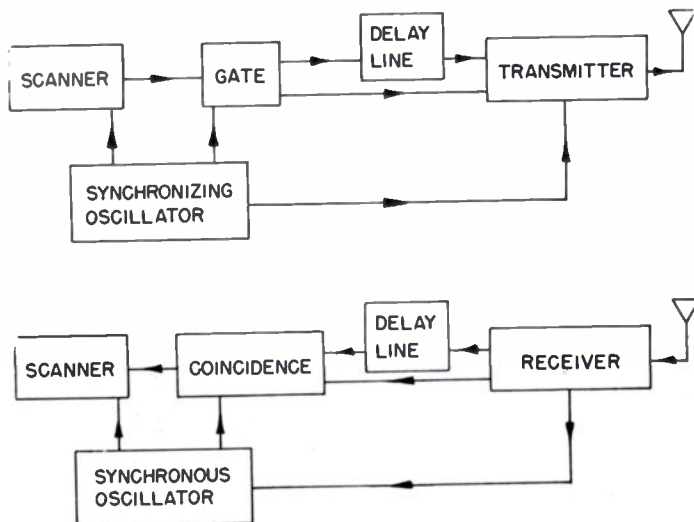

Fig. 5—Coincidence multiplex system.

dancy is added to a message by the expedient of transmitting each piece of information twice, once immediately and then again after a delay. At the receiver, we have an electronic switch operating in synchronism with the electronic switch at the transmitter. The switch routes the incoming signal first through a delay line and then directly to a coincidence circuit. The rate at which this switching is done is different for each of the channels and provides the basis upon which the signals are separated. The output of the coincidence circuit contains pulses corresponding only to those pairs of pulses that have the correct spacing at the input. Since each channel would have its own unique delay time, the undesired channels are, except for random coincidences, rejected by the coincidence circuit.

To make this clearer, Fig. 6 shows the timing relations involved. Three different transmitted signals are shown,

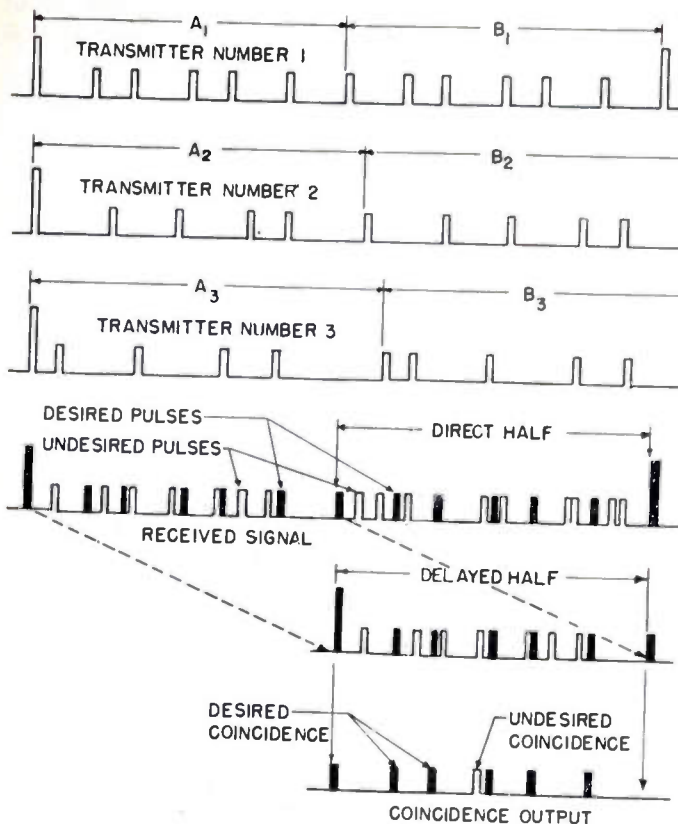

Fig. 6—Coincidence multiplex signal.

the desired signal being on the top line. Although the synchronizing pulses are shown as double-height pulses, what is required is merely that they be made distinctive by some convenient means. We see that each transmitted sequence consists of two identical halves labeled "A" and "B." The first half of the composite received signal is then delayed and matched with the second half in the coincidence circuit. Pulses corresponding to the desired signal are shown solid, and the last line shows the output of the coincidence stage. It is seen that in this case one spurious pulse results from a random combination of a delayed pulse from channel 2 and an undelayed pulse from channel 3, but that the majority of the undesired pulses are removed.

This process can be extended by transmitting the information three times and requiring triple coincidence. If desired, we may go even further. Table I gives some numerical data for a six-station multiplex using single-pulse operation, double-pulse coincidence, and triple-pulse coincidence. The method of calculation is that outlined for single-pulse operation with suitable modifications.

The table shows that the total transmission rate falls off as we go to the more elaborate double-pulse and triple-pulse coincidence. This is because the type of coding that is used is not ideal and introduces inefficiencies of its own. We do, however, reduce the duty factor of the interfering pulses from 22.6 per cent to 1.16 per cent.

TABLE I
SIX-STATION MULTIPLEX

Communication characteristics	Single-pulse operation	Double-pulse coincidence	Triple-pulse coincidence
Duty factor, decoded interference	0.226	0.0512	0.0116
Transmitter entropy per station $H(x)$, bits per pulse-width	0.286	0.143	0.0953
Equivocation per station, $H_e(x)$ bits per pulse-width	0.186	0.049	0.0137
Transmission rate per station R , bits per pulse-width	0.100	0.094	0.0816
Total transmission nR (all stations), bits per pulse-width	0.600	0.564	0.490
Relative equivocation $H_e(x)/H(x)$	0.674	0.342	0.144

Note: Each station operating at a duty cycle of 5 per cent.

It is seen that this type of coding reduces the equivocation of the received message but does not result in a message completely free from error. Shannon has proved merely that it is always possible to so encode the message that the probability of error can be made arbitrarily small, if a sufficient time delay is allowed. In particular, he has shown that, in the limit, as the coding delay becomes very long, the probability of error for a particular sequence is bounded by

$$P \leq 2^{-T/\tau}$$

where T is the time required for decoding, P is the probability of at least one error in the time T , and τ is the difference between the theoretical maximum rate and the rate actually used.

If we are willing to allow sufficient delay time, we can always reduce both P and τ to arbitrarily small quantities. The required delay time and the complexity of the coding and decoding operations may in some cases, however, be excessive.

In the case of multiplex codes, it is possible to devise relatively simple codes in which the theoretical probability of error is zero. In this case, the transmitted signals are restricted in such a manner that no combination of undesired signals can result in a spurious code for the desired channel. Unfortunately, this procedure results in relatively inefficient operation when many channels are provided. Further study is required to determine the best code for a particular application.

LIMITATIONS OF THEORY

Although we have shown that it is theoretically possible to operate an asynchronous multiplex system without prohibitive loss of efficiency, the present theory is not complete. We have been unable as yet to determine the maximum efficiency but have merely succeeded in placing lower bounds. A more serious deficiency has been our inability to take into account the effects of multipath transmission. Although multipath propagation can be a serious limitation to nonmultiplexed circuits as well as to multiplexed circuits, circuits employ-

ing an asynchronous multiplex may suffer in comparison with circuits where all transmissions originate from a common point, because the multipath echoes will be different from each transmitter. As yet, no design procedure is known that will result in the optimum code for a particular situation.

CONCLUSIONS

Asynchronous multiplex techniques seem most applicable in cases where the nature of the service is such that the bandwidth tends to be much wider than is justified by the information to be transmitted over a single channel, and where circumstances make synchronous multiplex difficult or impossible. In particular, it is believed

that the principles discussed hold promise in air navigation and traffic control and in similar applications where a large number of mobile or widely separated transmitters must be accommodated in a limited bandwidth.

One feature of asynchronous multiplex that may make it attractive in some cases, even where a synchronous system or a discrete channel system could be used, is its flexibility. In the examples discussed, it was assumed that the information capacity was divided equally among the channels. This is not necessary, however, and if the traffic on some of the channels is light, it is possible for the other channels to make use of the extra capacity. This may prove beneficial in cases where the channel loads vary widely.

Methods for Obtaining the Voltage Standing-Wave Ratio on Transmission Lines Independently of the Detector Characteristics*

A. M. WINZEMER†, MEMBER, IRE

Summary—In the measurement of impedance at ultra-high frequencies by means of detecting standing waves on transmission lines, it is necessary to know the response law of the detector. This usually involves either a calibration of the detector or an assumption as to its characteristics. By means of the basic transmission line equations and the general law of detection, expressions are derived which give the voltage standing-wave ratio as a function of measurable electrical angles, the expressions being independent of the response law of the detector. Special cases of the general equations are discussed covering applications where high or low VSWR's are to be determined, with or without the use of the voltage maxima or minima. The extension of the methods to the case of attenuating transmission lines is given.

I. INTRODUCTION

IT IS WELL KNOWN that impedances at ultra-high frequencies are best measured by terminating a transmission line with the unknown impedance and observing the shape and position of the standing waves on the line by means of a traveling detector.¹ Whatever the relationship between probe input power and output meter indication, calibration of the system permits determination of the true nature of the standing waves.² However, this calibration must be repeated for different ranges of probe input power and whenever a significant

change has been made in the detector system. By means of the methods to be described, knowledge of the law of the detector becomes unnecessary, the expressions for the VSWR being independent of detector characteristics.

II. METHODS FOR OBTAINING THE VSWR ON LOSSLESS TRANSMISSION LINES USING A LOSSLESS SHORTING TERMINATION

For any standing wave on a smooth, lossless, arbitrarily terminated transmission line, the voltage distribution curve is given by the equation³

$$V^2 = V_{\min}^2 \cos^2 2\pi \frac{l}{\lambda} + V_{\max}^2 \sin^2 2\pi \frac{l}{\lambda} \quad (1)$$

where V is the voltage at distance l from a position of minimum voltage V_{\min} . Letting $l = \Delta/2$ and $\theta = \pi\Delta/\lambda$, (1) becomes

$$V^2 = V_{\min}^2 \cos^2 \theta + V_{\max}^2 \sin^2 \theta. \quad (2)$$

Equation (2) represents the true voltage distribution on a loaded line as shown in Fig. 1(a).

For two values of voltage V_{L1} and V_{L2} (2) can be written:

$$\begin{aligned} V_{L2}^2 &= V_{L\max}^2 \sin^2 \theta_{L2} + V_{L\min}^2 \cos^2 \theta_{L2} \\ \text{and} \quad V_{L1}^2 &= V_{L\max}^2 \sin^2 \theta_{L1} + V_{L\min}^2 \cos^2 \theta_{L1}. \end{aligned} \quad (3)$$

Similarly, for the voltage distribution on a shorted

* Decimal classification: R244.21. Original manuscript received by the Institute, October 28, 1948; revised manuscript received, October 24, 1949. Presented, Joint Meeting, American Section, URSI, and Washington Section, IRE, Washington, D. C., May 4, 1948. The material in this paper was used as the basis of a thesis for the M.E.E. degree at the Polytechnic Institute, Brooklyn, N. Y.

† Formerly, Naval Research Laboratory, Washington, D. C.; now, Naval Air Development Center, Johnsville, Pa.

¹ "The Technique of Microwave Measurements," Editor, C. G. Montgomery, McGraw-Hill Book Co., Inc., New York, N. Y., chap. 8; 1947.

² See p. 497 of footnote reference 1.

³ R. M. Redheffer, "The measurement of high reflections at low power," MIT Rad. Lab. Report 483-7, p. 1; November 20, 1944.

To make this clearer, Fig. 6 shows the timing relations involved. Three different transmitted signals are shown,

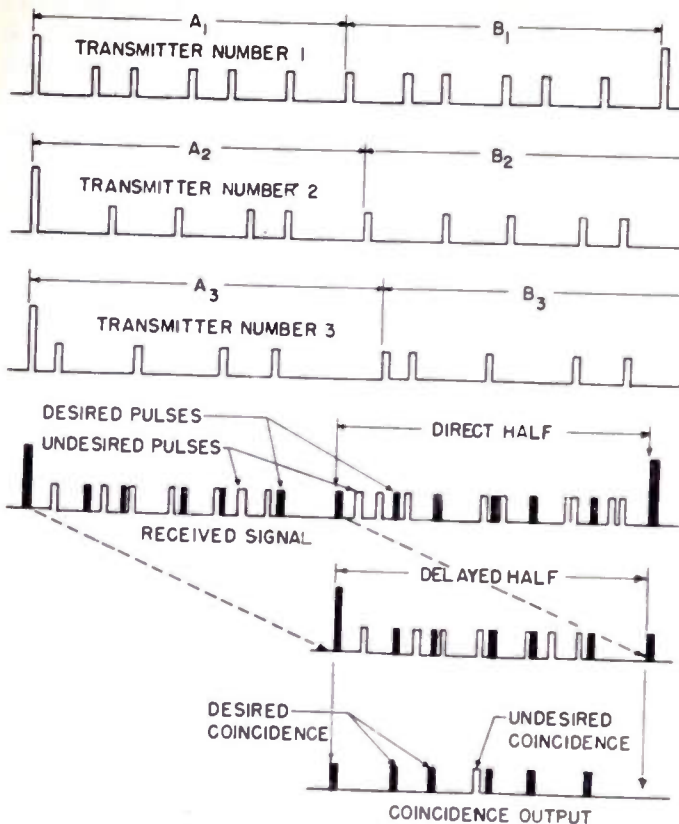

Fig. 6—Coincidence multiplex signal.

the desired signal being on the top line. Although the synchronizing pulses are shown as double-height pulses, what is required is merely that they be made distinctive by some convenient means. We see that each transmitted sequence consists of two identical halves labeled "A" and "B." The first half of the composite received signal is then delayed and matched with the second half in the coincidence circuit. Pulses corresponding to the desired signal are shown solid, and the last line shows the output of the coincidence stage. It is seen that in this case one spurious pulse results from a random combination of a delayed pulse from channel 2 and an undelayed pulse from channel 3, but that the majority of the undesired pulses are removed.

This process can be extended by transmitting the information three times and requiring triple coincidence. If desired, we may go even further. Table I gives some numerical data for a six-station multiplex using single-pulse operation, double-pulse coincidence, and triple-pulse coincidence. The method of calculation is that outlined for single-pulse operation with suitable modifications.

The table shows that the total transmission rate falls off as we go to the more elaborate double-pulse and triple-pulse coincidence. This is because the type of coding that is used is not ideal and introduces inefficiencies of its own. We do, however, reduce the duty factor of the interfering pulses from 22.6 per cent to 1.16 per cent.

TABLE I
SIX-STATION MULTIPLEX

Communication characteristics	Single-pulse operation	Double-pulse coincidence	Triple-pulse coincidence
Duty factor, decoded interference	0.226	0.0512	0.0116
Transmitter entropy per station $H(x)$, bits per pulse-width	0.286	0.143	0.0953
Equivocation per station, $H_v(x)$ bits per pulse-width	0.186	0.049	0.0137
Transmission rate per station R , bits per pulse-width	0.100	0.094	0.0816
Total transmission nR (all stations), bits per pulse-width	0.600	0.564	0.490
Relative equivocation $H_v(x)/H(x)$	0.674	0.342	0.144

Note: Each station operating at a duty cycle of 5 per cent.

It is seen that this type of coding reduces the equivocation of the received message but does not result in a message completely free from error. Shannon has proved merely that it is always possible to so encode the message that the probability of error can be made arbitrarily small, if a sufficient time delay is allowed. In particular, he has shown that, in the limit, as the coding delay becomes very long, the probability of error for a particular sequence is bounded by

$$P \leq 2^{-T}$$

where T is the time required for decoding, P is the probability of at least one error in the time T , and η is the difference between the theoretical maximum rate and the rate actually used.

If we are willing to allow sufficient delay time, we can always reduce both P and η to arbitrarily small quantities. The required delay time and the complexity of the coding and decoding operations may in some cases, however, be excessive.

In the case of multiplex codes, it is possible to devise relatively simple codes in which the theoretical probability of error is zero. In this case, the transmitted signals are restricted in such a manner that no combination of undesired signals can result in a spurious code for the desired channel. Unfortunately, this procedure results in relatively inefficient operation when many channels are provided. Further study is required to determine the best code for a particular application.

LIMITATIONS OF THEORY

Although we have shown that it is theoretically possible to operate an asynchronous multiplex system without prohibitive loss of efficiency, the present theory is not complete. We have been unable as yet to determine the maximum efficiency but have merely succeeded in placing lower bounds. A more serious deficiency has been our inability to take into account the effects of multipath transmission. Although multipath propagation can be a serious limitation to nonmultiplexed circuits as well as to multiplexed circuits, circuits employ-

in an asynchronous multiplex may suffer in comparison with circuits where all transmissions originate from a common point, because the multipath echoes will be different from each transmitter. As yet, no design procedure is known that will result in the optimum code for a particular situation.

CONCLUSIONS

Asynchronous multiplex techniques seem most applicable in cases where the nature of the service is such that the bandwidth tends to be much wider than is justified by the information to be transmitted over a single channel, and where circumstances make synchronous multiplexing difficult or impossible. In particular, it is believed

that the principles discussed hold promise in air navigation and traffic control and in similar applications where a large number of mobile or widely separated transmitters must be accommodated in a limited bandwidth.

One feature of asynchronous multiplex that may make it attractive in some cases, even where a synchronous system or a discrete channel system could be used, is its flexibility. In the examples discussed, it was assumed that the information capacity was divided equally among the channels. This is not necessary, however, and if the traffic on some of the channels is light, it is possible for the other channels to make use of the extra capacity. This may prove beneficial in cases where the channel loads vary widely.

Methods for Obtaining the Voltage Standing-Wave Ratio on Transmission Lines Independently of the Detector Characteristics*

A. M. WINZEMER†, MEMBER, IRE

Summary—In the measurement of impedance at ultra-high frequencies by means of detecting standing waves on transmission lines, it is necessary to know the response law of the detector. This usually involves either a calibration of the detector or an assumption as to its characteristics. By means of the basic transmission line equations and the general law of detection, expressions are derived which give the voltage standing-wave ratio as a function of measurable electrical angles, the expressions being independent of the response law of the detector. Special cases of the general equations are discussed covering applications where high or low VSWR's are to be determined, with or without the use of the voltage maxima or minima. The extension of the methods to the case of attenuating transmission lines is given.

I. INTRODUCTION

IT IS WELL KNOWN that impedances at ultra-high frequencies are best measured by terminating a transmission line with the unknown impedance and observing the shape and position of the standing waves on the line by means of a traveling detector.¹ Whatever the relationship between probe input power and output meter indication, calibration of the system permits determination of the true nature of the standing waves.² However, this calibration must be repeated for different angles of probe input power and whenever a significant

change has been made in the detector system. By means of the methods to be described, knowledge of the law of the detector becomes unnecessary, the expressions for the VSWR being independent of detector characteristics.

II. METHODS FOR OBTAINING THE VSWR ON LOSSLESS TRANSMISSION LINES USING A LOSSLESS SHORTING TERMINATION

For any standing wave on a smooth, lossless, arbitrarily terminated transmission line, the voltage distribution curve is given by the equation³

$$V^2 = V_{\min}^2 \cos^2 2\pi \frac{l}{\lambda} + V_{\max}^2 \sin^2 2\pi \frac{l}{\lambda} \quad (1)$$

where V is the voltage at distance l from a position of minimum voltage V_{\min} . Letting $l = \Delta/2$ and $\theta = \pi\Delta/\lambda$, (1) becomes

$$V^2 = V_{\min}^2 \cos^2 \theta + V_{\max}^2 \sin^2 \theta. \quad (2)$$

Equation (2) represents the true voltage distribution on a loaded line as shown in Fig. 1(a).

For two values of voltage V_{L1} and V_{L2} (2) can be written:

$$\begin{aligned} V_{L2}^2 &= V_{L\max}^2 \sin^2 \theta_{L2} + V_{L\min}^2 \cos^2 \theta_{L2} \\ \text{and} \quad V_{L1}^2 &= V_{L\max}^2 \sin^2 \theta_{L1} + V_{L\min}^2 \cos^2 \theta_{L1}. \end{aligned} \quad (3)$$

Similarly, for the voltage distribution on a shorted

* Decimal classification: R244.21. Original manuscript received at the Institute, October 28, 1948; revised manuscript received, October 24, 1949. Presented, Joint Meeting, American Section, URSI, and Washington Section, IRE, Washington, D. C., May 4, 1948. The material in this paper was used as the basis of a thesis for the M.E.E. degree at the Polytechnic Institute, Brooklyn, N. Y.

† Formerly, Naval Research Laboratory, Washington, D. C.; now, Naval Air Development Center, Johnstown, Pa.

¹ "The Technique of Microwave Measurements," Editor, C. G. Montgomery, McGraw-Hill Book Co., Inc., New York, N. Y., chap. 19, 1947.

² See p. 497 of footnote reference 1.

³ R. M. Redheffer, "The measurement of high reflections at low power," MIT Rad. Lab. Report 483-7, p. 1; November 20, 1944.

transmission line shown in Fig. 1(b), for which $V_{min}=0$, (2) can be written

$$\begin{aligned} V_{S2}^2 &= V_{Smax}^2 \sin^2 \theta_{S2} \\ V_{S1}^2 &= V_{Smax}^2 \sin^2 \theta_{S1}. \end{aligned} \tag{4}$$

and

is made equal to V_{S1} , (6b) can be equated to (6d). Equations (6a, b, c, and d) can thus be combined, giving

$$\frac{V_{Smax}^2 \sin^2 \theta_{S2}}{V_{Smax}^2 \sin^2 \theta_{S1}} = \frac{V_{Lmax}^2 \sin^2 \theta_{L2} + V_{Lmin}^2 \cos^2 \theta_{L2}}{V_{Lmax}^2 \sin^2 \theta_{L1} + V_{Lmin}^2 \cos^2 \theta_{L1}} \tag{7}$$

Recalling that the VSWR, ρ_L is equal to V_{Lmax}/V_{Lmin} , (7) becomes, after solving for ρ_L^2 ,

$$\rho_L^2 = \frac{\frac{\sin^2 \theta_{S2}}{\sin^2 \theta_{S1}} \cos^2 \theta_{L1} - \cos^2 \theta_{L2}}{\sin^2 \theta_{L2} - \frac{\sin^2 \theta_{S2}}{\sin^2 \theta_{S1}} \sin^2 \theta_{L1}} \tag{8}$$

Equation (8) thus gives the VSWR as a function of four measurable angles, the expression being independent of the detector characteristics at each of the two voltage levels at which the angles were measured.

When the current maxima on the loaded line are observable, they can be used as the higher current level, thereby making $\theta_{L2}=90^\circ$ in (8). This will usually be the case when low VSWR's are to be measured. When current minima are observable they can be used as the lower current level, making $\theta_{L1}=0^\circ$ in (8). This will generally be the case except when noise obscures the current minima. When the line is shorted, it is most convenient to make the maximum current on the shorted line equal to the higher current level used on the loaded line thereby making $\theta_{S2}=90^\circ$ in (8). These simplifications are summarized in Table I, recalling that $\theta = \pi\Delta/\lambda$. Nomographs of the equations can be made, the one for (9b) being shown in Fig. 2 and the curve for (9d) in Fig. 3.

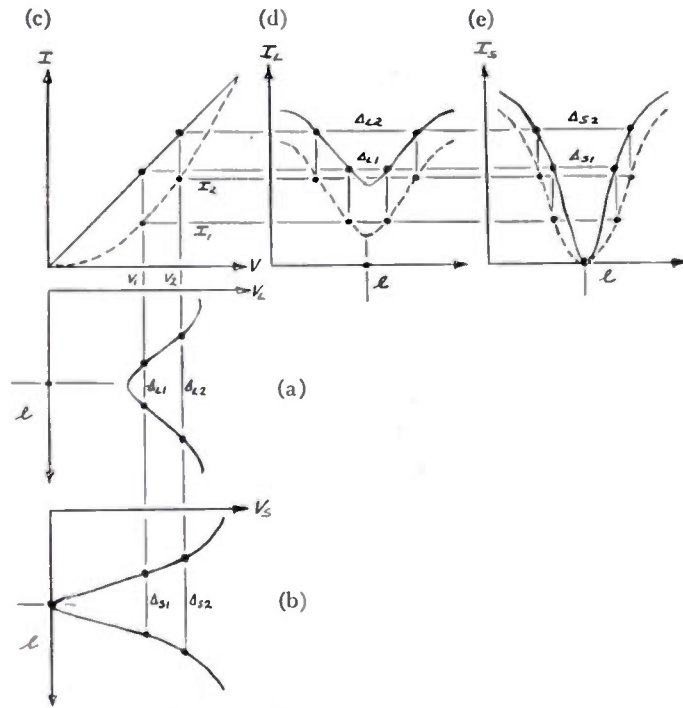

Fig. 1—Effect of detector characteristics on transmission line voltage distributions.

Shown in Fig. 1(c) are a linear detector characteristic (solid curve) and a nonlinear characteristic (dashed curve), with Figs. 1(d) and 1(e) showing the true voltage distributions (solid curves) which would be obtained from the linear detector and the indicated voltage distributions (dashed curves) which would be obtained from the nonlinear detector.

At any regular point of the nonlinear detector characteristic of Fig. 1(c), the input voltage will be some function of the output current, i.e.,

$$V^2 = f(I) \tag{5}$$

the particular form of the function depending only on the operating point considered. Substituting for V^2 into (3) and (4) gives

$$V_{Lmax}^2 \sin^2 \theta_{L2} + V_{Lmin}^2 \cos^2 \theta_{L2} = f(I_{L2}) \tag{6a}$$

$$V_{Lmax}^2 \sin^2 \theta_{L1} + V_{Lmin}^2 \cos^2 \theta_{L1} = f(I_{L1}) \tag{6b}$$

$$V_{Smax}^2 \sin^2 \theta_{S2} = f(I_{S2}) \tag{6c}$$

$$V_{Smax}^2 \sin^2 \theta_{S1} = f(I_{S1}). \tag{6d}$$

In effect, the substitution by means of (5) transforms the true voltage distributions of Figs. 1(d) and (e) into the indicated voltage distributions, the angles θ_{L2} , θ_{L1} , θ_{S2} , and θ_{S1} remaining unchanged during the transformation. If V_{L2} is made equal to V_{S2} , then $f(I_{L2})$ is equal to $f(I_{S2})$ and (6a) can be equated to (6c). Similarly, if V_{L1}

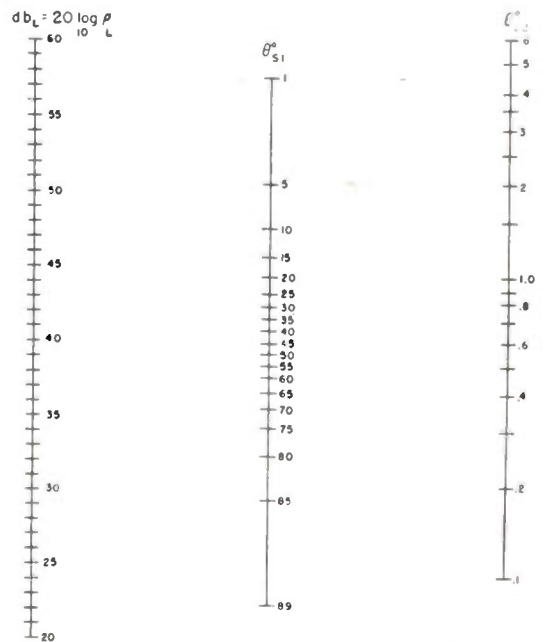

Fig. 2—Nomograph for method B of Table I.

An expression for the law of the detector can be obtained by making the assumption that the response of

the detector has the form

$$I = kV^n \tag{10}$$

where n is constant. It can be shown that for the methods of Table I the "law" of the detector is given by⁴

$$n = \frac{\log_{10} (I_2/I_1)}{\log_{10} \csc \theta_{S1}} \tag{11}$$

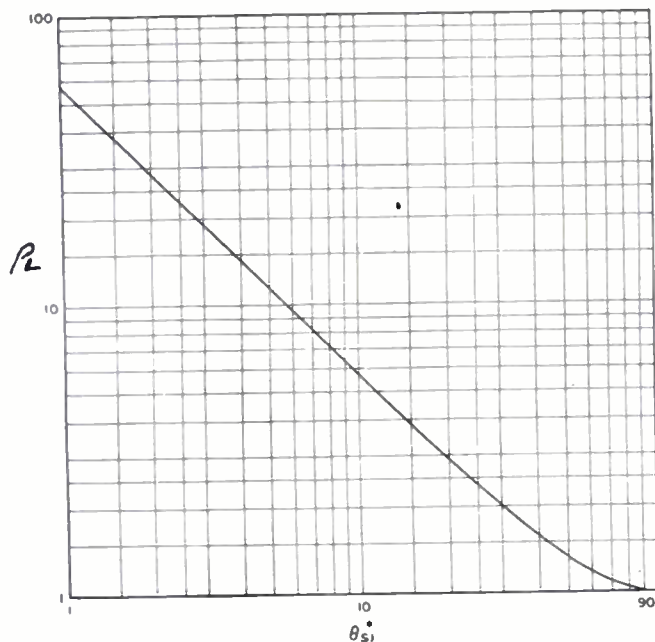

Fig. 3—Graph for method D of Table I.

III. METHODS FOR OBTAINING THE VSWR ON LOSSLESS TRANSMISSION LINES WITHOUT USING A SHORTING TERMINATION

Referring to Fig. 4, two voltage distributions on a loaded line are shown, that of Fig. 4(b) being for a some-

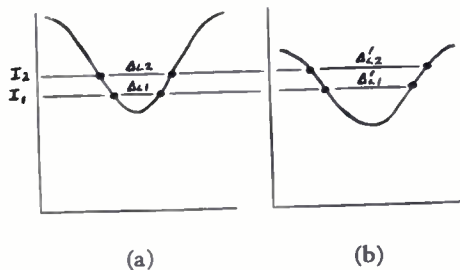

Fig. 4—Effect of power input on current distribution; (a) loaded line input power = P and (b) loaded line input power $< P$.

what lower input power than that of Fig. 4(a). Setting up equations similar to (6) and combining, we obtain

$$\frac{V_{Lmax}^2 \sin^2 \theta_{L2} + V_{Lmin}^2 \cos^2 \theta_{L2}}{V_{Lmax}^2 \sin^2 \theta_{L1} + V_{Lmin}^2 \cos^2 \theta_{L1}} = \frac{V_{Lmax}'^2 \sin^2 \theta_{L2}' + V_{Lmin}'^2 \cos^2 \theta_{L2}'}{V_{Lmax}'^2 \sin^2 \theta_{L1}' + V_{Lmin}'^2 \cos^2 \theta_{L1}'} \tag{12}$$

Recalling that

$$\rho_L = \frac{V_{Lmax}}{V_{Lmin}} = \frac{V_{Lmax}'}{V_{Lmin}'}$$

(12) is solved for ρ_L^2 giving

$$\rho_L^2 = \frac{\cos^2 \theta_{L1}' \cos^2 \theta_{L2} - \cos^2 \theta_{L2}' \cos^2 \theta_{L1}}{\sin^2 \theta_{L1}' \sin^2 \theta_{L2} - \sin^2 \theta_{L2}' \sin^2 \theta_{L1}} \tag{13}$$

TABLE I

	Current Distributions		Formula for VSWR	Useful for Measurement of	When Load Minima Are
	Loaded Line	Shorted Line			
A			$\rho_L^2 = \frac{\cos^2 \theta_{L1} - \cos^2 \theta_{L2} \sin^2 \theta_{S1}}{\sin^2 \theta_{S1} \sin^2 \theta_{L2} - \sin^2 \theta_{L1}}$ (9a)	High VSWR	Obscured
B			$\rho_L^2 = \frac{\cot^2 \theta_{S1}}{\sin^2 \theta_{L2}} + 1$ (9b)	High VSWR	Obtainable
C			$\rho_L^2 = \frac{\cos^2 \theta_{L1}}{\sin^2 \theta_{S1} - \sin^2 \theta_{L1}}$ (9c)	Low VSWR	Obscured
D			$\rho_L = \csc \theta_{S1}$ (9d)	Low VSWR	Obtainable

⁴ H. Krutter, "A simple method for determination of the law of a crystal," MIT Rad. Lab. Report 54-22; April 29, 1943.

Letting $\theta_{L1} = 0^\circ$, $\theta_{L2}' = 90^\circ$ gives the conditions of Fig. 5, and (13) becomes

$$\rho_L = \frac{\cot \theta_{L1}'}{\tan \theta_{L2}} \quad (14)$$

A nomograph of (14) appears in Fig. 6.

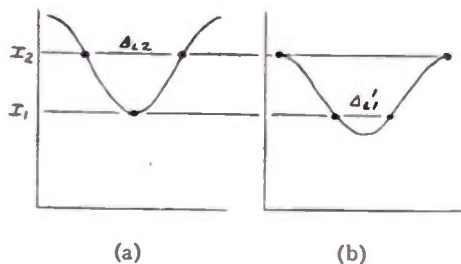

Fig. 5—Method for measuring VSWR without using a shorting termination; (a) loaded line input power = P and (b) loaded line input power $< P$.

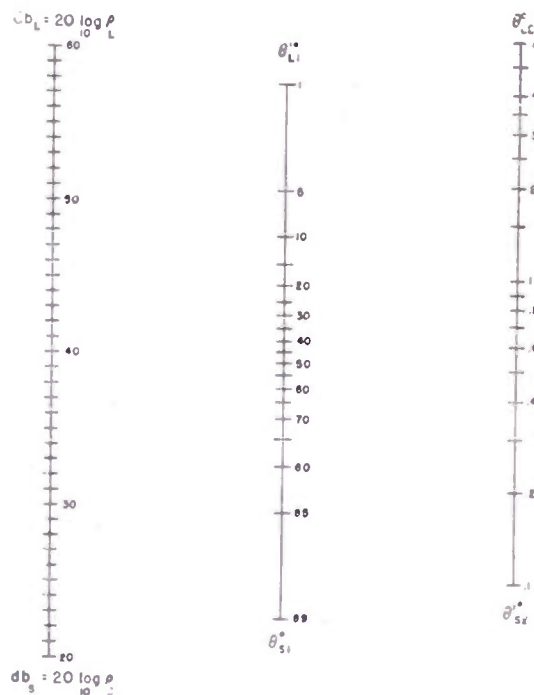

Fig. 6—The figures at the top of the nomograph refer to the determination of ρ_L in method of Fig. 5, and the figures at the bottom refer to the determination of ρ_S in method of Fig. 8.

IV. METHODS FOR OBTAINING THE VSWR ON LOSSLESS TRANSMISSION LINES INCLUDING THE EFFECT OF A LOSSY SHORTING TERMINATION

If the short circuit is lossy, the minimum voltage on the shorted line will not be equal to zero, the conditions of Fig. 7 being obtained.

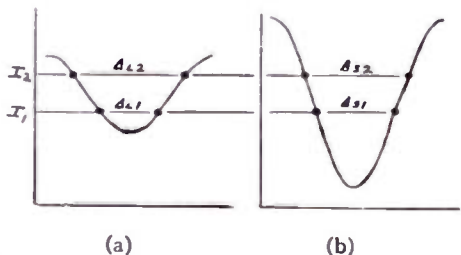

Fig. 7—Effect of lossy short on shorted line current distribution; (a) loaded line, and (b) line terminated with lossy short.

Writing the equations at the current levels I_1 and I_2 for loaded and shorted lines and combining, we have

$$\frac{V_{Lmax}^2 \sin^2 \theta_{L2} + V_{Lmin}^2 \cos^2 \theta_{L2}}{V_{Lmax}^2 \sin^2 \theta_{L1} + V_{Lmin}^2 \cos^2 \theta_{L1}} = \frac{V_{Smax}^2 \sin^2 \theta_{S2} + V_{Smin}^2 \cos^2 \theta_{S2}}{V_{Smax}^2 \sin^2 \theta_{S1} + V_{Smin}^2 \cos^2 \theta_{S1}} \quad (15)$$

Letting $\rho_L = V_{Lmax}/V_{Lmin}$ and $\rho_S = V_{Smax}/V_{Smin}$, and solving for ρ_L^2 we obtain

$$\rho_L^2 = \frac{Q \cos^2 \theta_{L1} - \cos^2 \theta_{L2}}{\sin^2 \theta_{L2} - Q \sin^2 \theta_{L1}} \quad (16)$$

and

$$Q = \frac{\rho_S^2 \sin^2 \theta_{S2} + \cos^2 \theta_{S2}}{\rho_S^2 \sin^2 \theta_{S1} + \cos^2 \theta_{S1}}$$

Letting $\theta_{L1} = \theta_{S2} = 90^\circ$ and $\theta_{L1} = 0^\circ$, the conditions of Fig. 8(a and b) are obtained, and (16) becomes

$$\rho_L^2 = \frac{\rho_S^2}{\rho_S^2 \sin^2 \theta_{S1} + \cos^2 \theta_{S1}} \quad (17)$$

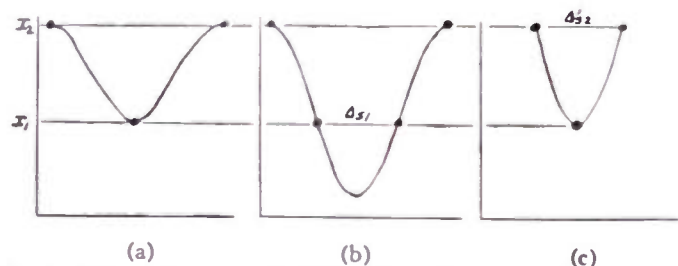

Fig. 8—Method for measuring VSWR including effect of lossy shorting termination: (a) loaded line, (b) line terminated with lossy short, low input power, and (c) line terminated with lossy short, high input power.

ρ_S can be determined as in Fig. 5 by increasing the power to the short circuited line as shown in Fig. 8(c). Comparison of Fig. 8(b) and (c) with Fig. 5 shows that ρ_S can be determined from (14) or Fig. (6).

$$\rho_S = \frac{\cot \theta_{S1}}{\tan \theta_{S2}'} \quad (18)$$

Substituting for ρ_S in (17) gives

$$\rho_L = \frac{\cos \theta_{S2}'}{\sin \theta_{S1}} \quad (19)$$

A nomograph of (19) is shown in Fig. 9.

V. EXTENSION OF THE METHODS FOR OBTAINING THE VSWR TO ATTENUATING TRANSMISSION LINES

For lines with attenuation it can be shown that the VSWR of the load is given by⁶

$$\rho_L = \frac{\rho_S' \rho_L' - 1}{\rho_S' - \rho_L'} \quad (20)$$

By means of this equation, the true value of VSWR at the load ρ_L can be obtained by measuring the VSWR on a shorted line ρ_S' at approximately the same point it was obtained on the loaded line ρ_L' , the distance from the measuring point to the load point being immaterial.

⁶ G. Glinski, "The solution of transmission line problems in the case of attenuating transmission line," *Trans. AIEE (Elec. Eng., February, 1946)*, vol. 65, p. 46; February, 1946.

It is evident that to obtain ρ_L' or ρ_S' by using the value of V_{max} as obtained at one point and the value V_{min} as obtained at a point $\lambda/4$ from the maximum is not strictly correct. However, values of V_{max} and V_{min} for both the loaded and shorted cases can be obtained within a length of the line equal to $\lambda/2$. For simplicity it must thus be assumed that although the line is attenuating, the attenuation of a half-wave length of the line is negligible. This requirement is fulfilled by well-designed transmission lines. The voltage distribution within a half-wave region can then be expressed by the same voltage distribution used in the lossless line case. Thus, for the loaded line case

$$V_L^2 = V_{Lmax}^2 \sin^2 \theta_L + V_{Lmin}^2 \cos^2 \theta_L \quad (21)$$

while for the shorted line case

$$V_S^2 = V_{Smax}^2 \sin^2 \theta_S + V_{Smin}^2 \cos^2 \theta_S. \quad (22)$$

However, these conditions are the same as those used in Section IV where the effect of lossy shorting termination was to give a small but finite value of V_{Smin} on the shorted line. The methods described in that section can be used here. However, the quantity ρ_L in section IV now becomes ρ_L' in (20). The quantity ρ_S' in (20) is given by (18). Consider the method of Fig. 8, for which

$$\rho_S' = \frac{\cot \theta_{S1}}{\tan \theta_{S2}'} \quad (18)$$

and

$$\rho_L' = \frac{\cos \theta_{S2}'}{\sin \theta_{S1}} \quad (19)$$

Substituting these into (20) gives

$$\rho_L = \frac{\cot \theta_{S1} \cos \theta_{S2}' - \tan \theta_{S2}' \sin \theta_{S1}}{\cos \theta_{S1} - \sin \theta_{S2}'} \quad (23)$$

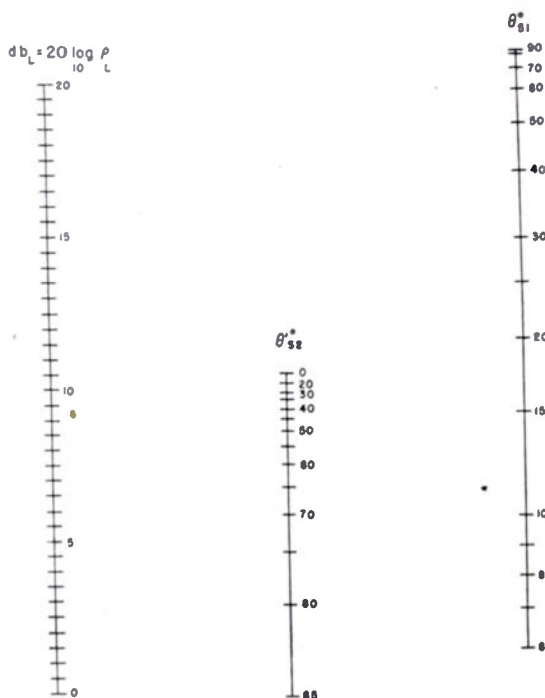

Fig. 9—Nomograph for method of Fig. 8.

Using (23) with the method of Fig. 8 automatically includes the effect of line attenuation as well as the effect of detector law and lossy short.

VI. DISCUSSION OF THE APPLICATION OF THE METHODS TO ACTUAL MEASUREMENTS

The foregoing equations have been derived assuming only the validity of the lossless transmission line equations which have been thoroughly verified experimentally. It is realized that the formulas presented will be of interest only when precise measurements of impedance are to be made. In that event, it is necessary that such problems as power and frequency stability of the applied signal and uniformity of the transmission line will have to be solved. To avoid distortion of the standing-wave pattern, small probe penetrations will have to be used. These requirements having been met, the remaining factor in applying the equations is the accuracy with which the quantity Δ can be determined. This quantity Δ in turn depends on the accuracy with which the positions corresponding to certain current levels can be obtained. Since it is the difference of two positions which determines Δ , errors in determination of each of the positions are likely to cancel if consistent measurement techniques are used. In any event, the nomographs and equations themselves can be used to determine the range over which the VSWR varies when one of the methods is used. Referring to Fig. 10, suppose the use of method B of Table I results in a measured variation of θ_{S1} from A to B while θ_{L2} varies from C to D. The range of variation of ρ_L will be obtained from the nomograph as the values between E and F.

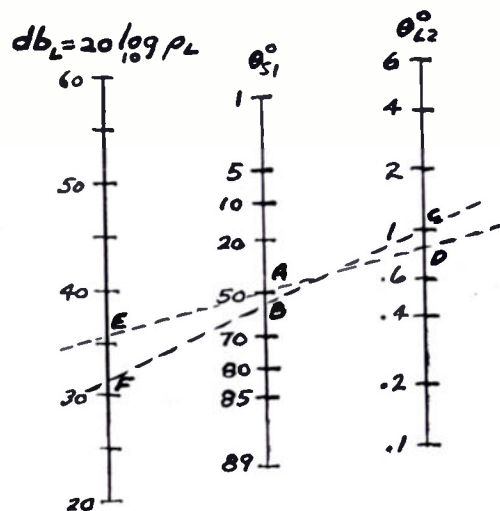

Fig. 10—Method for evaluating the range of VSWR values obtainable with method B of Table I.

The main features of the methods presented are that no assumption as to detector characteristics is required and that no independent detector calibration is necessary. Only a small amount of additional data is needed and computation is minimized by the use of nomographs.

It is hoped that future measurements will make it possible to determine more completely the relative merit of the various methods previously described.

Shunt-Excited Flat-Plate Antennas with Applications to Aircraft Structures*

J. V. N. GRANGER†, MEMBER, IRE

Summary—A shunt-excited flat-plate antenna is a structure comprised of a thin rectangular plate and a shunt-feeding circuit formed by a wire lying in the plane of the plate parallel and close to one of its long edges, the extremities of the wire being electrically bonded to the plate, and the wire broken at its center to provide driving terminals. In this paper, the electrical characteristics of this structure are examined experimentally and in terms of a simplified mechanism by means of which these characteristics can be predicted in a qualitative manner. The effect on these characteristics of the various important geometrical parameters is illustrated by measured data, and shown to conform to the predicted behavior. Two ways in which this structure may be used as the basis for low-drag antennas for high-speed aircraft are discussed in some detail.

I. INTRODUCTION

THE POSSIBILITY of utilizing the metallic structure of an aircraft as an antenna has attracted the interest of aeronautical radio engineers for many years. Such a device is desirable for several reasons. At the lower frequencies, where the wavelength may be several times the maximum dimensions of the aircraft, the aircraft structure itself represents a highly conducting metallic surface of the largest dimensions available, and hence should be capable of providing the best electrical performance possible within the limitations set by the air-frame dimensions. The mechanical problem of supporting a wire antenna, either fixed or trailing, can be circumvented in this way. Utilization of the air frame as an antenna offers the possibility of reducing parasite drag, or wind resistance, which has become a very serious problem as the speed of modern aircraft has been increased. In addition, the problems encountered in the use of conventional wire antennas with respect to icing, precipitation static, interference to the coverage of gun turrets in military aircraft, and interference to personnel in ground maintenance would be largely removed by the use of the aircraft structure itself as an antenna. This paper discusses some of the results obtained by earlier workers in this field, and presents information on a new technique for accomplishing this purpose which appears to have important potential applications.

II. HISTORICAL

Early attempts to achieve the excitation of the aircraft structure as a radiator were relatively unsuccessful.

* Decimal classification: R525XR326.21. Original manuscript received by the Institute, June 13, 1949; revised manuscript received, November 28, 1949. Presented, Joint Meeting, URSI, American Section, and IRE, Washington Section, Washington, D. C., October 21, 1947; also 1948 IRE National Convention, New York, N. Y., March 22, 1948. This work was conducted under Office of Naval Research Contract N5ori-76, Task Order No. 1.

† Formerly, Cruft Laboratory, Harvard University, Cambridge, Mass.; now, Aircraft Radio Systems Laboratory, Stanford Research Institute, Stanford, Calif.

A structure typical of those employed is sketched in Fig. 1(a).¹ A feed wire was brought out of the fuselage by means of a feed-through insulator, and bonded to the

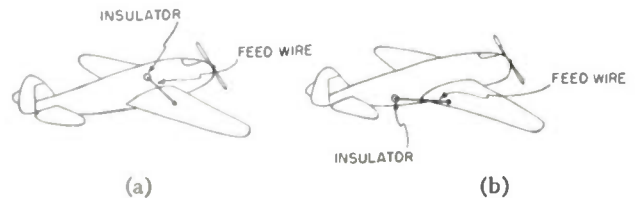

Fig. 1—(a) Sketch of an early method for shunt feed of an aircraft structure as an hf antenna; (b) shunt-feed arrangement which results in improved electrical characteristics.

upper surface of the wing a few feet outboard of the wing root. The plane of the feed wire was approximately perpendicular to the wing chord. The resulting structure resembles the "delta-match" antenna,² or the shunt-fed broadcast tower described by Morrison and Smith.³ For frequencies at which the wing span is in the order of a half wavelength, some excitation of the dipole mode along the wing is obtained, as can be seen from Fig. 2. In this figure is plotted the measured distribution of current amplitude along the periphery of the air frame. The measurements shown were made on a scale model of a JU-52 trimotor aircraft. The relative amplitude of surface-current density at each point is indicated by the length of the line drawn perpendicular to the air-frame surface at that point. The direction of current at a particular instant in the rf cycle is shown by the arrows. At

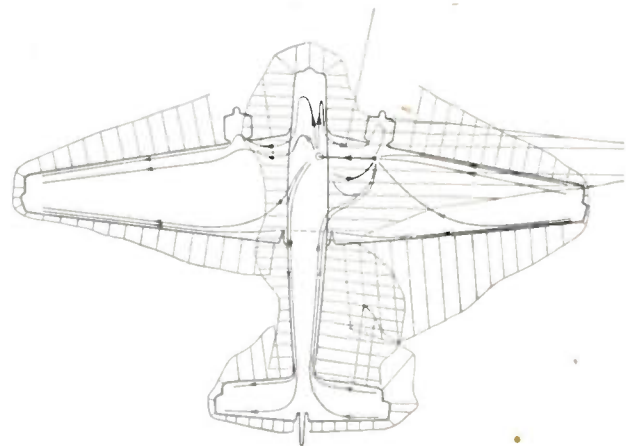

Fig. 2—Current distribution measured on a JU-52 aircraft with shunt-feed excitation of the wing. The length of the lines drawn perpendicular to the air frame is proportional to the amplitude of the current density at that point. The direction of the current at one instant of the rf cycle is shown by the arrows.

¹ G. L. Haller, "Aircraft antennas," *Proc. I.R.E.*, vol. 30, pp. 357-362; August, 1942.

² "The Radio Amateur's Handbook," American Radio Relay League, West Hartford, Conn.

³ J. F. Morrison and P. H. Smith, "The shunt-excited antenna," *Proc. I.R.E.*, vol. 25, p. 673; June, 1937.

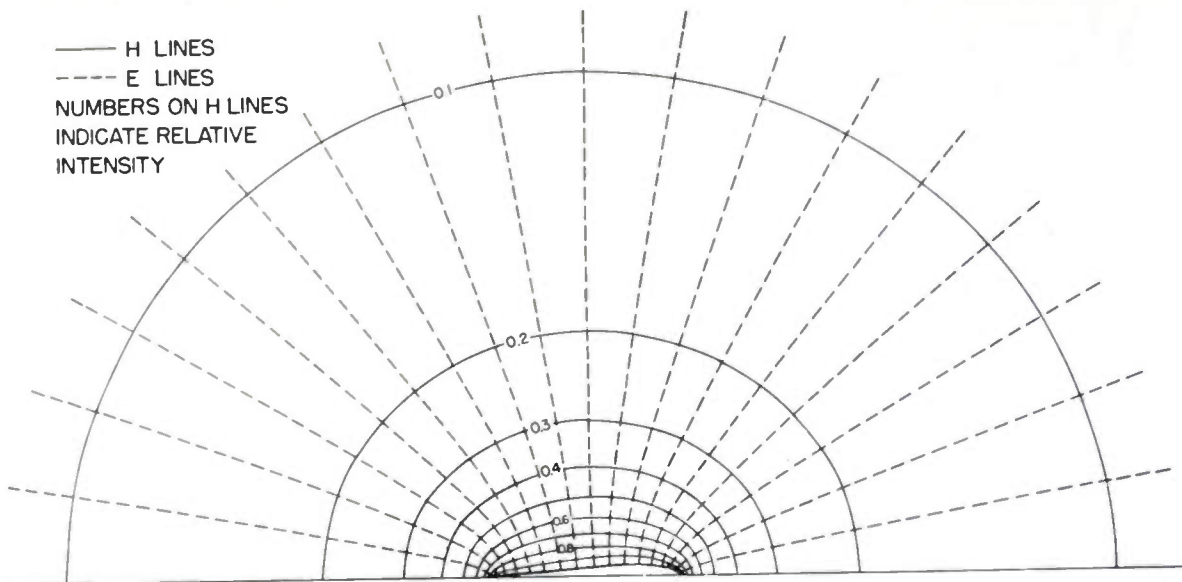

Fig. 4.—Calculated electric and magnetic field contours around a conductor of symmetrical air-foil cross section. The dashed lines refer to electric field and the solid lines to magnetic field. The numbers indicate relative intensity. Only half of the plot is shown. The other half is a mirror image of this figure.

the frequency used the wing span is a half wavelength.⁴ This structure is open to a number of objections. Its aerodynamic characteristics are poor, and the exposed feed wire introduces considerable parasite drag and is

susceptible to icing.⁵ Moreover, the input impedance characteristic is poorly adapted to the equipment with which the antenna system is conventionally employed. The measured input impedance of such a structure is shown by curves R_A and X_A of Fig. 3. The data shown were measured at full scale on an SNJ-4 aircraft, mounted on a wooden tower approximately 30 feet above the ground. An exceedingly wide range of resistance and reactance is encountered, which complicates very seriously the problem of providing suitable antenna-matching circuits of high power-transfer efficiency. One advantage is present, however. Over a wide band of frequencies in the lower end of the range the input reactance is positive, so that the antenna can be resonated with a capacitor which can be designed so that the tuning circuit losses are negligible. Conventional aircraft antennas exhibit high negative reactances in this frequency range, and lead to serious power losses in the loading coils needed to resonate the antenna. Loading coil losses are responsible for antenna circuit efficiencies as low as 10 per cent in many instances.⁶

The reason for the extremely wide variations of input impedance obtained with the antenna of Fig. 1(a) is the relatively poor coupling between the feed circuit and the dipole currents along the wing. For "tight" coupling, it is evidently a requirement that the exciting loop, consisting of the shunt-feed conductor and its return circuit through the wing, intercept within its limited area a maximum number of the magnetic flux linkages which surround the wing when it is oscillating in the dipole mode. The asymmetrical nature of the wing cross section leads to an asymmetrical distribution of magnetic flux in its local field. A knowledge of the nature of this

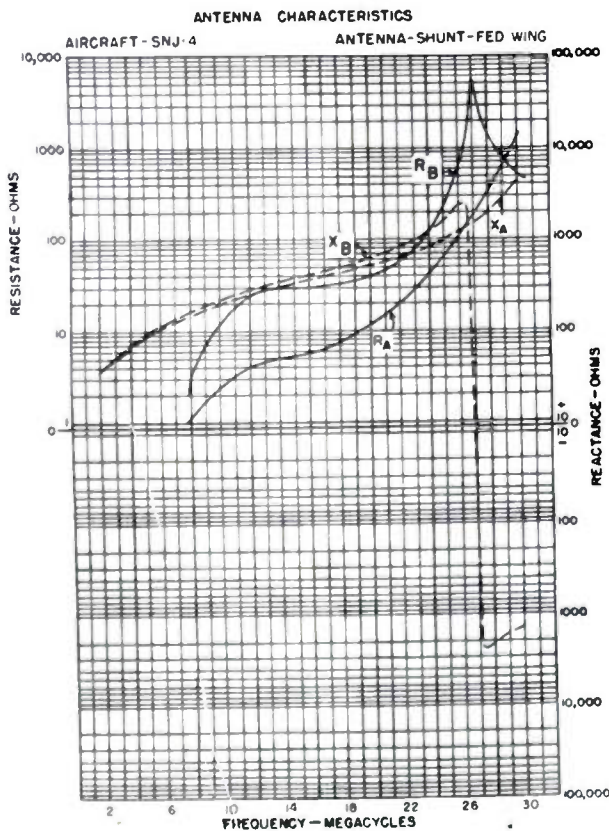

Fig. 3—Input impedance data on the antenna structures of Fig. 1. Curves labelled *A* refer to the arrangement shown in Fig. 1(a) and curves labelled *B* refer to Fig. 1(b).

⁴ Similar distribution plots made at full scale on an actual JU-52 are given in Pippel and Baerner, "Strom- und Spannungs-Verteilung auf Hochfrequent Schwingenden Flugzeugen," Forschungsbericht Nr. 915 Flugfunk-Forschungsinstitut Oberpfaffenhofen; February 28, 1938. USAF translation No. 511 Air Technical Service Command.

⁵ See p. 357 of footnote reference 1.

⁶ P. C. Sandretto, "Aeronautical Radio Engineering," McGraw-Hill Book Co., Inc., New York, N. Y.; 1941.

local field is important to an understanding of the shunt-feed problem. If the wing chord is a small fraction of a wavelength, as is the case here, the field distribution near the wing surface is adequately pictured by considering the static case. It is possible to utilize the well-known Joukowski transformation⁷ of conformal mapping to obtain a picture of the flux distribution near a conductor of air-foil cross section by transformation of the field map for a conductor of circular cross section. The resulting plot is shown in Fig. 4. The figure shows that the magnetic flux density near the surface is much greater near the leading and trailing edges of the air foil than anywhere along its "flat" surfaces. It follows that "tightest" coupling is obtained if the shunt-feed conductor lies in the plane of the wing. In addition, the largest share of coupling is due to those flux lines which pass through the area of the exciting loop closest to the wing, because of the rapid decrease in flux density with distance from the conductor. A modification of the original shunt-feed arrangement which results in tighter coupling is sketched in Fig. 1(b). The impedance curves labeled *B* of Fig. 3 illustrate the resulting improvement in the impedance characteristic.

III. SHUNT-FED FLAT PLATES

A consideration of the problem of effective shunt coupling led to the conclusion that the optimum degree of coupling would be obtained if the shunt-feed conductor were placed parallel to and a short distance from the leading or trailing edge of the wing.⁸ Interference with the normal functions of the control surfaces would seem to preclude the location of the feed wire along the trailing edge, and a practical form of the structure might be that sketched in Fig. 5. Use of a symmetrical structure would yield higher input resistance, fewer difficulties from circulating "ground" currents, and a symmetrical radiation pattern. The feed wire could be immersed entirely within the aircraft structure by undercutting the leading edge of the wing and replacing the cut-away portion with a suitable insulating fairing. The aerodynamic disadvantages of the previous structures could thus be eliminated completely. In some designs of aircraft, the leading edge of the wing is covered with a rubber "de-icing boot" which might interfere with the

operation of the new antenna. De-icing boots are not used in most of the newer high-speed aircraft. The electrical properties of the resulting structure remain to be investigated.

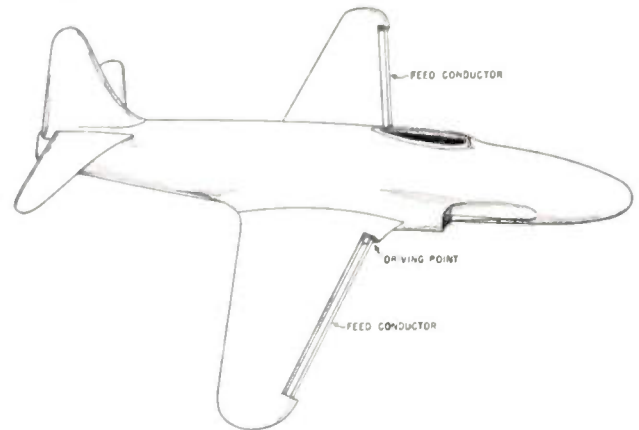

Fig. 5.—Sketch of a possible arrangement for shunt excitation of an aircraft structure as an hf antenna in which the entire antenna structure may be constructed within the aerodynamic contours of the air frame. In practice, the under-cut portion of the leading edge of the wing would be replaced by a suitable insulating material to preserve the required wing contour.

Fig. 5 suggests a relationship between this structure and the well-known folded dipole. While certain important structural differences are apparent, it may be expected that the electromagnetic properties of the folded dipole might serve as a useful guide to a study of the new structure. A simple and satisfactory theory of the operation of the folded dipole can be based on the notion of separating the currents on the structure into symmetrical and antisymmetrical components.⁹ When this is done, we find that the radiation pattern of a folded dipole is the same as that of a center-driven dipole of the same length, and that the input impedance of the folded dipole is given by the formula

$$Z_{in} = \frac{2Z_s Z_a}{Z_s + Z_a},$$

where Z_s is the impedance due to the symmetrical or "antenna" currents on the two conductors, and for ordinary folded dipoles is approximately twice the input impedance of a single center-driven dipole of the same length. Z_a is the impedance due to the antisymmetrical or "transmission-line" currents on the two conductors, and can be computed from the usual formulas for the input impedance of a short-circuited section of parallel-wire transmission line. Alternatively, one can write in admittance form

$$Y_{in} = \frac{1}{2}(Y_s + Y_a),$$

where the notation is equivalent to the above. The nature of the resulting impedance characteristic has been discussed previously.¹⁰

⁷ H. Glauert, "The Elements of Airfoil and Airscrew Theory," Cambridge University Press, London; 1946.
⁸ The initial work on this arrangement was commenced in 1946. In the spring of 1947, the release of a number of captured German documents by the Air Technical Service Command revealed that a similar scheme had been investigated by the Germans during the early part of the war. See "Ausgewählte Fragen über Theorie und Technik von Antennen," Part I, reports VI and VII, Zentrale für wissenschaftliches Berichtswesen der Luftfahrtforschung; Berlin, 1943. USAF translation No. F-TS-2222-RE, Air Materiel Command, Dayton, Ohio. A study of these and other reports from the same group of workers reveals that they came to the conclusion that since the measured input resistance appeared to increase linearly with the length of the shunted portion of the wing, and that this would be the behavior obtained if the resistance were due entirely to ohmic losses, the best efficiency obtainable was for very short lengths for the tapped portion. As a result, their best models had input resistances of about 1 ohm. The folded-dipole analogy developed here is not mentioned in the German work.
⁹ C. T. Tai, "The theory of coupled antennas and its applications," Cruft Laboratory Technical Report No. 12, April 30, 1947.
¹⁰ J. V. N. Granger, "A note on the broad band impedance characteristics of folded dipoles," Cruft Laboratory Technical Report No. 42, April 26, 1948.

For frequencies below that at which the over-all length of the antenna is a wavelength, the impedance variation takes the form sketched in Fig. 6, and is characterized by two antiresonances and two resonances. For conventional folded dipoles, the useful operating range in the fundamental mode lies between the first antiresonance and the second resonance, because the input resistance is very low for lower or higher frequencies. The behavior shown graphically in Fig. 6 is

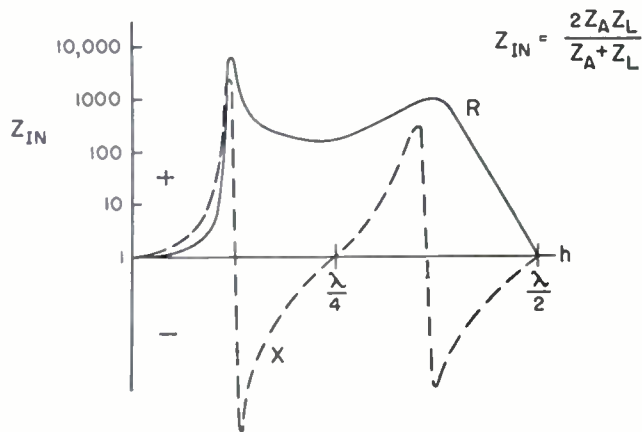

Fig. 6—Sketch of the input impedance of a symmetrical folded dipole of half-length h .

obtained by considering the structure to be made up of two closely spaced identical conductors of very small cross-sectional dimensions. This condition hardly obtains for the shunt-excited wing structure of Fig. 5. It is necessary, therefore, to investigate how this behavior is modified when one conductor of the folded dipole is extended to form what is, for all practical purposes, a flat plate.

IV. THE EFFECT OF THE FLAT PLATE

The theoretical analysis of coupled antennas, which forms the basis of the existing theory of the folded dipole, is restricted to the case of the coupling between identical wires.¹¹ The extension of the analysis to the case of dissimilar conductors involves the simultaneous solution of two integrodifferential equations and does not admit of a general solution. The behavior of shunt-excited flat plates has therefore been investigated experimentally. Figs. 7 and 8 show a family of curves of the input resistance and reactance, respectively, of shunt-excited flat plates for a variety of widths of plate. The plates used were all of rectangular cross section, with a thickness equal to the diameter of the circular feed conductor and equal to 0.0056 times the half-length of the antennas. The widths used varied over a range of from one-half the half-length of the antenna to approximately the thickness of the plate, so that the limiting case of narrowest width approximates very closely the conventional symmetrical folded dipole.

The antiresonances which occur near $h/\lambda = 0.15$ and 0.32 are due to the differences in sign between the symmetrical and antisymmetrical susceptances in these regions and the equality of their magnitudes at the antiresonant frequencies. The magnitude of $R_{in(max)}$ at these frequencies is determined by the loading due to radiation. The resonant impedance of the antenna is due almost entirely to the symmetrical current mode, since

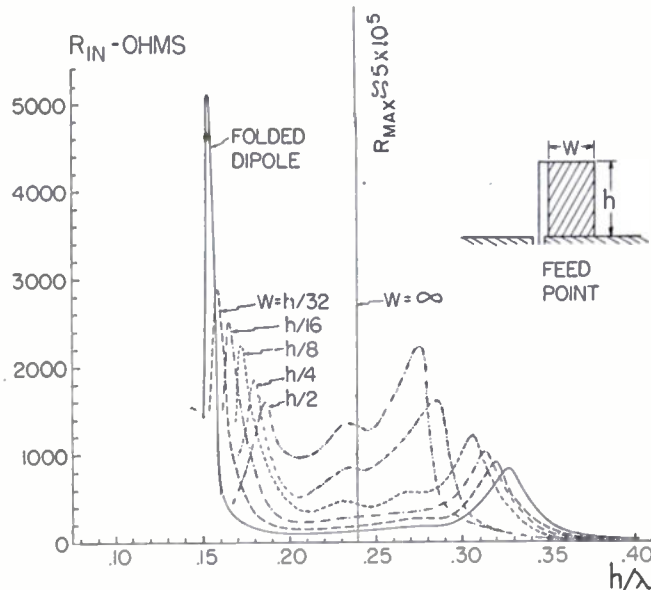

Fig. 7—Input resistance of a family of shunt-excited flat-plate dipoles. The monopole equivalent of the structure is sketched in the upper right corner of the figure to illustrate the notation used.

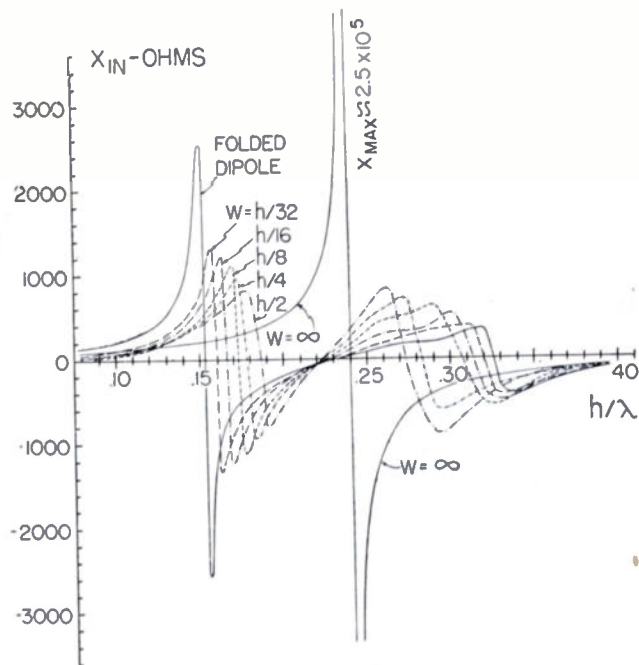

Fig. 8—Input reactance of the corresponding structures of Fig. 7.

near $h = 0.25\lambda$ the short-circuited section of transmission line formed by the feed conductor and the plate for antisymmetrical currents offers a very high shunting reactance. That is to say, at resonance $Z_a \rightarrow \infty$, ($Y_a \rightarrow 0$),

¹¹ See footnote reference 9.

so

$$Z_{in} = \frac{2Z_0 Z_\lambda}{Z_\lambda} = 2Z_0$$

or

$$Y_{in} = \frac{1}{2}Y_0$$

For the folded dipole $Z_{a(\text{resonance})} = 2Z_0$ where Z_0 is the input impedance of a center-driven dipole of half-length h . Substituting in the above expression yields

$$Z_{in(\text{resonance})} \doteq 4Z_0 \text{ for the folded dipole,}$$

which is the usual result. For flat-plate structures the symmetrical component of the current tends to flow more on the flat plate and less on the feed conductor as the plate width is increased. This effect results in an increase of Z_a at resonance, since Z_a is defined in terms of the terminal (i.e., feed conductor) current. A comparison of the data of Figs. 7 and 8 near $h/\lambda = 0.25$ clearly illustrates this behavior. The case of infinite plate width is the logical upper limit of this effect. As the width of the plate increases indefinitely, the symmetrical terminal current tends toward zero, so that Z_a tends toward infinity. From the impedance formula

$$Z_{in} = \frac{2Z_\lambda}{10^{-\infty}} = 2Z_\lambda$$

so that the impedance characteristic of the limiting case is similar to that of a short-circuited line. The input resistance is then sensibly zero except at $h/\lambda = 0.25$, where it rises to a very high value. The input reactance is very nearly

$$X_{in} = Z_0 \tan\left(\frac{2\pi h}{\lambda}\right)$$

This curve is plotted in Fig. 8. Examination of Figs. 7 and 8 shows the trend of the impedance behavior toward these limits as the width is increased. The trend of the antiresonant peaks of resistance toward this limit is particularly clear.

Increasing the width of the plate lowers the characteristic impedance associated with the antisymmetrical or "transmission-line" mode. This results in a decrease of Z_a . Increasing plate width is also accompanied by an increase in Z_s , as noted above. When h is less than $\lambda/4$, X_a is inductive, X_s is capacitive. Increasing plate width thus results in a decrease in both the equivalent inductance and equivalent capacitance when h is less than $\lambda/4$, so that the first antiresonant frequency increases with increasing plate width. The increase in $Z_s = R_s + jX_s$ increases the equivalent series resistance at the first antiresonance, so that the input resistance at the first antiresonance decreases with increasing plate width. The variation of R_s with frequency for any given plate width is small in this region.

The effect of increasing plate width on the second antiresonance is quite different. When h lies between $\lambda/4$ and $\lambda/2$, X_a is capacitive and X_s is inductive. In-

creasing plate width thus serves to increase the equivalent L and C in this region, so that the frequency of the second antiresonance decreases with increasing plate width. The variation of Z_s with frequency has a form similar to that of the impedance characteristic of an ordinary dipole. In the region where h is somewhat larger than $\lambda/4$, R_{in} increases rapidly with frequency, so that the decrease of the second antiresonant frequency with increasing plate width is accompanied by a decrease in R_s which more than compensates for the increase in R_s due to increasing plate width. Hence, the input resistance at the second antiresonance increases with increasing plate width.

An interesting check on the validity of this simple mechanism for predicting the impedance characteristics of shunt-fed flat plates can be obtained in the following way. We have

$$Y_{in} = \frac{1}{2}(Y_s + Y_a)$$

or, since Y_a is assumed to be a pure susceptance

$$G_{in} = \frac{1}{2}G_s$$

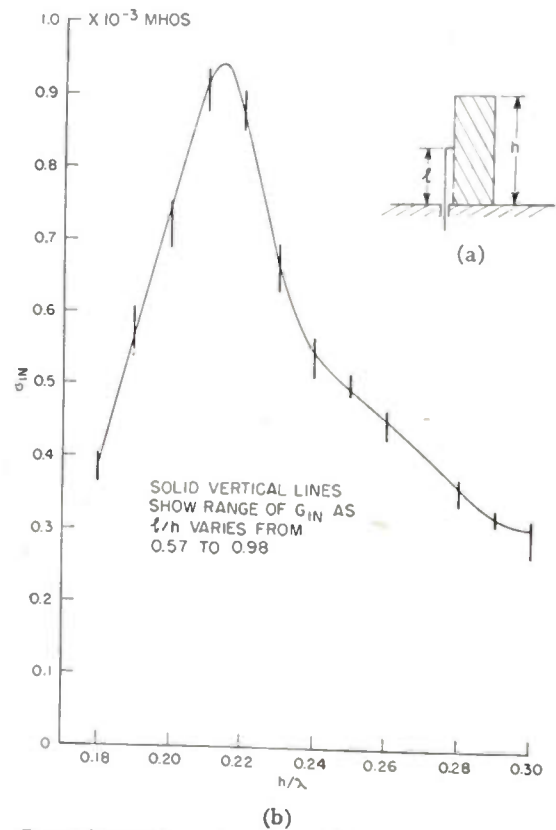

Fig. 9—Curve illustrating the effect on the input conductance of a shunt-excited flat-plate monopole as the length of the feed wire is varied.

Then, if the structure is changed in such a way that only Y_a is affected, G_{in} will not change. This can be done by tapping the junction of the feed conductor and the edge of the flat plate down to some intermediate point along the antenna. The resulting structure is sketched in Fig. 9(a). Impedance data on a series of such structures, al-

ready published elsewhere,¹² are replotted in admittance form as Fig. 9(b). The effect of varying the length of the feed conductor on these data is to produce a scatter of points about a single conductance curve. The "range of scatter" is approximately ± 5 per cent, or well within the experimental error in this particular set of data. Footnote reference 12 discusses the possible usefulness of tapped-down feeding as a means of controlling the impedance behavior of shunt-fed flat plates in any given frequency range.

It may be remarked as a matter of interest that the preceding discussion of the impedance characteristics of the shunt-fed flat plate may be applied equally well to folded dipoles in which the unbroken conductor has a circular cross section of larger diameter than that of the feed wire. The data of Figs. 7 and 8 may be used as a guide in estimating the performance of such structures by considering that a flat plate of width w can be replaced to a first approximation by a circular cylinder of diameter $w/2$.

V. APPLICATIONS TO AIRCRAFT AT HIGH FREQUENCIES

The shunt-excited flat-plate technique has been applied in the laboratory to two important aircraft antenna problems. In the first instance, the structure was investigated as an antenna system for high-frequency use on jet fighters. Fig. 5 shows a sketch of the system as installed on a one-tenth scale model of the F-80 aircraft. The feed conductor had a diameter of 0.0052 of the wing span (corresponding to 2.5 inches on the actual aircraft) and the total exposed length of the two feed conductors was made as large as possible, in this case 0.646 of the wing span. The feed conductor was set into an undercut portion of the leading edge, and surrounded by a plastic fairing. By this means a high-frequency antenna structure was obtained which had no exposed parts, and hence no parasite drag. The measured input impedance is plotted as a function of operating frequency (on the full-scale aircraft) in Fig. 10. A comparison with Figs. 7 and 8 indicates that in this case the entire operating range lies below the first antiresonance. At first thought this seems surprising, since the wing span is 0.56 wavelength at 14 Mc, and this point lies well above the first antiresonance for the cases of Figs. 7 and 8. Reference to Fig. 5 shows that the mechanical limitations imposed by the structure of the aircraft, in particular the wide spacing between the two feed points which is necessitated by the presence of the fuselage and air intake ducts, result in this case in a structure with a length of feed conductor that is much less than the total length of the antenna (i.e., the wing span). In spite of this limitation, the input impedance obtained is quite usable. At low frequencies the input resistance is low, i.e., only 1.1 ohms at 3 Mc. This figure looks somewhat more promising, however, when compared with data for wire antennas on aircraft of com-

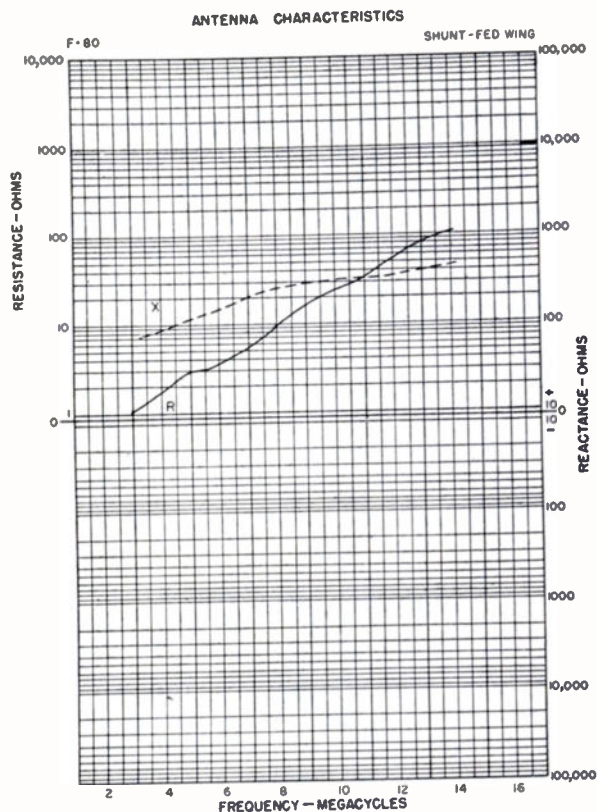

Fig. 10—Measured input impedance characteristic of the antenna structure shown in Fig. 5.

parable size. The mast-supported inverted-L antenna used on SNJ-4 aircraft, which is about the size of the F-80, has an input resistance of approximately 2 ohms at 3 Mc. In making a comparison between the two, the input reactance must be considered also. The SNJ-4 antenna has a negative input reactance of about 1,200 ohms at 3 Mc. If a loading coil is used to resonate the antenna, as is conventional, its losses may drastically lower the efficiency of the antenna system. For a loading coil with a Q of 200, the equivalent series loss resistance at 3 Mc would be 6 ohms, and the resulting antenna system efficiency would be less than 25 per cent. In contrast, an air-dielectric capacitor could be used to resonate the shunt-excited flat-plate structure, with a negligible increase in losses. The relative losses on the antenna structures themselves are harder to evaluate. D. D. King has compared the absorptive cross section of the shunt-excited flat plate with that of a linear dipole of the same over-all length.¹³ His measurements show that the absorptive cross section of the shunt-fed flat plate was at least as high as that of a dipole of the same over-all length, even when the feed conductor was tapped down to a point where its length was only one-fourth the length of the flat plate. From this it may be inferred that the presence of strong currents of the transmission-line (nonradiating) type on the shunt-fed structure results in no noticeable increase in antenna losses.

The azimuthal plane radiation pattern for the an-

¹² J. V. N. Granger, "Low-frequency aircraft antennas," Cruft Laboratory Technical Report No. 25, pp. 43ff.; December 30, 1947.

¹³ D. D. King, "The measurement and interpretation of antenna scattering," Proc. I.R.E., vol. 37, pp. 770-776; July, 1949.

tenna of Fig. 5, measured on a scale model at a frequency corresponding to 6 Mc on the actual aircraft is shown in Fig. 11 for horizontal polarization. The degree of uniformity obtained is remarkable, the maximum to minimum ratio being only 1.8:1. The absence of pronounced minima off the wing tips may be due to the fact that the two leading edges do not lie along a straight line, but form an angle of 160 degrees, or it may be due to the quadrature components of current set up along the fuselage.

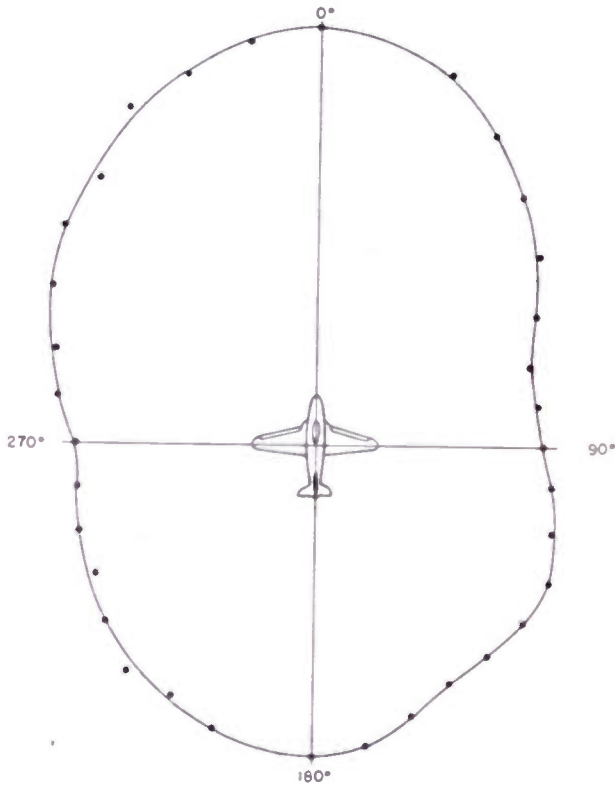

Fig. 11—Measured azimuthal-plane radiation pattern of the antenna structure of Fig. 5. The data shown are for horizontal polarization at a frequency of 6 Mc. The aircraft model used was of an F-80 jet fighter.

VI. APPLICATION TO AIRCRAFT AT VERY HIGH FREQUENCIES

The need for a vertically polarized, faired-in antenna for use in the 100-to-150-Mc range on fighter aircraft led to tests on the type of structure sketched in Fig. 12.¹⁴ The objective of this development was the use of the vertical stabilizer itself as an antenna for vhf. For test purposes a rough model of this structure was erected on a full-scale SNJ-4. Its measured input impedance characteristic is plotted in Fig. 13. Comparison with the curves of Figs. 7 and 8 reveals a strong similarity between the impedance characteristics of the shunt-fed tail structure and those obtained for the wide flat-plate models. As in the case of the hf wing installation, dis-

¹⁴ The Germans employed this type of antenna to some extent during World War II. Their structures were designed to have very low input resistances, however, as a result of their conclusions concerning the mechanism of the antenna, already mentioned in footnote reference 8.

cussed in the previous section, the most obvious difference between the impedance behavior of the actual

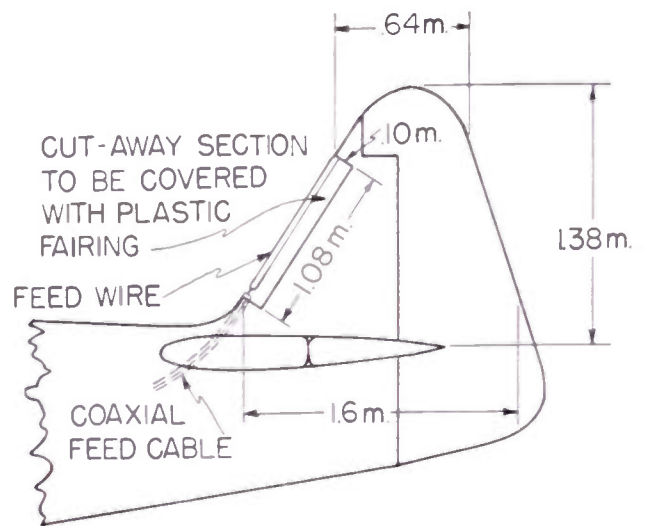

Fig. 12—Sketch of a possible arrangement for excitation of the vertical stabilizer of an SNJ-4 aircraft as a vhf antenna. Dimensions shown are in meters.

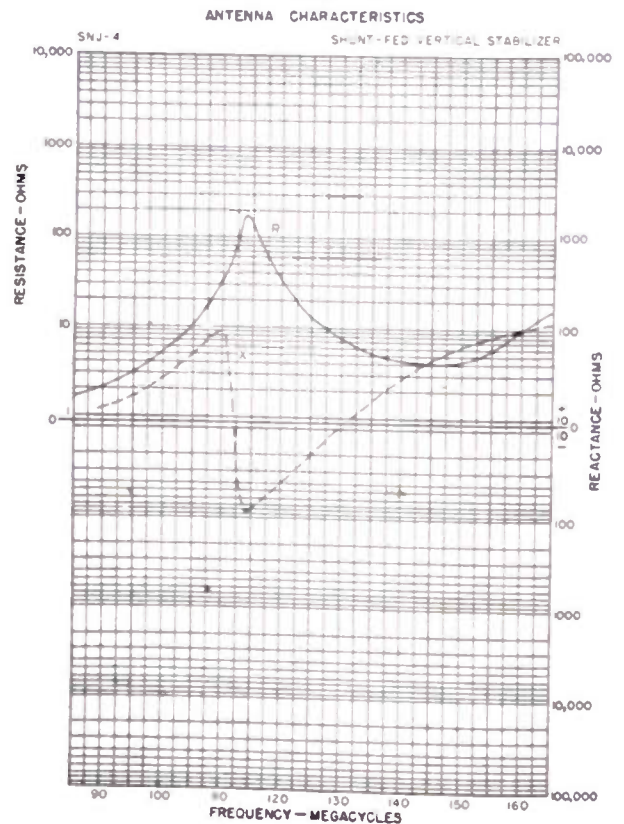

Fig. 13—Measured input impedance of the antenna structure of Fig. 12.

structure and the simplified model is in the lowest frequency portion of the curves. As in the wing excitation case, the explanation would seem to lie in the fact that the auxiliary feed conductor is tapped over a limited portion of the over-all length of the radiating member. In evaluating the data given in Fig. 12, it should be

cept in mind that the curves are shown simply to illustrate the general behavior. No attempt has been made to broad-band the antenna, or even to determine the feed arrangement that yields the best impedance characteristic.

The measured radiation pattern for this antenna is shown in Fig. 14. From the figure it is clear that the vertically polarized radiation pattern is not omnidirectional, as it would be for a folded dipole. Measurements made on the amplitude and phase of surface-current distribution on this structure indicate that the pattern

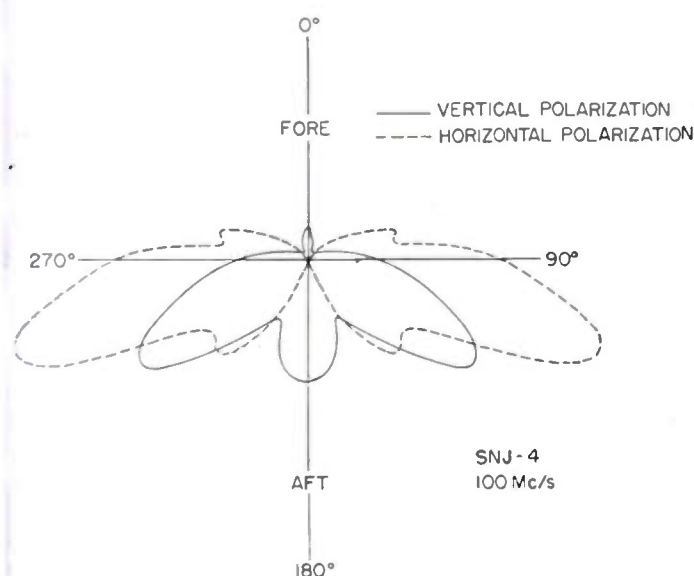

Fig. 14—Measured radiation pattern of the antenna structure of Fig. 12. Data taken at a frequency corresponding to 100 Mc.

behavior can be explained in terms of the amplitudes, relative phases, and separation of the strong current elements at the leading and trailing edges of the vertical stabilizer.¹⁵ The horizontally polarized component is due

¹⁵ These current distribution measurements, together with others made on a wide variety of other aircraft antenna structures, are discussed in Cruft Laboratory Technical Report No. 78.

primarily to the horizontal component of current along the inclined feed wire and leading edge of the vertical stabilizer. In vhf applications an omnidirectional radiation pattern (in azimuth) is desired. It should be pointed out that this type of pattern is not always obtainable with the vertical stub commonly used on aircraft. For mechanical reasons the stub is ordinarily mounted on top of the fuselage, where it tends to excite strong parasitic currents on the edges of the vertical stabilizer, unless the spacing is fairly large. These currents give rise to radiated fields which in combination with the fields due to the stub itself result in an azimuthal radiation pattern which is lobed, often deeply.

Through proper design it should be possible to incorporate the basic antenna structure sketched in Fig. 12 into an aircraft without any change in the external skin contours.

VII. CONCLUSION

This paper has discussed the characteristics of a shunt-excited flat-plate as an antenna. The effects of the various parameters on the input impedance, efficiency, and radiation pattern have been outlined. Two possible applications of this technique to the excitation of portions of an aircraft structure as antennas have been described. It is hoped that the information presented here will be of value to aircraft antenna workers in the solution of some of the important and difficult problems that have arisen as the speed and complexity of modern aircraft have been increased.

ACKNOWLEDGMENT

The author gratefully acknowledges the many helpful discussions with his colleagues at Cruft Laboratory which have contributed so much to this work. Miss Mary Lee Richardson carried out all the measurements represented by the data of Figs. 7 and 8.

Volume Scanning with Conical Beams*

DANIEL LEVINE†, MEMBER, IRE

Summary—The equations of motion for a radar scan that provides a nearly constant number of pulses to all point targets are derived. In addition, the periods for this scan and for the more conventional one having constant angular velocities are presented. For these types of scanners it is found that the optimum cross-over point between adjacent beams is at the 2.1-db point of the antenna pattern.

* Decimal classification: R116X R537.11. Original manuscript received by the Institute, March 11, 1949; revised manuscript received, November 7, 1949. Presented, 1949 National IRE Convention, March 9, 1949, New York, N. Y.

† Aircraft Radiation Laboratory, Air Materiel Command, Dayton, Ohio; now on leave at The Ohio State University, Columbus, Ohio.

SYMBOLS

- C = angle between crossover points: radians
- c = subscript that serves to indicate that a parameter refers to the volume scan that has constant angular velocities
- D = total vertical angle subtended by the region scanned: radians
- e = subscript that serves to indicate that a parameter refers to the volume scan having the shortest period while providing at least N_0 pulses per beamwidth

- F = flyback time of antenna system: seconds
 G = antenna power gain
 G_0 = antenna power gain at the peak of the beam
 H = horizontal beamwidth: radians
 N = number of pulses per beamwidth
 N_0 = number of pulses per beamwidth at a selected angle in the scan
 n = number of radar sets in a scanning system
 P = pulse repetition rate: pulses per second
 p = received radar power: watts
 s = subscript that serves to indicate that a parameter refers to a spiral scan
 T = period of scan: seconds
 V = vertical beamwidth: radians
 δ = time that a detection device is aimed at a point target: seconds
 ω = rate of rotation of antenna: radians per second
 θ = polar angle
 θ_i = polar angle of the lower edge of the i -th zone
 θ_M = maximum value of the polar angle
 θ_m = minimum value of the polar angle.

INTRODUCTION

THE PERFORMANCE of a radar system is affected by the number of echoes which are received from each point target in the region of space covered by the radar scan. As the number of echoes is increased, the integrated signal increases relative to the integrated noise, so that a target of fixed equivalent echoing area can be observed on the radar indicator at a greater range. On the other hand, it is generally necessary to scan a large volume of space in as short a time as possible, resulting in a small number of echoes being received from each target.

It follows that the design engineer is forced to compromise on the number of pulses which are transmitted and received back from each point target in space. The value which is selected depends upon the extent of the compromise that is necessary for a specific application, and will be designated by the symbol N_0 ; the reference points in the beam pattern between which pulses are counted are the half-power points.

This paper considers several aspects of the scanning problem, assuming that a suitable value for the number of pulses per beamwidth has been selected.

SCAN CONDITIONS FOR UNIFORM SCAN QUALITY

The time, τ , required for a radar beam to scan a spherical zone such as the one drawn in Fig. 1, while providing N_0 pulses per horizontal beamwidth at the lower edge of the zone is

$$\tau = \frac{2\pi N_0 \sin \theta_i}{HP} \text{ seconds.} \quad (1)$$

Then the ratio of the pulses per beamwidth at the upper edge of the zone to the value at the lower edge¹ is

¹ If the upper edge of the zone is on the polar axis, the value of the ratio is $2\pi C/H$.

$$\frac{\sin \theta_i}{\sin (\theta_i - C)} > 1. \quad (2)$$

For this type of scan, therefore, every point within the zone is illuminated by at least N_0 pulses.

If a series of zones which fill a region extending from a minimum polar angle θ_m to a maximum value of polar angle θ_M are scanned with the rate of rotation adjusted for each zone so as to provide exactly N_0 pulses per horizontal beamwidth on the lower edge, the total scan time is

$$T_s = \frac{2\pi N_0}{HP} [\sin (\theta_m + C) + \sin (\theta_m + 2C) + \dots + \sin (\theta_m + qC)] + F,$$

where $q = (\theta_M - \theta_m)/C$, $\theta_M \leq 90^\circ$.

By successive application of trigonometric identities² we are able to transform the above equation as follows:

$$\begin{aligned}
 T_s &= \frac{2\pi N_0}{HP} \frac{\sin \frac{1}{2}qC \sin [\theta_m + \frac{1}{2}(q+1)C]}{2 \sin C/2} + F \\
 &= \frac{2\pi N_0}{HCP} [\cos (\theta_m + C/2) - \cos (\theta_M + C/2)] \\
 &+ F \text{ seconds.}
 \end{aligned} \quad (3)$$

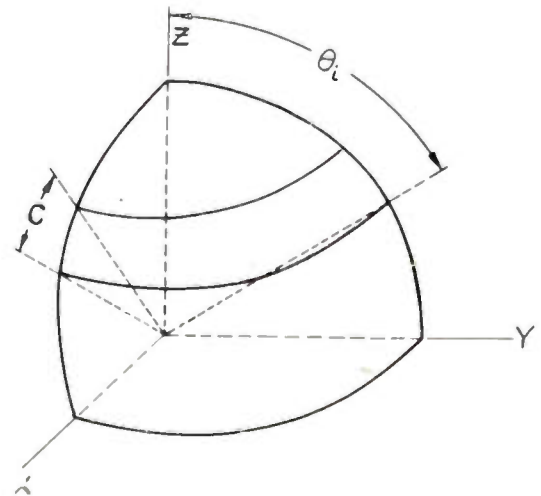

Fig. 1—Zonal type of scan.

The period T_s is the minimum amount of time in which any zonal scan can cover a volume of space while striking all point targets with at least N_0 pulses per beamwidth. From its derivation, it obviously provides a nearly constant number of pulses per beamwidth to all points within the region scanned.

The antenna angular velocity for each zone is

$$\omega_s = \frac{2\pi}{\tau} = \frac{HP}{N_0 \sin \theta_i} \text{ radians/second,} \quad (4)$$

² H. B. Dwight, "Tables of Integrals and Other Mathematical Data," The Macmillan Co., New York, N. Y.; see trigonometric identities, 420.3 and 401.07; 1947.

and the "smoothed out" rate of elevation is

$$\dot{\theta}_e = \frac{C}{\tau} = \frac{CPH}{2\pi N_0 \sin \theta_i} \text{ radians/second.} \quad (5)$$

Since the antenna generally follows a spiral path rather than successive zones as described above, we should like to know the corresponding results for a spiral scan; they are³

$$T_{e,s} = T_e - \frac{\pi N_0}{HP} (\sin \theta_M - \sin \theta_m) \text{ seconds,} \quad (6)$$

$$\omega_{e,s} = \frac{CPH}{2\pi N_0 \sin \theta [1 - (C/2) \cot(\theta - C/2)]} \text{ radians/second,} \quad (7)$$

$$\dot{\theta}_{e,s} = \frac{CPH}{2\pi N_0 \sin \theta [1 - (C/2) \cot(\theta - C/2)]} \text{ radians/second;} \quad (8)$$

these equations are valid for $\theta \geq 0.16 C$.

CONSTANT ANGULAR-VELOCITY SCANNER

Most radar sets scan at constant angular velocities; therefore, we shall next investigate this type of motion.

Initially we shall consider the characteristics of the system for a zonal method of scanning. If the scan provides N_0 pulses per beamwidth on the lower edge of the lowermost zone, there are

$$\frac{2\pi N_0 \sin \theta_M}{H} \text{ pulses/revolution.} \quad (9)$$

Consequently, at any polar angle, θ , the number of pulses per beamwidth is given by

$$N = \frac{N_0 \sin \theta_M}{\sin \theta} \text{ pulses/beamwidth.} \quad (10)$$

The expression for the period to scan a total vertical angle D is readily found to be

$$T_e = \frac{2\pi D N_0 \sin \theta_M}{HCP} + F \text{ seconds.} \quad (11)$$

The period and equations of motion for spiral scan in which the antenna has constant angular velocities are identical to those above since both base the rate of rotation upon the largest polar angle.

MULTIPLE RADAR SYSTEMS

In order to find the period when more than one radar set is used, a method of successive approximations may be employed. As the first step it is necessary to estimate the active scanning time, which is the difference between the period and the fly-back time. A good approximation is given by

$$T - F = \frac{2\pi N_0 (\cos \theta_m - \cos \theta_M)}{HCPn}, \quad (12)$$

³ D. Levine, "Principles of Volume Scan," Thesis, The Ohio State University, Columbus, Ohio, pp. 54-56; 1948.

where n is the number of radar sets if all sets have the same scanning characteristics.⁴

If the n radar sets in the system differ, one of them may be selected as a reference, and we define the quantity n' as

$$n' = 1 + \frac{\frac{N_2}{H_2 C_2 P_2}}{\frac{N_1}{H_1 C_1 P_1}} + \frac{\frac{N_3}{H_3 C_3 P_3}}{\frac{N_1}{H_1 C_1 P_1}} + \dots$$

$$= \sum_{k=1}^n \frac{H_1 C_1 P_1 N_k}{H_k C_k P_k N_1}; \quad (13)$$

then H_1, C_1, P_1 and n' are used in (12).

The trial value obtained for the scanning time is too small, so a somewhat larger value may be selected arbitrarily.

Now, knowing θ_M and the trial scanning time, we apply equation (6) [or (11)] to find θ_{m1} for the lowermost antenna beam, where θ_{m1} is the minimum value of the polar angle for this antenna beam.

For the second antenna beam, we start with θ_{m1} as θ_M , and find θ_{m2} , its minimum value. The process is the same for the remainder of the beams.

Then, if θ_{mn} is not the same as the minimum value of the polar angle for the scan, we select another trial value for the active scanning time, and repeat the above procedure.

SCANNING NEAR THE POLAR AXIS

The equations for a spiral scan that have been presented do not apply to scanning in the immediate vicinity of the pole. Since many applications of radar include coverage in this region, it is of interest to picture the scan for small polar angles.

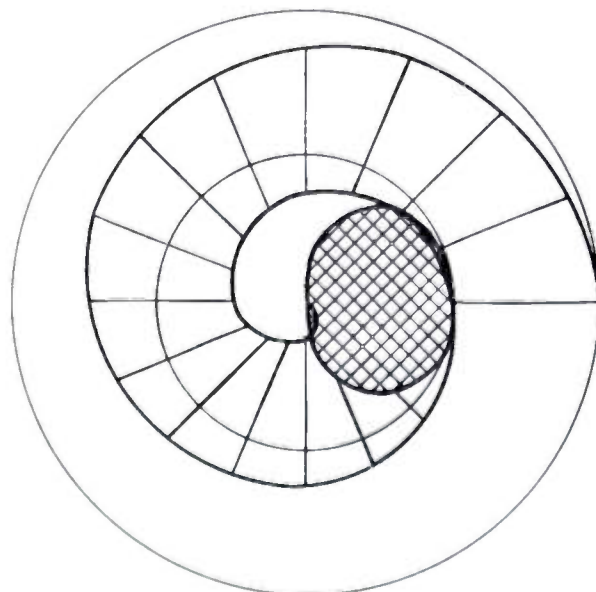

Fig. 2—Starting at its outer edge at an angle $2C$ from the pole (the outer circle), the radar beam touches the pole after one complete revolution. The region searched is indicated by radial lines.

⁴ See pp. 10-11 of footnote reference 3.

For this purpose we shall consider a radar beam that starts with its outer edge at an angle $2C$ from the pole, and spirals upward so as to change its polar angle by C radians during each complete azimuthal rotation.

After one complete revolution the upper part of the beam is at the pole, as drawn in Fig. 2. The radar beam covers a large part of the unscanned space, although only the portion of the scanned path having radial lines has received the full number of pulses when the variable-speed scan is employed.

Upon completing an additional quarter of a spiral rotation, the beam has covered just about all of the area, as drawn in Fig. 3. The antenna descent, therefore, may commence at this point.

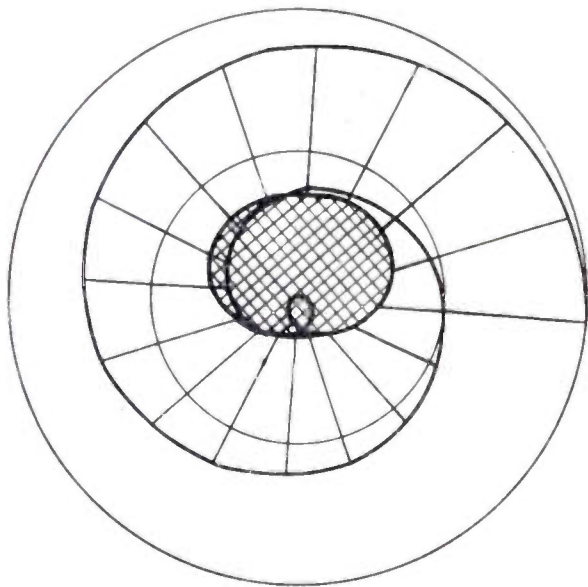

Fig. 3—A quarter revolution of the radar beam beyond the stage of Fig. 2 results in complete coverage of the polar region.

Although Figs. 2 and 3 were drawn for a radar system having an angle between crossover points that is eight-tenths of the horizontal beamwidth, the geometry of the problem does not yield very different solutions for other relations of these two angles, so long as the horizontal beamwidth is greater than the angle between crossover points.

As an example, we shall consider a radar scan that is to provide complete coverage between 0 and 30 degrees with an angle between crossover points of 10 degrees. In order to provide solid coverage for the 30 degree-cone, it is obvious that the scan must extend to 40 degrees (thereby providing partial coverage between 30 and 40 degrees). Then three and one-quarter revolutions are required for essentially complete scanning of the designated region.

OPTIMUM BEAM CROSS-OVER POINT

In order to find the optimum position for beam cross-over between adjacent zones, we shall assume that the antenna power pattern varies as $\sin^2 a\theta/(a\theta)^2$; that is

$$G = G_0 \frac{\sin^2 2.784\theta/V}{(2.784\theta/V)^2} \quad (14)$$

When all of the quantities in equation (6) [or (11)] are given, if we determine the vertical beamwidth V , we fix the maximum gain G_0 , since G_0 is inversely proportional to the product of the beamwidths. Consequently, we shall seek a relation for the optimum value of the vertical beamwidth. As the first step we express the gain as

$$G \propto \frac{1}{V} \frac{\sin^2 2.784\theta/V}{(2.784\theta/V)^2} \quad (15)$$

Now the received power p is directly proportional to the square of the antenna power gain in the direction of a target; hence, for the crossover angle, where $\theta = C/2$,

$$p \propto V^2 \sin^4 1.392C/V. \quad (16)$$

Upon maximizing the received power at the crossover angle by setting dp/dV equal to zero, we find

$$V = C/0.8373. \quad (17)$$

This result shows that the angle between crossover points is about 84 per cent of the vertical beamwidth for best performance.

Approximately the same value is obtained for antenna patterns that have Gaussian or cosine-squared variation of power gain with angle.⁵ The 2.1-db point, therefore, is preferable to the commonly used 3-db point as a crossover value for search radar systems.

EXTENSION TO OTHER SEARCH SYSTEMS

In the preceding equations we recognize the ratio of N_0 to P to be the time devoted to a target. Therefore, this ratio may be replaced by δ , the time in seconds that a detection device is aimed at a target. For example, the period for a scan having constant angular velocity is

$$T_{c..} = \frac{2\pi D\delta \sin \theta_M}{HCn} + F_n \text{ seconds}; \quad (18)$$

and the shortest period for a spiral scan which remains on all targets for at least δ seconds is

$$T_{c..} = \frac{2\pi\delta}{HC} [\cos(\theta_m + C/2) - \cos(\theta_M + C/2)] - \frac{\pi\delta}{H} [\sin \theta_M - \sin \theta_m] + F \text{ seconds}. \quad (19)$$

These equations can be applied not only to other special radio detection systems but also to various search methods, such as acoustic search or search-lights.

ACKNOWLEDGMENT

The author wishes to express his appreciation of many helpful discussions on this subject with Sidney Bertram of the Ohio State University and Saul Gorn of Aircraft Radiation Laboratory.

⁵ See pp. 51-53 of footnote reference 3.

Frequency Analysis of Variable Networks*

LOTFI A. ZADEH†, ASSOCIATE, IRE

Summary—This paper describes an approach to the analysis of linear variable networks which is essentially an extension of the frequency analysis techniques commonly used in connection with fixed networks. It is shown that a function $H(j\omega; t)$, termed the system function of a variable network, possesses most of the fundamental properties of the system function of a fixed network. Thus, once $H(j\omega; t)$ has been determined, the response to any given input can be obtained by treating $H(j\omega; t)$ as if it were the system function of a fixed network. It is further shown that $H(j\omega; t)$ satisfies a linear differential equation in t , which has complex coefficients and is for the same order as the differential equation relating the input and the output of the network. Two methods of solution of this equation covering most cases of practical interest are given. In addition to $H(j\omega; t)$, a network function introduced is the *bi-frequency system function* $\Gamma(j\omega; j\omega')$ which is shown to relate the Fourier transforms of the input and the output through a superposition integral in the frequency domain. On the basis of the results obtained in this paper it appears that the frequency domain approach using $H(j\omega; t)$ possesses significant advantages over the conventional approach using the impulsive response of the network.

I. INTRODUCTION

IN RECENT years there has been an increasing recognition on the part of communication engineers and investigators in allied fields of the potentialities of so-called dynamic or variable networks. Generally speaking, a variable network is one in which one or more element-values are dependent in a specified manner upon a combination of the three variables—time, input, and output. The simplest, though not necessarily the most useful type of variable network, is that in which the element-values are functions of time only.

The rather limited use of variable networks at the present time is due largely to lack of practical means for their analysis, synthesis, and mechanization. In particular, the available tools for the analysis of linear variable systems consist essentially of Green's function¹ approach and various perturbation methods of which certain variants of Picard's method,² and Schelkunoff's method,^{3,4} are probably the most powerful. These methods are quite useful in certain cases, but on the whole would not be considered practical by an electrical engineer.

A basically different approach to the analysis of variable networks is developed in this paper. The method to be described consists essentially of an extension of the frequency analysis techniques commonly used in connection with fixed linear networks. The advantages of frequency domain analysis, as compared to time domain analysis, are well known to electrical engineers. It will be shown that similar advantages can be secured in the case of variable linear networks in which the elements are functions of time and possibly the input, but not the output.

It should be remarked that several attempts have been made in the past, notably by Carson,⁵ and Neufeld,⁶ toward extension of Heaviside's operational calculus to variable linear systems. Carson's method is similar in some respects to Schelkunoff's wave perturbation method, while that of Neufeld is based on regarding variability of an element as due to a continuous series of switching operations. Both procedures are essentially "time domain" methods, as contrasted to the "frequency domain" approach used in this paper.

II. SYSTEM FUNCTION OF A VARIABLE NETWORK

The conventional steady-state as well as transient analysis of fixed linear networks is based on the use of a function $H(j\omega)$ which is variously known as the transmission function, transfer factor, gain, system function, etc., of the network under consideration. The physical significance of $H(j\omega)$ needs no explanation, but for the purposes of this analysis it will be useful to recall that $H(j\omega)$ may be regarded as the Fourier transform of the response of the network to a unit impulse applied at $t=0$. More generally, denoting a unit impulse occurring at $t=\xi$ by the usual symbol $\delta(t-\xi)$, and representing the associated response by $W(t-\xi)$, we can write

$$H(j\omega) = \int_{-\infty}^{\infty} W(t-\xi)e^{-j\omega(t-\xi)}d\xi. \quad (1)$$

The fundamental characteristic of fixed networks is that their impulsive response is dependent solely upon the so-called *age variable*, that is, the difference between the instant of observation t and the instant ξ of application of the unit impulse. No such property is possessed by variable networks, for in these the impulsive response is of the general form $W(t, \xi)$. Nevertheless, by analogy with (1) we define the system function of a variable

* Decimal classification: R143. Original manuscript received by the Institute, April 11, 1949. Presented, 1949 IRE West Coast Convention, San Francisco, Calif., September 1, 1949.

† Columbia University, New York, N. Y.

¹ E. L. Ince, "Ordinary Differential Equations," Dover Publications, New York, N. Y., p. 254. et seq.

² See p. 63 of footnote reference 1. Additional references are given in the text.

³ S. A. Schelkunoff, "Solution of linear and slightly non-linear equations," *Quart. App. Math.*, vol. 3, pp. 348-355; January, 1946.

⁴ M. C. Gray and S. A. Schelkunoff, "Approximate solution of linear differential equations," *Bell Sys. Tech. Jour.*, vol. 27, pp. 350-364; April, 1948. Additional references will be found in the text.

⁵ J. R. Carson, "Theory and calculation of variable systems," *Phys. Rev.*, vol. 17, pp. 116-134; February, 1921.

⁶ J. Neufeld, "Extension of Heaviside's calculus to networks whose parameters vary with time," *Phil. Mag.*, vol. 15, pp. 170-177; January, 1933.

linear network⁷ by the relation

$$H(j\omega; t) = \int_{-\infty}^{\infty} W(t, \xi) e^{-j\omega(t-\xi)} d\xi \quad (2)$$

where the upper limit of the integral is actually t , since the impulsive response is zero prior to application of the unit impulse, i.e., $W(t, \xi) \equiv 0$ for $t < \xi$.

It will be observed that in contrast to $H(j\omega)$, $H(j\omega; t)$ as defined by (2) is a function of $j\omega$ involving t as a parameter. In what follows it will be demonstrated that $H(j\omega; t)$ represents a natural extension of the notion of the system function of a fixed network. Thus, it will appear that $H(j\omega; t)$ not only possesses many of the fundamental properties of $H(j\omega)$ but, what is more important, can also be used in a similar manner to obtain the steady-state as well as the transient response of a variable network to any prescribed input.

Formulation

Analysis of a variable linear network in which the parameters are functions of time reduces in general to the solution of a linear differential equation of the form

$$[a_n(t)p^n + \dots + a_1(t)p + a_0(t)]e_2(t) = [b_m(t)p^m + \dots + b_1(t)p + b_0(t)]e_1(t), \quad (3)$$

or, more compactly,

$$L(p; t)e_2(t) = K(p; t)e_1(t) \quad (4)$$

where $e_1(t)$ and $e_2(t)$ denote respectively the input and output signals; the a 's and b 's are known functions of time; and $p = d/dt$. Throughout this paper it will be assumed that the system is of the type described above; that the a 's and b 's are continuous functions of time, and that the system is unexcited, though not necessarily fixed, prior to application of $e_1(t)$. Equation (3) will be referred to as the *fundamental equation* of the system.

We shall now proceed with establishing a few of the more important properties of the system function of a variable network. First, it will be recalled that by the principle of superposition,

$$e_2(t) = \int_{-\infty}^{\infty} W(t, \xi) e_1(\xi) d\xi \quad (5)$$

where $W(t, \xi)$, the impulsive response of the system, is defined by the relation

$$L(p; t)W(t, \xi) = K(p; t)\delta(t - \xi). \quad (6)$$

Expressing $e_1(\xi)$ in terms of its Fourier transform $E_1(j\omega)$,

$$e_1(\xi) = \frac{1}{2\pi} \int_{-\infty}^{\infty} E_1(j\omega) e^{j\omega\xi} d\omega, \quad (7)$$

and substituting (7) into (5), we obtain upon inversion of the order of integration,

$$e_2(t) = \frac{1}{2\pi} \int_{-\infty}^{\infty} d\omega E_1(j\omega) \int_{-\infty}^{\infty} W(t, \xi) e^{j\omega\xi} d\xi. \quad (8)$$

But, by the definition of $H(j\omega; t)$ (see equation (2))

$$\int_{-\infty}^{\infty} W(t, \xi) e^{j\omega\xi} d\xi = H(j\omega; t) e^{j\omega t}, \quad (9)$$

and hence

$$e_2(t) = \frac{1}{2\pi} \int_{-\infty}^{\infty} H(j\omega; t) E_1(j\omega) e^{j\omega t} d\omega. \quad (10)$$

This result represents a generalization of a familiar relation used in the analysis of fixed networks, namely,

$$e_2(t) = \frac{1}{2\pi} \int_{-\infty}^{\infty} H(j\omega) E_1(j\omega) e^{j\omega t} d\omega. \quad (11)$$

Heaviside's Expansion in Variable Networks

It is not difficult to see that the conventional techniques used for the evaluation of (11) can be used as well for the evaluation of (10). In applying these techniques to (10), $H(j\omega; t)$ should be treated as if it were the system function of a fixed network; that is, in $H(j\omega; t)$, t should be regarded as a fixed parameter. For example, assuming that $H(j\omega; t) E_1(j\omega)$ has only simple poles, we can express $e_2(t)$ in a standard form of Heaviside's expansion

$$e_2(t) = \sum_{\mu} \frac{P(j\omega_{\mu}; t)}{\frac{\partial}{\partial(j\omega_{\mu})} Q(j\omega_{\mu}; t)} e^{j\omega_{\mu} t}, \quad (12)$$

where

$$\begin{aligned} P(j\omega; t) &= \text{numerator of } H(j\omega; t) E_1(j\omega) \\ Q(j\omega; t) &= \text{denominator of } H(j\omega; t) E_1(j\omega) \\ j\omega_{\mu}'s &= \text{poles of } H(j\omega; t) E_1(j\omega). \end{aligned}$$

The main advantage of frequency domain analysis over time domain analyses is due largely to the fact that once $H(j\omega; t)$ has been determined, the output can be obtained from Laplace transform tables—or more generally—by means of contour integration. Methods for the direct determination of $H(j\omega; t)$ will be described in part III. In the meantime, it will be instructive to compare the steps involved in the calculation of $e_2(t)$ (on the assumption that $W(t, \xi)$ is known a priori), first through use of the superposition integral, and alternatively through use of Heaviside's expansion.

When $W(t, \xi)$ is known, calculation of $e_2(t)$ reduces essentially to evaluation of (5), which in most cases would be a difficult problem. On the other hand, calculation of $H(j\omega; t)$ requires evaluation of a generally

⁷ The relation of $H(j\omega; t)$ to Green's function of the system, as well as certain other aspects of the problem, will be considered in a forthcoming paper. It recently came to the attention of the writer that a similar, though somewhat less general, definition has been given by C. Blanc in his paper "Sur les equations differentielles lineaires a coefficients lentement variables," *Bull. Tech. Suisse Romande*, vol. 74, pp. 185-188; July, 1948. Blanc's paper does not contain the results given in the present paper.

simpler integral, namely,

$$H(j\omega; t) = e^{-j\omega t} \int_{-\infty}^{\infty} W(t, \xi) e^{j\omega \xi} d\xi. \quad (13)$$

Once $H(j\omega; t)$ has been determined, the second step in the calculation of $e_2(t)$, i.e., use of Heaviside's expansion, does not entail any difficulties, since it involves only algebraic operations. Hence, on the whole it would be simpler, in general, to use frequency analysis even when $W(t, \xi)$ is known a priori.

When $W(t, \xi)$ is not known a priori—as would usually be the case in practice—the simplest procedure to follow in most cases would be to determine $H(j\omega; t)$ directly by using one of the methods described later; and then use Heaviside's expansion or some other standard technique for the evaluation of (10).

In passing, it may be noted that the question of stability of a variable network may be resolved in much the same way as in the case of a fixed network. That is, a variable network is stable at all times if the poles of $H(j\omega; t)$ (whose location in general varies with time) do not pass into the right-half of the complex frequency plane.

Steady-State Response to Periodic and Almost Periodic Inputs

In many cases of practical interest the input signal is periodic or almost periodic in nature; in other words it is of the form

$$e_1(t) = C_0 + A_1 \cos \omega_1 t + B_1 \sin \omega_1 t + A_2 \cos \omega_2 t + B_2 \sin \omega_2 t + \dots \quad (14)$$

where C_0 , the A 's, the B 's, and the ω 's are constants.

Steady-state response to signals of this type can be expressed in a convenient form through use of (10). Thus, it can easily be verified that for (14)

$$E_1(j\omega) = \pi [2C_0 \delta(\omega) + (A_1 - jB_1) \delta(\omega - \omega_1) + (A_1 + jB_1) \delta(\omega + \omega_1) + \dots] \quad (15)$$

where $\delta(\omega)$ represents a unit impulse in the frequency domain. Substituting (15) into (10), we obtain $e_2(t)$; the result can be expressed in several different forms of which the one most useful for the purposes of this analysis is

$$e_2(t) = C_0 H(0; t) + A_1 \operatorname{Re} \{ H(j\omega_1; t) e^{j\omega_1 t} \} + \dots + B_1 \operatorname{Im} \{ H(j\omega_1; t) e^{j\omega_1 t} \} + \dots \quad (16)$$

where Re and Im have their conventional meaning. It will be noticed that (16) is identical in form to the expression used in the case of fixed networks, the only difference being, as usual, that in (16) $H(j\omega; t)$ involves t , whereas in the case of fixed networks $H(j\omega)$ is independent of t . It will also be noted that from (16) it follows that the response of a variable network to a complex exponential $e^{j\omega t}$ is $H(j\omega; t) e^{j\omega t}$. It is thus evident that $H(j\omega; t)$ may alternatively be defined as

$$H(j\omega; t) = \frac{\text{response of the network to } e^{j\omega t}}{e^{j\omega t}},$$

which is identical with the usual definition of the system function of a fixed network. In other words, $H(j\omega; t)$ is the complex envelope of the response of the system to $e^{j\omega t}$.

The Case of Noisy Input

The case where the input signal contains some noise can be treated very conveniently by means of (16). It will be necessary, however, to restrict the analysis to systems in which the variable parameters are largely independent of noise. In other words, the parameters of the system must either be completely independent of the input signal, or else the signal-to-noise ratio at the input must be reasonably high. The method of analysis outlined below applies only to such cases.

In view of the assumption made above, the output noise $e_{2N}(t)$ is related to the input noise $e_{1N}(t)$ through the fundamental equation of the system, i.e.,

$$L(p; t) e_{2N}(t) = K(p; t) e_{1N}(t). \quad (17)$$

Assuming further that $e_{1N}(t)$ is stationary and Gaussian with a power spectrum $S(f)$, we can express $e_{1N}(t)$ in the form of a Fourier series⁸

$$e_{1N}(t) = A_1 \cos \frac{2\pi}{T} t + B_1 \sin \frac{2\pi}{T} t + A_2 \cos \frac{4\pi}{T} t + B_2 \sin \frac{4\pi}{T} t + \dots \quad (18)$$

where T is a long period of time, and the A 's and B 's are normally distributed random variables with the following properties:

$$\overline{A_\mu} = \overline{B_\mu} = 0, \quad (19)$$

$$\overline{A_\mu^2} = \overline{B_\mu^2} = S(f_\mu) \Delta f, \quad \left(\Delta f = \frac{1}{T}, f_\mu = \mu \Delta f \right) \quad (20)$$

and

$$\overline{A_\mu B_\mu} = 0. \quad (21)$$

In (19), (20), and (21), the bars indicate, as usual, the mean (expected) values.

A similar representation of the output noise may be obtained immediately through use of (16). Thus, we find

$$e_{2N}(t) = \sum_{\mu} [A_{\mu} \operatorname{Re} \{ H(j\omega_{\mu}; t) e^{j\omega_{\mu} t} \} + B_{\mu} \operatorname{Im} \{ H(j\omega_{\mu}; t) e^{j\omega_{\mu} t} \}]. \quad (22)$$

It will be observed that $e_{2N}(t)$ is a linear combination of normally distributed random variables having zero mean, and hence at any fixed instant of time $e_{2N}(t)$ is likewise a normally distributed random variable with

⁸ S. O. Rice, "Mathematical analysis of random noise," *Bell Sys. Tech. Jour.*, vol. 23, p. 328; July, 1944.

zero mean. The ensemble variance $\sigma^2(t)$ of $e_{2N}(t)$ may be determined as follows.

By the definition of $\sigma^2(t)$,

$$\sigma^2(t) = \overline{e_{2N}^2(t)}, \tag{23}$$

or

$$\sigma^2(t) = \sum_{\mu} [\overline{A_{\mu}^2} \operatorname{Re}^2 \{ H(j\omega_{\mu}; t) e^{j\omega_{\mu}t} \} + \overline{B_{\mu}^2} \operatorname{Im}^2 \{ H(j\omega_{\mu}; t) e^{j\omega_{\mu}t} \}]. \tag{24}$$

Making use of (20), (24) reduces to

$$\sigma^2(t) = \sum_{\mu} S(f_{\mu}) \Delta f [\operatorname{Re}^2 \{ H(j\omega_{\mu}; t) e^{j\omega_{\mu}t} \} + \operatorname{Im}^2 \{ H(j\omega_{\mu}; t) e^{j\omega_{\mu}t} \}] \tag{25}$$

or,

$$\sigma^2(t) = \sum_{\mu} S(f_{\mu}) \Delta f | H(j\omega_{\mu}; t) |^2, \tag{26}$$

and in the limit as $T \rightarrow \infty$ we obtain

$$\sigma^2(t) = \int_0^{\infty} | H(j\omega; t) |^2 S(f) df. \tag{27}$$

This result is a generalization of the well-known relation

$$\sigma^2 = \int_0^{\infty} | H(j\omega) |^2 S(f) df \tag{28}$$

which holds in the case of fixed networks.

Expansion of Variable Networks

It is evident that the system function of a network having periodically varying parameters, is itself a periodic function of time. Letting ω_0 denote the fundamental frequency of variation of parameters, it follows that the system function of a periodically varying network may be expressed in the form of a Fourier series, such as

$$H(j\omega; t) = H_0(j\omega) + H_1'(j\omega) \cos \omega_0 t + H_1''(j\omega) \sin \omega_0 t + H_2'(j\omega) \cos 2\omega_0 t + \dots \tag{29}$$

where $H_0(j\omega)$, $H_1'(j\omega)$, $H_1''(j\omega)$, etc., assume the place of usual constants. It will be noticed that $H_0(j\omega)$, $H_1'(j\omega)$, $H_1''(j\omega)$, etc., do not involve time, and hence represent system functions of fixed networks; in practice they would be automatically provided in the process of determination of $H(j\omega; t)$. (See the illustrative example at the end of part III.)

Physically, (29) means that a periodically varying network may be "expanded" as a parallel-series combination of a number of fixed networks having sinusoidally varying gains (see Fig. 1). The advantage of this type of representation is that it places in evidence the mechanism of formation of the sidebands in the output.

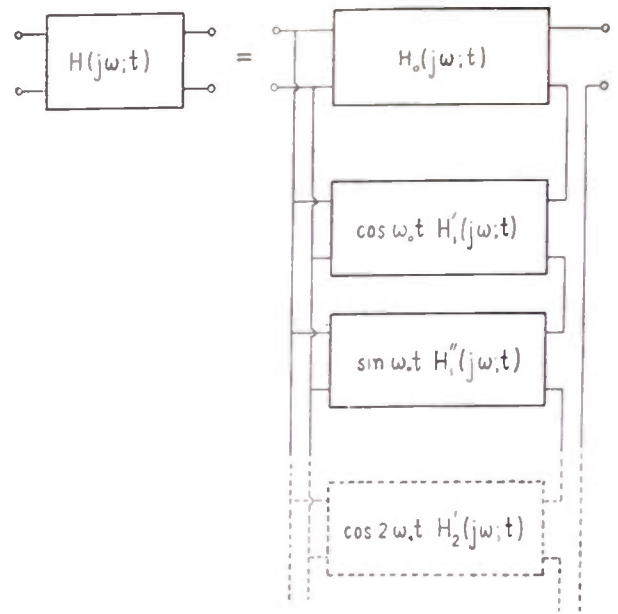

Fig. 1—Expansion of a periodically varying network.

The type of expansion indicated above suggests a natural extension to networks in which the variation of parameters is not periodical. Thus, we are led to introducing the notion of what might be called the *bi-frequency system function* of a variable network. This function $\Gamma(j\omega; ju)$ is simply the Fourier transform of $H(j\omega; t) e^{j\omega t}$ (the response to $e^{j\omega t}$) with respect to time, i.e.,

$$\Gamma(j\omega; ju) = \int_{-\infty}^{\infty} H(j\omega; t) e^{j\omega t} e^{-ju t} dt. \tag{30}$$

The bi-frequency system function has a number of interesting properties. For example, it can easily be verified that the Fourier transforms of the input and output are related to each other by $\Gamma(j\omega; ju)$ in the following manner:

$$E_2(ju) = \int_{-\infty}^{\infty} \Gamma(j\omega; ju) E_1(j\omega) d\omega. \tag{31}$$

This relation is a frequency domain analogue of the superposition integral (see (5)).

Differential Equation Satisfied by $H(j\omega; t)$

An important property of $H(j\omega; t)$ is that it satisfies a linear differential equation, which, in many practical cases, is easier to solve than the fundamental equation of the system. Furthermore, it should be remembered that possession of $H(j\omega; t)$ enables one to find the response to any input signal provided, of course, the parameters of the system are functions of time only; in contrast, solution of the fundamental equation yields only the response to a particular input signal.

A convenient starting point for the derivation of the differential equation in question is furnished by the definition of the impulsive response of the system, i.e.,

$$L(p; t) W(t, \xi) = K(p; t) \delta(t - \xi). \tag{6}$$

Thus, transforming both sides of (6) with respect to ξ we obtain

$$L(p; t) \int_{-\infty}^{\infty} W(t, \xi) e^{i\omega t} d\xi = K(p; t) \int_{-\infty}^{\infty} \delta(t - \xi) e^{i\omega t} d\xi, \quad (32)$$

which in view of (9) reduces to

$$L(p; t) H(j\omega; t) e^{i\omega t} = K(p; t) e^{i\omega t}. \quad (33)$$

This result may also be obtained by noting that $H(j\omega; t) e^{i\omega t}$ is the response to $e^{i\omega t}$.

Now, it can be verified easily that the result of operation of any polynomial operator $F(p; t)$ upon the product of two time functions $u(t)$ and $v(t)$ is given by the expression

$$F(p, t) uv = uF(p; t)v + \frac{du}{dt} \frac{\partial F(p; t)}{\partial p} v + \dots + \frac{1}{n!} \frac{d^n u}{dt^n} \frac{\partial^n F(p; t)}{\partial p^n} v. \quad (34)$$

Identifying u with $H(j\omega; t)$, v with $e^{i\omega t}$, and noting that

$$\frac{\partial^n L(p; t)}{\partial p^n} e^{i\omega t} = \frac{\partial^n L(j\omega; t)}{\partial (j\omega)^n} e^{i\omega t}, \quad (35)$$

and

$$K(p; t) e^{i\omega t} = K(j\omega; t) e^{i\omega t}, \quad (36)$$

we obtain after minor simplifications the following differential equation:

$$\left[\frac{1}{n!L} \frac{\partial^n L}{\partial (j\omega)^n} \right] \frac{d^n H}{dt^n} + \dots + \left[\frac{1}{L} \frac{\partial L}{\partial (j\omega)} \right] \frac{dH}{dt} + H = \frac{K}{L} \quad (37)$$

where K , L , and H are abbreviations for $K(j\omega; t)$, $L(j\omega; t)$, and $H(j\omega; t)$, respectively. It should be understood that in (37) $j\omega$ is regarded as a fixed parameter. Equation (37) could be obtained alternatively by noting that the left-hand member in (33) is equivalent to $e^{i\omega t} L(p + j\omega; t) H(j\omega; t)$.

Equation (37) shows that $H(j\omega; t)$ satisfies a non-homogeneous linear differential equation with complex coefficients, the order of which is the same as that of the fundamental equation of the system. The problem of solution of this equation will be discussed in part III. In the meantime it will be expedient to examine the limiting form of (37) in the case of a slowly varying system.

As the rate of variation of a system decreases the time derivatives in (37) decrease accordingly until in the limit $H(j\omega; t)$ becomes equal to

$$H(j\omega; t) = \frac{K(j\omega; t)}{L(j\omega; t)}$$

$$= \frac{b_m(t)(j\omega)^m + \dots + b_1(t)j\omega + b_0(t)}{a_n(t)(j\omega)^n + \dots + a_1(t)j\omega + a_0(t)}. \quad (38)$$

The physical significance of (38) is rather obvious. In plain words it means that the system function of a very slowly varying system is the system function of the fixed network resulting from freezing the variable network at the instant of consideration. Because of this fact, the ratio $H_f(j\omega; t) = K(j\omega; t)/L(j\omega; t)$ shall be referred to as the *frozen system function* of the network (the subscript f standing for "frozen").

The notion of the "frozen system function" provides the basis for a useful interpretation of (37). Thus, referring to (37) it will be seen that $H(j\omega; t)$ may be formally regarded as the response of a virtual system—of which (37) is the fundamental equation—to an input consisting of the frozen system function of the network. This point of view will be found particularly useful in connection with the solution of (37).

It will be seen later that in the case of a slowly varying system $H_f(j\omega; t)$ furnishes the first approximation to $H(j\omega; t)$. The question of goodness of this approximation will be discussed in part III. Tentatively, a convenient though rather rough criterion may be stated as follows:

The frozen system function may be regarded as a first approximation to the actual system function of a variable network whenever the coefficients of the fundamental equation do not vary appreciably over the width⁹ of the impulsive response of the system.

It can be shown easily that for large values of ω the actual system function tends asymptotically to the frozen system function, regardless of the rate of variation of the system. The physical significance of this statement becomes quite obvious when one considers the fact that in the case of input signals of very-high frequency the coefficients of the fundamental equation do not change appreciably over a relatively great number of cycles of the applied signal. In other words, from the point of view of the signal, the system behaves as if it were varying at a very slow rate.

III. DETERMINATION OF SYSTEM FUNCTION

The problem of finding the response of a variable network through analysis in the frequency domain reduces essentially to the determination of the system function of the network. There are two distinct approaches to the solution of the latter problem. The first, and most practical, is to obtain $H(j\omega; t)$ through the solution of (37). The alternative approach is to determine the impulsive response of the system, and then obtain $H(j\omega; t)$ through use of (9). This approach is not, in

⁹ Roughly speaking, the width of $W(t, \xi)$ is the length of the time interval outside of which $W(t, \xi)$ is small by comparison with its maximum value.

general, very convenient, even though it is preferable to the use of the superposition integral. It will be found that the two direct methods described in the sequel are generally adequate for the determination of $H(j\omega; t)$ in most practical cases. As a prerequisite to the solution of (37), it is necessary to establish the boundary conditions to which $H(j\omega; t)$ is subjected. This matter is examined in the following article.

Boundary Conditions.

The question of boundary values of $H(j\omega; t)$ in the time domain arises whenever there is a transition in the state of variability of the system. Physically, a transition can assume a variety of forms. For instance, the process of initiation of variability represents essentially a transition from a fixed state to a variable state. A further example is furnished by the case of a dynamic network controlled by the input. Here, at the instant of application of the signal there occurs a transition from the state of variability existing prior to application of the signal, to a different state which is dependent upon the signal. From a more general point of view, a transition taking place at, say, $t=t_0$, corresponds to a nonanalyticity at $t=t_0$ in one or more of the coefficients of the fundamental equation of the system.

It is obvious that, regardless of the nature of variability of a given system, it is always permissible to assume that the system has been fixed prior to $t=-\infty$. Adopting this point of view we can restate a statement made earlier, in a more expressive form which is as follows:

The system function of a variable network may be formally regarded as the response of an initially unexcited system, of which (37) is the fundamental equation, to the frozen system function of the network.

The above statement is perfectly general and applies, in particular, to cases where the period of observation, i.e., the time interval during which the response is observed, includes one or more transitions in the state of variability of the network. Thus, considering the fact that $H(j\omega; t)$ satisfies a nonhomogeneous linear differential equation of n th order having continuous coefficients, it follows immediately that:

$H(j\omega; t)$ and its first $n-1$ derivatives with respect to t are continuous at a transition. That is,

$$\frac{\partial^\mu}{\partial t^\mu} H(j\omega; t)_{(t=t_0+)} = \frac{\partial^\mu}{\partial t^\mu} H(j\omega; t)_{(t=t_0-)}, \quad \mu = 0, 1, \dots, n-1. \quad (39)$$

Equation (39) provides the necessary information regarding the boundary values of $H(j\omega; t)$.

In many practical cases the period of observation is "transitionless." In such cases, it is not difficult to see that any particular solution of (37) within the interval of observation may be chosen as the system function of the network. This follows from the fact that the behavior of $H(j\omega; t)$ outside the period of observation

should not have any effect upon the response, and hence the initial values of $H(j\omega; t)$ within the period of observation can be chosen at will. The apparent arbitrariness that is involved in the choice of a particular solution is eliminated in the process of evaluation of (10). It should be remarked that in most transitionless cases evaluation of (10) is simplest when $H(j\omega; t)$ is set equal to the steady-state solution of (37). Actually, this is true in most practical cases so that ordinarily the problem of determination of $H(j\omega; t)$ reduces to finding the steady-state solution of (37).

General Solution

For the purpose of solution of (37) it is somewhat more convenient to rewrite (37) in the following form:

$$\alpha_n(t) \frac{d^n H}{dt^n} + \dots + \alpha_1(t) \frac{dH}{dt} + \alpha_0(t) H = K \quad (40)$$

where

$$\alpha_\mu(t) = \frac{1}{\mu!} \frac{\partial^\mu L}{\partial (j\omega)^\mu}, \quad \mu = 0, 1, \dots, n.$$

Now $H(j\omega; t)$ is, so to say, the response of (40) to $K=K(j\omega; t)$ and hence it can be expressed in the form of a superposition integral. Thus denoting the impulsive response of (40) by¹⁰ $U_H(t, \xi)$ it follows that

$$H(j\omega; t) = \int_{-\infty}^{\infty} U_H(t, \xi) K(j\omega; \xi) d\xi. \quad (41)$$

The general solution provided by (41) is largely of academic value since the determination of $U_H(t, \xi)$ would usually constitute a difficult problem. This means that ordinarily it would be necessary to use approximate methods for the solution of (40). Two such methods covering many, if not most, cases of practical interest are described in the sequel.

First Method

This method is essentially an adaptation of Schelkunoff's wave perturbation method;^{3,4} it yields $H(j\omega; t)$ in the form of a series

$$H(j\omega; t) = H_1(j\omega; t) + H_2(j\omega; t) + H_3(j\omega; t) + \dots \quad (42)$$

which is rapidly convergent when the coefficients of (40) oscillate in the neighborhood of their mean values. This condition is present in many practical cases, particularly in systems having periodically varying parameters.

As the first step in application of the method, (40) is rewritten as

$$\bar{\alpha}_n \frac{d^n H}{dt^n} + \dots + \bar{\alpha}_1 \frac{dH}{dt} + \bar{\alpha}_0 H = K + P\{H\} \quad (43)$$

¹⁰ In mathematical terminology $U_H(t, \xi)$ is a Green's function of (40) satisfying homogeneous boundary conditions at $t=-\infty$.

where $\bar{\alpha}_\mu$ is the mean value of $\alpha_\mu(t)$ or, more generally, a constant approximating $\alpha_\mu(t)$; and $P\{II\}$ represents the aggregate of perturbation terms, i.e.,

$$P\{II\} = [\bar{\alpha}_n - \alpha_n(t)] \frac{d^n II}{dt^n} + \dots + [\bar{\alpha}_1 - \alpha_1(t)] \frac{dII}{dt} + [\bar{\alpha}_0 - \alpha_0(t)] II. \tag{44}$$

It will be observed that (43) is a nonhomogeneous linear equation with constant coefficients. The first approximation to $II(j\omega; t)$ is obtained by solving the equation

$$\bar{\alpha}_n \frac{d^n H_1}{dt^n} + \dots + \bar{\alpha}_1 \frac{dH_1}{dt} + \bar{\alpha}_0 H_1 = K, \tag{45}$$

while the successive corrections appearing in (42), i.e., H_2, H_3 , etc. are obtained iteratively from the solution of

$$\bar{\alpha}_n \frac{d^n H_\mu}{dt^n} + \dots + \bar{\alpha}_1 \frac{dH_\mu}{dt} + \bar{\alpha}_0 H_\mu = P\{H_{\mu-1}\}. \tag{46}$$

In this manner the solution of (45) and (46) yields the successive terms of (42). The boundary conditions that should be used in conjunction with (45) and (46) are the same as those used with (40). It should be remembered, of course, that in transitionless cases it will be sufficient to determine the steady-state (or particular) solutions of (45) and (46).

In practice, the first two terms of (42) will generally provide an adequate approximation. Usually it is found that (42) develops as a power series in a small parameter so that in many cases the question of convergence of (42) can be resolved by inspection. An example illustrating the use of this method is given at the end of the section.

Second Method

This method is far simpler in use than the first method; its usefulness, however, is limited to slowly varying systems. The system function furnished by this method has the form of a series such as (42). As in the case of the first method, it is usually found that (42) develops as a power series in a small parameter, so that the matter of convergence of (42) can be investigated in most cases by inspection.

As is usual with all other perturbation methods, the first step in the procedure consists of rewriting (37) in a form that places in evidence the perturbation terms. Ordinarily it will be found simplest to regard all derivatives¹¹ of II as perturbations, and write

$$II = II_f = P\{II\} \tag{47}$$

where

$$P\{II\} = -\frac{1}{L} \left\{ \alpha_n(t) \frac{d^n II}{dt^n} + \dots + \alpha_1(t) \frac{dII}{dt} \right\}. \tag{48}$$

¹¹ More generally, only those terms involving derivatives of II beyond a certain order would be regarded as perturbations.

As the first-order approximation to II , (47) gives

$$II_1 = II_f = \text{frozen system function.} \tag{49}$$

Successive corrections to II_1 are given by the iterative relation

$$II_\mu = P\{II_{\mu-1}\}, \quad \mu = 2, 3, \dots \tag{50}$$

It will be noticed that the solution obtained by this procedure is in reality a particular solution of (37); hence, strictly speaking, the method is valid only in transitionless cases. This limitation, however, would generally not be important in practice.

Illustrative Example

The main points of the two methods described above may be conveniently illustrated by applying these methods to a simple variable network such as, for example, a low-pass bandwidth-modulated RC half-section. The fundamental equation of this network, on the assumption that the bandwidth is varied sinusoidally, may be expressed in the following normalized form:

$$(p + 1 + \rho \cos \omega_0 t) e_2(t) = (1 + \rho \cos \omega_0 t) e_1(t) \tag{51}$$

where

$$\rho = \frac{\text{amplitude of bandwidth variation}}{\text{mean bandwidth}}$$

$$\omega_0 = \frac{\text{frequency of bandwidth variation}}{\text{mean bandwidth}}$$

$$t = \text{actual time} \times \text{mean bandwidth.}$$

Using (40) it is found immediately that the differential equation satisfied by $II(j\omega; t)$ is

$$\frac{dII}{dt} + (j\omega + 1 + \rho \cos \omega_0 t) II = 1 + \rho \cos \omega_0 t. \tag{52}$$

First, we shall make the assumption that ρ is small by comparison with unity, and on this basis apply the first method. Next, it will be assumed that ω_0 is small by comparison with unity, thus making the second method applicable. And, finally, it will be shown that the same result is obtained from the use of the two methods when it is assumed that both ρ and ω_0 are small by comparison with unity.

Application of the First Method

Following the general procedure (52) is rewritten as

$$\frac{dII}{dt} + (1 + j\omega) II = 1 + \rho \cos \omega_0 t - II \rho \cos \omega_0 t, \tag{53}$$

from which it follows that the first two terms in (42) are the steady-state solutions of

$$\frac{dII_1}{dt} + (1 + j\omega) II_1 = 1 + \rho \cos \omega_0 t \tag{54}$$

general, very convenient, even though it is preferable to the use of the superposition integral. It will be found that the two direct methods described in the sequel are generally adequate for the determination of $H(j\omega; t)$ in most practical cases. As a prerequisite to the solution of (37), it is necessary to establish the boundary conditions to which $H(j\omega; t)$ is subjected. This matter is examined in the following article.

Boundary Conditions

The question of boundary values of $H(j\omega; t)$ in the time domain arises whenever there is a transition in the state of variability of the system. Physically, a transition can assume a variety of forms. For instance, the process of initiation of variability represents essentially a transition from a fixed state to a variable state. A further example is furnished by the case of a dynamic network controlled by the input. Here, at the instant of application of the signal there occurs a transition from the state of variability existing prior to application of the signal, to a different state which is dependent upon the signal. From a more general point of view, a transition taking place at, say, $t=t_0$, corresponds to a nonanalyticity at $t=t_0$ in one or more of the coefficients of the fundamental equation of the system.

It is obvious that, regardless of the nature of variability of a given system, it is always permissible to assume that the system has been fixed prior to $t=-\infty$. Adopting this point of view we can restate a statement made earlier, in a more expressive form which is as follows:

The system function of a variable network may be formally regarded as the response of an initially unexcited system, of which (37) is the fundamental equation, to the frozen system function of the network.

The above statement is perfectly general and applies, in particular, to cases where the period of observation, i.e., the time interval during which the response is observed, includes one or more transitions in the state of variability of the network. Thus, considering the fact that $H(j\omega; t)$ satisfies a nonhomogeneous linear differential equation of n th order having continuous coefficients, it follows immediately that:

$H(j\omega; t)$ and its first $n-1$ derivatives with respect to t are continuous at a transition. That is,

$$\frac{\partial^\mu}{\partial t^\mu} H(j\omega; t)_{(t=t_0+)} = \frac{\partial^\mu}{\partial t^\mu} H(j\omega; t)_{(t=t_0-)}, \quad \mu = 0, 1, \dots, n-1. \quad (39)$$

Equation (39) provides the necessary information regarding the boundary values of $H(j\omega; t)$.

In many practical cases the period of observation is "transitionless." In such cases, it is not difficult to see that any particular solution of (37) within the interval of observation may be chosen as the system function of the network. This follows from the fact that the behavior of $H(j\omega; t)$ outside the period of observation

should not have any effect upon the response, and hence the initial values of $H(j\omega; t)$ within the period of observation can be chosen at will. The apparent arbitrariness that is involved in the choice of a particular solution is eliminated in the process of evaluation of (10). It should be remarked that in most transitionless cases evaluation of (10) is simplest when $H(j\omega; t)$ is set equal to the steady-state solution of (37). Actually, this is true in most practical cases so that ordinarily the problem of determination of $H(j\omega; t)$ reduces to finding the steady-state solution of (37).

General Solution

For the purpose of solution of (37) it is somewhat more convenient to rewrite (37) in the following form:

$$\alpha_n(t) \frac{d^n H}{dt^n} + \dots + \alpha_1(t) \frac{dH}{dt} + \alpha_0(t) H = K \quad (40)$$

where

$$\alpha_\mu(t) = \frac{1}{\mu!} \frac{\partial^\mu L}{\partial (j\omega)^\mu}, \quad \mu = 0, 1, \dots, n.$$

Now $H(j\omega; t)$ is, so to say, the response of (40) to $K=K(j\omega; t)$ and hence it can be expressed in the form of a superposition integral. Thus denoting the impulsive response of (40) by¹⁰ $U_H(t, \xi)$ it follows that

$$H(j\omega; t) = \int_{-\infty}^{\infty} U_H(t, \xi) K(j\omega; \xi) d\xi. \quad (41)$$

The general solution provided by (41) is largely of academic value since the determination of $U_H(t, \xi)$ would usually constitute a difficult problem. This means that ordinarily it would be necessary to use approximate methods for the solution of (40). Two such methods covering many, if not most, cases of practical interest are described in the sequel.

First Method

This method is essentially an adaptation of Schelkunoff's wave perturbation method;^{3,4} it yields $H(j\omega; t)$ in the form of a series

$$H(j\omega; t) = H_1(j\omega; t) + H_2(j\omega; t) + H_3(j\omega; t) + \dots \quad (42)$$

which is rapidly convergent when the coefficients of (40) oscillate in the neighborhood of their mean values. This condition is present in many practical cases, particularly in systems having periodically varying parameters.

As the first step in application of the method, (40) is rewritten as

$$\bar{\alpha}_n \frac{d^n H}{dt^n} + \dots + \bar{\alpha}_1 \frac{dH}{dt} + \bar{\alpha}_0 H = K + P\{H\} \quad (43)$$

¹⁰ In mathematical terminology $U_H(t, \xi)$ is a Green's function of (40) satisfying homogeneous boundary conditions at $t=-\infty$.

where $\bar{\alpha}_\mu$ is the mean value of $\alpha_\mu(t)$ or, more generally, a constant approximating $\alpha_\mu(t)$; and $P\{H\}$ represents the aggregate of perturbation terms, i.e.,

$$P\{H\} = [\bar{\alpha}_n - \alpha_n(t)] \frac{d^n H}{dt^n} + \dots + [\bar{\alpha}_1 - \alpha_1(t)] \frac{dH}{dt} + [\bar{\alpha}_0 - \alpha_0(t)] H. \quad (44)$$

It will be observed that (43) is a nonhomogeneous linear equation with constant coefficients. The first approximation to $H(j\omega; t)$ is obtained by solving the equation

$$\bar{\alpha}_n \frac{d^n H_1}{dt^n} + \dots + \bar{\alpha}_1 \frac{dH_1}{dt} + \bar{\alpha}_0 H_1 = K, \quad (45)$$

while the successive corrections appearing in (42), i.e., H_2, H_3 , etc. are obtained iteratively from the solution of

$$\bar{\alpha}_n \frac{d^n H_\mu}{dt^n} + \dots + \bar{\alpha}_1 \frac{dH_\mu}{dt} + \bar{\alpha}_0 H_\mu = P\{H_{\mu-1}\}. \quad (46)$$

In this manner the solution of (45) and (46) yields the successive terms of (42). The boundary conditions that should be used in conjunction with (45) and (46) are the same as those used with (40). It should be remembered, of course, that in transitionless cases it will be sufficient to determine the steady-state (or particular) solutions of (45) and (46).

In practice, the first two terms of (42) will generally provide an adequate approximation. Usually it is found that (42) develops as a power series in a small parameter so that in many cases the question of convergence of (42) can be resolved by inspection. An example illustrating the use of this method is given at the end of the section.

Second Method

This method is far simpler in use than the first method; its usefulness, however, is limited to slowly varying systems. The system function furnished by this method has the form of a series such as (42). As in the case of the first method, it is usually found that (42) develops as a power series in a small parameter, so that the matter of convergence of (42) can be investigated in most cases by inspection.

As is usual with all other perturbation methods, the first step in the procedure consists of rewriting (37) in a form that places in evidence the perturbation terms. Ordinarily it will be found simplest to regard all derivatives¹¹ of H as perturbations, and write

$$H = H_f = P\{H\} \quad (47)$$

where

$$P\{H\} = -\frac{1}{L} \left\{ \alpha_n(t) \frac{d^n H}{dt^n} + \dots + \alpha_1(t) \frac{dH}{dt} \right\}. \quad (48)$$

¹¹ More generally, only those terms involving derivatives of H beyond a certain order would be regarded as perturbations.

As the first-order approximation to H , (47) gives

$$H_1 = H_f = \text{frozen system function}. \quad (49)$$

Successive corrections to H_1 are given by the iterative relation

$$H_\mu = P\{H_{\mu-1}\}, \quad \mu = 2, 3, \dots \quad (50)$$

It will be noticed that the solution obtained by this procedure is in reality a particular solution of (37); hence, strictly speaking, the method is valid only in transitionless cases. This limitation, however, would generally not be important in practice.

Illustrative Example

The main points of the two methods described above may be conveniently illustrated by applying these methods to a simple variable network such as, for example, a low-pass bandwidth-modulated RC half-section. The fundamental equation of this network, on the assumption that the bandwidth is varied sinusoidally, may be expressed in the following normalized form:

$$(\rho + 1 + \rho \cos \omega_0 t) e_c(t) = (1 + \rho \cos \omega_0 t) e_1(t) \quad (51)$$

where

$$\rho = \frac{\text{amplitude of bandwidth variation}}{\text{mean bandwidth}}$$

$$\omega_0 = \frac{\text{frequency of bandwidth variation}}{\text{mean bandwidth}}$$

$$t = \text{actual time} \times \text{mean bandwidth}.$$

Using (40) it is found immediately that the differential equation satisfied by $H(j\omega; t)$ is

$$\frac{dH}{dt} + (j\omega + 1 + \rho \cos \omega_0 t) H = 1 + \rho \cos \omega_0 t. \quad (52)$$

First, we shall make the assumption that ρ is small by comparison with unity, and on this basis apply the first method. Next, it will be assumed that ω_0 is small by comparison with unity, thus making the second method applicable. And, finally, it will be shown that the same result is obtained from the use of the two methods when it is assumed that both ρ and ω_0 are small by comparison with unity.

Application of the First Method

Following the general procedure (52) is rewritten as

$$\frac{dH}{dt} + (1 + j\omega) H = 1 + \rho \cos \omega_0 t - H \rho \cos \omega_0 t, \quad (53)$$

from which it follows that the first two terms in (42) are the steady-state solutions of

$$\frac{dH_1}{dt} + (1 + j\omega) H_1 = 1 + \rho \cos \omega_0 t \quad (54)$$

and

$$\frac{dH_2}{dt} + (1 + j\omega)H_2 = -H_1\rho \cos \omega_0 t, \quad (55)$$

respectively.

Treating the complex coefficient $1 + j\omega$ as if it were real, we find from (54) the first-order approximation to H ,

$$H_1 = \frac{1}{1 + j\omega} + \rho\omega_0 \sin \omega_0 t \frac{1}{(1 + j\omega)^2 + \omega_0^2} + \rho \cos \omega_0 t \frac{1 + j\omega}{(1 + j\omega)^2 + \omega_0^2}. \quad (56)$$

Substituting H_1 as given by (56) into (55) we find next

$$H_2 = -\frac{1}{1 + j\omega} \left[\rho \cos \omega_0 t \frac{1 + j\omega}{(1 + j\omega)^2 + \omega_0^2} + \rho\omega_0 \sin \omega_0 t \frac{1}{(1 + j\omega)^2 + \omega_0^2} \right]. \quad (57)$$

Adding H_1 and H_2 we obtain the second-order approximation to H , namely,

$$H(j\omega; t) = \frac{1}{1 + j\omega} + \rho \cos \omega_0 t \frac{j\omega}{(1 + j\omega)^2 + \omega_0^2} + \rho\omega_0 \sin \omega_0 t \frac{j\omega}{[(1 + j\omega)^2 + \omega_0^2](1 + j\omega)} + 0(\rho^2) \quad (58)$$

where $0(\rho^2)$ stands for the terms involving the second and higher powers of ρ . It will be noticed that if higher-order approximations were included in (58), $H(j\omega; t)$ would appear as a power series in ρ and, at the same time, a Fourier series of $\omega_0 t$. This, of course, is in accordance with the general remarks made earlier.

The second-order approximation given by (58) would be considered adequate when ρ is reasonably small by comparison with unity. Higher-order approximations, if necessary, may be obtained in exactly the same way as the second-order approximation. Once the desired approximation is obtained, the response to any prescribed input may be found by standard means treating $H(j\omega; t)$ as if it were the system function of a fixed network.

Application of the Second Method

In this case the assumption is that ω_0 is small by comparison with unity; no restrictions are placed on the magnitude of ρ . Following the general procedure (52) is rewritten as

$$H = \frac{1 + \rho \cos \omega_0 t}{j\omega + 1 + \rho \cos \omega_0 t} - \frac{1}{j\omega + 1 + \rho \cos \omega_0 t} \frac{dH}{dt}, \quad (59)$$

from where it follows that the first two terms in (42) are

$$H_1 = H_f = \frac{1 + \rho \cos \omega_0 t}{j\omega + 1 + \rho \cos \omega_0 t} \quad (60)$$

and

$$H_2 = -\frac{1}{j\omega + 1 + \rho \cos \omega_0 t} \frac{dH_1}{dt}, \quad (61)$$

respectively.

Substituting H_1 as given by (60) into (61) and adding H_1 and H_2 we find the second-order approximation to H , which is

$$H(j\omega; t) = \frac{1 + \rho \cos \omega_0 t}{j\omega + 1 + \rho \cos \omega_0 t} + \rho\omega_0 \sin \omega_0 t \frac{j\omega}{(j\omega + 1 + \rho \cos \omega_0 t)^2} + 0(\omega_0^2). \quad (62)$$

It will be observed that in this case $H(j\omega; t)$ develops as a power series in ω_0 . If in (62) an additional assumption is made to the effect that ρ is small by comparison with unity, $H(j\omega; t)$ reduces to

$$H(j\omega; t) = \frac{1}{1 + j\omega} + \rho \cos \omega_0 t \frac{j\omega}{(1 + j\omega)^2} + \rho\omega_0 \sin \omega_0 t \frac{j\omega}{(1 + j\omega)^3} + 0(\rho^2, \omega_0^2). \quad (63)$$

It can easily be verified that (58) reduces to the same expression when it is assumed that $\omega_0 \ll 1$. Thus, as should be expected, the first and second methods lead to identical results when they are based on identical assumptions concerning the behavior of the system.

As was mentioned previously, possession of $H(j\omega; t)$ enables one to find the response of the system to any prescribed input by using the conventional "fixed network" techniques. Thus, for example, assuming that the input signal is $e_1(t) = \cos \omega_s t$, and using (58) and (16), we find

$$e_2(t) = \frac{1}{1 + \omega_s^2} \cos \omega_s t + \frac{\omega_s}{1 + \omega_s^2} \sin \omega_s t + \frac{\rho\omega_s(2\omega_s + \omega_0)}{2(1 + \omega_s^2)[1 + (\omega_s + \omega_0)^2]} \cos(\omega_s + \omega_0)t + \frac{\rho\omega_s(2\omega_s - \omega_0)}{2(1 + \omega_s^2)[1 + (\omega_s - \omega_0)^2]} \cos(\omega_s - \omega_0)t + \frac{\rho\omega_s[\omega_s(\omega_s + \omega_0) - 1]}{2(1 + \omega_s^2)[1 + (\omega_s + \omega_0)^2]} \sin(\omega_s + \omega_0)t + \frac{\rho\omega_s[\omega_s(\omega_s - \omega_0) - 1]}{2(1 + \omega_s^2)[1 + (\omega_s - \omega_0)^2]} \sin(\omega_s - \omega_0)t + 0(\rho^2). \quad (64)$$

It can easily be verified that the direct solution of (51) leads to the same result.

CONCLUSIONS

The frequency domain technique described in this paper provides a powerful mathematical tool for the analysis of linear variable systems. An important advantage of this technique, at least from the point of view of an electrical engineer, is its similarity with the standard procedures used in the analysis of fixed networks. In general, it may be said that frequency analysis works best when the system under consideration is varying at a relatively slow rate, and when, furthermore, the period of observation is transitionless. On the other hand, the advantages of frequency analysis are least when the system is controlled by the input,

and is varying at a rapid rate. It should be recognized however, that cases such as these are difficult to handle by any means available at present.

ACKNOWLEDGMENT

The author wishes to express his appreciation of the continued help and encouragement given him by John R. Ragazzini, under whose supervision this work was carried out. Thanks are also due John B. Russell for many helpful suggestions, and to staff members of the department of electrical engineering, Columbia University, for their constructive criticism and cooperation.

Input Impedance of a Two-Wire Open-Line and Cylindrical-Center Driven Antenna*

T. W. WINTERNITZ†, ASSOCIATE, IRE

Summary—Using the potential theory, a method of analysis of the input impedance of a transmission line terminated by a cylindrical antenna is described. The results of application of this method to a particular configuration of line and antenna are presented.

THE ANALYSIS of the cylindrical antenna by Hallén¹ and King^{2,3} using an integral equation to obtain the current distribution has proven itself to be a very effective approach and has given good values for the input impedance of such antennas. However, in this approach, the assumed driving source of potential has been taken as an infinitesimally thin charge separating region at the center of the antenna.

Since such a source is physically unrealizable, and since the values of impedance predicted by this analysis can only apply to antennas whose driving conditions closely simulate such a "slice generator," a further analysis applying to an antenna center driven by a balanced two-wire line terminated in the center of the antenna across a finite gap has been carried through.

This analysis leads to values of impedance for the antenna and line taken at a point down the line and away from the antenna a sufficient distance so that the mutual coupling terms have died out. For convenience, this distance may be taken as an integral number of half-wave lengths, so that for a lossless line, as assumed, the impedance values may be construed as antenna imped-

ance. The analysis applies only to the configuration shown in Fig. 1. The method used is to set up two equations in vector and scalar potential differences—one along the line in a manner analogous to that used in an exact transmission line analysis,⁴ but including the effect of the vector potential along the antenna, and one analogous to that of the Hallén and King analyses, but including the effect of the vector potential due to the antenna currents.

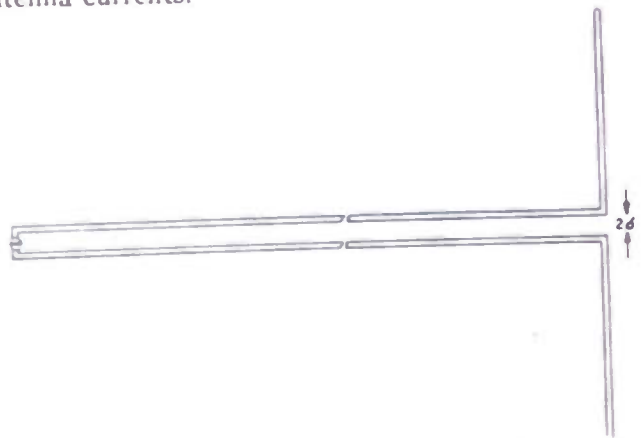

Fig. 1—Cylindrical antenna driven by two-wire open transmission line.

These equations may both be converted to equations in current and scalar potential difference, and from the line equation an expression for the desired input impedance at the generator may be obtained in terms of the ratio of scalar potential difference to current at the junction of line and antenna (Z_0). From the antenna equation a second independent value for this ratio may be obtained, and it may be then eliminated by substitution into the line equation.

* Decimal classification: R221XR326.611. Original manuscript received by the Institute, February 3, 1949. Revised manuscript received, October 5, 1949. This paper is based on a doctoral dissertation presented at Harvard University in 1948 under the direction of R. W. P. King.

† Formerly, Cruft Laboratory, Harvard University, Cambridge, Mass.; now, Bell Telephone Laboratories, Whippany, N. J.

¹ E. Hallén, *Nova Acta Royal Soc. Sci.*, Upsala 11, p. 1; 1938.

² R. King and D. Middleton, "The cylindrical antenna; current and impedance," *Quart. Appl. Math.*, vol. 3, p. 302; January, 1946.

³ R. King and T. W. Winternitz "The cylindrical antenna with gap," *Quart. Appl. Math.*, vol. 5, p. 403; January, 1948.

⁴ R. King, "Electromagnetic Engineering," vol. I, McGraw-Hill Book Co., New York, N. Y.; 1945.

The input impedance may now be written in approximate form as

$$Z_{in} = R_c \frac{Z'_i [1 + C_a/\psi] + j60(S_a - S_l)}{R_c(a) + 60C_l} \quad (1)$$

where

- R_c = the ordinary characteristic impedance of the line
- Z'_i = the input impedance of a cylindrical antenna with gap only as derived in footnote reference 3
- $R_c(a)$ = the characteristic impedance of the line evaluated at the junction of line and antenna
- ψ = the King-Middleton expansion parameter from footnote reference 2,

and the S and C terms are integral terms in vector potential which represent the coupling between line and antenna. These terms depend on the geometry of the gap and antenna and line conductors near the gap, as well as the current distribution on line and antenna at the junction. The impedance from (1) has been evaluated and plotted for certain special antennas.

These curves show that the resistive part of input impedance is only slightly changed in the region of resonance $\beta h \approx 1.5$, while the reactance curves are shifted toward shorter antennas by approximately the thickness of the gap. In the region of antiresonance ($\beta h \approx 3.0$) the resistive part of the input impedance is raised by as much as 50 per cent due to the gap and coupling effects, while the reactance is shifted by considerably more than the width of the gap.

The change in impedance due to the gap and coupling terms as shown in Fig. 2 is due in part to the presence of the transmission line and in part to the existence of the gap. The contributions of these two factors are not simply separable in the present analysis, but an idea of the effect of each may be obtained from consideration of curves of impedance due to the gap alone. A curve showing the gap effect is shown in Fig. 3 for the same antenna as in Fig. 2. These curves result from the analysis of footnote reference 3. Comparison of Figs. 2 and 3 shows that the effects in the region of resonance may be attributed, to a large extent, to the "gap effect,"

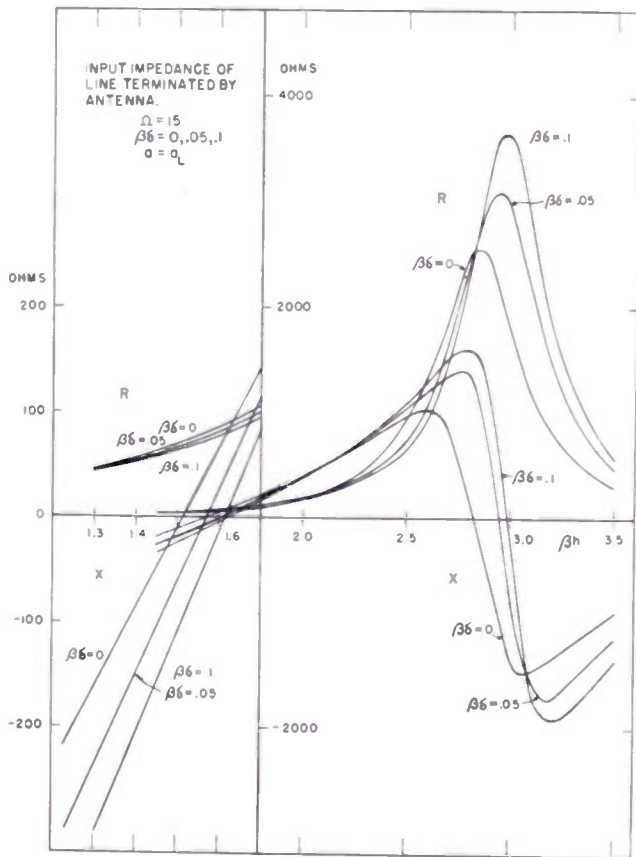

Fig. 2—Input impedance of line terminated by antenna.

Fig. 2 shows the input resistance and reactance of an antenna and line for which $\Omega (= 2 \ln(2h/a))$ is 15 and the radius of antenna and line are equal. h is the half length of the antenna and $2a$ is the diameter of antenna conductor. Curves of this impedance are shown for gaps for which $\beta\delta = 0.1, 0.05$, and 0 ($\beta\delta = (2\pi/\lambda)\delta$ where λ is the wavelength and δ is half the gap width) as a function of antenna length.

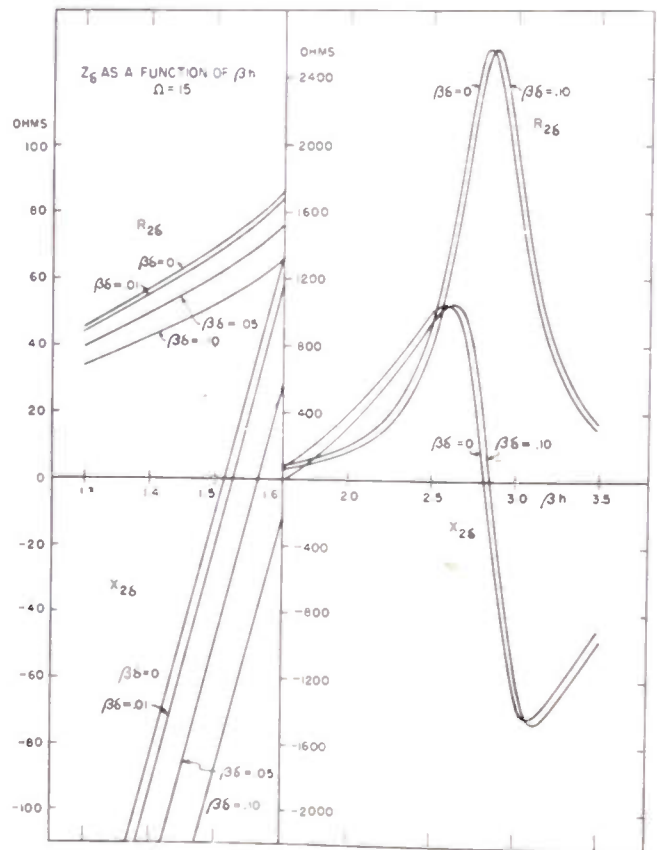

Fig. 3— Z_i as a function of βh ; $\Omega = 15$.

while the changes and shifts in the region of antiresonance appear to be largely due to the mutual coupling between line and antenna.

The general trend of these changes agrees with experimental measurements as reported by King⁵ and Essen and Oliver.⁶

⁵ D. D. King, "Microwave antenna impedance" (thesis), Harvard University, 1946.

⁶ L. Essen and M. H. Oliver "Aerial impedance measurements," *Wireless Eng.*, vol. 22, p. 587; December, 1945.

Reflection of Radio Waves from a Rough Sea*

LAMONT V. BLAKE†, MEMBER, IRE

Summary—At microwave frequencies, the sea cannot always be assumed to be a smooth, or mirror-like, reflecting surface. It is shown that when the sea is rough the reflected field will be a randomly fluctuating one, or will at least have a fluctuating component, even though the radiated signal is of constant amplitude and frequency. The central limit theorem of mathematical probability theory is used to derive the probability-density functions for the amplitude of the reflected signal, and for the amplitude of the combined reflected and direct-path signals. The possible practical significance of these results is discussed.

I. INTRODUCTION

REFLECTION OF electromagnetic waves from surfaces such as that of the sea play an important part in the theory of propagation of waves over such surfaces. At the longer wavelengths, such as were almost exclusively used for practical radio applications prior to the wartime development of microwave techniques, many surfaces which had some degree of irregularity could be treated for practical purposes as smooth surfaces. In particular, the sea surface was so treated. The pattern of field strength calculated for the case of propagation over such a smooth plane surface is described in many general radio-engineering texts.¹

With the increasing use of wavelengths for which the sea surface definitely cannot always be treated as a smooth surface—that is, wavelengths of less than a few meters—it becomes of some importance to consider how to describe the field when there is reflection from a rough sea (or, as a general question of theoretical interest, from any rough surface having similar characteristics).

In the case of reflection from a smooth surface, radiation from a point source is reflected from all points of the surface, but destructive interference occurs in such a way that the net reflected "signal" appears to be emanating from a single point of the surface, the "point of reflection" where an observer sees a mirror image of the source. But if the surface is irregularly rough, it is well known that there will be no mirror image, and the reflection is said to be diffuse. The reflected field at an arbitrary point above the surface will now have an amplitude and phase—and even, to some extent, a polarization—which is a random function of position. If the surface is not only rough, but also in motion in a random

manner, the field will also be a random function of time. That is, the values of amplitude and phase at any point and at any instant cannot be predicted; but there will be associated with any specified values of the amplitude and phase a certain density of probability.

If the dependence of this probability density on the values of amplitude and phase can be determined, the resulting functional relationship may be useful in engineering applications. In the present case the desired probability-density function can be derived without recourse to direct experiment.

In the following analysis it is necessary to assign certain statistical properties to the sea surface. Fortunately some recently reported work provides an experimental basis for doing this. Seiwel and Wadsworth,² of the Woods Hole Oceanographic Institution, applied the techniques of autocorrelation analysis to time-height ocean wave data, and found that the motion of the sea surface has in general two components—one completely random, and the other purely periodic with a period of the order of several seconds. The periodic component may represent a considerable part of the total disturbance, or it may in some circumstances be virtually absent. In this paper the main concern is with the effects due to the random part of the sea-surface roughness, and the effect of the periodic part will not be considered, except to point out that when it is present the fluctuation of the field due to reflection will also contain a periodic component.

II. ANALYSIS OF ROUGH-SEA REFLECTION

The entire surface of the sea may be assumed to be marked off in some regular manner into small, approximately equal areas, and it may be supposed that a cw signal is radiated omnidirectionally from a source located many wavelengths above the sea (as, for example, from a microwave antenna located on the mast of a ship or on an airplane). The signal received at some other elevated point above the sea will be the vector sum of direct-path and sea-reflected components. The sea-reflected component can itself be regarded as the vector sum of components reflected from each of the marked-off areas, which will be referred to subsequently as "elements of area" or just "elements."

* Decimal classification: R115.23. Original manuscript received by the Institute, April 29, 1949; revised manuscript received, November 2, 1949.

† Naval Research Laboratory, Washington, D. C.

¹ F. E. Terman, "Radio Engineers' Handbook," McGraw-Hill Book Co., Inc., New York, N. Y., Sec. 10, 1943.

² H. R. Seiwel, and G. P. Wadsworth, "A new development in ocean wave research," *Science*, vol. 109, no. 2849, pp. 271-274; March 18, 1949. Further discussion of this work was presented by Dr. Seiwel at seminars on "Applications of Autocorrelation Analysis to Physical Problems," held at Woods Hole Oceanographic Institution on June 13 and 14, 1949, and at the Naval Research Laboratory in August, 1949.

Because each element of the surface is in random motion, changing both its height and its orientation, or tilt, each reflected-signal component will be a random variable, in amplitude, phase, and polarization. For convenience it may be assumed that the source of radiation is linearly polarized (as will usually be the case practically) and that observation of the reflected field is being made at some remote point with a receiving dipole polarized the same as the source. Polarization differences of the received field will therefore show up as differences in amplitude of the voltage induced in the receiving antenna.

It is this induced voltage that will be meant in this paper when the terms "field voltage" or "received signal" are used. By the field voltage vector will be meant the 2-dimensional quantity having length (r) representing the rms value of this radio-frequency voltage, and direction representing its phase angle (θ). The reference voltage for this phase-angle measurement will be that due to the signal transmitted directly over the path from transmitter to receiver, although in the first part of this analysis only that part of the received signal due to reflection will be considered.

The probability-density function for this voltage can be obtained by means of a theorem of mathematical probability usually called the central limit theorem.^{3,4} This theorem, due originally to Laplace and called by Uspensky³ the Laplace-Liapounoff Theorem, is concerned with the distribution of the sum of a large number of independent random variables whose individual distributions need not be known in detail. It is in order to employ this theorem that the sea surface is considered marked off into elemental areas; this artifice gives the necessary "large number" of random variables. The question of independence is a little more difficult. Two points of the surface of the sea do not have completely independent motions if they are separated by only a small distance.⁵ However, if the separation is large, the motions are substantially independent. This corresponds to a similar situation⁶ treated by Rice⁴ in connection with electrical noise voltage of finite bandwidth. Here the same sort of correlation exists between values of voltage separated by various time intervals as exists between the heights of points on the rough sea surface separated by various distances. Rice points out⁶ that in considering the distribution of the total energy E in a large time interval, obtained by summing the noise

energies E , in all the subintervals, "If the subintervals are large enough, the E_r 's are *substantially independent* random variables" (italics supplied). Since the subintervals can be sufficiently large and still satisfy the requirement that there be a large number of them, the applicability of the central limit theorem is assured. A similar argument may be applied to provide the necessary independence of the signals reflected from the "subintervals" (area elements) of the sea surface.

The central limit theorem states that, provided the foregoing conditions are satisfied, together with one or two others which are almost automatically satisfied in most practical cases, including this one, the distribution of the sum is nearly normal, or Gaussian. More precisely, the distribution of the sum tends asymptotically to normal as the number of component random variables tends to infinity. Thus if the number of independent random components is very large, the distribution of the sum may be regarded for all practical purposes as exactly normal.

In the present case the random variables are two-dimensional quantities, or vectors, and accordingly the distribution of the sum is normal in two dimensions.³ The rms voltage r at the receiving dipole, and its phase angle θ , may be taken as polar co-ordinates in a plane, whereupon the normal probability-density function $P(r, \theta)$ will be represented by a bell-shaped surface lying above the plane, with its maximum point above the origin, according to the relation

$$P(r, \theta)rdrd\theta = \frac{r}{\pi a^2} \left[\exp \frac{-r^2}{a^2} \right] drd\theta. \quad (1)$$

$P(r, \theta)rdrd\theta$ is the probability that the fluctuating voltage will, at an arbitrarily chosen instant, have an amplitude between r and $r+dr$, and a phase angle between θ and $\theta+d\theta$. It will be observed that the probability density is independent of θ ; that is, the distribution of phases is uniform.

For many practical purposes, there is little or no concern with the phase of the received voltage; what is of interest is the probability of a given amplitude irrespective of phase angle (this is what is wanted, for example, if the signal is to be "detected"—i.e., rectified and filtered—before it is put to any use). This is obtained by integrating (1) with respect to θ , from 0 to 2π , giving

$$F(r)dr = \int_0^{2\pi} [P(r, \theta)rdr]d\theta = \frac{2r}{a^2} \left[\exp \frac{-r^2}{a^2} \right] dr. \quad (2)$$

The quantity a in these expressions is the "long time" (constant) rms value of the voltage, in contrast with r which is the "momentary" (variable) rms value.

It is of some interest to note that this function $F(r)$ is mathematically the same as the probability-density function obtained for the envelope of normally distributed random noise of limited bandwidth (bandwidth

³ J. V. Uspensky, "Introduction to Mathematical Probability," McGraw-Hill Book Co., Inc., New York, N. Y., pp. 284, 314-315, and 323; 1937.

⁴ S. O. Rice, "Mathematical analysis of random noise," *Bell Sys. Tech. Jour.*, July, 1944, vol. 23, pp. 282-333, and vol. 24, pp. 46-156; January, 1945. Subsequently reprinted as Bell Telephone System Monograph B-1589.

⁵ I am indebted to Dr. K. M. Watson, formerly of the Naval Research Laboratory, for pointing this out to me.

⁶ See p. 91 of footnote reference 4, volume 24.

small compared to midband frequency). In fact, the signal due to reflection from a rough sea may be regarded as a noise voltage of this character. Since noise of this type has been the subject of intensive study and much has been written about it, there are excellent references^{4,7} which go into the mathematical analysis in much more detail than would be possible or desirable in this paper.

III. ADDITION OF THE DIRECT-PATH COMPONENT

In most practical cases, the total field at the receiving dipole would have another component—that due to direct propagation over the path between transmitter and receiver. If the voltage due to this direct radiation has a fixed rms amplitude A and a phase angle arbitrarily taken to be the zero reference for phase, in terms of (1) it would be represented by a constant vector of length A in the direction corresponding to $\theta=0$. The probability-density surface representing the total received voltage, including now the direct-path component, will thus be the same surface as before with its maximum point shifted from the origin ($r=0$) to the point $r=A$, $\theta=0$. Therefore the new equation corresponding to (1) is

$$P'(r, \theta) r dr d\theta = \frac{r}{\pi a^2} \left[\exp - \frac{(r^2 + A^2 - 2Ar \cos \theta)}{a^2} \right] dr d\theta. \quad (3)$$

Again integrating with respect to θ from 0 to 2π to get probability density for amplitude irrespective of phase

$$F'(r) dr = \frac{r}{\pi a^2} \left[\exp - \frac{A^2 + r^2}{a^2} \right] dr \int_0^{2\pi} \left[\exp \frac{2Ar \cos \theta}{a^2} \right] d\theta. \quad (4)$$

The evaluation of this integral is the same problem that occurs in the analysis of the envelope of a mixture of noise of limited bandwidth (as in the if channel of a receiver) and a cw signal. As given by a number of investigators who have performed this analysis, the solution is

$$F'(r) dr = \frac{2r}{a^2} \left[\exp - \frac{A^2 + r^2}{a^2} \right] \left[I_0 \left(\frac{2Ar}{a^2} \right) \right] dr. \quad (5)$$

where I_0 is the modified Bessel function of the first kind, order zero.

A plot of $F'(r)$ is given in Fig. 1 for a number of values of the parameter A/a . It should be noted that for $A=0$, (5) reduces, as it should, to (2) since $I_0(0)=1$. Therefore the $A=0$ curve of Fig. 1 is a plot of the probability-density function $F(r)$ in (2).

⁷ V. D. Landon, "The distribution of amplitude with time in fluctuation noise," PROC. I.R.E., vol. 29, pp. 50-55; February, 1941.

The long-time rms value of the received voltage with the direct-path component included is simply the square root of the sum of the squares of the direct-path rms voltage A , and the reflected rms voltage, a —i.e., $\sqrt{A^2 + a^2}$ —since these two voltages, although from the same source, are not any longer *coherent*.

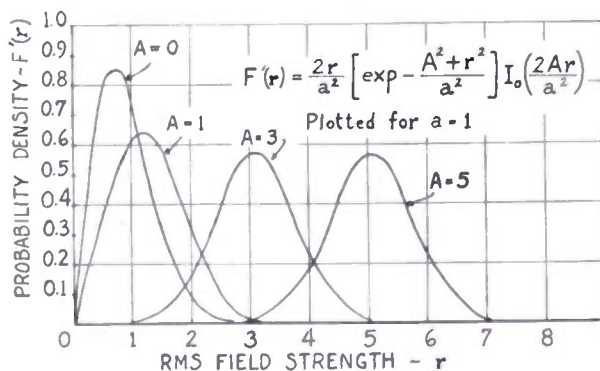

Fig. 1—Probability-density curves for various ratios of direct-path to reflected rms signal strength.

No further exploration will be made of the field-voltage statistics as defined by (5), although this equation is capable of yielding further information which might be of interest in particular cases. As previously remarked, those who are interested will find a more thorough discussion of the mathematics in some of the footnote references.

IV. SEMISPECULAR REFLECTION

The foregoing analysis has assumed that reflection from the sea is either completely specular, when the sea is smooth, or completely diffuse, when the sea is rough. Actually, of course, the sea may at times be "slightly rough," and the reflected signal will consist of both a specular and a diffuse component. Furthermore, even when the sea is quite rough physically, it will appear optically smooth when the angle (ϕ) between the horizontal plane and the direction of the incident radiation is sufficiently small. There must be, therefore, in the region adjacent to $\phi=0$, an angular region of transition in which the reflection is "semispecular." As the angle ϕ becomes larger, the magnitude of the specular component decreases, presumably becoming negligible (for a sufficiently rough sea) at an angle dependent upon the roughness of the surface.⁸

Equations (3) through (5) may be modified to take this behavior into account simply by defining the

⁸ The writer is indebted to W. S. Ament of the Naval Research Laboratory for his explanation, which is given here only in bare outline, of this aspect of rough-sea reflection. In his opinion this "transition" region actually extends over the full range of angles, from $\phi=0$ to $\phi=90^\circ$; that is, there will be some specular component, however small, even for $\phi=90^\circ$.

quantity A as the rms value of the resultant field voltage due to the combination of the direct-path wave with the specular component of the reflected wave.

V. WAVE FORM AND SPECTRUM

There are two different and independent properties of a randomly fluctuating voltage which must both be specified for a complete mathematical description. The first, its probability distribution, or probability-density function, has been discussed. The second is its frequency spectrum, which is related to the wave form and rapidity of fluctuation. No mathematical statement can be offered about this property of the fluctuations due to reflection from a rough sea, except for the remark that the resulting received signal is fully equivalent to a noise voltage of bandwidth small compared to midband frequency.⁴ It may be guessed that the bandwidth will be greater in the case of a "choppy" sea than for one which is characterized by long, slow swells.

The phenomenon of radar called "sea return"—the echo signal received from the rough surface of the sea—presumably has statistical properties similar to those of reflected cw signals, although the fact that the signal is pulsed does make some difference, as does also the fact that microwave radars often have very narrow radiated beams, so that the surface area of the sea⁹ illuminated at

⁹ It is assumed in a recent book, "Radar System Engineering," by L. N. Ridenour, et al. (McGraw-Hill Book Co., Inc., New York, N. Y., 1947), pp. 81, et seq., that radar sea-return signals do have the probability densities given by (2).

any instant may not be very large. At any rate it is of interest to note that the sea-return signal observed on a radar indicator does have the general appearance of a noise voltage. As an estimate based purely on the appearance of the signal on the radar indicator, the major portion of this sea-return signal seems to be contained in a band of a few hundred cycles in typical cases.

VI. SIGNIFICANCE OF RESULTS

In the operation of ordinary amplitude-modulated microwave communication equipment at sea, the fluctuating component of the signal due to reflection from the sea would be heard as a noise signal superimposed on the modulation. In the operation of radar equipment, in addition to the "sea return" effect, reflection of signals from a rough sea would cause a fluctuation of signal strength at the target, and hence a fluctuation of echo signals. Other similar effects may occur in other applications.

The question will doubtless be asked, what is the practical importance of these effects? That is, are these fluctuations of appreciable magnitude? A "yes" or "no" answer cannot be given. Since fluctuations of signal strength can arise from many other causes, it is believed quite likely that the effects described in this paper have occurred and have been observed in microwave applications without being recognized, and that in many practical cases they may be of appreciable magnitude.

Correction

D. K. C. MacDonald and R. Kompfner, authors of the paper, "Fluctuation phenomena arising in the quantum interaction of electrons with high-frequency fields," which appeared on pages 1424-1427, of the December, 1949, issue of the PROCEEDINGS OF THE I.R.E., have brought the following error to the attention of the editors.

On page 1426, equations (9a) and (10a) should read

$$3.2 \times 10^{-31} \cdot \Gamma^2 + 5 \times 10^{-33} \cdot T^2 \quad + \quad \begin{cases} 2.4 \times 10^{-35} \Gamma^2 \\ 3.2 \times 10^{-34} \end{cases} \quad \begin{matrix} (9a) \\ (10a) \end{matrix}$$

A Note on Coaxial Bethe-Hole Directional Couplers*

EDWARD L. GINZTON†, SENIOR MEMBER, IRE, AND PAUL S. GOODWIN‡, MEMBER, IRE

Summary—The coaxial directional coupler of the Bethe-Hole type consists of two coaxial transmission lines crossed at an angle of 50° and coupled by a single circular hole. It has been previously shown that this device should have perfect directivity at any wavelength, provided that (a) the diameter of the coupling hole is small compared with $\lambda/8$, (b) the thickness of the hole is infinitesimal, and (c) only the dominant *TEM* mode is allowed to exist in the transmission lines. These requirements can easily be satisfied in practice. However, with coupling holes small compared with $\lambda/8$, the coupling is too weak for many of the conventional applications (a typical coupling is 50 db).

If the above requirements on hole size are disregarded and the hole is made large enough to provide stronger coupling, such as 25 db, the device no longer behaves in a simple manner. The directivity is no longer perfect, the angle for optimum directivity is no longer 60° , being dependent upon frequency. A reflection is also caused in the main transmission line due to the presence of this large hole.

It was found that the behavior of the large hole coupler could be explained by assuming the presence of higher order modes in the vicinity of the coupling hole. These higher order modes can be represented by an equivalent circuit which consists of a series inductance in the line. The harmful effect of the higher order modes can be eliminated by making the equivalent inductance an element of a low-pass filter. This is done by introducing an appropriate lump capacity in the region of the coupling hole. It is found that the directivity of a compensated large-hole coupler becomes perfect at one frequency and remains high over a very large band; the angle between the transmission lines for best activity then becomes 60° ; and the reflection in the main line becomes nearly zero. Experiments conducted over 2.5 to 1 frequency range showed excellent performance.

It is believed that, with the aid of proper compensating discontinuities, very close coupling can be obtained, retaining at the same time the ideal properties of the small-hole device.

I. DESCRIPTION OF THE COUPLER AND THE PRINCIPAL OPERATION

A PHOTOGRAPH of the directional coupler is shown in Fig 1(a). The circular coupling hole is located at the intersection of the two coaxial lines. Fig. 1(b) shows the appearance of the coupling hole and the two coaxial lines. Figs. 2(a) and 2(b) show the electric field and the magnetic field in the main line of the coupler, respectively. For the purpose of discussion, let it be assumed that in the main line of the coupler there is a traveling wave from left to right, and that there is no reflected wave in the main line. The magnetic and electric fields at the hole are in time phase, and the resultant fields which are coupled into the auxiliary line can therefore be superimposed and added directly. It is evident from the geometry of the structure that the electric field in the main line will induce waves in the auxiliary line which will be symmetric with re-

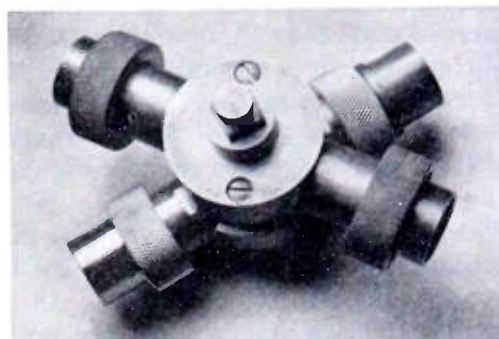

(a)

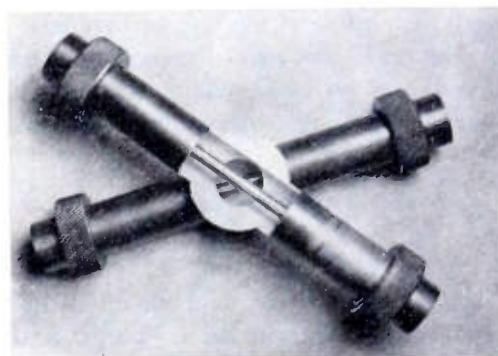

(b)

Fig. 1—(a) Photograph showing a compensated large-hole coupler. (b) Photograph of the coupler partially cut away to show the region of the coupling hole.

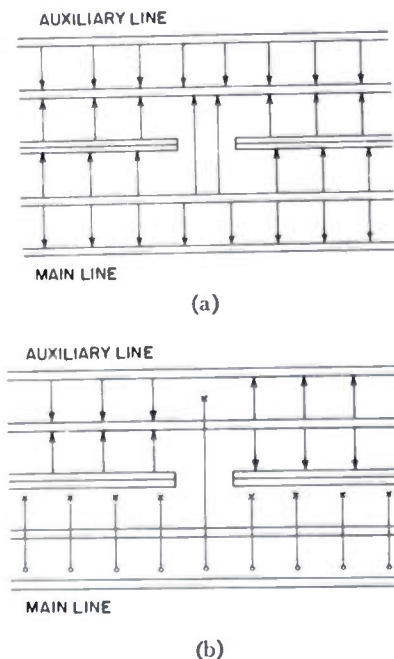

(b)

Fig. 2—(a) A schematic drawing showing the electric field in the auxiliary line produced by electric field component of a traveling wave in the main line. (b) A schematic drawing showing the electric field in the auxiliary line produced by the magnetic field component of the traveling wave in the main line.

* Decimal classification: R310.4. Original manuscript received by the Institute, August 10, 1948; revised manuscript received, November 3, 1949.

† Stanford University, Stanford, Calif.

‡ Formerly, Stanford University, Stanford, Calif.; now, Consolidated Engineering Corporation, Pasadena, Calif.

spect to the hole, whereas, the magnetic coupling will induce waves in the auxiliary line which will be anti-symmetric, as shown in Fig. 2(b). Thus, it can be seen that the combined electric field in the auxiliary line will be stronger on one side of the hole than on the other. It is to be observed that the strength of the electric coupling should be independent of the angle between the transmission lines, while the magnetic coupling should vary as the cosine of this angle. It so happens that magnetic coupling for a circular hole is twice as strong as the electric coupling, so that at an angle of 60° the two coupled fields are equal. Thus, at 60° one can expect perfect cancellation of fields on one side of the hole, and reinforcement on the other.

Bethe (1) has shown that electric coupling and magnetic coupling for a circular hole have identical dependence upon wavelength. In coaxial lines, in the dominant *TEM* mode, the ratio of electric to magnetic field is a constant. Hence, in this special case, cancellation of the two fields should be independent of wavelength. The strength of the coupling, however, will vary and is given by

$$\frac{\text{Power in auxiliary line}}{\text{Power in main line}} = C \left(\frac{a^6}{\lambda^2} \right)$$

where C is a constant which depends upon the diameter and the impedance of the coaxial lines, a is the radius of the coupling hole, and λ is the wavelength.

Experimental confirmation of the above statements is shown in Figs. 3 and 4. Fig. 3 shows angular dependence of the electric and magnetic coupling through a small hole (diameter of the coupling hole was equal to 0.14λ). The two types of coupling were separated by placing shorts $\lambda/4$ and $\lambda/2$ away from the center of the hole.

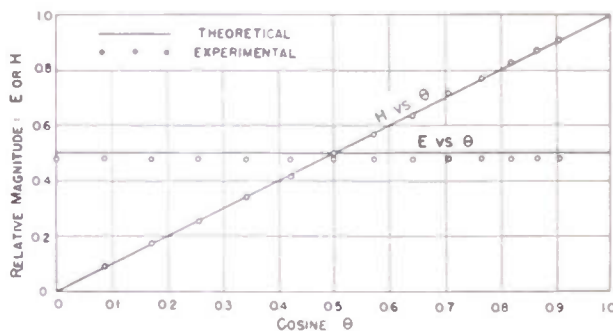

Fig. 3—Dependence of the electric coupling E and the magnetic coupling H upon the angle between the two lines.

In the first of these cases, the magnetic field at the hole is zero, and the coupling is due to the electric field only. In the second case, the electric field at the hole is zero, and the coupling is due entirely to the magnetic field. Fig. 3 shows that the electric field is independent of the angle between the coaxial lines, whereas, the magnetic coupling varies as cosine of the angle between the lines. Within small experimental errors, Fig. 3 demonstrates the validity of the elementary theory.

The dependence of coupling upon hole size is shown in Fig. 4. The coupling was found to vary in the theoretical manner when the coupling hole is smaller than $2a/\lambda = 0.1$. Larger holes produce less coupling than would be expected from Bethe's theory.

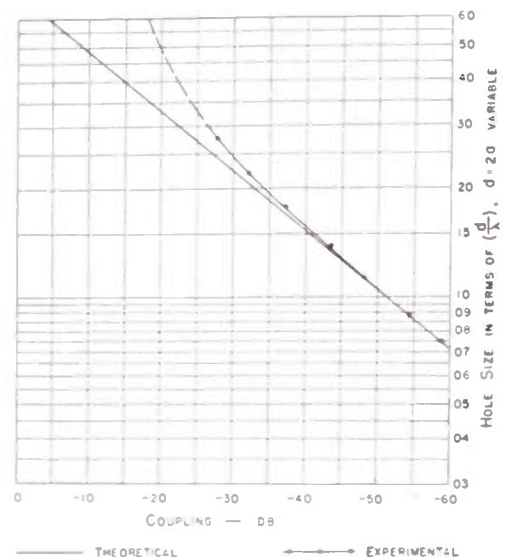

Fig. 4—Dependence of the coupling for the Bethe-Hole coupler upon the hole diameter. Wavelength was held constant during this test. $2a = 0.14\lambda$; the coupler was not compensated.

II. LARGE COUPLING HOLES

A. General Remarks

In an effort to study the effects of close coupling, a directional coupler was built using a 0.875-inch inside diameter coaxial line, and a coupling hole of 1.098 inches in diameter. (The coupling hole is larger than the inside diameter of the tubing.) The ratio of the diameter of the hole to the wavelength used was $(2a/\lambda) = 0.28$, which is obviously outside the scope of Bethe's predictions. Indeed, an experimental study of this coupler showed a number of significant deviations from the simple theory discussed above.

In the tests of the large hole coupler, it was found that, (a) SWR (in voltage) of 1.38 was produced by the presence of the hole in the main line. It was found, as could have been expected, that discontinuity could be represented by a series inductance.

(b) The angle at which directivity was best was no longer 60° but approximately 55° .

(c) The directivity was very poor.

Since the discontinuity was of a series inductance type, it was immediately apparent that the simplest way to eliminate the effect of the discontinuity was to construct a T-section filter, making use of the series inductance and adding an appropriate shunt capacity. If the characteristic impedance of this filter section is made equal to the impedance of the line, then the reflections from the hole should be eliminated. It is not immediately obvious that such compensation would also be beneficial in the case of the other two difficulties. How-

ver, it is plausible to think that since all of these difficulties are due to the fringing fields, and if one of the troubles is eliminated, then the others may be improved as well. While this reasoning is not on safe grounds, experiments have confirmed the general concepts.

B. Optimum Directivity Angle

There are many forms that an appropriate shunt capacity might take. For simplicity, a cylindrical probe was chosen to test the ideas described above. It consisted of a $\frac{1}{4}$ -inch machine screw placed diametrically opposite the hole in each of the two lines. The penetration of this probe was varied, and the effect upon the angle of optimum directivity θ_a was noted. The results appear in Fig. 5, where it is seen that the $\frac{1}{4}$ -inch probe has a small effect until its length becomes appreciable. A penetration of 0.312 inch is the maximum possible before the probe touches the inner conductor. From this figure, it is seen that equal penetrations of approximately 0.240 inch resulted in the directivity angle of 60° and, at the same time, in optimum directivity.

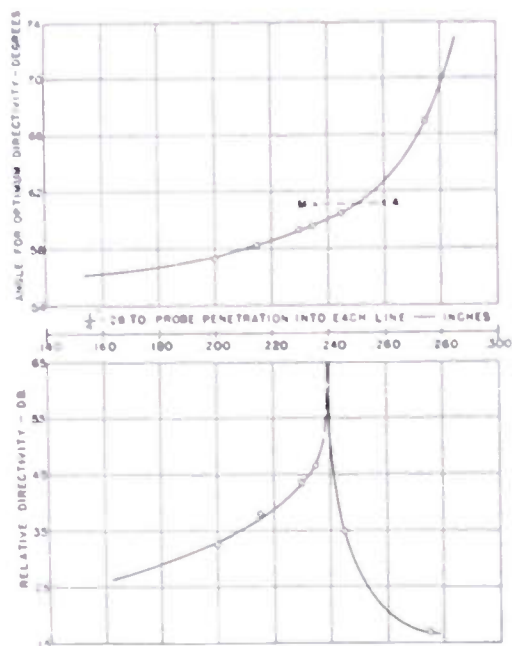

Fig. 5—The effect of capacity compensation upon the directivity and the optimum angle of a Bethe-hole coupler. The compensating capacity is introduced by means of a $\frac{1}{4}$ -inch screw. The abscissa in this graph is the depth of penetration of the screws into the coaxial lines. The diameter of the hole = 1.098 inch. Inside diameter of the coaxial line = 0.875 inch.

The two points labelled *M* and *A* in this figure represent the case in which the main line and auxiliary line probes were not placed symmetrically. In this respect, it is interesting to note that equivalent penetration of either probe is roughly the average of the two points. The two probes were then adjusted to give maximum directivity without attempting to keep them symmetrical. The angle of optimum directivity with such an adjustment became 60° . The test of the combined discontinuity showed that reflection in the lines was extremely small.

C. Directivity of the Compensated Directional Coupler as a Function of Frequency

Fig. 6 shows the directivity of the compensated 1.098-inch hole directional coupler. It is to be observed that for wavelengths greater than 10 cm, the angle for optimum directivity is independent of frequency, while the relative directivity falls from its very high value at 10 cm and asymptotically approaches some moderately high value.¹ The region above 10 cm represents the usable range of this particular coupler.

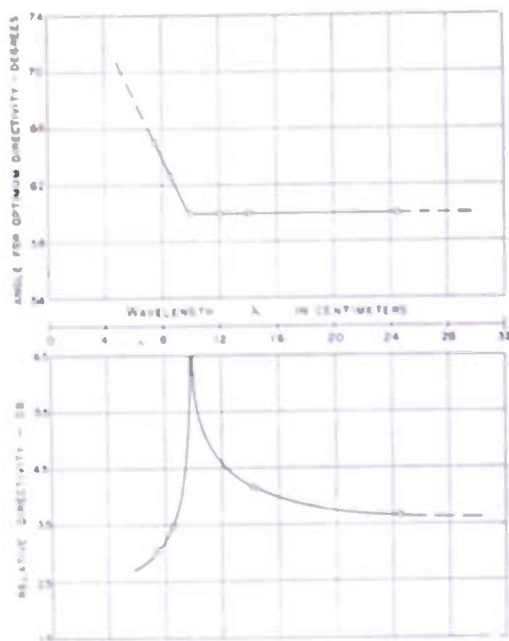

Fig. 6—The directivity and optimum angle for a properly compensated large hole coupler as a function of wavelength. The diameter of the hole = 1.098 inch; inside diameter of coaxial line = 0.875 inch.

Wavelengths less than 10 cm cause the angle of optimum directivity to be greater than 60° , and the directivity itself to decrease sharply. The change in the properties of the device in the region below 10 cm is due to the behavior of the probe. With the particular probe used, the depth of penetration was quite large, and with such a large penetration a series resonance in the probe is possible, with the result that the equivalent T section acquires the form of an *m*-derived section, rather than of a conventional constant *k*-section as it was first assumed. A compensating probe larger in diameter would have had more capacitance and less inductance than the $\frac{1}{4}$ -inch probe, and for the same capacity should extend the high-frequency cutoff point to a higher value. It should be mentioned that more complicated filter sections are possible. If two such probes are used at the edges of the hole, then resonant properties of the probe could have been used to construct a proper *m*-derived filter which would have had more uniform properties than the section used in these experiments.

¹ The method of measurement did not accurately determine the absolute value of directivity, but gave relative values. The absolute error is on the conservative side.

III. EXPERIMENTAL TECHNIQUES AND RESULTS

Fig. 7 shows a block diagram of the equipment used in the measurement of the directivity of the directional

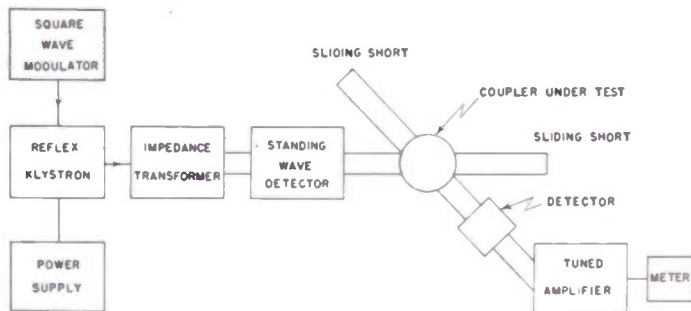

Fig. 7—A block diagram of the equipment used in the measurement of directivity of the couplers.

couplers. The two terminations indicated in Fig. 7 were made movable in position for reasons which will be explained below. The best possible artificial terminations cause measurable reflections, and these interfere with the task of measuring high directivity. Some special techniques must be used, by means of which reflection due to the terminations may be separated from the signals caused by imperfect directivity properties of the coupler.

If the two terminations are made so that they are almost perfect, then a change in position of the termination in the line will cause a change in phase of the reflected wave without changing the magnitude of the reflection. One then adjusts the position of the two sliding terminations so that the directivity signal is the maximum possible; this happens when the two reflections add in phase with the imperfect directivity signal. Data are then taken of directivity signal as a function of the angle between coaxial lines θ . The two terminations are then moved $\lambda/4$ which makes the combined reflection from the terminations subtract from the imperfect directivity signal. Data of signal versus angle are again taken, and sample data are shown plotted in Fig. 8. The curve of mean values of the two experimental tests may be taken as the true directivity signal versus angle θ .

Referring to Fig. 8, it is evident that the experimental points do not pass through zero, but approach a small finite value at some angle. This residual voltage is real and cannot be eliminated. This is the voltage that is due to the fact that fringing fields are present at the hole, and that the fields induced into the auxiliary line are in time quadrature and cannot be cancelled. Thus, the mean of the two curves gives the angle of optimum directivity, and the finite value of the voltage observed at the discontinuity of experimental curves gives one a measure of directivity voltage.

Such a procedure was used in obtaining the data shown in Fig. 6.

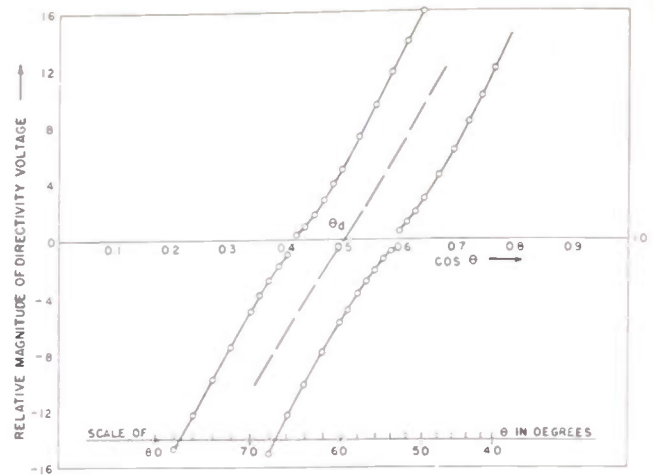

Fig. 8—A typical curve obtained in the determination of the directivity signal and optimum angle with the aid of sliding terminations. Upper curve: Termination reflections in phase with directivity voltage. Lower curve: Termination reflections subtract from directivity voltage. The mean curve shows the true directivity voltage.

CONCLUSION

Experiments have shown that a small-hole theory of Bethe predicts accurately the behavior of the single hole directional coupler, provided that the ratio of the hole diameter to wavelength is 0.1 or less. In particular, the directivity is perfect and it does not depend upon wavelength. The angle for a perfect directivity is the theoretical 60° .

The successful operation of this device is not limited to the region of small hole sizes previously thought necessary, provided that the proper compensation is used. The use of holes larger than the diameter of the line allows coupling in the range of 20 to 30 db at 3,000 Mc. The directivity of a properly compensated directional coupler is excellent over a very wide band. Experiments have shown that directivity is excellent over a 2.5-to-1 frequency range. Moreover, this measured range did not indicate that the limit has been reached.

It is believed that the useful frequency range of this device in any given application will be determined only by the loss of coupling at the lower frequencies.

ACKNOWLEDGMENTS

The authors wish to express their gratitude to F. Kane and J. K. Mann for assisting in the formulation of many of the experimental techniques employed in this work; and to M. Chodorow who read this paper and rendered many useful suggestions.

BIBLIOGRAPHY

1. H. A. Bethe, "Theory of diffraction by small holes," *Phys. Rev.*, vol. 66, 2nd ser., pp. 163-182; October 1 and 15, 1944.
2. H. A. Bethe, "Lumped constants for small irises," *MIT Rad. Lab. Report*, 43-22; Unclassified; March, 1943.
3. H. A. Bethe, "Excitation of cavities through windows," *MIT Rad. Lab. Report* 43-30; Unclassified; 1943.
4. H. C. Early, "A wideband wattmeter for waveguide," *Proc. I.R.E.*, vol. 34, pp. 803-807; October, 1946.
5. H. C. Early, "A wide-band directional coupler for wave guide," *Proc. I.R.E.*, vol. 34, pp. 883-886; November, 1946.

- F. J. Gaffney, "Microwave measurements and test equipment," *PROC. I.R.E.*, vol. 34, pp. 775-793; October, 1946.
- E. I. Green, H. J. Fisher, and J. G. Ferguson, "Techniques and facilities for microwave radar testing," *Elec. Eng.*, vol. 65, pp. 274-289; May, 1946.
- C. F. Hadley, "Microwave wattmeter," *Harvard University Rad. Res. Lab. Report*, No. 411-246, Unclassified; September, 1945.
- R. J. Harrison, "Design considerations for directional couplers," *MIT Rad. Lab. Report* 724; Unclassified, 1945.
- M. C. Jones and C. Sontheimer, "The micromatch," *QST*, vol. 31, pp. 15-18; April, 1947.
- B. A. Lippmann, "Theory of directional couplers," *MIT Rad. Lab. Report* 860; December, 1945.
- T. Moreno, "A new directional coupler for waveguide," *Sperry Gyroscope Co. Engineer's Report*, unpublished; July, 1946.
- W. W. Mumford, "Directional couplers," *PROC. I.R.E.*, vol. 35, pp. 160-165; February, 1947.
- A. A. Pistolcourse and M. S. Neuman, "Device for direct measurement of the coefficient of a traveling wave in feeders," *Elek-trosvyas*, vol. 9, pp. 9-15; April, 1941. Summarized in *Wireless Eng.*, vol. 20, pp. 365-367; August, 1943.
- H. J. Riblett, "A mathematical theory of directional couplers," *PROC. I.R.E.*, vol. 35, pp. 1306-1313; November, 1947.
- H. J. Riblett and T. S. Saad, "A new type of waveguide directional coupler," *PROC. I.R.E.*, vol. 36, pp. 61-64; January, 1948.
- H. A. Bethe, "Theory of side windows in waveguides," *MIT Rad. Lab. Report* 43-27; April, 1943.

Admittance and Transfer Function for an n -Mesh RC Filter Network*

E. W. TSCHUDI†

Summary—The exact evaluation of the coefficients in the admittance and transfer functions of an n -mesh low-pass filter are given as functions of n . It is shown by induction that if these coefficients are true for n , then they also are true for $n+1$. In particular, they are shown to be true for $n=1$.

A n -MESH RC filter network consisting of n identical meshes is shown in Fig. 1. The general expression of the transfer function for this network has the form

$$\left(\frac{E_0}{E_i}\right)_n = \frac{1}{1 + a_1 T p + a_2 T^2 p^2 + \cdots + a_{n-2} T^{n-2} p^{n-2} + a_{n-1} T^{n-1} p^{n-1} + T^n p^n} = F_n(p) \quad (1)$$

and of the admittance

$$G_n = \frac{C p [n + b_1 T p + b_2 T^2 p^2 + \cdots + b_{n-2} T^{n-2} p^{n-2} + T^{n-1} p^{n-1}]}{1 + a_1 T p + a_2 T^2 p^2 + \cdots + a_{n-2} T^{n-2} p^{n-2} + a_{n-1} T^{n-1} p^{n-1} + T^n p^n} \quad (2)$$

where $T=RC$ and $p=j\omega$. It is desired to evaluate the coefficients $a_1, a_2, \cdots, a_{n-1}$ and $b_1, b_2, \cdots, b_{n-2}$ as functions of n .

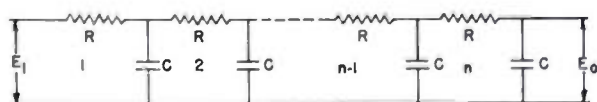

Fig. 1

If we adopt the convention of letting $a_{m,n}$ be the m th coefficient for the case of n meshes, it can be shown that the general a coefficient is given by

$$a_{m,n} = \frac{(n+m)!}{(n-m)!(2m)!} \quad (3)$$

* Decimal classification: R143.2×R386.2. Original manuscript received by the Institute, May 26, 1949; revised manuscript received, November 9, 1949.

† Fairchild Engine and Airplane Corporation, Farmingdale, N. Y.

and the general b coefficient by

$$b_{m,n} = \frac{(n+m)!}{(n-m-1)!(2m+1)!} \quad (4)$$

An analytic proof of the above results will be given by induction. It will be shown that if (3) and (4) are true for some particular value of n , then they also hold for $n+1$; and in particular that they are true for $n=1$

This will prove (3) and (4) valid for all values of n greater than zero.

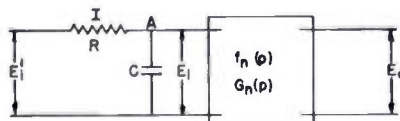

Fig. 2

In Fig. 2 the box represents the n -mesh network whose transfer function and admittance are given by equations (1) and (2). The driving point admittance at point A is $G=G_n+Cp$. The driving point impedance of the $(n+1)$ meshes is

$$Z_{n+1} = R + \frac{1}{G} = \frac{1 + RG_n + Tp}{G_n + Cp}$$

and the admittance of the $(n+1)$ meshes is

$$G_{n+1} = \frac{1}{Z_{n+1}} = \frac{G_n + Cp}{1 + Tp + RG_n} \quad (5)$$

Substituting (2) in (5) we have, after simplification,

$$G_{n+1} = \frac{Cp[(n+1) + (a_1 + b_1)Tp + (a_2 + b_2)T^2p^2 + \dots + (a_{n-2} + b_{n-2})T^{n-2}p^{n-2} + (a_{n-1} + 1)T^{n-1}p^{n-1} + T^np^n]}{1 + (1 + a_1 + n)Tp + (a_1 + a_2 + b_1)T^2p^2 + \dots + (a_{n-1} + 1 + 1)T^np^n + T^{n+1}p^{n+1}} \quad (6)$$

The general b coefficient is seen to be

$$\begin{aligned} b'_{m,n+1} &= a_{m,n} + b_{m,n} \\ &= \frac{(n+m)!}{(n-m)!(2m)!} + \frac{(n+m)!}{(n-m-1)!(2m+1)!} \\ &= \frac{(2m+1+n-m)(n+m)!}{(n-m)!(2m+1)!} \\ &= \frac{(n+1+m)!}{(n-m)!(2m+1)!} = b_{m,n+1} \end{aligned} \quad (7)$$

$$\begin{aligned} F_{n+1} &= \frac{1}{1 + Tp + \frac{1 + a_1Tp + a_2T^2p^2 + \dots + a_{n-1}T^{n-1}p^{n-1}}{1 + a_1Tp + a_2T^2p^2 + \dots + a_{n-1}T^{n-1}p^{n-1} + T^np^n}} \\ &= \frac{1}{1 + (1 + a_1 + n)Tp + (a_1 + a_2 + b_1)T^2p^2 + \dots + (a_{n-1} + 1 + 1)T^np^n + T^{n+1}p^{n+1}} \end{aligned} \quad (13)$$

The general a coefficient is

$$\begin{aligned} a'_{m,n+1} &= a_{m-1,n} + a_{m,n} + b_{m-1,n} \\ &= \frac{(n+m-1)!}{(n-m+1)!(2m-2)!} + \frac{(n+m)!}{(n-m)!(2m)!} \\ &\quad + \frac{(n+m-1)!}{(n-m)!(2m-1)!} \\ &= \frac{(n+1+m)!}{(n+1-m)!(2m)!} = a_{m,n+1} \end{aligned} \quad (8)$$

Hence, if in the admittance function of an n -mesh filter network, (2), with coefficients given by (3) and (4), n is replaced by $(n+1)$, there is obtained the admittance function of an $(n+1)$ -mesh network. It is seen readily that for $n=1$ in (3) and (4), the admittance of a single mesh filter is

$$G_1 = \frac{Cp}{1 + Tp} \quad (9)$$

which, obviously, is correct.

To prove the result for the transfer function, referring to Fig. 2 we note that

$$\begin{aligned} E_i &= E_i' - IR \\ \frac{E_i}{E_i'} &= 1 - R \frac{I}{E_i'} = 1 - RG_{n+1} \end{aligned} \quad (10)$$

Substituting (5) in (10)

$$\frac{E_i}{E_i'} = 1 - \frac{R(G_n + Cp)}{1 + Tp + RG_n} \quad (11)$$

We have the identity

$$\begin{aligned} \frac{E_0}{E_i'} &= \frac{E_0}{E_i} \frac{E_i}{E_i'} \\ &= F_n(p) \left[1 - \frac{R(G_n + Cp)}{1 + Tp + RG_n} \right] \end{aligned}$$

or

$$F_{n+1} = \frac{F_n}{1 + Tp + RG_n} \quad (12)$$

Substituting (1) and (2) in (12) we have

The general a coefficient in (13) is the same as the general a coefficient in (6) and it has already been shown that $a_{m,n+1}$ is obtained from $a_{m,n}$ when n is replaced by $(n+1)$. This proves that equation (1) is the transfer function of an n -mesh filter network with coefficients given by (3). Substituting $n=1$ in (3) the transfer function of a single mesh filter is found to be

$$\left(\frac{E_0}{E_i} \right)_1 = \frac{1}{1 + Tp},$$

which obviously is correct.

CONCLUSION

It is possible to write the exact transfer and admittance functions for any number of meshes of the type in Fig. 1 by using formulas (1) and (2) and the coefficients given by (3) and (4).

ACKNOWLEDGMENT

Appreciation is expressed for suggestions made by John Sweer, head of the analytical group of the Pilotless Plane Division, during the above development.

Contributors to Proceedings of the I.R.E.

William R. Bennett (SM'45) was born in Des Moines, Iowa, on June 5, 1904. He received the degree of B.S. in electrical engineering from Oregon State College in 1925, and the degrees of M.A. and Ph.D. in physics from Columbia University in 1928 and 1949, respectively. He has been a member of the technical staff in the research department of the Bell Telephone Laboratories since 1925.



W. R. BENNETT

Dr. Bennett is the author of numerous papers related to multiplex telephony. He is a member of Tau Beta Pi, Eta Kappa Nu, Sigma Xi, the American Institute of Electrical Engineers, and the American Physical Society. He is now serving on the Circuits Committee of the IRE.



John L. Bower (SM'45) was born in Tolono, Ill., on October 15, 1914. He holds the degree of Bachelor of Science from the United States Military Academy and that of Ph.D. from Yale University. He was associated with General Electric Company from 1936 to 1945, during which time he was in charge of various developments in the field of fire control, including amplidyne- and thyratron-powered gun controls, servomechanisms for aircraft automatic-tracking radar, and miscellaneous electronic controls in the same field.



JOHN L. BOWER

While with the Control Instrument Company from 1945 to 1946, he directed further developments in the same general field. During the period of this work on military equipment, he obtained various patents on synchronizing circuits, phase-shifting circuits for servomechanisms, and others in the field of electronics.

Dr. Bower is now engaged in graduate instruction in servomechanisms at Dunham Laboratory, Yale University, where he is associate professor of electrical engineering. He has served as a consultant for various industrial and aircraft companies, and has directed a number of research projects for the university in network synthesis, hydraulic control theory, and theory of prediction.

Dr. Bower is a member of Sigma Xi and of the American Institute of Electrical Engineers.

Lamont V. Blake (A'42-M'45) was born in Somerville, Mass., on November 7, 1913. He received the B.S. degree from the University of Massachusetts (then called Massachusetts State College) in 1935, and is engaged in part-time graduate study in physics at the University of Maryland at present.



LAMONT V. BLAKE

From 1937 to 1940 he was employed by the Arkansas Power and Light Company as a radio interference investigator. Since 1940 he has been associated with the Naval Research Laboratory, where he is now a section head in the Search Radar Branch of Radio Division 2.

During most of the war Mr. Blake was engaged in work on radar countermeasures. Before this time, and since, he has been concerned with naval search radar research and development.

Mr. Blake is a member of the American Association for the Advancement of Science, and of the American Physical Society.



W. Noel Eldred (S'32-A'35-SM'45) was born in California on December 25, 1907. He received the A.B. degree in 1931 and the E.E. degree in 1933, both from Stanford University, after which he was employed by Heintz and Kaufman, Ltd., as a radio engineer in 1934. His work was principally connected with aircraft transmitter design, communication equipment, and vacuum-tube application.



W. NOEL ELDRED

In 1937 he was appointed sales engineer for this organization, and in 1940 was made plant superintendent.

Mr. Eldred became associated with the Hewlett-Packard Company in 1944 as an engineer, and in 1947 was appointed sales manager, his present position.

He is a member of the American Institute of Electrical Engineers, of Phi Beta Kappa, and an associate member of Sigma Xi. He is past Chairman of the San Francisco Section of the IRE, and is president of the West Coast Electronic Manufacturers' Association.

Edward L. Ginzton (S'39-A'40-SM'46) was born in Russia on December 27, 1915, and came to the United States in 1929. He received the B.S. degree in electrical engineering from the University of California in 1936, and the M.S. degree from the same institution in 1937. Continuing graduate study at Stanford University, he received the E.E. degree in 1938, and the Ph.D. degree in 1940.



EDWARD L. GINZTON

From 1937 until 1939 Dr. Ginzton acted as assistant in teaching and research at Stanford University, and in 1940 he became a research associate in the physics department.

From 1940 until 1947 he was employed in the research laboratories of the Sperry Gyroscope Company, where he was successively in charge of the microwave research, and klystron research and development departments. Since 1946, Dr. Ginzton has been an assistant professor of applied physics at Stanford University. He is a member of Sigma Xi, Tau Beta Pi, and Eta Kappa Nu.



Paul S. Goodwin (S'42-A'44-M'45) was born in Los Angeles, Calif., on November 9, 1919. He attended Stanford University, and received the bachelor's degree in 1942. Following graduation Mr. Goodwin became an assistant project engineer in the Research Laboratories of Sperry Gyroscope Company, in Garden City, L. I., N. Y. At Sperry he was engaged in component development for an airborne gun-laying radar. In January, 1946, he returned to Stanford University to undertake graduate study, receiving the master's degree in September of that year. At Stanford he was employed as a laboratory assistant in the Microwave Laboratory of the physics department. His paper in this issue on directional couplers is the result of work done in the Microwave Laboratory, which culminated in his receiving the E.E. degree in 1947.



PAUL S. GOODWIN

Upon graduation, Mr. Goodwin became an electronic engineer at Consolidated Engineering Corporation, Pasadena, Calif., where he is currently employed. He has been active in the IRE for several years, organizing the formation of a joint AIEE-IRE student branch from the then-existing AIEE student branch while at Stanford University. Since graduation he has been active on the committees of the Los Angeles Section. Mr. Goodwin is also an associate member of Sigma Xi.

John Van Nuys Granger (S'42-A'45-M'46) was born in Iowa in 1918. He received the A.B. degree from Cornell College in 1941, and the M.S. and Ph.D. degrees from Harvard University in 1942 and 1948, respectively. During a part of 1942, he was a member of the staff of the Pre-Radar School at Cruft Laboratory, Harvard University, Cambridge, Mass. In November, 1942, he joined the Radio Research Laboratory of Division 15, OSRD, where he remained until 1945. During that interval he served with the American British Laboratory in Great Malvern, Worcestershire, England, and as a technical observer with the U. S. Air Forces in France and the Low Countries.

In 1945 he joined the staff of the Central Communications Research Laboratories of Division 13, OSRD, at Harvard, leaving in 1946 to resume his studies. In 1947 he became group leader of the Antenna Group at the Cruft Laboratory. In May, 1949, he was named Supervisor of the Aircraft Radio Systems Laboratory, Stanford Research Institute, Stanford, California.

Dr. Granger is a member of the American Physical Society and of Commission 6 of the U.S.A. National Committee of the URSI.

Robert T. Hamlett (SM'46) was born in February, 1902, in Fulton, Ky. He received the B.S. degree in electrical engineering in 1928 from the University of Illinois. From 1928 to 1941 Mr. Hamlett served in the engineering division of the Western Union Telegraph Company, where some of his research resulted in seven patents covering improvements in electrical networks and communication equipment.

In 1941 he joined the Sperry Gyroscope Company as a technical writer, and in 1942 was made publications editor in charge of aeronautical, aircraft armament, and radio products. In 1945 he was transferred from Brooklyn to the Garden City, L. I., Research Laboratories, where he served as engineering publications editor, assuming charge of the publications department in 1947 after Sperry activities were concentrated at Great Neck, L. I., N. Y.

Harold E. Haynes (M'47) was born in Lincoln, Neb., on April 1, 1918. He received the B.Sc. degree in electrical engineering in June, 1939, from the University of Nebraska. During the latter part of that year he was employed by the Nebraska Power Company in Omaha, and following this, he was an instructor in electrical engineering at the South Dakota State School of Mines at Rapid City, S. D. In July, 1940, he joined the Radio Corporation of America, RCA Victor Division, where he has been a member of the sound products advanced development group of the engineering products department since 1941.

Mr. Haynes is a member of the Society of Motion Picture Engineers, and of Sigma Xi.

Archie P. King (A'27-SM'45) was born at Paris, France, on May 4, 1901. He received the B.S. degree from the California Institute of Technology in 1927. From 1927 to 1930 he was in the seismological research department of the Carnegie Institution of Washington, at the end of which time he joined the research department of the Bell Telephone Laboratories, Inc.

During the interval to 1941, Mr. King was engaged in research on short-wave radio systems, waveguide techniques, and waveguide antennas. From 1941 to 1945 he was occupied with the development and performance studies of radar systems.

Since 1945 Mr. King has been engaged in microwave research at the Holmdel Laboratory of the Bell Telephone Laboratories. He is a member of the American Physical Society.

For a biography and photograph of DANIEL LEVINE, see page 1218 of the October, 1949, issue of the PROCEEDINGS OF THE I.R.E.

Mr. Levine is currently on leave from the Air Materiel Command in order to attend the Ohio State University, Columbus, Ohio, where he is engaged in a predoctoral course of study.

Ernest R. Kretzmer (S'46-A'49) was born on December 24, 1924, in M. Gladbach, Germany, and came to the United States in 1940. He received the B.S. degree in electrical engineering from Worcester Polytechnic Institute in 1944, and the S.M. and Sc.D. degrees in the same field from the Massachusetts Institute of Technology in 1946 and 1949, respectively. From 1944 to 1949 he was a member of the electrical engineering staff of MIT, engaged in communication research during the greater part of this period.

In September, 1949, Dr. Kretzmer joined the technical staff of the Bell Telephone Laboratories, where he is now engaged in television research. He is a member of Sigma Xi.

Lester Y. Lacy (SM'48) was born at Kansas, Ill., on September 27, 1907. He received the B.S. degree in electrical engineering from the University of Illinois in 1929. Since that time he has been employed by the Bell Telephone Laboratories as a member of the technical staff, first in the research department where he engaged in fundamental studies of speech and hearing.

During the war he was concerned with secret projects at the Laboratories for the Armed Forces. More recently he has been working in the transmission engineering department on broad-band carrier and mobile radiotelephone systems. He is a member of Eta Kappa Nu and Pi Mu Epsilon.

Philip F. Ordung (S'40-A'43-M'48-SM'49) was born on August 12, 1919, in Luverne, Minn. He received the B.S. degree in electrical engineering at South Dakota State College of Agriculture and Mechanic Arts in 1940; the Master of Engineering degree in 1942 and the Doctor of Engineering degree in 1949 from Yale University. Dr. Ordung was a laboratory assistant in the department of electrical engineering at Yale from 1940 to 1942, and an instructor from 1942



J. V. N. GRANGER



HAROLD E. HAYNES



ERNEST R. KRETZMER



ARCHIE P. KING



L. Y. LACY



ROBERT T. HAMLETT



PHILIP F. ORDUNG

1944. From 1944 to 1945, he was employed by the Naval Research Laboratory in connection with the development of radar modulators. In 1945, he returned to Yale as an instructor, and was advanced to an assistant professor of electrical engineering in 1947.

Dr. Ordnung is an associate of the American Institute of Electrical Engineers and a member of Sigma Xi.



H. E. Roys (A'27-SM'47) was born in Weaver Falls, Pa., on January 7, 1902. He received the B.S. degree in electrical engineering from the University of Colorado in 1925. From 1925 to 1930 he was associated with the General Electric Company in Schenectady, N. Y., on radio transmitter testing, and later on receiving engineering. He was transferred to the RCA Manufacturing Company at Camden, N. J., in 1930, and in 1931 he joined the phonograph section.

In 1937 Mr. Roys became a member of the advanced development group of the photophone section, which later became part of the engineering products department. From 1941 to 1946 he was located with this group in Indianapolis, Ind., working mainly on disc recording and reproducing problems. At present he is located in Camden, and is still associated with the advanced development group.

Mr. Roys is a member of Tau Beta Pi and Eta Kappa Nu.



Erwin W. Tschudi was born on June 2, 1898, in Cincinnati, Ohio. He was graduated from the University of Cincinnati in 1920 with the A.B. degree, and was awarded the A.M. degree in 1921. In 1925 he received the Ph.D. degree in physics and mathematics from the Johns Hopkins University. He has taught these subjects for 12 years at the University of Cincinnati, Johns Hopkins University, Winthrop College, and the College of the City of New York. Dr. Tschudi was associated with the Nela Research Laboratory, Western Electric Company, and Sperry Gyroscope Company, before joining the Fairchild Engine and Airplane Corporation, in Farmingdale, N. Y., in 1947. He has been engaged in independent research on long-range weather forecasting for a number of years. At Fairchild Dr. Tschudi worked in the Pilotless Plane Division, where his research was mainly concerned with servomechanisms and feedback circuits.



ERWIN W. TSCHUDI

Warren D. White (A'47-SM'48) was born in Springfield, Mo., on July 7, 1915. He received the B.S.E.E. degree from the Missouri School of Mines and Metallurgy in 1938. From 1939 to 1940 he was employed by John Barron, a consulting radio engineer in Washington, D. C. From 1940 to 1942 he was a member of the General Engineering Department of the Columbia Broadcasting System. In 1942 he joined the staff of the Radio Research Laboratory at Harvard University, returning in 1945 for a short stay in the Engineering Research and Development Department of CBS. Since January, 1946, Mr. White has been a member of the Radar and Air Navigation Group of the Airborne Instruments Laboratory in Mineola, L. I., N. Y.



WARREN D. WHITE



William Bruce Wholey (S'41-A'45-M'45) was born on November 16, 1920, in Alberta, Canada. He received the B.Sc. degree in engineering physics in 1942 from the University of Alberta, and the M.A. degree in electrical engineering in 1943 from Stanford University. From 1943 to 1945 Mr. Wholey was employed as a special research associate by the Radio Research Laboratory of Harvard University.



W. B. WHOLEY

While with this Laboratory, he was engaged in research and development of broadband high-frequency test equipment. Since 1945 Mr. Wholey has been associated with the Hewlett-Packard Company in the capacity of development engineer.



Frederick O. Viol was born in Adelaide, Australia, on August 14, 1908. He entered the Postmaster-General's Department at Perth, Western Australia, in 1925, and was a technical officer in that State for a number of years.



FREDERICK O. VIOL

He was transferred, in 1936, to the Postmaster-General's Research Laboratories, Central Administration, where he assisted engineers on audio-frequency investigations. In 1940 he was transferred to the Radio and Broadcasting Section, Chief Engineer's Branch

and, in 1942, was appointed to that Section after qualifying for promotion as Engineer.

Mr. Viol was engaged on the standardization and purchase of audio-frequency equipment, including sound recording and replay systems for the National Broadcasting Service. For a number of years he also had the technical control of interstate program channels, and was responsible for the planning and organizing of large interstate broadcast networks.

Recently, Mr. Viol was transferred to the Department of Civil Aviation and he is now a Senior Airways Engineer responsible for the airways engineering of a region.



Thomas W. Winternitz (S'39-A'41) was born in 1916, at Baltimore, Md. He received the B.S. degree from the University of Chicago in 1938, and the M.S. degree from Harvard University in 1940. From 1940 to 1942 he was employed by the Western Electric Company in Chicago, Ill., in the equipment engineering department, and later as a test engineer on radar apparatus.



T. W. WINTERNITZ

In 1942 Dr. Winternitz was transferred to the Bell Telephone Laboratories in New York, N. Y., where he worked on radar and associated projects as a member of the technical staff. From September, 1945, to February, 1948, he held a part-time teaching fellowship at the Cruft Laboratory of Harvard University, where he received the Ph.D. degree in June, 1948. Since March, 1948, he has been associated with the Bell Telephone Laboratories at Whippany, N. J.



A. M. Winzemer (A'42-M'48) was born on November 15, 1917, in Cleveland, Ohio. He received the B.E.E. degree from the College of the City of New York in 1940, and the M.E.E. degree from the Polytechnic Institute of Brooklyn in 1948.



A. M. WINZEMER

From 1941 to 1944 Mr. Winzemer was an inspector of electrical instruments for the Navy Department, and from 1945 to 1948 he was employed as a radio engineer in the Antenna Design Subsection of the Airborne Radio Division, Naval Research Laboratory, Washington, D. C. He has been an electronics engineer in the Antenna and Radome Development Branch of the Aeronautical Electronic and Electrical Laboratory, Naval Air Development Center, Johnsville, Pa., since 1948.

W. Rae Young, Jr., (A'42) was born in Michigan in 1915. He received the B.S. degree in electrical engineering from the University of Michigan in 1937. Upon graduation he joined the technical staff of the Bell Telephone Laboratories, Inc., where, until the beginning of the war, he worked on teletypewriter circuit problems. During the war he was assigned to do development work on radar systems for the Armed Forces, and later to problems on radio systems for the National



W. RAE YOUNG, JR.

Defense Research Committee. Since the war he has been working on the development of mobile radio systems.



Lotfi A. Zadeh (S'45-A'47) was born on February 4, 1921, at Baku, Russia. He attended Alborz College of Teheran, which is an American missionary school, and received the B.S. degree in electrical engineering from the University of Teheran in 1942. He worked for a year as a technical contractor with the U. S. Army Forces in Iran, and came to the United States in 1944. After a brief association with International Electronics Laboratories in New York,

N. Y., he resumed his studies at the Massachusetts Institute of Technology, receiving the M.S. degree in 1946. He was granted the Ph.D. degree from Columbia University in 1949. Since 1946 he has been an instructor in electrical engineering at Columbia University.



LOTFI A. ZADEH

Dr. Zadeh is an associate member of the American Institute of Electrical Engineers, and a member of the American Physical Society, the American Mathematical Society, and Sigma Xi.

Correspondence

Increase in Q -Value and Reduction of Aging of Quartz-Crystal Blanks*

The importance of quartz-crystal units for frequency control derives from the very high- Q (ratio of reactance to resistance) and the low frequency-temperature coefficient of quartz, and the very steep slope of the reactance curve of the crystal blank. The Q of quartz is higher than that of any other frequency-controlling device used to date.

The Q and frequency of a given quartz-crystal blank change, however, with time; these changes are results of the so-called aging process. During World War II, crystal units were used in very large quantities in military communications equipment. Considerable difficulty was experienced during the first years of the war because the useful life of a crystal unit was greatly reduced by reason of its "aging out of frequency" or "going dead." A usable reduction in aging was later accomplished during 1944 by etching the surfaces of the crystal blanks. This only mitigated the effect, however, and its more complete elimination was highly desirable. A method has recently been developed¹ whereby the Q value of the quartz blank has been materially increased, and the aging has been very greatly reduced. The method consists of annealing the quartz blank by heating it almost to the inversion temperature of quartz, or 500°C, and cooling it down extremely slowly.

This simple treatment yields values of Q which are at least double those of untreated quartz blanks, and variations in frequency and Q are minute. These improvements in Q and aging characteristics appear to be of a permanent character. A paper describing the results in greater detail is in preparation.

A. C. PRICHARD
M. A. A. DRUESNE
D. G. McCAA

Signal Corps Engineering Laboratories
Fort Monmouth, N. J.

* Received by the Institute, July 15, 1949.

¹ Signal Corps Engineering Labs., Fort Monmouth, N. J.

Calculation of Ground-Wave Field Strength*

The problem of calculation of ground-wave field intensity over a nonhomogenous earth, discussed by H. L. Kirke in his paper in the May, 1949, issue of the PROCEEDINGS OF THE I.R.E.,¹ is not only of theoretical, but also of practical importance.

I was faced with this problem very recently when I attempted to calculate the field intensities at various points inside the Travancore State, India, due to a 5-kw transmitter (658 kc) located at Trivandrum, the capital.

The geological characteristics of the State are such that it can be divided longitudinally into four well-defined regions of widely differing ground conductivities. The nature of the country and the soil were so well known that it was felt that the soil conductivities could be predicted more or less accurately.

The calculations were carried out using the P. P. Eckersley method. This instance is cited simply to show that once a correct method of calculating field intensities over a nonhomogenous path is established, it will be very easily possible to calculate the field intensity at a point due to a transmitter, as the soil conductivity can be fixed up fairly accurately from a knowledge of the geological characteristics of the soil and the nature of the country. Enough data are available regarding the values of conductivities of different types of ground at various frequencies. On the other hand, if this problem is not solved, the excellent work of Sommerfeld will be of very little practical use, as more often than not it is a case of nonhomogenous propagation with which we have to deal.

* Received by the Institute, September 30, 1949.

¹ H. L. Kirke, "Calculation of ground-wave field strength over a composite land and sea path," *Proc. I.R.E.*, vol. 37, pp. 489-497; May, 1949.

Regarding the "filling in" effect mentioned in the paper, it is true that the argument put forward regarding this phenomenon appeals to reason, but as Mr. Millington has said in a different context, "a seemingly intelligent guess may be erroneous just because it is a guess and not based on a rigid argument." In this case I would add "and unless it is supported by strong experimental evidence." It is really unfortunate that in the measurements made from Start-Point to Happpisburgh, no measurements were made immediately ahead of and immediately beyond the Dorset Coast. A few measurements in this region would have served to verify the phenomenon.

In Figs. 4, 5, and 6 in the paper, a small rise in intensity is noted immediately beyond 250 km. The author has stated that beyond 250 km there is a region of better conductivity. I would like to know whether Mr. Kirke thinks this is a case of the "filling in" effect.

The conditions in Denmark seem to have been ideal to verify this effect, but the results as given in Figs. 9, 10, and 11 are all very misleading, both for verifying the above effect and for determining the relative efficacy of the three methods.

The results published clearly establish the inadequacy of the P. P. Eckersley method, but from these data it is difficult to say which of the remaining two methods is better.

As both Mr. Millington and Mr. Kirke have suggested, further work on this subject is needed and this work should not be confined only to a land-sea boundary, but should also include a composite land path.

Conclusions drawn from results obtained in an extreme case are likely to be erroneous.

K. VENKITARAMAN
Department of Communication Engineering
College of Engineering
Trivandrum, Travancore,
S. India

Institute News and Radio Notes

TECHNICAL COMMITTEE NOTES

Under the Chairmanship of John G. Brainerd, the Standards Committee, at a meeting on December 29, officially approved the Standards on Designations for Electrical Electronic and Mechanical Parts and Their Symbols, 1949. The Standards was published in the February issue of the PROCEEDINGS. Definitions prepared by the Electron Tubes and Solid-State Devices Committee were approved by the Standards Committee and will be published within a short time. The Standards Committee also approved the proposals on Standard Methods of Measurements of TV Signal Level; Standard Measurements of Timing on Video Switching Systems; and Standards on Methods of Measurement of Resolution on Television as prepared by Video Technique Committee. Chairman Brainerd reported that the Executive Committee authorized the change in the name of the Railroad and Vehicular Communications Committee to the Committee on Mobile Communications, and that of the Instruments and Measurements Committee to the Committee on Measurements and Instrumentation in accordance with the request of the Standards Committee. The following IRE Standards have been adopted by the American Standards Association as American Standards: 48 IRE 2. S2, Standards on Antennas: Methods of Testing, 1948 (ASA CL6. 11-1949); 47 IRE 17. S1, Standards on Radio Receivers: Methods of Testing Frequency Modulation Broadcast Receivers; 1947 (ASA C16. 12-1949); 48 IRE 22. S2, Standards on Television: Methods of Testing Television Receivers, 1948 (ASA C16. 3-1949). Axel G. Jensen, Chairman of the Definitions Co-ordinating Subcommittee, reported that work has been started by the Task Group on Transducers, under the Chairmanship of J. A. Morton. Charles J. Hirsch, Chairman of the Task Group on Pulse Definitions, reported on the activities of this Committee. Chairman M. W. Baldwin of the Television Co-ordinating Subcommittee, reported that his group will query other professional societies to determine the scope of their standards activities. Chairman Burrows of the Wave Propagation Committee reported that his Committee is preparing definitions which will soon be ready for publication as a standard. . . . The Navigation Aids Committee at a meeting December 5, under the Chairmanship of Henri Busignies, assigned a review of the operational scope of coverage of Radio Aids to Navigation to C. J. Hirsch. Chairman Hirsch is preparing material relative to "the extracting time of a radio navigation system." . . . At a meeting of the Circuits Committee on December 9, under the Chairmanship of W. N. Tuttle, the program for the Circuit Theory Symposium held on March 7, during the 1950 IRE National Convention, was arranged by W. H. Huggins who reported that the theme of the Symposium was "Network Synthesis in the

Time Domain." The papers included (1) "A Comparison of Frequency and Time Domain Viewpoints in Circuit Design," by W. H. Huggins; (2) "Study of Transient Effects by a New Method of Integral Approximation," by M. V. Cerrillo; (3) "Applications of the Integral Approximation Method of Transient Evaluation," by W. H. Kautz; and (4) "Transient Response of Asymmetrical Carrier Systems," by G. M. Anderson and E. M. Williams. J. A. Morton has been appointed Chairman of the Task Group reviewing transducer definitions. . . . The Industrial Electronics Committee held a meeting on December 28, under the Chairmanship of D. E. Watts. C. W. Frick, Chairman of the Subcommittee on Good Engineering Practices, reported on the Federal Communication Commission Conference on Incidental Radiation Devices which was held November 1, 1949, in Washington, D. C. Mr. Frick also represented the Industrial Electronics Committee on the IRE Measurements and Instrumentation Committee with regard to instruments measuring radiation from industrial electronics equipment. J. L. Dalke, Chairman of the Dielectric Measurements Subcommittee, reported on the work of his group. A report of the Definitions Subcommittee was given by Walther Richter in the absence of the Chairman. W. C. Rudd, Chairman of the AIEE Subcommittee on Induction Dielectric Heating, submitted a report of the activities of his group. Eugene Mittelmann submitted a report on the Subcommittee on Methods of Measurements of which he is Chairman. . . . The National Research Council held a meeting on January 13, in Washington, D. C. to determine the procedure and plans for the publication of a glossary of nuclear terms and technology. The IRE was represented at this meeting by Urner Liddell and L. C. Van Atta. It was decided that ASME would publish the glossary under the copyright of the National Research Council as a proposed American Standard. . . . The Administrative Committee of the Vehicular and Railroad Communications Professional Group met on December 16 at the Engineering Society of Detroit, under the Chairmanship of A. B. Buchanan. The Chairman appointed Robert E. Stinson, Chairman of the Admissions Committee; C. N. Kimball, Chairman of the Conference Papers Committee; and H. E. Wepler, Chairman of Membership Committee. This group is planning a National Conference. The time, place, and registration fees will be announced when details are completed. . . . The Steering and Technical Program Committee of the IRE/AIEE/RMA Conference on Improved Quality Electronic Components held a meeting on December 14 under the Chairmanship of F. J. Given. The Conference will be held on May 9, 10, 11 in Washington, D. C. Advance registration fee will be \$2.00, and registration at the door, \$3.00. Titles of papers and speakers will be announced. . . . The Joint Technical

Advisory Committee held a meeting on Friday, January 13, at the Hotel Statler, Washington, D. C., under the Chairmanship of Donald G. Fink. The JTAC subsequently held an informal conference with the Commissioners of the FCC to assist in the solution of the over-all problems of color television.

IRE/URSI ANNOUNCE MEETING ON ANTENNAS AND PROPAGATION

A Symposium on Antennas and Propagation, arranged by the IRE Professional Group on Antennas and Propagation, will be held at the Navy Electronics Laboratory, San Diego, Calif., on April 3-5. Serving as hosts at the meeting will be the Navy Electronics Laboratory and the IRE San Diego Section. URSI Commissions 2, 3, and 6 will be co-sponsors.

Sessions will be held on the following subjects: Antenna Theory, T. T. Taylor, Chairman; Slot Radiators, Samuel Silver, Chairman; Antenna Development, J. V. Grainger, Chairman; Antenna Instrumentation, T. J. Keary, Chairman; Tropospheric Propagation, J. B. Smyth, Chairman; Ionospheric Propagation, R. A. Helliwell, Chairman. In addition, on April 5 there will be a tour of the Navy Electronics Laboratory and administrative sessions of IRE Antennas and Propagation Group Administrative Committee and of URSI Commissions 2, 3, and 6.

On April 6-7 there will be a classified Military Conference on the same subject at the Navy Electronics Laboratory at which the three services will participate.

SMPE ANNOUNCES NAME CHANGE

Effective January 1, 1950, the name of the Society of Motion Picture Engineers was changed officially to the Society of Motion Picture and Television Engineers. Outstanding among the reasons for the change are the increasing mutual interests of technical people in both motion pictures and television, as well as the Society's active participation in the development of new television techniques.

NUCLEONICS CONFERENCE PAPERS AVAILABLE

Papers delivered at the second annual joint IRE-AIEE Conference on Electronic Instrumentation in Nucleonics and Medicine held in New York City, October 31-November 2, 1949, will be published together in a proceedings of the conference which may be obtained from The Institute of Radio Engineers, 1 East 79 Street, New York 21, N. Y., at \$3.50 per copy.

IRE-AIEE-RMA CONFERENCE IS SCHEDULED FOR MAY 9-11

A Conference on Improved Quality Electronic Components will be sponsored jointly by The Institute of Radio Engineers, the American Institute of Electrical Engineers, and the Radio Manufacturers Association, with the assistance of the Military Services, the Research and Development Board, and the National Bureau of Standards. Featuring Unitization, Quality Elements, and Miniaturization, the Symposium will be held on May 9, 10, and 11, at Washington, D. C.

John G. Reid, Jr., is chairman of the program committee. The conference will pose the problem of achieving the same high degree of dependability and service life in electronic equipments as is now possible in electrical equipment of other types.

Emphasis will be placed on the following topics: "Improved quality of circuit elements for greater dependability of electronic equipments"; "Unitized packaging as a means for greater dependability through simplified maintenance"; "Miniaturization, particularly as applied to the unit package"; and "Circuit elements compatible with design requirements of the unit package."

Trends in the design and manufacture of electronic equipment will be discussed during the conference, and pertinent standards and specifications will be reviewed.

CEDAR RAPIDS SECTION SLATES 1950 STUDENT PAPERS CONTEST

Sponsorship of a 1950 Student Papers Contest by the Cedar Rapids Section of The Institute of Radio Engineers has been announced to provide an incentive for the performance of undergraduate engineering research and to encourage and emphasize the ability to communicate technical ideas to others. All undergraduate students pursuing courses leading to degrees in electrical engineering at the State University of Iowa are eligible to take part in the contest.

Faculty members of the State University of Iowa and members of the Cedar Rapids Section will judge the contest on the basis of work performed in conjunction with the paper, and the quality of both written and oral presentations. One-year student memberships in the IRE will be given to the best five entries. In addition, three cash prizes of \$15.00, \$10.00, and \$5.00, respectively, will be awarded.

MARCH RAILWAY CONVENTION

A convention on Electric Railway Traction will be held March 20-23 at the headquarters of The Institution of Electrical Engineers, in London. The Society is sponsoring the meeting in collaboration with others professionally engaged with British Railways and Industry.

UNIVERSITY ENGINEERS UNVEIL \$250,000 ELECTRIC COMPUTER

An electronic computer, costing a quarter of a million dollars and financed and owned by the Bureau of Aeronautics, U. S. Navy, has been unveiled at the Technological Institute of Northwestern University. Part of the machine was built by the Westinghouse Electric Corp., which constructed the first computer of this type.

Engineers of Northwestern's Aerial Measurements Laboratory designed most of the electronic components, all of which were built by Northwestern students. It is believed that the computer can save scientists years of research on a variety of problems, ranging from the design of the automobile springs to intricate relations in the field of economics. It required two years to bring the machine into service, and it is being improved continually as new problems arise.

A mechanical, economic, or some other system is represented through a group of equations by a mathematician and then plugged into the computer. The equations and the system are thus set up in electrical form on the computer in what scientists call an analogue or analogy. Once the engineer has the system represented on the computer, he has only to turn dials to experiment with it. The results are observed in graphical form on an oscilloscope, which looks much like a television screen.

IRE Professional Group Program

YOU SHOULD JOIN ONE OR MORE OF THE FOLLOWING IRE PROFESSIONAL GROUPS:

- Antennas and Propagation
- Audio
- Broadcast Transmission Systems
- Broadcasting and Television Receivers
- Vehicular and Railroad Radio Communications
- Circuit Theory
- Electronic Instrumentation
- Nuclear Science
- Quality Control

THIS IS WHY YOU SHOULD JOIN:

- No additional dues are required.
- You will increase your opportunities to follow activities in your favorite fields.
- You will benefit by more active participation in IRE local and national events.
- Frequent groups meetings will be held and material of interest will be distributed.

IF YOU ARE AN IRE MEMBER ABOVE STUDENT GRADE AND WISH TO TAKE PART IN THE IRE PROFESSIONAL GROUP PROGRAM, WRITE NOW TO

L. G. CUMMING, *Technical Secretary*
The Institute of Radio Engineers
1 East 79 Street
New York 21, N. Y.

ENGINEERS REFLECT RADIO WAVES AROUND PENNSYLVANIA MOUNTAIN

A. A. Johnson, manager of central station engineering for the Westinghouse Electric Corporation, has reported that radio waves are being "bounced" around a mountain in Pennsylvania. A microwave communication system recently installed between a substation and generating plant of the Pennsylvania Electric Company at Johnstown has shown the reflection principle to be both efficient and economical. Separated by a large hill, the substation and generating plant are 12 miles apart, and the expense of installing and maintaining multiple telephone lines for control purposes would have been very high.

In operation, the microwaves are beamed at a large aluminum reflector sheet placed some two miles from the substation. This sheet, which measures 20 feet square, is mounted on a 50-foot tower and is in the "line of sight" of both the substation and the generating plant. Microwaves striking this mirror-like reflector are deflected around the side of the mountain to the receiving apparatus.

The two-way microwave installation operates either by voice or electrical impulses. With the former, seven voice conversations can be sent simultaneously.

GENERAL ELECTRIC CO. X RAY SHOWS DETAILS OF MATERIALS

Scientists at General Electric Company have developed a new type of X-ray microscope which makes visible internal details of materials through which light cannot pass. It does not require that samples under study be in a high vacuum, as does the electron microscope. GE scientists believe that it may be possible to examine living materials at much higher magnifications than ever before.

The microscope operates on the principle that X rays can be reflected from polished surfaces, as can visible light, provided that they strike the surfaces at very small angles, almost parallel to the surfaces. It consists of an X-ray tube and a pair of curved mirrors, which the X rays strike at an angle of less than one-half degree, after having passed through the sample. The mirrors, acting in a manner like that of a convex lens with a light beam, bend the rays in such a manner as to form a magnified X-ray image of the sample on a photographic film.

ATTENTION, FOREIGN MEMBERS!

In the future, IRE membership dues bills will be sent to foreign members overseas by air mail to facilitate payment of dues without lapse of membership.

Industrial Engineering Notes¹

TELEVISION NEWS

Sales of cathode-ray tubes for television receivers in October increased more than 100 per cent over the sales average for the third quarter of 1949, RMA has reported. The October report marks a change from quarterly to monthly statistical compilations of TV picture tube sales by the RMA Tube Division. October sales of television-receiver type cathode-ray tubes totalled 456,375 units valued at \$11,719,674, compared with a third-quarter monthly average of 216,274 units valued at \$5,718,150, or increases of 111 and 105 per cent, respectively. The trend toward larger picture screens was further emphasized as more than 48 per cent of tubes sold to equipment manufacturers were 12 through 13.9 inches in size; tubes nine through 11.9 inches accounted for 30.8 per cent of the total, and tubes above 14 inches for 17 per cent. Tubes smaller than six inches and six through 8.9 inches amounted to only 3.4 per cent, and projection-type cathode-ray tubes represented 0.02 per cent of October sales.

Television receiver production reported to RMA skyrocketed to 414,223 sets during a five-week November period, according to tabulations, as the industry headed for a new all-time record in set sales for the year 1949. With a month to go, television receiver production by RMA set manufacturers and a few nonmembers at the end of 11 months had reached 2,121,836, with total industry output estimated at more than 2,400,000 TV sets. Radio, and particularly FM-AM, set production also rose during November in response to a revived demand for radios as well as television receivers. FM-AM sets reported by RMA manufacturers totalled 122,603—the highest output since last January—and an additional 60,108 TV sets were reported as equipped with FM reception facilities. Total set production, TV and radio, for the first time this year passed the million mark and by a good margin, the number being 1,324,359. . . . Communication Measurements Laboratory, Inc., on December 16 filed a petition describing a revised proposed television allocations plan utilizing the uhf band exclusively for a nationwide color and black-and-white TV system. The concern made a similar suggestion last August. (*RMA Industry Report*, Vol. 5, No. 31). The proposal would abandon the present vhf television channels after a transition period of at least three years. . . . The year 1949 ended with 98 commercial TV stations on the air and with broadcasting expansion possibilities in the immediate future limited to 13 additional outlets—the number of construction permits outstanding and not affected by the FCC "freeze" on new stations. Of the 13 outstanding construction

permits, only five will open completely new markets for television receivers. These are: Ames, Iowa; Kalamazoo, Mich.; Lansing, Mich.; Nashville, Tenn.; and Norfolk, Va. Other localities where new stations are to be erected, possibly in 1950, are: Jacksonville, Fla.; Atlanta, Ga.; Rock Island, Ill.; Louisville, Ky.; New Orleans, La.; Boston, Mass.; Syracuse, N. Y.; and San Antonio, Texas. The year also ended with 27 cities interconnected for television network service by common carrier and other facilities. . . . RMA co-operation in arranging an international demonstration of American television equipment, as a further move to promote world-wide adoption of U. S. television standards, was formally asked of President R. C. Cosgrove by Assistant Secretary of State Willard L. Thorp. The demonstrations are to be held on March 27 through April 7 in this country before Study Group 11 of the International Radio Consultative Committee which met last July in Zurich, Switzerland, and to which meeting RMA sent a representative, Donald G. Fink. American representatives at that meeting invited the foreign delegates to the United States to witness demonstrations, as did the British and other nations.

The Report of the Color Television Committee of the RMA Engineering Department is now available and may be purchased from The Institute of Radio Engineers, 1 East 79 Street, New York 21, N. Y., at \$6.00 per copy.

FCC ACTIONS

A new color television system proposal has been reported to the FCC by its inventor, Theodore A. Wetzel of Milwaukee, said to be an amateur radio operator, who asked to be heard when the Commission reopens its television hearing in February. Mr. Wetzel, in a brief filed with the FCC, claimed that the proposed color TV system is capable of "adaption to the present standards for black-and-white television, that present sets could receive color broadcasts in black and white, and that monochrome sets can be adapted 'at a very low cost' to receive color transmissions."

The FCC on December 23 adopted its report and order holding unjust, unreasonable, and unlawful, tariff regulations of the Bell Telephone System restricting interconnections of intercity television channels furnished by it with channels of other carriers. The Commission, upon its own motion, also ordered an investigation and hearing to determine whether it is necessary or desirable in the public interest to require interconnection of Bell System intercity video facilities with those of Western Union. . . . The FCC, in response to 26 petitions filed by various organizations in the motion picture industry, announced it will hold a "preliminary fact-finding hearing" on theater television at a time and place to be determined later. The FCC will cover all issues involved in theater television proposals, including the question of assigning specific

¹ The data on which these NOTES are based were selected, by permission from *Industry Reports*, issues of December 16, December 22, January 6, January 13, published by the Radio Manufacturers Association, whose helpful attitude is gladly acknowledged.

frequencies to the service. Pending the proceeding, the FCC extended to April 3 the outstanding temporary authorizations covering experimental television relay stations now held by motion picture concerns. Interested persons desiring to appear and submit evidence at the hearing were requested to file notices of appearance on or before February 27. . . . The FCC authorized the Columbia Broadcasting System to construct and test in its February color television demonstrations an automatic color adapter for television receivers which was developed by members of the FCC Laboratory and assigned to the Government. The adapter includes a switch that changes receivers automatically from 525 lines to 405 lines, depending on whether standard black-and-white or CBS color is transmitted. . . . It was demonstrated by the FCC during the November comparative demonstrations. . . . **The Radio Corporation of America in a progress report on color television** filed with the FCC told the Commission that for purposes of allocation, co-channel and adjacent-channel requirements of color TV will be the same as for black-and-white television. RCA said its tests indicate that for color systems now being considered "there are no practical differences" for co-channel and adjacent-channel interference requirements of the standard monochrome system. RCA said it tested all three color systems (CBS, CTI, and RCA) and found them substantially alike from an interference standpoint. Equipment similar to that utilized by JTAC in preparing its report on co-channel and adjacent-channel interference for black-and-white TV was used by RCA in its color inquiry. . . . The FCC annual report, covering the fiscal year ending June 30, 1949, which was submitted to Congress on January 11, is available from the U. S. Government Printing Office, Washington 25, D. C., at 35 cents a copy. It traces the activities of the FCC during the last fiscal year and contains much statistical information. . . . The FCC has announced it has rejected the proposal of Communication Measurements Laboratory, Inc., that the FCC television allocation proposal of last July be withdrawn, but had accepted the CML proposal as an amendment to an earlier petition filed by the manufacturer. CML's proposals, the FCC pointed out, will be considered during the allocation phase of the Commission's broad inquiry into television which will be resumed following comparative color television demonstrations. . . . The National Association of Broadcasters has asked the FCC to change its proposed rules and regulations to allow **television stations to broadcast music with their test patterns** for 15-minute periods immediately before starting program schedules. This practice would allow viewers who wished to tune in on the first program to do so prior to its commencement, without being annoyed by the single tone or series of variable tones now required as aural accompaniment to a test pattern. NAB also suggested the proposal would encourage viewers to utilize a proper warm-up period so as to avoid oscillator drift, and the consequent necessity of re-tuning during the program.

FM NEWS

FM authorizations and applications declined in 1949, according to FCC year-end statistics, which showed that the total of FM stations on the air, CPs outstanding, and applications as of December 31, were 216 under the corresponding total at the close of 1948. The box score at the end of 1949 was 733 FM stations operating, 55 CPs outstanding, and 47 applications pending as compared with 700 stations, 262 CPs, and 89 applications at the close of 1948. A number of FM stations, moreover, had ceased operation. AM broadcasting stations on December 31 totalled 2,086 with 148 under construction, compared with 1,865 on the air and 262 with CPs at the end of 1948. . . . The District of Columbia Public Utilities Commission has approved the **reception of radio programs in buses and streetcars** operated in Washington by the Capital Transit Co. Opponents of the transit radio programs indicate they will continue their fight against the ruling and will carry the case to court. Transit company officials, on the other hand, said the concern will now resume its program of installing FM radio receivers in all of its 1,500 vehicles suitable for the installations. About 200 Capital Transit vehicles are now radio equipped.

RADIO AND TELEVISION NEWS ABROAD

At present there are no radios manufactured in Colombia, but one U. S. firm and Philips of Holland are contemplating the assembly of sets from imported parts, according to a report from the U. S. Embassy at Bogota. The report estimates that 89 per cent of the radio sets in use in Colombia are of U. S. manufacture; ten per cent are of the Philips brand, and the remainder are of United Kingdom manufacture. . . . The number of licensed radios in Denmark was 1,201,639 on September 30, 1949, an increase of approximately four and one-half per cent over the number registered on the corresponding date in 1948, according to information received by the U. S. Department of Commerce. Radio prices decreased considerably during recent months resulting in sustained sales despite generally slower consumer purchasing, the report said. . . . At the end of October, 1949, there were 181,861 outstanding television licenses in **Great Britain**, and a total of 12,080,308 radio and TV licenses in force, according to information received by the U. S. Department of Commerce. Yugoslavia reports 21 radio stations in operation and claims it has surpassed the Five Year Plan goal for radio stations by 20 per cent. . . . There are an estimated 12,000 radio receivers in use in **Indo-China** with 95 per cent of them being of French origin, according to information received by the U. S. Department of Commerce. Production of radio tubes in **Austria** during January-June, 1949, totalled 393,000 units. Production in 1948 was 853,000 units, 423,000 in 1947, and 1,375,000 in 1937. Imports of radio receivers in **Lebanon** during the first six months of 1949 totalled 11,151 units. About 25 per cent of the sets imported were of U. S. manufacture. The market for U. S. receivers is adversely affected by their high price, which is re-

Calendar of COMING EVENTS

1950 IRE National Convention, New York, N. Y., March 6-9

Optical Society of America, Winter Meeting, Hotel Statler, New York, N. Y., March 9-11

NAB Annual Engineering Conference, Chicago, Ill., April 12-15

IRE/URSI Meeting, Commissions 1, 4, 6, 7, Washington, D. C., April 17-19

Fourth Annual Spring Technical Conference, Cincinnati Section, IRE, April 29, Cincinnati, Ohio

1950 IRE Technical Conference, Dayton, Ohio, May 3-5

Conference on Improved Quality Electronic Components, sponsored by IRE, AIEE, RMA, Washington, D. C., May 9, 10, and 11

Armed Forces Communications Association 1950 Annual Meeting, Photographic Center, Astoria, L. I., N. Y., and New York City, May 12: Signal Corps Center, Fort Monmouth, N. J., May 13

IRE West Coast Convention of 1950, Municipal Auditorium, Long Beach, Calif., Sept. 13-15

Radio Fall Meeting, Syracuse, N. Y., October 30, 31, November 1

ported to be 30 per cent greater than for comparable models of European manufacture, according to a report from the U. S. Embassy.

AIR FORCE PROVIDES \$50 MILLION FOR WORK ON U. S.-ALASKA RADAR SYSTEM

The Air Force has announced that it has cancelled or reduced other approved projects to the extent of \$50 million from its regular 1950 appropriations to speed completion of the first phase of the radar system for the United States and Alaska, authorized during the past session of Congress.

Air Force officials point out that Congress has already approved the air defense project and authorized an over-all expenditure of \$85,500,000 for the construction of facilities. Congress also stipulated that funds for the initial phase of the program must be diverted from money already appropriated for other Air Force activities, and that such expenditures should not exceed \$50 million during the fiscal year 1950.

Under present plans, \$18,800,000 of the sum allocated is being used for the construction of facilities in the United States, while the remaining \$31,200,000 is being devoted to the Alaskan stations in the aircraft control and warning chain.

IRE People

Albert W. Hull (M'41-SM'43-F'44), of the General Electric Research Laboratory, who has been credited with the invention of more types of electron tubes than any other scientist, has retired from his post as assistant director of the Laboratory. He will continue to serve as a consultant.

One of the tubes invented by Dr. Hull was the magnetron, his basic invention having been in 1921. Later it was modified and improved by scientists in many countries, and during World War II formed the heart of microwave radar. Magnetrons are now being applied for quick heating of plastics and other materials in many industrial processes.

He also made basic inventions in the screen-grid tube, which made possible modern radio and television receivers. The thyatron is another Hull invention. This tube, employed for automatic control of electric welding and many other industrial processes, is used in addition to regulate the lighting in Radio City Music Hall in New York. Up to the present, Dr. Hull has been awarded 92 patents.

Some of his first researches at General Electric were on the analysis of crystals by X rays. In 1916 he announced the discovery of a new method of using powdered crystals in such analyses. This technique, which was independently discovered in Europe, has since been widely used. During World War I he did considerable work on the submarine problem, and originated the use of crystals of Rochelle salts to pick up vibrations from the submarines when received through the water.

His World War II work was largely in the development of electron tubes needed for radar and radar countermeasures. For this he was awarded the presidential certificate of merit.

Dr. Hull was president of the American Physical Society in 1942; he is a member of the National Academy of Sciences, Phi Beta Kappa, and Sigma Xi. He has been awarded the honorary degree of Doctor of Science from Yale, Union College, and Middlebury College, and of Doctor of Engineering from Worcester Polytechnic Institute.

He received the Potts Medal from the Franklin Institute for his work on X-ray crystal analysis, and the IRE Morris Liebmann Memorial Prize for his researches and inventions in connection with electron tubes.



Harry F. Olson (A'37-SM'48-F'49), head of Acoustical Research of the RCA Laboratories, has been awarded the first John H. Potts Memorial Award and Medal presented October 28, 1949, at the Annual Meeting of the Audio Engineering Society at the Hotel New Yorker. The award and medal will be given yearly by the Audio Engineering Society for outstanding achievements in the field of audio engineering.

Lloyd A. Briggs (M'29-SM'43), former vice-president and general superintendent of RCA Communications, Inc., died recently at New Haven, Conn. Hospital following a long illness. Mr. Briggs, who had retired in 1947, had been in the communications industry for more than thirty years.

A native of East Gary, Ind., he started as a telegrapher in the Chicago and North Western Railway. During World War I, he served in the U. S. Navy as a radio man in the trans-Atlantic communications service.

He joined the Marconi Wireless Telegraph Company of America a few weeks before it was acquired by the Radio Corporation of America in 1919 and transferred to RCA.

Mr. Briggs first was a supervisor, later a traffic engineer, and from 1934 until 1938 he was European communications manager. Then he became assistant to the vice-president and general manager, general superintendent, and, in 1943, vice-president and general superintendent.

Mr. Briggs attended all major international radio conferences from 1929 to 1938 as a representative of RCA. In 1946 he received a patent with James A. Spencer on a secret communication system in which a cryptographic message tape is used.

Appointments have been announced of **George C. Connor (A'35-VA'39)** as general sales manager for the Photoflash Division, and **Alfred C. Viebranz (A'48)** as general sales manager of the Electronics Division of Sylvania Electric Products Inc.

Mr. Connor became a member of the field engineering staff of the Radio Tube Division in 1934, later serving as manager of equipment tube sales on the Pacific Coast. After the war he was appointed sales manager for the Electronics Division, and, in 1946, general sales manager.

Mr. Viebranz, who was formerly government sales representative for the Electronics Division at Washington, D. C., joined Sylvania as a sales engineer for the Electronics Division in 1946. During the war he served in the submarine service as a Lieutenant, U.S.N.R. and was awarded two silver stars and a bronze star for combat duty in the South Pacific. He received the B.S. in physics from St. Lawrence University in 1942. He later attended the postgraduate school of the United States Naval Academy and was graduated as a communications engineer.

T. DeWitt Talmage (M'44) has been appointed assistant sales manager of the Kellogg Switchboard and Supply Company. His initial work will be in aiding independent companies in co-ordinating their telephone expansion programs.

Mr. Talmage is well known to the readers of technical publications in his field. His proved versatility in the planning, designing, and maintenance of telephone systems, as well as in the commercial phases of the industry, has enabled him to direct many notable communication projects and to write with authority a great number of articles and addresses on a variety of related subjects. In the Tennessee Valley Area, Mr. Talmage directed the construction of the largest power line carrier system in the world, which was co-ordinated with a modern mobile-radio network for operating the vast properties of the TVA.

The professional engineering experience of Mr. Talmage embraces work on manual and automatic telephone systems, local and toll installations, and the many other activities which modern telephony embraces. One of his outstanding contributions to the industry were the papers describing communication projects in the TVA's 80,000 square mile area.

Mr. Talmage was born in Lincoln, Ill., in 1903. He majored in communication engineering at the Milwaukee School of Engineering and the College of Engineering and Commerce of the University of Cincinnati. While attending the latter he was a student telephone engineer in the plant department of the Cincinnati and Suburban Bell Telephone Company. Then he served for seven years as a member of the staff of the Illinois Telephone Association, and subsequently spent 16 years with the TVA as assistant electrical signal engineer, associated electrical signal and communication engineer, senior communication engineer, and principal communication engineer.



Joseph L. Fouts (A'44), electronics engineer at Puget Sound Naval Shipyard, Bremerton, Washington, died recently. Mr. Fouts, who was born July 31, 1904, was a native of Missouri.

Upon completion of an electrical course at Bremerton Evening School he worked as an electrician's helper from 1928 until 1937 when he became a blue printer. He was a radio material clerk the following year. Prior to his connection at the Puget Sound Naval Shipyard, he made inspection tests of radio transmitting and receiving equipment.

Dundas P. Tucker (A'36-SM'46), Captain, U. S. Navy, after nearly three years on the Staff of the Chief of Naval Research, has recently become Director of Electronics Design and Development in the Navy Bureau of Ships. His division has responsibility for all technical features of naval electronic equipment, and for the co-ordination of electronic standards within the Navy.

Born in New York City in 1902, he first became active in "wireless" over thirty years ago. He was graduated from the U. S. Naval Academy in 1925, and was awarded the Master's Degree in Communication Engineering by Harvard in 1934.

Captain Tucker's prewar career covers a wide variety of naval service all over the world. It includes duty as Radio Officer of the U. S. Fleet, and as Officer-in-Charge of Radio Research for the Navy during the development of the first radar. Many of the electronic equipments later used by the Navy during the war were designed under his supervision.

In World War II, Captain Tucker organized and headed the radar and guided missile research, design, and electronic planning activities of the Navy Bureau of Ordnance. During this war period, he originated the Navy's "Bat," the first American automatic guided missile to be put into regular service use against the enemy. He also served as Chairman of the Radar Committee of the Combined Chiefs of Staff.

Captain Tucker holds the Legion of Merit for "exceptional services" in the radar and guided missile programs, and the Air Medal for "meritorious" combat operations, where he used the "Bat" against Japanese ships during the Okinawa campaign.

❖

Delman E. Rowe (M'47) has been appointed senior test director in the guided missiles research laboratory of the National Bureau of Standards. Formerly he was associated with the Naval Aviation Ordnance Test Station at Chincoteague, Va., where he headed the electronics development division.

Mr. Rowe has extensive experience in both military and commercial electronics. He was with the Naval Air Missile Test Center at Point Mugu, Calif., in 1946. He also held various supervisory positions in the Army Signal Corps radar training program. From 1937 to 1942 Mr. Rowe was with the Troy Radio Company in Los Angeles.

While a staff member of MIT's experimental unit at the National Bureau of Standards, from 1943 to 1945, he was engaged in developing the Bat and Pelican guided missiles.

Mr. Rowe, who was born in Owensboro, Ky., received the A.B. degree in physics and mathematics from Whittier College in 1942. He also studied radio communication at the University of California in 1942.

He received the Naval Ordnance Development Award with Certificate by the Naval Bureau of Ordnance in 1945. Mr. Rowe has published technical papers in the electronics field, and is the inventor of a microwave switch and attenuator.

Norman L. Harvey (A'41-M'46-SM'48), formerly head of the Applied Research Branch of the Physics Laboratory of Sylvania Electric Products Inc., has been named director of engineering of Colonial Radio Corporation, a wholly-owned subsidiary of Sylvania Electric. Mr. Harvey became a member of Sylvania's engineering group in 1941 under the direction of **Robert M. Bowie (A'34-M'37-SM'43-F'48)**, now manager of Sylvania's Physics Laboratory.

During the war he served actively in research and development on a variety of projects including proximity fuses, airborne electronic navigation instruments, and advanced types of radar equipments including the equipment which was adapted for use in the Signal Corps' moon radar experiments conducted early in 1946.

Since the war he has supervised research and development work done in Sylvania Research Laboratories on television circuits and electron tubes important to commercial television applications in the proposed high-frequency channels. He has also been active in the supervision of research for improvements in conventional television receiver circuits and viewing tubes.

Mr. Harvey, who was born at Ossian, Iowa, received the B.S. degree in electrical engineering in 1934 at Iowa State College. He is an associate member of AIEE.

Morris Duncan Douglas (A'48), vice-president of The Cleveland Container Company of Cleveland, Ohio, manufacturers of fiber containers and plastic coil forms for radio and video receivers, died recently.

Mr. Douglas was born September 20, 1891, in New Jersey. He was graduated from Mercerburg Academy, and received a mechanical engineering degree from Lehigh University in 1913.

He began his career with the Midvale Steel Company in Philadelphia, Pa., in 1913. From 1915 to 1917 he was superintendent at Rolling Mills at the Han-Yen Pig Iron Co., Han-yang, China. During the following two years he served as a lieutenant in the U. S. Army.

After working as sales manager of the Bush Electric Company and as general manager of the Great Lakes Paper Box Company, in Cleveland, he assumed his duties as vice-president and engineer of The Cleveland Container Company in 1934.

Werner C. Kruger (A'48) of Kruger and Conover, 25 West 45 St., New York, N. Y., died recently. Mr. Kruger was engaged in research and empirical experimentation on electrical potentials in the human system, and the human system as a transmitter, in collaboration with physicians. He was a native of Germany.

Lucien P. Tuckerman (A'25-M'33-SM'43) has joined the staff of the National Bureau of Standards, where he will be liaison engineer in the Guided Missiles Laboratory. Mr. Tuckerman will apply his extensive experience in electronics to the design and engineering of guided missiles.

Born in Wallingford, Conn., in 1905, he is also a member of the American Institute of Electrical Engineers, an associate member of the Society of Motion Picture Engineers, a member of the National Rifle Association, a fellow of the Radio Club of America, and a charter member of the Engineers Club of Washington.

From 1947 until 1949, Mr. Tuckerman was the chief engineer in charge of all military specification equipment for the International Industrial Development Company. During the war he served as a Commander at the U. S. Navy Bureau of Ordnance, where he was engaged in ordnance research and development. He was also the project officer for the "Bat" Guided Missile.

Mr. Tuckerman was a senior radio engineer for the Federal Telegraph Company from 1927 to 1942, designing direction finders, marine and commercial radio receivers, public address systems, and also broadcast station WCBS in New York City. Previously he worked two years for the de Forest Radio Company on the development of broadcast receivers and their components. From 1922 to 1925 Mr. Tuckerman was an assistant engineer at the Bell Telephone Laboratories engaged in the development of telephones and radio telephonic systems. He holds a patent for the invention of a peak limiting amplifier.

❖

M. K. Goldstein (A'30-SM'46), member of the technical staff of the Air Navigation Development Board of the Civil Aeronautics Administration, has been granted the "1948 Academy Award in the Engineering Sciences" by the Washington Academy of Sciences in "recognition of his distinguished research and development in the field of electronic engineering."

A graduate of The Johns Hopkins University, Dr. Goldstein received the B.S. and the Ph.D. degrees in electrical engineering. From 1935 to 1937, he participated actively in the development of radio navigation aids at Wright Field. Then he continued these developments and their applications to civil aviation with the Civil Aeronautics Authority.

Dr. Goldstein was later in charge of the Radio Direction Finder Section at the Naval Research Laboratory, and was awarded the Distinguished Civilian Service Award by the Navy. He subsequently became head of the Airborne Radio Division of the Systems Engineering Section.

❖

Stuart L. Seaton (A'41-M'43-SM'43), Director of the Geophysical Institute, University of Alaska, was elected a Fellow of the New York Academy of Sciences at its annual meeting, December 7, 1949, in New York, N. Y. The honor was conferred for outstanding work towards the advancement of science.

Sections*

Chairman		Secretary	Chairman		Secretary
H. R. Hegbar 2145 12th St. Cuyahoga Falls, Ohio	AKRON (4)	H. G. Shively 736 Garfield St. Akron Ohio	G. L. Foster Sparton of Canada London, Ont., Canada	LONDON, ONTARIO (8)	G. R. Hosker Richards-Wilcox London, Ont., Canada
H. I. Metz C.A.A. 84 Marietta St., N.W. Atlanta, Ga.	ATLANTA (6) March 17-April 21	M. S. Alexander 2289 Memorial Dr., S.E. Atlanta, Ga.	R. L. Sink Consolidated Eng. Co. 620 N. Lake Ave. Pasadena 4, Calif.	LOS ANGELES (7)	W. G. Hodson 524 Hampton Rd. Burbank, Calif.
E. W. Chapin 2805 Shirley Ave. Baltimore 14, Md.	BALTIMORE (3)	J. V. Lebacqz Johns Hopkins Un. Baltimore, Md.	D. C. Summerford Radio Station WKLO Henry Clay Hotel Louisville, Ky.	LOUISVILLE (5)	R. B. McGregor 2100 Confederate Pl. Louisville, Ky.
T. B. Lawrence 1833 Grand Beaumont, Texas	BEAUMONT- PORT ARTHUR (6)	C. B. Trevey 2555 Pierce St. Beaumont, Texas	E. J. Limpel A. O. Smith Corp. 3533 N. 27 St. Milwaukee 1, Wis.	MILWAUKEE (5)	W. H. Elliot 4747 N. Larkin St. Milwaukee 11, Wis.
H. H. Scott Hermon Hosmer Scott, Inc. 385 Putnam Ave. Cambridge 39, Mass.	BOSTON (1)	F. D. Lewis General Radio Co. 275 Massachusetts Ave. Cambridge 39, Mass.	A. B. Oxley R.C.A. Victor Co. 1001 Lenoir St. Montreal, P.Q. Canada	MONTREAL, QUEBEC (8) March 8-April 12	H. A. Audet Canadian Broadcasting Corp. 1231 St. Catherine St. Montreal, Que, Canada
J. P. Arnaud Guemes 827 Vte. Lopez F.C.C.A., Argentina, S.A.	BUENOS AIRES	L. Brandt Uruguay 618 Buenois Aires, Argentina, S.A.	C. W. Carnahan 3169-41 Place Sandia Base Branch Albuquerque, N. M.	NEW MEXICO (7)	T. S. Church 3230 B 'A' St. Sandia Base Branch Albuquerque, N. M.
L. P. Haner 75 Koenig Rd. Tonawanda, N. Y.	BUFFALO-NIAGARA (4) March 15-April 19	K. R. Wendt Colonial Radio Corp. 1280 Main St. Buffalo 9, N. Y.	H. F. Dart 33 Burnett St. Glen Ridge, N. J.	NEW YORK (2)	Earl Schoenfeld W. L. Maxson Corp. 460 W. 34th St. New York 1, N. Y.
M. S. Smith 1701 10th St. Marion, Iowa	CEDAR RAPIDS (5)	V. R. Hudek Collins Radio Co. Cedar Rapids, Iowa	C. M. Smith Radio Station WMIT 419 N. Spruce St. Winston Salem, N. Car.	NORTH CAROLINA- VIRGINIA (3)	V. S. Carson Elec. Eng. Dept. N. C. State College Raleigh, N. Car.
E. H. Schulz Elec. Engr. Dept. Armour Research Found. Chicago, Ill.	CHICAGO (5) March 17-April 21	L. H. Clardy Research Labs. Swift & Co., U. S. Yards Chicago 9, Ill.	M. W. Bullock Capital Broadcasting Co. 501 Federal Securities Bldg. Lincoln 8, Neb.	OMAHA-LINCOLN (5)	B. L. Dunbar Radio Station WOW Omaha, Neb.
F. W. King 6249 Banning Rd. Cincinnati 24, Ohio	CINCINNATI (5) March 14-April 18	J. P. Quitter 509 Missouri Ave. Cincinnati 20, Ohio	A. W. Y. Des Brisay 240 Clewom Ave. Ottawa, Ont., Canada	OTTAWA, ONTARIO (8) March 16-April 20	A. G. Sheffield 11 Fern Ave. Ottawa, Ont., Canada
J. F. Dobosy 31748 Lake Rd. Avon Lake, Ohio	CLEVELAND (4) March 23-April 27	T. B. Friedman 2909 Washington Blvd. Cleveland Heights 18, Ohio	J. T. Brothers Philco Radio and Tele- vision Tiogo and 'C' Sis. Philadelphia 34, Pa.	PHILADELPHIA (3) March 2-April 6	L. M. Rodgers 400 Wellesley Rd. Philadelphia 19, Pa.
R. B. Jacques 226 W. Como Ave. Columbus, Ohio	COLUMBUS (4) March 10-April 14	S. N. Friedman 144 N. Edgevale Columbus, Ohio	M. Glenn Jarrett 416 Seventh Ave. Pittsburgh 19, Pa.	PITTSBURGH (4) March 13-April 10	W. P. Caywood, Jr. 23 Sandy Creed Rd. Pittsburgh 21, Pa.
Lawrence Grew S. N. E. Telephone Co New Haven, Conn.	CONNECTICUT VALLEY (1) March 16-April 20	J. E. Merrill 16 Granada Terr. New London, Conn.	F. E. Miller 3122 S.E. 73 Ave. Portland 6, Ore.	PORTLAND (7)	Henry Sturtevant 8211 S.W. Westgard Ave. Portland 1, Ore.
A. S. Levell 801 Telephone Bldg. Dallas 2, Texas	DALLAS-FORT WORTH (6)	E. A. Hegar 802 Telephone Bldg. Dallas 2, Texas	E. W. Herold RCA Laboratories Princeton, N. J.	PRINCETON (3)	W. H. Bliss 300 Western Way Princeton, N. J.
H. E. Ruble 3011 Athens Ave. Dayton 6, Ohio	DAYTON (5)	G. H. Arenstein 1224 Windsor Drive Dayton 7, Ohio	K. J. Gardner 111 East Ave. Rochester 4, N. Y.	ROCHESTER (4) March 16-April 20	Gerrard Mountjoy Stromberg Carlson Co. 100 Carlson Rd. Rochester, N. Y.
T. G. Morrissey Radio Station KFEL Albany Hotel Denver, Colo.	DENVER (5)	Hubert Sharp Box 960 Denver 1, Colo.	N. D. Webster 515 Blackwood N. Sacramento, Calif.	SACRAMENTO (7)	J. R. Miller 3991 3rd Ave. Sacramento, Calif.
F. E. Bartlett Radio Station KSO Old Colony Bldg. Des Moines 9, Iowa	DES MOINES- AMES (5)	O. A. Tennant 1408 Walnut St. Des Moines Iowa	L. A. Mollman Union Electric Co. 12 and Locust Sts. St. Louis 1 Mo.	ST. LOUIS (5)	H. G. Wise 1705 N. 48 St. E. St. Louis, Ill.
N. C. Fisk 3005 W. Chicago Ave. Detroit 6, Mich.	DETROIT (4) March 17-April 21	P. L. Gundy 55 W. Canfield Ave. Detroit Mich.	C. R. Evans Radio Station KSL Salt Lake City, Utah	SALT LAKE (7)	E. C. Madsen Dept. of Elec. Eng. University of Utah Salt Lake City, Utah
W. J. Petersen 322 E. Allegheny Ave. Emporium, Pa.	EMPORIUM (4)	W. R. Rolf 364 E. Fifth St. Emporium, Pa.	C. L. Jeffers Radio Station WOAI 1031 Navarro St. San Antonio, Texas	SAN ANTONIO (6)	L. K. Jonas 267 E. Mayfield Blvd. San Antonio, Texas
H. W. G. Salinger 2527 Hoagland Ave. Ft. Wayne 6, Ind.	FORT WAYNE (5)	J. F. Conway 4610 Plaza Dr. Ft. Wayne, Ind.	E. W. Thatcher 2661 Poinsettia Dr. San Diego 6, Calif.	SAN DIEGO (7)	S. H. Sessions U. S. Navy Electronics Lab. San Diego 52, Calif.
C. R. Wischmeyer 808 N. Rice Ave. Bellaire, Texas	HOUSTON (6)	Wayne Phelps 26 N. Wynden St. Houston 6, Texas	W. R. Hewlett 395 Page Mill Rd. Palo Alto, Calif.	SAN FRANCISCO (7)	J. R. Whinnery Elec. Engr. Dept. University of Calif. Berkeley, Calif.
E. H. Pulliam 931 N. Parker Ave. Indianapolis 1, Ind.	INDIANAPOLIS (5)	J. H. Schult Indianapolis Elec. School 312 E. Washington St. Indianapolis 4, Ind.			
E. R. Toporeck Naval Ordnance Test Sta. Inyokern, Calif.	INYOKERN (7)	R. W. Johnson 303 B. Langley China Lake, Calif.			
C. F. Heister Fed. Com. Comm. 838 U. S. Court House Kansas City 6, Mo.	KANSAS CITY (5)	Mrs. G. L. Curtis 6005 El Monte Mission, Kan.			

* Numerals in parentheses following Section designate Region number

Sections

Chairman		Secretary		Chairman		Secretary	
S. D. Bennett 3437-36 Ave W. Seattle 99, Wash.	SEATTLE (7) March 9-April 13	J. E. Mason 2318 Tenth St. Bremerton, Wash.		F. T. Hall Dept. of Elec. Engr. Pennsylvania St. College State College, Pa.	CENTRE COUNTY (4) (Emporium Subsection)	J. H. Slaton Dept. of Eng. Research Pennsylvania St. College State College, Pa.	
L. R. Fink 416 Cherry Rd. Syracuse 9, N. Y.	SYRACUSE (4)	S. E. Clements Dept. of Elec. Engr. Syracuse University Syracuse, N. Y.		A. H. Sievert Canadian Westinghouse Co. Hamilton, Ont., Canada	HAMILTON (8) (Toronto Subsection)	J. H. Pickett Aerovox Canada Ltd. 1551 Barten St. E. Hamilton, Ont., Canada	
A. M. Okun 344 Boston Pl. Toledo 10, Ohio	TOLEDO (4)	R. G. Larson 2647 Scottwood Ave. Toledo 10, Ohio		R. B. Ayer RCA Victor Division New Holland Pike Lancaster, Pa.	LANCASTER (3) (Philadelphia Subsection)	J. L. Quinn RCA Victor Division New Holland Pike Lancaster, Pa.	
C. Graydon Lloyd Canadian General Electric Co., Ltd. 212 King St., W. Toronto, Ont., Canada	TORONTO, ONTARIO (8)	Walter Ward Canadian General Electric Co., Ltd. 212 King St., W. Toronto, Ont., Canada		O. M. Dunning Hazeltine Elec. Corp. 5825 Little Neck Pkwy. Little Neck, L. I., N. Y.	LONG ISLAND (2) (New York Subsection)	David Dettinger Wheeler Labs. 259-09 Northern Blvd. Great Neck, L. I., N. Y.	
W. G. Pree 2500 W. 66 St. Minneapolis, Minn.	TWIN CITIES (5)	O. A. Schott 4224 Elmer Ave. Minneapolis 16, Minn.		H. Sherman Watson Labs.-ENRPS- Red Bank N. J.	MONMOUTH (2) (New York Subsection)	W. L. Rehm Signal Corps Eng. Labs. Rm. 247, Squier Lab. Fort Monmouth, N. J.	
H. W. Wells Carnegie Inst. of Wash. 5241 Broad Branch Rd. N.W. Washington, D. C.	WASHINGTON (3) March 13-April 10	Mark Swanson 8704 Maywood Ave. Silver Spring, Md.		N. Young, Jr. F.C.C. Nutley, N. J.	NORTHERN N. J. (2) (New York Subsection)	J. H. Redington Measurements Corp. Boonton, N. J.	
G. C. Larson Westinghouse Elec. Corp. Sunbury, Pa.	WILLIAMSPORT (4) March 1-April 4	R. C. Walker Box 414, Bucknell Univ. Lewisburg, Pa.		A. R. Kahn Electro-Voice, Inc. Buchanan, Mich.	SOUTH BEND (5) (Chicago Subsection) March 16-April 20	A. M. Wiggins Electro-Voice, Inc. Buchanan, Mich.	
SUBSECTIONS							
Chairman		Secretary					
H. W. Harris 711 Kentucky St. Amarillo, Tex.	AMARILLO-LUBBOCK (6) (Dallas-Ft. Worth Subsection)	E. N. Luddy Station KFDA Amarillo, Tex.		R. M. Wainwright Elec. Eng. Department University of Illinois Urbana, Ill.	URBANA (5) (Chicago Subsection)	M. H. Crothers Elec. Eng. Department University of Illinois Urbana, Ill.	
				R. D. Cahoon C.B.C. Winnipeg, Man., Canada	WINNIPEG (8) (Toronto Subsection)	J. R. B. Brown Suite 2 642 St. Marys Rd. Winnipeg, Man., Canada	

Books

Transformation Calculus and Electrical Transients by Stanford Goldman, Ph.D.

Published (1949) by Prentice Hall Inc., 70 Fifth Ave., New York 11, N. Y. 398 pages+5-page index +xiv pages+150 figures. 8 1/2 X 5 1/2. \$8.35.

Many problems treated in this text are circuit problems frequently handled by the Heaviside operational calculus. Since the emphasis here has been shifted from the point of view of operational methods to that of transformations between the t axis and the complex S plane, the author has felt it preferable to designate the techniques by the name "Transformation Calculus."

The text covers the following topics: Determinants; Properties of Electrical Circuits; Transient Solutions of Circuit Problems by Means of the Laplace Transformation; Fundamental Concepts in Circuit Theory; Functions of a Complex Variable; Loci of Complex Functions; The Inversion Theorem and Related Topics; Gamma and Error Functions; Bessel Functions; Transients in Transmission Lines-Solution of Partial Differential Equations; Solution in Series; Additional Applications to Electrical Engineering. Appendices include: "A Table of Integrals; A Table of Identities Involving Hyperbolic Functions; Basic Theory of Transmission Lines in the Steady State; Table of Laplace Transformations; Fourier Integral Analysis.

The book is introductory in character, covering a very broad field of mathematics. The most important chapters are 3 and 7. These chapters deal with the Laplace Transformations and the Inverse Transformations. The objective throughout apparently is to encourage vigor in the application of analysis to circuit theory, sometimes at the expense of rigor. A sufficient amount of material is presented under each of the various headings to acquaint the student with the nature of the circuit problems which might be solved by an application of the tools introduced, but none of the topics are carried far enough to render the student a master of his machine. The text contains many illustrative examples, as well as exercises which furnish student practice in the application of methods presented.

This reviewer cannot refrain from commenting that this text, in common with most texts on applied mathematics, can scarcely be considered an adequate substitute for the specialized mathematical treatise on differential equations, complex variables, Laplace transforms, etc. It does furnish an introduction which guides the student in his choice of mathematical training but is certainly not a substitute for that specialized training.

LLOYD T. DEVORE
University of Illinois
Urbana, Ill.

Fourier Transforms by S. Bochner and K. Chandrasekharan

Published (1949) by Princeton University Press, Princeton, N. J. 219 pages+11 pages of Notes. 9 X 6. \$3.50.

The tract "Fourier Transforms" is principally a collection of theorems and topics connected with Fourier transforms. Although the material will probably be familiar to workers in the field, the chief merit of the book is the orderly drawing together of classical material from scattered sources in mathematical literature. In some instances, the authors present their own developments of certain topics.

Probably the appeal of this work will be chiefly to the pure mathematician. Specific application to the physical sciences is not attempted.

The discussion opens with a consideration of Fourier transforms with reference to functions of the Lebesgue class with one variable and then with several variables. There follows a collection of theorems dealing with L_p space and Fourier transforms, and general transforms in L_2 functions including Watson transforms. In the closing chapter several general Tauberian theorems are developed.

GORDON L. FREDENDALL
RCA Laboratories
Princeton, N. J.

Abstracts and References

Prepared by the National Physical Laboratory, Teddington, England, Published by Arrangement with the Department of Scientific and Industrial Research, England, and *Wireless Engineer*, London, England

NOTE: The Institute of Radio Engineers does not have available copies of the publications mentioned in these pages, nor does it have reprints of the articles abstracted. Correspondence regarding these articles and requests for their procurement should be addressed to the individual publications, and not to the IRE.

Acoustics and Audio Frequencies.....	323
Antennas and Transmission Lines.....	323
Circuits and Circuit Elements.....	324
General Physics.....	327
Geophysical and Extraterrestrial Phenomena.....	327
Location and Aids to Navigation.....	328
Materials and Subsidiary Techniques.....	328
Mathematics.....	329
Measurements and Test Gear.....	329
Other Applications of Radio and Electronics.....	330
Propagation of Waves.....	331
Reception.....	332
Stations and Communication Systems.....	332
Subsidiary Apparatus.....	333
Television and Phototelegraphy.....	333
Transmission.....	333
Vacuum Tubes and Thermionics.....	334
Miscellaneous.....	336

The number in heavy type at the upper left of each Abstract is its Universal Decimal Classification number and is not to be confused with the Decimal Classification used by the United States National Bureau of Standards. The number in heavy type at the top right is the serial number of the Abstract. DC numbers marked with a dagger (†) must be regarded as provisional.

ACOUSTICS AND AUDIO FREQUENCIES

- 534.321.9 269
Ultrasonics: A Brief Survey—J. H. Jupe. (*Electronic Eng.*, vol. 21, pp. 422-423; November, 1949. Bibliography, pp. 423-424.)
- 534.78 270
Speech Communication under Conditions of Deafness or Loud Noise—W. G. Radley. (*Proc. IEE (London)*, vol. 96, pp. 312-313; November, 1949.) Discussion on 2690 of 1948.
- 534.78 271
The Sonograph: Elements and Principles—J. Dreyfus-Graf. (*Schweiz. Arch. Angew. Wiss. Tech.*, vol. 14, pp. 353-362; December, 1948. In French.) Description of an instrument which transforms each sound into a group of electrical pulses and then into mechanical motions characterizing certain elements of the sound. It can transform speech into writing and may have wide application in linguistic investigations.
- 534.851:621.395.813 272
Measuring Turntable Speed Fluctuations—E. W. Berth-Jones. (*Wireless World*, vol. 55, pp. 471-474; December, 1949.) Fluctuations of the order of 0.01 per cent must be detected. An af oscillator is used which generates a tone of known frequency, constant within less than 0.01 per cent. This tone is fed through the recording channel to the cutter head, which is mounted in position on the recording lathe to be tested. A pickup is mounted so that it will track the groove cut by the recording head, at a distance of a few inches behind it. The output of the pickup is amplified and matched in level with a second output obtained from the recording channel. If these outputs are ad-

The Annual Index to these Abstracts and References, covering those published in the PROC. I.R.E. from February, 1948, through January, 1949, may be obtained for 2s. 8d. postage included from the *Wireless Engineer*, Dorset House, Stamford St., London S. E., England. This index includes a list of the journals abstracted together with the addresses of their publishers.

justed to be in phase initially, they can be combined to have zero resultant at constant turntable speed; small variations in this speed cause the resultant to have an amplitude dependent on the change in speed. The method can be adapted to magnetic as well as disk recording. Sensitivity can be adjusted by varying the oscillator frequency.

621.395.625 273
The Development of Mobile Recording Technique—M. J. L. Pulling. (*BBC Quart.*, vol. 4, pp. 179-192; October, 1949.) Description of various types of apparatus used by the British Broadcasting Corporation since 1936, notably the Type-C equipment which operated from two 6-v accumulators in series and could be carried in a private car, and the Midget Disk Recorder which weighs 35 lb complete. Magnetic recorders have not so far been used much; they have marked advantages for recording sporting events where important incidents occur infrequently and unexpectedly. Problems of organization and possible future improvements are discussed. See also 11 of 1949.

621.395.625.2:621.396.97 274
Reproduction from Disks and Records for Broadcasting—J. W. Godfrey. (*BBC Quart.*, vol. 4, pp. 170-175; October, 1949.) Variations in recording standards and in reproducing devices, particularly playback needles, make it difficult to obtain consistency in quality and signal-to-noise ratio. A reasonable compromise is possible if light-weight pickups and a standardized sapphire-tipped reproducing stylus are used, and if selective equalization is used in reproducing circuits. The effects of variations in playback time, in the linear speed of the groove, in recording characteristic, and in needle and groove radius are considered separately.

681.85:621.317.616† 275
The Variable-Disk-Speed Method of Measuring the Frequency Characteristics of Pick-Ups—P. R. Terry. (*BBC Quart.*, vol. 4, pp. 176-178; October, 1949.) A test disk has a single band of recorded tone, and its speed of rotation is varied in a 4:1 range. A portion of the pickup frequency-response curve is thus obtained, which can easily be joined to similar portions at other frequencies. Although the response of a pickup cannot be fully defined in a simple manner, this method gives adequate information for practical purposes without requiring calibrated test disks.

ANTENNAS AND TRANSMISSION LINES

- 621.315.212:621.397.5 276
London-Birmingham Television Cable—H.

Stanesby and W. K. Weston. (*Elec. Commun.* vol. 26, pp. 186-200; September, 1949.) Reprint. See 1279 and 1857 of 1949.

621.315.65 277
Notes on a Coaxial Line Bead—W. D. Peterson. (*Proc. I.R.E.*, vol. 37, p. 1294; November, 1949.) Comment on 1582 of 1949 (Cornes).

621.392.26† 278
Electromagnetic Waves in Metal Tubes—R. Honerjäger. (*FIAT Review of German Science, 1939-1946; Electronics, incl. Fundamental Emission Phenomena*, Part 2, pp. 31-44; 1948. In German.) A concise treatment of the propagation of E-, H-, and Lecher-type waves, which are grouped under the term "line waves" (Leitungswellen). The principal formulas for the propagation constants for waveguides of rectangular or circular cross section and for concentric cables are summarized. The excitation of line waves by electric or magnetic dipoles, and their reflection, refraction, and diffraction, are also considered. References to over 30 articles and reviews published in Germany are given.

621.392.26†:621.3.09 279
The Propagation of Electromagnetic Waves in a [cylindrical] Tube Containing a Coaxial D.C. Discharge—P. Rosen. (*Jour. Appl. Phys.*, vol. 20, pp. 868-877; September, 1949.) The boundary-value problem is solved. Ohm's law is assumed to hold for the ac; this has been verified theoretically for the case where the ac field is small compared with the dc field. "Curves which give the relationship between the complex propagation constant γ and the complex dielectric coefficient K_c' have been computed for the solution in which the TEM mode of the coaxial line is approached as K_c' becomes infinite."

621.392.26†:621.396.662 280
Corrections to the Attenuation Constants of Piston Attenuators—J. Brown. (*Proc. IEE (London)*, vol. 96, pp. 491-495; November, 1949.) The modes existing in a circular waveguide with walls of finite conductivity are investigated and the effect of an oxide layer on the inner surface of the attenuator is considered. Expressions are derived for the corrections to the attenuation constant, which are of importance in the case of H modes when an accuracy within 1 part in 10^4 is desired.

621.396.67+621.315.14 281
Antennas and Open-Wire Lines: Part I—Theory and Summary of Measurements—R. King. (*Jour. Appl. Phys.*, vol. 20, pp. 832-850; September, 1949.) The apparent impedance of an antenna as a load on an open-wire trans-

mission line may be determined from the theoretical impedance of the isolated antenna if the transmission-line end effects and the coupling between the line and the antenna are represented by an inductance in series and a capacitance in parallel with the antenna. The inductive effects are small, while the capacitive effects may be large, so that the general variation of the apparent antenna impedance, with various types of transmission line and methods of connection, may be derived by determining the effect of a lumped positive or negative capacitance in parallel with the isolated antenna. Curves are given showing the good agreement obtained between the experimental and theoretical results. Part 2, 399 below.

621.396.67 282
Aerials—K. Fränz. (*FIAT Review of German Science, 1939-1946; Electronics, incl. Fundamental Emission Phenomena, Part 2*, pp. 65-89; 1948. In German.) Discussion of the properties of dipole, long-wire, and parabolic antennas, slot and dielectric radiators, and of various measurement methods, with references to 26 relevant papers.

621.396.67 283
The Influence of Conductor Size on the Properties of Helical Beam Antennas—T. E. Tice and J. D. Kraus. (*Proc. I.R.E.*, vol. 37, p. 1296; November, 1949.) Results of measurements on three helices of identical construction, except for conductor diameter, indicate that the frequency range of the beam mode is only slightly affected by conductor diameter. See also 306 and 1860 of 1949 (Kraus).

621.396.67:538.566.2 284
The Magnetic Dipole in a Stratified Atmosphere—G. Eckart. (*Onde Élec.*, vol. 29, pp. 378-381; October, 1949.) The em field is determined for a dipole in a free atmosphere whose dielectric constant is a linear function of the z coordinate. The case of such an atmosphere above a plane earth is also considered. The physical interpretation of the results is discussed.

621.396.67:551.510.535 285
Impedance Characteristics of Some Experimental Broad-Band Antennas for Vertical Incidence Ionosphere Sounding—H. N. Cones. (*Bur. Stand. Jour. Res.*, vol. 43, pp. 71-78; July, 1949.) Results of measurements of the modulus of input impedance of a number of nonresonant antennas over a continuous frequency range from 1 to 25 Mc are shown graphically and discussed. The antennas are compared with each other from the standpoint of uniformity of impedance over the frequency range. The use of multiple-wire construction to lower the average input impedance, to minimize impedance variations, and to increase radiation efficiency is considered.

621.396.67:629.135 286
Suppressed Aircraft Aerials—G. E. Beck. (*Wireless World*, vol. 55, pp. 468-470; December, 1949.) Drag is reduced by using (a) the whole aircraft as an antenna excitation being provided by a small coil in the root of the wing, (b) rod or loop antennas buried in a portion of the wing or fuselage, any drag-producing cavities being filled in with a woven-glass type of dielectric, and (c) slot antennas. Each of these methods is briefly discussed. See also 1335 of 1947 (Booker) and 2457 of 1948 (Johnson).

621.396.671 287
Gain of Aerial Systems—J. Brown. (*Wireless Eng.*, vol. 26, pp. 409-410; December, 1949.) When an aperture of given size is used as an end-fire radiator instead of as a broad-side radiator, only the normal increase in gain

is realized which occurs when a radiator is situated at the surface of a perfect reflector. This increase is less than that predicted by Bell (3057 of 1949), because the field strength near the plane of the aperture is not zero, at any rate in the direction of the beam.

621.396.671 288
Input-Impedance of Wide-Angle Conical Antennas Fed by a Coaxial Line—C. H. Papas and R. King. (*Proc. I.R.E.*, vol. 37, pp. 1269-1271; November, 1949.) Such impedances have been computed for several flare angles; certain auxiliary functions are shown graphically.

621.396.671:621.317.336 289
Antennas and Open-Wire Lines: Part 2—Measurements on Two-Wire Lines—Tomiyasu. (See 399.)

621.396.677 290
Analysis of the Metal-Strip Delay Structure for Microwave Lenses—S. B. Cohn. (*Jour. Appl. Phys.*, vol. 20, p. 1011; October, 1949.) Addendum to 2147 of 1949.

621.396.679.4 291
Open-Wire Line for F.M.—J. W. Ecklin. (*Electronics*, vol. 22, pp. 80-81; November, 1949.) Two 0-gauge wires, spaced 6 in. apart, were used for connecting a 10-kw transmitter to a high-gain antenna at the top of a 240-ft tower. Matching was effected at each end of the line by means of a bazooka, which is essentially a 1:1 transformer for taking care of the balanced-to-unbalanced to ground conditions, together with a $\lambda/4$ coaxial impedance-matching section. This arrangement is cheaper and more efficient than a comparable coaxial feeder and is substantially unaffected by the weather. Construction and installation details are discussed.

CIRCUITS AND CIRCUIT ELEMENTS

621.3.012.3 292
"G" Curves in Tube Circuit Design—K. A. Pullen. (*Tele-Tech*, vol. 8, pp. 34-36 and 33-35, 59; July and August, 1949.) Curves and abacs for the determination of dynamic operating characteristics of tube circuits directly and for evaluation of distortion. Applications to various amplifier and oscillator circuits are discussed.

621.3.016.352 293
A Generalization of Nyquist's Stability Criteria—A. Vazsonyi. (*Jour. Appl. Phys.*, vol. 20, pp. 863-867; September, 1949.) A new type of diagram is developed, from which the lower limits of the "damping ratios" can be determined, and hence the degree of stability of systems characterized by ordinary linear differential equations. See also 294 below.

621.3.016.352 294
A Generalization of Nyquist's Stability Criteria—S. J. Mason. (*Jour. Appl. Phys.*, vol. 20, p. 867; September, 1949.) Comment on 293 above. An alternative method of Q -determination is described in which the ordinary Nyquist diagram is used.

621.3.018.83† 295
R-Q Factor—W. W. Harman. (*Proc. I.R.E.*, vol. 37, p. 1295; November, 1949.) The relation between the Q of an electrical resonator and its resonance or shunt resistance R can be written in the form $R = \xi Q / \omega_0 C$, where $0 < \xi < 1$. The R - Q factor ξ is a measure of how effectively the electric field in the resonator is concentrated in the capacitance.

621.314.2.045:621.3.011.4 296
Winding Capacitance—N. H. Crowhurst. (*Electronic Eng.*, vol. 21, pp. 417-421, 431; November, 1949.) Discussion of winding ca-

pacitance for interleaved or random-wound multilayer of transformers, chokes, etc. Charts are given for determining distributed, interwinding, or winding-to-screen capacitance. Practical examples are considered.

621.314.26:621.396.645.371 297
Frequency Changers and Amplifiers with Constant Gain—D. G. Tucker. (*Proc. I.R.E.*, vol. 37, pp. 1324-1327; November, 1949.) A method of applying negative feedback to a frequency changer by using a similar frequency changer in the feedback path is described. If the reduction of conversion gain due to the feedback is adjusted to 6 db, equal changes of ± 2 db in each frequency changer only alter the overall conversion gain by ± 0.1 db. A typical pentode circuit is described. Nonlinear distortion is reduced by the feedback. The application of the principle to stable-gain linear amplifiers is discussed; constancy of gain compares favorably with that of conventional feedback systems, but the conditions for linearity are more difficult to realize.

621.314.3† 298
Barkhausen Noise and Magnetic Amplifiers: Part 2—Analysis of the Noise—J. A. Krumhansl and R. T. Beyer. (*Jour. Appl. Phys.*, vol. 20, pp. 582-586; June, 1949.) The Barkhausen noise is calculated for ferromagnetic cores by a method similar to that used for analyzing the shot effect. The signal-to-noise ratio of a typical amplifier circuit is calculated and compared with experiment. Part 1: 2730 of 1949.

621.314.3† 299
On the No-Load Characteristics of a Transductor—K. Kühnert and M. Delattre. (*Compt. Rend. Acad. Sci. (Paris)*, vol. 229, pp. 751-753; October 17, 1949.)

621.316.8 300
Fixed Resistors for Use in Communication Equipment—P. R. Coursey. (*Proc. IEE (London)*, vol. 96, p. 482; November, 1949.) Discussion on 2735 of 1949.

621.316.8 301
Resistors for Deposited-Circuit Techniques—W. R. Conway. (*Electronic Eng.*, vol. 21, pp. 403-408; November, 1949.) Charts are given from which the dimensions of a rectangular film resistor of given wattage can be determined in terms of the aspect ratio. The case of fractional electrodes is also considered.

621.316.86 302
Investigations on Carbon-Layer Resistors—A. Schulze and D. Bender. (*Elektrotechnik (Berlin)*, vol. 1, pp. 97-105; October, 1947.) A short general discussion of methods of production, properties, and methods of measurement, with experimental curves showing the dependence of the resistance on age, temperature, humidity, and loading.

621.316.86 303
Negative Temperature Coefficient Resistors—(*Philips Tech. Commun. (Australia)*, Nos. 2/3, pp. 35-39; 1949.) The resistors consist of mixed crystals of Fe_2O_3 and other spinels, such as $MgAl_2O_4$ and Zn_2TiO_4 . Properties and applications are discussed.

621.318.572:621.396.1 304
Electronic Diversity Switching—H. V. Griffiths and R. W. Bayliff. (*Wireless World*, vol. 55, pp. 414-418 and 486-488; November and December, 1949.) The previous diversity switching system (1878 of 1949) required Type EF8 tubes. Since these tubes are no longer in production and no other type is available with a similar low ratio of screen to anode current, a modified dual-diversity switch using pre-

ferred types of tube was designed. This makes some simplification of the prototype triple-diversity system possible. Advantages over combined diversity systems are discussed.

621.392 305

Network Theorem—E. R. Wigan. (*Wireless Eng.*, vol. 26, p. 409; December, 1949.) The theorem enunciated is derived very simply from the basic equations which define the properties of a quadrupole. It states that the ratio between the output open-circuit voltage and the input voltage is identically equal to the ratio of the output short-circuit current to the input current, the direction of transmission of power through the network being reversed in the second case. An example of the application of the theorem is given.

621.392 306

A Note on Thévenin's Theorem—(*Electrician*, vol. 143, pp. 1473-1474; November 4, 1949.) A simple proof, based on Kirchhoff's laws.

621.392:517.512.2 307

Application of Fourier Transforms to Variable-Frequency Circuit Analysis—A. G. Clavier. (*Proc. I.R.E.*, vol. 37, pp. 1287-1290; November, 1949.) The behavior of passive circuits is studied for the case where FM is applied to the driving force. The output current or voltage is expressed in the form of a convolution integral, which can lead either to the expansion of Carson and Fry (464 of 1938) or preferably to that of van der Pol (2310 of 1946); the latter is expressed in terms of the values of the transfer impedance or admittance for the instantaneous frequency, and its derivatives. Convergence conditions are discussed. The particular case of broad-band FM line discriminators, for which the convolution integral can be expressed in terms of known functions, is considered. See also 1860 of 1943.

621.392:621.385.3 308

The Application of Power Series to the Solution of Non-Linear Circuit Problems—A. W. Gillies. (*Proc. IEE (London)*, vol. 96, pp. 453-475; November, 1949.) Discussion of circuit problems in which a triode is associated with any kind of linear network; Carson's power series solution for a triode circuit can be extended to cover such cases. See also 3825 of 1945 (Tucker) and 2740 of 1948 (Cartwright).

Part 1: Triode Circuit with Negative Feedback. The reduction of nonlinear distortion in an amplifier by means of negative feedback is discussed. Conditions of stability are derived. The power-series solution remains convergent even when the circuit is regenerative, failing completely only at the point of critical regeneration. When the circuit is unstable and an emf of nearly the natural frequency is applied, the solution represents an unstable oscillation, but when the frequency of the applied emf is not near the resonance frequency, the solution represents a stable forced oscillation if the amplitude is sufficiently large.

Part 2: The Free Oscillations of a Regenerative Triode Circuit. A single complex equation determines the frequency of oscillation and the amplitude of the fundamental; the complex amplitudes of the harmonics are expressed by power series. A particular circuit is considered in detail.

Part 3: The Forced Oscillations of a Regenerative Triode Circuit. The conditions for synchronization and for the suppression of the free oscillation are discussed, and also the asymmetry of the resonance curves. The analysis is extended to harmonic and subharmonic resonance, and the mechanism by which the various effects are produced is explained.

621.392:621.396.619.13 309

The Solution of Steady-State Problems in F.M.—B. Gold. (*Proc. I.R.E.*, vol. 37, pp. 1264-1269; November, 1949.) A method is described for deriving a polynomial approximation to the admittance of a given network. The degree of the polynomial depends on the ratio of the width of the sideband spectrum to the bandwidth of the network. This polynomial approximation can be used with advantage when the sideband method is impracticable and the quasi-steady-state method invalid; it enables the output wave to be expressed in terms of the derivatives of the input wave.

If the range of approximation coincides with the part of the spectrum of the input wave that is not negligible, and if the approximating function is derived from a set of orthogonal polynomials, a practical method for solving steady-state FM problems can be established. The validity of this method is investigated and examples are included.

621.392.5 310

Delay Networks Having Maximally Flat Frequency Characteristics—W. E. Thomson. (*Proc. IEE (London)*, vol. 96, pp. 487-490; November, 1949.) "A lumped-constant equivalent of a transmission line can be obtained in general in the form of a symmetrical lattice, in which the series and lattice arms are inverse and approximate respectively to the short-circuit and open-circuit impedances of half the line. One such set of approximations can be derived from the infinite ladder networks (Cauer's canonical form) equivalent to these impedances.

These approximations produce all-pass constant-impedance networks (dissipation being neglected) in which the delay is maximally flat in the sense that the first $2m-1$ derivatives of the delay with respect to frequency are zero at the origin; m is an integer expressing the order of the approximation."

621.392.52 311

A Generalized Formula for Recurrent Filters—M. C. Pease. (*Proc. I.R.E.*, vol. 37, p. 1293; November, 1949.) A generalization of the formula given by Fano and Lawson (695 of 1948).

621.392.52 312

Impedance Transformations in Four-Element Band-Pass Filters—R. O. Rowlands. (*Proc. I.R.E.*, vol. 37, pp. 1337-1340; November, 1949.) By using a different type of basic section for constructing the filter, a similar transformation to that described by Belevitch (3818 of 1947) can be achieved with slightly greater economy, both in particular cases and in the general case.

621.392.6 313

Theory of $2n$ -Pole Networks—R. Feldtkeller. (*FIAT Review of German Science, 1939-1946; Electronics, incl. Fundamental Emission Phenomena*, Part 2, pp. 91-102; 1948. In German.) General review, with references to 56 relevant German papers. A note is added by N. T. Ming with reference to unpublished work, from papers left by W. Cauer, on (a) the practical calculation of reactance, bridge, and recurrent quadrupoles for given characteristics, (b) the design of filters with prescribed minimum damping curve in the blocking region, (c) the design of amplifiers with oscillatory-circuit coupling and with prescribed amplitude characteristics, and (d) the calculation of hf amplifiers with relatively narrow pass-band.

621.395.645.37:621.395.44 314

Transmitting Amplifier for the K2 Carrier System—H. C. Fleming. (*Bell Lab. Rec.*, vol.

27, pp. 391-393; November, 1949.) The line amplifiers for this system have thermistor control that keeps their output approximately constant. The amplifier at the transmitting terminal must therefore have a constant output, however many channels are in use. This is achieved by using the amplifier also as a 60-kc oscillator; its 60-kc output is varied so that the combined output, consisting of voice sidebands plus 60-cps signal, remains nearly constant. The method is explained with the aid of circuit diagrams.

621.396.029.65† 315

Millimetre Waves: A General Survey—A. W. Lines. (*T.R.E. Jour.*, pp. 1-20; July, 1949.) Discussion of: (a) the behavior of the klystron and the rising sun magnetron at $m\lambda$, (b) other possible types of mm-wave generator, (c) atmospheric absorption, (d) the hobbing technique for anode construction, (e) possible methods of increasing resonator size or resonator separation, (f) tunable reflex klystrons for $\lambda-8-9$ mm, (g) frequency instability, (h) techniques for constructing small waveguides, (i) techniques for propagation in larger waveguides, (j) optical methods of transmission, (k) reception technique, for which the crystal tube and reflex klystron local oscillator, with a balanced mixer, are essential, and (l) methods of measurement.

621.396.611.1+621.392.52 316

Resonance Curves from Tables of Functions, and Some Simplifications in the Theory of Electrical Filters—H. Nitz. (*Frequenz*, vol. 3, pp. 237-244; August, 1949.) Simple series and parallel oscillatory circuits are considered and expressions are derived for their apparent impedance. By suitable transformations these expressions are put into a form which enables both branches of the resonance curve to be determined directly from tables of functions. Essential simplification of known formulas for filter characteristics results from similar transformations including the transformation of hyperbolic functions into a form scarcely used hitherto. These transformations give an appreciably better insight into the functional behavior of many characteristics and in conjunction with Hayashi's tables of functions reduce the time required for numerical computations. The methods are applied to T and II filters of general form and to the simplification of certain quadrupole formulas. The functions used are tabulated.

621.396.611.1 317

Frequency Contours for Microwave Oscillator with Resonant Load—M. S. Wheeler. (*Proc. I.R.E.*, vol. 37, pp. 1332-1336; November, 1949.) Discussion of a method of representing frequency and power relations in an oscillator coupled through a transmission line to a frequency-sensitive load. The method is applied to the case of a reactance tube coupled to a magnetron, and a solution is obtained, making certain simplifying assumptions. A more general method, not requiring these assumptions, is then developed and used to determine the limiting conditions for the appearance of frequency discontinuities in the characteristics.

621.396.611.3 318

Theory of Systems with Transmission-Line Coupling—A. Weissfloch. (*FIAT Review of German Science, 1939-1946; Electronics, incl. Fundamental Emission Phenomena*, part 2, pp. 103-119; 1948. In German.) Discussion with special reference to 4-pole and 6-pole devices for decimeter and centimeter waves. 35 relevant German papers are noted.

621.396.611.4 319

Cavity Resonators—R. Müller. (*FIAT*

Review of German Science, 1939-1946; Electronics, incl. Fundamental Emission Phenomena, Part 2, pp. 44-48; 1948. A short review, with references to 28 relevant German papers.

621.396.611.4 320

Theory of Cavity-Resonator Systems—G. Goubau. (*FIAT Review of German Science, 1939-1946; Electronics, incl. Fundamental Emission Phenomena, Part 2, pp. 120-126; 1948.* In German.) Short discussion of the coupling theory developed by Dahlke, the cavity resonator being regarded as a quasi-stationary oscillatory circuit, and an outline of the $2n$ -pole theory developed by Goubau.

621.396.611.4 321

On the Experimental Determination of the Resonance Resistance of E.M. Cavities—F. Borgnia. (*Helv. Phys. Acta, vol. 22, pp. 555-578; October 15, 1949.* In German.) Various general methods available for the determination of resonance resistance, using microwave technique, are discussed and applied to cavity resonators, for which the em field in certain regions, to which the resonance resistance is related, can be regarded as either homogeneous or rotationally symmetrical. The necessary theoretical relationships are derived; experimental investigations for $\lambda/4$ cm on resonators of different shapes confirm the suitability and the accuracy of the methods considered.

621.396.611.4:621.384.611.2† 322

Quarter-Wavelength Coaxial-Line Resonators for Betatron-Started Synchrotrons—Goward Wilkins, Holmes & Watson. (*See 430.*)

621.396.615 323

Design of Nonlinear Sine-Wave Oscillators by the Moving-Axis Method—J. Abelé. (*Ann. Phys. (Paris), vol. 3, pp. 655-679; November and December, 1948.*) The amplitude of an oscillation represented by a differential equation of the second or higher order is defined as the locus of the maxima of a family of oscillations. This definition is applied to a linear oscillator, and a geometrical construction for determining the amplitude is described. This is extended to a certain class of nonlinear oscillators which are capable of steady-state oscillations that are rigorously sinusoidal; such oscillators include those with amplitude control. See also 2525 of 1946.

621.396.615 324

Phase-Shift Oscillator—W. C. Vaughan. (*Wireless Eng., vol. 26, pp. 391-399, December, 1949.*) An examination of the mechanism of three- and four-mesh phase-shifting networks. The condition considered is that of steady oscillation, assuming that (a) oscillations can be initiated, (b) the waveform is sinusoidal, and (c) the load resistance is substantially less than the input impedance of the network. From simple derivations of the values of voltage and current for each component in the network, three tables are compiled: (a) formulas for the frequency at which 180° phase reversal occurs, and the corresponding relations which define the voltage loss in a four-mesh network as each shunt and series impedance is varied in turn, (b) corresponding formulas for a three-mesh network, and (c) the voltage and current formulas for a uniform three-mesh phase-advancing network. See also 1298 of 1948 (Dawe).

621.396.615 325

A Variable Phase-Shift Frequency-Modulated Oscillator—O. E. De Lange. (*Proc. I.R.E., vol. 37, pp. 1328-1330; November, 1949.*) The theory of operation is discussed for an oscillator consisting of a broad-band amplifier whose output is fed back to the input

through a phase-shifting circuit. The instantaneous frequency is controlled by the phase shift. The frequency deviation is directly proportional to the instantaneous amplitude of the modulating signal and substantially independent of the modulation frequency. A practical 65-Mc circuit is described.

621.396.615 326

The Reactance-Tube Oscillator—H. Chang and V. C. Rideout. (*Proc. I.R.E., vol. 37, pp. 1330-1331; November, 1949.*) A single-tube combination of a capacitive or inductive reactance-tube circuit and an oscillator circuit. The capacitive type is similar to the Hartley oscillator and the inductive to the Colpitts oscillator. A linear frequency/grid-voltage relationship and constant output amplitude can be obtained over a range of more than 5 per cent around center frequencies in the range 1-4 Mc.

621.396.615.17 327

The Blocking Oscillator as a Variable-Frequency Source—L. Fleming. (*Proc. I.R.E., vol. 37, p. 1293; November, 1949.*) A blocking oscillator can be used instead of the positive-bias multivibrator described by Bertram (1884 of 1948) to transform variations of a dc voltage into variations in the frequency of a sub-carrier.

621.396.615.17:621.317.755 328

The Integration Method of Linearizing Exponential Waveforms—A. W. Keen. (*Jour. Brit. I.R.E., vol. 9, pp. 414-423; November, 1949.*) The exponential response of the simple CR integrator to a step voltage differs from linearity by an error voltage proportional to the integral of the exponential output. Three methods of nearly cancelling this error voltage by means of an additional CR integrating circuit are given. Each corrected network has an LR equivalent and may be arranged for voltage or current excitation. Practical arrangements are discussed for (a) linear sawtooth voltage generation, (b) waveform linearization in timebase voltage amplifiers, and (c) linear sawtooth current generation, as in television reception timebases. In case (c), split deflecting coils are used.

621.396.645 329

Valve Amplifiers for Decimetre Waves—W. Bürck. (*FIAT Review of German Science, 1939-1946; Electronics, incl. Fundamental Emission Phenomena, Part 2, pp. 1-11; 1948.* In German.) The special tube and circuit problems for dm- λ apparatus are discussed and an illustrated description is given of a 3-stage amplifier for λ 59 cm. This uses disk tubes Type LD12, and tubular tank circuits, and has a power amplification of about 10 per stage. Another amplifier, using two push-pull Type-LV4 pentodes and with a power amplification of 3-4 per stage and a bandwidth of about 8 Mc, is mentioned. Development of tubes of the ceramic-disk type enabled amplifiers to be constructed with a tuning range of 48-53 cm, a bandwidth of about 1 Mc and over-all power amplification of about 400 for 2 stages.

621.396.645 330

Various Types of Amplifier—K. Schönhammer. (*FIAT Review of German Science, 1939-1946; Electronics, incl. Fundamental Emission Phenomena, Part 2, pp. 12-19; 1948.* In German.) Brief discussion, with references to 64 papers published in Germany, of investigations on dc amplification, broad-band amplification, gain limits, linearity, feedback, and on amplifiers for voice-frequency and carrier-frequency telephony, for the transmission of speech and music, and for measurement purposes.

621.396.645 331

A New Wide-Band Amplifier Circuit—R. Aschen. (*TSF Pour Tous, vol. 25, pp. 349-352; November, 1949.*) The principles and construction are described of an aperiodic amplifier with a remarkably linear gain curve from 25 cps to above 10 Mc. The two tubes used are Types EF42 and EL41, which give a gain of 20. The tubes have a common load resistor and strong negative feedback from one anode to the other. Followed by a sensitive detector using a double triode, Type ECC40, and giving full-scale deflection on a 100- μ a meter for an applied voltage of 250 mv, the amplifier constitutes an aperiodic monitor with many practical applications.

621.396.645 332

Distributed Amplification—T. Sárkány. (*Proc. I.R.E., vol. 37, p. 1294; November, 1949.*) Comment on 3375 of 1948 (Ginzton et al.).

621.396.645 333

Amplification of E.M. Waves by Interaction between Electron Beams under the Influence of Crossed Electric and Magnetic Fields—R. Warnecke, O. Doehler, and W. Kleen. (*Compt. Rend. Acad. Sci. (Paris), vol. 229, pp. 709-710; October 10, 1949.*) Increased amplification can be obtained by an arrangement such that the electrons move in a direction normal to the directions of the crossed fields. A plane structure is here considered in which there are two narrow parallel beams between parallel electrodes; a formula is derived for the complex propagation constant. The expression for the imaginary part of this constant may explain certain phenomena associated with magnetrons.

621.396.645:537.311.33:621.315.59 334

Some Circuit Aspects of the Transistor—R. M. Ryder and R. J. Kircher. (*Bell Sys. Tech. Jour., vol. 28, pp. 367-400; July, 1949.*) An analysis of the type-A transistor as an active quadripole is given and the equivalent circuits for single-stage and cascade amplifiers are discussed in relation to gain, stability, and termination. Gains of 15-20 db per stage can be realized and examination of the dependence of the frequency response on collector voltage and point spacing shows that useful gain is possible at frequencies up to 10 Mc. Large-signal operation is discussed with reference to the power output and the distortion in amplifiers and oscillators; power transistors giving outputs of 200-600 mw are described.

Over the frequency range 20 to 20,000 cps the noise power per unit bandwidth is proportional to (frequency)^{-1.1} and appears to be a mixture of smooth and impulse noise. The noise factor at 1,000 cps is about 60 db.

621.396.645.029.3 335

High-Quality Amplifier: New Version: Parts 2-4—D. T. N. Williamson. (*Wireless World, vol. 55, pp. 365-369, 423-427, and 477-479, October-December, 1949.*) Design details of tone controls, auxiliary gramophone circuits, and a complete tone-compensation and filter unit, with the circuit of a receiver for use in districts where the spacing between the carrier frequencies of the principal local transmitters is of the order of 200 kc. Part 1: 3101 of 1949. See also 70 of February.

621.396.645.36:621.385 336

Secondary Emission Tubes in Wideband Amplifiers—N. F. Moody and G. J. R. McLusky. (*Wireless Eng., vol. 26, pp. 410-411, December, 1949.*) Push-pull output can be obtained from a single tube, by fitting appropriate loads in series with both dynode and anode. The application of this principle to the Type-EFP60 tubes of an amplifier with distrib-

ated amplification is briefly considered. See also 3375 of 1948 (Ginzton et al.).

621.396.662:621.392.26† 337
Magnetically Controlled Wave-Guide Attenuators—T. Miller. (*Jour. Appl. Phys.*, vol. 20, pp. 878–883; September, 1949.) Discussion of experiments on the power loss in a waveguide filled with various iron powders, and the variations due to an external magnetic field applied either parallel or perpendicular to the magnetic component of the em wave in the guide. Effects are observed which may be due to ferromagnetic resonance. A theoretical formula for the power loss of low-conductivity powders is developed and compared with experimental results.

621.396.69 338
Circuit Components for V.H.F.—H. Meinke (*FIAT Review of German Science, 1939–1946; Electronics, incl. Fundamental Emission Phenomena*, Part 2, pp. 48–64; 1948. In German.) Reflection-free elements of uniform transmission lines and waveguides, transformers, connections between conductors of different types (such as balanced and unbalanced lines or concentric and parallel twin conductors), reflection-free terminating impedors, voltage dividers, chokes, and resonance circuits are considered. References are given to 68 German publications.

621.397.645 339
Cathode Neutralization of Video Amplifiers—J. M. Miller, Jr. (*Proc. I.R.E.*, vol. 37, p. 1345; November, 1949.) Addendum to 3393 of 1949.

621.318.2 340
Permanent Magnets [Book Review]—F. G. Spreadbury. Publishers: Pitman and Sons, Ltd, London, 280 pp., 35s. (*Wireless Eng.*, vol. 26, p. 411; December, 1949.) A well-written, up-to-date, and comprehensive work covering fundamental theory, materials, circuit design, applications, measurements, etc. The treatment of the subjects is concise and appropriately mathematical or descriptive.

621.318.4+621.314.2 341
Einführung in die Theorie der Spulen und Übertrager mit Eisenblechkernen (Introduction to the Theory of Coils and Transformers with Laminated-Iron Cores) [Book Review]—R. Feldtkeller. Publishers: S. Hirzel Verlag, Stuttgart, 2nd edn. Part 1, 190 pp., 10.50 DM. Part 2, 130 pp., 8 DM. Part 3, 65 pp., 4 DM. (*Wireless Eng.*, vol. 26, pp. 411–412; December, 1949.) The second edition, revised and extended, of one of a series of monographs dealing with telegraphy and telephony. It treats the subject both mathematically and from the practical point of view for the telecommunications engineer. The three parts deal with (a) coils, (b) transformers, and (c) design data. "The book is . . . a valuable addition to the available information on this subject."

621.392:51 342
The Mathematics of Circuit Analysis [Book Review]—Guillemin. (See 389.)

GENERAL PHYSICS

530.12:531.18:537.122 343
Special Relativity and the Electron—W. W. Harman. (*Proc. I.R.E.*, vol. 37, pp. 1308–1314; November, 1949.) An elementary paper, intended to introduce the subject "in a manner attractive to the engineer." See also 82 of February (Kübler)

535.412 344
Study of Interference Fringes in the Neighbourhood of Caustics—É. Durand. (*Ann. Phys. (Paris)*, vol. 3, pp. 621–636; November

and December, 1948.) The interference fringes near the caustic of a concave spherical mirror inclined at 45° to an incident beam of parallel rays is considered. The intensities in the system of fringes are calculated by geometrical optics and the interferences by Huyghens' principle; results are verified experimentally.

535.42 345
On the General Laws of Diffraction. Critical Review—G. Toraldo di Francia. (*Rev. d'Optique*, vol. 28, pp. 597–611; November, 1949.) Difficulties encountered in the practical application of various classic theories are discussed. Different expressions for Huyghens' principle are considered; that of Luneberg appears to be most suitable for present-day applications. Luneberg has chosen a single-layer and double-layer distribution on the surface of integration which differs from that of Helmholtz and Kirchhoff. The principle of inverse interference, which is related to Huyghens' principle, is used to explain (a) the existence of evanescent waves, (b) transmission and total reflection phenomena, (c) diffraction of nonplanar incident waves by grids, and (d) a thermodynamic conception of diffraction.

535.8 346
On the Corrector Plates of Schmidt Cameras—E. H. Linfoot and E. Wolf. (*Jour. Opt. Soc. Amer.*, vol. 39, pp. 752–756; September, 1949.) Discussion of the design of the aspherical surface of a Schmidt corrector so as to obtain optimum performance, in an agreed sense, over the field taken as a whole.

535.8 347
On the Optics of the Schmidt Camera—E. H. Linfoot. (*Mon. Not. R. Astr. Soc.*, vol. 109, pp. 279–297; 1949.) "A fifth-order aberration function is derived for the ordinary Schmidt camera. Color correction is also considered and a proof is given of J. G. Baker's formulas for the first three coefficients in the aspheric plate profile of a system with minimized axial color-spreads (*Proc. Amer. Phil. Soc.*, vol. 82, pp. 323–338; 1940). Aberration functions are used to design a modified system in which the monochromatic aberrations are balanced over a finite field, and the performance of this system is compared with that of the ordinary Schmidt camera by means of spot diagrams."

537.213:517.564.4 348
The Application of Non-Integral Legendre Functions to Potential Problems—Hall. (See 384.)

537.311.4:621.315.59 349
On the Theory of the A.C. Impedance of a Contact Rectifier—J. Bardeen. (*Bell Sys. Tech. Jour.*, vol. 28, pp. 428–434; July, 1949.) An extension of Dilworth's dc analysis (2769 of 1948) to the ac case, leading to the usual equivalent circuit (R and C in parallel, with R_0 in series) which was discussed by Spenke in an earlier comprehensive analysis (532 of 1942). R and C may depend upon the dc flowing and also on frequency, because of the effect of ionic drift.

537.311.5+537.312.6 350
Distribution of Temperature and Current in Cylindrical Bodies—C. F. Muckenhoupt. (*Jour. Appl. Phys.*, vol. 20, pp. 939–942; October, 1949.) These distributions depend not only on skin effect but also on the variation of resistivity with temperature. Since the resistivity change is 3–4 per cent for every 10°C rise in temperature for metals, and greater for insulators, its effect can be appreciable. A complete solution for the steady state is given.

537.525:621.396.61 351
Relaxation Oscillations in Discharge Tubes:

Application to the Study of [discharge] Ignition—J. Moussiegt. (*Ann. Phys. (Paris)*, vol. 4, pp. 593–670; September and October, 1949.) A detailed investigation is described of the phenomena associated with intermittent discharges in a commercial neon tube with twisted stranded electrodes lying along the axis, their free ends being about 3 mm apart. The critical capacitance value for the production of relaxation oscillations and the conditions during the relaxation cycle are particularly considered. Previous theories of the intermittent discharge are discussed and a theory is developed which involves a time constant for the ignition period, assuming an exponential law. This theory is confirmed for the discharge tube with axial electrodes. For other types, with different electrode structures, the theory certainly holds good in some cases. Values of the ignition time constant, determined from measurements of current maxima, are given.

538.5 352
The Induction of Electric Currents in Non-Uniform Thin Sheets and Shells—A. T. Price. (*Quart. Jour. Mech. Appl. Math.*, vol. 2, pp. 283–310; September, 1949.) General equations are obtained for the induction of electric currents, in any thin-sheet distribution of conducting material, by periodic or aperiodic fields. Methods of solving these equations are considered, with special reference to plane sheets and spherical shells.

538.541 353
On the Theory of the Eddy-Current Anomaly—R. Feldtkeller. (*Frequenz*, vol. 3, pp. 229–237; August, 1949.) Any explanation of this anomaly for ordinary transformer sheet must take account of the effect of variation of the initial permeability and of the doubling of the field-strength from the surface to the middle of the material.

538.56.029.64:531.61 354
Torque and Angular Momentum of Centimetre Electromagnetic Waves—N. Carrara. (*Nature (London)*, vol. 164, pp. 882–884; November 19, 1949.) When a plane circularly polarized em wave is absorbed by a screen at right angles to the direction of propagation, it exerts a mechanical torque S/ω per unit surface, where S is the Poynting vector and $\omega/2\pi$ is the frequency. Beth (2451 of 1936) measured this torque for light waves; a method of measuring it for centimeter waves is here discussed. Results are in qualitative agreement with theory; the fact that circularly polarized waves possess angular momentum is established.

538.3 355
The Fundamentals of Electromagnetism [Book Review]—E. G. Cullwick. Publishers: Cambridge University Press, 2nd edn, 327 pp., 18s. (*Wireless Eng.*, vol. 26, pp. 383–384; December, 1949.) For comment on first edition see 4764 of 1939 and 1260 of 1940.

GEOPHYSICAL AND EXTRATERRESTRIAL PHENOMENA

523.72+523.854+523.53]:621.396.822 356
Radio Astronomy—J. S. Hey. (*Nature (London)*, vol. 164, pp. 815–817; November 12, 1949.) Report on a British Association meeting at which recent progress was reviewed. Summaries are included of: (a) a paper by J. S. Hey describing investigations undertaken by the Army Operational Research Group on rf emission from sunspots and solar flares, (b) a paper by F. G. Smith on recent investigations at the Cavendish Laboratory, Cambridge, on galactic rf radiation, and (c) a paper by A. C. B. Lovell on recent research in meteor astronomy at the University of Manchester by means of radio reflection or radar methods.

523.75 357

The Emission of Radiation from Flares—R. G. Giovanelli. (*Mon. Not. R. Astr. Soc.*, vol. 109, pp. 337-342; 1949.) "An extension of recent theories of the emission and absorption of radiation indicates that the temperature in a typical flare is $< 2 \times 10^6$ deg. K and the electron concentration is $< 10^{13}$ per cc."

551.510.535:621.3.087.4 358

A Single-Band 0-20-Mc/s Ionosphere Recorder embodying some New Techniques—Wadley. (See 392.)

551.510.535:621.396.11 359

Thermal Expansion of Ionospheric Layer and Temporary Morning Disappearance of Radio Signals—Banerjee and Singh. (See 440.)

551.576:621.396.9 360

Application of Radar Equipment to Storm Location in South East Asia—Lutkin and Chisholm. (See 362.)

551.594.6:621.396.821 361

Atmospherics—H. Siedentopf. (*FIAT Review of German Science 1939-1946; Electronics incl. Fundamental Emission Phenomena*, Part 2, pp. 167-171; 1948. In German.) Short discussion of different types, their relation to weather conditions, and their seasonal variations.

LOCATION AND AIDS TO NAVIGATION

621.396.9:551.576 362

Application of Radar Equipment to Storm Location in South East Asia—F. E. Lutkin and J. Chisholm. (*T.R.E. Jour.*, pp. 21-30; July, 1949.) The American 40-kw, 3-cm radar Type AN/APS-15 was fitted in a vehicle, with a 30-in. scanner mounted on the roof at each of 7 Royal Air Force meteorological stations. Plan presentation of clouds within 50 miles was obtained, though response was reduced at extreme range when there was rain near the observing station. On Singapore Island an AMES Type 13 radar was installed, this 500-kw, 10-cm set has a narrow beam in the vertical plane which sweeps over 25° in elevation. Maximum range was 150 miles; cloud responses and permanent echoes could be distinguished. The general nature of storm clouds in this region and of their radar responses is discussed. There was good correlation between cloud reports by pilots or from local meteorological stations and those given by the equipments; the radar information both increased the forecaster's knowledge of atmospheric processes and was of immediate practical value for short-term forecasts for aviation.

621.396.93 363

Direction Finding—P. v. Handel. (*FIAT Review of German Science, 1939-1946; Electronics, incl. Fundamental Emission Phenomena*, Part 2, pp. 173-183; 1948. In German.) The term "direction finding" is used in the wider sense to include bearing and distance measurements with hf waves. Small-base arrangements, in which the base length is small compared with λ , are first considered, then large-base systems, and finally methods of distance measurement. References are given to 35 relevant German publications.

621.395.93 364

Some Relations Between Speed of Indication, Bandwidth, and Signal-to-Random-Noise Ratio in Radio Navigation and Direction Finding—H. Busignies and M. Dishal. (*Elec. Commun.*, vol. 26, pp. 228-242; September 1949.) Reprint. See 2232 of 1949.

621.396.933:621.396.619.16 365

Pulse-Multiplex System for Distance-

Measuring Equipment (DME)—C. J. Hirsch. (*Proc. I.R.E.*, vol. 37, pp. 1236-1242; November, 1949.) Distance from a ground transponder beacon is determined by measuring the time interval between sending an interrogator pulse and receiving the reply. Traffic among several beacons with overlapping service areas can be handled by frequency and pulse-pair coding arrangements so that each signal consists of a pulse pair of distinctive spacing, of the order of $10/25 \mu\text{s}$. Circuits are described which recognize signals having only one such spacing. The equipment described is for 52 channels, but the same method could be used for 100 channels. See also 102 of February (Burgmann).

MATERIALS AND SUBSIDIARY TECHNIQUES

531.788 366

McLeod-Type Alloy-Filled Vacuum Gauge—J. Grozowski. (*Nature (London)*, vol. 164, pp. 886-887; November 19, 1949.) Certain disadvantages associated with the Hg filled McLeod gauge can be avoided if Hg is replaced by an easily fused alloy, such as that comprising 27 per cent Pb, 13 per cent Sn, 50 per cent Bi, and 10 per cent Cd; the effects of this change on gauge design are discussed.

535.37 367

Dielectric Changes in Phosphors Containing more than One Activator—G. F. J. Garlick and A. F. Gibson. (*Proc. Phys. Soc.*, vol. 62, pp. 731-736; November 1, 1949.) Measurements of these dielectric changes are discussed. Assuming that the changes are due to electron trapping, information regarding the nature of the traps and their apparent association with luminescence centers is derived.

535.37:535.61-15 368

The Rise in Brightness of Infra-Red Sensitive Phosphors—R. C. Herman and C. F. Meyer. (*Jour. Opt. Soc. Amer.*, vol. 39, pp. 729-731; September, 1949.) "A phenomenological theory of infra-red sensitive phosphors is given which assumes the existence of two types of luminescent centers in order to account for the so-called 'inertia' effects in the rise of brightness. The equations describing the electron transfer processes have been integrated and show under certain conditions a very rapid initial rise in brightness followed by a relatively slow attainment of the maximum. The effect of varying the intensity of the stimulating infra-red radiation is discussed."

535.61-15:535.215 369

The Temperature Variation of the Long-Wave Limit of Infra-Red Photoconductivity in Lead Sulphide and Similar Substances—T. S. Moss. (*Proc. Phys. Soc.*, vol. 62, pp. 741-748; November 1, 1949.)

538.221 370

Ferro-Magnetism—(*Elec. Times*, vol. 116, pp. 687-688; November 17, 1949.) Discussions at an IEE symposium.

538.221 371

Ferrocube—(*Philips Tech. Commun.* (Australian), Nos. 2/3, pp. 28-34; 1949.) Manufacture, properties, and applications of two varieties of low-loss ferrites.

538.221 372

Magnetic Characteristics of an Oriented 50 Percent Nickel-Iron Alloy—J. H. Crede and J. P. Martin. (*Jour. Appl. Phys.*, vol. 20, pp. 966-971; October, 1949.) Single-crystal magnetic properties have been closely approached in a polycrystalline 50 per cent Ni, 50 per cent Fe alloy by the development of a favorable grain orientation. Elimination of the first and third steps of the normal magnetization proc-

ess produced a hysteresis loop of nearly rectangular shape.

538.221 373

Magnetic Viscosity in Mn-Zn Ferrite—R. Street and J. C. Woolley. (*Proc. Phys. Soc.*, vol. 62, pp. 743-745; November 1, 1949.)

546.431.82:536.48 374

Symmetry Changes in Barium Titanate at Low Temperatures and Their Relation to its Ferroelectric Properties—H. F. Kay and P. Vonslen. (*Phil. Mag.*, vol. 40, pp. 1019-1040, October, 1949.) The optical changes in BaTiO_3 are described; they can be completely explained if the crystal symmetry changes from tetragonal to orthorhombic at $+5^\circ\text{C}$. and then to rhombohedral at $+90^\circ\text{C}$. These changes have been confirmed by X-ray investigations; they are due to successive spontaneous polarizations along the [100], [110], and [111] cube directions. The relation of polarization to the cell structure is discussed, the simple Lorentz equation does not apply if the Ti/O interaction energy is large. The three transitions are explained on the basis of this interaction; difficulties of electrical dipole cooperative effects in BaTiO_3 are considered.

549.514.51 375

Increase in Q-Value and Reduction of Aging of Quartz Crystal Blanks—A. C. Prichard, M. A. A. Druesne, and D. G. McCua. (*Jour. Appl. Phys.*, vol. 20, p. 1011; October, 1949.) The quartz blank is annealed by heating it almost to the inversion temperature of quartz, or 500°C . and cooling it down extremely slowly. Values of Q thus obtained are at least double those of untreated quartz blanks, and variations in frequency and Q are minute. These improvements appear to be permanent. A more detailed report is being prepared.

549.514.51 376

Salvaging Electrically Twinned Quartz—J. L. Rycroft and L. A. Thomas. (*Electronic Eng.*, vol. 21, pp. 410-415; November, 1949. Correction, *ibid.*, vol. 21, p. 477; December, 1949.) For another account see 112 of 1949 (Woolster, Woolster, Rycroft, and Thomas)

621.315.59 377

Editorial Note Regarding Semiconductors—(*Bell Sys. Tech. Jour.*, vol. 28, pp. 335-343, July, 1949.) Surveys briefly the atomic physics of impurity semiconductors, with special reference to Si and Ge and the phenomena of rectification and amplification in semiconductor devices.

621.315.59 378

Theory of Transient Phenomena in the Transport of Holes in an Excess Semiconductor—C. Herring. (*Bell Sys. Tech. Jour.*, vol. 28, pp. 401-427, July, 1949.) "An analysis is given of the transient behavior of the density of holes n_h in an excess semiconductor as a function of time t and of position x with respect to the electrode from which they are being injected. When the geometry is one-dimensional, an exact solution for the function $n_h(x, t)$ can be constructed, provided certain simplifying assumptions are fulfilled, of which the most important are that there be no appreciable trapping of holes or electrons and that diffusion be negligible. An attempt is made to estimate the range of conditions over which the neglect of diffusion will be justified. A few applications of the theory to possible experiments are discussed."

621.315.59:537.311.33:621.396.645 379

The Theory of p-n Junctions in Semiconductors and p-n Junction Transistors—W. Shockley. (*Bell Sys. Tech. Jour.*, vol. 28, pp

35-489; July, 1949.) "In a single crystal of semiconductor the impurity concentration may vary from p -type to n -type producing a mechanically continuous rectifying junction. The theory of potential distribution and rectification for p - n junctions is developed with emphasis on germanium. The currents across the junction are carried by the diffusion of holes in a n -type material and electrons in p -type material, resulting in an admittance for a simple case varying as $(1+i\omega\tau_p)^{1/2}$ where τ_p is the lifetime of a hole in the n -region. Contact potentials across p - n junctions, involving current, may develop when hole or electron injection occurs. The principles and theory of a p - n - p transistor are described."

621.315.59:537.311.33:621.396.645 380

Hole Injection in Germanium—Quantitative Studies and Elementary Transistors—V. Shockley, G. L. Pearson, and J. R. Haynes. *Bell Sys. Tech. Jour.*, vol. 28, pp. 344-366; July, 1949.) Holes injected by an emitter point into thin single-crystal filaments of germanium can be detected by collector points. From studies of transient phenomena the drift velocity and lifetimes (as long as 140 μ s) can be directly observed and the mobility measured. Hole concentrations and hole currents are measured in terms of the modulation of the conductivity produced by their presence. Filamentary transistors utilizing this modulation of conductivity are described.

521.315.611.011.5:548.0 381

Polarisability and Dielectric Constant of Ionic Crystals—B. Szigeti. (*Trans. Faraday Soc.*, vol. 45, pp. 155-166; February, 1949.) The polarizability α of a crystal is connected with its natural frequencies. In static fields or for very long external waves it depends on the shape of the material, but for short waves it depends only upon whether the wave is longitudinal or transverse. The Clausius-Mosotti formula connecting α with the dielectric constant ϵ is $(\epsilon+1)/(\epsilon+2)=4\pi\alpha/3$; it holds for a sphere in very long waves. The Drude formula $\epsilon+1=4\pi\alpha$ is valid for short transverse waves. For short longitudinal waves, $4\pi\alpha=(\epsilon+1)/\epsilon$.

669.177 382

Electrolytic Iron—C. Tschäppät. (*Schweiz. Arch. Angew. Wiss. Tech.*, vol. 15, pp. 225-242; August, 1949. In French.) The production of thin sheets of electrolytic iron has hitherto been a matter of great difficulty. An account is given of investigations, extending over the last 20 years, with the object of producing thin sheets directly by electrolysis, thus eliminating melting and rolling processes. The principles of the process evolved are explained and the mechanical and electrical properties of the sheets produced are described. Such sheets of thickness 0.05-0.3 mm appear to be ideal for many electrotechnical applications as well as for the production of small mechanical parts.

621.775.7 383

Treatise on Powder Metallurgy: Vol. 1—Technology of Metal Powders and their Products [Book Review]—C. G. Goetzl. Publishers: Interscience Publishers, London, 778 pp., £6. (*Metal Ind.* (London), vol. 75, pp. 495-496; December 9, 1949.) The first of 3 volumes planned "to organize the mass of present-day knowledge on powder metallurgy in a standard manner." A short introductory chapter maps out the whole field; succeeding chapters fill in the details. "... this work can be unreservedly recommended to all who have any interest in powder metallurgy."

MATHEMATICS

517.564.4:537.213 384
The Application of Non-Integral Legendre

Functions to Potential Problems—R. N. Hall. (*Jour. Appl. Phys.*, vol. 20, pp. 925-931; October, 1949.) The numerical evaluation of various potentials requires knowledge of zero-order Legendre functions of real but non-integral degree. Tables and curves are given for the zeros of these functions and for certain integrals, together with a number of associated approximate formulas. Illustrative examples involving conducting cones, spheres, and rings are included.

517.942:538.566 385

On Weber's Function—C. G. Darwin. (*Quart. Jour. Mech. Appl. Math.* vol. 2, pp. 311-320; September, 1949.) Discussion of the behavior of real solutions of the differential equation

$$(d^2u/dx^2) + (1/4x^2 + a)u = 0$$

which occurs in connecting with em wave propagation in the ionosphere and in vibration problems. Convergent power series are given for the two solutions, and also associated asymptotic series for large values of x and for large values of a . Tables of the real solutions are being prepared.

681.142 386

An Electronic Differential Analyzer—A. B. Macnee. (*Proc. I.R.E.*, vol. 37, pp. 1315-1324; November, 1949.) The analyzer described can be used to solve ordinary differential equations, both linear and nonlinear, of orders up to and including the sixth. The coefficients may be constant or variable. The analyzer has a high speed of operation and is extremely flexible. Questions of periodicity and stability and of the continuity of solutions can be investigated, as well as problems in which final rather than initial values are specified. New types of electronic function generator and of electronic multiplier are used. Accuracy is within 1-5 per cent; solutions can be repeated within 0.002-0.1 per cent. Sources of error are analyzed.

681.142 387

The Bell Relay Computer—F. L. Alt. (*Instruments*, vol. 21, pp. 912-913; October, 1948.) A brief illustrated discussion. This computer is a great deal slower than the ENIAC, but much more flexible; it can be instructed to choose between alternative courses of action. See also IRE paper by G. R. Stibitz entitled "Counting Computers," of which a summary was noted in 1703 of 1949.

51:621.39 388

Compléments de Mathématiques à l'Usage des Ingénieurs de l'Électrotechnique et des Télécommunications (Mathematics for Electrical and Telecommunications Engineers) [Book Review]—A. Angot. Publishers: Éditions de la Revue d'Optique, Paris, 1949, 660 pp. (*Nature* (London), vol. 164, pp. 809-810; November 12, 1949.) In the reviewer's opinion the book provides "a common language" for the pure mathematician and the practical man. It shows both the relevant applications of theory and the theoretical basis of familiar practical results. Many subjects are covered. Fundamental groundwork is included for each, with full discussion of appropriate numerical examples. A sufficient basis for the reader's further progress by himself is thus provided. The book is "recommended both as a textbook and especially as a reference book."

51:621.392 389

The Mathematics of Circuit Analysis [Book Review]—E. A. Guillemin. Publishers: J. Wiley and Sons, New York, 1949, 575 pp., \$7.50. (*Proc. I.R.E.*, vol. 37, p. 1304; November, 1949.) *Jour. Frank. Inst.*, vol. 248, pp. 356-357; October, 1949.) "It is not a mathematical textbook on the principles of circuit analysis, but rather ... a presentation, within

the compass of a single volume, of material appropriate to provide for the student fundamental mathematical equipment for the understanding of the theory underlying advances in the subject of circuit analysis. Applications of the theory are reserved for later publications ... Each chapter furnishes a well-rounded treatment of its subject."

517.948 390

Integralgleichungen (Integral Equations) [Book Review]—G. Hamel. Publishers: Springer-Verlag, Berlin-Göttingen-Heidelberg, 2nd edn., 1949, 166 pp., 15.60 DM. (*Phys. Blätter*, vol. 5, pp. 481-482; 1949.) Theory and applications. Based on a course of external lectures at the Technical College, Berlin.

MEASUREMENTS AND TEST GEAR

531.761 391

Direct Reading Timer and Clock—A. E. Wolfe, Jr., and F. G. Steele. (*Radio and Telev. News, Radio-Electronic Eng. Supplement*, vol. 13, pp. 3-5, 28; November, 1949.) Design and construction details of an electronic clock for measuring intervals from 0.01 sec to 24 hr. For another account see *Electronics*, vol. 22, pp. 75-77; December, 1949.

621.3.087.4:551.510.535 392

A Single-Band 0-20-Mc/s Ionosphere Recorder embodying some New Techniques—T. L. Wadley. (*Proc. IEE* (London), vol. 96, pp. 483-486; November, 1949.) Description of a recorder developed in South Africa. See also 229 of 1948 (F. J. Hewitt, J. Hewitt, and Wadley).

621.317.3 393

Measurement of [electrical] Constants of Materials—C. Schmelzer. (*FIAT Review of German Science, 1939-1946; Electronics, incl. Fundamental Emission Phenomena*, Part 2, pp. 268-278; 1948. In German.) A review of various methods for measurement of dielectric constant, loss factor, hf resistance, etc., including methods suitable for uhf. References to 32 relevant German publications are given.

621.317.3:621.396.11 394

Wave-Propagation Measurements—Beckmann. (See 441.)

621.317.324† 395

Measurement of Field Distribution—A. Stenzel. (*FIAT Review of German Science, 1939-1946; Electronics, incl. Fundamental Emission Phenomena*, Part 2, pp. 264-268; 1948. In German.) A short account of the "test-body" method used first by Müller for loss-free cavity resonators (1379 of 1940) and extended by Goubau to the general linear 2-pole (1870 of 1944).

621.317.335.3†:621.315.615 396

The Measurement of Dielectric Constants of Liquids by a Frequency Deviation Method—W. L. G. Gent. (*Trans. Faraday Soc.*, vol. 45, pp. 758-759; August, 1949.) A method which allows a continuous check to be made on the standard capacitance by calibration against a crystal oscillator.

621.317.335.3†:621.317.374]:621.396.611.4 397

Measurement of the Dielectric Constant and Loss of Solids and Liquids by a Cavity Perturbation Method—G. Birnbaum and J. Francau. (*Jour. Appl. Phys.*, vol. 20, pp. 817-818; August, 1949.) The changes Δf , ΔQ in the resonance frequency and Q of a cavity resonator when a small cylindrical sample of a solid is inserted are measured by a method in which the resonance curve, together with a pair of

calibrated variable frequency markers, are displayed on a cro screen. Formulas due to Bethe and Schwinger relate Δf and ΔQ to the complex dielectric constant of the solid. A block diagram of the equipment is given. Typical results are tabulated and compared with those of Bleaney, Loubser, and Penrose (3187 of 1947). The method described extends the usefulness of Sproull and Linder's method (2240 of 1946) by its sensitive technique for measuring small frequency differences.

621.317.336 398

Impedance Measurements—A. Weissfloch. (*FIAT Review of German Science, 1939-1946; Electronics, incl. Fundamental Emission Phenomena*, Part 2, pp. 234-241; 1948. In German.) A general description of methods suitable for use in the dm- λ and cm- λ regions. The methods mainly use resonance effects or the properties of transmission lines. References to 14 relevant German papers are given.

621.317.336:621.396.671 399

Antennas and Open-Wire Lines. Part 2—Measurements on Two-Wire Lines—K. Tomiyasu. (*Jour. Appl. Phys.*, vol. 20, pp. 892-896; October, 1949.) Difficulties involved in such measurements are discussed. These include the problem of balance. The impedance of antennas is shown to depend on the nature of the driving structures. Measured impedances agree well with theoretical values. Part 1: 281 above.

621.317.372 400

Microwave Q Measurements in the Presence of Series Losses—L. Malter and G. R. Brewer. (*Jour. Appl. Phys.*, vol. 20, pp. 918-925; October, 1949.) Appreciable errors can result from neglecting the losses in coupling devices, which appear in equivalent circuits in the form of series resistance. Formulas are derived and curves are plotted for determining Q and the circuit efficiency, given the SWR at resonance and far from resonance, and knowing whether the resonant system is undermatched or overmatched to the external load.

621.317.616†:681.85 401

The Variable-Disk-Speed Method of Measuring the Frequency Characteristics of Pick-Ups—Terry. (See 275.)

621.317.7.001.4 402

Operation and Care of Circular-Scale Instruments: Part 3—Electrodynamic Type Instruments—J. Spencer. (*Instruments*, vol. 21, pp. 836-839, 852; September, 1948.) Discussion of single-phase and polyphase wattmeters and frequency meters, with special reference to the Westinghouse Type KF-24 and the General Electric Type AB-12. Parts 1 & 2: 146 of February.

621.317.7.029.64:621.392.26† 403

A Michelson-Type Interferometer for Microwave Measurements—B. A. Lengyel. (*Proc. I.R.E.*, vol. 37, pp. 1242-1244; November, 1949.) 1949 IRE National Convention paper noted in 1713 of 1949 [No. 14]. The optical Michelson interferometer is modified by replacing one of its branches by a directional coupler and a waveguide. Various applications are discussed. An instrument for λ 3.2 cm is described. For a similar instrument, see 162 of February (Pippard).

621.317.74:621.396.9 404

A Radar Test Set for the Super-High Frequency Band of 9,000-9,700 Mc/s—W. Rosenberg, J. S. Fleming, and E. D. Hart. (*Proc. IEE* (London), vol. 96, pp. 476-482; November, 1949.) The quantities such a test set must be able to measure are: (a) mean power output of transmitter, (b) mean transmitter frequency, (c) SWR in the antenna feed-

er, (d) width of the transmitter spectrum, (e) recovery time of the tr switch, (f) receiver sensitivity, and (g) the if response curve. Facilities must also be provided for checking receiver afc and for tuning. The waveguide system and circuits of a set meeting these requirements are described, and the methods of making the various measurements are outlined.

621.317.755 405

High-Frequency Oscillography—R. Theile. (*FIAT Review of German Science, 1939-1946; Electronics, incl. Fundamental Emission Phenomena*, Part 2, pp. 241-264; 1948. In German.) The development of high-power sealed cr tubes is described and some details of the AEG tube (noted in 1946 of 1943) are given. Hollmann's microwave oscillograph (1977 of 1940) and transit-time oscillography using dynamic Lissajous figures (544 of 1940) are discussed and also single-sweep methods (2198 of 1941). References to 33 relevant German papers are given.

621.317.755:621.317.761 406

Frequency Spectrometer—W. Kroebel. (*FIAT Review of German Science, 1939-1946; Electronics, incl. Fundamental Emission Phenomena*, Part 2, pp. 227-233; 1948. In German.) A method is described for analyzing the signals from a transmitter and displaying the frequency spectrum on a cro. The method can be used throughout the range from the longest waves to cm waves.

621.317.755.087.4 407

A Miniature Portable Cathode-Ray Oscillograph Recorder—C. F. Johnson. (*Instruments*, vol. 22, pp. 800-801; September, 1949.) A 1-in cro Type RCA-913 is fixed inside a 3-in brass tube which is silver-soldered to the top of a light-tight sheet-metal box of dimensions 2X2.5X5 in, containing the readily removable paper-drive mechanism. A tape mask forming a 1/64-in slit is placed over the face of the cro, and the intensity and size of the spot are adjusted to give the correct exposure. For a given spot intensity, the width of the trace is inversely proportional to the speed of the spot. A dry battery supplies power to the speed of the spot. A dry battery supplies power to the cro and to an associated high-gain af amplifier.

621.317.761 408

Absolute Frequency Measurement—S. Scheibe. (*FIAT Review of German Science, 1939-1946; Electronics, incl. Fundamental Emission Phenomena*, Part 2, pp. 216-226; 1948. In German.) An account of the quartz clocks, frequency and wavelength standards, oscillation generators, and associated magnetron tubes, and indicators for measurements with cm and mm waves, of the Physikalisch-Technische Reichsanstalt in the years 1936 to 1945.

621.317.78 409

Power Meter for Communication Frequencies—R. L. Linton, Jr. (*Proc. I.R.E.*, vol. 37, pp. 1245-1246; November, 1949.) A portable, rugged instrument which is easy to use, for measuring the power delivered to an antenna in the frequency range 2-20 Mc and power range 1-200 w. Accuracy is within +50 per cent. A directional coupler loop of the type described by Early (1007 of 1947) is used.

621.317.79:621.396.61 410

Signal Generators—C. Schmelzer. (*FIAT Review of German Science, 1939-1946; Electronics, incl. Fundamental Emission Phenomena*, Part 2, pp. 211-216; 1948. In German.) Sources are considered which will provide oscillations approximating closely to sine waves over a wide range of both frequency and

amplitude. References to 27 relevant German papers are given.

621.385.001.4 411

A Universal Visual Valve Tester—F. L. Hill and C. W. Brown. (*Electronic Eng.*, vol. 21, pp. 425-430; November, 1949.) The tube tester described incorporates a cr tube on which is displayed a complete family of V_{0}/I_{0} curves for ten different grid voltages. Sockets are provided to accommodate all modern types of tube, and a universal connection board enables any electrode to be connected to any supply. The 12-phase generator used is operated from 3-phase or single-phase mains.

621.392.26†:621.396.662 412

Corrections to the Attenuation Constants of Piston Attenuators—Brown. (See 280.)

OTHER APPLICATIONS OF RADIO AND ELECTRONICS

531.768:549.514.51 413

A Piezoelectric Device for Measuring Momentary Accelerations—E. Völcker. (*Frequenz*, vol. 3, pp. 244-249; August, 1949.) Details of the construction and calibration of apparatus in which the acceleration to be measured is applied to a small cylinder whose slight motion compresses a quartz rod. The resulting potential developed on the side of the rod is amplified and applied to one pair of deflection plates of a cro.

534.321.9 414

Ultrasonics: A Brief Survey—Jupe. (See 269.)

534.321.9.001.8:534.88 415

Obstacle Detection Using Ultrasonic Waves in Air—G. Bradfield. (*Electronic Eng.*, vol. 21, pp. 464-468; December, 1949.) Discussion of experimental results obtained with a spark transmitter using a standard 14-mm spark plug with the 1-mm gap at the focus of a 7½-in paraboloid; the microphone included a hollow double bimorph Rochelle-salt crystal of dimensions 9.5X9.5X3 mm, resonant at about 19 kc, and was used with a Type-CV138 head amplifier. Frequencies of 52 and 110 kc were used. Signal strengths obtained from various objects at different distances are tabulated. The directivity of the apparatus was very high, giving good resolution of objects which are side by side; poor scattering surfaces such as walls gave feeble returns, especially at oblique incidence. At this stage of development, ultimate success with equipment of this type as an obstacle detector for use by the blind, or as a fog safety device, cannot be confidently predicted.

620.91:537.56 416

Comparative Survey of Ion Guns: Parts 1-3—M. Hoyaux and I. Dujardin. (*Nucleonics*, vol. 4, pp. 7-9, 12-29, and vol. 5, pp. 67-71; May-July, 1949.) Part 1: General properties and specific characteristics of typical guns. Part 2: Properties and relative merits of representative ion sources, with bibliography of 86 references. Part 3: Necessary refinements of ion gun design.

621.317.39:531.77 417

Precision Speed Measurement of Rotating Equipment—M. W. Hellar, Jr. (*Gen. Elec. Rev.*, vol. 52, pp. 22-26; October, 1949.) An instrument is described which will measure instantaneous values of speed of rotation with accuracies of ± 0.025 per cent and ± 0.125 per cent over the ranges 1,710-1,780 rpm and 1,350-1,700 rpm respectively. A signal-frequency voltage is derived from the machine under test by a generator loading device or by a photocell method, and mixed with a standard-

frequency voltage generated by a synchronous motor driving a small induction alternator. The difference frequency is selected and measured to give slip speed in rpm, from which running speed is at once determined.

621.317.39:620.172.222 418

The Measurement of Changes in Length with the Aid of Strain Gauges—A. L. Biermasz and H. Hoekstra. (*Philips Tech. Rev.*, vol. 11, pp. 23-31; July, 1949.) Description of strain gauges Types GM4472 and GM4473 manufactured by Philips, and associated bridges. Various applications are considered.

621.365.54† 419

Radio-Frequency Induction Furnaces—(*Metallurgia* (Manchester), vol. 40, p. 336; October, 1949.) Brief illustrated description of a Metropolitan-Vickers 25-kw 600-kc unit which can be used to melt 20 lb of ferrous metal in about 30 min, using 380-460-v 50-cps 3-phase power supply. Similar 5-kw and 10-kw units are also mentioned.

621.365.54† 420

High Frequency Induction Heating—(*Metallurgia* (Manchester), vol. 40, pp. 332-334; October, 1949.) Description of a new forging shop at John Garrington and Sons, Bromsgrove. Three 10-kc generators are installed, each consisting of two 150-kw units driven by a common motor and feeding separate induction heaters for small billets. There are also three 3-kc generators, each with two 250-kw units which can be run independently or in parallel, for heating larger billets. Power consumption varies from 400 to 500 kwh per ton according to the size of billet. By using induction heating, high rates of production can be maintained in clean and airy buildings. Forging can be begun within a few minutes of starting up.

621.365.54† 421

Induction Heating—(*Metal Ind.* (London), vol. 75, pp. 498-501; December 9, 1949.) Illustrated description of various applications in the nonferrous metal industry.

621.365.54†:621.785.6 422

Multi-Purpose Induction Hardening Units—Please alter title of 188 of February to read as above.

621.365.55 423

Dielectric Heating: Applications in the Foundry—J. Pound. (*Metal Ind.* (London), vol. 75, pp. 351-353, 379-381, and 399-400; October 21, and November 4, 1949.) The use of dielectric heating for the baking of resin-bonded sand cores is considered.

621.38.001.8 424

Industrial Applications of Electronic Techniques—H. A. Thomas. (*Proc. IEE* (London), vol. 96, pp. 323-324; November, 1949.) Discussion on 3992 of 1947.

621.38.001.8:578.088.7 425

Biological Properties of Microwaves—L. de Seguin. (*Ondes Elec.*, vol. 29, pp. 368-377; October, 1949; *Ann. Radioelect.*, vol. 4, pp. 331-343, October, 1949.) Experiments were conducted to determine the effect of microwaves on bacteria, tissue growth, and capillary circulation, and their penetration of dead and living tissue. Microwaves have much greater penetration than infra-red rays and are preferable to the longer em waves for therapeutic heat treatment.

621.38.001.8:786.6 426

The Hammond Spinet—A. Douglas. (*Electronic Eng.*, vol. 21, pp. 461-463; December, 1949.) General description and circuit details

of a simplified type of instrument for home use, similar to the organ noted in 470 of 1949 (Wells) and back references.

621.383:551.576 427

Telemetry of Clouds by Means of Light Pulses—A. Baude. (*Radio Franc.*, no. 10, pp. 3-17; October, 1949.) A very short pulse of light is sent vertically upwards from a source at the focus of a parabolic mirror; the light scattered from the base of a cloud toward a receiving photocell near the transmitter is concentrated by a second parabolic mirror. Electronic methods are used to measure the time interval t between the transmitted and received pulses; the cloud height is at once given by $h=150t$, where t is in μ s. Measurement accuracy to a fraction of 1 μ s is necessary. Equipment details of two French sets, with typical records, are given. See also 1943 and 2657 of 1946.

621.384.6:[615.849+53 428

The Development of Linear Accelerators and Synchrotrons for Radiotherapy and for Research in Physics—J. Cockcroft. (*Proc. IEE* (London), vol. 96, pp. 296-303; November, 1949. A general survey, with brief reference to early types, the traveling-wave accelerator, the Atomic Energy Research Establishment accelerator, the 10-MeV accelerator developed by Metropolitan-Vickers for the Medical Research Council, and a 30-MeV betatron-started synchrotron. Applications to radiotherapy and physical research are considered. See also 175-177, 1148, and 2595 of 1949.

621.384.611.1+ 429

Electronics applied to the Betatron—T. W. Dietze and T. M. Dickinson. (*Proc. I.R.E.* vol. 37, pp. 1171-1178; October, 1949.) Discussion of circuits for electron injection and ejection, and X-ray monitoring.

621.384.611.2†:621.396.611.4 430

Quarter-Wavelength Coaxial-Line Resonators for Betatron-Started Synchrotrons—F. K. Goward, J. J. Wilkins, L. S. Holmes, and H. H. H. Watson. (*Proc. IEE* (London), vol. 96, pp. 508-516; November, 1949.) Description of air-spaced and silvered-dielectric resonators for use in synchrotrons giving energies < 400 MeV. Methods of feeding, monitoring and tuning, modes of resonance, power requirements, and measurements on resonators which have been incorporated in 8-MeV and 30-MeV synchrotrons are considered.

621.385.833 431

The Design and Construction of a New Electron Microscope—M. E. Haine. (*Proc. IEE* (London), vol. 96, pp. 303-304; November, 1949.) Discussion on 2041 of 1948.

621.385.833:016 432

Metallurgical Achievements of the Electron Microscope—G. A. Geach. (*Metallurgia* (Manchester), vol. 40, pp. 319-324; October, 1949. Bibliography, pp. 324-326.) A review of the literature to the end of 1948.

621.385.833:669.017 433

Electron Microscope and Diffraction Study of Metal Crystal Textures by means of Thin Sections—R. D. Heidenreich. (*Jour. Appl. Phys.*, vol. 20, pp. 993-1010; October, 1949.)

621.365.5 434

Radio-Frequency Heating Equipment [Book Review]—L. L. Langton. Publishers: Pitman and Sons, London, 196 pp. 17s 6d. (*Metal Ind.* (London), vol. 75, p. 496; December 9, 1949.) "... the time is suitable for such a book on the theory and practice of the generator. This book covers the subject in detail and is one that should be on the list of all engineers interested in this field of electronics."

621.38.001.8 435

Electronics in the Factory [Book Review]—H. F. Trewman (Ed.). Publishers: Pitman and Sons, London, 183 pp., 20s. (*Electronic Eng.*, vol. 21, pp. 475-476; December, 1949.) "Compiled by members of the staff of Electrical and Musical Industries, Ltd. ... but the contents are well representative of all branches and manufacturers. ... The writing is clear and not too tedious to be read by the directors, general managers, and production engineers to whom the book is addressed." Subjects covered include timing circuits, counting, motor control, regulation, heating, servomechanisms, photocell applications, and strain gauges.

PROPAGATION OF WAVES

538.566 436

On the Boundary Conditions in the case of Two Absorbent Media in Contact—H. Arzeliès. (*Ann. Phys.* (Paris), vol. 3, pp. 637-654; November and December, 1948.) The general boundary conditions for such media are derived from Maxwell's equations. The results can be used to express the theory of reflection in a very simple form. See also 3250 of 1947 (Booker).

538.566.2:621.396.67 437

The Magnetic Dipole in a Stratified Atmosphere—Eckart. (See 284.)

621.396.11 438

Theory of Wave Propagation over the Earth, Including the Influence of the Troposphere—W. Pfister. (*FIAT Review of German Science, 1939-1946; Electronics, incl. Fundamental Emission Phenomena*, Part 2, pp. 127-133; 1948. In German.) The results of investigations on wave propagation carried out before the war are mostly to be found in three books: (a) *Lehrbuch der drahtlosen Nachrichtentechnik*, Band 2; *Ausstrahlung, Ausbreitung und Aufnahme elektromagnetischer Wellen*, by H. Lassen (Springer, 1940); (b) *Die Ausbreitung der elektromagnetischen Wellen*, by B. Beckmann (Akad. Verl. Ges., 1940); and (c) vol. 1 of *Fortschritte der Hochfrequenztechnik* (Akad. Verl. Ges., 1941), which includes contributions by H. Lassen, J. Grosskopf, and B. Beckmann. References to 15 later papers are given.

621.396.11:551.510.535 439

Theory of Wave Propagation in the Ionosphere—W. Becker. (*FIAT Review of German Science, 1939-1946; Electronics, incl. Fundamental Emission Phenomena*, Part 2, pp. 134-142; 1948. In German.) Discussion of investigations on (a) partial reflection by ionosphere layers, (b) the validity of the ray theory, (c) the perpendicular incidence of plane em waves on a plane layered ionized medium under the influence of a magnetic field, (d) the propagation of em waves in a layered ionized medium under the influence of a magnetic field, for oblique incidence, and (e) indirect signals and transmission of SW signals round the earth. References to 13 relevant papers are given.

621.396.11:551.510.535 440

Thermal Expansion of Ionospheric Layer and Temporary Morning Disappearance of Radio Signals—S. S. Banerjee and R. N. Singh. (*Nature* (London), vol. 164, p. 925; November 26, 1949.) The reception in India of signals via the ionosphere, at wavelengths of the order of 20 m, often ceases for an hour or more after sunrise. It is suggested that this is due to a thermal expansion of the F_2 layer which is more than sufficient to counterbalance the increase in ionization as the sun's altitude increases.

621.396.11:621.317.3 441

Wave-Propagation Measurements—B.

Beckmann. (*FIAT Review of German Science, 1939-1946; Electronics, incl. Fundamental Emission Phenomena*, Part 2, pp. 143-167; 1948. In German.) Review of investigations concerning ground waves, propagation mechanism, angle of incidence, polarization, scattering, attenuation, and of usw measurements of tropospheric propagation, with references to 47 relevant German papers.

621.396.812.3:551.510.535 442
Statistical Analysis of Fading of a Single Downcoming Wave from the Ionosphere—S. N. Mitra. (*Proc. IEE* (London), vol. 96, pp. 505-507; November, 1949.) The fading of a single magneto-ionic component of a radio wave of frequency 2-6 Mc, incident vertically on the ionosphere and reflected downwards, was recorded at two points 100 m apart. The records which indicate that the fading was not due to a regular ionospheric drift are analyzed. The results agree, to the first order, with the assumption that in the reflecting region there are irregularities moving with velocities in the line of sight having a Gaussian distribution with rms value about 2-3 m/sec. Possible ionospheric causes for a significant discrepancy between the records and the simple theory are discussed. There is some experimental evidence to suggest that the irregularities responsible for the fading are situated below the E-region reflection point for 4-Mc waves. See also 96 of February and 443 below.

621.396.812.3:551.510.535 443
The Fading of [downcoming] Radio Waves of Medium and High Frequencies—R. W. E. McNicol. (*Proc. IEE* (London), vol. 96, pp. 517-524; November, 1949.) The production of fading is considered in terms of an ionosphere with irregularities varying horizontally. The theoretical nature of the fading curve, with regard to both the distribution of amplitude and the variation with time, is indicated and compared with the experimental results. The relative magnitudes of the steady and random components of a wave exhibiting fading were determined for different conditions; the results are summarized. From the rate of change of amplitude it is possible to calculate the effective velocity of the irregularities in the ionosphere, assuming that the fading is caused either by turbulent motion of the irregularities, or by a steady drift of the irregular ionosphere as a whole. The effective velocities deduced from 122 records made for vertical incidence and 55 for oblique incidence, lie between 0.3 and 8.0 m/sec, with an average value of 1.9 m/sec. See also 442 above.

621.396.11:621.396.813 444
An Analysis of Distortion Resulting from Two-Path Propagation—Gerks. (See 451.)

RECEPTION

621.396.621 445
Ekco Model CR61—(*Wireless World*, vol. 55, pp. 480-482; December, 1949.) Test report on an all-wave car receiver with permeability tuning.

621.396.621:621.396.619.11/.13 446
A Simple Frequency Discriminator for A.M.—F.M. Receivers—E. G. B. (*Philips Tech. Commun.* (Australia), Nos. 2/3, pp. 17-22, 27; 1949.)

621.396.621:621.396.619.11/.13:621.396.615 447
Signal Frequency and Oscillator Circuits for A.M.—F.M. Receivers—E. G. Beard. (*Philips Tech. Commun.* (Australia), Nos. 2/3, pp. 23-27; 1949.) The input and oscillator circuits of a medium-wave receiver can be modified at small cost for FM reception. Small inductors inserted in the signal-grid and oscil-

lator-grid leads are "series-tuned" by the normal medium-wave 350-pf tuning capacitors. A cathode choke is inserted and switching is effected by short-circuiting the medium-frequency coils. Tests show that the modification is effective while only one or two stations are operating on the mf band. Details of modifications of the remaining AM receiver circuits will be given later.

621.396.621:621.396.619.13 448
The Demodulation of a Frequency-Modulated Carrier and Random Noise by a Discriminator—N. M. Blachman. (*Jour. Appl. Phys.*, vol. 20, pp. 976-983; October, 1949.) The discriminator is regarded as consisting of two selective circuits, both fed by the output of the if amplifier but peaked at different frequencies, feeding rectifiers whose outputs are subtracted. The effect of passing random noise through each of these circuits is considered by Rice's method (440, 2168, and 2169 of 1945) with due regard to the correlation between the noise voltages fed to the two rectifiers. Quadratic and linear rectification are considered. The results are applied to the case of a rectangular if noise spectrum, and the signal-to-noise ratio is determined for the cases of narrow-band and wide-band FM. The results are very much like those for Middleton's idealized representation of the discriminator (2619 and 3532 of 1949), and are tabulated with corresponding AM results. The optimum signal-to-noise ratio for narrow-band FM without a limiter occurs when the discriminator is designed for the least possible bandwidth; this optimum ratio differs very little from that for AM.

621.396.621:621.396.645.371 449
Some Dangers in the Use of Negative Feedback in Radio Receivers—E. G. Beard. (*Philips Tech. Commun.* (Australia), Nos. 2/3, pp. 3-13; 1949.) A nonmathematical discussion of the principles of negative feedback, with criticism of some popular feedback circuits in audio amplifiers. Wrong positioning of the feedback resistor or volume control in the circuit can increase hum or lead to anomalies in amplifier gain. Recommended general-purpose feedback circuits are shown. Positive envelope feedback can occur by accident in a negative-feedback circuit; a circuit is described in which this is avoided. Distortion in a reflex receiver circuit due to an unwanted envelope feedback effect, and methods of circumventing this, are discussed from a practical point of view.

621.396.622.7:621.385.5:621.396.619.13 450
The "φ-Detector," A Detector Valve for Frequency Modulation—Jonker and van Overbeek. (See 505.)

621.396.813:621.396.11 451
An Analysis of Distortion Resulting from Two-Path Propagation—I. H. Gerks. (*Proc. I.R.E.*, vol. 37, pp. 1272-1277; November, 1949.) For AM, nonlinear distortion caused by two-path propagation is a result of overmodulation in the resultant signal. This distortion becomes severe only when the time delay on the secondary path is large and the amplitudes are nearly equal. For FM, the instantaneous frequency of the resultant signal has spike-shaped variations which reach large amplitude when the signals are nearly equal. When the discriminator is designed to respond linearly to a very wide frequency deviation, an averaging process takes place in the receiver which tends to minimize distortion; a discriminator range of several megacycles per second may be necessary for optimum reduction of distortion.

621.396.821:551.594.6 452
Atmospherics—Siedentopf. (See 361.)

621.396.828 453
Suppressing Impulse Noise—D. C. Rogers. (*Wireless World*, vol. 55, pp. 489-492; December, 1949.) The duration of impulse noise is nearly always substantially less than 1 μs, and the impulses seldom overlap. A circuit is described in which this short duration is used to distinguish noise from signal, whatever their relative amplitudes. The output from the receiver detector is divided into two parts, one passing through a phase inverter and an attenuator, the other through a high-pass filter and a pulse shaper; these parts are then recombined to form a noise-free resultant. The principal use of the circuit is for frequencies above 30 Mc and it is restricted to cases where selectivity is unimportant; it can thus be used for suppressing ignition interference in the sound section of a television receiver but not with broadcast or communication receivers.

STATIONS AND COMMUNICATION SYSTEMS

621.39.001.11:621.396.41:621.396.619 454
Band Width and Transmission Performance—C. B. Feldman and W. R. Bennett. (*Bell Sys. Tech. Jour.*, vol. 28, pp. 490-595; July, 1949.) A general and very comprehensive discussion is given of the relation between transmission bandwidth, power noise, interference, and overall performance for various multiplex systems with due attention to all the relevant practical factors. Frequency division and time division are considered in combination with either AM or FM of a carrier by pulse-position, pulse-amplitude, or pulse-code signals. The advantages and disadvantages of trading bandwidth for improved transmission are discussed in detail. The superiority of pcm arising from the facility of signal regeneration, coding and power reduction is stressed, and the advantages of pcm/AM over FM for long television relay routes are noted.

621.395:061.3 455
C.C.I.F. Meetings, May and July, 1949—(*P.O. Elec. Eng. Jour.*, vol. 42, 3, pp. 168-171; October, 1949.) Brief summaries are given of work done by committees on protection, corrosion, long-distance transmission, local transmission, signalling, switching, and symbols.

621.395.44:621.395.645.37 456
Transmitting Amplifier for the K2 Carrier System—Fleming. (See 314.)

621.395.47 457
Analysis-Synthesis Telephony, with Special Reference to the Vocoder—R. J. Halsey and J. Swaffield. (*Proc. IEE* (London), vol. 96, pp. 497-504; November, 1949.) Discussion on 513 of 1949.

621.396.1:061.3 458
The High Frequency Broadcasting Conference, Mexico City, October 1948-April 1949—(*P.O. Elec. Eng. Jour.*, vol. 42, pp. 166-168; October, 1949.) The detailed allocation of frequencies within the bands scheduled at the Atlantic City conference was discussed.

621.396.619.16 459
Pulse Modulation—E. M. Deloraine. (*Elec. Commun.*, vol. 26, pp. 222-227; September, 1949.) Reprint. See 2636 of 1949

621.396.619.16 460
Signal-to-Noise-Ratio Improvement in a Pulse-Count-Modulation System—A. G. Clavier, P. F. Panter, and W. Dite. (*Elec. Commun.*, vol. 26, pp. 257-262; September, 1949.) Reprint. See 2325 of 1949.

621.396.619.16 461
Theoretical Study of Pulse-Frequency Modulation—A. E. Ross. (*Proc. I.R.E.*, vol.

37, pp. 1277-1286; November, 1949.) The accuracy in reconstruction of the signal depends not only on the number of sampling points per period but also on their distribution. Assuming a fixed average pulse frequency (sampling rate), the maximum range of the signal frequency for which the corresponding periodic signal may be transmitted with acceptable accuracy is determined. PFM is as far as possible considered independently of the circuit used to realize it. The sampling for certain ranges of the ratio of signal frequency to pulse frequency is considered specially. The behavior of the general periodic signal cannot be deduced from that of its sinusoidal components; the methods here developed must be applied directly to the particular waveform considered. An example is given

621.396.619.16:621.396.41 462
A Technique for the Design of Pulse Time Multichannel Radio Systems—M. M. Levy. (*Jour. Brit. I. R. E.*, vol. 9, pp. 386-411; November, 1949.) The transmitter uses a delay line in a special feedback circuit, and a square wave. Each channel is selected by a correct tapping on the delay line, and the channel boundaries are accurately timed by the square wave. The whole system is automatic. Special 3-tube "power multivibrators" are used as generators which produce pulses of high peak power in impedors of low value, a shock-excited tuned circuit is used to define the length of the pulse. Trapezoidal pulses trigger these generators. When a signal pulse is added, the instant of triggering is modulated in time. The use of trapezoidal pulses ensures that the pulse time modulation never crosses the boundaries of the channel.

The demodulation process consists of transforming the time modulation into pulse length modulation by means of another type of multivibrator which is sensitive only during the time allocated to the corresponding channel, and which triggers only when the corresponding channel pulse appears. The demodulated signal is filtered with a low-pass filter. A single circuit is used for several channels: this reduces the number of tubes required to about 3 per 2 channels, including mixing tubes. The mixer circuit comprises cathode followers with cathodes connected together. Crosstalk is negligible if "power multivibrators" are used. The optimum number of channels seems to be 20-40, and the maximum number 100. Block and simplified circuit diagrams are given for a 24-channel system, and an experimental 20-channel system built in 1943 is described which was satisfactorily tested for distances up to about 36 miles in mobile vans. See also 3054 of 1947 and 2620 of 1948.

621.396.65:621.397.5 463
Television Radio Relay: London-Birmingham Link. (See 471.)

621.396.931 464
V.H.F. Radio Equipment for Railways and Heavy Industries—(*Engineer* (London), vol. 188, p. 502; October 28, 1949.) A brief description of a specially designed 15-20-w FM transmitter and receiver. The whole is mounted in a light-alloy dustproof and weatherproof case and can be installed in any position. A built-in selective-calling device using uniselectors makes constant monitoring of the mobile units unnecessary, and is applicable to simplex, two-frequency simplex or duplex working. A 3-digit system will cover 500 substations. The control unit is in the form of a telephone handset. Provision is made for mains or battery operation and for the substitution of AM units if desired.

SUBSIDIARY APPARATUS

621.314.63 465
Image Force in Rectifiers—P. T. Landsberg. (*Nature* (London), vol. 164, pp. 967-968; December 3, 1949.) A theoretical characteristic which allows for the effect of image force was given by Mott (4136 of 1939). A general method of allowing for this force is given, and applied to the Cu_2O rectifier.

621.315.59:537.311.4 466
On the Theory of the A.C. Impedance of a Contact Rectifier—Bardeen. (See 349.)

621.316.721 467
A Stabilized 100-A Power Supply—D. E. Caro and J. K. Parry. (*Jour. Sci. Instr.*, vol. 26, pp. 374-377; November, 1949.) "A system is described for maintaining constant currents of up to 100 amp through highly inductive loads. The system stabilizes against changes in mains voltage and generator characteristics, reducing the short-period current variations to less than 1 part in 2,000. Current changes due to load-impedance variations are reduced by a factor of approximately 20. The main interest in the system is the electromagnetic method of comparing the load current with a standard current."

621.396.682:621.316.722 468
Heater Compensation Improves Stabilized Power Supplies—(*Tech. Bull. Nat. Bur. Stand.*, vol. 33, pp. 115-116; October, 1949.) A method developed by R. C. Ellenwood and H. E. Sorrows. Heater-voltage fluctuations are used to compensate for line-voltage fluctuations. The method can be applied to power supplies using degenerative voltage stabilizers in which the output voltage is compared with a fixed reference voltage, the difference voltage being used to alter the resistance of a control tube. Circuit and component details are given. For another account see *Radio and Telev. News, Radio-Electronic Eng. Supplement*, vol. 13, pp. 8, 30; November, 1949.

621.396.682:621.319.3 469
Stabilized High Voltage Power Supply for Electrostatic Analyzer—R. L. Henkel and B. Petree. (*Rev. Sci. Instr.*, vol. 20, pp. 729-732; October, 1949.) A description of an ac operated power supply which provides a voltage continuously variable from 5 to 50 kv with stability and accuracy of measurement within ± 0.01 per cent. The stabilizer is of the usual degenerative type, but the error signal is amplified by a photocell galvanometer, dc amplifier and applied to a series impedance in the hv transformer primary circuit. The generator beam energy automatically follows adjustments of a 1v potentiometer used for voltage measurements in this supply.

771.3:621.3.087.5:551.510.535 470
Continuous [Recording] Oscillograph Camera for Ionosphere Measurements—J. E. Hacke, Jr. (*Instruments*, vol. 21, pp. 914-915; October, 1948.) Illustrated description, with special reference to the mechanism for moving the photographic paper.

TELEVISION AND PHOTO-TELEGRAPHY

621.396.65:621.397.5 471
Television Radio Relay: London-Birmingham Link—(*Wireless World*, vol. 55, pp. 474-476; December, 1949.) The link has four unattended relay stations. It provides a single vision channel which can be used in either direction. The installation is permanent and designed for reliability; all apparatus is duplicated. Transmission frequencies of 870 Mc and 890 Mc are used. At the terminal station the video-frequency signal is used for FM of a 34-Mc carrier; this modulated carrier modulates a 904-

Mc carrier and the sideband in the range 868.5-871.5 Mc is fed to the antenna. Relay-station transmitter output is about 10 w and the gain is about 70 db. Dipole antennas with reflectors are used; their gain is about 28 db. A special filter provides 70-db discrimination between wanted and unwanted frequencies in the AM process; it uses coaxial resonant circuits in which the conductors are separated by alternate short sections of air and polythene, so that the total length of the filter is reduced from 10 ft to 18 in. A rf switch is used for the coaxial circuits of the transmitters and receivers and for bringing in duplicate equipment when a fault occurs. It has no contacts and operates by moving plungers into coaxial stubs, so that in either extreme position an infinite impedance is presented on one side and a zero impedance on the other. The quality of the picture originating in London and seen in Birmingham is as good as that usually obtained near London. See also 297 of 1948, 1279 and 1857 of 1949 (Stanesby and Weston), and *Electronic Eng.*, vol. 21, pp. 457-460; December, 1949.

621.397.5 472
Television (including Scanning)—F. Schröter. (*FIAT Review of German Science, 1939-1946; Electronics, incl. Fundamental Emission Phenomena*, Part 2, pp. 185-210; 1948. In German.) The principal developments in fundamental investigations in Germany during the war years were concerned with improvement of cr tube spot sharpness, reduction of errors in the deflection system, sensitive photoelectric layers, and secondary-emission layers with a high multiplication factor, with applications to picture-scanning tubes, projection apparatus, and color television. These questions are reviewed and also improvements in technique and in transmitting and receiving equipment. References to 53 relevant German publications are included.

621.397.5:621.315.212 473
London-Birmingham Television Cable—H. Stanesby and W. K. Weston. (*Elec. Commun.*, vol. 26, pp. 186-200; September, 1949.) Reprint. See 1279 and 1857 of 1949.

TRANSMISSION

621.396.61 474
Power Tubes in Parallel at U.H.F.—J. R. Day. (*Electronics*, vol. 22, pp. 166, 170; November, 1949.) An arrangement in which the power output is proportional to the number of tubes in parallel and the upper frequency limit is the same as for each individual tube used alone. The active input and output circuits comprise 3 coaxial cylinders and 4 shorting rings. The tubes which must be either of the planar type or have an external disk connection to the separation electrode, are arranged with their axes lying in a plane normal to the cylinders and meeting the cylinder axis. The plane of the tubes is about halfway between the shorting rings, so that they are, in effect, at or near the voltage loop of a resonant half-wave coaxial circuit. Spurious modes presented no difficulty. An alternative rectangular arrangement with tubes on opposite sides is briefly considered.

621.396.61 475
Miniature Tubes in a Band-Switching Exciter—W. Mayer. (*QST*, vol. 33, pp. 11-15; December, 1949.) Description of a 75-w variable-frequency driver unit, built for eliminating television interference, contained in one compact shielded unit, with complete band-switching for amateur frequencies.

621.396.61 476
TVI on 160 Meters?—P. S. Rand. (*CQ*, vol. 5, pp. 11-14, 62; December, 1949.) Circuit

diagram and component details for an amateur transmitter free from television interference. Part of the circuit was also used for the 10-m transmitter discussed in 1530 of 1949.

621.396.61:621.396.712 477
KTBS' New Transmitter—W. M. Witty. (*Broadcast News*, no. 56, pp. 46-53; September, 1949.) A general illustrated description. A 6-element directional antenna array is used. Special precautions against possible flooding, lightning, etc., are discussed. The power is 10 kw during the day and 5 kw at night, with a frequency of 710 kc.

621.396.619.22 478
Non-Linear Inductance and Capacitance as Modulators for Amplitude-Modulation Systems—D. G. Tucker. (*P.O. Elec. Eng. Jour.*, vol. 42, pp. 156-159; October, 1949.) The performance of modulators using the nonlinear characteristics of suitable inductors and capacitors is discussed theoretically. The output of any sideband depends upon its frequency, and low-frequency products have a small amplitude. Practical circuits and measurement results are given for a magnetic modulator using a nonlinear inductor.

621.396.619.23 479
New Modulator Circuit Utilizes 807's in Class B with Zero Bias—A. M. Seybold. (*Radiotronics*, no. 138, pp. 64-65; July and August, 1949.) A 20,000- Ω 1-w resistor connects the control grid to the screen grid of each of the Type-807 tubes, the cathodes are earthed and the secondary of the driver output transformer is connected to the two screen grids, the center tap being also earthed. With a supply voltage of 750 v and peak grid-to-grid input of 555 v, audio output into a 6600- Ω load is 120 w. Type-2A3 tubes are recommended for the driver. A circuit diagram, with component details, and functional curves for the Type-807 tubes for various signal voltages are given.

621.396.619.231 480
Modulators for High Power Transmitters—H. A. Teunissen. (*Commun. News* vol. 10, pp. 41-51; June, 1949.) Anode modulation with a class-B modulator is generally used for medium and short-wave transmitters; it is more efficient than other possible systems mentioned. Efficiency has recently been improved by using feedback and a cathode-follower driver stage. Damping resistors are not then needed in the grid circuit, and no transformer is necessary in the chain of amplifier stages over which feedback is acting; it is difficult to build transformers without introducing a considerable phase shift which might endanger stability. The feedback factor should be as large as possible; the best solution is to feed from the primary of the modulation transformer back to the cathode of the first stage, so that a very low output impedance is obtained. A coupling arrangement in which the anode of the modulated amplifier is shunt-fed is advantageous. The application of these principles to the design of the modulator of a 100-kw transmitter is discussed, and experimental results obtained during the testing of the modulator of a 40-kw transmitter are considered.

VACUUM TUBES AND THERMIONICS

537.291+538.691 481
On the Theory of Axially Symmetric Electron Beams in an Axial Magnetic Field—A. L. Samuel. (*Proc. I.R.E.*, vol. 37, pp. 1252-1258; November, 1949.) A type of electron beam is proposed in which the space-charge repulsive forces are balanced by magnetic focusing forces, so that the beam may be made as long as required without any change in its cross section. The equations governing the existence of such beams are derived.

621.385 482
A Survey of Modern Radio Valves: Part 1—Introduction—H. Stanesby. (*P.O. Elec. Eng. Jour.*, vol. 42, pp. 117-118; October, 1949.) Introduction to a series of articles on basic principles common to most tubes and on tubes for use in various frequency ranges up to 30 kMc. See also 483 below.

621.385 483
A Survey of Modern Radio Valves: Part 2—The Physical Principles of Thermionic Valve Operation—K. D. Bomford. (*P.O. Elec. Eng. Jour.*, vol. 42, pp. 118-123; October, 1949.) Phenomena common to most tubes are surveyed. Primary and secondary emission, space charge, transit time, and the functions of various electrodes in conventional tubes are discussed. See also 482 above.

621.385 484
Low-Distortion Power Valves—G. Diemer and J. L. H. Jonker. (*Wireless Eng.*, vol. 26, pp. 385-390; December, 1949.) A survey is given of various low-distortion tube constructions. Two new constructions for pentodes are described which involve (a) alignment of the first and second grids, and (b) introduction of additional focusing rods into the electrode system. By either means the second harmonic of a single-stage class-A pentode amplifier can be considerably reduced. The total distortion can be halved for an output up to about 25 per cent of the static anode dissipation. The new tubes have I_a/V_g characteristics that are practically linear in the neighborhood of the normal operating point. See also 4110 of 1937 (Kleen).

621.385:538.691 485
Study of the Magnetic Focusing of Cylindrical [electron] Beams—G. Convert. (*Bull. Soc. Franç. Elec.*, vol. 9, pp. 550-558; October, 1949.) General equations are developed for the electron motion in a system with axial symmetry, consisting of an electron gun sending a beam along a drift tube maintained at a constant potential, with a uniform axial magnetic field. Cylindrical beams are considered for the two cases in which the rotational moment has or has not the same value for all the electrons. Undulations of the beam within the drift tube are discussed and the importance is stressed of proper adjustment of the magnetic field at the entrance of the tube by fitting suitable screens.

621.385.001.4:533.59 486
An Improved Method of Testing for Residual Gas in Electron Tubes and Vacuum Systems—E. W. Herold. (*RCA Rev.*, vol. 10, pp. 430-439; September, 1949.) An ionization-gauge method in which the ion current due to the residual gas is converted into ac by modulation of the ionizing electron stream, while stray currents are left relatively unmodulated. The sensitivity limit of 10^{-11} A, or 10^{-9} A without neutralization of undesired quadrature components, compares favorably with the sensitivity limit of 10^{-7} A for conventional dc ionization gauges. Some applications of the method are shown.

621.385.012:517.54 487
Potential Functions for a Thermionic Vacuum Tube—E. C. Okress. (*Jour. Appl. Phys.*, vol. 20, pp. 850-856; September, 1949.) Potential functions are derived, by application of conformal transformations, for a system comprising two parallel metal plates at the same potential, with three flat parallel-wire grids evenly spaced between them. The wires in the central grid are orthogonal to those in the other two grids. The results are applied to the Western Electric Type 104D tube, the construction of which approximates to the theoretical system considered.

621.385.032.2:771.1 488
Electrodes for Vacuum Tubes by Photogravure—M. P. Wilder. (*Proc. I.R.E.*, vol. 37, pp. 1182-1184; October, 1949.) An improved method which enables complicated designs to be cut with little effort; its chief utility is in the manufacture of precision parts for experimental tubes.

621.385.032.212 489
Circuits for Cold Cathode Glow Tubes—W. A. Depp and W. H. T. Holden. (*Elec. Mfg.* vol. 44, pp. 92-97; July, 1949.) Discussion of fundamental operating characteristics and typical circuits using these tubes for relays, impulse generators, pulse counting, and interlocking.

621.385.032.216 490
Some Properties of the Ba_2SiO_4 Oxide-Cathode Interface—A. Eisenstein. (*Jour. Appl. Phys.*, vol. 20, pp. 776-790; August, 1949.) The thickness of the interface, its effective specific electrical conductivity, and the interface voltage developed by the flow of emission current are considered. Methods of measuring these quantities and results obtained are discussed.

621.385.032.216 491
Electron Emission and Conduction Mechanism of Oxide-Coated Cathodes—R. Loosjes and H. J. Vink. (*Jour. Appl. Phys.*, vol. 20, p. 884; September, 1949.) Experiments with oxide cathodes, showing that the curve of $\log \sigma$ against $1/T$ has a bend at 750°K, suggest that there are two conduction mechanisms operating in parallel in the coating, one with a low activation energy which predominates below 750°K and one with a high activation energy which predominates above that temperature. This theory gives a simple explanation of Mahlman's results (2094 of 1949). A fuller account of these investigations will appear in *Philips Res. Rep.*

621.385.032.216 492
Microanalysis of Gas in Cathode Coating Assemblies—H. Jacobs and B. Wolk. (*Proc. I.R.E.*, vol. 37, pp. 1247-1251; November, 1949.) Gases evolved during degassing and activation of oxide cathodes are considered.

621.385.032.216:536.7 493
Application of Thermodynamics to Chemical Problems Involving the Oxide Cathode—A. H. White. (*Jour. Appl. Phys.*, vol. 20, pp. 856-860; September, 1949.)

621.385.15 494
Microwave Secondary Electron Multiplier—M. H. Greenblatt. (*Rev. Sci. Instr.*, vol. 20, pp. 646-650; September, 1949.) The multiplier, a dynamic electron multiplier, consists of two parallel secondary-emission plates with an ac voltage across them which is adjusted so that the transit time across the gap, for electrons starting with zero velocity from one of the plates when the field is passing through zero, is half the period of the ac voltage. Primary and secondary electrons are thus made to oscillate between the plates and multiplication takes place. Phase relations between the electrons and the field are discussed. When the multiplier was used as a γ -ray detector and the ac voltage was obtained from 10-cm power, the rise time of the pulse obtained was calculated as 5×10^{-10} seconds and measured to be $< 10^{-7}$ seconds. The dead-time was about 5 μ s.

621.385.18,032.213:621.396.615.12 495
The Generation of High-Frequency Oscillations by Hot-Cathode Discharge Tubes Containing Gas at Low Pressure—E. B. Armstrong and K. G. Emeleus. (*Proc. IEE* (London), vol. 96, pp. 390-394; September, 1949.) Discussion of experimental results concerning the generation of plasma electron oscillations

by the discharge from a hot filament through ionized Hg vapor, Ar, and other gases. Oscillations are produced both with bare metal cathodes and with oxide cathodes. The vacuum wavelengths of the em waves produced range from 5 cm to 2 m. Under favorable conditions 1 per cent of the anode power can be converted into energy of oscillation in a coupled external circuit. Restricted regions of oscillating plasma appear to exist; primary electron beams traversing these regions undergo vm.

621.385.2 496

The High-Frequency Response of Cylindrical Diodes—E. H. Gamble. (*Proc. I.R.E.*, vol. 37, p. 1206; October, 1949.) Summary only. The investigation includes the case of large signals which have components varying with time through an amplitude comparable with that of the constant polarizing voltage. The problem is regarded as quasi-stationary; the solution is based on Poisson's equation, Newton's equation and the continuity equation. The method of integral equations is used. A method of successive approximations is devised for each specific form of applied voltage. Though the solutions are approximate they throw light on the inner mechanism of the cylindrical diode. The simplifying assumptions applicable to the cases of space-charge-limited and temperature-limited operation are mentioned. A first approximation to numerical solutions was obtained by means of an analogue computer; the solutions are shown graphically and satisfy the integral equations to an accuracy within 2 per cent. For large signals, considerable modulation of the electric field and of the velocity and trajectory of the electrons occurs. In some cases, electrons are returned to the cathode or oscillate radially in the inter-electrode space. For large electrode radii, the solutions reduce to those applicable to the planar diode.

621.385.2 497

Extension of the Planar Diode Transit-Time Solution—N. A. Begovich. (*Proc. I.R.E.*, vol. 37, pp. 1340-1344; November, 1949.) Llewellyn's small-signal theory for the plane-parallel diode (552 of 1936 and 1669 of 1941) has been extended to include a closed-form second-order and third-order solution for complete space-charge operation. This solution includes terms not given by Benham's conservation-of-charge method (148 of 1939).

621.385.2:621.3.011 498

The Unit of Perveance—G. D. O'Neill. (*Proc. I.R.E.*, vol. 37, p. 1295; November, 1949.) Perveance is defined as the constant G in the current/voltage relation $I = GV^{3/2}$ applicable to a space-charge-limited diode. It is suggested that the unit for G should be associated with the name of Langmuir.

621.385.2:621.396.822 499

Transit Time Correction Factor for Cylindrical Noise Diodes—H. Ashcroft and C. Hurst. (*Proc. Phys. Soc.*, vol. 62, pp. 639-646; October 1, 1949.) The noise generated by a diode is always less than it would be if the transit of the electrons were instantaneous. The factor by which it is reduced is tabulated for transit angles θ up to $12\frac{1}{2}$ radians and for ratios r of anode to cathode radius up to 20. The reduction is zero when $\theta = 7.498$ radians and $\log_e r = 1.246$.

621.385.2:621.396.822 500

Temperature-Limited Noise Diode Design—R. W. Silnkman. (*Sylvania Technologist*, vol. 2, pp. 6-8; October, 1949.) A general discussion of design problems and of the more important characteristics of such diodes. Design and construction details are given for a diode with approximately 8 w total dissipation and maxi-

mum operating frequency 500 Mc. A 50-w tube is in the experimental stage.

621.385.3 501

Pencil-Type U.H.F. Triodes—G. M. Rose, D. W. Power, and W. A. Harris. (*RCA Rev.*, vol. 10, pp. 321-338; September, 1949.) 1949 IRE National Convention paper noted in 1824 of 1949 [No. 141]. A new type of triode is described which satisfies basic requirements of minimum transit time, lead inductance, and internal capacitance. It is small, has good thermal stability and low heater wattage, and is suitable for mass production. A double-ended construction is used, with the rod-type anode and cathode connections extending outwards from the two sides of a control-grid disk. The internal elements are cylindrical and coaxial. Characteristics and performance data are included for 4 different tubes of this type, designed for use as amplifiers and low-power oscillators. Typical applications are described.

621.385.38 502

Hydrogen Thyratrons—J. Grolleau. (*Bull. Soc. Franç. Élec.*, vol. 9, pp. 522-524; October, 1949.) The advantages and disadvantages of hydrogen thyratrons are enumerated and a thyatron capable of handling high peak power is described. This tube developed by the Compagnie Générale de Télégraphie sans Fil (C.S.F.), has an indirectly heated cathode in the form of a cylinder covered with fine-meshed Ni gauze to avoid flaking of the coating which usually occurs with large metal surfaces. Two thermal screens are arranged on either side of the cathode in order to maintain the cathode at its correct operating temperature of 820°C with the minimum heating current. The grid completely surrounds the anode/cathode space and the part which controls the damping of the arc consists of three baffles. Deionization is aided by keeping the anode/grid space reasonably small. The heater current is 11.5 a at 6.3 v, maximum peak voltage 16 kv, maximum peak current 160 a and mean current 100 ma. Pulses of duration up to 6 μ s, with a recurrence frequency of 4,000 per second, can be handled. Tube life is of the order of 500 hours. For peak powers higher than 1-2 mw, the thyratrons can be connected either in series or in parallel.

621.385.38 503

Extended Range D.C. Bias Control of Thyatron Plate Current—L. Reiffel. (*Rev. Sci. Instr.*, vol. 20, pp. 699-702; September, 1949.) Advantages and disadvantages of three existing methods of controlling the average current in a thyatron with alternating anode voltage are discussed. In a new method, an alternating voltage is applied to the anode of the thyatron and another alternating voltage to the screen grid. The phase of the screen-grid voltage is shifted about 90° behind that of the anode voltage by a fixed phase-shifting network. An asymmetry is thus introduced into the critical grid bias control curve of the thyatron, and the minimum of this curve is shifted towards the 180° point of the anode voltage. Modifications of this simple system are discussed.

621.385.38 504

Hot-Cathode Thyratrons: Practical Studies of Characteristics—H. de B. Knight. (*Proc. IEE*, vol. 96, pp. 361-378; September, 1949. Discussion, pp. 379-381.) A survey of the main factors affecting the characteristics and life of thyratrons, based on experimental results. Such factors include electron emission from the cathode, ionization and current build-up, grid control, current-carrying capacity, the decay of ionization at the end of conduction, and the provision of suitable operating conditions. Other factors, such as positive-ion bombardment, may affect tube life but not electrical

performance. The control characteristics of different types of grid are discussed, with special reference to the pentode design, which enables heavy currents to be controlled from high-impedance grid circuits. The arc voltage drop varies considerably with filling pressure and current. If the current-carrying capacity of the arc path is exceeded, the arc may suddenly go out, and undesirable hv surges may result. A method of measuring de-ionization time is described. Results are given showing how this time varies according to the nature of the filling gas and its pressure. See also 3168 of 1949.

621.385.5:621.396.622.7:621.396.619.13 505

The " ϕ -Detector," A Detector Valve for Frequency Modulation—J. L. H. Jonker and A. J. W. M. van Overbeek. (*Philips Tech. Rev.*, vol. 11, pp. 1-11; July, 1949.) Description of a new tube with 7 grids, which can replace several circuits and tubes needed in other detection systems. The second, fourth, and sixth grids are screen grids, and the seventh is a suppressor grid. The third and fifth grids are control grids, to each of which an output voltage is applied from an if transformer. The rms value of these voltages must be at least 8 v. The mean value of the anode current is a function of the phase shift ϕ between the two control voltages. ϕ is a function of the frequency deviation. Both these functions are approximately linear when ϕ has a sweep between 60° and 120°. The amplitude of the anode current is independent of the magnitude of the control voltages, provided these exceed 8 v. The tube thus acts as a limiter; this renders certain sources of noise and of distortion harmless. No inertia other than electron inertia is involved, so that short impulsive interference bursts are also limited. The " ϕ -detector" has an af output voltage of 20-25 v. No if transformer is needed. The first grid can be used for blocking the cathode current if the control voltages are not large enough, thus suppressing interchannel noise. Type EQ80 is made in the same way as Rimlock tubes but has a "Noval" base with 9 pins. The mean anode current is 0.25ma.

621.385.832 506

Cathode-Ray Tubes for the Study of Rapid Phenomena—P. Patriarche and P. Bonvalot. (*Bull. Soc. Franç. Élec.*, vol. 9, pp. 525-531; October, 1949.) Improvement of the performance of cr tubes by better design of electron guns, by reduction of distortion and aberration of the electron-optical systems, and particularly by the use of post-deflection acceleration, is discussed and optimum conditions for the observation of transient effects are considered.

621.396.615.141.2 507

Methods of Measurement Used in the Study of Magnetrons. Results Obtained on New Types of Magnetron—J. Legros and C. Azéma. (*Bull. Soc. Franç. Élec.*, vol. 9, pp. 568-576; October, 1949.) Measurements necessary prior to evacuation, such as the determination of the resonance frequencies of the anode block, and measurements of various parameters for completed magnetrons under pulse or cw conditions, are outlined. Operating characteristics are given for the following new tubes: (a) Type MV.201, a miniature tube with glass envelope and overlapping segments giving a mean power of 6 w on wavelengths from 19 to 28 cm, with frequency variation by means of an external circuit. (b) Type MCV.81, for cw operation with a power of 80 w in the range 8.2-8.8 cm, with mechanical regulation. (c) Type MC.1011, for high-power radar pulse operation; the anode block has double strapping on both faces; air-jet cooling is used and the useful power with 1- μ s pulses at 500 per second can reach 1 mw. (d) Type MC.231, for

cw operation on a wavelength of about 23 cm, with a useful power of 1 kw; the anode is water-cooled, but air-cooling will be used on later models.

621.396.615.141.2 508

The Modes of Oscillation for Magnetron Anodes—C. Azéma. (*Bull. Soc. Franç. Élec.*, vol. 9, pp. 559–567; October, 1949.) Two methods are available for determining the resonance frequency for cavity magnetrons, one based on calculations of em fields by the methods of mathematical physics, the other based on the concept of equivalent circuits, to which ordinary circuit technique can be applied. Both methods are used to obtain information as to the characteristics of the frequency spectrum for magnetrons with different types of strapping, and for rising-sun magnetrons. Three methods of anode isolation that have been tried by the Compagnie Générale de T.S.F., involving the use of rounded fins, decoupled cavities or unequal cavities, are briefly mentioned.

621.396.615.141.2 509

Modes in Interdigital Magnetrons—J. F. Hull and L. W. Greenwald. (*PROC. I.R.E.*, vol. 37, pp. 1258–1263; November, 1949.) A set of design equations is derived, by means of which the resonance wavelength and external Q can be calculated for each mode of these magnetrons. Results thus obtained are compared with experimental results. See also 908 of 1949 (Hull and Randsal).

621.396.615.142:621.385.029.63/.64 510

Electron Bunching in a Velocity-Modulation Valve by Means of a Travelling-Wave Device—R. Warnecke, W. Kleen, O. Doehler, and H. Huber. (*Compt. Rend. Acad. Sci.* (Paris), vol. 229, pp. 648–649; October 3, 1949.) The gain of traveling-wave amplifiers of the Kompfner-Pierce type is of the order of magnitude of the ratio of the real part to the imaginary part of the propagation constant of the amplified wave; only the energy corresponding to a small excess of the electron velocity over the traveling-wave velocity can be converted to hf energy. The efficiency of the energy exchange can be improved by means of a system in which the electron beam, modulated in density and velocity by means of a wave applied at the input of a retarding system, is injected into a cavity resonator in the field of which the electron packets give up a large part of their kinetic energy. The hf energy transported by the traveling wave to the output end of the retarding system is either absorbed by a matched attenuating element or added, by means of a phase transformer, to that which appears in the resonator. This arrangement can

thus be considered as an improvement of the ordinary traveling-wave tube, or of the vm tube with two interaction fields. Theory of this method of amplification is summarized. Electron bunching and energy conversion factors as high as those for vm tubes can be obtained. The method has the advantage of requiring no tuned device, with the properties of an oscillatory circuit, at the input. This results in an essential simplification of the adjustments and avoids the limitation of the pass band which, in klystron amplifiers, involves the high Q of the tuned device. With the new amplifier, in fact, the pass band is that of the output cavity resonator and this band is widened by the operational load.

621.396.645 511

Amplification by Direct Electronic Interaction in Valves without Circuits—P. Guénard, R. Berterottière, and O. Doehler. (*Bull. Soc. Franç. Élec.*, vol. 9, pp. 543–549; October, 1949.) See 2977 of 1949.

621.396.645:537.311.33:621.315.59 512

The Theory of p - n Junctions in Semiconductors and p - n Junction Transistors—Shockley. (See 379.)

621.396.645:537.311.33:621.315.59 513

Hole Injection in Germanium—Quantitative Studies and Filamentary Transistors—Shockley, Pearson and Haynes. (See 380.)

621.396.645:537.311.33:621.315.59 514

Some Circuit Aspects of the Transistor—Ryder and Kircher. (See 334.)

621.396.822 515

On the Theory of the Shot Effect—L. A. Weinstein. (*Zh. Tekh. Fiz.*, vol. 17, pp. 1045–1050; September, 1947. In Russian.) A mathematical discussion of the shot effect in a cylindrical diode when the current is limited by space charge, taking into account the transit time of electrons. When space charge is present the velocity distribution of emitted electrons must be considered. Further investigations are required to determine the relation between the fluctuations of the velocity distribution and those of the anode current.

621.396.822 516

Suppression of Shot Effect Noise in Triodes and Pentodes—K. S. Knol and A. Versnel. (*Physica's Grav.*, vol. 15, pp. 462–464; July, 1949. In English.) Strutt and van der Ziel (3358 of 1948) suggested that spontaneous fluctuations arising from the shot effect could be suppressed by using induced grid noise and capacitive detuning of the input circuit. The connection of a capacitor between the con-

trol grid and the anode results in a much larger suppression of noise by detuning than is possible without the capacitor. Noise measurements at frequencies of 43 and 120 Mc on a Type-EF50 tube used first as a triode and then as a pentode are discussed. The method of measurement was analogous to that of van der Ziel and Versnel (249 of 1949).

621.396.822 517

Measurements on Total-Emission Conductance at 35 cm and 15 cm Wavelength—G. Diemer and K. S. Knol. (*Physica's Grav.*, vol. 15, pp. 459–462; July, 1949. In English.) An experimental disk-seal diode was used, the cathode-grid spacing being 15 μ at a saturation current of 35 ma and 20 μ at a saturation current of 0.1 ma. The active area was 0.75 mm². Measurements were made at cathode temperatures between 1100° K and 1350° K. The tube was studied in a coaxial circuit loosely coupled to a modulated standard signal generator and also to a crystal detector and hf amplifier; the tube conductance was calculated from Q measurements on this circuit for various saturation currents and anode voltages. Results are shown graphically and discussed; they do not support the "linear field theory." See also 3310–3313 of 1949.

621.396.822:621.385 518

Shot Effect in Valves and the Limits of Amplification—K. Fränz. (*FIAT Review of German Science, 1939–1946; Electronics, incl. Fundamental Emission Phenomena, Part 2*, pp. 21–29; 1948. In German.) A general review, with references to 19 German publications. Input-circuit design is considered.

621.385 519

Fundamentals of Radio-Valve Technique [Book Review]—J. Deketh. Publishers: Cleaver-Hume Press, London, 535 pp., 35s. (*Wireless Eng.*, vol. 26, p. 413; December, 1949.) A translation of the first of a series of books on tubes originated by Philips, Eindhoven. A fairly elementary treatment suited to the student and with useful references for the engineer.

MISCELLANEOUS

5+6(43) 520

FIAT Review of German Science, 1939–1946. Electronics, incl. Fundamental Emission Phenomena: Part 2 [Book Notice]—G. Goubau and J. Zenneck (Senior authors). Publishers: Office of Military Government for Germany, Field Information Agencies Technical, British, French, U. S., 1948, 288 pp. In German. Part 1 was noted in 2414 of 1949. For abstracts of papers see various sections.

SEE CENTRALAB'S NEW BABY..

AT THE
I.R.E. SHOW
Grand Central Palace
New York
MARCH 6-9

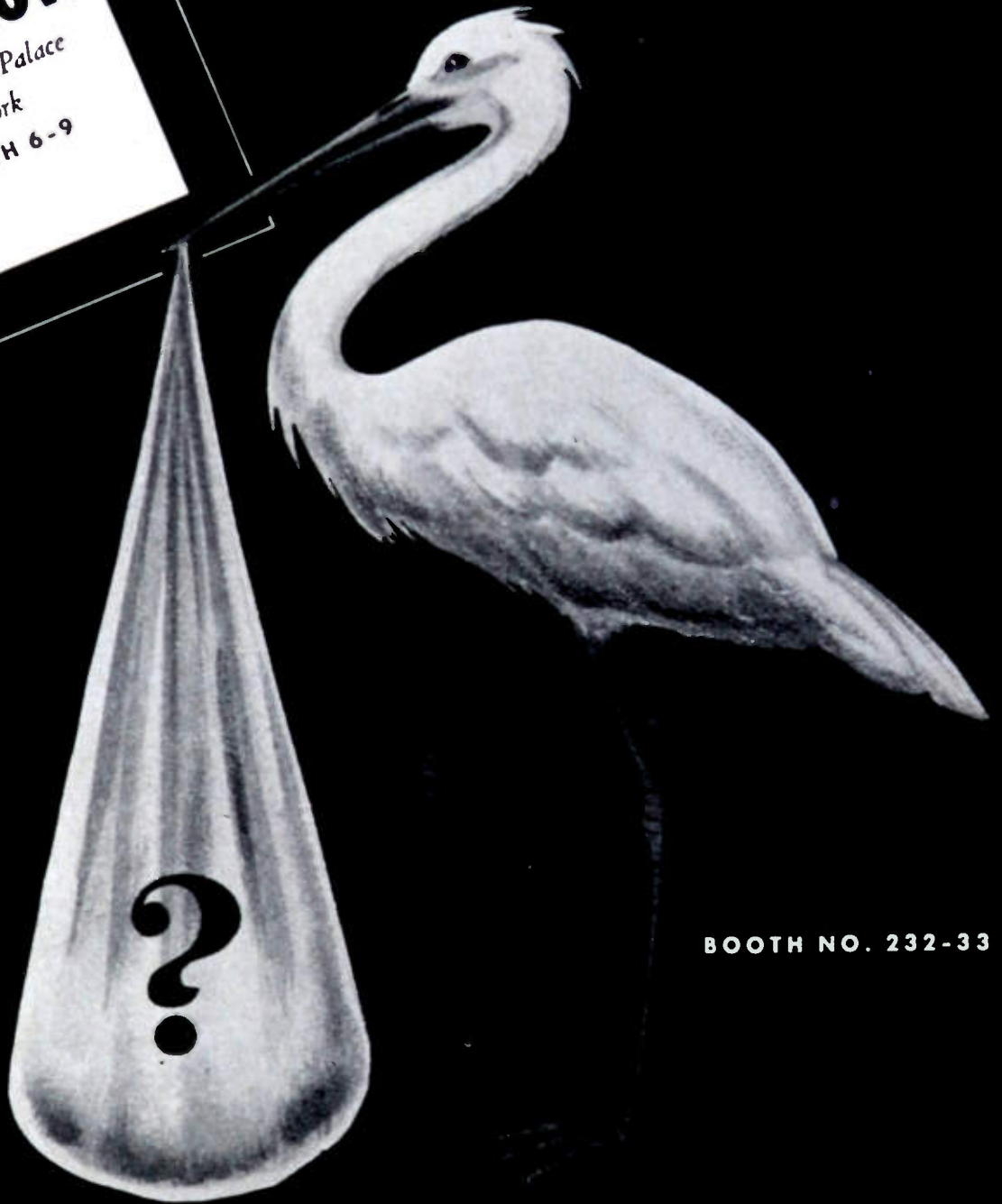

BOOTH NO. 232-33

ANOTHER **Centralab** **FIRST** →



NEW! NEW! Centralab's

**MARCH
1950**

**New Model 2
Radiohm
Ideal for TV**

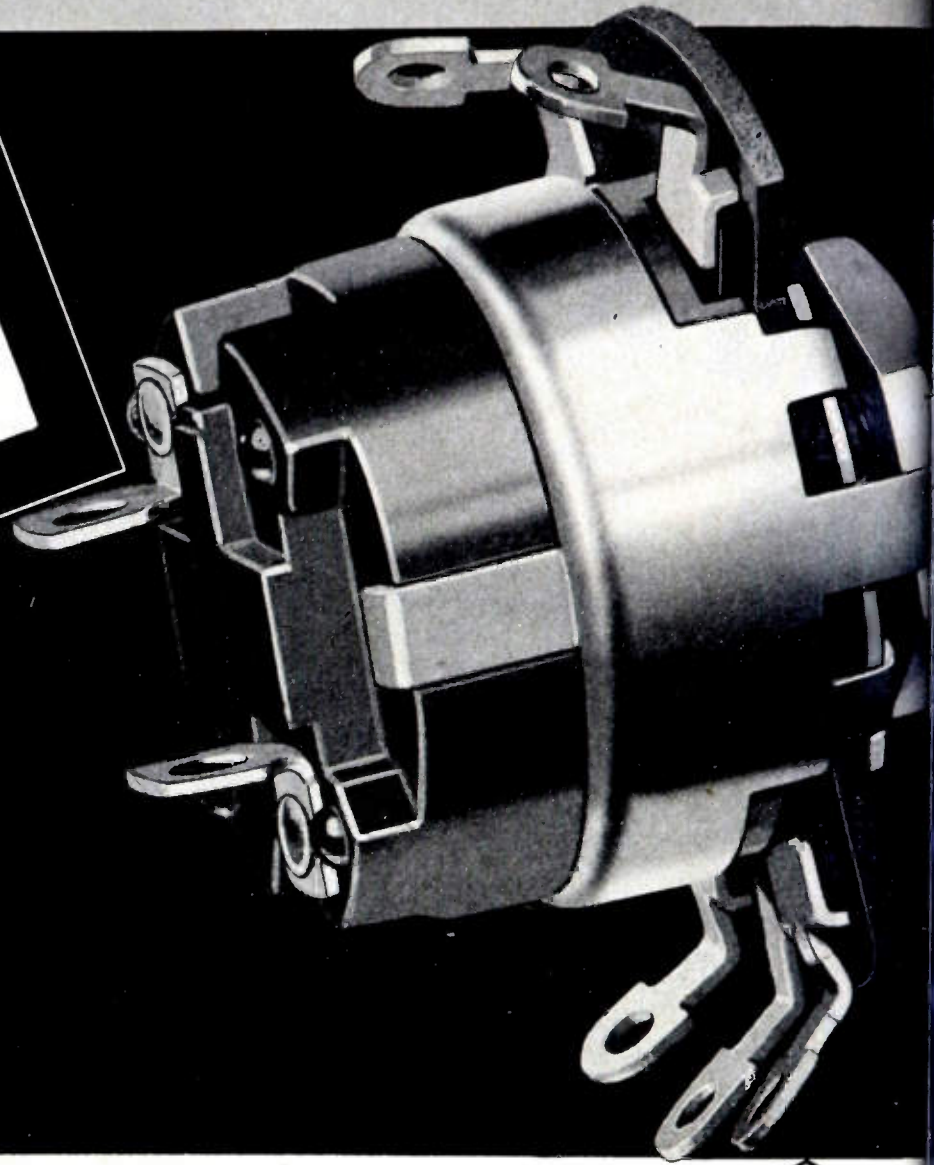

NOW READY — A COMPLETE LINE OF 



TV AM FM

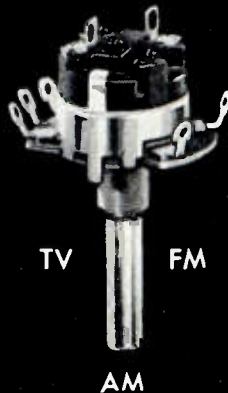

TV FM
AM



TV FM
AM

New Centralab Model 2 Radiohm Control — Left, single unit plain type, untapped; right, twin unit plain type, untapped. Both with single shafts.

New Centralab Model 2 Radiohm Control — control shown is a single unit switch type, tapped. Control has single shaft.

New Centralab Model 2 Radiohm Control — this control is a twin unit switch type, untapped. It has a single shaft.

Model 2 Radiohm Control

A NEW CONTROL WITH NEW PERFORMANCE!

Centralab's new Model 2 Radiohm control gives you application possibilities and construction features never before available. (1) New uniform small size (15/16" diameter on all units, regardless of combination or resistance value). (2) New resistance element provides extremely low noise level. (3) New dual resistance contacts and collector take-off. (4) New clinch-type, rock-solid terminals. (5) New choice of line

switch combinations directly operated from shaft. (6) Eight different switch current ratings. (7) Seven standard resistance tapers. (8) All control combinations available with or without taps. (9) Wide variety of single and concentric shaft and bushing combinations. See the Model 2 Radiohm Control display and get complete information at the show — or see your nearest Centralab representative — or write direct.

CONTROLS TO MEET EVERY DESIGN NEED!

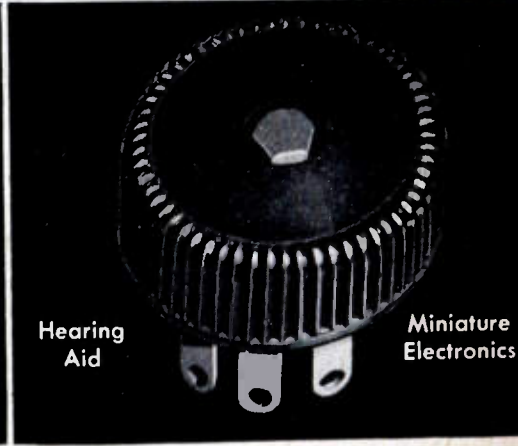
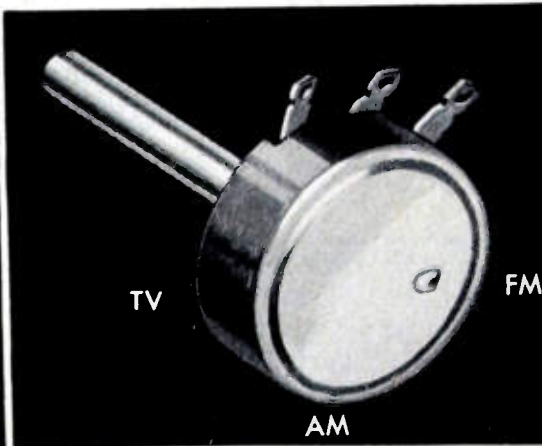
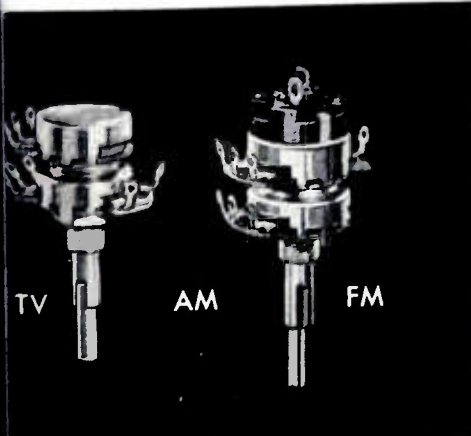

New Centralab Model 2 Radiohm Control — Left, twin unit plain type, front section tapped; right, twin unit switch type, rear section tapped. Both units have concentric shafts.

Centralab's Model "R" Radiohm Control — This control is wire-wound, 3 watts. Linear taper. Resistance: 2 to 10,000 ohms.

Centralab's Model 1 Radiohm Control — Model 1 Radiohm control available in plain or switch types. No larger than a dime! Rated 1/10 watt. Ideal for miniature uses.

IMPORTANT BULLETINS FOR YOUR TECHNICAL LIBRARY!

They're factual!



THEY'RE FREE!

Choose From This List!

Centralab Printed Electronic Circuits

- 973 — AMPEC — three-tube P. E. C. amplifier.
- 42-6 — COUPLATE — P. E. C. interstage coupling plate.
- 42-22 — VERTICAL INTEGRATOR — for TV application.
- 42-24 — CERAMIC PLATE COMPONENTS — for use in low-power miniature electronic equipment.
- 42-27 — MODEL 2 COUPLATE — for small or portable set applications.
- 999 — PENTODE COUPLATE — specialized P. E. C. coupling plate.
- 42-9 — FILPEC — Printed Electronic Circuit filter.

Centralab Capacitors

- 42-3 — BC TUBULAR HI-KAPS — capacitors for use where temperature compensation is unimportant.
- 42-4 — BC DISC HI-KAPS — miniature ceramic BC capacitors.
- 42-10 — HI-VO-KAPS — high voltage capacitors for TV application.
- 695 — CERAMIC TRIMMERS — CRL trimmer catalog.
- 981 — HI-VO-KAPS — capacitors for TV application. For jobbers.

- 42-18 — TC CAPACITORS — temperature compensating capacitors.
- 814 — CAPACITORS — high-voltage capacitors.
- 975 — FT HI-KAPS — feed-thru capacitors.

Centralab Switches

- 953 — SLIDE SWITCH — applies to AM and FM switching circuits.
- 970 — LEVER SWITCH — shows indexing combinations.
- 995 — ROTARY SWITCH — schematic application diagrams.
- 722 — SWITCH CATALOG — facts on CRL's complete line of switches.

Centralab Controls

- 42-19 — MODEL "I" RADIOHM — world's smallest commercially produced control.

Centralab Ceramics

- 967 — CERAMIC CAPACITOR DIELECTRIC MATERIALS.
- 720 — CERAMIC CATALOG—CRL. steatite, ceramic products.

Look to CENTRALAB in 1950! First in component research that means lower costs for the electronic industry. If you're planning new equipment, let Centralab's sales and engineering service work with you. For complete information on all CRL products, get in touch with your Centralab Representative. Or write direct.

CENTRALAB
Division of Globe-Union Inc.
900 East Keefe Avenue, Milwaukee, Wisconsin

Yes—I would like to have the CRL bulletins, checked below, for my technical library!

- | | | | | | | |
|--------------------------------|--------------------------------|-------------------------------|--------------------------------|--------------------------------|------------------------------|--------------------------------|
| <input type="checkbox"/> 973 | <input type="checkbox"/> 42-24 | <input type="checkbox"/> 42-9 | <input type="checkbox"/> 42-10 | <input type="checkbox"/> 42-18 | <input type="checkbox"/> 953 | <input type="checkbox"/> 722 |
| <input type="checkbox"/> 42-6 | <input type="checkbox"/> 42-27 | <input type="checkbox"/> 42-3 | <input type="checkbox"/> 695 | <input type="checkbox"/> 814 | <input type="checkbox"/> 970 | <input type="checkbox"/> 42-19 |
| <input type="checkbox"/> 42-22 | <input type="checkbox"/> 999 | <input type="checkbox"/> 42-4 | <input type="checkbox"/> 981 | <input type="checkbox"/> 975 | <input type="checkbox"/> 995 | <input type="checkbox"/> 967 |
| | | | | | | <input type="checkbox"/> 720 |

Name.....

Address.....

City..... State.....

TEAR OUT COUPON

← for the Bulletins you want →

Centralab
CRL
Division of GLOBE-UNION INC. • Milwaukee

SECTION MEETINGS

ATLANTA

"Notes on Some Characteristics of Simple Antennas," by N. B. Fowler, American Telephone and Telegraph Company; November 18, 1949.

"Radar Tracking of Hurricanes," by M. H. Latour, Faculty, University of Florida; December 16, 1949.

BALTIMORE

"The Hammond Organ—After a Decade and a Half of Progress," by F. P. Stieff, Charles M. Stieff, Inc., and H. J. Servais, Hammond Instrument Company; December 15, 1949.

BOSTON

"Recent Developments in Electron-Tube Memory Devices," by Patrick Youtz, Massachusetts Institute of Technology; October 27, 1949.

"Developments in Aerial Navigation," by Norman Kaplan, Air Navigation Development Board; December 8, 1949.

BUENOS AIRES

Comments on the Last International Telecommunication Committees; by J. A. Autelli; September 9, 1949.

"Latest Developments on Microwave Tubes," by A. B. Lapiere; October 7, 1949.

"Broadcast Studio and Transmitter Radio Link," by Federico Harris; October 21, 1949.

"Quartz Crystals, Electromechanical Transducers, and Some Ultrasonics Applications," by Alejandro Rojo; November 18, 1949.

"Microwave Measurements," by Kurt Franz; December 2, 1949.

"Long Waves versus Microwaves," by P. J. Noizeux and J. P. Arnaud; December 16, 1949.

BUFFALO-NIAGARA

"Magnetic Amplifiers," by F. H. Shepard, Shepard Laboratories; October 19, 1949.

"Aircraft Application of Electronics," by R. W. Carlson and F. A. Gray, Bell Aircraft Corp; November 16, 1949.

"A Direct-Drive Horizontal Scan System," by R. R. Thalner, Colonial Radio Corp.; December 14, 1949.

CEDAR RAPIDS

"The Lunar Eclipse by Microwaves," by W. W. Salisbury, Collins Radio Company; December 21, 1949.

CHICAGO

"From Pony Express to Mile-Long Trains," by C. O. Jett, Union Pacific Railroad; "Engineering Railroad Radio," by L. P. Morris, Motorola, Inc; and "A New Industrial and Public Service," by R. F. McCall, Motorola, Inc; November 18, 1949.

"Tape or Disks for Home Music?" by R. P. Glover, Jensen Manufacturing Company; and Panel Discussion; December 16, 1949.

CINCINNATI

"Recording Styli," by Isabel Capps, F. L. Capps and Company; November 15, 1949.

"Reproduction of Sound," by H. F. Olsen, Radio Corporation of America; December 20, 1949.

"Television in General," by S. W. Seeley, Radio Corporation of America; January 17, 1950.

COLUMBUS

"Magnetic Amplifiers," by E. L. Harler, Westinghouse Electric Corp.; December 16, 1949.

CONNECTICUT VALLEY

"Ultra-Sonics," by W. M. A. Anderson, Faculty, CRL School of Electronics and Research Laboratory; and "WHUS—A College Radio Station," by A. G. Grimall, Student, University of Connecticut; December 15, 1949.

(Continued on page 38A)

CURRENT
REGULATION

POWER
REGULATION

VOLTAGE
REGULATION

can you put your Finger
on the TROUBLE?

If you can, a SORENSEN Electronically controlled, magnetic amplifier regulating circuit can solve it!

Sorensen's new line of Electronic AC Voltage Regulators is the most accurate and most economical line of Electronic Voltage Regulators on the market today. Standard specifications offer Accuracy to within $\pm 0.1\%$ and Distortion as low as 2%. Load range from zero to full load. All models are temperature Compensated and can be supplied hermetically sealed or fosterited. And the Sorensen line uses less tubes than other electronic type regulators.

Sorensen Engineers are always at your service to solve unusual problems and give you the benefits of years of experience. Describe your needs and let a Sorensen Engineer suggest a solution. It will save you time and money to try Sorensen first.

CATALOG A1049 DESCRIBES
COMPLETE LINE

TYPICAL AC REGULATORS



Model 5000-25—high power
Input 95 to 130; distortion 3%; load 0-5000 VA;
Accuracy $\pm 0.1\%$ against line or load; 50-60 cycles



Model 3000S—medium power
Input 95 to 130; distortion 3%; load 0-3000 VA;
Accuracy $\pm 0.1\%$ against line or load; 50-60 cycles



Model 500S—low power
Input 95 to 130; distortion 3%; load 0-500 VA;
Accuracy $\pm 0.1\%$ against line or load; 50-60 cycles

POWER
controlled converted

Sorensen and company, inc.
375 FAIRFIELD AVE. • STAMFORD, CONN.

MANUFACTURERS OF AC LINE REGULATORS, 60 AND 400 CYCLES; REGULATED DC POWER SOURCES; ELECTRONIC DIODES; VOLTAGE REFERENCE STANDARD; CUSTOM BUILT TRANSFORMERS; SATURABLE CORE REACTORS

Laboratory and Research Instruments

ENGINEERED FOR ENGINEERS

OSCILLOSYNCHROSCOPE Model OL-15B

Designed for maximum usefulness in laboratories doing a variety of research work, this instrument is suited to radar, television, communication, facsimile, and applications involving extremely short pulses or transients. It provides a variety of time bases, triggers, phasing and delay circuits, and extended-range amplifiers in combination with all standard oscilloscope functions.

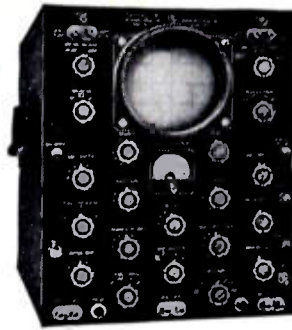

THESE FEATURES ARE IMPORTANT TO YOU

- Extended range amplifiers: vertical, flat within 3 db 5 cycles to 6 megacycles, full tube deflection; horizontal, flat within 1 db 5 cycles to 1 megacycle.
- High sensitivity: vertical, 0.05 RMS volts per inch; horizontal 0.1 RMS volts per inch.
- Single-sweep triggered time base permits observation of transients or irregularly recurring phenomena.
- Variable delay circuit usable with external or internal trigger or separate from scope.
- Sawtooth sweep range covers 5 cycles to 500 kilocycles per second.
- 4,000-volt acceleration gives superior intensity and definition.

For complete data, request Bulletin RO-250

SWEEP CALIBRATOR



Model GL-22A

This versatile source of timing markers provides these requisites for accurate time and frequency measurements with an oscilloscope:

- Positive and negative markers at 0.1, 1.0, 10, and 100 micro-seconds.
- Marker amplitude variable to 50 volts.
- Gate having variable width and amplitude for blanking or timing.
- Trigger generator with positive and negative outputs. Further details are given in Bulletin RC-250.

Model MD-25



Ask for your FREE copy of our brochure illustrating and describing all Browning products.

In Canada, address Measurement Engineering Ltd., Arnprior, Ontario.

Export Sales
9 Rockefeller Plaza
Room 1422, New York 20



BROWNING
Laboratories, Inc.
Winchester, Mass.
ENGINEERED FOR ENGINEERS

New! FM MODULATION METER MD-25

A simple and inexpensive instrument for checking fixed and mobile transmitters for compliance with FCC regulations on FM carrier frequency swing due to modulation so as to prevent adjacent-channel interference. General coverage of all communication bands: 30-50 mc., 72-76 mc., 152-162 mc. Measures deviation up to ± 20 kc.

Write for Bulletin RD-250 containing full details of this useful instrument



(Continued from page 37A)

"Telephone Voice Super-Highways," by J. O. Perrine, American Telephone and Telegraph Company; January 17, 1950.

DALLAS-Ft. WORTH

1949 Southwestern IRE Conference; December 9-10, 1949.

DAYTON

"The Human Side of the Engineer," by W. L. Webb, Bendix Aviation Corp.; January 12, 1950.

DENVER

"Transition from Present Type of Air Navigation Aids to New Omnidirectional Range, Distance Measuring Equipment and Course Line Computer Systems," by E. A. Post, United Air Lines; January 13, 1950.

DETROIT

"A New Coupling Circuit for Audio Amplifiers," by F. H. McIntosh; and Election of Officers; December 16, 1949.

EMPORIUM

"Air Navigation and Traffic Control," by J. W. Leas, Air Transport Association; January 14, 1949.
"The Stratovision System," by F. G. Mullins, Jr., Westinghouse Electric Corp; February 3, 1949.
"Electron Beam Amplifier Tubes," by R. G. E. Hutter, Sylvania Electric Products Inc.; March 3, 1949.

"Motion Picture Photography at Ten Million Frames per Second," by G. G. Milne, Faculty, University of Rochester; April 7, 1949.

"The Properties and Uses of Emission Materials," by Harold Jacobs, Sylvania Electric Products Inc.; May 5, 1949.

"Carrier Power Requirements for Long Distance Communication by Microwaves," by A. G. Clavier, Federal Telecommunication Laboratories; and "Design Features of a New Television Receiver," by Garrard Mountjoy, Stromberg-Carlson Company; August 19, 1949.

"A Modern Orthicon Camera Chain in Television," by Michael Landis, Allen B. DuMont Laboratories; and "Problems of Television Deflection and High Voltage Supply," by A. A. Bario, Radio Corporation of America; August 20, 1949.
Film: "Atomic Energy"; September 8, 1949.

"Recent Trends in Color Television," by M. G. Nicholson, Colonial Radio Corp.; December 1, 1949.
"Television—North and South," by R. A. Hackbusch, Stromberg-Carlson Company; and Election of Officers; December; 15, 1949.

Ft. WAYNE

"Personal Problems in the Education and Practice of Engineers," by O. W. Eshbach, Faculty, Northwestern University; and "Where Are We Drifting?" by Lucille Zink, Chamber of Commerce; January 19, 1950.

HOUSTON

"Acoustical Design of Broadcasting Studios," by C. P. Boner, Faculty, University of Texas; December 13, 1949.

"Motion Picture Sound Recording on Film," by Charles Fermaglich, Empire Motion Picture Studios; January 17, 1950.

LONDON

"Function, Mission, and Requirements of Electronics in the Royal Canadian Air Force," by E. A. D. Hutton, Royal Canadian Air Force; December 12, 1949.

LOS ANGELES

"Microwave Spectroscopy and Frequency Control Using Spectral Lines," by W. D. Hershberger, Faculty, University of California at Los Angeles; and "A Miniature Type Condenser Microphone," by J. K. Hilliard, Altec-Lansing Corp.; January 3, 1950.

(Continued on page 40A)



Tube Sockets

We are now producing 7 and 9 pin miniature tube sockets of MYCALEX at prices formerly paid for mica-filled phenolics and general purpose bakelite but with electrical characteristics which place them in the ceramic class. MYCALEX is highly superior in quality yet costs no more than less effective insulating materials.

MYCALEX miniature tube sockets are produced of glass-bonded mica by injection molding. It permits closer tolerances, low dielectric loss with high dielectric strength, high arc resistance and dimensional stability over wide humidity and temperature ranges.

MYCALEX miniature tube sockets are produced in two qualities.

MYCALEX 410 for applications requiring close dimensional tolerances not possible in ceramics and with a much lower loss factor than mica-filled phenolics. This top grade insulating agent has an insulation loss factor of .015 (at 1 M.C.). It compares favorably in price with mica-filled phenolics.

MYCALEX 410X for applications where general purpose bakelite was acceptable but with a loss factor of only one fourth of that material. MYCALEX 410X has an insulation loss factor of .083 (at 1 M.C.). Prices compare with lowest quality insulation materials.

Write us today and let us quote you prices on your particular requirements.

Mycalex Tube Socket Corporation

"Under Exclusive License of Mycalex Corporation of America"

30 Rockefeller Plaza, New York 20, N.Y.



MYCALEX CORP. OF AMERICA

"Owners of 'MYCALEX' Patents"

Executive Offices: 30 Rockefeller Plaza, New York 20, N. Y.

Plant and General Offices: Clifton, N. J.

The little **SHURE** cartridges
that fill the Big need
for High Fidelity
Phonograph Reproduction . .

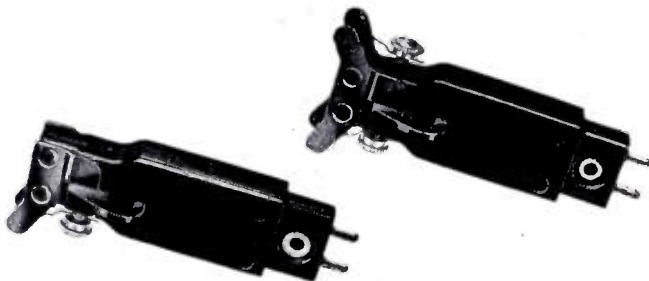

THE
NEW SHURE "VERTICAL
DRIVE"
CRYSTAL PICKUP CARTRIDGES

Big things often come in little packages . . . So it is with the superlative new Shure "Vertical Drive" Crystal Cartridges. They reproduce *all* the recorded music on the new fine-groove recordings—a reproduction that meets the strict requirements of high compliance and full fidelity. The "Vertical Drive" cartridges are requisite for the critical listener—the lover of fine music. They are especially recommended for those applications where *true fidelity* is essential.

SINGLE MODELS:

W 23 A for standard width-groove records.

W 21 A for fine-groove records.

TURNOVER MODELS:

W 22 A and W 22 AB for both standard and fine-groove recordings.

Unusually highly compliant, these "Vertical Drive" Cartridges will faithfully track standard records with a force of only 6 grams—micro-groove records with a force of only 5 grams (an added protection for treasured recordings). Will fit standard or special mountings. Have more than adequate output for the average audio stage.

SHURE

SHURE BROTHERS, INC.

Microphones and Acoustic Devices

225 WEST HURON STREET, CHICAGO 10, ILL. • CABLE ADDRESS: SHUREMICRO



(Continued from page 38A)

LOUISVILLE

"Television Equipment," by F. S. Jordan, WAVE; and "Television Systems," by M. C. Probst, United Television Laboratories; December 9, 1949.

"Design for Television Reception Under Weak Signal Conditions," by R. B. McGregor, Radio Station WHAS, Inc.; January 13, 1950.

MILWAUKEE

"A Universal Phonograph Stylus," by J. D. Reid, Crosley Division, Avco Manufacturing Corp.; September 19, 1949.

"A Review of the Status of Magnetic Recording Today," by J. S. Boyers, Magnecord, Inc; November 16, 1949.

"Design and Operational Problems Involved in Coaxial Loud Speakers," by Karl Kramer, Jensen Manufacturing Company; November 29, 1949.

"Electric Analog Computers," by E. L. Harder, Westinghouse Electric Corp; December 14, 1949.

NEW MEXICO

"Radioactive Sensitive Instruments," by R. J. Watts, Los Alamos Scientific Laboratory; December 2, 1949.

NEW YORK

"Optical Automatic Ranging Method and a Blind Aid Device," by H. E. Kallmann; January 4, 1950.

OMAHA-LINCOLN

"KFAB's Kilowatt and 5-Kilowatt Standby Installations," by A. C. Stewart, Radio Station KFAB; February 21, 1949.

"Engineering Aspects of the Transistor," and "A New Microwave Triode," by R. M. Ryder, Bell Telephone Laboratories; April 26, 1949.

OTTAWA

"High-Fidelity Audio Amplifiers," by F. M. McIntosh, McIntosh Engineering Laboratories, Inc; December 13, 1949.

"VHF Oscillator Stability," by J. R. G. Bennett; January 5, 1950.

PITTSBURGH

"Measure of Atmospheric Electricity," by James Hitt, Student, Duquesne University; "Electronic Computers," by J. R. Horsch, Student, Carnegie Institute of Technology; "Comparison of Single Unit and Array-Type Loud Speaker Systems" by D. C. Palmer, Student, University of Pittsburgh; and "Technical Applications of Electron Optics" by Barth Reisdorf, Student, Duquesne University; January 9, 1950.

PORTLAND

"Recent and Unorthodox Recording Techniques," by Howard Endicott, Alladin Recording Company and Northwest Broadcasting School; September 30, 1949.

"Operational Impedance Characteristics of Horn Type Loudspeakers," by H. L. Thurman, Bonneville Power Administration; October 6, 1949.

"Laplacian Transform Analysis," by P. C. Magnusson, Faculty, Oregon State College; October 28, 1949.

"Propagation of Very High Frequencies," by G. S. Feikert, Faculty, Oregon State College; November 9, 1949.

"Squelch Circuits and Modulation Limiters in FM Mobile Equipment," by Virgil Brittain, Radio Specialty Manufacturing Company; November 21, 1949.

"The New 60-Inch Cyclotron at University of Washington," by J. E. Henderson, Faculty, University of Washington; and Field Trip to Television Stations KOMO and KING-TV; November 26, 1949.

(Continued on page 41A)

SECTION MEETINGS

(Continued from page 40A)

Annual Reports; and Election of Officers; December 12, 1949.

PRINCETON

"Bulk Electrical Properties of Semiconductors," by P. H. Miller, Jr., Faculty, University of Pennsylvania; January 12, 1950.

ROCHESTER

"Characteristics and Application of Recently Announced Tubes," by G. D. Hanchett, Jr., RCA Victor Division; December 15, 1949.

ST. LOUIS

"Noise in Radio Communication," by Juan Gottschalk, Graduate Student, Washington University; December 15, 1949.

SAN DIEGO

"Design Considerations in High-Speed Distributed Amplifiers," by W. R. Hewlett, Hewlett Packard Company; December 7, 1949.

"Microwave Spectroscopy," by A. J. Critchlow, Consolidated-Vultee Corp.; and Election of Officers; January 10, 1950.

SAN FRANCISCO

"New Tools—The Complex Frequency Plane and the Potential Analogue," by J. M. Pettit, Faculty, Stanford University; December 14, 1949.

SEATTLE

"Measurement of Nonlinear Distortion," by Arnold Peterson, General Radio Corp.; September 15, 1949.

"Doppler Radio," by A. E. Harrison, Faculty, University of Washington; October 14, 1949.

"The New University of Washington 60-Inch Cyclotron," by J. E. Henderson, Faculty, University of Washington; and Field Trip through Television Stations KOMO and KING-TV; November 26, 1949.

"Problems in High-Power High-Frequency Tube Design," by M. H. Brown, Machlett Tube Laboratories; and Election of Officers; December 9, 1949.

TOLEDO

Tour of Toledo Edison Company conducted by M. W. Keck; and Business Meeting; December 19, 1949.

"Magnetic Tape Recorders," by H. N. Rowe, Rowe Industries; January 16, 1950.

TWIN CITIES

"Radio Interference Researches," by Morris Newman, Lightning and Transients Institute; November 17, 1949.

"The Transistor," by H. T. Mooers, Faculty, University of Minnesota; January 12, 1950.

WASHINGTON

"Aeronautical Need for Navigation Aid," by D'Arcy Harvey, Civil Aeronautics Administration; "Development of the Common (Military-Civil) System of All-Weather Air Navigation and Traffic Control," by M. K. Goldstein, Air Navigation Development Board; and "Color Television," by P. C. Goldmark, Columbia Broadcasting System, Inc.; January 9, 1950.

SUBSECTIONS

CENTRE COUNTY

"Organization of an Engineering Society," by H. H. Henline, American Institute of Electrical Engineers; and "Polar Vector Indicators," by E. A. Walker, Faculty, Pennsylvania State College; December 14, 1948.

"Jet Propulsion," by R. E. Mueser, Faculty, Pennsylvania State College; and "Gas Turbine

(Continued on page 42A)

Gentlemen: IT'S A KNOCKOUT!

it's the new CP MODEL 55 SWITCH FOR RF AND POWER SERVICE

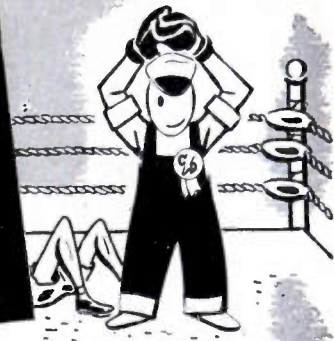

NO BIGGER'N A WRISTWATCH BUT PACKED WITH PERFORMANCE!

The new model 55 shorting type switch reflects, in miniature, many design features of large CP switches. With a maximum of 18 contact positions in the single pole style, it's also available in two or three pole styles. Of course several sections may be "ganged". Silver path from terminal to terminal is provided. Flash-over voltage at 60 cycles is 1000 volts peak. Current rating is 2 amperes. Model 55 is only one of seven standard stock model switches of our manufacture. A catalog describing them all will be sent upon request.

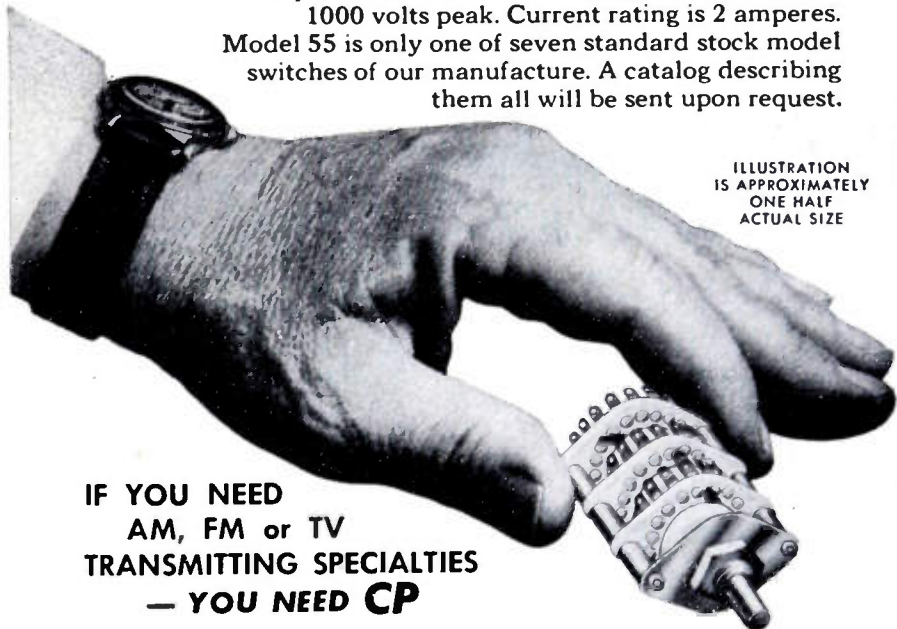

ILLUSTRATION
IS APPROXIMATELY
ONE HALF
ACTUAL SIZE

IF YOU NEED AM, FM or TV TRANSMITTING SPECIALTIES — YOU NEED CP

Because CP Transmission Equipment has proven outstanding in service and performance in hundreds of major installations throughout the nation. If you have a specific problem pertaining to any of the products listed, our engineers will be happy to help you solve it. Consultation can be arranged to suit your convenience—without obligation.

- SEAL-O-FLANGE TRANSMISSION LINE
- TOWER HARDWARE
- AUTO-DRY-AIRE DEHYDRATORS
- LO-LOSS SWITCHES
- COAXIAL DIPOLE ANTENNAS

Communication Products Company, Inc.

KEYPORT  NEW JERSEY

DIRECT WRITING RECORDERS

Records are produced by a heated writing stylus in contact with heat sensitive paper. The paper is pulled over a sharp edge in the paper drive mechanism (standard speed 25 mm/sec., slower available) and the stylus wipes along this edge as it swings, thus producing records in true rectangular coordinates. The writing arm is driven by a D'Arsonval moving coil Galvanometer with an extremely high torque movement (200,000 dyne cms per cm deflection).

This recorder assembly may be obtained in bare chassis form, as illustrated (51-600) with or without built-in timer; or, with the addition of a stylus heating transformer, temperature controls, and control panel (127); or, with the entire assembly, controls and control panel enclosed in a mahogany carrying case (127C). Complete catalog available, see below.

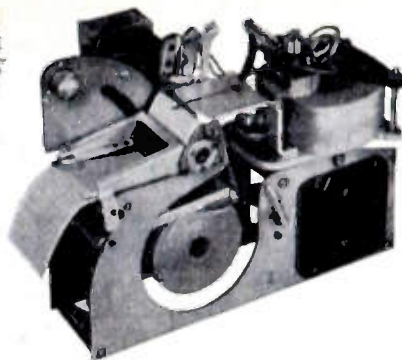

SINGLE CHANNEL
NO INK
RECTANGULAR COORDINATES
PERMANENT RECORDS

INSTRUMENT AMPLIFIERS

A general purpose, A.C. operated driver amplifier for use with model 127 Recorder, comprising three direct coupled push-pull stages. Maximum sensitivity 50 mv. per cm., minimum sensitivity 50 volts per cm., with four intermediate ranges. Balanced input terminals available with impedances of 5 megohms to ground. Complete information in catalog shown below.

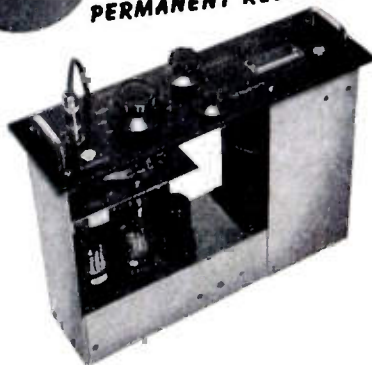

AMPLIFIER-RECORDERS

Model shown at right is a single channel unit comprising above Amplifier 126 and Recorder 127, contained in one mahogany carrying case, and designed for use in the industrial field as a direct writing vacuum tube recording voltmeter capable of reproducing any electrical phenomena from the order of a few millivolts to more than 200 volts. More complete data in catalog shown below.

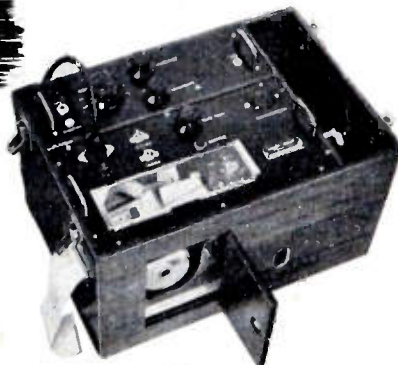

MULTI-CHANNEL
NO INK
RECTANGULAR COORDINATES
PERMANENT RECORDS

At lower right is a typical "Poly-Viso" multiple channel direct writing Recorder and Amplifier in console. Numerous combinations of this recording equipment and associated amplifiers and accessories are available. The Multi-channel Recorder (Model 165) provides for the simultaneous registration of up to four input phenomena, using the same principles and method as for the Recorder Assembly above. In addition, the "Poly-Viso" Recorder provides a selection of eight paper speeds: 50, 25, 10, 5, 2.5, 1.0, 0.5 and 0.25 mm/sec., and for the use of 4, 2, or 1 channel recording Permapaper. The Amplifier equipment is housed in a rack which has space for four individual driver amplifiers (electrically identical to model 126, above) and one 4-channel preamplifier.



For complete catalog giving tables of constants, sizes and weights, illustrations, general description, and prices, address:

SANBORN COMPANY
Industrial Division
CAMBRIDGE 39, MASS.

Sanborn Recorders and Amplifiers have evolved from those originally designed by Sanborn Company for use in electrocardiographs, and have, by actual practice, proven to have wide applications in the industrial field as well.

Section Meetings

(Continued from page 41A)

Applications," by G. M. Dushinberre, Faculty, Pennsylvania State College; January 18, 1949.

"Design Considerations for a Dual Control Grid Pentode," by R. W. Slinkman, Sylvania Electric Products Inc., February 15, 1949.

"Automatic Industrial Process Control—Principles and Practices," by J. C. Peters and E. T. Davids, Leeds and Northrup Company; March 15, 1949.

"Magnetic Amplifiers—Some Methods of Analysis," by Leo Finzi, Faculty, Carnegie Institute of Technology; April 12, 1949.

"Industrial Applications of the Transistor," by J. A. Hutchison, Westinghouse Research Laboratories; May 17, 1949.

"Series Motor Control for Velocity Servo Applications," by W. E. Boop, Faculty, Pennsylvania State College; and "Predicting Maximum Usable Frequencies," by A. H. Benner, Faculty, Pennsylvania State College, August 9, 1949.

"Magnetic Tape Recording," by P. B. Sebring, Faculty, Pennsylvania State College; October 18, 1949.

"Field Tests of UHF Television," by Joseph Fisher, Philco Company; November 15, 1949.

LONG ISLAND

"Basic Principles of Slot Antennas," by Henry Jasik, Airborne Instruments Laboratory; January 18, 1950.

NORTHERN NEW JERSEY

"Design Trends in Electronic Components for Airborne Equipment," by F. J. Given, Bell Telephone Laboratories; December 14, 1949.

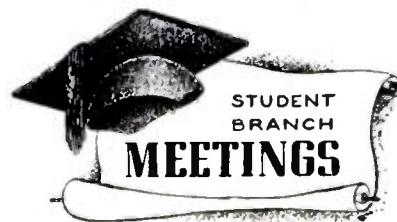

AGRICULTURAL AND MECHANICAL COLLEGE OF TEXAS, IRE-AIEE BRANCH

"Importance of Corrosion," by Mr. Judah and Mr. Thorney, American Association of Corrosion Engineers; January 10, 1950.

CASE INSTITUTE OF TECHNOLOGY, IRE BRANCH

"Radio Speakers (Transducers)," by Arnold Briggs, Cleveland Electronics Company; and Business Meeting; November 29, 1949.

"Magnetic Recording," by T. E. Lynch, Brush Development Company; December 7, 1949.

CLARKSON COLLEGE OF TECHNOLOGY, IRE BRANCH

"Types of Modulation," by L. L. Merrill, Faculty, Clarkson College of Technology; December 15, 1949.

Films: "Echoes in War and Peace," and "Crystal Clear"; January 5, 1950.

UNIVERSITY OF COLORADO, IRE-AIEE BRANCH,

"Instrumentation," by W. C. DuVall, Faculty, University of Colorado; January 11, 1950.

CORNELL UNIVERSITY, IRE-AIEE BRANCH

"Atomic Research Activities at Brookhaven National Laboratory," by H. B. Hansteen, Faculty, Cornell University; January 13, 1950.

(Continued on page 43A)

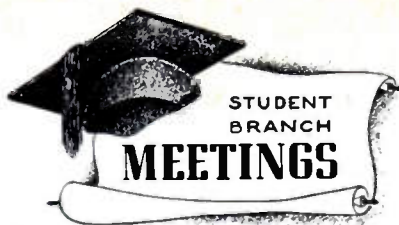

**STUDENT
BRANCH
MEETINGS**

(Continued from page 42A)

FENN COLLEGE, IRE BRANCH

"Activities of Amateur Radio," by E. W. Earle, Student, Fenn College; December 14, 1949.

GEORGE WASHINGTON UNIVERSITY, IRE BRANCH

Job Symposium: "The Engineer and Civil Service," by P. A. Willis, Civil Service Examiner; "The Engineer and Private Industry," by Dean Steidinger, Allis-Chalmers Company; and "The Engineer and Public Utilities," by W. J. Lank, Potomac Electric Power Company; December 7, 1949.

"A Ripple Tank for the Visualization of Phase Fronts," by A. H. Schooley, Naval Research Laboratory; January 4, 1950.

STATE UNIVERSITY OF IOWA, IRE BRANCH

"Are You Suited to Engineering?" by R. P. Larson; "TV Towers," by W. T. Metz; and "Electronic Impedance Meter, Designed by Collins Radio," by B. W. Lillick; Students, State University of Iowa; January 4, 1950.

"The Highways of Communication," by C. D. Peebler, Northwestern Bell Telephone Company; January 11, 1950.

JOHN CARROLL UNIVERSITY, IRE BRANCH

Tour and Film: "General Electric's Lamp Department"; November 15, 1949.

"The Direct-Coupled Amplifier," by Mark Grisez, Student, John Carroll University; December 6, 1949.

LEHIGH UNIVERSITY, IRE BRANCH

Field Trip: Radio Station WGPA; and Business Meeting; December 15, 1949.

UNIVERSITY OF MAINE, IRE BRANCH

"Television Receivers," by Carl Blake, Faculty, University of Maine; November 22, 1949.

MANHATTAN COLLEGE, IRE BRANCH

Two Films: "Varidrive" and "Syncrogear Motors," by M. J. Ryan, United States Motors; January 18, 1950.

MARQUETTE UNIVERSITY, IRE-AIEE BRANCH

Business Meeting and Election of Officers; November 9, 1949.

UNIVERSITY OF MICHIGAN, IRE-AIEE BRANCH

"Some Electrical Manifestations of the Central Nervous System," by Robert Gesell, Faculty, University of Michigan; January 11, 1950.

MISSISSIPPI STATE COLLEGE, IRE BRANCH

Films: "Telephone Screen Review—Transistors, Coin Collection, and Palletization; and "Bottle of Magic"; December 15, 1949.

UNIVERSITY OF NEBRASKA, IRE-AIEE BRANCH

"Television," by O. J. Stone, General Electric Sales Division; September 27, 1949.

Election of Engineer's Week Candidates; October 20, 1949.

"Developments in the Fields of Lighting and Phosphorescent Materials," by Carl Jensen, Westinghouse Lamp Division; November 2, 1949.

Business Meeting; November 15, 1949.

Business Meeting; December 14, 1949.

Business Meeting; and Election of Officers; January 11, 1950.

NEWARK COLLEGE OF ENGINEERING, IRE BRANCH

Business Meeting; January 10, 1950.

(Continued on page 44A)

Perfection
FROM A TINY PERFORMER



That's what you'll say when you try the new Astatic "AC" Crystal Cartridge—perfection of performance entirely unrelated to its tiny size. Weighs only five grams, is approximately 15/16" thick, 1/2" high and 1-1/2" long, not including pins. Yet, frequency response, particularly in the high frequencies, is amazingly excellent. A new low measure of inertia of the mechanical drive system is chiefly responsible for full wide range response and excellent tracking characteristics. Also assures low needle talk and long life for needle and records.

The "AC" employs Astatic's exclusive Taper-Lock Needle, easily changeable without tools. Molded Bakelite housing, with metal mounting brackets (fit standard 1/2" mounting) and needle guards. Available in four models: AC-78 with 3-mil stylus tip, precious metal or sapphire; AC, with 1-mil stylus tip, precious metal or sapphire; AC-AG with new Astatic "ALL-GROOVE" stylus; ACD turnover type, with both 1 and 3-mil point needles. Write for complete details.

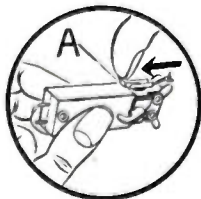

Changing the Taper-Lock Needle

Placing thumbnail against stub at rear of needle (A), simply push in direction of arrow to remove. To insert, fold card, on which new needle comes, along scored line; place narrow end of needle shank in wide end of metal cartridge groove (B) and pull card in direction of arrow.

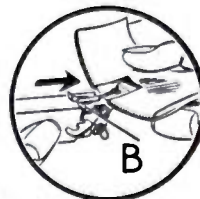

**THE HOME OF
ASTATIC PRODUCTS**



THE Astatic CORPORATION
CONNEAUT, OHIO

83,196 SQ. FEET OF FLOOR SPACE

Astatic Crystal Devices manufactured under Brush Development Co. patents

NEW- THE HI-GAIN Industrial POCKETSCOPE

BY WATERMAN

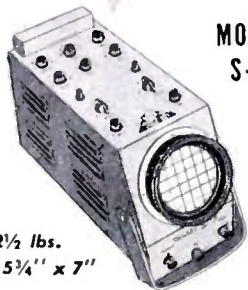

MODEL
S-14-A

Wt. 12½ lbs.
12" x 5¼" x 7"

A portable oscilloscope engineered to the exacting requirements of the electronic designer . . . a precision instrument that sacrifices nothing in performance characteristics or dependability because of its portable size or budget price . . . A giant in performance, a midget in size, the S-14-A POCKETSCOPE invites critical comparisons!

Identical Vertical and Horizontal channels with 10 mv/in sensitivity, response from 0 to 200KC within -2DB . . . Non frequency discriminating attenuators and gain controls . . . Internal calibration of trace amplitude . . . Linear time base oscillators with \pm sync for either repetitive or trigger sweeps, from ½ cycle to 50KC . . . Trace expansion . . . Filter screen . . . Mu metal shield . . . and a host of other features.



WATERMAN PRODUCTS CO., INC.
PHILADELPHIA 25, PA.

Waterman products include . . .

S-10-B GENERAL POCKETSCOPE
S-11-A INDUSTRIAL POCKETSCOPE
S-14-B WIDE BAND POCKETSCOPE
S-15-A TWIN-TUBE POCKETSCOPE

Also, RAKSCOPES, Linear Amplifiers, RAYONIC tubes and other equipment.

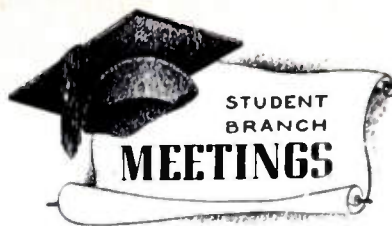

(Continued from page 43A)

COLLEGE OF THE CITY OF NEW YORK,
IRE BRANCH

"Industrial Applications of the CKO," by Hymen Mansberg, Allen B. DuMont Company; December 13, 1949.

"Electron Tube Manufacture Problems," by John Cherry, Westinghouse Electric Corp. December 15, 1949.

NEW YORK UNIVERSITY (DAY DIVISION),
IRE BRANCH

"Ballistic Photography," by B. J. Ley, Faculty, New York University; December 20, 1949.

"Role of Electrical Engineer in Medicine," by Renato Contini, Research Co-ordinator, and Winthrop Sullivan, Research Assistant, New York University; January 5, 1950.

UNIVERSITY OF NOTRE DAME,
IRE-AIEE BRANCH

"Phonograph Pickups," by Dan Tomick, Electro-Voice Company; December 7, 1949.

PENNSYLVANIA STATE COLLEGE,
IRE-AIEE BRANCH

"Bell Telephone Organization," by Jesse Caum, Bell Telephone Company; December 15, 1949

UNIVERSITY OF PENNSYLVANIA,
IRE-AIEE BRANCH

Job Forum by W. F. Henn, General Electric Company; C. J. Pearce, Westinghouse Electric Corp. L. Rodgers, Philco Corp. and C. C. Farrell, Philadelphia Electric Company; December 20, 1949.

Business Meeting; and Election of Officers; January 13, 1950.

PRATT INSTITUTE, IRE BRANCH

Business Meeting; and Election of Officers; December 16, 1949.

UNIVERSITY OF FLORIDA, IRE-AIEE BRANCH

"Industrial Application of Motors," by C. W. Drake, Faculty, University of Florida; January 3, 1950.

SAN DIEGO STATE COLLEGE, IRE BRANCH

Business Meeting; November 22, 1949.

"Magnetic Amplifiers," by M. Mintz, Student, San Diego State College; December 15, 1949.

ST. LOUIS UNIVERSITY, IRE BRANCH

Discussion of Missouri Society of Professional Engineers Examination; December 15, 1949.

"Designs and Applications of DC Motors," by Robert Munier, Emerson Electric Manufacturing Company; January 12, 1950.

SEATTLE UNIVERSITY, IRE BRANCH

"Modern Physics," by Walter Higa, Faculty, Seattle University; December 2, 1949.

STANFORD UNIVERSITY, IRE-AIEE BRANCH

Field Trip conducted by Harry Jacobs, Television Station KGO; November 8, 1949.

"What Can Be Done With Two Wires," by Harvey Smith, Lenkurt Electric Company; November 29, 1949.

Field Trip conducted by Harvey Smith, Lenkurt Electric Company, December 9, 1949.

SYRACUSE UNIVERSITY, IRE-AIEE BRANCH

"Law and the Engineer," by R. E. Stone, Faculty, Syracuse University; November 14, 1949.

"The National Electric Code," by Mr. Klock, Underwriters Laboratories; December 14, 1949.

(Continued on page 45A)

Dependable
PERFORMANCE
at
LOWER COST



TOWER
LIGHTING
EQUIPMENT

H & P lighting equipment, consistently specified by outstanding radio engineers, is furnished as standard equipment by most leading tower manufacturers.



300 MM
CODE BEACON

Patented ventilator dome circulates the air, assures cooler operation, longer lamp life. Concave base with drainage port at lowest point. Glass-to-glass color screen supports virtually eliminate color screen breakage. Neoprene gaskets throughout. CAA approved.

MERCURY
CODE FLASHER

Lifetime-lubricated ball bearings. No contact points to wear out. Highest quality bronze gears. Adjustable, 14 to 52 flashes per minute



SINGLE and DOUBLE
OBSTRUCTION
LIGHTS

Designed for standard A-21 traffic signal lamps. Prismatic globes meet CAA specifications.



"PECA" SERIES
PHOTO-ELECTRIC
CONTROL

Turns lights on at 35 f.c.; off at 58 f.c., as recommended by CAA. High-wattage industrial type resistors. Low-loss circuit insulation.



ALSO COMPLETE LIGHT KITS
FOR A-2, A-3, A-4 and A-5 TOWERS

PROMPT SERVICE and DELIVERY

First-day shipments out of stock. Immediate attention to specifications and unusual requirements.

WRITE OR WIRE FOR CATALOG
AND DETAILED INFORMATION

HUGHEY & PHILLIPS

TOWER LIGHTING DIVISION

326 N. LA CIENEGA BLVD.
LOS ANGELES 48, CALIF.

60 E. 42ND ST. NEW YORK 17, N. Y.

Student Branch Meetings

(Continued from page 44A)

UNIVERSITY OF TENNESSEE, IRE BRANCH

"Installation and Operation of Radio Telephone Equipment for Public Utilities," by W. W. Bedwell, Jr., Knoxville Utilities Board; January 10, 1950.

UNIVERSITY OF TEXAS, IRE-AIEE BRANCH

Demonstration of Electronic Theremin, by Jack Hook, Student, University of Texas; and Election of Officers; January 16, 1950.

TUFTS COLLEGE, IRE-AIEE BRANCH

"Tufts College Placement Service," by Viola Saltmarsh, Director of Placement Office, Tufts College; December 15, 1949.

Panel Discussion: "American Engineers Overseas"; January 12, 1950.

TULANE UNIVERSITY, IRE-AIEE BRANCH

Business Meeting and Film: Industrial Illumination; October 31, 1949.

Business Meeting; November 21, 1949.

Business Meeting and Film: Television; December 12, 1949.

Field Trip to Radio Station WPIX; January 4, 1950.

Business Meeting; January 9, 1950.

WORCESTER POLYTECHNIC INSTITUTE IRE-AIEE BRANCH

"Electronic Control in Industry," by Walter Hansen, General Electric Company; December 15, 1949.

"A Comparison of the Two Electrical Engineering Societies, IRE vs AIEE," by D. B. Sinclair, General Radio Company, and Victor Sigfried, American Steel and Wire Company; January 12, 1950.



The following transfers and admissions have been approved and will be effective as of March 1, 1950:

Transfer to Senior Member

Atwood, B. E., Box 227, Penfield, N. Y.

Berens, G. E., 1000 Acorn Dr., Dayton 9, Ohio

Blackman, B. G., 2730 Angus St., Los Angeles, 39, Calif.

Brockner, C. E., 150 Bayview Ave., Amityville, N. Y.

Charp, S., 39 Maple Ave., Upper Darby, Pa.

Fristoe, H. T., School of Electrical Engineering, Oklahoma A & M College, Stillwater, Okla.

Howard, G. M., 413 Ridgcrest Rd., N. E., Atlanta, Ga.

Kenyon, H. S., 534 48 St., Sandusky, Ohio

King, C. J., Jr., 709 N. Overlook Dr., Alexandria, Va.

Klyce, B. H., 835 Hope St., Springdale, Conn.

Kovski, J. J., 4208 Delhi Dr., Dayton 3, Ohio

Luck, D. G. C., RCA Laboratories Division, Princeton, N. J.

Marchand, N., Riversville Rd., Greenwich, Conn.

O'Brien, J. C., 283 Malden St., Rochester 13, N. Y.

Owen, R. P., 9130 Orion Ave., San Fernando, Calif.

Palmer, W., 313 Collins Lane, West Hempstead, L. I., N. Y.

Peters, L. J., Box 2038, Pittsburgh 30, Pa.

Rountree, J. G., 4333 Southwestern Blvd., Dallas, Tex.

Seal, P. M., 3 Lord Hall, University of Maine, Orono, Me.

Swinney, J. G. C., Jr., Near East Resources, Graham Station, Beirut, Lebanon

Van Zeeland, F. J., 2461 S. 60 St., Milwaukee 14, Wis.

(Continued on page 46A)

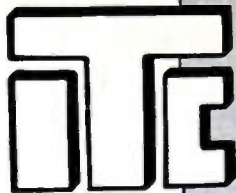

INSTRUMENTS THAT BELONG IN *Your* LABORATORY

TIC Type 310-A Z-Angle Meter — 30 to 20,000 c.p.s.

Measures impedance directly in polar coordinates as an impedance magnitude in ohms and phase angle in degrees $Z/\pm \ominus$. Measures, with equal ease, pure resistance, inductance, capacitance or complex impedances comprised of most any RLC combinations. Range: Impedance (Z), 0.5 to 100,000 ohms; Phase Angle (\ominus), $+90^\circ$ (X_L) through 0° (R) to -90° (X_C). Accuracy: Within $\pm 1\%$ for impedance and $\pm 2^\circ$ for phase angle. Price: \$425.00.

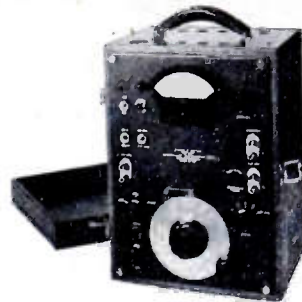

TIC Type 311-A R-F Z-Angle Meter for radio frequencies — 100 kc to 2 mc.

Simplifies laboratory and field impedance and phase angle measurements. Ideal for checking impedance of coils, transformers, coupling networks, lines, filters, antennas, etc. Direct-reading Impedance Range: 10 to 5,000 ohms up to 200 kc, and 10 to 1,000 ohms at 1 mc. Phase Angle: $+90^\circ$ (X_L) through 0° (R) to -90° (X_C). Accuracy: Impedance to within $\pm 3\%$, and phase angle $\pm 4^\circ$. Price: \$350.00.

TIC Type 410-A R-F Oscillator — 100 kc to 10 mc. (Special models 46.5 kc to 4.65 mc available.)

Power oscillator for use as bridge driver and general laboratory measurements. Features: High stability, high output (approximate 30 volts), 50-60 Ω output impedance, expanded frequency scale, direct reading output voltmeter, compact design. Price: \$350.00.

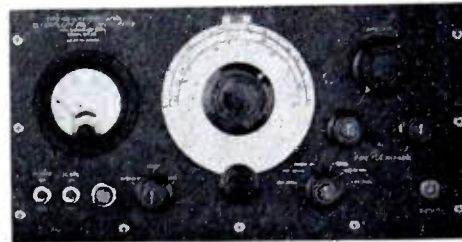

TIC Type 320-A Phase Meter — frequency range 20 cycles to 100 kc.

The first commercially available all-electronic instrument that directly measures the phase angle between two voltages in a simple operation. Ideally suited to applications in such fields as audio facilities, ultrasonics, servomechanisms, geophysics, vibrations, acoustics and many others.

Phase angle readings made directly without balancing . . . stable at frequencies as low as 2 to 3 cycles. Voltage range: 1 to 170 peak volts. Terminals for recorder . . . choice of relay-rack or cabinet mounting. Price \$475.00. Cabinet \$20.00.

TIC Type 110 Slide-Wire Resistance Box

Convenient combination consisting of precision decade resistor and continuously adjustable slide-wire which provides smooth, continuous variation of resistance between decade steps (permits adjustment of resistance to one part in 10,000). For most applications, eliminates need for more elaborate multi-dial decade boxes. Ideal for student and general laboratory use. Decade resistance cards adjusted to within $\pm 0.1\%$ of nominal values, and slide-wire resistors direct-reading to within 1% of their maximum values. Cast aluminum cabinet. All resistance elements completely enclosed. Suitable for use at audio and ultrasonic frequencies. Type 110-A, range 0-11,000 ohms: \$42.50. Type 110-B, range 0-110,000 ohms: \$45.00.

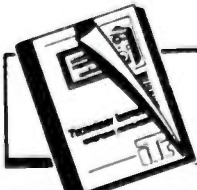

Technical catalog—yours for the asking. Contains detailed information on all TIC Instruments, Potentiometers and other equipment. Get your copy without obligation—write today.

TIC TECHNOLOGY INSTRUMENT CORP.

1058 Main Street, Waltham 54, Massachusetts
Engineering Representatives Cleveland, Ohio PRospect 6171

Chicago, Ill.—UPtown 8-1141 Dallas, Tex.—LOgan 6-5097 Rochester, N.Y.—Charlotte 3193-J
Cambridge, Mass.—ELiot 4-1751 Canaan, Conn.—Canaan 649 Hollywood, Cal.—HOLlywood 9-6305

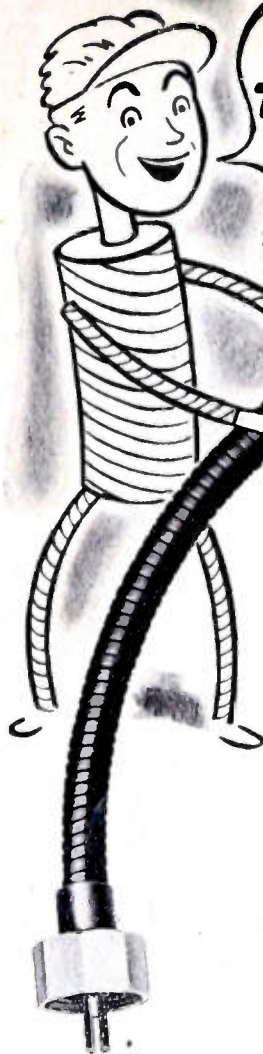

CAN YOU ANSWER THESE QUESTIONS ABOUT REMOTE CONTROL FLEXIBLE SHAFTS?

Q. What are Remote Control Flexible Shafts Used for in Electronic Equipment?

A. To couple variable elements to their tuning knobs.

Q. What Advantage Does This Use of Flexible Shafts Offer?

A. They give full freedom in locating elements to gain optimum circuit efficiency and to meet wiring, assembly and space requirements. At the same time they allow the control knobs to be grouped in an orderly and convenient arrangement.

Q. How Sensitive Are Flexible Shaft Controls?

A. With proper application, you can get any desired degree of sensitivity with S.S.White remote control shafts. Their torsional deflection is slight and is practically equal for either direction of rotation.

Q. Where Can You Get Further Information on Flexible Shafts?

BULLETIN 4501 has basic details and engineering information on how to select and apply flexible shafts. Write for your free copy today on your business letterhead. And don't forget that S.S.White engineers are ready to cooperate with you in working out specific applications. Their help and advice entails no obligation.



S.S. WHITE INDUSTRIAL
 THE S. S. WHITE DENTAL MFG. CO. DIVISION
 DEPT. G 10 EAST 40th ST., NEW YORK 16, N. Y.



FLEXIBLE SHAFTS AND ACCESSORIES
 MOLDED PLASTICS PRODUCTS—MOLDED RESISTORS

One of America's AAAA Industrial Enterprises



(Continued from page 45A)

Admission to Senior Member

- Davis, B. E., 886 Elmwood Ave., Lincoln 8, Neb.
- Lapp, R. E., 171 Victoria Ave., Buffalo, N. Y.
- Lyons, H., 2319 40 Pl., N.W., Washington 7, D.C.
- Mead, D. C., 70 Forsyth St., Boston 15, Mass.
- Tillotson, L. C., Box 107, Red Bank, N.J.

Transfer to Member

- Brockman, M. H., 160 Old Country Rd., Mineola, L. I., N. Y.
- Bryant, J. H., 100 Warren St., Nutley 10, N. J.
- Clardy, L., 11730 S. Longwood Dr., Chicago 43, Ill.
- Cunningham, L. W., 1060 Broadview Blvd., S., Dayton, Ohio
- Devey, G. B., Undersea Warfare Branch, Office of Naval Research, Navy Department, Washington, D. C.
- Eaton, T. T., RCA Victor Division, Camden, N. J.
- Eberle, E. E., 22 Beverly Ave., Floral Park, L. I., N. Y.
- Ettenberg, M., Sperry Gyroscope Company, C-39, Great Neck, L. I., N. Y.
- Foster, G. E., 7917 S. Yale Ave., Chicago 20, Ill.
- Heitner, A. J., 139 Garfield Pl., Lynbrook, N. Y.
- Herrick, M. P., 26 Upton Park, Rochester 7, N. Y.
- Landis, M., 146 Carlton Ave., Jersey City 6, N. J.
- Lumsden, R. B., 332 Hale St., London, Ont., Canada
- Munster, A. C., 175 Earl Lane, Hatboro, Pa.
- Palmer, R. C., 144 Whitford Ave., Nutley 10, N. J.
- Parker, S. R., 289 Westgate, W., Cambridge, Mass.
- Tompkins, H. E., 303 E. Rodgers St., Ridley Park, Pa.
- Walker, G. A., 14560 Sherman Cir., Van Nuys, Calif.
- Wirth, S. R., 10835 Farragut Dr., Culver City, Calif.
- Wolin, S., 4825 N. Camac St., Philadelphia 41, Pa.
- Ziolkowski, A., Nolan's Point, Lake Hopatcong, N. J.

Admission to Member

- Arvidson, P. G., 710 Brown, Bettendorf, Iowa
- Brindle, T. A., 2018 W. Monroe St., Sandusky, Ohio
- Buys, W. L., 20 Sas. Termonde, Belgium
- Farrand, W. A., 12938 Kittridge St., N. Hollywood, Calif.
- Granger, W. T., 83-30 Kew Gardens Rd., Kew Gardens, N. Y.
- King, C. J., 4100 San Carlos, Tampa 9, Fla.
- Lawson, C. J. V., c/o Cable & Wireless (W.I.), Ltd., Barbados, B. W. I.
- Marion, J. F., Physics Department, Rockefeller Hall, Cornell University, Ithaca, N. Y.
- Michael, R. R., Electrical Engineering Department, Oregon State College, Corvallis, Ore.
- Mohler, C. W., Alaska Broadcasting Company, Box 1040, Anchorage, Alaska
- Scheible, W. R., Box 1697, Wright Field, Dayton, Ohio
- Scull, W. E., Jr., 40 Lincoln Ave., Haddonfield, N. J.
- Unger, E. E., 3430 Parker Ave., Chicago 47, Ill.

The following elections to Associate were approved and will be effective as of February 1, 1950:

- Acker, A. E., 34 Hugh St., West Hartford 7, Conn.
- Anderson, J. W., Box 154, Manor, Pa.
- Arment, D. E., 251 Chestnut St., Xenia, Ohio
- Armour, R. B., 7013 15, N. E., Seattle 5, Wash.
- Armstrong, D. G., 297 Derby St., West Newton, Mass.
- Arp, R. H., 35 Mountainside Terr., Clifton, N. J.
- Bhatti, M. H., Hasan Munzil, 31 Muslim Town, Lahore, Pakistan
- Biamonte, O. A., 460 Second St., Palisades Park, N. J.

(Continued on page 47A)



(Continued from page 46A)

- Bliss, G. B., Electrical Engineering Department, University of New Mexico, Albuquerque, N. Mex.
- Book, E. G., 1503 Elm St., Valparaiso, Ind.
- Bridges, J. E., Zenith Radio Corporation, 6001 W. Pickens Ave., Chicago, Ill.
- Callaghan, J. W., 5425 Ridgewood St., Philadelphia 43, Pa.
- Castillo, E. A., 5146 N. Broadway, Chicago 40, Ill.
- Chapman, J. M., 14 Patterson Ave., Dayton 9, Ohio
- Clark, W. D., Jr., c/o W. V. Clark, 1025 Utica St., Fulton, N. Y.
- Crago, R. P., R. D. 4, South Rd., Poughkeepsie, N. Y.
- Craiglow, R. L., 1534 Third Ave., S. E., Cedar Rapids, Iowa
- Crockett, A. E., 139 Goliad St., San Antonio, Tex.
- Dallas, W. K., 1585 S. W. Highland Pkwy., Portland, Ore.
- Davis, G. W., 2311 Homestead Dr., Silver Spring, Md.
- Demer, F. M., Country Club Rd., R. D. 2, Johnson City, N. Y.
- Depew, H. D., Jr., 29 N. Jerusalem Rd., Levittown, Hicksville, L. I., N. Y.
- Downey, R. L., 142 Burdick Ave., Syracuse, N. Y.
- Earle, D. H., 4794 Ivanhoe, Detroit 4, Mich.
- Ferrell, R. W., General Electric Company, Syracuse, N. Y.
- Ferrin, K. S., 5735 N. Dixie Dr., Dayton 5, Ohio
- Fingerhood, S. A., 25 W. 81 St., New York, N. Y.
- Finke, H. J., 1357 Hertel Ave., Buffalo 16, N. Y.
- Hammond, N. B., 1827 Park Rd., N. W., Washington, D. C.
- Hansen, G. M., 92 Linden Ave., Dayton, Ohio
- Haskell, I. I., 485 Howard Ave., Brooklyn 33, N. Y.
- Helgeson, V. L., 7104 Florian, Normandy 20, Mo.
- Hertel, V. E., Jr., 2533 Far Hills Ave., Dayton, Ohio
- Hibbs, R. J., 430 Monroe Ave., Magnolia, N. J.
- Jackson, N. B., 5 Bellevue Ave., London, Ont., Canada
- Jiral, J., Jr., 1825 East Ave., Berwyn, Ill.
- Johnston, S. N. A., 632 Elias St., London, Ont., Canada
- Kennedy, J. B., 125 Heaton Ave., Dayton, Ohio
- Kercher, R. B., A.F.I.T., Wright-Patterson A.F.B., Dayton, Ohio
- Klein, H. M., 202-14 104 Ave., Hollis, L. I., N. Y.
- Knudsen, T. R., 2738 N. Wilton Ave., Chicago, Ill.
- Koch, R. C., 2229 Bellaire St., Denver 7, Colo.
- Koehl, H. L., 45 Vine St., Dayton, Ohio
- Laufman, T. D., 2201 Haviland Ave., New York 61, N. Y.
- Lee, A. W., 3821 N. Pine Grove Ave., Chicago 13, Ill.
- Lee, W. M., 4431 S. W. Fifth St., Miami 34, Fla.
- Lopez, J. L., Rm. 525, Central Y.M.C.A., Dayton 2, Ohio
- Lynch, L. J., 24 Brittany Lane, Rock Island, Ill.
- Martin, J. R., 355 Bath Ave., Long Branch, N. J.
- Mason, L., 629 St. Marks Ave., Brooklyn 16, N. Y.
- Miller, G. S., R. R. 1, Box 47, Fairborn, Ohio
- Mittelman, W., 730 W. Liberty St., Rome, N. Y.
- Miwa, G. Y., 129 W. Canfield St., Detroit 1, Mich.
- Moglia, R. E., 433 E. 117 St., New York 35, N. Y.
- Morgenstern, A., 89-39-164 St., Jamaica 3, L. I., N. Y.
- Nelson, B. R., 35-B Tremont St., Malden 48, Mass.
- Orth, J. W., 5712-38 St., Seattle 5, Wash.
- Paller, J. L., 4341 Ambrose Ave., Los Angeles 27, Calif.
- Perrin, L. A., 401 N. Dwight St., Endicott, N. Y.
- Pierce, W. E., Box 501, Tularosa, N. Mex.
- Rangachari, M., 381 Hardikar Bagh, Hyderabad State, India
- Ravindranath, T., c/o T. S. Prakasam, Fourth Line, Brodiepet, Tuntur, India
- Reichenthal, A., 273 Rutledge St., Brooklyn 11, N. Y.

(Continued on page 48A)

V. L. F.!
Very Low Frequencies!

CONFORMS TO ALL REQUIREMENTS OF C63.2 RADIO NOISE METER SPECIFICATION ADOPTED BY AMERICAN STANDARDS ASSOCIATION, OCTOBER 26, 1949



STODDART NM-10A RADIO INTERFERENCE AND FIELD INTENSITY METER

- MEASURES radiated and conducted signals.
- RANGE—14 kc to 250 kc.
- SENSITIVITY — Field strength using rod antennas one microvolt-per-meter to 2 volts-per-meter. Field strength using shielded loop antennas 10 microvolts-per-meter to 100 volts-per-meter.
- READS directly in microvolts and db.
- A.C. POWER SUPPLY 105 to 125 volts or 210 to 250 volts, 50 CPS AND 1600 CPS. No shock hazard.

Write for complete technical data

STODDART AIRCRAFT RADIO CO.

Main office and plant:
6644 SANTA MONICA BLVD., HOLLYWOOD 38, CALIF., Phone: Hillside 9294



**HIGH VOLTAGE
HIGH CURRENT**

call for **JOHNSON**
TYPES BC & BCD Variable Condensers

For Commercial and Broadcast Applications where high voltage and high current conditions prevail, there is no happier choice of variable condensers than JOHNSON.

The new aluminum die cast plates have a heavy beaded round outer edge that increases the voltage breakdown and reduces corona effect.

The cast aluminum end frame, with rounded edges, further reduces corona effect, provides longer creepage paths and lighter weight.

Shielded contact spring eliminates dust accumulation, provides large contact area. L-4 Steatite insulation, nickel-plated hardware.

SPECIFICATIONS

TYPE BC—SINGLE SECTION				TYPE BCD—DUAL SECTION			
Type No.	Min. Cap.	Max. Cap.	No. Plates	Type No.	Min. Cap.	Max. Cap.	No. Plates
50BC140	23	61	8	50BCD140	21	58	12
150BC140	48	160	18	100BCD140	34	97	22
350BC140	70	355	38	200BCD140	52	196	42
50BC160	25	56	7	50BCD160	22	53	14
100BC160	40	107	13	75BCD160	28	72	18
250BC160	63	243	31	100BCD160	38	103	26
25BC180	19	32	4	25BCD180	13	31	8
75BC180	37	75	10	50BCD180	18	51	14
150BC180	57	152	21	75BCD180	29	72	20

Last three numbers of type No. multiplied by 100 indicate peak voltage breakdown. For further specifications or information write:

E. F. JOHNSON COMPANY
WASECA, MINN.

QUANTITATIVE MEASUREMENT

The **Tektronix Type 512** Cathode Ray Oscilloscope is particularly well adapted for use in the detailed examination of complex waveforms.

The calibration accuracy of **5%** in time and amplitude; the **direct coupled** amplifiers; the **wide band pass** and **extended sweep range** will permit your research and development staff to better evaluate and measure the performance of electronic circuitry.

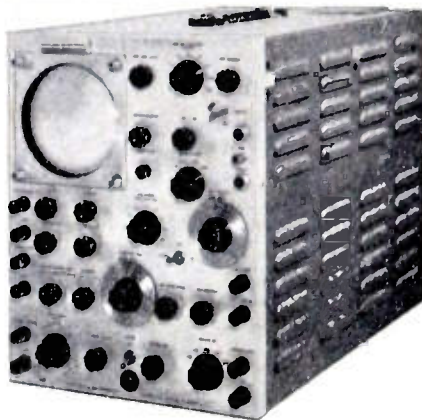

\$950.00
f.o.b. Portland, Ore.

DC - 2MC **5 Millivolt sensitivity, DC or AC**
Sweeps 3 Sec. to 30 MSec.



TEKTRONIX, INC.

Cables, Tektronix
712 S.E. Hawthorne Blvd. Portland 14, Ore.



(Continued from page 47A)

- Ross, D. K., 2295 W. Forest, Decatur, Ill.
Rourke, C. R., 68 Teresa Ave., Yonkers 4, N. Y.
Ruggl, A. G., 2354 85 St., Brooklyn 14, N. Y.
Runit, A. J., 2805 Temple Ave., Cincinnati 11, Ohio
Sanger, R. B., 170 Midwood Rd., Glen Rock, N. J.
Saunders, H. O., Jr., 1528 Forest Ave., Wilmette, Ill.
Sawyer, D. S., 93 Cambridge St., Winchester, Mass.
Schinazi, B. N., 14656 Huston St., Sherman Oaks, Calif.
Schmeck, J. S., 341 Spirea Dr., Dayton, Ohio
Schneider, J. R., 97 N. Chatsworth Ave., Larchmont, N. Y.
Schott, J. E., 4637 Magnolia Ave., Chicago 40, Ill.
Schowalter, E. A., 3908 N. 36 St., Milwaukee 10, Wis.
Schweimer, K. P., Qta. Samay Huasi, Rangelagh FCNGR, Argentina
Searle, W. B., 37 Lincoln Ave., Binghamton, N. Y.
Shimp, R. P., c/o Electronics Office, U. S. Naval Shipyard, Charleston, S. C.
Shropshire, H. C., Jr., 5507 Cedella Ave., Baltimore, Md.
Slavics, J. W., 925 Windsor Ave., Chicago 40, Ill.
Spergel, J., 33 Statesir Pl., Red Bank, N. J.
Tejuja, M. M., 29 Negandi Nagar, Sitladevi Temple Rd., Mahim, Bombay 16, India
Ventoso, O. H., Altolaguirre No. 166, Avellaneda F.N.G.R., Argentina
Wakankar, M. S., S. W. Radio Corporation, 5 Shenvidwadi Khadilkar Rd., Bombay 4, India
Weden, C. W., Jr., Machlett Laboratories, Inc., Springdale, Conn.
Yamagami, Y., 25 Prospect Ave., Montclair, N. J.
Yingst, T. E., 1134 Wrightwood, Chicago, Ill.
Yoshida, H., 1330 N. LaSalle St., Chicago 10, Ill.

The following transfers to the Associate grade were approved to be effective as of December 1, 1949:

- Abrams, H., 123 Bragaw Ave., Newark 8, N. J.
Aitel, M. L., 103 Clark St., Dedham, Mass.
Bargellini, P. L., Via R. Sangio 25, Fierenge, Italy
Busby, L. A., 1108 College Ave., Apt. 27, Indianapolis, Ind.
Delicath, R. C., 1627 Howett, Peoria 6, Ill.
Dunbar, G. R., 209 N. Lang Ave., Pittsburgh 8, Pa.
Gould, R. G., 333 Central Park West, New York 25, N. Y.
Jensen, J., College of Engineering, Tulane University, New Orleans 18, La.
Kasai, G. S., 323 West 108 St., New York 25, N. Y.
Kienker, J. E., 1612 West Main, Richmond, Ind.
Kleason, D. B., 1C Oak Grove Dr., Baltimore 20, Md.
Larson, H. T., 931 N. Pass Ave., Burbank, Calif.
Manfredi, R. E., 2027 Cardiff Road, Schenectady 10, N. Y.
Martin, G. W., Jr., 817 S. Waverly Dr., Dallas 11, Tex.
Nash, A., 33 Statesir Pl., Red Bank, N. J.
Pantchechnikoff, J. I., RCA Laboratories, Princeton, N. J.
Pitman, J. E., Westview & Wissahickon, Philadelphia 19, Pa.
Riegel, R. B., 6022 Sansom St., Philadelphia 39, Pa.
Schectman, N., 2221 South Seventh St., Camden 4, N. J.
Shulman, H., 597 Spruce Ave., Niagara Falls, N. Y.
Smale, W. R., Officers Mess, Royal Canadian School of Signals, Kingston, Ont., Canada
Spielberg, A. M., 2935-C Washington St., Camden 5, N. J.
Wood, J. R., Bldg. 117, Stanford Village, Stanford, Calif.

The following transfers to the Associate grade were approved to be effective as of January 1, 1950:

- Achard, F. H., Jr., 836 Boulevard, Westfield, N. J.
(Continued on page 49A)

CO-AX AIR-SPACED ARTICULATED R.F. CABLES

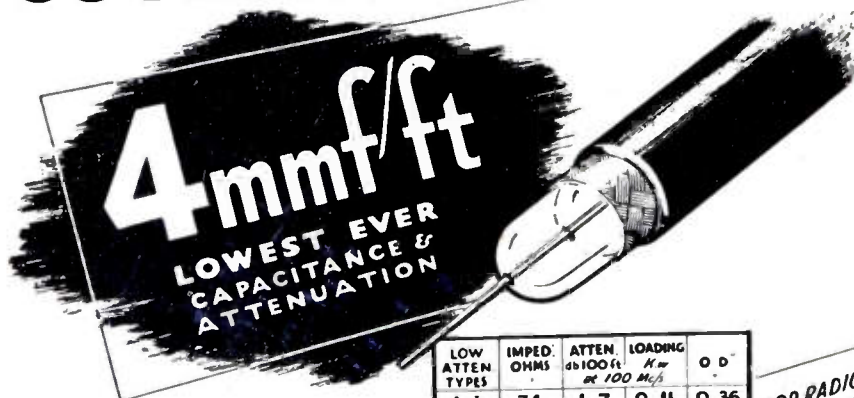

We are specially organized to handle direct enquiries from overseas and can give IMMEDIATE DELIVERIES to U.S.A.

Cable your rush order for delivery by air. Settlement in dollars by check on your own bank. Transaction as simple as any local purchase and delivery just as quick.

HIGH POWER FLEXIBLE

PHOTOCELL CABLE

VERY LOW CAPACITANCE CABLES

LOW ATTEN TYPES	IMPED. OHMS	ATTEN db/100ft at 100 Mc/s	LOADING K _{max}	α 0°
A.1	74	1.7	0.11	0.36
A.2	74	1.3	0.24	0.44
A.34	73	0.6	1.5	0.85

FOR RADIO FREQUENCIES

LOW CAPAC. TYPES	CAPAC. pF/ft	IMPED. OHMS	ATTEN db/100ft 100 Mc/s	α 0°
C.1	7.3	150	2.5	0.36
P.C.1	10.2	132	3.1	0.36
C.11	6.3	173	3.2	0.36
C.2	6.3	171	2.15	0.44
C.22	5.5	184	2.8	0.44
C.3	5.4	197	1.9	0.64
C.93	4.8	220	2.4	0.64
C.44	4.1	252	2.1	1.03

FOR VIDEO and SPECIAL APPLICATIONS

TRANSRADIO LTD
CONTRACTORS TO H.M. GOVERNMENT.

138A CROMWELL ROAD
LONDON S.W.7-ENGLAND

CABLES: TRANSRAD · LONDON



(Continued from page 48A)

- Allworth, J. C., 174 Nepean St., Suite 6, Ottawa, Ont., Canada
- Anderson, A. W., 419 East Joppa Rd., Towson 4, Md.
- Anderson, D. A., 3526 Addington Ave., Montreal, Que., Canada
- Anderson, A. E., 1054 34 St., N. E., Cedar Rapids, Iowa
- Anderson, G. W., 3011 Addison St., Chicago 18, Ill.
- An Wang, A., Computation Laboratory, Cambridge 38, Mass.
- Arndt, R. B., 132 Wayne Ave., Haddonfield, N. J.
- Aronoff, M., 901 73 St., Brooklyn 28, N. Y.
- Atkinson, E. E., 1110 N. Vernon St., Arlington, Va.
- Axelrod, A., 250 East 178 St., New York 57, N. Y.
- Bagby, C. K., Box 306, Fairborn, Ohio
- Bagnall, J. J., Jr., 1303 Chelton Ave., Philadelphia 26, Pa.
- Bailey, C. W., Jr., The Citadel, Charleston, S. C.
- Baker, J. H., Bldg. 13, Apt. 127, 251 Tenth St., N. W., Atlanta, Ga.
- Barlow, D. P., R. F. D. 1, Giffords Corners, Duaneburg, N. Y.
- Barney, K. H., 812 Colfax, Evanston, Ill.
- Barrie, W. H., c/o W. C. Barrie, R. F. D. 7, Galt, Ont., Canada
- Bartlett, O. H., Jr., 3402 Wilson Blvd., Arlington, Va.
- Barton, D. K., SCEL, WSPG, Las Cruces, N. Mex.
- Beane, T. E., 315 No. Filmore Ave., Scranton 4, Pa.
- Beauchamp, L. J., 427 Allen St., Syracuse 10, N. Y.
- Benner, B., 145 S. Maple Ave., Webster Groves 19, Mo.
- Berger, D., 3021 Brighton 13 St., Brooklyn, N. Y.
- Berry, F. G., 86 Gormley Ave., Toronto 12, Ont., Canada
- Bigda, F. J., 15 Gilmore St., Chicopee, Mass.
- Boire, P. C., Measurement Engineering Ltd., Arrprior, Ont., Canada
- Bonner, M. K., Harry W. Smith, Inc., 507 Fifth Ave., New York 17, N. Y.
- Bordewisch, J. F., 4001 East Third, Dayton 3, Ohio
- Bostrom, R. C., Ira Vail Apt., Bayville Rd., Locust Valley, L. I., N. Y.
- Bresett, C. K., CEC, U. S. Navy, 1507 NCB, c/o Fleet Post Office, San Francisco, Calif.
- Broen, J. H., Jr., 5955 S. W. Fourth St., Miami 44, Fla.
- Buchalter, M., 14 East 208 St., New York 67, N. Y.
- Byrd, E. W., 3529 Beachgrove Rd., Dayton 9, Ohio
- Carlson, P. N., 942 West 31 St., Erie, Pa.
- Casey, R. D., 5033 West 33 Ave., Denver, Colo.
- Chapman, C. M., c/o American Friends Service Comm., 8 Sharia Dar el Shifa, Garden City, Cairo, Egypt
- Church, M. E., R. F. D. 2, Uniontown, Ohio
- Colgin, J. R., 1770 Poplar Ave., Apt. 2, Memphis, Tenn.
- Coltin, A. H., R. F. D. 1, Box 358, Camarillo, Calif
- Comstock, A. M., 1404 Hampton Dr., Newport News, Va.
- Cooper, A. E., 2100 Shroyer Rd., Dayton 9, Ohio
- Cox, L. H., 806 Hill St., Ann Arbor, Mich.
- Cox, N. W., 49 Westover Rd., New Britain, Conn.
- Crane, R., 68 Forest Row, Great Neck, L. I., N. Y.
- Culbertson, C. H., 715 W. Wilkinson St., Goshen, Ind.
- Dale, E. H., 384 Provident Ave., Winnetka, Ill.
- D'Amico, S. P., 929 71 St., Brooklyn 28, N. Y.
- Deer, J. W., 1126 E. Lead Ave., Albuquerque, N. Mex.
- Dellenbaugh, F. S., III, 30 Alden Ave., New Haven 15, Conn.
- Dennis, J., 204 Bartlett Ave., Toronto, Ont., Canada
- Dethlefsen, D. G., 405 Lytton Ave., Apt. 1, Palo Alto, Calif.
- Dicker, P. E., Electrical Engineering Dept., Princeton University, Princeton, N. J.

(Continued on page 55A)

MEASUREMENTS CORPORATION MODEL 80 STANDARD SIGNAL GENERATOR



2 to 400 MEGACYCLES

MODULATION: Amplitude modulation is continuously variable from 0 to 30%, indicated by a meter on the panel. An internal 400 or 1000 cycle audio oscillator is provided. Modulation may also be applied from an external source. Pulse modulation may be applied to the oscillator from an external source through a special connector. Pulses of 1 microsecond can be obtained at higher carrier frequencies.

FREQUENCY ACCURACY $\pm .5\%$

OUTPUT VOLTAGE
0.1 to 100,000
microvolts

OUTPUT IMPEDANCE
50 ohms

MANUFACTURERS OF
Standard Signal Generators
Pulse Generators
FM Signal Generators
Square Wave Generators
Vacuum Tube Voltmeters
UHF Radio Noise & Field Strength Meters
Capacity Bridges
Megohm Meters
Phase Sequence Indicators
Television and FM Test Equipment

MEASUREMENTS CORPORATION

BOONTON NEW JERSEY

New

100 MC BANDWIDTH PULSE AMPLIFIER

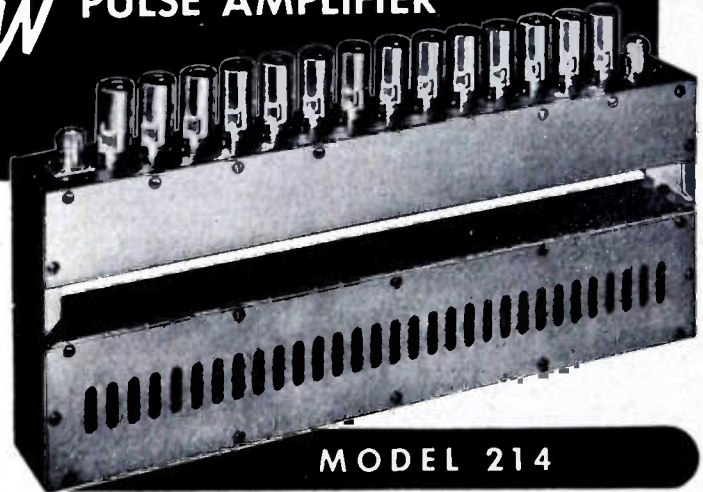

65 VOLTS
OUTPUT

RISE TIME
.006
USECS.

Supplied with
or without
Power Supply

MODEL 214

Specially designed to meet the demand for high output voltage and fast rise time, the — SKL — Model 214 Chain Pulse Amplifier has a band-width of 40 KC to 100 MC and a rise time of 0.006 microseconds. High gain — 30 db — and output — 65 volts — are available. A specially designed terminating cable allows connection to either deflection plate or control grid of cathode ray tubes. An input impedance of 200 ohms is provided so that the Series 200 Wide-Band Chain Amplifiers can be used where additional gain is required. Used together, the low level voltages encountered in radar, television, and nuclear physics can be displayed conveniently and accurately.

Write today for complete specifications.

SKL SPENCER-KENNEDY LABORATORIES, INC.
186 MASSACHUSETTS AVE., CAMBRIDGE 39, MASS.

RCA VICTOR Camden, N. J.

Requires Experienced Electronics Engineers

RCA's steady growth in the field of electronics results in attractive opportunities for electrical and mechanical engineers and physicists. Experienced engineers are finding the "right position" in the wide scope of RCA's activities. Equipment is being developed for the following applications: communications and navigational equipment for the aviation industry, mobile transmitters, microwave relay links, radar systems and components, and ultra high frequency test equipment.

These requirements represent permanent expansion in RCA Victor's Engineering Division at Camden, which will provide excellent opportunities for men of high caliber with appropriate training and experience.

If you meet these specifications, and if you are looking for a career which will open wide the door to the complete expression of your talents in the fields of electronics, write, giving full details to:

National Recruiting Division
Box 350, RCA Victor Division
Radio Corporation of America
Camden, New Jersey

Electronic Engineers

BENDIX RADIO DIVISION
Baltimore, Maryland
manufacturer of

RADIO AND RADAR EQUIPMENT

requires:

PROJECT ENGINEERS

Five or more years experience in the design and development, for production, of major components in radio and radar equipment.

ASSISTANT PROJECT ENGINEERS

Two or more years experience in the development, for production, of components in radio and radar equipment. Capable of designing components under supervision of project engineer.

Well equipped laboratories in modern radio plant . . . Excellent opportunity . . . advancement on individual merit.

Baltimore Has Adequate Housing

Arrangements will be made to contact personally all applicants who submit satisfactory resumes. Send resume to Mr. John Siena:

BENDIX RADIO DIVISION
BENDIX AVIATION CORPORATION
Baltimore 4, Maryland



The following positions of interest to I.R.E. members have been reported as open. Apply in writing, addressing reply to company mentioned or to Box No. . . .

The Institute reserves the right to refuse any announcement without giving a reason for the refusal.

PROCEEDINGS of the I.R.E.

1 East 79th St., New York 21, N.Y.

INSTRUCTOR

A small eastern college is in need of a young man with a Doctors degree who has an electronic background and is interested in teaching undergraduate and graduate work. Age 30 years or under. Write Box 589.

SALES ENGINEER

Good technical man with background in electrical, electronic and instrument fields. Sales experience necessary, and a reasonably good connection in the industrial electronic and instrument industry. Position involves sales and promotion of recognized line of industrial electronic components. State qualifications and salary requirements. Applicants located in New York area preferred. Box 590.

ENGINEER

Experienced engineer to supervise laboratory and production design work on antennas and transmission lines. A minimum of 3 years experience desired, preferably on antenna design, although this is not essential. Salary is open, depending on qualifications and experience. Location is Chicago. Write giving personnel information to Andrew Corporation, 363 East 75th Street, Chicago 19, Illinois.

ANTENNA ENGINEER

Graduate engineer one or more years experience in design and testing of airborne VHF antennas. Desirable California location, unusual opportunity for advancement. For application form write Box 394, Camarillo, California.

INSTRUCTOR

Wanted—radio and television instructor. No previous teaching experience necessary. State work experience and education. \$85.00 per week. Apply Tru-Way Radio & Television School, 231 Arch St., Nanticoke, Pennsylvania.

ELECTRICAL ENGINEER

Graduate electrical engineer from college of recognized standing. Must have majored in communications division of E.E. or be a graduate physicist with training in electronic and communications subjects. Must thoroughly understand principles underlying design and test of VHF radio transmitters and receivers. Must be familiar with all modern testing instruments for VHF communication. Experience in VHF receiver design important. Box 591.

(Continued on page 51A)

PHYSICISTS AND ENGINEERS

This expanding scientist-operated organization offers excellent opportunities to alert physicists and engineers who are interested in exploring new fields. We desire applicants with experience in the design of electronic circuits (either pulse or c. w.), computers, gyros, antennas, or precision mechanical instruments. A few openings for Junior Engineers and Technicians also exist. This company specializes in research and development work. Laboratories are located in suburbs of Washington, D.C.

JACOBS INSTRUMENT CO.

4718 Bethesda Ave.
Bethesda 14, Maryland

Senior Electronic Circuit Physicists

for advanced Research and
Development

Minimum Requirements:

1. M.S. or Ph.D. in Physics or E.E.
2. Not less than five years experience in advanced electronic circuit development with a record of accomplishment giving evidence of an unusual degree of ingenuity and ability in the field.
3. Minimum age 28 years.

HUGHES AIRCRAFT COMPANY

Attention: Mr. Jack Harwood
Culver City, California

POSITIONS OPEN

For SENIOR RESEARCH ENGINEERS AND PHYSICISTS

Established Electronic and Control Laboratory in the Los Angeles, California area, offers exceptional opportunities for Senior Engineers and Physicists having outstanding academic background and experience in the fields of:

- Microwave Techniques
- Moving Target Indication
- Servomechanisms
- Applied Physics
- Gyroscopic Equipment
- Optical Equipment
- Computers
- Pulse Techniques
- Radar
- Fire Control
- Circuit Analysis
- Autopilot Design
- Applied Mathematics
- Electronic Subminiaturization
- Instrument Design
- Automatic Production Equipment
- Test Equipment
- Electronic Design
- Flight Test Instrumentation

Salaries commensurate with ability, experience and background. Working conditions and opportunities for advancement are excellent. Send information as to age, education, experience and work preference to:

NORTH AMERICAN AVIATION, INC.

Aerophysics Laboratory
Box No. N3
12214 South Lakewood Blvd.
Downey, California

PHOSPHOR RESEARCH

WESTINGHOUSE RESEARCH Laboratories in East Pittsburgh, Pa., has immediate need for a Scientist with experience or training in preparation of cathode-luminescent materials for basic research in connection with color Television. For applications write

Manager, Technical Employment, Westinghouse Electric Corporation, 306 Fourth Avenue, Pittsburgh 30, Pa.



(Continued from page 50A)

ENGINEER

Graduate E.E.—prefer electronics or servos major. 3 to 5 years development laboratory experience in pulse electronics, servos or electronic computers. 25 to 30 years. Location, New York City. Salary up to \$5,000. Box 593.

TELEVISION ENGINEERS

Television Engineering Department requires the services of 5 project engineers for advance circuit development and product design for television receivers. These vacancies are the result of the ever-expanding television activities in this department. Company is a major producer of finer television receivers and is well established. Company is located in northwestern New York State. Opportunities of advancement are excellent. Salaries commensurate with experience. Our employees know of this ad. Box 594.

ENGINEERS

Several engineers needed by contractor for work at Naval Air Missile Test Center 50 miles northwest of Los Angeles. College degree and several years experience essential. Radar, computer, or telemetering experience preferable. Contact Electronic Engineering Co. of California, 2008 West Seventh St., Los Angeles 5, Calif.

ENGINEERING PHYSICIST OR SPECIALIST

For research and development work on cracked carbon resistors. Men with some experience preferred. Progressive mid-western manufacturing concern. Give full data as to experience and schooling. Box 597.

ENGINEERS AND PHYSICISTS

Engineers and physicists, age 25-40, with experience in navigational and fire control instrumentation or related equipment involving a combination of electronics and electro-mechanical devices. Client is progressive well-established precision instrument manufacturer with design, development and product engineering opportunities. Electrical engineers or physicists with strong electrical and mathematical ability desired. Starting salaries \$6,000-\$8,000. Metropolitan New York area. Box 600.



BUY BONDS TODAY!

Top Calibre—Experienced

PHYSICISTS and ENGINEERS

(Doctor's and Master's Degrees Preferred; Advanced Training and Experience Necessary)

Required by

BELL AIRCRAFT CORPORATION

Buffalo, New York

for rapidly expanding projects in

ELECTRONICS SERVOMECHANISMS and GUIDED MISSILES

to perform advanced Mechanical and Electrical Research and Development work in the fields of

General Electronics
Radar—all branches
Servomechanisms
Autopilots and Gyroscopes
Precision Mechanical Devices
Applied Physics and Mathematics
Electrical and Mechanical Systems

Salary commensurate with ability to produce results. Inquire for Bell representatives at Hotel Commodore during I.R.E. Convention March 6 to 9, or write for application to Manager, Engineering Personnel, Bell Aircraft Corporation, P.O. Box 1, Buffalo 5, N.Y.

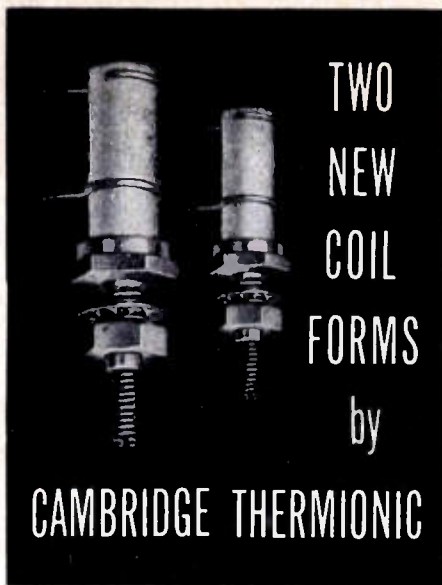

These two new slug tuned coil forms by Cambridge Thermionic Corporation are designed to give you top performance while fitting easily into small or hard-to-reach places. Illustrations are actual size.

Both have silicone impregnated ceramic bodies, grade L-5, JAN-I-10 for high resistance to moisture and fungi. Ring terminals are adjustable. Both sizes are provided with a spring lock for the slug, and the mounting stud is cadmium plated to withstand severe service conditions.

The LS-5 and LS-6 are available with high, medium or low frequency slugs. Mounting hardware is supplied.

Ask for CTC's new Catalog #300 describing our complete line of *Guaranteed Components*.

See us at Booth 287 at the IRE Exposition, Grand Central Palace, March 6-9. Our representatives will be glad to discuss problems concerning electronic components with you.

**Custom or Standard
The Guaranteed
Components**

CAMBRIDGE THERMIONIC CORP.
456 Concord Ave., Cambridge 38, Mass.



Positions Wanted By Armed Forces Veterans

In order to give a reasonably equal opportunity to all applicants, and to avoid overcrowding of the corresponding column, the following rules have been adopted:

The Institute publishes free of charge notices of positions wanted by I.R.E. members who are now in the Service or have received an honorable discharge. Such notices should not have more than five lines. They may be inserted only after a lapse of one month or more following a previous insertion and the maximum number of insertions is three per year. The Institute necessarily reserves the right to decline any announcement without assignment of reason.

RADIO ENGINEER

B.E.E. 1947, Polytechnic Institute of Brooklyn, Eta Kappa Nu. Age 24, single. Two years radio and radar tests and installations, 2 years Navy electronics, teaching experience. FCC license radio-telephone 1st class. Desires sales or electronic development. Will travel. Box 366 W.

ENGINEER

B.E.E. December 1949, Georgia Institute of Technology. Communications major. Age 25, married. Former Air Force pilot. Dependable, conscientious. Desires position with future in electronics or television. Box 367.

ELECTRONIC ENGINEER

B.E.E. June 1948. Age 25. Married. 18 credits toward M.Sc. in mathematics. Electronic engineer in Government component testing laboratory since July 1948. 2½ years Army communications experience. Interested in sales or production of electronic equipment. Pleasing personality. Box 368 W.

ELECTRONIC ENGINEER

Electronic engineer, M.E.E. 2 years research and development experience in servomechanisms electronics and radar technique plus laboratory instruction in electrical engineering and Navy radar experience. Top scholastic record, Tau Beta Pi, Eta Kappa Nu. Box 369 W.

ENGINEER

B.S.E.E. June 1948 and M.S.E.E., communications option, August 1949. Purdue University. Age 26. Single. Desires position in design and development of radio or television equipment. Box 371 W.

RADIO ENGINEER

B.S. in radio engineering, December 1949. Tri-State College and Valparaiso Technical Institute. Age 25. Married, no children. Desires position in research or product engineering in electronics or television. 2 years experience as aircraft electrician in Air Forces. Will consider position anywhere. Box 372 W.

(Continued on page 53A)

OPPORTUNITY FOR TELEVISION ENGINEERS

Senior Development Engineer

Man, experienced in commercial design, wanted to supervise development of new receivers for important manufacturer of quality instruments. Must have strong academic and theoretical background.

Junior Television Engineers

Men with practical experience and good academic background.

Write today, furnishing complete details including salary required, to Director of Research & Development

FREED RADIO CORPORATION

200 Hudson Street, N.Y. 13, N.Y.

PROJECT ENGINEERS

Real opportunities exist for Graduate Engineers with design and development experience in any of the following: Servomechanisms, radar, microwave techniques, microwave antenna design, communications equipment, electron optics, pulse transformers, fractional h.p. motors.

SEND COMPLETE RESUME TO
EMPLOYMENT OFFICE.

SPERRY GYROSCOPE CO.

DIVISION OF
THE SPERRY CORP.
GREAT NECK, LONG ISLAND

Positions Wanted

(Continued from page 52A)

ELECTRONICS ENGINEER

Electronics engineer, age 30. B.S. and graduate work. 8 years experience in the design of automatic control, telemetering, and data recording devices. Thorough knowledge of power line communications. In mid-west at present, free to move anywhere. Box 373 W.

ELECTRONIC ENGINEER

Summer employment. Contact in field of electronics, nucleonics or atomics by physics professor. B.S. and M.S. in physics, radar and proximity fuse experience. Applicable practical work for modern physics perspective desired. Box 375 W.

ELECTRONIC TECHNICIAN

Graduate Navy Aviation Electronics school. Desires position in laboratory or broadcast—television station. 1st class radiotelephone license. Experienced in radar, audio and broadcast station operation. Single. Age 21. Box 376 W.

ENGINEER

B.S. University of California at Los Angeles, communications major. January 1949. Married. Technician experience, Air Force instrument mechanic. Good mathematical background, teaching experience. Some experience with automatic control circuits. Location no object. Box 378 W.

PATENT CLERK—TECHNICAL WRITER

B.E.E. June 1948, New York University. Age 28. Married. Presently enrolled evenings in Brooklyn law school for law degree LL.B. in 1951. 1 year technical writing for Navy, 2 years Electronic Technician, and 6 months Army Signal Corps maintenance. 1st class radio-telephone FCC license. Desires permanent position in east with opportunity for advancement. Salary secondary. Resumé on request. Box 379 W.

ENGINEER

M.S.E.E. Purdue, Tau Beta Pi, Sigma Xi. One year experience in circuitry involving pulse techniques. Desires position in development or design. Box 391 W.

ENGINEERING LAW

B.S.E.E. June 1944, Purdue University. Now in second year of Law at University of Notre Dame. 14 months at Oak Ridge, Tenn., doing electronic and high vacuum work while in Army. Other experience. Single. Age 26. Desires position for summer of 1950. Box 392 W.

ELECTRONIC ENGINEER

M.E.E. Jan. 1950, Polytechnic Institute of Brooklyn. B.E.E. Cooper Union. Age 25. Graduate school fellowship. N.Y. State Regents scholarship. 2 years as electronic technician U.S.N. 1½ years design and development of radar receivers and microwave components. Prefer position in vicinity of New York City. Box 393 W.

ELECTRICAL ENGINEER

Electrical Engineer, graduated ninth in class. Former Navy Electronic Technician. Desires development work in New York City or New Jersey. Salary secondary. Box 394 W.

(Continued on page 54A)

NEW BUD PRODUCTS

For BETTER PERFORMANCE
For GREATER UTILITY

• BUD MINIBOXES



There are thousands of uses in the fields of radio and electronics for these new boxes. They are made from heavy gauge aluminum. The design of the box permits installation of more components than the conventionally designed box of the same size. It is of two piece construction, each half forming three sides. The flange type construction assures adequate shielding. Available in etched aluminum finish and gray hammerloid finish.

would be possible in the conventionally designed box of the same size. It is of two piece construction, each half forming three sides. The flange type construction assures adequate shielding. Available in etched aluminum finish and gray hammerloid finish.

Catalog Number	Numbers	Length	Width	Height	Dealer Cost
CU-2100	CU-3000	2½"	2½"	1½"	.50
CU-2101	CU-3001	3½"	2½"	1½"	.50
CU-2102	CU-3002	4"	2½"	1½"	.50
CU-2103	CU-3003	4"	2½"	2½"	.70
CU-2104	CU-3004	5"	2½"	2½"	.72
CU-2105	CU-3005	5"	4"	3"	.72
CU-2106	CU-3006	5½"	3"	2½"	.72
CU-2107	CU-3007	6"	5"	4"	.81
CU-2108	CU-3008	7"	6"	3"	1.05
CU-2109	CU-3009	8"	6"	3½"	1.68
CU-2110	CU-3010	10"	6"	3½"	1.80
CU-2111	CU-3011	12"	7"	4"	2.34
CU-2112	CU-3012	17"	5"	4"	2.76

Prices 10% higher west of the Mississippi River



• BUD ALUMINUM CHASSIS

The construction and design of these chassis is exactly the same as our steel chassis. The aluminum chassis are welded on government approved spot welders that are the same as used in the welding of aluminum airplane parts. The gauges in the table below are aluminum gauges. As a result you can depend on BUD Aluminum Chassis to do a perfect job. Etched aluminum finish. NEW ADDITIONS TO THIS LINE ARE MARKED WITH AN ASTERISK.

Catalog Number	Depth	Width	Height	Gauge	Dealer Cost	Catalog Number	Depth	Width	Height	Gauge	Dealer Cost
*AC-430	4"	6"	3"	18	\$.78	AC-424	8"	12"	3"	16	\$1.38
*AC-431	4"	6"	3"	18	.78	AC-425	8"	17"	2"	16	1.52
*AC-432	4"	17"	3"	16	1.43	AC-412	8"	17"	3"	16	1.77
*AC-429	5"	7"	3"	18	.89	AC-413	10"	12"	3"	16	1.44
*AC-403	5"	9½"	2"	18	.81	AC-414	10"	14"	3"	16	1.92
AC-421	5"	9½"	3"	18	.89	AC-415	10"	17"	2"	16	1.80
AC-404	5"	10½"	3"	18	.89	AC-416	10"	17"	3"	16	2.04
*AC-422	5"	13"	3"	18	.98	AC-426	11"	17"	2"	14	1.89
*AC-433	6"	17"	3"	16	1.44	AC-428	11"	17"	3"	14	2.40
AC-405	7"	7"	2"	18	.81	AC-417	11"	17"	3"	14	2.52
AC-406	7"	9"	2"	18	.80	AC-418	12"	17"	3"	14	2.25
AC-407	7"	11"	2"	18	.86	AC-419	13"	17"	3"	14	2.67
AC-408	7"	12"	3"	18	1.14	AC-420	13"	17"	3"	14	2.87
AC-409	7"	13"	2"	18	1.02	AC-427	10"	17"	4"	14	2.36
AC-411	7"	15"	3"	16	1.68	AC-428	13"	17"	4"	14	3.05
AC-423	7"	17"	2"	16	1.43						

Prices 10% higher west of the Mississippi River



BUD RADIO, INC.

2110 EAST 55TH STREET

CLEVELAND 3, OHIO

Pioneer in Radio Engineering Instruction Since 1927

CAPITOL RADIO

ENGINEERING INSTITUTE

An Accredited Technical Institute

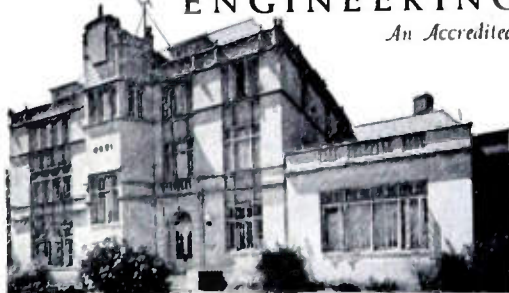

ADVANCED HOME STUDY AND RESIDENCE COURSES IN PRACTICAL RADIO-ELECTRONICS AND TELEVISION ENGINEERING

Request your free home study or resident school catalog by writing to:

DEPT. 263B
16th and PARK ROAD, N.W.
WASHINGTON 10, D.C.

Approved for Veteran Training

Positions Wanted

(Continued from page 53A)

COMMUNICATIONS ENGINEER

B.E.E. 1947 Polytechnic Institute of
gust 1949, Eta Kappa Nu, Sigma Pi
Sigma. Age 24, married. 2 years AAF
Radio Maintenance. Desires communica-
tions or electronic work anywhere in U.S.
Box 395 W.

PHYSICIST

M.A. Columbia 1949, Physics; B.S. Yale
1943, Chemistry, highest honors; Phi Beta
Kappa, Sigma Xi. 2½ years Atomic Bomb
Project; 1½ years Graduate Assistant.
Desires work not exclusively in laboratory
using my fundamental background. Box
396 W.

ELECTRICAL ENGINEER

Graduate University of Illinois, Febru-
ary 1950. Majored in electronics and com-
munications. Prefers position in New York
or New Jersey area. 5 years Army expe-
rience with Anti-Aircraft equipment in-
cluding radar. Engineered a wired-wire-
less radio station in Champaign, Illinois.
Box 397 W.

JUNIOR ENGINEER

B.E.E. Cooper Union, June 1949, elec-
tronics option. Age 26. 6 months of radio
test experience. 1 year drafting experience.
Studying for M.S.E.E. evenings. Looking
hard for a real job. New York City pre-
ferred. Box 398 W.

JUNIOR ENGINEER

B.E.E., Top third New York University,
communications major. Graduate work in
Administrative engineering. Some experi-
ence in design. Excellent references. FCC
1st class phone I.t. Army Signal Corps.
Will take graduate work in your field.
Relocate permanently anywhere in U.S.
Single. Salary secondary to future. Box
399 W.

ELECTRICAL ENGINEER

B.S.E.E. University of Illinois, 1946.
Electrical officer in U.S. Navy, 2 years
aeronautical instrument development. Age
24, single. Desires development engineer-
ing position in northeast. Box 400 W.

ENGINEER

B.S.E.E., M.S.E.E., completion of aca-
demic work for Ph.D. in June 1950; Sigma
Xi, Sigma Pi Sigma. Age 25. Class A
Amateur license 10 years, 1st class Radio-
telephone license 5 years, intermittent AM
and FM experience; 1 year teaching; 1
year microwave research. Interested in
microwave circuitry or antenna research
which will lead to thesis credit. Available
June 1950. Box 401 W.

ENGINEER

B.M.E. June 1948. 4½ years Air Forces
electronics and R.C.M. officer, 2 years
telemetering weapons, 1½ years electro-
mechanical instrumentation in medical field
at leading eastern university. Desires suit-
able position in industry in or near Balti-
more, Md. Married, age 29. Box 402 W.

ELECTRONICS ENGINEER TEACHER

B.S.E.E. Illinois; M.S.E. Michigan. De-
sires position teaching or in development
work with opportunity to work on Ph.D.
1 year experience in radar development,
3 years Assistant Professor of Electrical
Engineering. Served as Electronics Main-
tenance Officer in U.S. Navy. Married,
family. Box 403 W.

(Continued on page 55A)

**Portable Precision
for the
Field Engineer!**

**CONFORMS TO ALL REQUIREMENTS
OF C63.2 RADIO NOISE METER
SPECIFICATION ADOPTED
BY AMERICAN STANDARDS
ASSOCIATION, OCTOBER 26, 1949**



**STODDART NM-20A
RADIO INTERFERENCE
AND
FIELD INTENSITY
METER**

- A portable unit that you can **DEPEND** upon!
- Measures **FIELD INTENSITIES** of radio signals and r.f. disturbances using either a rod antenna or a rotatable loop antenna.
- **CONTINUOUS RANGE** 150 kc to 25 mc.
- **ONE MICROVOLT SENSITIVITY** as a two-terminal voltmeter; 2 microvolts-per-meter using rod antenna.
- Operates from self-contained dry bat-teries or external A.C. power unit.

Write for complete technical data

STODDART AIRCRAFT RADIO CO.

Main office and plant:

6644 SANTA MONICA BLVD., HOLLYWOOD '38, CALIF., Phone: Hillside 9294

**New Type 2A TAP SWITCHES
HAVE A CONSTANT CONTACT RESISTANCE OF
ONLY 1 or 2 MILLIOHMS!**

These high quality switches with up to 24 contacts were specifically developed to meet the need for rugged precision instrument switches that have longer operating life and are economical components in competitively priced electronic instruments and military equipment.

Write for Technical
Bulletin No. 28.

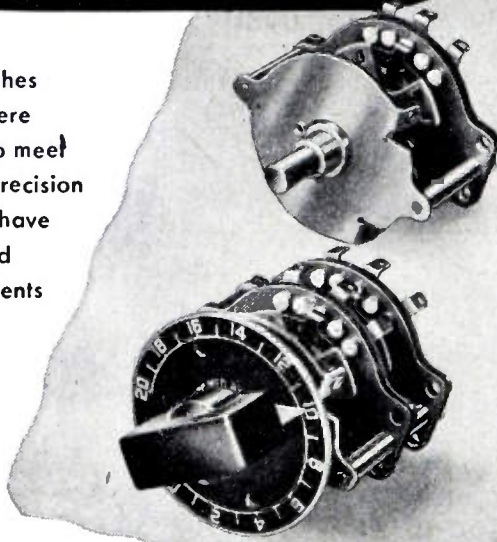

TECH LABORATORIES PALISADES PARK
NEW JERSEY

CANNON PLUGS

Quality
in Every
Part

"AN" SERIES

EXPLODED VIEW

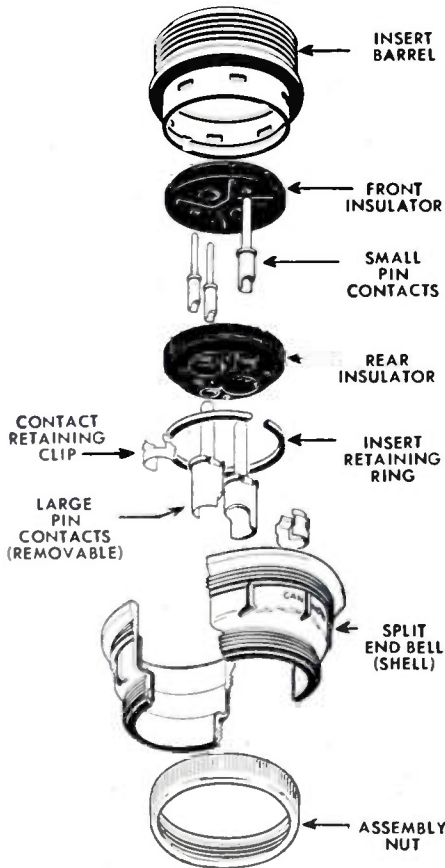

TYPE AN3101B
CABLE CONNECTING RECEPTACLE



One of six shell types in the "AN" line: AN3100A, AN3102A, AN3106B, AN3107B, AN3108B.

Cannon Electric Development Company, Division of Cannon Manufacturing Corporation, 3209 Humholdt St., Los Angeles 31, California. Canadian factory: Toronto. World Export: Frazer & Hansen, San Francisco, New York, Los Angeles.

SINCE 1915
CANNON ELECTRIC

Positions Wanted

(Continued from page 54A)

ENGINEER

B.S.E.E. New York University, M.S.E.E. Northwestern 1948, Eta Kappa Nu. Age 25, married. Experience: Army, 1½ years Pulse Code Modulation; 2 years teaching communications at Polytechnic Institute of Brooklyn. Interested in micro-waves, UHF, antennas. Box 404 W.



(Continued from page 49A)

Dickman, A., 1334 Ft. Stevens Dr., N. W., Washington 11, D. C.

Drilling, N. G., 716 Middle Dr., Woodruff Pl., Indianapolis 1, Ind.

Engert, G. W., 41 B Ivy Lane, Bergenfield, N. J.
Felmors, R. S., 76 Corbett Ave., Toronto, Ont., Canada

Fivel, M. J., 3-D Suburban Circle, Portsmouth, Va
Flato, M., 8519 Milford Ave., Silver Spring, Md

Floyd, R. A., Jr., 211 W. University Ave., Champaign, Ill.

Ford, J. R., 922 Clark Pl., El Cerrito, Calif.

Foundas, G. J., 191 Lake St., Boston 35, Mass

Freedman, R. H., 1355 E. Seventh St., Brooklyn 30, N. Y.

Freeland, T., Box 296, Greentown, Ind.

Friedman, D., 42-17 Saull St., Flushing, L. I., N. Y.

Frisch, E. S., 201 Clinton Ave., Brooklyn 5, N. Y.

Gegenheimer, R. F., 44 Norwood Ave., Irvington 11, N. Y.

(Continued on page 56A)

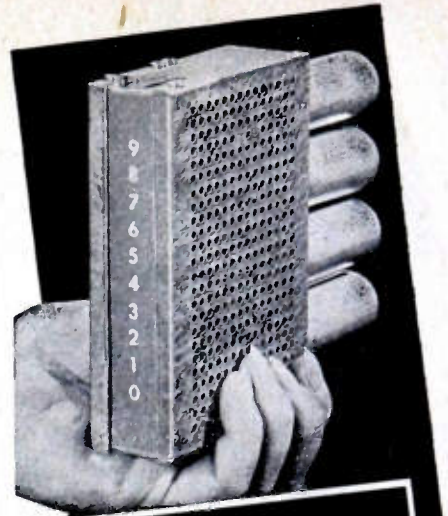

THE NEW
BERKELEY
MODEL 700
DECIMAL COUNTING UNIT

This unique packaged component is easily built into your apparatus. It has true decimal reading, and simple binary circuit with reliable automatic interpolation. Miniature size. Moderate price. Immediate shipment.

Send for Bulletin DCU-116

Berkeley Scientific Company

SIXTH AND NEVIN AVE • RICHMOND, CALIFORNIA

SYNTHESIS

IS A HIGH CLASS WORD
FOR DESIGNING
SERVO MECHANISMS



... SERVOSCOPE IS A HIGH CLASS INSTRUMENT FOR SERVO SYNTHESIS!

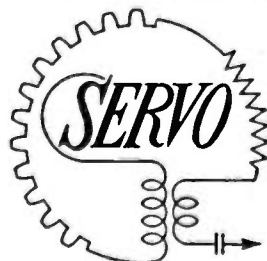

Write for
Information

MEASURES amplitude & phase vs. frequency
CARRIERS accepted, 50 to 800 cps
MODULATES chosen carrier, 0.1 to 20 cps
ANALYZES D.C. or A.C. automatic controls
SUB-AUDIO sine generator, 0.1 to 20 cps
SQUARE WAVE generator, 0.1 to 20 cps
PHASE READING to 1° accuracy, 2 methods
LINEAR SWEEP for external use, 0.1 to 20 cps

SERVO CORP. OF AMERICA

NEW HYDE PARK, N. Y.

TEN BILLIONTHS OF A VOLT FULL SCALE

MODEL 33 SUPERSENSITIVE AMPLIFIERS

COMPACT—Insensitive to electrical and mechanical disturbances—Low internal noise level—High selectivity—Tunable from 9 to 11 cycles—One cycle band-width—Complete AC operation.

Model 33A for high impedance circuits (full scale 1.0 micro-volt). Ideal for photocells.



Model 33B for low impedance inputs (10 to 50 ohms standard, other ranges also available). For thermocouples and low-resistance bolometers. 0.01 μ volt full scale.

These amplifiers may be used to great advantage in 10-volt measuring circuits, and in control and recording networks, replacing DC bridges and amplifiers.

For optical work the EMR Model 35A Chopper is convenient for modulating the received radiation.

PRICES

Model 33A and 33B \$390.00
Model 35A Chopper 65.00



ELECTRO-MECHANICAL RESEARCH, INC.
Ridgefield, Conn.



(Continued from page 55A)

- Geisa, G. K., 48 Shepard Ave., East Orange, N. J.
Gere, A. J., 1836-A Tenth St., Santa Monica, Calif.
Goldich, N. H., 159 Bala Ave., Bala-Cynwyd, Pa.
Goldsmith, A. S., 4760 Matilda Ave., New York 66, N. Y.
Gordon, R. T., 7 Fredonia Ave., Lynchburg, Va.
Gore, E. M., 222 Rosalind Ave., Gloucester, N. J.
Griffith, W. A., 822 Steward, Jackson, Mich.
Grimmett, C. A., 924 Mac Vicar Ave., Topeka, Kans.
Grobowski, Z. V., c/o E. Anthony & Sons, Box 912, New Bedford, Mass.
Hammond, C. K., 1412 W. Nora, Spokane, Wash.
Harnack, W. P., 51 Villard Ave., Hastings-on-Hudson, N. Y.
Haskins, D. E., Southern Methodist University, Box 725, Dallas, Tex.
Hawkins, E. M., 672 Cypress Ave., Panama City, Fla.
Heider, W. H., Jr., R.F.D. 2, Box 200, Albuquerque, N. Mex.
Hellerman, H., 1110 Teall Ave., Syracuse, N. Y.
Hinkle, J. E., 290 Caldwell St., Chillicothe, Ohio
Hollandbeck, R. F., Electrical & Nuclear Physics Dept., Westinghouse Research Laboratory, Ardmore Blvd., East Pittsburgh, Pa.
Hollander, A. G., H. Bourbon, Ind.
Hollister, D. G., 24 Berkshire Rd., Great Neck, L. I., N. Y.
Horton, A. B., Jr., 123 W. Winspear Ave., Buffalo 14, N. Y.
Houpis, C. H., 12901 Kelly Rd., Detroit 24, Mich.
Howard, D. D., 4301 S. Capitol Ter., S. W., Washington 20, D. C.
Jagoe, R. W., 94 Maple Ave., Seacliff, L. I., N. Y.
Jayne, A. W., 385 Shawmut Ave., Boston 18, Mass.
Jelinek, G. S., 3324 North 53 St., Omaha, Nebr.
Jenkins, E. W., Jr., 314 Iowa St., Alice, Tex.
Julie, L., 549 Riverside Dr., New York 27, N. Y.
Juviler, P. H., 441 West End Ave., New York 24, N. Y.
Kalman, J., Zenith Radio Corp., c/o Transmitting Room, 6001 Dickens Ave., Chicago 39, Ill.
Kaplan, J., 1648 64 St., Brooklyn 4, N. Y.
Kardauskas, E., 201 West 16 St., Linden, N. J.
Keesler, E. F., 21 Shepard St., Cambridge, Mass.
Kent, J. S., 2501 East 22 St., Brooklyn 29, N. Y.
Kocan, J., 58 Bradford, Ave., Little Falls, N. J.
Konrad, L. J., 117 Fairmount Ave., Philadelphia 23, Pa.
Kroencke, E. A., Jr., 104 East 81 St., Kansas City 5, Mo.
Kruse, L. C., 14 Beech Tree Lane, Pelham 65, N. Y.
Kuck, G. P., 9006 180 St., Jamaica 3, N. Y.
Lampl, S., 3511 Davenport St., N. W., Apt. 104, Washington 8, D. C.
Larsen, H. F., 238 Sandercock, San Luis Obispo, Calif.
Lasby, R. O., Parkway Apts., 85-D, Munn Ave., Haddonfield, N. J.
Latson, F. W., 67-52 230 St., Oakland Gardens, Bayside, L. I., N. Y.
Linker, J. B., Jr., Box 654, Chapel Hill, N. C.
Linne, E. R., 12 Englebart Dr., Schenectady 2, N. Y.
Lorence, E. L., 515 West 29 St., Lorain, Ohio
Lyon, D. J., 4534 1/2 Canal St., New Orleans, La.
Lyons, L. H., 4719 21 Ave., N. E., Seattle 5, Wash.
Mackenstadt, R. A., E. 3811 Sixth Ave., Spokane 15, Wash.
MacLean, W. D., 4637 El Campo, Fort Worth 7, Tex.
Majerus, J. B., 1026 S. Fourth St., Aurora, Ill.
Majorowicz, G. A., 1828 East 76 St., Ter., Kansas City 5, Mo.
Marsh, R. F., 72 Pine St., North Amherst, Mass.
McMahon, J. P., 3607 W. 60 Pl., Chicago 29, Ill.
McRuer, D. T., 3309 West 73 St., Los Angeles 43, Calif.
McWhorter, W. F., 1236 N. Oakland Ave., Indianapolis 1, Ind.

(Continued on page 57A)

KENYON Fits Your Production To A "T"



KENYON "T's"—high quality, uniform transformers, are your best bet for development, production and experimental work. For over 20 years, the KENYON "K" has been a sign of skillful engineering, progressive design and sound construction.

Now—reduce inventory problems, improve deliveries, maintain your quality—specify KENYON "T's," the finest transformer line for all high quality equipment applications.

New Catalog Edition! Write Today!

KENYON new modified edition tells the complete story about specific ratings on all transformers. Our standard line saves you time and expense.

Send for your copy of our latest catalog edition now!

KENYON TRANSFORMER CO., Inc.
840 BARRY STREET · NEW YORK 59, N. Y.



(Continued from page 56A)

- Miller, A. H., 5853 Logan Ave., S., Minneapolis 19, Minn.
- Miller, S. W., Stanford Research Institute, Menlo Park, Calif.
- Moore, M. H., R. F. D. 2, Box 27, Oxnard, Calif.
- Moulton, C. H., R. F. D. 2, Box 556, Portland 10, Ore.
- Noland, A. R., 467 Lincoln Ave., Orange, N. J.
- Norsell, H. C., 613 N. Keystone Ave., Indianapolis 1, Ind.
- Nymberg, R. J., 9111 Annapolis, Detroit 4, Mich.
- O'Brien, J. A., 4009 19 Ave., S., Minneapolis 7, Minn.
- Ocnaschek, F. J., 1410 South 14 Ave., Maywood, Ill.
- Oderkirk, M. D., 202-5704 16 Ave., Hyattsville, Md.
- Ogg, W. M., Jr., 901 Baldwin Rd., Richmond 26, Va.
- Olson, D. L., 1821 25 Ave., N., Seattle 2, Wash.
- Olson, W. J., R. F. D. 4, Elkhart, Ind.
- Ornstein, W., 750 Bloomfield Ave., Outremont, Que., Canada
- Paddon, E. A., 8 Frontenac, Clayton 24, Mo.
- Paley, A. I., 6 Buttercup Lane, Levittown, L. I., N. Y.
- Peterson, R. E., 167 Fifth Ave., North Troy, N. Y.
- Pickrell, R. L., Jr., 107 Cagle St., Clinton, Tenn.
- Pickus, M. L., 104 E. Fourth St., New York 3, N. Y.
- Plamjack, H. J., 2274 Strauss St., Brooklyn 12, N. Y. (July 1, 1949)
- Poorte, G. E., 6 Walter Ter., Somerville 45, Mass.
- Pottebaum, R. J., 1606 Dauner Ave., Cincinnati 7, Ohio
- Powers, W. D., 429 East 20 St., Anniston, Ala.
- Prince, M. D., 8 Shenandoah Ave., N. E., Atlanta, Ga.
- Quate, C. F., R. F. D. 2, Box 437, Los Altos, Calif.
- Queen, J. L., 8801 Greentree Rd., Bethesda 14, Md.
- Reader, M., 616 Nostrand Ave., Brooklyn 16, N. Y.
- Reed, D. N., c/o Radio Station KPRS, Olathe, Kans.
- Reeve, R. C., 8641 Harms Rd., Skokie, Ill.
- Reickord, A. W., 318 Duke, Alexandria, Va.
- Rett, H. C., 81 Beauparc Dr., Akron 3, Ohio
- Richardson, G. E., 157 Broadway Ave., Toronto 12, Ont., Canada
- Rizzo, J. E., 1327 Croes Ave., New York 60, N. Y.
- Robinson, R. B., 3226 Fuhrman Ave., Seattle 2, Wash.
- Roedel, J., 1518 25 Ave., S., Seattle 44, Wash.
- Sakonyi, F. W., Box 712, Orient, Ill.
- Sampson, G. L., 450 Avenue 64, Pasadena 2, Calif.
- Sander, M. H., 4525 West 111 St., Inglewood, Calif.
- Schaffner, G., 5248 Drexel Ave., Chicago 15, Ill.
- Scharding, R. M., 5943 S. Green St., Chicago 21, Ill.
- Scharla-Nielsen, H., 1523 State St., Schenectady, N. Y.
- Schmidt, F. J., 2987 Perry Ave., New York 58, N. Y.
- Schneider, R. J., 7029 Pine Ave., Niagara Falls, N. Y.
- Schulman, M., 4068 1/2 Iowa St., San Diego 4, Calif.
- Selender, H., 738 Howard Ave., Brooklyn 12, N. Y.
- Shallon, S. C., 528 First Ave., N. W., Cedar Rapids, Iowa
- Shapiro, C. M., 87 Wolcott St., Malden 48, Mass.
- Sheetz, J. I., Midland Moor, Mentor, Ohio
- Shulman, J., 600 Logan St., Brooklyn 8, N. Y.
- Sferrazza, P. J., 41 Needle Lane, Levittown, Hicksville, L. I., N. Y.
- Sheppard, R. D. B., 332 Hillcrest Ave., Lansing, Ont., Canada
- Sixbey, S. R., 990 Pacific St., Lindenhurst, L. I., N. Y.
- Skene, R. A., Box 104, Sparta, N. J.
- Slack, R. W., 728 Kinnaird Ave., Fort Wayne 6, Ind.
- Smith, G. W., 10324 119 St., Edmonton, Alta., Canada
- Smith, G. E., Electrical Engineering Dept., University of Kentucky, Lexington, Ky.
- Smith, W. A., 56 Pierce St., Milton 86, Mass.

(Continued on page 60A)

IT'S KINGS FOR CONNECTORS

Pictured here are some of the more widely used R. F. co-axial, U. H. F. and Pulse connectors. They are all Precision-made and Pressurized when required. Over 300 types available, most of them in stock.



Backed by the name KINGS—the leader in the manufacture of co-axial connectors. Write for illustrated catalogs, Department "T"



811 LEXINGTON AVE., BROOKLYN 21, N. Y.

Manufacturers of Radar, Whip, and Aircraft antennas
Microphone Plugs and Jacks.
Radar Assemblies, Cable Assemblies, Microwave and
Special Electronic Equipment

Look It Up In Your IRE Yearbook Use Its Engineering Products Listings!

R. F. COMPONENTS - MICROWAVE - TEST EQUIPMENT

 10 cm. horn and rotating joint assembly, gold plated \$65.00 ea.
ROTARY JOINT choke to choke \$17.50
ROTARY JOINT choke to choke with clock mounting \$17.50

BC 987A PPI, 12" Indicator Console w/additional, A Scope 10" 988B Compl/w/all Pwr Sply One, Control Unit, desk shelf \$350.00
12 GPT Tubes for above \$14.95

TR-ATR Section for above with 724 ATR Cavity \$8.50
TR-ATR Section, APS 15, for 11B24, with 724 ATR Cavity with 11B24 and 724 tubes, Complete \$21.00
TR CAVITY for 724 A Tube \$3.50

RADAR BEACONS

CPN-3 10 cm. Used \$1500.00
CPN-8 10 cm. Used \$1500.00
CXBR (3 cm.) CPN-6 Prototype \$1500.00

 **APS-31 mixer section for mounting two 2K25's, Beacon reference cavity, 11B24 TR tube, New and complete with attenuating slugs \$42.50 ea.**
DUPLXER SECTION for 11B24 \$10.00

AIRBORNE RADAR

APS-4 3 cm Compl, Write
APS-15 All Major Components \$500.00
APS-3 New & Complete \$750.00

3 cm 180° bend with pressurizing nipple \$6.00 ea.
3 cm, 90 bend, 14" long 90° twist with pressurizing nipple \$6.00 ea.

THERMISTOR BRIDGE: Power meter 1-203-A, 10 cm. infg, W.E. Complete with meter, interpolation chart, portable carrying case \$72.50

 **12" SECTION 45 deg twist 90 deg bend \$6.00**
15 DEG BEND 10" choke to cover \$4.50

PULSE EQUIPMENT

MIT. MOD. 3 HARD TUBE PULSER: Output Pulse Power: 114 KW (12 KV at 12 amp.), Duty Ratio: .001 max, KV duration: .5, 1.0 2.0 microsec, Input voltage: 115 v 100 to 2400 cps, Uses 1-715-B, 1-829-B, 3-72's, 1-73 New \$110.00

3 cm 90° twist 6" ch. to cover \$8.00

DEHYDRATOR UNIT, CPD 10137 Automatic Cycling, Compressor to 50 lbs., Compl for Radar XSMN, Line, New \$425.00

 **SWR MEAS. SECTION, with 2 type "N" output probes MTD full wave apart, Bell sizes guide, Silver plated \$16.00**

200 MC COAXIAL PLUMBING

Right Angle Bend \$35.00
T Section \$55.00
T Section with Adapter to 7/8" in rigid coax \$65.00
Running Ftg. \$5 per Ft.

"K" BAND FEEDBACK TO PARA. BOLA HORN, with pressurized window \$30.00
MITRED ELBOW cover to cover \$4.00
FLEXIBLE SECTION 1" choke to choke \$5.00
WAVE GUIDE 1/2 x 3/8 per ft. \$4.00

AS14A/AP-10cm Pick up Dipole with "N" Cables \$1.00

 **TWIST 45 deg., 6" long \$8.00**
90 degree twist, 6 inches long \$8.00
TWIST 90 deg, 5" choke to Cover w/press nipple \$6.50

RL 26, Gas driven reversible engine, for laying & pick up field tel. wire \$125.00
WIRE PIKES \$4.50

TELEPHONE EQUIPMENT

101-A APPLIQUE
 Provides necessary balancing facilities for four wire repeater when used on two wire lines which may be voice-frequency telephone lines or open wire, or non-loaded or loaded cable. Std. 19" channel from rack mtg. Price, new, complete with tech manual \$54.00

MARK IV RADAR CONSOLE

Compl. "T" hand plg. Operating fr. 115 v. 60 cy. c/o Pulser, Rec. 700A Max. Out. Pwr. Sply. w/inout tubes \$750.00
 Individ. Chassis avail. separately

 **3 cm. wavemeter, Ordnance type micrometer head, New: Absorption type \$85.00**
9000-9500 MCHS Transmission type \$92.50

H.V. PWR. SUPPLY

1500 v 30 ma. DC Bridge Rect. 1Pwr Sply. Over. FM, 115v 60 cy. \$115.00

10 cm. Wavemeter, WE type B 435430
 Transmission type, Type N Fittings, Veeder Root Micrometer dial, Gold Plated W/Calib. Chart, P/o Freq. Meter X66404A, New \$99.50

SURFACE SEARCH RADAR

S.E. 10 cm, 115 VDC New \$1200.00
SQ-1 10 cm, 115 VDC Used \$1200.00
SF-1 10 cm, 115 VDC New w/spares \$2800.00

 **TR/ATR SECTION choke to cover \$4.00**
MITRED ELBOW and 8 sections choke to cover \$4.50

UG 65/U 10 cm. flanges \$6.75 each
UG 53/U Cover 4.00 each
UG 54/U Choke 4.50 each

ADAPTER, rd. cover to sq. cover \$5.00

APS-2 10CM RF HEAD COMPLETE WITH HARD TUBE (715H) Pulser, 714 Magneron 417A Mixer all 7/8" rigid coax, incl. revr. front end \$210.00

MAGNETRONS

QK 61 2975-3200 mc \$65.00
QK 60 2800-3025 mc \$65.00
QK 62 3150-3375 mc \$65.00
QK 59 2975 2900 mc \$65.00



FILAMENT TRANSFORMER

for above 115V/60 cy Pri: four 6.3V/4A Sec. 5000Vt \$27.00
Magnetron Kit of four QK's 2675-3375 inc. w/trans special \$250.00

BRAND NEW ORIG. PACKED GUARANTEED GOOD

2131	2138	3131	
2121-A	2139	5130	
2122	2140	714AY, A	
2126	2149	718DY	
2127	2161	720BY	
2132	QK915	720CY	
2134		725-A	
2137		730-A	
728-A, B, C, D		730-A, B, C, D	
706-A, B, C, D, E, F, G, Y			

Klystrons: 723A/B, 707B W/Cavity 417A 2K41

Electromagnets for magnetrons 700A \$24.50 ea.
GE Magnet type M7765115, G1 distance between pole face variable from 2 1/16" (19.0 Gauss) to 1 1/2" (2200 Gauss). Pole dia. 1 1/8" P/o SCIT 586, New \$34.50

RT32/APS 6A RF HEAD, Compl. with 725A Magnetron magnet pulse xfr. TR-ATR, 723 A/B local osc and beacon mount, pre amplifier, Used but exc. cond. \$97.50

MAGNETRON MAGNETS

Gauss	Pole Diam.	Spacing	Price
4850	3 4 in.	5 8 in.	\$12.50
4200	2 1/2 in.	3 4 in.	\$15.50
1300	1 5/8 in.	1 5/16 in.	\$12.50
1860	1 5/8 in.	1 1/2 in.	\$14.50

CS390

CONTROL EQUIPMENT
FOR AIRPORT CONTROL GROUND STATION—
 Standard relay rack housing, monitor loudspeaker, dual channel receiver amplifier, Type 109 A control panel, microphone speech amplifier, etc. spare parts, new and complete \$750.00 each

AT-48 Horn Silver Plate, "N" Inpt. New \$6.50
AT-08 Horn, Sperry, "N" Inpt. New \$6.50
TS 235 UP, Dummy Load, New \$87.50

I.F.F. KW Pulsed output Pkg. Tunable 154-186 mc. adj. modulating pulses 4-10 micro sec. comp. 115v 60cy ac pwr. supply. Video output receiver New w/tubes \$350.00
Wavemeter for above \$75.00
Dipole Array for above \$85.00

 **RIGHT ANGLE BEND, with flexible coax output pickup loop \$8.00**
STUB-SUPPORTED RIGID COAX, gold plated 5" lengths, Per length \$5.00

10CM ECHO BOX CABY 14ABA-1 of ORU-3, 2890 MC to 3170 MCHS direct reading micrometer head, Ring prediction scale plus 9% to minus 9%, Type "N" input, Resonance Indicator meter, New and Comp. w/access, Box and 10 CM Directional Coupler \$350.00

MODEL TS-268/U

Test set designed to provide a means of rapid checking of crystal diodes 1N21, 1N21A, 1N21B, 1N23, 1N23A, 1N23B, Operates on 1 1/2 volt dry cell battery, 3x6x7, New \$35.00



CRYSTAL DIODES

No.	Each
1N21	\$1.00
1N22	1.50
1N23	1.50
1N26	3.00

APS-10 Med. Deck less tubes, New \$75.00
L. V. Pwr. Sply less tubes, New \$18.50

 **Rotating joint, with deck mounting \$15.00**
RIGID COAX slotted section CU-60/Al' \$5.00

LHTR. LIGHTHOUSE ASSEMBLY, Part of RT-39/APG-5 & APG-15, Receiver and Transmitter Lighthouse Cavities with assoc. Tr. Cavity and Type N C.P.L.G. To Rerr. Usca 2040, 2043, 11B27, Tunable APX 2400-2700 MCHS, Silver plated \$49.50

Magnetron Cplg. 7/8 rigid coax, 3/4 I. C. \$7.50
7/8" rigid coaxial tuning stubs with vernier stub adjustment, Gold Plated \$17.50

SCR 584 SPARE PARTS AVAILABLE

 **TS 89/AP Voltage Divider, Ranges 100: 1/2 for 2000 to 20000; 10:1 for 200 to 2000v. Input Z 2000 ohms. Output: Z 4 meg ohms flat response 150 cy to 5 meg cy \$42.50**

AN/APS-15A "N" Band compl. RF head and mod. 725-A magnetron two 723A B 11B24, TR, revr-amp, duplexer, HV supply, blower, Peak-Pwr Out: 45 KW appx, Input: 115, 400 cy. Mod. pulse dur. 5 to 2 micro-sec. appx. 13 KV Pk Pulse. Compl. with all tubes incl. 715-B, 829B, RK1E 73, two 72's, New \$210.00

TRANSITION 1 x 1/2 to 1 1/4 x 5/8, 11 in. \$8.00
723 A/B Klystron mixer section with crystal mount, choke flange and Hg flange output \$22.50
3 cm. right angle bends, "E" plane 18" long cover to cover \$6.50 each

APS 4 AIRBORNE RADAR

Complete sets and various components available.

 **WAVEGUIDE TO 7/8" RIGID COAX "DOORKNOB" ADAPTER, CHOKE FLANGE, SILVER PLATED BROAD BAND \$37.50**
WAVEGUIDE DIRECTIONAL COUPLER, 20 Navy type CABV-47AAN, with 4 in. slotted section \$32.50

SO-3 RECEIVER

30 mc. 1F, 6 stages 6AC7, 10 mc. Band width inpt. 5.1 mc B.W. per stg., 9.6 volt gain per stage as desc. In ch. 13 vol. 23 M.I.T. Rad. Lab. Series \$99.50



All merchandise guaranteed. Mail orders promptly filled. All prices, F.O.B. New York City. Send Money Order or Check. Only shipping charges sent C.O.D. Rated Concerns send P.O.

COMMUNICATIONS EQUIPMENT CO.

131 Liberty St., New York, N.Y.

Dept. 13

Phone: Digby 9-4124

ATT. Mr. Paul Plishner

CHOKES INVERTERS

TRANSFORMERS

THERMISTORS VARISTORS

Power Transformers—115/V50-60 cps Input					
Volts. Out	Amp.	Filaments	Each		
770V	.0025	2.5V/3A	\$1.98		
550VCT	.050	6.3V/1.5, 2.5VCT/1.75	2.49		
2 x 110VCT	.01	6.3V/10, 2.5VCT/7	2.75		
2 x 110V	.010	6.3/2.5, 2 x 2.5VCT/7	3.45		
550VCT	.100	6.3V/1.8, 6.3/1.6	2.29		
580VCT	.040	5VCT/3A	2.49		
100VCT	.017	5VCT/3A	2.25		
2300V	.004	2.5/2A	7.49		
100VCT, 65V	.100	6.3VCT/10, 40V/1.1, 18VCT/1.1, 18.6/1.1 } 6.3/1	3.49		
1500V	.160	2.5VCT/12, 30V/0.1	6.95		
1100V, 400V	.250	6.3V/6A	6.95		
78V	.300	6.3V/2A	1.79		
2 x 300V	.042	55V/125, 45/3.5	3.95		
585	.086	5V/2.5, 6.3V/3	3.95		
1380VCT	.055	6.3V/1.2, 6.3/1.2	5.95		
600VCT	.155	6.3VCT/5, 5VCT/3	3.95		
1120V	.600	2 x 5VCT/6-2A, 6.3VCT/3, 6.3/300 }	14.95		

Plate Transformers—115V/50-60 cps Input					
Volts Out	Amp.	Each	Volts Out	Amp.	Each
2-65V	.500	\$1.49	70V	1	\$1.95
500VCT	.150	1.49	100V	3	1.95
600VCT	.015	3.00	121V	1.5	
2 x 150V	2 x .940	4.25	126.5	1.5	2.25
600VCT	.0165		132V	1.5	
250VCT	.077	2.49	600V	.450	4.95
			1470VCT	1.2	24.00

Filament Transformers—115V/50-60 cps input			
Rating	Each	Rating	Each
6.3V/2A, 78/30	\$1.79	6V/3A	1.10
36V/1.11	1.49	30VCT/330,	
5VCT/20A	5.49	34VCT/330	\$1.95
4V/16A, 2.5V/1.75			
HV Ins.	4.75	6.3V/2.5, 2 x 2.5/7	3.25
5V/115A	12.95	2 x 2.5VCT/6.5A	3.25
7.2V7, 6.4/10, 6.4/2,		2.5V/1.75, 5V/3A,	3.85
2 x 26.2/2.5, 18V/1,	5.95	6.5/8A, 6.5V/6A	
6.3VCT/20, 6.3V/1.8,		5VCT/13.5,	6.95
6.3V/6	5.25	2 x 5VCT/6.75	2.95
6.3VCT/1, 6.3VCT/7	2.75	1.3V/0.091Kva	2.95
6.3/5, 6.3/1A	2.25	6.3VCT/6A, 5V/2A	1.85
6.3VCT/3.2,		6.3VCT/2A,	2.45
6.3VCT/1	2.25	5.3VCT/2A,	1.95
5V/6A	2.25	6.3V/1A, 6.3V/1A	3.25
6.3VCT/1A, 5V/2A	1.65	6.3/2.5/7A, 2.5V/7A	

SPECIAL TYPES		
Input	Output	Each
6, 12, 24 or 115VDC, or 250VAC	420VCT/85Ma, 6.3V/1.9, Univ. Vibrator Xfmr	\$2.39
230V 60 cy	230V/.05A	1.10
115V 60 cy	115V/78V-410A/.800MA	1.59
110/115/120/125	13.5V/1.11A	1.49
210/220/230	2.5VCT/4A	1.49
230V 60 cy	200V/20A, 4 x 6.3/.900A	1.95
230V 60 cy	286VCT/200MA	2.95
220V 60 cy	260V/.03, 100/1, 6.3/4.2	2.95
200V 60 cy	700VCT/.75, 40VCT/1A, 15/10/15V/1A	2.39
45/78/90	Tapped 1V to 10V	2.95
220V 60 cy	2 x 40V/0.5, 2 x 5V/6A, 12.6V/1A	2.95
220V 60 cy	24V/6A, 5V/3, 2 x 6.3/1A	2.29
43/78/90/115/180/230	2.5V/6.5A, 2.5/6.5, 6.3/4A	3.95
110/115/120/125	6.12/18/24/75/100/115V/150A	2.49
230V 60 cy	5V/9A MV INS	3.25
200V 60 cy	700VCT/.08A, 110VCT/.08A, 1.5V/.08, 6.3V/3, 6.3VCT/2A, 2.5V/5A, 2.7V/5A	4.25
230V 60 cy	400V/0.3, 190V/0.3A, 5/2.5, 5V/2.5A, W/2-866 Sockets	4.25
50V 60cy	2 x 750V/.001A	1.95
6V & 12V	84V/.009, 51V/.003, 1.4V/500	1.95
230V 60 cy	250V/1A, 5V/2A 5V/9A	4.95
220-440	3 x 2.5/6A, 2.5V/15A	5.95
230V-115V	5VCT/7.5, 5V/7.5, 5VCT/15A	10.95
440V/60 cy 3PH	220V 30W 3 phase or 220V & 6V 1 phase 60 cy	6.95
230V 60 cy	110V/200, 33V/200, 5V/10A, 2.5-1.1/10A, 1500V/100	7.95
95-130V 60 cy	115V/3.8A, 40.9V/3/3A	10.95
220/440V	115V/6.52A	12.95
220-440V	115V/10/105/17A	13.95

SEE YOU AT THE

IRE SHOW

BOOTH L, 2ND FLOOR
MARCH 6 TO 9TH INCL.

IMPORTANT NOTICE
WE PURCHASED 80% OF THE N.Y. INVENTORY OF DEMORNAV BUDD MICROWAVE PLUMBING. WRITE FOR CATALOGUE. AT SURPLUS PRICES

3 CENTIMETER

Choke Flanges UG40/U	\$.85
Cover Flanges UG39/U	.65
Uni-Directional Couplers CU105 Aps-31, Type "N" Terminated 25DB	10.00
Uni-Directional Couplers Cover Flange Terminated 20DB	9.50
"E" Plane Bends 2 1/2" Radius CH. to CVR.	10.00
"H" Plane Bends 2 1/2" Radius CH. to CVR.	10.00
12" Straight Sections Square CH. to CVR. S. P. Crystal Mount	3.00
Bi-Directional Coupler Type "N" Terminated	15.00
Bi-Directional Coupler Type "N" Terminated, CG Broad Band	15.00
Eg-176/AP Dir. Coupler 20DB Nominal "N" Terminated	15.00
Xa Band Miltred Elbows	9.00
Bulkhead Feed-Thru	10.00
Press Test Sections Ch to CVR W/15 lb. gauge	9.00
Miltred Elbows	8.00
Adapter UG39/U to UG40/U	3.50

TEST EQUIPMENT

"L" Band Slotted Line With Probe And Carriage And "N" Terminated Directional Coupler	300.00
"C" Band Flap Attenuator Gold Plated	90.00
% Rigid Coax % Bullet Directional Couplers 20DB	17.50
% Rigid Coax % Bullet To Type "N" Adapter	10.00

"K" BAND

90 Deg Bend Sq. CH. to CVR.	5.00
90 Deg Bend Sq. CH. to CH.	5.00
90 Deg Bend Sq. CVR. to CVR.	49.50
Bi-Directional Couplers 20DB P/O APS-34	39.50
Uni-Directional Couplers	49.50
Rotary Joints P/O APS 34	3.00
Straight Sections CH. to CVR. 6"	

"C" BAND

RT Angle Bends Circ CH to CIRC CVR Un-plated	13.50
CIRC CHOKE FLANGES	
Miltred Elbows CIRC CH. to CIRC CVR.	16.50

WHOLESALE ONLY

Phone or Write
for Quantity & Price
DIGBY 9-4124

ATT. MR. C. ROSEN

1,000,000 Bathtub	
4,000,000 Micats	
300,000 Sil. Micats	
100,000 Oil Cond.	
4,000,000 Resistors	
400,000 Electrolytics	
400,000 H. V. Micats	
5,000 K. V. Cond.	
150,000 Prec. Resis.	
500,000 Tube Clamps	
1,000,000 An. Connectors	
50,000 Dynamotors	
20,000 Power Xfmrns	
20,000 Chokes	
100,000 Antennas	
50,000 Audio Xfmrns	
100,000 400 Cy Xfmrns	
100,000 Shock Mts.	
25,000 Magnetrons	
5,000 Magnets	
50,000 Pulse Xfmrns	
50,000 Control Boxes	
500,000 Tubes	
300,000 Relays	
600,000 Pots	
35,000 Vibrators	
200,000 UG Connectors	
2,000 Sockets	
1,500 Ass. Phones	
20,000 Headsets	
5,000 Mikes	
100,000 Elements	
Tons of Nuts & Bolts	
Screws, Etc.	
1,000 Gibson Girls	
500 RC 375	
Complete	
500,000 Insulators	
150,000 Binding Posts	
200,000 Wafer Switches	
300,000 Ceramicons	
500,000 Ferrule Resis.	
50,000 P1.5	
25,000 JK 28	

WRITE FOR
C.E.C. MICRO-
WAVE CATALOG
NOW AVAILABLE

400 CYCLE TRANSFORMERS

Input	Rating	Price Each
115V	6.3V/1.8A, P/O APG2	\$1.49
57.5V	2 x 57.5V/.0001A, P/O APG2	1.49
115V	2 x 145V/.000145A	1.95
115V	780V, 27V/4.3, 6.3V/2.0, 1.25V/.20A	3.95
115V	6.4V/11 Amp, P/O APQ7	2.25
115V	2 x 6.3V/1.25A, P/O APQ13	1.95
80v	6.3V/1A, 2.5V/2A, P/O PE172A	3.95
115V	15.35VCT/1A	1.95
115V	59.2V/118, 63V/8.1, 5V/2A, P/O APQ13	3.95
118V	6.3/9, 6.3V/6.5V/6, 640/200 MA,	4.95
115V	2 x 14CV/00014A, 12QV/00012A, P/O APG2	1.95
115V	3460V/400 Ma, P/O APT 4	7.95
115V	23.5V Tapped 22V/47 MA	1.95
115V	600VCT/36 Ma	1.95
115V	408VCT/118, 120VCT/250a, 6.3V/6.15, 5V/2A, 45V, Tapped 28V/8 and .3a	4.95
115-80V	6.4V/2.5, 400VCT/35Ma, 6.4/150a,	3.95
115V	6.4V/7.5, 6.4/3.8, 6.4/2.5a,	3.49
115V	780V/-, 27V/4.7, 6.3/2.9, 1.25/.2a,	2.49
115V	6.4V/8A, 6.4V/1A,	1.95
115V	6.3V/9.1A, 6.3VCT/6.5a, 2 x 2.5/3.5a,	2.49
80-115V	5V/2a, 6.3V/2a, 5V/2a, 6.3/5a	2.99
115V	5V/15A, 5000V Ins.	3.95
115V	6.3/2.7, 6.3/6.6, 6.3VCT/21A	5.95
118V	780V, 6.3V, 6.3V, 5V, 320V, 6.3V/20A	
110V	220V	
110V	3V	
55V	20V/20V	1.49
115V	6.4/7.5, 6.4/3.8, 6.4/2.5	2.95
115V	592V/118Ma, 6.3/8.1a, 5V/2 W.E.	4.95
115V	6.3V/9.1, 6.3VCT/65a, 2 x 2.5V/3.5A	2.95
115V	6VCT/00006 KVA	.98
115V	6.4V/8a, 6.4V/1a	1.49
115V	1034 VCT/111a, 6.9V/10, 2 x 6.3V/1, 5V/2, 6.3/2, 6.3/1	6.49
80-180V	526VCT/50a, 6.3VCT/2a, 5VCT/20	3.49
115-80V	400VCT/35Ma, 6.4/2.5, 6.4/15a	3.25
115V	2300VCT Large Qty	2.23
115-V	600VCT/36Ma	1.49
80-115V	2.5V/1.75, 5V/3A, 6.5V/6.5, 6.5/2a, For SCR729	3.95
115V	640V/500Ma, 2.5V/1.75a, P/O APS 15B	2.95
80-115V	360VCT/20Ma, 1500V/1MA, 2.5V, 6.3/2.5, 6.3V/6a, P/O 720A	3.95
115V	2 x 2.5V/5A, 2.5V/10A, P/O APT 4	4.95
118V	2 x 2.5V/2.5a, 6.3V/2.25a, 1200V, Tap	4.95
115V	1000V-750V, P/O AN/APS-15, 742.5V/50 MA, 709V, 47 MA, 671V/45	2.95
115V	600VCT/36 MA, 2 1/2 x 2 1/2 x 3 1/2	
115V	1150-1150, 2 1/2 x 2 1/2 x 3 1/2	
115V	640VCT/250 MA, 6.3V/9, 6.3V/6, 5V/6A	3.95
115V	6.3V/9.1a, 2.5V/3.5a, 6.3VCT/65a, 2.5V/3.5a	3.25
115V	9800V or 8000V/32 MA	12.50
115V	592 VCT/120 MA, 6.3V/8a, 5V/2a,	3.50
115V	440VCT/250 MA	7.50
115V	5V/3a, 6.3V, 2a	1.75
115V	70 to 111V @ 247-622VA	1.35
115V	5000V/200 MA, 5V/10A	12.50
115V	2200V/350	5.45
115V	2.5V/5, 5200V/2 MA	14.45
115V	13.5 KV/3.5 MA	11.50
115V	734VCT/177a, 1710VCT/177a	6.95
115V	6.3V/9A, 7.7V/365A	2.79
100/110, 120/130	2.5/20A	4.85
115V	6.3V/12a, 6.3V/2a, 6.3V/1a, P/O AN/APQ-5	5.85
115V	6.4VCT/7.5, 6.4VCT/3.8, 6.4VCT/2.5a	4.35
115V	6.3V/2.7, 6.3V/6.6A, 6.3VCT/21A	2.95
115V	6.5V/12a, 250V/100 MA, 5V/2a P/O AN/APS-15	3.50
115V	400VCT/35 MA, 6.4V/15a, 6.4V/2.5a	2.25
80-115V	650VCT/50 MA, 6.3VCT/2A, 5VCT/2a	2.45
115V	P/O R58/ALQ8	
115V	2400CT/5MA, 640V/5MA, 2.5V/1.75A	3.85

MICROWAVE ANTENNAS

APS-15 Antennas, New	\$99.50
AN M1G-1 Antenna, Rotary feed type high speed scanner antenna assembly, including horn parabolic reflector, Less internal mechanisms, 10 deg. sector scan, Approx. 12" x 4" x 3" H. Unused. (Gov't Cost—\$4500.00)	\$250.00
AP8-4, 3 cm. antenna, Complete 1 1/2" dish, Cutter feed dipole directional coupler, all standard 1" x 1/2" waveguide, Drive motor and gear mechanism for horizontal and vertical scan, New, complete	\$65.00
AN/TPS-3, Parabolic dish type reflector approx. 10" diam. Extremely lightweight construction. New, in carrying cases	\$89.50
RELAY SYSTEM PARABOLIC REFLECTORS: approx. range: 200 to 6000 mc. Dimensions: 4 1/2" x 3", rectangle, new	\$85.00
TDY "JAM" RADAR ROTATING ANTENNA, 10 cm., 30 deg. beam, 115 v.a.c. drive, New	\$100.00

NEW T. V. IDEAS

NEED ACME ELECTRIC TRANSFORMER performance

New engineering ideas, to advance the reception qualities of Television, need better than average transformer performance. Acme Electric engineers will assist your ideas by helping you design a transformer, exactly in accordance with your needs.

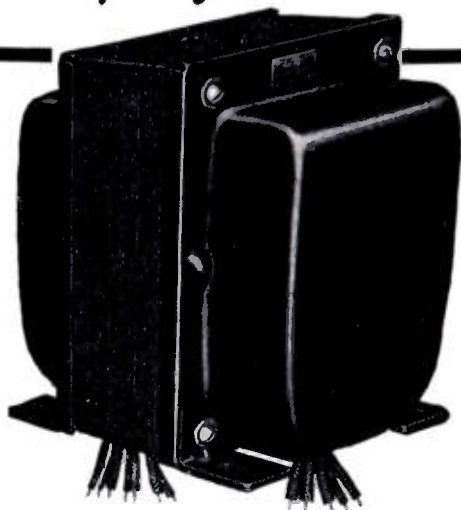

Acme Electric
TRANSFORMERS

ACME ELECTRIC CORPORATION
443 Water St.
Cuba, N.Y., U.S.A.



(Continued from page 57A)

- Stalford, W. E., 5309 Greenway Dr., Hyattsville, Md.
 Sternick, L., 91 East 208 St., New York 67, N. Y.
 Stimson, J. D., 610 Woodland Rd., Pasadena 5, Calif.
 Stock, E. H., Radio & Electrical Engineering Division, National Research Council, Sussex St., Ottawa, Ont., Canada
 Sutton, J. G., Jr., 1001 Ridge Ave., Pittsburgh, Pa.
 Swatko, J. J., 67-01 53 Dr., Maspeth, L. I., N. Y.
 Tapernoux, P. J., 35 Elmerost Rd., Rochester 9, N. Y.
 Teske, J. A., 8519 Garland Ave., Takoma Park 12, Md.
 Theobald, D. J., 516 S. Smithville Rd., Dayton, Ohio
 Thigpen, B. B., Box 113, Lamesa, Tex.
 Thompson, A. C., 8622 55 Rd., Elmhurst, L. I., N. Y.
 Thompson, E. E., 802 West 6 Ave., Pine Bluff, Ark.
 Thurman, H., 709 West 41 St., Vancouver, Wash.
 Tice, T. E., 1296 Franklin Ave., Columbus 5, Ohio
 Van Every, A., Rm. 18, Bldg. 105 "A" St., Sandia Base, N. Mex.
 Van Meter, J. L., 705 Federal Office Bldg., Seattle 4, Wash.
 Vincent, R. S., Box 874, De Quincy, La.
 Wales, R. O., 2702 Harmon Rd., Silver Spring, Md.
 Wallace, B., 406 California Ave., Oakmont, Pa.
 Weisbrod, S., 6971 Glidden St., San Diego 11, Calif.
 Weitz, M. K., 1554 East 27 St., Brooklyn 29, N. Y.
 West, K. W., Box F, Glensville, Va.
 Westerholt, H. H., 1038 Palazini Dr., Schenectady, N. Y.
 Wheelock, W. I., 301 Edgewood Ct., Dayton 7, Ohio
 Williams, E. A., 5530A Highland Ave., Pennsauken, N. J.
 Williams, N., 219 Harbor Rd., Bldg. 6, Section 1, San Francisco 24, Calif.
 Williams, W. R., 1305 Batts Blvd., Springfield, Tenn.
 Wilson, J. L., 5 Epsom Ave., Toronto 13, Ont., Canada
 Windus, W. A., 3427 Oakland Rd., Cedar Rapids, Iowa
 Wipson, J. W., 2211 Budlong, Los Angeles 7, Calif.
 Wolf, F. E., Jr., 1238 College Ave., New York 56, N. Y.
 Wolf, I. B., 13706 Linwood, Detroit 6, Mich.
 Wolken, I. I., 6307 N. Francisco Ave., Chicago 45, Ill.
 Wright, G. M., 27 Aylmer Ave., Ottawa, Ont., Canada
 Zehr, R. M., 1232 Norwood Ave., Niagara Falls, N. Y.
 Zilis, G. S., 10731 S. Wabash Ave., Chicago 28, Ill.
 Zimmerman, J., Rm. 911, Lawson Y.M.C.A., 30 W. Chicago Ave., Chicago, Ill.

AT LAST... A Unified Account of the Whole Field of Microwaves Including Particle Accelerators and the Traveling-wave Amplifier

MICROWAVE ELECTRONICS

By John C. Slater, Ph.D., Sc.D.
Head of the Department of Physics,
Massachusetts Institute of Technology

In this broad treatment of microwave theory, both wartime and post-war developments are included. Based upon Dr. Slater's extensive work at Bell Telephone Laboratories and M.I.T. Radiation Laboratory on magnetron research and the general theory of microwaves, this comprehensive account also treats the theory of the linear accelerator, the cyclotron and the synchrotron.

Grounded in the most rigorous mathematical approach so far attempted, yet fully intelligible to the reader of only moderate mathematical training, this truly fundamental work has the widest usefulness for physicists, electrical engineers and research workers as a reference and practical handbook.

See for yourself how valuable this book can be to you. Examine it for ten days without obligation.

MAIL THIS COUPON

D. Van Nostrand Company, Inc. Publishers
250 Fourth Ave., New York 3, N.Y. Since 1848

Please send me a copy of "Microwave Electronics". After ten days I will either return the book or send you \$6.00, plus a few cents postage.

Name

Address

City Zone State

PTRE-350

ELECTRONICALLY REGULATED LABORATORY POWER SUPPLIES



BENCH MODEL 25

- STABLE
- DEPENDABLE
- MODERATELY PRICED

- INPUT: 105 to 125 VAC, 50-60 cy
- OUTPUT #1: 200 to 325 Volts DC at 100 ma regulated
- OUTPUT #2: 6.3 Volts AC CT at 3A unregulated
- RIPPLE OUTPUT: Less than 10 millivolts rms

For complete information write for Bulletin G

WIDTH 14"
DEPTH 6"
HEIGHT 8"
WT: 17 LBS.



LAMBDA ELECTRONICS CORPORATION
CORONA NEW YORK

News—New Products

These manufacturers have invited PROCEEDINGS readers to write for literature and further technical information. Please mention your I.R.E. affiliation.

Volume Level Meters

A new and completely redesigned line of volume level indicators is announced by Daven Co., 191 Central Ave., Newark 4, N. J.

The indicating meter is a copper-oxide type instrument possessing nearly ideal characteristics for monitoring purposes. The adjustment is such that the pointer will indicate 99 per cent normal deflection at zero vu in approximately 0.3 seconds. Overswing is not more than 1 to 1½ per-

(Continued on page 62A)

SAVE on Miniature and Toggle Switches at WELLS

Miniature Switches

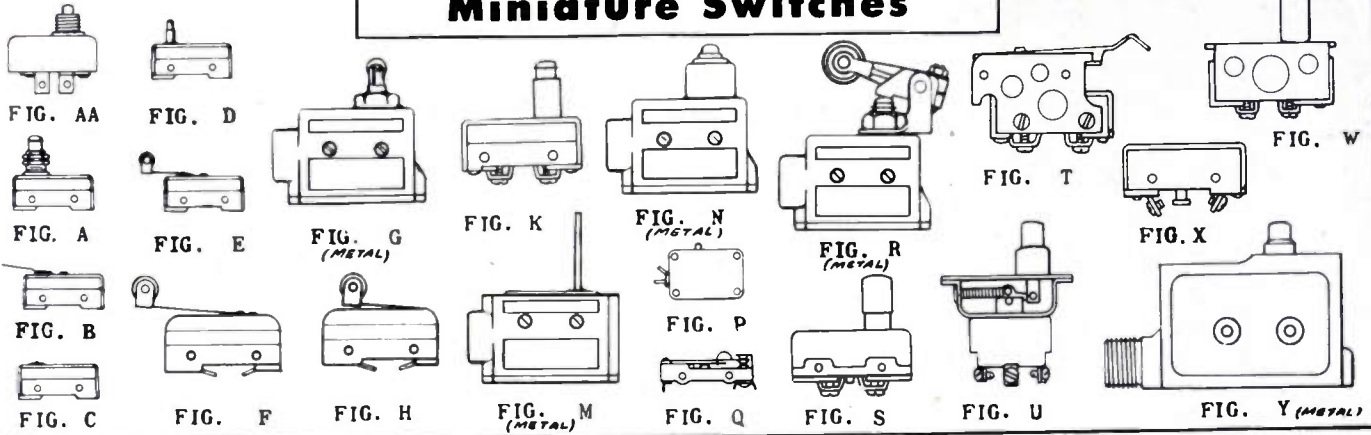

STOCK NUMBER	MANUFACTURER	MFR. TYPE NO.	CONTACTS	ILLUSTRATION	PRICE EACH	STOCK NUMBER	MANUFACTURER	MFR. TYPE NO.	CONTACTS	ILLUSTRATION	PRICE EACH
305-10	Microswitch	WP3M5	N.C.	FIG. AA	\$0.40	311-116	Microswitch	SWD196	N.C.	FIG. D	.63
305-160	Microswitch	WP-5M3	N.C.	FIG. AA	.40	303-49	Microswitch	YZ2YST	SPDT	FIG. O	.68
307-210	Microswitch	YP3A	N.O.	FIG. AF	.50	309-93	Microswitch	BRS36	SPDT	FIG. D	.68
L305-75	Microswitch	YZ-RQ1	N.O.	FIG. A	.92	370-17	MU-Switch	QRS	SPDT	FIG. D	.75
303-67	Microswitch	YZ7RA6	N.O.	FIG. A	.71	PH-112	MU-Switch	MBW	SPDT	FIG. E	.72
PH-100	Acro	RO1P2T	N.D.	FIG. A	.71	305-64	Microswitch	WZRI2	N.C.	FIG. E	.65
301-46	MU-Switch	MLB-321	SPDT	FIG. B	.85	311-25	Microswitch	CUN24155	N.C.	FIG. E	.85
301-93	Microswitch	YZ-2YLC1	SPDT	FIG. B	1.01	370-10	MU-Switch	RO2M12T	N.O.	FIG. E	.70
301-30	MU-Switch	RO2M	SPDT	FIG. B	.95	303-32	Acro	YZ-3RW2T	N.O.	FIG. F	.65
301-78	MU-Switch	Green Dot	SPDT	FIG. B	.75	306-18	Microswitch	BZE-2RQ9TM1	SPDT	FIG. G	2.48
303-79	Microswitch	BZ-RL32	SPDT	FIG. B	.75	309-101	Microswitch	BZ-2FW221	SPDT	FIG. H	.95
303-85	MU-Switch	MLB329	SPDT	FIG. B	.67	PH-113	Microswitch	RZBQT	SPDT	FIG. K	.58
305-154	Acro	XD4-5L	SPDT	FIG. B	.78	L306-1010	Acro	RO7-8586	N.O.	FIG. K	.55
311-130	Acro	---	SPDT	FIG. B	.70	370-18	Acro	HRD71P2TSF1	N.O.	FIG. K	.60
PH-101	Microswitch	BRL18	SPDT	FIG. B	.78	370-19	Acro	YZRQ41	N.O.	FIG. K	.65
PH-102	Microswitch	YZRL812	N.O.	FIG. B	.65	370-40	Cutter Hammer	---	N.O.	FIG. K	.75
PH-103	MU-Switch	Blue Dot	SPDT	FIG. B	.68	370-8	Microswitch	RN-11-H03	SPDT	FIG. M	1.50
PH-104	Microswitch	YZ3RLTC2	N.O.	FIG. B	.64	309-157	Microswitch	---	N.C.	FIG. N	1.15
PH-105	Microswitch	YZR31	N.O.	FIG. C	.53	370-15	MU-Switch	AHB203	SPDT	FIG. N	1.25
PH-106	Microswitch	R-R36	N.C.	FIG. C	.50	370-7	Microswitch	WZE-7RQTN	N.C.	FIG. N	1.35
PH-107	Microswitch	G-R36	N.C.	FIG. C	.53	305-11	Acro	2M031A	N.O.	FIG. P	.37
PH-108	Microswitch	WZ-2RT	N.C.	FIG. C	.50	305-71	Acro	2M041A	SPDT	FIG. P	.37
305-161	Microswitch	YZ3R3	N.O.	FIG. C	.71	305-90	Microswitch	Open Type	SPDT	FIG. Q	.35
311-115	Microswitch	WZR31	N.C.	FIG. C	.71	370-28	Microswitch	YZE-RQ22	N.O.	FIG. R	2.75
311-123	Microswitch	WZ-7R	N.C.	FIG. C	.60	303-84	Acro	HR07-4PST	N.O.	FIG. S	.50
311-126	Acro	HRR07.1A	N.C.	FIG. C	.50	303-83	Microswitch	YZ-RQ4	N.O.	FIG. S	.50
311-125	Acro	HRR07.1A	N.O.	FIG. C	.53	PH-114	Microswitch	WZR-31	N.C.	FIG. T	.65
311-121	Microswitch	WZ7RTC	N.C.	FIG. C	.50	PH-115	Cutter Hammer	8905K564	DPDT	FIG. U	.65
311-128B	Microswitch	YZ	N.O.	FIG. C	.53	PH-116	Microswitch	WZRQ41	N.O.	FIG. W	.60
370-6	Microswitch	X757	N.C.	FIG. C	.45	PH-118	Microswitch	BZRQ41	SPDT	FIG. W	.60
PM-109	Microswitch	RRS13	N.C.	FIG. D	.45	311-128A	Microswitch	YZ-RTX1	N.O.	FIG. X	.90
PH-110	Microswitch	BRS36	SPDT	FIG. D	.53	PH-117	MU-Switch	Z	N.C.	FIG. Y	1.35
PH-111	Microswitch	GRS	N.O.	FIG. D	.49						

Toggle and Push Switches

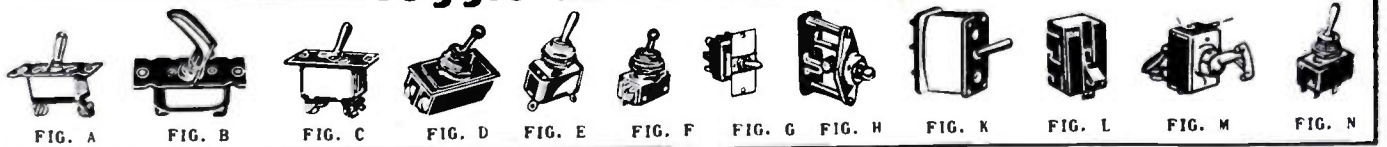

STOCK NUMBER	FIG.	CONTACT ARRANGEMENT	MANUFACTURER & NUMBER	PRICE EACH	STOCK NUMBER	FIG.	CONTACT ARRANGEMENT	MANUFACTURER & NUMBER	PRICE EACH
PH-500	A	SPDT	B1B	.35	305-174	C	DPDT CENTER OFF MOM 1 SIDE	AN-3023-5	.50
PH-501	A	SPDT	AN3022-3B	.35	305-177	C	OPDT CENTER OFF MDM EACH SIDE	C-3	.50
PH-502	A	SPST MOMENTARY	B10	.30	305-176	C	OPDT CENTER OFF MDM EACH SIDE	AN-3023-7	.50
PH-503	A	SPDT CENTER OFF MOM EACH SIDE	B11	.32	305-173	C	DPDT	8710K3	.55
PH-504	A	SPDT CENTER OFF	B14	.35	305-175	C	OPDT CENTER OFF MOM EACH SIDE	3712K3	.50
PH-505	A	SPDT MOMENTARY	B21	.30	305-179	C	DPDT CENTER OFF MOM EACH SIDE	8732-K2	.50
PH-505	A	SPST	AN-3022-2B	.30	309-163	C	OPDT CENTER OFF MOMENTARY	CH C-11	.55
PH-506	A	SPDT CENTER OFF	AN-3022-1	.35	309-162	C	DPST	CH C-1	.45
PH-507	A	SPDT CENTER OFF MOM EACH SIDE	AN-3022-7B	.32	309-164	C	DPST MOMENTARY	CH 8711K3	.40
PH-508	A	SPST MOMENTARY	AN-3022-8	.28	370-31	C	DPDT	CH C-1B	.55
PH-513	A	SPDT CENTER OFF	CH AN-3022-1B	.38	305-87	D	I SIDE DPST MOM 1 SIDE SPST	AH & H	.95
PH-514	A	SPST	CH B-5 A	.35	305-111	E	SPST MOMENTARY	CH 8817K2	.28
LT-104	A	SPDT 1 SIDE MOMENTARY	CH 8905K568	.35	305-153	E	SPDT CENTER OFF	CH AN-3021-1B	.35
309-168	A	SPST	168553	.34	LT-100	F	SPST	CH	.22
309-171	A	SPDT CENTER OFF MOM 1 SIDE	CH 8209K5	.35	LT-101	F	SPST MOMENTARY	AH & H w/LEADS	.20
370-1	A	SPST MOMENTARY	CH AN-3022-8B	.25	301-51	G	4PDT MOMENTARY	CH 8905K12	.75
370-4	A	SPDT CENTER OFF	CH B-9A	.35	305-140	H	DT NO MAKE EACH SIDE	OPEN FRAME	.25
370-14	A	SPDT CENTER OFF 1 SIDE MOM	CH B-7A	.30	309-161	K	SPST	CH 8781K3	1.95
370-25	A	SPST MOMENTARY	CH B-6B	.25	305-76	L	DPST	AH & H OPEN FRAME	.75
305-171	A	SPDT CENTER OFF MOM 1 SIDE	8209K5	.32	311-77	L	DPST	AH & H	1.25
309-169	B	SPST MOMENTARY	CH B-19	.35	301-12	M	DPST	AH & H SPECIAL FOR HAN DY	.40
PH-509	C	DPST	AN-3023-2B	.45	LT-107	N	OPST	AH & H TALKIE	.25
PH-510	C	DPDT MOMENTARY	CH 8715K2	.50					
PH-511	C	DPDT MOMENTARY	CH 8715K3	.50					
PH-512	C	DPST CENTER OFF	CH 8720K1	.55					
303-65	C	DPST	CH AN-3023-2	.45					

Distributors: Our standard distributor arrangement applies on these items.

Many More Types in Stock. Send Us Your Requirements.

JUST OUT: CATALOG H500 Manufacturers, Distributors and Amateurs write for the brand new Wells Electronic Catalog H500. Full of tremendous values in highest quality components.



Order directly from this ad or through your local parts jobber—

320 N. LA SALLE ST. DEPT. P, CHICAGO 10, ILL.

JOHNSON

Offers-

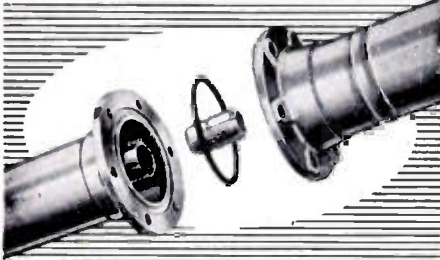

LONG-FLANGE CO-AX LINE...

GREATER MECHANICAL STRENGTH
No Brazing—No Cracking—No Distortion!
Solder Joint Stronger Than Tubing Itself!

This is the type of copper tubing joint which has proved most successful in other applications for many years!

There is less distortion, better all-around contact—a joint that is stronger than the tubing itself!

JOHNSON hard temper, 70 ohm, and 51.5 ohm, flange type line is supplied in 20 foot lengths. Special high conductivity copper is used in both outer and inner conductors and rigid tolerances are maintained to insure precision mechanical assembly, low loss and low standing wave ratio.

The 70 ohm line is intended primarily for AM and has grade L-4 or better steatite beads. The 51.5 ohm line was designed primarily for high frequencies, has grade L-5 or better steatite and meets RMA standards for FM line. Both are fitted with flange couplings at the factory, which greatly simplifies field installation.

In addition, JOHNSON manufactures a complete line of elbows, fittings, gas equipment and hardware for the above as well as semi-flexible, soft temper line in continuous lengths up to 1200 feet in 5/16", 3/8" and 7/8". No expansion joints nor elbows are needed for the latter because of its flexibility.

The 5/16" line is especially recommended for phase sampling and other low power applications.

Whatever your co-ax requirements may be, JOHNSON — the oldest manufacturer of concentric line in the field — can meet them to your utmost satisfaction.



JOHNSON

E. F. JOHNSON CO., WASECA, MINN.

News—New Products

These manufacturers have invited PROCEEDINGS readers to write for literature and further technical information. Please mention your I.R.E. affiliation.

(Continued from page 60A)

cent. The meter scale is calibrated in vu and per cent.

Two meter controls are provided; one a small decade with screw-driver adjustment for zero level setting of the meter pointer; the other a constant impedance "T" type network for extending the range of the instrument in steps of 2 db.

Because of the length of the meter scale, small differences in pointer indications are easily noticed. For this reason, the screw-driver type vernier is provided. All volume indicating meters can thus be adjusted to the same scale reading. This is particularly convenient in complex installations where several volume indicating meters must be read by one operator, or in co-ordinating the various meter at different points in a network

Three New Receiving Tube Types

Three new receiving tube types including an audio-frequency amplifier; an rf amplifier for television; and a horizontal deflection amplifier for television have been announced by Radio Tube Div. Sylvania Electric Products Inc., Emporium, Pa.

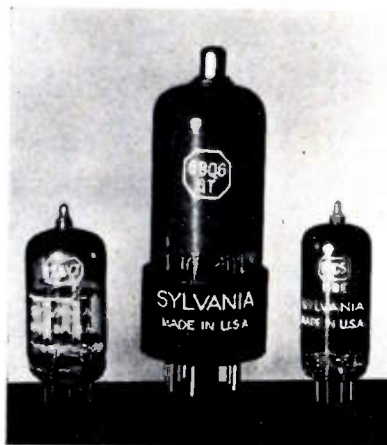

The audio amplifier, Type 12AY7, is a T6½ miniature, medium-mu duotriode particularly suitable for use in the first stage of af amplifiers where absence of noise and microphonism is desirable. The tube is supplied with a center-tap heater for use with 6.3-volt or 12.6 volt-source.

The rf amplifier, Type 6BC5, is a T5½ miniature sharp cutoff pentode having high mutual conductance, designed for rf and if amplifier applications in television receivers. The tube is listed as an equivalent of Type 6AG5, but it provides higher gain.

The horizontal deflection amplifier for television receivers, Type 6BQ6GT, has been designed and processed for transformer operated sets where high peak inter-electrode voltages are encountered.

Low-Power Miniature Relay

Resistance to the shock and vibration encountered in portable, mobile, aircraft,

(Continued on page 63A)

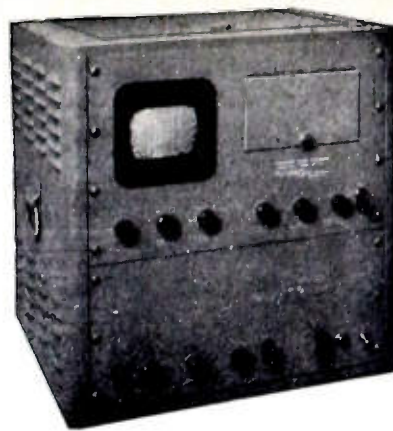

In only 1 SECOND! COMPLETE AUDIO WAVEFORM ANALYSIS with the AP-1 PANORAMIC SONIC ANALYZER



Oscillograph of waveform to be analyzed

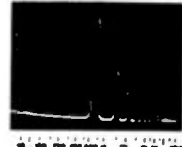

Panoramic Sonic Analysis of the same wave

Provides the very utmost in speed, simplicity and directness of complex waveform analysis. In only one second the AP-1 automatically separates and measures the frequency and amplitude of wave components between 40 and 20,000 cps. Optimum frequency resolution is maintained throughout the entire frequency range. Measures components down to 0.1%.

- Direct Reading
- Logarithmic Frequency Scale
- Linear and Two Decade Log Voltage Scales
- Input voltage range 10,000,000:1

AP-1 is THE answer for practical investigations of waveforms which vary in a random manner or while operating or design constants are changed. If your problem is measurement of harmonics, high frequency vibration, noise, intermodulation, acoustics or other sonic phenomena, investigate the overall advantages offered by AP-1.

Write NOW for complete specifications, price and delivery.



COSSOR for QUALITY

TWIN-BEAM OSCILLOSCOPES

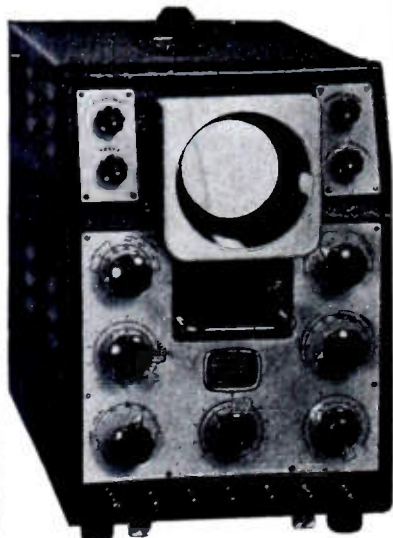

MODEL 1035 Provides *FAST SWEEPS*, from 150 Millisee. to 5 Microsec., and *Video Frequency Amplifiers*, Stepped -VE Feedback Type, with Gain of 3 at 7 Mc. Bandwidth to Gain of 3000 at 60 Kc. Bandwidth, ± 1.5 DB., PLUS Triggered Sweeps, Suppressed Flyback, \pm VE Sync.

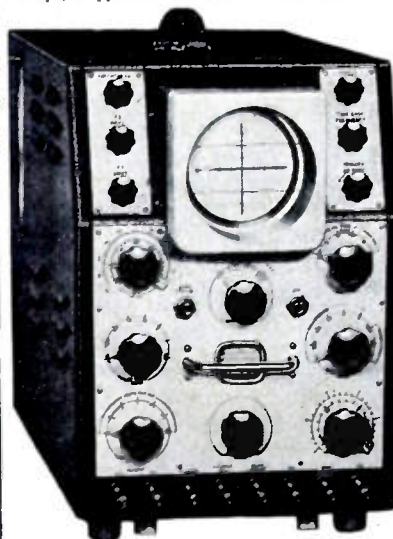

MODEL 1049 Provides *SLOW SWEEPS* from 1.5 Sec. to 50 Microsec., and *D.C. Amplifiers* Completely Stabilized Throughout, Response 0-100 Kc., ± 1.5 DB., Gain 900, PLUS Beam Blanking Circuits, Triggered Sweeps, \pm VE Sync.

PLUS

Unique *TWIN BEAM Flat Face CRT* in *BOTH* Instruments Providing Instant Directly Calibrated Measurement for Accurate Voltage, Time and Phase Comparisons.

WRITE TODAY FOR LITERATURE AND DEMONSTRATION

COSSOR (CANADA) LIMITED
WINDSOR ST., HALIFAX, N.S.

BEAM INSTRUMENTS CORP.
Room 208, 55w. 42nd St., New York 18

News—New Products

These manufacturers have invited PROCEEDINGS readers to write for literature and further technical information. Please mention your I.R.E. affiliation.

(Continued from page 62A)

and military applications has been combined with low-power consumption in a new line of miniature relays for low voltage dc operation, by Struthers-Dunn, Inc., 150 N. 13 St., Philadelphia 6, Pa.

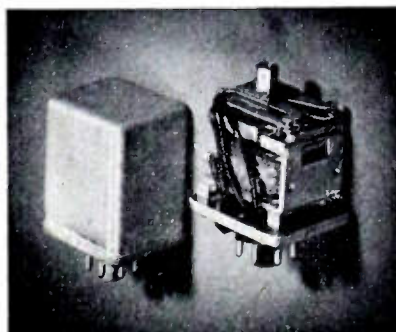

Identified as Frame 181, this box-like really structure offers maximum resistance to mechanical stress. A completely balanced armature minimizes false contact operation under shock and vibration. The manufacturer claims that positive operation of strong leaf spring contacts is assured as the new relays have approximately 50 per cent more coil volume than existing types of comparable size, and an efficient magnetic structure with two working air gaps.

Any contact arrangement up to 4-pole, double-throw can be furnished as a standard open-type relay or with plug-in base and removable or hermetically sealed metal cover.

Bulletin 2610 describing these relays will gladly be sent on request.

Broadcast Controls

Gates Radio Co., Quincy, Ill., manufacturers of commercial radio broadcast equipment, announces their new Model 52-CS Studioette, a medium size studio control console that may be used for AM, FM, or TV in main or substudio service.

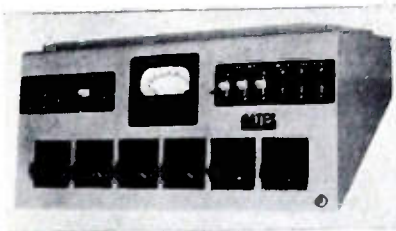

It may also be used as part of master control installation. The Studioette is a complete self-contained speech input system having provisions for four microphones, two transcription turntables, network and remote lines. It is provided with preamplifiers for microphones, plus line and monitoring amplifier for the high-level circuits. The usual facilities of loudspeaker muting, cueing, and circuit facilities have been elaborated upon in this new equipment. A complete descriptive brochure on this product is available by writing to the Gates Radio Co.

(Continued on page 64A)

Etched TUNGSTEN WIRE

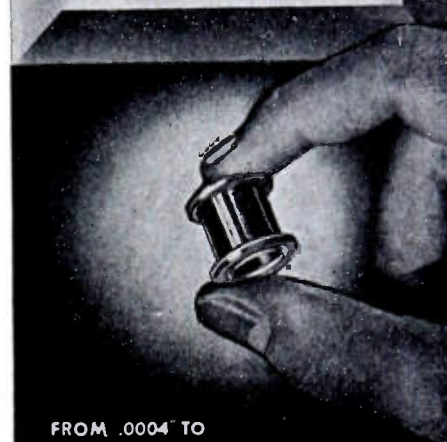

FROM .0004 TO
.00015" AND EVEN SMALLER



Accurate, uniform
and smooth

Also available in
Molybdenum and
other metals

Write for details
and
List of Products

SIGMUND COHN CORP.

44 GOLD ST. NEW YORK

SINCE  1901

News—New Products

These manufacturers have invited PROCEEDINGS readers to write for literature and further technical information. Please mention your I.R.E. affiliation.

(Continued from page 63A)

Optical Lens Principle Loudspeaker

The optical lens principles have been introduced into the manufacture of loudspeakers by the Jensen Mfg. Co., 6601 South Laramie Ave., Chicago 38, Ill.

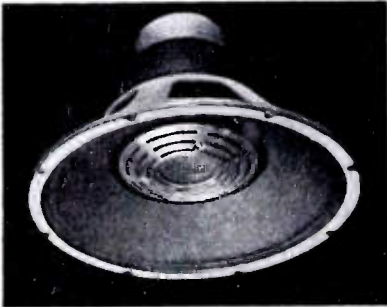

The Jensen Model H-510 employs a direct radiator low end with a separate hf horn and compression driver for the high channel. Presence was enhanced by employing the acoustical analog of the optical diverging lens. As in optics, the acoustic lens with its offset circumferential slots and central opening, permits a controlled time

delay by progressively increasing the acoustic ray path from the center to the edge of the lens. The result is a spherical wavefront maintained out to very high frequencies. This yields a polar pattern that is uniform over an unusually wide angle.

New EMC Volometer Available!

Electronic Measurements Corporation, 423 Broome St., New York, N. Y., has just made available a new 1000 ohms per volt meter with a $4\frac{1}{2}$ -inch square meter (1 Mil D' Arsonval Type meter 2 per cent accurate).

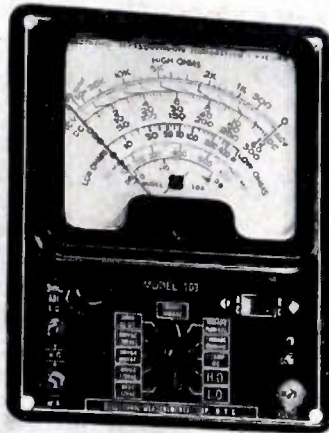

This Model 103 Volometer has 5 db ranges from -4 to +64 db, in addition to 5 ac voltage ranges, 5 dc voltage ranges, 4 dc current ranges, and 3 ac current ranges. The volometer has 2 resistance ranges from 0-1000 ohms and 0-1 megohm.

This model employs the same zero adjustment for both resistance ranges.

Signal Tracer

The Model 777A Dynatracer is a new model signal tracer marketed by Radio City Products Co., 152 W. 25 St., New York 1, N. Y.

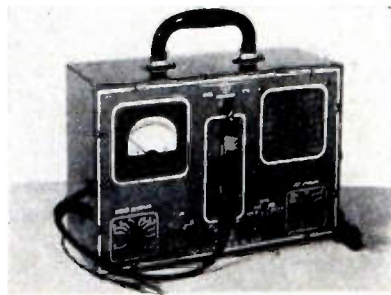

The new model provides for tracing any type of disturbance or circuit defect from the antenna to the speaker. It indicates noise pickup at the aerial, checks AVC, AFC, link and filter circuits. The operator

(Continued on page 65A)

Webster Electric Quality Cartridge

MODEL A

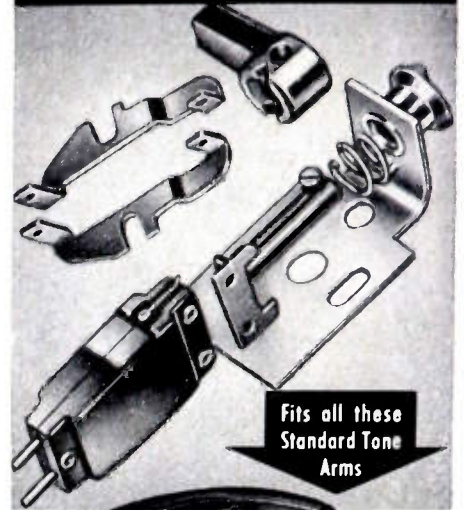

Fits all these Standard Tone Arms

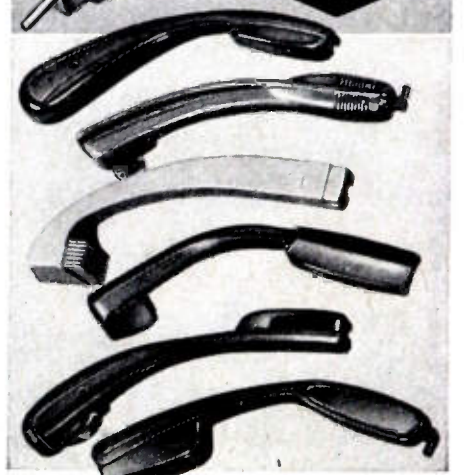

Plays 33 $\frac{1}{3}$ and 45 RPM or 78 RPM Records

Webster Electric Cartridge Model A is a versatile, miniature-size cartridge which is furnished complete with brackets permitting its use in nearly every record changer tone arm on the market today. Designed to play 33 $\frac{1}{3}$ and 45 RPM or 78 RPM records, it tracks at only 7 grams. Its extremely light weight simplifies counter-balancing problems. Its small size and simplified, foolproof mechanism make it the ideal cartridge for three speed record changers.

Write us for complete information, prices or samples for tests.

WEBSTER ELECTRIC

Webster Electric Company, Racine, Wisconsin - Established 1909 - Export Dept., 13 East 40th Street, New York 16, N. Y. Cable Address: "Arlob", New York City.

"Where Quality is a Responsibility and Fair Dealing an Obligation"

DO YOU HAVE THE Lafayette Radio 1950 CATALOG?

All famous makes at lowest prevailing prices: Television and Radio Parts—High Fidelity Equipment—P.A. Systems—Tools—Test Equipment, etc.



A valuable 164-page reference book no engineer should be without. Serving the field for 29 years. Send for your FREE copy today.

INTERESTED IN HIGH FIDELITY?

Check the coupon, and we'll also send you the new "High Fidelity Music Guide" prepared by David Randolph, noted musicologist and music consultant to Lafayette Radio.

Lafayette Radio

NEW YORK: 100 Sixth Avenue and 542 E. Fordham Road CHICAGO: 901 W. Jackson Blvd. BOSTON: 110 Federal St. NEWARK: 24 Central Avenue. ATLANTA: 265 Peachtree St.

LAFAYETTE RADIO, Dept. PC-50
100 6th Avenue, New York 13, N.Y.
or 901 W. Jackson Blvd., Chicago 7, Ill.

Rush me FREE copy of

1950 Lafayette Catalog (Please do not request if you have already received a copy.)

David Randolph's "High Fidelity Music Guide"

Name

Address

City

Zone

State

PASTE ON PENNY POSTCARD

News—New Products

These manufacturers have invited PROCEEDINGS readers to write for literature and further technical information. Please mention your I.R.E. affiliation.

(Continued from page 64A)

gets readings of signal strength and actually hears the signal and any variation or distortion at any point in the circuit. It permits him to follow through from the antenna through each stage of rf, if, af step by step without operating any switch or changing to different channels in the instrument.

Attenuation is 10,000 to 1 by means of a ladder attenuator with vernier control. Sensitivity is 10,000 microvolts for full-scale deflection of meter, or 200 microvolts per division. Frequency range covers approximately 160 Mc.

Automatic control switch permits either speaker or meter to be used alone, together, or standby.

RF Phase Monitor

Clarke Instrument Corp., 910 King St., Silver Spring, Md., has recently announced its Model 109 high-precision phase monitor for measuring phase relations at radio frequencies.

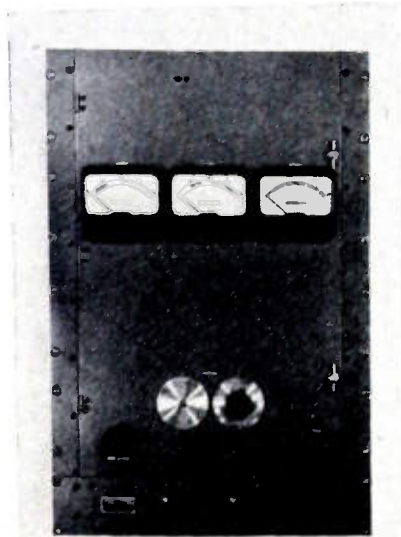

The instrument has an absolute accuracy of $\pm 1^\circ$ and resolution and repeatability of $\pm 0.1^\circ$. Phase is read directly from two dials calibrated in 0.1° increments. "Operator error" is eliminated, since the answer obtained is not dependent upon the skill of the operator in making preliminary adjustments. The instrument continuously and automatically indicates the phase difference, and requires no manipulation on the part of the operator. Provision is made to indicate antenna current in the various towers of a directional array, as well as to indicate the phase relations.

New Model Radiation Survey Meter

The Model 263B (a modification of the 263A) beta-gamma survey meter is being

manufactured by Victoreen Instrument Co., 5806 Hough Ave., Cleveland 3, Ohio.



The Model 263B was designed for semiquantitative work and is highly sensitive to beta and gamma ray radiation. Full scale sensitivity on three ranges is 130, 1300, and 13000 counts per second. A microammeter calibrated (with gamma rays from radium) in milliroentgens per hour, measures the average intensity of beta and/or gamma radiation.

The counter tube is housed in a probe which mounts on the outside of the case and is capable of detecting individual ionizing particles. A movable shield on the probe facilitates the measurement of either beta and gamma rays, or gamma rays alone.

Selenium Rectifiers for Bias Supply

Two miniature types have been added to the line of Seletron rectifiers manufactured by Radio Receptor Co., Inc., 84 N. 9 St., Brooklyn 11, N. Y.

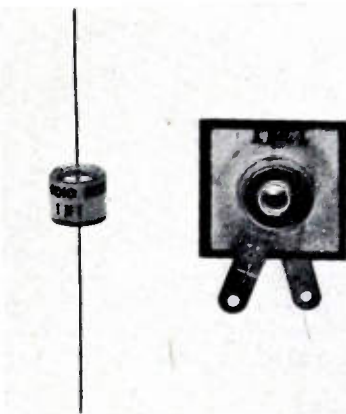

They are designed for bias supply, but may be applied to other half-wave applications within specified limits. Number 1X1, the cartridge type, is rated at 10 volts ac input and 10 milliamps dc output; number 1M1, the plate type, is rated at 25 volts ac input and 100 milliamps dc output.

The manufacturer states that the fixed bias offers advantages over the conventional cathode bias supply for biasing power output tube grids in radio-receiver and amplifier bias supplies. It gives more power output, increased stability, and less distortion for a given current.

Which pin saves the money?

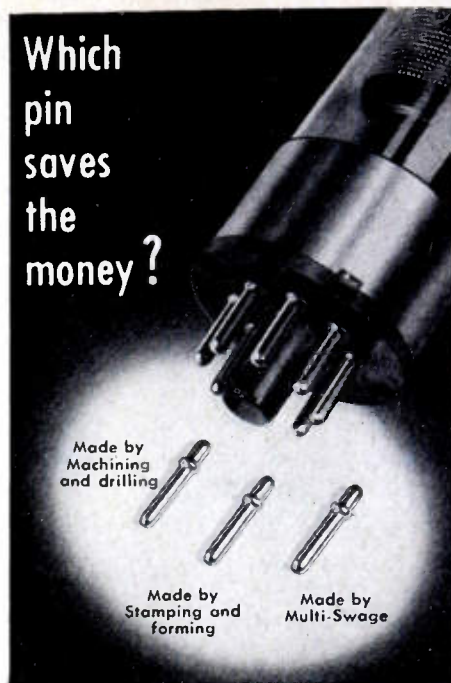

Choose right and make Big Savings on SMALL METAL PARTS

COSTS HALVED! Instead of turning and drilling parts like these from solid rod, or stamping and forming them, the BEAD CHAIN MULTI-SWAGE Process automatically swages them from flat stock. By doubling the production rate and eliminating scrap, this advanced process can save you as much as fifty percent of the cost of other methods.

The BEAD CHAIN MULTI-SWAGE Process produces a wide variety of hollow or solid metal parts—beaded, grooved, shouldered—from flat stock, tubing, rod, or wire—of any metal. Sizes to $\frac{1}{4}$ " dia. and $1\frac{1}{2}$ " length.

GET COST COMPARISON ON YOUR PARTS—If you use small metal parts in quantities of about 100,000, don't overlook the almost certain savings of this high-speed, precision process. Send sketch, blueprint or sample part and our engineers will furnish facts about Multi-Swage economy. Or, write for Catalog. The Bead Chain Manufacturing Co., 60 Mountain Grove St., Bridgeport, Conn.

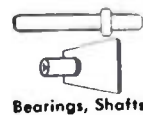

Bearings, Shafts

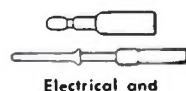

Electrical and Electronic Parts

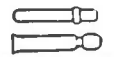

Friction Fasteners



Guides



Stops



Posts, Pins

B BEAD CHAIN MULTI-SWAGE PROCESS



Do Radio-Electronic Engineers KNOW what you make?

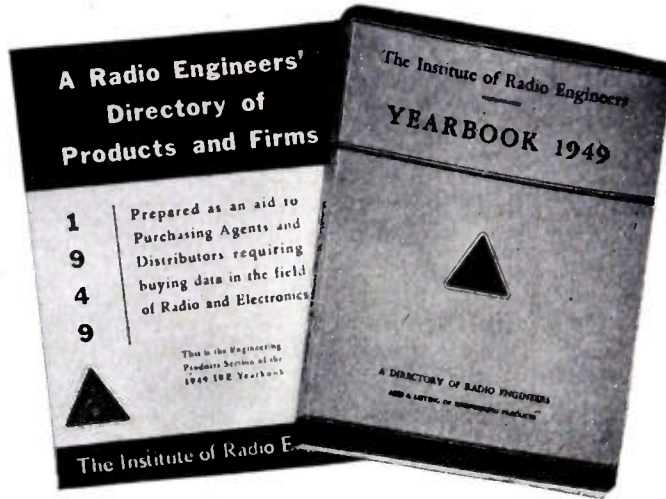

Distributors Edition, over 200 pages of supply firms index, plus comprehensive engineering products list. Advertising repeated here.

Full IRE YEARBOOK supplied to members, nearly 500 pages of three directories in one, engineers, firms and products. Advertising originates here.

● If they ought to know, tell them in the IRE YEARBOOK. This is the Directory in which they have a personal interest. It lists more than 17,500 members of The Institute of Radio Engineers and gives their membership grade, length of membership, business connection and address. It contains the annual report of the Institute, its Constitution, an index to supply firms in the radio-electronic field, and an engineers' guide to products.

● 3327 different firms have cooperated in helping set up the company and product indexes, supplying detailed listings of the radio-and-electronic products they make or services offered. 17,500 members have helped by furnishing their personal reports. The whole project is a co-operative, non-profit service to members and the industry they serve by supplying an annually corrected directory of engineers, firms and products in one, easy-to-use volume.

● The information provided is unique. Engineers work with engineers and the membership lists provide both a fellowship service and a record of experience and standing, vital in a technical and scientific industry.

The product data is arranged in fundamental classifications, established by engineers, for engineers. They are director, and faster to use than terminology classifications. In the alphabetical list of firms, number coding reveals all the engineering products each firm makes for our industry. This gives a more comprehensive picture of manufacturing and service firms than appears in any other directory in the field.

● One advertisement works a whole year for your firm in the IRE YEARBOOK. Issued annually in Sep-

tember, this book is kept as a prized possession by each member until the next comes out. It is used again and again because of its three important services — engineers, firms and products, so completely and clearly indexed. Moreover, the advertiser gets all the “breaks” in this Directory because all his listings are in bold type, with cross-reference to the page of his display message.

● Space costs are economical, and requirements very flexible, ranging from a one inch engineers card, or a sixth of a page display unit to complete catalog inserts. All ad unit sizes are standard to the 7x10 inch, 3 column page. Rates are:

1/6th page	\$ 60.
1/3rd page	\$100.
2/3rd page	\$180.
Full page	\$250.
2 pages or spread	\$450.
Catalog insert rates on request.	

Identical to one Time “Proceedings of the I.R.E.” rates. Contract advertisers get same discounts.

● The economical catalog insert plan started in 1948 has proved a boon to firms wishing radio engineers to have their full data in a permanent and always available file. Catalog advertisers doubled in 1949. Prices will be quoted simply for inserting preprinted 8 1/2" x 11" technical catalogs, or including production and printing.

● The IRE YEARBOOK is the “product reference” part of the IRE Balanced Promotion Program. Advertising in “Proceedings of the I.R.E.” provides “product promotion,” and a Radio Engineering Show exhibit is “product presentation.” Ask us for the Program Plan.



TO SELL THE
RADIO
INDUSTRY

THE INSTITUTE OF RADIO ENGINEERS

Established  1913

A Balanced Promotion Package

“Proceedings of the I.R.E.” The IRE Yearbook
The Radio Engineering Show

303 WEST 42nd STREET, NEW YORK 18, N. Y.
Circle 6-6357

TELL THE
RADIO
ENGINEERS

INDEX AND DISPLAY ADVERTISERS

Section Meetings	37A
Student Branch Meetings	42A
Membership	45A
Positions Open	50A
Positions Wanted	52A
News-New Products	60A

DISPLAY ADVERTISERS

Acme Electric Corp.	60A
Aerovox Corp.	22A
Amperex Electronic Corp.	Cover II
Arnold Engineering Co.	4A
Astatic Corp.	43A
Antara Products	30A & 31A
Bead Chain Mfg. Co.	65A
Bell Aircraft Corporation	51A
Bell Telephone Laboratories	2A
Bendix Aviation—Radio Div.	50A
Berkeley Scientific Co.	55A
W. J. Brown	67A
Browning Labs.	38A
Bud Radio, Inc.	53A
Cambridge Thermionic Corp.	52A
Cannon Electric Development Co.	55A
Capitol Radio Eng. Inst.	53A
Centralab	33A, 34A, 35A, 36A
Cleveland Container Co.	14A
Sigmund Cohn Corp.	63A
Collins Radio Co.	21A
Communication Products Co.	23A, 41A
Communications Equipment Co.	58A & 59A
E. J. Content	67A
Cornell-Dubilier Electric Corp.	Cover III
Cossor Ltd.	63A
Crosby Labs	67A
Allen B. DuMont Labs.	12A & 13A, 26A
Eitel-McCullough, Inc.	8A
Electrical Reactance Corp.	5A
Electro Mechanical Research	56A
Electro-Motive Mfg. Co.	7A
Electro Search	67A
Elk Electronics	67A
W. L. Foss	67A
Freed Radio Corp.	52A
General Aniline & Film Corp.	30A & 31A
General Electric Co.	10A & 11A
General Radio Co.	Cover IV
Paul Godley	67A
H. L. Gordon	67A
S. Gubin	67A
Hewlett-Packard Co.	3A
Hughes Aircraft Co.	50A
Hughey & Phillips	44A
Jacobs Instrument Co.	50A
E. F. Johnson Co.	47A, 62A
Kings Electronics	57A
Kenyon Transformer Co., Inc.	56A
Lafayette Radio	64A
Lambda Electronics Corp.	60A
D. E. Makepeace Co.	27A
P. R. Mallory & Co., Inc.	18A
Marion Electrical Inst. Co.	25A
Measurements Corp.	49A, 67A
Mycalex Corp. of America	16A, 39A
National Carbon Co.	9A
North American Aviation, Inc.	51A
Ohmite Mfg. Co.	17A

Panoramic Radio Products, Inc.	62A
Pickard & Burns	67A
Radio Corp. of American	32A, 50A, 68A
Paul Rosenberg	67A
Sanborn Co.	42A
Servo Corp. of America	55A
Sheldon Electric Co.	20A
Shure Bros.	40A
Simpson Electric Co.	19A
Sorensen & Co., Inc.	37A
Spencer Kennedy Labs.	49A
Sperry Gyroscope Co., Inc.	15A, 52A
Sprague Electric Co.	1A
Stackpole Carbon Co.	24A
Stoddart Aircraft Radio Co.	47A, 54A
Sylvania Electric Prod. Co.	6A
Tech Labs.	54A
Technology Instrument Corp.	45A
Tektronix Inc.	48A
Transradio Ltd.	48A
Truscon Steel Co.	28A
United Transformer Corp.	29A
D. Van Nostrand Co., Inc.	60A
Waterman Products Co., Inc.	44A
Webster Electric Co.	64A
Wells Sales Inc.	61A
Westinghouse Electric Corp.	51A
H. A. Wheeler	67A
S. S. White Dental Mfg. Co.	46A

PROFESSIONAL CARDS

W. J. BROWN

Registered Professional Engineer Specializing in
INDUSTRIAL ELECTRONICS
New Systems developed from Basic Principles
512 Marshall Bldg., Cleveland 13, Ohio
TOwer 1-6498 FAirmount 1-0030

EDWARD J. CONTENT

Acoustical Consultant
Functional Studio-Theater Design
FM — Television — AM
Audio Systems Engineering
Roxbury Road Stamford 3-7459
Stamford, Conn.

CROSBY LABORATORIES

Murray G. Crosby & Staff
FM, Communications, TV
Industrial Electronics
High-Frequency Heating
Offices, Laboratory & Model Shop at:
126 Herricks Rd. Mineola, N.Y.
Garden City 7-0284

Richard B. Schulz

Electro-Search

Radio-Interference Reduction;
Development of
Interference-Free Equipment,
Filters, Shielded Rooms
515 W. Wyoming Ave., Philadelphia 40, Pa.
Gladstone 5-5353

ELK ELECTRONIC LABORATORIES

Jack Rosenbaum
Specializing in the design and
development of
Test Equipment for the communications,
radar and allied fields.
12 Elk Street Telephone:
New York 7, N.Y. WOrth 2-4963

WILLIAM L. FOSS, INC.

927 15th St., N.W. REpublic 3883
WASHINGTON, D.C.

PAUL GODLEY CO.

Consulting Radio Engineers
P.O. Box J, Upper Montclair, N.J.
Offs & Lab.: Great Notch, N.J.
Phone: Montclair 3-3000
Established 1926

HERMAN LEWIS GORDON

Registered Patent Attorney
Patent Investigations and Opinions
Wamer Building 100 Normandy Drive
Washington 4, D.C. Silver Spring, Md.
National 2497 Shepherd 2433

SAMUEL GUBIN, Electronics G. F. Knowles, Mech. Eng. SPECTRUM ENGINEERS, Inc.

Electronic & Mechanical Designers
540 North 63rd Street
Philadelphia 31, Pa.
GRanite 2-2333; 2-3135

MEASUREMENTS CORP.

RESEARCH & MANUFACTURING
ENGINEERS
Harry W. Houck Jerry B. Minter
John M. van Beuren
Specialists in the Design and
Development of Electronic Test Instruments
BOONTON, N.J.

PICKARD AND BURNS, INC.

Consulting Electronic Engineers.
Analysis and Evaluation
of Radio Systems
Research, Development & Design
of Special Electronic Equipment
240 Highland Ave., Needham 94, Mass.

PAUL ROSENBERG ASSOCIATES

Consulting Physicists
Main office: Woolworth Building,
New York 7, N.Y.
Cable Address Telephone
PHYSICIST WOrth 2-1939
Laboratory: 21 Park Place, New York 7, N.Y.

TECHNICAL MATERIEL CORPORATION

COMMUNICATIONS CONSULTANTS
RADIOTELETYPE - FREQUENCY SHIFT
INK SLIP RECORDING - TELETYPE NETWORKS
453 West 47th Street, New York 19, N.Y.

WHEELER LABORATORIES, INC.

Radio and Electronics
Consulting — Research — Development
R-F Circuits — Lines — Antennas
Microwave Components — Test Equipment
Harold A. Wheeler and Engineering Staff
Great Neck, N.Y. Great Neck 2-7806



New scintillation counter, using electron tube developed at RCA Laboratories, gives faster, more accurate measurements of atomic radiations.

What can you hear through an *ear of grain*?

When agriculturists want to learn what nourishment a plant is getting, they inject radioactive materials into the soil and trace their absorption with sensitive instruments. Industry and medicine also use this ingenious technique to gain needed knowledge.

Until recently, scientists literally *heard* what was happening, for they followed the passage of atomic materials through plants or machines, or even the human body, with a clicking Geiger counter. Now a more sensitive instrument — a new scintillation

counter made possible by a development of RCA Laboratories—can do the job more efficiently.

Heart of this counter is a new multiplier phototube, so sensitive that it can react to the light of a firefly 250 feet away! In the scintillation counter, tiny flashes, set off by the impact of atomic particles on a fluorescent crystal, are converted into pulses of electrical current and multiplied as much as a million times by this tube.

See the newest advances in radio, television, and electronic science at RCA Exhibition Hall, 36 W. 49th St., New York. Admission is free. Radio Corporation of America, Radio City, N. Y.



The principle of RCA's multiplier phototube is also used in the super-sensitive RCA Image Orthicon television camera, to give you clear television pictures in dim light.



RADIO CORPORATION of AMERICA
World Leader in Radio — First in Television

new

TINY
MIKE®

miniature ceramic
disc capacitors



Now — take advantage of these new, space-saving, miniature ceramic capacitors, designed for bypass and coupling in ultra-compact assemblies. These ceramics incorporate the same dependable performance built into the highly specialized C-D ceramic capacitors, used for years by the world's largest manufacturers of radio equipment.

C-D TINYMIKES OFFER YOU DISTINCT ADVANTAGES IN CAPACITOR DESIGN:

- Ideal for cramped chassis layouts: only 19/32" in diameter, only 5/32" thick.
- TINYMIKES are lighter than other types of same capacity and voltage rating.
- Short current path and parallel leads reduce inductance to lowest possible level.
- Resistance is fixed at a low level by solder-connected leads directly to the high-purity silver electrodes.
- Use of two electrodes accurately positioned in relation to each other reduces eddy current losses to a minimum and increases the Q.

- High dielectric strength of the C-D ceramic, high insulation resistance and low power factor assure constant and dependable service.
- Protected against the effects of humidity by a special phenolic coating and high-temperature wax impregnation.
- Presently available in 500 volts DC working, with units in the range of 1000 mmfd. to 5000 mmfd. rated on a basis of guaranteed minimum capacity over a temperature range of + 10°C to + 65°C. Units in the 100 to 150 mmfd. range can be supplied at a tolerance of ± 10% or ± 20%.

Write today for complete technical data on these new C-D TINYMIKE Ceramic Capacitors. Engineering inquiries solicited. CORNELL-DUBILIER ELECTRIC CORPORATION, Dept. M30, South Plainfield, New Jersey. Other plants in New Bedford, Brookline and Worcester, Mass.; Providence, R. I.; Indianapolis, Ind., and subsidiary, The Radiart Corp., Cleveland, Ohio.

C-D Best by Field Test!

CONSISTENTLY DEPENDABLE

CORNELL-DUBILIER

CAPACITORS — VIBRATORS

ANTENNAS — ROTATORS — CONVERTERS



1910 1950



100 to 500 Mc OSCILLATOR



THIS oscillator, designed for use as a power source for general laboratory measurements and testing, covers the frequency range of 100 Mc to 500 Mc. With its associated power supply it is small, lightweight and compact. The entire range is covered with a single-dial frequency control with a slow-motion drive equipped with an auxiliary scale.

FEATURES

- Dial calibrated directly in megacycles to an accuracy of $\pm 1\%$
- Vernier dial with 100 divisions, covering the oscillator range in ten turns
- Output through a coaxial jack with provision for varying coupling
- Output of $\frac{1}{2}$ -watt at 500 Mc
- Electron-ray tube in power supply to indicate grid current and furnish indication of oscillation
- Filament and plate power furnished by the Type 857-P1 Power Supply which is furnished with the oscillator

TYPE 857-A U-H-F OSCILLATOR (with power supply) . . . \$285

The tuned circuit of the Type 857-A Oscillator is our well-known Butterfly type. The difficulty of sliding contacts in any part of the oscillator circuit is avoided in this unique construction. The photograph above shows the output coupling loop and output jack. Coupling can be changed from maximum to almost zero by rotating the output jack.



GENERAL RADIO COMPANY

Cambridge 39,
Massachusetts

90 West St., New York 6 920 S. Michigan Ave., Chicago 5 1000 N. Seward St., Los Angeles 38