

# Proceedings



of the I·R·E

**A Journal of Communications and Electronic Engineering**  
(Including the WAVES AND ELECTRONS Section)

**November, 1948**

Volume 36

Number 11

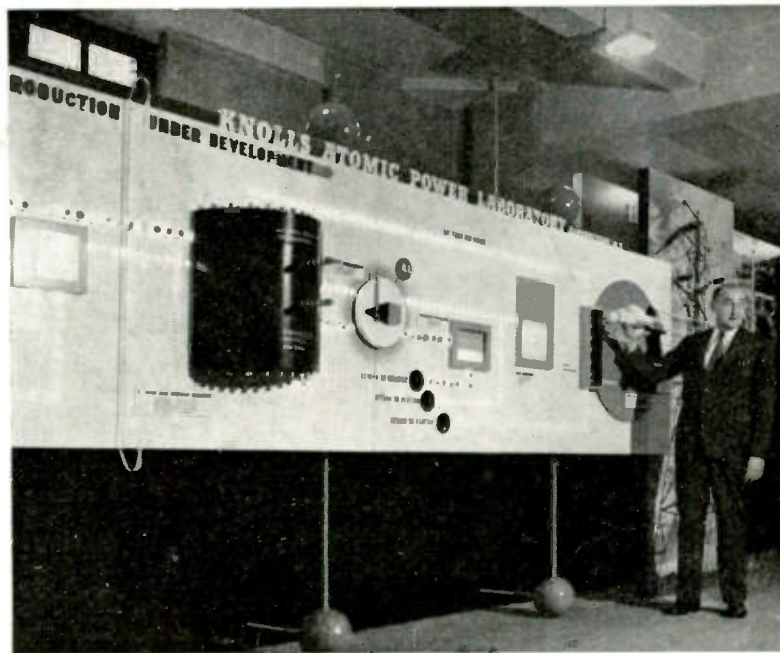

*Atomic Energy Commission and General Electric Company*

## PUBLIC EDUCATION IN NUCLEAR OPERATIONS

Schematic presentation shows flow of materials and energy as two uranium isotopes spawn plutonium, energy, and many by-products. (This model was shown in New York City, starting in August, 1948.)

## PROCEEDINGS OF THE I.R.E.

The Philosophy of PCM  
Pentriode Amplifiers  
Isotopes and Nuclear Structure  
Duplex Tetrode UHF Power Tubes  
Electrostatically Focused Radial-Beam Tube  
High-Power Interdigital Magnetrons  
Electromagnetic Systems Model Theory  
HF Polyphase Transmission Line  
Coaxial Transmission-Line Elements in Low-Pass Filters  
Parabolic Loci for Two Tuned Coupled Circuits

## Waves and Electrons Section

Technical Problems of Future Military Radio Communications  
Telemetry Guided-Missile Performance  
Waveguide Bridge for Measuring 4000-Mc Gain  
High-Level Single-Sideband Transmitter  
Antenna for Controlling the Nonfading Range of Broadcasting Stations  
Light-Pattern Meter  
Abstracts and References

TABLE OF CONTENTS FOLLOWS PAGE 32A

# The Institute of Radio Engineers



# AMPEREX

is FIRST again

with the most extensive line of  
production-standardized, self-quenching

## RADIATION COUNTER TUBES



**A**MPEREX has the most complete line of standardized types of radiation counter tubes that are actual production line models. If you are working on anything which requires radiation counter tubes, chances are that Amperex can fit you neatly with a tube from our regular line. Save time...save money...write today for detailed Amperex literature.

*re-tube with  
Amperex...*

**AMPEREX ELECTRONIC CORP.**

25 WASHINGTON STREET, BROOKLYN 1, N. Y.

In Canada and Newfoundland: Rogers Majestic Limited  
11-19 Brentcliffe Road, Leaside, Toronto, Ontario, Canada



# VITAL LINKS IN Nuclear Research

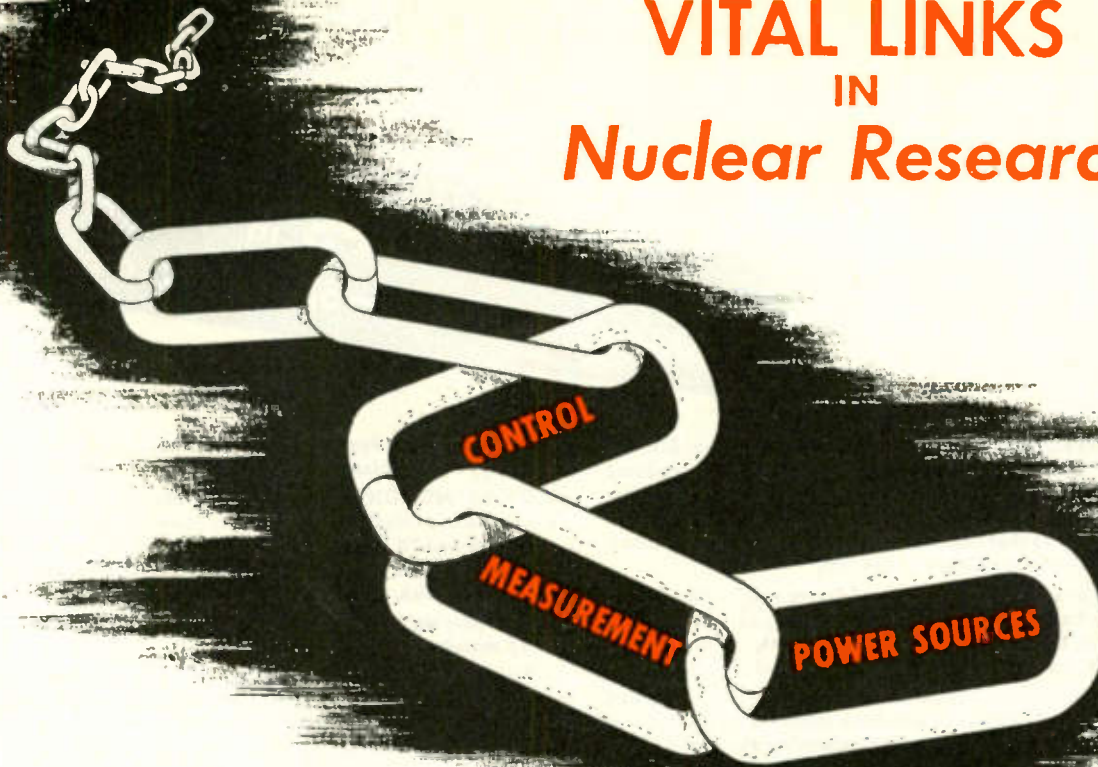

## SHERRON CAN DESIGN AND MANUFACTURE:

**COUNTERS:** Maximum count as required. Pre-determined setting anywhere within the counting range. Resolution in the micro-second region.

**COMPUTERS:** Mechanical linkages. Electrical analogues of any complexity. Digital computers.

**SERVO-MECHANISMS:** Control to any desired accuracy. Power as desired. Linear control, logarithmic control.

**AMPLIFIERS:** R.F., Video, A.F., D.C. to fit any application. Particular emphasis on high gain, high stability characteristics.

**OSCILLATORS:** All frequencies.

**POWER SUPPLIES:** Electronic—Regulation  $\frac{1}{2}$  % and less.

**REGULATORS:** Electronic—direct or through servo control. Regulation, drift, etc. to specification.

**MEASUREMENT—CONTROL:** Devices for measuring and control of all parameters capable of being controlled and producing proportional electrical, optical or measuring displacement. Electronic microammeters, radiation counters.

**CONTROL OF ACCELERATOR ACCESSORIES:** Grouping of controls, supplementary apparatus, and experimental system into a compact versatile unit.

## SHERRON PROVIDES ALL 3

In each of these essential elements of nuclear research, Sherron can give you expert service.

Years of active experience in electronics manufacture provide a practical background for our readiness to produce special designs in custom made precision instruments for nuclear exploration. A complete staff of veteran physicists and engineers is always on hand to study your problems and work out your requirements. Inquire!



# SHERRON ELECTRONICS CO.

Division of Sherron Metallic Corporation

1201 FLUSHING AVE. • BROOKLYN 6, NEW YORK

# The 1304 is *TOPS!*

**TOPS** in  
Reproduction quality—operating convenience

**REPRODUCTION QUALITY?** The Western Electric 1304 Set combines the 109 Type Reproducer Group with its extremely low intermodulation distortion and a unique new driving mechanism (shown in Fig. 1) that cuts flutter to a value lower than many standard recording equipments.

Even the small amount of flutter originating in the mechanism's simple gearing is damped in the novel filter of Fig. 2. Result: a flutter level, including wow, of less than 1/10 of 1% at both 78 and 33-1/3 rpm.

The platter has been isolated from the sources of rumble by means of the drive isolation coupling (Fig. 4), the fabric belt, and by mounting the entire drive mechanism on rubber vibration mounts (Fig. 3). The large drive pulleys, the use of large belt wrap around,

and an adjustable spring loaded idler pulley prevent belt slippage problems.

**OPERATING CONVENIENCE?** Speed change-over at the throw of a switch. Acceleration to 33-1/3 rpm in 1/9 revolution—to 78 rpm in less than 1/2 revolution. Rapid slowdown—no overdrive—convenient flange on platter for quick stopping.

And playing time variation is less than  $\pm 2$  seconds in 15 minutes!

Scientific placement of elements facilitates operation. An annular groove in the platter makes it easy to grasp edge of 10- or 12-inch records. 706A Guard provides automatic arm rest, keeps stylus from dropping on panel, catching in turntable felt, or striking edge of revolving platter.

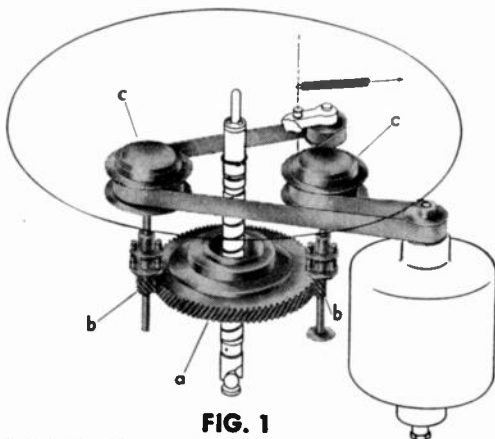

FIG. 1

A single helical ring gear (a), is permanently meshed with two pinion gears (b), each driven by an overriding clutch (c). Reversing direction of motor rotation disengages one overriding clutch, engages the other to change platter speed. Permanently meshed gears eliminate possibility of flutter caused by wear of engaging and disengaging.

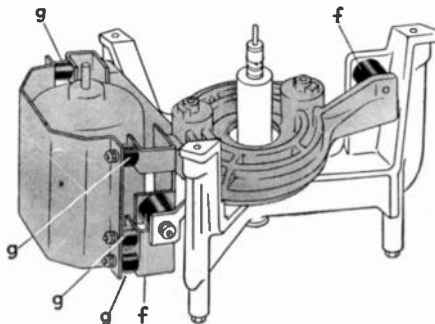

FIG. 3

The entire mechanism, including motor, floats separately from frame and platter shaft on three large rubber mountings (f). Motor, in turn, is isolated from the gear system by smaller rubber mountings (g) and the use of belt drive.

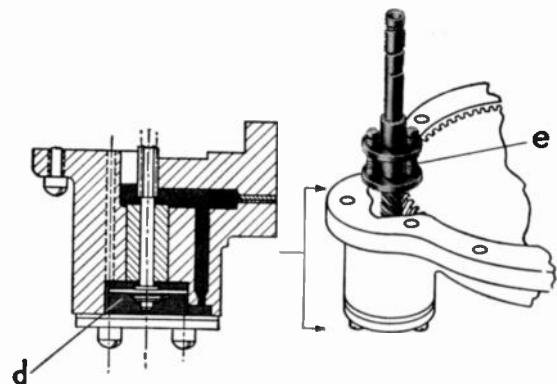

FIG. 2

As shown in cut-away view, a coupling (e) allows each pinion and associated shaft to move a short distance along its axis. The bottom of each pinion shaft projects into an oil-filled chamber (d) for damping axial motion. Because of the helical gearing and the high inertia of the turntable platter, irregularities in the drive tending to cause flutter are taken up and damped in axial motion of the driving pinion.

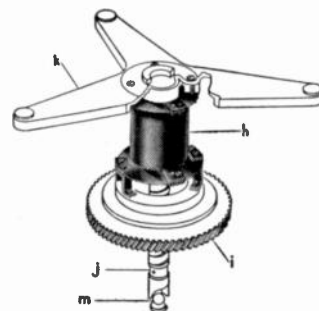

FIG. 4

Drive isolation coupling (h), provides the only connection between driving gear (i), platter shaft (j) and platter support (k), completing the separation of drive mechanism from platter. This coupling—very rigid in rotational plane, highly flexible in all others—transmits the driving motion, but isolates the rumble-causing motion. Platter and support ride on a hardened single ball thrust bearing (m).

# TOPS in flexibility of installation

**T**HE WESTERN ELECTRIC 1304 Type Reproducer Set is a single compact unit, readily adaptable to a wide range of installation require-

ments. It is available in a variety of cabinet arrangements to permit the greatest possible flexibility in installation.

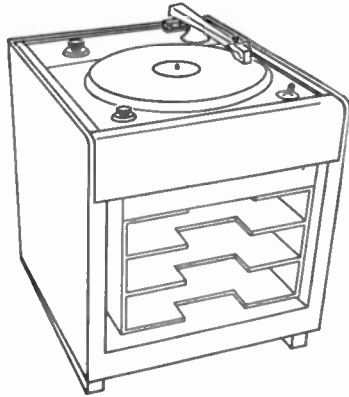

**FIG. 5**

The 1304 Reproducer Set, includes a floor type cabinet with or without a removable door. The 701A Shelf is available which provides record storage space (Fig. 5), or the cabinet may be arranged for

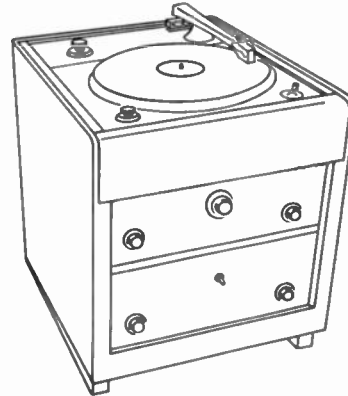

**FIG. 6**

mounting standard amplifying equipment (Fig. 6). In either case, additional space for equipment is available at the rear of the cabinet.



**FIG. 7**

If you want the superb reproduction and the operating convenience of the 1304—but prefer to use an existing table or a specially built cabinet—just specify the 304 Type Reproducer Panel. This is a complete panel unit, all ready to install, with exactly the same drive mechanism used in the 1304. The 109 Group with 706A Guard, on-off and speed-change switches and platter are all included.

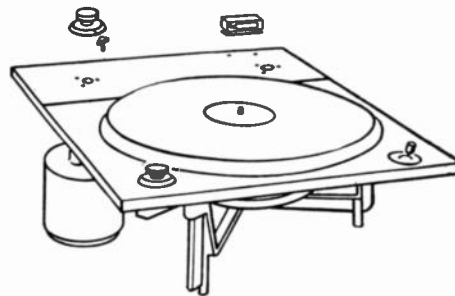

**FIG. 8**

You can also use the drive mechanism of the 1304 with your own reproducer group. The 305A Panel is drilled to take the 109 Type Group, and is furnished with 706A Guard, equalizer knob and the required hardware for mounting the 109 Type Group. The 305B Panel can be drilled in the field to mount reproducer groups other than the 109. (706A Guard and equalizer knob not included.)

**For complete information on the 1304 Reproducer or Reproducer Group—or on the 304, 305A or 305B Panels—call your nearest Graybar Broadcast Representative. Or write Graybar Electric Company, 420 Lexington Avenue, New York 17, N. Y.**



**DISTRIBUTORS: IN THE U.S.A.—Graybar Electric Company. IN CANADA AND NEW-FOUNDLAND—Northern Electric Co., Ltd.**

# Western Electric

**—QUALITY COUNTS—**

**NEW ELECTROLYTICS**  
*fully dependable*  
**TO 450 VOLTS AT 85°C**

ILLUSTRATIONS  
 ACTUAL SIZE

**for TELEVISION'S exacting applications**

Designed for dependable operation up to 450 volts at 85°C. these new Sprague electrolytics are a good match for television's severest capacitor assignments. An extremely high stability characteristic is assured, even after extended shelf life, thanks to a special Sprague processing technique. Greatly increased manufacturing facilities are now available.

*Your inquiries concerning these new units are invited.*

**DEPENDABILITY  
 TO MATCH THESE  
 NEW ELECTROLYTICS!  
 SPRAGUE PHENOLIC  
 MOLDED TUBULARS...**

Highly heat- and moisture-resistant—  
 Non-inflammable—Moderately priced—  
 Conservatively rated for -40°C.  
 to +85°C. operation—Small in size  
 —Completely insulated—Mechani-  
 cally rugged—Thoroughly field-tested  
 Write for Engineering Bulletin 210A

SPRAGUE ELECTRIC COMPANY · NORTH ADAMS, MASS.

**SPRAGUE**

Capacitors  
 \* Koolohm Resistors

PIONEERS OF

ELECTRIC AND ELECTRONIC PROGRESS

\*T. M. Reg. U. S. Pat. Off.

NORTH

SOUTH

EAST

WEST...

millions listen to broadcasts

from local low-power

AM transmitters using

General Electric economy tubes!

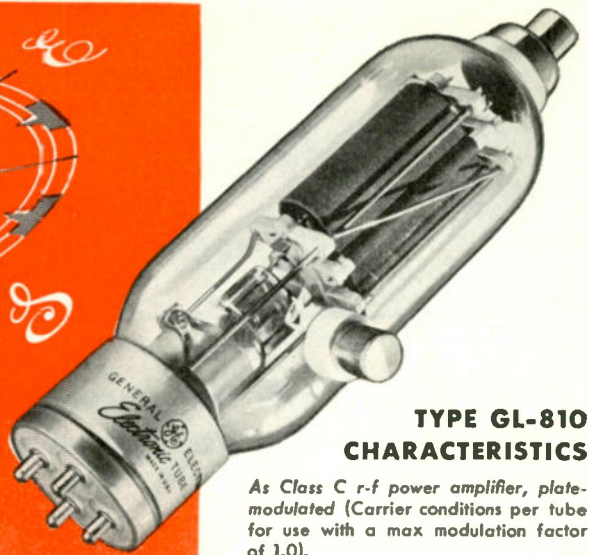

**TYPE GL-810  
CHARACTERISTICS**

As Class C r-f power amplifier, plate-modulated (Carrier conditions per tube for use with a max modulation factor of 1.0).

Filament voltage 10 v  
current 4.5 amp

Max ratings (CCS):  
d-c plate voltage 1,600 v  
d-c grid voltage -500 v  
d-c plate current 210 ma  
d-c grid current (approx) 70 ma  
plate input 335 w  
plate dissipation 85 w

Typical operation:  
d-c plate voltage 1,600 v  
d-c grid voltage -200 v  
d-c plate current 210 ma  
d-c grid current (approx) 50 ma  
driving power (approx) 17 w  
plate power output 250 w



**GL-810  
TRIODE**

**GL-828  
BEAM  
POWER  
TUBE**

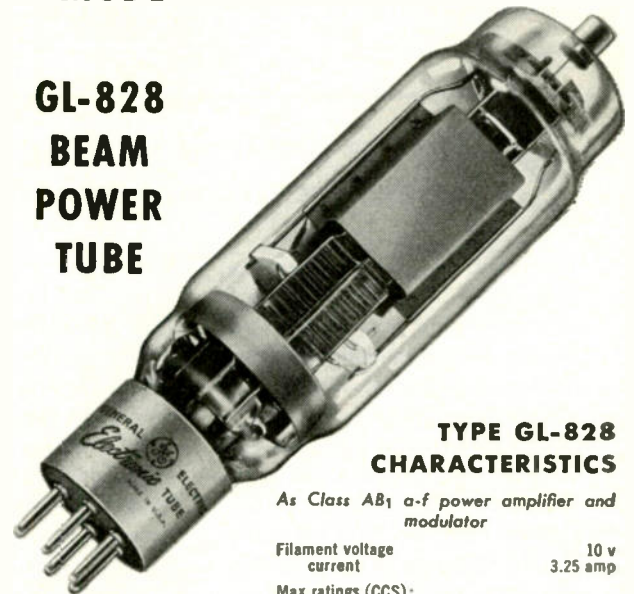

**TYPE GL-828  
CHARACTERISTICS**

As Class AB<sub>1</sub> a-f power amplifier and modulator

Filament voltage 10 v  
current 3.25 amp

Max ratings (CCS):  
d-c plate voltage 1,750 v  
d-c suppressor voltage 100 v  
d-c screen voltage 750 v  
\*max signal d-c plate current 150 ma  
\*max signal d-c plate input 225 w  
\*screen input 16 w  
\*plate dissipation 70 w

Typical operation (CCS), 2 tubes:  
d-c plate voltage 1,700 v  
d-c suppressor voltage 60 v  
d-c screen voltage 750 v  
d-c grid voltage -120 v  
peak a-f grid-to-grid voltage 240 v  
zero signal d-c plate current 50 ma  
max signal d-c plate current 248 ma  
d-c suppressor current 9 ma  
zero signal d-c screen current 4 ma  
max signal d-c screen current 43 ma  
effective load, plate-to-plate 16,200 ohms  
\*\*max signal plate power output 300 w



\* Averaged over any a-f cycle of sine-wave form.

\*\* Distortion only 1 per cent with 20 db of feedback to grid of driver.

**L**OW-PRICED because of large production . . . due to large demand! Shown here are representative G-E power tubes with a nation-wide name for reliability. Specify General Electric tubes in that new transmitter you're designing, to get the biggest dollar-value . . . to get the right tubes (G.E., from its wide list of types, can match precisely your circuit requirements) . . . to enhance your product's standing in the eyes of quality-conscious buyers. A phone-call to your nearby G-E electronics office will bring helpful counsel from tube engineers glad to focus their experience on your problems. Act today!

If you operate a broadcast station, you're interested in fast replacement service. Time off the air is money out-of-pocket. General Electric tubes score again . . . there's a G-E distributor or dealer right in your area, with ample stocks on hand, waiting for your request to rush new tubes to you. You get the types you want, when you want them—built right, priced right, sold right with the solid backing of General Electric's tube warranty! Electronics Department, General Electric Company, Schenectady 5, New York.

**GENERAL ELECTRIC**



FIRST AND GREATEST NAME IN ELECTRONICS

# *This NEW DuMont Type 248-A* does the work of **2** oscillographs

## **1** WITH THE TYPE 5RP-A CATHODE-RAY TUBE AT 4000 VOLTS ACCELERATING POTENTIAL

The new Du Mont Type 248-A, which replaces the former Type 248 in the medium-voltage field, now employs the Type 5RP-A Cathode-ray Tube at an accelerating potential of 4000 volts. As a wide-band oscillograph (5mc) for studies of pulses and other signals containing high-frequency components, the Type 248-A still provides all the desirable features of the discontinued Type 248. In addition, it may be used immediately as a high-voltage os-

cillograph simply by plugging in a suitable power supply. No modification is necessary.

Thus the new Type 248-A can take the place of two instruments—a medium-voltage and a high-voltage cathode-ray oscillograph. And, best of all, production economies allow the new Type 248-A to be sold at the same low price of the former Type 248.

Now, more than ever, the Type 248-A excels any instrument in its class!

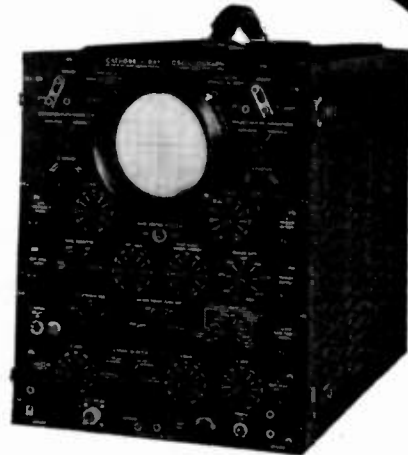

Du Mont Type 248-A  
Cat. No. 1244-E, with 5RP2-A  
\$1870.00

## **2** AND FOR OPERATION AT 14,000 VOLTS ACCELERATING POTENTIAL, JUST PLUG IN THE TYPE 263-B HIGH-VOLTAGE POWER SUPPLY

The requirements of modern oscillography frequently demand relatively high accelerating potentials for the investigation and photo-recording of high-speed transients and pulses of extremely low repetition-rates. 14,000 volts accelerating potential is immediately available for these studies, with the Type 248-A, by simply plugging in a power supply such as the new Du Mont Type 263-B. No modification is necessary.

With the power supply and the Type 2088 Projection Lens, the Type 248-A becomes also a projection oscillograph.

The facility with which the range and versatility of the Type 248-A are thus increased, together with the availability of such Du Mont accessories as projection lenses, power supplies and oscillograph record cameras, is further evidence that in oscillography, Du Mont is always your best buy.



Du Mont Type 263-B  
High-Voltage Power Supply  
Cat. No. 1208-E \$142.50

◆ **Technical details on request**

© ALLEN B. DUMONT LABORATORIES, INC.

# DUMONT

## *for Oscillography*

ALLEN B. DUMONT LABORATORIES, INC., PASSAIC, N. J.  
CABLE ADDRESS: ALBEEDU, NEW YORK, N. Y., U. S. A.





# FOR COMPACT HIGH FIDELITY EQUIPMENT

Ultra compact, lightweight, these UTC audio units are ideal for remote control amplifier and similar small equipment. New design methods provide high fidelity in all individual units, the frequency response being  $\pm 2$  DB from 30 to 20,000 cycles. There is no need to resonate one unit in an amplifier to compensate for the drop of another unit. All units, except those carrying DC in Primary, employ a true hum balancing coil structure which, combined with a high conductivity outer case, effects good inductive shielding. Maximum operating level +10 DB. Weight—5½ ounces. Dimensions—1½" wide x 1½" deep x 2" high.



Unit shown is actual size. 6V6 tube shown for comparison only.

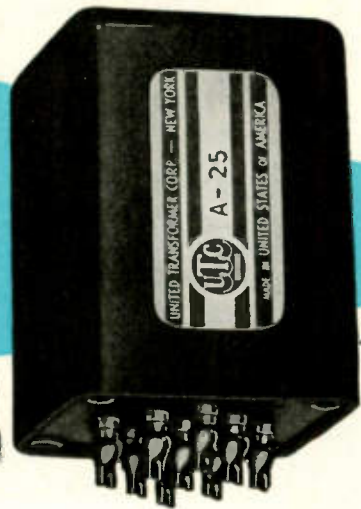

## FOR IMMEDIATE DELIVERY

From Your Distributor

### ULTRA COMPACT HIGH FIDELITY AUDIO UNITS

Type No.	Application	Primary Impedance	Secondary Impedance	$\pm 2$ DB from	List Price
A-10	Low impedance mike, pickup, or multiple line to grid	50, 125, 200, 250, 333, 500 ohms	50,000 ohms	30-20,000	\$15.00
A-11	Low impedance mike, pickup, or line to 1 or 2 grids	50, 200, 500 ohms	50,000 ohms	50-10,000 multiple alloy shield for extremely low hum pickup	16.00
A-12	Low impedance mike, pickup, or multiple line to push pull grids	50, 125, 200, 250, 333, 500 ohms	80,000 ohms overall in two sections	30-20,000	15.00
A-18	Single plate to two grids	8,000 to 15,000 ohms	80,000 ohms overall, 2.3:1 turn ratio overall	30-20,000	14.00
A-24	Single plate to multiple line	8,000 to 15,000 ohms	50, 125, 200, 250, 333, 500 ohms	30-20,000	15.00
A-25	Single plate to multiple line 8 MA unbalanced D.C.	8,000 to 15,000 ohms	50, 125, 200, 250, 333, 500 ohms	50-12,000	14.00
A-26	Push pull low level plates to multiple line	8,000 to 15,000 ohms each side	50, 125, 200, 250, 333, 500 ohms	30-20,000	15.00
A-30	Audio choke, 300 henrys with na D.C. 450 henrys @ 2 MA 6000 ohms D.C., 75 henrys @ 4 MA 1500 ohms D.C., inductance				10.00

The above listing includes only a few of the many Ultra Compact Audio Units available . . . write for more details.

*United Transformer Co.*  
 NEW YORK 13, N. Y.  
 150 VARICK STREET  
 EXPORT DIVISION: 13 EAST 40th STREET, NEW YORK 16, N. Y. CABLES: "ARLAB"

# IT PAYS TO LOOK AT COST PER PART NOT PRICE PER POUND!

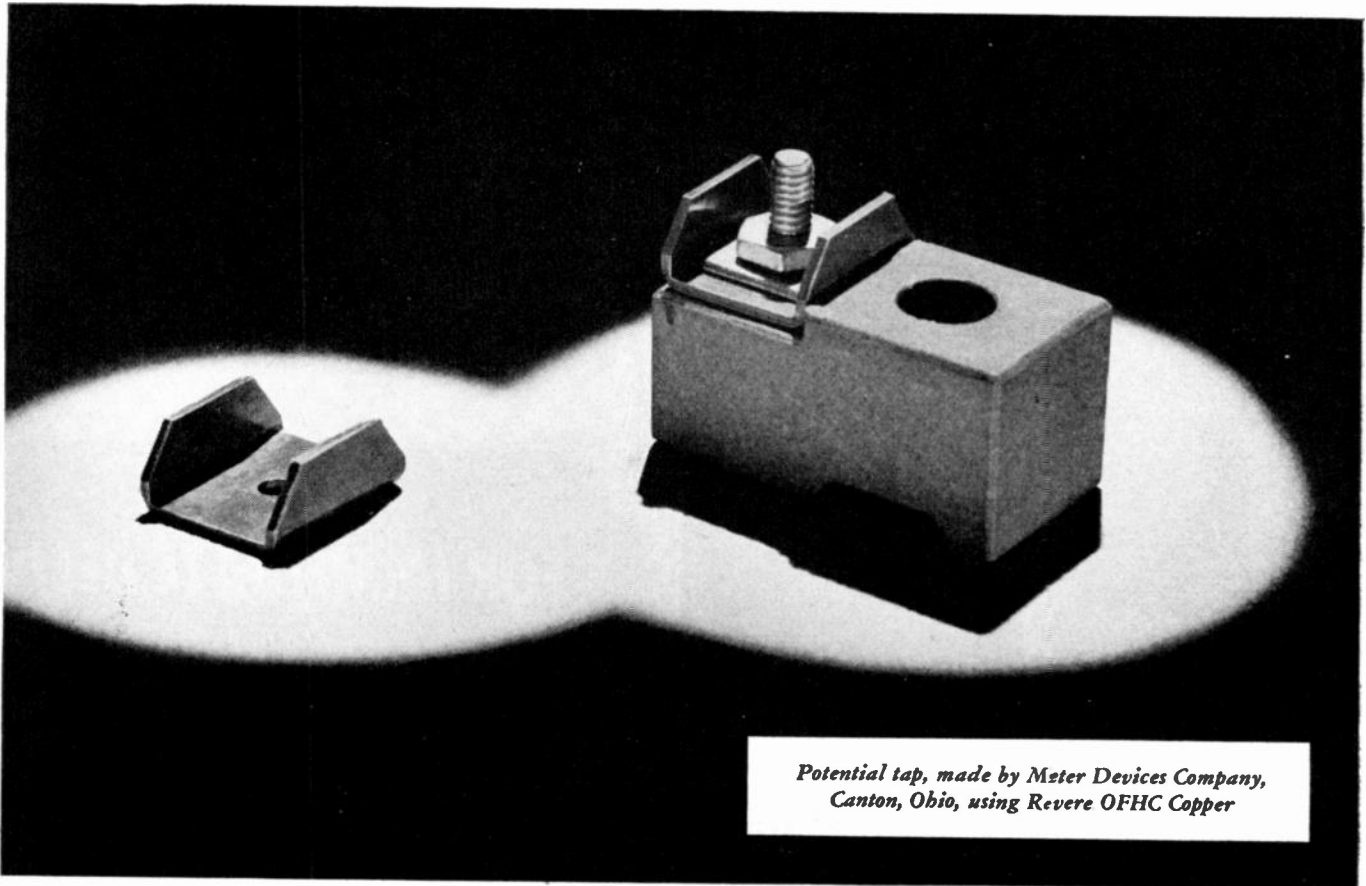

*Potential tap, made by Meter Devices Company,  
Canton, Ohio, using Revere OFHC Copper*

**T**HERE'S certainly nothing complicated-looking about the small stamped channel section of .042" gauge copper shown in the accompanying illustration. And that's what makes this story all the more interesting.

It is told by Mr. T. J. Newman, Manager of the Meter Devices Company, Canton, Ohio.

"Even a relatively simple application can cause trouble," says Mr. Newman, "a lot of trouble—if you are not using exactly the right metal for the particular job.

"In our case the problem centered around this small stamped channel, originally made of electrolytic copper with a Rockwell B 35/45. The part is bolted to a porcelain base and mounted on the test panel in a standard electric meter box. Used on the service box for test purposes, it allows the connection of a small feed-in wire off the main lines to supply the potential coils in the meter.

"Sounds simple enough. Yet complicated trouble came quickly. It started with cracks in the bends. And that resulted in a high percentage of rejections, along with expensively close inspection.

"It was then that we called in the Revere Technical Advisory Service. Acting on their recommendation, we exactly tested potential taps made of OFHC Copper with Rockwell B 49/50. Results were so satisfactory that we plated a considerable production order.

"In doing so we frankly paid a premium for OFHC.

But that premium is much more than offset by our saving in scrap and the all-around reduction in costs. Our potential taps now have no more cracks in the bends—there are no rejections whatever—and expensive inspection has been eliminated."

Thus the Meter Devices Company has learned, by its own exacting tests, that the premium purchase of OFHC Copper is a real economy. Once again it is proved that the real guide to economy is the cost of the finished part, not the price per pound of the metal of which it is made.

This progressive company is only one of the many modern industrial organizations that have profited by calling in the Revere Technical Advisory Service. Perhaps you would profit too. We suggest that you ask the nearest Revere Sales Office for more information.

## **REVERE**

### **COPPER AND BRASS INCORPORATED**

*Founded by Paul Revere in 1801*

230 Park Avenue, New York 17, New York

*Mills: Baltimore, Md.; Chicago, Ill.; Detroit, Mich.; New Bedford, Mass.;  
Rome, N. Y.—Sales Offices in Principal Cities, Distributors Everywhere*



### MOLDED INSULATED TUBULAR GP CERAMICONS

Have extremely rugged, malded insulation, axial leads. Capacity range 10-5,000 MMF. Smallest size .250" x .562" max.

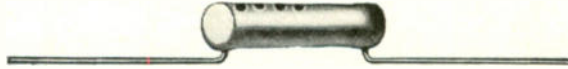

### DIPPED INSULATED GP CERAMICONS

For use where space is at a premium and radial leads are desired Capacity range 10-15,000 MMF. Smallest size .240" x .460" max.



### NON-INSULATED GP CERAMICONS

Smallest size units. Have baked enamel coating, radial leads. Capacity range 10-15,000 MMF. Smallest size .200" x .400" max.



### INSULATED STAND-OFF CERAMICONS

Rugged, molded insulated construction. Mounts with 6-32 nut. Style 323 mounts 19/32" high above chassis. Capacity range 0.5-700 MMF. Style 324 mounts 27/32" high Capacity range 710-1,500 MMF. Available with 20 gauge wire lead or post type top terminal.



### NON-INSULATED STAND-OFF CERAMICONS

Style 318 (left) mounts 1/2" high above chassis, has .032" diameter wire top terminal. Capacity range 1-560 MMF. Style 319 (right) mounts .520" high, has .067" diameter top terminal. Capacity range 2-1,000 MMF. Both styles have 3-48 thread.

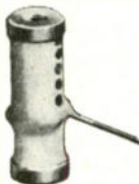

### SIDE-LEAD STAND-OFF CERAMICONS

Wire leads are correct height from chassis for shortest possible connection to tube sockets. Style 2322 (left) 45/64" high. Capacity range 5-2,500 MMF. Style 2336 (right) 15/16" high. Capacity range 6-5,000 MMF.

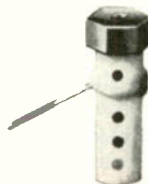

### FEED-THRU CERAMICONS

By-pass R. F. to ground when feeding through chassis or metal can. Body length 3/8"; mounted with 12-28 nut. Type 362 (above) has 20 gauge feed-thru wire. Capacity range 5-1,500 MMF. Type 357 (below) has 0.55" diameter hooked ends feed-thru wire; capacity range 5-1,000 MMF.



### FOR UHF COMMUNICATIONS EQUIPMENT ERIE BUTTON SILVER MICAS

These extremely compact silver mica condensers have 360° current path from short, heavy terminals to ground, providing very low inductance. Made in Stand-off and Feed-thru styles. Capacity range 15-1,000 MMF in .447" diameter, 1,000-6,000 MMF in .651" diameter.

# For Any and All By-Passing Requirements ERIE CERAMICONS®

Erie Ceramicons fulfil all the requisites for efficient by-passing—low inductance, compact design, and conservative 500 volt D. C. rating. Erie Resistor offers the most complete line of ceramic by-pass units available. Each design has been thoroughly proven in domestic and military equipment. Check the products listed on this page for your future designs. Full description and specifications will be sent on request.



Electronics Division

## ERIE RESISTOR CORP., ERIE, PA.

LONDON, ENGLAND

TORONTO, CANADA

**PROGRESS REPORT  
ON  
P.E.C.\***

**How Microtone uses  
twelve Printed Electronic Circuit units  
to save space and simplify  
production of fine hearing aids!**



**Microtone's Sealed Power Amplifiers consist of 12 Centralab Filpecs molded into two units for greater compactness . . . quicker installation . . . faster servicing.**

*Models courtesy of The Microtone Co.*

**\*Centralab's "Printed Electronic Circuit"  
— Industry's newest method for  
improving design and manufacturing efficiency!**

**H**EARING AIDS are smaller and lighter. Hearing aid performance is better . . . absolutely unaffected by moisture and humidity. Centralab's amazing *Printed Electronic Circuit* is an important reason . . . and the Microtone hearing aid is important proof. When Microtone engineers switched to P.E.C. "Filpec," here's what they found. Centralab's *Filpec* cuts down size and weight by reducing the number of components needed. It makes increased production possible by eliminating many assembling operations. It improves performance by minimizing the chance of broken or loose connections.

*Integral Ceramic Construction:* Each *Printed Electronic Circuit* is an integral assembly of "Hi-Kap" capacitors and resistors closely bonded to a steatite ceramic plate and mutually connected by means of metallic silver paths "printed" on the base plate.

You'll want to see and test this exciting new electronic development. For complete information about "Filpec" as well as other CRL *Printed Electronic Circuits*, see your nearest Centralab Representative, or write for Bulletin 976.

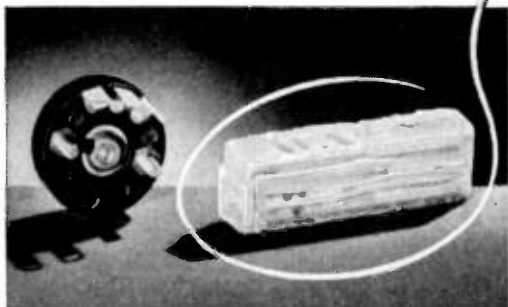

**MODEL No. 1 RADIOHM** (above, left) and ten "Filpecs" molded into a single amplifying unit (above, right) help Microtone build hearing aids that are smaller, more efficient and easily serviced. "Filpec" is shown below.

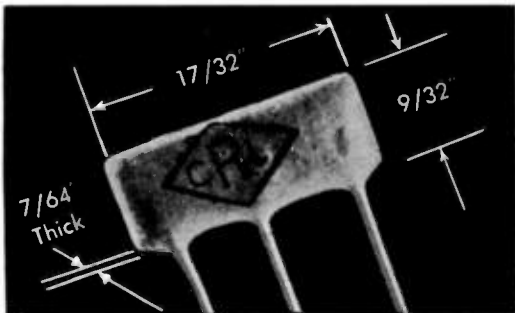

**LOOK TO *Centralab* IN 1948!**

**Division of GLOBE-UNION INC., Milwaukee**

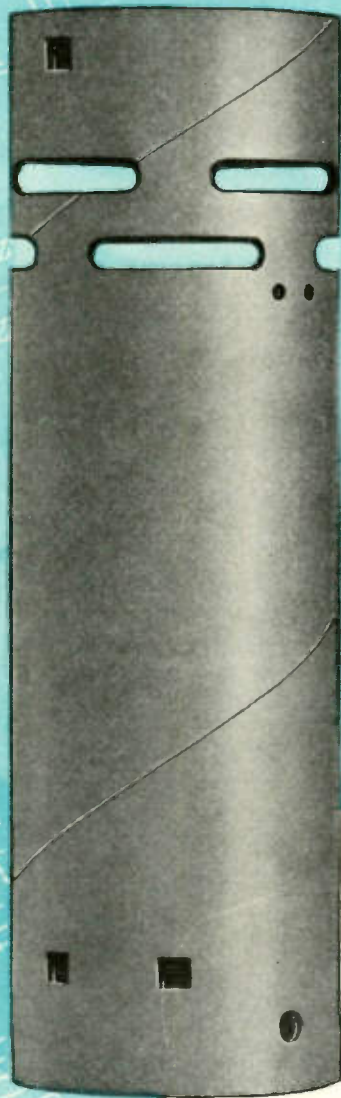

...punching dies available  
in endless *Variety* for  
**COSMALITE\***  
**COIL FORMS**

Manufacturers of radio and television receivers  
KNOW the outstanding advantages of COSMA-  
LITE in both performance and price.

There is a further saving in time and costs through  
the use of our extensive number of dies available  
to purchasers of Cosmalite Coil Forms.

\* Reg. U.S. Pat. Off.

Tell us your needs. Quite prob-  
ably we can be of value to  
you in your planning and  
production. Your inquiry will  
receive personal and experi-  
enced attention.

*The* **CLEVELAND CONTAINER Co.**

6201 BARBERTON AVE. CLEVELAND 2, OHIO

- All-Fibre Cons • Combination Metal and Paper Cans
- Spirally Wound Tubes and Cores for all Purposes
- Plastic and Combination Paper and Plastic Items

PRODUCTION PLANTS also at Plymouth, Wisc., Ogdenburg, N.Y., Chicago, Ill., Detroit, Mich., Amesburg, N.J.  
PLASTICS DIVISION at Plymouth, Wisc. • ABRASIVE DIVISION at Cleveland, Ohio  
SALES OFFICES: Room 5632 Grand Central Term. Bldg., New York 17, N.Y., also 647 Main St., Hartford, Conn.  
CANADIAN PLANT: The Cleveland Container Canada, Ltd., Prescott, Ontario



*Baird  
Associates  
Incorporated*

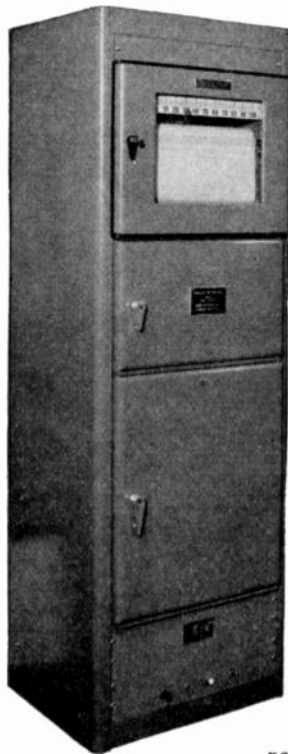

*specifies  
Sorensen  
electronic  
voltage  
regulation*

Shown above is the Infrared Gas Analyzer. Baird Associates, Incorporated, manufacturers of precision optical instruments for production and research analytical control use a Sorensen Model 250 A.C. line voltage regulator with their Infrared Gas Analyzer. Only Sorensen units provide the degree of line voltage stabilization necessary to increase the sensitivity of the Analyzer readings. SIX IMPORTANT SORENSEN FEATURES: • *Precise regulation accuracy; • Excellent wave form; • Output regulation over wide input voltage range; • Fast recovery time; • Adjustable output voltage, that once set, remains constant; • Insensitivity to line frequency fluctuations between 50 and 60 cycles.* If you calibrate meters, need quality control on test lines, work with X-ray equipment, or are a research physicist or chemist, there is a standard Sorensen AC or DC unit to solve your voltage problem. The Sorensen Catalog contains complete specifications on standard Voltage Regulators and Nobatrons. *It will be sent to you upon request.*

THE FIRST LINE OF STANDARD ELECTRONIC VOLTAGE REGULATORS.

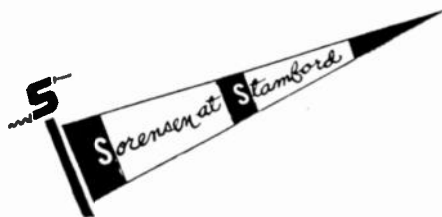

**SORENSEN & Company, Inc.**

Stamford, Connecticut

*Represented in all principal cities.*

**better components  
build better  
REPUTATIONS**

**...specify EL-Menco**

No product is better than its weakest component. This is why more and more manufacturers now use EL-MENCO mica capacitors. Rather than risk their reputations on inferior components they automatically specify El-Menco — the mica capacitor with the kind of performance that always gives customer satisfaction and builds better reputations.

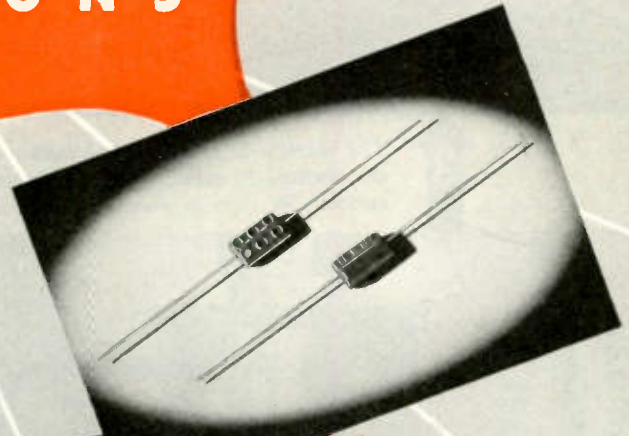

*New*

**CM 15 MINIATURE CAPACITOR**

9/32" x 1/2" x 3/16"

For Radio, Television and Other Electronic Applications

2 to 420 mmf. capacity at 500 v DCA

2 to 525 mmf. capacity at 300 v DCA

Temp. Co-efficient  $\pm 50$  parts per million per degree C for most capacity values

6-dot standard color coded

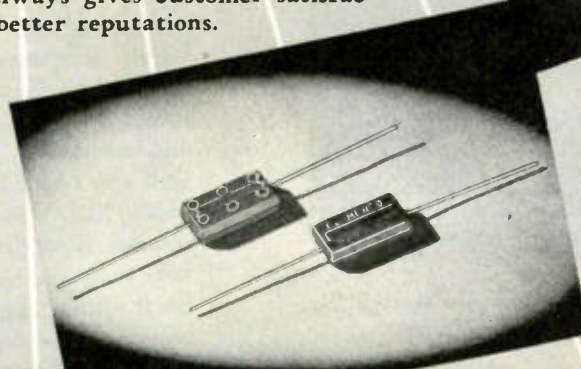

**CM 20 CAPACITOR**

Available in "A", "B", "C" and "D" characteristics

2 to 1500 mmf. in tolerances down to  $\pm 1\%$  or

.5 mmf. at 500 D.C. working voltage

6-dot color coded

\*Whichever is greater

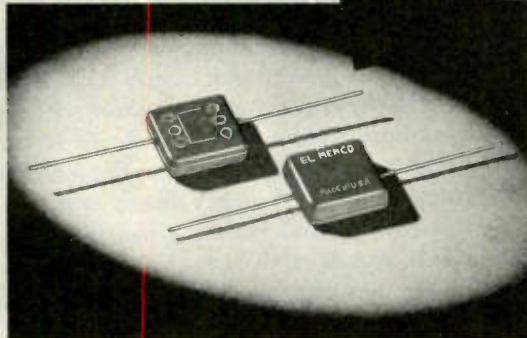

**CM 35 CAPACITOR**

Available in "A", "B", "C", "D" and "E" characteristics

Minimum tolerance 1%

500 D.C. working voltage

6-dot color coded

**ARCO ELECTRONICS**

135 Liberty St., New York, N. Y.  
Sole Agent for Jobbers and  
Distributors in U. S. and Canada

Foreign Radio and Electronic Manufacturers communicate direct with our Export Dept. at Willimantic, Conn. for information

**THE ELECTRO MOTIVE MFG. CO., INC.  
WILLIMANTIC CONNECTICUT**

**EL-Menco**  
**CAPACITORS**



Write on your firm letterhead for Catalog and Samples

**MOLDED MICA**

**MICA TRIMMER**

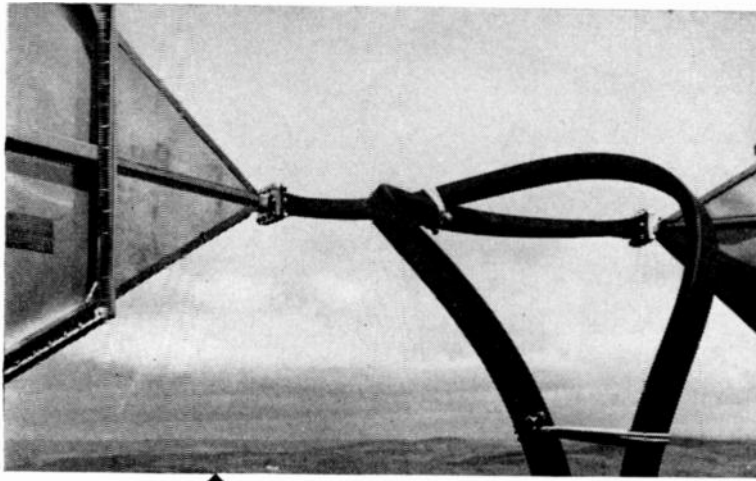

**3** The waveguide connects with antennas, which are oriented in azimuth with antennas at next station. At right is complete repeater station.

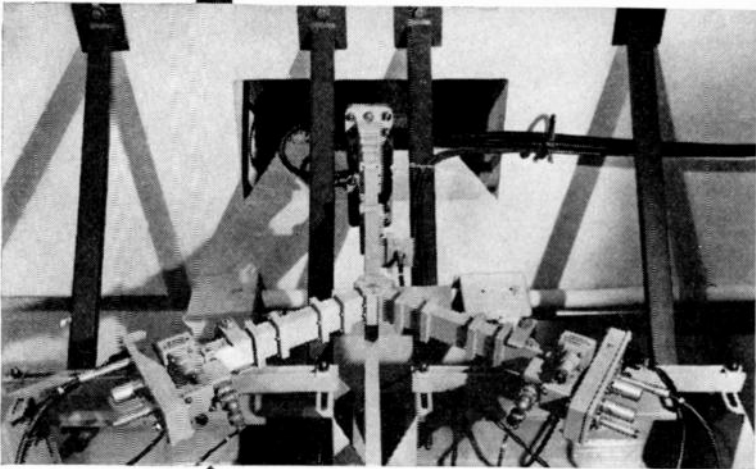

**2** The waveguide continues upward through the roof of the station toward the antennas.

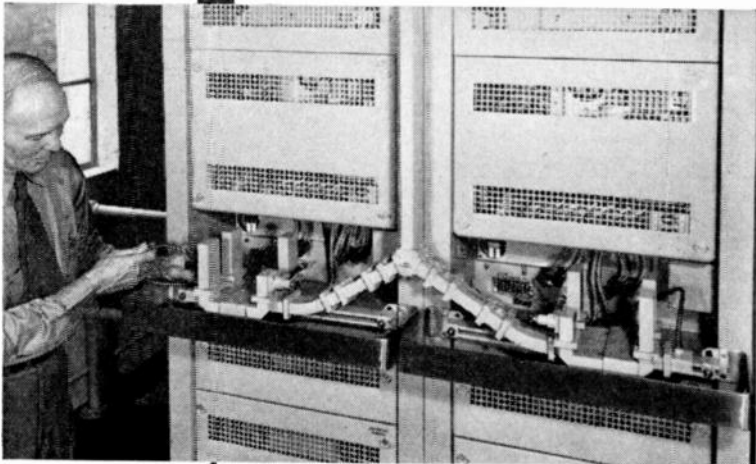

**1** Base of a waveguide circuit in a repeater station of the New York-Boston radio relay system.

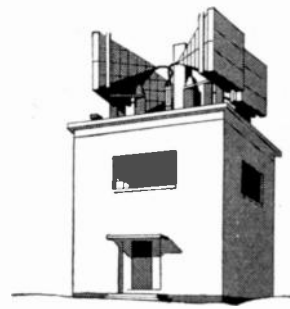

# Pipe Circuits

**U**NLIKE radio broadcast waves, microwaves are too short to be handled effectively in wire circuits. So, for carrying microwaves to and from antennas, Bell Laboratories scientists have developed circuits in "pipes," or waveguides.

Although the waves travel in the space within the waveguides, still they are influenced by those characteristics which are common to wire circuits, such as capacitance and inductance. A screw through the guide wall acts like a capacitor; a rod across the inside, like an inductance coil. Thus transformers, wave filters, resonant circuits — all have their counterpart in waveguide fittings. Such fittings, together with the connection sections of waveguide, constitute a waveguide circuit.

From Bell Laboratories research came the waveguide circuits which carry radio waves between apparatus and antennas of the New York-Boston radio relay system. As in long distance wire communication, the aim is to transmit wide frequency bands with high efficiency — band widths which some day can be expanded to carry thousands of telephone conversations and many television pictures.

Practical aspects of waveguides were demonstrated by Bell Telephone Laboratories back in 1932. Steady exploration in new fields, years ahead of commercial use, continues to keep your telephone system the most advanced in the world.

## BELL TELEPHONE LABORATORIES

EXPLORING AND INVENTING, DEVSING AND PERFECTING FOR CONTINUED IMPROVEMENTS AND ECONOMIES IN TELEPHONE SERVICE.





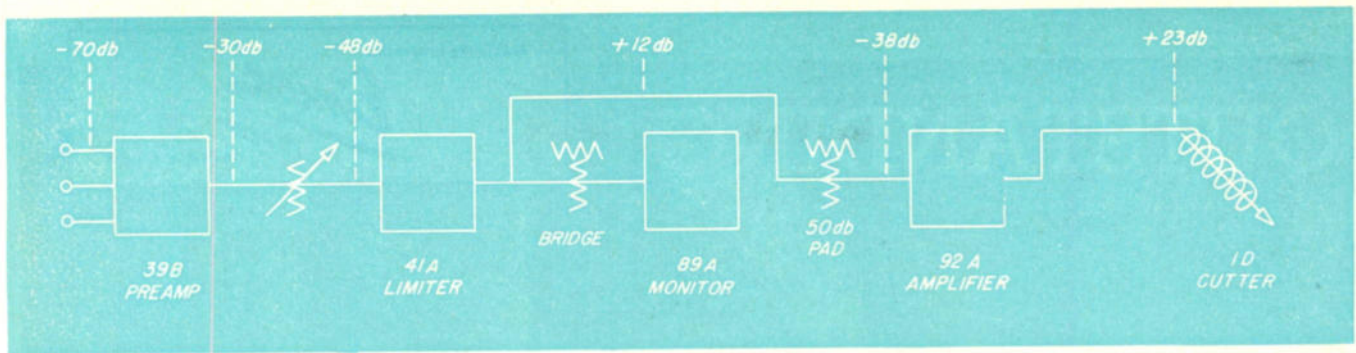

# *You're sure*

## WHEN IT'S 100% PRESTO

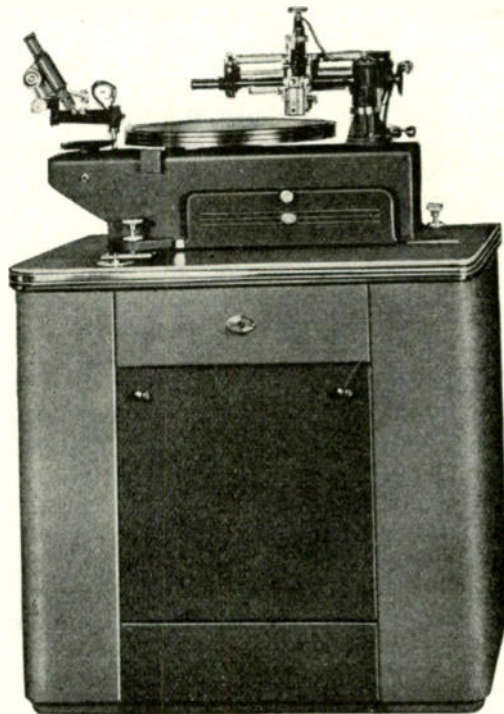

Pictured here is an all-Presto single channel recording system. Above is the block diagram, worked out for this equipment by Presto engineers.

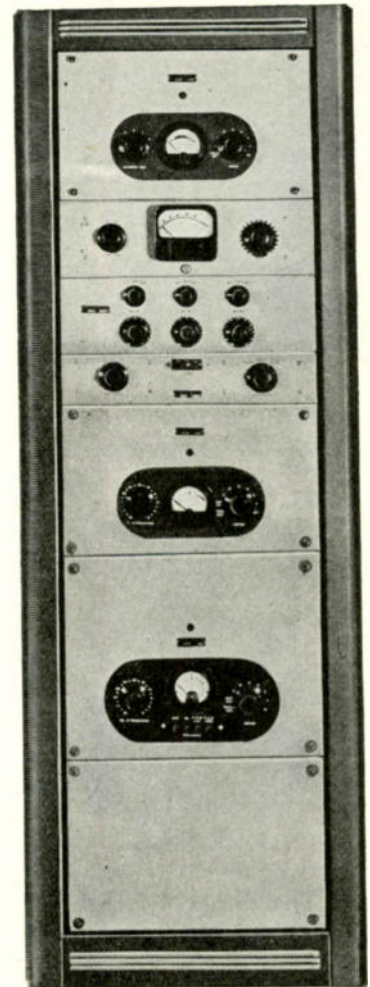

**W**HEN YOU NEED recording or transcription equipment you can't go wrong if you make the complete system 100% Presto.

For Presto is the world's foremost manufacturer of recording and transcription equipment and discs. And Presto's experience with countless installations, including all the big ones, will aid you in achieving greater efficiency and trouble-free operation.

The recorder is the 8DG with direct gear drive. The amplifiers are the 39-B three channel preamp, the 41-A limiter, the 92-A 60 watt recording amplifier, and the 89-A monitor.

Multiple channel installations consist of as many duplications of the basic channel as are needed with the addition of switch or patching facilities. When you think of recording, think of PRESTO.

**PRESTO**

**RECORDING CORPORATION**

Pararr.us, New Jersey

Mailing Address: P.O. Box 500, Hackensack, N. J.  
In Canada: WALTER P. DOWNS, Ltd., Dominion Sq. Bldg., Montreal

WORLD'S LARGEST MANUFACTURER OF INSTANTANEOUS SOUND RECORDING EQUIPMENT AND DISCS

# OUTSTANDING

Follow the Leaders to

**Eimac**  
TUBES  
The Power for R-F

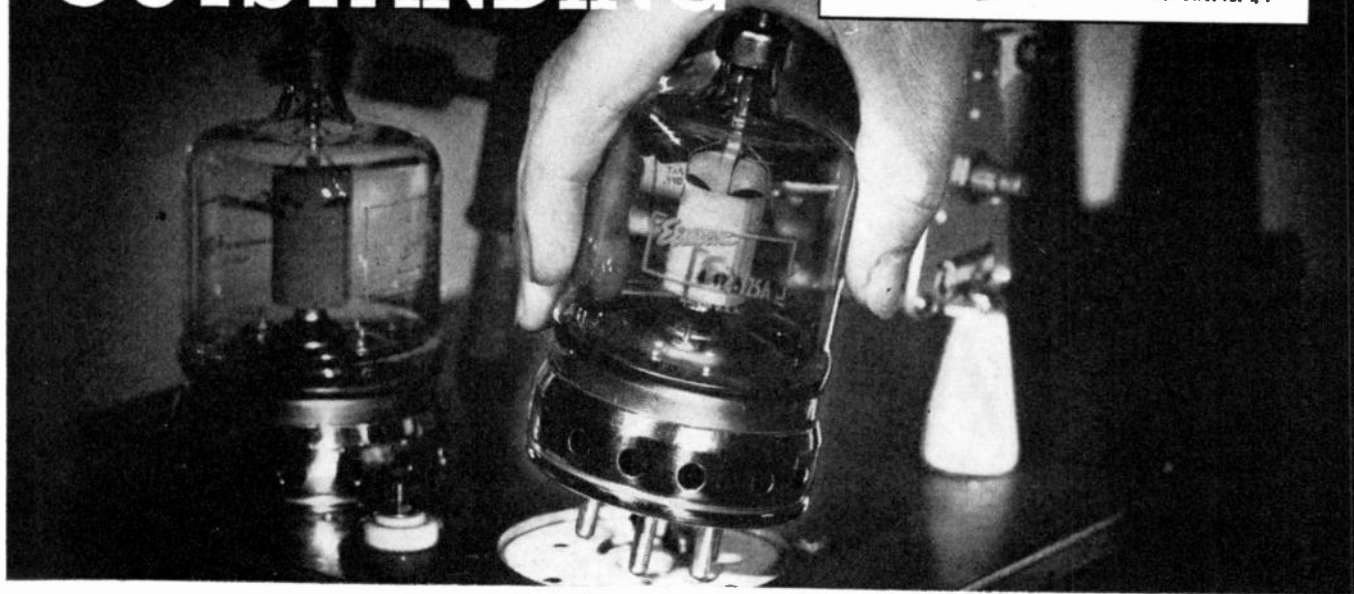

The Eimac 4-125A

Look about you . . . check the equipment shows . . . thumb through the trade magazines . . . talk to design engineers . . . yes, the Eimac 4-125A power tetrode is the standout vacuum tube, accepted in all fields of electronic endeavor for its stability, long-life and dependability.

Each tube is backed by the combined engineering resources of Eitel-McCullough plus over a million hours of proven field-service. It's Pyrovac<sup>®</sup> plate is highly resistant to momentary overloads and contributes to the tube's long life. Processed grids control primary and secondary emission, providing a high degree of operational stability. The tube is ruggedly designed to withstand abnormal physical as well as electrical abuse.

Detailed data and application notes are immediately available and statistics for unusual applications will be supplied on request.

## EITEL-McCULLOUGH, INC.

204 San Mateo Ave., San Bruno, California

Export Agents: Frazer & Hansen, 310 Clay Street, San Francisco 11, California

\*Reg. Trade Mark

RADIO FREQUENCY POWER AMPLIFIER AND OSCILLATOR		HIGH-LEVEL MODULATED RADIO FREQUENCY AMPLIFIER		AUDIO FREQUENCY POWER AMPLIFIER AND MODULATOR						
Class-C Telephony or FM Telephony Maximum Ratings (Key-down conditions, 1 tube)		Class-C Telephony (Carrier conditions unless otherwise specified, 1 tube)		Class AB <sub>1</sub> (Sinusoidal wave, two tubes unless otherwise specified)		Class AB <sub>2</sub> (Sinusoidal wave, two tubes unless otherwise specified)				
D-C PLATE VOLTAGE	3000 MAX. VOLTS	2500 MAX. VOLTS	400 MAX. VOLTS	MAXIMUM RATINGS		3000 MAX. VOLTS				
D-C SCREEN VOLTAGE	400 MAX. VOLTS	400 MAX. VOLTS	400 MAX. VOLTS	D-C PLATE VOLTAGE	3000 MAX. VOLTS	3000 MAX. VOLTS				
D-C GRID VOLTAGE	-500 MAX. VOLTS	-500 MAX. VOLTS	-500 MAX. VOLTS	D-C SCREEN VOLTAGE	600 MAX. VOLTS	400 MAX. VOLTS				
D-C PLATE CURRENT	275 MAX. MA.	200 MAX. MA.	200 MAX. MA.	MAX-SIGNAL D-C PLATE CURRENT PER TUBE	225 MAX. MA.	225 MAX. MA.				
PLATE DISSIPATION	125 MAX. WATTS	85 MAX. WATTS	20 MAX. WATTS	PLATE DISSIPATION, PER TUBE	125 MAX. WATTS	125 MAX. WATTS				
SCREEN DISSIPATION	20 MAX. WATTS	20 MAX. WATTS	5 MAX. WATTS	SCREEN DISSIPATION, PER TUBE	20 MAX. WATTS	20 MAX. WATTS				
GRID DISSIPATION	5 MAX. WATTS	5 MAX. WATTS	5 MAX. WATTS	TYPICAL OPERATION						
Typical Operation (Frequencies below 120 Mc.)				D-C Plate Voltage	2000	2500	volts	2000	2500	volts
D-C Plate Voltage	2500	3000	volts	D-C Screen Voltage	600	600	volts	350	350	volts
D-C Screen Voltage	350	350	volts	D-C Grid Voltage	-94	-94	volts	-45	-43	volts
D-C Grid Voltage	-150	-150	volts	Zero-Signal D-C Plate Current	50	50	ma.	72	93	ma.
D-C Plate Current	200	167	ma.	Max-Signal D-C Plate Current	240	232	ma.	300	260	ma.
D-C Screen Current	40	30	ma.	Zero-Signal D-C Screen Current	0	0	ma.	0	0	ma.
D-C Grid Current	12	9	ma.	Max-Signal D-C Screen Current	6.4	8.5	ma.	5	6	ma.
Screen Dissipation	14	10.5	watts	Effective Load, Plate-to-Plate	13,400	20,300	ohms	13,600	22,200	ohms
Grid Dissipation	2	1.2	watts	Peak A-F Grid Input Voltage (per tube)	94	96	volts	105	89	volts
Peak R-F Grid Input Voltage (approx.)	320	280	volts	Driving Power	0	0	watts	1.4	1	watts
Driving Power (approx.)	3.8	2.5	watts	Max-Signal Plate Dissipation (per tube)	125	125	watts	125	122	watts
Plate Power Input	500	500	watts	Max-Signal Plate Power Output	230	330	watts	350	400	watts
Plate Dissipation	125	125	watts	Total Harmonic Distortion	2	2.6	perct.	1	2.2	perct.
Plate Power Output	375	375	watts							

NOW WITH . . . Pyrovac Plates · Processed Grids

**PRESENT THINKING  
ON RESISTORS IS**

**OBSOLETE!**



**discard your current standards of  
performance for fixed composition resistors**

**IRC**

**ANNOUNCES A NEW  
ADVANCED RESISTOR**

Read  
the  
following  
pages  
carefully,  
they will  
affect your  
planning  
for years  
to come.

# NEW IRC BT RESISTORS obsolete all present standards



Review your resistor requirements in the light of this advanced resistor.

*New, advanced*



## TYPE BT

- BTR . . . . . unexcelled at 1/3 watt
- BTS . . . . . unexcelled at 1/2 watt
- BTA . . . . . unexcelled at 1 watt
- BT-2 . . . . . unexcelled at 2 watts

IRC's leadership proven by these Test Results for 1/2 watt Type BTS — equally outstanding performance of 1/3, 1 and 2 watt types is shown in Catalog Bulletin B-1.

**BT** means **Better Technically**

# compare this **ADVANCED** resistor to **JAN-R-11 SPECS**

**IRC**  
MEETS  
JAN-R-11

Tempera-  
ture ex-  
tremes  
used to  
play  
havoc—no  
longer true.

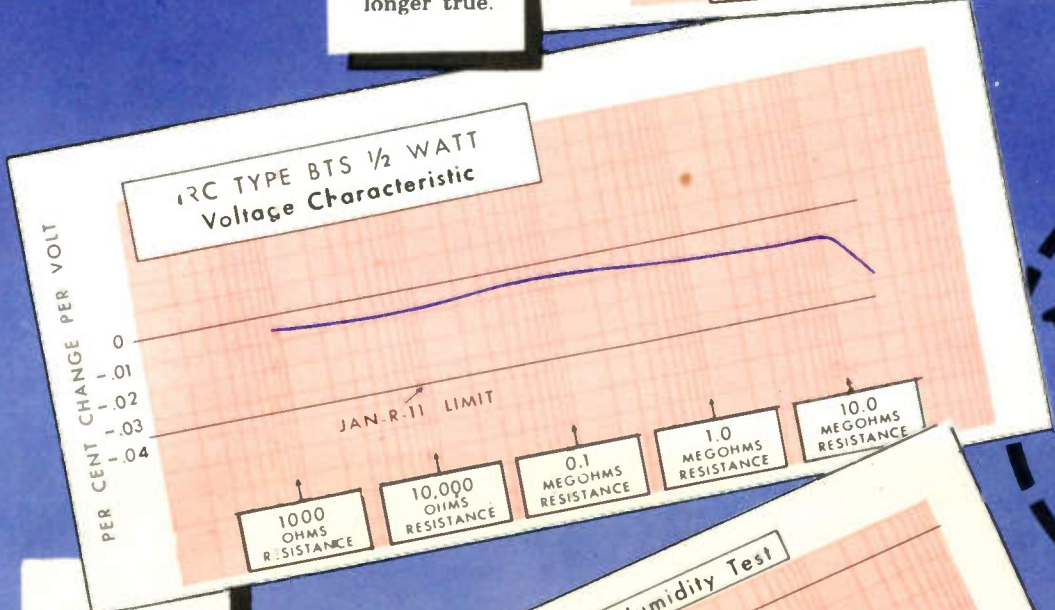
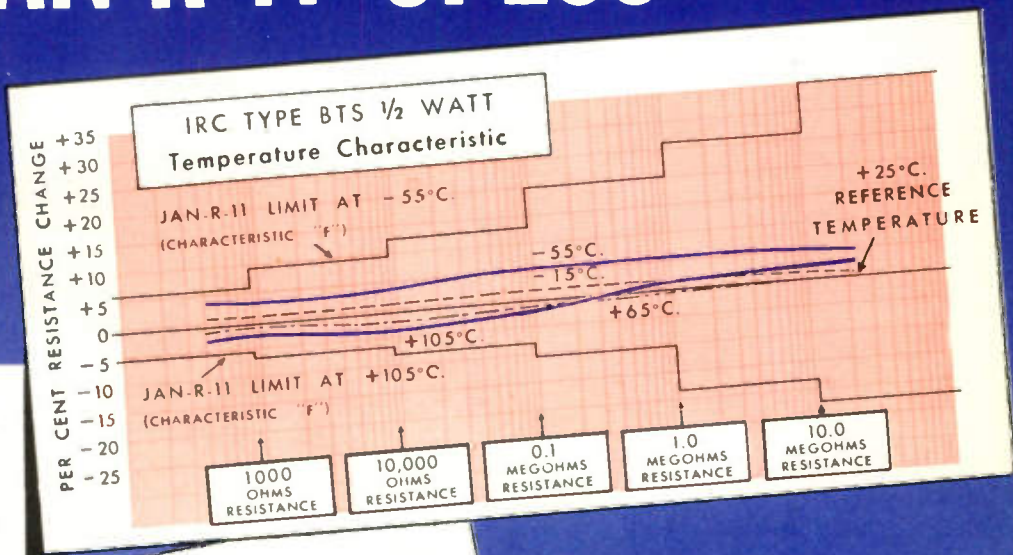

Critical cir-  
cuits need  
stability  
under al.  
conditions

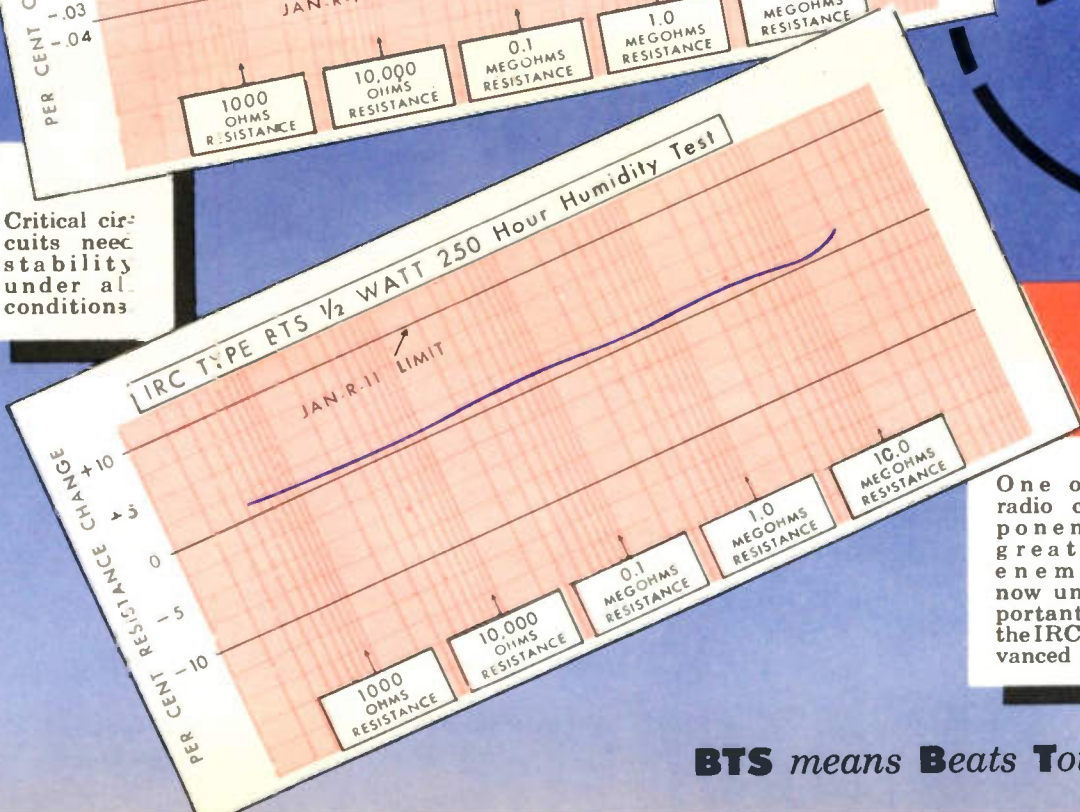

**IRC**  
BEATS  
JAN-R-11

One of a  
radio com-  
ponent's  
greatest  
enemies  
now unim-  
portant to  
the IRC Ad-  
vanced BT.

NEXT PAGE  
SHOWS EQUALLY  
AMAZING RESULTS  
IN OTHER  
CHARACTERISTICS

**BTS means Beats Toughest Specs**

**IRC'S ADVANCED BT AGAIN DEMONSTRATES SUPERIOR IRC ENGINEERING AND PRODUCTION TECHNIQUES**

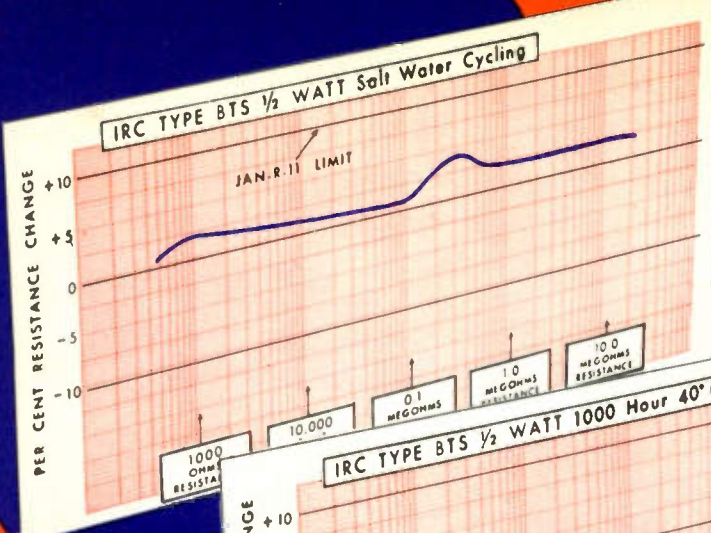

The Armed Forces need these results.

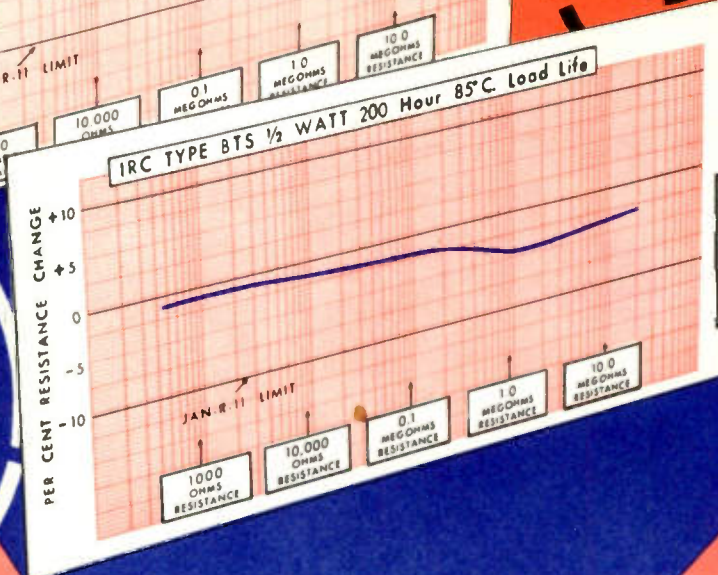
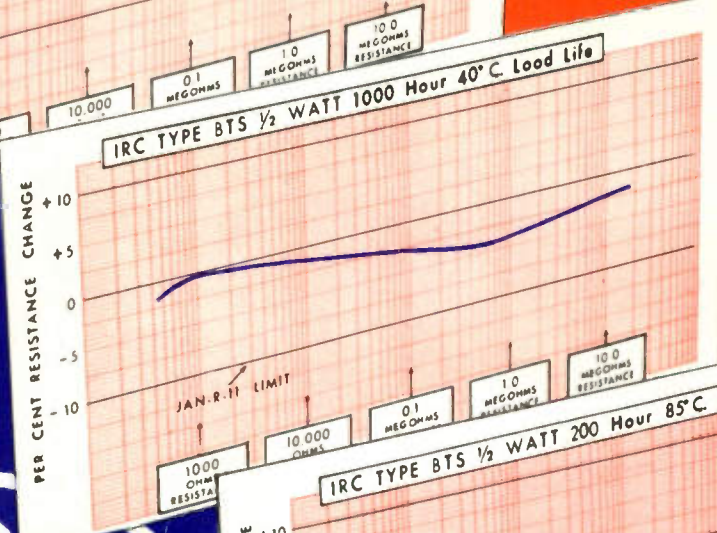

High ambi-ents and de-pendability need these results.

**BT means Better Television**

There is no blue sky surrounding this advanced resistor. Performance of this new Type BT has been proved by independent testing agencies. It is in production now . . . hundreds of thousands are coming off production lines daily. Its outstanding characteristics are particularly evident in high ambient temperatures, and it easily performs the rigorous requirements of television.

Standards for resistor performance set by this new IRC

resistor are so advanced, you need complete information on its characteristics. Although Test Results shown here are only for 1/2 watt Type BTS, comparable data is available for BTR, BTA and BT-2 . . . Technical Data Bulletin B-1 gives you the full story. We shall be glad to rush it to your desk or drawing board . . . or to have our representative review your requirements in the light of this advanced resistor. Use the handy coupon below.

International Resistance Co.  
401 N. Broad St., Phila. 8, Pa.

I want to know more about IRC's advanced BT Resistor:

- Send me Technical Data Bulletin B-1
- Have your representative call—no obligation.

Name.....  
 Title.....  
 Company.....  
 Address.....



- POWER RESISTORS •
- PRECISIONS • INSULATED
- COMPOSITION RESISTORS •
- LOW WATTAGE WIRE
- WOUNDS • RHEOSTATS
- CONTROLS • VOLTMETER
- MULTIPLIERS • VOLTAGE
- DIVIDERS • HF AND HIGH
- VOLTAGE RESISTORS

INTERNATIONAL RESISTANCE CO., 401 N. Broad St., Philadelphia 8, Pa.  
 IN CANADA: International Resistance Company, Ltd., Toronto, Licensee

# Sealed in Vitreous Enamel for Life-Time Protection



**OHMITE**  
RESISTORS

RESISTS SHOCK,  
VIBRATION, COLD, HEAT, FUMES  
OR HUMIDITY

- 1 VITREOUS ENAMEL COVERING** Special Ohmite vitreous enamel holds the winding rigidly in place and protects it from mechanical damage.
- 2 STRONG CERAMIC CORE** Provides a strong base for the winding, unaffected by cold, heat, fumes, or high humidity.
- 3 EVEN, UNIFORM WINDING** The unsurpassed uniformity of the resistance winding prevents "hot spots" and resultant failures.
- 4 TINNED COPPER TERMINALS** Terminal lugs are tin-dipped for ease in soldering. The resistance wire is both mechanically locked and brazed to the terminal lugs, assuring a perfect electrical connection.
- 5 RESILIENT MOUNTING BRACKETS** Mounting brackets hold the resistor firmly yet resiliently in place. They are simple to mount and can be easily removed by a slight upward pressure at the base.
- 6 RATING CLEARLY INDICATED** On each resistor the resistance value and rating are clearly marked for easy identification.

Send for Catalog  
and Engineering  
Manual No. 40

Write now, on your  
company letterhead,  
for your copy of this  
valuable 96-page  
Ohmite catalog.



OHMITE MANUFACTURING COMPANY—4861 Flournoy St., Chicago 44, U.S.A.



**OHMITE**  
RESISTORS • RHEOSTATS  
TAP SWITCHES

# No Space to Spare

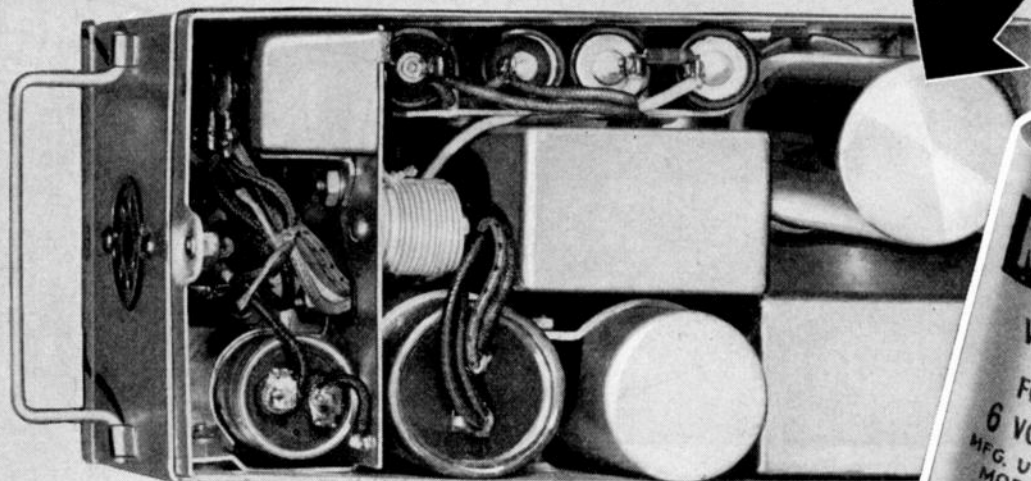

So this **MALLORY**  
*Self-Rectifying* **VIBRATOR**  
came to the rescue



The vibrator power supply unit pictured above was developed and built by Mallory for mobile equipment and field use. Measuring less than 7" x 4" x 4", it had to economize on parts—and it did!

The Mallory self-rectifying vibrator, shown beside it, was the part that especially turned the trick. A pretty small vibrator to begin with, it eliminated the need of a rectifying tube.

What's more, this vibrator was rugged and dependable. It stood up under a lot of bouncing around—"took" the gaff of weather extremes.

Do you have a product where vibrator compactness and dependability are important requirements? Call on Mallory—"Vibrator Headquarters." Begin by contacting the nearest Mallory field representative. Or write direct for the comprehensive Mallory Vibrator Questionnaire.

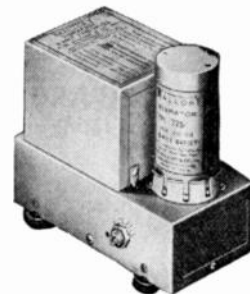

## MALLORY VIBRAPACK\* POWER SUPPLIES

Mallory Vibrapacks deliver voltages from 125 to 400 from low voltage sources... with high efficiency, low battery drain, ease of installation, long life.

\*Reg. U. S. Pat. Off.

**P. R. MALLORY & CO. Inc.**  
**MALLORY** VIBRATORS  
AND VIBRATOR POWER SUPPLIES

P. R. MALLORY & CO., Inc., INDIANAPOLIS 6, INDIANA

*More Mallory Vibra-  
tors are in use today  
than all other makes  
combined*





**ENGINEERING GIVES YOU**

*-better readability-*

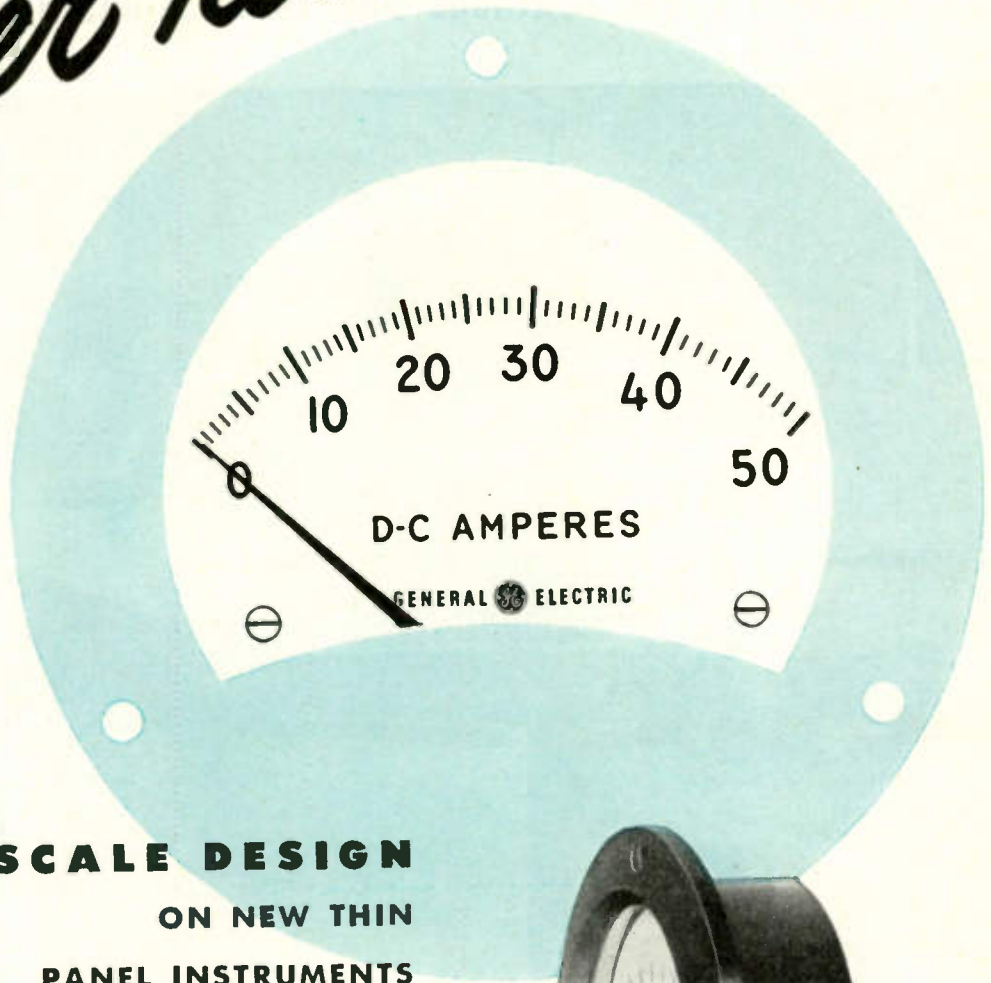

**IMPROVED SCALE DESIGN  
ON NEW THIN  
PANEL INSTRUMENTS**

The new General Electric thin panel instruments have been designed especially for easy reading. Arc lines have been eliminated to make scale divisions stand out by themselves. New lance-type pointer gives precise indications. Restyled figures are bigger, and shaped for maximum legibility. A mask covers distracting mechanism at base of pointer. And, notice the scale as a whole. All extraneous printing has been removed. You can be sure of quicker, more accurate readings with these new Type DO-71 instruments, as proved by tests before large audiences.

Greater sturdiness, more reliable operation, and longer life are assured by the internal-pivot construction, temperature compensation, and other features described more fully in Bulletin GEA-5102. Write for your copy today. Apparatus Department, General Electric Company, Schenectady 5, N. Y.

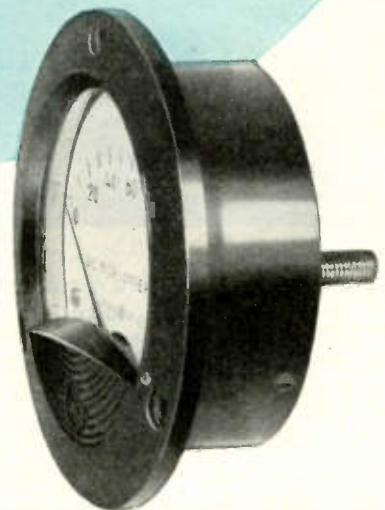

Also available as d-c ammeters, milliammeters, microammeters, voltmeters, thermocouple ammeter, rectifier ammeters and voltmeters. A-c instruments of same appearance and frontal dimension also available as ammeters and voltmeters.

**GENERAL  ELECTRIC**

602-126

# SPECTROGRAPH USED IN SYLVANIA LABORATORIES DETECTS MINUTE IMPURITIES IN MATERIALS

Study And Control Of Fluorescent And Emissive Materials For  
Electron Tubes, Cathode Ray Tubes, Constantly Carried On

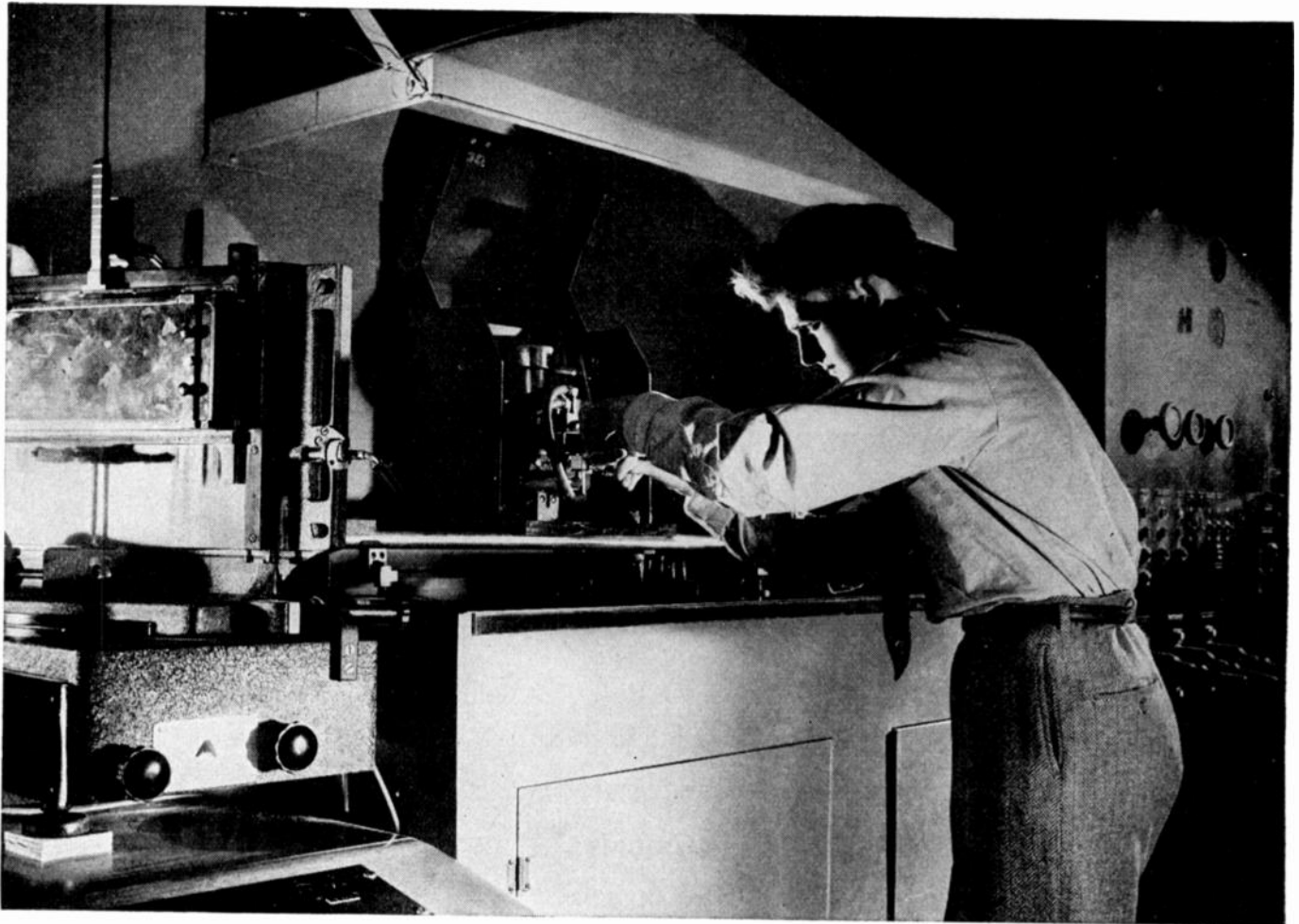

As part of Sylvania's continuing study and research in tungsten, and other materials used in radio and television tube manufacture, the a-c arc and spectrograph equipment shown here detect the most minute traces of impurities.

One of the major portions of the work is concerned with phosphors for television tubes. Another is the control of the processing of the emission coating sprayed on the cathodes of radio tubes for thermionic emitters.























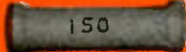

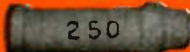

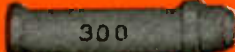

The photograph shows laboratory technician placing electrodes in arc chamber. Power supply controls for a-c and d-c arcs are at far right. Image of arc is focused by collimator lens for spectrograph at left. By study of spectrum photographed impurities are detected. Control standards like this assure performance standards of Sylvania Radio and Television Tubes, Sylvania Electric Products Inc., Radio Tube Division, Emporium, Pa.

# SYLVANIA ELECTRIC

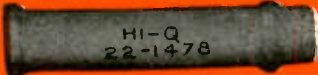
RADIO TUBES; CATHODE RAY TUBES; ELECTRONIC DEVICES; FLUORESCENT LAMPS, FIXTURES, WIRING DEVICES; PHOTOLAMPS; LIGHT BULBS

# Hi-Q

## TUBULAR CERAMIC CAPACITORS

 CN-1      .200 x .375	 SI-1      .234 x .437	 CI-1      .250 x .562
 CN-13     .200 x .437	 SI-13     .234 x .468	 CI-2      .250 x .812
 CN-2      .200 x .625	 SI-2      .234 x .687	 CI-3      .340 x 1.320
 CN-27     .230 x .460	 SI-27     .275 x .500	 CS-1
 CN-7      .230 x .812	 SI-7      .275 x .875	 CS-2
 CN-19     .253 x .850	 SI-19     .312 x .937	 CS-3
 CN-3      .253 x 1.078	 SI-3      .312 x 1.125	 CS-4
 CN-4      .340 x 1.062	 SI-4      .375 x 1.093	 CF-1
 CN-5      .340 x 1.500	 SI-5      .375 x 1.600	 CF-2
 CN-6      .340 x 1.875	 SI-6      .375 x 1.968	 CF-3
		 CF-4

ALL DIMENSIONS ARE MAXIMUM

**ELECTRICAL REACTANCE  
CORPORATION**

GENERAL OFFICES:  
● FRANKLINVILLE, N. Y.  
SALES OFFICES:  
● IN ALL PRINCIPAL CITIES

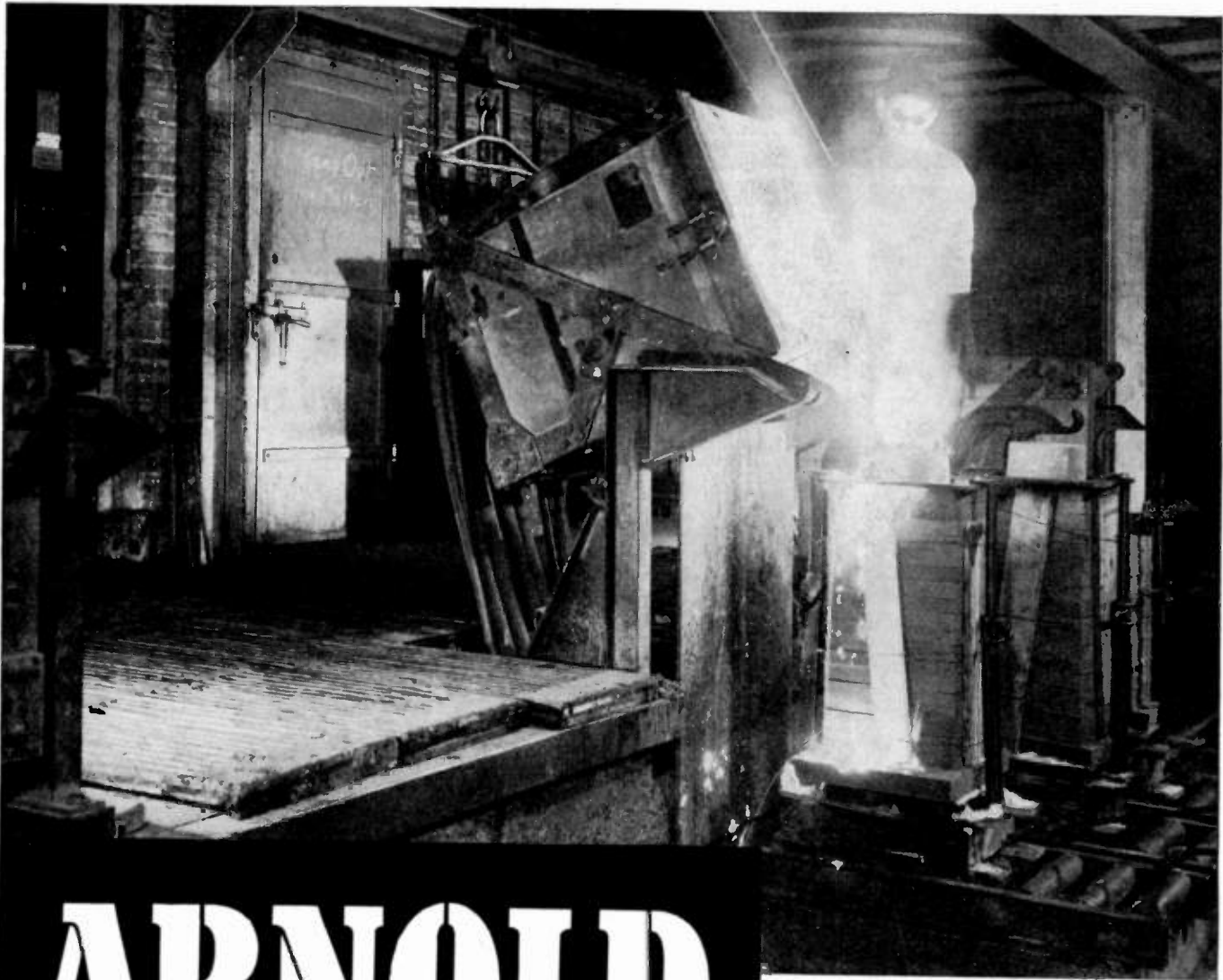

# ARNOLD

## PERMANENT MAGNETS

*100% quality-controlled  
at every step from  
the design board  
to final assembly*

The increased efficiency and economy you'll realize in the use of Arnold Permanent Magnets are *constant* factors. The thousandth unit is exactly like the first—because they're produced under controlled conditions at every step of manufacture, to bring you complete uniformity in every magnetic and physical characteristic. Count on Arnold Products to do your magnet job *best*—and they're available in any grade of material, size, shape, or degree of finish you require. Write us direct, or check with any Allegheny Ludlum field representative.

### **THE ARNOLD ENGINEERING CO.**



Subsidiary of  
**ALLEGHENY LUDLUM STEEL  
CORPORATION**

147 East Ontario Street, Chicago 11, Illinois

Specialists and Leaders in the Design, Engineering and Manufacture of  
**PERMANENT MAGNETS**

W&D 1297

# NOW! 10 cps to 10 mc

## ...with the New -hp- 650A RESISTANCE-TUNED OSCILLATOR

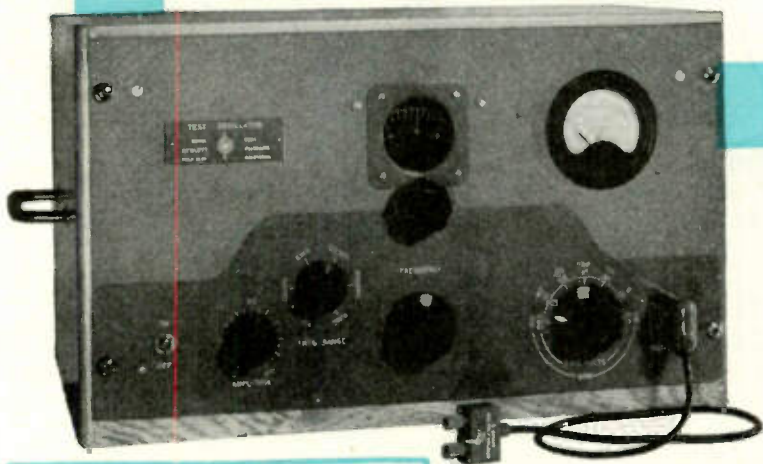

### SPECIFICATIONS

FREQUENCY RANGE: 10 cps to 10 mc  
FREQUENCY CALIBRATION: 0.9 to 10.

Multiplying factors are:

MF	Freq. Range
X10 cps	9 to 100 cps
X100 cps	90 to 1000 cps
X1kc	900 to 10,000 cps
X10kc	9 to 100 kc
X100kc	90 to 1000 kc
X1mc	0.9 to 10 mc

STABILITY:  $\pm 2\%$ , 10 cps to 100 kc;  $\pm 3\%$ , 100 kc to 10 mc including warmup, line voltage, and tube changes.

OUTPUT: 10 milliwatts or 3 volts into 600 ohm resistive load. Open circuit voltage is at least 6 volts. 600 ohm reflected impedance. Output impedance of 6 ohms also available.

FREQUENCY RESPONSE: Flat within  $\pm 1$  db, 10 cps to 10 mc.

DISTORTION: Less than 1% from 100 cps to 100 kc. Approx. 5% from 100 kc to 10 mc.

OUTPUT MONITOR: Vacuum tube voltmeter monitors output level in volts or db at 600 ohm level. Output response beyond monitor is accurate within  $\pm 5\%$  all levels and frequencies.

OUTPUT ATTENUATOR: Output level attenuated 50 db in 10 db steps, providing continuously variable output voltage from +10 dbm to -50 dbm, 3 volts to 3 millivolts, or down to 30 microvolts with voltage divider.

HUM VOLTAGE: Less than 0.5% below maximum attenuated signal level.

POWER SUPPLY: 115 volts 50/60 cps. Consumption 135 watts. Plate supply electronically regulated.

MOUNTING: Cabinet or relay rack. Panel size 19" x 10 1/2". Depth 13".

**HERE IT IS . . .** another -hp- "first" . . . a new resistance-tuned oscillator that not only covers a frequency range of 10 cps to 10 mc, but brings to the r-f and video field all the speed, accuracy and ease of measurement traditional to famous -hp- audio oscillators. And, this important addition to the -hp- line incorporates all the family characteristics of other -hp- oscillators . . . no zero setting, minimum adjustment during operation, virtual in-

dependence of line and tube characteristics, accurate calibration, and streamlined circuits for long, trouble-free performance.

The result is a highly stable, wide-band precision instrument which provides output flat within 1 db from 10 cps to 10 mc, and a voltage range of .00003 to 3 volts. Output impedance is 600 ohms or 6 ohms with output voltage divider.

**LIKE OTHER -hp- resistance-tuned oscillators,** the new 650A gives you the advantage of decade frequency ranges, a 94" scale length, and a 6 to 1 micro-controlled vernier drive. A complete vacuum tube voltmeter, included in the 650A circuit, monitors output in volts or db at the 600 ohm level. A continuously variable output voltage is obtained by means of an output attenuator of 50 db, variable in 10 db steps and an amplitude control which adjusts the level to the monitor vacuum tube voltmeter.

Where it is desirable that the measurements be made with a low source impedance, an output voltage divider unit is supplied. This attachment consists of a cable, which may be extended to the point of measurement and provides an internal impedance of 6 ohms. It also reduces the output voltage 100 to 1.

**THE COMPACT,** efficient -hp- 650A is available now for making a wide number of measurements . . . testing television amplifiers, wide-band systems, filter transmission characteristics, tuned circuits, receiver alignments. And . . . it serves admirably as a power source for bridge measurements or as a signal generator modulator.

For full information . . . write today

Hewlett-Packard Company • 1495D Page Mill Road • Palo Alto, Calif.

Attention FM Engineers!  
Full information on the new -hp-  
FM TEST EQUIPMENT  
Available on Request.  
Write Today!

**hp laboratory instruments**  
FOR SPEED AND ACCURACY

**COMPLETE  
TV  
EQUIPMENT**

*from camera chain  
to transmitter*

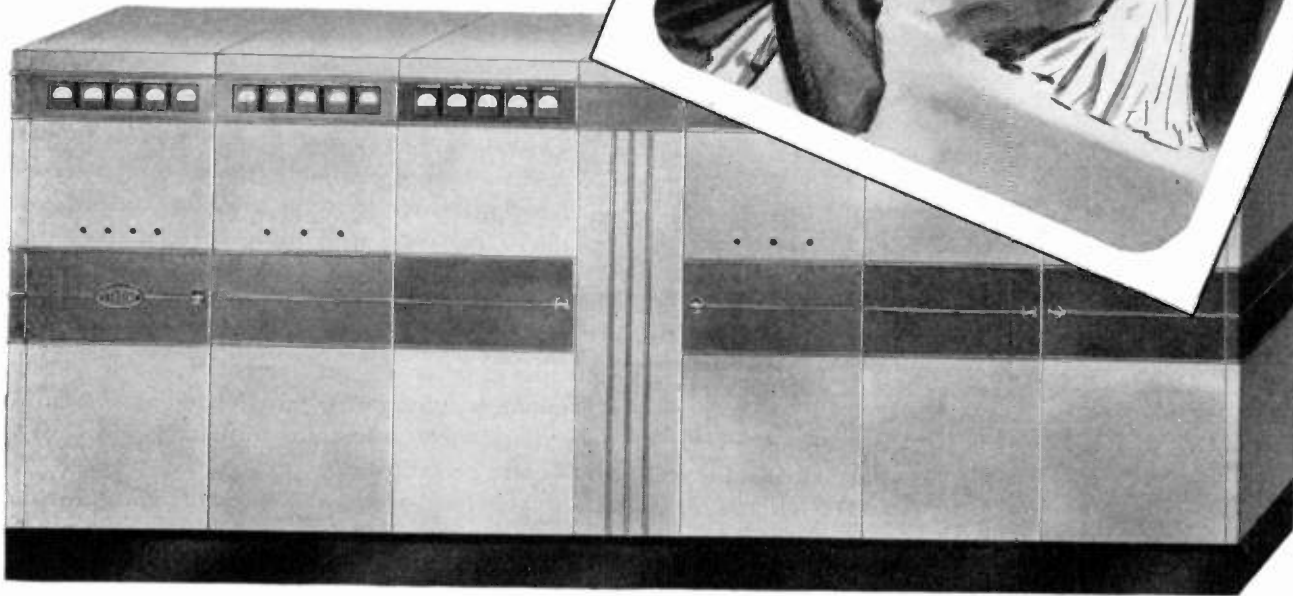

**LOOK TO RAYTHEON  
FOR ALL YOUR NEEDS**

RAYTHEON is prepared to furnish complete equipment for television stations. Through this one dependable and reliable source of supply you can obtain any single item or an entire installation ranging from camera chains to antenna and associated equipment... including 50 watt microwave equipment for remote pickup, STL, or point-to-point relay. Raytheon stands ready to provide you with prompt and intelligent service at all times.



*Excellence in Electronics*



**NEW ENGLAND**

Albert Keleher, Jr.  
Raytheon Manufacturing Co.  
Waltham 54, Mass.  
WA. 5-5860, Ex. 422

**CHATTANOOGA, TENNESSEE**

W. B. Taylor  
Signal Mountain  
8-2487

**CHICAGO 6, ILLINOIS**

Warren Cozzens  
Ben Farmer  
222 West Adams Street  
Ran. 7457

**DALLAS 8, TEXAS**

Howard D. Crissey  
414 East 10th Street  
Yale 2-1904

**NEW YORK 17, NEW YORK**

Henry J. Geist  
60 East 42nd Street  
MU. 7-1550

**SAN FRANCISCO, California**

E. J. Rome  
49 California Street  
Sutter 1-0475

**SEATTLE, WASHINGTON**

Adrian VanSanten  
135 Harvard North  
Minor 3537

**WASHINGTON 4, D. C.**

Raytheon Manufacturing Co.  
739 Munsey Building  
Republic 5897

**WILMINGTON, CALIFORNIA**

J. L. Lovett  
404 North Avalon Blvd., Terminal 4-1721

**RAYTHEON MANUFACTURING COMPANY**

Industrial and Commercial Electronic Equipment,  
FM, AM and TV Broadcast Equipment, Tubes and Accessories

**WALTHAM 54, MASSACHUSETTS**

**WE CAN HELP YOU WITH**

# Energy-Storage Capacitors!

Our experience—in engineering, designing, and building performance into energy-storage and discharge capacitors—may provide just the help you are looking for.

Do you make discharge welding or photographic flash-tube equipment? Radar equipment? Flash beacons, aircraft signalling, or similar devices? Or research tools, from spectrosopes to cyclotrons? We have furnished a large proportion of the capacitors used for all of these applications.

Unusual applications, too—like those listed below—are a specialty with us. Whatever your problem, let our engineers give you a hand. Apparatus Dept., General Electric Company, Schenectady 5, N. Y.

**NEED SQUARE WAVES?** Pulse-forming networks can provide them. Networks are used where the normal capacitor discharge wave shape is not suitable and where an impulse must have definite energy content and duration. The Type E network, produced by General Electric, consists of capacitor and coil sections, adjusted to close tolerances, and hermetically sealed in single metal containers. Built by the thousands for radar, they are now available for commercial use.

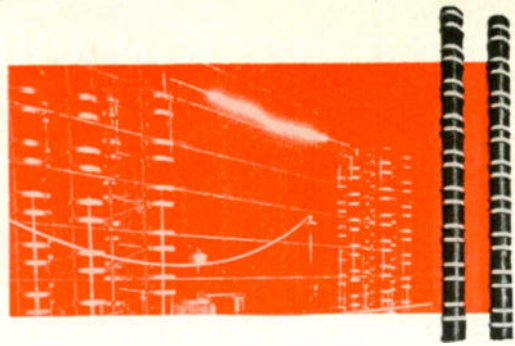
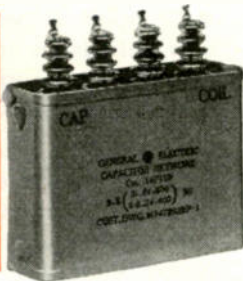
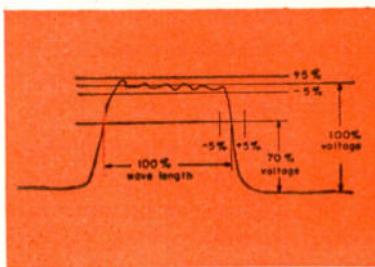

**NEED ARTIFICIAL LIGHTNING?** Potent artificial lightning bolts—at voltages up to 10,000,000—are not a usual need. But when required—for universities, laboratory testing, or exhibition—General Electric can build the capacitors. A typical example is the 100-kv d-c unit, about 3 feet in diameter and 2 feet high. Units can be stacked, as shown, for ease of installation and minimum space. In some instances as many as 100 separate units have been placed in series to produce 10,000,000 volt discharges.



**OR DO YOU WANT TO TAKE A PICTURE?** A maker of flash-tube photographic equipment wanted a lighter capacitor for his portable sets. Our designers went to work and came up with just what he desired—and one which he could use, also, for his studio equipment at a considerable saving in price. (In case you're interested, this capacitor is rated 14 muf, weighs 2 1/2 lb, and delivers 43.8 watt-seconds with 1000 hour service life or 58 watt-seconds at 400 hours. Used in pairs, they replace a 28 muf-studio capacitor, save in cost too.)

## GENERAL ELECTRIC

607-175

*Specialty Capacitors*  
FOR

Motors  
Luminous-tube transformers  
Fluorescent lamp ballasts

Industrial control  
Radio filters  
Radar  
Electronic equipment  
Communication systems  
Capacitor discharge welding

Flash photography  
Stroboscopic equipment  
Television  
Dust precipitators  
Radio interference suppression  
Impulse generators

AND MANY OTHER APPLICATIONS



AS TELEVISION VOLTAGES

# CLIMB and CLIMB

... these New Aerovox Electrolytics, Aerovox Oil-filled Capacitors and Aerovox Duranite Capacitors show the way

### HIGHER-VOLTAGE ELECTROLYTICS

Many types of Aerovox electrolytics are available to meet the severe-service conditions encountered in television equipment. Especially where temperatures of 85° C may be reached in hour-after-hour use. The Type AF twist-prong base electrolytic here shown is typical of the Aerovox trend towards higher voltages.



### DURANITE—THE SUPERIOR CAPACITOR

Brand new—designed from scratch. Utilizing the new Aerolene impregnant; the new Duranite casing material; and entirely new processing methods. Not to be confused with usual plastic tubulars. Duranite casing is unaffected by wide range of temperatures. Nothing to melt or burn. Moistureproof. No shelf deterioration. Pig-tails won't pull out. 200 to 1600 v. D.C.W. Popular capacitance values.



### HIGHER-VOLTAGE OIL TUBULARS

Popular Type —89 midget-can oil tubulars. Ratings increased from 2500 to 6000 v. D.C.W. Capacitances to .1\*. Higher voltage units with special terminals to provide necessary creepage distance without increasing diameter or length. Oil-impregnated paper section. Hermetically-sealed can. Insulated jacket. Center radial mounting strap.

\*Write for descriptive listings.



• Component performance can make or break this new television industry. Greater capacitor safety factors become imperative. And that is where these new Aerovox capacitors blaze the trail.

Now standard types, they are typical of how Aerovox application engineering anticipates circuit and operational requirements. Yes, regardless of your voltage, temperature and other severe-service conditions, Aerovox can deliver capacitors that will stand the gaff.

• Send us your capacitance problems for engineering collaboration. Let us quote on your capacitance requirements.



## FOR RADIO-ELECTRONIC AND INDUSTRIAL APPLICATIONS

AEROVOX CORPORATION, NEW BEDFORD, MASS., U.S.A.

SALES OFFICES IN ALL PRINCIPAL CITIES • Export: 13 E. 40th St., NEW YORK 16, N. Y.

Cable: 'ARLAB' • In Canada: AEROVOX CANADA LTD., HAMILTON, ONT.





Exclusive Manufacturers of Communications Network Components

# TOROIDAL COIL FILTERS AND TOROIDAL COILS DESIGNED FOR CRITICAL APPLICATIONS

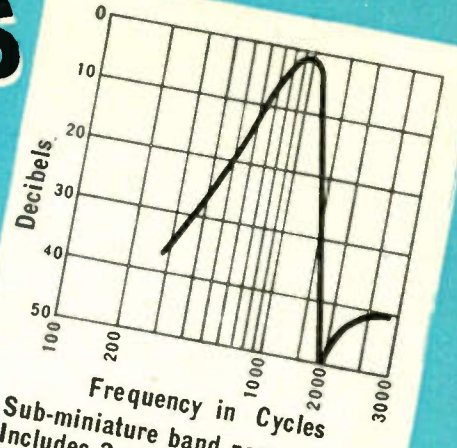

Sub-miniature band pass.  
Includes 3 coils and 4 condensers.  
Volume—4 1/2 cubic inches.

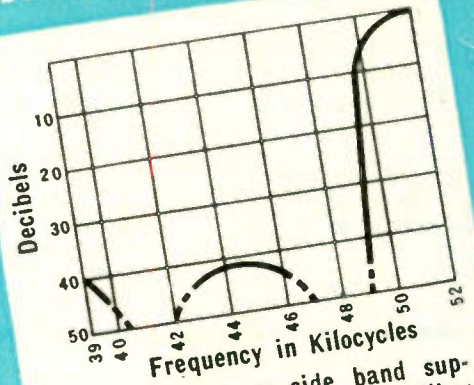

Extremely sharp side band suppression filter. Available in either low or high pass.  
Size: 2 1/2 x 4 x 2 1/2.

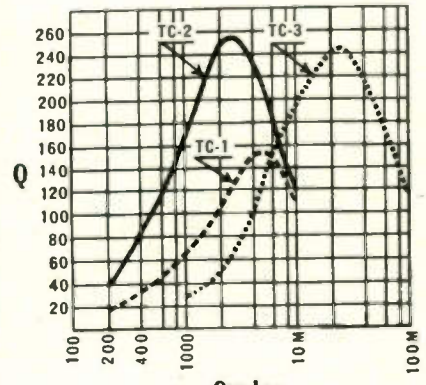

The big three out of 30 types of toroidal coils we are supplying.  
TC-1 any ind. up to 10 hys.  
TC-2 any ind. up to 30 hys.  
TC-3 any ind. up to .750 hys.

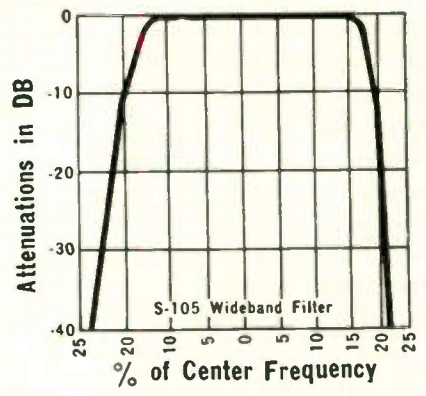

Wide band sharp cutoff band pass.  
Size: 2 x 3 1/2 x 6 5/8.

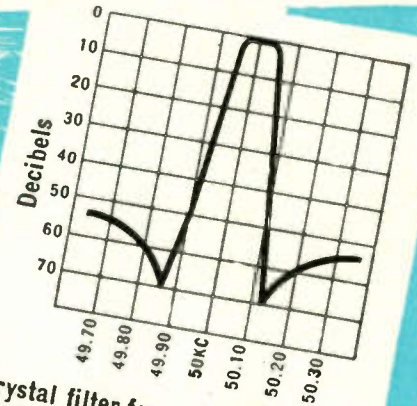

Crystal filter for narrow band pass applications too critical even for toroidal coils.

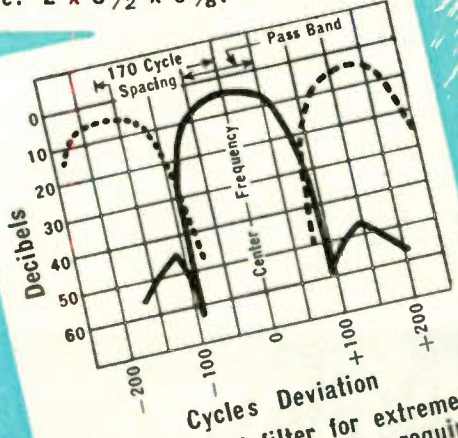

Tone channel filter for extremely high crossover attenuation requirement. Size: 2 1/2 x 2 1/2 x 5.



**Burnell & Company**  
YONKERS 2, NEW YORK  
CABLE ADDRESS "BURNELL"

ALL INQUIRIES WILL BE PROMPTLY HANDLED . . . WRITE FOR TECHNICAL INFORMATION



**EXPERIENCE  
PLUS  
COOPERATION  
*DOES IT!***

There's a lot of satisfaction in working with radio engineers who know exactly what they need to get top efficiency from the transmitter. To their specifications Blaw-Knox applies an experience in antenna tower building that dates back to the days of "wireless" . . . Together we get results that reflect credit on our structural designers and the station's technical experts . . . If your plans call for more effective coverage or directional changes we would welcome an engineering interview at your convenience.

**BLAW-KNOX DIVISION**

OF BLAW-KNOX COMPANY

2037 FARMERS BANK BUILDING

PITTSBURGH 22, PA.

◀ Blaw-Knox 550' Heavy Duty Type H40 Tower supporting a Federal 8 square loop FM antenna 74' high. Station WTMJ-FM, Richfield, Wisconsin.

**BLAW-KNOX ANTENNA TOWERS**

# No value equal to it...

## Model 260 Volt-Ohm-Milliammeter

There's good reason why this is the world's most popular high sensitivity volt-ohm-milliammeter. In every part, from smallest component to overall design, no competing instrument can show superiority. It outsells because it outranks every similar instrument. And in the Simpson patented Roll Top safety case, shown here, it brings you important and exclusive protection and convenience.

- • • in staying accuracy
- • • in functional design
- • • in useful ranges
- • • in sensitivity
- • • in ruggedness
- • • in precision

### Sub-Panel Assembly—Strong, Simple, Accessible

with cover over resistor pockets removed to show design

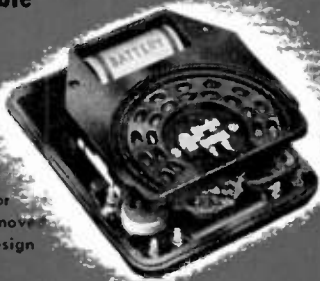

The ruggedness, the simplicity of design, and the consequent accessibility of components are shown here. Molded of sturdiest bakelite, the sub-panel provides separate pockets for resistors. This separation makes for orderly assembly, highest possible accessibility, and added insulation for preventing shorts. All connections are short and direct. Cable wiring is eliminated. Each battery has its own compartment, again increasing accessibility.



**The New Simpson Switch Mechanism.** You will find no other switch mechanism on the market like this Simpson switch. It is built of molded bakelite discs. Unusually sturdy contacts, of heavy stamped brass, silver-plated for superior conductivity are molded permanently into each disc. They can never come loose, never get out of position. When the discs are assembled into the complete switch, these contacts are self-enclosed against dust. Danger of shorts is automatically eliminated. As the switch is actuated from range to range, the contact is always positive and unvarying.

A ball-and-spring mechanism positions the switch at the selected range by a 3-point pressure. Switch is thus held securely in place, yet smoothly repositions to each new range. This mechanism is also self-enclosed against dust in a bakelite housing.



A flick of the finger opens or closes the Roll Top front.

High voltage probe (25,000 volts) for TV, radar, x-ray and other high voltage tests, also available.

### RANGES

- 20,000 Ohms per Volt D.C., 1,000 Ohms per Volt A.C.
- Volts: A.C. and D.C.: 2.5, 10, 50, 250, 1000, 5000
- Output: 2.5, 10, 50, 250, 1000
- Milliamperes, D.C.: 10, 100, 500
- Microamperes, D.C.: 100
- Amperes, D.C.: 10
- Decibels (5 ranges): -10 to +52 D.B.
- Ohms: 0-2000 (12 ohms center), 0-200,000 (1200 ohms center), 0-20 megohms (120,000 ohms center).
- Model 260, Size: 5 1/4" x 7" x 3 3/8".....\$38.95
- Model 260 in Roll Top Safety Case, as shown.....\$45.95
- Size: 5 3/8" x 7" x 4 3/4"
- Both complete with test leads and 32-page Operator's Manual

Ask your jabber or write for complete descriptive literature.

# Simpson

INSTRUMENTS THAT STAY ACCURATE

**SIMPSON ELECTRIC COMPANY**  
 5200-5218 W. Kinzie St., Chicago 44, Ill.  
 In Canada: Bach-Simpson, Ltd., London, Ont.

*Write type BH6  
into your design  
specifications!*



**BLILEY TYPE BH6  
APPROVED FOR  
PRODUCTION**



**TECHNIQUALITY  
CRYSTALS**

Engineered to the "MUST" requirements of current military and commercial communications

When you write Bliley Type BH6 into your specifications you meet all requirements, military or commercial . . . and you have simplified your design considerations by the elimination of unnecessary multiplier stages. Type BH6 is available up to 100 MC. Write us for oscillator circuit recommendations based on your particular requirements.

**Bliley  
CRYSTALS**

BLILEY ELECTRIC COMPANY  
UNION STATION BLDG., ERIE, PA.

**News—New Products**

These manufacturers have invited PROCEEDINGS readers to write for literature and further technical information. Please mention your I.R.E. affiliation.

**A Filter Selector Unit**

What interference filter to use and how to connect it may be readily and positively determined by the Aerovox Interference Filter offered by Aerovox Corp., New Bedford, Mass.

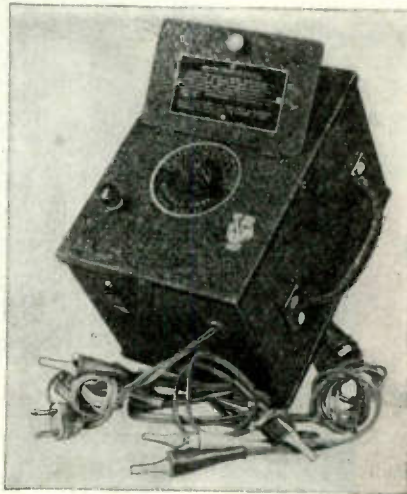

The "Selector" is portable, housed in a metal cabinet with a slide handle and hinged-cover compartment holding the assortment of connecting cords, plugs, receptacles and clips, which are readily connected in various ways with the noise-producing appliance or equipment. The knob is then turned through the series of different settings, each bringing into circuit the same circuit elements as found in Aerovox interference filters of corresponding type numbers. Thus the type of filter to use, as well as the appropriate connections, are immediately known, and the permanent installation can be made accordingly.

**Recent Catalogs**

- • • Bulletin E-133 explains Hytron 3B4, a vhf beam pentode power amplifier, from Hytron Radio & Electronics Corp., 76 Lafayette St., Salem, Mass.
- • • A folder describing the Compa-Station, a complete compact 2 way radio communication system, by Motorola, Inc., 4545 Augusta Blvd., Chicago 5, Ill.
- • • On type 1684 D, Furzehill direct coupled cathode ray oscilloscope, from American British Technology, Inc., 57 Park Ave., New York 16, N. Y.
- • • A brochure with detailed information about Models P54 and P55 pulse generators, by Raymond M. Wilmotte, Inc., 1469 Church St., N. W., Washington 5, D. C.
- • • A bulletin on "W" waterproof connectors has been reprinted, revised, and enlarged to include typical insert arrangements and tabular data "AN" layouts in shell sizes Nos. 16, 22, and 36 adaptable to "W" shells, by Cannon Electric Development Co., 3209 Humboldt St., Los Angeles 31, Calif.

(Continued on page 40A)

**"XL" PLUGS STANDARD**



**ON TURNER "77" MIKES  
ALSO MODEL "87"**

**TYPE XL PLUGS**



**XL-3-12  
Pin Contacts**

**XL-3-11  
Socket Contacts**

**THREE 15 AMP. CONTACTS  
FOR NO. 14 B & S STRANDED  
WIRE**

**BRIGHT NICKLE FINISH**

CANNON ELECTRIC "XL" Plugs are standard on the two above mentioned microphones; also on RCA's "Announce" microphones and various Electro-Voice models.

More and more microphone manufacturers are turning to Cannon Plugs for quality connector performance at a price that pays off in service and operation satisfaction.

You can buy the "XL" series in more than 375 radio parts stores over the country. For example: in *Kansas City*, Radiolab; in *San Francisco*, Graybar, C. C. Brown, Offenbach-Reimus, Pacific Wholesale, Zack Radio, C. R. Skinner and S. F. Radio; in *New Orleans*, Graybar, Radio Parts, Southern Radio and Wm. B. Allen.

For catalog information, write for XL-347 Bulletin, and the RJC-2 Special Condensed Catalog with list prices. Address Department K-377.

SINCE 1915

**CANNON  
ELECTRIC**

*Development Company*

3209 HUMBOLDT ST., LOS ANGELES 31, CALIF.

IN CANADA & BRITISH EMPIRE:  
CANNON ELECTRIC CO., LTD., TORONTO 13, ONT.

WORLD EXPORT (Excepting British Empire):  
FRAZAR & HANSEN, 301 CLAY ST., SAN FRANCISCO

# BENDIX-SCINTILLA

## ELECTRICAL CONNECTORS

*the finest  
money can buy!*

*these are the features* THAT HAVE  
MADE IT *the* QUALITY CONNECTOR

- Moisture-proof, Pressure-tight
- Radio Quiet
- Single-piece Inserts
- Vibration-proof
- Light Weight
- High Arc Resistance
- Easy Assembly and Disassembly
- Fewer Parts than any other Connector

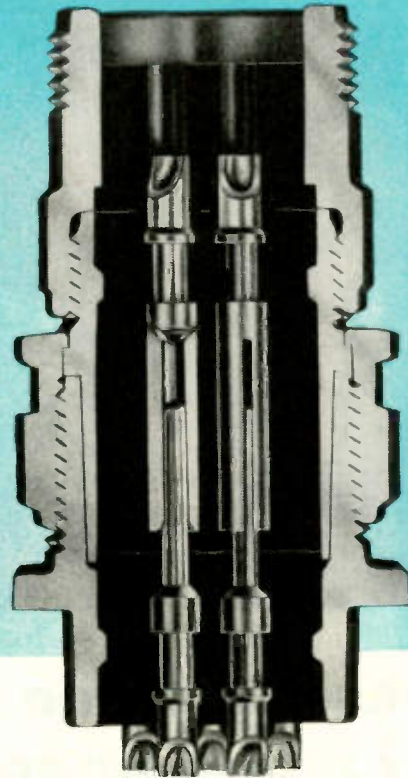

*Plus this Important Advantage—*  
**PRACTICALLY NO VOLTAGE DROP!**

Contacts that carry maximum currents with a minimum voltage drop are only part of the many new advantages you get with Bendix-Scintilla\* Electrical Connectors. The use of "Scinflex" dielectric material, an exclusive new Bendix-Scintilla development of outstanding stability, increases flashover and creepage distances. In temperature extremes, from  $-67^{\circ}$  F. to  $+300^{\circ}$  F., performance is remarkable. Dielectric strength is never less than 300 volts per mil. Bendix-Scintilla Connectors have fewer parts than any other connector on the market—and that means lower maintenance costs and better performance.

\*TRADEMARK

*Available in all Standard A.N. Contact Configurations.  
Write our Sales Department for detailed information.*



**BENDIX  
SCINTILLA**

**SCINTILLA MAGNETO DIVISION of**  
SIDNEY, NEW YORK



*RCA—the pioneer in miniatures—*



**... presents three new types of major importance**

● Here are three new miniature tubes... additions to RCA's large family of miniature types... that have particular significance in FM receiver design and voltage reference applications.

RCA 6BA7 and 12BA7 are pentagrid converters—alike except for heater ratings. They have high conversion gain, because of their high conversion transconductance; and a separate connection for direct grounding of the suppressor. These features in combination with the short internal leads characteristic of miniature tubes, result in efficient operation of either type in the 88 to 108-megacycle FM band. In addition to realizing substantial gains at the higher frequencies, the RCA 6BA7

and 12BA7 contribute a highly favorable signal-to-noise ratio.

RCA-5651 is a voltage reference tube of the cold-cathode, glow-discharge type. It maintains a dc operating potential of 87 volts, has an operating current range of 1.5 to 3.5 ma., an operating characteristic essentially independent of ambient temperature, and a voltage stability at any current level of better than 0.1 volt.

RCA Application Engineers will be pleased to consult with you on the incorporation of these new miniatures in your equipment designs. For further information write RCA, Commercial Engineering, Section KR-42, Harrison, N.J.

THE FOUNTAINHEAD OF MODERN TUBE DEVELOPMENT IS RCA

**RATINGS AND CHARACTERISTICS**

6BA7 and 12BA7 Pentagrid Converters

	6BA7	12BA7
Heater Voltage (ac or dc)	6.3	12.6 Volts
Heater Current	0.3	0.15 Ampere
<b>Characteristics — Separate Excitation*</b>		
Plate Voltage	100	250 Volts
Grid No. 5 and Internal Shield	Connected directly to ground	
Grids No. 2 and No. 4	100	100 Volts
Grid No. 3	-1.0	-1.0 Volt
Grid No. 1 Resistor	0.02	0.02 Megohm
Plate Resistance (Approx.)	0.5	1.0 Megohm
Conversion Transconductance	900	950 Micromhos
Conversion Transconductance (approx.)	Grid No. 3 ot. —20 volts	
Plate Current	3.5	3.5 Micromhos
Grids Nos. 2 and 4 Current	3.6	3.8 Ma.
Grid No. 1 Current	10.2	10 Ma.
Total Cathode Current	0.35	0.35 Ma.
	14.2	14.2 Ma.

\*Characteristics correspond very closely with those obtained in a self-excited oscillator circuit operating with zero bias.

**5651 Voltage-Reference Tube**

	Min.	Av.	Max.
DC Starting Voltage	—	107	115 Volts
DC Operating Voltage	82	87	92 Volts
DC Operating Current	1.5	—	3.5 Ma.
Regulation (1.5 to 3.5 Ma.)	—	—	3 Volts
Stability*	—	—	0.1 Volt
Ambient Temperature Range	-35 to +90° C		

\*Defined as the maximum voltage fluctuation of any current level within operating current range.



**TUBE DEPARTMENT**

**RADIO CORPORATION of AMERICA**

**HARRISON, N. J.**

# PROCEEDINGS OF THE I.R.E.

(Including the WAVES AND ELECTRONS Section)

Published Monthly by

The Institute of Radio Engineers, Inc.

VOLUME 36

November, 1948

NUMBER 11

BOARD OF DIRECTORS, 1948  
Benjamin E. Shackelford  
*President*  
R. L. Smith-Rose  
*Vice-President*  
S. L. Bailey  
*Treasurer*  
Haraden Pratt  
*Secretary*  
Alfred N. Goldsmith  
*Editor*  
Frederick B. Llewellyn  
*Senior Past President*  
W. R. G. Baker  
*Junior Past President*

1948-1949

J. B. Coleman  
Murray G. Crosby  
Raymond A. Heising  
T. A. Hunter  
H. J. Reich  
F. E. Terman

1948-1950

J. E. Shepherd  
J. A. Stratton

1948

A. E. Cullum, Jr.  
Virgil M. Graham  
Raymond F. Guy  
Keith Henney  
J. V. L. Hogan  
F. S. Howes  
J. A. Hutcheson  
I. J. Kaar  
D. B. Sinclair

Harold R. Zeamans  
*General Counsel*

George W. Bailey  
*Executive Secretary*

Laurence G. Cumming  
*Technical Secretary*

E. K. Gannett  
*Assistant Secretary*

BOARD OF EDITORS

Alfred N. Goldsmith  
*Chairman*

PAPERS REVIEW COMMITTEE

Murray G. Crosby  
*Chairman*

PAPERS PROCUREMENT COMMITTEE

John D. Reid  
*General Chairman*

## PROCEEDINGS OF THE I.R.E.

Theodore A. Hunter—Director, 1948-1949	1322
Electronics in Industry	Ralph R. Batcher 1323
3192. The Philosophy of PCM	B. M. Oliver, J. R. Pierce, and C. E. Shannon 1324
3193. Pentriode Amplifiers	H. M. Zeidler and J. D. Noe 1332
3194. Isotopes and Nuclear Structure	R. E. Lapp and H. L. Andrews 1339
3195. Duplex Tetrode UHF Power Tubes	Philip T. Smith and Howard R. Hegbar 1348
3196. Electrostatically Focused Radial-Beam Tube	A. M. Skellett 1354
3197. High-Power Interdigital Magnetrons	Joseph F. Hull and Arthur W. Randals 1357
3169. Correction to "Antenna Design for Television and FM Reception," by Frederick A. Kolster	1363
3198. Theory of Models of Electromagnetic Systems	George Sinclair 1364
3199. High-Frequency Polyphase Transmission Line	C. T. Tai 1370
3200. Low-Pass Filters Using Coaxial Transmission Lines as Elements	Douglas E. Mode 1376
3201. Parabolic Loci for Two Tuned Coupled Circuits	Sze-Hou Chang 1384
Contributors to PROCEEDINGS OF THE I.R.E.	1388
Correspondence:	
3119. "Avenues of Improvement in Present-Day Television"	Scott Helt 1390
3030. "Cathode-Follower Oscillators"	L. Rosenthal 1390

## INSTITUTE NEWS AND RADIO NOTES SECTION

Industrial Engineering Notes	1391
Sections	1393
Books:	
3202. "Microwave Magnetrons" edited by George B. Collins	1394
Reviewed by J. Ernest Smith	
3203. "The Principles and Practice of Wave Guides" by L. G. H. Huxley	1395
Reviewed by Simon Ramo	
3204. "Vacuum Tubes" by Karl R. Spangenberg	1395
Reviewed by R. M. Bowie	
3205. "Pulse Generators" edited by G. N. Glasoe and Jean V. Lebacqz	1396
Reviewed by William L. Mraz	
3206. "Klystrons and Microwave Triodes" by Donald R. Hamilton, Julian K. Knipp, and J. B. H. Kuper	1396
Reviewed by A. E. Harrison	
3207. "Electronic Circuits and Tubes" by Cruft Laboratory	1396
Reviewed by J. D. Ryder	
3208. "Elements of Acoustical Engineering" by Harry F. Olson	1397
Reviewed by F. V. Hunt	
3209. "Preparing for Federal Radio Operator Examinations" by Arnold Shostak	1397
Reviewed by Neal McNaughten	
IRE People	1398

## WAVES AND ELECTRONS SECTION

W. Ryland Hill, Jr., and Andrew Friedenthal, Section Chairmen	1401
3210. Technical Problems of Military Radio Communications of the Future	John Hessel 1402
3211. Telemetry Guided-Missile Performance	James C. Coe 1404
3212. A Waveguide Bridge for Measuring Gain at 4000 Mc	A. L. Samuel and C. F. Crandell 1414
3213. A High-Level Single-Sideband Transmitter	Oswald G. Villard, Jr. 1419
3214. An Antenna for Controlling the Nonfading Range of Broadcasting Stations	Charles L. Jeffers 1426
3215. The Light-Pattern Meter	R. E. Santo 1431
Contributors to Waves and Electrons Section	1434
3216. Abstracts and References	1435
News—New Products	30A Positions Open 50A
Section Meetings	34A Positions Wanted 58A
Membership	36A Advertising Index 66A

## EDITORIAL DEPARTMENT

Alfred N. Goldsmith  
*Editor*

Clinton B. DeSoto  
*Technical Editor*

Mary L. Potter  
*Assistant Editor*

William C. Copp  
*Advertising Manager*

Lillian Petranek  
*Assistant Advertising Manager*

Responsibility for the contents of papers published in the PROCEEDINGS OF THE I.R.E. rests upon the authors. Statements made in papers are not binding on the Institute or its members.

Changes of address (with advance notice of fifteen days) and communications regarding subscriptions and payments should be mailed to the Secretary of the Institute, at 450 Ahnaip St., Menasha, Wisconsin, or 1 East 79 Street, New York 21, N. Y. All rights of republication, including translation into foreign languages, are reserved by the Institute. Abstracts of papers, with mention of their source, may be printed. Requests for republication privileges should be addressed to The Institute of Radio Engineers.





## Theodore A. Hunter

DIRECTOR, 1948-1949

Theodore A. Hunter was born on December 5, 1900, in Dike, Iowa. He received the B.S. and M.S. degrees in electrical engineering from the University of Iowa in 1922 and 1924, respectively, and the professional E.E. degree in 1931.

While attending college, Mr. Hunter took an active part in campus pioneer radio work, and he also engaged in early research on extremely high-gain amplifiers for nerve-current measurements and other medical work. After completing school, he became a transmission-line inspector for the Northwestern Bell Telephone Company, and later joined the Crosley Radio Corporation to supervise loudspeaker development. Subsequently he taught at the University of Pittsburgh and the Rose Polytechnic Institute.

Following a period of semiretirement, during which he engaged in consulting work on police radio systems, Mr. Hunter joined the Collins Radio Company at Cedar Rapids, Iowa, in 1940. There he developed the Navy Model TCS series transmitter, one of the mainstay

mobile transmitters used by the Allies in World War II. Becoming interested in the design and construction of extremely stable master oscillators, his many published articles include several on the subject, and he has also presented papers dealing with oscillators before several IRE sections.

In 1947, Mr. Hunter left Collins in order to form his own organization—the Hunter Manufacturing Company—where he specializes in electronic equipment for amateurs and for use by the medical profession. He is also working as a consultant for the University of Iowa on a Navy project.

Becoming an Associate Member and a Member of the IRE in the same year, 1945, Mr. Hunter was made a Senior Member in 1946. In 1944 he was the prime mover behind the formation of the Cedar Rapids Section of the IRE. Mr. Hunter is a member of Sigma Xi, a past member of the American Physical Society, a district director of the Iowa Engineering Society, and president of the Cedar Rapids Engineer's Club.



Electronic engineering—healthy child of communications technique—has shown the characteristic strength and vagaries of youth. As it approaches maturity, its problems and their solutions become increasingly evident. These are discussed, on the basis of wide experience, in the following guest editorial by a skilled electronic consulting engineer who was executive editor of the periodical *Electronic Industries*.—*The Editor*.

## Electronics in Industry

RALPH R. BATCHER

For two decades industry has been acquainted with electronic methods as possible solutions to production problems. Many practical applications have been installed and tested. Widespread publicity has been given to the economics of the installations. Yet an analysis of such progress as has been made finds that equipment sales in this field have hardly begun, in effect, when their potentialities are considered.

Through the years many radio concerns with excellent engineering staffs and adequate production facilities have introduced many items to industry as a sideline. Nevertheless, with few exceptions these devices hardly ever paid their development costs. Why?

During the nineteen-twenties, industrial electronics meant phototube door openers, high-frequency corn poppers, diathermy machines, photocell registration devices, and the like. For these services, and others which came later, many packaged devices are on sale that are expected to fit any problem. Many that were sold have never seen service, mainly because of the difficulty in getting the accessories needed. Adherence to this policy of producing a package containing the electronic elements of some useful system is not helping to advance the art. It is necessary to forget that there is such a thing as an electronic black box that can be set down anywhere to do a job.

In so many cases, electronics is not something new that can be added to any existing process. For example, high-frequency heating of "preforms," a valuable use for electronics, requires extensive relaying out of molding processes, different operating cycles, and so forth. Electronic equipment to be of value must be an integral part of the whole setup—just as a motor is a part of the system. While it can be sold or installed separately, to be most effective it should come as part of a planned installation.

Electronic equipment is a small but necessary cog in the modern technique of manufacturing. Nevertheless, there seems very little chance for radio equipment companies to get into this field extensively, except by building equipment that ties in as a part of some manufacturing setup, so that the customer will be sure that, once installed, the equipment will function as a whole. However, there will be no mass market here in most cases, as each problem requires a separate approach.

Cost savings and product improvements become a part of the whole system, and the part played by the purely electronic portion usually cannot be estimated separately, although its value is evident. The present attempt to promote electronic devices as accessories is like publicizing automobiles in order to sell balloon tires to the public. Everyone agrees on their value, but everyone also knows that they must be designed into the car, not added later as accessories. Electronic control will be extensively used when machine-tool manufacturers make machinery availa-

ble with all of the necessary electron-tube circuits in place.

The radio manufacturer usually forgets, when he promotes a packaged electronic unit to industry at large, that a great amount of nonelectronic machinery must be tracked down, purchased, and assembled before the unit may be applied to the job. For example, in printing registration it is next to impossible to apply phototube devices to many of the existing presses without virtually reconstructing the whole machine. A fifty-dollar electronic registration control might take many thousands of dollars worth of mechanical equipment to complete the job. Such controls must be added by the manufacturer of the press if they are to be used.

Another deterrent is a lack of clear understanding of industrial problems by electronic engineers who have grown up in the communication field. For example, one field to which electronics may be applied is that of automatic control in the so-called process industries: textiles, rubber, chemicals, oils, plastics, and so on. The whole process of control is rapidly being instrumentized, frequently by pneumatic and hydraulic controls. Here electronic methods have keen competition. Many radio men have been surprised upon investigating pneumatic control methods to find them exceedingly ingenious and to discover that they do many jobs surprisingly well without much complicated equipment requirements. They also discover that a different language is used in these fields, with terms and ideas completely different from those used in radio. Since pneumatic and other control methods started along with industry itself, industry does not have to learn a new language in order to use these systems. Electronic men trying to get industrial business must learn industry's problems and interpret their circuits and systems into its own terms.

They will discover that many of the electronic devices now in use are not too well designed. Equipment designed by tube circuit men is often too frail and ill-suited to plant use. On the other hand, the equipment set up by designers acquainted with these hazards uses circuits that are far from being reliable and constant over months or years. They tend to use one or two tubes to do complicated jobs, on the now-obsolete theory that, since tubes are "fragile and unpredictable," the fewer used the better.

With everything "trimmed up to the peak," it is no wonder that such apparatus drifts around. Industry needs the services of engineers who can set up circuits that are reliable and simple to service in that over-the-counter tubes may be put in without harm.

In other words, what is needed is the use of a few of the ideas learned in the radio industry several years ago, chiefly that tubes are cheap, and that an extra tube or so can serve well in making a circuit simpler and it may compensate for variations due to aging and many industrial hazards.

# The Philosophy of PCM\*

B. M. OLIVER†, MEMBER, IRE, J. R. PIERCE†, FELLOW, IRE, AND C. E. SHANNON†

*Summary*—Recent papers<sup>1,6</sup> describe experiments in transmitting speech by PCM (pulse code modulation). This paper shows in a general way some of the advantages of PCM, and distinguishes between what can be achieved with PCM and with other broadband systems, such as large-index FM. The intent is to explain the various points simply, rather than to elaborate them in detail. The paper is for those who want to find out about PCM rather than for those who want to design a system. Many important factors will arise in the design of a system which are not considered in this paper.

## I. PCM AND ITS FEATURES

THERE ARE SEVERAL important elements of a PCM (pulse-code modulation) system. These will be introduced, and the part each plays in PCM will be explained in this section.

### Sampling

In general, the object of a transmission system is to reproduce at the output any function of time which appears at the input. In any practical system only a certain class of functions, namely, those limited to a finite frequency band, are admissible inputs. A signal which contains no frequencies greater than  $W_0$  cps cannot assume an infinite number of independent values per second. It can, in fact, assume exactly  $2W_0$  independent values per second, and the amplitudes at any set of points in time spaced  $\tau_0$  seconds apart, where  $\tau_0 = 1/2W_0$ , specify the signal completely. A simple proof of this is given in Appendix I. Hence, to transmit a band-limited signal of duration  $T$ , we do not need to send the entire continuous function of time. It suffices to send the finite set of  $2W_0T$  independent values obtained by sampling the instantaneous amplitude of the signal at a regular rate of  $2W_0$  samples per second.

If it surprises the reader to find that  $2W_0T$  pieces of data will describe a continuous function completely over the interval  $T$ , it should be remembered that the  $2W_0T$  coefficients of the sine and cosine terms of a Fourier series do just this, if, as we have assumed, the function contains no frequencies higher than  $W_0$ .

### Reconstruction

Let us now proceed to the receiving end of the system, and assume that, by some means, the sample values rep-

resenting the signal are there and available in proper time sequence, and can be used at the regular rate  $2W_0$ . To reconstruct the signal it is merely necessary to generate from each sample a proportional impulse, and to pass this regularly spaced series of impulses through an ideal low-pass filter of cutoff frequency  $W_0$ . The output of this filter will then be (except for an over-all time delay and possibly a constant of proportionality) identical to the input signal. Since the response of an ideal low-pass filter to an impulse is a  $\sin x/x$  pulse, and since the total output is the linear sum of the responses to all inputs, this method of reconstruction is simply the physical embodiment of the method indicated in Appendix I.

Ideally, then, we could achieve perfect reproduction of a signal if we could transmit information giving us exactly the instantaneous amplitude of the signal at intervals spaced  $1/2W_0$  apart in time.

### Quantization

It is, of course, impossible to transmit the *exact* amplitude of a sample. The amplitude of a sample is often transmitted as the amplitude of a pulse, or as the time position of a pulse. Noise, distortion, and crosstalk between pulses will disturb the amplitude and position, and hence cause errors in the recovered information concerning the size of the sample. Ordinarily the error becomes greater as the signal is amplified by successive repeaters, and hence the accumulation of noise sets a limit to the distance a signal can be transmitted even with enough amplification.

It is possible, however, to allow only certain discrete levels of amplitude or position of the transmitted pulse. Then, when the signal is sampled, the level nearest the true signal level is sent. When this is received and amplified, it will have a level a little different from any of the specified levels. If the noise and distortion are not too great, we can surely tell which level the signal was supposed to have. Then the signal can be reformed, or a new signal created, which again has the level originally sent.

Representing the signal by certain discrete allowed levels only is called *quantizing*. It inherently introduces an initial error in the amplitude of the samples, giving rise to *quantization noise*. But once the signal is in a quantized state, it can be relayed for any distance without further loss in quality, provided only that the added noise in the signal received at each repeater is not too great to prevent correct recognition of the particular level each given signal is intended to represent. By quantizing we limit our "alphabet." If the received signal lies between  $a$  and  $b$ , and is closer (say) to  $b$ , we guess that  $b$  was sent. If the noise is small enough, we shall always be right.

\* Decimal classification: R148.6. Original manuscript received by the Institute, May 24, 1948.

† Bell Telephone Laboratories, Inc., New York, N. Y.

<sup>1</sup> W. M. Goodall, "Telephony by pulse code modulation," *Bell Sys. Tech. Jour.*, vol. 26, pp. 395-409; July, 1947.

<sup>2</sup> D. D. Grieg, "Pulse count modulation system," *Tele-Tech.*, vol. 6, pp. 48-52; September, 1947.

<sup>3</sup> D. D. Grieg, "Pulse count modulation," *Elec. Commun.*, vol. 24, pp. 287-296; September, 1947.

<sup>4</sup> H. S. Black and J. O. Edson, "PCM equipment," *Elec. Eng.*, vol. 66, pp. 1123-25; November, 1947.

<sup>5</sup> A. C. Clavier, D. D. Grieg, and P. F. Panter, "PCM distortion analysis," *Elec. Eng.*, vol. 66, pp. 1110-1122; November, 1947.

<sup>6</sup> L. A. Meacham and E. Peterson, "An experimental multi-channel pulse code modulation system of toll quality," *Bell Sys. Tech. Jour.*, vol. 27, pp. 1-43; January, 1948.

Coding

A quantized sample could be sent as a single pulse which would have certain possible discrete amplitudes, or certain discrete positions with respect to a reference position. However, if many allowed sample amplitudes are required, one hundred, for example, it would be difficult to make circuits to distinguish these one from another. On the other hand, it is very easy to make a circuit which will tell whether or not a pulse is present. Suppose, then, that several pulses are used as a *code group* to describe the amplitude of a single sample. Each pulse can be on (1) or off (0). If we have three pulses, for instance, we can have the combinations representing the amplitudes shown in Table I.

TABLE I

Amplitude Represented	Code
0	000
1	001
2	010
3	011
4	100
5	101
6	110
7	111

The codes are, in fact, just the numbers (amplitudes) at the left written in binary notation. In this notation, the place-values are 1, 2, 4, 8,—; i.e., a unit in the right-hand column represents 1, a unit in the middle (second) column represents 2, a unit in the left (third) column represents 4, etc. We see that with a code group of  $n$  on-off pulses we can represent  $2^n$  amplitudes. For example, 7 pulses yield 128 sample levels.

It is possible, of course, to code the amplitude in terms of a number of pulses which have allowed amplitudes of 0, 1, 2 (base 3 or ternary code), or 0, 1, 2, 3 (base 4 or quaternary code), etc., instead of the pulses with allowed amplitudes 0, 1 (base 2 or binary code). If ten levels were allowed for each pulse, then each pulse in a code group would be simply a digit of an ordinary decimal number expressing the amplitude of the sample. If  $n$  is the number of pulses and  $b$  is the base, the number of quantizing levels the code can express is  $b^n$ .

Decoding

To decode a code group of the type just described, one must generate a pulse which is the linear sum of all the pulses in the group, each multiplied by its place value ( $1, b, b^2, b^3, \dots$ ) in the code. This can be done in a number of ways. Perhaps the simplest way which has been used involves sending the code group in "reverse" order, i.e., the "units" pulse first, and the pulse with the highest place value last. The pulses are then stored as charge on a capacitor-resistor combination with a time constant such that the charge decreases by the factor  $1/b$  between pulses. After the last pulse, the charge (voltage) is sampled.

A Complete PCM System

A PCM system embodies all the processes just described. The input signal is band-limited to exclude any frequencies greater than  $W_0$ . This signal is then sampled at the rate  $2W_0$ . The samples are then quantized and encoded. Since only certain discrete code groups are possible, the selection of the nearest code group automatically quantizes the sample, and with certain types of devices it is therefore not necessary to quantize as a separate, prior operation. The code groups are then transmitted, either as a time sequence of pulses (time division) over the same channel, or by frequency division, or over separate channels. The code groups are regenerated (i.e., reshaped) at intervals as required. At the receiver the (regenerated) code groups are decoded to form a series of impulses proportional to the original samples (except quantized), and these impulses are sent through a low-pass filter of bandwidth  $W_0$  to recover the signal wave.

II. TRANSMISSION REQUIREMENTS FOR PCM

Suppose we consider what requirements exist, ideally, on the channel which is to carry the encoded PCM signal; that is, ruling out physically impossible devices, but allowing ideal components such as ideal filters, ideal gates, etc.

Bandwidth

If a channel has a bandwidth  $W$  cps, it is possible to send up to  $2W$  independent pulses per second over it. We can show this very simply. Let the pulses occur (or not occur) at the time  $t=0, \tau, 2\tau, \dots, m\tau$  where  $\tau = 1/2W$ , and let each pulse as received be of the form

$$V = V_0 \frac{\sin \frac{\pi}{\tau} (t - m\tau)}{\frac{\pi}{\tau} (t - m\tau)} \tag{1}$$

The shape of this pulse is shown in Fig. 1. It will be seen that the pulse centered at time  $m\tau$  will be zero at  $t = k\tau$

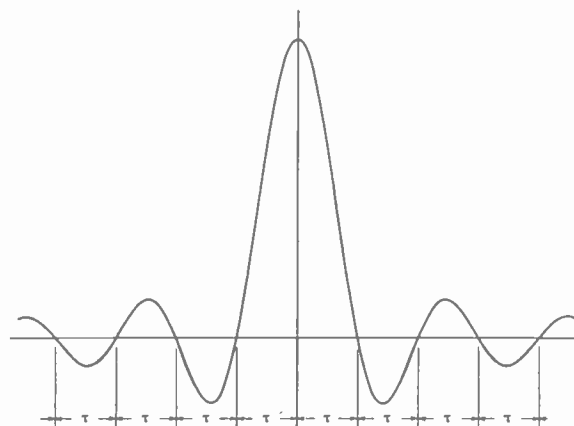

Fig. 1—Pulse of the form  $V_0 \frac{\sin(\pi t/\tau)}{\pi t/\tau}$ .

where  $k \neq m$ . Thus, if we sample the pulse train at the time  $t = m\tau$ , we will see only the pulse belonging to that time and none of the others.

Further, the pulse given by (1) contains no frequencies higher than  $W$ . It is the pulse one would get out of an ideal low-pass filter of cutoff  $W$ , on applying a very short impulse to the input.

Now, to send a signal of bandwidth  $W_0$  by PCM, we must send  $2W_0$  code groups per second and each code group contains (say)  $n$  pulse places. We must be prepared, therefore, to send  $2nW_0$  pulses per second, and this requires a bandwidth  $W = nW_0$ . The pulses may be sent in time sequence over one channel or by frequency division. In either case the total bandwidth will be the same. Of course, if double-sideband transmission is used in the frequency-division case, or if the time-division signal is sent as double-sideband rf pulses, the total bandwidth will be  $2nW_0$ .

In short, the bandwidth required for PCM is, in the ideal case,  $n$  times as great as that required for direct transmission of the signal, where  $n$  is the number of pulses per code group.

#### Threshold Power

To detect the presence or absence of a pulse reliably requires a certain signal-to-noise ratio. If the pulse power is too low compared to the noise, even the best possible detector will make mistakes and indicate an occasional pulse when there is none, or vice versa. Let us assume that we have an ideal detector, i.e., one which makes the fewest possible mistakes. If the received pulses are of the form (1), and if the noise is "white" noise (i.e., noise with a uniform power spectrum and gaussian amplitude distribution as, for example, thermal noise), ideal detection could be achieved by passing the signal through an ideal low-pass filter of bandwidth  $W (=nW_0$  in the ideal case) and sampling the output at the pulse times  $k\tau$ . If the signal when sampled exceeds  $V_0/2$ , we say a pulse is present; if less than  $V_0/2$ , we say there is no pulse. The result will be in error if the noise at that instant exceeds  $V_0/2$  in the right direction. With gaussian noise, the probability of this happening is proportional to the complementary error function<sup>7</sup> of

$$\frac{V_0}{2\sigma} = \sqrt{\frac{P_s}{4N}}$$

where

$\sigma$  = rms noise amplitude

$P_s$  = signal (pulse) "power" =  $V_0^2$

$N$  = noise power in bandwidth  $W = \sigma^2$ .

As the signal power  $P_s$  is increased, this function decreases very rapidly, so that if  $P_s/N$  is large enough to make the signal intelligible at all, only a small increase

will make the transmission nearly perfect. An idea of how rapidly this improvement occurs may be had from Table II. The last column in the table assumes a pulse rate of  $10^5$  per second.

TABLE II

Signal to Noise $\frac{P_s}{N}$	Probability of Error	This Is About One Error Every
13.3 db	$10^{-2}$	$10^{-3}$ sec
17.4 db	$10^{-4}$	$10^{-1}$ sec
19.6 db	$10^{-6}$	10 sec
21.0 db	$10^{-8}$	20 min
22.0 db	$10^{-10}$	1 day
23.0 db	$10^{-12}$	3 months

Clearly, there is a fairly definite *threshold* (at about 20 db, say) below which the interference is serious, and above which the interference is negligible. Comparing this figure of 20 db with the 60- to 70-odd db required for high-quality straight AM transmission of speech, it will be seen that PCM requires much less signal power, even though the noise power is increased by the  $n$ -fold increase in bandwidth.

The above discussion has assumed an on-off (base 2) system. In this system pulses will be present half the time, on the average, and the *average* signal power<sup>8</sup> will be  $P_s/2$ . If a balanced base 2 system were used, i.e., one in which 1 is sent as a + pulse (say) and 0 as a - pulse, the peak-to-peak signal swing would have to be the same as in the on-off system for the same noise margin, and this swing would be provided by pulses of only half the former amplitude. Since either a + or - pulse would always be present, the signal power would be  $P_s/4$ .

If pulses are used which have  $b$  different amplitude levels (i.e., a base  $b$  system), then a certain amplitude separation must exist between the adjacent levels to provide adequate noise margin. Call this separation  $K\sigma$ , where  $K$  = a constant. (From the preceding discussion we see that  $K$  is about 10.) The total amplitude range is therefore  $K\sigma(b-1)$ . The signal power will be least if this amplitude range is symmetrical about zero, i.e., from  $-K\sigma(b-1)/2$  to  $+K\sigma(b-1)/2$ . The average signal power  $S$ , assuming all levels to be equally likely, is then<sup>8</sup>

$$\begin{aligned} S &= K^2\sigma^2 \frac{b^2 - 1}{12} \\ &= K^2N \frac{b^2 - 1}{12}. \end{aligned} \quad (2)$$

It will be noticed that the required signal power increases rapidly with the base  $b$ .

#### Regeneration: The Pay-Off

In most transmission systems, the noise and distortion from the individual links cumulate. For a given

<sup>7</sup> Complementary error function of  $x = 1/\sqrt{2\pi} \int_x^\infty e^{-\lambda^2/2} d\lambda$ .

<sup>8</sup> See Appendix II.

quality of over-all transmission, the longer the system, the more severe are the requirements on each link. For example, if 100 links are to be used in tandem, the noise power added per link can only be one-hundredth as great as would be permissible in a single link.

Because the signal in a PCM system can be regenerated as often as necessary, the effects of amplitude and phase and nonlinear distortions in one link, if not too great, produce no effect whatever on the regenerated input signal to the next link. If noise in a single link causes a certain fraction  $p$  of the pulses to be regenerated incorrectly, then after  $m$  links, if  $p \ll 1$ , the fraction incorrect will be approximately  $mp$ . However, to reduce  $p$  to a value  $p' = p/m$  requires only a slight increase in the power in each link, as we have seen in the section on threshold power. Practically, then, the transmission requirements for a PCM link are almost independent of the total length of the system. The importance of this fact can hardly be overstated.

### III. PERFORMANCE OF A PCM SYSTEM

We have seen that PCM requires more bandwidth and less power than is required with direct transmission of the signal itself, or with straight AM. We have, in a sense, exchanged bandwidth for power. Has the exchange been an efficient one? Are good signal-to-noise ratios in the recovered signal feasible in PCM? And how sensitive to interference is PCM? We shall now try to answer these questions.

#### Channel Capacity

A good measure of the bandwidth efficiency is the information capacity of the system as compared with the theoretical limit for a channel of the same bandwidth and power. The information capacity of a system may be thought of as the number of independent symbols or characters which can be transmitted without error in unit time. The simplest, most elementary character is a binary digit, and it is convenient to express the information capacity as the equivalent number of binary digits per second,  $C$ , which the channel can handle. Shannon and others have shown that an ideal system has the capacity<sup>9</sup>

$$C = W \log_2 \left( 1 + \frac{P}{N} \right) \quad (3)$$

where

$W$  = bandwidth

$P$  = average signal power

$N$  = white noise power.

Two channels having the same  $C$  have the same capacity for transmitting information, even though the quantities  $W$ ,  $P$ , and  $N$  may be different.

In a PCM system, operating over the threshold so that the frequency of errors is negligible,

$$C = sm$$

where

$s$  = sampling rate =  $2W_0$

$m$  = equivalent number of binary digits per code group.

If there are  $l$  quantizing levels, the number of binary digits required per code group is given by  $l = 2^m$ , while the actual number of (base  $b$ ) digits  $n$  will be given by

$$l = b^n.$$

Thus,

$$2^m = b^n$$

$$m = n \log_2 b$$

and

$$C = sn \log_2 b.$$

Now  $sn$  is the actual pulse frequency, and is ideally twice the system bandwidth  $W$ .

Therefore,

$$C = 2W \log_2 b$$

$$= W \log_2 b^2.$$

Substituting for  $b$  the power required for this base (from (2)), we have

$$C = W \log_2 \left( 1 + \frac{12S}{K^2 N} \right). \quad (4)$$

Comparing (4) with (3), we see they are identical if  $S = (K^2/12)P$ . In other words, PCM requires  $K^2/12$  (or about 8) times the power theoretically required to realize a given channel capacity for a given bandwidth.

Perhaps the most important thing to notice about (4) is that the form is right. Power and bandwidth are exchanged on a logarithmic basis, and the channel capacity is proportional<sup>10</sup> to  $W$ . In most broadband systems, which improve signal-to-noise ratio at the expense of bandwidth,  $C$  is proportional only to  $\log W$ .

#### Signal-to-Noise Ratio

There are two types of noise introduced by a PCM system. One of these is the quantizing noise mentioned in the section on quantization. This is a noise introduced at the transmitting end of the system and nowhere else. The other is *false pulse* noise caused by the incorrect interpretation of the intended amplitude of a pulse by the receiver or by any repeater. This noise may arise anywhere along the system, and is cumulative. However, as we have seen earlier, this noise decreases so rapidly as the signal power is increased above threshold that in any practical system it would be made negligible by design. As a result, the signal-to-noise ratio in PCM systems is set by the quantizing noise alone.

<sup>9</sup> C. E. Shannon, "A mathematical theory of communication," *Bell Sys. Tech. Jour.*, vol. 27, July, October, 1948.

<sup>10</sup> Provided  $S$  is increased in proportion to  $W$  to compensate for the similar increase in  $N$ .

If the signal is large compared with a single quantizing step, the errors introduced in successive samples by quantizing will be substantially uncorrelated. The maximum error which can be introduced is one-half of one quantizing step in either direction. All values of error up to this maximum value are equally likely. The rms error introduced is, therefore,  $1/2\sqrt{3}$  times the height of a single quantizing step.<sup>8</sup> When the signal is reconstructed from the decoded samples (containing this quantizing error), what is obtained is the original signal plus a noise having a uniform frequency spectrum out to  $W_0$  and an rms amplitude of  $1/2\sqrt{3}$  times a quantizing step height. The ratio of peak-to-peak signal to rms noise is, therefore,

$$R = 2\sqrt{3} b^n,$$

since  $b^n$  is the number of levels. Expressing this ratio in db, we have

$$\begin{aligned} 20 \log_{10} R &= 20 \log_{10} 2\sqrt{3} + n(20 \log_{10} b) \\ &= 10.8 + n(20 \log_{10} b). \end{aligned} \quad (5)$$

In a binary system,  $b=2$ , and

$$20 \log_{10} R \cong 10.8 + 6n.$$

In examining (5) let us remember that  $n$ , the number of digits, is a factor relating the *total bandwidth used in transmission* to the *bandwidth of the signal to be transmitted*, i.e.,  $W = nW_0$ . It is something like the index of modulation in FM. Now, for every increment of  $W_0$  added to the bandwidth used for transmission,  $n$  may be increased by one, and this increases the signal-to-noise ratio by a constant number of db. In other words, in PCM, *the signal-to-noise ratio in db varies linearly with the number of digits per code group, and hence with the bandwidth*. Of course, as the bandwidth is increased the noise power increases, and a proportional increase in signal power is required to stay adequately above threshold.

A binary PCM system using ten times the bandwidth of the original signal will give a 70-db signal-to-noise ratio. Higher base systems will require less bandwidth.

#### Ruggedness

One important characteristic of a transmission system is its susceptibility to interference. We have seen that noise in a PCM circuit produces no effect unless the peak amplitude is greater than half the separation between pulse levels. In a binary (on-off) system, this is half the pulse height. Similarly, interference such as stray impulses, or pulse crosstalk from a near-by channel, will produce no effect unless the peak amplitude of this interference plus the peak noise is half the pulse height. The presence of interference thus increases the threshold required for satisfactory operation. But, if an adequate margin over threshold is provided, comparatively large amounts of interference can be present with-

out affecting the performance of the circuit at all. A PCM system, particularly an on-off (binary) system, is therefore quite "rugged."

When a number of radio communication routes must converge on a single terminal, or follow similar routes between cities, the ruggedness of the channels is a particularly important consideration. If the susceptibility of the channels to mutual interference is high, many separate frequency bands will be required, and the total bandwidth required for the service will be large. Although PCM requires an initial increase of bandwidth for each channel, the resulting ruggedness permits many routes originating from, or converging toward, a single terminal to occupy the same frequency band. Different planes of polarization for two channels over the same path can often be used, and the directivities of practical antennas are such that only a small difference in direction of arrival will separate two routes on the same frequency. As a result, the frequency occupancy of PCM is exceptionally good, and its other transmission advantages are then obtained with little, if any, increase in *total* bandwidth.

#### IV. COMPARISON OF PCM AND FM

One feature of PCM is that the signal-to-noise ratio can be substantially improved by increasing the transmission bandwidth. This is an advantage shared with certain other pulse systems and with FM. As FM is the best known of these other systems, it is interesting to compare PCM and FM.

#### Broadband Gain

In going to high-deviation FM, the gain in signal-to-noise voltage ratio over AM (with the same power and the same noise per unit bandwidth) is proportional to the deviation ratio, or to the ratio of half the bandwidth actually used in transmission to the bandwidth of the signal to be transmitted. This ratio corresponds to  $n$  in our notation. If noise power is uniformly distributed with respect to frequency, and if one desires to provide the same margin over threshold in FM with various bandwidths, the transmitter power must be proportional to bandwidth (to  $n$ ). If we so vary the power in varying the bandwidth of wide-deviation FM, the signal-to-noise voltage ratio will vary as  $n(n^{1/2})$ , where the factor  $n^{1/2}$  comes about through the increased signal voltage. Thus the signal-to-noise ratio  $R$  will be given by

$$\begin{aligned} R &= (\text{const})n^{3/2} \\ 20 \log_{10} R &= 30 \log_{10} n + \text{const}. \end{aligned} \quad (6)$$

For binary (on-off) PCM we have, from (5), for the same simultaneous variation of bandwidth and power

$$20 \log_{10} R = 6n + 10.8.$$

Or, for ternary (base 3) PCM,

$$20 \log_{10} R = 9.54n + 10.8.$$

We see that, as the bandwidth (proportional to  $n$ ) is increased in FM, the signal-to-noise ratio varies as  $\log n$ , while in PCM it varies as  $n$ . Thus, as bandwidth is increased, PCM is bound to exhibit more improvement in the end. Further, a more elaborate analysis shows that, ideally at least, PCM can provide, for any bandwidth, nearly as high a signal-to-noise ratio as is possible with any system of modulation.

Why is PCM so good in utilizing bandwidth to in-

crease the signal-to-noise ratio? A very clear picture of the reason can be had by considering a simple PCM system in which four binary digits are transmitted on four adjacent frequency bands with powers just sufficient to over-ride noise. In Fig. 2(a) the signals in these four channels  $B_1, B_2, B_3, B_4$  are shown versus time. A black rectangle represents a pulse; a white rectangle, the absence of a pulse. The rectangles are  $\tau_0 = (1/2W_0)$  long. The particular sequence of code groups shown in the figure represents a quantized approximation to a linear change of amplitude with time, as shown in Fig. 2(b).

Now suppose, instead, that we confine ourselves to sending a pulse in only one channel at a time, as shown in Fig. 2(c). The best quantized representation of the signal we can get is shown in Fig. 2(d). Here the number of levels is four, while in Fig. 2(b) there are sixteen. In other words, Fig. 2(b) represents four times as good a signal-to-noise amplitude ratio as Fig. 2(d).

The total energy transmitted is in each case represented by the total black area; we see that on the average twice as much power is used in Fig. 2(a) as in Fig. 2(c). Thus we obtain a 12-db increase in signal-to-noise ratio with a power increase of only 3 db by sending the signal according to Fig. 2(a) rather than Fig. 2(c). If we had started out with six channels instead of four, we would have obtained a signal-to-noise improvement of 21 db for 4.77 db more average power. The greater the number of channels, and hence the wider the frequency band used, the better the method of transmission represented by Fig. 2(a) as compared to that represented by Fig. 2(c).

Now Fig. 2(a) represents PCM, while Fig. 2(c) represents what is essentially quantized FM with sampling. The signal in Fig. 2(c) varies with frequency according to the amplitude of the signal. Hence, we have compared PCM and a sort of FM, to the obvious advantage of PCM.

The trouble with the FM type of signal of Fig. 2(c) is that only a few of the possible signals which might be sent in the four bands  $B_1$ - $B_4$  are ever produced; all the others, those for which there is a signal in more than one band at a time, are wasted. Ideally, PCM takes advantage of every possible signal which can be transmitted over a given band of frequencies with pulses having discrete amplitudes.<sup>11</sup>

The relation between FM and PCM is closely analogous to the relation between the two types of computing machines: the so-called analogue machines and the digital machines. In analogue machines the numbers involved are represented as proportional to some physical quantity capable of continuous variation. Typical examples are the slide rule, network analyzers, and the differential analyzer. An increase in precision requires,

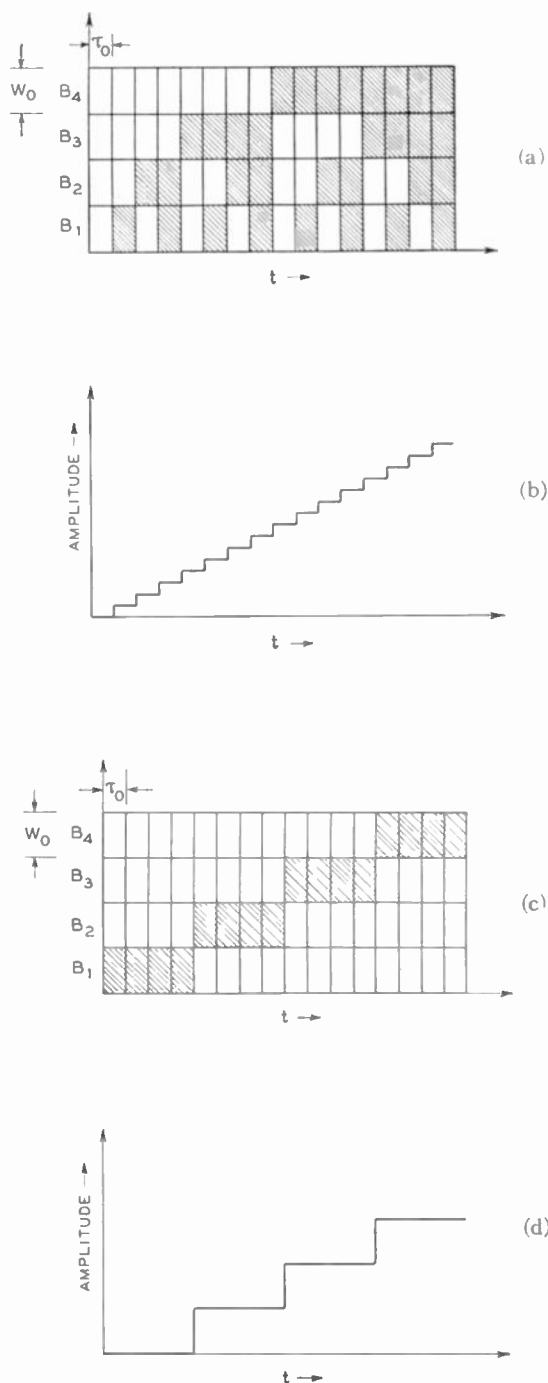

Fig. 2—The signals in channels  $B_1, B_2, B_3,$  and  $B_4$ . (a) Signal in a frequency-division PCM system. (b) Amplitudes corresponding to (a). (c) Signal in a quantized FM system. (d) Amplitudes corresponding to (c).

<sup>11</sup> It might be objected that one could have signals with a finer structure in the frequency direction than those shown in Fig. 2(a). This is possible only if  $\tau$  is made larger, so that the pulses representing samples occur less frequently, are broader, and have narrower spectra. This means reducing  $W_0$ .

in general, a proportional increase in the range of physical variables used to represent the numbers. Furthermore, small errors tend to accumulate and cannot be eliminated. In digital machines the numbers are expressed in digital form, and the digits are represented by the states of certain physical parts of the machine which can assume one of a finite set of possible states. Typical digital machines are the abacus, ordinary desk computers, and the Eniac. In this type of machine the precision increases exponentially with the number of digits, and hence with the size of the machine. Small errors, which are not large enough to carry any part from one state to another state, have no effect and do not cumulate.

In FM (analogue), the amplitude of the audio signal is measured by the radio frequency. To improve the precision by 2 to 1 requires roughly a 2 to 1 increase in the frequency swing, and hence the bandwidth. In PCM doubling the bandwidth permits twice the number of digits, and therefore *squares* rather than doubles the number of distinguishable levels.

#### Other Factors

There are other considerations in a comparison between PCM and ordinary, unquantized FM, however. For instance, PCM allows the use of regenerative repeaters, and FM does not. PCM lends itself, like other pulse systems, to time-division multiplex. On the other hand, when the received signal rises considerably above threshold during good reception, the signal-to-noise ratio improves with FM but not with PCM. When we come to consider transmitters and receivers, we find that, for high signal-to-noise ratios at least, an FM transmitter and receiver will be somewhat less complicated than those for PCM are at present.

### V. CONCLUSIONS

PCM offers a greater improvement in signal-to-noise than other systems, such as FM, which also depend upon the use of wide bands.

By using binary (on-off) PCM, a high-quality signal can be obtained under conditions of noise and interference so bad that it is just possible to recognize the presence of each pulse. Further, by using regenerative repeaters which detect the presence or absence of pulses and then emit reshaped, respaced pulses, the initial signal-to-noise ratio can be maintained through a long chain of repeaters.

PCM lends itself to time-division multiplex.

PCM offers no improvement in signal-to-noise ratio during periods of high signal or low noise.

PCM transmitters and receivers are somewhat more complex than are those used for some other forms of modulation.

In all, PCM seems ideally suited for multiplex message circuits, where a standard quality and high reliability are required.

### APPENDIX I

We wish to show that a function of time  $f(t)$  which contains no frequency components greater than  $W_0$  cps is uniquely determined by the values of  $f(t)$  at any set of sampling points spaced  $1/2W_0$  seconds apart. Let  $F(\omega)$  be the complex spectrum of the function, i.e.,

$$F(\omega) = \int_{-\infty}^{\infty} e^{-i\omega t} f(t) dt.$$

By assumption,  $F(\omega) = 0$  for  $|\omega| > 2\pi W_0$ .  $F(\omega)$  can be expanded in the interval  $-2\pi W_0$  to  $+2\pi W_0$  in a Fourier series having the coefficients

$$a_n = \frac{1}{4\pi W_0} \int_{-2\pi W_0}^{2\pi W_0} F(\omega) e^{-i(\omega n/2W_0)} d\omega. \quad (1)$$

Now, since  $F(\omega)$  is the Fourier transform of  $f(t)$ ,  $f(t)$  is the inverse transform of  $F(\omega)$ .

$$\begin{aligned} f(t) &= \frac{1}{2\pi} \int_{-\infty}^{\infty} F(\omega) e^{i\omega t} d\omega \\ &= \frac{1}{2\pi} \int_{-2\pi W_0}^{2\pi W_0} F(\omega) e^{i\omega t} d\omega, \end{aligned}$$

since  $F(\omega)$  is zero outside these limits.

If we let  $t = n/2W_0$ , we have

$$f\left(\frac{n}{2W_0}\right) = \frac{1}{2\pi} \int_{-2\pi W_0}^{2\pi W_0} F(\omega) e^{i(\omega n/2W_0)} d\omega. \quad (2)$$

Comparing (1) and (2), we see that

$$a_n = \frac{1}{2W_0} f\left(\frac{-n}{2W_0}\right).$$

Thus, if the function  $f(t)$  is known at the sampling points,  $\dots - (2/2W_0), 1/2W_0, 0, 1/2W_0, 2/2W_0 \dots$ , then the coefficients  $a_n$  are determined. These coefficients determine the spectrum  $F(\omega)$  and  $F(\omega)$  determines  $f(t)$  for all values of  $t$ . This shows that there is exactly one function containing no frequencies over  $W_0$  and passing through a given set of amplitudes at sampling points  $1/2W_0$  apart.

To reconstruct the function, given these amplitudes, we note that

$$\begin{aligned} F(\omega) &= \sum_n a_n e^{i(\omega n/2W_0)} \text{ for } |\omega| < 2\pi W_0 \\ F(\omega) &= 0 \text{ for } |\omega| > 2\pi W_0. \end{aligned}$$

Taking the inverse transform, we have

$$\begin{aligned} f(t) &= 2W_0 \sum_n a_n \frac{\sin \pi(2W_0 t + n)}{\pi(2W_0 t + n)} \\ &= \sum_n f\left(-\frac{n}{2W_0}\right) \frac{\sin \pi(2W_0 t + n)}{\pi(2W_0 t + n)} \\ &= \sum_n f\left(\frac{n}{2W_0}\right) \frac{\sin \pi(2W_0 t - n)}{\pi(2W_0 t - n)}. \end{aligned}$$



In other words, the function  $f(t)$  may be thought of as the sum of a series of elementary functions of the form  $\sin x/x$  centered at the sampling points, and each having a peak value equal to  $f(t)$  at the corresponding sampling point. To reconstruct the function  $f(t)$ , then, we merely need to generate a series of  $\sin x/x$  pulses proportional to the samples and add the ensemble.

APPENDIX II

We wish to find the average power in a series of pulses of the form

$$f(t) = \frac{\sin \pi \frac{t}{\tau}}{\pi \frac{t}{\tau}}$$

occurring at the regular rate  $1/\tau$ .

The signal wave may then be written

$$v(t) = \sum_{k=1}^n V_k f(t - k\tau)$$

where  $V_k$  = peak amplitude of pulse occurring at the time  $t = k\tau$ . The average "power" (i.e., mean-square amplitude)  $S$  of the signal will then be

$$\begin{aligned} S = \overline{v^2} &= \lim_{n \rightarrow \infty} \frac{1}{n\tau} \int_{-\infty}^{\infty} v^2(t) dt \\ &= \lim_{n \rightarrow \infty} \frac{1}{n\tau} \left[ \sum_{k=1}^n V_k^2 \int_{-\infty}^{\infty} f^2(t - k\tau) dt \right. \\ &\quad \left. + \sum_{j=1}^n \sum_{k=1}^n V_j V_k \int_{-\infty}^{\infty} f(t - j\tau) f(t - k\tau) dt \right]_{j \neq k} \end{aligned}$$

For the assumed pulse shape, the first integral is equal to  $\tau$ , while the second integral is equal to zero. Thus

$$S = \lim_{n \rightarrow \infty} \frac{1}{n} \sum_{k=1}^n V_k^2.$$

$S$  is simply the mean-square value of the individual pulse peak amplitudes, and may also be written

$$S = \int_{-\infty}^{\infty} V^2 p(V) dV$$

where

$p(V)dV$  = probability that pulse amplitude lies between  $V$  and  $V+dV$ .

Suppose the pulses have  $b$  discrete amplitude levels  $K\sigma$  apart, ranging from 0 to  $(b-1)K\sigma$ . Each pulse then

has an amplitude  $aK\sigma$  where  $a$  is an integer. The average power will be

$$S = K^2\sigma^2 \sum_{a=0}^{a=b-1} p(a)a^2$$

where  $p(a)$  = probability of level  $a$ . If all levels are equally likely,  $p(a) = 1/b$ , and

$$\begin{aligned} S &= K^2\sigma^2 \frac{1}{b} \sum_0^{b-1} a^2 \\ S &= K^2\sigma^2 \frac{(b-1)(2b-1)}{6} \end{aligned}$$

The quantity

$$\frac{1}{b} \sum_0^{b-1} a^2$$

is the square of the radius of gyration (i.e., the mean-square radius) about one end of a linear array of  $b$  points separated by unit distance. The average power of any amplitude distribution is the average of the squares of the amplitudes and is therefore proportional to the square of the radius of gyration of the distribution. The radius of gyration about any point is

$$r^2 = r_0^2 + d^2$$

where

- $r$  = radius of gyration about chosen point
- $r_0$  = radius of gyration about center of gravity
- $d$  = distance to center of gravity from chosen point.

Obviously,  $r_0 < r$ , so that the average power will be least if the average amplitude is zero.  $S$  will be least if the pulse amplitude range is from  $-K\sigma(b-1)/2$  to  $+K\sigma(b-1)/2$ , and will then be given by

$$\begin{aligned} S &= K^2\sigma^2 \left[ \frac{(b-1)(2b-1)}{6} - \left( \frac{b-1}{2} \right)^2 \right] \\ S &= K^2\sigma^2 \frac{b^2 - 1}{12} \end{aligned}$$

This may also be written

$$S = \frac{A^2}{12} \frac{(b+1)}{(b-1)}$$

where  $A$  = total amplitude range =  $(b-1)K\sigma$ . As  $b \rightarrow \infty$ ,

$$S \rightarrow \frac{A^2}{12}$$

Thus, if all amplitude levels in a range  $A$  are possible and equally likely, the rms amplitude of the distribution will be  $\sqrt{S} = (A/2\sqrt{3})$ .

# Pentriode Amplifiers\*

H. M. ZEIDLER†, MEMBER, IRE, AND J. D. NOE‡, STUDENT, IRE

**Summary**—Conventional video-amplifier design is complicated by low-frequency phase shift and degenerative decrease in gain caused by inefficient screen-grid and cathode by-pass circuits. This paper describes two amplifier circuits in which phase shift and degeneration in those by-pass circuits may be eliminated throughout the entire range to zero frequency. Small paper or mica capacitors may be substituted for bulky electrolytic units, with consequent improvement in electrical and physical amplifier characteristics.

These circuits are applicable to amplifiers with stage gains less than the control-grid to screen-grid amplification factor of the tube. Inasmuch as common tubes have factors ranging from approximately 10 to 50, the circuits described are primarily applicable to video amplifiers. In practice, the interstage circuits are designed in accordance with conventional methods involving either two-terminal or four-terminal networks. The by-pass circuits herein described may then be incorporated into the design to provide the advantages outlined above with no loss in stage gain.

## I. INTRODUCTION

THE DESIGN of screen and cathode by-pass circuits for conventional video amplifiers is influenced by conflicting requirements. From the standpoint of physical size and cost, it is desirable to use the smallest by-pass capacitors allowable. Considerations of circuit performance, however, dictate large values of capacitance in order that adequate screen and cathode by-passing be assured at very low frequencies. This is particularly true in amplifiers in which negative feedback is utilized around a loop containing several stages, in which case it may be necessary to by-pass some, or all, of the screen and cathode circuits to a frequency so low that they exert negligible influence on the feedback-loop cutoff characteristics.

This paper describes two circuits, known as "pentriode circuits," which circumvent this conflict in design criteria.<sup>1</sup> Both circuits eliminate the gain decrease and phase shift associated with insufficient by-pass, and furthermore allow use of small by-pass capacitors. The idea fundamental to these circuits is simple. At low frequencies for which the by-pass circuits begin to be ineffective in the conventional sense, additional plate impedance is introduced to compensate for the decrease in signal current due to screen and cathode degeneration. This compensation can be made exact, leaving no net gain variation or phase shift in the transition region.

It should be noted that the terms "amplitude response" and "phase shift" are used in this paper with reference only to the effect of screen and cathode by-pass circuits. The over-all gain will, of course, drop off at low frequencies due to the interstage coupling capac-

itor, and at the high frequencies due to shunting capacitances, but these considerations are independent of the circuit configurations herein described.

## II. THE TYPE-I PENTRIODE AMPLIFIER

The basic circuit of the type-I amplifier is indicated in Fig. 1. At high frequencies, where  $C_2$  can be considered a short circuit, the amplifier operates in normal pentode fashion. There is no high-frequency degeneration in  $R_k$  or in  $R_2$ , since all plate and screen signal currents are returned directly to the cathode through  $C_2$ . At low frequencies, the signal currents must return to the cathode through  $R_2$ , the power supply, and the cathode resistor  $R_k$  because of the high reactance of  $C_2$ . Both screen and cathode degeneration are thereby in-

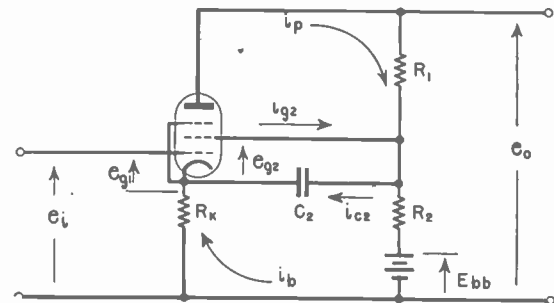

Fig. 1—Basic circuit—type I-amplifier.

duced, with a consequent decrease in signal current. However, if  $R_2$  is made to provide a sufficient increase of effective load resistance in excess of the value  $R_1$ , it is possible to compensate exactly the degenerative effect. In this manner the low-frequency gain can be made equal to the high-frequency gain, which condition further specifies that there shall be zero phase shift at low frequencies relative to high frequencies.<sup>2</sup> This concept is extended by a more comprehensive analysis in Section III. This analysis shows that the gain and phase characteristics of the amplifier can be made invariant at all frequencies—even at those intermediate frequencies where the capacitor  $C_2$  is only partially effective in by-passing plate and screen circuits directly to the cathode.

The tube of the circuit discussed above operates in an unorthodox manner at low frequencies. Since the screen grid at the junction of  $R_1$  and  $R_2$  is neither at ground nor at plate potential at low frequencies, the tube operates as neither pentode nor triode in the true sense of the words. Hence, the name "pentriode" has been applied. The transition between pentriode and pentode operation occurs in an intermediate frequency range

\* Decimal classification: R363.4. Original manuscript received by the Institute, November 24, 1947; revised manuscript received, July 6, 1948.

† Hewlett-Packard Company, Palo Alto, Calif.

‡ Hewlett-Packard Company and Stanford University, Palo Alto, Calif.

<sup>1</sup> U. S. Patent Application Nos. 789,153 and 789,282.

<sup>2</sup> H. W. Bode, "Network Analysis and Feedback Amplifier Design," D. Van Nostrand Company, Inc., New York, N. Y., 1945; pp. 286-288.

where the by-pass capacitor can be considered neither a short nor an open circuit, and that intermediate range shall hereafter be termed the "crossover" region.

The basic features of the pentriode amplifier are enumerated briefly below:

1. When the design criteria are fulfilled, there can be no phase shifts due to screen and cathode by-pass elements at any frequency. This is particularly advantageous when the circuits are to be used within a negative-feedback loop containing two or more stages. Elimination of these phase shifts leaves only the inter-stage blocking capacitors and grid resistances to control the low-frequency cutoff characteristic, and low-frequency stability is thus more easily attained.

2. The capacitor  $C_2$  need be only large enough to assure full pentode operation at high frequencies where the undesirable effects due to tube and stray capacitances would otherwise be intolerable. For normal video amplifiers,  $C_2$  is specified to be only 0.01  $\mu\text{f}$  or less, the crossover to full pentode operation being achieved for frequencies higher than approximately 0.1 Mc.

3. Use of the pentriode amplifier involves *no loss in gain* compared to more conventional circuits. However, it is shown in Section VI that pentriode circuits cannot be used where the stage gain is greater than the control-grid to screen-grid amplification factor of the tube. They consequently apply primarily to video amplifiers.

4. Degeneration is introduced in the cathode and/or screen-grid circuits at frequencies below the crossover region. In certain applications this may be advantageous, as it provides increased gain stability and decreased distortion at these low frequencies.

These features apply fundamentally not only to the type-I but also to the type-II pentriode circuit which is discussed in Section IV. In either case, however, variations in gain and phase occur in the crossover region if the design criteria are not satisfied exactly. These variations are considered in Sections V and VI.

### III. DERIVATION OF THE DESIGN EQUATION, TYPE-I PENTRIODE AMPLIFIER

The symbols and assumptions specified below apply throughout the entire paper. It should be noted that all electrode signal voltages are specified as positive with respect to the cathode, and that all signal currents are electron currents flowing away from the cathode inside the tube.

#### 1. Symbols

- $e_{v1}$  = cathode to control-grid signal voltage
- $e_{v2}$  = cathode to screen-grid signal voltage
- $e_i$  = input signal voltage
- $e_o$  = output signal voltage
- $i_p$  = plate signal current
- $i_{v2}$  = screen-grid signal current
- $i_t$  = total cathode signal current
- $i_b$  = signal current flowing through the power supply
- $g_m$  = control-grid to plate transconductance

$$g_m = \left. \frac{\partial i_p}{\partial e_{v1}} \right|_{e_{v2}=0}$$

$g_{12}$  = control-grid to screen-grid transconductance

$$g_{12} = \left. \frac{\partial i_{v2}}{\partial e_{v1}} \right|_{e_{v2}=0}$$

$\mu_{12}$  = control-grid to screen-grid amplification factor

$$\mu_{12} = \left. \frac{\partial e_{v2}}{\partial e_{v1}} \right|_{i_t=0}$$

$C_{12}$  = control-grid to screen-grid capacitance

$E_{bb}$  = power-supply voltage

$A$  = magnitude of amplifier gain

$\bar{A}$  = amplifier vector gain.

#### 2. Assumptions

- a. The tube characteristics are linear and the tube parameters are constants.
- b. Shunting of plate resistance and of external load on circuit resistances is negligible.
- c. Power-supply impedance is negligible compared to circuit resistances.
- d. Plate signal voltage does not influence signal current.
- e. No control-grid current flows.

The qualitative discussion of Section II can be used as a basis for the derivation of the design equations of the type-I pentriode amplifier. Such a derivation proves only that the gains, and hence the phase shifts, are equal at high and low frequencies. The fact that both the gain and the phase are actually invariant at all frequencies is proved in the following more general derivation which involves calculation of the expression for the vector gain of the amplifier. The circuit diagram is that of Fig. 1.

An expression for total signal current at any frequency may be written as a function of the degenerative current  $i_b$ .

$$i_t = (g_m + g_{12}) \left[ (e_i - i_b R_k) + \frac{-i_b (R_2 + R_k)}{\mu_{12}} \right]. \quad (1)$$

Furthermore,  $i_b$  may be expressed as a fractional part of  $i_t$  in terms of the relative admittances of the two paths which  $i_t$  may take at the screen-grid terminal.

$$i_b = i_t \left[ \frac{\left( \frac{1}{R_2 + R_k} \right)}{\left( \frac{1}{R_2 + R_k} \right) + j\omega C_2} \right] \\ = i_t \left[ \frac{1}{1 + j\omega C_2 (R_2 + R_k)} \right]. \quad (2)$$

Substituting (2) into (1) and collecting terms,

$$i_t = \mu_{12}(g_m + g_{12})e_i \left[ \frac{1 + j\omega C_2(R_2 + R_k)}{\mu_{12} + (g_m + g_{12})R_2 + (g_m + g_{12})(\mu_{12} + 1)R_k + j\omega C_2\mu_{12}(R_2 + R_k)} \right]. \quad (3)$$

The output voltage may be written in terms of  $i_t$ , and the vector gain equation follows directly.

$$e_o = -[i_p R_1 + i_b R_2] = -i_t \left[ \frac{g_m R_1}{(g_m + g_{12})} + \frac{R_2}{1 + j\omega C_2(R_2 + R_k)} \right] \quad (4)$$

$$\bar{A}_I = -\mu_{12} \left[ \frac{g_m R_1 + (g_m + g_{12})R_2}{\mu_{12} + (g_m + g_{12})R_2 + (g_m + g_{12})(\mu_{12} + 1)R_k} \right] \left[ \frac{1 + j\omega \frac{g_m R_1 C_2 (R_2 + R_k)}{(g_m + g_{12})R_2 + g_m R_1}}{1 + j\omega \frac{\mu_{12} C_2 (R_2 + R_k)}{\mu_{12} + (g_m + g_{12})R_2 + (g_m + g_{12})(\mu_{12} + 1)R_k}} \right] \quad (5)$$

$$\bar{A}_I = -K \left[ \frac{1 + jM\omega}{1 + jN\omega} \right]. \quad (6)$$

Equations (5) and (6) have been written in the basic form of the bilinear equation. It is apparent that if the circuit is so arranged that the coefficients of the frequency-variable terms are made equal, both the gain and the phase are invariant at all frequencies. The required design equation is obtained when  $M$  and  $N$  are equated, and the results rearranged to yield  $R_2$  as a function of  $R_k$ .

$$R_2 = R_k \left[ \frac{(\mu_{12} + 1)g_m R_1}{\mu_{12} - g_m R_1} \right] = R_k \left[ \frac{(\mu_{12} + 1)A_I}{\mu_{12} - A_I} \right]. \quad (7)$$

Further reference to (5) and (6) reveals that the magnitude of the gain is given by the expression corresponding to the coefficient  $K$ . However, since the amplifier operates in normal pentode fashion at high frequencies, the magnitude of the gain is simply

$$A_I = [g_m R_1]. \quad (8)$$

The coefficient  $K$  is actually the expression obtained for the gain of the amplifier at low frequencies. Consequently, (7) may also be obtained by equating  $K$  to (8) and simplifying.

#### IV. TYPE-II PENTRIODE AMPLIFIER

The type-II pentriode amplifier is diagramed in Fig. 2. It should be noted that the capacitance  $C_1$  and inductance  $L_1$  do not enter into the pentriode circuit design considerations, and are included in Fig. 2 merely to indicate the normal position of two-terminal high-frequency compensation elements. The capacitance  $C_{12}$  is a parasitic element which is discussed in Section V. This circuit is similar in operation to the type-I amplifier with the following exceptions:

1. The cathode degeneration is constant (or zero) at all frequencies. Hence, the increase in effective load resistance at frequencies below the crossover region is

counteracted entirely by screen-grid degeneration in  $R_3$  and  $R_4$ . (Refer to Section V.)

2. Since signal currents flow through the cathode resistor at all frequencies, it may be utilized as a feedback element.

3. The separate screen resistor,  $R_4$ , permits independent control of the quiescent operating voltages of the plate and screen grid. This control may be of advantage in low-frequency amplifiers where the voltage drop across  $R_1$  is relatively large.

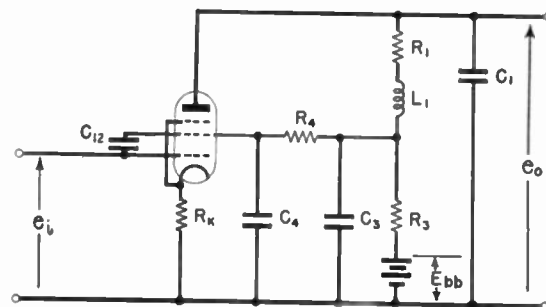

Fig. 2—Complete circuit—type-II amplifier.

The derivation of the design equations for the type-II amplifier is too lengthy for inclusion in this paper. Equating of the high- and the low-frequency gains yields a resistance design equation as with the type-I amplifier, but does not comprise the complete solution in this case. The primary difference is that the two capacitors  $C_3$  and  $C_4$  impose an additional restriction on the circuit if uniform response is to be achieved in the crossover region. Hence, a derivation including the frequency variable is required to yield the following two design equations:

$$R_3 = R_4 \left[ \frac{g_{12}}{g_m + g_{12}} \right] \left[ \frac{g_m R_1}{\mu_{12} - g_m R_1 + (g_m + g_{12})(\mu_{12} + 1)R_k} \right] \quad (9)$$

$$C_4 = C_3 \left[ \frac{g_{12} R_1}{\mu_{12} + (g_m + g_{12})(\mu_{12} + 1)R_k} \right]. \quad (10)$$

Equation (10) does not impose any serious complication in circuit adjustment. The capacitor balance is non-critical, as is indicated in Fig. 3, where measured responses are indicated for widely different capacitor ratios. As is the case with the type-I amplifier, the re-

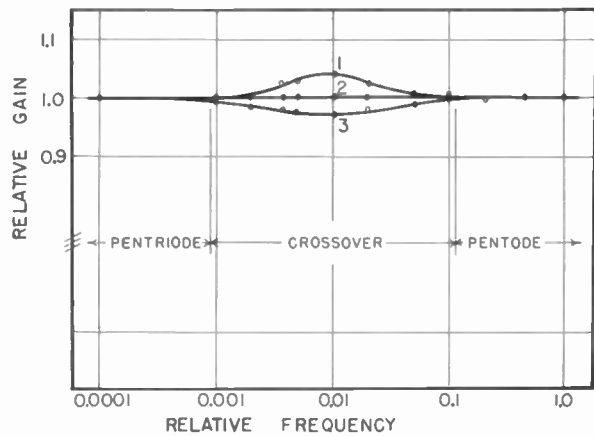

Fig. 3—Effect of improper capacitor ratio  $C_3/C_4$ —type-II amplifier,  $C_3 = 0.005 \mu\text{f}$ .

- Curve 1— $C_3/C_4 = 10$ .
- Curve 2— $C_3/C_4 = 16$ .
- Curve 3— $C_3/C_4 = 20$ .

sponse is perfectly uniform at all frequencies when the design equations are satisfied. The magnitude of the gain of the type-II amplifier at high frequencies is the same as that of the conventional pentode amplifier.

$$A_{II} = \left[ \frac{g_m R_1}{1 + (g_m + g_{12}) R_k} \right] \quad (11)$$

V. EFFECT OF PARASITIC CAPACITANCES

The preceding analyses have dealt only with the fundamental elements of the circuits in order that a clear understanding of the basic circuit operation might be more readily achieved. At video frequencies, however, the reactances of interelectrode and stray capacitances indicated in Fig. 4 become of the same order of magnitude as the circuit resistances, and must therefore be included in the analysis. Fortunately, the requirements imposed upon the circuit design by these capacitances are in no sense critical, so the corresponding approximate analyses deal with what may be termed "design inequalities," rather than "design equations."

The spurious effect in the type-I amplifier which is to be considered first is that associated with the stray capacitance  $C_1$  from the plate terminal to ground. It should

<sup>3</sup> Figs. 3, 5, 6, and 7 are plotted from data obtained from circuits with the capacitance values increased 100:1. This technique permitted independent insertion of the parasitic capacitances for experimental verification of the design inequalities considered in Section V. The basic circuit parameters were: Type-I circuit— $g_m = 4650$  micromhos,  $g_{12} = 1650$  micromhos,  $\mu_{12} = 31$ ,  $R_1 = 1400$  ohms,  $R_2 = 1040$  ohms,  $R_k = 120$  ohms,  $R_z = 1400$  ohms,  $L_1 = 0$ ,  $C_{12} = 1.2 \mu\text{f}$ . Type-II circuit— $g_m = 5150$  micromhos,  $g_{12} = 1780$  micromhos,  $\mu_{12} = 31$ ,  $R_1 = 1400$  ohms,  $R_3 = 390$  ohms,  $R_4 = 6800$  ohms,  $R_k = 38$  ohms (with additional fixed bias). The unity point of the normalized frequency scale represents 10 Mc, but it should be noted that, in general, the crossover region bears no fixed relation to this unity frequency point.

be noted that the capacitance  $C_1$  includes the stray capacitance of coupling elements and the input capacitance of the following stage, as well as the plate-to-ground capacitance of the tube indicated. The reasoning of Section II was based upon the assumption that all of the plate signal current is by-passed directly to the cathode through  $C_2$  at high frequencies, thereby assuring

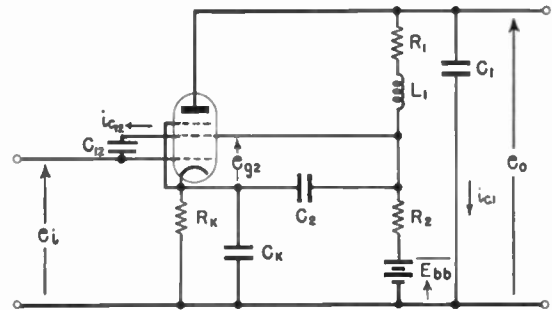

Fig. 4—Complete circuit—type-I amplifier.

zero degeneration in  $R_2$  and  $R_k$ . In the practical circuit, however, the high-frequency currents which flow through  $C_1$  return to the cathode through the ground, thereby causing high-frequency degeneration in any impedance existing between cathode and ground. It is, therefore, necessary that the cathode resistor be by-passed for high frequencies, the size of the capacitor  $C_k$  being determined by the inequality

$$C_k \geq C_1 \left( \frac{100}{n} \right) g_m R_1, \quad (12)$$

which is derived in Appendix I. The factor  $n$  is the maximum percentage degenerative drop in gain which may be tolerated. The type of response resulting from inadequate cathode by-pass is indicated in Fig. 5, where gain characteristics for several values of  $C_k$  are shown. (Note that high-frequency compensation was omitted in the experimental amplifier for simplification.)

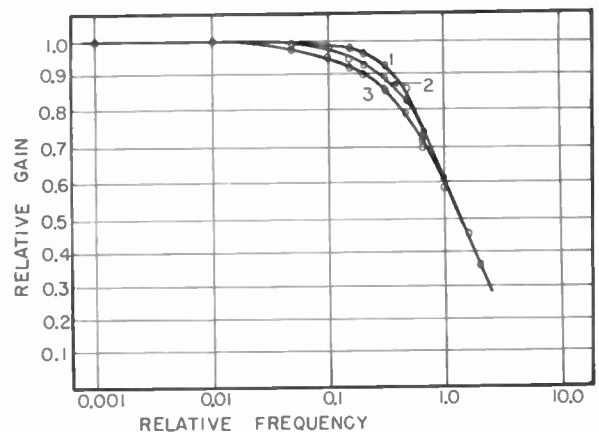

Fig. 5—Effect of insufficient ratio  $C_k/C_1$ —Type-I amplifier,  $C_1 = 14 \mu\text{f}$ .

- Curve 1— $C_k/C_1 = \infty$ .
- Curve 2— $C_k/C_1 = 140$ .
- Curve 3— $C_k/C_1 = 76$ .

The requirement that the cathode-to-ground impedance be minimized at high frequencies imposes a limitation on the type-I circuit application. In general the shunting action of  $C_k$  on  $R_k$  at high frequencies prevents utilizing  $R_k$  as a feedback element. In special cases, however, where the feedback resistance required is relatively small, satisfactory results are achieved by utilizing an *unby-passed* part of  $R_k$  as the feedback element.

Once the value of  $C_k$  has been specified, the requirements on  $C_2$  may be determined. Unless  $C_2$  is made sufficiently large so that all plate and screen currents are returned directly to the cathode through  $C_2$  before  $C_k$  begins to by-pass the cathode resistor as the frequency is increased, the latter by-passing action improperly decreases the required degenerative function of  $R_k$  in the low-frequency region, thereby causing a hump in the frequency-response characteristic. Typical humps are illustrated in Fig. 6 for a number of values of  $C_2$ . The ap-

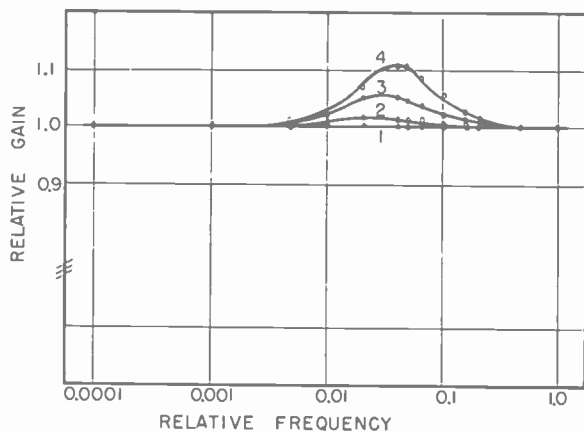

Fig. 6—Effect of insufficient ratio  $C_2/C_k$ —Type-I amplifier,  $C_k = 2000 \mu\text{f}$ .

- Curve 1— $C_2/C_k = \infty$ .
- Curve 2— $C_2/C_k = 5.6$ .
- Curve 3— $C_2/C_k = 1.1$ .
- Curve 4— $C_2/C_k = 0.56$ .

proximate derivation of Appendix II yields the design inequality

$$C_2 \geq C_k \left[ \frac{100R_k(g_m + g_{12})(\mu_{12} + g_{12}R_2)}{m\mu_{12}g_mR_1(1 + g_mR_k)} \right] \left[ \frac{\mu_{12} - g_mR_1}{\mu_{12} + (g_m + g_{12})R_2} \right] \quad (13)$$

where  $m$  is the maximum percentage rise in gain which may be tolerated.

An additional condition must be imposed upon the size of  $C_2$ . A considerable signal voltage exists on the screen grid at frequencies below the crossover region. This voltage<sup>4</sup> causes currents to flow through the inter-

grid capacitance  $C_{12}$ , thereby introducing resistive and reactive loading into the input circuit. Such loading would shunt the load impedance of the preceding stage appreciably at high frequencies if  $C_2$  were not sufficiently large, causing a decrease in gain. A relatively conventional derivation yields the design inequality

$$C_2 \geq C_{12} \left[ \frac{100(g_m + g_{12})(R_x + R_k)}{p} \right] \quad (14)$$

as a function of the factor  $p$ , which is the maximum percentage decrease in gain which can be permitted, and of  $R_x$ , the load resistance of the preceding stage. In most practical amplifiers, inequality (13) generally specifies a much larger size for  $C_2$  than does inequality (14). However, both should be checked for every set of design conditions, and the larger value of  $C_2$  incorporated into the amplifier.

The type-II amplifier is less susceptible to spurious effects because the cathode resistor is unby-passed at all frequencies. The only requirement involved is that which specifies that  $C_4$  shall be large enough to prevent excessive input-circuit conductance loading of the preceding stage. The design inequality

$$C_4 \geq C_{12} \left[ \frac{100g_{12}R_x}{q} \right] \quad (15)$$

determines the requirements on  $C_4$ . The factor  $q$  is the maximum-permissible percentage decrease in gain, and  $R_x$  is the load resistance of the preceding stage. The absence of any cathode by-pass capacitor in the type-II circuit permits use of all or a fraction of  $R_k$  as a feedback element.

## VI. PRACTICAL DESIGN CONSIDERATIONS

This section treats the practical design considerations and limitations of both the type-I and type-II pentriode amplifiers. Examination of (7) and (9) reveals a fundamental limitation on the applicability of pentriode amplifiers. The difference terms in the denominators of those equations impose a theoretical maximum on the product  $g_mR_1$  which would require infinite values of  $R_2$  or  $R_3$ . For all practical purposes, the limit for both type-I and type-II circuits is equal to  $\mu_{12}$ , the control-grid to screen-grid amplification factor of the tube. The actual maximum gain which can be attained in the practical amplifier is below this theoretical limit, as determined by the maximum supply-voltage drop across  $R_2$  or  $R_3$  which can be made available. Furthermore, if these resistances were to become too large, assumption number 2b, Section III, would not be valid, and it would be necessary to develop modified design equations. According to Table I, the maximum value of  $\mu_{12}$  available in common tubes is of the order of fifty. The corresponding maximum practical gain would be of the order of forty or forty-five.

The type-I circuit is subject to an additional restric-

<sup>4</sup> F. E. Terman, "Radio Engineers' Handbook," McGraw-Hill Book Co., Inc., New York, N. Y., and London, 1943; pp. 467-469. The derivation in the above reference is for triodes rather than pentodes, but this circuit calls for the same type of analysis, since signal voltages exist on the screen grid.

tion on the maximum stage gain obtainable. The quiescent plate voltage is decreased below that of the screen grid by the voltage drop across  $R_1$ , and satisfactory tube operating conditions will not be attainable for excessive values of  $R_1$ . Since the type-II circuit provides independent control of plate and screen-grid quiescent voltages, it may be used to advantage in specific cases where the maximum gain obtainable with the type-I circuit would be limited by the voltage drop across  $R_1$ .

TABLE I  
AVERAGE CONSTANTS FOR A NUMBER OF COMMON TUBES

Tube	$g_m(\mu\text{mhos})$	$g_{12}(\mu\text{mhos})$	$\mu_{12}$	$C_{12}(\mu\mu\text{f})$
6AC7	9,500	2,800	50	4.1
6AG5	5,300	1,500	50	2.4
6AG7	10,000	2,600	25	4.6
6AH6	9,000	2,300	48	3.8
6AK5	4,800	1,700	30	1.2
6AK6	2,200	350	10	1.8
6AQ5	4,200	600	11	5.0
6AU6	5,000	2,000	47	1.6
6BJ6	3,500	1,400	25	1.8

Inspection of (7), (9), and (10) indicates that the relationships required for uniform amplifier response are functions not only of the load resistance  $R_1$ , but also of the tube parameters. Consequently, as the transconductances or amplification factor of a tube change from the design values with age or operating conditions, the frequency response deviates slightly from the perfectly uniform characteristic as illustrated for the type-I circuit in Fig. 7. In the high-frequency region, a 10 per

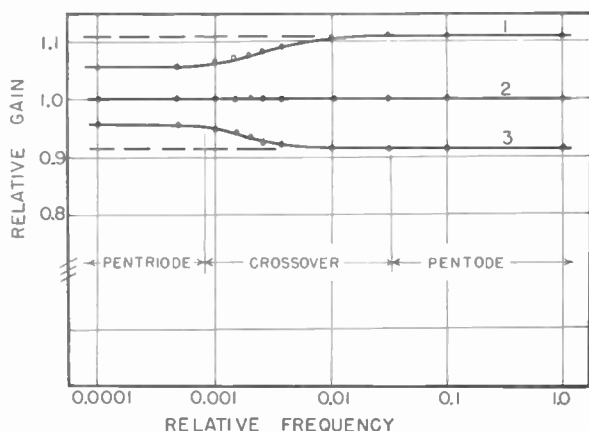

Fig. 7—Influence of deviations in tube transconductance on frequency response.

Curve 1— $g_m = 1.11$  design  $g_m$ .  
Curve 2— $g_m =$  design  $g_m$ .  
Curve 3— $g_m = 0.91$  design  $g_m$ .

cent change from the design value of transconductance causes a corresponding 10 per cent change in gain, since the tube operates in normal pentode fashion at those frequencies. However, at frequencies below the crossover,<sup>5</sup> the tube operates with screen-grid and cathode degener-

<sup>5</sup> A phase shift naturally accompanies the change in gain in cases where the design requirements are not exactly fulfilled. However, the gain inequalities are seldom in excess of 15 per cent in practice, and the corresponding phase-shift peak is only 6 degrees or less. The effect of such a small phase shift is generally negligible.

ation, the resultant change in gain being less than 10 per cent from the design value. For apparatus such as vacuum-tube voltmeters and other absolute indicating devices, this increased stability of gain (and decreased distortion) at low frequencies is of definite value, since it is achieved without any sacrifice in high-frequency performance. The slight gain irregularity seldom offers serious trouble in practice, because feedback, which is usually incorporated into practical units, serves to maintain uniform gain characteristics. In the event that the available feedback is not adequate to guarantee the gain uniformity required over the frequency range where the crossover region would normally occur, either of two alternatives may be utilized. First, the tubes could be selected and the power supplies regulated to maintain the design values of the tube parameters. The second technique would require the use of sufficiently large values of capacitance of  $C_2$  or  $C_3$  and  $C_4$  to place the crossover region below the critical frequency range. Under these latter conditions, the amplifier tube would operate as an ordinary pentode throughout the entire frequency range of primary interest. However, pentriode operation would occur at very low frequencies, and the advantages gained by virtually zero phase shift to zero frequency would still be achieved.

The information disclosed in the preceding analyses provides complete design information. Brief summaries of suggested design procedures are tabulated in Table II to expedite the design of practical amplifiers.

TABLE II

TYPE-I CIRCUIT

1. Choose stage gain,  $g_m R_1$ .
2. If necessary, design high-frequency compensation circuits (e.g., shunt or series-peaking) in accordance with standard procedures.
3. Check the value of control-grid to screen-grid amplification factor of the tube to see if pentriode circuit can be used.
4. Choose  $R_k$  for bias.
5. Calculate  $R_2$  from (7).
6. Determine  $E_{bb}$ .
7. Calculate  $C_k$  from (12).
8. Calculate  $C_2$  from (13).
9. Check  $C_2$  from (14).

TYPE-II CIRCUIT

- 1, 2, 3. Same as for Type-I circuit above.
4. Choose  $R_k$  for bias and/or as a feedback element.
5. Choose  $R_4$  to give the desired operating point for the tube.
6. Calculate  $R_3$  from (9).
7. Determine  $E_{bb}$ .
8. Calculate  $C_4$  from (15).
9. Calculate  $C_3$  from (10).

ACKNOWLEDGMENT

The authors wish to express their appreciation to W. R. Hewlett for his suggestions concerning circuit analysis, and to W. H. Huggins for his assistance in checking and revising the manuscript.

APPENDIX I

*Design Inequality for  $C_k$  versus  $C_1$  (Refer to Fig. 4).*

An approximate derivation for the maximum decrease in gain caused by capacitive load currents flowing

through  $C_1$  and the cathode-to-ground reactance at high frequencies can be made on the basis of the following assumptions:

1. Full pentode operation is in effect. (This condition is fully satisfied in practical circuits.)

2. The cathode impedance is essentially the reactance of  $C_k$  at frequencies above that where the current through  $C_1$  begins to become significant. This condition must be fulfilled in practical circuits where the degenerative effect must be minimized by specifying  $C_k$  sufficiently large.

3. The amplifier gain is not appreciably modified in magnitude or phase by the shunting effect of  $C_1$  on  $R_1$  in an intermediate range of frequencies where the degenerative effect commences.<sup>6</sup>

The current  $i_{c_1}$  may be expressed in simple form:

$$i_{c_1} = -e_i g_m R_1 (j\omega C_1). \quad (16)$$

The total signal current may then be expressed as a function of the degenerative current  $i_{c_1}$  and of the reactance of  $C_k$ .

$$i_i' = e_i (g_m + g_{12}) \left[ 1 - g_m R_1 \left( \frac{C_1}{C_k} \right) \right]. \quad (17)$$

The gain as modified by the degeneration may then be determined approximately.

$$A_I' = \left| \frac{-i_p' R_1}{e_i} \right| = A_I \left[ 1 - g_m R_1 \left( \frac{C_1}{C_k} \right) \right]. \quad (18)$$

The second term in the brackets is the fractional decrease in gain. This decrease may be expressed in terms of the factor  $n$ , the percentage decrease in gain below the normal level.

$$n = 100 \left[ g_m R_1 \left( \frac{C_1}{C_k} \right) \right]. \quad (19)$$

For design purposes, the preceding equation is most conveniently written in the form of an inequality which expresses  $C_k$  as a function of the maximum permissible decrease in gain which can be tolerated.

$$C_k \geq C_1 \left[ \frac{100 g_m R_1}{n} \right]. \quad (20)$$

## APPENDIX II

*Design Inequality for  $C_2$  versus  $C_k$  (Refer to Fig. 4).*

The magnitude of the gain of the type-I pentriode amplifier may be obtained from (5), which includes the degenerative terms:

$$A_I = \mu_{12} \left[ \frac{g_m R_1 + (g_m + g_{12}) R_2}{\mu_{12} + (g_m + g_{12}) R_2 + (g_m + g_{12}) (\mu_{12} + 1) R_1} \right]. \quad (21)$$

If  $R_k$  is improperly by-passed by a capacitor  $C_k$  large

<sup>6</sup> It should be noted that, as the frequency is increased above the intermediate range, the gain and hence the degenerative current are both decreased and changed in phase. These magnitude and phase changes cause a decrease in the degenerative effect at very high frequencies, and the gain becomes independent of  $C_k$  as indicated in Fig. 5.

enough to eliminate the degenerative cathode impedance at any frequency below the crossover region (as determined by  $C_2$ ), the gain is increased to the following value:

$$A_I' = \mu_{12} \left[ \frac{g_m R_1 + (g_m + g_{12}) R_2}{\mu_{12} + (g_m + g_{12}) R_2} \right]. \quad (22)$$

The percentage rise in gain above the nominal level indicated in (8) may be expressed:

$$\begin{aligned} \Delta A_I &= 100 \left[ \frac{A_I' - A_I}{A_I} \right] \\ &= 100 \frac{R_2}{R_1} \left( \frac{g_m + g_{12}}{g_m} \right) \left[ \frac{\mu_{12} - g_m R_1}{\mu_{12} + (g_m + g_{12}) R_2} \right]. \end{aligned} \quad (23)$$

This is the maximum percentage error that can possibly occur because of an insufficiently high ratio  $C_2/C_k$ . In practice, the ratio is generally large enough so that only a fraction of the gain rise of (23) will occur. The approximate derivation is based upon the following conditions and assumptions:

1.  $C_k$  by-passes the shunt combination of  $R_k$  and  $1/g_m$  (impedance of tube at the cathode). The shunt combination may be written as  $R_k/(1+g_m R_k)$ .

2.  $C_2$  by-passes the shunt combination of  $\mu_{12}/g_{12}$  (screen resistance) and  $R_2$ , the combination being written as

$$(\mu_{12} R_2)/(\mu_{12} + g_{12} R_2).$$

3. The effectiveness of the by-passing action of these two circuits at any frequency may be related by a factor  $\rho$ .

$$\frac{\left( \frac{\mu_{12} R_2}{\mu_{12} + g_{12} R_2} \right)}{X_{c_2}} \equiv \rho \frac{\left( \frac{R_k}{1 + g_m R_k} \right)}{X_{o_k}}. \quad (24)$$

In the practical amplifier, the screen must be by-passed much more heavily than the cathode ( $\rho \gg 1$ ) in order to prevent excessive rise in gain.

4. Virtually the maximum rise in gain specified in (23) would be attained if the cathode by-pass were to be increased to the extent that ( $\rho=1$ ). Sufficiently accurate results are obtained when the assumption is made that an increase in  $\rho$  causes the actual percentage rise in gain  $m$  to be decreased below the maximum value in accordance with the simple equation:

$$m \cong \frac{1}{\rho} [\Delta A_I]. \quad (25)$$

The design inequality relating  $C_2$  and  $C_k$  is then obtained by direct substitution and rearrangement of (23), (24), and (25).

$$\begin{aligned} C_2 \geq C_k \left[ \frac{100 R_k (g_m + g_{12}) (\mu_{12} + g_{12} R_2)}{m \mu_{12} g_m R_1 (1 + g_m R_k)} \right] \\ \cdot \left[ \frac{\mu_{12} - g_m R_1}{\mu_{12} + (g_m + g_{12}) R_2} \right]. \end{aligned} \quad (26)$$



# Isotopes and Nuclear Structure\*

R. E. LAPP†, AND H. L. ANDREWS‡

In the September, 1948, issue of the PROCEEDINGS OF THE I.R.E., there appeared a paper by R. E. Lapp and H. L. Andrews on "Atomic Structure." This paper was published by courteous permission of the authors and of Prentice-Hall, Inc., publishers of a book entitled "Nuclear Radiation Physics," by these authors. Both the paper appearing in the September issue of the PROCEEDINGS, and the following related paper, are substantially chapters of the book in question.

These papers appear in the PROCEEDINGS OF THE I.R.E. in view of the interest of communications and electronic engineers in instrumentation and control methods and equipment useful in the field of nuclear phenomena. Such papers as these lay the ground work for the necessary understanding of nuclear phenomena upon which control or instrumentation technique is based.—*The Editor.*

## MASS SPECTROSCOPY

IT IS WELL-KNOWN that positive ions can be deflected with appropriate electric and magnetic fields and thus they can be weighed. Instruments designed specifically for analyzing and weighing positive ions are known as *mass spectrographs*. A diagram of a Dempster-type double-focusing mass spectrograph appears in Fig. 1. Fig. 2 is a photograph of an assembled spectrograph box. This box fits between the poles of a large electromagnet and connects to a vacuum system which maintains the box assembly at a pressure of less than  $10^{-5}$  mm Hg pressure.

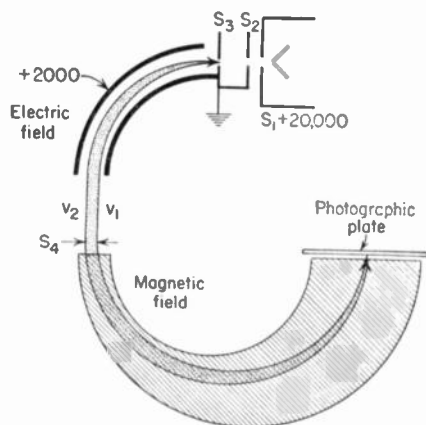

Fig. 1—Diagram of a Dempster-type mass spectrograph.

Positive ions are produced by sparking two electrodes in a vacuum. The ions thus generated are accelerated by a voltage source of about 15,000 volts into a slit system which effectively collimates the ion beam. Upon entering slit  $S_3$ , the ions are bent by the  $90^\circ$  electric field of several thousand volts, whereupon they emerge from the field and pass through a defining slit  $S_4$ . At this point, all ions of velocity  $v_1$  come to a common focus; the faster ions of velocity  $v_2$  come to a second common focus. There is, therefore, a velocity spectrum

\* Decimal classification: 539. Original manuscript received by the Institute, August 6, 1948.

† Research and Development Board, Washington, D. C.

‡ National Institutes of Health, Bethesda, Md.

of ions over the breadth of this slit. As the ions enter the magnetic field they are bent through  $180^\circ$ , and all which have the same value of  $e/m$  are focused at a common point on the photographic plate, where they produce an image. This latter type of focusing is known as direction focusing and is independent of the velocity of the ions.

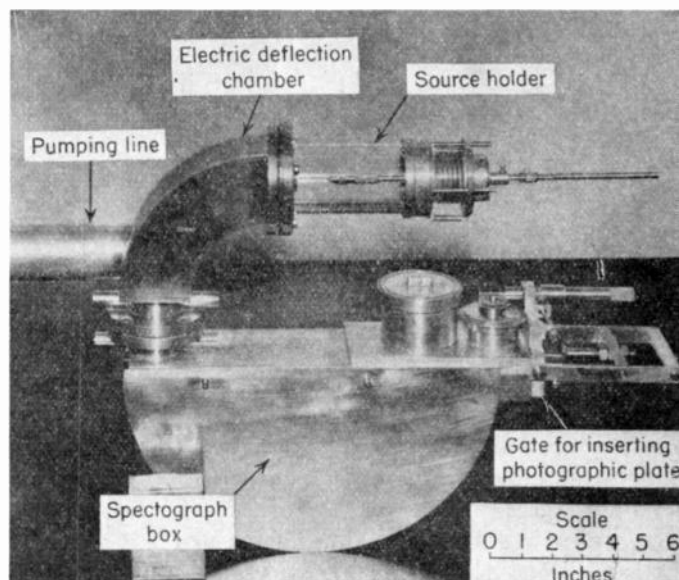

Courtesy of A. J. Dempster and R. E. Lapp

Fig. 2—A modern Dempster spectrograph. Auxiliary equipment (magnet, circuits) are not shown.

Fig. 3 is a reproduction of a typical mass spectrum taken with the instrument shown in the preceding figure. The spectrum shown was obtained from the impurities which were present in a sample of uranium which was being analyzed. Some of these elements were present to the extent of only 1 part in 1 million, and yet they are readily identified on the plate. Since the instrument focuses all ions of the same  $e/m$  ratio, singly ionized atoms of mass 7 (lithium) fall at the same point on the plate as doubly ionized atoms of mass 14 (nitrogen). As evidence of this, notice that the strong line between lithium and beryllium is due to doubly charged oxygen.

In 1913, Thomson used a mass spectrograph in estab-

lishing that the element neon had two separate components, one of mass 20 and one of mass 22. Prior to his discovery of neon 22, the fact that the atomic (chemical) weights of many elements differed widely from whole numbers had no reasonable explanation. Indeed, chlorine with an atomic weight of 35.46 diverged widely from the whole numbers 35 and 36. Thomson solved this vexing problem by assuming that each element may have atoms which have different mass but are chemically identical. Such atoms are called isotopes. From Thomson's assumption it follows that the chemical atomic weight is an average weight of the various isotopes of that element. Chlorine, for example, has been shown to have two isotopes, one  $\text{Cl}^{37}$  and the  $\text{Cl}^{35}$ . The weighted average of these isotopes yields an average atomic weight in good agreement with the measured weight.

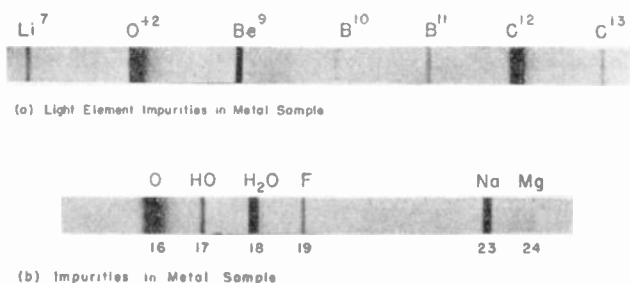

Courtesy of A. J. Dempster and R. E. Lapp

Fig. 3—Typical mass spectra. Impurities shown are present (some to only a few parts per million) in a uranium-metal sample.

A variety of different types of mass-analysis instruments have been devised. Some employ a  $60^\circ$  magnetic field (Nier type) and are designed to analyze gas samples, while others are specially designed to work with solid or metallic samples. In general, an instrument which measures the positive ion current by collection on electrodes with subsequent amplification so that the output is continuously fed into a recording potentiometer is known as a *mass spectrometer*. On the other hand,

those mass analysis instruments which use a photographic plate for recording the positive ions are called *mass spectrographs*. Different types of instruments are also designed to work in different parts of the mass range of the elements. One instrument, in particular, is designed to measure only  $\text{He}^4$  for the special purpose of serving as a "leak" detector for application to vacuum systems.

Instruments designed to separate two neighboring isotopes with the greatest possible dispersion are said to have high *resolving power*. Such spectrographs have been used extensively in the exact comparisons of isotopic weights. In addition, special mass spectrometers are sometimes used to measure the relative percentage of the isotopes of an element and are so constructed that even extremely small amounts of an isotope can be measured. Data supplied by mass-spectrometric analysis have been extremely useful in the field of nuclear physics; furthermore, the data serve to provide the newcomer to the subject of nuclear physics with a graphic concept of isotopes and nuclear structure.

#### THE RELATIVE ABUNDANCE OF ISOTOPES

Suppose that an element such as the heavy metal, molybdenum, is measured with a mass spectrometer of the Nier type. Fig. 4 shows the plot of positive ion current recorded for each mass number. In Table I are given the relative abundances, that is, the relative number of atoms of any mass number to the most abundant isotope of the element, as well as values of the *percentage abundance*. The latter term is simply the fraction (given in per cent) of any isotope of the element to the total

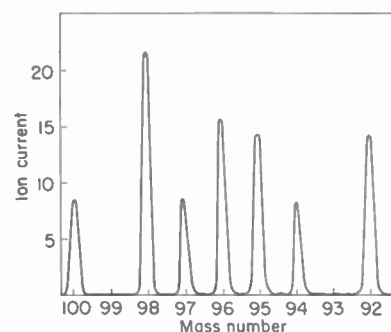

Fig. 4—Mass spectrum of molybdenum. (After D. Williams and P. Yuster, *Phys. Rev.*, vol. 69, p. 563; 1946.)

TABLE I  
RELATIVE ABUNDANCE OF MOLYBDENUM ISOTOPES\*

Mass Number	Relative Abundance	Percentage Abundance
92	66.6	15.8
93	†	—
94	38.0	9.0
95	66.1	15.7
96	69.5	16.6
97	39.8	9.5
98	100.0‡	23.8
99	†	—
100	40.5	9.6
	420.5	100.0

\* After D. Williams and P. Yuster, *Phys. Rev.*, vol. 69, p. 556; 1946.

† Not present to 1/10,000 that of isotope  $\text{Mo}^{98}$ .

‡ Abundance arbitrarily taken as 100 in arbitrary units.

number of all isotopes of the atom. Molybdenum has seven isotopes, as shown in the table, in the mass range from  $A = 92$  to 100; isotopes of mass number 93 and 99 are not present, at least not to more than 1 part to 10,000 of  $\text{Mo}^{98}$ .

A survey of all elements occurring in nature has shown that the percentage abundance of isotopes of any element may vary widely. For example, tin has ten isotopes some of which are present to only a fraction of 1 per cent, while other elements, such as gold and tantalum, have only one isotope. Certain regularities



Analytically, the experimental stability curve is approximated by the following equation:

$$Z = \frac{A}{2 + 0.0146A^{2/3}} \quad (1)$$

Instead of plotting isotopes on an  $N$ - $P$  plot, we may use the trilinear scheme, which is of more recent origin. Fig. 6 illustrates the essential features of this plotting technique, which has the virtue that it constitutes a

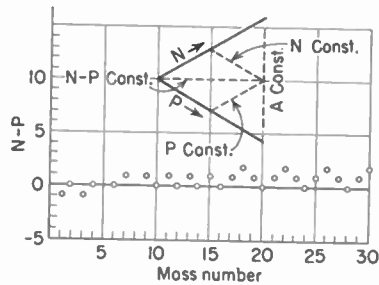

Fig. 6—The trilinear plot of isotopes.

simultaneous  $A$  versus  $Z$ ,  $N$  versus  $Z$ , and  $A$  versus  $N$  plot. Furthermore, it allows for an extensive plot of many isotopes from  $A=0$  to 240 on a single strip of paper which may be folded into a convenient size. The trilinear diagram has the following characteristics:

1. All isotopes of a given element ( $Z = \text{constant}$ ) lie on a line at  $30^\circ$  to the horizontal.
2. Isobars ( $A = \text{constant}$ ) fall on a vertical line.
3. Isotones ( $N = \text{constant}$ ) are grouped on a line at  $30^\circ$  below the horizontal. We will not make extensive use of the word *isotone*, which refers to isotopes of equal neutron number.
4. All isotopes having a constant isotopic number ( $I = N - Z = \text{constant}$ ) fall on a horizontal line. Such isotopes are known as isodiaphores.

#### THE STABILITY OF NUCLEI

The relative abundance of the isotopes of molybdenum is given in Table I. It is remarkable that this same relative abundance is obtained for any sample of molybdenum, no matter where it is mined. Furthermore, the isotope ratios do not change with time, and there is no reason to believe that they ever will undergo a natural change. For this reason, molybdenum is said to consist of stable isotopes. There are only a relatively few naturally occurring elements which do not always exhibit the same isotope ratio, regardless of their origin. One of these is lead. It is found that samples of lead taken from the Belgian Congo show a different isotope ratio than lead mined in some other parts of the world. There is no reason to believe, however, that any sample of lead, independent of its origin, changes its isotopic ratio with time. Lead which exhibits an anomalous isotopic abundance ratio is natural ore which has been contaminated with radiogenic lead (lead which is the end product of radioactive series). In certain parts of the

world there are varying amounts of thorium and uranium. Since the thorium and uranium series terminate with a different stable isotope of lead, it is easy to understand how one sample of lead may contain an anomalous proportion of one of these isotopes.

The term "stability" as applied to an isotope is really a relative term. It implies that during any time interval of observation the isotope does not change its atomic number or mass. Thus an isotope may be said to be

TABLE III  
EXACT ISOTOPIC WEIGHTS OF VARIOUS ELEMENTS

Element	Isotope	Isotopic Weight $M$	Percentage Abundance
Hydrogen	$^1\text{H}^1$	1.00813	99.98
	$^2\text{H}^2$	2.01472	0.02
Helium	$^3\text{He}^3$	3.01698	$\sim 10^{-6}$
	$^4\text{He}^4$	4.00386	100
Lithium	$^6\text{Li}^6$	6.01692	7.5
	$^7\text{Li}^7$	7.01816	92.5
Beryllium	$^9\text{Be}^9$	9.01496	100
Boron	$^{10}\text{B}^{10}$	10.01617	18.4
	$^{11}\text{B}^{11}$	11.01290	81.6
Carbon	$^{12}\text{C}^{12}$	12.00388	98.9
	$^{13}\text{C}^{13}$	13.00756	1.1
Nitrogen	$^{14}\text{N}^{14}$	14.00753	99.62
	$^{15}\text{N}^{15}$	15.00487	0.38
Oxygen	$^{16}\text{O}^{16}$	16.00000	99.76
	$^{17}\text{O}^{17}$	17.0045	0.04
	$^{18}\text{O}^{18}$	18.00485	0.20
Fluorine	$^{19}\text{F}^{19}$	19.00454	100
Neon	$^{20}\text{Ne}^{20}$	19.99890	90.00
	$^{21}\text{Ne}^{21}$	21.00002	0.27
	$^{22}\text{Ne}^{22}$	21.99858	9.73
Sodium	$^{23}\text{Na}^{23}$	22.99645	100
Magnesium	$^{24}\text{Mg}^{24}$	23.99300	77.4
	$^{25}\text{Mg}^{25}$	24.99462	11.5
	$^{26}\text{Mg}^{26}$	25.99012	11.1
Aluminum	$^{27}\text{Al}^{27}$	26.99069	100
Silicon	$^{28}\text{Si}^{28}$	27.98723	89.6
	$^{29}\text{Si}^{29}$	28.98651	6.2
	$^{30}\text{Si}^{30}$	29.98399	4.2
Phosphorus	$^{31}\text{P}^{31}$	30.98441	100
Sulfur	$^{32}\text{S}^{32}$	31.98252	95.1
	$^{33}\text{S}^{33}$	32.98190	0.74
	$^{34}\text{S}^{34}$	33.97981	4.2
Chlorine	$^{35}\text{Cl}^{35}$	34.97884	75.4
	$^{37}\text{Cl}^{37}$	36.97770	24.6
Potassium	$^{39}\text{K}^{39}$	38.976	93.38
Vanadium	$^{51}\text{V}^{51}$	50.96035	100
Iron	$^{56}\text{Fe}^{56}$	55.9571	91.57
	$^{58}\text{Ni}^{58}$	57.95971	67.4
Copper	$^{63}\text{Cu}^{63}$	62.957	70.13
	$^{65}\text{Cu}^{65}$	64.955	29.87
Zinc	$^{64}\text{Zn}^{64}$	63.957	50.9
Rhodium	$^{103}\text{Rh}^{103}$	102.949	100
Silver	$^{107}\text{Ag}^{107}$	106.950	51.9
	$^{109}\text{Ag}^{109}$	108.949	48.1
	$^{118}\text{Sn}^{118}$	117.940	28.5
Xenon	$^{131}\text{Xe}^{131}$	132.946	27.0
Neodymium	$^{146}\text{Nd}^{146}$	145.964	16.5
Gadolinium	$^{156}\text{Gd}^{156}$	155.977	22
Platinum	$^{196}\text{Pt}^{196}$	196.039	35.3
Gold	$^{197}\text{Au}^{197}$	197.039	100
Lead	$^{208}\text{Pb}^{208}$	208.060	52.3

stable if it remains unchanged for a period of time which is long compared with whatever time period the observer is concerned. At the present stage of atomic research, our definition of stability is a function of the sensitivity of our measurement techniques, and we should regard this limit for continued investigation as a challenge that invites the discovery of new unstable isotopes.

With precision mass spectrographs at their disposal, physicists have been able to determine the atomic masses of many isotopes to a high degree of precision. The chemists had already selected oxygen as the standard element upon which their system of atomic weights was based. Viewed from the vantage point of our present knowledge, this choice was rather unfortunate, since we know that oxygen has three isotopes. In comparing atomic weights, physicists use the most abundant isotope of oxygen as a standard in the physical atomic weight scale and take it equal to 16.00000. The masses of isotopes of other elements can be accurately measured with respect to  $O^{16}$ . *Isotopic weights* thus obtained for a few typical isotopes are tabulated in Table III. Had we not already defined mass number, we could easily define it as the whole number which is nearest the given isotopic weight (denoted by  $M$ ).

We define a new term—the *mass decrement*  $\delta$ —as the difference between the isotopic weight  $M$  and the mass number  $A$  of an isotope.

Thus

$$\delta = M - A. \quad (2)$$

Another term, the *packing fraction*  $f$ , is simply the mass decrement per nucleon and is given by

$$f = \frac{\delta}{A} = \frac{M - A}{A}. \quad (3)$$

Since the mass decrement is always very small (less than 0.1 mass unit) the packing fraction is usually given in parts per ten thousand. It is, of course, a dimensionless quantity.

*Illustrative Example:* Using the data given in Table I, calculate the mass decrement and packing fraction of  ${}^7_3\text{Li}$  and  ${}^{58}_{28}\text{Ni}$ .

Considering the lithium isotope first, we have

$$\delta_{\text{Li}} = 7.01816 - 7.00000 = +0.01816 \text{ m.u.}$$

$$f_{\text{Li}} = \frac{0.01816}{7} = +25.9 \times 10^{-4}.$$

Similarly, for nickel

$$\delta_{\text{Ni}} = 57.95971 - 57.00000 = -0.04029 \text{ m.u.}$$

$$f_{\text{Ni}} = -\frac{0.04029}{58} = -6.95 \times 10^{-4}.$$

In general, we find that light isotopes up to  $A = 20$  have a positive packing fraction, as do the elements of

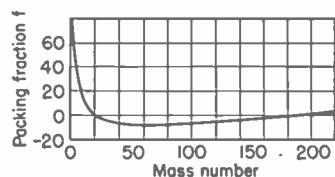

Fig. 7—Aston's original packing-fraction curve.

atomic weight greater than 180. Intermediate isotopes from  $A = 20$  to 180 have negative packing fractions. The variation of  $f$  with  $A$  is shown in Fig. 7, where there is reproduced a redrawn copy of Aston's original packing-fraction curve. Rather than discuss this curve in detail, we postpone our discussion to the next section, where we will find that another curve is much easier to interpret. This short discussion of the packing fraction has been included for the sake of completeness.

#### THE BINDING ENERGY PER NUCLEON

The exact measurement of nuclear masses with the mass spectrometer makes it possible to calculate the energy with which nuclei are bound together. Consider any nucleus of mass  $M$  (accurately measured) which contains  $N$  neutrons and  $P$  protons. Both the mass of the neutron ( $m_n$ ) and that of the proton ( $m_p$ ) have been accurately measured and are known to be

$$m_n = 1.008938 \text{ m.u.}$$

$$m_p = 1.007579 \text{ m.u.}$$

But, by definition, the atomic mass unit is a mass equal to 1/16 of the mass of the  ${}^{16}_8\text{O}$  isotope. One mass unit therefore equals  $1.6603 \times 10^{-24}$  grams. Suppose that one calculates what the mass of this nucleus should be if it is simply the sum of the masses of the individual neutrons inside the nucleus. Let this value to be calculated be  $W$ ; then

$$W = Nm_n + Pm_p. \quad (4)$$

From the Einstein equation it follows that the total energy associated with this mass is obtained by multiplying the right-hand side of the equation by the factor  $c^2$ .

We now introduce a term, called the *mass defect*  $\Delta$ , which is defined as the difference between the mass  $W$ , as given by (4), and the actually measured isotopic mass  $M$ . Thus

$$\Delta = W - M. \quad (5)$$

The reader should note that there is a difference between the mass decrement  $\delta$  given by (1) and the mass defect. Mass numbers ( $A$ ) are whole numbers which usually differ from the masses ( $W$ ) given by (4) by a significant amount. In many textbooks mass defect is often defined by (1) rather than by (5), and this leads to confusion. To illustrate the application of (4) and (5), let us consider the following examples:

*Illustrative Example:* Calculate the mass of an alpha particle using (3). In this case we have  $N = 2$  and  $P = Z$ , so that  $W$  is given by

$$\begin{aligned} W &= 2m_n + 2m_p \\ &= 2(1.00894) + 2(1.00758) \\ &= 4.03304 \text{ m.u.} \end{aligned}$$

However, the mass spectrographic value for the mass of the helium atom is 4.00389 m.u. and if we subtract 0.00055 m.u. for each electron in the helium atom, we see that the mass of the nucleus is 4.00279 m.u. There is thus a difference of

$$\begin{aligned} W &= 4.03304 \\ - M &= 4.00279 \\ \hline \Delta &= 0.03025 \text{ m.u.} \end{aligned}$$

Since 1 m.u. = 931 Mev, this mass defect is equivalent to  $(0.03025) \times (931)$  or 28.20 Mev.

TABLE IV  
BINDING ENERGIES FOR VARIOUS NUCLEI

Nucleus	Mass Defect $\Delta$ (m.u.)	Binding Energy (Mev)	Binding Energy per Nucleon (Mev)
${}^1_1\text{H}^2$	0.00235	2.19	1.09
${}^2_1\text{H}^3$	0.000753	8.32	2.77
${}^3_2\text{He}^3$	0.00821	7.62	2.55
${}^4_2\text{He}^4$	0.03029	28.20	7.05
${}^6_3\text{Li}^6$	0.03431	31.94	5.32
${}^7_3\text{Li}^7$	0.04201	39.11	5.59
${}^9_4\text{Be}^9$	0.06229	57.99	6.44
${}^{10}_5\text{B}^{10}$	0.06921	64.44	6.44
${}^{11}_5\text{B}^{11}$	0.08142	75.80	6.89
${}^{12}_6\text{C}^{12}$	0.09858	91.77	7.65
${}^{13}_6\text{C}^{13}$	0.10384	96.67	7.44
${}^{14}_7\text{N}^{14}$	0.11200	104.27	7.44
${}^{15}_7\text{N}^{15}$	0.12361	115.08	7.67
${}^{16}_8\text{O}^{16}$	0.13661	127.18	8.01
${}^{17}_8\text{O}^{17}$	0.14105	131.32	7.72
${}^{18}_8\text{O}^{18}$	0.14965	139.32	7.74
${}^{19}_9\text{F}^{19}$	0.15809	147.18	7.74
${}^{20}_{10}\text{Ne}^{20}$	0.17186	160.00	8.00
${}^{21}_{10}\text{Ne}^{21}$	0.17968	167.29	7.96
${}^{22}_{10}\text{Ne}^{22}$	0.19007	176.96	8.04
${}^{27}_{13}\text{Al}^{27}$	0.24024	223.67	8.28
${}^{38}_{18}\text{Ar}^{38}$	0.35063	326.43	8.59
${}^{52}_{24}\text{Cr}^{52}$	0.4866	453.0	8.71
${}^{63}_{29}\text{Cu}^{63}$	0.5829	542.7	8.61
${}^{82}_{36}\text{Kr}^{82}$	0.7662	713.3	8.69
${}^{100}_{42}\text{Mo}^{100}$	0.921	857	8.57
${}^{124}_{50}\text{Sn}^{124}$	1.123	1045	8.43
${}^{160}_{64}\text{Gd}^{160}$	1.403	1306	8.16
${}^{196}_{78}\text{Pt}^{196}$	1.651	1536	7.84
${}^{209}_{83}\text{Bi}^{209}$	1.746	1625	7.77
${}^{238}_{92}\text{U}^{238}$	1.915	1783	7.60

If we were able to fuse together or synthesize two neutrons and two protons to form an alpha particle, the resulting nucleus would actually be lighter (by 0.03025 m.u.) than the total mass of the original nucleons. In this fusion process, mass would apparently be lost. Actually, the mass is not lost but rather constitutes the *binding energy* which holds the nucleons together in the helium nucleus. Conversely, if a means were available to disintegrate an alpha particle into two neutrons and two protons, it is clear that 28 Mev of energy would be required for the reaction.

Just as we calculated the binding energy for the helium nucleus, we can deduce the binding energies of other nuclei. In this connection, we list in Table IV mass defects, binding energies, and binding energies per nucleon for a variety of nuclei. Binding energy is simply given by multiplying the mass defect by  $c^2$ . Thus

$$\text{binding energy} = (W - M)c^2. \quad (6)$$

If  $W$  and  $M$  are expressed in mass units, then (6) becomes

$$\text{binding energy (Mev)} = 931(W - M).$$

An important quantity, the *binding energy per nucleon* denoted by  $\Sigma$ , is defined as

$$\Sigma = \left( \frac{W - M}{A} \right) c^2. \quad (7)$$

As is evident from (7), the binding energy per nucleon is equal to the total binding energy for a nucleus divided by the total number of nucleons in the nucleus. The various values of  $\Sigma$  given in Table IV have been plotted as a function of mass number in Fig. 8. Since the elements which have the greatest binding energy per nucleon are the most stable, it is clear from the curve that nuclei of intermediate mass number are more stable than those at either end of the mass number

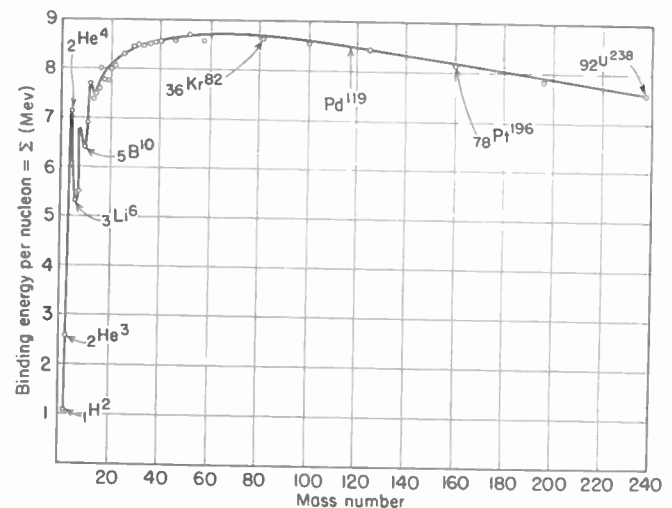

Fig. 8—The variation of binding energy per nucleon with mass number.

range. Furthermore, stability of nuclei for the lightest elements increases very sharply initially and then gradually becomes fairly constant at about mass number  $A = 50$ . Thereafter the stability decreases slowly, reaching a value of  $\Sigma = 7.4$  Mev for uranium, as contrasted with a maximum value of  $\Sigma = 8.7$  Mev for chromium. If we examine the part of the curve for elements lighter than those corresponding to  $A = 30$ , we note that the curve is not smooth but is marked by severe irregularities. This jaggedness must mean that certain of the light nuclei must be much more stable than others of almost equal mass. For example,  $\text{He}^4$ ,  $\text{C}^{12}$ , and  $\text{O}^{16}$  have higher values of  $\Sigma$  than nuclei immediately adjacent to them in the periodic table. It would thus appear that those nuclei which, in a sense, contain subgroups of alpha particles are more stable than other light nuclei. These data constitute graphic evidence that alpha-particle groups form subshells within the nucleus.

## NUCLEAR FORCES

On the basis of the laws of physics which have been discussed up to now, one might attempt to explain nuclear forces in either of two ways. First, it might be assumed that the forces are coulomb or electric forces. However, such an assumption only illustrates that the nucleus should not be bound together at all, for the only charged particles in the nucleus are protons, and these being of like charge and close together would repel each other and constitute a disruptive force. Second, it might be assumed that the forces are gravitational. Now the gravitational force between two particles  $m_n$  and  $m_p$  (neutron and proton, as in the deuterium nucleus) separated by a distance  $r$  is given by

$$F = \frac{Gm_p m_n}{r^2} \quad (8)$$

where  $G$  is the gravitational constant and is  $=6.66 \times 10^{-8}$  gram<sup>-1</sup> cm<sup>3</sup> sec<sup>-2</sup>. Here the force would be attractive, but for a value of  $r = 10^{-13}$  cm, which is a typical separation for nucleons, the force between a neutron and proton is extremely small. Actually, the force is about  $10^{38}$  times less than that required to account for the observed binding energy of the deuteron.

Since neither of these assumptions lead to a solution of the problem, it is necessary to assume that nuclear forces are of a new type not previously found in physics. From experimental data, certain characteristics of this new type of force are known. These are:

(a) Except for the repulsive force due to the coulomb intersection of the protons, the force between nucleons is always attractive. Furthermore, the nuclear forces are considerably larger than the coulomb forces. Were this not true, no nuclei would exist at all, for the coulomb force would disrupt them.

(b) Nuclear forces are not strongly dependent upon the nature of the interacting nucleons. In other words, the nuclear force ( $n-p$ ) is not much different from that acting between two neutrons.

(c) The force between two protons is approximately the same as that between two neutrons. Evidence for this equality is found in the fact that, for light nuclei, the number of neutrons tends to be the same as the number of protons. Furthermore, we have seen that the combination of two neutrons and two protons in He<sup>4</sup>, C<sup>12</sup>, and O<sup>16</sup> forms a very stable configuration.

This last property of nuclear forces is rather unusual, and we will, therefore, discuss it in detail. The four nucleons making up a He<sup>4</sup> nucleus form a closed system in which each nucleon is fully *saturated*, with respect to its interaction, with the other three nucleons. We might describe this saturation property as a pairing of nucleons; that is, each nucleon tends to pair off or interact with one other nucleon to the exclusion of others which may be present. In effect, then, heavy nuclei are made up of subgroups of nucleons, rather than being composed of nucleons which interact with all others in

the nucleus. Were the latter to be true, the total binding energy of a nucleus would be proportional to  $A^2$ , rather than conform to the known dependence which is essentially proportional to the first power of the mass number. Reference to the curve in Fig. 7 illustrates this saturation property of nuclear forces, for most nuclei tend to have about the same value for the binding energy per nucleon ( $\sim 8$  Mev), just as for the nucleons in He<sup>4</sup>. Let us consider the nuclei of mass number greater than  $A=4$  in order to see the effect of saturation. No isotope of mass number 5 exists in nature. An explanation is afforded by assuming that the nucleons within the He<sup>4</sup> nucleus are fully saturated and will not interact strongly enough with an additional nucleon to form an isotope of mass number 5. An isotope of mass 6 exists because it is essentially a system of three neutrons and three protons which pair off to form a stable configuration.

Nuclear forces are distinctly short-range forces. By "short range," we mean that the forces have a fairly constant (saturation) value up to a distance of the order of  $10^{-13}$  cm. As an illustration of the actual distances involved, let us consider the following example:

*Illustrative Example:* The binding energy of the deuteron is 2.19 Mev. Assuming that the neutron and proton can be considered as a proton-proton combination, make an estimate of the separation of the protons.

To do this we assume that the coulomb energy of the system is about one-fourth that of the binding energy (this assumption is arbitrarily made to obtain an "order of magnitude" answer). The coulomb repulsive energy is given by  $e^2/r$ , so that

$$\begin{aligned} e^2/r &= 1/4(2.19 \times 10^6)(1.6 \times 10^{-12}) \\ r &= 3 \times 10^{-13} \text{ cm.} \end{aligned}$$

It is instructive to consider the tritium-helium isobars ( ${}^3_1\text{H}$ ,  ${}^3_2\text{He}$ ) in order to gain an appreciation of ( $n-n$ ) and ( $p-p$ ) forces. Suppose we illustrate the fact that the ( $n-n$ ) force is almost equal to the ( $p-p$ ) interaction by the following examples:

*Illustrative Example:* Given that the isotopic weights of H<sup>3</sup> and He<sup>3</sup> are 3.01705 and 3.01699, respectively, calculate the binding energy of each nucleus and explain the difference between the two results.

Suppose we arrange the data as shown in Table V.

TABLE V

	${}^3_1\text{H}$	${}^3_2\text{He}$
Isotopic Weight $M$	3.01705	3.01699
Subtract the weight of electron(s)*	0.00055	0.00110
Weights of nuclei	3.01650	2.01589
Weight $W - (Nm_n + Pm_p)$	3.02546	3.02410
Mass defect	0.00896	0.00821 m.u.
Binding energy	8.32	7.63 Mev
=====		
Difference in binding energies = 0.69 Mev		

\* Isotope weights are conventionally given as weights of the entire atom.

To interpret the difference in binding energy shown, consider the forces between nucleons in each nucleus. In tritium, we have two ( $n-p$ ) force and one ( $n-n$ ) interaction; whereas for helium, we have two ( $n-p$ ) and one ( $p-p$ ) force. Thus we may write

$$(n - n) = (p - p) + 0.69 \text{ Mev.}$$

and we see that the difference must be due to the coulomb force acting between the two protons.

#### THE BINDING-ENERGY EQUATION

A semi-empirical equation has been deduced so that the mass, and therefore the binding energy, of any isotope may be calculated. We will simply write down this equation without attempting to deduce it, and then we will explain the significance of each term in the equation and relate this to the binding energy per nucleon curve shown in Fig. 7. The equation is

$$M = m_n(A - Z) + m_p Z - a_1 A + a_2 A^{2/3} + a_3 \frac{Z^2}{A^{1/3}} + a_4 \frac{\left(\frac{A}{2} - Z\right)^2}{A} + \delta \quad (9)$$

(a)      (b)      (c)      (d)      (e)      (f)      (g)

where  $M$  is the exact mass of an isotope of atomic number  $Z$  and mass number  $A$  which would result from building up the nucleus from  $Z$  protons and  $A - Z$  neutrons, taking into account the observed decreases in mass of the neutron and proton due to binding. Formidable as the equation may seem at first, it is extremely useful, especially in calculating the probability that a neutron will cause fission in a heavy element. The significance of each term is as follows:

Term (a) [ $m_n(A - Z)$ ] is simply the product of the mass of the free neutron ( $m_n$ ) and the total number of neutrons in the nucleus.

Term (b) [ $m_p Z$ ] is similarly the product of the mass of the free proton ( $m_p$ ) and the total number of protons in the nucleus.

Terms (c) through (g) all make up the binding energy which is released when the free neutrons and protons are brought together to form the nucleus under consideration. This is equivalent to expressing analytically the empirical fact that nuclei have uniform density. This means that the volume occupied by a nucleus is proportional to the number of nucleons, and consequently the radius is proportional to  $A^{1/3}$ . More exactly, the nuclear radius is  $1.4 \times 10^{-13} A^{1/3}$ .

Term (c) [ $a_1 A$ ] expresses the fact that nucleons are held together by the attractive nuclear force, and therefore work is done and energy lost when the particles are fused together. The constant of proportionality  $a_1$  is numerically  $+0.01504$ .

Term (d) [ $a_2 A^{2/3}$ ] is an expression which takes into account the fact that the surface of the nucleus contains nucleons which are not subject to the same inter-

action with other nucleons as are those in the interior. Surface nucleons are less tightly bound. It is for this reason that light nuclei have binding energies per nucleon less than those for medium-heavy nuclei, since light nuclei have relatively greater surface area per unit volume. Since the nuclear surface area is proportional to  $r^2$  and since  $r$  is proportional to  $A^{1/3}$ , this effect will be proportional to  $A^{2/3}$ . Empirically,  $a_2$  is a constant  $= +0.014$ .

Term (e)  $\left[ a_3 \frac{Z^2}{A^{1/3}} \right]$  expresses the repulsive effect of

the protons within the nucleus. For  $A > 120$ , this coulomb repulsion of the protons increases sufficiently to offset the attractive forces.

The constant  $a_3 = 0.000627$ .

Term (f)  $\left[ a_4 \frac{\left(\frac{A}{2} - Z\right)^2}{A} \right]$  takes account of the empir-

ical fact that the number of protons in any nucleus tends to be equal to one-half the total number of nucleons. This tendency may not seem apparent in heavy nuclei, where the number of neutrons is greater than the number of protons, but the two would be equal were it not for the electrostatic repulsion of the protons. The constant of proportionality,  $a_4$ , is equal to 0.083.

Term (g) [ $\delta$ ] is a correction term which adjusts for small changes in energy due to the pairing of nucleons in the nucleus. This term may be

$$\delta = +k \text{ if } A \text{ is even but } Z \text{ is odd}$$

$$\delta = 0 \text{ if } A \text{ is odd}$$

$$\delta = -k \text{ if } A \text{ is even and } Z \text{ is even}$$

and

$$k = \frac{0.036}{A^{3/4}}$$

By simplifying (9) and substituting the numerical values of the constants, we obtain

$$M = 0.99389A - 0.0081Z + 0.014A^{2/3} + 0.000627 \frac{Z^2}{A^{1/3}} + 0.083 \frac{\left(Z - \frac{A}{2}\right)^2}{A} + \delta \quad (10)$$

Into this semi-empirical equation has been put the contribution of all factors which are empirically known



to affect the binding energy. For all but low values of  $A$ , the equation yields approximate but fairly reliable values for the nuclear masses.

*Illustrative Example:* Calculate the binding energy of  ${}_{28}\text{Ni}^{60}$ . Substituting in (10), we have

$$\begin{aligned} M &= 0.99389(60) - 0.00081(28) + 0.014(60)^{2/3} \\ &\quad + 0.000627 \frac{(28)^2}{60^{1/3}} + 0.083 \frac{(-2)^2}{60} - \frac{0.036}{(60)^{3/4}} \\ &= 59.6334 - 0.0227 + 0.2145 + 0.1255 \\ &\quad + 0.0055 - 0.0017 = 59.9545. \end{aligned}$$

This agrees reasonably well with the measured value of 59.94977.

$$\begin{aligned} \text{From (4), } W &= 32(1.00894) + 28(1.00758) \\ &= 32.2861 + 28.2122 \\ &= 60.4983. \end{aligned}$$

$$\begin{aligned} \text{The mass defect} &= W - M \text{ (using the calculated value of } M) \\ &= 60.4983 - 59.9545 \\ &= 0.5438 \text{ m.u.} \end{aligned}$$

$$\begin{aligned} \text{The binding energy is then, from (6),} \\ \text{binding energy} &= 931(0.5438) \\ &= 506 \text{ Mev,} \end{aligned}$$

and the binding energy per nucleon, by (7), is

$$\Sigma = \frac{506}{60} = 8.4 \text{ Mev.}$$

#### A NUCLEAR MODEL

Just as Bohr developed the concept of atomic structure, he likewise advanced a model of nuclear structure. Basing his idea upon the characteristics of nuclear forces as they have been outlined, and upon the fact that only certain ratios of neutrons to protons are allowed for stable atoms, Bohr proposed that the nucleus could be thought of as a compact aggregate of nucleons, all in a constant state of motion and yet restricted to motion within a sphere of small radius. On this model, the nucleus corresponds to a small sphere of liquid, the constituents of which are nucleons which are fairly uniformly distributed throughout the sphere. For this reason, the Bohr model of the nucleus has been called the *liquid-drop model*. Since the nucleus is extremely small in diameter, these particles make many collisions per second, and they all tend to have the same average energy. It is, therefore, easy to see that the nucleus has a uniform density.

The short-range nuclear forces which have been introduced into the discussion are known in quantum mechanics as resonance or exchange forces. These forces are not well understood, and much of the current research in physics is directed toward understanding the nature of the interactions between nucleons. At the pres-

ent time theoretical physicists believe that an intermediate mass particle known as the *meson* is the means by which the nucleons interact. The Japanese physicist Yukawa first proposed that nucleons might virtually "share" a particle of about 200 electron masses in weight and thus serve to exchange energy between themselves. Modern meson theories, involving abstruse mathematical analysis, have been only partially successful in explaining a few of the observed properties of nuclear forces. Mesons of both positive and negative charge are postulated in order to conserve electric charge in the process whereby a proton virtually emits a positive meson or a neutron virtually produces a negative meson. These two reactions can be expressed by the equations:



These processes are thought of as occurring at an extremely high frequency, and the meson thus never leaves the field of the nucleon but is virtually absorbed. The high-frequency virtual emission and absorption of mesons by nucleons is assumed to constitute an exchange force which binds the nucleons together. These exchange forces are essentially the nuclear analogs of the covalent forces postulated to explain interatomic forces. In the case of proton-proton or neutron-neutron interactions, a charged meson would obviously be impossible, and for this reason the existence of a neutral meson (neutretto) has been postulated.

One of the most remarkable discoveries in modern physics occurred when Anderson found conclusive evidence for the existence of an intermediate mass particle in the cosmic radiation. This particle, known as the *mesotron* or *meson* (both names are in common use), is about 200 electron masses in weight, has a half-life of  $2.1 \times 10^{-6}$  seconds, and is found as a positively ( $+e$ ) and as a negatively ( $-e$ ) charged particle. As yet there is no experimental evidence for a neutral mesotron.

Early in 1948 the discovery of the production of mesons by artificial means was announced. The 184-inch Berkeley cyclotron was used to produce 490-Mev alpha particles, and these led to the production of mesons when they struck a carbon target. As a result of this discovery, physicists now have a known source of mesons many millions of times more intense than that provided by the cosmic radiation. Undoubtedly, in the not-too-distant future, researches will turn up new discoveries about nuclear structure which will shed more light upon the mysterious role of the meson in the nucleus.

Before leaving the subject of nuclear structure, we touch briefly upon the magnetic properties of the nucleus and nuclear particles. If we regard a charged particle, say, an electron, as a tiny sphere of electric charge which spins rapidly about its own axis, then it follows that this motion of electric charge should pro-

duce a magnetic field, for an electric current is merely charge in motion and it is well known that currents produce magnetic fields. Goudsmit and Uhlenbeck first recognized that an electron has its own intrinsic spin and associated magnetic field or, to be more exact, its own magnetic moment. An electron has a character-

TABLE VI\*

NUCLEAR SPINS IN UNITS OF  $h/2\pi$ , AND NUCLEAR MAGNETIC MOMENTS IN UNITS OF THE NUCLEAR MAGNETON,  $\mu_0$ †

Nucleus	$I$	$\mu/\mu_0$	Nucleus	$I$	$\mu/\mu_0$
${}^1_0\text{N}^1$	1/2	-1.910	${}^9_4\text{Be}^9$	3/2	-1.176
${}^1_1\text{H}^1$	1/2	2.7896	${}^{10}_5\text{B}^{10}$	1	0.598
${}^2_1\text{H}^2$	1	0.8564	${}^{11}_5\text{B}^{11}$	3/2	2.687
${}^3_1\text{H}^3$	1/2	2.9756	${}^{12}_6\text{C}^{12}$	0	0
${}^3_2\text{He}^3$	1/2	-2.131	${}^{13}_6\text{C}^{13}$	1/2	0.701
${}^4_2\text{He}^4$	0	0	${}^{14}_7\text{N}^{14}$	1	0.403
${}^6_3\text{Li}^6$	1	0.8214	${}^{15}_7\text{N}^{15}$	1/2	0.280
${}^7_3\text{Li}^7$	3/2	3.2535	${}^8_8\text{O}^8$	0	0

\* From E. M. Purcell, *Science*, vol. 107, p. 433, 1948. The value for  ${}^3_2\text{He}^3$  is from H. L. Anderson and A. Novick, *Phys. Rev.*, vol. 73, p. 919, 1948.

† The sign of the magnetic moment refers to the polarity of the nuclear dipole with respect to the direction of the angular-momentum vector.

istic intrinsic angular momentum or *spin* with which there is associated a magnetic moment equal to  $eh/4\pi mc$ , where all the symbols have their usual values and  $m$  is the mass of the electron. If we regard the proton as a spinning sphere of positive electric charge which has a definite angular momentum, then the

proton should likewise have a definite magnetic moment. In effect, a proton should exhibit the magnetic behavior characteristic of a small (infinitesimal) dipole. While this picture is helpful for an elementary discussion, it is not adequate for a thorough understanding of nuclear magnetism.

In general, the magnetic moments associated with nuclei are about one thousand times smaller than that of the electron, since the magnetic moment is inversely proportional to the mass of the particle. For example, the magnetic moment of the proton is measured in units of  $eh/4\pi Mc$  where  $M$  is the mass of the proton; the later expression is usually called a *nuclear magneton* and is the unit for measuring nuclear magnetic moments. Both the nuclear spin (denoted by  $I$ ) and the nuclear magnetic moment are properties which are uniquely characteristic of nuclei. The spin may assume either integral or half-integral values, as is illustrated in Table VI, wherein there appear the spins and magnetic moments of several light nuclei. Certain rules exist which prescribe the spin value for a given nucleus, but as yet no consistent theory predicts the value of the magnetic moment for nuclei. Our simple picture of spinning charge brings us to despair when we note that the neutron, an uncharged particle, has an associated magnetic moment.

## Duplex Tetrode UHF Power Tubes\*

PHILIP T. SMITH†, SENIOR MEMBER, IRE, AND HOWARD R. HEGBAR‡, SENIOR MEMBER, IRE

**Summary**—Major factors affecting the design and development of wide-band uhf power tubes are considered and emphasis is given to the television application. A qualitative discussion of methods for obtaining the required performance is presented, and a 5-kw 300-Mc liquid-cooled, internally neutralized duplex tetrode is described.

### INTRODUCTION

IN CONSIDERING the design and development of electron tubes suitable for use as grid-modulated television power amplifiers, there are certain performance characteristics that must be attained, and others that are highly desirable. The fixed tube-performance characteristics, such as bandwidth, power output, and carrier frequency, are determined by the standards adopted for television broadcasting, and must be accepted as minimum values in the design. When the other tube characteristics, grid currents, power gain, impedance presented to the modulator, efficiency, and feedback are considered, the desired values are not all attainable in a given design, and the

best compromise is sought. Attempts to satisfy requirements of bandwidth, power gain, linearity, ease of modulation, and power output at the higher carrier frequencies can be resolved into a search for means of obtaining large cathode emission-current densities, large average anode-current densities, electrodes capable of handling large power dissipation per unit area of bombarded surface, small interelectrode spacings, small electron currents to the grids, and a tube geometry and circuit-wise arrangement of tube elements that will provide adequate utilization of the aforementioned.

Realizing that these requirements could not be adequately met if the limitations imposed by conventional tube design were assumed, Zworykin organized a laboratory group for research in high-power electron tubes in 1937. It was his continued interest and good counsel which made possible the development of a 50-kw tube which served as the background for the development of the smaller, higher-frequency power tube herein described.

Early in 1938 the senior author introduced a duplex tetrode with an electron-beam-forming electrode configuration and high-dissipation anodes. The initial tests

\* Decimal classification: R339.2. Original manuscript received by the Institute, March 1, 1948; revised manuscript received, May 26, 1948.

† RCA Laboratories Division, Princeton, N. J.

‡ Goodyear Aircraft Corporation, Akron, Ohio.

were made in continuously pumped demountable metal envelopes. Sealed-off demountable tubes were made possible when fitted with a copper-gasket demountable seal introduced by Garner, a member of the group. Many laboratory tubes were built and tested before a tube capable of a 5-kw output at 300 Mc with a total output bandwidth of 10 Mc could be properly designed. This paper describes such a tube.

#### DESIGN CONSIDERATIONS

In arriving at a tube design, it is difficult to formulate a mathematical expression containing all of the factors affecting the design and to obtain the unique or the best solution. Tube design represents a compromise between conflicting factors which are individually studied to advantage, and which must be combined with care and ingenuity and with a view toward the circuit and application problems. A detailed analysis of the individual factors will not be attempted here, but only qualitative indications of the trends required for providing an improvement in the factors pertinent to the design of grid-controlled power tubes will be discussed.

The frequencies for the present commercial and experimental television channels are sufficiently high to make the electron-transit time between tube elements of importance. Many of the effects of long transit times are known, and have been observed in cathode back-bombardment, control-grid loading, and loss in efficiency and power output. Therefore, one of the present considerations is that of extending the usable frequency range of grid-controlled tubes by reducing the electron-transit time. Such a reduction in transit time is obtained by decreasing the interelectrode spacings and increasing the electron acceleration. Under conditions of space-charge-limited emission from the cathode, the increased electron acceleration is obtained only when increased cathode-current densities may be drawn. For example, the electron-transit time in a region between parallel-plane electrodes of large extent is proportional to the one-third power of the ratio of the electrode spacing to the current density when operated with space-charge-limited emission and assuming zero emission velocity. In grid-controlled high-frequency tubes, effective electrode spacings are obviously to be made as small as is practical without sacrificing mechanical rigidity of the electrode structure, and the longitudinal thermal conduction required for cooling. Large cathode-current densities are available from such surfaces as the thorium-tantalum cathode under steady-state conditions with a reasonable life. Since we are concerned with continuous operation, the large pulse emission-current densities from barium-strontium-oxide cathodes cannot be utilized.

An attempt to utilize large current densities increases the difficulty of providing an adequate control-electrode configuration, particularly for the high-frequency applications where close interelectrode spacings are of importance. Since grid control of the large-density

electron emission is sought, it is evident that a beam-forming electrode arrangement can be used to advantage. A focusing electric field is provided in the region adjacent to the cathode surface by means of focusing elements electrically connected to the cathode, and projecting slightly beyond the cathode into the cathode-grid space. Many such focusing arrangements are possible and the details must be chosen to fit the method of construction and other tube parameters. A typical cathode and focusing-element arrangement is shown in Fig. 1.

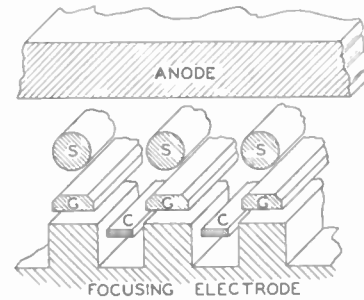

Fig. 1—A beam-forming electrode configuration. S=screen-grid element, G=control-grid element, C=electron emitting filament.

Since the instantaneous voltages of the control grids and the anodes vary with respect to time, the electron beam focusing is not constant over the operating cycle. In a practical design, the electrode configuration and electric fields are so arranged that at the instant of maximum beam spreading the portions of the beam intercepted by the No. 1 and No. 2 grid elements are small enough to prevent excessive power dissipation at these elements. Also, the portion intercepted by the No. 1 grid should be sufficiently small to cause a negligible variation in the impedance presented to the rf driving stage and to the modulator over the modulation cycle. It is just this beam spreading and the possible formation of potential minima in the interelectrode regions that determines the values of applied voltages and the amplitude of the control-grid and anode rf voltages for a given structure. The electric fields must be sufficiently great at the maximum of the grid-voltage swing to support the large space-current densities and to maintain sufficiently narrow beams. Considerations of transit time and beam spreading determine the minimum gradients to be provided in the regions between the cathode and No. 1 grid, between the No. 1 grid and No. 2 grid, and between the No. 2 grid and the anode. Because of the gradients required in the latter region of a high-frequency power tetrode, the minimum of the instantaneous anode voltage of a high-frequency tetrode should be substantially above the screen-grid voltage to utilize in the best manner the current available in the plane of the No. 2 grid.

It is well recognized that the wide-band high-frequency power tube requires large power dissipation per unit area at the anode. In order that the greatest power and bandwidth be obtained from a tube with a given

anode current, the ratio of the tube output capacitance to the anode current should be small and the anode power dissipation per unit area should be large. When sufficient anode dissipation is available, the maximum tube output load impedance is determined by the required bandwidth and the tube output capacitance plus whatever effective capacitance is added by the output circuit. It is assumed that the anode voltage can be increased to the required value without failure of the tube or circuit. This assumption is reasonable for total bandwidths of 10 Mc or more, but leads to excessively high voltages for bandwidths less than 1 Mc. When the allowable anode dissipation is too low, in a given tube, the tube must be operated with a reduced anode voltage, a reduced output load impedance, and consequently a reduced efficiency and power output. At this expense, an output circuit is obtained whose bandwidth is increased beyond that required.

The requirement of large anode dissipation per unit area of bombarded surface can be met by the use of high-velocity water in cooling channels formed in a copper or silver anode body. This construction increases the area of metal in contact with the water and reduces the tendency for diversion of the cooling water by steam bubbles. Such an anode structure is shown in Fig. 6. This structure permits anode dissipations of from 500 to 1000 watts per square cm averaged over the anode face. This is to be compared with an allowable dissipation of 50 to 100 watts per square cm in conventional structures.

With an electron-beam system such that but a small portion of the beam current is collected by the No. 1 grid and such that the electron-transit-time effects are small, a large power gain can be achieved if the circuit losses are low and if there is no feedback. Small amounts of feedback from the output circuit to the input circuit give rise to asymmetric distortion of the sidebands, while larger values of feedback will produce instability and oscillation. It is common practice to add a load to the input grid circuit to minimize the effects of the feedback, even though such loading decreases the power gain. The feedback can be made small by designing the tube such that the anode and output circuit are shielded from the input by special grids, as is done in the tetrode, and somewhat similarly in the grounded-grid triode; or a neutralizing circuit may be applied. In the design of grids, the requirements for obtaining good shielding conflict with those for obtaining the desired electronic performance, and a compromise is usually made. As a result, most tetrodes and grounded-grid triodes require some neutralization for wide-band amplification at a high frequency. The selectivity of the neutralizing circuits for such application introduces an added difficulty in obtaining wide-band amplification. The selectivity of the neutralizing circuits can be decreased by making their elements very short compared to a quarter wavelength at the operating frequency. In a duplex tetrode arranged for push-pull operation, such

short neutralizing elements can be located internally. This is done in the described developmental tube.

In order that the circuit losses be kept to low values to increase the power gain and to prevent mechanical failure as a result of heating, it is desirable that metal-to-glass seals be used that have low  $I^2R$  losses in the metal member. Among the seals suitable for power-tube construction, two such types are well known. These are the feather-edge copper-to-glass Housekeeper seal and the silver-plated-chrome iron-to-glass seal. The Housekeeper seal has good electrical conductivity but lacks the mechanical strength and rigidity of the kovar seal, and because of its construction is difficult to apply in some designs. The silver-plated-chrome iron-to-glass seals are made with *rf* induction heating and require carefully controlled heating conditions. These seals use a glass with a lower softening temperature than that of the kovar sealing glasses.

The kovar-to-glass seal is widely accepted and is satisfactory, except for its high electrical resistivity, which may become troublesome in some high-frequency tubes. During the work on the described tetrodes, methods have been developed for coating the kovar with a high-conductivity film and for sealing kovar matching glasses to this film. A coating of either copper, silver, gold, or chromium is electroplated to a thickness of several mils and is bonded to the kovar. Seals made to kovar coating in this manner have an electrical conductivity 10 to 20 times that of uncoated kovar at frequencies in excess of 50 Mc, and are particularly adaptable to the structures and requirements herein described.

In the design of a tube for application as a grid-modulated amplifier, a linear modulation characteristic is usually sought. While some curvature of the modulation characteristic is acceptable, it is important that the shape and slope of the characteristic be independent of the frequency and amplitude of the modulating voltage. Large variations in the required *rf* driving power with modulating voltage applied will make the modulation characteristic substantially dependent on the modulating frequency, unless the input grid circuit has a bandwidth equal to, or greater than, the tube output circuit. Such variations in the required grid driving power can be reduced by reducing the feedback, the electron current to the No. 1 grids, and the electron-transit times. These reductions will also act to make the impedance presented to the modulator more nearly constant over the modulating cycle.

The duplex tetrode tube arrangement was selected by the authors as lending itself to internal neutralization and being capable of providing an effective utilization of beam-forming electrode configurations, thoriated filaments, and large-dissipation anodes in a tube to be operated as a wide-band grid-modulated power amplifier in the present commercial television channels. In the duplex tetrode the two tetrode units can be placed in very close proximity and can use, in effect, common

screen-grid and cathode structures. The two screen grids are directly connected and by-passed to the cathode structure by low-impedance members, as in Fig. 4 and Fig. 5. The cathodes of the two tetrode units can be provided as the opposite legs of a "U"-shaped filament. These features permit the design of a high-gain wide-band grid-modulated high-frequency power tube that has exceptionally low feedback and good modulation characteristics.

Since a maximum of shielding is required between the input and output circuits, a metal envelope can be used to advantage to provide a convenient connection to external shielding in such a way as to make the envelope act as part of the shield. The metal envelope is also convenient when a demountable structure is desired. Two types of copper-gasketed compression joints are shown in Fig. 2. One of these uses a flat copper-ring gasket compressed between a flat and a curved surface, while the other uses two round wire rings clamped be-

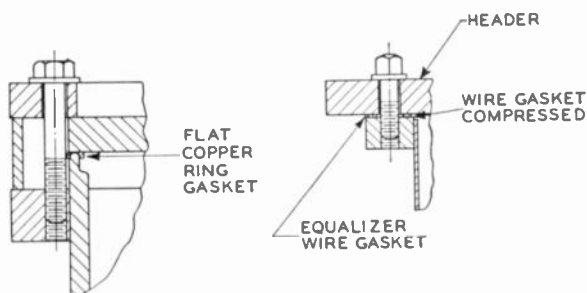

Fig. 2—Details of the copper-gasket vacuum seals.

tween two flat surfaces, the outer ring acting only as a support ring to prevent distortion of the clamping plates. Ground and polished clamping surfaces are used with annealed OFHC copper gaskets. These demountable joints may be baked to 450°C in the processing of the tube, and are regularly used in sealed-off tubes. The tube shown in Fig. 7 is constructed with a compression joint and metal envelope, and is operated as a sealed-off tube.

#### THE DUPLEX TETRODE

The tube described is a developmental liquid-cooled duplex tetrode arranged for push-pull operation as a grid-modulated television power amplifier, and is designed to give a power output, at the maximum of the synchronizing pulse, of 5 kw at 300 Mc, and a total output bandwidth of 16 Mc. Neutralization is provided by elements attached to the No. 1 grids and included within the vacuum envelope.

An electron-beam-forming electrode configuration is used with a thoria-coated "U"-shaped filament in the arrangement shown in Fig. 1. The opposite sides of the filament act as the cathodes for the two tetrode units. The construction of the cathode and focusing-electrode assembly is shown in Fig. 3. Each of the two focusing-electrode blocks is connected to the filament, and func-

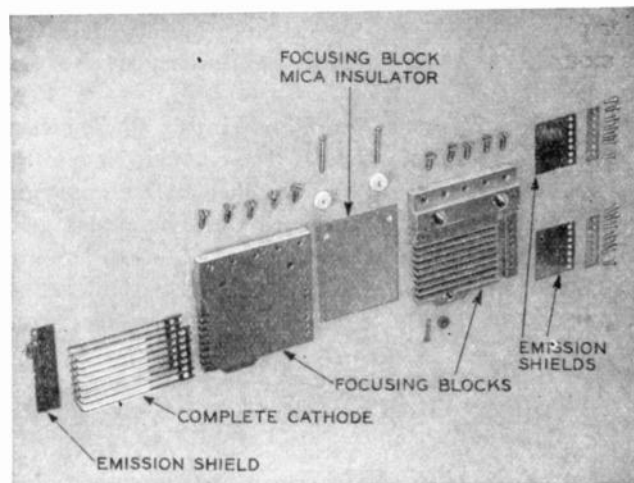

Fig. 3—The filament, filament shields, and focusing blocks.

tions as the connection to the filament-heating supply. A mica sheet is used to insulate the two focusing-electrode blocks, which are supported and cooled by water-cooled blocks fixed to the header plate. Tantalum heat and emission shields are used, and are shown as part of the cathode assembly in Fig. 3. The electron-emitting surface of each of the two halves of the 8-strand filament is approximately 1.6 square cm in area. The filament strands are formed from tantalum sheet. A layer of thoria powder is sintered to the surface of the tantalum after the filament is formed. The filament operates at approximately 2000°K.

The No. 1 grids consist of molybdenum bars silver-soldered to water-cooled tubes which also carry the neutralizing elements. These grids are supported by the glass of the metal-to-glass vacuum seal mounted in the header plates as shown in Fig. 4. This figure shows the

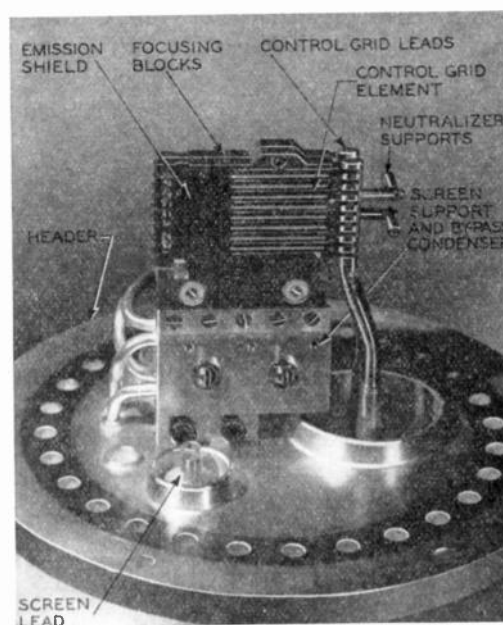

Fig. 4—The header with filament, filament shields, No. 2 mounting blocks, and No. 1 grids mounted.

header plate with the cathode structure, and the No. 1 grids mounted and prepared for the addition of the No. 2 grids.

The two No. 2 grids are combined into a single structure which is rigidly clamped to the cathode assembly, and is insulated therefrom by mica sheets which provide a by-pass capacitance to the cathode. The No. 2 grid elements are molybdenum rods and are silver-soldered to water-cooled copper plates. This structure with attached shields is shown in Fig. 5. The cooling of the electrode

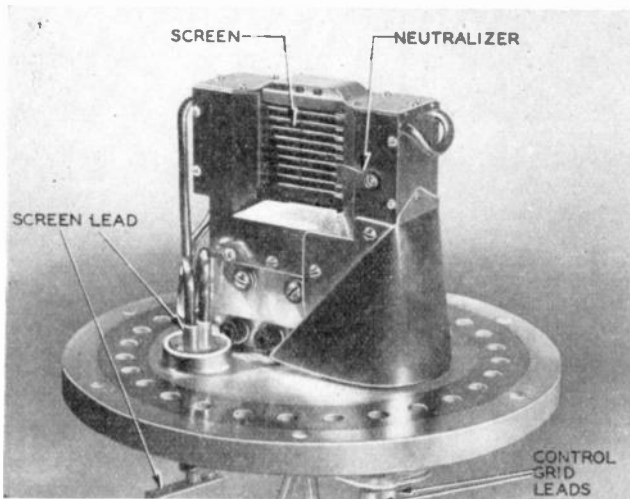

Fig. 5—A completed header assembly showing No. 2 grids and neutralizers mounted.

elements is obtained by thermal conduction along the length of the elements to the cooled supporting copper plates.

The complete header assembly containing all of the electrodes excepting the anodes is shown in Fig. 5. The neutralizing tabs are shown mounted on elements fixed to the No. 1 grids and projecting through apertures in the No. 2 grid blocks. This use of a header for mounting the close-spaced electrodes permits accurate electrode alignment and inspection before the anode dome is mounted.

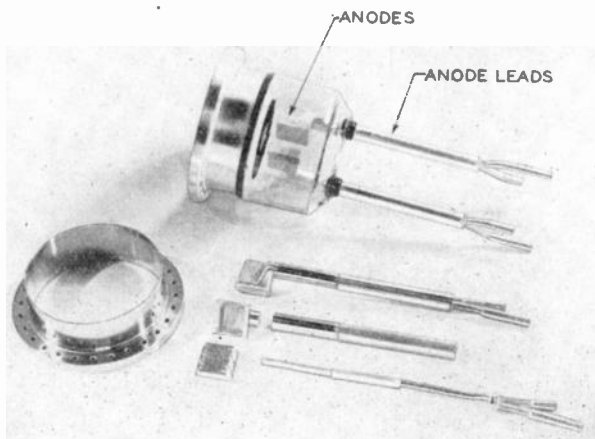

Fig. 6—The anode dome assembly, anode parts, and leads.

The anode dome and the details of the anode construction are shown in Fig. 6. The anode face has an area of 6.5 square cm., and is cooled by water circulated in the channels shown. Since the anode cooling water is carried by the anode supporting tube which functions as an element of the output tank circuit, the anode glass seals are water cooled. This cooling is adequate to permit the use of kovar at 300 Mc, if a high-conductivity coating is applied to kovar as previously described. With cooling water at a pressure of 60 pounds per square inch, these anodes have been operated without failure to a dissipation of 6 kw per anode.

The final step in assembly of this tube is the bolting of the anode dome to the header; this compresses the two copper-ring gaskets and provides the final vacuum closure of the envelope. The anodes, anode leads, and anode dome ring can be electroplated, cleaned, and washed before this operation, and are not subjected to any glass-working fires or other heating in making the final vacuum closure. The copper-ring gaskets are made from wire. This compression gasket seal, shown in Fig. 2, has proved to be an entirely satisfactory vacuum-

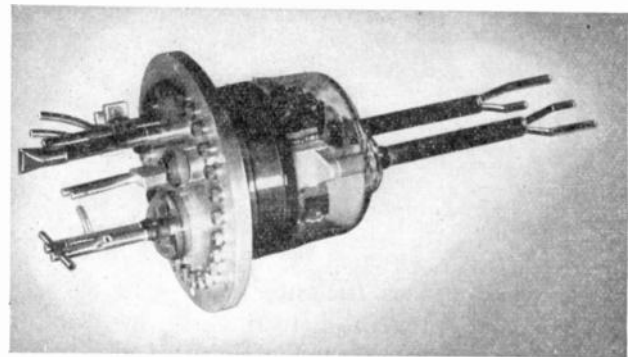

Fig. 7—The duplex tetrode.

#### TUBE DATA<sup>1</sup>

Direct interelectrode capacitance (each unit),

Grid No. 1 to anode	0.12 $\mu\text{mf}$
Input	24 $\mu\text{mf}$
Output	5 $\mu\text{mf}$
Grid No. 2 by-pass (approximate)	200 $\mu\text{mf}$
Grid No. 1 to anode feedback with neutralization	0.01 $\mu\text{mf}$

Filament—3.9 volts—105 amperes single phase

Electrode dissipation (maximum operating values):

Anodes	8 kilowatts total
No. 2 grids	400 watts total
No. 1 grids	50 watts total

Typical operating voltages:

Anode	5000–6000 volts dc
No. 2 grid	700 volts dc
No. 1 grid (cutoff bias)	—180 volts dc

Cooling water flow at 60 pounds per square inch pressure:

Anode of each unit	0.6 gallons per minute
Filament blocks in series	0.25 gallons per minute
No. 2 grid	0.3 gallons per minute
No. 1 grids in series	0.25 gallons per minute

<sup>1</sup> In the 8D21, or commercial model, some changes in these data were found necessary because of manufacturing techniques.

tight joint which can be used both in demountable and in sealed-off tubes.

A completely processed tube is shown in the operating position in Fig. 7. This position is determined by the filament, which must hang vertically to prevent distortion and sagging. The tube is supported by the header plate rim, which acts as a flange, and which when installed is bolted to the shield wall separating the input and output circuits.

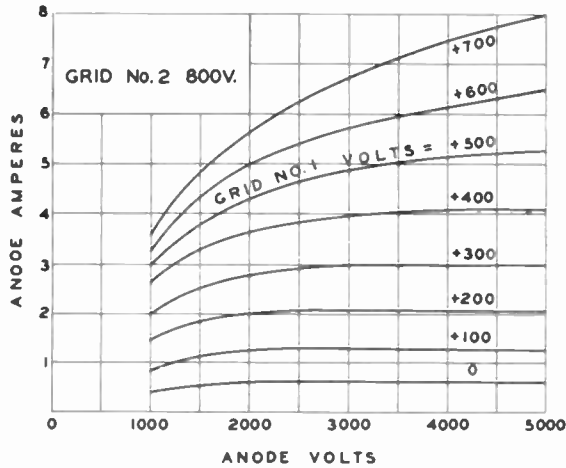

Fig. 8—Anode characteristics for each unit.

The static characteristics are given in Figs. 8, 9, and 10. A modulation characteristic, shown in Fig. 11, was obtained at 288 Mc with a total output bandwidth of 16 Mc. A maximum power output of 10 kw was obtained at an efficiency of 60 per cent. The instantaneous bias at this point was 100 volts positive with respect to

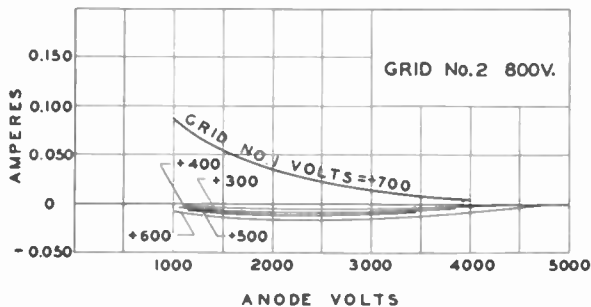

Fig. 9—No. 1 grid characteristics for each unit.

the cathode. In the television application the bias at the maximum of the synchronizing pulse may be reduced to zero or made positive to reduce the amplitude of the rf grid driving voltage. This does not substantially change the required modulating voltage.

Under power output and bandwidth conditions as given above, a power gain at maximum power output of 25 to 30 is obtained. The driving power in these tests

was approximately 350 watts. When the tube is used as a 5-kw amplifier with a bandwidth less than 1 Mc, power gains in excess of 100 are obtainable. These power gains for either application are not obtainable at 300 Mc, unless low-loss grid seals such as described in this paper are used.

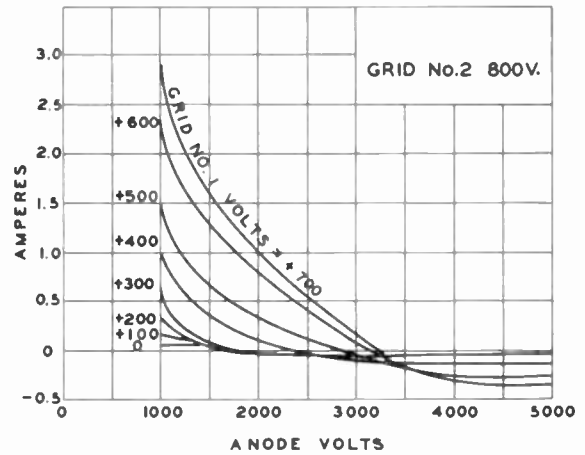

Fig. 10—No. 2 grid characteristics for each unit.

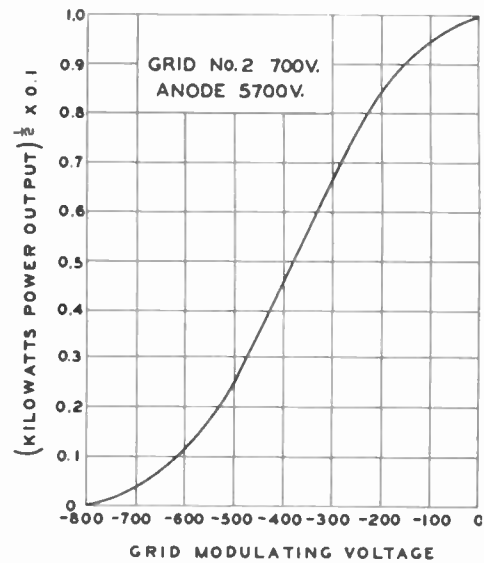

Fig. 11—Modulation characteristic.

ACKNOWLEDGMENT

The authors wish to express their appreciation to V. K. Zworykin, of the RCA Laboratories, whose vision, initiative, and constant interest made these developments possible. They also wish to express thanks to L. P. Garner, of the RCA Victor Division, at Lancaster, Pa., who was associated with the senior author during the development of many tubes and test structures which served as a background for these developments. We are indebted to L. S. Nergaard, of the RCA Laboratories, for circuit designs, tests, and measurements at 288 Mc.

# Electrostatically Focused Radial-Beam Tube\*

A. M. SKELLETT†, MEMBER, IRE

**Summary**—The addition of the electrostatic field between coaxial cylinders to a uniform electrostatic field provides the correct properties for focusing a beam of electrons in the positive direction of the uniform field. In the electrostatically focused radial-beam tube, this combination of fields produces a single radial electron beam which may be rotated by rotating the uniform component of the combined fields. The center coaxial electrode may be either the cathode or a grid surrounding the cathode, and the outer coaxial electrode is broken up into segments to which polyphase potentials are applied. At any instant these polyphase potentials produce an approximation to a uniform field which rotates at the cyclic frequency of the polyphase potentials.

A number of tubes have been made incorporating these principles. Details are given of such a tube with twelve anodes and twelve associated control grids which is no larger than an ordinary radio receiving tube. The beam current is of the order of 1 ma and the frequency of rotation is limited only by the inductance and capacitance of the elements of the tube. This tube is an inertialess distributor with applications to time-division multiplex, telemetering, remote control, and other high-speed switching functions.

## INTRODUCTION

AN EARLIER PAPER<sup>1</sup> described the magnetically focused radial-beam tube in which a radial beam of electrons is focused and deflected (usually rotated) by means of a magnetic field. This tube requires an external magnetic structure, and is practically limited in rotational speed to about 10,000 cps by the losses in this structure. The electrostatically focused radial-beam tube is similar in general structure and principle, but since the focus and rotation are obtained with an internal electrostatic field the external structure is not required, and there is no practical limit to the speed of rotation other than that set by the capacities of the tube elements themselves. It has one disadvantage in comparison with the magnetically focused type; the beam current for the same applied voltages is less.

## THE ELECTROSTATIC FIELD

The field within the tube consists of a uniform electrostatic field (positive on one side of a diameter and negative on the other) that has been distorted by the presence of a cylindrical cathode at its center on which a positive potential has been applied. Stated in another way, it is the combination of a uniform field like that between two parallel planes, and a cylindrical field like that between two coaxial cylinders. Since the structure is a cylindrical one, it is necessary to apply a number of potentials to the outer boundary in order to obtain the uniform field. Ideally, the potential varies around the

periphery according to the cosine  $\theta$  (see Fig. 1). This potential distribution alone would produce a uniform field with the center a point of zero potential.

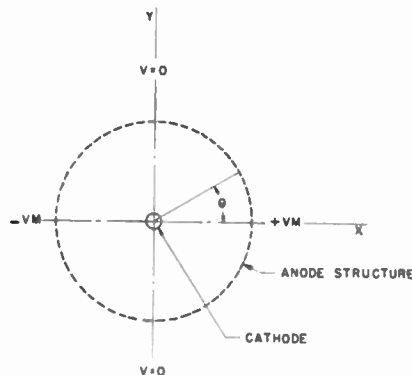

Fig. 1—Ideal cosine distribution of potentials around the anode structure of the tube.

Let the direction of the field  $E$  be parallel to the  $X$  axis, and the  $Z$  axis chosen as parallel to the axis of the cylinder. It can be shown that the anode cylinder may be replaced by two line images within the space occupied by the cathode cylinder, for these would give a circular equipotential line at the position of the cathode. If the potential of the cathode cylinder is zero, this analysis gives for the potential  $V_F$  of any point in the field outside the cathode cylinder

$$V_F = \left( Er - \frac{ER_1^2}{r} \right) \cos \theta$$

where  $r$  and  $\theta$  are polar co-ordinates and  $R_1$  is the radius of the cathode cylinder.

For a potential on the cathode other than zero the field is altered, and to get an expression for this new configuration consider first the field due only to the potential on the cylinder. This gives

$$E' = \frac{V_c}{r} \frac{1}{\log \frac{R_2}{R_1}}$$

where  $R_2$  is the radius of the anode structure and  $V_c$  is the potential difference between anode and cathode cylinders. The potential  $V_{F'}$  at any point  $r$  is

$$V_{F'} = \int_r^{R_2} \frac{V_c dr}{r \log \frac{R_2}{R_1}}$$

or

$$V_{F'} = \frac{V_c \log \frac{R_2}{r}}{\log \frac{R_2}{R_1}}$$

\* Decimal classification: R339. Original manuscript received by the Institute, May 24, 1948. Presented, 1948 IRE National Convention, March 25, 1948, New York, N. Y.

† National Union Radio Corporation, Orange, N. J.

<sup>1</sup> A. M. Skellett, "The magnetically focussed radial beam vacuum tube," *Bell Sys. Tech. Jour.*, vol. 23, pp. 190-202; April, 1944.



since the anode is assumed to be at zero potential.

Superposing this field on the previous one gives

$$V_F = \left( Er - \frac{ER_1^2}{r} \right) \cos \theta + V_c \frac{\log \frac{R_2}{r}}{\log \frac{R_2}{R_1}}$$

where logarithms are to the base  $e$ .

For the case under consideration,  $V_c$  will be the potential of the cathode with respect to the average potential of the anode structure. Varying this potential changes the width of the beam, and it is, therefore, the focusing voltage. By means of this voltage the beam can be reduced to zero width, or it can be opened up so wide that it covers most of the tube and there is effectively a negative beam in the opposite direction.

This field is plotted on Fig. 2 for the following values of the variables taken from the twelve-anode tube described below under focusing conditions:  $R_2 = 0.828$  cm and  $R_1 = 0.203$  cm,  $V_c = 94$  volts, and  $V_{max} = 250$  volts. It

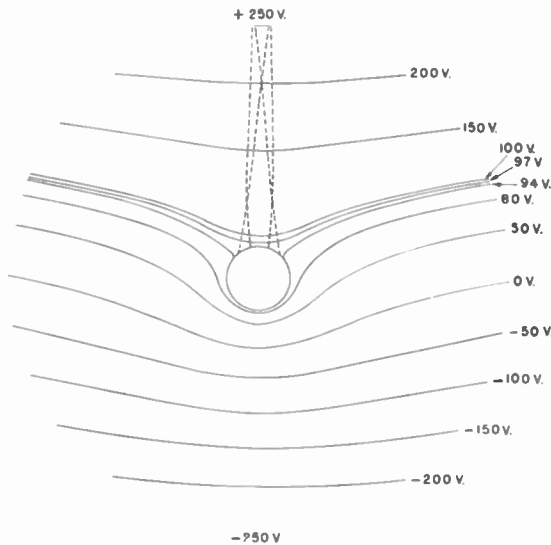

Fig. 2—Electrostatic field within the tube with the ideal cosine distribution. Electron trajectories are shown as dotted lines.

may be seen that the curvature of the equipotential lines is such as to give concentration to the electrons about the radius where  $\theta = 0$ . The electron trajectories shown by dashed lines were obtained by setting up the mechanical analogue of this field with a rubber membrane in the usual way,<sup>2</sup> and following the trajectories by means of steel balls released from the position of the cathode.

The potential gradient around the cathode is important in determining the angular spread of the electrons that leave the cathode. It may be shown that the gradient is zero at the angles for which

$$\cos \theta = \frac{V_c R_2}{2V_m R_1} - \frac{1}{\log \frac{R_2}{R_1}}$$

<sup>2</sup> P. H. J. A. Kleyven, "The motion of an electron in a two dimensional electrostatic field," *Philips. Tech. Rev.*, vol. 2, pp. 321-352; November, 1937.

where  $V_m$  is the maximum of the voltages applied to the anode cylinder.

For the focal conditions mentioned above and shown on Fig. 2, this gives

$$\theta = \pm 54^\circ 32' 30''.$$

This is the angle at which the gradient changes sign, and thus the emergent angle for this set of voltages is  $109^\circ 5'$ .

Similar focusing conditions apply if the cathode cylinder is replaced by a grid with a cathode located within it. The potential of the grid cylinder becomes the focusing voltage, and the cathode may be operated several volts positive with respect to the grid in the usual manner.

In actual tubes the cosine distribution of potential is approximated by separating the anode structure into a small number of elements and applying polyphase potentials to them. At any instant in the cycle these potentials approximate the cosine potential distribution. The circuit for the power supply to the tube is shown on Fig. 3. The position of the beam is shown for the instant when phase 1 is passing through its maximum value.  $V_c$  is the focusing voltage.

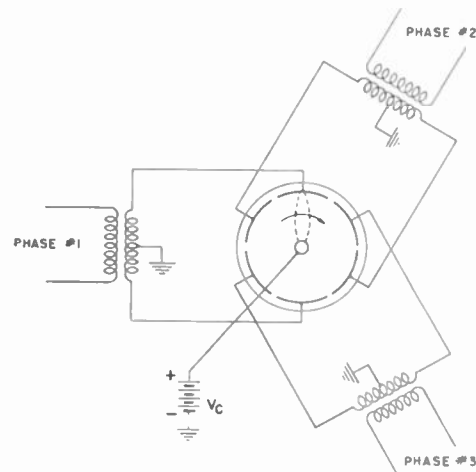

Fig. 3—Circuit of the polyphase supply and focusing voltage.

Tubes have been made using only two-phase supply (four screen elements), but the deviation from the ideal cosine distribution in this case is so great that focus conditions vary markedly between the center and edge of a screen element.

#### THE TWELVE-ANODE TUBE

Fig. 4 shows the internal structure of the twelve-anode tube. Here the anode cylinder referred to above has been replaced by the screen elements, and the beam is focused in the space between the cathode and these elements. The polyphase potentials are applied to the six screen elements in the circuit shown in Fig. 3.

A window in each of these elements lets the beam through to a control grid and to an anode. Other windows are provided between adjacent screen elements to

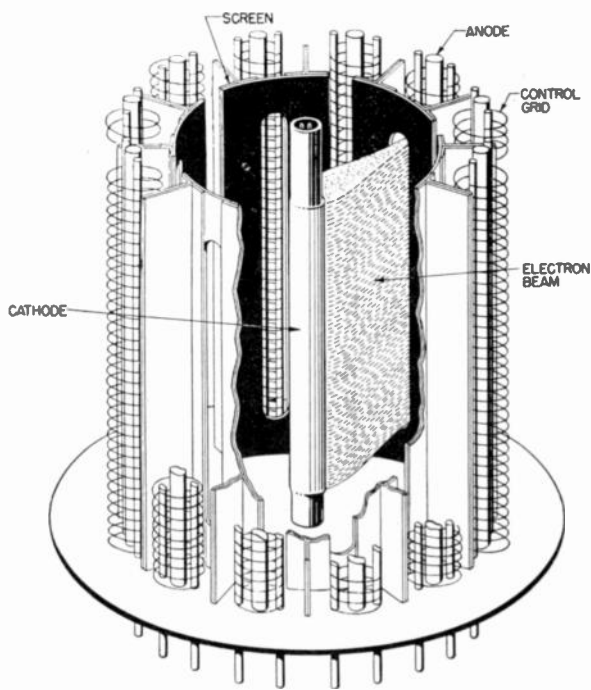

Fig. 4—Internal structure of the twelve-anode tube.

provide twelve windows in all. There are thus twelve control grids and twelve anodes. Fins on the outer side of the screen elements prevent electrons that are directed toward one anode from reaching an adjacent one.

The anodes in this particular tube are in the form of rods centrally located within their control grids. This design is effective in assuring that all electrons must pass through the grid in order to reach the anode. It gives a good control-grid characteristic.

Fig. 5 is the anode-current versus grid-voltage characteristic for one of the twelve sections of the tube taken with the beam directed toward that section. For an applied three-phase voltage of 285 rms (400 volts peak), the beam current varies linearly with grid voltage up to approximately 1 ma.

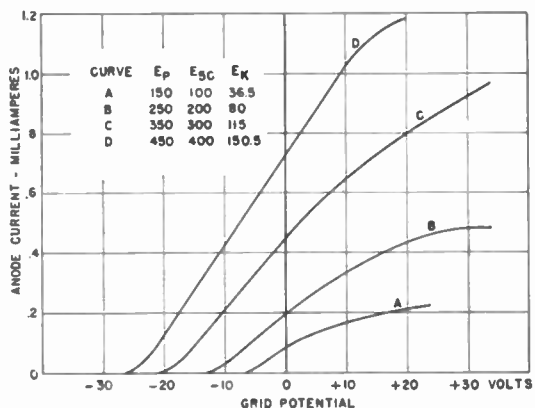

Fig. 5—Grid-anode characteristics of one section of the twelve-anode tube.

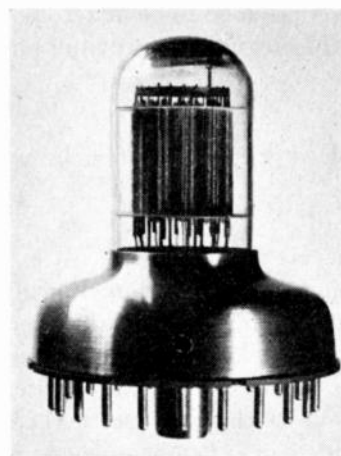

Fig. 6—Photograph of the twelve-anode tube.

POWER-SUPPLY CONSIDERATIONS

For applications where three-phase power at the desired frequency is not available, the circuit shown in Fig. 7 is useful. Here a single-phase supply is split into six phases by means of three series capacitors in connection with the inductances of the transformers. Since the power required is less than 1 watt, these transformers may be very small.

A cathode series resistance is used to provide the focusing voltage. It may be varied to focus the beam. The density of the current is very nearly constant for all focus conditions; e.g., if the beam cross section is increased by a factor of two, the beam current is increased in proportion.

The grid-bias voltage may be derived from the cathode resistor by tapping down from the cathode, and if the anode supply voltages are obtained from extra windings on the three transformers, it is possible to operate the tube satisfactorily without any dc supply.

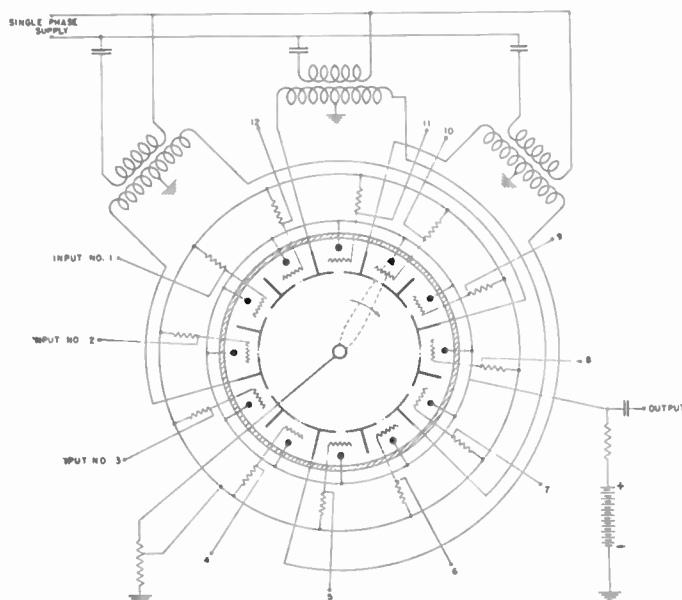

Fig. 7—Complete circuit for operation of the twelve-anode tube from single-phase supply.

Fig. 6 is a photograph of the twelve-anode tube with a special large base to keep the leads widely separated.

## OTHER TUBE DESIGNS

Two types of the twelve-anode tube are available. In one, the grid leads are all brought out individually with a common lead for the anodes. In the other there is a common grid lead and the anode leads are brought out separately. The first type may be used at the input of a multiplex communication or telemetering system where twelve channels feed into the tube, and the second may be used as a distributor at the output end of such a system.

Tubes have been made with as many as forty-eight anodes or sections, but as the number of anodes is increased the beam current decreases. If the diameter of the screen structure is held constant, the beam must be narrower and hence the beam current is reduced. If the screen diameter is increased without increasing the axial length of the tube, it becomes difficult to maintain the electrostatic field configuration near the ends of the cathode because of mica charging, and special electrodes must be added to cover the micas in order to maintain focus.

A thirty-element tube is in the final stages of development. It also uses six-phase voltages and is similar in most respects to the twelve-anode tube just described. It will be described in a later paper.

## APPLICATIONS

These tubes are ideally suited to multiplex telegraphy and telephony, and to telemetering. Their usefulness is not limited, however, to these fields. For example, they provide an excellent means of scanning a number of circuits or points at high speed; they are useful as frequency multipliers, harmonic, and tone generators; and, by varying the shape of the windows, predetermined wave forms may be generated. Advantages of these tubes over other electron-beam commutators such as the cyclophon<sup>3</sup> are their small size and low voltage requirements.

## ACKNOWLEDGMENTS

Some preliminary development work on this type of tube was carried on at the Bell Telephone Laboratories prior to the war. This work is described in Patent No. 2,433,403, issued on December 30, 1947. The work described herein was done at the National Union Research Division with the able assistance of H. J. Koch, P. W. Charton, W. L. Hyde, and Miss Catherine Stephens.

<sup>3</sup> D. D. Grieg, J. J. Glauber, and S. Moskowitz, "Cyclophon: a multipurpose electronic computer tube," *Proc. I.R.E.*, vol. 35, pp. 1251-1258; November, 1947.

## High-Power Interdigital Magnetrons\*

JOSEPH F. HULL† AND ARTHUR W. RANDALS†

**Summary**—This paper deals with the pill-box-cavity interdigital magnetrons operating in the cavity mode. An analysis of the cathode coupling problem indicates the desirability of cathode decoupling chokes presenting a capacitive impedance to the cathode-anode space. Cold tests and operating tests have confirmed this analysis. The high efficiency to be expected from operation in this mode has been realized, measured efficiencies being comparable to the best obtained in conventional magnetrons. Peak power outputs up to 1.4 kw and continuous outputs up to 500 watts have been obtained in the vicinity of 10 cm wavelength, with efficiencies of about 70 per cent. Tubes built without cathode decoupling chokes operated unstably, gave little power in the cavity mode, and had a strong tendency to operate in the first-order mode.

## INTRODUCTION

BECAUSE OF wide-tuning possibilities and simplicity of mechanical structure, it has been considered desirable to investigate the potentialities of the pill-box-cavity interdigital magnetron as a generator of high-power centimeter waves. Most of the

work on this type of magnetron to date has been done in the first-order mode. (A complete description of the modes follows shortly.) Benedict and others have developed a glass-enclosed, external-cavity, interdigital magnetron<sup>1</sup> which gives a peak pulse power output of 80 watts at 40 per cent efficiency. The first-order-mode resonant wavelength was approximately 6 cm. Crawford and Hare have developed an all-metal interdigital magnetron<sup>2</sup> which gives a continuous-wave power output of 50 watts at about the same frequency and efficiency. Attempts to operate these interdigital magnetrons in the cavity mode have met with little success because of the very strong tendency of the tubes to oscillate in the first-order mode.

If the cause of moding trouble is eliminated, the cavity mode offers the greater possibilities for both high-power output and high efficiency, because in this mode the tooth structure presents an uncontaminated

\* Decimal classification: R339.2×R355.912.1. Original manuscript received by the Institute, April 12, 1948; revised manuscript received, June 8, 1948. Presented, IRE Electron Tube Conference, Syracuse, N. Y., June, 1947.

† Evans Signal Corps Engineering Laboratory, Belmar, N. J.

<sup>1</sup> G. D. O'Neill, "Separate cavity tunable magnetrons," *Electronic Ind.*, vol. 5, pp. 48-50, 23; June, 1946.

<sup>2</sup> F. H. Crawford and Milton D. Hare, "Tunable squirrel cage magnetron—the Donutron," *Proc. I.R.E.*, vol. 35, pp. 361-369; April, 1947.

$\pi$ -mode field configuration to the interaction space. The greater portion of the effort of this project was directed toward obtaining good operation in the cavity mode. Fig. 1, shows a pill-box interdigital magnetron cavity.

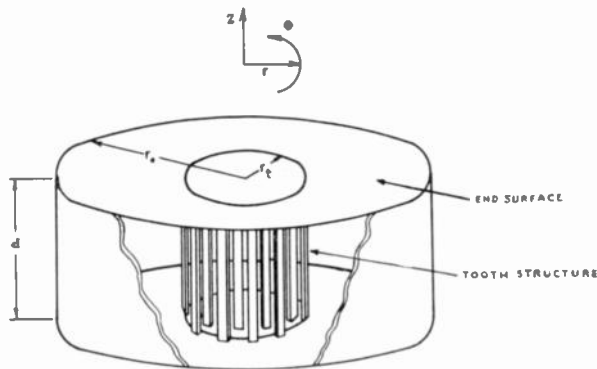

Fig. 1—Interdigital magnetron cavity.

It consists of a toroidal shell with its inner surface replaced by interleaving teeth extending from the end surfaces.

#### DESCRIPTION OF MODES IN INTERDIGITAL MAGNETRONS

In order to better describe the operational and cold-test results of these tubes, a brief description of the modes will be given. The field configurations, as well as current and voltage distributions in the *cavity mode*, will first be described. The local fields at the tooth structure are neglected.

Fig. 2(a) shows the currents on one of the end surfaces of the cavity in a view parallel to the axis. The currents in the opposite end are in the opposite direc-

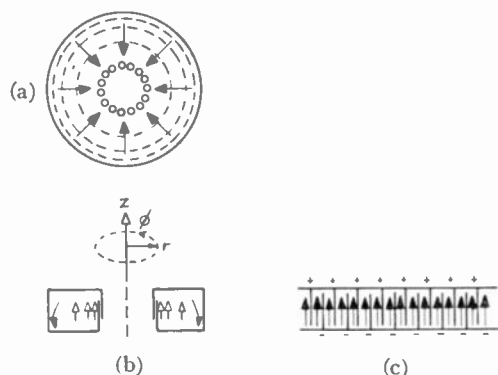

Fig. 2—Field and current configurations in an interdigital magnetron cavity resonating in the cavity mode.

tion. Fig. 2(b) shows the currents and electric fields in a cross-sectional view. The arrows with solid barbs indicate the current flow, and the arrows with the open barbs indicate electric fields. All the magnetic field lines are concentric with the axis, and are shown by dotted lines. The magnetic field intensity is independent of

$Z$  and  $\phi$ , but varies with  $r$  as the sum of Bessel functions of the first and second kinds. The electric field is in the  $Z$  direction and is independent of  $Z$  and  $\phi$ , but also varies with  $r$  as the sum of Bessel functions of the first and second kinds.

Fig. 2(c) shows a rolled-out view of the anode as seen from the axis. The important feature of the cavity mode is that the current and potential distributions do not vary with angular displacement, and lines of magnetic flux within the cavity do not thread through the tooth structure.

The field and current configurations in the *first-order mode* will now be described. Again the local fields at the teeth are neglected and the cathode is assumed to be absent. Fig. 3(a) shows the current flow in one end surface of the cavity. The current flow in the opposite end surface is in the opposite direction, at all corresponding points. The magnetic field is independent

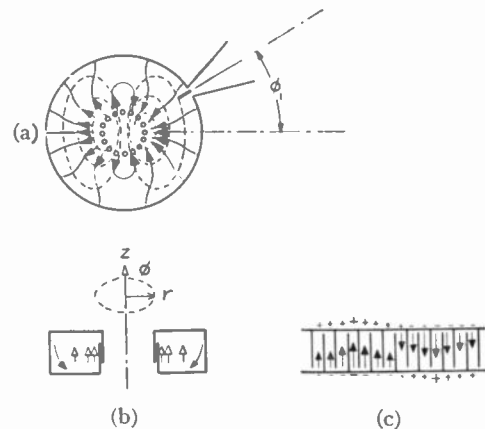

Fig. 3—Field and current configurations in an interdigital magnetron cavity resonating in the first-order mode.

of  $Z$ . Both radial and tangential components of the magnetic field vary sinusoidally with  $\phi$  and are in space quadrature; they also vary with  $r$  as the sum of Bessel functions of the first and second kinds. The electric field is in the  $Z$  direction only, is independent of  $Z$ , varies sinusoidally with  $\phi$ , and varies with  $r$  as the sum of Bessel functions of the first and second kinds. The dotted lines indicate magnetic flux lines, which are orthogonal to the lines of current flow. It is to be noted that there are both radial and tangential components of magnetic field at the tooth structure, and that therefore a threading of the magnetic flux through the teeth and interaction space occurs. Fig. 3(c) shows the current and potential distributions on the anode faces as seen looking outward from the axis. It may be seen that they vary sinusoidally through one cycle around the anode circumference.

The field and current distributions in the  $n$ th-order mode are analogous to those of the first-order mode, but have  $n$  sinusoidal variations around the circumference of the anode.

ANALYSIS OF POWER-OUTPUT COUPLING BY THE CATHODE IN THE CAVITY MODE

Fig. 4(a) shows an interdigital magnetron cavity and cathode, and Fig. 4(b) is the equivalent circuit for the cathode structure.  $C_1$  is essentially the capacitance between the top end hat and the surface  $A$ , and  $C_2$  is the capacitance between the bottom end hat and the surface  $B$ .  $R + jX$  is the impedance between the cathode support and the outside of the cavity looking outward from the cathode. From Fig. 4(b) one may obtain:

power dissipated in  $R$

$$= \frac{E^2 R}{R^2 \left(1 + \frac{C_2}{C_1}\right)^2 + \left(X \left[1 + \frac{C_2}{C_1}\right] - \frac{1}{\omega C_1}\right)^2} \quad (1)$$

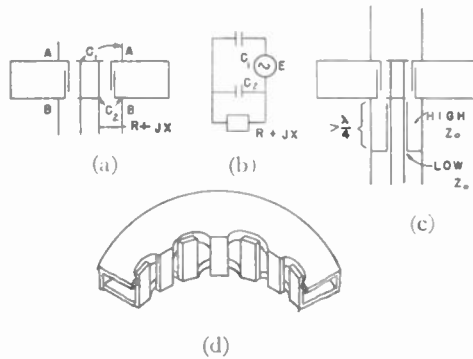

Fig. 4—These drawings illustrate the problem of power-output coupling by the cathode, and how this problem may be resolved.

A brief analysis of (1) shows that, if  $X$  is a large capacitive reactance and if  $R$  is small, the power coupled out by the cathode is small. The power coupled out may be further reduced by decreasing  $C_1$ .  $C_2$  must also be made small in order to isolate the bottom end hat from surface  $B$  so that the cathode does not assume the potential of  $B$ .  $C_1$  and  $C_2$  may be decreased by cutting recesses in the end surfaces  $A$  and  $B$  between the teeth and allowing the teeth to extend through to the outer side of the opposite end surface as shown in Fig. 4(d). This tends to neutralize the capacitance between the surfaces  $A$  and  $B$  and the end hats of the cathode. This construction will hereinafter be referred to as *overlapped tooth structure*.

$X$  may be made to be a large capacitive reactance by inserting a choke which is longer than a quarter wavelength into the coaxial line consisting of the cathode support and the outer tubular housing as shown in Fig. 4(c). The capacitive reactance of the choke adds to the reactive component of this coaxial-line impedance to give a total reactive component which has a high capacitive value. The low-impedance section of line between the cathode support and the inner

diameter of the choke transforms the external cathode-lead impedance to a low value at the open end of the choke. Thus the resistive component of the cathode-lead impedance presented to the magnetron is low.

If the power coupled out by the cathode support is minimized, the rf potential between the cathode support and the inner surface of the choke, or tubular housing below the choke, is small. Therefore the cathode assumes ground potential. This is an important desideratum for obtaining high electronic efficiency, because an electrically unbalanced cathode greatly distorts the rf fields in the interaction space.

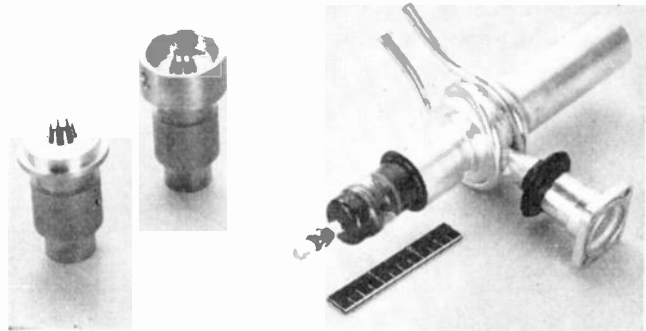

Fig. 5—Interdigital magnetron, ESM-15.

It may be shown in contrast that, for higher-order modes, the transverse electromagnetic mode is not excited in the cathode circuit, because currents contributed by different portions of the circuit cancel. Even an off-center cathode is not serious, provided

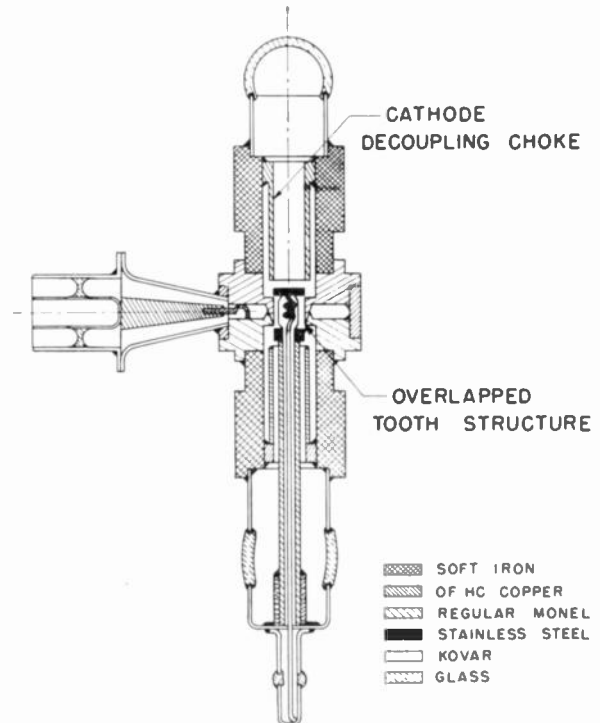

Fig. 6—Cross-sectional view of interdigital magnetron ESM-15.

the axis of the cathode is parallel to the tube axis; but if the cathode is tilted, a large amount of coupling can result.

OPERATIONAL RESULTS

Tubes which were built according to Fig. 6 oscillated only in the cavity mode and gave power outputs of the order of 1500 watts (peak) at efficiencies between 60 and 80 per cent with 5 per cent duty-cycle pulse operation. Five hundred watts of continuous-wave power output was easily obtained from these tubes at efficiencies between 65 and 75 per cent. The 500-watt cw output level did not represent the upper limit, but it was thought inadvisable to subject the output seal to more rf power loss. Operational curves for these tubes are found in Figs. 7, 8, and 9. Another observation was that at 500 watts cw output the back-bombardment

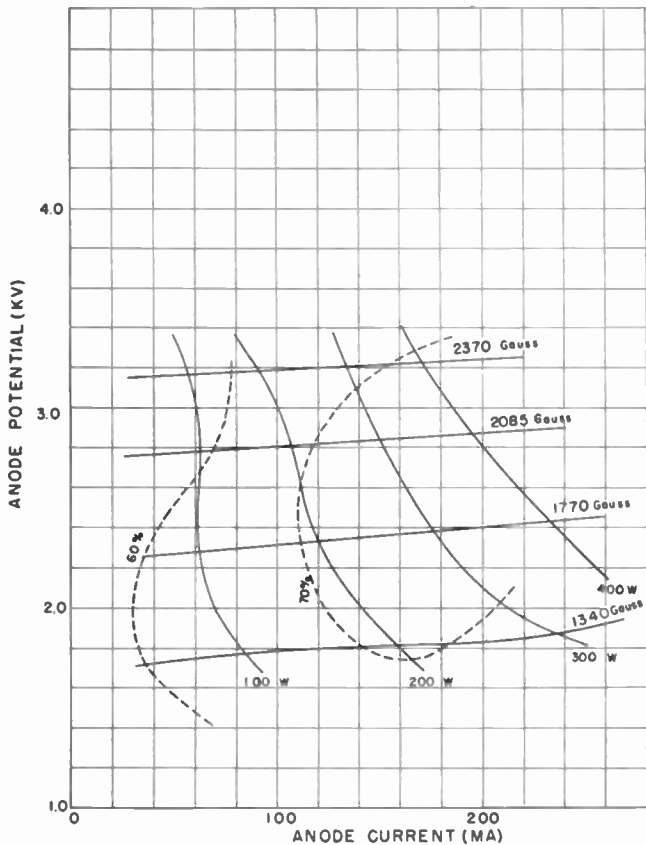

Fig. 7—Continuous-wave performance plot of interdigital magnetron ESM-15-3, operating into a reflectionless line. This tube has an oxide-coated cathode and cathode decoupling chokes, and operates only in the cavity mode with a mean resonant wavelength of 11.5 cm.

power was less than 18 watts. The tubes were operated with a barium-oxide-coated cathode which required 6 volts at 3 amperes for primary heating power, and at 500 watts output the cathodes were subjected to no disastrous punishment.

One tube, ESM-15-2, was built without the cathode decoupling chokes. It oscillated in either the cavity mode or first-order mode, depending on the anode voltage and output impedance. The stability of operation

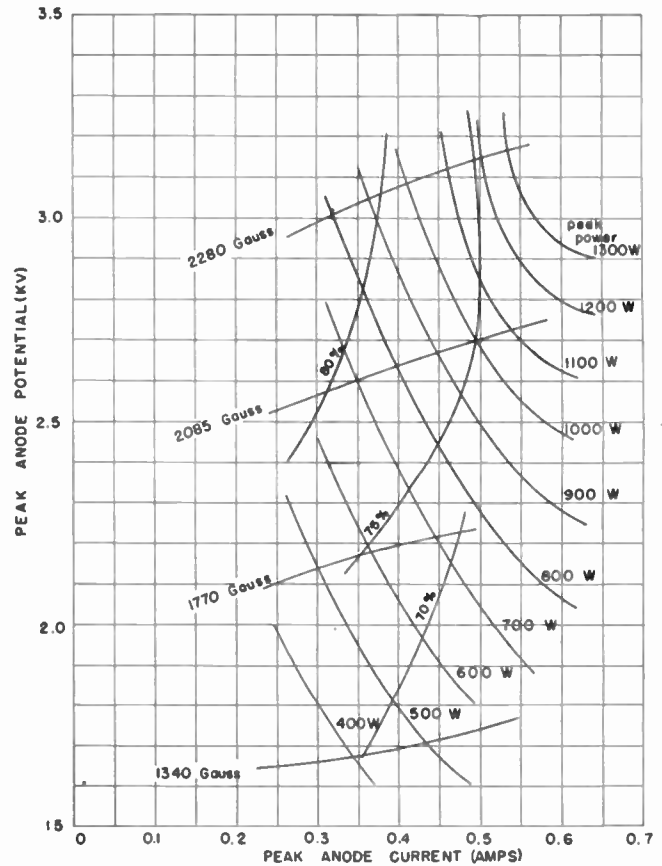

Fig. 8—Performance plot of interdigital magnetron ESM-15-3 (see Fig. 7). Pulse operation, 5 per cent duty cycle, 5  $\mu$ s pulse length. Operation is only in the cavity mode, 11.5 cm mean resonant wavelength.

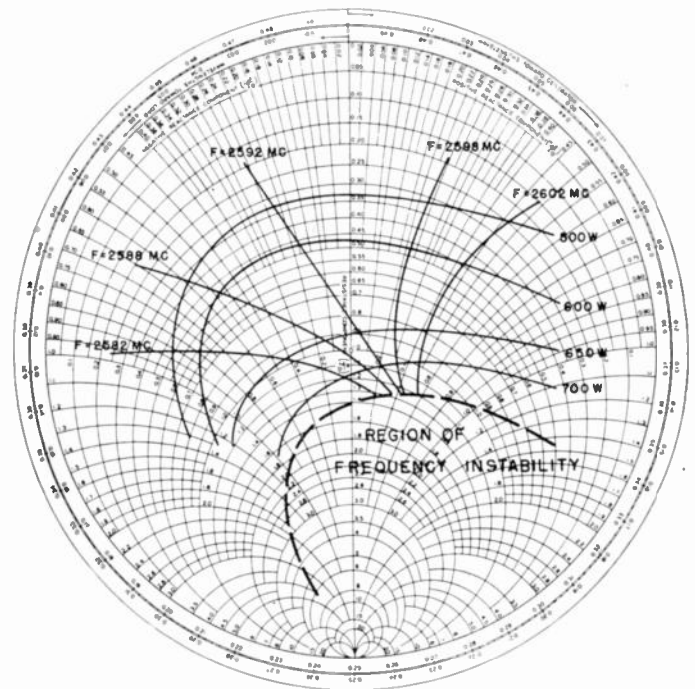

Fig. 9—Rieke Diagram, interdigital magnetron ESM-15-3 (see Fig. 7). Pulse operation, 5 per cent duty cycle, 5  $\mu$ s pulse length, 0.380 amperes peak anode current, 2.76 kw peak anode voltage, 2260 gauss magnetic field, 11.58 cm mean resonant wavelength.

of this tube was very poor. The maximum power obtainable in the cavity mode before moding occurred was about 250 watts, and when the current was increased in an attempt to obtain more power, the tube oscillated in the first-order mode. Although this tube did not operate satisfactorily in the cavity mode, the operational results for the first-order mode may be of interest. In the first-order mode of oscillation, when looking into a reasonably reflectionless line, peak power outputs of 1600 watts at 50 per cent efficiency were obtained with 5 per cent duty-cycle pulse operation. However, the power decreased rather rapidly as the standing-wave ratio was increased. Operational curves for this tube are shown in Figs. 10 and 11. Relatively good over-all efficiency was obtained in this tube without the use of cavity-mode suppressors such as "phase-reversal teeth,"<sup>2</sup> vanes in the cavity, or radial slots at the high-voltage points in the end surfaces of the cavity. With any or all three of these features, however, the magnetron would probably oscillate only in the first-order mode, and operation would be much more stable, since the moding tendency would be diminished.

COLD-TEST RESULTS AND COMPARISONS OF MEASURED RESULTS WITH THEORETICAL CALCULATIONS

Expressions for resonant wavelength and external Q of interdigital magnetron cavities were derived by applying Maxwell's equations (subject to appropriate boundary conditions) to the region inside the cavity. The resonant wavelength equation in the *n*th-order mode is:

$$\lambda = -\frac{\alpha cd}{\epsilon_1 r_t} \left[ \frac{J_n\left(\frac{2\pi r_t}{\lambda}\right) - \frac{J_n\left(\frac{2\pi r_0}{\lambda}\right)}{N_n\left(\frac{2\pi r_0}{\lambda}\right)} N_n\left(\frac{2\pi r_t}{\lambda}\right)}{J_{n-1}\left(\frac{2\pi r_t}{\lambda}\right) - \left(\frac{n\lambda}{2\pi r_t} + \frac{n^2 M \lambda \Delta r}{2\pi r_t^2}\right) J_n\left(\frac{2\pi r_t}{\lambda}\right) - \frac{J_n\left(\frac{2\pi r_0}{\lambda}\right)}{N_n\left(\frac{2\pi r_0}{\lambda}\right)} \left[ N_{n-1}\left(\frac{2\pi r_t}{\lambda}\right) - \left(\frac{n\lambda}{2\pi r_t} + \frac{n^2 M \lambda \Delta r}{2\pi r_t^2}\right) N_n\left(\frac{2\pi r_t}{\lambda}\right) \right]} \right] \quad (2)$$

where

- $r_t$  = mean radius of tooth structure
- $\epsilon_1$  = permittivity of free space
- $\alpha$  = number of teeth
- $d$  = cavity height
- $c$  = capacitance between teeth per tooth
- $\Delta r$  = radial tooth thickness
- $r_0$  = radius of cavity

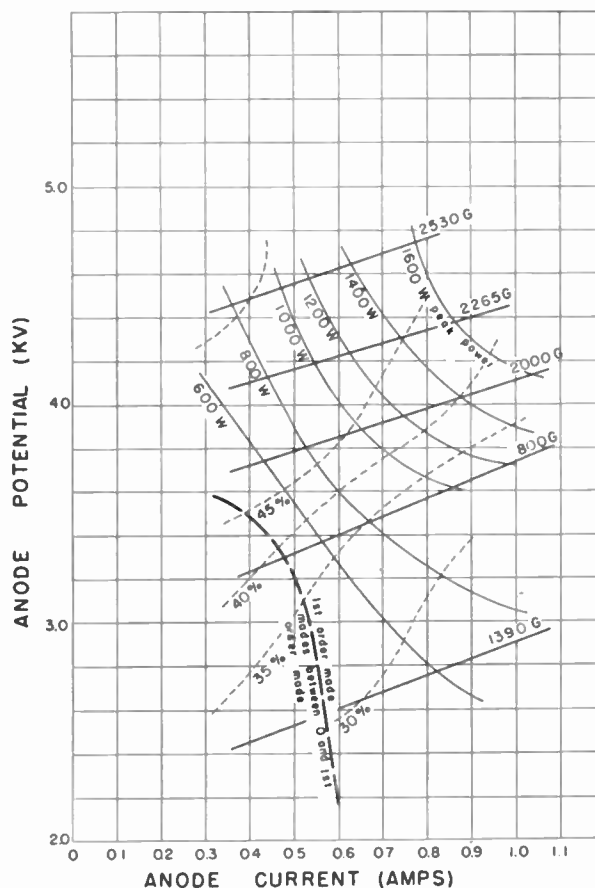

Fig. 10—Performance plot of interdigital magnetron, ESM-15-2, operating into reflectionless line. Pulse operation, 5 per cent duty cycle, 5  $\mu$ s pulse length. This tube is identical to ESM-15-3, except that it has no cathode decoupling chokes. The dark line represents the boundary of moding between cavity and first-order modes. Below this line the tube operates unstably between the cavity and first-order modes. Operation above the line is in the first-order mode only.

- $\lambda$  = wavelength at resonance
  - $J_n( )$  = Bessel function of 1st kind and *n*th order
  - $N_n( )$  = Bessel function of 2nd kind and *n*th order
  - $M$  = factor of concentration of magnetic flux which threads through the tooth structure. Approximately equal to the ratio of the distance between tooth centers to gap between teeth.
- (All quantities in mks units.)

For the cavity mode, these constants were:

- $c = 0.164 \mu\text{f}$
- $\alpha = 16$
- $r_i = 0.00595 \text{ meter}$
- $r_o = 0.0175 \text{ meter}$
- $\Delta r = 0.00127 \text{ meter}$
- $d = 0.00477 \text{ meter}$
- $n = 0.$

(The tooth capacitance  $C$  was both calculated and measured by cold test means.) From (2) the resonant wavelengths for the cavity mode ( $n=0$ ) and first-order mode were calculated to be 10.4 and 7.8 cm, respectively. The resonant wavelengths of these modes were measured both with and without the cathode. These values are shown in Table I.

TABLE I

Mode Order	Cathode Out		Cathode In
	$\lambda$ Calculated	$\lambda$ Measured	$\lambda$ Measured
Cavity Mode	10.4 cm	10.87 cm	11.27 cm
First-Order Mode	7.8 cm	7.5 cm	7.23 cm

The formula for external  $Q_x(Q_z)$  in the  $n$ th-order mode is:

$$Q_z = \frac{adW_n \left( Z_0 + \frac{\omega^2 L_i^2}{Z_0} \right)}{S^2 \omega \mu_1 \epsilon_1 \cos^2(n\phi_1) \left[ J_{n-1} \left( \frac{2\pi r_0}{\lambda} \right) - \frac{J_n \left( \frac{2\pi r_0}{\lambda} \right)}{N_n \left( \frac{2\pi r_0}{\lambda} \right)} N_{n-1} \left( \frac{2\pi r_0}{\lambda} \right) \right]^2} \tag{3}$$

where

$$W_n = \pi \epsilon_1 \int_{r_i}^{r_o} r \left[ J_n \left( \frac{2\pi r}{\lambda} \right) - \frac{J_n \left( \frac{2\pi r_0}{\lambda} \right)}{N_n \left( \frac{2\pi r_0}{\lambda} \right)} N_n \left( \frac{2\pi r}{\lambda} \right) \right]^2 dr + \frac{d\alpha c}{2} \left[ J_n \left( \frac{2\pi r_t}{\lambda} \right) - \frac{J_n \left( \frac{2\pi r_0}{\lambda} \right)}{N_n \left( \frac{2\pi r_0}{\lambda} \right)} N_n \left( \frac{2\pi r_t}{\lambda} \right) \right]^2$$

- $L_i$  = loop inductance
- $S$  = loop area
- $Z_0$  = characteristic impedance of output line (assumed to be reflectionless)
- $\phi_1$  = angle between position of the loop and current maximum (see Fig. 3(a))

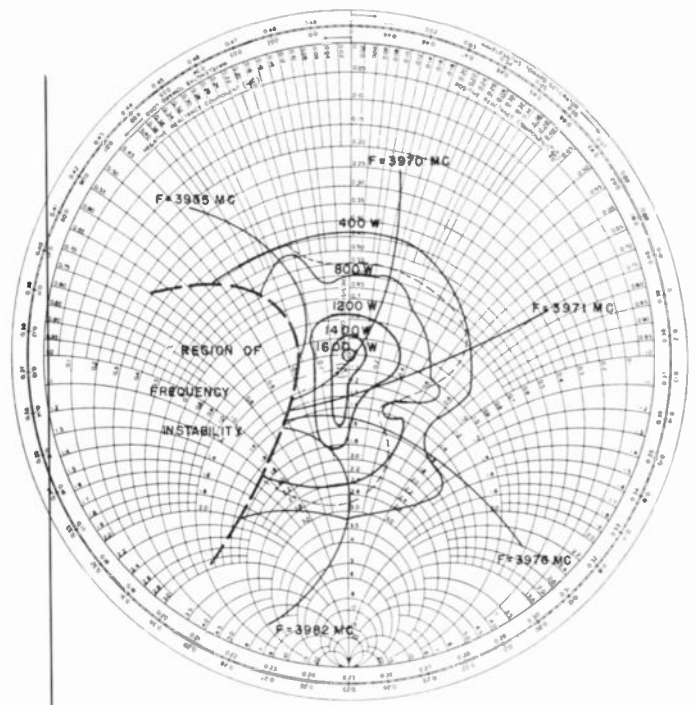

Fig. 11—Rieke diagram, interdigital magnetron ESM-15-2 (see Fig. 10). Pulse operation, 5 per cent duty cycle, 5  $\mu\text{s}$  pulse length, 0.712 amperes peak anode current, 4.3 kv peak anode voltage, 2260 gauss magnetic field, 7.551 cm mean resonant wavelength. The dotted line represents boundary of moding between cavity and first-order modes. In the region outside of the boundary the tube operates unstably between the cavity and first-order modes. Operation inside the boundary is in the first-order mode only.

- $\mu_1$  = permeability of free space
  - $\epsilon_1$  = permittivity of free space
  - $a = 2$  when  $n = 0$
  - $a = 1$  when  $n > 0.$
- The quantity  $S^2 Q_z$  for the cavity mode was calculated to be:
- $$S^2 Q_z = 1.86 \text{ cm}^4.$$



TABLE II

Tube No.	$S$ (loop area)	$Q_x$ (calc.)	$Q_x$ (meas.)
ESM-15-1	0.136 cm <sup>2</sup>	100	100
ESM-15-2	0.160	73	87
ESM-15-3	0.178	58.6	57.5
ESM-15-4	0.158	75	70.1

TABLE III

Tube No.	$Q_x$	$Q_w$	$Q_1$	Circ. Eff.
ESM-15-1	100	649	86.5	85.6%
ESM-15-2	87	44	29.3	33.7
ESM-15-3	57.5	575	52.3	90.8
ESM-15-4	70.1	280	56.1	80.0

The external  $Q$  (cavity mode) was calculated and measured for four magnetrons, ESM-15-1, ESM-15-2, ESM-15-3, and ESM-15-4. These values are tabulated in Table II.

The complete  $Q$  measurements for the cavity mode are given in Table III, for four tubes of the ESM-15 series.

All tubes except the ESM-15-2 had cathode decoupling chokes. There is a conspicuous difference between the unloaded  $Q$  of this tube and that of the other tubes, which may be interpreted to mean that the cathode in the cavity mode, unless decoupled, acts as a power-output coupler, and causes the same effect as a very lossy cavity. This explains the tendency of the ESM-15-2 to stop oscillating in the cavity mode at the higher power outputs. The circuit efficiency of the ESM-15-2 is 34 per cent, compared to about 85 per cent for the tubes with the cathode decoupling chokes. The effect of the cathode power-output coupling was also definitely demonstrated, during the taking of the cold-test data, by the fact that touching the cathode leads of the ESM-15-2 radically changed the standing-wave ratio at resonance, while similarly touching the leads of the other tubes did not affect the standing-wave ratio.

## CONCLUSIONS

Substantial evidence has been obtained to show that interdigital magnetrons can be operated satisfactorily in the cavity mode, and will give essentially the same performance as conventional vane-type cavity magnetrons with regard to power output, efficiency, pulling figure, magnetic field, and voltage. Interdigital magnetrons, however, have completely different mode families with inherently wider mode separations than vane-type magnetrons. Interdigital magnetrons operating in the cavity mode have been tuned over wide frequency ranges.<sup>2</sup>

Operation of interdigital magnetrons in the cavity mode, however, requires some kind of cathode decoupling. The analysis of cathode coupling shows that, if a high capacitive impedance is placed in series with the cathode-support impedance, and if the capacitance between the tooth supporting structures and the end hats is reduced to a low value, the power coupling by the cathode is minimized. The requirement of a cathode choke, however, does not seriously restrain the tuning possibilities, because a foreshortened quarter-wave choke essentially fulfills the requirements of a capacitive impedance in series with the cathode-support impedance over a 2 to 1 tuning range.

The cold-test results show that the equations for resonant wavelength and external  $Q$  are sufficiently accurate for the cavity mode ( $n=0$ ). These equations have been widely checked. The resonant wavelength equation (2), when  $n>0$ , has also been shown to be accurate, although this has not been very widely checked. More experimental work is required for evaluating the external- $Q$  equation for the higher-order modes.

## ACKNOWLEDGMENTS

The authors wish to extend their appreciation for contributions by G. R. Kilgore and D. L. Benedict, who gave valuable suggestions regarding theoretical aspects of the problems.



## Correction

The author has called to the attention of the editors an error in the paper, "Antenna Design for Television and FM Reception," by Frederick A. Kolster, which appeared in pages 1242-1248, in the October, 1948, issue of the PROCEEDINGS OF THE I.R.E.

The formula at the top of the left-hand column on page 1243 should read as follows:

$$K = \sqrt{\left[ \frac{R^2 - Z_0^2 + X^2}{(R + Z_0)^2 + X^2} \right]^2 + \left[ \frac{2ZX}{(R + Z_0)^2 + X^2} \right]^2}$$

# Theory of Models of Electromagnetic Systems\*

GEORGE SINCLAIR†, SENIOR MEMBER, IRE

**Summary**—Most model measurements are made on models which simulate only the geometrical configurations of the lines of force in the fields of the full-scale system, and thus yield only relative results for many of the properties of the system. It is possible, however, to devise models in which the measurements are on a quantitative or absolute basis in terms of the full-scale system. The conditions to be satisfied in an absolute model for accurate simulation are derived. The limitations imposed on practical models are discussed.

## INTRODUCTION

MODELS OF electromagnetic systems have been used for a number of years in studying various properties of such systems and have proved to be a useful tool.<sup>1-12</sup> While in the past the principal applications have been in investigations of the patterns of antennas, models of electromagnetic systems are capable of providing information on any property of the system which is of interest. At the present time most model measurements are made on a relative basis only, but the conditions to be satisfied in order to obtain measurements on an absolute basis are known.<sup>9</sup>

The purpose of this paper is to show the relationship between models for relative measurements and models for absolute measurements, and to discuss the limitations imposed on practical models of electromagnetic fields.

\* Decimal classification: 510×537.6. Original manuscript received by the Institute, March 31, 1948. The research described in this paper was conducted in the Antenna Laboratory of the Department of Electrical Engineering, The Ohio State University, Columbus, Ohio, under Contract W-36-039sc33634 with the Signal Corps Engineering Laboratories, Fort Monmouth, N. J.

† Formerly, The Ohio State University Research Foundation, Columbus, Ohio; now, University of Toronto, Toronto, Ont., Canada.

<sup>1</sup> M. Abraham, "Die elektrischen schwingungen um einen stabförmigen Leiter behandelt nach der Maxwellschen Theorie," *Ann. der Phys.*, vol. 66, pp. 435-472; 1898.

<sup>2</sup> M. Abraham, "Ein Satz über Modelle von Antennen," *Mitteil. der Phys. Ges. Zurich.*, vol. 19, p. 17; 1919.

<sup>3</sup> J. Tykocinski-Tykociner, "Investigation of Antennas by Means of Models," *University of Illinois Bulletin* 22, No. 39; May, 1925.

<sup>4</sup> P. A. Petrov, "Investigation of airplane antennas on models," *Westnik Elektrot.*, sec. 1, pp. 131-137; 1931.

<sup>5</sup> A. W. Nagy, "Experimentelle Bestätigung des Ähnlichkeits-theorems Hertzscher Antennen mit Ultrakurzwellen," *Elek. Nach. Tech.*, vol. 11, pp. 305-309; September, 1934.

<sup>6</sup> G. H. Brown and R. King, "High-frequency models in antenna investigations," *Proc. I.R.E.*, vol. 22, pp. 457-480; April, 1934.

<sup>7</sup> E. Harmening and W. Pfister, "Modellmessungen An Flugzeugfestantennen zur Aufnahme von Strahlungskennlinien im Kurzwellenbereich," *Hochfreq. und Elek.*, vol. 53, pp. 41-45; 1939.

<sup>8</sup> G. L. Haller, "Aircraft antennas," *Proc. I.R.E.*, vol. 30, pp. 357-362; August, 1942.

<sup>9</sup> H. König, "Die Ähnlichkeitsgesetze des elektromagnetischen Feldes und ihre Anwendung auf Hohlraumresonatoren," *Hochfreq. und Elek.*, vol. 58, pp. 174-180; December, 1941.

<sup>10</sup> J. A. Stratton, "Electromagnetic Theory," McGraw-Hill Book Company, New York, N. Y., pp. 488-490; 1941.

<sup>11</sup> R. W. P. King, "Electromagnetic Engineering," vol. 1, McGraw-Hill Book Company, New York, N. Y., pp. 316-320; 1946.

<sup>12</sup> G. Sinclair, E. C. Jordan, and E. W. Vaughan, "Measurement of aircraft antenna patterns using models," *Proc. I.R.E.*, vol. 35, pp. 1451-1462; December, 1947.

## TYPES OF MODELS

The usual model-antenna-pattern measurements are made on a type of model which may be called a *qualitative* or *geometrical* model; i.e., a model in which only the geometrical configurations of the lines of force in the field are modeled, no attempt being made to simulate power levels of the full-scale system. A geometrical model directly yields data on those properties of the system which do not depend on power level (such as impedance, polarization, relative antenna patterns, relative patterns of radar echoes, etc.).

If, in addition to simulating the configurations of the lines of force in the field, the power level of the full-scale system is also simulated in the model, the model may be termed a *quantitative* or *absolute* model. This type of model is capable of yielding quantitative data on all electromagnetic properties of the system, so that, for example, measurements could be made of field intensity, radar echo field intensity, absolute radar echoing area, and the like.

Both of the above types of models generally require some sort of *mechanical* model of the material portions of the full-scale system. A mechanical model is thus one in which there is geometrical similarity in the shapes of corresponding material parts.

## REQUIREMENTS FOR ACCURATE SIMULATION OF A SYSTEM<sup>9-11</sup>

The possibility of constructing a model of a given electromagnetic system arises from the linearity of the differential equations (Maxwell's equations) which describe the fields in any electromagnetic system. Therefore, for a model to be possible, it is necessary to exclude from the system nonlinear media (such as ferromagnetic media and ionized media in the presence of magnetic fields as in the ionosphere). It is not necessary to exclude nonhomogeneous media, since Maxwell's equations are valid for nonhomogeneous as well as for homogeneous media. Such media must be linear, however, so that, although the parameters which describe the media may vary from point to point throughout space, they must be independent of time.

Consider a region of space which is occupied by a system of objects (*A*, *B*, and *C* in Fig. 1) fulfilling the requirements of the previous paragraph. Suppose now that a generator is applied to the system and an electromagnetic field is established. It is required to determine the conditions which have to be satisfied in a model of this system to simulate power levels as well as the configurations of the lines of force; i.e., the conditions for an absolute model.

Let any point  $P$  in the full-scale system be located by the rectangular co-ordinates  $x$ ,  $y$ , and  $z$ . (Rectangular co-ordinates are used in the following analysis for sim-

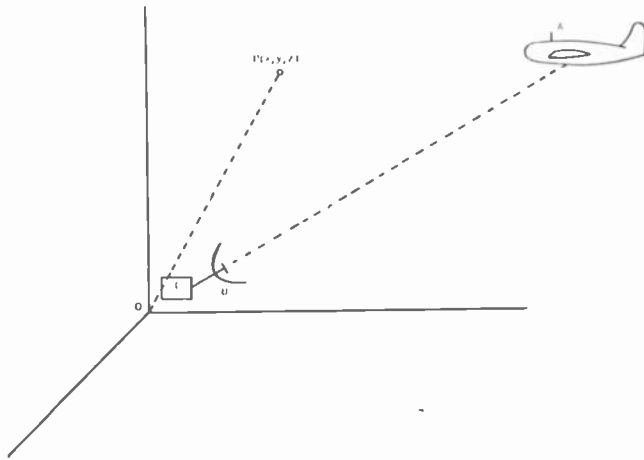

Fig. 1

plicity, but there is no loss in generality since a field is independent of the co-ordinate system used to describe it.) Then any point  $P'$  of the model is located by the co-ordinates  $x'$ ,  $y'$ , and  $z'$  in a corresponding model co-ordinate system. The two co-ordinate systems are related by the transformations:

$$x = p x' \quad (1a)$$

$$y = p y' \quad (1b)$$

$$z = p z' \quad (1c)$$

where  $p$  is the mechanical scale factor. The conditions imposed by (1) represent the principal requirements for a *mechanical* model. The parameter  $p$  is often chosen as an integer, but need not be so restricted. The co-ordinates  $(x, y, z)$  and  $(x', y', z')$  are measured in terms of a unit of length, and the same unit of length (for example, meters) must be used for both systems of co-ordinates.

For an absolute electromagnetic model, the following conditions must be added to those of (1):

$$t = \gamma t' \quad (2)$$

$$E(x, y, z, t) = \alpha E'(x', y', z', t') \quad (3a)$$

$$H(x, y, z, t) = \beta H'(x', y', z', t') \quad (3b)$$

where  $\gamma$  = the scale factor for time

$\alpha$  = the scale factor for electric intensity

$\beta$  = the scale factor for magnetic intensity

$E$  = the vector electric intensity

$H$  = the vector magnetic intensity.

Unprimed quantities always refer to the full-scale system, and primed quantities to the model system. It may be noted that four scale factors ( $\alpha$ ,  $\beta$ ,  $\gamma$ ,  $p$ ) are all that are needed, since there are only four fundamental units (mass, length, time, and charge) required to describe any electromagnetic quantity. While a more funda-

mental method of scaling would be to scale these four fundamental units, the scale factors introduced in (1)–(3) are more suitable for the present application.

When the scale factors  $p$ ,  $\alpha$ ,  $\beta$ , and  $\gamma$  are definitely known quantities, (1), (2), and (3) represent the conditions which have to be satisfied in an “absolute” model. If only the quantities  $p$ ,  $\gamma$ , and the ratio  $\alpha/\beta$  are known, then the model is a “geometrical” model.

When the four scale factors have been chosen, then the relationships between all other electromagnetic quantities of the two systems are fixed. The way various quantities are related may be determined from Maxwell's equations, since the fields in both systems must satisfy them. The conditions for an absolute model will be considered in detail in the following.

The fields in the full-scale systems are described by the following equations (rationalized mks-coulomb units are used throughout):

$$\text{curl } H(x, y, z, t) = \sigma(x, y, z) E(x, y, z, t) + \epsilon(x, y, z) \frac{\partial E(x, y, z, t)}{\partial t} \quad (4)$$

$$\text{curl } E(x, y, z, t) = -\mu(x, y, z) \frac{\partial H(x, y, z, t)}{\partial t} \quad (5)$$

where  $\epsilon$  = the dielectric constant

$\mu$  = the permeability

$\sigma$  = the conductivity.

The variables on which each quantity depends are written explicitly for clarity.

The field in the model may be described by using either the full-scale co-ordinate system or the model co-ordinate system. Using the model co-ordinate system, Maxwell's equations take the following form:

$$\text{curl}' H'(x', y', z', t') = \sigma'(x', y', z') E'(x', y', z', t') + \epsilon'(x', y', z') \frac{\partial E'(x', y', z', t')}{\partial t'} \quad (6)$$

$$\text{curl}' E'(x', y', z', t') = -\mu'(x', y', z') \frac{\partial H'(x', y', z', t')}{\partial t'} \quad (7)$$

where the symbol  $\text{curl}'$  means that the differentiations are to be performed in the primed co-ordinate system; so that, for example, the component of  $\text{curl}' H'$  directed parallel to the  $x'$  axis is

$$\text{curl}'_{x'} H' = \frac{\partial H'_{z'}}{\partial y'} - \frac{\partial H'_{y'}}{\partial z'} \quad (8)$$

where  $H'_{z'}$  is the component of the vector  $H'$  which is directed parallel to the  $z'$  axis, etc.

If the model system is an accurate simulation of the full-scale system, then inserting the transformations relating model quantities to full-scale quantities should transform (6) and (7) into (4) and (5). Hence, by inserting the transformations of (1), (2), and (3) into (6) and (7) and comparing the result with (4) and (5), it is pos-

sible to determine the transformations which relate the parameters  $\epsilon$ ,  $\sigma$ , and  $\mu$  of the two systems.

The vector operator  $\text{curl}'$  transforms according to (1). Hence, using the usual rules for the transformation of variables in a derivative,

$$\frac{\partial H'_{z'}}{\partial y'} = \frac{\partial H'_{z'}}{\partial y} \frac{dy}{dy'} = p \frac{\partial H'_{z'}}{\partial y}, \quad (9)$$

and similarly for the other components, it is evident that

$$\text{curl}' H' = p \text{curl} H = \frac{p}{\beta} \text{curl} H \quad (10)$$

when the transformation in (3b) is employed. Similarly, it can be shown that

$$\text{curl}' E' = \frac{p}{\alpha} \text{curl} E_0. \quad (11)$$

Also, from (2) it is apparent that

$$\frac{\partial E'}{\partial t'} = \gamma \frac{\partial E'}{\partial t} = \frac{\gamma}{\alpha} \frac{\partial E}{\partial t}. \quad (12)$$

When these results are substituted in (6) and (7), it is found that they transform into

$$\begin{aligned} \frac{p}{\beta} \text{curl} H(x, y, z, t) &= \sigma'(x', y', z') \frac{E}{\alpha}(x, y, z, t) \\ &+ \frac{\gamma}{\alpha} \epsilon'(x', y', z') \frac{\partial}{\partial t} E(x, y, z, t) \end{aligned} \quad (13)$$

$$\begin{aligned} \frac{p}{\alpha} \text{curl} E(x, y, z, t) \\ = -\mu'(x', y', z') \frac{\gamma}{\beta} \frac{\partial}{\partial t} H(x, y, z, t). \end{aligned} \quad (14)$$

But these two equations must be identical with (4) and (5) for accurate simulation. Hence, it is apparent that

$$\frac{\beta}{p\alpha} \sigma'(x', y', z') = \sigma(x, y, z) \quad (15)$$

$$\frac{\beta\gamma}{p\alpha} \epsilon'(x', y', z') = \epsilon(x, y, z) \quad (16)$$

$$\frac{\alpha\gamma}{p\beta} \mu'(x', y', z') = \mu(x, y, z). \quad (17)$$

These equations are interpreted as follows: (15) requires the conductivity  $\sigma'$  at the point  $P'(x', y', z')$  in the model to be equal to  $p\alpha/\beta$  times the conductivity  $\sigma$  at the corresponding point  $P(x, y, z)$  in the full-scale system. The other two equations are interpreted similarly. Therefore,

$$\sigma' = \frac{p\alpha}{\beta} \sigma \quad (18)$$

$$\epsilon' = \frac{p\alpha}{\beta\gamma} \epsilon \quad (19)$$

$$\mu' = \frac{p\beta}{\alpha\gamma} \mu. \quad (20)$$

These three equations represent the conditions which have to be satisfied by the media used for constructing the model in order that the simulation be accurate.

#### CONDITIONS FOR AN ABSOLUTE MODEL

The transformations which relate any quantity in one system to the corresponding quantity in the other system can now be obtained by considering the definition of the quantity in terms of the fundamental units, the characteristic parameters of the media ( $\epsilon$ ,  $\sigma$ , and  $\mu$ ), and the field vectors  $E$  and  $H$ .

The Poynting vector for the full-scale system is defined to be the vector  $S$  and such that

$$S = E \times H. \quad (21)$$

Similarly, the corresponding Poynting vector for the model system is

$$S' = E' \times H' = \frac{E}{\alpha} \times \frac{H}{\beta} = \frac{S}{\alpha\beta}. \quad (22)$$

The total power  $P$  passing through a surface  $s$  in the full-scale system is

$$P = \int_s S \cdot n da \quad (23)$$

where  $n$  is a unit vector normal to the surface  $s$  and  $da$  is an element of area on the surface. Hence, in the model the corresponding power is

$$P' = \int_{s'} S' \cdot n' da' = \int_s \frac{S \cdot n da}{\alpha\beta p} = \frac{P}{\alpha\beta p^2}. \quad (24)$$

The normal vectors  $n$  and  $n'$  have the same length since they are *unit* vectors (i.e., vectors of unit length). It should be noted that (24) is consistent with (22) since the vector  $S$  is measured in power per unit area and area transforms by the factor  $p'$ . The voltage  $V$  existing between two points  $P_1$  and  $P_2$  in the full-scale system is defined as

$$V = \int_{P_1}^{P_2} E \cdot dl \quad (25)$$

where  $dl$  is a vector element of length along the curve joining  $P_1$  and  $P_2$ . The corresponding voltage  $V'$  in the model is

$$V' = \int_{P_1'}^{P_2'} E' \cdot dl' = \int_{P_1}^{P_2} \frac{E}{\alpha} \cdot \frac{dl}{p} = \frac{V}{\alpha p}. \quad (26)$$

The current-density vector  $J$  is

$$J = \sigma E. \quad (27)$$

For the model,

$$J' = \sigma' E' = \frac{p\alpha\sigma}{\beta} \frac{E}{\alpha} = \frac{p}{\beta} J. \quad (28)$$

From this, the transformation which relates corresponding total currents in the two systems is readily found to be

$$I' = \int_{s'} J' \cdot n' da' = \int_s \rho \frac{J}{\beta} \cdot n \frac{da}{\rho^2} = \frac{I}{\rho\beta} \quad (29)$$

For resistance,

$$R = \frac{l}{\sigma A} \quad (30)$$

$$R' = \frac{l'}{\sigma' A'} = \frac{l/\rho}{\frac{\rho\alpha\sigma}{\beta} \frac{A}{\rho^2}} = \frac{\beta}{\alpha} R \quad (31)$$

It is readily shown that reactance and impedance transform in the same way as resistance.

A commonly used definition for radar echo area  $A$  is the following:

$$A = 4\pi r^2 \frac{W_r}{W_i} \quad (32)$$

where  $W_i$  = power per unit area in the incident plane wave

$W_r$  = power per unit area in the reflected wave at a distance  $r$  from the reflecting object.

Hence, the corresponding echo area in the model system is

$$A' = 4\pi r'^2 \frac{W_r'}{W_i'} = 4\pi \left(\frac{r}{\rho}\right)^2 \frac{W_r}{\frac{\alpha\beta}{\rho^2} \frac{W_i}{\alpha\beta}} = \frac{A}{\rho^2} \quad (33)$$

since  $W_r'$  and  $W_i'$  transform according to (22). Therefore, radar echoing area transforms in the same manner as a physical area.

The gain  $g$  of an antenna is defined by

$$g = 4\pi r^2 \frac{W}{P} \quad (34)$$

where  $W$  = power per unit area in the radiated wave at a distance  $r$  from the antenna

$P$  = radiated power.

Hence, for the model,

$$g' = 4\pi r'^2 \frac{W'}{P'} = 4\pi \left(\frac{r}{\rho}\right)^2 \frac{\frac{W}{\alpha\beta}}{\frac{P}{\alpha\beta\rho^2}} = g \quad (35)$$

since  $W$  transforms according to (22) and  $P$  according to (24). The gain of a model antenna is therefore the same as the gain of the full-scale antenna.

TABLE I  
CONDITIONS FOR AN ABSOLUTE MODEL

Name of Quantity	Full-Scale System	Model System
Length	$l$	$l' = \frac{l}{\rho}$
Time	$t$	$t' = \frac{t}{\gamma}$
Electric field intensity	$E$	$E' = \frac{E}{\alpha}$
Magnetic field intensity	$H$	$H' = \frac{H}{\beta}$
Conductivity	$\sigma$	$\sigma' = \frac{\rho\alpha\sigma}{\beta}$
Dielectric constant	$\epsilon$	$\epsilon' = \frac{\rho\alpha}{\beta\gamma} \epsilon$
Permeability	$\mu$	$\mu' = \frac{\rho\beta}{\alpha\gamma} \mu$
Voltage	$V$	$V' = \frac{V}{\alpha\rho}$
Current density	$J$	$J' = \frac{\rho J}{\beta}$
Current	$I$	$I' = \frac{I}{\beta\rho}$
Power per unit area	$W$	$W' = \frac{W}{\alpha\beta}$
Total power	$P$	$P' = \frac{P}{\alpha\beta\rho^2}$
Charge density	$\rho$	$\rho' = \frac{\rho^2}{\beta\gamma} \rho$
Charge	$Q$	$Q' = \frac{1}{\beta\gamma\rho} Q$
Frequency	$f$	$f' = \gamma f$
Angular frequency	$\omega$	$\omega' = \gamma\omega$
Wavelength	$\lambda$	$\lambda' = \frac{\lambda}{\rho}$
Phase velocity	$v$	$v' = \frac{\gamma v}{\rho}$
Propagation constant	$k$	$k' = \rho k$
Resistance	$R$	$R' = \frac{\rho^2}{\alpha} R$
Reactance	$X$	$X' = \frac{\beta}{\alpha} X$
Impedance	$Z$	$Z' = \frac{\rho^2}{\alpha} Z$
Dielectric displacement	$D$	$D' = \frac{\rho}{\beta\gamma} D$
Capacitance	$C$	$C' = \frac{\alpha}{\gamma\rho^2} C$
Inductance	$L$	$L' = \frac{\beta}{\alpha\gamma} L$
Flux density	$B$	$B' = \frac{\rho}{\alpha\gamma} B$
Radar echoing area	$A$	$A' = \frac{A}{\rho^2}$
Gain of an antenna	$g$	$g' = g$

Table I is a list of the relationships between model and full-scale quantities which are required for an absolute model. The proofs of these relationships are made by transforming the quantities which are involved in the definitions, as was done above.

#### PRACTICAL CONSIDERATIONS IN CHOICE OF SCALE FACTORS

For any arbitrary choices of the four scale factors  $p$ ,  $\alpha$ ,  $\beta$ , and  $\gamma$  it is theoretically possible to construct an exact model to simulate a given full-scale system. However, in practice there are certain restrictions on the choice of scale factors which result from the limited ranges of variation of  $\epsilon$ ,  $\sigma$ , and  $\mu$  available in actual media which can be used for models. For example, when ferromagnetic media are excluded from the model, it is evident that the permeability of the model media cannot differ appreciably from the value of the permeability for free space. Therefore, for all media

$$\mu'(x', y', z') = \mu(x, y, z) = 4\pi \times 10^{-7} \text{ henry per meter, (36)}$$

and it follows from (20) that

$$\frac{p\beta}{\gamma\alpha} = 1. \quad (37)$$

Furthermore, when waves in free space are involved in the full-scale system it is apparent that the medium in which they travel (air) must be correctly simulated in the model. It is general practice at the present time to simulate the air in the full-scale system with air in the model system. This is partly because of convenience and partly because the use of any other medium usually means higher attenuation of the waves than can be tolerated. Thus, it is sometimes suggested that the model measurements be made under water in order to use lower frequencies with a given size of model. However, the attenuation of electromagnetic waves in water is so high as to cause considerable distortion of the fields. Therefore, air is generally used, and it follows that, for these regions of the model,

$$\epsilon'(x', y', z') = \epsilon(x, y, z). \quad (38)$$

But, since (19) has to be satisfied everywhere in the model system, (38) must therefore be true for all media. Hence,

$$\frac{p\alpha}{\gamma\beta} = 1. \quad (39)$$

A comparison of the requirements imposed by (37) and (39) shows that these equations can only be satisfied simultaneously by choosing

$$\frac{\alpha}{\beta} = 1. \quad (40)$$

Hence,

$$\alpha = \beta \quad (41)$$

and

$$p = \gamma. \quad (42)$$

These conditions therefore require that the relationship between conductivities in (18) take the form

$$\sigma'(x', y', z') = p\sigma(x, y, z). \quad (43)$$

Thus it is apparent that for a practical model which is subject to the above restrictions there are actually only two scale factors ( $p$  and either  $\alpha$  or  $\beta$ ) which can be arbitrarily chosen. The other scale factors are then fixed by (41) and (42).

It should be noted that the condition for conductivities required by (43) is not necessarily satisfied by using air for the model to simulate air in the full-scale system. Actually, the air has a small conductivity which varies with frequency, and which therefore should be taken into account in designing the model and simulated according to (43). However, for most frequencies the air can be considered to be a perfect insulator and the error made in neglecting its conductivity is generally very small.

The restriction that  $\alpha = \beta$ , imposed by (41), can be illustrated by noting from (3a) and (3b) that the ratio  $\alpha/\beta$  is the ratio of the impedance of space in the full-scale system to the impedance of the medium which simulates free space in the model. Since the same medium is to be used in both systems, the impedance of this medium must be the same in both systems. Furthermore, it should be noted that (40) fixes only the ratio of  $\alpha$  to  $\beta$ , and does not restrict the choice of one of them. If a specific value is assigned to either  $\alpha$  or  $\beta$ , the model becomes an absolute model and it can be used to obtain quantitative results for all quantities. Otherwise, the model is a geometrical model.

#### GEOMETRICAL MODELS

If a definite value is assigned only to the mechanical scale factor  $p$ , so that the values of  $\alpha$  and  $\beta$  are unknown (but their ratio being equal to unity), the model becomes a geometrical model. A value may be assigned to  $p$  which results in a model of convenient size for measurements. The important requirements to be satisfied in constructing a geometrical model are, therefore, the following:

$$x' = x/p \quad (44)$$

$$y' = y/p \quad (45)$$

$$z' = z/p \quad (46)$$

$$t' = t/p \quad (47)$$

$$\epsilon' = \epsilon \quad (48)$$

$$\sigma' = p\sigma \quad (49)$$

$$\mu' = \mu. \quad (50)$$

The parameter  $p$  which determines the scale of the model is arbitrarily chosen to yield a model of convenient size. The relationships between various full-scale

and model quantities which can be obtained directly from model measurements are listed in Table II. In addition to these properties of the system, it is possible to determine such characteristics as polarization, bandwidth, relative antenna patterns, relative radar echo patterns, and the like, which do not depend on a knowledge of power level.

In spite of the fact that the power level being used in a geometrical model may be unknown, it is still possible to obtain quantitative results from such a model in a number of ways. The most common method consists of using a standard model whose performance is known, and comparing the model under test with this standard. The performance of the standard model may be obtained from calculations, from full-scale measurements, or by any other means. The comparison between the test model and the standard model must be made at the same power level (although the actual level need not be known) or at power levels whose ratio is known.

TABLE II  
CONDITIONS FOR A PRACTICAL GEOMETRICAL MODEL

Name of Quantity	Full-Scale System	Model System
Length	$l$	$l' = l/p$
Time	$t$	$t' = t/p$
Conductivity	$\sigma$	$\sigma' = p\sigma$
Inductive capacity	$\epsilon$	$\epsilon' = \epsilon$
Permeability	$\mu$	$\mu' = \mu$
Frequency	$f$	$f' = pf$
Wavelength	$\lambda$	$\lambda' = \lambda/p$
Phase velocity	$v$	$v' = v$
Propagation constant	$k$	$k' = pk$
Resistance	$R$	$R' = R$
Reactance	$X$	$X' = X$
Impedance	$Z$	$Z' = Z$
Capacitance	$C$	$C' = c/p$
Inductance	$L$	$L' = L/p$
Echoing area	$A$	$A' = A/p^2$
Antenna gain	$g$	$g' = g$

$p$  = ratio of any full-scale length to the corresponding model length.

For antenna model measurements, the standard model is usually a half-wave dipole antenna whose characteristics are known from calculations. By comparing the field produced by the test model antenna with the field produced by a half-wave dipole when fed with an equal amount of power, the performance of the full-scale test antenna can be determined.

Another method for converting relative measurements of field intensities of antennas to absolute values makes use of the properties of the Poynting vector. From relative measurements of field intensity, the value of the Poynting vector at each point in space can be determined, except for a constant multiplier which depends only on the power levels. But, if the Poynting vector is integrated over the surface of a sphere of large radius, the result must equal the power radiated by the antenna. Hence, the actual value of the unknown multiplying factor which must be used to convert the relative Poynting vector to absolute values may be obtained by choosing it to make the integral equal to the known value of full-scale radiated power.

## SIMULATION OF RADAR ECHOES

To construct a model which yields absolute values for radar echoes and radar echoing areas, it is necessary to simulate quantities according to the rules listed in Table I. This means that it is necessary in the model system to make measurements of the actual values of transmitted and received power when the reflecting object is in the field of the model system.

Suppose that definitely known values are assigned to  $\alpha$  and  $\beta$ , giving an absolute model system which simulates a given radar equipment. (Specific values can be assigned to  $\alpha$  and  $\beta$  by knowing the ratio of any power level in the model to the corresponding power level in the full-scale system.) Then, if measurements of field intensity  $E'$  and power  $W'$  in the model are made under a given set of circumstances, the corresponding field intensity and power in the full-scale system are given by the relations

$$E = \alpha E' \quad (51)$$

$$W = \alpha\beta W' \quad (52)$$

In this way, the actual values which exist in the full-scale radar equipment can be determined directly from measurements on the model. Therefore, by making suitable measurements of the transmitted and received power in the model for a specified model reflecting object, the full-scale values, required for insertion into (32) defining the echoing area of the object, can be determined.

In practice, it is inconvenient to measure power in model systems operating at very high frequency and at low power levels. Hence, geometrical models are commonly used in preference to the absolute models described in the previous paragraph. In a geometrical model, the power level at which the equipment operates is unknown, so that the measurements yield only relative values of echoes and echoing areas. Using a properly constructed model, it is possible to obtain relative patterns of echoes showing how the echo varies with the orientation of the reflecting object and with the polarization of the incident wave. To convert these relative measurements to absolute values it is necessary to adopt special means, as is done for antenna patterns.

The most convenient method for converting relative measurements of radar echoes to absolute values is to use a standard of known echoing area. The power radiated in the model system is held constant (at a level which need not be known), and the echo from the test object is compared with the echo from a standard object when placed in the position previously occupied by the test object. From the ratio of these measured values and the known echoing area of the standard, the absolute echoing area of the test object can be determined.

There are two points of view which may be adopted in interpreting the measurements made on the model system. One point of view is to consider a full-scale system in which there are two reflecting objects, one being the

test object having an echoing area  $A_1$  which is to be determined from the measurements, and the other being the standard object whose known echoing area is  $A_2$ . Suppose, now, that measurements are made in the full-scale system to determine the ratio of the power  $W_1$  reflected by the test object to the power  $W_2$  reflected by the standard object when subjected to the same illumination. It follows from the definition of echoing area, (32), that this ratio is

$$a = W_1/W_2 = A_1/A_2. \quad (53)$$

Since  $A_2$  is known, measurement of the ratio  $a$  yields the echoing area  $A_1$  of the test object. But this ratio  $a$  can just as well be determined from measurements on a geometrical model of the system. To determine it from a model, it is only necessary to model the system so that it satisfies the requirements of (44) to (50). It is important to note that, in making the geometrical model for measuring the ratio  $a$ , it is necessary to *model both the test object and the standard object*. Having correctly constructed the model, it is a simple matter to determine the ratio  $a$  by merely comparing the amounts of power reflected by the model test object and the model standard object. This ratio  $a$  can then be inserted in (53) to determine the echoing area  $A_1$  of the full-scale test object.

It should be noted that this procedure requires no knowledge of the actual echoing area of the model standard object at the model frequency and, in fact, the numerical value of the model scale factor  $p$  does not even appear anywhere in the calculations.

Another point of view is to carry out the calculations in terms of the model frequency, and then convert the results to full-scale value by using (33), which relates the echoing area in the two systems. The ratio  $a$  is again measured on a model system. Then, at the *model frequency*, the ratio of the echoing area of the model test object to the echoing area of the model standard object is

$$a = A_1'/A_2'. \quad (54)$$

The echoing area  $A_2'$  for the model standard object at the model frequency is presumably known, so that  $A_1'$  can be calculated. Hence, using (35), the echoing area for the full-scale test object at the full-scale frequency is readily found to be

$$A_1 = p^2 A_1' = a p^2 A_2' \quad (55)$$

where  $A_2'$  = echoing area of the model of the standard object for waves at the model frequency. In this method of calculation, the model scale factor  $p$  appears explicitly in the calculations. However, the result actually depends only on the measured ratio  $a$  and the known value of  $A_2$ , because, for the standard object,

$$A_2 = p^2 A_2'. \quad (56)$$

Inserting (55) and (56) in (54) yields (53), which was used in the other method of calculation, and in which the parameter  $p$  does not appear. Hence, the two points of view are equivalent.

## High-Frequency Polyphase Transmission Line\*

C. T. TAI†, ASSOCIATE, IRE

**Summary**—The problems of the polyphase transmission line and the single-phase multiwire line have been formulated, based upon the vector-potential method. The transmission-line equations that determine the current and voltage relationships on these lines have been derived and solved. Formulas for the characteristic impedance of the lines have been thus obtained. They are useful in designing lines to feed polyphase radiating systems, and in computing the input impedance of triple-folded dipoles and other antennas.

### INTRODUCTION

IN STUDYING the problems of three coupled antennas arranged as a triangular array, it has been found convenient to decompose the excitations into three simple modes. Each mode can then be analyzed by the method of vector potential, as for the case of an

isolated antenna.<sup>1,2</sup> The situation is illustrated schematically in Fig. 1, where the three antennas are assumed to be of identical size, both in diameter and in length.

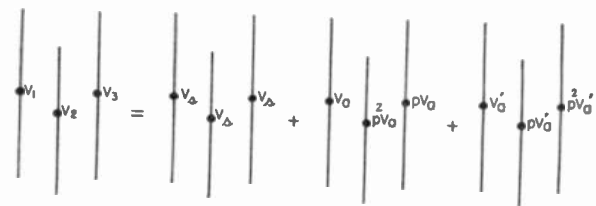

Fig. 1—Three different types of excitation occurring in the problem of three coupled antennas.

But, electrically, they may be driven by three different generators of voltages, say,  $V_1$ ,  $V_2$ , and  $V_3$ , respectively.

<sup>1</sup> E. Hallen, "Theoretical investigations into the transmitting and receiving qualities of antennas," *Nov. Acta, Roy. Soc. Sci. (Upsala)* vol. 77, p. 1; 1938.

<sup>2</sup> R. King, and D. Middleton, "The cylindrical antenna, current and impedance," *Quar. Appl. Math.* vol. 3, no. 4, p. 302; 1946.

\* Decimal classification: R117.1×R320.41. Original manuscript received by the Institute, February 20, 1948; revised manuscript received, June 4, 1948. The research reported in this paper was made possible through support extended Cruft Laboratory, Harvard University, jointly by the Navy Department (Office of Naval Research) and the Signal Corps, U. S. Army, under Contract N5ori-76, T.O.I.

† Cruft Laboratory, Harvard University, Cambridge, Mass.



By the method of symmetrical components, the three voltages can be decomposed to form three groups designated by zero sequence, positive sequence, and negative sequence. Mathematically, they are connected in the following linear equations:

$$V_1 = V_s + V_a + V_a' \tag{1}$$

$$V_2 = V_s + pV_a + p^2V_a' \tag{2}$$

$$V_3 = V_s + p^2V_a + pV_a' \tag{3}$$

where  $p$  denotes the phase factor  $e^{j2\pi/3}$ . Conversely, one may solve  $V_s$ ,  $V_a$ , and  $V_a'$  in terms of  $V_1$ ,  $V_2$ , and  $V_3$  from (1)–(3). By the superposition theorem, the three coupled antennas driven by three arbitrary voltages can thus be considered as driven by three sequences, and the general problem concerning the current distribution, input impedances, and the like will be solved, once the solution of each sequence is known. If the antennas are closely coupled to each other, the positive sequence or the negative sequence forms a conventional excitation of the three-phase open-end transmission line, while the zero sequence forms an excitation which is mainly responsible for the radiation from the system. In the present paper, discussion will be limited to transmission-line modes, and the formulation will be extended to any number of phases exceeding three. The analysis of the radiation modes was treated in another paper<sup>3</sup> as an antenna problem. Single-phase multiwire transmission lines, which are of equal interest, are also treated here.

GENERAL EQUATIONS AND THEIR SOLUTIONS FOR A THREE-PHASE LINE

The problem to be treated is illustrated in Fig. 2. Three generators with a successive phase difference of 120 degrees are connected at one terminal of the com-

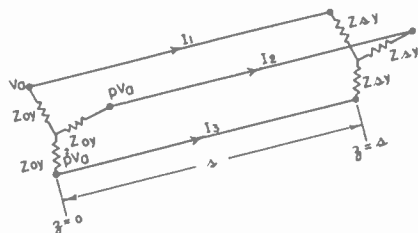

Fig. 2—A three-phase transmission line terminated by y-connected impedances.

posite line with a  $y$ -connected impedance net  $Z_{oy}'s$  terminated at the transmitting end. At the rear end, the line is terminated in three  $y$ -connected load impedances  $Z_{ay}'s$ . It is essential in the present analysis that the composite line be balanced both geometrically and electrically, so that the following equations hold true:

$$I_{3z} = pI_{2z} = p^2I_{1z}. \tag{4}$$

<sup>3</sup> C. T. Tai, "Coupled antennas," PROC. I.R.E., vol. 36, pp. 487–501; April, 1948.

The analysis of this problem is well established for short lines in power engineering. At high frequencies, or when the length of the line is comparable to the wavelength, the analysis has not been so thoroughly studied as that of a two-wire line. It is almost universally true that earlier works<sup>4,5</sup> were developed by introducing such coefficients as mutual inductance or mutual capacitance between the wires. Some of these concepts are based upon the theory of static electricity. As an analysis of an electrodynamic problem, they are sometimes quite misleading. To clarify many of these ambiguities, the theory of the polyphase transmission line will be developed on a more substantial base by making use of the so-called vector-potential method.<sup>6</sup>

By starting with Maxwell's equations in a homogeneous, isotropic medium, with harmonic time dependence, namely,

$$\left. \begin{aligned} \text{curl } \bar{E} &= -j\omega\bar{B} \\ \frac{1}{\mu} \text{curl } \bar{B} &= \bar{J} + j\omega\epsilon\bar{E} \\ \text{div } \epsilon\bar{E} &= \rho \\ \text{div } \bar{B} &= 0 \end{aligned} \right\} \tag{5}$$

two potential functions  $\bar{A}$  and  $\phi$  can be defined in terms of  $\bar{E}$  and  $\bar{B}$  according to the following two equations:

$$\text{curl } \bar{A} = \bar{B} \tag{6}$$

$$\text{grad } \phi = -\bar{E} - j\omega\bar{A}. \tag{7}$$

An additional relation is then assumed between  $\bar{A}$  and  $\phi$  such that both functions will satisfy the three-dimensional wave equations, one of which is a vector wave equation, while the other is a scalar one. They are

$$\text{div } \bar{A} = -j \left( \frac{\beta^2}{\omega} \right) \phi \tag{8}$$

$$\nabla^2 \bar{A} + \beta^2 \bar{A} = -\mu \bar{J} \tag{9}$$

$$\nabla^2 \phi + \beta^2 \phi = -\frac{1}{\epsilon} \rho \tag{10}$$

where

$$\beta^2 = \frac{\omega^2}{v^2}; \quad v^2 = \frac{1}{\mu\epsilon}$$

The particular integrals of (9) and (10) that represent the solution of the potentials for a certain distribution of charges and currents in a finite region are known as Helmholtz's integrals, which are given by

$$\bar{A} = \frac{\mu}{4\pi} \int_{\tau} \frac{\bar{J}' e^{-j\beta r}}{r} d\tau' + \frac{\mu}{4\pi} \int_{\sigma} \frac{\rho' e^{-j\beta r}}{r} d\sigma' \tag{11}$$

<sup>4</sup> A. Russell "A. C. Circuits," vol. 2, Cambridge University Press, 1946; p. 547.

<sup>5</sup> L. A. Woodruff, "Principles of Electrical Power Transmission," John Wiley and Sons, Inc., New York, N. Y., 1938.

<sup>6</sup> R. King, "Electromagnetic Engineering," vol. 1, chap. 3, McGraw-Hill Book Co., New York, N. Y., 1945.

$$\phi = \frac{1}{4\pi\epsilon} \int_{\tau} \frac{\rho' e^{-i\beta r}}{r} d\tau' + \frac{1}{4\pi\epsilon} \int_{\sigma} \frac{\eta'}{r} e^{-i\beta r} d\sigma' \quad (12)$$

where  $\eta'$  and  $\bar{I}'$  are surface density of charges and currents that may exist at the surfaces of the bodies immersed in the medium, apart from the continuous distribution of volume charges and volume current,  $\rho'$  and  $\bar{J}'$ , while  $\sigma$  and  $\tau$  denote respectively the surface and volume where the integration is performed.

In dealing with three cylindrical wires as shown in Fig. 2, (7), (8), and (11) can be reduced to

$$\frac{\partial \phi_1}{\partial z} = -E_{1z} - j\omega A_{1z} \quad (13)$$

$$\frac{\partial A_{1z}}{\partial z} = -j \frac{\beta^2}{\omega} \phi_1 \quad (14)$$

$$A_{1z} = \frac{\mu}{4\pi} \int_0^s \left( I_{1z'} \frac{e^{-i\beta r_{11}}}{r_{11}} + I_{2z'} \frac{e^{-i\beta r_{12}}}{r_{12}} + I_{3z'} \frac{e^{-i\beta r_{13}}}{r_{13}} \right) dz' \quad (15)$$

where

$$\begin{cases} r_{11} = \sqrt{(z_1' - z_1)^2 + a^2} \\ r_{12} = \sqrt{(z_2' - z_1)^2 + b^2} \\ r_{13} = \sqrt{(z_3' - z_1)^2 + b^2} \end{cases}$$

$a$  and  $b$  denoting respectively the radius of each wire and the distance between the centers of any two adjacent wires;  $z$  denoting the position of a fixed point where  $A_{1z}$  is defined; and  $z_1'$ ,  $z_2'$ , and  $z_3'$  being the positions of the variable points where the integrations are performed. Two similar sets of equations like (13)–(15) can be derived for  $A_{2z}$ ,  $\phi_2$ ,  $E_{2z}$ ;  $A_{3z}$ ,  $\phi_3$ , and  $E_{3z}$ . It is understood that only the values of  $\phi$  and  $\bar{A}$  defined at the surface of the conductor are of interest in the present analysis. In reducing the equations from three-dimensional form to the one-dimensional form, the contribution due to the end leads has been neglected. Derivations of these equations similar to (13)–(15) are described in great detail in footnote reference 6. Equation (15) can be simplified by substituting the values of  $I_{2z}$  and  $I_{3z}$  in terms of  $I_{1z}$  according to (4), and by making use of the relation

$$1 + p + p^2 = 0. \quad (16)$$

One then has

$$A_{1z} = \frac{\mu}{4\pi} \int_0^s I_{1z'} \left( \frac{e^{-i\beta r_{11}}}{r_{11}} - \frac{e^{-i\beta r_{12}}}{r_{12}} \right) dz'. \quad (17)$$

By defining

$$V_{12} = \phi_1 - \phi_2, \quad V_{23} = \phi_2 - \phi_3, \quad (18)$$

$$V_{31} = \phi_3 - \phi_1$$

$$W_{12} = A_1 - A_2, \quad W_{23} = A_2 - A_3, \quad (19)$$

$$W_{31} = A_3 - A_1$$

and substituting

$$E = z_1' I$$

where  $z_1'$  is the internal impedance per unit length for a single wire and  $I$  the total axial current in each conductor, the following equations can be derived from (13)–(15) and similar equations for  $A_2$ ,  $\phi_2$ ,  $E_2$ ;  $A_3$ ,  $\phi_3$ ,  $E_3$ . (For simplicity, the subscript  $z$  is omitted.) They are

$$\frac{\partial V_{12}}{\partial z} = -z_1'(1-p)I_1 - j\omega W_{12} \quad (20)$$

$$\frac{\partial W_{12}}{\partial z} = -j \frac{\beta^2}{\omega} V_{12}, \quad (21)$$

and two similar pairs for  $V_{23}$ ,  $W_{23}$ ,  $V_{31}$ , and  $W_{31}$ . By means of (4) and (17),  $W_{12}$  can be written as

$$W_{12} = A_1 - A_2 = \frac{\mu}{4\pi} \int_0^s I_1'(1-p) \left( \frac{e^{-i\beta r_{11}}}{r_{11}} - \frac{e^{-i\beta r_{12}}}{r_{12}} \right) dz'. \quad (22)$$

Equation (22) can be simplified by introducing a distribution function defined by

$$I_1(z') = I_1(z)f(zz'). \quad (23)$$

Then one has

$$W_{12} = \frac{\mu}{4\pi} (1-p)I_1 \int_0^s f(zz') \left( \frac{e^{-i\beta r_{11}}}{r_{11}} - \frac{e^{-i\beta r_{12}}}{r_{12}} \right) dz'. \quad (24)$$

If the spacing between two adjacent wires is small compared with a wavelength, it has been demonstrated<sup>7</sup> that the function defined by the definite integral in (24) is practically constant, being independent of  $z$  except near the two ends of the line. This constant can be evaluated from the following definite integral:

$$K = \int_0^s \left( \frac{1}{r_{11}} - \frac{1}{r_{12}} \right) dz' \doteq 2 \ln \frac{b}{a}; \quad (25)$$

$$z^2 \gg b^2, \quad (s-z)^2 \gg b^2.$$

Now let another constant  $z^e$  be defined:

$$z^e = j\omega \frac{\mu}{2} K = j\omega \frac{\mu}{\pi} \ln \frac{b}{a};$$

then  $W_{12}$  can be written as

$$W_{12} = \frac{-j(1-p)}{\omega} \frac{z^e I_1}{2}. \quad (26)$$

Substituting (26) in (20)–(21), one obtains the following two differential equations:

$$\frac{\partial V_{12}}{\partial z} = -\frac{(1-p)}{2} (r + j\omega l) I_1 \quad (27)$$

$$\frac{\partial I_1}{\partial z} = -\frac{2}{(1-p)} (g + j\omega c) V_{12} \quad (28)$$

<sup>7</sup> See pp. 478–485 of footnote reference 6.

where

$$r + j\omega l = 2z_1^i + z^e \tag{29}$$

$$g + j\omega c = y^e = \frac{-\beta^2}{z^e} = \frac{-\mu\omega^2\left(\epsilon - j\frac{\sigma}{\omega}\right)}{z^e} \tag{30}$$

In (30),  $\epsilon$  and  $\sigma$  are the effective dielectric constant and conductivity of the surrounding medium. Formulas for  $r$ ,  $l$ ,  $g$ , and  $c$  can be derived easily from (29) and (30). They are

$$r = 2r^i = \frac{1}{\pi a} \sqrt{\frac{\omega\mu c}{2\sigma_c}} \tag{31}$$

$$l \doteq l^e = \frac{\mu}{\pi} \ln \frac{b}{a} \tag{32}$$

$$g = \frac{\pi\sigma}{\ln \frac{b}{a}} \tag{33}$$

$$c = \frac{\pi\epsilon}{\ln \frac{b}{a}} \tag{34}$$

It is understood that these formulas are derived under the assumption that  $(2a/b)^2 \ll 1$ . Expressions defined by (31)–(34) are precisely the line constants of an isolated two-wire transmission line with separation equal to  $b$  and the radius of the conductors equal to  $a$ . It is seen that by means of the vector-potential method one can derive formally the transmission-line equations of a three-phase line without relying upon the so-called distributed constants of such a composite line.

By introducing hyperbolic functions,<sup>8</sup> and inserting the proper boundary conditions, the solution for  $I_1$  and  $V_{12}$  is found to be

$$I_1 = \frac{V_a}{Z_{cy}} \frac{\sinh \theta_0 \sinh [k(s-z) + \theta_s]}{\sinh (ks + \theta_0 + \theta_s)} \tag{35}$$

$$V_{12} = (1-p)V_a \frac{\sinh \theta_0 \cosh [k(s-z) + \theta_s]}{\sinh (ks + \theta_0 + \theta_s)} \tag{36}$$

where the constants are defined in the following equations:

$$k = \sqrt{(r + j\omega l)(g + j\omega c)} \tag{37}$$

$$Z_c = \sqrt{\frac{r + j\omega l}{g + j\omega c}} \tag{38}$$

$$Z_{cy} = \frac{1}{2}Z_c \tag{39}$$

$$\coth \theta_0 = Z_{oy}/Z_{cy} \tag{40}$$

$$\coth \theta_s = Z_{sy}/Z_{cy} \tag{41}$$

For a  $y$  load, it can be readily verified that

$$(I_1)_s = \frac{(V_{12})_s}{(1-p)Z_{sy}} \tag{42}$$

Thus for any given pair of values of  $I_1$  and  $V_{12}$  an equivalent  $y$  input impedance can be defined by

$$Z_{iny} = \frac{V_{12}}{(1-p)I_1} \tag{43}$$

For a section of line of length  $s$  terminated by a  $y$  load of impedances equal to  $Z_{sy}$ , the input impedance is

$$Z_{iny} = Z_{cy} \coth (ks + \theta_s) \tag{44}$$

From (41) it is seen that, if  $Z_{sy} = Z_{cy}$ ,  $\theta_s$  becomes infinite; therefore, from (44),  $Z_{iny} = Z_{cy}$ , or if one lets  $s$  become infinitely large in (44),  $Z_{iny}$  will also be equal to  $Z_{cy}$ . This proves that  $Z_{cy}$  is actually the characteristic impedance of the line. There is no difficulty in defining an equivalent- $\Delta$  characteristic impedance of the line if the load is  $\Delta$ -connected as shown in Fig. 3. For a three-phase line, the relation between  $Z_{c\Delta}$  and  $Z_{cy}$  is simply

$$Z_{c\Delta} = 3Z_{cy} = \frac{3}{2}Z_c \tag{45}$$

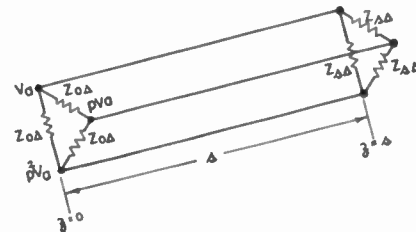

Fig. 3—A three-phase transmission line terminated by  $\Delta$ -connected impedances.

where  $Z_c$  is the characteristic impedance of an isolated two-wire line.

EXTENSION TO AN  $n$ -PHASE LINE

The method described can be easily extended to an  $n$ -phase line with a configuration shown in Fig. 4. Although the formulation was quite complicated at the beginning,

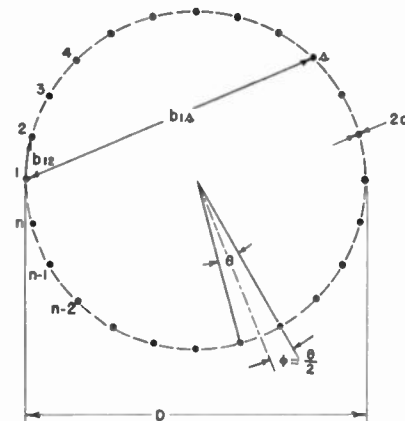

Fig. 4—An  $n$ -wire line illustrating the notation used in the text.

<sup>8</sup> R. King, "Transmission line theory and its application," *Jour. App. Phys.*, vol. 14, pp. 577-600; November, 1943.

the results turned out to be very simple. For a low-loss line placed in air, the equivalent- $\gamma$  characteristic impedance of an  $n$ -phase line is found to be

$$R_{cn\gamma} = 60 \ln \frac{D}{a} - 120 \ln [(\sin \phi)^{\cos 2\phi} \cdot (\sin 2\phi)^{\cos 4\phi} \cdot \dots \cdot (\sin (k-1)\phi)^{\cos 2(k-1)\phi}]$$

$$= 60 \ln \frac{b_{12}}{a \sin \phi} - 120 \ln [(\sin \phi)^{\cos 2\phi} \cdot (\sin 2\phi)^{\cos 4\phi} \cdot \dots \cdot (\sin (k-1)\phi)^{\cos 2(k-1)\phi}] \quad (46)$$

where

$$k = \begin{cases} \frac{n+1}{2}, & n = \text{odd} \\ \frac{n}{2}, & n = \text{even.} \end{cases}$$

The meaning of  $D$ ,  $b_{12}$ , and  $\phi$  is explained in Fig. 4. The equivalent- $\Delta$  characteristic impedance is given by

$$R_{n\Delta} = 4 \sin^2 \phi R_{cn\gamma}. \quad (47)$$

To the knowledge of the writer, this formula has never appeared before. Previous workers<sup>9</sup> dealing with this subject often had their formulas presented numerically, because most of the line constants, including mutual and self-coefficients, have been presented in this way. The analytic formula derived here is believed to have applications for long-distance power transmission, as well as for high-frequency power transmission.

Since the characteristic impedance of a polyphase transmission line is defined with respect to all the terminals of the composite line, it is not directly related to that of a two-wire line. In order to determine whether a line is relatively of low impedance or of high impedance, one may resort to the power relation. Suppose that a polyphase line has been terminated with its characteristic impedance; then the total power input is

$$P = \frac{nV^2}{R_{cn\Delta}} \quad (48)$$

where  $V$  is the line voltage between two phases. If the same amount of power is to be transmitted by a non-resonant two-wire line maintained at the same voltage, the line must be designed to have a characteristic impedance  $R_c$  equal to  $R_{cn\Delta}/n$ . It is thus seen that the quantity  $R_{cn\Delta}/n$  is a measure of the effective characteristic impedance of a composite line. Numerical values of  $R_{cn\Delta}$ ,  $R_{cn\gamma}$ , and  $R_{cn\Delta}/n$  will be given later.

SINGLE-PHASE MULTIWIRE TRANSMISSION LINE

If the  $n$  wires shown in Fig. 4 are excited so that any two adjacent wires will carry equal and opposite cur-

rents, the system forms a single-phase multiwire transmission line. It is necessary that  $n$  be an even number. The analysis of this problem follows the same method outlined previously. The characteristic impedance of the line is found to be

$$R_{cn} = \frac{240}{n} \ln \left( \frac{2D}{na} \right) - \frac{240}{n} \ln \left( \frac{2b_{12}}{na \sin \phi} \right). \quad (49)$$

The simplicity of this expression is attributed to a not-very-well-known trigonometrical identity, namely,

$$\frac{\sin 2\phi \sin 4\phi}{\sin \phi \sin 3\phi} \cdot \dots \cdot \left( \sin \left( \frac{n-2}{2} \right) \phi \right)^{(-1)^{(n+2)/2}} = \sqrt{\frac{n}{2}}$$

$$\phi = \frac{\pi}{n}. \quad (50)$$

For  $n=2$ , (49) reduces to the well-known formula of the characteristic impedance of a two-wire line. For  $n=4$ , the formula checks with the result obtained by King.<sup>10</sup> It is seen that a single-phase multiwire line can be regarded as a link between a two-wire line and a coaxial line as the number of wires is increased.

NUMERICAL COMPUTATIONS

To study the variation of the characteristic impedances of a polyphase or a single-phase multiwire transmission line, as the number of wires is changed, one can either keep constant  $b_{12}$ , the separation between two

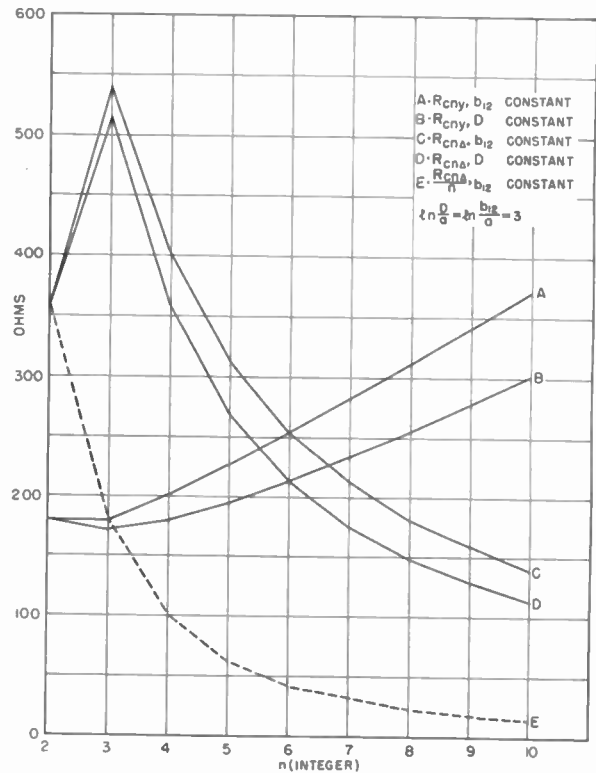

Fig. 5—Characteristic impedance of a polyphase transmission line as a function of  $n$ .

<sup>9</sup> H. B. Dwight, "Transmission Line Formulas," D Van Nostrand Co., Inc., New York, N. Y., 1925.

<sup>10</sup> See chapter 4 of footnote reference 6.

adjacent wires, or constant  $D$ , the diameter of the composite line. For a polyphase line, this is illustrated graphically in Fig. 5, where curve A represents the values of  $R_{cn}$  at constant  $D$ , and curve B the values at constant  $b_{12}$ . The equivalent- $y$  characteristic impedance of a two-wire line is taken as one-half of its actual value. In both cases,  $\ln(D/a)$  and  $\ln(b_{12}/a)$  are assumed to be equal to 3. Curves C and D are the equivalent characteristic impedance defined in terms of a  $\Delta$  connection. The curve marked E shows the values of  $R_{cn\Delta}/n$ , which is a measure of the effective characteristic impedance of a polyphase line. It is seen that the polyphase line is essentially a low-impedance line as compared to a two-wire line.

The value of  $R_{cn}$  for a single-phase multiwire line is plotted on Fig. 6. For other values of  $D/a$  or  $b_{12}/a$ , complete information may be obtained from this figure by an appropriate shifting of the curves. To use (46) and (49) one must not overlook the fact that these formulas are derived under the assumption that  $b_{12}^2$  is large compared with  $a^2$ .

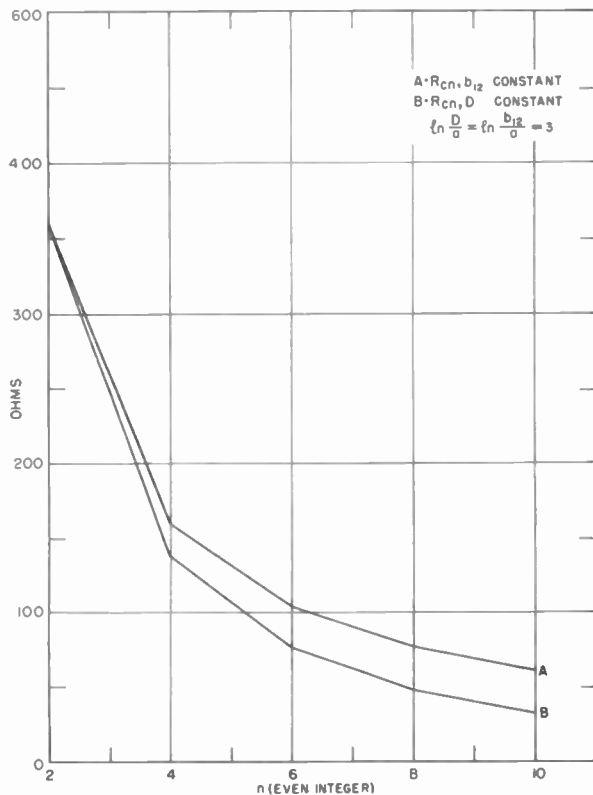

Fig. 6—Characteristic impedance of a single-phase multiwire transmission line as a function of  $n$ .

As a check on the validity of these formulas, we like to compare the primary constants derived using the

conventional method, as quoted in the literature.<sup>11</sup> For a three-phase balanced line, the inductance per meter per phase is given by

$$L' = 2 \ln \frac{b_{12}}{r} \times 10^{-7} \text{ henry/meter} \quad (51)$$

while the "capacitance to neutral" as computed by the so-called indirect method is

$$C' = \frac{1}{18 \ln \frac{b_{12}}{r}} \times 10^{-9} \text{ farad/meter.} \quad (52)$$

The equivalent  $y$ -characteristic impedance is therefore given by

$$R_{cy} = \sqrt{\frac{L'}{C'}} = 60 \ln \frac{b_{12}}{r}, \quad (53)$$

which is the same as (46) by putting  $k=2$  or  $n=3$ . As explained by the same two authors,<sup>11</sup> the term "capacitance to neutral" is quite misleading. The situation is even worse when we are going to derive the transmission-line equation for a polyphase line by means of the conventional method, where the coefficients of mutual capacitance and mutual inductance are bound to be introduced.

#### CONCLUSION

The preceding analysis shows an interesting application of the vector-potential method in dealing with polyphase transmission-line problems. Equations that determine the current and voltage distribution on the lines have thus been derived and solved without making use of the distribution constants of the lines that would be very involved otherwise. The theory used in this study of the polyphase transmission line is useful in computing the input impedance of a number of radiating systems, including, especially, the triple-folded dipole and the corner-reflector antenna.<sup>12</sup> The formula for the characteristic impedance of these lines is useful in designing lines to feed polyphase radiating systems.<sup>13,14</sup>

#### ACKNOWLEDGMENT

The writer wishes to acknowledge his indebtedness to Ronold King for guiding his work in the course of this investigation.

<sup>11</sup> F. W. Norris and L. A. Bingham, "Electrical Characteristics of Power and Telephone Transmission Lines," International Textbook Co., Scranton, Pa., 1936.

<sup>12</sup> C. T. Tai, "The theory of coupled antennas and its applications," Technical Report 12, Cruft Laboratory, Harvard University Cambridge, Mass., 1947.

<sup>13</sup> G. H. Brown, "The turnstile antenna," *Electronics*, vol. 9, pp. 14-17, 48; April, 1936.

<sup>14</sup> F. E. Terman, "Radio Engineers' Handbook," pp. 816-818, McGraw-Hill Book Co., New York, N. Y., 1943.

# Low-Pass Filters Using Coaxial Transmission Lines as Elements\*

DOUGLAS E. MODE†, SENIOR MEMBER, IRE

**Summary**—Transmission-line low-pass filter design is in large measure dependent upon the frequency band in which the filter is to be used. Certain approximations may be made at comparatively low frequencies which simplify the problem, refinements in the analysis having to be introduced as the filter pass band is extended to higher and higher frequencies. Four transmission-line low-pass filter designs are presented which specify the mechanical dimensions required for constructing low-pass transmission-line filters having pass bands with a width of as much as 4000 Mc.

## I. INTRODUCTION

THE USE OF TRANSMISSION LINES as filter elements is not new, considerable research on the subject having been done before the war, with the beginning perhaps going back to a paper by Mason and Sykes.<sup>1</sup> Other work concerning such filters for rather special applications has also appeared.<sup>2-5</sup> A group of investigators at Harvard<sup>6</sup> developed a number of filters using combinations of transmission lines and lumped-parameter elements. At about the same time, a program of filter development was being pursued by the Naval Research Laboratory.<sup>7</sup> The Harvard efforts were chiefly concerned with filter applications in the microwave bands (around 4000 Mc), while the Naval Research Laboratory had concentrated on filter designs for use at frequencies below 1000 Mc. Further theoretical work on transmission-line filters by the Harvard staff has recently appeared.<sup>8</sup>

Practical considerations indicate that filters made up of coaxial transmission-line elements are of use above 200 Mc, where lumped-parameter-element filters are difficult to construct, up to about 4000 Mc, where waveguides and their associated reactive elements are most

effective. The transmission-line filters to be discussed in this paper are limited to low-pass types and are based on the prototype section shown in Fig. 1. Electrically, this section may be thought of as a tee, having coaxial

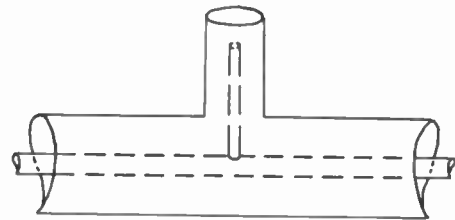

Fig. 1—Sketch of a typical mid-series low-pass transmission-line filter.

transmission lines for both its series and shunt elements. Because of the repetitive nature of the reactance versus frequency characteristics of transmission lines, a low-pass filter using such lines as elements cannot be expected to exhibit but one pass band, spurious or "secondary" pass bands being found above the first or "primary" cutoff frequency of the filter. Such secondary pass bands must, of course, be considered when a practical design is attempted.

## II. CRITERIA FOR LOW-PASS FILTER DESIGN

There are a number of factors which dictate the choice of a particular filter design for a given application. Among these are the insertion loss in the pass band, the attenuation in the stop band, the steepness of the attenuation slope near the boundary of the attenuation band, and the over-all phase-shift characteristics of the filter. Depending upon the service for which the filter is intended, one or more of these may be of primary consequence. The pass-band insertion loss has been chosen in what follows as the factor to be used in judging the relative merit of a filter.

Most low-pass transmission-line filters exhibit a fairly constant image impedance in the low-frequency portion of their pass bands. Depending upon the design, this constant or "flat" portion of the image-impedance characteristic may extend over a large or small part of the pass band. As the pass-band insertion loss of a filter depends upon the amount by which its image impedance differs from that of the circuit in which it is to work, a first comparison of the relative merit of two filters may be had by making a plot of their image-impedance characteristics, the better filter being the one which has the "flatter" image-impedance curve.

Certain simplifying approximations have been made throughout this paper. First, transmission lines shorter

\* Decimal classification: R386.2×R117.2. Original manuscript received by the Institute, February 12, 1947; revised manuscript received, April 20, 1948. A dissertation in electrical engineering presented to the faculty of the graduate school in partial fulfillment of the requirements for the degree of Doctor of Philosophy, Moore School of Electrical Engineering, University of Pennsylvania, Philadelphia, Pa. Most of this work was carried out for the Army Air Forces, Watson Laboratories, under contract number W28-099-ac-128.

† Lehigh University, Bethlehem, Pa.

<sup>1</sup> W. P. Mason and R. A. Sykes, "The use of coaxial and balanced transmission lines in filters and wide-band transformers for high radio frequencies," *Bell Sys. Tech. Jour.*, vol. 16, pp. 275-302; July, 1937.

<sup>2</sup> L. M. Leeds, "Concentric narrow-band elimination filter," *PROC. I.R.E.*, vol. 26, pp. 576-589; May, 1938.

<sup>3</sup> H. Salinger, "A coaxial filter for vestigial side-band transmission in television," *PROC. I.R.E.*, vol. 29, pp. 115-120; March, 1941.

<sup>4</sup> L. R. Quarles, "Transmission lines as filters," *Communications*, vol. 26, pp. 34-38; June, 1946.

<sup>5</sup> C. L. Cuccia and H. R. Hegbar, "An ultra-high-frequency low-pass filter of coaxial construction," *RCA Rev.* Vol. 8, pp. 743-750; December, 1947.

<sup>6</sup> Harvard Radio Research Laboratory Reports, nos. 411-115A to D, United States Dept. of Commerce Publication PB 14175, 1945.

<sup>7</sup> Naval Research Laboratory Report, no. 2770, September, 1946.

<sup>8</sup> Radio Research Laboratory Staff, "Very-High-Frequency Techniques," McGraw-Hill Book Company, Inc., New York, N. Y., 1947; chaps. 26 and 27.

than about 5 electrical degrees have been neglected (connecting leads may fall in this class). Second, transmission lines of less than about 25 electrical degrees are treated as lumped inductors (the electrical lengths are computed at the cutoff frequency). Finally, dissipation has not been included because the  $Q$  of all of the filter elements is high.

### III. LOW-PASS TRANSMISSION-LINE FILTERS FOR USE BELOW 1000 Mc

Low-pass transmission-line filters with cutoff frequencies below 1000 Mc may be constructed with dimensions such that the series transmission lines may be treated as lumped inductors and the leads connecting the shunt transmission lines may be neglected. Either midseries or midshunt termination may be used, but the midshunt termination gives a much flatter image-impedance characteristic, and hence is adopted. The equivalent circuit of the filter section is shown in Fig. 2 where  $L$  is the inductance representing the series transmission line,  $Z_{02}$  is the characteristic impedance of

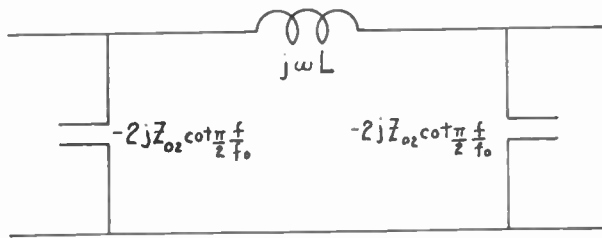

Fig. 2—Equivalent circuit of a low-pass transmission-line filter applicable below 1000 Mc.

the shunt transmission line, and  $f_0$  is the frequency at which the shunt transmission line is quarter-wave resonant. The equation for the image impedance of a symmetrical midshunt filter section is

$$Z_{0\pi} = \frac{2Z_2}{\sqrt{1 + \frac{4Z_2}{Z_1}}} \tag{1}$$

where

$Z_2$  = the total shunt impedance, and

$Z_1$  = the total series impedance of a section.

If  $\theta_2$  be defined as the electrical length of the shunt transmission line at the filter cutoff frequency  $f_c$ , there results

$$\frac{Z_{0\pi}}{Z_{02}} = \frac{2 \cot \frac{\theta_2 f}{f_c}}{\sqrt{\frac{4f_c}{bf} \cot \frac{\theta_2 f}{f_c} - 1}} \tag{2}$$

where

$$b = \frac{\omega_c L}{Z_{02}} \tag{3}$$

The beginning of the primary stop band requires that

$$Z_1/4Z_2 = -1, \tag{4}$$

which introduces the relation between the parameters

$$b = 4 \cot \theta_2. \tag{5}$$

A family of image-impedance curves obtained from (2) with  $b$  as the parameter is shown in Fig. 3. Inspection shows that if  $b$  is taken equal to 1.22 the image impedance varies by about 2 per cent over 80 per cent of the pass band.

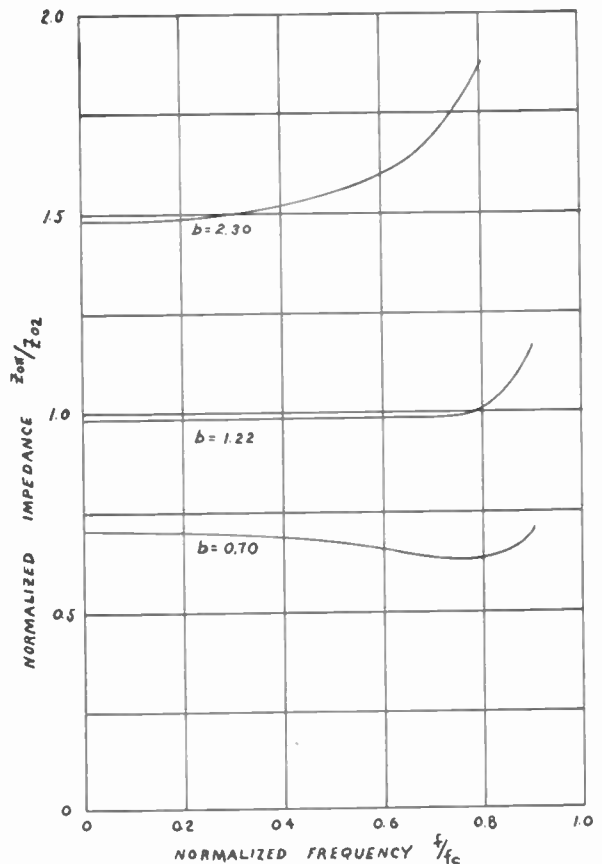

Fig. 3—Typical normalized image-impedance characteristics for the low-pass transmission-line filter prototype shown in Fig. 2.

To illustrate the ease with which a low-pass transmission-line filter of this type may be designed, suppose it is required that a low-pass filter to match a 50-ohm circuit and to cut off at 700 Mc be constructed. Fig. 3 indicates that for  $b=1.22$  the normalized image impedance is equal to 0.985 in the "flat" region, which gives for  $Z_{02}$  the value  $50/0.985 = 51$  ohms. A coaxial transmission line having this characteristic impedance may be constructed in many ways; for instance, a  $\frac{1}{2}$ -inch pipe of 1/32-inch wall thickness may be used for the outer conductor, and a 3/16-inch diameter rod for the inner conductor. The terminating sections require shunt transmission lines with a characteristic impedance of 102 ohms. From (5), the electrical length of the shunt transmission lines is 73 electrical degrees at 700 Mc, corresponding to a physical length

of 3.42 inches. (This must be reduced somewhat in order to include the effect of fringing flux at the open end of the transmission line.) It is good practice to specify the outer conductors of the shunt transmission lines somewhat longer than the inner conductors, in order to confine stray fields which would otherwise appear at the open end of the lines. Finally, the dimensions of the series transmission line must be fixed such that the required value of  $L$  is obtained for each section. If the series transmission line is constructed as shown in Fig. 1 (that is, if it is a coaxial line whose inner and outer conductors are circular cylinders), there is little difficulty in calculating its length and the diameters of the inner and outer conductors. The early designs of the Naval Research Laboratory<sup>7</sup> used a series transmission line composed of a rectangular cylinder for an outer conductor and an inner conductor of circular cross section.

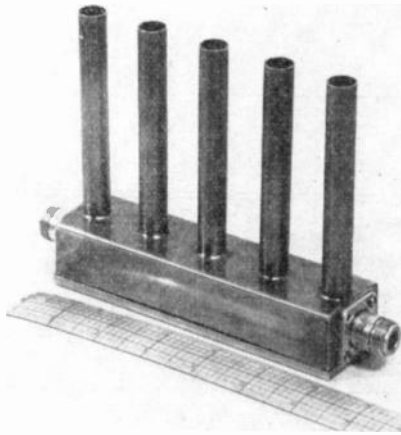

Fig. 4—External view of a low-pass transmission-line filter designed for a cutoff frequency of 700 Mc.

In such cases, perhaps the best method for arriving at a satisfactory design is to estimate the dimensions required and then make a final adjustment by varying the diameter of the inner conductor of the series transmission line. A filter constructed in this way is shown in Fig. 4. The calculated reactive attenuation and experimental insertion-loss curves are plotted in Fig. 5.

#### IV. LOW-PASS TRANSMISSION-LINE FILTERS FOR USE BELOW 2000 MC

If a low-pass transmission-line filter is to have a cutoff frequency in the 1000 to 2000 Mc band, the lead connecting the shunt and series transmission lines may be electrically longer than 5 degrees and, therefore, should be considered in the analysis. This leads to the prototype filter section shown in Fig. 6, where the shunt

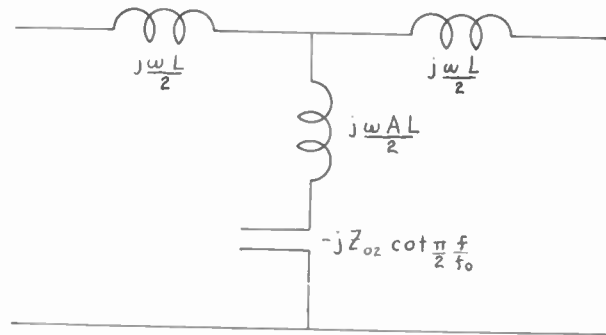

Fig. 6—Equivalent circuit of a mid series-terminated low-pass transmission-line filter prototype including shunt transmission-line lead inductance.

transmission-line lead inductance is taken as  $A$  times the inductance of one of the series-arm inductors. The

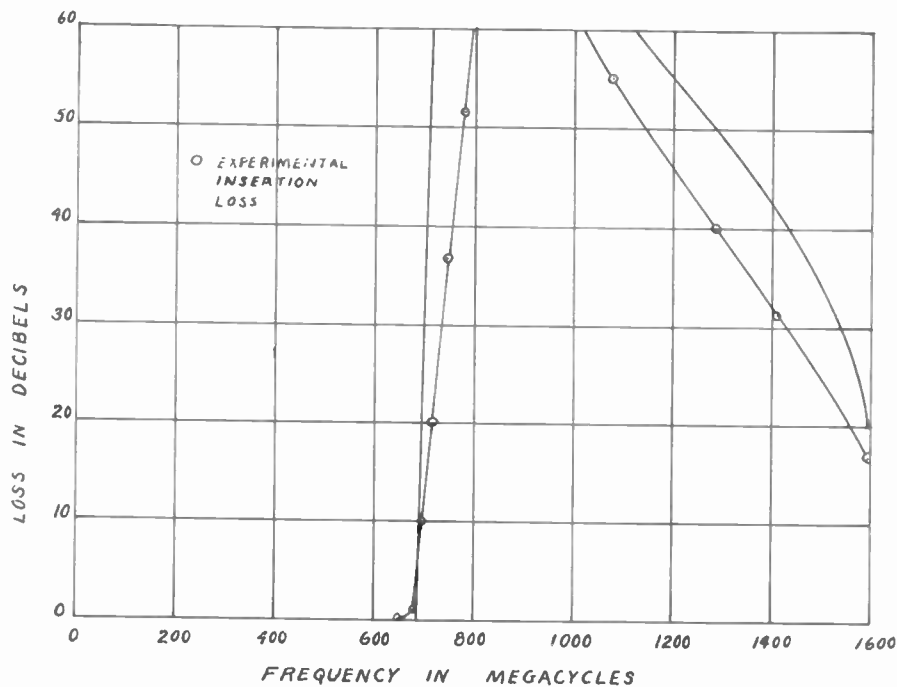

Fig. 5—Calculated attenuation and experimental insertion loss of the low-pass transmission-line filter shown in Fig. 4.



midshunt image impedance is

$$\frac{Z_{0\pi}}{Z_{02}} = \frac{2 \cot \frac{\theta_2 f}{f_c} - \frac{b'A}{(1+2A)} \frac{f}{f_c}}{\sqrt{(1+2A) \left[ \frac{4f_c}{b'f} \cot \frac{\theta_2 f}{f_c} - 1 \right]}} \quad (6)$$

in which

$$b' = 4 \cot \theta_2 = \frac{\omega_c L(1+2A)}{Z_{02}} \quad (7)$$

If the quantities  $A$  and  $b'$  are chosen as design parameters, it remains to determine combinations of these parameters which yield acceptable image-impedance characteristics. An empirical way of doing this is to select an arbitrary value for one of them and then fix the other by use of the relation

$$\left. \frac{Z_{0\pi}}{Z_{02}} \right|_{f/f_c=0.1} = \left. \frac{Z_{0\pi}}{Z_{02}} \right|_{f/f_c=0.7} \quad (8)$$

Typical image-impedance characteristics obtained by this method are shown in Fig. 7. As all of them are relatively "flat," the values of  $A$  and  $b'$  which define any one of them may be used as the basis for a filter design. However, since the design parameter  $A$  merely indicates the value which the shunt transmission-line lead in-

ductance must have and no method of designing a lead which has a given inductance has been given, the problem of specifying the dimensions of a lead in order that it have a prescribed inductance remains to be solved.

Equation (7) indicates that the cutoff frequency of a low-pass transmission-line filter is lowered by the presence of shunt transmission-line lead inductance. If it be assumed that all of the circuit parameters involved in a given filter design may be accurately calculated with the exception of a shunt transmission-line lead inductance, then a laboratory measurement of the cutoff frequency of a sample filter should enable the calculation of  $A$ . One parameter, other than the sought-for lead inductance, requires further refinement in its calculation. This is the electrical length of the shunt transmission line, for the fringing flux at the open end of such a line results in the equivalent electrical length of the line being longer than the actual mechanical dimensions dictate. Two methods of translating this fringing effect into analytical terms are available; either the line may be considered terminated by a capacitor of such magnitude as to electrically simulate the fringing flux, or the line may be considered longer by an amount sufficient to account for the end effect. Using these ideas, a filter design based on the methods of Section III was worked out, but with a cutoff frequency of 1600 Mc—a frequency thought sufficiently high to show up the effect of shunt transmission-line lead inductance. Photographs of this filter are shown in Figs. 8 and 9. It may be seen that the shunt transmission lines are identical for both

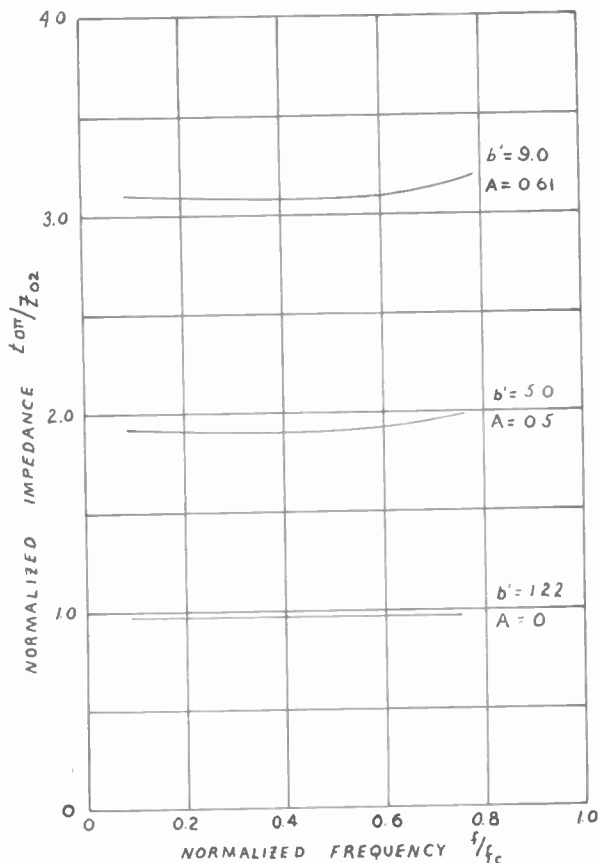

Fig. 7—Typical image-impedance characteristics for the low-pass transmission-line filter prototype shown in Fig. 6 (midshunt termination).

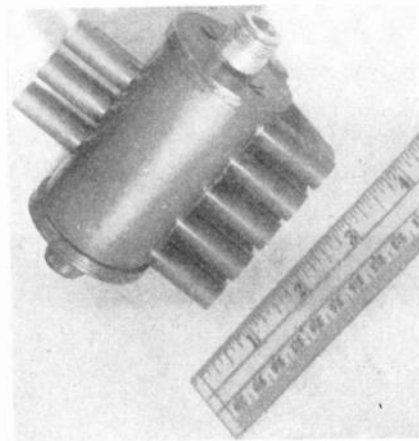

Fig. 8—External view of a low-pass transmission-line filter designed to cut off at 1600 Mc.

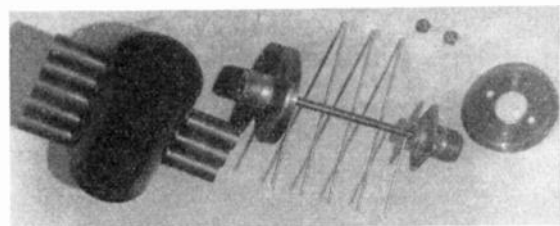

Fig. 9—Internal construction of the filter shown in Fig. 8.

the midseries and midshunt sections; the terminating sections, however, use a single shunt transmission line whereas the midseries sections employ two such lines in parallel. As expected, the experimental cutoff frequency was less than the design value of 1600 Mc. Accordingly, the shunt transmission lines were shortened until the filter cut off at about 1600 Mc. An empirical equation for the calculation of shunt transmission-line lead inductance obtained from these test results is

$$L_s = \frac{\mu}{4\pi} (D_k - d_k) \log_e \frac{3/8l_k}{d_1} \quad (9)$$

where

$L_s$  = shunt transmission-line lead inductance in henries

$\mu$  = permeability,  $1.26 \times 10^{-8}$  for air

$D_k$  = inner diameter of the outer conductor of the series transmission line (cm)

$d_k$  = outer diameter of the inner conductor of the series transmission line (cm)

$l_k$  = length of the series transmission line between adjacent shunt transmission lines (cm)

$d_1$  = diameter of the shunt transmission-line lead (cm).

In order to get a first check of (9), a larger filter having about the same cutoff frequency was constructed as shown in Fig. 10. Calculation of the parameter  $A$  by use of (9) gave a value of 2.09, whereas test results substituted into (7) indicated that  $A$  should be about 2.15.

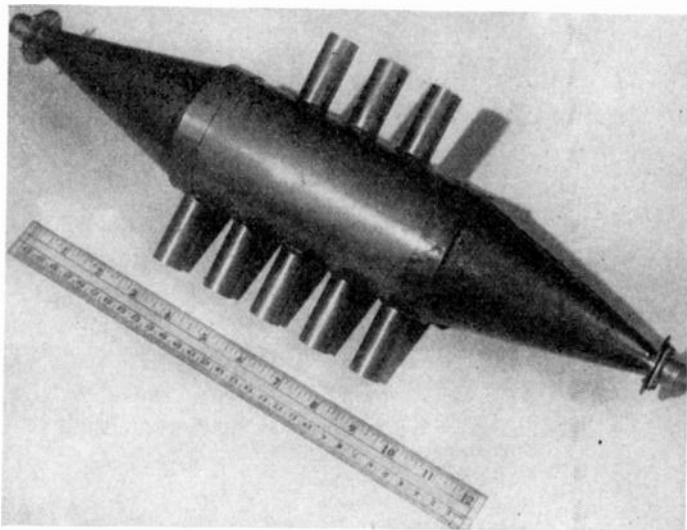

Fig. 10—External view of a mechanically large low-pass transmission-line filter designed to cut off at 1600 Mc. The internal details are substantially the same as for the smaller filter shown in Fig. 12.

Therefore, it appears that for filters having dimensions of the order of those shown in the photographs, the empirical equation (9) may be used.

### V. LOW-PASS TRANSMISSION-LINE FILTERS FOR USE BELOW 3000 Mc

When the cutoff frequency of a transmission-line low-pass filter is extended up to about 3000 Mc, the series transmission line may have to be treated as a true line rather than as a lumped-parameter circuit element. That this is so may perhaps best be shown by comparing the insertion loss of the filters discussed in Section IV with the calculated attenuation. Figs. 11 and

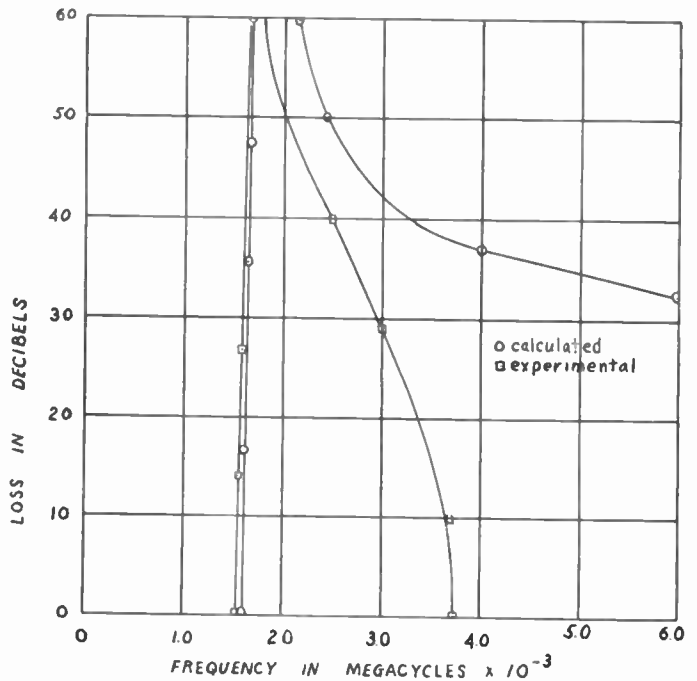

Fig. 11—Calculated attenuation and experimental insertion loss for the low-pass transmission-line filter shown in Figs. 8 and 9. The calculated attenuation is based on the analysis of Section IV.

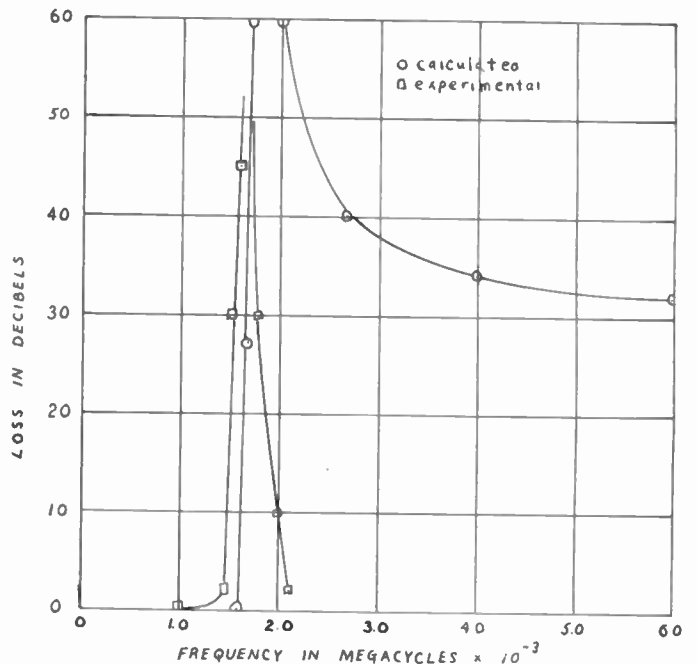

Fig. 12—Calculated attenuation and experimental insertion loss for the low-pass transmission-line filter shown in Fig. 10. The calculated attenuation is based on the analysis of Section IV.

12 show the experimental insertion loss and the reactive attenuation calculated from the equivalent circuit of Fig. 6 for the small and large filters, respectively. No agreement between theoretical and experimental results is evident except in the lower one-third of the frequency band shown. It is not expected that the insertion and attenuation losses should be the same, for they are different quantities; however, the discrepancies shown in Figs. 11 and 12 cannot be explained on this basis.

If the filter analysis is modified in that the series transmission line is treated as a line, and, further, if this series transmission line is represented by its exact equivalent lumped-parameter representation, the filter prototype becomes that shown in Fig. 13, where

$$\begin{aligned} Z_A &= jZ_k \sin 2\phi/f_c \\ Z_B &= -jZ_k \cos \phi/f_c \end{aligned} \tag{10}$$

in which

$Z_k$  = the characteristic impedance of the series transmission line, and

$2\phi$  = the electrical length of this line at the cutoff frequency  $f_c$ . Two new parameters,  $b''$  and  $a$ , are introduced through the defining equations

$$b'' = \frac{\omega_c L_s}{Z_{02}} \quad \text{and} \quad a = Z_k/Z_{02} \tag{11}$$

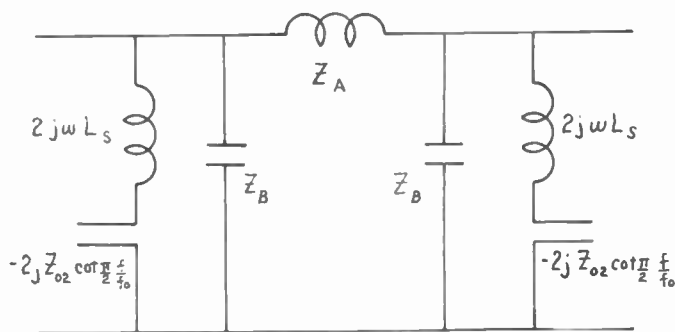

Fig. 13—Equivalent circuit of a midshunt-terminated low-pass transmission-line filter prototype including a more exact representation of the series transmission line.

The equation for the midshunt image impedance is

$$\frac{Z_{0r}}{Z_{02}} = \pm \frac{j[b''f/f_c - \cot \theta_2 f/f_c][a \cot \phi f/f_c]}{[b''f/f_c - \cot \theta_2 f/f_c - a \cot \phi f/f_c] \sqrt{1 + 4Z_2/Z_1}} \tag{12}$$

in which the algebraic sign is chosen such that the impedance is positive when real, and

$$\frac{Z_1}{4Z_2} = \frac{\sin 2\phi f/f_c [b''f/f_c - \cot \theta_2 f/f_c - a \cot \phi f/f_c]}{2 \cot \phi f/f_c [\cot \theta_2 f/f_c - b''f/f_c]} \tag{13}$$

The upper cutoff frequency introduces the relation

$$\frac{-2 \cot \phi [\cot \theta_2 - b'']}{b'' - \cot \theta_2 - a \cot \phi} = \sin 2\phi \tag{14}$$

or

$$b'' = \cot \theta_2 - a \tan \phi \tag{15}$$

In order to illustrate how the introduction of these equations improves the agreement between the experi-

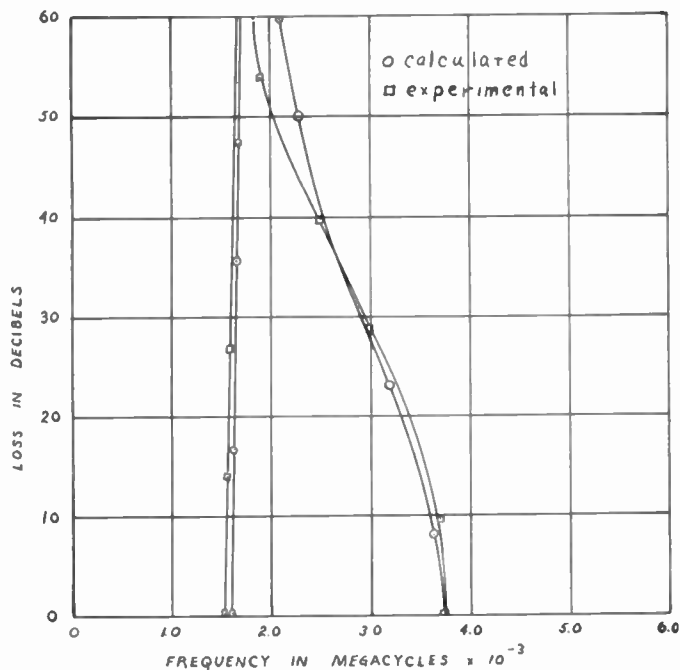

Fig. 14—Calculated attenuation and experimental insertion loss for the low-pass transmission-line filter shown in Figs. 8 and 9. The calculated attenuation is based on the analysis of Section V.

mental insertion loss and calculated reactive attenuation, the parameters  $\phi$ ,  $\theta_2$ ,  $a$ , and  $b''$  were evaluated for each of the filters under consideration, and the reactive attenuation recalculated. The results are shown in Fig. 14 for the small filter and in Fig. 15 for the larger one. A much better agreement between experimental and theoretical results is evident.

To make use of the analysis given in this section, it is necessary that combinations of design parameters yielding relatively flat image-impedance characteristics be obtained. Within limits set by mechanical considerations, any two of the parameters may be arbitrarily chosen and then the third one fixed such that the filter image-impedance characteristic is sufficiently flat in the

pass band. An example of the sort of characteristic which may be expected is shown in Fig. 16, the parameter values being  $a = 2$ ,  $\theta_2 = 0.7$ , and  $\phi = 0.3$ .

### VI. LOW-PASS TRANSMISSION-LINE FILTERS FOR USE BELOW 4000 MC

If a transmission-line low-pass filter is to have a cutoff frequency between 3000 and 4000 Mc, the shunt transmission-line leads may be sufficiently long to war-

rant a transmission-line representation. To illustrate the need for such a refinement, a filter model was constructed to have a cutoff frequency of 3500 Mc, the design method being that of Section V and the particular filter parameters those defining the image-impedance characteristic of Fig. 16. The design details are as follows:

From Fig. 16,

$$\frac{Z_{0\pi}}{Z_{02}} = 0.85, \tag{16}$$

and, in order to match a 52-ohm circuit,

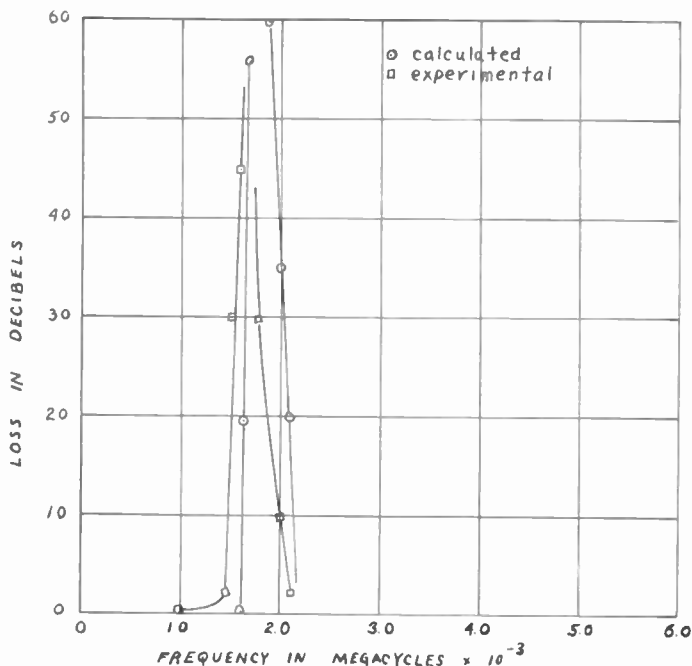

Fig. 15—Calculated attenuation and experimental insertion loss for the low-pass transmission-line filter shown in Fig. 10. The calculated attenuation is based on the analysis of Section V.

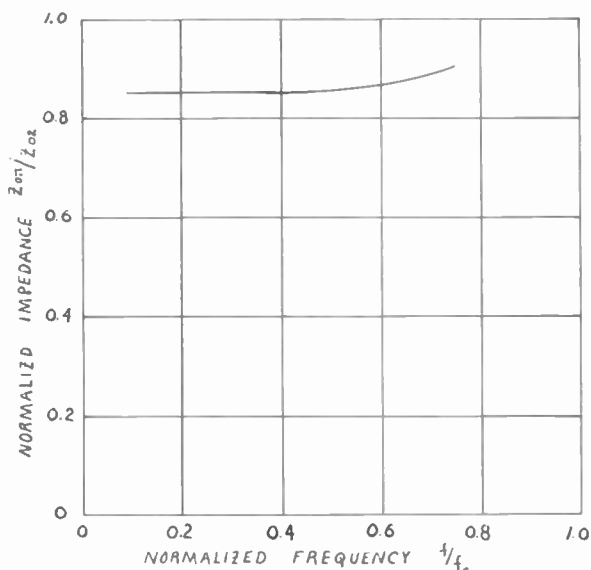

Fig. 16—Image-impedance characteristic derived from the equivalent circuit of Fig. 13. The parameters are  $a=2$ ,  $\phi=0.3$ , and  $\theta_2=0.7$ .

$$Z_{02} = 61.3 = 138 \log_{10} \frac{D_2}{d_2} \tag{17}$$

or

$$D_2 = 2.78d_2. \tag{18}$$

Also,

$$Z_k = 138 \log_{10} \frac{D_k}{d_k} = aZ_{02} = 122.6 \tag{19}$$

or

$$D_k = 7.74d_k. \tag{20}$$

The parameter  $b''$  is evaluated from (15) and is found to be equal to 0.569. From (11), the shunt transmission-line lead inductance is

$$L_s = \frac{9.96 \times 10^{-9}}{2\pi}. \tag{21}$$

Using this value of inductance in the empirical (9) and substituting the value of  $D_k$  in terms of  $d_k$ , there is

$$d_k = \frac{2 \times 0.996}{1.26 \times 6.74 \times \log_{10} \frac{3/8 l_k}{d_1}}. \tag{22}$$

Since  $\phi=0.3$  in the design, the series transmission-line length  $l_k$ , which is  $2\phi$  at the cutoff frequency, becomes 0.322 inch. As one dimension is arbitrary, set  $d_1=1/16$  inch. Then  $d_k$  is 0.14 inch and  $D_k$  becomes 1.08 inch. Mechanically,  $d_1$  and  $d_2$  are equal, since they are the same conductor. This gives

$$D_2 = 2.78d_2 = 2.78d_1 = 0.174 \text{ inch}. \tag{23}$$

The shunt transmission-line length is 0.7 radians at  $f_c$  or 0.375 inch which is reduced to about 0.275 inch when corrected for end fringing. A filter constructed according to these dimensions is shown in the photograph, Fig. 17. When tested, it was found that the shunt line length had to be reduced to 0.10 inch in order to obtain the 3500-Mc

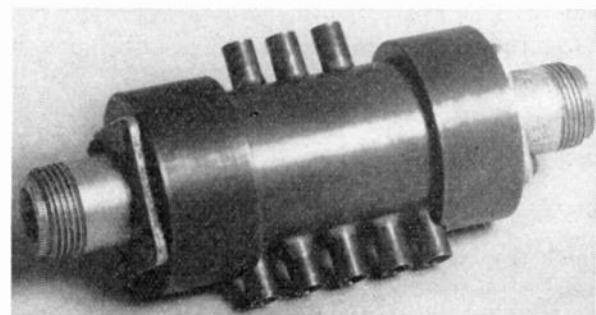

Fig. 17—External view of a low-pass transmission-line filter designed to cut off at 3500 Mc.

cutoff frequency. The large difference between the prescribed and required shunt transmission-line lengths underlines the need for a more exact analysis.

The consideration of the shunt transmission-line connecting lead as a transmission line requires some basis for calculating the electrical parameters of said lead. Since such a lead has as a return conductor the outer conductor of the series transmission line, and its inductance and capacitance are, therefore, functions of position along the lead, an exact representation of it would involve treating it as a nonuniform transmission line. An empirical relation which has yielded results which compare favorably with experiment is based on the assumption that the lead may be treated as a uniform coaxial transmission line in which the inner conductor is the lead itself and an imaginary outer conductor having a diameter equal to the spacing of adjacent shunt transmission lines is postulated. The shunt element of a filter section is then composed of two transmission lines connected in tandem, the first one being the lead to the shunt transmission line and the second the shunt transmission line itself. The input impedance to the combination is, then,

$$Z_i = \frac{jZ_{01} \left[ -Z_{02} \cot \frac{\theta_2 f}{f_c} \cos \frac{\theta_1 f}{f_c} + Z_{01} \sin \frac{\theta_1 f}{f_c} \right]}{Z_{01} \cos \frac{\theta_1 f}{f_c} + Z_{02} \cot \frac{\theta_2 f}{f_c} \sin \frac{\theta_1 f}{f_c}} \quad (24)$$

where

$Z_{01}$  = the characteristic impedance of the shunt transmission-line lead, and

$\theta_1$  = is its electrical length at the cutoff frequency  $f_c$ .

Making the substitution  $Z_{01} = Z_k/d$  and giving the quantity  $a$  the same significance as before, we may write

$$Z_1 = jZ_k \sin 2\phi/f_c \quad (25)$$

and

$$\frac{Z_1}{4Z_2} = \frac{\sin \frac{2\phi f}{f_c} \left[ ad \cot \frac{\phi f}{f_c} + d^2 \cot \frac{\theta_2 f}{f_c} \tan \frac{\theta_1 f}{f_c} \cot \frac{\phi f}{f_c} - a \tan \frac{\theta_1 f}{f_c} + d \cot \frac{\theta_2 f}{f_c} \right]}{2 \cot \frac{\phi f}{f_c} \left[ a \tan \frac{\theta_1 f}{f_c} - d \cot \frac{\theta_2 f}{f_c} \right]} \quad (26)$$

The upper cutoff frequency requires that

$$\begin{aligned} ad \sin 2\phi \cot \phi + d^2 \sin 2\phi \cot \phi \cot \theta_2 \tan \theta_1 \\ - a \sin 2\phi \tan \theta_1 + d \sin 2\phi \cot \theta_2 \\ = 2d \cot \phi \cot \theta_2 - 2a \cot \phi \tan \theta_1, \end{aligned} \quad (27)$$

from which the following may be obtained:

$$\tan \theta_1 = \frac{d \cot \theta_2 \cot \phi - ad}{d^2 \cot \theta_2 + a \cot \phi} \quad (28)$$

$$\tan \theta_2 = \frac{-(d^2 - d \cot \theta_1 \cot \phi)}{ad \cot \theta_1 + a \cot \phi} \quad (29)$$

$$\tan \phi = \frac{d \cot \theta_2 - a \tan \theta_1}{d(a + d \tan \theta_1 \cot \theta_2)} \quad (30)$$

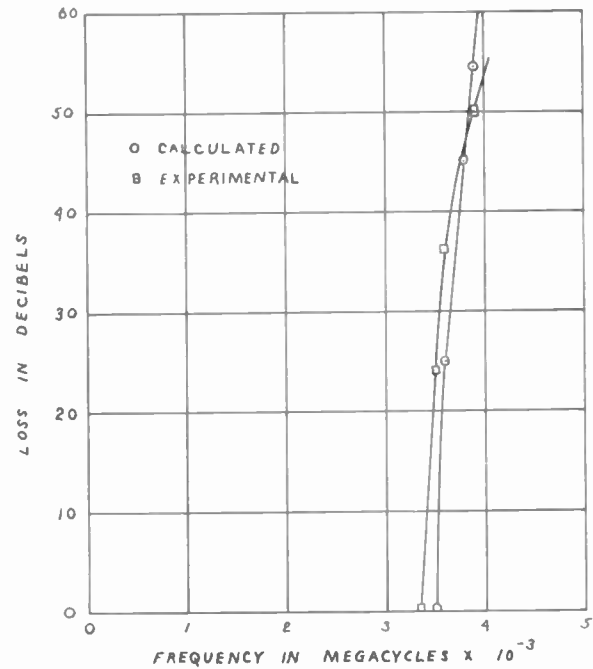

Fig. 18—Calculated attenuation and experimental insertion loss for the filter shown in Fig. 17.

To illustrate what may be expected from this final analysis of the low-pass transmission-line filter, the parameters of the filter defined by (16) to (23) were calculated with the exception of  $\theta_2$ , which resulted in such poor correlation between experimental and theoretical shunt transmission-line length. These are  $a = 2.0$ ,

$d = 1.25$ ,  $\theta_1 = 50^\circ$ , and  $\phi = 17.2^\circ$ . Substitution of these values into (29) gives a value for  $\theta_2$  equal to  $12.05^\circ$ . This is to be compared with the experimental value of  $12.9^\circ$  (corrected for end fringing). The calculated reactive attenuation and measured insertion loss are shown in Fig. 18. Measurements could not be carried above the frequency where the curves end because of limitations imposed by the laboratory test equipment.

#### ACKNOWLEDGMENT

The author wishes to thank R. T. Smith for his contributions to Sections IV and V of this paper.

# Parabolic Loci for Two Tuned Coupled Circuits\*

SZE-HOU CHANG†, ASSOCIATE, IRE

**Summary**—It is pointed out that the reciprocal of the system-response function  $E_1/E_2$ , or its equivalent, of conventional two-mesh tuned coupled circuits when plotted in the complex plane leads to parabolic loci under certain restrictions. The simple geometric properties of parabolas will facilitate the design work and may throw lights as to the applications and limitations of the coupled circuits in different fields, electrical or nonelectrical.

## 1. INTRODUCTION

TUNED COUPLED CIRCUITS have been the subject of many investigations.<sup>1,2</sup> They lead to analytic formulas or sets of precalculated curves. The formulas are usually quite complicated, and an enormous number of curves are usually required to meet the variations in different parameters. This paper points out that the reciprocal of the system-response function<sup>3</sup> of conventional two-mesh tuned coupled circuits, when plotted in the complex plane, will give a parabolic locus under certain restrictions. Many well-known properties of the coupled circuit can thus be deduced from the simple and familiar geometrical properties of the parabola. New lights may be thrown to the adaptabilities or limitations of the coupled circuit in its multiple fields of applications, either electrical or nonelectrical.

For the application in design work, in order to meet the variation in different parameters such as the tightness of coupling, ratios of the  $Q$ 's of the primary and secondary, and their detuning, a complete set of parabolas of different focal lengths, but with common vertex, is drawn. By choice of the proper parabola and the corresponding origin, the system-response function can be read directly with a suitable conversion of the scale of the  $j$  axis for the frequency.

We shall deal with the type of coupled circuits which have a narrow pass band as compared with the central frequency, and the ratios of  $Q$ 's and the detuning of primary and secondary are not too large. We shall also assume that the coupling impedance and the load impedance<sup>4</sup> do not vary very much in the narrow frequency range.

Then follows a specific and detailed treatment of the inductively coupled circuits with the driving voltage in

series with the primary. Conversion to a circuit having a constant-current source in parallel with the primary is well known. The treatment is divided into three cases: (A) primary and secondary circuits identically tuned and having the same  $Q$ ; (B) primary and secondary identically tuned but having different  $Q$ 's; (C) primary and secondary detuned and having different  $Q$ 's. This type of circuit was chosen because it is much discussed in literature and thus makes comparisons easier.<sup>5</sup> The idea can be extended to other types of circuits with similar restrictions.

## 2. GENERAL CIRCUIT WITH CONSTANT-VOLTAGE DRIVING SOURCE IN SERIES WITH THE PRIMARY

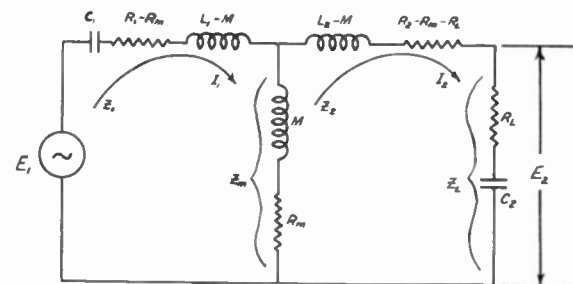

Fig. 1—General two coupled circuits with driving voltage in series with the primary.

The voltage at the output in Fig. 1 is

$$E_2 = I_2 Z_L = \frac{-E_1 Z_m Z_L}{Z_1 Z_2 - Z_m^2} \quad (1)$$

The reciprocal of the system-response function is

$$\frac{E_1}{E_2} = -\frac{1}{Z_m Z_L} (Z_1 Z_2 - Z_m^2) \quad (2)$$

To reduce the discussion to one of the dimensionless parameters, let

$$\frac{R_1 R_2}{Z_m Z_L} = g \quad (3)$$

$$\frac{Z_1}{R_1} = z_1 \quad (4)$$

$$\frac{Z_2}{R_2} = z_2 \quad (5)$$

and

$$\frac{Z_m^2}{R_1 R_2} = z_m^2 \quad (6)$$

Then (2) becomes

$$\frac{E_1}{E_2} = -g(z_1 z_2 - z_m^2) \quad (7)$$

\* See footnote references 1 and 2.

\* Decimal classification: R142.3. Original manuscript received by the Institute, February 14, 1947; revised manuscript received, June 28, 1948. Presented, 1947 IRE National Convention, New York, N. Y., March 4, 1947.

† Northeastern University, Boston, Mass.; formerly, Cambridge Field Station, AMC, Cambridge, Mass.

<sup>1</sup> C. B. Aiken, "Two-mesh tuned coupled circuit filters," *Proc. I.R.E.*, vol. 25, pp. 230-273; February, 1937.

<sup>2</sup> F. E. Terman, "Radio Engineers' Handbook," McGraw-Hill Book Co., New York, N. Y., 1943; section 3, pars. 3-9 and their included references.

<sup>3</sup> The reciprocal of the system-response function is here defined as  $E_1/E_2$  where  $E_1$  and  $E_2$  are voltages at input and output, respectively.

<sup>4</sup> The load impedance is here used to mean the portion of impedance of the secondary circuit across which  $E_2$  is developed; i.e.,  $Z_L = E_2/I_2$ .

Under the assumptions that the frequency range is narrow and  $Z_m$  and  $Z_L$  contain elements so that  $z_m^2$  and  $g$  vary very little with frequency as compared with  $z_1z_2$ , we may regard  $z_m^2$  and  $g$  as constant, although they may be complex.

Now, let

$$\frac{E_1}{E_2} / g = S/\theta. \tag{8}$$

Substituting (8) into (7),

$$S/\theta = \frac{E_1}{E_2} / g = -z_1z_2 + z_m^2. \tag{9}$$

The only variable part now left in the right-hand side is  $-z_1z_2$ , which we shall discuss more in detail.

From (4) and (5),

$$z_1 = \frac{Z_1}{R_1} = \frac{R_1 + jX_1}{R_1} = 1 + jx_1 \tag{10}$$

$$z_2 = \frac{Z_2}{R_2} = \frac{R_2 + jX_2}{R_2} = 1 + jx_2 \tag{11}$$

where

$X_1$  = total reactance of the primary circuit alone

$X_2$  = total reactance of the secondary circuit alone

$$\begin{aligned} x_1 &= \frac{X_1}{R_1} = j \frac{\left(\omega L_1 - \frac{1}{\omega C_1}\right)}{R_1} = j \frac{\omega_1 L_1}{R_1} \left(\frac{\omega}{\omega_1} - \frac{\omega_1}{\omega}\right) \\ &= jQ_1 \left(\frac{\omega}{\omega_1} - \frac{\omega_1}{\omega}\right) \end{aligned} \tag{12}$$

$$\begin{aligned} x_2 &= \frac{X_2}{R_2} = j \frac{\left(\omega L_2 - \frac{1}{\omega C_2}\right)}{R_2} = j \frac{\omega_2 L_2}{R_2} \left(\frac{\omega}{\omega_2} - \frac{\omega_2}{\omega}\right) \\ &= jQ_2 \left(\frac{\omega}{\omega_2} - \frac{\omega_2}{\omega}\right) \end{aligned} \tag{13}$$

$$\left. \begin{aligned} \omega_1 &= \frac{1}{\sqrt{L_1 C_1}} \\ \omega_2 &= \frac{1}{\sqrt{L_2 C_2}} \end{aligned} \right\} \tag{14}$$

$$Q_1 = \frac{\omega_1 L_1}{R_1}$$

$$Q_2 = \frac{\omega_2 L_2}{R_2}$$

Hence,

$$\begin{aligned} -z_1z_2 &= -(1+jx_1)(1+jx_2) \\ &= -\left[1+jQ_1\left(\frac{\omega}{\omega_1}-\frac{\omega_1}{\omega}\right)\right]\left[1+jQ_2\left(\frac{\omega}{\omega_2}-\frac{\omega_2}{\omega}\right)\right]. \end{aligned} \tag{15}$$

We shall discuss the following cases:

Case (A). Primary and secondary identically tuned and having the same  $Q$ .

Case (B). Primary and secondary identically tuned but having different  $Q$ 's.

Case (C). Primary and secondary detuned and having different  $Q$ 's.

Case (A).  $\omega_1 = \omega_2, Q_1 = Q_2$

Let

$$\left. \begin{aligned} \omega_1, \omega_2 &= \omega_0 \\ Q_1, Q_2 &= Q_0 \\ x_1 = x_2 &= x \\ z_1 = z_2 &= z \end{aligned} \right\} \tag{16}$$

Then

$$-z_1z_2 = -z^2 = -(1+jx)^2 = -(1-x^2) - j2x. \tag{17}$$

Let  $u$  and  $v$  be the real and imaginary part of  $z_1z_2$ , respectively; then

$$u = -(1-x^2) \tag{18}$$

$$v = -2x. \tag{19}$$

Here  $x$  is a variable with respect to frequency, and, by eliminating it from (18) and (19), we get

$$v^2 = 4(1+u) \tag{20}$$

which is an equation for the parabola, with vertex at  $(u, v) \equiv (-1, 0)$  and focus at the origin, the latus rectum is equal to 4. See Fig. 2.

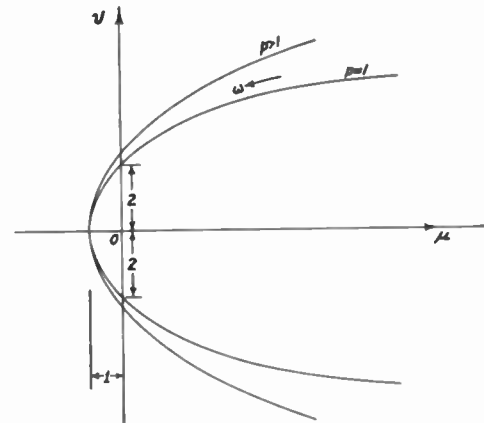

Fig. 2—Parabolic plottings of  $-z_1z_2$  in complex plane for case (A)

$$(\omega_1 = \omega_2, Q_1 = Q_2) \text{ and case (B) } \left(\omega_1 = \omega_2, \frac{Q_2}{Q_1} = e\right).$$

Case (B).  $\omega_1, \omega_2 = \omega_0, Q_1 = Q_0, Q_2 = eQ_0$

Let

$$\left. \begin{aligned} \frac{\omega}{\omega_1} - \frac{\omega_1}{\omega} &= \frac{\omega}{\omega_2} - \frac{\omega_2}{\omega} = \frac{\omega}{\omega_0} - \frac{\omega_0}{\omega} = \delta \\ x_1 &= jQ_0\delta \\ x_2 &= jeQ_0\delta \\ z_1 &= 1 + jQ_0\delta \\ z_2 &= 1 + jeQ_0\delta \end{aligned} \right\} \tag{21}$$

Then

$$\begin{aligned} -z_1 z_2 &= -(1 + jQ_0 \delta)(1 + jeQ_0 \delta) \\ &= -(1 - eQ_0^2 \delta^2) - jQ_0 \delta(1 + e) \end{aligned} \quad (22)$$

and

$$u = -(1 - eQ_0^2 \delta^2) \quad (23)$$

$$v = -Q_0 \delta(1 + e). \quad (24)$$

Eliminating  $\delta$ , which is variable with respect to  $\omega$ , from (23) and (24), we get

$$v^2 = \frac{(1 + e)^2}{e} (1 + u). \quad (25)$$

Let

$$p = \frac{1}{4} \frac{(1 + e)^2}{e}. \quad (26)$$

Then (25) becomes

$$v^2 = 4p(1 + u). \quad (27)$$

This is also an equation of parabola, with vertex at  $(u, v) \equiv (-1, 0)$ , and the latus rectum is  $4p$ . (See Fig. 2.)

Case (C).  $\omega_1 \neq \omega_2$ ,  $Q_1 \neq Q_2$

Let

$$\left. \begin{aligned} Q_1 &= Q_0 \\ Q_2 &= eQ_0 \\ \omega_1 &= \omega_0 \\ \omega_2 &= h\omega_0 \end{aligned} \right\} \quad (28)$$

Then

$$\begin{aligned} x_1 &= Q_1 \delta_1 = Q_1 \left( \frac{\omega}{\omega_1} - \frac{\omega_1}{\omega} \right) = Q_1 \left( \frac{\omega^2 - \omega_1^2}{\omega \omega_1} \right) \\ &= Q_1 \frac{\omega + \omega_1}{\omega \omega_1} (\omega - \omega_1) = 2Q_1 \frac{(\omega - \omega_1)^{**}}{\omega_1} \\ &= 2Q_1 (\gamma_1 - 1) = 2Q_0 (\gamma - 1) \end{aligned} \quad (29)$$

$$x_2 = 2Q_2 (\gamma_2 - 1) = 2eQ_0 \left( \frac{\gamma}{h} - 1 \right) \quad (30)$$

where

$$\begin{aligned} \gamma_1 &= \frac{\omega}{\omega_1} = \gamma \\ \gamma_2 &= \frac{\omega}{\omega_2} = \frac{\gamma}{h} \end{aligned} \quad (31)$$

and

$$\begin{aligned} -z_1 z_2 &= - \left[ 1 + j2Q_0 (\gamma - 1) \right] \left[ 1 + j2eQ_0 \left( \frac{\gamma}{h} - 1 \right) \right] \\ &= - \left[ 1 - 4eQ_0^2 (\gamma - 1) \left( \frac{\gamma}{h} - 1 \right) \right] \\ &\quad - j2Q_0 \left[ \gamma \left( 1 + \frac{e}{h} \right) - (1 + e) \right]. \end{aligned} \quad (32)$$

The real part is

$$u = - \left[ 1 - 4eQ_0^2 (\gamma - 1) \left( \frac{\gamma}{h} - 1 \right) \right], \quad (33)$$

and the imaginary part is

$$v = -2Q_0 \left[ \gamma \left( 1 + \frac{e}{h} \right) - 1 + e \right]. \quad (34)$$

Eliminating  $\gamma$  from (33) and (34), we get

$$(v - \beta)^2 = 4p[u + (1 + \alpha)] \quad (35)$$

where

$$p = \frac{1}{4} \frac{(h + e)^2}{eh} \quad (36)$$

$$\alpha = \frac{e}{h} Q_0^2 (h - 1)^2 \quad (37)$$

$$\beta = \frac{Q_0 (h - 1)(e - h)}{h}. \quad (38)$$

Equation (35) is again an equation of parabola, but here the vertex is at  $(u, v) \equiv (-1 - \alpha, \beta)$  and the  $u$ -axis is no longer the axis of symmetry. (See Fig. 3.)

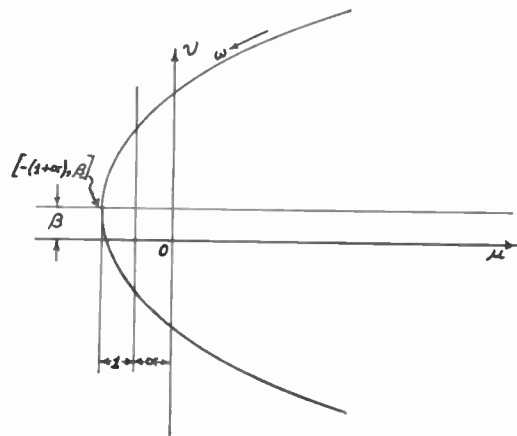

Fig. 3—Parabolic plotting of  $-z_1 z_2$  in complex plane for case (C)

$$\left( \frac{\omega_2}{\omega_1} = h, \frac{Q_2}{Q_1} = e \right).$$

### 3. PARABOLIC PLOTTINGS OF THE RECIPROCAL OF SYSTEM-RESPONSE FUNCTION IN COMPLEX PLANE

For convenience sake, we reproduce (9).

$$S/\theta = \frac{E_1}{E_2} / g = -z_1 z_2 + z_m^2. \quad (39)$$

We have shown in Sections 3 to 5 that the loci of  $-z_1 z_2$  are parabolas for three cases; we have assumed that the frequency range is narrow, and thus  $z_m^2$  and  $g$  may be regarded as constant. Referring to (39), the addition of  $z_m^2$  to  $-z_1 z_2$  is a linear transformation, which results in a translation of the original parabola of  $-z_1 z_2$ . The factor  $+z_m^2$  is a real dimensionless quantity if the coupling is purely resistive, inductive, or capacitive. For complex couplings, it will be complex.



So long as  $g$  may be regarded as constant,  $S/\theta$  will give both the relative amplitude and phase characteristic of the reciprocal of the system-response function  $E_1/E_2$ . If  $g$  is not constant and its variation with frequency is known,  $E_1/E_2$  may be found by multiplying the vector from the parabolic plotting by  $g$ .

The amplitude and phase characteristics of system-response function are usually plotted against frequency. Means for the determination of frequency scale can be found from the expression for  $v$ . Take the case (C), which is the most general, from (34).

$$v = -2Q_0 \left[ \gamma \left( 1 + \frac{e}{h} \right) - (1 + e) \right]$$

$$= -2Q_0 \left[ (\gamma - 1) \left( 1 + \frac{e}{h} \right) - e \left( 1 - \frac{1}{h} \right) \right]. \quad (40)$$

This expression is subject to the assumption that  $(\omega + \omega_1)/\omega\omega_1 = 2/\omega_1$  and  $(\omega + \omega_2)/\omega\omega_2 = 2/\omega_2$ .

Let

$$a = \gamma - 1 = \frac{\omega - \omega_0}{\omega_0}. \quad (41)$$

Equation (40) becomes

$$v = -2Q_0 \left[ a \left( 1 + \frac{e}{h} \right) - e \left( 1 - \frac{1}{h} \right) \right]. \quad (42)$$

Solving for  $a$ ,

Case (C).  $a = \left[ -\frac{v}{2Q_0} + e \left( 1 - \frac{1}{h} \right) \right] \frac{h}{h + e} \quad (43)$

Case (B).  $h = 1$

$$a = -\frac{v}{2Q_0} \frac{1}{1 + e} \quad (44)$$

Case (A).  $e = 1$

$$a = -\frac{v}{4Q_0}. \quad (45)$$

Equations (45) to (43) show that the fractional frequency deviation  $a$  is directly proportional to the scale of the  $v$ -axis.

A set of parabolas with different  $p$ 's corresponding to different ratios of  $Q_2/Q_1 = e$  and  $\omega_2/\omega_1 = h$  should be constructed. (See Fig. 4.) The correspondence between  $e$ ,  $h$ , and  $p$  as given by (36) is reproduced here.

Case (C).  $p = \frac{1}{4} \frac{(h + e)^2}{eh}. \quad (46)$

Case (B).

$$h = 1$$

$$p = \frac{1}{4} \frac{(1 + e)^2}{e}. \quad (47)$$

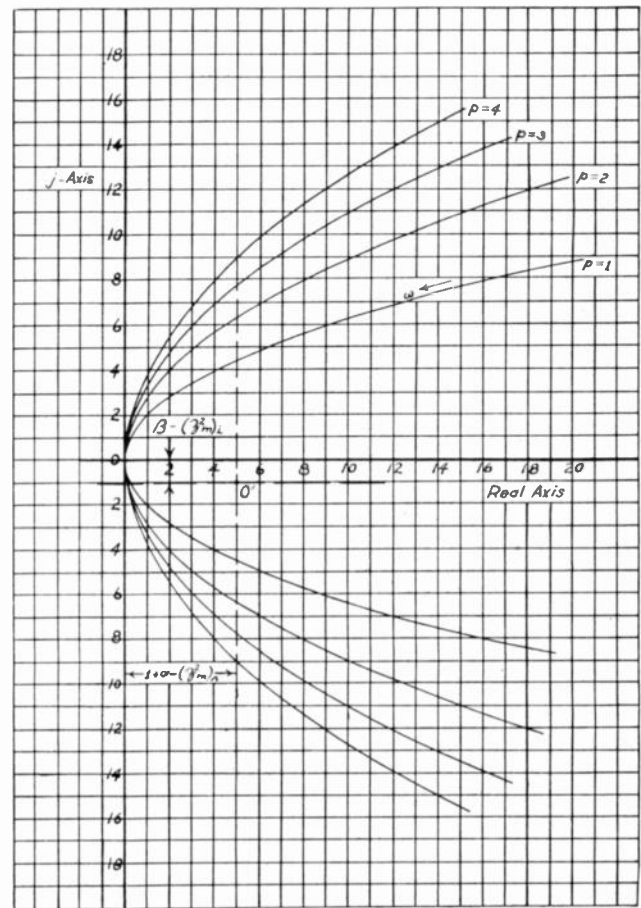

Fig. 4—Parabolic loci of  $\frac{E_1}{E_2}/g$  in complex plane for two coupled circuits.

Case (A).  $e = 1$   
 $p = 1. \quad (48)$

The vertex is located at:

Case (C).  $(u, v) \equiv [1 + \alpha - (z_m^2)_r, \beta - (z_m^2)_i]$

$$\left. \begin{aligned} \alpha &= \frac{e}{h} Q_0^2 (h - 1)^2 \\ \beta &= \frac{Q_0 (h - 1)(e - h)}{h} \end{aligned} \right\} \quad (49)$$

$$z_m^2 = \frac{Z_m^2}{R_1 R_2} = (z_m^2)_r + j(z_m^2)_i$$

Case (B).  $h = 1$   
 $\alpha = \beta = 0$

$$(u, v) \equiv [1 - (z_m^2)_r, - (z_m^2)_i]. \quad (50)$$

Case (A). Same as case (B).

$$(u, v) \equiv [1 - (z_m^2)_r, - (z_m^2)_i]. \quad (51)$$

In order to get the reciprocal of the system-response function

$$\frac{E_1}{E_2}/g$$

( $S$ , amplitude, and  $\theta$ , phase) for the coupled circuits, we may summarize the procedure as follows:

- (a) Compute  $e$ ,  $h$ ,  $p$ ,  $\alpha$ ,  $\beta$ , and  $z_m^2$  from the given data.
- (b) Choose the parabola with the proper  $p$  as computed in (a) and Fig. 4.
- (c) Determine the origin so that the vertex of the parabola is given by (49), (50), or (51).

(d) A transparent polar co-ordinate paper or cellulose sheet can be put over the parabola with the center set at the chosen origin.  $S$  and  $\theta$  can then be read directly on the parabola with the aid of a rotating bar pivoted at the center.

(e) The frequency is proportional to the scale of  $j$ -axis according to (43), (44), or (45).

(f) If coupled circuits are cascaded by isolating vacuum tubes the magnitude of the over-all response can be obtained by adding the ratio of  $E_1/E_2$  expressed in db; the angle can also be added directly.

## Contributors to Proceedings of the I.R.E.



SZE-HOU CHANG

Sze-Hou Chang (S'46-A'48) was born on September 23, 1913, in Ningpo, Chekiang, China. He was graduated from Chiao Tung University in Shanghai, with the B.S. degree in electrical communications in 1934. In 1946 he received the M.S. degree in communications engineering, and in 1948, the Ph.D. degree in engineering sciences and applied physics, both from Harvard University.

During the period 1934-1945, Dr. Chang served successively as assistant, lecturer, and professor in Tsing Hua University, Hunan University, and Chiao Tung University, all in China. He was associated with the Air Force's Electronic Research Laboratories (formerly, Cambridge Field Station of the Watson Laboratories) in Cambridge, Mass., as an electronic engineer from 1946 until 1948.

Dr. Chang is now associate professor of electronic research at Northeastern University, in Boston, Mass.

Wisconsin Alumni Research Scholar, Fellow and Research Assistant, receiving the Ph.D. degree in electrical engineering in 1941. He was associated with the research department of the RCA Manufacturing Co., at Harrison, N. J., until 1942, transferring then to RCA Laboratories Division at Princeton, N. J., as a research engineer working on uhf and microwave power tube problems.

In October, 1946, Dr. Hegbar joined the Goodyear Aircraft Corporation, in Akron, Ohio. He is a member of Sigma Xi, Tau Beta Pi, Phi Kappa Phi, and Gamma Alpha.



J. F. HULL

❖

Joseph F. Hull was born in Montello, Wis., on August 25, 1921. He received the B.S. degree in electrical engineering from the University of Wisconsin in June, 1943. He joined the U. S. Army Enlisted Reserve Corps in 1942, but was placed on inactive status during the war in order that he might carry on research work at the General Electric Research Laboratory, under the sponsorship of the Office of Scientific Research and Development. From 1943 to October, 1945, he worked on the development of high-power continuous-wave magnetrons for radar countermeasures at the General Electric Company.

On October 3, 1945, Mr. Hull was called to active duty by the Army and was assigned directly to the Thermionics Branch of the Signal Corps Engineering Laboratories, Belmar, N. J., to carry on research in the field of microwaves. He was discharged from the Army on March 1, 1946, and has since been employed as a civilian research engineer by the Signal Corps. He is a member of Tau Beta Pi and Eta Kappa Nu.



DOUGLAS E. MODE

Douglas E. Mode (SM'46) was born on April 4, 1911, in Brandon, Manitoba, Canada. He was graduated from the University of Pennsylvania, Moore School of Electrical Engineering, with the degrees of B.S. in 1935, M.S. in 1937, and Ph.D. in 1947. He

joined the engineering staff of the General Electric Co. in 1936, where he was engaged in the design and development of magnetic and electronic relaying devices.

In 1940 Dr. Mode became an instructor in electrical engineering at Lehigh University and was made an assistant professor in 1941, in which capacity he served until early 1944. On leave from Lehigh University, he joined the Columbia University Underwater Sound War Research Group at New London, Conn., later transferring to the Radiation Laboratory at MIT.

Returning from war work, Dr. Mode again took up teaching duties at Lehigh University, where he is now an associate professor of electrical engineering. He is a member of Eta Kappa Nu, Tau Beta Pi, and Sigma Xi.

❖

For a photograph and biography of HOWARD L. ANDREWS, see page 1132 of the September, 1948, issue of the PROCEEDINGS of the I.R.E.

❖

For a photograph and biography of R. E. LAPP, see page 1132 of the September, 1948, issue of the PROCEEDINGS OF THE I.R.E.



H. R. HEGBAR

Howard R. Hegbar (S'41-A'42-SM'46) was born in Valley City, N.D., on February 22, 1915. He received the B.S. degree in electrical engineering from the North Dakota Agricultural College in 1937. He then attended the University of Wisconsin as a

# Contributors to Proceedings of the I.R.E.



A. W. RANDALS

Arthur W. Randals was born in St. Louis, Mo., on January 21, 1920. He received the B.S. degree in physics from Lincoln University in Missouri in 1941. In 1942 Mr. Randals received an appointment to the Signal Corps Engineering Laboratory at Camp

Evans, Belmar N. J. Since 1943 he has been with the Thermionics Branch, Vacuum-Tube Development Section, at this Laboratory. At the present time he holds the position of research physicist, and is engaged in research and development problems of magnetrons.

Mr. Randals is also attending the graduate school of the Stevens Institute of Technology, where he is pursuing graduate study in the field of physics.



For a photograph and biography of J. D. NOE, see page 1003 of the August, 1948, issue of the PROCEEDINGS OF THE I.R.E.



For a photograph and biography of BERNARD M. OLIVER, see page 504 of the April, 1948, issue of the PROCEEDINGS OF THE I.R.E.



Claude E. Shannon was born in Petoskey, Mich., on April 30, 1916. He received the B.S. degree in electrical engineering from the University of Michigan in 1936, and the degrees of S.M. in electrical engineering and Ph.D. in mathematics from the Massachusetts Institute of Technology in 1940. In 1941 he was a National Research Fellow, and since then has been working at the Bell Telephone Laboratories.



C. E. SHANNON



GEORGE SINCLAIR

George Sinclair (A'37-SM'46) was born in Hamilton, Ontario, Canada, on November 5, 1912. He received the B.Sc. degree in electrical engineering in 1933 and the M.Sc. degree in 1935 from the University of Alberta, and the Ph.D. degree in 1946 from the Ohio State University. Dr. Sinclair was an instructor in electrical engineering at the University of Alberta for one year, and engineer for the Northern Broadcasting Corporation for two years.

From 1941 to 1947 Dr. Sinclair was a research associate in the department of electrical engineering of the Ohio State University, supervising the research program of the Antenna Laboratory. He is now an assistant professor of electrical engineering at the University of Toronto, and is also a consultant to the Ohio State University Antenna Laboratory.



Philip T. Smith (A'38-SM'46) was born on September 16, 1902, in St. Paul, Minn. He received the B.A. degree from the University of Minnesota in 1927, majoring in physics. He then attended the same University as a teaching assistant in physics, receiving the Ph.D. degree in 1931. From 1931 to 1933 he was a Rockefeller Research Fellow at the University of Minnesota, and the following year, he was a National Research Fellow in physics at Princeton University. He was an instructor of physics at the Massachusetts Institute of Technology until 1937.

Dr. Smith joined the Research staff of the RCA Manufacturing Company at Harrison, N. J., remaining until 1942, when he transferred to RCA Laboratories Division at Princeton, N. J., as a research engineer working on uhf problems. He is a member of the American Physical Society, Sigma Xi, and Gamma Alpha.



PHILIP T. SMITH



A. M. SKELLETT

A. Melvin Skellett (M'44) was born in 1901 in St. Louis, Mo. He received the A.B. and M.S. degrees from Washington University in 1924 and 1927, respectively, and the Ph.D. degree from Princeton University in 1933. He was an assistant professor of physics at the University of Florida during 1927 and 1928, and from 1929 until 1944 he was employed by the Bell Telephone Laboratories as a member of the technical staff.

Dr. Skellett is vice-president in charge of research of the National Union Radio Corporation in Orange, N. J. He is also a consultant to the Research and Development Board in the Department of National Defense of the United States Government.



For a photograph and biography of J. R. PIERCE, see page 1003 of the August, 1948, issue of the PROCEEDINGS OF THE I.R.E.



For a photograph and biography of C. T. TAI, see page 504 of the April, 1948, issue of the PROCEEDINGS OF THE I.R.E.



Howard M. Zeidler (M'45) was born in 1919 at Eudora, Kan. He received the B.S. degree from Kansas State College in 1941, and the S.M. degree from the Massachusetts Institute of Technology in 1943. From 1943 to 1946, he was a research associate at the Radio Research Laboratory at Harvard University, a portion of that period being spent as a technical representative with the

Army Air Forces in the Mediterranean Theatre of Operations.

Since 1946, Mr. Zeidler has been employed as an engineer at the Hewlett Packard Company in Palo Alto, Calif. He is a member of Sigma Xi Phi Kappa Phi, Sigma Tau, and Eta Kappa Nu.



H. M. ZEIDLER

# Correspondence

## Avenues of Improvement in Present-Day Television\*

I have read Mr. Fink's paper<sup>1</sup> with great interest. I was particularly impressed with his discourse on "geometric distortion," for this problem has been of interest to us here for some years.

Practically speaking, let me point out that the reason for geometric distortion originating in camera equipment is due to the following:

1. *Ambient gradient* surrounding the components in circuits which are responsible for the generation and amplification of the sawtooth currents and potentials necessary in the scanning systems. Changes in temperature of the air surrounding components (particularly capacitors), in circuits where the "saws" are produced, result in a change in the electrical constants of these components during periods of operation, resulting in nonlinearity of the sawtooth wave forms. Even when so-called negative-temperature-coefficient components are used, for instance, the difficulty still persists. This has been proved here by checking ambient temperature gradient in critical scanning circuits against changes in the degree of linearity of sawtooth wave forms.

2. The failure of the industry, as was said, universally to adopt a technique such as that suggested six years ago by Duke in his paper.<sup>2</sup>

3. The failure of the industry to develop sawtooth-generating circuits of greater stability for application to commercial television apparatus. Such circuits can be greatly improved, and with little research.

In the last instance ((3) above), I would like to point out the work of H. S. Black of Bell Telephone Laboratories in the development of feedback circuits, some of which can be applied to stabilize "saw" generating circuits. The use of inverse feedback for this purpose has already been pointed out by Groves,<sup>3</sup> and a circuit which can be modified for use in a sawtooth-generating circuit has been developed.<sup>4</sup> In this system, the exponential charge of a capacitor (producing a sawtooth wave) is fed back in series with the input potential, the out-of-phase potential compensating for the nonlinear rise of the exponential capacitor discharge.

The linearization of electromagnetic deflection currents by means of negative feedback has also been accomplished by a number of workers.<sup>5</sup> In one feedback circuit, the negative feedback arrangement has been

found to maintain the sawtooth current constant within 0.05 per cent.

In closing, let me say that the maintenance technicians at DuMont television Network stations religiously follow the problem of geometric distortion day by day in an effort to seek some improvement. However, with the circuits in use in this country today, ambient gradient in the equipment is such—particularly over long periods of operation—that "linearity," even though perfectly achieved before "program time," will not hold over long periods of operation. More stable circuits are needed.

I would suggest some work on the part of all the manufacturers toward applying inverse feedback to scanning potential generators and amplifiers. I think that herein will lie some hope of a successful solution to this embarrassing problem.

Our manufacturing organization is already applying the principles of inverse feedback to television equipment, and our new dual iconoscope film chain, in particular, makes use of such circuits in the deflection system. This equipment is just now coming off the production line.

SCOTT HELT  
Chief Engineer

Allen B. DuMont Laboratories  
New York, N. Y.

## Cathode-Follower Oscillators\*

Some recent papers have described cathode followers as oscillators.<sup>1,2</sup> Another interesting approach in analyzing this type of

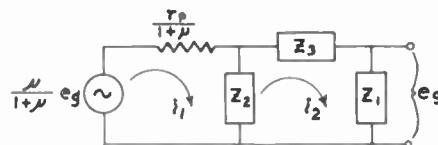

Fig. 1

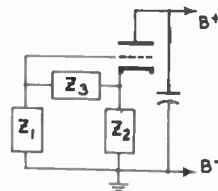

Fig. 2

oscillator is to solve the loop equations of the equivalent circuit (Fig. 1.) for the generalized oscillator (Fig. 2) under conditions of sustained oscillation. The relations between the various parameters can be expressed by the following determinantal equation:

$$\begin{vmatrix} \frac{r_p}{1+\mu} + Z_2 & -\left(Z_2 + \frac{\mu}{1+\mu} Z_1\right) \\ -Z_2 & Z_1 + Z_2 + Z_3 \end{vmatrix} = 0,$$

or when expanded, as:

$$r_p(Z_1 + Z_2 + Z_3) + (1 + \mu)Z_2Z_3 + Z_1Z_2 = 0. \quad (1)$$

This equation is the classical Barkhausen equation, and demonstrates the important fact that, independent of the point of grounding, the steady-state conditions for oscillation are identical.

If, in the determinant, the following approximations are made:

$$\frac{r_p}{1+\mu} \approx \frac{1}{gm} \quad \text{and} \quad \frac{\mu}{1+\mu} \approx 1,$$

then (1) is simply:

$$\frac{Z_1 + Z_2 + Z_3}{gm} + Z_2Z_3 = 0.$$

It can be seen that, in addition to the case having a capacitive  $Z_2$  and  $Z_3$ , there is also a cathode-follower oscillator requiring inductive components for these two impedances. In general,  $Z_2$  and  $Z_3$  must be of similar reactive component to make an oscillator.

The cathode-follower oscillator can be made a crystal oscillator by replacing an inductive arm with a crystal. If the cathode is capacitive, then the crystal can be placed from grid to ground, replacing  $Z_1$ ; while, if the cathode is inductive, the crystal can be placed from grid to cathode, replacing  $Z_3$ . These two possibilities are cathode-follower versions of the Pierce and Miller crystal oscillators, with the plate grounded instead of the cathode. A 10-Mc Pierce cfo is shown

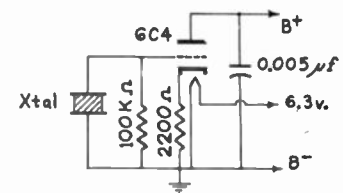

Fig. 3

in Fig. 3, where maximum use has been made of interelectrode capacitances. At lower frequencies, the grid-to-cathode and cathode-to-ground capacitances must be increased.

It can be seen that grounding the plate allows simpler circuit configurations.

L. ROSENTHAL  
Rutgers University  
New Brunswick, N. J.

\* Received by the Institute, July 9, 1948.

<sup>1</sup> D. G. Fink, "Avenues of improvement in present-day television," Proc. I.R.E., vol. 36, pp. 896-906; July, 1948.

<sup>2</sup> Vernon Duke, "A method for checking television scanning linearity," RCA Rev., vol. 2, pp. 190-202; October, 1941.

<sup>3</sup> W. R. Groves, letter to *Wireless World*, vol. 43, p. 278; September 22, 1938.

<sup>4</sup> E. S. L. Beale and R. Stansfield, British Patent 453887.

<sup>5</sup> A. D. Blumlein, British Patent 479113; M. Bowman-Manifold and W. S. Perceval, British Patent 424221; E. L. C. White, British Patent 518378.

\* Received by the Institute, July 26, 1948.

<sup>1</sup> J. M. Diamond, "Circle diagrams for cathode followers," Proc. I.R.E., vol. 36, pp. 416-420; March, 1948.

<sup>2</sup> K. Schlesinger, "Cathode-follower circuits," Proc. I.R.E., vol. 33, pp. 843-855; December, 1945.

# Institute News and Radio Notes

## AIEE-IRE CONFERENCE ON ELECTRONIC INSTRUMENTATION

At the AIEE-IRE Conference on Electronic Instrumentation in Nucleonics and Medicine, to be held at the Engineering Societies Building, 29 West 39 Street, New York, N. Y., over thirty outstanding papers on various aspects of the subject will be presented at three daily sessions.

On November 29, under W. A. Geohegan's leadership, Harry Grundfest will open the session with a paper on "Biological Requirements in Amplifiers," followed by "Present Practice in Biological Amplifier Design," by John P. Hervey. A group entitled "Biological Requirements in Recording Devices," will include "Cathode-Ray Photography," by Charles M. Berry; "The Electrocardiograph," by John L. Nickerson; "The Electroencephalograph," by Charles H. Richards, and "Miscellaneous Recorders," by John R. Pappenheimer. The session will conclude with "Engineering Aspects in Biological Recorder Design," by S. R. Gilford.

The second session, on November 30, with G. W. Dunlap as chairman, will offer the following papers: "An Introduction to Nucleonics Instrumentation," by A. Dahl; "Biological Requirements for Radioactive-Isotope Measurements," by C. A. Tobias, Jr., and a discussion of the latter by L. Marinelli; "Geiger Counters," by H. Friedman; "Thin-Window Beta Counters," by F. C. Henriques, Jr.; "Autoradiographic Technique," by George A. Boyd; "Stable Isotope Measurement," by David Rittenberg; "The Biological Effects of Radiation and Health Protection," by G. Failla; and "Health-Protection Instrumentation," by F. R. Shonka.

The final session, on December 1, will be headed by H. H. Goldsmith. S. A. Korff will start the session with a paper on "Proportional Counters, including Alpha and Neutron," followed by "Neutron Detection," by H. L. Anderson; "Ionization Chambers," by J. A. Victoreen; "Ionization-Chamber Measurements," by E. W. Mallou; "Stabilized High-Voltage Supply for Counters and Chambers," by W. A. Higginbotham; "Electron-Multiplier Counters," by P. S. Johnson; "Crystal Counters" by Robert Hofstadter; "Electronic Counting Techniques," by Matthew Sands; and "Photographic Emulsion," by J. Spence. Additional invited papers may also be presented.

## NATIONAL ELECTRONICS CONFERENCE IN NOVEMBER

The National Electronics Conference, to be held on November 4, 5, and 6, 1948, at the Edgewater Beach Hotel in Chicago, will consist of fifteen sessions, at which over sixty papers will be presented. At the first day's luncheon meeting, Anton J. Carlson will speak on "Science, Industry, and the Future of Man." Donald J. Fink, editor of *Electronics* magazine, will speak at the second

## Calendar of COMING EVENTS

National Electronics Conference, Chicago, Nov. 4-6, 1948.

Electronic Technicians' Town Meeting, Boston, Nov. 15-17

Technical Symposium for Electronic Engineers in Geophysics, Houston, Tex.; Nov. 22 (tent.)

American Physical Society Meeting, Chicago, Nov. 26-27

**IRE-RMA Rochester Fall Meeting, Rochester, N. Y., Nov. 8-10**

RMA Town Meeting, Boston, Mass., Nov. 15-17

**AIEE-IRE Conference on Electronic Instrumentation, New York City, Nov. 29-Dec. 1**

**1948 Southwestern IRE Conference, Dallas, Tex., Dec. 10-11**

AIEE Symposium High-Frequency Measurements, Washington, D. C., Jan. 10-12

American Physical Society Meeting, New York City, Jan. 27-29, 1949

**March 7-10, 1949 IRE National Convention, New York City**

day's luncheon on "The Decline and Fall of the Free Electron." A banquet will be held the evening of the first day for engineers and their families, at which there will be a floor show and dancing.

## SOUTHWESTERN IRE CONFERENCE SCHEDULED FOR DECEMBER

Prompted by the postwar increase in the scope and volume of electronic activity in the Southwest, particularly in the field of oil exploration, the Dallas-Fort Worth Section of the IRE is taking a step forward to direct attention toward an electronic industrial potential with capable manpower, and to bring inspiration and new ideas to a central point within reach of the engineers of the geographically large Southwest. In 1947, the Fort Worth Section alone embraced 880,000 square miles.

Dedicated to this purpose, the Southwestern IRE Conference will be held at the Baker Hotel, Dallas, Tex., on December 10 and 11, 1948. Following the registration of guests from 8:30 to 10:00 A.M. on Friday, December 10, papers in the fields of radio, television, and geophysics will be presented at the technical sessions, and manufacturers' exhibits of various electronic equipment will be on display both days of the conference.

Field trips to points of technical interest, including the Southwest's first and recently

completed television station WBAP-TV at Fort Worth, and Dallas' first frequency-modulation station, WFFA-FM, will supplement the technical sessions, exhibits, and entertainment. All radio stations and industrial laboratories, as well as the Southern Methodist University, have granted special privileges to visiting IRE members. A ladies' program for the engineers' wives and families has also been arranged, including a special visit to the world-famous Neiman-Marcus Department Store.

Further information concerning the conference may be obtained from A. S. LeVelle, 810 Telephone Building, Dallas 2, Tex.

## SYMPOSIA IN GEOPHYSICS FOR ELECTRONIC ENGINEERS

A series of technical symposia in geophysics of interest to electronic engineers is being planned for presentation in Houston, Tex., during the winter months. The symposia are being conducted as a joint project of the IRE, the AIEE, and the Society of Exploration Geophysicists. The primary purpose of these meetings is to bring together for group study and discussions the electronic specialists scattered throughout the various geophysical laboratories of the petroleum industry. The first meeting is tentatively scheduled for November 22.

Further details may be secured from W. M. Rust, Jr., of the Humble Oil and Refining Co., Houston, Tex., or from Lawrence G. Cowles, Superior Oil Co., Bellaire, Tex.

## Industrial Engineering Notes<sup>1</sup>

### GERMAN ELECTRONIC RESEARCH DESCRIBED IN NEW REPORTS

Two new OTS reports, PB 81566, "German Wartime Research and Development in Klystrons" (\$4, photostat; \$1.75, microfilm), and PB 81565, "German Wartime Crystal-Research and Manufacturing Techniques" (\$3, photostat; \$1.50, microfilm) may be purchased from the Library of Congress, Photoduplication Service, Publication Board Project, Washington 25, D. C. Check or money order should be made payable to the Librarian of Congress.

### NEW NSRB APPOINTMENTS

Arthur M. Hill, chairman of the National Security Resources Board, announced that Reginald E. Gilmor, a manufacturer of scientific apparatus, has been appointed vice-chairman to supervise the work of the

<sup>1</sup> The data on which these NOTES are based were selected, by permission from "Industry Reports," issues of August 13, 20, and 27, and September 3 and 10, published by the Radio Manufacturers' Association, whose helpful attitude in this matter is hereby gladly acknowledged.

Board's Mobilization Planning Staff; and that Gayle W. Arnold will head the Board's Division of Plant Dispersion. Mr. Gilmor, a former president of the Sperry Gyroscope Co., recently returned from Greece, where he directed the industry division of the American Mission. Mr. Arnold has served as industrial development manager of the Baltimore and Ohio Railroad Co., and during the war was special consultant to the U. S. Army Chief of Ordnance on safety and security and plant location problems.

#### SIGNAL CORPS ACTIVITIES

More than thirty-one million dollars in surplus electronic equipment has been made available to American educational institutions since the beginning of 1947 through the Signal Corps donation program. Requests for various types of equipment came from 2807 institutions. The Signal Corps was able to supply 13,655 items, with radio and radar sets comprising the bulk of the equipment. . . . In order to meet expanding training requirements, the Signal Corps will have to recall 471 reserve officers, who may, however, be recalled to extended active duty only with their consent.

#### NIC HOPES TO SOLVE RADIO PROBLEMS

The National Inventors Council issued a list of forty items, including a number of radio problems, which are among the technical problems affecting defense to which the Council hopes American inventors will submit solutions. Compiled by the Council in co-operation with the Armed Services, the list includes a statement of each problem together with approaches made to date, and their deficiencies or defects. Copies of the list ("Technical Problems Affecting National Defense," NIC List 1948-1) may be obtained without charge from the Council, Department of Commerce, Washington 25, D. C.

#### RECENT FCC RULINGS

The FCC announced a proposed revision of its multiple ownership rules which would limit common ownership or control by one person or corporation to not more than seven standard broadcast stations. The new rule would also forbid any person or corporation from serving as a stockholder, officer, or director of more than 14 AM stations. . . . Class II experimental construction permits, subject to final determination of proposed FCC rules and allocations for this class of radio service, were granted to two oil exploration companies, the Seismograph Service Corp., and the Frost Geophysical Corp., both of Tulsa, Okla., authorizing them to conduct experiments for a year in the Gulf of Mexico with two new radiolocation systems—Lorac and Raydist, respectively. The operating characteristics of the two systems differ to some extent, but are similar in that both involve phase-measuring techniques. FCC Commissioner Sterling pointed out that the radiolocation systems now available, including shoran, radar, and other high-frequency systems, do not fulfill the operational requirements

of exploration now being undertaken. The frequency location requirements of the two new systems raise a number of questions which involve present allocations and international treaties, but the FCC will institute a rule-making proceeding looking toward the allocation of 8 kc within the 200- to 2050-kc band to this radiolocation service. A similar proceeding will be instituted with respect to allocating three frequencies in the 29-Mc band.

#### TELEVISION DEVELOPMENTS HERE AND ABROAD

Ninety construction permits for new television outlets have been authorized and 303 applications filed. Westinghouse Radio Stations, Inc., filed an application to operate a commercial stratovision television broadcasting station in the Pittsburgh area. The application seeks Channel 8 for an airborne television station to operate at a point about 30 miles west of Pittsburgh. The stratovision plane is to be operated in conjunction with a ground station to be established at KDKA, Pittsburgh, for which a separate application has been filed.

Television receiver shipments by RMA member-companies were fifty per cent greater during the second quarter of 1948 than in the first quarter, and brought total postwar shipments for the first half of 1948 to 425,000, the total half-year production being 259,591. Shipments continued to lag behind production figures, which total 463,943 since the war and 278,896 during the first six months of 1948. The New York-Newark area remains the leader in the number of television sets received, with Philadelphia, Chicago, Los Angeles, Boston, Washington, D. C., and Baltimore following.

In Britain, the television system was frozen indefinitely in order to protect nearly 60,000 receiving sets from obsolescence. Prolonged research, requiring several years, will be necessary before substantial improvements, possibly including color, can be realized in practice; the London television station, therefore, will continue to operate for a number of years on the 405-line system, and the same system is being adopted for the Midlands station and is proposed for other British stations.

Czechoslovakia's first television station went on the air in May with an operating schedule of three hours daily. At present its operations are of technical interest only, as there are but five television sets in the country. However, 20 additional sets are to be installed at public places in Prague in the near future.

#### RMA CELEBRATES "SILVER ANNIVERSARY"

A gala radio industry celebration is planned in Chicago during the week of May 15, 1949, combining the twenty-fifth RMA "Silver Anniversary" convention and the annual Radio Parts Industry Trade Show. The Stevens Hotel has been virtually taken over for the celebration of RMA's founding in 1924 and the annual Parts Trade Show, with a "Silver Anniversary" banquet planned for Thursday evening, May 19, in the hotel's grand ballroom.

#### FM DEVELOPMENTS

At present 644 FM outlets are operating on the air, including 22 noncommercial stations. Conditional grants number 92, construction permits 706, and 95 applications are pending. New stations have recently gone on the air in the following states:

*Calif.*, Bakersfield (KMAR), Los Angeles (KFMV-FM), Merced (KUME), Redding (KVRE), and San Francisco (KDFC); *Conn.*, New Haven (WAVZ-FM); *D. C.*, Washington (WQQW-FM); *Fla.*, Miami (WGBI-FM); *Iowa*, Davenport (WOC-FM); *Kan.*, Wichita (KFH-FM); *Ky.*, Bowling Green (WBON); *Mich.*, Jackson (WJBM-FM); *Mo.*, Kansas City (WHB-FM), St. Louis, and Springfield (KTTS-FM); *N. C.*, Henderson (WHNC-FM) and Redsville (WREV); *N. Y.*, Ogdensburg (WSLB-FM) and Troy (WFLY); *Ohio*, Cincinnati (WSAI-FM) and Lima (WLOK-FM); *Ore.*, Portland (KOIN-FM); *Pa.*, DuBois (WCEB-FM); *S. C.*, Greenville (WESC-FM); *Tenn.*, Johnson City (WJHL-FM); *Tex.*, Belton (KHMB); *Va.*, Richmond (WRUB, WRNL-FM, and WLEE-FM); *W. Va.*, Oak Hill (WOAY-FM); *Wis.*, Green Bay (WTAQ-FM), Madison (WFOV), Racine (WRJN-FM), and Wausau (WSAU).

The FCC made final its proposed rules providing for low-power FM stations in the noncommercial educational broadcasting service. This amendment will enable many educational institutions which might not be able to afford high-powered stations to enter the noncommercial educational FM broadcast field.

#### JULY RADIO PRODUCTION DROPS

In July, 1948, radio receiver production dropped to 627,349 for the lowest monthly output since February, 1946. The previous month's production was 1,049,517 and production in the same month of the year before was 1,155,456. This represents the first time that set production by RMA member-companies fell below a million-a-month since May, 1946. RMA manufacturers produced 74,988 FM-AM sets during July, as compared with 90,414 in the previous month of June and with 70,649 in July, 1947. Production of automobile and portable radios also decreased sharply.

At the same time, July, 1948, collections of the ten per cent excise tax on radios and phonographs and certain of their components dropped more than two million dollars below the July, 1947, total, and fell about one-half million dollars under collections in June, 1948. Collections in July totalled \$4,060,785.34, as compared with \$6,450,451.19 in July of the previous year and \$4,606,382.67 this June.

#### CANADIAN RADIO SALES DROPPING

Sales of radio receiving sets by Canadian producers during the first five months of 1948 totalled 178,843 units valued at \$16,725,846, as against 318,408 units valued at \$20,484,088 in the same five months of 1947. From January to May, 1948, 1509 sets valued at \$170,375 were imported and 9266 units valued at \$355,830 were exported.

# Sections

Chairman		Secretary	Chairman		Secretary
W. A. Edson Georgia School of Tech. Atlanta, Ga.	ATLANTA October 15	M. S. Alexander 2289 Memorial Dr., S.E. Atlanta, Ga.	O. W. Towner Radio Station WHAS Third & Liberty Louisville, Ky.	LOUISVILLE	D. C. Summerford Radio Station WKLO Henry Clay Hotel Louisville, Ky.
	BALTIMORE	J. W. Hammond 4 Alabama Court Baltimore 28, Md.	F. J. Van Zeeland Milwaukee School of Eng. 1020 N. Broadway Milwaukee, Wis.	MILWAUKEE	H. F. Loeffler Wisconsin Telephone Co. 722 N. Broadway Milwaukee 1, Wis.
John Petkovsek 1015 Ave. E Beaumont, Texas	BEAUMONT— PORT ARTHUR	C. E. Laughlin 1292 Liberty Beaumont, Texas	K. R. Patrick RCA Victor Div. 1001 Lenoir St. Montreal, Canada	MONTREAL, QUEBEC October 13	S. F. Knights Canadian Marconi Co. P.O. Box 1690 Montreal, P. Q., Canada
R. W. Hickman Cruft Laboratory Harvard University Cambridge, Mass.	BOSTON	A. F. Coleman Mass. Inst. of Technology 77 Massachusetts Ave. Cambridge, Mass.	L. A. Hopkins, Jr. 1711 17th Loop Sandia Base Branch Albuquerque, N. M.	NEW MEXICO	T. S. Church 637 La Vega Rd. Albuquerque, N. M.
G. E. Van Spankeren San Martin 379 Buenos Aires, Arg.	BUENOS AIRES	A. C. Cambre San Martin 379 Buenos Aires, Arg.	J. W. McRae Bell Telephone Labs. Murray Hill, N. J.	NEW YORK November 3	R. D. Chipp DuMont Telev. Lab. 515 Madison Ave. New York, N. Y.
J. F. Myers 249 Linwood Ave. Buffalo 9, N. Y.	BUFFALO-NIAGARA October 20	R. F. Blinzler 558 Crescent Ave. Buffalo 14, N. Y.	C. G. Brennecke Dept. of Electrical Eng. North Carolina State Col- lege Raleigh, N. C.	NORTH CAROLINA- VIRGINIA	C. M. Smith Radio Station WMIT Winston-Salem, N. C.
G. P. Hixenbaugh Radio Station WMT Cedar Rapids, Iowa	CEDAR RAPIDS	W. W. Farley Collins Radio Co. Cedar Rapids, Iowa	W. L. Haney 117 Bourque St. Hull, P. Q.	OTTAWA, ONTARIO October 21	G. A. Davis 78 Holland Ave. Ottawa, Canada
K. W. Jarvis 6058 W. Fullerton Ave. Chicago 39, Ill.	CHICAGO October 15	Kipling Adams General Radio Co. 920 S. Michigan Ave. Chicago 5, Ill.	A. N. Curtiss Radio Corp. of America Camden, N. J.	PHILADELPHIA November 4	C. A. Gunther Radio Corp. of America Front & Cooper Sts. Camden, N. J.
C. K. Gieringer 3016 Lischer Ave. Cincinnati, Ohio	CINCINNATI October 19	F. W. King RR 9 Box 263 College Hill Cincinnati 24, Ohio	M. A. Schultz 635 Cascade Rd. Forest Hills Borough Pittsburgh, Pa.	PITTSBURGH November 8	E. W. Marlowe Union Switch & Sig. Co. Swissvale P.O. Pittsburgh 18, Pa.
F. B. Schramm 2403 Channing Way Cleveland 18, Ohio	CLEVELAND October 28	J. B. Epperson Box 228 Berea, Ohio	O. A. Steele 1506 S.W. Montgomery St. Portland 1, Ore.	PORTLAND	F. E. Miller 3122 S.E. 73 Ave. Portland 6, Ore.
Warren Bauer 376 Crestview Rd. Columbus 2, Ohio	COLUMBUS November 12	George Mueller Electrical Eng. Dept. Ohio State University Columbus, Ohio	A. V. Bedford RCA Laboratories Princeton, N. J.	PRINCETON	L. J. Giacoletto 9 Villa Pl. Eatontown, N. J.
S. E. Warner Aircraft Electronics As- soc. 1031 New Britain Ave. Hartford 10, Conn.	CONNECTICUT VALLEY October 21	H. L. Krauss Dunham Laboratory Yale University New Haven, Conn.	K. J. Gardner 111 East Ave. Rochester 4, N. Y.	ROCHESTER October 21	Gerrard Mountjoy Stramberg-Carlson Co. 100 Carleton Rd. Rochester, N. Y.
J. G. Rountree 4333 South Western Blvd. Dallas 5, Texas	DALLAS-Ft. WORTH	J. H. Homsy Box 5238 Dallas, Texas	E. S. Naechke 1073-57 St. Sacramento 16, Calif.	SACRAMENTO	W. F. Koch 1340 33rd St. Sacramento 14, Calif.
George Rappaport 132 East Court Harshman Homes Dayton 3, Ohio	DAYTON October 21	C. J. Marshall 1 Twain Place Dayton 10, Ohio	G. M. Cummings 7200 Delta Ave. Richmond Height 17, Mo.	St. LOUIS	C. E. Harrison 818 S. Kings Highway Blvd. St. Louis 10, Mo.
C. F. Quentin Radio Station KRNT Des Moines 4, Iowa	DES MOINES- AMES	F. E. Bartlett Radio Station KSO Old Colony Bldg. Des Moines 9, Iowa	C. L. Jeffers Radio Station WOAI 1031 Navarro St. San Antonio, Texas	SAN ANTONIO	H. G. Campbell 233 Lotus Ave. San Antonio 3, Texas
A. Friedenthal 5396 Oregon Detroit 4, Mich.	DETROIT October 15	N. C. Fisk 3005 W. Chicago Ave. Detroit 6, Mich.	C. N. Tirrell U. S. Navy Electronics Lab. San Diego 52, Calif.	SAN DIEGO November 2	S. H. Sessions U. S. Navy Electronics Lab. San Diego 52, Calif.
E. F. Kahl Sylvania Electric Prod- ucts Emporium, Pa.	EMPORIUM	R. W. Slinkman Sylvania Electric Prod- ucts Emporium, Pa.	F. R. Brace 955 Jones St. San Francisco 9, Calif.	SAN FRANCISCO	R. A. Isberg Radio Station KRON 901 Mission St. San Francisco 19, Calif.
W. H. Carter 1309 Marshall Ave. Houston 6, Texas	HOUSTON	J. C. Robinson 1422 San Jacinto St. Houston 2, Texas	W. R. Hill University of Washington Seattle 5, Wash.	SEATTLE November 11	W. R. Triplett 3840—44 Ave. S.W. Seattle 6, Wash.
R. E. McCormick 3466 Carrollton Ave. Indianapolis, Ind.	INDIANAPOLIS	Eugene Pulliam 931 N. Parker Ave. Indianapolis, Ind.	F. M. Deerhake 600 Oakwood St. Fayetteville, N. Y.	SYRACUSE	S. E. Clements Dept. of Electrical Eng. Syracuse University Syracuse 10, N. Y.
Karl Troeglen KCMO Broadcasting Co. Commerce Bldg. Kansas City 6, Mo.	KANSAS CITY	Mrs. G. L. Curtis 6005 El Monte Mission, Kan.	A. R. Bitter 4292 Monroe St. Toledo 6, Ohio	TOLEDO	J. K. Beins 435 Kenilworth Ave. Toledo 10, Ohio
R. W. Wilton 71 Carling St. London, Ont., Canada	LONDON, ONTARIO	G. H. Hadden 35 Becher St. London, Ont., Canada			
Walter Kenworth 1427 Lafayette St. San Gabriel, Calif.	LOS ANGELES October 19	R. A. Monfort L. A. Times 202 W. First St. Los Angeles 12, Calif.			

# Sections

Chairman	Secretary	Chairman	Secretary
C. J. Bridgland 266 S. Kingsway Toronto, Ont., Canada	TORONTO, ONTARIO T. I. Millen 289 Runnymede Rd. Toronto 9, Ont., Canada	G. P. Adair 1833 "M" St. N.W. Washington, D. C.	WASHINGTON H. W. Wells Dept. of Terrestrial Magnetism Carnegie Inst. of Washington Washington, D. C.
D. A. Murray Fed. Comm. Comm. 208 Uptown P.O. & Federal Cts. Bldg. Saint Paul, Minn.	TWIN CITIES C. I. Rice Northwest Airlines, Inc. Holman Field Saint Paul 1, Minn.	J. C. Starks Box 307 Sunbury, Pa.	WILLIAMSPORT R. G. Petts Sylvania Electric Products, Inc. 1004 Cherry St. Montoursville, Pa.

## SUBSECTIONS

Chairman	Secretary	Chairman	Secretary
H. R. Hegbar 2145 12th St. Cuyahoga Falls, Ohio	AKRON (Cleveland Subsection) H. G. Shively 736 Garfield St. Akron, Ohio	L. E. Hunt Bell Telephone Labs. Deal, N. J.	MONMOUTH (New York Subsection) G. E. Reynolds, Jr. Electronics Associates, Inc. Long Branch, N. J.
J. C. Ferguson Farnsworth Television & Radio Co. 3700 E. Pontiac St. Fort Wayne, Ind.	FORT WAYNE (Chicago Subsection) S. J. Harris Farnsworth Television and Radio Co. 3702 E. Pontiac Fort Wayne 1, Ind.	J. B. Minter Box 1 Boonton, N. J.	NORTHERN N. J. (New York Subsection) A. W. Parkes, Jr. 47 Cobb Rd. Mountain Lakes, N. J.
E. Olson 162 Haddon Ave., N Hamilton, Ont., Canada	HAMILTON (Toronto Subsection) E. Ruse 195 Ferguson Ave., S. Hamilton, Ont., Canada	A. R. Kahn Electro-Voice, Inc. Buchanan, Mich.	SOUTH BEND (Chicago Subsection) October 21 A. M. Wiggins Electro-Voice, Inc. Buchanan, Mich.
A. M. Glover RCA Victor Div. Lancaster, Pa.	LANCASTER (Philadelphia Subsection) C. E. Burnett RCA Victor Div. Lancaster, Pa.	R. M. Wainwright Elec. Eng. Department University of Illinois Urbana, Illinois	URBANA (Chicago Subsection) M. H. Crothers Elec. Eng. Department University of Illinois Urbana, Illinois
H. A. Wheeler Wheeler Laboratories 259-09 Northern Blvd. Great Neck, L. I., N. Y.	LONG ISLAND (New York Subsection) M. Lebenbaum† Airborne Inst. Lab. 160 Old Country Rd. Box 111 Mineola, L. I., N. Y.	S. S. Stevens Trans Canada Airlines Box 2973 Winnipeg, Manit., Canada	WINNIPEG (Toronto Subsection) S. G. L. Horner Hudson's Bay Co. Brandon Ave. Winnipeg, Manit., Canada

# Books

## Microwave Magnetrons, edited by George B. Collins.

Published (1948) by the McGraw-Hill Book Co., 330 W. 42 St., New York 18, N. Y. 796 pages, 10-page index, xviii pages. 366 figures. 6½×9½. \$9.00.

The publication of this book on magnetrons makes available, for the first time, important material derived from work performed on magnetrons at the Columbia and MIT Radiation Laboratories, and industrial laboratories associated with them. Its impact upon the field of magnetron development and design will be great.

That one book should be devoted to a single microwave component is not surprising when it is considered that the magnetron is the heart of microwave radar, which was such an important wartime development. Nor is it surprising that the book is limited to a discussion of the cavity-type traveling-wave magnetron, since nearly all the work of the Radiation Laboratory Magnetron Section was performed on this highly successful type of tube.

Although limited in subject material, the scope of the book is nonetheless ambitious. In addition to covering much of the material from both theoretical and design aspects, a considerable portion of the book is devoted to the actual mechanical construction of microwave magnetrons. Hence, the theorist, the development and design engineer, and

even the technician, can find much of interest.

The book begins with a forty-page introduction, invaluable to a novice in the field, and is then divided into five major parts: "Resonant Systems," "Analysis of Operation," "Design," "Tuning and Stabilization," and "Practice."

"Resonant Systems" deals with the unstrapped resonant system, the "rising-sun" system, the strapped system, and output circuits. Field theory is used very successfully for analysis of the mode spectra of the unstrapped and the "rising-sun" magnetrons. The network theory used for analysis of the strapped magnetron is of especial importance, since network theory will undoubtedly be used increasingly in the analysis of more complex magnetrons than those covered by this book. One regrets, however, that Walker did not also include a less profound network analysis, since a simplified network analysis gives results satisfactory for many purposes and would be useful to many engineers who would not be attracted to the more complete treatment.

The second part, entitled "Analysis of Operation," presents first a review of the attack that has been made on the problem of the interaction of the electrons and the electromagnetic field. No complete solution to this problem is given, but there is much ma-

terial of importance to one desiring to work on this problem. Walker sets up the fundamental equations of field theory and the equations of motion of a charged particle. The powerful Lagrange and Hamiltonian methods are used, and the work is carried through in both relativistic and nonrelativistic form. Some of the known laws, such as Hull's cutoff relation and the Hartree voltage relation, are derived. The fundamental steady states, such as the single-stream and multiple-stream case, are treated. Walker gives an illuminating treatment of the Brillouin steady-state, the Bunemann small-amplitude theory, and the self-consistent field attack. Both the successes and shortcomings of the theories are carefully pointed out. Included in this section, also, are treatments by Rieke, of the magnetron as a circuit element of the transient behavior of the magnetron, and of noise. The first and second of these subjects are of interest to the equipment engineer desiring to understand the behavior of a magnetron as a circuit element. The section on noise is barely an introduction to an involved, but very important, subject.

The section on design, together with Part V on practice, is chiefly of interest to those actually designing and building magnetrons. Cathode design, dimensioning for desired



wavelength, correct  $Q$  adjustment, scaling, limitations and ratings, test equipment, soldering techniques, and chemical processing, are representative of what may be found in these sections. Included are discussions and illustrations of several typical magnetrons.

Part IV deals with "Tuning and Stabilization of Magnetrons." The sections on tuning by W. V. Smith include both mechanical and electronic tuning, both of great importance in future development in both cw and pulsed magnetrons.

The book shows considerable repetition and difference in style, which is undoubtedly the result of the manner in which it was put together. In all, there are eleven contributing authors. Also, there is material from other sources included without either permission or reference.

As a treatise on microwave magnetrons, the book is not entirely complete. It does not include the interdigital and other types, and it is not completely up-to-date. Moreover, the authors have refrained from giving credit to some of the major developers of magnetron design and production.

On the whole, the over-all fine treatment of the subject matter in this book, in addition to the fact that it is a book in a very specialized field, will certainly make it the standard reference text for some time to come.

J. ERNEST SMITH  
Raytheon Manufacturing Co.  
Waltham, Mass.

#### The Principles and Practice of Wave Guides, by L. G. H. Huxley.

Published (1948) by the Macmillan Co., 60 Fifth Ave., New York, N. Y. 325 pages, 2-page index, 148 figures. 5½ X 8½. \$4.75.

This book, whose more complete title is "A Survey of the Principles and Practices of Wave Guides," is an excellent textbook. It will be found valuable by engineers, students, and teachers whose interest in microwaves may cover a rather large range. With all the wartime analyses, experiments, and apparatus design, a complete story of the theory and practice of microwave circuitry would have to consist of many volumes. A design or research engineer must expect from time to time to consult almost every aspect of the theory and data, since his physical apparatus may comprise a complexity of discontinuous waveguides. Ultimately, as with low-frequency circuit technique, what the engineer will want is a good treatise on the fundamentals of the art, on the basis of which the formulas and experimental set-ups are obtained, and then a large and clear handbook giving the needed information for the various conceivable wave-guiding system components. In the present text, the author has done a good job of surveying both aspects of the field.

To the reader who seeks a better general impression of waveguide technique, this book will provide good physical pictures and clear discussions free from long and difficult mathematical derivations. The practical designer interested in applying the various techniques of the art will appreciate the many illustrations and short discussions of practical points. A good bit of quantitative

information is presented, so that the designer will find this book a convenient reference for many things that would be more difficult to find in the larger, more detailed texts that are now becoming available or that may be expected in the future.

Of course, the author cannot in only 325 pages describe, even briefly, every one of the important characteristics of waveguides and techniques of application. However, it is difficult to imagine someone making a much better choice of topics than he has done with a survey as the objective. There are some mistakes, but on the whole the book is more free of them than the average text. An example is the discussion on page 36 in which the most important higher-order wave in a coaxial line, the one that gives considerable trouble in practice, is overlooked, and the statement is made that no such higher-order waves are excited unless the wavelength of the principle wave is reduced until it is of the order of the distance between inner and outer conductors. This is, of course, not correct, since the most easily excited wave is one that is analogous to the  $TE_{10}$  wave of a rectangular guide. This wave will propagate in a coaxial line if the average circumference of inner and outer conductors is about equal to the wavelength.

The final chapter is a treatment of selected topics in a more mathematical fashion. In most texts such a treatment would precede the main discussion. The author has chosen not to do so here, because the final chapter is intended only for those readers who will be interested in additional theoretical background and proofs for the material presented earlier.

SIMON RAMO  
Hughes Aircraft Co.  
Culver City, Calif.

#### Vacuum Tubes, by Karl R. Spangenberg.

Published (1948) by the McGraw-Hill Book Co., 330 W. 42 St., New York 18, N. Y. 848 pages, 12-page index, xvii pages, 423 figures, 6½ X 9½. \$7.50.

"Vacuum Tubes" is the first book in the "Electrical and Electronic Engineering Series" being published by McGraw-Hill, with F. E. Terman as consulting editor. It has grown out of a course in vacuum-tube design given for many years at Stanford University to senior and graduate students in electrical engineering and physics.

With certain exceptions the material presented tends to be mathematical or theoretical, rather than descriptive. Although the use of complex notation is circumvented in the early part of the book, it does become standard throughout the remainder. A knowledge of calculus and complex variables is adequate for a general understanding of the material presented, but a very much more thorough knowledge of mathematics is required to carry through some of the indicated derivations. References to commercial practices or specific commercial tubes are sparse. As the author has pointed out, the subject of vacuum tubes is so vast that much detail has been omitted and he has confined his attention almost exclusively to those phenomena taking place *within* vacuum tubes.

An assessment of the book's contents

may be made in the form of a tabulation:

	Chapters	Pages	%
Introductory material	3	22	3
Basic information	3	102	13
Space-charge-control tubes (ordinary tubes)	6	225	27
Noise	1	30	4
Cathode-ray tubes	3	147	18
Microwave tubes	2	141	18
Special and photo tubes	2	72	9
Evacuation	1	64	8

The introductory chapters, although much more elementary than the remainder of the text, are not out of proportion. The basic information following is in general well but succinctly presented, and the portion on determination of potential fields is good. However, the indicated proof of the analogy between the elastic membrane model and the solution of Poisson's equation in two dimensions does invoke Euler's equations at a place in the text in which vector notation is just being introduced. This, and the use of a conformal transformation in an illustration some 13 pages before this technique is discussed, may present some difficulties to less experienced readers.

The portion of the book dealing with the theory of space-charge control as used in ordinary tubes is most extensive and is particularly outstanding. Here much of the widely spread and controversial literature on the subject is brought together and unified. It is recognized that equations for the performance of grid-type tubes are approximations at best, which permit of wide differences of opinion as to validity and applicability. The discussion of amplification factor is very complete, including equations for particularly closely spaced electrodes.

The chapters on electric and magnetic lenses are principally theoretical, containing derivations of expressions for the cardinal points of lenses from first-order or paraxial-ray theory. Curves relating the physical dimensions of various forms of electric lenses to their optical characteristics are given and described. Types of aberrations are described, although the equation of motion is not solved for the higher-order terms which produce them.

In keeping with the tone of the book, the chapter on cathode-ray tubes contains little information on the various types of such tubes now available. A good share of the chapter is devoted to mathematical discussions of the maximum current which can be passed through a cylinder and of the Pierce gun.

Of the part of the book dealing with microwave tubes, the chapter on klystrons is the more complete, partly because the theory is better understood, and partly because the author has enjoyed extensive and close association with klystron development. The chapter on magnetrons is less complete, and, while reviewing the theoretical literature and describing the customary performance characteristics, does not provide a basis for magnetron design.

The chapters on noise, phototubes, and special tubes appear to have been added for sake of completeness. The first presents the basic concepts of various types of statistical tube noise, while the latter two are chiefly descriptive in nature. The photocell theory given is rather brief and is somewhat out of date, Fowler's method of determining work function not being mentioned.

In a book which so strongly stresses the mathematical approach, the final chapter on high-vacuum practice is perhaps a bit incongruous. As a brief review of the subject, it is quite well done, although the references, particularly the general references, are somewhat old.

The book contains little repetition. Topics follow a very logical sequence, particularly for teaching. The documentation, though not complete, cites many of the important references.

In an 850-page volume on a subject so new and diversified as electron tubes, especially when it is a first edition, it is to be expected that errors will occur. Professor Spangenberg's book contains no more than its just share, most of which may be ascribed to a lack of opportunity on his part to become aware of the many problems associated with commercial products. Several examples may be cited.

The effect of contact potential upon tube operation is dismissed as being insignificant. In describing the processing of thoriated tungsten filaments, it is stated that the resistance decreases, rather than increases, with carburization. Errors of similar nature occur on page 426 concerning the reason for preferring magnetic scan for some television cathode-ray tubes; on page 480, concerning the frequency limitations imposed by single-ended construction of receiving tubes; and on page 735, where the orthicon television pickup tube described is not the tube commonly known by this name.

Despite such errors, however, it is the reviewer's opinion that the book meets the needs of the class of reader for which it was intended, and constitutes an excellent reference volume for the radio engineer.

R. M. BOWIE  
Sylvania Electric Products Inc.  
Flushing, L. I., N. Y.

#### Pulse Generators, edited by G. N. Glasoe and Jean V. Lebacqz.

Published (1948) by the McGraw-Hill Book Co., 330 W. 42 St., New York 18, N. Y. 722 pages, 6-page list of symbols, 13-page index, xiv pages. 502 figures. 6½ × 9½. \$9.00.

This book is Volume 5 of the Radiation Laboratory Series of twenty-eight volumes devoted to radar and related techniques. The title, "Pulse Generators," is somewhat misleading, for the reader might expect a discussion of the many types of oscillators used for the generation of pulses; whereas the book might be more aptly titled, "Magnetron Modulators," for this is the true subject of the book. The various types of pulse generators used with magnetrons, and the associated components of such generators, are presented in detail. Pulse powers from 100 watts to 20 megawatts with pulse durations from 0.03 to 10 microseconds are considered. Pulse power shape, power transfer, efficiency, and impedance transformation are discussed. This material is covered in three major parts of the book and an appendix. Part One takes up the subject of "The Hard Tube Pulsar," a pulse generator in which a vacuum tube (hard tube) is used as a switch to partially discharge the energy of a storage device into the magnetron load.

Part Two considers "The Line Type Pulsar," in which energy is stored in an artificial transmission line (pulse-forming network) and then discharged into the load by a switch which may take the form of a rotary spark gap, series spark gap tubes, or a hydrogen thyatron. Part Three presents the theory and design of "Pulse Transformers," and the Appendix considers "Measurement Techniques," and the concepts of "Pulse Duration and Amplitude."

The subject material is covered well and in a most comprehensive manner. For a thorough understanding of the circuits and networks developed in this book, a working knowledge of Laplace transforms is necessary; however, all the more important circuits are considered from a physical and practical standpoint. The book thus has appeal both for the rigorous theoretician and the practical designer. The value of the book could have been enhanced if the theoretical developments were preceded with performance requirements. Considerable reduction of mathematical material could be effected if all the discussions were limited to developments having practical application. Reference is frequently made to wartime Radiation Laboratory reports; these reports may be very difficult for some readers to obtain.

All things considered, this book is the most informative and complete treatment of magnetron modulators and high-power pulse generators published to date. The book truly stands as a monument to the hundreds of scientific workers, engineers, and others whose work this book describes.

WILLIAM L. MRAZ  
Bell Telephone Laboratories, Inc.  
Whippany, N. J.

#### Klystrons and Microwave Triodes, by Donald R. Hamilton, Julian K. Knipp, and J. B. H. Kuper.

Published (1948) by the McGraw-Hill Book Co., 330 W. 42 St., New York 18, N. Y. 526 pages. 7-page index, xiv pages. 227 figures. 6½ × 9½. \$7.50.

An advanced theoretical analysis of microwave triodes and klystrons is presented in this volume (No. 7 of the Radiation Laboratory Series). The desire of the authors to present the technical and theoretical aspects of this field as completely as possible, even though this meant the exclusion of a great deal of descriptive material, makes the book most useful to tube designers and persons with considerable familiarity with the field. Readers desiring an introduction to the subject may find the material difficult to follow.

The book is divided into three distinct sections. Part I includes an introductory review of microwave techniques, microwave tube types and their applications, and a thorough treatment of the interaction between electrons and electric fields. Cavity resonators are discussed in this section because this material is also basic in character and applies equally well to triodes and klystrons. Triodes are considered specifically in Part II, and the third section on klystrons analyzes these tubes as amplifiers, frequency multipliers, and oscillators.

Almost half of the book is devoted to the analysis and discussion of reflex-klystron os-

cillators. Nonideal reflectors, hysteresis effects, output load characteristics, modulation, and noise are considered in this section. The other sections are equally complete in their treatment of advanced problems and second-order effects. The triode analysis is limited to the small-signal case, although material is included on the operation of triodes as oscillators under both cw and pulse conditions. Space-charge effects, large gap-transit angles, and noise are treated in considerable detail. Space-charge debunching in klystrons and large-signal conditions are included in the chapter on electron bunching.

References to outside sources are given more frequently than in some of the other volumes in the Radiation Laboratory Series, and the use of cross references has made the book relatively free of repetition. Some of the material has been adapted from previous publications, but the majority of the material is new. The representation of the transfer admittance (circuit transadmittance) of two coupled resonant circuits by a parabolic locus in Fig. 11.11 is an ideal method for the analysis of the two-resonator klystron oscillator. Apparently the beam coupling coefficient  $M$  was included in the normalized admittance  $Y_e$  and equations (3), (6), and (7) in error. Also, equation (8) should read  $\sqrt{G_1/G_2}$ , instead of  $\sqrt{G_1/G_2}$  as shown.

The tendency to depend upon equations being self-explanatory makes the book difficult to follow. For example, equation (1) in chapter 6 relating the input voltage of a grid-separation amplifier to the power input and an input resistance  $R_1$  may imply that the effect of plate current flowing in the input circuit has been included, but the confusion regarding this point is not clarified until mention of the usual low-frequency value of  $R_1 = 1/g_m$  occurs eight pages later. The editorial policy to exclude descriptive material has produced a compact volume which covers its field thoroughly and will be an invaluable reference text.

A. E. HARRISON  
Princeton University  
Princeton, N. J.

#### Electronic Circuits and Tubes, by the War Training Staff of the Cruft Laboratory, Harvard University.

Published (1947) by the McGraw-Hill Book Co., 330 W. 42 St., New York 18, N. Y., 933 pages. 14-page index, xxiv pages. 689 figures. 6 × 9. \$7.50.

The scope of this text ranges from complex algebra to the Fourier transform, from sinusoidal voltage to waveshaping circuits, from resonance to phase modulation, from regenerative one-tubers to FM receivers. A surprisingly broad coverage of each subject is given, and, although necessarily limited, enough mathematics is given to reinforce and support the discussion.

Written as a result of the Cruft Laboratories work in preradar courses, the book does not offer too many evidences of its having had eleven authors. It is readable and should serve as an excellent reference for information on the many branches of the radio field outside of any reader's particular specialty. With the introductory material on ac circuits and the appended material on mathematics and electricity, it might well serve

as an extracurricular text for a student not too conversant with electrical engineering.

The book's greatest deficiency is its inadequate coverage of tubes, only about four pages being given to thermal emission of electrons and only a page to space-charge-limited emission. Gaseous-conduction material is also insufficiently treated. Such over-emphasis of the circuit as compared to the tube was possibly desirable for preradar training, but it now seems to leave a sizable hole in the fundamental training of electronic or radio students.

J. D. RYDER  
Iowa State College  
Ames, Iowa

### Elements of Acoustical Engineering, by Harry F. Olson.

Published (1947) by D. Van Nostrand Co., Inc., 250 Fourth Ave., New York 3, N. Y. 539, xviii pages, 342 illustrations, 6 X 9 inches. \$7.50.

By the time this review is in print, it will be almost a year since the appearance of this second, and much-revised, edition of Dr. Olson's popular book on acoustical engineering. Nevertheless, the material still to be found only in this book is worth calling to the attention of those who may have missed the earlier reviews appearing in other technical periodicals.

Owners of the first edition of Dr. Olson's *Elements* will want to know, first of all, whether the new material introduced in the second edition will make it necessary for them to buy again. The answer is yes. The 57 per cent increase in the number of pages reflects the fact that almost every chapter contains new material, and there are two entirely new chapters devoted to underwater sound and ultrasonics. These chapters were prepared so soon after the war that they do not reflect some of the war work in these fields that has since been declassified; nevertheless, they represent virtually the only technological material on these topics that has yet appeared in book form.

The general scheme of the second edition follows closely that of the first. Most of the equations appear as compact statements of physical relationships, with relatively little emphasis on the derivation. The illustrations have been carefully executed and Dr. Olson has continued the commendable practice of making each figure a self-contained essay, with legend, mechanical structure, and the ubiquitous equivalent electric circuit appearing as necessary to carry out the objective of self-coherence. The chapter on acoustical radiating systems is especially well illustrated and qualifies as a useful catalog of directivity patterns. These charts would be even more useful if a logarithmic scale had been used so that more details of the minor-lobe structure could be exhibited. Also, one can lament the absence of a fuller treatment of the shading of extended sources for control of the directivity pattern. Part of the detailed material from the chapter on dynamical analogies has been omitted—pardonably, in view of its fuller treatment in the author's book on this subject published in the meantime.

The chapters on direct-radiation loudspeakers, horn loudspeakers, microphones, and miscellaneous transducers continue to comprise the central core of the book. Nu-

merous small-scale improvements have been made in the text of these chapters, along with the inclusion of new material on higher-order gradient microphones, phonograph pick-ups, magnetic recording; and additional material on transient response, distortion and noise, and on other miscellaneous transducers. The chapter on measurements has been expanded to include reciprocity calibration methods, the testing of phonograph pick-ups, hearing aids, and other incidental measurements about which acoustical engineers must be informed.

The chapter on architectural acoustics and the collection and dispersion of sound has been almost doubled in size and should prove invaluable to practicing sound engineers. This topic might well form the subject of a book in itself, in lieu of which Dr. Olson has fortified his digest with 74 references to the periodical literature. The chapter on speech, music, and hearing has also been approximately doubled in size, and provides a very much more adequate survey than did the first edition of this important aspect of acoustical engineering. Again one can lament the necessary omission of some of the war work on psychoacoustics.

It is doubtful whether any second edition can give the author the same psychological satisfaction afforded by a brand-new book. Nevertheless, Dr. Olson's second edition can qualify as not only bigger but better. It ought to be required reading for all radio engineers who deal with systems for the transmission of speech or music; the sound engineers already know that the contents of this book are their bread and butter.

F. V. HUNT  
Harvard University  
Cambridge 38, Mass.

### Preparing for Federal Radio Operator Examinations, by Arnold Shostak.

Published (1948) by Prentice-Hall, Inc., 70 Fifth Ave., New York 11, N. Y. 391 pages, 11 pages, xi pages, 161 figures. 5 1/2 X 7 1/2. \$3.75.

This book presents a set of prepared answers to questions appearing in a pamphlet issued by the Federal Communications Commission dated July 1, 1939, entitled "Study Guide and Reference Material for Commercial Radio Operator Examinations" (printed and sold by the Government Printing Office). Answers are given to approximately 1300 questions pertaining to the six examination elements presently set forth in the FCC Rules and Regulations concerning the various classes of commercial radio operators' licenses. Answers to approximately 250 questions appearing in three supplements to the Study Guide are not included. These supplements were released by the FCC in March, April, and June, respectively, of 1948. The book has three appendices, of which Appendix I sets forth Part 13 of the FCC Rules and Regulations Governing Commercial Radio Operators. Since publication of this book, Sections 13.1, 13.2, 13.11, and 13.74 of the Rules and Regulations have been amended, and Section 13.75 has been added. Appendix II contains extracts from the Communications Act of 1934, as amended; pertinent International Radio Treaties; and the Rules and Regulations of the FCC. Extracts from the Atlantic City

International Conference, 1947, recently ratified by the United States Senate but not yet effective, are not included. Appendix III is the same as Appendix II of the Study Guide and presents abbreviations used in radio communications, as well as the International Morse Code and other miscellaneous information.

The author states that he feels that supplementary study is desirable and is to be encouraged, but that conscientious study of the book will enable the applicant to pass an examination successfully. The reviewer must point out, however, that the book should not be considered as a textbook, and believes that supplementary study is most certainly desirable and would enhance an applicant's chances of passing an examination.

Questions are answered in an original manner and differ in wording and approach from the answers to be found in similar books, all of which provides the reader with additional information or information which is not repeated by other authors. This manner of answering questions should be of value to a reader with only a limited knowledge of the subject, who may be using this and similar books in connection with his studies for an examination. The liberal use of diagrams aids the reader to visualize in a clear manner many of the questions asked. Cross references are made from question to question and element to element, which is beneficial in developing background.

Only a very few errors in mathematics have been noted and, although some answers are brief, they are adequate. No errors in theory have been noted. The mathematical errors and brevity of some answers do not detract in any manner from the value of the book, which as a whole is very well prepared and is recommended for the purpose for which it was written—to enable the student to learn while he is preparing for federal radio operators examinations.

NEAL McNAUGHTEN  
National Association of Broadcasters  
Washington, D. C.

### ATTENTION, AUTHORS!

Donald B. Sinclair, Chairman of the Technical Program Committee for the 1949 IRE National Convention, requests that authors of papers to be considered for presentation submit the following information to him as soon as possible:

Name and address of the author, title of the paper, and sufficient information about the subject matter to enable the reviewing committee to assess its suitability for inclusion in the Technical Program.

Although it will not be necessary to submit a paper in its entirety, Chairman Sinclair urges authors to prepare the necessary material promptly and mail it to him at 275 Massachusetts Avenue, Cambridge 39, Mass. The last possible date for acceptance of material relative to Convention papers is December 1, 1948.

# IRE People

**Kenneth B. Warner** (A'18-M'22-F'36), for twenty-nine years secretary and general manager of the American Radio League, died recently of coronary thrombosis at his home in West Hartford, Conn.

Born in Cairo, Ill., on October 3, 1894, Mr. Warner was educated at a business school. After graduation, he worked as account and railroad freight routing agent until he became interested in radio. In Cairo he operated an amateur radio station under the call 9JT, and for many years he was licensed as W1EH.

Mr. Warner joined the ARRL in 1919, fairly soon after its organization, as managing secretary and editor of its official journal. The first World War had almost destroyed the League, but when he took over, the membership started mounting, and amateur radio was restored to the air after a legislative battle. Current total ARRL membership is esti-

ated at approximately 67,000. In 1925 he and Hiram Percy Maxim, then president, went to Paris, France, to form the International Amateur Radio Union, which, a few years later, assumed its present form as an international association of amateur radio societies of the world. From that time on, Mr. Warner acted as secretary of the IARU as well as of the ARRL.

He is credited with having played a major role in developing amateur radio into one of the more important branches of electronics. Known as the country's "Number One Ham," he was active in the development of many electronic improvements, including applications of the vacuum tube and pioneering in high frequencies.

From the very beginning of his association with the ARRL, Mr. Warner was the amateurs' spokesman at international conferences and at regulatory proceedings in Washing-

ton. He helped to represent radio amateurs at the Washington Conference in 1927, the Madrid Conference in 1932, Cairo in 1938, and Atlantic City in 1947. He attended meetings of the CCIR at the Hague in 1929, Copenhagen in 1931, and Lisbon in 1934.

During the second World War he helped to form the War Emergency Radio Service, in which amateurs cooperated with the Board of War Communications.

Mr. Warner was an honorary member of the Association EAR, Nederlandsche Vereniging voor International Radioamateurisme, Resau Belge, Radio Club de Cuba, Rede dos Emissores Portugueses, Union de Radio Emissores Espanoles, and the National Press Club. As a member of the IRE, he served on the Standardization Committee from 1928 until 1931, and on the Publicity Committee from 1931 to 1939.

**Ellery W. Stone** (A'14-M'16-F'24), after seventeen years of service in various executive capacities with the International Telephone and Telegraph Corp., has been elected president of the Federal Telephone and Radio Corp., a subsidiary of IT&T.

Born on January 14, 1894, in Oakland, Calif., Mr. Stone has been associated with the communications field since he became a licensed operator in 1911, while he was still a high-school student. Subsequently he attended the University of California, where he specialized in electrical and radio engineering.

After serving as a Naval officer during the first World War, Mr. Stone organized the Federal Telegraph Co. on the Pacific Coast. Later acquired by IT&T, this company became the Mackay Radio Co. of California. With IT&T, Mr. Stone successively held a number of executive posts on the various subsidiary companies.

Recalled to active duty with the U. S. Navy in 1943 as a Captain, Mr. Stone rose to the rank of rear admiral. In 1945 he received the U. S. Army Distinguished Service Medal for his outstanding work with the Allied Control Commission, as director of the Communications Subcommittee, vice-president, deputy chief commissioner, and finally chief commissioner. After having restored communications in liberated Italy, as "senior representative of the Allied Control Commission at Salerno . . . then the seat of the Italian government in liberated territory . . . he dealt directly with the Italian government and was responsible for the general enforcement and execution of the surrender terms." Crown Prince Umberto presented Admiral Stone with the Order of Knight of the Grand Cross of St. Maurice and St. Lazarus, the highest award of knighthood conferred in Italy.

Returning to the United States after a

distinguished four-year war career in the Mediterranean theater, Mr. Stone was elected a vice-president of IT&T. In addition to the awards already mentioned, he holds the Naval Reserve Medal with two bronze stars, the U. S. Navy Distinguished Service Medal, is a Knight Commander of the British Empire, a Grand Officer of the Crown of Italy, and a Knight of the Grand Cross of San Marino. The author of two books on radio and of various articles on communications, Mr. Stone has had a number of papers published in the PROCEEDINGS.



**George W. Henyan** (A'20-VA'37), assistant to the vice president, will be manager of a new division, called the Industrial and Transmitting Tube Division, which has been formed within the tube divisions of the General Electric Co.'s electronics department at Syracuse, N. Y. **Kenneth C. DeWalt** (A'29-M'45) and **E. F. Peterson** (M'44) have been named assistant managers—the former responsible for all design engineering and manufacturing activities related to cathode-ray-tube product lines, the latter for all design engineering and manufacturing activities related to receiving tube product lines. At the same time, **Otis W. Pike** (A'26-M'29-SM'43) was appointed manager of engineering, tube divisions.

Mr. Henyan was born in San Antonio, Tex. After having graduated from the University of Texas in 1916 with the B.S. degree in electrical engineering, he joined the General Electric Co., where he has been ever since.

Born in Vinton, Iowa, Mr. DeWalt received his B.S.E.E. from the University of Iowa in 1927. He, too, was employed by General Electric immediately after his graduation, becoming designing engineer of the

vacuum-tube engineering division in 1943.

Mr. Peterson, born in Waverly, Kan., was graduated from Kansas State University with the B.S. degree in electrical engineering in 1931 and the M.S. degree in 1932. After having taught physics at Sterling College in Sterling, Kan., for a year, he also joined General Electric, becoming section leader on receiving tubes in 1943.

Mr. Pike was born in Antrim, N. H., and also attended his state university, from which he received the B.S.E.E. Joining General Electric in 1920, he became engineer of the tube division in 1943. In 1948 he was awarded a distinguished service plaque for his work as first chairman of the Joint Electron Tube Engineering Council.



**Gilbert E. Gustafson** (A'27-M'38-F'40), the Zenith Radio Corp.'s vice-president in charge of engineering, recently received the President's Medal of Merit for his contribution to victory in World War II as chief of Zenith's engineering research, which helped make possible that company's successful production of war material, including the V-T proximity fuze.

Born November 15, 1905, in Rock Island, Ill., Mr. Gustafson joined Zenith as a development engineer in 1925. Subsequently he became chief engineer of the radio station the company then maintained at Mount Prospect, Ill., later returning to development work at the factory. In 1934 he was made chief engineer in charge of all engineering work. Nine years later he was elected vice-president by the board of directors.

A Director of The Institute of Radio Engineers in 1943, Mr. Gustafson has also served on a number of IRE committees, including Admissions, Awards, and the Board of Editors.

Thirty-two Members of The Institute of Radio Engineers were presented with the Presidential Certificate of Merit for their outstanding services in technological research and development during World War II.

**Henry B. Abajian** (M'46), who is an engineer at the L. H. Terpening Co., and **George W. Bailey** (SM'46) were among those honored. Mr. Bailey, Executive Secretary of the Institute, is president of the ARRL and of the International Amateur Radio Union. In 1946 he was awarded a Marconi Memorial Service award by the Veteran Wireless Operators Association.

**Wilmer L. Barrow** (A'28-VA'39-M'40-F'41), chief engineer at the Sperry Gyroscope Co., was the recipient of the Morris Liebmann Memorial Prize in 1943 for his theoretical investigations of ultra-high-frequency propagation in waveguides. He has served as a Director of the Institute, and as Chairman of the Boston Section.

**H. H. Benning** (SM'44) is senior engineer at the Aircraft Radio Corp. **Harold H. Beverage** (A'15-M'26-F'28), director of RCA's Radio Systems Research Laboratory, won the Liebmann Memorial Prize in 1923 for his work on directional antennas, the Institute Medal of Honor in 1945 for his achievements in radio research, and the Radio Club of America's Armstrong Medal in 1938. President of the IRE in 1937, he has also been a Director.

**K. Charlton Black** (M'29-SM'43), chief engineer of Air Associates, Inc., owns many patents on circuit and vacuum-tube designs. **Hendrik W. Bode** (M'41-SM'43) and **Ralph Bown** (M'22-F'25) are both members of the Bell Telephone Laboratories staff. Dr. Bown, who directs research for Bell, was President of the IRE in 1927, and Vice-President in 1926, when he also received the Liebmann Prize for his researches into the more difficult elements of wave transmission phenomena.

**Herbert E. Bragg** (M'46) is assistant director of research at Twentieth Century-Fox Film Corp., while **Henri G. Busignies** (M'42-SM'43-F'45) is a director of the Federal Telecommunication Laboratories and a past member of the IRE Navigation Aids Committee. **John F. Byrne** (SM'45) vice-president and director of engineering at the Airborne Instruments Laboratory, and **F. Clark Cahill** (S'38-A'40-SM'45), supervising engineer, were also awarded certificates.

**Howard A. Chinn** (A'42-SM'45-F'45), chief audio-video engineer of the Columbia Broadcasting System, was formerly a consultant to the National Defense Research Committee Division on Radio and Radar Countermeasures during the war. **Franklin S. Cooper** (A'36) is associate research director of the Haskins Laboratories, and **Ward F. Davidson** (SM'47) is a research engineer with Consolidated Edison.

**Howard D. Doolittle** (M'46) is Machlett Laboratories' chief engineer. **Ora Stanley Duffendack** (SM'45), president of the Philips Laboratories, was a director of research with the National Defense Research Committee during the war. This year he was also decorated by the British Consul General with the ribbon of the King's Medal for Service in the Cause of Freedom.

**John N. Dyer** (J'30-A'32-SM'45), supervisor of the Airborne Instruments Laboratory, was chief communications engineer with the Byrd Antarctic Expedition. **Donald G. Fink** (A'35-SM'45-F'47), editor-in-chief of *Electronics* magazine, has been a member of numerous Institute Committees, and in 1946 won the War Department's Medal of Freedom.

**Eugene G. Fubini** (A'36-SM'46), supervising engineer of the Airborne Instruments Laboratory, had charge of the radio countermeasures section of O.A.S., Eighth Air Force during the war, and, also served as associate at Harvard's Radio Research Laboratory. **Raymond L. Garman** (A'39) and **Byron L. Havens** (SM'46), research engineer at the Watson Scientific Computing Laboratories, were other recipients of the honor.

**L. Grant Hector** (A'26-M'43), the Sonotone Corp.'s director of technical operations, has written extensively on magnetic, dielectric, and acoustical measurements by electronic techniques. **William H. Martin** (SM'46) directs apparatus development at the Bell Telephone Laboratories. **James Harold Moore** (SM'46) is an engineer at the American Telephone and Telegraph Co.

**Haraden Pratt** (A'14-M'17-F'29), vice-president and chief engineer of the American Cable and Radio Corp., as well as an executive of a number of other organizations, is Secretary of the Institute and was President in 1938. In 1944 he received the Medal of Honor for his engineering contributions to the development of radio.

**John C. Schelleng** (A'23-M'25-F'28), radio research engineer at Bell, has been a member of numerous Institute Committees. **William P. Short** (SM'44), is assistant technical director of the Federal Telecommunication Laboratories. **Hector R. Skifter** (A'31-M'36-SM'43) is president of the Airborne Instruments Laboratory.

**Orrin W. Towner** (A'24-M'29-SM'43), technical director of radio station WHAS in Kansas City, Mo., received the certificate for his work in supervising the building of equipment to combat rocket bombs and the installation of submarine detecting equipment. **Ernst Weber** (M'41-SM'43) is a professor at the Polytechnic Institute of Brooklyn.

**Vladimir K. Zworykin** (M'30-F'38), director of electronics research at the RCA Laboratories, received the Liebmann Prize in 1934 for his contributions to the development of television, the Modern Pioneer Award from the National Association of Manufacturers in 1940, and the American Academy of Arts and Sciences' Rumford Medal in 1941.



The President's Certificate of Merit was also awarded posthumously to **Browder J. Thompson**, associate research director of the RCA Laboratories, who was killed in action overseas in 1944 while serving as a consultant to the Secretary of War. In 1945 the Browder J. Thompson Memorial Prize was established, to be awarded annually to the most outstanding paper published in the PROCEEDINGS OF THE I.R.E. by an author under thirty years of age.

**W. Nelson Goodwin, Jr.** (A'15-M'29-SM'43), has completed fifty years with the Weston Electrical Instrument Corp. in Newark, N. J.

Joining the organization in 1898, after his graduation from the University of Pennsylvania, Mr. Goodwin was chosen in 1906 by Edward Weston, the founder, as chief engineer and director of research, and was eventually elected vice-president in charge of research and engineering. Although Mr. Goodwin is now officially retired, he still serves Weston as a consultant.



**Finley W. Tatum** (A'43-SM'47), an instructor at Southern Methodist University since 1947, was recently appointed associate professor of electrical engineering. Prior to joining the university staff, Mr. Tatum was employed for approximately eleven years as section head of the American District Telegraph Company's design and development engineering department in New York City.



**Andrew W. Cruse** (M'38-SM'43) has been elected president of the Radio Corp. of Porto Rico, a subsidiary of the International Telephone and Telegraph Corp.

Captain Cruse (USNR), who has had extensive experience in the communications, electronics, and engineering fields, is assistant vice-president of the IT&T, with headquarters in New York. He has also been elected to the board of directors of the Radio Corporation of Porto Rico, which owns and operates radio station WKAQ in San Juan.



**Richard C. Hitchcock** (A'28-M'30-SM'43) has been appointed science lecturer for the Westinghouse Laboratories, in which capacity he will tour the nation with special science shows designed to make the latest scientific advances understandable to all.

Dr. Hitchcock was born in Tougaloo, Miss., on February 26, 1900. After receiving the B.S. degree in physics from Wesleyan University in 1922, he became an assistant in the physics department as well as a graduate student, winning the M.A. degree in 1924, although he had stopped teaching there the year before in order to become assistant principal of the Burr and Burton Seminary in Manchester, Vt. In 1925 he joined the physics department of Yale University as assistant and graduate student.

Dr. Hitchcock's scientific career began when SOS wireless messages from the S. S. *Titanic* led him to build his first "crystal" set. In 1926 he joined the research department of the Westinghouse Laboratories, where his work on quartz crystals solved one of the problems of early radio broadcasting. During the next fifteen years he developed an electronic organ, photoelectric traffic-light controls, meter dials that stay white indefinitely, a color-matching machine, and the Stroboglow. He received the doctorate in 1939 from New York University and two years later returned to teaching, at Indiana State Teachers College, Indiana, Pa., where he remained until his return to Westinghouse, with the exception of three years of Navy service.

**H. Myrl Stearns (S'39-A'40)**, formerly in charge of tube production and the tube research and development laboratory of the Sperry Gyroscope Co., has been appointed vice-president and general manager of Varian Associates, new microwave and electronic research and development laboratory at San Carlos, Calif., according to an announcement made by **Russell H. Varian (A'40)**, president, and one of the founders of the organization. Dr. Varian, who holds the honorary degree of Doctor of Science from the Brooklyn Polytechnic Institute, formerly was employed by the Sperry Gyroscope Co. and, for the past two years, has been working as a research assistant at Stanford University.

**Elliott Levinthal (A'44)**, former project engineer at the Sperry Gyroscope Co., who has just completed work for the Ph.D. degree in physics in the field of nuclear induction, has also joined the new laboratory. **William W. Hansen (A'39-F'47)** and **Edward L. Ginzton (S'39-A'40-SM'46)** of the Stanford University physics department are acting directors of the concern and will serve as consultants for specific projects. Dr. Hansen, who received an IRE Fellow Award in 1947, is one of the inventors of the klystron, which made possible radar, and also was consultant on some aspects of atomic bomb research. Dr. Ginzton, formerly in charge of the microwave research and klystron research and development departments at Sperry, has been an assistant professor of applied physics at Stanford University for the past two years.

**Harvey R. Butt (A'41)**, formerly Washington representative of the Radiomarine Corporation of America, was recently appointed manager of the Washington office of the same company.

**Toivo M. Liimatainen (S'412-A'4-M'45)** formerly associated with Sylvania Electric Products Inc., has been appointed to the staff of the National Bureau of Standards' Electron Tube Laboratory, where he will work on the engineering and development of microwave tubes.

A native of Massachusetts, Mr. Liimatainen attended schools in Peabody, Mass., and the Lowell Institute, at the Massachusetts Institute of Technology. From 1930 to 1938 he was employed by the Sylvania Electric Products Co., leaving this position in order to study at the University of Michigan. After having received the B.S. degree in 1941, he joined the staff of the General Electric Co., where he was concerned with problems related to the microwave oscillator tube of the "lighthouse" type. In 1946, he returned to Sylvania Electric Products Inc., where he worked on crystal and selenium rectifiers.

Mr. Liimatainen has done extensive work on the design and development of microwave oscillator tubes, gas discharge tubes, and the design and application of high-back-voltage selenium rectifiers. He built the first 10-centimeter microwave oscillator employing a triode of the "lighthouse" construction.

**D. Gordon Clifford (M'45)**, formerly chief engineer of Industrial and Commercial Electronics, has been appointed field engineer at the Lenkurt Electric Co., San Carlos, Calif.

Mr. Clifford, who was one of the development engineers working on the klystron, holds engineering degrees from Dartmouth College and Harvard University.

**Alva Edward Smith (A'39-M'47)**, radio installation supervisor of the Western Electric Radio Division, has left New York for Sydney, Australia, where he will supervise the installation of control and terminal equipment for the Australian Government. This equipment will be used in overseas telephone communications circuits between Australia, the United States, and other parts of the world.

**Harold W. Schaefer (J'26-A'31)**, veteran radio and electronics engineer, has been appointed assistant manager of the Westinghouse Home Radio Division, Sunbury, Pa.

A native of Chicago, Mr. Schaefer studied electrical engineering at the Lewis Institute, and physics at the University of Chicago. Starting his radio career with Majestic-Grigsby-Grunow in 1926 as an engineer, he later became assistant to the president.

During World War II, Mr. Schaefer served at the Applied Physics Laboratory of Johns Hopkins University, where, under the Office of Scientific Research and Development, he was in charge of engineering manufacturing of the proximity fuze used by the Army and Navy to explode anti-aircraft shells automatically within effective range of enemy aircraft. After his OSRD work, he was in charge of postwar radio and television planning and manufacture at the Radio Corporation of America before joining Westinghouse.

Mr. Schaefer is a member of the Physics Club of Chicago and of the AIEE.

**Ray Davis Kell (A'35-F'47)**, director of television research at the RCA Laboratories in Princeton, N. J., was the 1948 recipient of the Stuart Ballantine Medal of the Franklin Institute for "his outstanding pioneer work in television; the adaptation of this means of communication to military needs, and for his inventive contributions and leadership in the development of color television."

Born on June 7, 1904, in Kell, Ill., Mr. Kell was graduated from the University of Illinois in 1926 with the B.S. degree. He did graduate work at the same university until 1927, when he became associated with E. F. W. Alexanderson, of the General Electric Co.'s radio consulting laboratory. In 1930 he joined the RCA Victor Division of the Radio Corporation of America where, under his direction, many of the components of the present television system were developed, including the first high-power, high-

frequency television transmitter, the first iconoscope camera, and the first remote pickup and radio relay. Twelve years later he was appointed director of television research at the RCA Laboratories in Princeton. In 1940 he received a Modern Pioneer Award from the National Association of Manufacturers, and in 1947 he received a Fellow Award from the IRE, both for his contributions to television.

**Harry F. Dart (A'20-M'26-SM'43)** has been elected a trustee of the Technical Societies Council of New York, Inc., after serving two years as its treasurer. He is one of the two delegates to the Council from the New York Section of The Institute of Radio Engineers.

Mr. Dart studied electrical engineering at Purdue University, receiving the B.S. degree in 1917 and the professional degree of electrical engineer in 1923. After one year with the Western Electric Company in Chicago, he enlisted in the Signal Corps, becoming a second lieutenant in World War I. Subsequently he organized a radio course for the International Correspondence Schools in Scranton; then he taught electrical engineering for one year each at the Rice Institute and at Harvard University. In 1922, he joined the Westinghouse Electric Corp. in Bloomfield, N. J., where he has been continuously associated with various phases of radio and electronic tube engineering activities.

Elected Secretary-Treasurer of the New York Section of the IRE when it was organized late in 1942, Mr. Dart has served on several committees of the IRE and is currently a member of the Symbols Committee and of the Committee on Professional Recognition. He is also a member of the AIEE and the Radio Club of America.

**A. M. Zarem (S'42-A'46)**, research engineer, has been appointed chairman of physics research and manager of the new Los Angeles Division of the Stanford Research Institute.

Born in Illinois thirty-one years ago, Dr. Zarem was graduated from the Armour Institute of Technology in 1939. A year later he received the M.S. degree in electrical engineering from the California Institute of Technology, from which he also obtained the Ph.D. in 1943.

Before joining the Stanford staff, Dr. Zarem was chief of the electrical section of the physical research division of the U. S. Naval Ordnance's Pasadena Test Station. An authority on ultra-high-speed photography and measurement techniques, Dr. Zarem is the inventor of the Zarem camera, which heads the list of major precision instruments used in the photographic "microtime technique" developed at the Navy Test Station. During the war he was a research engineer and group leader on several secret government contracts in electronics and physics administered by the California Institute of Technology. He had previously been research and development engineer for the Allis-Chalmers Manufacturing Co. in Milwaukee, Wis.

## W. Ryland Hill, Jr.

Chairman, Seattle Section, 1948–1949



W. Ryland Hill, Jr., was born in Seattle, Wash., on February 1, 1911. After receiving the B.S. degree in electrical engineering from the University of Washington in 1934, he spent two years with the Northern Radio Co. of Seattle as a laboratory and design engineer.

From 1936 until 1938 Professor Hill taught at the University of California on a fellowship, and also did graduate work which, plus an additional year of part-time research, resulted in his receiving the degrees of M.S. in electrical engineering in 1939 and E.E. two years later.

Upon leaving the University in 1938, Professor Hill joined the staff of the Standard Oil Co. of California's general engineering department, where he remained until 1941, when he was appointed assistant professor of electrical engineering at the University of Washington. In 1947 his rank was advanced to that of associate professor.

At the University of Washington, Professor Hill has taught a variety of electrical engineering courses, especially electronic circuitry and electroacoustics. He is a firm believer in the basic engineering education with physics and mathematics as the core. Although he started teaching when the University was on a civilian basis, the staff was soon plunged into the communications option of the Navy V-12 program which occupied the college of engineering until the end of the war.

Professor Hill became an Associate Member of the IRE in 1943 and a Member the year following. Several of his numerous papers have appeared in the PROCEEDINGS OF THE I.R.E. He is a member of Tau Beta Pi, and an associate member of the University of Washington Research Society.

## Andrew Friedenthal

Chairman, Detroit Section, 1948–1949

Andrew Friedenthal was born in Detroit, Mich., on September 1, 1904. He became interested in radio at the age of fourteen, and was an active amateur enthusiast by the time he joined the U. S. Navy in 1920. After training at the U. S. Naval Radio Schools he was assigned to duty on the USS *Melville*. In 1922, however, he was transferred to Sitka, Alaska, where he helped maintain the Navy's high-powered radiotelegraph station NPB. After a year, he was transferred to NVH, Ketchikan, where he continued his radio work until he left the Navy in 1924.

The following summer he worked as a ship operator and in the fall of 1925 he was appointed manager of the Intercity Radiotelegraph Co.'s Detroit division. There he pioneered in what was then called "short wave" in the 10,000- to 20,000-kc band, establishing short-wave code channels for intercity communications.

In 1926 Mr. Friedenthal joined the engineering staff of WJR, Detroit. During 1930 and 1931 he also organized the engineering staff of WJR's sister station, WGAR, in Cleveland, Ohio. A short time later, he wrote the specifications for the first ac-operated high-level-switching program-distribution system, which is still in use at WJR. In 1938 he suggested and supervised the construction of a four-unit transcription turntable in one mounting. At present Mr. Friedenthal is engineer in charge of studios at WJR.

Joining the IRE as an Associate in 1935, Mr. Friedenthal became a Member three years later. He was Vice-Chairman of the Detroit Section before becoming Chairman. He is also a member of the Engineering Society of Detroit.



# Technical Problems of Military Radio Communications of the Future\*

JOHN HESSEL†, SENIOR MEMBER, IRE

*Summary*—The success of military operations in the future will depend greatly upon the availability of a communication system of adequate mobility, traffic capacity, and reliability. An analysis of the factors which prohibit the realization of such a system at the present time shows the need for research in all phases of radio communication. A number of the more pressing limitations of existing techniques are discussed to develop the basic research problems.

**A**N EXAMINATION of military history shows that in each new war there are improvements in offensive tactics which may take either of two forms, increase in fire power or increase in mobility, or both. History also teaches that the effective use of each new weapon and defense against it requires communications improved in speed, volume, and reliability proportionally greater than the increase in speed and power of the weapons.

No one can now foresee what military operations of the future may be, except that there will be atomic power instead of TNT, and rockets instead of aircraft. Defense as well as attack will depend upon the strategic deployment of small, fast-moving, hard-hitting forces transported and supplied by air for long periods. These units will require the closest of co-operation and co-ordination of all arms and services. In many respects, future operations may resemble those of the last war in the Pacific more than those in Europe. There will probably be many small theaters of operation, each of which must have communication with the others, and with the staff and supply organizations of the United States. In addition to the command and administrative traffic of the past, these circuits must carry other forms of electrical signals representing, for instance, facsimile, map co-ordinates, meteorological conditions, and others, for, with long-range missiles, one of the principal functions of these outposts will be defense of the Zone of the Interior.

The military services face the task of devising a system of communication capable of carrying all the types of traffic required by push-button warfare in volume far greater than anything previously experienced, with reliability comparable to the best commercial telephone and telegraph practice, and capable of being installed in any part of the world, inhabited or not, in any climate, in the shortest possible time. This means, of course, that the equipment must be air-transportable with the consequent drastic limitations on size, weight, and personnel. Regardless of advances in science, there have been

practically no improvements in mankind, and so this system must be usable by troops not very different in capability from those who manned the first crossbow infantry.

To provide the required speed and mobility, it is evident that there will be much greater reliance on radio in the future and, therefore, that the traffic capacity and reliability of radio communication must be greatly improved. Despite the advances made in the last war period, and the wide dispersion of our forces, wire lines still carried approximately 95 per cent of all message traffic. Wire lines must still be used, wherever they are available in the future, as the backbone of the communication system, leaving the radio-frequency spectrum free for those services which wire lines cannot provide.

## LONG-HAUL CIRCUITS

Radio communication is used for three primary functions. First, it provides communication over long-haul circuits where no wire facilities exist or are practical. An example of this type of circuit is the Army Command and Administrative Network which links the Department of the Army with its outposts over the world. The introduction of the carrier-shift radioteletype greatly increased the traffic capacity of these circuits during the war years, and made it possible to route teletype on a subscriber-to-subscriber basis without the immense waste of time and effort in message and signal centers at either end of the radio circuit.

But several basic difficulties remain. The usable frequency spectrum for long-range sky-wave transmission lies between about 3 and 30 Mc and cannot be expanded. High-frequency assignments are not private trunk circuits but party lines, subject not only to interference from the enemy, and from enemy sources beyond control, but also from natural static and the vagaries of the ionosphere. There are not enough usable frequency assignments in this spectrum to meet all requirements in time of war by present methods.

The fundamental problem is to develop the means for making the best possible use of every cycle of the spectrum. If it were practical to use single-sideband transmissions exclusively, the possible number of available voice channels would be doubled. But, before this can be done, single-sideband transmitters must be simplified to the point where they can be operated by GI operators, not engineers. Present-day carrier-shift teletype circuits require frequency assignments with about 5000 cps separation. On wire lines the standard bandwidth of teletype channels is 170 cps. When radio can do as well, the number of available teletype channels will be increased by a factor

of 30. One method is, of course, to multiplex the teletype signals on a frequency-division basis, and modulate the transmitter with the resultant on a single-sideband basis. By this means, it may be possible to get about sixteen circuits in a 5-kc transmitted band, an efficiency compared with wire circuits of about 80 per cent.

This has not been done yet, but is conceivable in the not-too-distant future; however, there are many requirements for single-channel radioteletype circuits, and methods are required by which it is possible to assign channels for such service with a separation of only a few hundred cycles, rather than 5 kc as at present. The fundamental fact is that there is not enough now known about circuitry, or about the fundamental chemical substances of which circuits are composed.

Still, one must reckon with the vagaries of the transmission medium, including the ever-varying ionosphere. Space-diversity reception can be used at fixed installations and when installation time is not critical, but mobile terminals are also required where space diversity is impossible. Frequency diversity is possible, of course, but this means that bandwidth is sacrificed. Double-frequency transmission loses all that has been gained by single-sideband transmission. There is need for the development of a method of diversity reception usable on mobile terminals, and which does not cost bandwidth.

## CIRCUITS TO MOVING TERMINALS

The second primary use of radio communication in the Army is to provide circuits to moving terminals where wire circuits cannot be installed. Examples of such circuits are the radio networks in armored forces and in air forces. Prior to the war, it was found advantageous to use frequencies above 20 Mc for this service. This freed sky-wave frequencies for use in long-haul circuits and, conversely, eliminated long-range interference with short-range circuits. The advent of FM practically eliminated all other interference, and permitted the operation of short-range tactical radio networks of quality and reliability comparable to telephone loops. Because of the limited interference range of such transmissions and capture effect, frequency assignments can be duplicated at rather short range; hence, thousands of such networks can be operated within a theater area. But the demands for such service again far exceed the available assignments within the interference range.

With present techniques using crystal-controlled oscillators in both receiver and transmitter, a 3000-cps voice band is transmitted with a 5 to 1 deviation ratio occupying an rf bandwidth of 30,000 cps. But still it is necessary to separate frequency assign-

\* Decimal classification: R560. Original manuscript received by the Institute, March 21, 1948; revised manuscript received, July 9, 1948. Presented, 1947 IRE West Coast Convention, San Francisco, Calif., September 24, 1947.

† Signal Corps Engineering Laboratories, Fort Monmouth, N. J.



ments by 100 kc because of instabilities and inadequate selectivity. Thus, two out of three possible assignments have been wasted not counting those lost due to interference at short range, even with this separation.

By the use of the most stable crystal-controlled oscillators and filters, it is possible that the channel separation can be cut to 50 kc, a saving of two to one. But the problem of producing crystals of this quality in quantities something like twenty times greater than were produced in the last war per unit of troops is formidable. The problem, then, is to develop oscillators and circuits of stability as good as modern quartz crystals, but without the crystals, and preferably tunable.

In this case, it is interesting to note the part which quartz plays in stable design. The best dielectric material for variable capacitors and for coil forms is fused quartz. To minimize the temperature effect caused by metals in variable capacitors, it is necessary to make the whole structure of quartz and to provide conductivity, where required, by plating. For stability in the microwave region, quartz is used for resonant cavities. The problem is to develop materials, both conducting and dielectric, having the stability of quartz without its manufacturing difficulties and its fragility. This is a problem for the chemists and physicists.

#### RADIO RELAY SYSTEMS

The third primary use of radio communications is for radio relay systems. This use grew out of the preceding two, in an attempt to provide long-distance circuits of good telephone quality without expending the precious high-frequency spectrum or being subject to its interference. The first attempts were simply forward-echelon very-high-frequency FM sets with the transmitters and receivers back-to-back at relay points. Later, pulse modulation of centimeter waves was introduced by adaptation of radar techniques. The frequency-modulated sets handled four voice channels, frequency-division multiplexed, while the centimeter-wave sets handled eight channels by time-division multiplex. Basically, radio relay provides an rf substitute for wire and cable long-distance trunk circuits. The advantage is that it costs much less shipping tons per circuit mile, and can be installed more quickly with less men.

The demand for this type of service is complete evidence of its value. But important as this new achievement now is, a comparison with telephone circuits indicates its present faults. The FM radio relay of World War II handled four telephone circuits over not more than five or six jumps of about thirty miles each, with a signal-to-noise plus crosstalk ratio of something like 20 db. A standard Bell System K carrier circuit handles twelve channels per cable pair over the same distance, with approximately 50 db signal-to-noise plus crosstalk ratio.

The centimeter-wave equipments were designed to perform as via trunks with 50

db signal-to-noise ratio. But they are limited to eight single voice channels, one of which is usually used as an order wire for maintenance purposes. There is no provision for transmission of wide-band signals, such as television or high-speed facsimile. On the other hand, coaxial telephone cables now handle frequency-stacked groups of 480 voice channels or television signals out to 4 Mc. It is necessary to provide very-high frequency FM radio relay comparable in performance with commercial carrier telephone service, and microwave radio relay circuits comparable with coaxial telephone cable.

Careful mathematical analyses have been made of all the aspects of this problem. These show that the most difficult problem to be solved is to devise a distortion-free means of modulating wide-band signals upon a microwave carrier and subsequently demodulating them. To handle a multiplexed group of 100 voice channels in a bandwidth of 500 kc, and to transmit them over 100 jumps averaging 30 miles and recover each with a signal-to-noise and crosstalk ratio of 50 db, requires that the distortion caused in each link be less than 0.1 per cent.

#### ANTENNAS

There are, of course, many other problems of a general nature which remain to be solved. One of these is the insistent demand for more efficient and more effective antennas. With the use of wider and wider frequency coverage, there is insistence upon the development of broadband antennas which need not be tuned and for smaller antennas (for instance, on tanks) which are not so visible and do not interfere with the guns. The infantryman demands an antenna which does not interfere with his progress in the jungle and make him the prime target of every sniper who knows what an antenna means. It is necessary to plan for major installations to be in deep bombproof shelters, and it may be unsafe even to make tuning adjustments on the surface, to say nothing of repairing bomb damage.

The terms "efficient" and "effective," used to describe the performance characteristics, may be differentiated in this way. A transmitting antenna is efficient if it radiates practically all of the energy available in the output circuit of a transmitter. A receiving antenna is efficient if it delivers substantially all of the energy which it collects at the receiver input terminals. Generally speaking, both transmitting and receiving antennas may be made efficient, if they operate near their resonant frequencies and are properly matched to the input and output circuits. This would seem to dictate that, for small, inconspicuous antennas, an extremely high frequency must be used. But the amount of energy which a receiving antenna collects is a function of its physical size, other factors being equal.

Therefore, as frequency is increased and the size of a resonant antenna decreased, its effectiveness as a collector goes down, although its efficiency may be constant. In

cases where a resonant antenna cannot be used, coupling circuits must be provided which cancel the reactive component, in addition to matching impedances. With these, good efficiencies can be achieved if the network is substantially loss-free. Theoretically, this technique could be carried to the point of efficiently radiating energy from antennas which are extremely short both physically and electrically. But the technique has yet to be devised whereby large amounts of energy can be collected with a receiving antenna which is physically short. What seems to be needed is an effective wave magnet.

The present understanding of the behavior of antennas is based on the work of Maxwell performed about eighty years ago. Since that time, his work has been studied repeatedly without discovering phenomena which cannot be explained by his equations. They are, therefore, considered valid and are accepted as a law of nature. If it is true that present-day antenna designs represent nearly the ultimate which can be achieved by these theories, then the radical improvements which are needed can be achieved only after fundamental discoveries as basic and as advanced as Maxwell's have been made.

#### PLANNING FUTURE RESEARCH

Planning the research and development program for the solution of problems such as these is one of the foremost jobs in which the service laboratories have been engaged since the end of hostilities. The Signal Corps alone is sponsoring research and development totaling millions of dollars in scores of universities and colleges and private and commercial laboratories, in addition to its own efforts.

But the service laboratories alone cannot possibly suggest, sponsor, and direct all of the work which will be necessary. Such problems as these cannot be reduced to terms of dollars and cents and solved simply by contracting for a certain amount of effort for a year or two. Their solutions will come from the mind of man, not from his hands. They require the careful thought and patient research of many men, their findings properly evaluated and correlated with other efforts, verified by experiments and aided now and then by sparks of genius to reconcile the irrational and so accomplish the impossible. Such work cannot be purchased; it cannot be hired; it must be inspired.

The radio engineering profession is challenged to produce advances in its science and techniques as far-reaching as those being made in other fields, for communications are the nervous system of our national defense and only radio can provide the speed and mobility which will be essential if ever again our national security is imperiled. The services rely upon the profession to keep the subject of national defense constantly in mind and to make many important contributions. Only through the co-operation of the entire profession with the efforts of the service laboratories can our full scientific potential be realized.

# Telemetering Guided-Missile Performance\*

JAMES C. COE†, VOTING ASSOCIATE, IRE

## INTRODUCTION

A STATEMENT was once made by Lord Kelvin to the effect that when you were able to measure something, then you were in a position to talk about it.

Progress in the development of pilotless aircraft and guided missiles, including testing techniques, has been extremely rapid since VE Day. It is imperative that adequate instrumentation be provided to test and evaluate all phases of guided-missile performance. The types referred to herein include target-type pilotless aircraft, and missiles in which the propelling force is not gravitational or delivered solely during the initial stages of the flight. There are aerodynamic control and supporting surfaces such as wings, flaperons, rudders, etc. Stated in the negative sense, these are pilotless aircraft rather than bombs, projectiles, or rockets.

In the field of pilotless aircraft, including targets and guided missiles, as in conventional aircraft, a great deal of information can be obtained on the ground, from wind tunnels, and from test stands. Pilotless aircraft and missiles can be carried under the wing of the parent plane in captive flight for additional information. Such an installation is shown in Fig. 1, with a KDD sus-

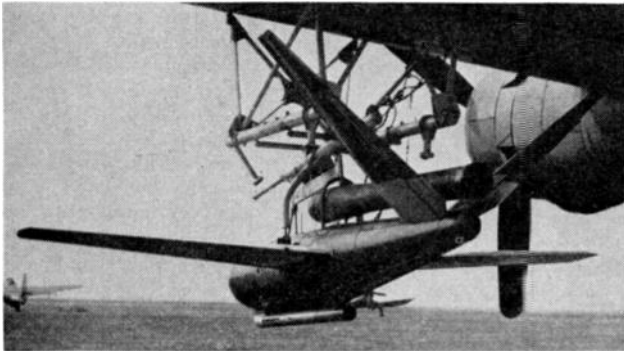

Official U. S. Navy Photograph

Fig. 1—KDD target-type pilotless aircraft suspended under a PB4Y-1.

pending under a PB4Y-1. With missiles capable of outdistancing any chaser plane, direct observation by the pilot is limited. Instruments being photographed inside the missile yield useful information, but they are not satisfactory where very rapid changes are involved and

\* Decimal classification: 621.375.616XR560. Original manuscript received by the Institute, October 15, 1947; revised manuscript received, May 17, 1948. Presented, 1947 IRE West Coast Convention, September 24, 1947, San Francisco, Calif.

† U. S. Naval Air Missile Test Center, Point Mugu, Calif.

the information only becomes available hours later, if ever. From the wreckage shown in Fig. 2, an armored film magazine was recovered.



Official U. S. Navy Photograph

Fig. 2—An armored film magazine was removed from this wreckage.

Under actual launching and flight conditions, information can be obtained by observation from the chaser plane, through phototheodolites, and by other optical means. Photographic data are extremely useful during the launching and early stages of flight. Fig. 3 shows a KUU after separation from the sled and the piston of the catapult. A small target-type pilotless aircraft is shown on its catapult in Fig. 4. This target

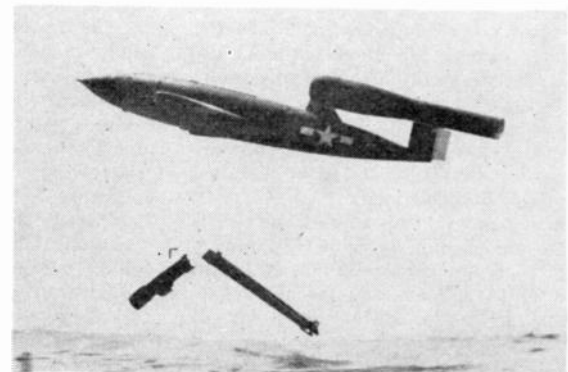

Official U. S. Navy Photograph

Fig. 3—KUU after separation from launching sled and piston.

is recovered by means of a parachute contained within the hatch which is aft of the wing. Extremely accurate position information is not so important with guided missiles also capable of homing on a target as it is with projectiles. Doppler radar and doppler radio

yield velocity information primarily, while position is obtained directly from tracking radar or from explosive charges dropped over water and located by underwater-sound measurements. Velocity and position information are valuable, but yield information only on the effect, leaving the causes open to conjecture. An integration of all the causes is required, and can best be supplied by telemetry.

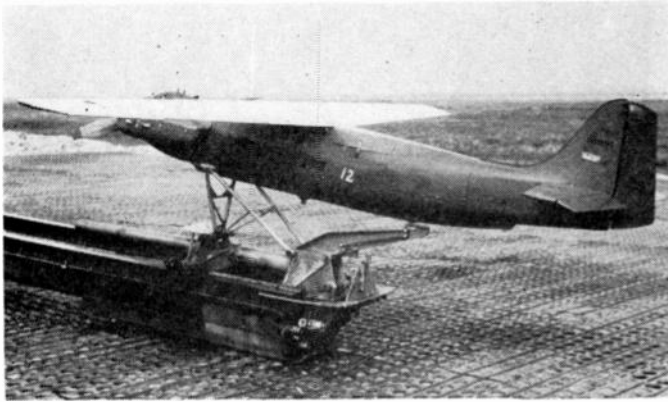

Official U. S. Navy Photograph

Fig. 4—XKD2R-1 on catapult.

All ground tests have obvious limitations. Aerodynamic factors cannot be adequately controlled simultaneously by scale factors in a reduced-scale wind tunnel. Supports, tunnel walls, tunnel temperature and pressure—all cause errors to enter into the determination of the aerodynamics of the missile. Vibrations occurring in free flight may augment those due to the propulsion to cause malfunctioning of many components. Ram air is necessary for the simulation of flight conditions in air engines. Control mechanisms likewise encounter a different set of conditions at high speeds and altitude. The effects of hot gases on radio control at higher altitudes has been the subject of some concern. Performance is different at speeds higher than the parent plane is capable of obtaining.

#### EARLY FORMS OF TELEMETERING

Telemetry is a word of Greek origin meaning measurement from a distance. The word is generally taken to include the conversion of quantities to be studied into electrical signals, the transmission of these over a radio link, their reception, and their presentation in the form of indications or permanent recordings. From the latter they may be studied at leisure. Thus, telemetering permits the measurement and study of performance from a remote point. Photographic or other recordings made aloft are not considered telemetering, since there is no distance involved between the instruments and the recorders. The use of the word "informer" as applied to the transmission of measurements by radio has been superseded by "telemeter." A simple form makes available only "yes-no" information, such as fuze arming time. This type simply tells an observer

when an event has taken place. A usual form that this takes is by changing an audio modulation frequency each time an event takes place. The frequency change gives evidence that the transmitter was working both before and after each successive event. In such a transmitter no rigid demands are made on the stability of the audio frequency, or upon its wave form. If an instrument panel were observed through the medium of television, this would constitute a form of telemetering having in effect a large number of channels in which quantitative information is made immediately available for observation and recording. Radiosondes, as suspended from weather balloons, provide weather information by sampling the readings of various meteorological instruments in sequence. Resistance values are caused to vary due to humidity, temperature, etc., which in turn cause modulation of the transmitter. Originally the transmitter consisted of a single channel which was commutated. Telemetering in one form or another has been used in radio-controlled and other airplanes for a number of years. Pilotless aircraft and missiles present their own peculiar problems, due to limited space, high launching acceleration, high speed, and the varied and numerous measurements required.

#### REQUIREMENTS OF TELEMETERING

A great deal of information is desired through the various stages of a missile test program, such as launching information, flight data, and automatic homing. It is required to know at one time changes in attitude including roll, pitch, and yaw; position determinations such as air speed and altitude; additional aerodynamic information such as is obtained from the various accelerations; ambient conditions such as temperature, humidity, and pressure; structural information such as vibration and strain; control functions such as the functioning of the control receiver, autopilot operation, servo operation, displacements of control surfaces, operation of the homing or target-seeking equipment; propulsion information including fuel flow and thrust; ordnance functions such as fuze arming time; upper-air research; the performance of the electrical system; and information regarding the telemetering equipment itself, including reference voltages for calibration and timing marks which permit synchronizing recordings as received by several receivers located along the flight path. Many of the above measurements are interrelated. Some require a high order of time resolution, especially as the speed of the missile increases, while for others a few samplings per second are entirely adequate. A telemetering system must be capable of transmitting large amounts of varied data per second. With so much information to be desired, a multichannel system is plainly indicated, since a single commutated channel would not give sufficient time resolution.

Except for certain target pilotless aircraft which are equipped with parachutes for their recovery, missiles are fired only once. During that flight certain informa-

tion is required before the next phase of the test program is started. Any malfunctioning is corrected and new functions are added. Due to unforeseen difficulties, the changes in the telemetering installation are made to fit the requirements of the particular test, and the exact functions to be telemetered for each flight must be carefully chosen. For example, a small number of functions, rather than a large number on a time-division basis, may be more exactly studied, and at a considerable saving in time necessary to instrument the missile. A common mistake is to demand the full utilization of the maximum number of end instruments without due regard to the selection of the functions as applied to the purposes of the test. Having determined the measurements to be made, the ranges of measurement should be properly selected so as to present that portion of the range most useful to the test being conducted. Since most missiles are fired only once, it is imperative that the telemetering be reliable, or a sizable expenditure of time and money will be wasted. It follows, therefore, that accuracy, stability, and simplicity are imperative. Because of this, telemetering personnel check their calibration work just prior to launching. Launchings are made from the mainland and San Nicolas Island, from shipboard or aircraft. Fig. 5 is a pictorial representation

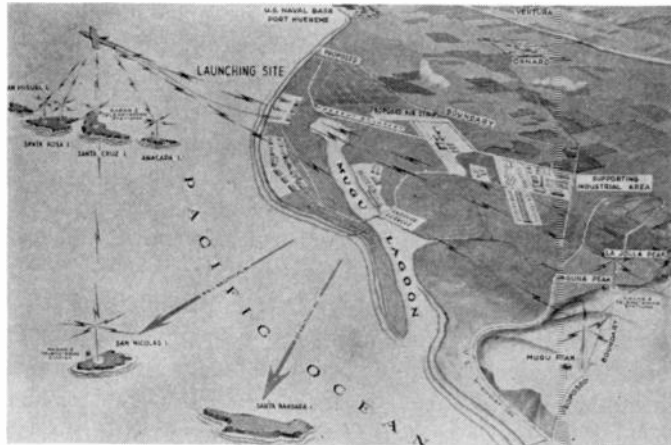

Official U. S. Navy Photograph

Fig. 5—Pictorial representation of Naval Aircraft Missiles Test Center, Point Mugu, Calif.

of the sea range of the Naval Aircraft Missiles Test Center, Point Mugu, Calif. Launchings subject the telemetering equipment to severe conditions, particularly due to acceleration or condensation. Thus before launching at high altitude from the parent plane, the parts will have become cooled; then, upon reaching a low altitude the condensation which takes place may impair operation of the telemetering equipment.

Malfunctioning of the control equipment may cause the missile to roll, or it may be thrown into a climb or steep dive, and through all these gyrations the telemetering equipment must continue to function. A direc-

tional antenna may cause the signal to be lost entirely, along with valuable information, at a critical time; therefore, such an antenna requires more receiving stations. The pattern of the antenna on the missile should be such that reception will not be impaired due to such changes in attitude. The antenna should not present

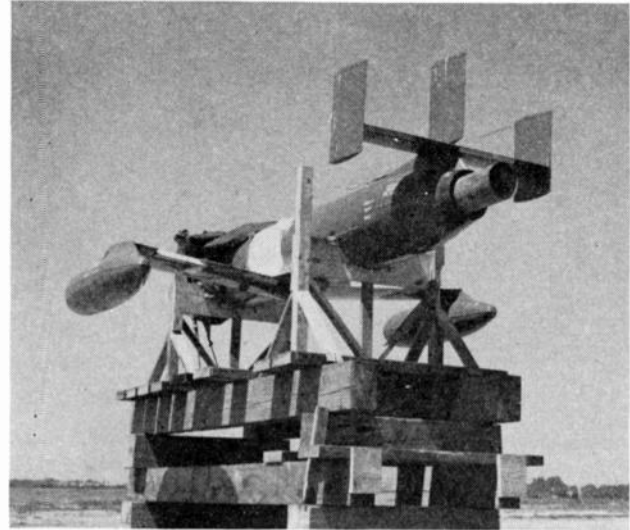

Official U. S. Navy Photograph

Fig. 6—KD2-C equipped with a stub which is not insulated from the airframe and which is fed internally.

too much drag, and with supersonic missiles this becomes an increasingly important factor. Pitot tubes or an insulated section of the nose have been used as radiators. These are not always efficient radiators, so the airframe itself may be excited through a feed line of one kind or another. At this activity there has been developed a "zero drag" antenna without slots or insulated sections, as shown in Fig. 6. To do this the airframe was excited at the base of the stabilizer by an internal feed line. This was possible by means of an opening around the tail pipe, and because of the fact that covers are attached with fasteners spaced at wide intervals. A spike extending aft supplied end loading and improved the three-dimensional pattern of radiation. Another spike, electrically continuous with the airframe, is shown in Fig. 7. In this instance the airframe was excited by a feed line external to the target pilotless aircraft.

As in any measurement, the telemetering equipment should not impair operation, nor should it exert an undue influence upon the quantity to be measured. In small target pilotless aircraft, for example, the distribution of telemetering equipment is important in order that the center of gravity remain unchanged. Telemetering equipment should be appropriately packaged to fit the particular requirements of the airframe, and this is generally done by utilizing a number of small components properly located with respect to vibration, temperature, etc.

The final requirement of telemetry is the proper recording of the data, and the most usual method is the recording on paper or film. The decoding equipment, which cuts down the routine work of data reduction, is part of the receiving equipment, as is indicating equipment which shows the variation of certain quantities as the flight progresses.

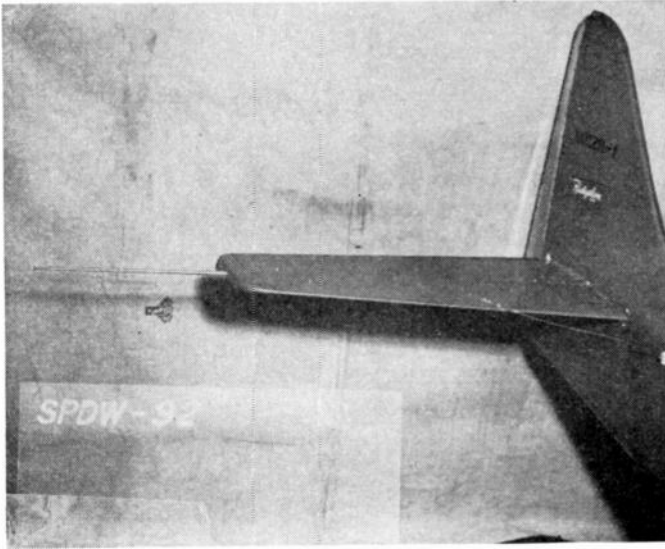

Official U. S. Navy Photograph

Fig. 7—XKD2R airframe excited by an external feed line. The spike is electrically continuous to the horizontal stabilizer.

#### FREQUENCY BANDS

While most of the work has been done under 100 Mc, this is at present on a noninterference basis. The new channels are from 217 to 220 Mc, and from 2200 to 2300 Mc. Some telemetry has also been done in the neighborhood of 440 and 520 Mc. Operation at higher frequencies poses so many difficulties that their use is not warranted in small missiles.

#### TIME RESOLUTION

As the speed of missiles increases and reaction times become less, accurate time studies become more important. When it is considered that the entire time required to home upon a target is only a small portion of the entire flight, the seriousness of the problem becomes readily apparent.

The problem starts with the end instruments, of which there are many varieties. The more common types depend either upon motion or upon a temperature or current change. Diaphragms, bellows, bourdon tubes, gyros, autosyns, vanes, and the like, depend upon motion for their action. These take in a large variety of measurements, including altitude, pressure, position, and flow. Force, pressure, velocity, and acceleration measurements usually involve mechanical motion. Even with strain-gage measurements there must be motion,

however slight, and wherever there is motion the mechanics of the system, including damping and inertia, become a factor. If the damping coefficient of an accelerometer for example, is 65 or 70 per cent of critical, as commonly used, it requires about one cycle to arrive within 5 per cent of the final value. The sensitivity generally varies inversely as the square of the frequency. In other words, a sensitive system is sluggish, and one with a more rapid response is less sensitive. A coil which cuts flux involves either motion or a change in flux. Due to the self-inductance of the winding, time is required between the initial and final conditions. Temperature measurements involve means which are usually sluggish, whether a change in position, resistance, or generated voltage is involved.

While the great majority of end instruments require time to reflect a change, the transducers attached to them would necessarily have to respond equally fast if the time resolution is to remain unimpaired. Potentiometers used as transducers have limitations in this respect. Resolution takes on a different meaning in the dynamic sense, rather than a static one involving only turns per inch or ohms per degree of rotation. Variable-reluctance-type transducers as described below are capable of a very rapid response.

The time resolution or frequency response of a telemetry channel need not exceed that of the end instrument or transducer. Progress in the radio end of telemetry toward the obtaining of frequency-response characteristics necessary for a high order of time resolution far exceeds that in most end instruments and transducers. It is odd that some telemetry systems, which are superior from the standpoint of bandwidth, are designed for potentiometer-type transducers which cannot give an intelligible response during rapid changes. The time resolution and accuracy of telemetry may also suffer due to the recording process. This may be due to the optics of the recording means when distortion results from the cathode-ray-tube and camera combination. The speed at which film or paper travels through the recorder is also a factor in obtaining data during rapid changes of the function being telemetered.

#### TRANSDUCERS

The transducer performs the function of converting the varying physical quantity under measurement into an electrical quantity. The transducer is generally referred to as the electrical link following the end instrument. It is just as important that the transducers be able to withstand the rigorous conditions of acceleration, vibration, temperature, humidity, etc., as any other link in the system. This conversion need not always be linear. It is sometimes desired to have it vary nonlinearly. The end instrument may not be linear, but by proper design of the transducer, the calibration curve of the variation of the physical quantity as plotted against the electrical output of the transducer may be linear. Also, it may be desired to emphasize a critical

part of the range by having a small change produce a relatively large change in transducer output. There are too many types of transducers as applied to end instruments to cover the entire field, except in a general way. They may be classified according to whether they are modulating or generating. Examples of the modulating type are the variable inductance, variable capacitance, and the variable resistance. Examples of the latter are potentiometers, resistance strain gages, and electron tubes. Electron tubes may also be operated as the generating type of transducer. Other kinds of generating transducers include the piezoelectric, photoelectric, thermoelectric, and magnetic. The generating type, as applied, is not always capable of completely modulating the designated circuit of the transmitter, nor is the modulating type always capable of completely performing this function. In these instances the transducer must be modified or the output amplified so that small initial variations are caused to produce the required modulation. For the sake of simplicity, weight, and space, it is extremely desirable to use simple transducers capable of producing the necessary output.

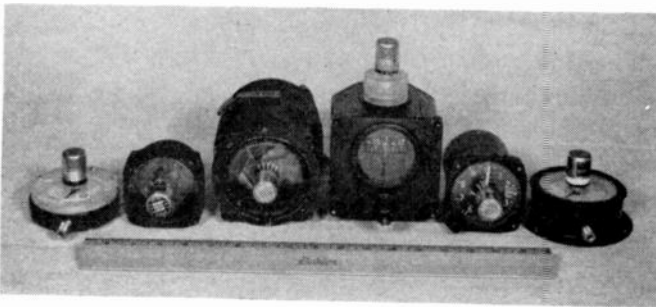

Official U. S. Navy Photograph

Fig. 8—Fuel pressure, airspeed, gyro horizon, direction gyro, altitude, and air-pressure instruments equipped with microtorque potentiometers for telemetry.

A primary step in instrumenting a missile is to calibrate each end instrument with its transducer attached. Often standard aircraft instruments are modified by the addition of the transducer, and the transducer must not impair the operation of the instrument. A group of such instruments with potentiometer-type transducers is shown in Fig. 8. A low-torque potentiometer requiring a torque of only a few thousandths of an inch-ounce will cause measurable drag on some instruments, such as the 1000-foot range of aircraft altimeters. If close indications of altitude are desired, an instrument and transducer in combination designed for the purpose is a better answer. Another method is to couple a variable-reluctance type of transducer to the instrument by attaching a small piece of magnetic material to the needle. The torque necessary to drive the metal is extremely low. This arrangement is best fitted to work into a frequency-changing arrangement such as results

when the reluctance of a frequency-controlling inductance is caused to vary with motion. Usually this is the tank coil of an audio oscillator, whose frequency then varies with the position of the metal segment. Correct operation is obtained when the metal and tank padder capacitor are adjusted to the center frequency of the carrier, and the shape or position of the metal is adjusted so that the frequency is caused to vary the desired amount. The frequency of the oscillator may be

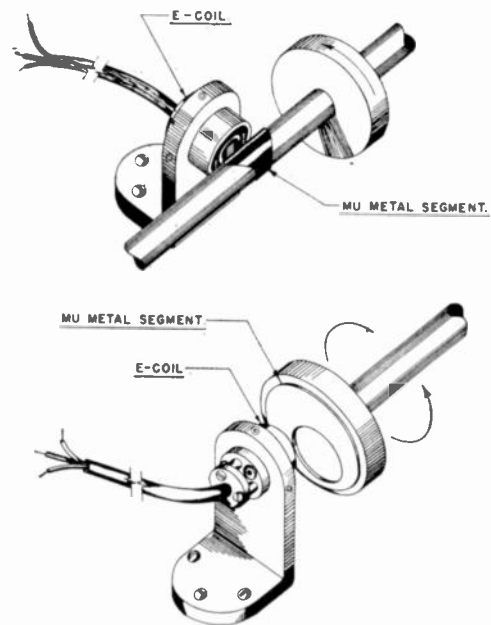
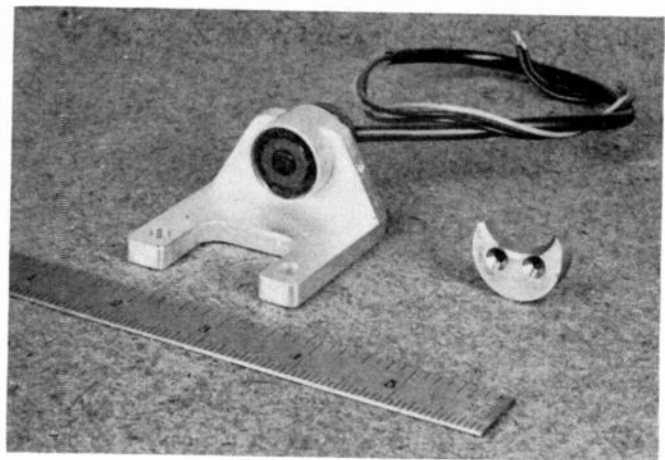

Fig. 9—Two methods of adapting an *E* coil for use as a tachometer.

varied over the desired range by causing a change of as little as a few thousandths of an inch in the transducer air gap. It is also possible to obtain the change in fre-



Official U. S. Navy Photograph

Fig. 10—*E* coil and mu-metal segment for tachometer or motion meter.

quency from a large change in air gap with increased spacing of the metal. These transducers are excellently adapted for attachment to such instruments as accelerometers, altimeters, airspeed indicators, pressure gages, tachometers, and various position and displacement meters. Figs. 9, 10, and 11 show some of these

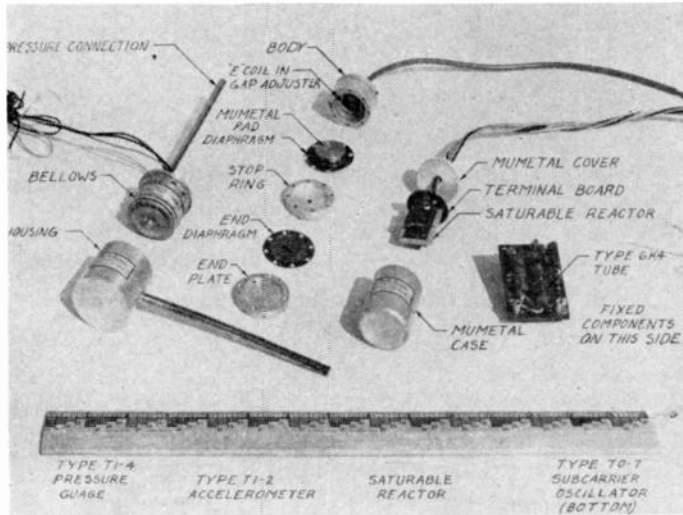

Official U. S. Navy Photograph

Fig. 11—Pressure gage and accelerometer with  $E$  coils, saturable reactor, and oscillator.

applications. A saturable reactor has been developed which also embodies the tank circuit of an audio oscillator, and is shown in Fig. 11. Information obtained from resistance strain-gage bridges, thermopiles, and current changes of a few milliamperes can thus be converted into af changes. Mu metal is widely used in order to reduce errors due to hysteresis.

#### TELEMETERING SYSTEMS

It is not possible to cover all the various types of systems, and so in this paper the telemetering systems which show particular promise will be discussed. They can be divided into two classifications; namely, frequency-modulated multiple subcarrier, frequency-modulated carrier (frequency-division), and pulse-position (time-division) systems which differ greatly in design.

Since the FM/FM system is used most commonly, it is covered in some detail. Synchronizing circuits are not required, since this is a function of the subcarriers, and distinction between channels is achieved by them. Frequency-modulated subcarrier FM telemeters are relatively simple since the total number of components in the system are few, resulting in low power requirements and small size. Test equipment and techniques are well established. The underlying theory of operation is similar to FM broadcasting, so the specialized training of technicians does not present a serious problem. This is a factor, considering the range crews required to oper-

ate the various island stations and to instrument a number of missiles and targets each week. Frequency modulation of the subcarriers also has an advantage from the standpoint of noise.

In the design of equipment employing frequency modulation of the subcarriers, emphasis is placed upon the frequency stability of the subcarrier oscillators, even though ambient conditions such as temperature, humidity, acceleration, or power-supply voltage vary as the flight progresses. Any drift in subcarrier frequency would appear as a change in the function being telemetered. By incorporating a switching arrangement in the receiver which, in effect, removes the intelligence from the subcarrier for a few hundredths of a second, any drift in center frequency becomes evident by a displacement of the recorded trace, which can be taken into account in the process of data reduction.

In Fig. 12 is shown a multivibrator type of oscillator circuit with a preamplifier and  $RC$  filter. This is used in connection with low-torque potentiometer-type trans-

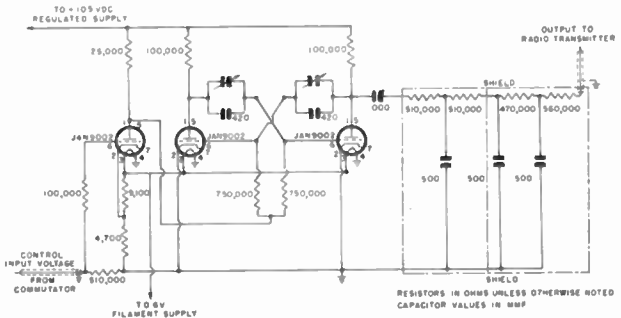

Fig. 12—Preamplifier, multivibrator, and  $RC$  filter used with end instruments equipped with low-torque potentiometers.

ducers. The function being telemetered causes a maximum variation of 3 volts to be impressed upon the preamplifier in order to obtain the desired frequency deviation. Fig. 13 is a phase-shift oscillator adapted to the telemetering of voltages from a high-impedance source.  $RC$  filtering of the plate supply to each oscillator is used to reduce interchannel interference through the power-supply leads. The simple oscillator shown in Fig. 11 has a very low harmonic output, and is used without filtering the output, although it would be a simple matter to add  $RC$  filtering since a high resistance is necessary to reduce the output to the necessary value. The higher harmonics coming from the low-frequency subcarriers would result in cross talk with the higher-frequency subcarrier channels, and it is therefore necessary that they be kept down. To preclude the possibility of second-harmonic cross modulation, the limit frequencies of each band are so selected that their second harmonics fall outside the ranges of the other channels. These frequencies are as follows: 2300, 3000, 3900, 5400, 7350, and 12,300 cps.

With a deviation of plus or minus 7.5 per cent there is less likelihood of cross modulation due to harmonics than if a greater deviation were used. The wave-form requirements of the modulated subcarriers are less exacting with this deviation than with a greater deviation. This has resulted in a corresponding reduction in the pass band, and of the modulating frequency of the intelligence. The characteristics of the several filters used

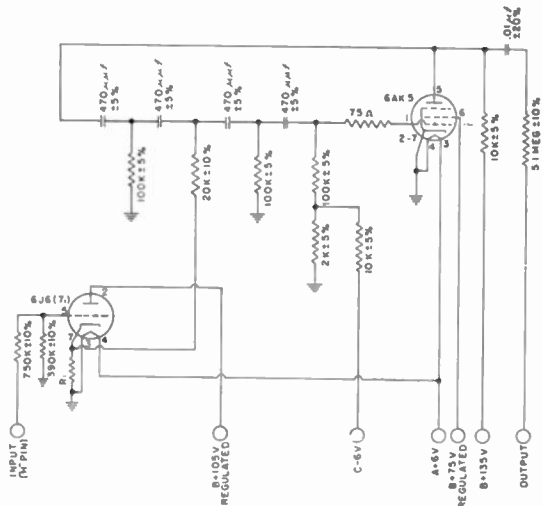
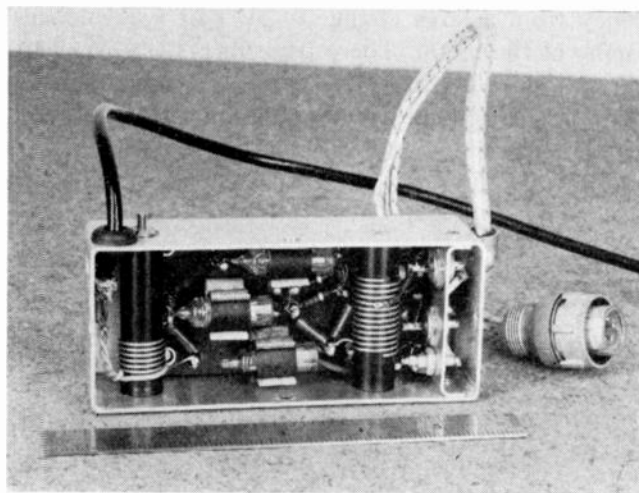

Fig. 13—Phase-shift oscillator for voltage from a high-impedance source.



Official U. S. Navy Photograph

Fig. 14—Bendix subminiature telemetering transmitter.

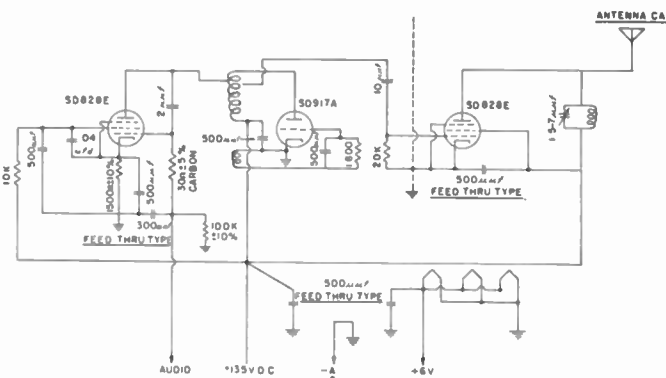

Fig. 15—Schematic of the subminiature telemetering transmitter, consisting of reactance-modulator, master-oscillator and power-amplifier circuits.

in the receiving equipment to separate the modulated subcarriers are likewise limited to pass the frequencies extending 7.5 per cent on each side of the center frequencies. Assuming that adequate performance can be obtained by admitting all the frequencies including the third harmonic of the intelligence frequency, then the intelligence frequency varies from 57.5 to 307.5 cps, depending upon the channel used, as shown in Table I.

TABLE I

Channel	Subcarrier	± 7.5 per cent	Intelligence Frequency
1	2,300	±172.5	57.5
2	3,000	±225	75
3	3,900	±292.5	97.5
4	5,400	±405	135
5	7,350	±551	183.6
6	12,300	±992.5	307.5

A subminiature telemetering transmitter, consisting of a reactance modulator, master oscillator, and power amplifier, is shown in Fig. 14, and the circuit is given in Fig. 15. The range of this equipment may be increased by means of an auxiliary power amplifier.

A typical receiving station is shown in Fig. 16. For convenience in calibrating the complete system on the mainland, the receiving equipment was installed in a truck. A modified RBF-3 Navy receiver and pano-

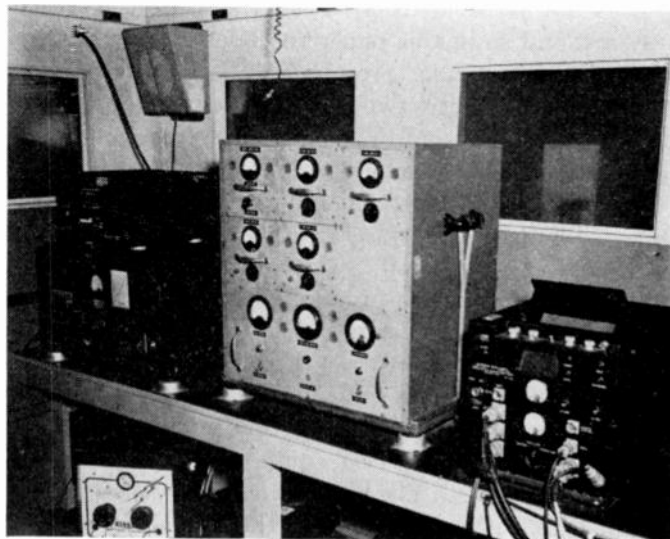

Fig. 16—Truck installation of subcarrier receiving equipment, consisting of FM receiver and panoramiscopes, subcarrier filters, audio discriminators, and recording oscillographs.



ramiscope are used with filters and discriminators for the various subcarriers. A fourteen-channel recording oscillograph is used to record the intelligence of the various channels, timing marks, and control signals.

Typical accuracies which may be expected from frequency-modulated multiple subcarrier telemetry are listed in Table II. Improvements in the accuracy of a function being telemetered may be improved by reducing the effects of vibration, acceleration, temperature, and other ambient conditions, particularly on the end instruments. In some instances the added accuracy obtainable by more complex end instruments and transducers cannot be utilized due to space limitations, or if instability results from their use under flight conditions.

TABLE II

ACCURACIES OBTAINED FROM FREQUENCY-MODULATED MULTIPLE SUBCARRIER TELEMETRY

<i>Over-All Accuracy Using Variable-Reactance Transducers:</i>		
Amplitude.....	2.0	per cent
Acceleration.....	3.0	per cent
Motion and Position		
Angular.....	1.0	per cent
Linear.....	1.0	per cent
Pressure.....	3.0	per cent
Velocity		
Rotational.....	0.05	per cent
Reciprocating.....	0.05	per cent
<i>Over-All Accuracy Using Saturable-Reactance Transducers:</i>		
Strain, Temperature, Voltage, or Current.....	5.0	per cent
<i>Over-All Accuracy Using Resistance Transducers:</i>		
Add approximately 1 per cent to the end instrument accuracy.		
<i>Accuracies of Typical End Instruments with Resistance Transducers Attached</i>		
<i>Altitude:</i>		
100 ft on 10,000 ft range; 150 ft on 10,000-20,000 ft range; 200 ft on 20,000-35,000 ft range.		
<i>Airspeed:</i>		
3 mph on 500 mph range; 5 mph on 700 mph range.		
<i>Linear Acceleration:</i>		
0.15g on 12g range.		
<i>Angle of Pitch and Yaw Vane Transmitters:</i>		
45°-0-45°		
<i>Direction Gyros:</i>		
Maximum drift not to exceed 3° in 15 min; 360°-0-360°		
<i>Altitude gyros:</i>		
2 per cent	100°-0-100° roll	70°-0-70° pitch
2 per cent	95°-0- 95° roll	65°-0- 65° pitch
2 per cent	360°-0-360° roll	360°-0-360° pitch
<i>Rate Gyros:</i>		
Rate of roll	1 per cent	0- 90° per sec
	1 per cent	0-180° per sec
	1 per cent	0-270° per sec
Rate of pitch	1 per cent	0- 90° per sec
	1 per cent	0-180° per sec
	1 per cent	0-270° per sec
Rate of yaw	1 per cent	0- 90° per sec
	1 per cent	0-180° per sec
	1 per cent	0-270° per sec
<i>Fluxgate Compass Indicator:</i>		
0.5 per cent	0-360° azimuth	
<i>Pressure:</i>		
2.0 per cent		
<i>Flow Rate:</i>		
0.5 per cent		
<i>Fuel Remaining:</i>		
0.5 per cent		
<i>Flow Totalizer:</i>		
0.5 per cent		

MULTIPLEXING SUBCARRIER SYSTEMS

In order to obtain additional telemetered information, several methods may be employed. The number of subcarriers may be increased at the expense of power per channel. It is better from the standpoint of space in the missile, as well as power, to obtain additional information by incremental frequency shift of the subcarrier, or by time division of one or more subcarriers. The former superimposes one function upon another without interrupting the first. Time and frequency information are particularly well adapted to this type of multiplexing. Tachometer indications, for example, may be made to appear as a sinusoidal trace on the oscillograph paper. A displacement in trace position will not change the number of alternations. This shift may be due to the arming of a fuze. In this manner "yes-no" information may be superimposed upon the speed indication. Physically this may be done by using a relay to connect a capacitor across the tank circuit to decrease the frequency. A pronounced and sudden change in amplitude of the trace can convey such information without impairing the usefulness of the original information. It is required that the frequency deviation of the function be limited so that the total does not cause overmodulation. A subminiature installation in which this method was used is shown in Fig. 17. The relay box was mounted

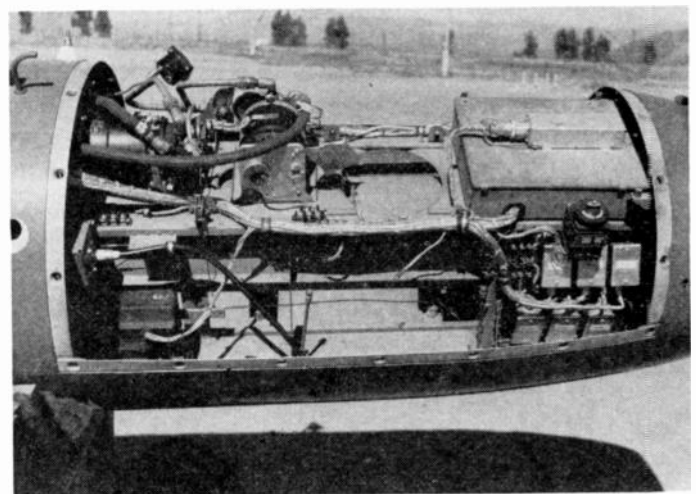

Official U. S. Navy Photograph

Fig. 17—Typical installation of subminiature telemetering equipment in KD2C.  
 Upper left: roll and pitch gyros with mu-metal segments and E coils.  
 Upper right: relay box for superimposing fixed displacements upon certain channels.  
 Lower left: power amplifier.  
 Lower right: six subcarrier oscillators.  
 Note: standoff insulator at upper left is for control receiver antenna.

on the cover of the box in the upper right. The subcarrier oscillators are shown at the lower right, the roll and pitch gyros with E coils are at the upper left, and the power amplifier with coax from the transmitter is located at the lower left.

Multiplexing by time division is adapted to measurements which do not require a high time resolution, such as result from many mechanical and electrical changes. A simple means of subdividing a channel is by means of a motor-driven switch shown in Fig. 18, which causes



Official U. S. Navy Photograph

Fig. 18—Motor-driven multiplexing.

one function to be recorded for the larger part of the cycle, and another to be recorded the smaller part of the time, resulting in short and long trace indications. The difference in dwelling time readily distinguishes each function. The period time is about one-tenth of a second. It is therefore necessary to select functions not subject to more rapid changes. Temperature or other functions not subject to rapid change may be telemetered on a relatively slow divided-time basis such as

instruments to share a channel, for example, there is less time per instrument than if there were only two end instruments. It is possible that four end instruments have as much time per end instrument as if only two were used, by employing four oscillators on two channels, with one end instrument per oscillator. A two-position switch can be made to select between the outputs of two pairs of oscillators as shown in Fig. 19. One oscillator of each pair would be set for 2300 cps. and the other for 3000 cps. During a part of the time these two and their end instruments would be connected, and during the remainder of the time the other 2300 cps and 3000 cps oscillators and their particular end instruments would be connected to the modulator. A difference in dwelling time or of spacing is necessary to distinguish between pairs. This method is extremely simple, but involves dividing time on more than one channel.

A multisegment, motor-driven switch, spoken of as a commutator, provides another means of dividing the time of a channel. The various end instruments would connect to their respective segments. The commutated channel thus provides many sources of information, not all of which are available for end instruments, since reference voltages are transmitted for calibration purposes, where voltage variations in flight would be reflected in accuracy. Timing pulses are also transmitted and are particularly necessary for the establishment of the proper time sequencing of the recordings of the several receiving stations as the missile comes into the effective range of each. At this activity a low-speed 24-segment commutator has been developed in which the

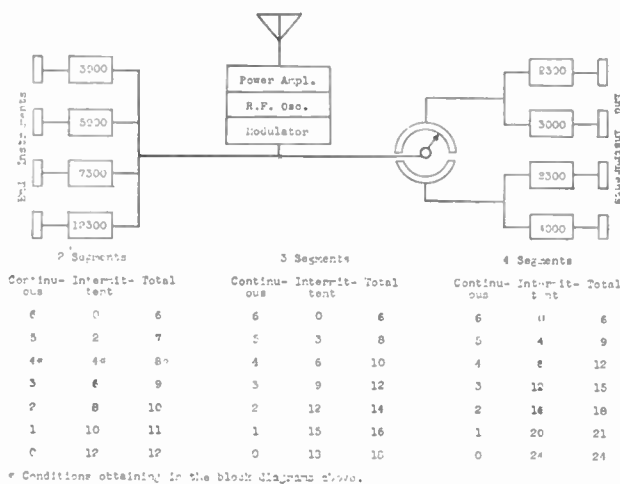

Fig. 19—Subcarrier output multiplexing.

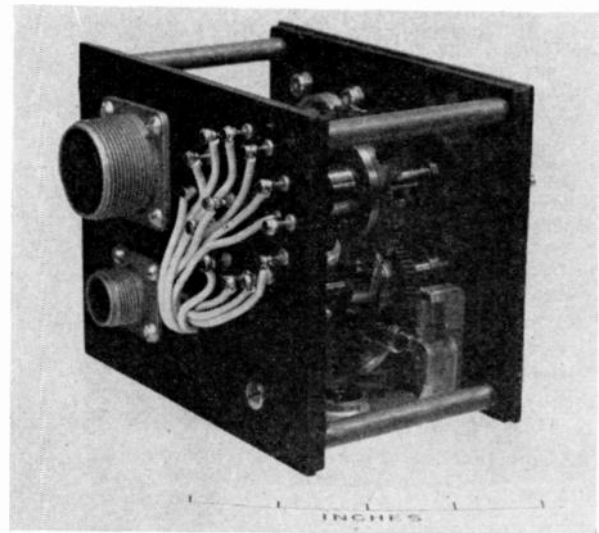
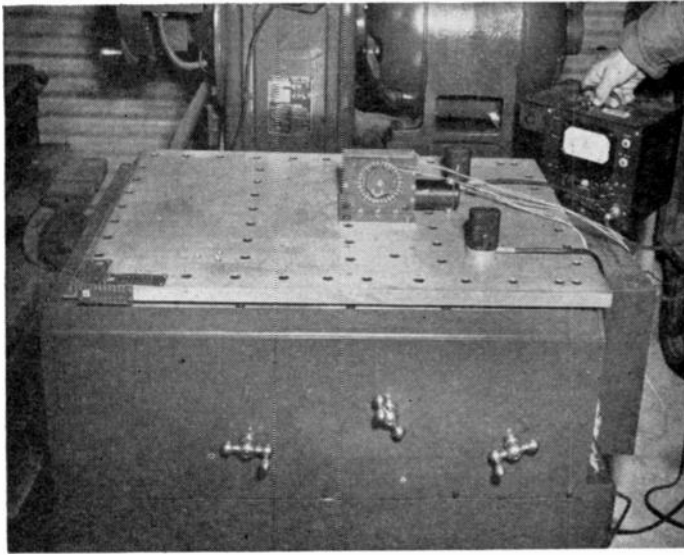

Fig. 20—Low-speed commutator with high duty cycle.

this. Circuitwise this may be accomplished by inserting the motor-driven switch between the end instruments and the oscillator, in which case only one channel is divided between the end instruments. With four end

dwelling time is nine times the transfer time. A Geneva movement was used in this commutator, shown in Fig. 20, in order to obtain this ratio. In Fig. 21 is shown

a higher-speed mechanical commutator which is driven at 5 revolutions per second. With 30 segments, this represents a total of 150 samplings per second. Since this number imposes more stringent bandwidth requirements, it is generally used on the 7350 or 12,300 cps subcarrier frequencies where the bandwidths are adequate for this commutator. If more than five samplings per second are desired of a particular function, the number may be increased by utilizing more segments, at the expense of the number of functions to be telemetered. For example, if segments number one and number sixteen are multiplied, ten samplings per second result, but one less function can be telemetered. If numbers one, eleven, and twenty-one are multiplied, then fifteen samplings per second are obtained of this function, and at the expense of two functions.



Official U. S. Navy Photograph

Fig. 21—Experimental high-duty-cycle commutator being subjected to vibration tests.

Avenues for the improvement of mechanical commutation have by no means been exhausted. Some work has been done with electronic commutation arrangements, but this is in the experimental stage.

#### PULSE SYSTEMS

Pulse systems are fundamentally based upon time division, characterized by pulses of high amplitude and with one-half to two microseconds duration. Also, a synchronizing means must be supplied. Because of the comparatively long intervals between pulses, some pulse systems are capable of expansion or contraction into a greater or lesser number of channels. Pulse systems are numerous and varied.

Pulse-position modulation apparently offers the most encouragement for missile work. Once during each period each channel is sampled. The channel pulses are advanced or retarded about their quiescent positions due to modulation. The amount of advancement or re-

tardation is dependent upon the amplitude and polarity of the input voltage at the instant each sample is taken. The input frequency determines the rate at which the pulses corresponding to a given channel vary from the quiescent position. The maximum change in pulse position must be limited to prevent adjacent channels from overlapping, and to reduce crosstalk. If each channel occupies 10 degrees, a total of thirty-five channels excluding the sync channel are obtained. With a one-half microsecond pulse length and a sampling time of twenty times this amount, the time per channel is 10 microseconds, and a maximum sampling rate of 2777 samplings per second would result. A greater pulse length would result in a lower sampling rate. Many ways of producing pulse-position modulation are possible; however, the method should be precise so that random errors in pulse position would be minimized.

An experimental transmitter is shown in Fig. 22. The power supply for this transmitter is somewhat larger and heavier than the transmitter itself. Potentiometer-type

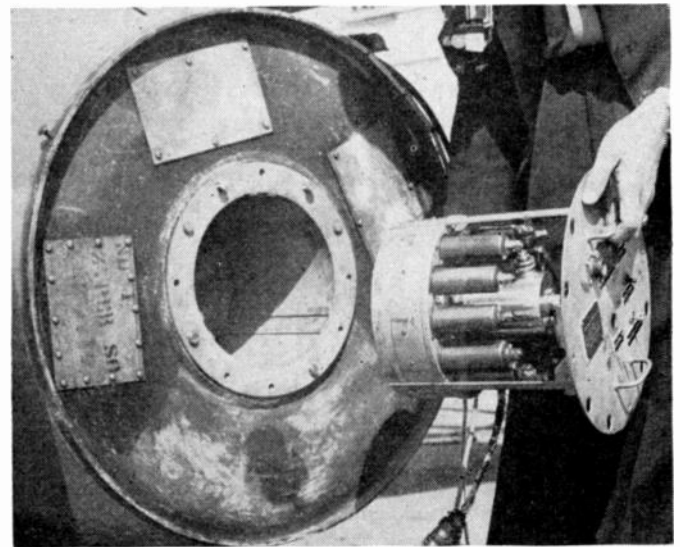

Official U. S. Navy Photograph

Fig. 22—Experimental pulse-position telemetering transmitter and location within KUW.

transducers are employed with this equipment. A similar type of pulse telemetering is described by Heeren, Hoepfner, Kauke, Lichtman, and Schifflett.<sup>1</sup>

The principal difficulty with pulse-position systems has been their dependence upon absolute timing circuits. This has been improved by causing each channel to assume a fixed relative position with respect to the others. It is not necessary to break a cycle down into eight parts directly (from a delay line, for example), since phase-doubling transformation can be used to obtain eight phase displacements from an original four. This is analogous to the use of transformers to convert

<sup>1</sup> V. L. Heeren, C. H. Hoepfner, J. R. Kauke, S. W. Lichtman, and P. R. Schifflett "Telemetry from V-2 rockets," *Electronics*, vol. 20, pp. 100-107; March, 1947.

three-phase power to six-phase power. With the eighth channel used for synchronizing pulses, seven channels therefore result. Thirty-five channels would result from the breakdown of a cycle into 10-degree samplings.

In another pulse-position system, a subcarrier transducer system is employed in order to make it unnecessary to introduce reference level markers. The quiescent frequency of the subcarrier rather than the quiescent time position of the pulse determines zero level. The time interval between the marker pulse and each channel pulse is varied at an audio rate by the incoming signal from the transducer. The oscillator-frequency output is then used to modulate a channel whose pulse output is transmitted, received, and demodulated to produce the original signal. When it is desired to telemeter a voltage, it can control the frequency of the oscillator directly, just as is the case with frequency-modulated subcarrier systems employing phase-shift oscillators. Beyond this the similarity between these types of systems ends.

Restrictions imposed by security regulations prohibit a complete discussion of Navy pulse telemetering systems.

#### CONCLUSIONS

Numerous telemetering systems have been proposed,

and a number have been built which are as different as the functions to be telemetered.

Telemetering systems may be compared on the basis of several factors:

Bandwidth is only a factor when the end instruments and transducers warrant an equally high time resolution.

With a number of island stations, range is not as important as reliability with various missile attitudes.

Reliability is a factor which is based largely upon the number of links in the chain of circuits.

Speed in equipping and calibrating before flight is important in a test program, and depends largely upon the number of items which can go wrong.

In small target pilotless aircraft, space is a particularly critical factor, and the volume of the equipment depends again upon the number of circuits, power, and number of functions to be telemetered.

The time required to make an installation, and the cost of the telemetering installation, is largely a function of the number of functions to be telemetered; however, this cost is low compared to the missile which is expended in a test flight. A failure of the telemetering results in the waste of a large sum because of the loss of the necessary data, necessitating the complete conditioning and instrumenting of another missile.

## A Waveguide Bridge for Measuring Gain at 4000 Mc\*

A. L. SAMUEL†, FELLOW, IRE, AND C. F. CRANDELL‡, MEMBER, IRE

**Summary**—A bridge has been constructed for measuring the gain and phase delay of amplifiers in the vicinity of 4000 Mc. The equipment is described, and the methods employed to reduce the possible errors are discussed. The general method may be adapted for use in any desired frequency range.

**B**RIDGE CIRCUITS, although much used at lower frequencies, have not been applied to any great extent at the high radio frequencies. The present paper describes a waveguide bridge which has been constructed to measure gain (or loss) and phase delay of devices at frequencies in the vicinity of 4000 Mc. The general method consists in comparing the output of the device under test to its input by means of a null balance. As in any ac bridge, this balance involves both amplitude and phase. The amplitude balance is obtained by varying a calibrated attenuator, the calibra-

tion giving the gain directly. Phase balance is obtained by moving the position of a pickup point on a standing-wave detector, the distance by which this point must be moved when the amplifier is replaced by a passive circuit of known characteristics (usually a short section of waveguide) being a measure of the phase shift. Balance is indicated by a null observation on a cathode-ray oscilloscope which simultaneously presents the output versus frequency characteristic of the amplifier on a second trace.

#### GENERAL EXPLANATION

A photograph of the complete bridge is shown in Fig. 1. It consists of (1) the high-frequency oscillator and driving amplifier with their coaxial-line connections located on the extreme upper right corner of the bench, and partly obscured by the waveguide assembly; (2) the waveguide assembly which constitutes the bridge proper; and (3) the associated power supplies, monitoring circuits and switching circuits, etc., which are mounted on the racks to the right and left and on the shelf above the waveguide unit.

\* Decimal classification: R255.11. Original manuscript received by the Institute, December 1, 1947. Presented, 1948 IRE National Convention, March 24, 1948, New York, N. Y.

† Formerly, Bell Telephone Laboratories, New York, N. Y.; now, University of Illinois, Urbana, Ill.

‡ Formerly, Bell Telephone Laboratories, New York, N. Y.; now, Southwestern Bell Telephone Company, Dallas, Texas.



Fig. 1—The complete bridge assembly with all auxiliary equipment and power supplies.

The waveguide section only is shown in greater detail in Fig. 2. Power from the high-frequency oscillator, shown in the upper right with its motor modulating device, is supplied to the driving amplifier (partially hidden by the waveguide assembly) by means of a flexible coaxial cable and from there to the input of the waveguide which is located just outside the picture to the right. The unseen portion of guide to the right contains wave meters and an impedance-matching unit. Entering the visible portion of rectangular waveguide from the right, the first unit encountered is an input attenuator (with circular dial), then the input directional coupler (the three-tier guide section), where samples of input power and input reflected power are obtained. The amplifier under test is in the center foreground between the input directional coupler to its right and a similar output directional coupler to its left. The traveling probe of the standing-wave detector, with its flexible coaxial output, is seen behind the amplifier. The calibrated attenuator with its dial indicator (white faced) can be seen in the waveguide section between the output directional coupler and the traveling probe.

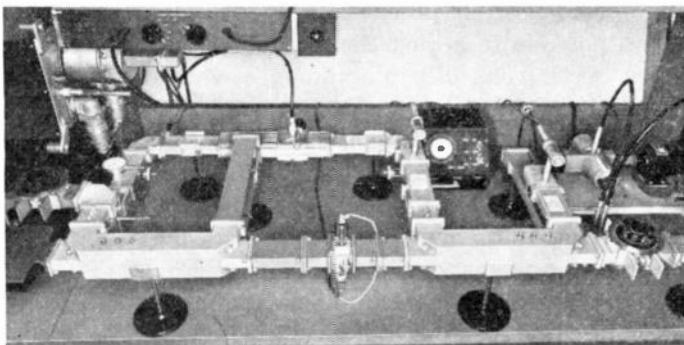

Fig. 2—The waveguide bridge proper showing the arrangement of the parts.

#### MEASUREMENT OF GAIN

A simplified schematic of the bridge is shown in Fig. 3. The wave pattern existing in the section of guide containing the traveling probe can be considered as result-

ing from two independent waves. One of these, proportional to the input power to the amplifier under test, is traveling to the right, while the other is proportional to the output power, and is traveling to the left. If the loss introduced by attenuator No. 1 is exactly equal to the gain introduced by the amplifier (assuming the directional couplers to be identical), the amplitudes of these two wave components will be equal, producing a resulting standing-wave pattern with a series of nodes. A null balance can therefore be obtained by moving the pickup probe along the slotted section to one of these nodal points, and by a critical adjustment of the attenuator.

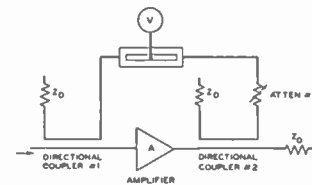

Fig. 3—A simplified schematic of the bridge illustrating the basic principle.

It should be noted that this bridge compares the forward power in the input line with the forward power in the output line. The bridge, therefore, measures gain defined as the ratio of the power impressed on the output line to the power impressed on the input to the amplifier. The actual power delivered to a useful load may be reduced by an impedance mismatch, and the power absorbed by the amplifier input may be similarly reduced by an input mismatch. Measurements made under mismatch conditions must be properly interpreted, but they are otherwise perfectly valid. However, it is customary to make gain measurements under matched conditions where the distinctions between available power, impressed power, and absorbed power are of no consequence.

Although the circuit shown in Fig. 3 is perfectly usable for the measurement of gain on an unmodulated cw basis, the measurement is greatly facilitated by the use of a frequency-modulated source which, in effect, periodically sweeps the frequency of the high-frequency oscillator through the pass range of the amplifier. By means of a synchronous switch the oscillator is turned off for every alternate half cycle of the frequency excursion, so that the frequency sweep is unidirectional. The off period also provides a zero reference line on the oscilloscope. Under these conditions it is possible to observe the band-pass characteristics of the amplifier as a function of frequency. By means of a channel switch one may view this band-pass characteristic on the oscilloscope at the same time that the oscilloscope is being used to observe the null balance of the bridge. Of course this balance will now occur at only a single frequency (within the range being swept) for which the gain and phase setting are correct.

Fig. 4 is a schematic drawing of the complete bridge circuit. It includes the frequency-modulated source, together with a number of additional features which have

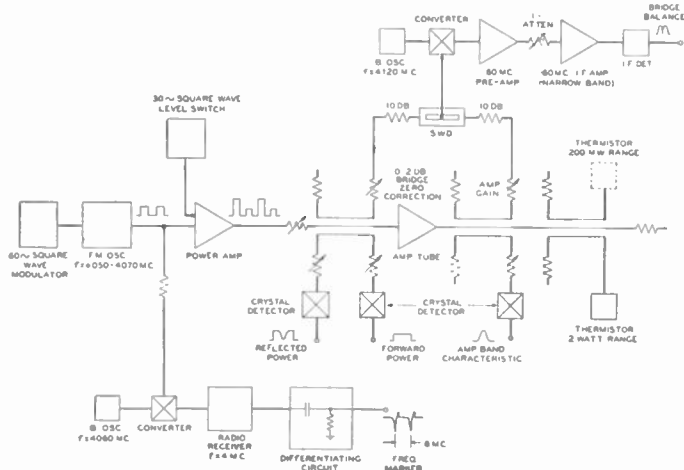

Fig. 4—Schematic drawing of the complete bridge.

not yet been described. Small sketches indicate the approximate appearance of the signal (or its envelope) existing at various parts of the circuit. These plots are against time as an abscissa, but in most cases they can be thought of as plots against frequency because of the nature of the frequency modulation on the high-frequency oscillator. Fig. 4 is a composite drawing and contains features which are not all used simultaneously.

The two-channel display on the oscilloscope makes it possible to adjust for a null at any desired point in the amplifier pass band, while simultaneously insuring that the pass band is of the desired shape. The appearance of the oscilloscope is indicated in Fig. 5. One trace

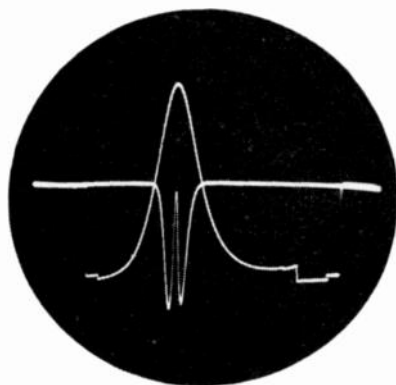

Fig. 5—An unretouched photograph of the oscilloscope screen showing the simultaneous display of the amplifier pass-band characteristic and the bridge balance indication.

shows the bridge balance, while the second shows the pass-band characteristic, which is in the form of the usual resonance curve. Both curves are plotted against a common abscissa scale proportional to frequency. The null point is the center point of the "W" where it comes into alignment with the horizontal zero lines. The amplitude rises rapidly for frequencies to either side of the

balance. A narrow-band amplifier is used in the bridge output channel to prevent overloading at far off-balance frequencies, thus giving the "W"-shaped pattern. This enables one to operate the bridge under conditions of maximum sensitivity. The location of the null point along the abscissa scale corresponding to the maximum output on the other trace indicates that the gain is being measured at this point in the pass band.

#### GAIN MEASUREMENT ERRORS

Reflections in the balancing arm of the bridge will introduce an error in the measurement of gain. If the directional couplers, their terminations, and the waveguide components, particularly the elbows, are not all properly matched in impedance, reflections of one wave component will be added to the other wave component in random phases, depending upon the exact locations and magnitudes of the discontinuities which produce them. Furthermore, the relative phases between the output wave sample and the input wave sample, and hence the relative phases between the direct waves and the additive reflected-wave components, will depend upon the exact phase delay through the amplifier under test and upon the frequency. The balance obtained under these conditions is dependent upon these reflections in a complicated way, and an error is introduced which cannot be allowed for in the calibration. Instead, this error must be reduced to a tolerable value. Care was exercised in the construction of the individual circuit components and, in addition, they were all individually trimmed to match the impedance of the standard waveguide. Adjustment screws opposite the slots of the directional couplers (the top ones being visible in Fig. 2), were used to compensate for the reflection caused by these slots. The elbows were designed to be reasonably well matched, with the final trimming being provided by tuning plugs. The terminations were of a design which matched the waveguide with little or no trimming. In spite of all possible precautions of this sort it was not found possible to adjust the individual components to much better than 0.1 db standing-wave ratio over the desired frequency band. Since there are a relatively large number of these discontinuities in the system, the over-all error could easily reach 1 db or more. The effect of these discontinuities was further reduced by introducing 10-db attenuating pads on each side of the slotted section, as shown in Fig. 4. Because of these pads, the output signal sample on the input side of the slotted section is reduced in level by 20 db, with respect to the level of the input signal sample at this same location. The input signal sample is similarly reduced by 20 db, with respect to the output signal sample on the output side of the slotted section. This reduces the effective size of the reflected signals by 20 db, and greatly improves the accuracy of the bridge. The attenuating pads themselves must not introduce serious reflections; the pads actually used were somewhat better than 0.1 db

over the necessary band. The maximum error from this source is probably well under 0.2 db.

Errors in the measurement of phase will occur as a result of differences in the lengths of the waveguide paths traversed by the input and output wave samples, and because of the variations in phase delay through the calibrated attenuator. No serious attempt has yet been made to evaluate or reduce this type of error.

#### MEASUREMENT OF COMPRESSION

An additional power amplifier, as shown in Fig. 4, is of value when one desires to study compression; that is, the variation in gain with power level. It cannot be used if one wishes to examine the pass-band characteristic of the amplifier tube under test because of the effect of its own relatively narrow pass band on the resulting picture. This driver amplifier can be arranged so that its output is switched at a 30-cps rate between two different power levels, which may be adjusted so that the power output from the tube under test is in turn alternated between two desired levels, say 1.0 watt and 0.1 watt. It is, of course, necessary to remove the frequency modulation on the high-frequency oscillator and to operate the amplifier on a cw basis, in order to measure the output power levels by the thermistor wattmeter and to adjust the drive to the desired values. After this has been done, the frequency modulation can then be restored for the gain measurements. By appropriate switching means, it is possible to observe the bridge balance signals corresponding to the two different levels, simultaneously, each on a separate oscillograph trace. If there is any difference in the tube gain at these two power levels, only one of the traces can be made to balance at a time. The amount by which the "Amp. Gain" attenuator must be changed to obtain a balance on the second trace is a measure of the compression between these two power levels. The ability to measure the difference in gain between the two power levels while the tube is being alternately pulsed between these two levels eliminates errors due to drifts in adjustment and to long-time variations in gain caused by heating effects. Changes in gain can be measured to an accuracy of the order of 0.1 db by this method, even though the absolute accuracy of the bridge is probably no better than 0.2 db.

#### MEASUREMENT OF BANDWIDTH

Bandwidth measurements are made by employing the circuit shown on the bottom of Fig. 4 to provide two frequency-marker pips which can be switched on one channel of the 'scope at the same time that the pass-band characteristic is being presented on the other channel. The appearance of these marker pips is illustrated in Fig. 6, where they are shown together with the pass-band characteristic of the amplifier. These pips are separately adjustable as to amplitude, mean frequency,

and frequency spread, so that it is relatively easy to measure the difference in frequency between any two desired points on the pattern, say between the 3-db-down points. The calibration of the ordinate scale on the pass-band characteristic may be made in terms of a calibrated attenuator in the output circuit.

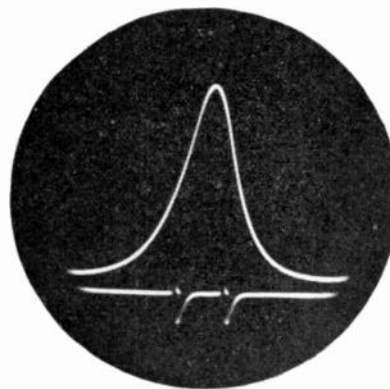

Fig. 6—The frequency marker pips as they appear when viewed with the amplifier pass-band characteristic.

#### SIGNAL MONITORS

The bridge is arranged to furnish, in addition to the amplifier output, two other monitoring signals which come from crystals connected to either end of the top deck of the input directional coupler. They are schematically shown in Fig. 4, where they are labeled "Reflected Power" and "Forward Power." The signal from the "Forward Power" crystal represents the power supplied to the bridge from the FM oscillator. When the oscillator and bridge are properly adjusted, this signal is a pulse of constant amplitude (with the reference zero

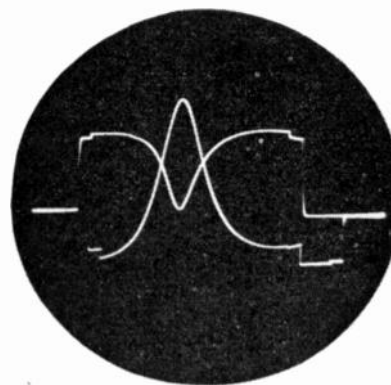

Fig. 7—The input reflected-power pattern of an amplifier, shown with the amplifier pass band.

line at each end) but of varying frequency. If the input level is not constant, an error will be introduced in the bandwidth measurements. By having the "Forward Power" monitor built into the bridge circuit, it is pos-

sible at any time to check the adjustment of the oscillator and the bridge circuits.

The appearance of the "Reflected Power" pattern from an amplifier with the input circuit tuned to match the impedance of the waveguide at center frequency is shown in Fig. 7 (with the transmission pass-band characteristic on the other channel). This pattern provides a very quick method of adjusting the input to the amplifier, since the effects of mistuning and mismatching can be easily seen separated, and without regard to the adjustment of the output circuit. With the input circuit properly adjusted, it then becomes a simple matter to adjust the output circuit for maximum gain. This method is considerably faster than the method of tuning both circuits simultaneously with the output as the only indication, since there may be no visible output signal if the cavities are far out of tune and it then becomes a matter of trial and error to determine the correct adjustment.

#### THE RADIO-FREQUENCY OSCILLATOR

The FM oscillator shown in Fig. 8 consists of an experimental oscillator tube in a wide-range cavity. The

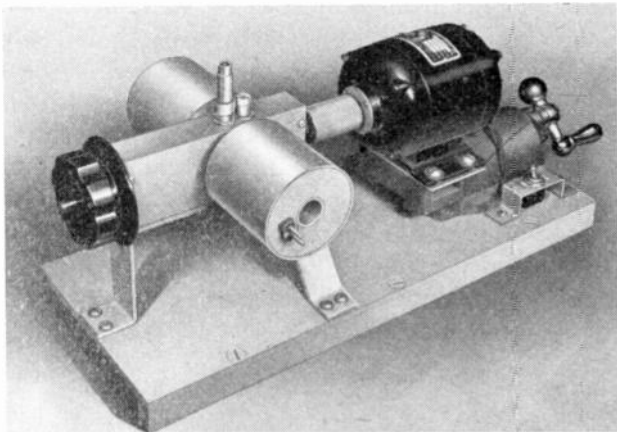

Fig. 8—The FM oscillator.

mean frequency of this oscillator is determined by the position of a movable piston in one end of the resonant cavity, while the periodic variations in frequency are produced by a paddle (shown in detail in Fig. 9) which is driven by a synchronous motor. This oscillator will tune from 6.8 to 8.1 cm.

At 4000 Mc, the frequency where the bridge is normally used, the oscillator output can be adjusted to be constant to within 0.2 db over a frequency swing of 50 Mc. By introducing an alternating voltage in the power supply, it is possible to increase the frequency sweep to 600 Mc with not too great a sacrifice in constancy of output. A Western Electric D-168479 relay operating at a 60-cps rate is used to supply the oscillator with a square-wave input voltage.

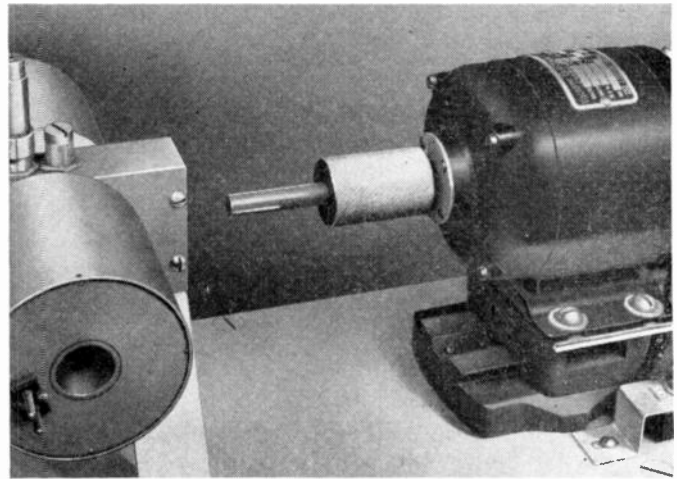

Fig. 9—The paddle used in the oscillator of Fig. 8 to produce the frequency variation.

#### THE CHANNEL SWITCH

A relay circuit provides the desired synchronous switching between any two selected channels. This relay is driven by a 30-cps vacuum-tube oscillator which is synchronized by its 60-cps plate supply. This arrangement is much superior to an electronic switch which was originally used, and which was unsatisfactory at 30 cps because of its poor low-frequency response. A balance control provides for the injection of a small variable dc voltage of either sign into one of the two relay signal channels to displace one trace on the oscilloscope with respect to the other. A bank of six input terminals and input potentiometers, and the associated switches, enable one to select the desired pairs of signal channels for simultaneous observation.

#### ACKNOWLEDGMENT

The construction of this waveguide bridge was originally undertaken after its feasibility had become apparent through discussion held between the writers, J. W. Clark, A. F. Fox, and W. W. Mumford. These individuals, and others, contributed a number of useful ideas which have been incorporated into the bridge in its final form. L. E. Cheesman assisted in the design, construction, and testing of many of the bridge components.

#### BIBLIOGRAPHY

- (1) Allen F. Pomeroy, "Precision measurement of impedance mismatches in wave guide," *Bell. Sys. Tech. Jour.*, vol. 26, pp. 446-459; July, 1947.
- (2) W. W. Mumford, "Directional couplers," *Proc. I.R.E.*, vol. 35, pp. 160-166; February, 1947.
- (3) W. A. Tyrrell, "Hybrid circuits for microwaves," *Proc. I.R.E.*, vol. 35, pp. 1294-1307; November, 1947.
- (4) Henry J. Riblet, "Mathematical theory of directional couplers," *Proc. I.R.E.*, vol. 35, pp. 1307-1313; November, 1947.
- (5) William Alter, F. B. Marshall, and L. P. Hunter, "Probe error in standing-wave detectors," *Proc. I.R.E.*, vol. 35, pp. 35P-45 P; January, 1946.



# A High-Level Single-Sideband Transmitter\*

OSWALD G. VILLARD, JR.†, ASSOCIATE, IRE

**Summary**—Double-sideband suppressed-carrier signals can be generated with relatively high efficiency at high power levels in grid-modulated balanced modulators so biased that very little plate current flows in the absence of audio input. When tubes having a constant-current characteristic are used, and the necessary quadrature phase shift between pairs of audio- and radio-frequency excitation voltages exists, two high-power balanced modulators of this type may be connected to a common output circuit to produce suppressed-carrier single-sideband signals. The peak efficiency of the combination for sinusoidal modulation is  $\pi/4$  times or 78 per cent that obtainable when the same tubes are used as linear amplifiers. Operating adjustments are shown to be straightforward. The simplicity and power economy of this circuit make it attractive for those applications where moderately low distortion and reasonably good rejection of the undesired sideband are satisfactory.

THE ADVANTAGES of single-sideband radio-telephone transmission in terms of bandwidth and power requirements have been understood for many years. However, difficulties of single-sideband generation and reception have so far prevented the general use of this system except in cases of absolute necessity, such as radiotelephony below 100 kc, carrier-current communication, or long-distance multichannel short-wave telephone transmission.

The classical method of producing single-sideband signals, employing sharp filters, balanced modulators, and frequency changers, is undeniably complex, and does not lend itself readily to incorporation in radio-telephone equipment where flexibility in operation, as well as ease in adjustment and maintenance, are important.

The phase-rotation method of single-sideband generation, in which two sets of carrierless double sidebands are combined in such a way that the undesired upper or lower sideband is cancelled out, is fundamentally simpler (now that practical 90-degree audio phase-shift networks are available<sup>1</sup>), but in the systems so far disclosed<sup>2-4</sup> linear amplification is required in order to achieve the desired output power level.

It is the purpose of this paper to describe a transmitter of the phase-rotation type in which the single sideband is generated at high level and good efficiency directly in the final stage. The rf circuitry and circuit adjustments have been reduced to a minimum. The result is a transmitter which is scarcely more compli-

cated or more difficult to adjust than the conventional plate-modulated one, which produces its output at an efficiency closely approaching that of a linear amplifier, and which gives reasonably good suppression of the undesired sideband together with moderately low distortion.

A block diagram of the basic method is shown in Fig. 1. Two balanced modulators, excited by rf voltages 90° out of phase, and by af voltages in phase quadrature, are

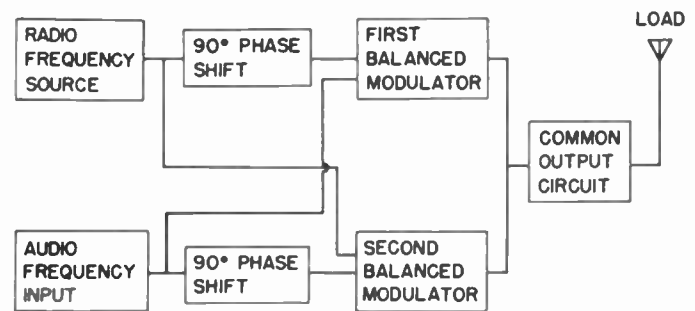

Fig. 1—Block diagram of sideband-cancellation method.

connected directly to a common output circuit. Four tubes having a substantially constant-current characteristic are used, so that the amplitude and phase of their plate-current pulses is determined only by excitation and modulation voltages, and is independent of the loading and the tuning of the output circuit. The tubes are so

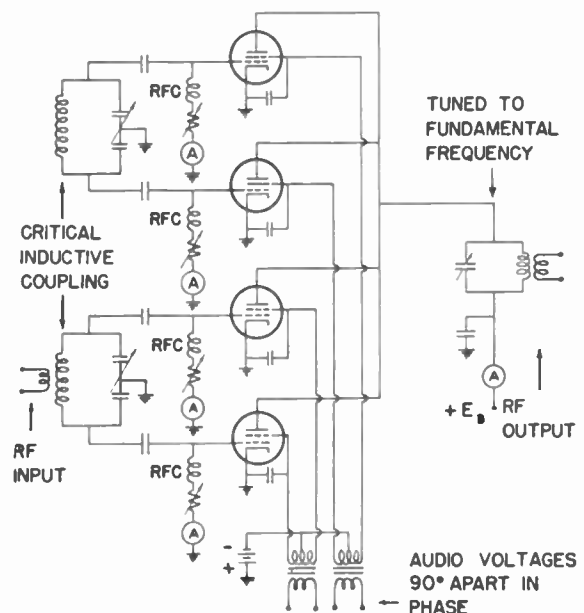

Fig. 2—Schematic of twin balanced modulator.

\* Decimal classification: R423.52. Original manuscript received by the Institute, April 6, 1948; revised manuscript received, June 28, 1948.

† Stanford University, Stanford, Calif.

<sup>1</sup> R. B. Dome, "Wideband phase shift networks," *Electronics*, vol. 19, pp. 112-115; December, 1946.

<sup>2</sup> Paul Loyet, "Experimental polyphase broadcasting," *Proc. I.R.E.*, vol. 30, pp. 213-222; May, 1942.

<sup>3</sup> M. A. Honnell, "Single sideband generator," *Electronics*, vol. 18, pp. 166-168; November, 1945.

<sup>4</sup> B. E. Lenehan, "A new single sideband carrier system for power lines," *Elec. Eng.*, vol. 66, pp. 549-592; June, 1947.

biased that very little plate current is drawn in the absence of an audio signal. The combination might be called a "twin balanced modulator." The schematic of a practical circuit is shown in Fig. 2.

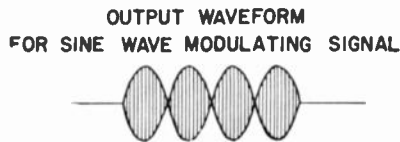
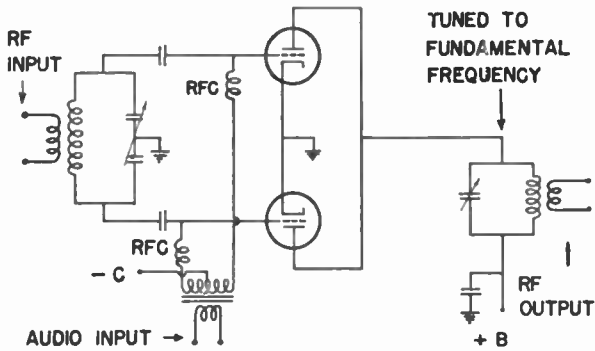

Fig. 3—Schematic of high-level, grid-bias-modulated balanced modulator.

The operation of the circuit may be more easily visualized after a review of the mathematical and vector relationships involved. The equation of the output of an ordinary balanced modulator (see Fig. 3) may be written as:

$$e = m \sin 2\pi ft \cos 2\pi f_s t \tag{1}$$

where

- $e$  = instantaneous amplitude of the wave
- $m$  = a constant proportional to the amplitude of the modulating wave, i.e., degree of modulation
- $f_s$  = modulating (or audio) frequency
- $f$  = radio (or carrier) frequency.

This equation may be thought of as representing a wave of carrier frequency whose instantaneous amplitude is proportional to the cosine of the angle of the modulating wave. When this angle is in the second and third quadrants, its cosine is negative, and the phase of the wave of carrier frequency changes by 180°. We therefore have an rf wave which starts out from zero with given rf phase, builds up sinusoidally to a maximum, and then returns to zero again in the first half of the af cycle. This process is repeated in the second half, but the phase of the rf wave is reversed.

Cancellation of the undesired sideband in a double balanced modulator may be shown as follows. Equation (1) can be expanded to:

$$e = \frac{m}{2} [\sin 2\pi(f + f_s)t + \sin 2\pi(f - f_s)t]. \tag{2}$$

Now the output of a second balanced modulator, fed by a rf voltage 90° out of phase with that of the first, as well as an af voltage in quadrature with that of the first, has the form:

$$e = m \cos 2\pi ft \sin 2\pi f_s t \tag{3}$$

which, when expanded, is

$$e = \frac{m}{2} [\sin 2\pi(f + f_s)t - \sin 2\pi(f - f_s)t]. \tag{4}$$

It will be seen that, when (2) and (4) are added, the difference-frequency sidebands cancel, while the sum-frequency sidebands add. The opposite result may be obtained by reversing the phase of either the rf voltage or the af voltage fed to one of the balanced modulators.

The two voltages of (1) and (3) (the rf outputs of the two balanced modulators) may be represented vectorially as in Fig. 4. The dotted vectors  $E_A$  and  $E_B$  represent

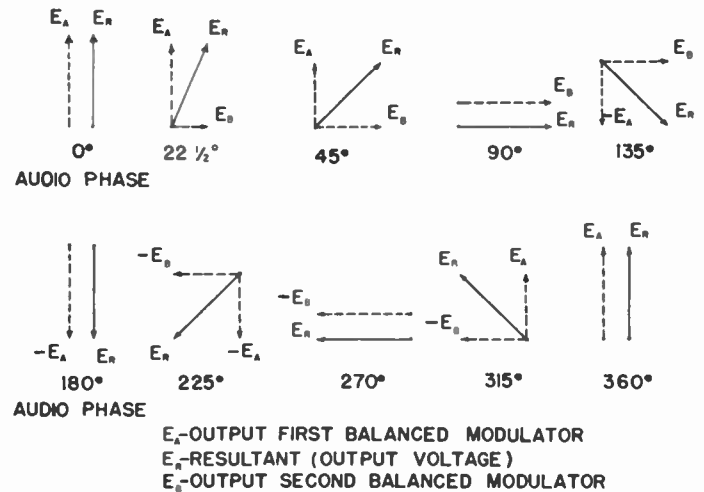

Fig. 4—Vector diagram of twin balanced-modulator action (sine-wave modulating voltage).

the magnitude and phase of the individual balanced-modulator output currents as viewed at intervals during one sinusoidal audio cycle. These two currents are in quadrature, and their amplitudes vary in accordance with af modulating voltages 90° apart. The heavy solid line ( $E_R$ ) represents their vector sum; i.e., the voltage developed across the common tank circuit of the twin balanced modulator, assuming the tubes to be constant-current generators. It will be seen that the resultant vector maintains a constant amplitude while making one complete revolution for each cycle of audio frequency. The resultant is a new radio frequency different from that of the carrier—the upper, or the lower sideband, as the case may be.

The efficiency obtainable with a twin balanced modulator of this type can readily be determined by examining the efficiency of a high-level balanced modulator by itself. (Throughout this paper it will be assumed that

the modulating voltage is a single-frequency wave.) Consider the circuit of Fig. 3. It is assumed that a steady rf input signal is applied, and that the tubes are so biased that no plate current flows in the absence of modulation. In the course of one cycle of modulation, the tubes alternately deliver their maximum power output to the common tank circuit, under conditions exactly the same as those obtaining at the positive crest of the modulating cycle in an ordinary grid-modulated amplifier. Let the peak efficiency at this point in the cycle be called  $\eta$ . The envelope of the balanced-modulator output is shown in Fig. 3. The average rf output is exactly 0.5 times the peak output power  $P_m$ , since the output voltage has the form of a series of half sine waves, and the average of a series of half sine waves squared is one-half the peak value. The peak dc input power  $P_{in}$  equals the peak output power  $P_m$  divided by the peak efficiency, namely,  $P_m/\eta$ . If the dc plate voltage is  $E_b$ , the peak dc plate current must be  $P_m/\eta E_b$ . Now the waveform of the dc input current is exactly the same as that of the rf output envelope—a series of half sine waves whose average is  $2/\pi$  or 0.636 times their peak value. Therefore, the average dc input current is  $2/\pi$  times the peak current, or  $2P_m/\pi\eta E_b$ . The efficiency, or average output power divided by average input power, is then  $0.5 P_m / (2P_m E_b / \pi\eta E_b) = \pi\eta/4$ . For  $\eta = 0.66$ , the efficiency is 52 per cent.

This is, of course, only true at full output, corresponding to complete modulation with a single-frequency tone. As with any grid-modulated or linear amplifier, the efficiency of a single or twin balanced modulator for lesser amplitudes is proportional to the amplitude of the modulating signal.

It is interesting to note that the efficiency of the twin balanced modulator is exactly equal to that of one high-level balanced modulator by itself. Since the dc plate current drawn by the tubes is independent of the rf plate voltage in the common tank circuit, the input power drawn by the two balanced modulators is exactly twice that drawn by one. The combined average output power, on the other hand, is equal to the peak power developed by each component balanced modulator (as may be seen in Fig. 4), or twice the average power output of each balanced modulator alone. Therefore, the efficiency of the pair is equal to that of its components, or  $0.785\eta$ .

Since the circuit is symmetrical, each tube dissipates on its plate one-fourth the total power lost. This means that, for full utilization of tube plate dissipation capacity, somewhat higher operating voltages may be used than are customary for a single tube in class-C amplifier service.

Screen-grid modulation, with this circuit, offers the greatest ease in adjustment, and is therefore to be preferred. Where the saving in audio power or voltage required for screen modulation outweighs a considerable increase in the complexity of adjustment, control-grid modulation may be used. Plate modulation is not satis-

factory, because at one point in the audio cycle the two tubes must operate with equal dc plate voltages of 0.707 of maximum, yet must produce a combined rf output of 1.0 times the maximum. To support this output, the instantaneous voltage at the tube plates would have to swing negative during the rf cycle at a time when plate current would normally be flowing, even when the various phase relationships are taken into account. Suppressor-grid modulation will also be found to be unsatisfactory; although it can be used, screen current and dissipation are high when the suppressor grid is biased to cutoff, thus preventing full utilization of tube capacity.

The steady dc grid-current flow, which is present with screen modulation, greatly facilitates setting the  $90^\circ$  phase shift between rf voltages applied to the two component balanced modulators of the twin balanced modulator. The two grid tuned circuits of the two pairs of tubes in Fig. 2 may be inductively coupled together, and excitation fed to one. When the secondary circuit is tuned to resonance, (as evidenced by maximum grid current) a  $90^\circ$  phase shift exists between the voltage across this circuit and that of the primary. By adjusting for critical coupling, the magnitudes of these voltages are made equal, so that all four tubes receive the same excitation. Somewhat less than the normal class-C grid excitation may be applied, the exact amount depending on the operating conditions chosen.

The screen grids must be given a slight negative bias in order to prevent excessive plate-current flow in the absence of an audio signal. The exact amount is dependent on the tube characteristics, the rf drive applied to the control grids of the tubes, and on the plate voltage. The correct value is not especially critical and may readily be found in practice. A no-signal plate current of roughly one-tenth the full-output plate current is generally satisfactory.

The question of sideband suppression, and the various circuit adjustments necessary to maintain it, are considered next. First, it should be observed that high-level balanced modulators are inherently "balanced," insofar as carrier suppression is concerned. Since the tubes are biased nearly to cutoff, virtually nothing will be radiated until an audio signal is applied. In cases where complete and automatic suppression of the carrier during quiet intervals is desired, this feature is very convenient; however, it is obvious that, if the circuit is not properly adjusted, the carrier will reappear along with any sideband output.

Suppression of the undesired sideband, in any sideband cancellation system, is dependent on the accuracy of setting of both the rf and the af phases. Since this suppression depends on the difference between large quantities, it will always be difficult to maintain completely in practice. The situation for a misadjustment of either rf or af phase by itself is illustrated in Fig. 5. The voltages  $e_1$  and  $e_2$  represent the two upper or the two lower sidebands, whichever are to be cancelled. If it is

assumed that these voltages are equal in magnitude,  $R$ , their resultant, equals  $2e_1 \sin \alpha/2$  where  $\alpha$  is the angle by which either the rf or the af phase differs from  $90^\circ$ . The ratio of the desired sideband (very nearly  $2e_1$ ) to this undesired resultant is approximately  $2e_1/2e_1 \sin \alpha/2$ , or  $115/\alpha$ , where  $\alpha$  is small and is expressed in degrees. ( $\alpha$  may, of course, be considered to be the algebraic sum of rf and af phase deviations.) It is seen that when  $\alpha=1^\circ$ , the ratio of desired to undesired sideband is

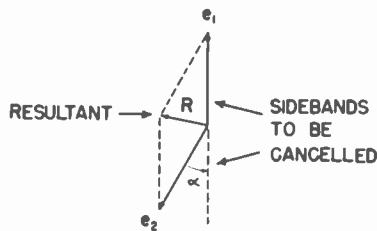

Fig. 5—Effect of rf or af phase angle on sideband cancellation.

roughly 40 db. This ratio drops to 20 db when  $\alpha$  becomes approximately  $10^\circ$ . The necessity for close control of phase is clear.

A simple audio phase-shift network of the sort shown in Fig. 6 (taken from footnote reference 1) provides a

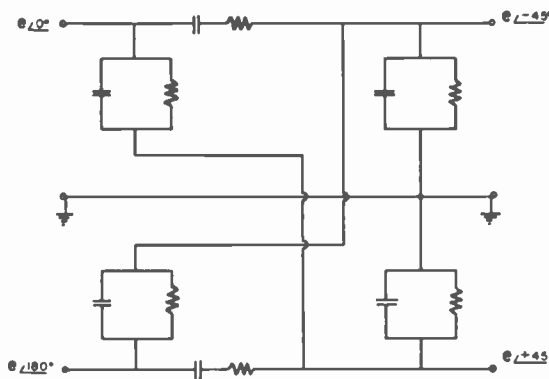

Fig. 6—Sample  $90^\circ$  wideband audio phase shift network (as shown in footnote reference 1).

phase shift departing from  $90^\circ$  by no more than  $5^\circ$  over the range 200–3000 cps. Over appreciable portions of the range, the phase characteristic is within  $2^\circ$ .

By way of comparison, assuming the phase settings to be perfect, if one of the sidebands to be cancelled is 11 per cent larger than the other, the ratio of desired to undesired sideband is nearly 25 db. Thus, a given inaccuracy in phase setting is slightly more serious than a given inaccuracy in relative magnitude.

Presence of any sizeable amount of the undesired sideband shows up as a distortion of the envelope of the combined output, when the audio input is a sine wave. The undesired frequency component in the output com-

bins with the desired sideband and causes the envelope of the combination to have a “modulation,” or ripple whose frequency is twice that of the audio modulating frequency. Small inaccuracies in either magnitude or phase setting (af or rf) produce ripples nearly identical in appearance, since in each case the effect of the misadjustment is to permit some undesired sideband to appear as a result of incomplete cancellation.

This ripple may conveniently be used to find the correct rf phase setting. Assuming the audio phase shift to be correct, the operator must first equalize the individual balanced-modulator output amplitudes, which may be done by adjusting the relative gain of the two af input channels. One balanced modulator should be operated at a time, and its output may conveniently be measured by means of a meter or oscilloscope. The two are set to produce rf outputs of equal magnitude for a given common modulating signal. The rf phase may then be adjusted until the ripple on the output envelope disappears.

This indication is quite sensitive, as may be seen with the aid of Fig. 7. Here  $E_A$  and  $E_B$  represent the instan-

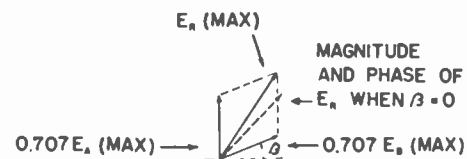

Fig. 7—Vector diagram illustrating sideband envelope modulation due to error in radio-frequency phase setting.

taneous rf outputs of each pair of balanced modulators. It may be shown that for a given radio-frequency phase error  $\beta$ , the resultant of these two voltages  $E_{R(max)}$  has its greatest value at the point in the audio cycle at which the two modulator outputs are equal, and 0.707 times the maximum; i.e., the condition illustrated. Since the angle  $\beta$  represents the deviation of the radio-frequency phase from quadrature, it follows that at this point in the audio cycle

$$E_{R(max)} = 2 \cdot 0.707 \cdot E_A \cos 1/2(90^\circ - \beta) \tag{5}$$

$$= E_{A(max)}(\cos \beta/2 + \sin \beta/2)$$

where  $E_{A(max)}$  represents the output of one balanced modulator at the crest of the audio cycle. The percentage ripple superimposed on the twin-balanced-modulator output envelope may be defined as follows:

$$\text{percentage of ripple} = \frac{E_{R(max)} - E_{A(max)}}{E_{A(max)}} \times 100. \tag{6}$$

$E_{A(max)}$ , the peak output of one balanced modulator alone, is also the amplitude of the single-sideband output in the absence of any ripple. The percentage of

ripple then equals

$$\begin{aligned} \text{percentage of ripple} &= 100(\cos \beta/2 + \sin \beta/2 - 1) \quad (7) \\ &\cong 100 \sin \beta/2 \\ &\cong 0.8\beta, \end{aligned}$$

where  $\beta$  is small and expressed in degrees.

Thus a  $10^\circ$  inaccuracy in phase setting results in an 8 per cent ripple "modulation" of the single-sideband envelope, which is quite readily visible on an oscilloscope.

modulators. One possible way to adjust their outputs is to vary the grid-bias resistors shown in Fig. 2, until each tube produces the same rf output for a given positive dc screen voltage. To set the resistors, it is best to turn off one balanced modulator. If the remaining two tubes are not equalized with respect to each other, a trapezoidal oscilloscope pattern will resemble Fig. 8 or Fig. 11.

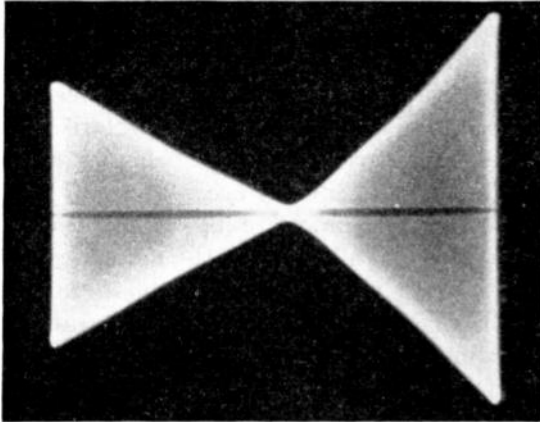

Fig. 8—Trapezoidal pattern: one balanced modulator, balancing resistors improperly set.

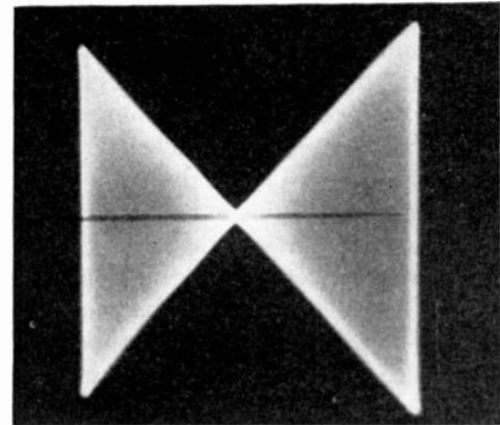

Fig. 10—Trapezoidal pattern: correct adjustment.

When highest accuracy of setting is desired, it is best to observe the output envelope with an oscilloscope, "touching up" the grid tuning (i.e., the rf phase setting) until the ripple is at a minimum. Alternatively, a simple rectifier connected to a pair of earphones may be excited from the output: correct phase setting will result in a disappearance of the audible tone caused by the ripple.

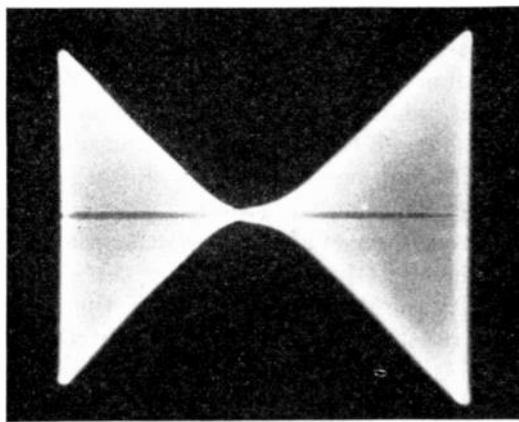

Fig. 9—Trapezoidal pattern: balancing resistors correct, but too high a negative bias on screen grids.

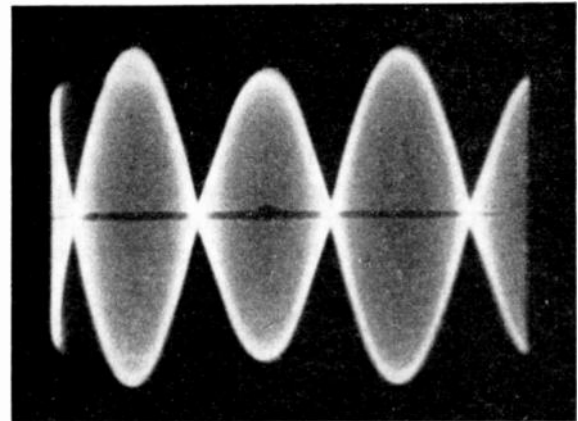

Fig. 11—Output envelope, same as Fig. 8.

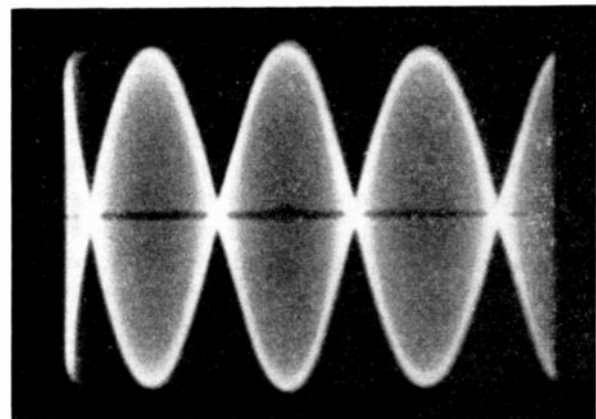

Fig. 12—Output envelope, same as Fig. 10.

A similar procedure can also be employed to equalize the outputs of the two tubes in each pair of balanced

Adjustment of the grid resistors for equal tube efficiencies will give a pattern like that of Fig. 10 or Fig. 12. The process is then repeated for the second pair of balanced modulators comprising the twin balanced modulator. If an oscilloscope is not available, it is possible with some practice to set the grid resistors by listening to the rectified output envelope of each balanced modulator in turn. The change in harmonic structure of the output envelope, when the two tubes of each modulator are equalized, may be detected by ear.

The proper antenna loading is that which just allows, at full output, the dc plate voltage  $E_b$  in Fig. 2 minus the peak rf output voltage  $E_{ac}$  across the common tank circuit, to equal the voltage at which a virtual cathode forms within the tubes. This is the point at which the tube plate current just begins to be appreciably affected by the instantaneous plate voltage and corresponds to the condition where saturation begins to occur.

The first step in designing a twin balanced modulator is the selection of tetrode or pentode tubes (preferably the former, because of their lesser output capacitance) whose rated plate dissipation is one-fourth the desired peak rf power output. (This follows because the full-output efficiency for a sine-wave modulating signal is approximately 50 per cent in practice, and each tube dissipates one-fourth the total power lost.)

The rated tube carrier power output for class-B linear or grid-modulated telephony is noted, as well as the rated plate and screen potentials for this class of service. In order to produce the greatest peak power for single-sideband service, it is desirable to scale the operating potentials upward by a factor equal to the square root of the ratio between the peak power desired and the peak power developed in linear or grid-bias modulated amplifier service. This will ordinarily be by a factor of the order of 1.5 times. The average dc plate current consumed at full output may be calculated on the basis of the assumed over-all efficiency, which is  $\pi/4$  times, or 78.5 per cent, that of one tube operating as a linear amplifier of single-sideband signals.

The screen input power required by the four tubes is supplied by the two audio amplifiers. The audio power needed is, in point of fact, far less than what would be expected if it were assumed that the screen current drawn in this class of service was in direct proportion to that drawn in class-C telegraph operation. On the basis of such an assumption, it may be shown that the two audio amplifiers would each be required to supply an audio power output equal to the normal class-C telegraph dc screen input to one tube of the four-tube twin balanced modulator. This in itself is not a large amount of power, as the dc screen input to a tetrode tube is commonly of the order of one-twentieth the radio-frequency output power.

However in twin balanced modulator service, a considerable saving in screen modulating power results from the fact that virtual cathode formation is not permitted

to occur at any point in the rf or af cycle. In normal class-C operation of tetrodes, the minimum plate voltage is allowed to swing down to the point where a large share of the space current is momentarily attracted to the screen grid, thus increasing the average screen current and input power. With aligned-grid tetrodes—now almost universally used—when the minimum plate voltage is not allowed to swing this low, an exceedingly small fraction of the space current is diverted to the screen grid. This is a result of the normal electron focusing action within the tube. In consequence, a screen-grid-modulated balanced modulator requires a remarkably small amount of audio power, of the order of 3 or 4 watts for a 500-watt output. The regulation of the voltage source must, of course, be good; a requirement which can readily be met by use of inverse feedback.

The linearity of the modulation characteristic obtainable with a screen-grid-modulated balanced modulator has been found to be entirely acceptable.

The output capacitances of the four tetrode tubes, which are all in parallel across the common tank circuit, may lead to lower-than-normal tank-circuit efficiency in the 15- to 30-Mc frequency range. With coils of ordinary  $Q$ , the inductance required for resonance, and therefore the parallel-resonant impedance, become small. It will be found that tubes of recent design tend to have much lower output capacitances than their older counterparts. The 125-watt RCA type 803 pentode, for example, has an output capacitance of 29  $\mu\text{mf}$ ; yet the 1000-watt Eimac type 4-1000A tetrode has an output capacitance of but 7.6  $\mu\text{mf}$ .

The effects of tube output capacitance may, of course, be mitigated by designing the tank circuit as a pi network rather than as a simple resonant circuit, as is sometimes done in television practice.

Choice of the proper tank-circuit  $Q$  is conventional. It may be of help to recall here that, at one point in the audio cycle, one of the four tubes is delivering the entire output, under conditions equivalent to those obtaining in any class-C amplifier.

Oscillograms illustrating the operation of an experimental twin balanced modulator are shown in Figs. 8 through 14. Figs. 8 through 10 are trapezoidal patterns obtained with only one balanced modulator running. In Fig. 8, the grid-bias resistors are improperly set, so that one tube has a lower efficiency than the other. The correct adjustment is that which makes the slopes of the diagonal lines the same in each half of the pattern. In Fig. 9, the resistors are set correctly, but the negative screen bias is excessive in relation to the tube plate voltage and rf excitation. Both tubes are cut off during a portion of the audio cycle. Fig. 10 shows the correct adjustment. (The right-hand half of this pattern is somewhat larger than the left because of stray carrier voltage being picked up from a buffer stage.) Fig. 11 shows the appearance of the output envelope for the conditions of Fig. 8, while Fig. 12 shows the correct

adjustment. In Fig. 13 both balanced modulators are running, but the undesired sideband is not completely

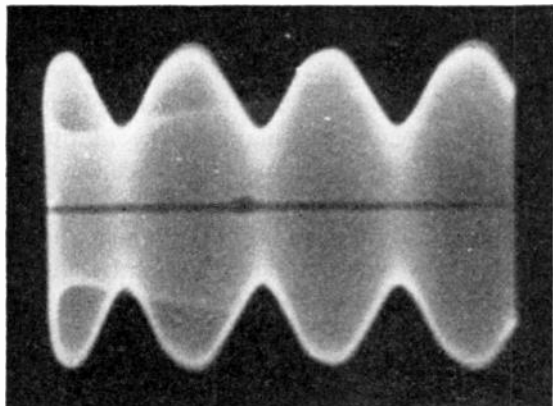

Fig. 13—Output envelope, both modulators: either amplitudes equal, rf phases incorrect, or amplitudes unequal, rf phase correct.

cancelled due to inaccuracies in either phase or amplitude setting, or both. The correct phase and amplitude settings produce an output envelope very nearly free from ripple, as will be seen in Fig. 14.

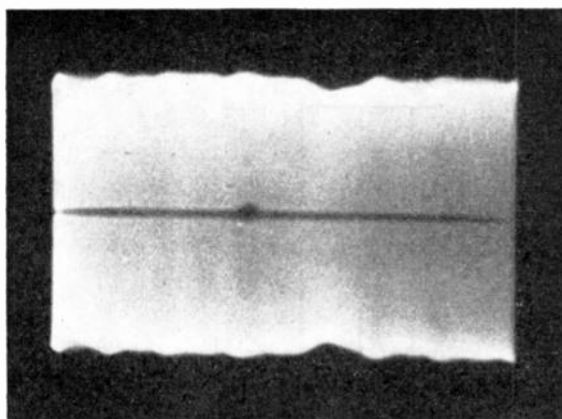

Fig. 14—Output envelope, both modulators: amplitudes and phases correct.

It is worth noting that the undesired-sideband rejection obtainable with the twin balanced-modulator circuit can be made as complete as desired by proper adjustment of phase and amplitude settings. (The rejection is to some extent dependent on audio level.) The amount of rejection achieved in practice over a band of modulating frequencies, then, is primarily determined by the phase and amplitude characteristics of the audio phase-shift network. Tests have shown that it is readily possible, at a single audio frequency, to attenuate the undesired sideband far below the level of the higher-order sidebands caused by the presence of har-

monic distortion in the audio amplifiers and by nonlinearities in the modulation process.

An advantage of phase-rotation single-sideband transmitters, in general, is the fact that the sideband radiated may be changed by reversing the polarity of the audio input to one of the component balanced modulators. This may be an operating convenience, particularly when the receiver is one of the type deriving its effective selectivity from a combination of an audio low-pass filter and  $90^\circ$  wideband phase-shift networks.<sup>5</sup> In this instance, both transmission and reception can be changed from one sideband to the other merely by throwing switches at the transmitter and receiver, no retuning being needed. In certain cases, such flexibility is of great assistance in avoiding interference.

To radiate a reduced carrier with the twin-balanced modulator, a positive bias voltage may be applied to the screen grid of one of the four tubes.

Finally, it seems desirable to point out that one program may be transmitted on one side of the suppressed carrier, and another on the other side, by providing a second pair of audio inputs between which a  $90^\circ$  phase shift exists. The polarity of one of these channels is reversed with respect to that of its counterpart in the first pair. These two pairs of audio voltages, when added and fed to the input terminals of the twin balanced modulator, will produce two independent sets of single sidebands, one on either side of the carrier.

## CONCLUSIONS

Two high-power balanced modulators, biased to cut-off in the absence of an audio input and using tubes which behave substantially as constant-current sources, may be connected to a common tank circuit for the generation of single-sideband signals by the phase-rotation method. The efficiency obtainable with this arrangement approximates that of a conventional linear amplifier.

Simplicity, ease of adjustment, and power economy recommend this circuit for applications where a certain amount of distortion and undesired sideband output can be tolerated.

## ACKNOWLEDGMENT

The work described in this paper represents an outgrowth of research carried out under Contract W28-099-ac-131 between Stanford University and the Air Matériel Command, Watson Laboratories. The author is indebted to the Air Matériel Command for permission to publish, and to Frederick E. Terman, Dean of the Stanford School of Engineering, for inspiration, help, and guidance.

<sup>5</sup>O. G. Villard, Jr., "Simplified single-sideband receiver," *Electronics*, vol. 21, pp. 82-86; May, 1948.

# An Antenna for Controlling the Nonfading Range of Broadcasting Stations\*

CHARLES L. JEFFERS†, SENIOR MEMBER, IRE

**Summary**—A new type of broadcast antenna is described which radiates very little energy over a wide, high angle. The angle above which minimum energy is radiated can be varied electrically from  $40^\circ$  to  $60^\circ$ , thus permitting the fading wall to be adjusted for maximum primary service. The electrical height of the antenna is dependent upon the specific vertical pattern desired but is approximately  $300^\circ$ . The results of experiments with small model antennas are in good agreement with theory.

## INTRODUCTION

THE PRIMARY SERVICE area of a broadcast station is important from a service and a commercial point of view. The ideal antenna for a high-powered broadcast station, providing both a groundwave and a skywave service, should have a vertical radiation characteristic such that the skywave signal does not interfere with the desirable groundwave service. The nighttime primary service area would then be practically as large as the daytime area, since the fading or distortion wall would not be the limiting factor. It is further desirable that the skywave signal strength rise rapidly in order to limit the intense fading area to a narrow band around the station.

The power, frequency, and the ground conductivity around the individual station determine the signal strength at a given location, while the general noise level fixes the minimum signal intensity required to provide a satisfactory service. Thus, the limit of satisfactory service is unique with each individual station; and a definite vertical radiation characteristic is required to achieve the ideal in each case.

In recent years, considerable work<sup>1-9</sup> has been done toward improving the vertical radiation characteristics of broadcast antennas, and today a uniform-cross-section

tower approximately 0.53-wavelength high is generally used to secure the maximum nonfading range. This antenna is still far from ideal, since the distortion zone usually limits the primary service area at night. This undesirable limitation is caused by the radiation of considerable power at the higher vertical angles.

The purpose of this paper is to describe a new type of antenna that radiates practically all energy at angles below  $50^\circ$  of the horizontal, and extremely little energy above this elevation. Further, this angle can be varied from  $40^\circ$  to  $60^\circ$  by a simple electrical adjustment with but a small increase in higher-angle radiation. These limits are equivalent to distances of 80 to 160 miles for the first-reflection skywave signal, fixing the location of the center of the fading zone at approximately 100 to 200 miles from the transmitter.

## ELECTRICAL CHARACTERISTICS

The antenna consists of a linear array of two vertical elements, one directly above the other as shown in Fig. 1. It is apparent that this is a combination of an an-

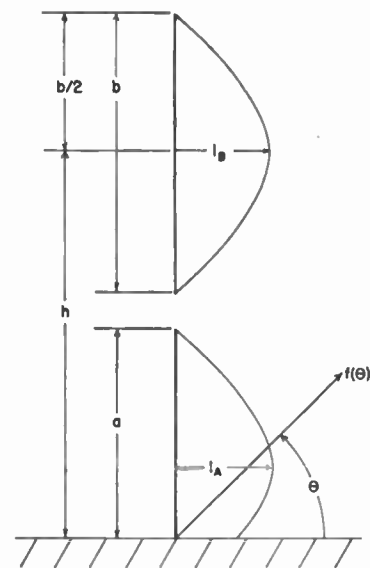

Fig. 1—Diagram illustrating notations used in developing the vertical radiation characteristics of the antenna.

tenna at ground elevation, and an antenna elevated above the earth. The vertical radiation characteristics of each of these antenna types are well known. It is the unique combination of these two antennas into a single radiator that reduces the high-angle radiation.

\* Decimal classification: R326.4. Original manuscript received by the Institute, October 27, 1947.

† Radio Station WOAI, San Antonio, Texas.

<sup>1</sup> S. Ballantine, "On the optimum transmitting wavelength for a vertical antenna over perfect earth," *PROC. I.R.E.*, vol. 12, pp. 833-839; December, 1924.

<sup>2</sup> S. Ballantine, "High-quality radio broadcast transmission and reception," *PROC. I.R.E.*, vol. 22, pp. 616-629; May, 1934.

<sup>3</sup> H. E. Gihring and G. H. Brown, "General consideration of tower antennas for broadcast use," *PROC. I.R.E.*, vol. 23, pp. 311-356; April, 1935.

<sup>4</sup> A. B. Chamberlain and W. B. Lodge, "The broadcast antenna," *PROC. I.R.E.*, vol. 24, pp. 11-35; January, 1936.

<sup>5</sup> R. N. Harmon, "Some comments on broadcast antennas," *PROC. I.R.E.*, vol. 24, pp. 36-47; January, 1936.

<sup>6</sup> G. H. Brown, "A critical study of the characteristics of broadcast antennas affected by antenna current distribution," *PROC. I.R.E.*, vol. 24, pp. 48-81; January, 1936.

<sup>7</sup> G. H. Brown and John G. Leitch, "The fading characteristics of the top-loaded WCAU antenna," *PROC. I.R.E.*, vol. 25, pp. 583-611; May, 1937.

<sup>8</sup> P. E. Patrick, "The service area of medium power broadcast stations," *PROC. I.R.E.*, vol. 30, pp. 404-410; September, 1942.

<sup>9</sup> J. F. Morrison and P. H. Smith, "The shunt-excited antenna," *Bell Telephone System Monograph B-938*, 1936.



In Fig. 1, element  $A$ , the section at ground elevation has a length  $a$ ; and  $B$ , the elevated section, a length  $b$  with the center of this section at a height  $h$  above ground. We then have, for a free-space wavelength  $\lambda$ ,

$$A = 360 a/\lambda \text{ degrees}$$

$$B = 360 b/\lambda \text{ degrees}$$

$$H = 360 h/\lambda \text{ degrees.}$$

The antenna is driven so that the loop currents in elements  $A$  and  $B$  are in phase. If the magnitude of the loop current in  $A$  is considered as unity, the current ratio can be expressed as

$$m = I_B/I_A = I_B. \quad (1)$$

It has been shown<sup>6</sup> that the vertical radiation characteristic for the lower section  $A$  is

$$K_A f(\theta) = [\cos(A \sin \theta) - \cos A]/\cos \theta \quad (2)$$

where  $\theta$  is the angle above the horizontal. For the upper section  $B$ , which for simplicity in calculations is considered a half-wave element, the vertical characteristic<sup>10</sup> is

$$K_B f(\theta) = 2m \cos(90 \sin \theta) \cos(H \sin \theta)/\cos \theta \quad (3)$$

and for both sections, adding (2) and (3), we have

$$K_0 f(\theta) = [\cos(A \sin \theta) - \cos A]/\cos \theta + 2m \cos(90 \sin \theta) \cos(H \sin \theta)/\cos \theta. \quad (4)$$

The form factor  $K_0$  referred to the current loop is

$$1 - \cos A + 2m$$

and the vertical radiation characteristic for the antenna is

$$f(\theta) = \frac{\cos(A \sin \theta) - \cos A + 2m \cos(90 \sin \theta) \cos(H \sin \theta)}{(1 - \cos A + 2m) \cos \theta}. \quad (5)$$

Since the vertical characteristic of a half-wave element in space,  $\cos(90 \sin \theta)/\cos \theta$ , is practically equal<sup>11</sup> to  $\cos \theta$ , (4) and likewise (5) will hold as an approximation if the upper element is made less than one-half wavelength long.

The form factor  $K_0$  is a constant for a particular combination of element length  $A$ , and current ratio  $m$ , and  $\cos \theta$  affects both elements similarly; therefore, it is convenient to omit the effect of the denominator of (5) in

<sup>10</sup> While the mutual reaction is small in this antenna, it is not necessary to consider it in the formula developed for the vertical characteristics. As in all arrays, it must, however, be considered to determine the networks required to properly match the individual elements to the transmission line.

<sup>11</sup> The exact equation of an element of any length in free space is given by the Federal Telephone and Radio Corporation's "Reference Data for Radio Engineers" as

$$f(\theta) = [1 + \cos^2 B + \sin^2 \theta \sin^2 B - 2 \cos(B \sin \theta) \cos B - 2 \sin \theta \sin(B \sin \theta) \sin B]^{1/2}/\cos \theta.$$

developing the optimum design of an antenna to give a particular radiation characteristic. This is done by evaluating separately the first part of the numerator of (5) for

$$K_0 \cos \theta f(\theta)_A = \cos(A \sin \theta) - \cos A, \quad (6)$$

and the second part of the numerator for

$$K_0 \cos \theta f(\theta)_B/m = 2 \cos(90 \sin \theta) \cos(H \sin \theta). \quad (7)$$

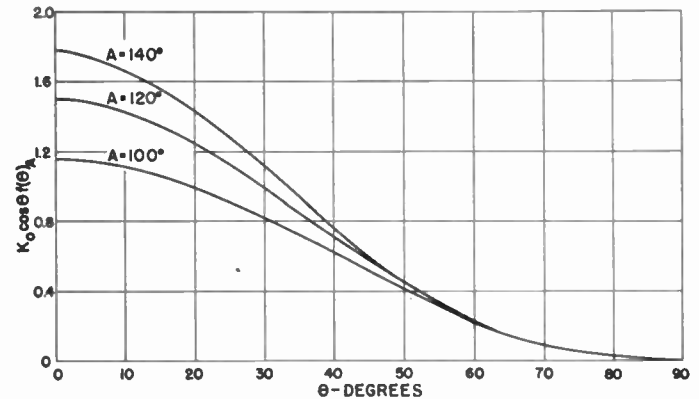

Fig. 2— $K_0 \cos \theta$  times the vertical radiation characteristics of the lower element of the antenna.

Fig. 2 is a plot of (6),  $K_0 \cos \theta$  times the vertical radiation characteristics of the lower section  $A$  for various lengths  $A$ , while Fig. 3 is a similar plot of (7) for the upper section  $B$  for certain center heights  $H$ .

An examination of Fig. 3 shows, for the values of  $H$  considered, that the field from the elevated element goes through a phase reversal around  $25^\circ$ , and above this point will be  $180^\circ$  out of phase with the high-angle field

from the lower element. If the parameters  $A$  and  $H$  are correctly selected, and if the loop current in the elevated element is made less than the current in the lower element by the proper amount, the fields of the two elements can be made nearly equal, and will cancel for angles deviating considerably from  $90^\circ$ .

#### ANTENNA DESIGN

For mechanical simplicity, a design was chosen in which the upper half-wave section rested on the top of the lower section. For minimum radiation above an angle of  $50^\circ$ , we have, from Figs. 3 and 4, a lower-element length of  $120^\circ$  and a center height of the upper element of  $210^\circ$ . The value of  $m$  for the  $50^\circ$  null is 0.69. It is of interest to note from Fig. 4 that this design results in practically no radiation above  $50^\circ$ —the maximum occurring at  $56^\circ$ , where it is less than 0.02 of that in the horizontal plane.

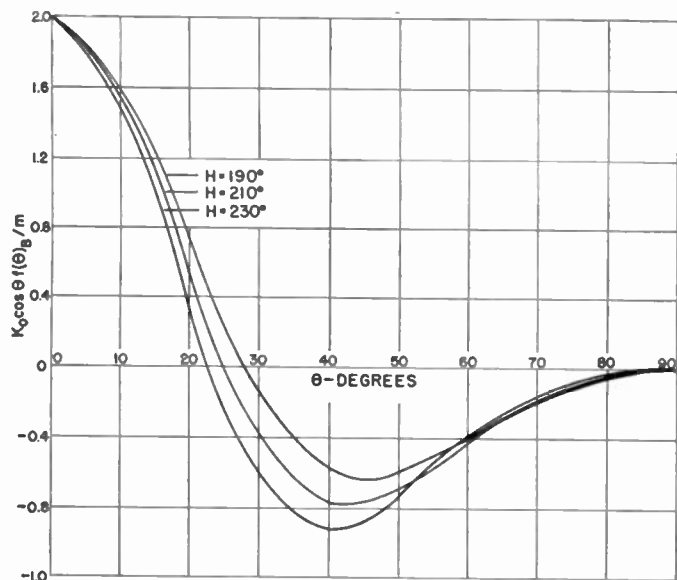

Fig. 3— $K_0 \cos \theta / m$  times the vertical radiation characteristics of the elevated element of the antenna.

In Fig. 4, in addition to the current ratio of 0.69, the vertical radiation characteristics of other  $m$  values have been plotted. It is apparent that a change of  $m$  from 0.9 to 0.6, merely an electrical adjustment, can vary the angle above which little energy is radiated from  $40^\circ$  to  $60^\circ$ .

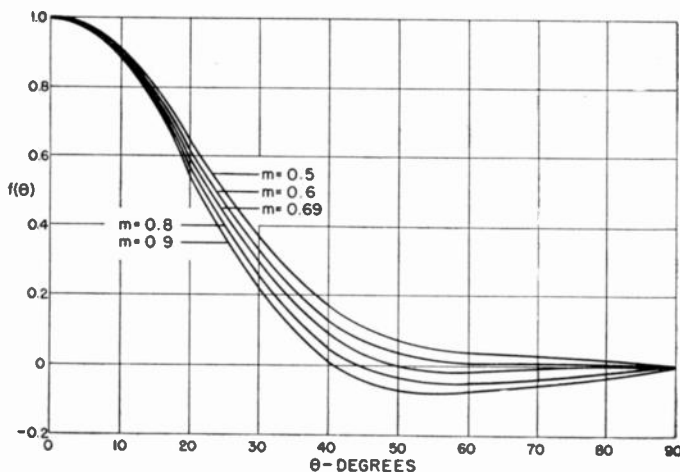

Fig. 4—The vertical radiation characteristics of the antenna for various current ratios  $m$ , when  $A$  is  $120^\circ$ ,  $B$  is  $180^\circ$ , and  $H$  is  $210^\circ$ .

The theoretical field gain of this antenna, for an  $m$  ratio of 0.69, is 14.5 per cent compared to a 0.53-wavelength antenna, or 41.5 per cent referred to a quarter-wavelength antenna. These field gains are equivalent to power gains of 32 and 100 per cent respectively.

The advantages of the new arrangement are readily seen in Fig. 5, which compares the performance of the proposed antenna with a 0.53-wavelength antenna. Both antennas are assumed to radiate a field of 1770 millivolts per meter at one mile on a frequency of 1000

kc over earth with a conductivity of  $10^{-13}$  emu. The sky-wave signal values are for 50 per cent of the time. For the 0.53-wavelength antenna, the center of the fading zone is at 127 miles where the groundwave signal has an intensity of 0.6 mv/m. The proposed antenna has the same distortion point at 164 miles and at a signal intensity of 0.29 mv/m. The width of the two-to-one signal ratio skywave and groundwave fading zone has been reduced from 36 miles to 24 miles, because of the difference in the angle of the skywave signal rise. In other words, the distortion zone of bad fading has been moved from a point of good rural primary service to a point

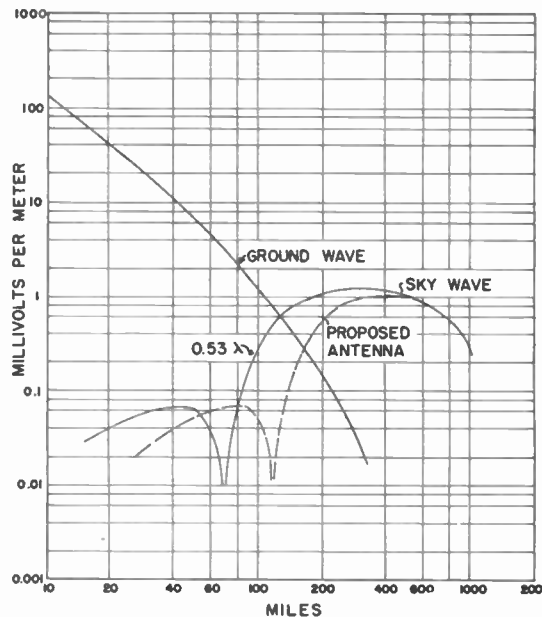

Fig. 5—Comparison of the fading range of a 0.53-wavelength antenna and the new antenna. Both antennas produce a field of 1770 millivolts per meter at one mile for a transmitter frequency of 1000 kc over earth with a conductivity of  $10^{-13}$  emu.

where the groundwave signal strength is hardly adequate for year-round noise-free reception. If a current ratio  $m$  of 0.9 had been used, the point of maximum fading would have been moved to a distance of 185 miles for a signal level of 0.2 mv/m.

#### EXPERIMENTAL TESTS WITH MODELS

Experimental verification of the predicted radiation characteristics of this antenna was made by the use of small models operating close to 100 Mc. The model used as a comparison standard was, as nearly as possible, an exact scale duplicate of the WOAI 425-foot guyed uniform-cross-section tower. This is an insulated tower supported by a foundation pier, with an over-all height above ground of 435 feet. The model of the proposed antenna consisted of a  $\frac{3}{8}$ -inch-diameter conductor  $300^\circ$  long, with the lower  $120^\circ$  shielded by a 1-inch conductor. This in effect gave a lower, or  $A$ , section of  $120^\circ$  and an upper, or  $B$ , section of  $180^\circ$ . At broadcast frequencies, the outer shield could be a wire cage insulated from a vertical

tower. The two different sections were fed so that the current could be adjusted both as to magnitude and phase angle. The magnitude of the current was adjusted by connecting the two feed lines to the antenna at the proper points along a shorted one-quarter-wave slotted coaxial line. Power from the transmitter was fed to this same one-quarter-wavelength line. The phase of the current was controlled by a trombone-type section in the feed line to the upper element.

The frequency used for these tests was 116.1 Mc, giving a reduction factor of 96.9 over 1200 kc, which made the 0.53-wavelength antenna 52.6 inches high. A propagation constant of 0.937 was used for the new antenna, making it 79.2 inches high.

The vertical radiation characteristics were measured by means of a receiving antenna mounted at the apex of a wooden "A" frame. The two pivot points were 20 feet apart, with the model antenna under test located halfway between these two points. (Fig. 6.) The apex of the "A" frame was 50 feet from the model. This distance



Fig. 6—The scale model of the new antenna in position between the pivot points of the "A" frame.

provides less than  $10^\circ$  phase differential between the top and bottom of the 300' antenna for elevations above  $45^\circ$ . The "A" frame was moved by means of a block and tackle from a minimum elevation of  $19.5^\circ$  to a maximum elevation of  $85^\circ$ . These limits were imposed by mechanical factors. The receiving antenna, Fig. 7, consisted of a vertical dipole and corner reflector with 14 elements in the reflector. The directivity was used to minimize the reflections from objects in the vicinity of the equipment.

The voltage induced in the dipole was rectified by means of a Sylvania 1N34 crystal rectifier with the dc

component being fed down one leg of the "A" frame by a shielded wire. This current was measured by means of a 100-microampere meter. The detector was calibrated by connecting the high-frequency probe of a vacuum-tube voltmeter to the lower end of the 0.53-wavelength antenna and varying the power output of the transmitter. A comparison of the two meter readings provided the required calibration.

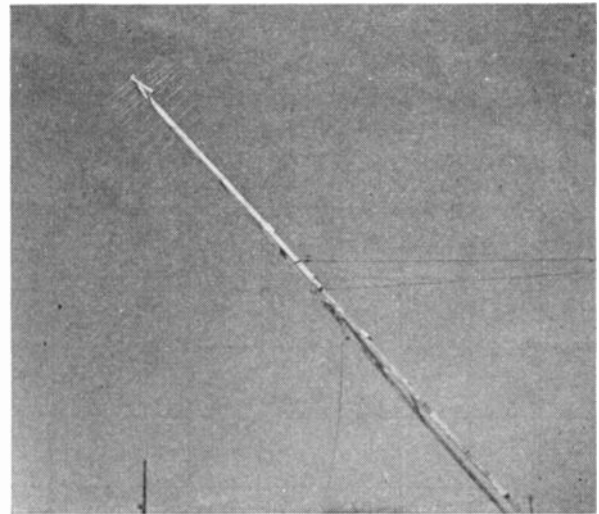

Fig. 7—The receiving antenna used in experimental measurements of the vertical radiation characteristics of the scale models.

The model antennas were excited with approximately 5 watts of rf energy from an Army Air Forces Type SCR-522 transmitter through 100 feet of RG 8/U coaxial cable. This long cable permitted placing the transmitter equipment outside of the pickup field of the receiving antenna. The coaxial-cable was matched to the antenna by means of a shielded matching network.

The vertical fields radiated from the 0.53-wavelength antenna were measured by adjusting the meter to read 0.76, the theoretical relative amplitude at an elevation of  $19.5^\circ$ . The "A" frame was then moved by increments to the maximum elevation, readings being taken at each position. The ground-plane field strength was measured with a separate detector, using a short vertical antenna at ground elevation. Three separate measurements were made with this separate antenna, with quite close agreement.

In the case of the new antenna, the "A" frame was raised to an elevation of  $50^\circ$ , and the antenna currents were adjusted for minimum  $50^\circ$ -angle field and maximum zero degree field. Measurements of the vertical fields were made in a similar manner as for the 0.53-wavelength antenna, except that the meter was adjusted to read 0.62 at  $19.5^\circ$ , the theoretical value.

#### EXPERIMENTAL RESULTS

Preliminary tests were made with the models erected on top of a chicken-wire ground plane 20 feet wide and

16 feet long, with a small 5-inch-square copper plate directly under the antenna support to simulate the normal 40-foot-square ground mat. The results of these tests are plotted in Fig. 8. While there is considerable deviation from the expected theoretical characteristics, the proposed antenna has a vertical radiation characteristic which is a decided improvement over that of the 0.53-wavelength model. The irregularities on the curves at  $40^\circ$  were caused by reflections from the edge of the ground screen. The dotted lines on Fig. 8 illustrate the results to be expected in the absence of the ground-screen reflection.

It has been shown<sup>12</sup> that, for a model antenna to be a simulation of a full-scale system, the dielectric constant

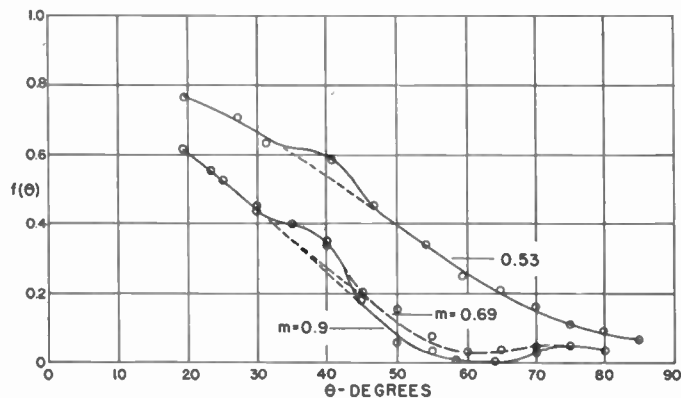

Fig. 8—The measured vertical radiation characteristics for the two models when operating over very poor earth.

of the soil should be the same as the full-scale system, but the conductivity should be increased by the ratio of the frequency of the model to that of the system. The results shown in Fig. 8 would indicate that the chicken-wire mesh apparently made little improvement over the existing soil, having a conductivity of approximately

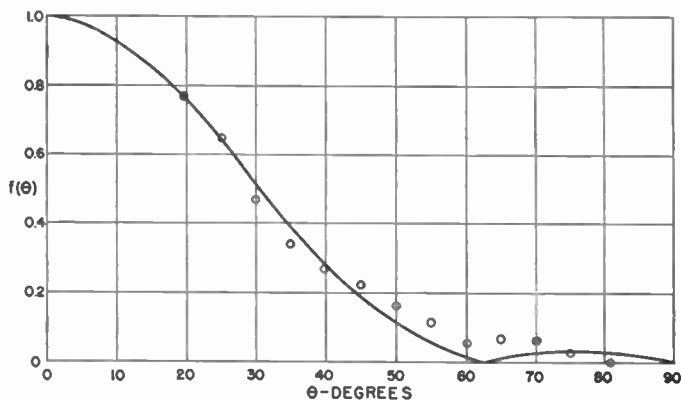

Fig. 9—The theoretical and measured vertical radiation characteristics for the 0.53-wavelength model. The circles are experimental.

<sup>12</sup> G. Sinclair, "Notes on modeling vehicular antennas," The Ohio State University Research Foundation, October, 1945; not published.

$20 \times 10^{-14}$ . At 116.1 Mc the conductivity would be equivalent to  $2.07 \times 10^{-16}$ , which represents a very poor earth.

Since, for these experiments, it was not practicable to increase the conductivity of a large area of earth by a factor of 96.9, the mesh was removed and replaced by a copper-screen wire ground plane 16 feet wide and 33 feet long. The screen was placed so that the model was 21 feet from the end nearer the receiving antenna at minimum elevation.

The theoretical and measured vertical characteristics for the 0.53-wavelength antenna using the new ground screen are plotted in Fig. 9; Fig. 10 is a similar plot for

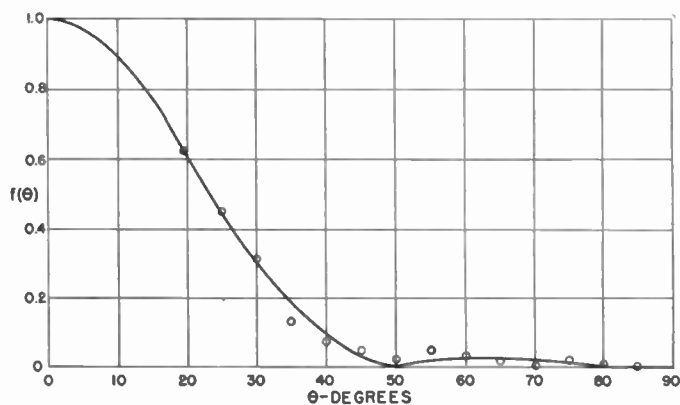

Fig. 10—The theoretical and measured vertical radiation characteristics for the new antenna. The circles are experimental.

the new antenna. Minimum  $50^\circ$  radiation for the latter was secured with a current, or  $m$  ratio, of 0.70. The ground-plane measurements showed a field reading of 68 microamperes for the 0.53-wavelength antenna and 78 microamperes for the new antenna, or a signal gain of 14.6 per cent. For  $m$  adjusted to 0.84, the field gain measured 16 per cent, the maximum secured. The slight deviations at  $35^\circ$  were due to reflections from the edge of the copper-screen ground plane. This effect appeared on all measurements made.

Additional tests were made for current ratios  $m$  from 0.41 to 1.23, with the phase being adjusted for each measurement, to zero angle or maximum ground-plane field. For both the lower and higher ratios, there was a considerable increase in high-angle radiation, but within the limits of  $m = 0.5$  to 0.9 the increase was small, as predicted by theory.

Fig. 11 shows the relative current distribution on the two types of antennas. The currents were measured by means of a small loop mounted within a Faraday shield. The loop was tuned to resonance and the rectified dc output was conducted by means of a twin-conductor choke coil mounted within a 3-foot fiber handle to a 200-microampere meter with suitable shunt. A "V"-shaped guide at the end of the probe maintained equal spacing and angle with respect to the antenna element. The current distribution was measured by placing the guide on

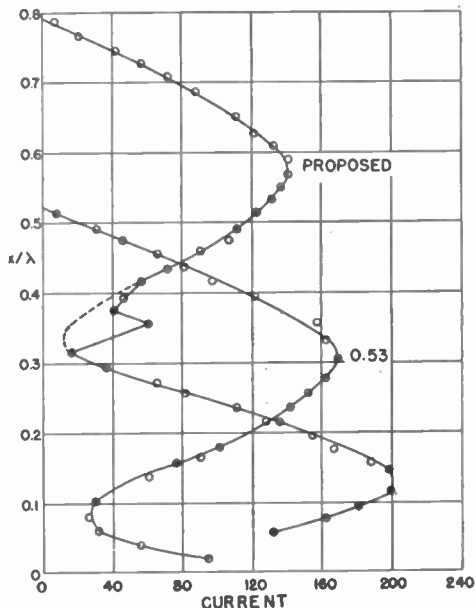

Fig. 11—Experimental relative current distribution on the two models.

the end of the probe against the antenna and noting the meter reading at each increment of height. The finite

size of the probe or end radiation from the open top of the lower section made it impossible to secure expected results at the junction of the upper and lower sections of the antenna.

CONCLUSIONS

The proposed antenna achieves a notable reduction of higher angle radiation and a substantial gain in signal strength. For the higher-powered stations, these advantages should more than compensate for the necessary increase in tower cost. Furthermore, the ability to adjust electrically the angle of minimum radiation by variation of the current ratio  $m$  will prove of considerable value in securing the proper nonfading range by field measurements.

ACKNOWLEDGMENT

Appreciation is expressed to A. D. Ring for helpful comment on the development of this antenna; to John H. DeWitt, Jr., for suggestions used in making the experimental tests; and to Louis Rhein, for assistance in the preparation of this paper.

# The Light-Pattern Meter\*

R. E. SANTO†

**Summary**—A new meter which determines the amplitudes of sine waves recorded on disks is described. It is accurate to 0.5 db and obviates the need of a dark room for measurement of the useful “christmas-tree pattern.”

THE BUCHMANN-MEYER, or optical, system of measuring the velocity of sine waves recorded on disks has been used for a number of years by many people without all the necessary precautions being taken to obtain full accuracy. These precautions have been pointed out by Bauer<sup>1</sup> and Hornbostel<sup>2</sup> in the literature. Their papers derive formulas giving the maximum instantaneous velocity when the light and observer are not at infinity.

This paper describes an instrument which employs a modified form of the Buchmann-Meyer principle, and

has been constructed so that it is contained completely in a portable box and is free from errors assignable to its mode of operation.

\* Decimal classification: 621.375.607×621.385.971. Original manuscript received by the Institute, January 2, 1948; revised manuscript received, June 24, 1948.

† Canadian Broadcasting Corporation, Montreal, Quebec, Canada.

<sup>1</sup> B. B. Bauer, “Measurement of recording characteristics by mean of light patterns,” *Jour. Acous. Soc. Amer.*, vol. 18, pp. 387-395; October, 1946.

<sup>2</sup> J. Hornbostel, “Improved theory of the light-pattern method for the modulation measurement in groove recording,” *Jour. Acous. Soc. Amer.*, vol. 19, pp. 165-169; January, 1947.

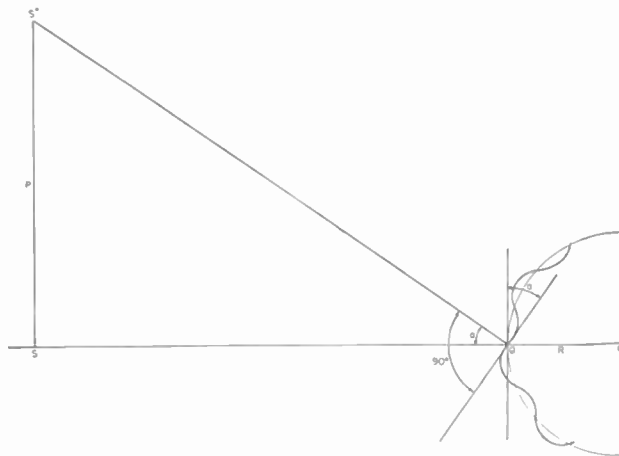

Fig. 1—Illustration of the general theory of the light-pattern meter.

Fig. 1 shows a portion of a sine wave recorded on a disk at a radius  $R$  from the center  $C$ . The eye of the ob-

server is placed on a line perpendicular to the surface of the disk and passing through the point 0. If a point source of light is movable along a line, between the points  $S-S''$ , which is perpendicular to the line joining the center of the disk  $C$  and the point 0, reflected light will reach the eye. Since these perpendicular reflections do occur, the edge of the groove must be slightly rounded. The point  $S''$  is on a line drawn perpendicular to the line of maximum slope of the recorded groove at 0. When the light is beyond  $S''$  there is no reflecting surface element on the record which is perpendicular to the plane containing  $S''$  and the line between the eye and the point 0. Therefore, no reflected light will reach the eye. If the light is set so that the borderline between the light and dark appearance occurs at 0, the tangent of the angle  $S''OS$  will, with no correction, be equal to slope of the sine wave at 0. In order to maintain the line of sight to the eye exactly perpendicular to the disk surface at 0, a small pointer and a peephole are required. The exactly vertical rays of light only must be used; therefore, no lenses (which widen the angle of vision) can be permitted. Under these conditions the eye and the point source of light may be at *any* distance from the point 0, and not affect the accuracy.

Fig. 2 shows that the incident light ray is not in the plane of the disk surface, but at an angle  $m$  above it.

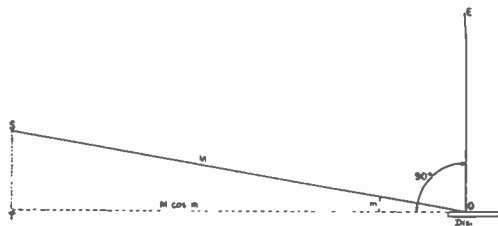

Fig. 2—Drawing showing the angles between the surface of the disk and the rays of light.

The distance from  $S$  to 0 is called  $M$ , and so the horizontal distance  $OT$  is equal to  $M \cos m$ . If the distance of light travel  $S-S''$  or  $T-T''$  is equal to  $P$  (measured in the same units as  $M$ ), then the slope of the sine wave at 0 will be given by  $\tan a = P/M \cos m$ .

The stylus velocity of interest in a recording is the maximum instantaneous linear velocity of the stylus tip back and forth along a radius of the disk as it follows the modulated groove.

The maximum instantaneous radial velocity of a stylus following a sine wave whose maximum slope is  $\tan a$  at a radius  $R$  on a disk turning at  $33\frac{1}{3}$  rpm is given by the following:

$$V = \frac{33.33}{60} \times 2\pi R \tan a \text{ cm/sec if } R \text{ is in centimeters;}$$

$$\text{i.e., } V = 3.485 R \tan a \text{ cm/sec.}$$

But

$$\tan a = \frac{P}{M \cos m};$$

therefore,

$$V = \frac{3.485RP}{M \cos m} \text{ cm/sec at } 33\frac{1}{3} \text{ rpm.}$$

Using these principles, a light-pattern meter was constructed. Since  $M$  and  $m$  are fixed quantities in any particular meter, the absolute value of the velocity is equal to a constant times the product of  $R$  and  $P$ . The lengths of  $R$  and  $P$  as measured by the light-pattern meter are converted to two electrical voltages proportional to  $R$  and  $P$ , respectively. These two quantities are multiplied together in an electrical circuit and the result shown on a meter. The meter is calibrated to read in db above and below the reference level  $V = 5$  cm/sec.

Fig. 3 shows an external view of the new meter. The dial at the upper left controls the movement of the light;

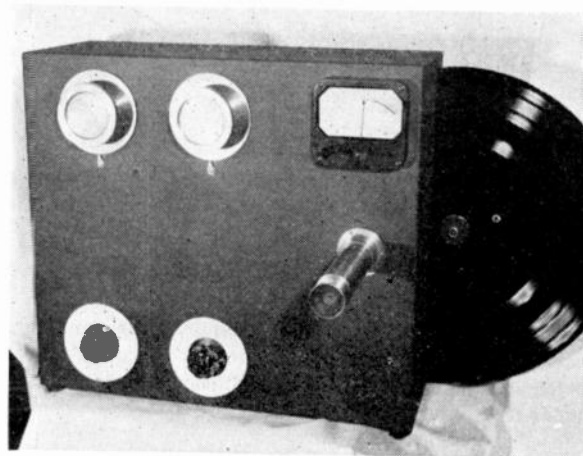

Fig. 3—External view of the light-pattern meter.

the other dial at the top controls the position of the disk under test. The lower left knob ( $P1$ ) is used to calibrate the electrical circuit, and the remaining knob is used to control the meter range switch ( $S1$ ). This switch is calibrated for use with disks recorded at 78.26 and  $33\frac{1}{3}$  rpm.

Fig. 4 shows the meter with the cover removed. The light is provided with sliding contacts on the metal tracks which are used to supply it with power. The light control turns the potentiometer  $P2$  in exact proportion to the movement of the light. The turntable control turns the potentiometer  $P3$  in exact proportion to the radius  $R$ , which is the distance from the turntable center to the pointer. The turntable is moved by a rack and pinion from the control dial. The center line through the eyepiece and the tip of the pointer must be perpendicular to the disk surface.

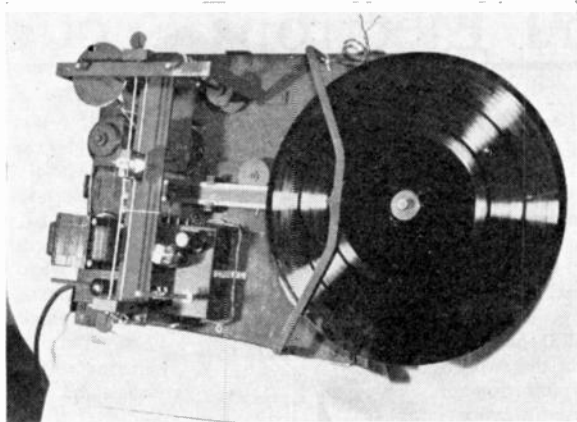

Fig. 4—Internal view of the light-pattern meter.

The circuit used in the instrument is shown in Fig. 5. It is based on the fact that the output voltage from two

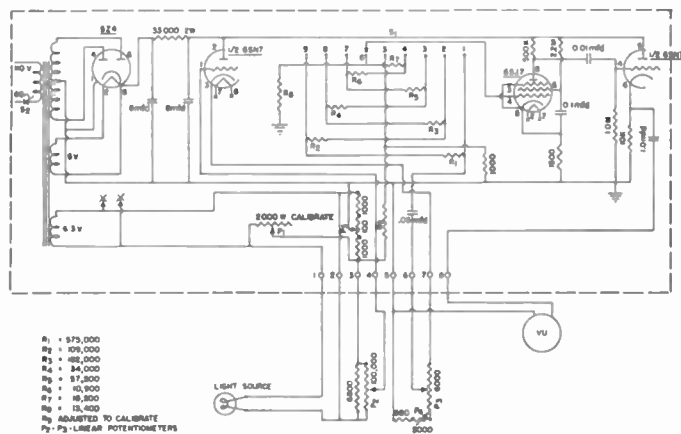

Fig. 5—Electrical circuit of the light-pattern meter.

potentiometers in cascade will be proportional to the product of the arm positions. The potentiometer  $P_2$  gives an output voltage proportional to the movement of the light. A 100,000-ohm potentiometer is used here in order that small increments of voltage may be measured as the pointer moves from wire to wire. Zero output voltage is obtained at the center of the potentiometer movement. This zero must coincide with the mechanical zero of the instrument; that is, when the center of the light-pattern is directly under the pointer. Exact tracking is obtained by using screwdriver-controlled  $P_5$ . The output from  $P_2$  is fed to the first cathode follower.

The cathode resistor of this tube is the potentiometer  $P_3$ , which gives an output proportional to the radius  $R$ . Tracking of  $P_3$  with  $R$  is adjusted by screwdriver-controlled  $P_4$ .

To measure the velocity of a sine wave recorded on a disk, the disk is mounted on the small turntable. The radius control is then adjusted until the required track is seen under the tip of the pointer. The meter switch is

set at the "calibrate" position and the calibrate control adjusted until the meter reads zero vu. This calibration will vary with line voltage, and therefore needs to be checked occasionally. The light-control dial is adjusted until one light-pattern edge is directly under the pointer. The meter switch is then turned to the appropriate range and the velocity read in db relative to a zero level of 5 cm per second. A reading may be taken using the opposite edge of the light pattern, also. Any difference in the two readings indicates either that the control  $P_5$  was not properly adjusted, or that there is distortion in the recorded wave shape.

Fig. 6 shows the pattern as seen in the meter. Relative widths of the bands of light do not represent rela-

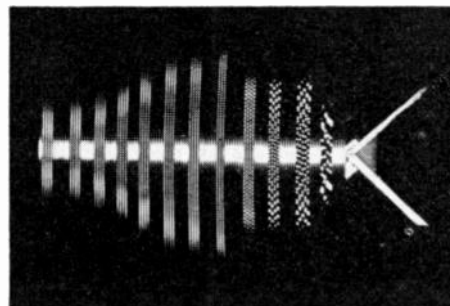

Fig. 6—Light pattern as observed through the meter eyepiece.

tive velocities in the photograph, since the bands must be moved under the pointer tip one by one for measurement. The narrow light strip between successive bands of light represents irregularities in smoothness of groove surface. These irregularities are the cause of "surface noise" when the disk is played on a reproducer. The width of this band as measured by the light-pattern meter does not indicate the noise level of the disk, since the waveform is nonsinusoidal.

The reason for the small turntable is to provide a definite edge to the light-pattern at the very low frequencies. By turning the disk slightly by hand, it is possible to line up several waves on successive grooves along the same radius line, and these individual reflections, combined with the retentivity of the eye, provide the necessary definite edge.

This paper has shown that a means is available of enclosing the equipment for light-pattern measurements in a box of reasonable dimensions. The light-pattern meter provides an accurate, portable, and time-saving device for the otherwise tedious job of light-pattern measurements. Measurements have been made consistently within 0.5 db.

#### ACKNOWLEDGMENT

The writer wishes to acknowledge the helpful suggestions and advice of J. E. Hayes and others of the staff of the Canadian Broadcasting Corporation.

# Contributors to Waves and Electrons Section



JAMES C. COE

James Clarence Coe (A'25-VA'39) was born in 1900 at Niobrara, Neb. He attended various colleges and universities and received the bachelor and master's degrees in electrical engineering, followed by a doctorate. He was an instructor at the Massachusetts Institute of Technology, and an assistant professor at the Oklahoma Agricultural and Mechanical College. In the military service he became a major.

As a radio engineer with the Signal Corps, Dr. Coe was engaged in high-speed transoceanic radio work, airways control, and in the development of aircraft electronics equipment, serving at Schenectady, Honolulu, and Wright Field. As an electronics engineer with the Navy Department, he served successively in the development of airborne electronics equipment, of substitute materials, of receivers less vulnerable to man-made and natural noise fields, of measuring equipment for determining intensity and reaction time of explosives, telemetering of bombs and missiles, and miscellaneous measurements incidental to testing pilotless aircraft.

Dr. Coe has been on the national membership committee of the AIEE and on the test procedures subcommittee of the Radio Technical Committee for Aeronautics. He presently heads the Internal Instrumentation Branch at the U. S. Naval Air Missile Test Center, Point Mugu, Calif.



C. F. CRANDELL

C. F. Crandell (M'46) was born on October 8, 1913, at Nebraska City, Neb. He received the B.S. degree in electrical engineering from Kansas State College in 1935, and the M.S. degree in 1937. He was a graduate research assistant at Kansas State College from 1936 to 1937, when he became associated with the engineering department of Southwestern Bell Telephone Company. From 1943 through 1945 he was a member of the technical staff of the Bell Telephone Laboratories, Inc., engaged in research work on microwave amplifier tubes and gas switching tubes. In 1946 he returned to the engineering department of the Southwestern Bell Telephone Company.

John Hessel (A'32-VA'39-SM'48) was born in Grand Rapids, Mich., on March 15, 1908. He received the B.S.A. degree from the University of Michigan in electrical engineering in 1929 and M.S.E. in 1930.



JOHN HESSEL

He began his career in radio as an amateur operator in 1923 and was granted a commercial operator's license in 1924. Joining the staff of the Signal Corps Engineering Laboratories in 1931, he was in charge of the Army's first exploitation of vhf communications, the development of the original "walkie talkie" and, in 1937, with the earliest experiments in radar.

Commissioned a major in the Signal Corps in 1942, Mr. Hessel served two years overseas as Deputy Director of the Technical Liaison Division, Office of the Chief Signal Officer, European Theater of Operations, and with the Seacoast Artillery Evaluation Board. He was decorated with the Legion of Merit in 1945, with an Oak Leaf Cluster in 1946, and discharged with the rank of colonel, Signal Corps Reserve in 1946.

Mr. Hessel presently serves as Chief of the Radio Communication Branch, Signal Corps Engineering Laboratories, Fort Monmouth, N. J. He is a member of Tau Beta Pi, Phi Kappa Phi, and Sigma Xi.

Charles L. Jeffers (A'38-SM'47) was born in San Antonio, Texas, on February 9, 1908. He entered the University of Texas in 1925, and received the B.S. degree in electrical engineering in 1929. From 1930 to 1934 he was engaged by Whites Uvalde Mines, near Uvalde, Texas. In 1937 he became associated with radio station WOAI and was appointed technical director in 1939. In 1942, on leave of absence from WOAI, he was Assistant Chief Radio Engineer, and in 1944 was Chief Radio Engineer, of the Communication Facilities Bureau, Overseas Branch, Office of War Information, Washington, D. C., where he was engaged in the installation and operation of medium- and short-wave transmitters, in the United States and overseas. In 1945 he returned to WOAI.



CHARLES L. JEFFERS

Arthur L. Samuel (A'24-SM'44-F'45) was born on December 5, 1901, at Emporia, Kan. He received the A.B. degree from the College of Emporia in 1923; the degrees of S.B. and S.M. in electrical engineering from MIT in 1926. He was awarded the honorary degree of S.D. from the College of Emporia in 1946.



ARTHUR L. SAMUEL

Dr. Samuel was employed by the General Electric Company intermittently from 1923 to 1927, and was an instructor in the electrical engineering department at MIT from 1926 to 1928. Dr. Samuel joined the technical staff of the Bell Telephone Laboratories in 1928. From 1931 to 1946 his principal interest was in the development of vacuum tubes for use at ultra-high frequencies. In 1946 Dr. Samuel joined the faculty of the University of Illinois where he is now professor of electrical engineering. He is a member of Sigma Xi, the American Physical Society, the American Institute of Electrical Engineers, and the American Association for the Advancement of Science.



O. G. VILLARD, JR.

Oswald G. Villard, Jr. (S'38-A'41) was born at Dobbs Ferry, N. Y., on September 17, 1916. In 1938 he received the A.B. degree from Yale University. He received the degree of electrical engineer from Stanford University in 1943, and from 1941 to 1942 he was an acting instructor in electrical engineering at that University. From 1942 to 1946 he was a research associate at the Radio Research Laboratory, Harvard University. Since 1946 he has been an acting assistant professor at Stanford University.

Mr. Villard is a member of Sigma Xi and Phi Beta Kappa.



ROBERT E. SANTO

Robert E. Santo was born on May 28, 1913, in London Ontario, Canada. He received the B.A.Sc. degree in electrical engineering in 1935 at the University of Toronto, and was an instructor at that University from January, 1936, to April, 1937. Some time was spent doing disk recording before joining the Canadian Broadcasting Corporation in 1939.

From 1939 to 1943 Mr. Santo did maintenance work for the Toronto Studios of the CBC. From 1943 to date he has been with the Transmission and Development Department of the CBC in Montreal. He is a member of the Corporation of Professional Engineers of Quebec.



# Abstracts and References

Prepared by the National Physical Laboratory, Teddington, England, Published by Arrangement with the Department of Scientific and Industrial Research, England, and *Wireless Engineer*, London, England

NOTE: The Institute of Radio Engineers does not have available copies of the publications mentioned in these pages, nor does it have reprints of the articles abstracted. Correspondence regarding these articles and requests for their procurement should be addressed to the individual publications and not to the IRE.

Acoustics and Audio Frequencies . . . . .	1435
Antennas and Transmission Lines . . . . .	1437
Circuits and Circuit Elements . . . . .	1437
General Physics . . . . .	1439
Geophysical and Extraterrestrial Phenomena . . . . .	1439
Location and Aids to Navigation . . . . .	1440
Materials and Subsidiary Techniques . . . . .	1440
Mathematics . . . . .	1442
Measurements and Test Gear . . . . .	1442
Other Applications of Radio and Electronics . . . . .	1443
Propagation of Waves . . . . .	1444
Reception . . . . .	1444
Stations and Communication Systems . . . . .	1445
Subsidiary Apparatus . . . . .	1446
Television and Phototelegraphy . . . . .	1446
Transmission . . . . .	1447
Vacuum Tubes and Thermionics . . . . .	1447
Miscellaneous . . . . .	1448

The number in heavy type at the upper left of each Abstract is its Universal Decimal Classification number and is not to be confused with the Decimal Classification used by the United States National Bureau of Standards. The number in heavy type at the top right is the serial number of the Abstract. DC numbers marked with a dagger (†) must be regarded as provisional.

## ACOUSTICS AND AUDIO FREQUENCIES

- 016:534 **2684**  
References to Contemporary Papers on Acoustics—A. Taber Jones. (*Jour. Acous. Soc. Amer.*, vol. 20, pp. 350–355; May, 1948.) Continuation of 2118 of September.
- 534.213:532.584 **2685**  
The Absorption of Sound in Suspensions of Irregular Particles—R. J. Urick. (*Jour. Acous. Soc. Amer.*, vol. 20, pp. 283–289; May, 1948.) For small spherical particles, the greater part of the absorption can be attributed to the viscous drag between the fluid and the particles in the sound field; the absorption thus found agrees with that obtained otherwise by Lamb. Experimental results for suspensions of irregular particles of sand and kaolin, obtained by a pulse-reflection method at megacycle frequencies, agree approximately with the idealized theory as the particle size, viscosity, and frequency are varied.
- 534.23/.24 **2686**  
Reflection and Transmission of Sound by a Spherical Shell—J. B. Keller and H. B. Keller. (*Jour. Acous. Soc. Amer.*, vol. 20, pp. 310–313; May, 1948.) A modification of Rayleigh's method for the reflection of a plane wave by an infinite plate of finite thickness is applied to obtain an exact solution for a spherical shell with the sound source at the center. Agreement is obtained with the results of Primakoff and Keller (912 of May).
- 534.241:534.213 **2687**  
Reflection of Sound from Coastal Sea Bottoms—L. N. Liebermann. (*Jour. Acous. Soc. Amer.*, vol. 20, pp. 305–309; May, 1948.) Values of the reflection coefficient were obtained experimentally for ultrasonic waves at grazing incidence. The reflection coefficient appears to depend on the average and relative size of the particles, and on bottom topography.

The Institute of Radio Engineers has made arrangements to have these Abstracts and References reprinted on suitable paper, on one side of the sheet only. This makes it possible for subscribers to this special service to cut and mount the individual Abstracts for cataloging or otherwise to file and refer to them. Subscriptions to this special edition will be accepted only from members of the IRE and subscribers to the Proc. IRE at \$15.00 per year. The Annual Index to these Abstracts and References, covering those published from February, 1947, through January, 1948, may be obtained for 2s. 8d. postage included from the *Wireless Engineer*, Dorset House, Stamford St., London S. E., England.

534.321.9:538.569.4:546.212 **2688**  
The Origin of Ultrasonic Absorption in Water—Hall. (*See 2774.*)

534.78 **2689**  
Effects of High Pass and Low Pass Filtering on the Intelligibility of Speech in [fluctuation] Noise—I. Pollack. (*Jour. Acous. Soc. Amer.*, vol. 20, pp. 259–266; May, 1948.) Discussion of articulation tests, using speech of limited frequency range, in the presence of fluctuation noise having a level of 81.5 db above 0.0002 dyne/cm<sup>2</sup>. The Bell Telephone Laboratories' method for computing the articulation index was found to be adequate for assessing the efficiency of communication systems. The relative contribution of the higher speech frequencies to the articulation increased with the intensity level of the speech signal.

534.78 **2690**  
Speech Communication under Conditions of Deafness or Loud Noise—W. G. Radley. (*Jour. IEE* (London), part I, vol. 95, pp. 201–212; May, 1948. Discussion, pp. 212–216.) A theoretical study indicates that when speech has to be very loud in order to be distinguished, the

greatest intelligibility can usually be expected if the amplification varies with frequency in a manner indicated graphically by J. O. Ackroyd in an appendix. This was confirmed by tests on a large number of deaf people.

The noise level in some armored fighting vehicles, and the effectiveness of ear pads in excluding the noise, are discussed. The over-all amplifications versus frequency characteristics of the intercommunication and radio telephone systems for such vehicles are considered. For optimum results, the response should have no sudden changes with frequency.

534.833.4 **2691**  
Absorption-Frequency Characteristics of Plywood Panels—P. E. Sabine and L. G. Ramer. (*Jour. Acous. Soc. Amer.*, vol. 20, pp. 267–270; May, 1948.)

534.851 **2692**  
Balanced Clipper Noise Suppressor—S. L. Price. (*Audio Eng.*, vol. 32, pp. 13–16, 37; March, 1948.) Design details of a circuit for the suppression of surface noise without any sacrifice of high-frequency fidelity. Development work is discussed and a diagram is given of the

## IMPORTANT NOTICE

All readers of these ABSTRACTS AND REFERENCES are strongly urged to express their opinion concerning the value to them of the continuance of ABSTRACTS AND REFERENCES. The steadily increasing cost of publication and the large amount of available technical material makes it desirable that space in the PROCEEDINGS be assigned only to material which will most benefit the greatest number of readers. Accordingly, the PROCEEDINGS contents are under analysis and subject to revision. It is possible, therefore, that these ABSTRACTS AND REFERENCES may be discontinued in 1949. The ABSTRACTS AND REFERENCES were furnished as a service during a period when they were not generally available to those who found them of use. This condition may have been altered.

The original sources of material cited in the ABSTRACTS AND

REFERENCES are now generally available in libraries to those who find such ABSTRACTS most useful. Indeed, the value of the ABSTRACTS AND REFERENCES depends upon ready access to the numerous publications and periodicals there listed.

It is conceivable that the ABSTRACTS AND REFERENCES are less frequently used or are of more limited interest to the PROCEEDINGS readers than the equivalent number of pages of technical papers which are now available.

If those who find the ABSTRACTS AND REFERENCES valuable to them and who desire their continuance, or those who feel otherwise, will promptly write to the Institute, addressing their letters to the Technical Editor, their views will be collated and laid before the Executive Committee and the Board of Directors. The IRE address is 1 East 79 Street, New York 21, N.Y.

circuit finally adopted, with a frequency-response curve for normal suppression at maximum output. See also 3006 of 1947 (Scott) and 1233 of June (Goodell).

534.851:621.396.645.029.3:621.395.813 2693  
An Amplifier and Noise-Suppressor Unit—Scott and Dyett. (See 2759.)

534.851.6 2694  
Misconceptions about Record Wear—N. C. Pickering. (*Audio Eng.*, vol. 32, pp. 11-14, 47; June, 1948.) For minimum record wear, a highly compliant pickup of low moving mass and with a highly polished diamond stylus is preferable. Arm friction and turntable vibration should be avoided and tracking pressure should be low. Some improvement can be effected at the expense of the very high frequencies by introducing compliance between the stylus and the moving system. Lacquer and vinylite disks do not show wear as readily as shellac records, but are much more susceptible to surface dirt and are easily damaged by a worn stylus. Tests indicate that with standard commercial records, a stylus radius of 0.003 inch or larger produces more rapid wear than one of radius 0.0023 to 0.0025 inch.

534.86:534.322.1 2695  
Influence of Reproducing System on Tonal-Range Preferences—H. A. Chinn and P. Eisenberg. (*Proc. I.R.E.*, vol. 36, pp. 572-580; May, 1948.) An investigation of listeners' preferences when the transmission system is compensated for the changes in the response of the ear with loudness level. The main conclusions are: (a) A wide frequency range is not preferred even with a fully compensated system. (b) A similar bandwidth is favored for both uncompensated and compensated systems. (c) Bass is preferred to high frequencies in music; sibilance in speech is disliked. (d) Changes other than compensation in the reproducing system do not affect tonal range preferences. See also 3567 of 1945, 612 of 1947, and 1236 of June (Olson).

534.86:534.322.1 2696  
Optimum Frequency Range—J. Moir. (*Electronic Eng.* (London), vol. 20, pp. 98-99; March, 1948.) Discussion of the results of Olson's listener preference tests (10 of February). For earlier work see 1185 of 1947.

534.862.4:621.396.665 2697  
A Modern Sound-Reinforcement System for Theaters—C. E. Talley and R. W. Kautzky (*Jour. Soc. Mot. Pic. Eng.*, vol. 50, pp. 149-161; February, 1948.) Description of a system used at the Roxy Theatre, New York, N. Y., which includes a control console of unusual design, equipped with mixers and volume controls of a new type. Stereophonic reproduction is also discussed.

534.87 2698  
The Magnetostrictive Radial Vibrator—L. Camp. (*Jour. Acous. Soc. Amer.*, vol. 20, pp. 289-293; May, 1948.) A vibrator for underwater sound signaling. Operating characteristics are specified. A plastic cast to protect the windings improves rather than decreases the potential efficiency.

534.87:621.395.61/.62 2699  
Characteristics of Stepped-Frequency Transducer Elements—F. P. Bundy. (*Jour. Acous. Soc. Amer.*, vol. 20, pp. 297-304; May, 1948.) Transducers for underwater signaling made up of elements tuned to slightly different frequencies, to produce a broad response curve, are no more efficient than more heavily damped single-frequency elements. They have also a more irregular frequency and phase response.

534.88(26.03):621.396.932 2700  
Sofar [sound fixing and ranging]—Stifer and Saars. (See 2797.)

621.395.61/.62 2701  
A New Electro-Acoustic Transducer—

G. Bradfield. (*Electronic Eng.* (London), vol. 20, pp. 74-78; March, 1948.) Instead of traversing and re-traversing a path of limited length in the transducer, the wave is here generated at a point remote from the ends of the body in which it is propagated; it gives rise to two waves moving in opposite directions, one of which is propagated freely in the body and does not interfere with the other, which is launched from the end of the body, and can be used for exploration. Apparatus generating such waves is illustrated and described in detail. Its mode of operation is discussed, and oscillograms of various test pieces are included. The apparatus has been applied to determining the thickness of a concrete slab.

621.395.623.7 2702  
Single-Diaphragm Loudspeakers—A. C. Barker. (*Wireless World*, vol. 54, pp. 217-219; June, 1948.) A composite moving coil is used, consisting of an energized primary coil and a closed-turn secondary energized by induction. The secondary is separated from the primary by a resilient material which permits relative movement at high frequencies. The secondary thus gives improved high-frequency response and provides magnetic damping at low frequencies. An improved type of cone is described.

621.395.623.7 2703  
The Energy Transformation in Electrodynamic Loudspeakers—E. Synek. (*Radio Tech.* (Vienna), vol. 23, nos. 2 and 3, pp. 124 ff.; 1947; and vol. 24, no. 5, pp. 232-236; May, 1948.) Electromechanical relations are first considered. By transformation of the fundamental equations for cone loudspeakers and by use of electroacoustic analogies, an equivalent system is derived from which the current distribution, the various losses, the radiation, and the frequency characteristics are easily obtained. It is found that, below the fundamental resonance frequency, the radiation falls off very rapidly; at resonance it has a high maximum and above the resonance frequency it is practically constant throughout a relatively wide frequency band. Nonlinear distortion can be minimized by suitable design and by avoiding overloading. The absolute value of the efficiency and its dependence on frequency are also derived by means of an equivalent system. The efficiency, except for a small range near the resonance frequency, is extraordinarily small, and the current heating losses in the moving coil exceed the radiated acoustic power. For the electrodynamic cone loudspeaker, only increase of the air-gap flux can give an appreciable increase of efficiency.

621.395.623.8 2704  
The Problem of Sound Distribution: Part I—O. L. Angevine, Jr., and R. S. Anderson. (*Audio Eng.*, vol. 32, pp. 18-23; June, 1948.) Discussion of the planning of complete sound systems for speech or music either indoors or outdoors. Graphs assist in determining the loudspeaker power required for assigned intensity levels.

621.395.623.8 2705  
Three-Way Speaker System—G. A. Douglas. (*Audio Eng.*, vol. 32, pp. 15, 47; June, 1948.) Two series-type dividing networks are connected in cascade to give low-pass, band-pass, and high-pass transmission characteristics suited to the three loudspeakers, with crossovers at 500 and 3000 cps. The method of obtaining correct phasing is described briefly.

621.395.625 2706  
The Recording and Reproduction of Sound: Parts 14-17—O. Read. (*Radio News*, vol. 39, pp. 72-73, 120; 60-61, 187; 65-67, 170; and 52-53, 126; April to July, 1948.) Part 14: Discussion of phonograph pickup tracking error, groove skating, and record wear. Part 15: Theory, design, and construction of a dynamic noise suppressor unit having standard parts. Part 16: Performance testing of voltage and power amplifiers used in recording units. Part

17: A study of the decibel. For earlier parts see 2441 of October and back references. To be continued.

621.395.625.2 2707  
Increasing Volume Level in Disc Recording—E. Cook. (*Audio Eng.*, vol. 32, pp. 17-20, 38; March, 1948.) The average recorded level can be increased by 6 to 12 db if two limiting amplifiers working on different parts of the af spectrum are used. The response versus frequency characteristic of the recording channel is modified during high-level bursts, giving a marked improvement in apparent dynamic range.

621.395.625.2:621.395.667 2708  
A Bass Correction Circuit for Moving Coil Pickups—N. Winder. (*Electronic Eng.* (London), vol. 20, pp. 187-189; June, 1948.) Complete circuit details, with the calculated response curves, for a pre-amplifier stage. A high-pass circuit, in which  $|X_c| = \frac{1}{2}R$  and  $|X_L| = R$ , is used for negative feedback in the cathode circuit of a pentode tube. The anode wave form is constant down to any given frequency, with a sensibly linear increase for the lower three octaves or more, according to circuit values. See also 833 of 1946 (Haines).

621.395.625.6 2709  
Synthetic Sound on Film—R. E. Lewis and N. McLaren. (*Jour. Soc. Mot. Pic. Eng.*, vol. 50, pp. 233-247; March, 1948.) An analysis of both hand-drawn and machine-made sound tracks.

621.395.667:621.396.611.3 2710  
RC Circuits as Equalizers—Dahl. (See 2742.)

621.395.92 2711  
The Comparative Performance of an Experimental Hearing Aid and Two Commercial Instruments—C. V. Hudgins, R. J. Marquis, R. H. Nichols, Jr., G. E. Peterson, and D. A. Ross. (*Jour. Acous. Soc. Amer.*, vol. 20, pp. 241-258; May, 1948.) Discussion of systematic articulation tests with hard-of-hearing subjects as listeners. For most listeners, the experimental hearing aid, described in an appendix, was found to be superior to the commercial instruments.

621.396.611 2712  
A New Electro-Mechanical Oscillator and Resonator—P. J. Neilson. (*Marconi Rev.*, vol. 11, pp. 14-16; January to March, 1948.) The resonant properties of a mild steel ring can be used for fundamental or harmonic frequencies above 1 kc. A curve is given relating frequency and thickness for a given diameter of annulus. In a particular case, the temperature coefficient of frequency was  $\pm 160 \times 10^{-6}$  per  $1^\circ\text{C}$  at 2550 cps with a  $Q$  value in excess of 1000.

534.78 2713  
Visible Speech [Book Review]—R. K. Potter, G. A. Kopp, and H. C. Green. D. Van Nostrand, New York, N. Y., and Macmillan, London, 1947, 441 pp., 25s. (*Nature* (London): vol. 161, p. 334; March 6, 1948.) A detailed treatment of the major results and development to date. "Can be unreservedly recommended to all those who have a specialist's interest in speech sounds, and in particular, to those who are intimately concerned with the interests of the deaf."

621.395.92 2714  
Hearing Aids [Book Review]—H. Davis, S. S. Stevens, R. H. Nichols, Jr., C. V. Hudgins, R. J. Marquis, G. E. Peterson, and D. A. Ross. Harvard University Press, Cambridge, Mass., 1947, 197 pp., \$2.00. (*Electronics*, vol. 21, pp. 242-243; June, 1948.) The results of war-time work on the adaptation of hearing aids to individual users. Intelligibility tests were conducted on 18 hard-of-hearing men and women; tone quality and ease of listening were not considered. Conclusions from the results do not agree with the general experience of the reviewers.

### ANTENNAS AND TRANSMISSION LINES

- 621.315 2715  
On the Theory of a Coaxial Spiral Line—L. N. Loshakov and E. B. Ol'derogge. (*Radio-tekhnika* (Moscow), vol. 3, pp. 11-20; March and April, 1948. In Russian.)
- 621.315.212:621.317.333.4 2716  
Pulse Techniques in Coaxial Cable Testing—Roberts. (See 2842.)
- 621.315.68.011.2 2717  
The Characteristic Impedance of Cable Junctions.—P. G. Violet. (*Frequenz*, vol. 2, pp. 80-82; March, 1948.) Formulas applicable to coaxial cables are derived.
- 621.392.029.64 2718  
Structure of a Wave of Phase Velocity  $c$ —A. Abagam. (*Compt. Rend. Acad. Sci.* (Paris), vol. 226, pp. 1356-1357; April 26, 1948.) Theory shows that only waves of phase velocity equal or nearly equal to  $c$  (the velocity of light) can impart large amounts of energy to an electron in an ordinary accelerator. Discussion of waves propagated axially in a waveguide shows that waves of phase velocity  $c$  cannot, in general, be obtained by combining a  $TM$  wave with a  $TE$  wave. The properties of waves with phase velocity  $c$  are discussed. Transverse effects become negligible for the case of symmetry of revolution.
- 621.392.029.64 2719  
Directional Couplers—W. H. Watson. (*Proc. I.R.E.*, vol. 36, p. 632; May, 1948.) A basic combination of slots described in 1855 of August (Riblet and Saad) has previously been recorded in the author's publications noted in 1360 and 2689 of 1947.
- 621.392.029.64 2720  
Properties and Applications of Waveguides of Oval Section—M. Jouguet. (*Compt. Rend. Acad. Sci.* (Paris), vol. 226, pp. 1515-1517; May 10, 1948.) By use of a section of nearly circular waveguide of suitable length and cross section, a wave with plane polarization can be transformed into a wave of the same type, but with the plane of polarization rotated through any required angle. A plane-polarized wave can also be transformed into one with elliptical polarization of any ellipticity. Applications are described in which these principles are used for the transmission of waves round elbows of any total angle.  
The remarkable property, that the attenuation of  $H_0$  waves decreases with increase of frequency, does not hold when the waveguide section ceases to be exactly circular, because the least deformation of the cross section of the waveguide causes a longitudinal current to appear, with a consequent attenuation which increases with frequency. See also 2724 below.
- 621.392.029.64:512.831 2721  
Reflections from Circular Bends in Rectangular Wave Guides—Matrix Theory—S. O. Rice. (*Bell Sys. Tech. Jour.*, vol. 27, pp. 305-349; April, 1948.) A general matrix theory is developed for propagation in waveguides, and applied to  $E$ - and  $H$ -bends in a guide of rectangular cross section. The application of the method involves considerable computation. Approximate solutions are derived which apply strictly to large radii of curvature but which appear to be useful for rather sharp bends. These solutions agree with those previously derived by other methods.
- 621.392.029.64:513.3 2722  
Geometry of Rectangular Waveguides—A. C. Bartlett. (*Wireless Eng.*, vol. 25, pp. 202-210; July, 1948.) Discussion of transmission, critical wavelengths, resonant wavelengths, attenuation,  $H_{0n}$  and  $H_{m0}$  modes, etc., for waveguides in vacuo or containing dissipative dielectric. All results are obtained by simple geometrical constructions based on geometrical properties implied in the standard waveguide formulas and equations.
- 621.392.029.64:621.3.09 2723  
Note on the Propagation of Electromagnetic Waves in a Cylindrical Waveguide—R. Rigal. (*Onde Élec.*, vol. 28, pp. 158-163; April, 1948.) A simplified treatment based on a fundamental theorem, proof of which is given, and on a generalization of the concept of phase velocity. Expressions are derived for the cutoff frequency and the impedance for  $TM$  and  $TE$  waves. The case of  $H_{01}$  waves in a guide of rectangular section is considered briefly.
- 621.392.029.64:621.3.09 2724  
Wave Propagation in a Guide of Nearly Circular Section—M. Jouguet. (*Compt. Rend. Acad. Sci.* (Paris), vol. 226, pp. 1436-1438; May 3, 1948.) Detailed discussion of the principal and secondary effects of slight deformation of a waveguide from an exactly circular shape shows that all waves resulting from an  $E_p$  wave in the circular waveguide, except the  $E_0$  and  $H_0$  waves, are unstable. Numerical calculation shows that the effects of the instability are considerable. As regards the secondary effects, each of the two waves which correspond to a given wave can be regarded as the superposition of a principal wave of the same type and of perturbations of small amplitude. See also 2000 of 1947 and 2720 above.
- 621.392.029.64:012.8 2725  
 $E$ -Plane Bend—J. W. Miles. (*Proc. I.R.E.*, vol. 36, p. 632; May, 1948.) It is admitted that results described in Radiation Laboratory (MIT) Report 43, dated July 2, 1944, are more accurate than those in the author's paper noted in 648 of April.
- 621.396.67 2726  
Short Receiving-Antenna Design Factors—H. Kees. (*Communications*, vol. 28, pp. 26-27, 35; May, 1948.) Discussion of design problems for aircraft and other antennas with an electrical length less than about 10 ft at standard broadcasting frequencies.
- 621.396.67 2727  
Antenna Pattern Measurement—H. R. Skifter and J. S. Prichard. (*Communications*, vol. 28, pp. 26-28, 43; March, 1948.) Discussion of various methods and short description of a scale-model system of measurement.
- 621.396.67:517.512.2 2728  
The Fourier Transform of the Incomplete Gaussian Function—Millington. (See 2833.)
- 621.396.671 2729  
Radiation Resistance of an Antenna with Arbitrary Current Distribution—C. J. Bouwkamp. (*Philips Res. Rep.*, vol. 1, pp. 65-76; January, 1946.) The radiation resistance is expressed as the integral of a function which depends in a very simple way on the antenna current distribution. It is thus possible to calculate the radiation without knowledge of the radiation pattern. The formula is applied to many "classical" cases and the results are compared with those of other authors.
- 621.396.671 2730  
The Problem of Optimum Antenna Current Distribution—C. J. Bouwkamp and N. G. de Bruijn. (*Philips Res. Rep.*, vol. 1, pp. 135-158; January, 1946.) La Paz and Miller (2138 of 1943) define the theoretical optimum current distribution in a vertical antenna of given length as that current distribution which gives the maximum possible field strength on the horizon for a given power output. It is shown that this problem of optimum current distribution has no "exact" solution.  
A method is here developed to realize any given vertical radiation pattern by suitable choice of the current distribution. This gives theoretical distributions far better than the "optimum distributions" of La Paz and Miller. See also 2732 below.
- 621.396.677 2731  
Note on the Maximum Directivity of an Antenna—H. J. Riblet. (*Proc. I.R.E.*, vol.

36, pp. 620-623; May, 1948.) "It has been shown by Bouwkamp and de Bruijn [2730 above] that the directivity of a linear current distribution of fixed length may be made arbitrarily large. By a slight extension of their arguments, the same conclusion is demonstrated for a two-dimensional current distribution and for a distribution of current on an infinite strip."

621.396.677:621.317.733 2732  
Transmission-Line Bridge—Westcott. (See 2854.)

621.396.679.4 2733  
Feeding the Beam with Inductively Coupled Loops—H. E. Stewart. (*CQ*, vol. 4, pp. 42-47, 70; March, 1948.) The driven element of a parasitic array can be inductively coupled to its transmission line by means of two loops coaxial with the vertical shaft on which the antenna system rotates. The theory of inductive coupling, as applied to antennas, is discussed. This method can also be used as an impedance transforming device. Practical data are included.

### CIRCUITS AND CIRCUIT ELEMENTS

- 621.3.018.12 2734  
Phase—"Cathode Ray." (*Wireless World*, vol. 54, pp. 187-190 and 227-230; May and June, 1948.) An elementary discussion.
- 621.392 2735  
On a Remarkable Property of the Bridged-T Line and Its Application to the Calculation of the Powers Distributed in the Branches of this Line.—C. Kafian. (*Radio Franç.*, pp. 18-20 and 11-14; March and April, 1948.) Methods of calculation of bridged-T lines are usually rather long, or require a knowledge of general network theory. Starting from a  $\Gamma$  line, simple theory shows that for the bridged-T line, the potential of the midpoint is equal to the output potential. This property greatly simplifies the calculation of the powers distributed in the different branches of the line. Simple relations between these powers are derived and curves are given from which the maximum power dissipated in the various branches can be found for bridged-T lines with linear attenuation variation.
- 621.392 2736  
The Response of a Linear Diode-Voltmeter to Single and Recurrent R. F. Impulses of Various Shapes—R. E. Burgess. (*Jour. IEE* (London), part 111, vol. 95, pp. 106-110; March 1948.) "The response to a short single impulse of arbitrary shape is evaluated in terms of the time integral or area of its envelope. The ratio of this area to the peak amplitude is termed the effective duration of the impulse." The response to recurrent impulses whose spacing is small compared with the discharge time constant is expressed in a general manner; graphs are given for the cases of rectangular and triangular impulses. The "effective charge time constant" of the voltmeter depends on impulse and circuit parameters. The rectification efficiency for triangular impulses lies between 0.75 and 1.0 times that for rectangular impulses of the same effective duration and periodicity.  
The maximum indication of a critically damped meter corresponding to the rectified voltage produced by the application of a single impulse is evaluated in terms of the ratio of the meter and discharge time constants.  
The damping imposed by the diode rectifier on a sharply tuned circuit is calculated for single and recurrent impulses; it is considerably greater than for continuous waves.
- 621.392:003.62 2737  
Improving Circuit Diagrams—L. H. Bainbridge-Bell. (*Electronic Eng.* (London), vol. 20, pp. 175-177; June, 1948.) A selection from the recommendations contained in the new edition of Inter-Service Standard Graphical Symbols is given, with comments and illustrative diagrams. See also 2030 of 1947 (Keen), and 3812 of 1947 for which the above U. D. C. would have been preferable.

- 621.392:621.314.2 2738  
**On the Generation of Two Out-of-Phase Voltages**—H. Thiede. (*Funk und Ton*, vol. 2, pp. 219–222; May, 1948.) The conditions are determined for obtaining two voltages of the same amplitude but of different phases, from two in-phase voltages of different amplitudes. The particular case is considered where the amplitudes of the in-phase voltages are proportional to the sine and cosine of an angle.
- 621.395.665.1 2739  
**Surgeless Volume Expansion**—A. A. Tomkins. (*Wireless World*, vol. 54, pp. 234–235; June, 1948.) Description of a circuit using an auxiliary tube which is modulated in parallel with the expander tube by variations of the bias on the suppressor grids. The auxiliary tube screen grid is connected to the expander tube anode and the total current measured at this anode thus remains constant. No distortion was apparent for inputs up to  $\frac{1}{2}v$  from 20 to 16,000 cps.
- 621.396.611.1:517.942.932 2740  
**Forced Oscillations in Nearly Sinusoidal Systems**—M. L. Cartwright. (*Jour. IEE* (London), part III, vol. 95, pp. 88–96; March, 1948; summary, *ibid.*, part I, vol. 95, p. 223; May, 1948.) The behavior, near resonance, of the solutions of the equation 
$$j\dot{y} - (\alpha + \beta y - \gamma v^2)\dot{y} + \omega_0^2 y = E\omega_1^2 \sin \omega_1 t$$
 where  $\alpha/\omega$ ,  $\beta/\omega$  and  $\gamma/\omega$  are small, has been discussed by Appleton, van der Pol and others. A more complete discussion is given of the synchronized and quasiperiodic solutions near resonance, their phases, amplitudes and energy, and also the passage from one stable solution to another as the parameters of the system vary. The phase and amplitude favorable to synchronization are prolonged just before synchronization. This agrees with Appleton's experimental results. Hysteresis also occurs. "The decrease in energy with decrease in detuning is explained by the fact that the phase favorable to synchronization is that which opposes the motion and is prolonged."
- 621.396.611.21:549.514.51 2741  
**Quartz Crystals**—Fielding. (See 2812.)
- 621.396.611.3:621.395.667 2742  
**RC Circuits as Equalizers**—H. M. Dahl. (*Audio Eng.*, vol. 32, pp. 16–17; June, 1948.) A simplified method of computing the values of circuit components to give the required response curve.
- 621.396.611.4 2743  
**Resonant Cavities**—A. V. J. Martin. (*Radio Tech. Dig.* (Franç.), vol. 2, pp. 69–83; April, 1948.) General discussion, with formulas for resonance frequency  $Q$  and shunt impedance for various types of cavity.
- 621.396.615 2744  
**A Selsyn Driven V.F.O.**—R. V. McGraw. (*CQ*, vol. 4, pp. 17–20, 92; March, 1948.) A remote-controlled variable-frequency master oscillator which is sufficiently well screened for simultaneous operation with a receiver on the same frequency. This enables the transmitter to be keyed at a stage following the oscillator, with a consequent improvement in the keyed wave form.
- 621.396.615.17 2745  
**Milli-Microsecond Pulse Generation by Electron Bunching**—J. B. Hasted. (*Proc. Phys. Soc.*, vol. 60, p. 397; April 1, 1948.) Details of a method for producing pulses of duration  $10^{-9}$  sec or less by bunching electrons with alternating voltages of frequency 210 Mc. The electronic arrangement consists essentially of a klystron in which the resonant catcher is replaced by a nonresonant collector in the form of a coaxial line. Satisfactory agreement is found between experimental results and Harrison's mathematical theory of electron bunching (617 of March). The theoretical pulse width is of the order of  $2 \times 10^{-10}$  sec, with spacing about  $5 \times 10^{-9}$  sec. It is hoped to verify these figures with viewing equipment. The device is expected to be capable of supplying pulses of variable width and of duration short enough for testing wide-band coincidence counting circuits.
- 621.396.615.17 2746  
**Linear Saw-Tooth Generators**—A. W. Keen. (*Wireless Eng.*, vol. 25, pp. 210–214; July, 1948.) By including a constant-current charging tube in the discharge-circuit loop, a circuit is obtained whose linearity and fly-back time are satisfactory over a wide frequency range. Only two tubes are required. The charging tube assists the discharge tube during the fly-back period.
- 621.396.615.17 2747  
**Multivibrator Step-Down by Fractional Ratios**—K. H. Davis. (*Bell Lab. Rec.*, vol. 26, pp. 114–118; March, 1948.) Step-down by rational ratios such as 1789 to 121 is possible by application of feedback to multistage multivibrators. Typical circuits are analyzed.
- 621.396.615.17:518.4 2748  
**Multivibrator Design by Graphic Methods**—A. E. Abbot. (*Electronics*, vol. 21, pp. 118–120; June, 1948.) Curves are given for commonly used tubes. All phenomena affecting circuit operation are taken into account.
- 621.396.615.17:621.317.755 2749  
**Improving Fly-Back Time on a Miller Time-base**—V. Attree. (*Electronic Eng.* (London), vol. 20, p. 97; March, 1948.) By means of a cathode follower, fly-back time may be reduced by a factor of approximately 100 for sweep durations greater than 1 ms.
- 621.396.615.17:621.317.755 2750  
**A Linear Hard-Valve Time-Base for Oscilloscopes**—(*Radio and Electronics* (Wellington, N. Z.), vol. 3, pp. 4–8, 48; April 1, 1948.) A 3-tube time-base unit which generates an accurately linear sweep. The ratio of fly-back time to sweep time is independent of the sweep frequency.
- 621.396.619.13 2751  
**Factors Affecting the Frequency Deviation in Reactance-Tube Frequency Modulation Circuits**—Chai Yeh and Y. K. Tz'u. (*Chin. Jour. Phys.*, vol. 7, pp. 72–80; December, 1947.) Theoretical discussion of the frequency deviation of both inductive and capacitive circuits as affected by the phase-shift constants and the  $L/C$  ratio of the oscillator tank circuit. Experimental results are in fair agreement with theory.
- 621.396.645 2752  
**Constant Amplification in Spite of Changeability of the Circuit Elements**—J. J. Zaalberg van Zelst. (*Philips Tech. Rev.*, vol. 9, no. 10, pp. 309–315; 1947 and 1948.) Methods of making the amplification depend very little on tube slope were discussed in 3063 of 1947. Here the problem of keeping amplification constant within limits narrower than the tolerances of other variable circuit elements is solved similarly. Circuits can thus be made with an amplification per tube of say  $8 \pm 1$  per cent for a tolerance of  $\pm 5$  per cent in component ratings. A number of such stages can be placed in cascade.
- 621.396.645 2753  
**Wide-Band Amplification**—L. Ratheiser. (*Radio Tech.* (Vienna), vol. 24, pp. 200–204; May, 1948.) Discussion of (a) direct and (b) carrier-frequency amplification, with design methods for practical amplifiers and charts for determining the numerical values of circuit components.
- 621.396.645 2754  
**Wide-Band Power Amplifiers**—J. A. Hodelin. (*Radio Franç.*, pp. 20–25, April, 1948.) Discussion of (a) voltage amplification and compensation circuits; (b) counter-reaction and its use for distortion reduction, stability improvement, increase of bandwidth, and decrease of the internal resistance viewed from the output terminals; (c) transformer and cathode-follower output stages.
- 621.396.645 2755  
**High Quality Amplifier with the 6AS7G**—C. G. McProud. (*Audio Eng.*, vol. 32, pp. 21–24; March, 1948.) The twin-triode 6AS7G is discussed briefly; a circuit diagram and performance details are given which show that this tube is an ideal substitute for a pair of conventional tubes in the output stage of an amplifier. See also 2756 below.
- 621.396.645 2756  
**General Purpose 6AS7G Amplifier**—C. G. McProud. (*Audio Eng.*, vol. 32, pp. 24–29; June, 1948.) Modifications of the amplifier referred to in 2755 above are described, to provide bass and treble tone controls, a dynamic noise suppressor of a modified Scott type (932 of May), a high-gain input stage, and connections for a recorder. Unit construction makes the instrument readily adaptable.
- 621.396.645:537.533.9 2757  
**Insulator Amplifies Current 500 Times**—(*Tele-Tech*, vol. 7, pp. 72, 74; March, 1948.) A method of controlling the flow and amplification of electric current, based on the discovery that when beams of electrons are shot at an insulator, such as a diamond chip, electric currents are produced which may be 500 times as large as the current in the original electron beam. See also *Electronics*, vol. 21, pp. 140, 172; April, 1948; and 2575 of October.
- 621.396.645.011.2 2758  
**Shunted-Amplifier Input Admittance**—A. Shadowitz. (*Elec. Commun.*, vol. 24, pp. 468–477; December, 1947.) A method of calculating the admittance is given, and several cases are worked out for a shunting capacitance. "Application to a frequency modulator is given in detail. Extensions are indicated to the theory of the tuned-plate tuned-grid oscillator, multivibrator, and negative-impedance devices."
- 621.396.645.029.3:534.851:621.395.813 2759  
**An Amplifier and Noise-Suppressor Unit**—H. H. Scott and E. G. Dyett, Jr. (*FM and Telev.*, vol. 8, pp. 28–30, 44; March, 1948.) Discussion of the performance and characteristics of a 20-w af amplifier for use with the Scott noise suppressor (991 of 1947 and 932 of May). The response is within the proposed RMA limits for the audio equipment of FM or AM broadcast transmitters. A preamplifier is built in, the response of which is designed to equalize the output of magnetic pickups.
- 621.396.645.371 2760  
**Quiet High-Gain Amplifier**—C. C. Whitehead. (*Wireless World*, vol. 54, pp. 208–210; June, 1948.) A push-pull af amplifier with tone control by negative feedback.
- 621.396.662 2761  
**Wavechanging and Tuning in Receivers between 30 and 180 Mcs**—L. R. Head. (*Marconi Rev.*, vol. 11, pp. 9–13; January to March, 1948.) Discussion of various factors, such as stray inductance, which affect the range of frequency available with a given tuning capacitor.
- 621.396.662 2762  
**Theory and Design of a Cavity Attenuator**—J. J. Freeman. (*Jour. Res. Nat. Bur. Stand.*, vol. 40, pp. 235–243; March, 1948.) The fields generated by an arbitrary current distribution exciting a piston-type or cavity attenuator are developed, and symmetrical distributions exciting maximum amplitudes of the dominant mode and minimum amplitudes of unwanted modes are investigated. The relative error in voltage measurement due to spurious modes is computed as a function of spacing between exciting and receiving coils for certain simple current distributions. The relative merits of circular and rectangular attenuator cross sections are discussed.
- 621.396.69 2763  
**Operating Characteristics of Film Resistors**



to Michelson's stellar interferometer, show that during periods of very great intensity the radiation originates in an area comparable with that of a sunspot. During periods of increased activity, the radiation is mainly circularly polarized. See also 96 of February.

523.75 2785

**On the Structure of the Solar Corona and Chromosphere**—H. Bondi, F. Hoyle, and R. A. Lyttleton. (*Mon. Not. R. Astr. Soc.*, vol. 107, no. 2, pp. 184–210; 1947.) The existence of the solar atmosphere is explained on the assumption of the accretion of interstellar material, arriving at the sun with a high energy per unit mass. The steady state of this atmosphere is examined mathematically. The nature of non-steady states is also discussed with particular reference to prominences and other features of the solar atmosphere. See also 2409 of 1947 (Waldmeier).

523.75 2786

**Granulation, Magneto-Hydrodynamic Waves, and the Heating of the Solar Corona**—H. Alfvén. (*Mon. Not. R. Astr. Soc.*, vol. 107, no. 2, pp. 211–219; 1947.)

537.591 2787

**Cosmic Rays: Parts 1 and 2**—C. W. Hewlett. (*Gen. Elec. Rev.*, vol. 51, pp. 11–16 and 23–31; March and May, 1948.) A concise account of the various types of cosmic rays and their properties, with methods of investigation and discussion of possible explanations of their origin.

550.384+550.37 2788

**Electrical and Magnetic Effects of Marine Currents**—(*Observatory*, vol. 68, pp. 55–59; April, 1948.) Report of a Royal Astronomical Society discussion. Measurements of the variation of the vertical component of the earth's magnetic field on opposite sides of a water channel indicate that short-period fluctuations are due to electric currents flowing in the earth, the water channel providing a low-resistance path. Measurements of the electric potential gradient produced in tidal streams by the vertical component are also described.

550.384“1941.06” 2789

**A Distinctive Geomagnetic Epoch, 1941 June 9–14**—H. W. Newton. (*Observatory*, vol. 68, pp. 60–65; April, 1948.) Description of some world-wide sudden commencements that occurred in June, 1941, between the two intense geomagnetic storms of March and September.

550.384.4 2790

**Daily Variation of the Horizontal Magnetic Force at the Magnetic Equator**—J. Egedal. (*Nature* (London), vol. 161, pp. 443–444; March 20, 1948.) Discussion of the unusually large variations observed at Huancayo and Kodaikanal. See also 1936 of August.

551.508.94:621.317.32 2791

**A Radiosonde Method for Atmospheric Potential Gradient Measurements**—Belin. (See 2840.)

551.510.52 2792

**On the Ionic Equilibrium of the Lower Atmosphere**—J. Bricard. (*Compt. Rend. Acad. Sci.* (Paris), vol. 226, pp. 1536–1538; May 10, 1948.) Theoretical treatment, with derivation of a formula for the intensity of ionization.

621.317.792 2793

**A Lightning Warning Device**—B. F. J. Schonland and P. G. Gane. (*Trans. S. Afr. Inst. Elec. Eng.*, vol. 39, pp. 58–59; February, 1948.) Discussion on 3987 of 1947. R. Davis calls attention to a somewhat similar device noted in 3138 of 1946. See also 2794 below.

621.317.792 2794

**The Ceraunometer**—P. G. Gane and B. F. J. Schonland. (*Weather* (London), vol. 3, pp. 174–178; June, 1948.) A device to record the number of lightning discharges within a given radius. See also 3987 of 1947, and 2793 above.

551.510.535+551.594.5 2795

**Ionospheric Research at College, Alaska, July 1941–June 1946**—S. L. Seaton, H. W. Wells, and L. V. Berkner. **Auroral Research at College, Alaska, 1941–1944**—S. L. Seaton and C. W. Malich. Combined in Carnegie Institution of Washington Publication 175, 396 pp., \$1.85. (*Proc. I.R.E.*, vol. 36, p. 646; May, 1948.) 335 pages are devoted to hourly values of ionospheric data. 14 pages of tables give zenith auroral intensity measurements. Instruments and instrumental procedures are described fully.

#### LOCATION AND AIDS TO NAVIGATION

621.396.663 2796

**Marconi Multi Channel Visual H.F. Direction Finder Type DFG 28**—D. J. Fewings. (*Marconi Rev.*, vol. 11, pp. 1–8; January to March, 1948.) A single spinning goniometer without range switching provides bearings on four channels for frequencies between 3 and 17.5 Mc. The channels are independent both for bearings and for sense and all may work simultaneously, bearings being shown on cathode-ray tubes with linear scales. Spaced vertical mast antennas of the Marconi Adcock type are used with buried feeders; no vertical sense antenna is necessary. A signal-to-noise ratio of 20 db is obtained with signal strengths varying between 0.5 and 6 $\mu$ v/m. The case containing the goniometer and driving motor is specially designed to reduce noise.

621.396.932:534.88(26.03) 2797

**Sofar [sound fixing and ranging]**—W. W. Stifler, Jr. and W. F. Saars. (*Electronics*, vol. 21, pp. 98–101; June, 1948.) A hyperbolic position-fixing system depending upon the propagation of sound from a small bomb exploded at a critical depth in the ocean. With a combination of three or more receiving stations, the system gives a fix accurate to within 5 miles at a range of 2000 miles. Continuous-monitoring equipment, used to time the arrival of impulses, is described, with sample records.

621.396.96 2798

**Principles of Frequency-Modulated Radar**—I. Wolff and D. G. C. Luck. (*RCA Rev.*, vol. 9, pp. 50–75; March, 1948.) Principles of operation are discussed in detail and quantitative expressions for the determination of range and speed in terms of the output frequency are derived. The main advantage claimed is that lower peak power is required, the main disadvantages being the slowness of search and the complexity of apparatus required to increase the search speed. To be continued.

#### MATERIALS AND SUBSIDIARY TECHNIQUES

533.5:621.3.032.53 2799

**The Effect of Various Treatments on the Stresses in Glass-to-Metal Seals**—G. D. Redston and J. E. Stanworth. (*Jour. Sci. Instr.*, vol. 25, pp. 138–140; April, 1948.) The photo-elastic method of axial sighting on a bead seal is adapted to the measurement of (a) the variation of seal stress with temperature, (b) the effect of high temperature and of intensified humidity on seal stress. The seal stress versus temperature curve agrees with theory. Most seals are unaffected by humidity; certain types, notably alkali-borosilicate versus tungsten seals show irregular and striking stress changes after one or more humidity cycles.

533.5:621.3.032.53 2800

**A Titanium Technique for Metal-Ceramic Seals**—H. W. Greenwood. (*Electronic Eng.* (London), vol. 20, p. 100; March, 1948.) Extract by H. W. Greenwood from R. I. Bondley's paper noted in 3917 of 1947.

535.37 2801

**Luminescence Efficiency Changes in Zinc Sulphide Phosphors below Room Temperature**—G. F. J. Garlick and A. F. Gibson. (*Nature* (London), vol. 161, p. 359; March 6,

1948.) Variation of efficiency at temperatures below that of thermal quenching of luminescence may be either positive or negative, depending on the wavelength of the excitation. Typical curves for a self-activated ZnS phosphor are given and discussed.

535.37 2802

**The Temperature Dependence of the Fluorescence of Tungstates and Molybdates in Relation to the Perfection of the Lattice**—F. A. Kröger. (*Philips Res. Rep.*, vol. 2, pp. 340–348; October, 1947.)

537.228.1 2803

**EDT and DKT Crystals for Carrier Channel Filters**—W. P. Mason. (*Bell Lab. Rec.*, vol. 26, pp. 222–225; May, 1948.) A short account of their principal properties and of the methods of cutting to secure a low temperature coefficient of frequency. See also 740 of April.

538.221 2804

**The Adiabatic Temperature Changes Accompanying the Magnetization of Some Ferromagnetic Alloys in Low and Moderate Fields**.—L. F. Bates and E. G. Harrison. (*Proc. Phys. Soc.*, vol. 60, pp. 213–225; March 1, 1948.) The temperature changes which occur when a ferromagnetic substance is taken through a single hysteresis cycle have been measured for seven ferromagnetic alloys. A cooling effect is observed initially as the magnetization is reduced from its maximum value. Results indicate that large changes in thermomagnetic properties are caused by small changes in composition. See also 896 of 1941 (Bates and Weston) and 2805 below.

538.221 2805

**The Adiabatic Temperature Changes Accompanying Magnetization in Low and Moderate Fields: A Further Study of Iron**—L. F. Bates and E. G. Harrison. (*Proc. Phys. Soc.*, vol. 60, pp. 225–235; March 1, 1948. Discussion pp. 235–236.) A commercial moving-coil ballistic galvanometer was used with the Bates and Weston method (896 of 1941) of measuring small changes of temperature in the magnetization of iron. Measurements were made on Armco iron, 99.89 per cent pure, and Hilger H. S. electrolytic iron, 99.96 per cent pure. Heat changes associated with the virgin magnetization curve have been measured for the first time. See also 2804 above.

538.221 2806

**Supermalloy**—(*Bell Lab. Rec.*, vol. 26, pp. 111–113; March, 1948.) A brief general discussion. See also 2802 of 1947 (Boothby and Bozorth).

538.221:621.317.41 2807

**The Measurement of the Permeability of Low-Conductivity Ferromagnetic Materials at Centimetre Wavelengths**—J. B. Birks. (*Proc. Phys. Soc.*, vol. 60, pp. 282–292; March 1, 1948.) The complex magnetic and dielectric properties of a specimen filling a section of waveguide are derived from standing-wave measurements of the short-circuit and open-circuit impedances of the section. Measurements were made for  $\lambda$  60 to 1 $\frac{1}{2}$  cm; typical results for  $\gamma$ -ferric oxide are given. Magnetic dispersion is apparently an inherent property of the material and is not attributable to skin effect.

538.27 2808

**The Effect of an Airgap on the Complex Permeability of Coil Cores**—R. Feldtkeller and E. Stegmaier. (*Frequenz*, vol. 2, pp. 71–79; March, 1948.) Experimental results for various core materials show how the curves connecting the complex permeability with the amplitude of the ac induction and with the frequency are displaced when an airgap is used. The curves relating the  $Q$  of a coil to frequency are displaced toward higher frequencies, in a direction parallel to the frequency axis; the amount of the shift depends on the effective width of the airgap used.

- 546.23:537.311.33 2809  
On the Electrical Conductivity of Selenium Crystals—F. de Boer. (*Philips Res. Rep.*, vol. 2, pp. 352–356; October, 1947.) Values ranging from  $2 \times 10^4$  to  $5 \times 10^4 \Omega$  cm were obtained for the specific resistance of Se monocrystals parallel to the  $c$ -axis; it is suggested that the value for a pure monocrystal lies near the lower limit. The specific resistance at right angles to the  $c$ -axis was found to be  $2 \times 10^6 \Omega$  cm. Experimental results concerning the effect of temperature and pressure on the conductivity are also discussed.
- 546.431.82:548.5 2810  
The Growth of Barium Titanate Crystals—B. Matthias. (*Phys. Rev.*, vol. 73, pp. 808–809; April 1, 1948.) Quantitative data for an advanced growing technique. See also 2535 of October (Walker).
- 548.0:53 2811  
Physical Properties of Crystals and Their Symmetry—M. Tournier. (*Elec. Commun.*, vol. 24, pp. 478–525; December, 1947.) The particular symmetry conditions of various crystalline substances indicate certain phenomena that are likely to take place in the material. A short review of the historical background of piezoelectricity is followed by an introduction to linear transformation theory, tensor algebra and matrix algebra. Proofs of theorems of symmetry are obtained by matrix multiplication. Symmetry in crystals is determined whether the moduli relating physical effects to their causes are finite or zero. Pyroelectricity, dielectric susceptibility, piezoelectricity, elasticity, and piezomagnetism are examined in this way. The 32 classes of symmetry in crystals are described and illustrated, and the components of the characteristic tensors are tabulated for each class.
- 549.514.51:621.396.611.21 2812  
Quartz Crystals—E. A. Fielding. (*Proc. RSGB*, no. 3, pp. 1–7; Spring, 1948.) Long summary of RSGB paper. A general discussion of the production of quartz crystal plates, their defects and piezoelectric properties, and of the use of such crystals in resonant circuits and filters.
- 549.514.51(73) 2813  
Domestic Sources of Piezoelectric Quartz—H. H. Woesche. (*Amer. Jour. Sci.*, vol. 246, pp. 182–185; March, 1948.) Discussion of possible American sources of supply other than Brazil.
- 549.623.5 2814  
Mica: Its Preparation and Some Applications—A. E. Williams. (*Engineer* (London), vol. 185, pp. 227–229; March 5, 1948.) An account of the different varieties of mica, their chemical composition, physical properties, and place of origin, with details of the manufacture and properties of micanite.
- 620.193+620.197 2815  
Tropical Proofing of Radio Apparatus for Use in Tropical Climates—(*Radio Component Mfrs' Fed. Tech. Bull.*, vol. 1, pp. 3–5; February, 1948.) In the tropics destructive insects abound, and temperatures of 85 to 90°F with relative humidity 100 per cent are common. The effect on radio and other equipment is discussed. Protective measures are suggested. High-quality components must be used, as radio service hardly exists. See also 2816 below.
- 621.3(54):[620.193+620.197 2816  
Electrical Engineering Problems in the Tropics—R. Allan. (*Jour. IEE* (London), part II, vol. 95, pp. 275–283; June, 1948; summary, *ibid.*, part I, vol. 95, p. 274; June, 1948. Discussion, pp. 283–289.) Full paper; summarized in 1378 of June and 1658 of July.
- 521.3.013.783†:621.316.97 2817  
Screening at V.H.F.—B. Roston. (*Wireless Eng.*, vol. 25, pp. 221–230; July, 1948.) An experimental method of testing the effectiveness of various sprayed and deposited metal surfaces. The change in width of a resonance curve is observed when the screen is introduced the surface resistivity is deduced. Results are given for Cu and Zn sprayed on a plastic base and for Cu and Ni electro deposited on a steel base.
- 621.3.015.5.029.63/64:546.217 2818  
The Microwave Spark—D. Q. Posin. (*Phys. Rev.*, vol. 73, pp. 496–509; March 1, 1948.) The breakdown of an airgap was studied experimentally for  $\lambda$  1.25, 3, and 10 cm. The required field is strongly dependent on the width of the pulse, the intensity of initial ionization (as determined by nearby radioactive materials), gap width and pressure, and to a less degree on pulse repetition rate. See also 750 of April (Cooper).
- 621.315.61 2819  
Recent Researches on Insulating Materials—L. Piaux and G. Beauvais. (*Tech. Mod.*, vol. 40, pp. 85–88; March 1 to 15, 1948. In French.) A review, partly from the chemical and partly from the electrical standpoint, of present knowledge of polymer plastics and of ceramics of the titanate groups.
- 621.315.61:546.287 2820  
Silicone Rubbers and Their Use as Insulators in Electrotechnics—M. de Buccar. (*Rev. Gén. Élec.*, vol. 57, pp. 93–102; March, 1948.) A short discussion of their chemical structure and a detailed account of their physical and electrical properties. The wide range of temperature over which the mechanical and electrical characteristics are maintained renders these rubbers particularly useful for extreme operating conditions. Resilience and flexibility are maintained down to about  $-60^\circ\text{C}$  and cables insulated with silastic have shown no signs of damage after heating to  $250^\circ\text{C}$ . Numerous practical applications are mentioned.
- 621.315.61.011.5 2821  
Dielectric Losses—J. Granier. (*Compt. Rend. Acad. Sci.* (Paris), vol. 226, pp. 1354–1356; April 26, 1948.) A modification of Debye's theory leads to a formula representing the "goodness" of a dielectric, which gives results in good agreement with measured values for glycerine and for a phenolic resin.
- 621.315.616:621.785.545.45 2822  
The Hardening of Synthetic Materials in High-Frequency Fields—H. Stäger. (*Brown Boveri Rev.*, vol. 34, pp. 129–138; June and July, 1947.) Results of a comprehensive series of tests on laminated materials and wood/wood bonds. Optimum working conditions are established by which setting time is greatly reduced and maximum strength attained. Synthetic resins with a nitrogen constituent give a wood bond immune to tropical conditions and bacterial attack.
- 621.315.616:666.18:679.86 2823  
Scale Glass as a Substitute for Mica—J. M. Stevels. (*Philips Res. Rep.*, vol. 1, pp. 129–134; January, 1946.) A product composed of small scales, preferably of thickness 1–5 $\mu$ , which adhere under certain conditions and are formed into plates in distilled water to which is added a little  $\text{H}_2\text{PO}_4$  and  $\text{K}_2\text{SiO}_3$ . The plates when partly dried are deformable. Various applications are suggested.
- 621.315.618 2824  
New Researches on the Dielectric Strength of Compressed Gases—N. J. Félici and Y. Marchal. (*Rev. Gén. Élec.*, vol. 57, pp. 155–162; April, 1948.) The breakdown properties of gases at ordinary pressure are discussed with particular reference to Townsend's theory. Possible causes of discrepancies with Paschen's law are examined. The apparatus and method used for investigations at potentials up to 250 kv and pressures up to 70 atmospheres are described. Results are tabulated for air and for  $\text{H}_2$ , with electrodes of different materials. While stainless steel electrodes only give a breakdown strength, in vacuo, of 20 kv/mm, in compressed gases they give values 5 or 6 times greater.
- 621.316.99 2825  
Earthing Problems—R. W. Ryder. (*Jour. IEE* (London), part II, vol. 95, pp. 175–184; April, 1948. Summary, *ibid.*, part I, vol. 95, p. 226; May, 1948.) Discussion of the various factors which affect the resistance of earth electrodes with a review of earthing practice.
- 621.318.22:621.775.7 2826  
Permanent Magnets—S. J. Garvin. (*Elec. Times*, vol. 113, pp. 633–636; May 27, 1948.) Discussion of the properties of various materials, with special reference to the advantages and limitations of the sintering process.
- 621.791.3:669.715 2827  
Soldering Aluminum Alloys—F. W. Thomas and E. Simon. (*Electronics*, vol. 21, pp. 90–92; June, 1948.) The soldering-iron tip is vibrated at an ultrasonic frequency by means of a magnetostriction tube-driven oscillator. Surface oxidation is thus removed. The method can be applied to other surfaces which are difficult to solder normally.
- 666+669]:621.775.7 2828  
Metal Ceramics—H. H. Hausner. (*Metal Ind.* (London), vol. 72, pp. 405–407; May 14, 1948.) A description of the properties of "ceramics," materials formed from ceramic and metal powders. Two groups are considered: (a) mixtures of metallic and ceramic powders, and (b) combinations using different layers of metal powders and ceramic powders. The metal powders in the first group act as producers of free electrons or reducing agents for the ceramic oxides. Different combinations give a wide range of temperature coefficients. The second group includes materials resistant to high temperatures and suitable for use in jet engines and for turbine blades.
- 666.1 2829  
The Physical Properties of Glass in Relation to Its Structure—J. M. Stevels. (*Jour. Soc. Glass Tech.*, vol. 30, pp. 31–53; 1946. Summary in *Philips Res. Rep.*, vol. 2, p. 400; October, 1947.) A discussion of present knowledge of the structure of glass in relation to its density and electrical conductivity.
- 669.74/.75:621.3.011.2 2830  
Study of the Variation of Electrical Resistance with Temperature of MnSB Ferromagnetic Alloy—G. Mannevy-Tassy. (*Compt. Rend. Acad. Sci.* (Paris), vol. 226, pp. 1592–1593; May 19, 1948.) Curves are given showing the resistance variation between  $-200^\circ\text{C}$  and  $+650^\circ\text{C}$ . The changes are cyclic up to about  $450^\circ\text{C}$ , but if this temperature is exceeded, the resistance for decreasing temperatures is considerably less than for increasing temperatures.
- 678:[620.193+620.197 2831  
Rubber and the Weather—J. Crabtree. (*Bell Lab. Rec.*, vol. 26, pp. 119–123; March, 1948.) A general discussion of the various kinds of damage that can be caused by exposure, and of methods of producing such damage artificially and of preventing it in practice.

## MATHEMATICS

513.3:621.392.029.64 2832  
Geometry of Rectangular Waveguides—Bartlett. (See 2722.)

517.512.2:621.396.97 2833  
The Fourier Transform of the Incomplete Gaussian Function—G. Millington. (*Marconi Rev.*, vol. 11, pp. 17–30; January to March, 1948.) The function  $G(z/\pi a) = 2/\alpha \int_0^\alpha \exp(-y^n) \cos(zy/k) dy$  is considered by studying an allied contour integral. The method of steepest descents is used to obtain asymptotic forms for large values of the argument; a MacLaurin expansion is used for small values.  $G(z/\pi a)$  has "side lobes" even for an infinite aperture when  $n > 2$ . The important case when  $n = 2$  is discussed by an alternative method involving approximate numerical integration of a differential equation; "side lobe" amplitudes are given as functions of the width of the finite aperture.

519.5: [512.25 + 512.831] 2834  
**An Automatic Simultaneous Equation Computer and Its Use in Solving Secular [i.e. characteristic] Equations**—W. A. Adcock. (*Rev. Sci. Instr.*, vol. 19, pp. 181-187; March, 1948.) Discussion of the design of an analogue computer based on a feedback method which is more general than the Gauss-Siedel iteration method discussed on p. 85 of Murray's book [noted in 1074 of May]. Resistive voltage dividers represent the coefficients, and voltages represent the variables, which are automatically adjusted by the feedback system. Accuracy within 1 per cent can be expected. The operation is explained in detail for sets of four equations. Problems where the characteristic equation has repeated roots can be solved. [Note. No indication is given of the maximum number of equations and variables for which the method will work.]

518.61 2835  
**The Approximate Solution of Linear Differential Equations**—M. C. Gray and S. A. Schelkunoff. (*Bell Sys. Tech. Jour.*, vol. 27, pp. 350-364; April, 1948.) Examples of the application of a wave perturbation method, illustrating its high accuracy in solving certain equations used in electromagnetic and other problems. See also 1570 of 1946.

519.2:621.385.1 2836  
**Notes on the Exponential Distribution in Statistics [of valve life]**—N. W. Lewis. (*P.O. Elec. Eng. Jour.*, vol. 41, part 1, pp. 10-12; April, 1948.) An elementary account, indicating the relation between the exponential and Poisson distributions.

#### MEASUREMENTS AND TEST GEAR

53.08 + 621.3.08 2837  
**Précis of a Discussion on "Practical Considerations in Instrument Design"**—London, 1948.—(*Jour. Sci. Instr.*, vol. 25, pp. 122-124; April, 1948.) Suggestions made included: (a) Scales should be easy to read. (b) Difficulties connected with wear and lubrication may be lessened by substituting rolling spheres or cylinders or sliding constraints. (c) Precision measuring instruments of the future should use inertialess beams of light or cathode rays. The relative merits of kinematic and electrical instruments were discussed and improvements in design detail were suggested. Another account in *Engineer* (London), vol. 185, p. 257; March 12, 1948.

531.76:681.11 2838  
**Measuring the Rate of Watches with a Cathode-Ray Oscilloscope**—H. van Suchtelen. (*Philips Tech. Rev.*, vol. 9, pp. 317-320; 1947 and 1948.) By means of a microphone and amplifiers, watch ticks are converted to voltage peaks producing a vertical deflections on a cro. The time base voltage is synchronized with a standard frequency of 60 cps derived from a quartz oscillator by frequency division. The speed at which the voltage peaks move across the cro screen thus gives a measure of the rate error of the watch. Rate errors of a few seconds per day can be determined in a few minutes. See also 1669 of July (Mackay and Soule).

621.317.029.63 2839  
**Improvements in Decimetre-Wave Measurement Technique**—H. H. Meinke. (*Frequenz*, vol. 2, pp. 41-49; February, 1948.) General account of modern methods using concentric transmission lines.

621.317.32:551.508.94 2840  
**A Radiosonde Method for Atmospheric Potential Gradient Measurements**—R. E. Belin. (*Proc. Phys. Soc.*, vol. 60, pp. 381-397; April 1, 1948.) For another account see 1674 of July.

621.317.333 + 621.317.37]:621.315.212.029.6 2841  
**The Voltage Characteristics of Polythene Cables**—R. Davis, A. E. W. Austen, and W. Jackson. (*Jour. IEE* (London), part III,

vol. 95, pp. 111-112; March, 1948.) Discussion on 3179 of 1947.

621.317.333.4:621.315.212 2842  
**Pulse Techniques in Coaxial Cable Testing**—F. F. Roberts. (*P.O. Elec. Eng. Jour.*, vol. 41, part 1, pp. 13-17; April, 1948.) The principles of fault location by pulse technique are discussed. Intermittent faults can be found by display of echoes of 3- $\mu$ s dc pulses on a cro. Equipment has been developed for measuring small impedance irregularities under conditions similar to those in long-distance television relay systems. This equipment gives 0.3- $\mu$ s pulses of a 20-Mc carrier, with a spacing of about 500  $\mu$ s.

621.317.336 2843  
**A Note on the Lecher Wire Method of Measuring Impedance**—M. Williamson. (*Proc. Phys. Soc.*, vol. 60, pp. 388-391; April 1, 1948.) Discussion of factors which affect the accuracy of measurements by Williams' method (1255 of 1944).

621.317.374 2844  
**On the Determination of the Loss Angle of a Dielectric Inserted in a Double Line**—P. Abadie. (*Compt. Rend. Acad. Sci.* (Paris), vol. 226, pp. 1590-1592; May 19, 1948.) Formulas are derived which can be used for frequencies as high as 3000 Mc.

621.317.41:538.221 2845  
**The Measurement of the Permeability of Low-Conductivity Ferromagnetic Materials at Centimetre Wavelengths**—Birks. (See 2807.)

621.317.715.5 2846  
**Anti-Vibration Immersion Galvanometer**—M. Picard. (*Rev. Gén. Eléc.*, vol. 57, pp. 141-146; April, 1948.) The mean density of the moving system is the same as that of the  $C_2Cl_4$  in which it is immersed, and its center of gravity coincides with the geometric center, so that the instrument is insensitive to all translation acceleration. Sensitivity is not very high, but the robust construction and freedom from shock effects makes the galvanometer particularly useful under conditions which would put other instruments out of action.

621.317.725/.726 2847  
**Stable Voltmeter Amplifier**—J. D. Clare. (*Wireless Eng.*, vol. 25, pp. 231-236; July, 1948.) Analysis of a dc amplifier circuit which can be used either as an electrostatic voltmeter or, with a diode probe, as an ac peak voltmeter. Changes in supply voltages and tube parameters have practically no effect on the meter reading.

621.317.725 2848  
**Inverted Valve Voltmeter**—W. Geyer. (*Arch. Tech.* (Messen), no. 155, T78-79, 4 pp.) June, 1948.) Discussion of the principles and performance of voltmeters in which the voltage to be measured is applied between anode and cathode of a triode tube. For ac voltages, the use of a small voltage transformer with a center-tapped secondary, whose two sections are connected to the anodes of a double triode and to the common cathode, gives greater sensitivity. See also 3974 of 1945 (Foster).

621.317.725.027.7 2849  
**The Design of an Ellipsoid Voltmeter for the Precision Measurement of High Alternating Voltages**—F. M. Bruce. (*Jour. IEE* (London), part II, vol. 95, pp. 364-365; June, 1948.) Discussion on 3584 of 1947.

621.317.728.029.6 2850  
**Calibration of Uniform-Field Spark-Gaps for High-Voltage Measurement at Power Frequencies**—F. M. Bruce. (*Jour. IEE* (London), part II, vol. 95, pp. 364-365; June, 1948.) Discussion on 3585 of 1947.

621.317.73 2851  
**Direct-Reading Impedance Meter**—J. Schiffrine. (*Rev. Tech. Comp. Franc.*, Thomson-Houston, pp. 31-40; April, 1948.) In French,

with English summary.) Theory and circuit details of instruments which give both the real and imaginary components of an impedance. Accuracy is within about 3 per cent. One instrument can measure impedances up to several hundred ohms at frequencies in the range 0 to 10,000 cps, with impedance currents up to 0.5 amp. The second can be used for impedances up to 1 M $\Omega$ , has a frequency range of 30 to 10,000 cps, and is independent of the power in the impedance.

621.317.73:621.317.755 2852  
**Frequency-Scanning VHF Impedance Meter**—L. L. Libby. (*Electronics*, vol. 21, pp. 94-97) June, 1948.) An instrument designed to display at any instant the impedance versus frequency curve; it can scan rapidly bandwidths up to 30 Mc in the range 10 to 250 Mc. The output, which can be used with any cro is proportional to the amount of energy reflected from the end of a transmission delay line to which the apparatus under test is connected. Details of design are given and the method of operation is described, with an example.

621.317.733 2853  
**Theory of Wagner Ground Balance for Alternating-Current Bridges**—R. K. Cook. (*Jour. Res., Nat. Bur. Stand.*, vol. 40, pp. 245-249; March, 1948.) A method is described for using a Wagner earth with any 3-terminal source for elimination of earth capacitance effects. The basic idea is the insertion of impedances between the two ungrounded terminals of the source and the corresponding terminals of the Wagner earth and the bridge, so as to balance approximately the currents from the source. The method is applicable to high-voltage Schering bridges. A Schering bridge incorporating the principles of the new method is described; this is designed primarily for the measurement of the small capacitances, about 50pF, of some types of capacitor microphone.

621.317.733:621.396.677 2854  
**Transmission-Line Bridge**—C. H. Westcott. (*Wireless Eng.*, vol. 25, pp. 215-220; July, 1948.) Four  $\lambda/4$  sections of transmission line are connected in a re-entrant loop, one section containing a transposition of the two feeder wires. Equal loads connected to opposite corners of the loop may be fed simultaneously by two generators connected to the two remaining corners. No interaction occurs between the generators, but by altering their relative phase, the total power can be applied to each load in turn. When this principle is applied to a receiving array, using two receivers as the loads, one receiver may be made to respond to off-target bearings only, and its output used to cancel (at video frequency) the output of the main receiver, resulting in an apparent lobe narrowing. Another application is the production of split beams with a common antenna. The system may be used over a fairly wide frequency range, as its action depends only on symmetry. See also 1355 of 1947 (Taylor and Westcott).

621.317.755:621.396.813 2855  
**Technique for Distortion Analysis**—S. S. Baroff. (*Electronics*, vol. 21, pp. 114-117; June, 1948.) The effect of the circuits under observation on clipped sine waves is displayed on a cro. Typical patterns are reproduced, and simple equipment comprising biased crystal rectifiers is described.

621.317.761 2856  
**Checking FM Transmitter Frequencies with WWV**—R. R. Freeland. (*Communications*, vol. 28, pp. 16-18, 31; May, 1948.) The equipment includes a specially designed secondary standard consisting of a 6F6 oscillator driving a 10-kc multivibrator, which in turn drives a 2-kc multivibrator. Two stages of amplification provide harmonic outputs up to 110 Mc. The transmitter frequency and a standard WWV frequency are both compared with this secondary standard.



- 621.317.79:621.394.813 2857  
**The Measurement of Telegraph Distortion**—A. B. Shone and R. T. Fatehchand. (*Electronic Eng.* (London), vol. 20, pp. 181-185; June, 1948.) The main features of the BBC "start-stop" distortion measurement set, are the phantastron timebase and the "Multiar." The "start" pulse triggers the timebase; the sweep duration is 125 ms, so that the entire teleprinter signal between successive start pulses can be displayed on a cro. The phantastron output also feeds the Multiar. By adjustment of a calibrated auxiliary voltage, the Multiar will fire at any point on the timebase to produce a bright spot. The auxiliary voltage is regulated by a potentiometer network calibrated from 0 to 130 ms. Distortion can be measured to an accuracy within  $2\frac{1}{2}$  per cent.  
 Details of the phantastron and Multiar circuits, given fully in 985 of May (Williams and Moody), are summarized in an appendix. See also 2478 of October (Close and Lehenbaum).
- 621.317.79:621.396.615.12:621.395.813 2858  
**An Improved Intermodulation Measuring System**—G. W. Read and R. R. Scoville. (*Jour. Soc. Mot. Pic. Eng.*, vol. 50, pp. 162-173; February, 1948.) Description of an intermodulation analyzer and associated two-signal generator, for measuring distortion in af systems. Paired signals are used; they can be selected in several combinations from 40 to 12,000 cps. The equipment is particularly useful for determining optimum processing conditions for variable-density recording.
- 621.317.79:621.396.813 2859  
**The Measurement of Delay Distortion in Microwave Repeaters**—D. H. Ring. (*Bell Sys. Tech. Jour.*, vol. 27, pp. 247-264; April, 1948.) IRE 1947 National Convention paper. Description of equipment which can measure delay distortion of the order of  $10^{-9}$  sec in a wide-band television relay repeater. Circuits are discussed (a) for measuring relative phase shift as a function of frequency, from which the delay distortion is computed, (b) for direct delay measurement. The equipment is designed for an if between 50 and 80 Mc but can be adapted for use at microwave frequencies.
- 621.317.79:621.396.822 2860  
**Method of Measurement of Noise Ratios and Noise Factors**—A. van der Ziel. (*Philips Res. Rep.*, vol. 2, pp. 321-330; October, 1947.) Crystals, tube circuits, and receivers are tested by this method. A saturated diode provides a noise output for use as a test signal, its output level being monitored by a linear amplifier (bandwidth 50 to 100 kc) and a thermocouple.
- 621.317.79:621.396.97 2861  
**Monitor for Frequency-Modulation Broadcasting**—M. Silver. (*Elec. Commun.*, vol. 24, pp. 428-432; December, 1947.) A detailed description of a monitor designed to meet FCC specifications. Using separate discriminators, center transmission frequency is measured with an error of  $\pm 100$  cps under full modulation conditions, and modulation percentage is measured within  $\pm 5$  per cent. Noise and distortion monitoring facilities and an overmodulation warning are provided. The inherent noise and distortion in the monitor are estimated.
- 621.317.794.029.64 2862  
**The D.C. Thermal Characteristics of Microwave Bolometers**—E. Peskin and E. Weber. (*Rev. Sci. Instr.*, vol. 19, pp. 188-195; March, 1948.) A theoretical study of the temperature distribution and variation of resistance of a temperature-sensitive, resistive rod. Both linear and quadratic thermal laws are postulated, and the results are compared with experimental curves for actual bolometers. The sensitivity of resistance to changes in the direct current is defined and computed.
- 621.319.4.089.6 2863  
**The Calibration of Capacitors at the National Physical Laboratory, 1947**—G. H. Rayner and L. H. Ford. (*Jour. IEE* (London), part II, vol. 95, pp. 312-318; June, 1948. Summary, *ibid.*, part I, vol. 95, p. 234; May, 1948.) Astbury's modification of the Carey-Foster bridge is described briefly and a more detailed account is given of the precision Schering bridge used, in which particular attention is paid to screening. Possible errors are within 1 part in  $10^4$  for capacitance and 0.002 per cent for power factor when measuring any but the smallest capacitances.
- 621.396.69.001.4 2864  
**Tests for the Selection of Components for Broadcast Receivers**—G. D. Reynolds. (*Jour. IEE* (London), part III, vol. 95, pp. 54-64; March, 1948. Discussion, pp. 64-68.) Methods are described for finding out whether a given component is suitable for incorporation in a range of radio or television receivers; the results of such tests are surveyed. Fuller details are given for the less usual methods.
- 621.317.7.029.64 2865  
**Techniques of Microwave Measurements [Book Review]**—C. G. Montgomery (Ed.). McGraw-Hill, New York, N. Y., 1947, 922 pp., \$10.00. (PROC. I.R.E., vol. 36, p. 645; May, 1948.) Volume 2 of the Radiation Laboratory series. Laboratory types of measuring equipment are described. "Fourteen authors, each an expert in one or more fields, have contributed to write a complete story. Although complete, it does not pretend to be exhaustive. There are numerous references . . ."
- OTHER APPLICATIONS OF RADIO AND ELECTRONICS**
- 533.15:537.534 2866  
**Vapor Leak Detection by Thermionic Effects**—W. C. White and H. S. Hickey. (*Electronic Ind.*, vol. 2, pp. 7-8; March, 1948.) Another account noted in 2303 of September.
- 534.321.9.001.8:57 2867  
**Applications of Ultrasonics to Biology**—S. Y. White. (*Audio Eng.*, vol. 32, pp. 30, 45; June, 1948.) Discussion of applications to the sterilizing of liquids and also in medical research.
- 535.61-14/-15 2868  
**Infra-Red Instrumentation and Techniques**—V. Z. Williams. (*Rev. Sci. Instr.*, vol. 19, pp. 135-178; March, 1948.) An extensive summary of instruments and experimental methods used for  $\lambda$  between 2.5  $\mu$  and 1 cm. Molecular absorption in the near infrared (2.5 to 25  $\mu$ ) is discussed, and industrial application of spectrometry in this region described, with details of the sources, dispersive media, optical systems, absorption cells, and detectors used. Photosensitive detectors and grating spectrometers used in the far infrared (up to 350  $\mu$ ) are described briefly. Some experiments on gaseous absorption in the microwave region are mentioned, in which bolometers, crystals, or radiometers are used as detectors. Infrared filters are described, together with various applications of infrared radiation in pyrometry and military equipment. A bibliography of 210 items is included.
- 536.53 2869  
**Electronic Instruments in Temperature Measurement**—I. P. Buchanan. (*Aust. Jour. Inst. Tech.*, vol. 3, pp. 88-106; March, 1947.) Only instruments whose actuating elements are thermocouples or resistance thermometers are considered. Two main classes are (a) those for which a galvanometer is the detecting device, but the movement of the pointer is not impeded, (b) the "null" balance type, which has no galvanometer. Several commercial instruments in both classes are described. Tubes used in such instruments should be operated well below their ratings for radio receiver design; a reserve of power is usually available so that aging seldom causes failure.
- 539.16.08 2870  
**Modern Geiger-Muller Tubes**—O. J. Russell. (*Electronic Eng.* (London), vol. 20, pp. 70-73; March, 1948.) A brief discussion of their modes of operation, typical performance figures, and their use for estimating natural potassium, which contains an isotope emitting  $\beta$  rays.
- 621.317.792 2871  
**A Lightning Warning Device**—Schonland and Gane. (*See* 2793 and 2794.)
- 621.365.5 2872  
**Melting Metals by Induction Heating**—N. Y. Stansel. (*Gen. Elec. Rev.*, vol. 51, pp. 35-42; March, 1948.) Operation data, electrical features, construction, and applications of coreless-induction and submerged-resistor types of heating equipment.
- 621.384.6 2873  
**On the Dynamics of Electrons in a Linear Accelerator**—A. Messiah. (*Compt. Rend. Acad. Sci.* (Paris), vol. 226, pp. 1357-1359; April 26, 1948.) Discussion of the effect of fluctuations of the electron velocity, in the neighborhood of the velocity of light on the output energy spectrum.
- 621.384.6 2874  
**A High Frequency Cyclotron Generator with Demountable Tubes**—H. Atterling and G. Lindström. (*Ark. Mat. Astr. Fys.*, vol. 35, part 1, section A, 9 pp.; April 16, 1948. In English.) Description of the high-frequency oscillator now in use for 32-inch cyclotron at the Nobel Institute for Physics in Stockholm.
- 621.384.6 2875  
**An Equipment for Automatic [cyclotron] Resonance Control**—G. Lindström (*Ark. Mat. Astr. Fys.*, vol. 35, part 1, section A, 8 pp.; April 16, 1948. In English.) For cyclotron resonance, the product of the magnetic field and the wavelength of the high-frequency system is constant. Both these quantities, however, are liable to drift slowly and steadily. By charging two capacitors in successive equal intervals, and then coupling the capacitors in series, a difference voltage dependent on the rate of drift is obtained. This voltage is used to correct for the drift by altering the magnet current.
- 621.384.6:621.386 2876  
**Recent Progress in the Production of X Rays**—J. Saget. (*Bull. Soc. Franç. Elec.*, vol. 8, pp. 245-254; May, 1948.) Modern developments of high-voltage equipment, including Van de Graaff generators and all types of particle accelerators, whose principles of operation are described and characteristics tabulated.
- 621.385.833 2877  
**The Focal Length of a Long Magnetic Lens**—N. Svartholm. (*Ark. Mat. Astr. Fys.*, vol. 35, part 1, section A, 9 pp.; April 16, 1948. In English.) A formula is obtained for the focal length under stated assumptions. Two types of definite integral are involved. See also 2205 of 1941 (Glaser).
- 621.385.833 2878  
**100-kV Electron Microscope**—(*Elec. Times*, vol. 113, p. 463; April 15, 1948.) A new Metropolitan-Vickers model, E.M.3, which differs from Type E.M.2 principally in the redesign of the electron gun and in the introduction of an extra intermediate projection lens. This lens allows the magnification to be varied continuously from 1000 to 100,000 without alteration of the focal length of the object lens, and also enables the over-all length of the instrument to be reduced considerably.
- 621.385.833 2879  
**Experimental Electron Microscope**—(*Engineer* (London), vol. 185, p. 517; May 28, 1948.) An illustrated description of the Plessey Co.'s instrument. Suitable specimens can be directly viewed at magnifications up to 20,000 diameters and the images can be further enlarged 10 times by optical methods.

- 621.385.833 2880  
On the Shape of the Field for Electrostatic Lenses—V. V. Sorokina and P. V. Timofeev. (*Zh. Tekh. Fiz.*, vol. 18, pp. 509-516; April, 1948. In Russian.)
- 621.395.658 2881  
A Magnetic Stepping Switch for Control Applications—A. F. Horlacher. (*Electronic Ind.*, vol. 2, pp. 3-5, 11; March, 1948.) Discussion of a switch, essentially similar to those used in automatic telephones, for (a) selection of one channel out of 20 or 40, (b) sequence control, (c) counting, (d) cumulative addition, (e) production of a coded series of pulses.
- 621.396.9:623.26 2882  
Buried Metal Detection—(*Elec. Times*, vol. 113, p. 307; March 11, 1948. Discussion, p. 308.) Summary of two IEE papers. The first, "Development and Use of Magnetic Apparatus for Bomb and Mine Detection," by A. Butterworth, shows the superiority of magnetic over induction detectors for location at great depths. The second, "Development of Locators for Small Metallic Bodies Buried in the Ground," by Roston, discusses the history and future design trends of af detectors, which can be used to discriminate against low-conductivity magnetic materials.
- 629.13.05 2883  
The Physical Principles of Some Basic Aircraft Instruments—W. H. Hoather. (*Jour. Sci. Instr.*, vol. 25, pp. 113-122; April, 1948.) General theory and design of altimeter, air speed indicator, Machmeter, climb indicator, magnetic compass, and similar instruments. Particulars of performance and accuracy are included.
- PROPAGATION OF WAVES
- 621.396.11:551.510:535 2884  
Ionospheric Refraction—S. Estrabaud. (*Onde Elec.*, vol. 28, pp. 146-149; April, 1948.) A rigorous law of refraction is established, and the approximations of Försterling and Lassen are critically discussed. Comparison between results deduced from an approximate formula and from that of Försterling and Lassen shows their approximation to be satisfactory in practice. In consequence, the English abacs are to be trusted in all cases where the ion distribution is truly parabolic.
- 621.396.11:551.510.535 2885  
Ionospheric Disturbances—G. H. M. Gleade. (*P.O. Elec. Eng. Jour.*, vol. 41, part 1, pp. 34-38; April, 1948.) Discussion of the two main kinds of disturbance that upset long-distance short-wave radio communication and of methods of counteracting them, with special reference to the great solar flare of July, 1946.
- 621.396.11:551.510.535 2886  
Techniques for the Application of Ionosphere Data to Practical Short Wave Transmission and Reception—T. W. Bennington. (*Proc. RSGB*, no. 2, pp. 1-7; 1948.) A review of the present knowledge of the ionosphere with particular reference to its effect on long distance short-wave propagation. Typical curves of diurnal, seasonal, and solar cycle variations of the critical frequency are given, and methods of maximum usable frequency forecasting are outlined.
- 621.396.11:551.510.535 2887  
The Determination of Maximum Usable Frequencies for Radio Links—P. Lejay. (*Onde Elec.*, vol. 28, pp. 129-146; April, 1948.) A detailed account, with critical comparison, of American and English methods for the case of (a) a plane earth, and (b) a curved earth. Modification of the results when account is taken of the effect of the earth's magnetic field is also considered.
- 621.396.11:551.594.6 2888  
A Possible Mode of Propagation of the "Slow" or Tail Component in Atmospherics—A. L. Hales. (*Proc. Roy. Soc. A.*, vol. 193, pp. 60-71; April 22, 1948.) Surface wave solutions for the propagation of electromotive waves between infinite plane conductors are obtained. If one of the layers is of finite conductivity, there is a solution which corresponds qualitatively with the observed velocities and periods of the slow component.
- 621.396.11.029.58 2889  
Short-Wave Echoes—H. A. Hess. (*Funk und Ton*, vol. 2, pp. 244-253; May, 1948.) Describes investigations of the reception of signals from stations less than 1000 km distant, where multipath effects and scattering are often observed. The bearing of such effects on the measurement of the time taken for a signal to travel round the earth, and on the measurement of the distance of a transmitter, are discussed. Measurements on signals that have traveled several times round the earth, and on split signals, are also described. See also 2053 of August.
- 621.396.81 2890  
Some Effects of Obstacles on the Propagation of Very Short Radio Waves—E. C. S. Megaw. (*Jour. IEE* (London), part III, vol. 95, pp. 97-105; March, 1948.) Diffraction at a straight edge and round a cylinder is considered, and the scattering of electromotive waves from cylinders is discussed theoretically. Experimental results show the effects of ships' masts and superstructures on vhf communication and navigational radar. In most of the practical problems discussed, prediction to a useful degree of approximation is found possible. Results are also given for transmission over land, showing the effects on decimeter and centimeter waves of hills, trees, buildings, etc., near to or directly in the path of the beam. See also 509, 511, and 518 of 1947.
- 621.396.81:518.3 2891  
Free Space Microwave Propagation—A. L. Hammerschmidt. (*RCA Rev.*, vol. 9, pp. 159-166; March, 1948.) Abacs for calculating the performance of microwave relay equipment.
- 620.396.812 2892  
Simultaneous Field Strength Recording on 47.1, 106.5, and 700 Megacycles—W. L. Carlson. (*RCA Rev.*, vol. 9, pp. 76-84; March, 1948.) For the lower frequencies, the 45-mile path was just beyond optical range, but the 700-Mc transmitting antenna was 340 ft higher than the others; the receiving antennas were located together. Transmissions were recorded on all three frequencies during the summer of 1946 and intermittently thereafter on 47.1 and 106.5 Mc until May 21, 1947. Early afternoon signals usually had steady values, assumed to be those which occur when the gradient  $g$  of the atmospheric dielectric constant is normal. Abnormal values of  $g$  were more favorable to reception on the higher frequencies. The received 700-Mc field strength was sometimes abnormally high, particularly when rainstorms occurred near the receiver. Typical records are reproduced and discussed.
- 621.396.812:621.396.97(494) 2893  
Broadcasting Research with F.M. Ultra-Short Waves—W. Klein and J. Dufour. (*Tech. Mitt. Schweiz. Telegr.-Teleph. Verw.*, vol. 26, pp. 1-21 and 61-83; February 1 and April 1, 1948. In German.) A comprehensive account of reception tests for transmissions from Chasseral, an elevated station N.E. of Neuchâtel. Three characteristic reception zones were noted. In Zone A, the region of direct radiation, appreciably higher field strengths were observed when using horizontally polarized waves, whereas in Zone B, beyond the optical range, vertical polarization gave the greater signal strength. In Zone C, between A and B, reception was markedly dependent on local conditions. A simple type of directive antenna usually gave a decided improvement in reception in this zone, but made little difference in Zone B. See also 546 of March or 2632 of October (Gerber and Tank).
- 621.396.812.4.029.64 2894  
Microwave Propagation Experiments—L. E. Thompson. (*Proc. I.R.E.*, vol. 36, pp. 671-676; May, 1948.) One-way propagation tests at frequencies between 3000 and 4000 Mc are described, for three optical paths. The effect of changes in atmospheric refraction is discussed and methods of reducing signal variations are considered, with special reference to microwave relay communication systems. Theoretical diffraction data are included.
- RECEPTION
- 621.396.621 2895  
Bush Model EBS4—(*Wireless World*, vol. 54, pp. 214-215; June, 1948.) Test report. Coverage is continuous for  $\lambda$  10 to 560 m. Full circuit details are given. The set is designed to withstand tropical conditions.
- 621.396.621:621.396.619.11 2896  
The Synchrodyne Receiver Again—(*Radio and Electronics* (Wellington, N. Z.), vol. 3, pp. 30-34; April 1, 1948.) Abridged version of 525 and 526 of March (Tucker).
- 621.396.621.2 2897  
Input Circuits for Broadcasting Receivers—L. de Valroger. (*Rev. Tech. Comp. Franç. Thomson-Houston*, pp. 5-30; April, 1948. In French.) Conclusion of 2068 of August.
- 621.396.621.53 2898  
Band Spreading by Double Heterodyning—J. Baumgartner. (*Radio Tech.* (Vienna), vol. 24, pp. 185-190; May, 1948.) Various techniques for short-wave band spreading are reviewed and a method is described which gives increased sensitivity, is less susceptible to image-frequency interference and gives a linear frequency distribution on all bands.
- 621.396.81:621.396.96 2899  
Signal-Noise Ratio in Radar—M. Levy. (*Wireless Eng.*, vol. 25, pp. 236-237; July, 1948.) Author's reply to criticism of 1146 of May by de Walden (1739 of July).
- 621.396.82 2900  
Radio Interference in Ships—S. F. Pearce. (*Engineer* (London), vol. 185, pp. 261-263; March 12, 1948.) Details of experiments on interference conducted aboard five merchant ships. The coupling between supply wiring and the antennas, measured at several places on the ship, was  $-70 \pm 13$  db. Results indicate that suppression on the ancillary electrical equipment may be reduced to a negligible amount if suitable precautions are taken in the design and layout of the wireless room and nearby supply circuits. High-quality reception should be possible when machines of rf terminal voltage as high as 5 mv are in operation. See also 2348 of September (Matthews and Borrow).
- 621.396.82 2901  
Impulsive Interference in Amplitude-Modulation Receivers—D. Weighton. (*Jour. IEE* (London), part III, vol. 95, pp. 69-79; March, 1948.) The response of an AM receiver to impulsive interference is analyzed, using the Fourier integral theorem. The general behavior of such receivers is deduced from the formulas obtained. The method is applied to the calculation of the performance of noise-suppression circuits, which are classified as amplitude, differential, or delay limiters. Simple expressions are derived for estimating the suppression in any particular case. Experimental results for the first two types are in fair agreement with the calculated values. A comparison is made between the behavior, under conditions of impulsive interference, of FM, pulse-length-modulation, and suppressed AM systems.
- 621.396.821:551.594.6 2902  
Pulse Flux Defining the Operation Threshold for a Receiver-Recorder of the Mean Level of Atmospherics—F. Carbenay. (*Compt. Rend. Acad. Sci.* (Paris), vol. 226, pp. 1710-1712; May 24, 1948.)

621.396.822 2903

Some Fundamental Considerations Concerning Noise Reduction and Range in Radar and Communication—S. Goldman. (PROC. I.R.E., vol. 36, pp. 584-594; May, 1948.) 1947 National Electronics Conference paper. A general analysis of fundamental principles based upon "information theory" and the theory of probability. Three general theorems concerning the probability relations between signal and noise are proved, and one is applied to investigate the effect of pulse length and repetition rate on radar range. The following subjects are discussed: (a) existing noise-improvement systems, and reasons why more powerful systems should be possible; (b) noise improvement thresholds and their dependence upon a coherence standard; (c) laws governing the maximum operating range of a radar or communication system for a given average power, and general methods of increasing this range; (d) the use of extra bandwidth to reduce distortion; (e) possible relations of this work to biology and psychology.

621.396.822:523.16 2904

Radio Noise of Extra-Terrestrial Origin and Its Effect on the Technique of Telecommunications—Lehmann. (See 2777.)

621.396.822:621.317.79 2905

Method of Measurement of Noise Ratios and Noise Factors—van der Ziel. (See 2860.)

621.396.712:621.396.828 2906

Eliminating Interference Resulting from Coupled Antennas—F. E. Butterfield. (Communications, vol. 28, pp. 18, 40; March, 1948.) Serious interference between two 250-w transmitters, operating on frequencies of 1450 kc and 1490 kc respectively and with their antennas 560 ft apart, was practically eliminated by fitting rejection filters in the tuning units of the transmitters. Details of these filters and of their adjustment are given.

#### STATIONS AND COMMUNICATION SYSTEMS

621.39:[384+620.193.21 2907

The Development and Design of Colonial Telecommunication Systems and Plant; and The General Planning and Organization of Colonial Telecommunication Systems.—C. Lawton and V. H. Winson. (Jour. IEE (London), part III, vol. 95, pp. 79-87; March, 1948.) Discussion on 1149 and 1150 of May.

621.391.63/.64 2908

Survey of Near Infra-red Communication Systems—W. S. Huxford and J. R. Platt. (Jour. Opt. Soc. Amer., vol. 38, pp. 253-268; March, 1948.) Sixty years' work is reviewed; only voice and code systems are considered. Discussion of: (a) components used and qualities desirable in such systems; (b) early systems developed before World War I in Germany, and during that war, in America and England; (c) latest equipment developed during World War II in Italy, Japan, Germany, and America. A bibliography of 61 papers is included.

621.391.63/.64 2909

Principles of Optical Communication Systems—H. S. Snyder and J. R. Platt. (Jour. Opt. Soc. Amer., vol. 38, pp. 269-278; March, 1948.) Factors governing the range of optical communication systems are enumerated and discussed. A general equation relating the range to these factors is derived. Laboratory measurements on components are described; from these the field range of a system may be predicted to within  $\pm \frac{1}{4}$  mile if the attenuation due to the atmosphere is known.

621.395.43 2910

Multi-Channel Telephony—(Elec. Times, vol. 113, p. 432; April 8, 1948.) Short account of an IEE paper by R. J. Halsey and J. Swaffield entitled "Analysis-Synthesis Telephony with Special Reference to the Vocoder." The vocoder uses about 10 frequency bands, se-

lected by band-pass filters whose rectified outputs define the energy in the corresponding parts of the speech spectrum. Transmission of these code signals need only occupy a bandwidth of the order of 300 cps. Details were given of the construction of both the transmitting and receiving equipment, but these details are not included in the present summary.

621.395.47 2911

The Potentialities of the Vocoder for Telephony over Very Long Distances—J. Swaffield. (P.O. Elec. Eng. Jour., vol. 41, part 1, pp. 22-28; April, 1948.) A speech analysis-synthesis system whose design and performance are described. Some of the article is taken from the paper noted in 2910 above.

621.396.41 2912

A Two-Phase Telecommunication System: Parts 1 and 2—D. G. Tucker. (Electronic Eng. (London), vol. 20, pp. 150-151 and 192-195; May and June, 1948.) The fundamental principles of a two-phase transmission system are discussed. Two signals in the same frequency band may be separated on demodulation, provided they are originally modulated with carriers having the same frequency but differing in phase, preferably by  $\pi/2$ . The demodulation is achieved in each of two branches, by carriers whose phase is such that one signal is eliminated in each branch. Stability of phase throughout the system is essential; methods for achieving this are outlined. Other practical difficulties in the design of a system for single- or multiple-channel working are discussed and suggestions are made for suitable equipment.

621.396.619.15 2913

Frequency Shift Telegraphy—Radio and Wire Applications—J. R. Davey and A. L. Matte. (Bell Sys. Tech. Jour., vol. 27, pp. 265-304; April, 1948.) Reprint abstracted in 2362 of September.

621.396.65 2914

A Portable Microwave Communication Set—C. E. Sharp and R. E. Lacy. (PROC. I.R.E., vol. 36, pp. 676-680; May, 1948.) IRE 1947 National Convention paper. A double concentric transmission-line oscillator tube is used in the transmitter, while the receiver is super-regenerative. Duplex operation is provided. The total power consumption is about 20 w and the practical communication range in rolling country is 5 miles. The frequency used is 2200 to 2400 Mc.

621.396.65:523.3 2915

Considerations of Moon-Relay Communication—D. D. Grieg, S. Metzger, and R. Waer. (PROC. I.R.E., vol. 36, pp. 652-663; May, 1948.) IRE 1947 National Convention paper. Discussion of communication between two places on the earth's surface by means of radio waves reflected from the moon.

621.396.65:621.396.41 2916

Microwave Radio Communication: Eight-Channel Multiplex Point-to-Point Equipment—(Electrician, vol. 140, p. 963; March 26, 1948.) A v.m.  $\frac{1}{2}$ -w transmitting tube for  $\lambda$  6 cm is used, with pulse-width modulation for the individual channels, which are sampled at a repetition frequency of 9 kc. At the receiver, the relatively long synchronizing pulse is used to generate a gating pulse in each channel unit. Successful tests have been carried out on an 8-channel link extending 25 miles across London. See also Wireless World, vol. 54, p. 179; May, 1948.

621.396.65.029.64 2917

Experimental Studies of a Remodulating Repeater—W. M. Goodall. (PROC. I.R.E., vol. 36, pp. 580-583; May, 1948.) A superheterodyne receiver is used with a microwave reflex-oscillator transmitter to form a repeater. Arrangements are described for testing this system by circulating 1- $\mu$ s pulses through it and observing the deterioration of the pulse shape after several circulations. Oscillograms show

the performance, with and without phase equalization, for 1 to 30 circulations.

621.396.65.029.64 2918

Microwave Repeater Research—H. T. Friis (Ed.). (Bell Sys. Tech. Jour., vol. 27, pp. 183-246; April, 1948.) Discussion of a comprehensive research program, as yet incomplete, for which the New York to Boston link (1755 and 1756 of July) was an initial objective. Sections by various authors deal with (a) propagation studies, (b) repeater circuit planning, (c) antenna research, (d) filter research, (e) repeater amplifier, (f) receiving converter, (g) transmitting converter or modulator, (h) rf amplifier, and (i) the complete repeater.

621.396.65.029.64 2919

Repeaters for the New York to Boston Radio Relay System—A. A. Roetken. (Bell Lab. Rec., vol. 26, pp. 193-198; May, 1948.) Each of the seven repeater stations has 4 repeaters, 2 for each direction of transmission. Si rectifiers are used to shift the signal band from 4000 Mc to an if band with mid-frequency at 65 Mc. After amplification at this frequency, a second varistor modulator is used to shift the frequency back to the microwave range. In the second modulation, an additional shift of 40 Mc is provided so that the signals sent out by the repeater are 40 Mc higher or lower than those received. Amplitude-variations are less than 0.1 db over the 10-Mc pass band and the total noise due to the complete system is barely discernible in a television picture. See also 1755 of July (Durkee).

621.396.65.029.64 2920

Terminals for the New York to Boston Radio Relay System—J. G. Chaffee. (Bell Lab. Rec., vol. 26, pp. 97-100; March, 1948.) Each repeater station is provided with equipment which converts received microwave signals to an if of 65 Mc, amplifies them and translates them back to microwaves for further transmission. At the terminals, television signals and multiplex telephone and other broadband signals are accepted; from these a modulated if wave is produced and then impressed on the microwave transmission. The necessary equipment is described and a block diagram given. See also 1755 of July (Durkee) and 1756 of July (J. M.).

621.396.65.029.64:621.397.743 2921

Two-Way TV Relay—W. H. Forster. (Tele-Tech, vol. 7, pp. 46-48; April, 1948.) A wide-band FM system between Philadelphia and New York. It operates in the 1295 to 1425-Mc band and requires a 20-Mc channel. The 84 miles are covered by 3 links with an over-all signal-to-noise ratio of 45 db. A block diagram of the transmitter, receiver, and repeater is given and their operation fully described. See also 1756 of July (J. M.).

621.396.712(44) 2922

Allouis OCIII Centre for Broadcasting on Decametre Waves—M. Matricon. (Onde Elec., vol. 28, pp. 121-128; April, 1948.) Details of a new station for world-wide communication, and of its equipment. The station should be in service before the end of 1948. Transmitting power will be not less than 100 kw on the shortest wavelength and will reach 150 kw for  $\lambda$  50 m. Operating frequencies, which are quartz controlled, range from 6 to 21 Mc. Twelve rhombic antennas are installed and are fed through a specially designed commutation system which permits various combinations of transmitter connections.

621.396.712(493) 2923

Speech-Input Equipment of Brussels Broadcasting House—F. Mortiaux. (Elec. Commun., vol. 24, pp. 415-427; December, 1947.) General description of the equipment, which includes 19 studios, 5 recording rooms, and the necessary communication, signaling and supervisory accessories.

621.396.712.3 2924

Enlarged WOAI/WOAI-FM Studio Technical Facilities—C. Jeffers. (Communications,

vol. 28, pp. 12-15, 36; March, 1948.) An account of the modifications of existing facilities and the new equipment rendered necessary for dual AM and FM operation when a FM transmitter was installed.

**621.396.931** 2925  
**The Development of a Radio Communication Network for the South African Railways—**G. D. Walker. (*Trans. S. Afr. Inst. Elec. Eng.*, vol. 39, part 2, pp. 54-58; February, 1948.) Author's reply to discussion on 2942 of 1947.

**621.396.932** 2926  
**Radio in the Merchant Marine—**J. J. Canavan. (*Electronics*, vol. 21, pp. 84-89; June, 1948.) A survey of ship communication equipment. Legal requirements and future developments are considered.

#### SUBSIDIARY APPARATUS

**621.3.013.783†:621.316.97** 2927  
**Screening at V.H.F.—**Roston. (*See* 2817.)

**621.314.653:621.316.722** 2928  
**Ignitrons in Broadcast Service—**H. E. Zuvers. (*Tele-Tech*, vol. 7, pp. 27-29, 70; April, 1948.) A combination of ignitor and grid control can be used to regulate rectifier output voltage and also to provide "circuit-breaker" action in the ignitrons themselves in case of a fault in the dc circuit. The general design of a high-voltage ignitron is described and illustrated, and diagrams of ignitron control circuits are given.

**621.316.722.1** 2929  
**Shunt Voltage Stabilizer—**J. McG. Sowerby. (*Wireless World*, vol. 54, pp. 200-203; June, 1948.) Design details for low internal resistance or high stabilization ratio. Bridge and feedback types are considered. See also 1691 of 1939 (Hunt and Hickman) and 2105 of 1939 (Neher and Pickering).

**621.316.722.1** 2930  
**A Negative-Current Voltage-Stabilization Circuit—**Peilin Luo. (*Proc. I.R.E.*, vol. 36, p. 583; May, 1948.) The circuit of a stabilizer using two triodes is analyzed. With this circuit, stabilization within 0.21 per cent was obtained; the corresponding value for a simpler conventional circuit was 7.5 per cent.

**621.317.755:778.3** 2931  
**An Oscilloscope Camera—**H. E. Hale and H. P. Mansberg. (*Electronics*, vol. 21, pp. 102-107; June, 1948.) Continuous records of cro patterns are made on film or paper at speeds from 1 inch per minute to 5 ft per sec, using electronic motor control.

**621.352.1:536.48/.49** 2932  
**Operation of Lead-Acid Batteries under Extreme Climatic Conditions—**W. Lever. (*Elec. Times*, vol. 113, pp. 329-331; March 18, 1948.) At 0°F the effective capacity is reduced by as much as 50 per cent of that at 75 to 80°F; there is a serious risk of freezing of the acid when the battery is discharged; charging is inefficient, on account of higher internal resistance. At high temperatures—above 90°F—serious sulphation may occur with acid of customary specific gravity, so that the working specific gravity must be reduced. Self-discharge rates are also greatly increased.

**621.352.7** 2933  
**Correlations of the Gel Strength of Paste Walls and the Shelf Life of Electric Dry Cells—**W. J. Hamer. (*Jour. Res. Nat. Bur. Stand.*, vol. 40, pp. 251-262; March, 1948.)

**621.396.68:621.316.722.1** 2934  
**A Note on Stabilising Power Supplies—**E. J. Harris. (*Electronic Eng. (London)*, vol. 20, pp. 96-97; March, 1948.) The Miller circuit uses two double triodes to mix and amplify fractions of the input and output voltages. Both these functions are here performed by a single hexode.

**621.396.68:621.397.6** 2935  
**Television E.H.T. [extra high voltage] Supply—**A. H. B. Walker. (*Wireless World*, vol. 54, p. 215; June, 1948.) Corrections to 2390 of September.

**TELEVISION AND PHOTOTELEGRAPHY**  
**621.397:621.383** 2936  
**Facsimile Modulator Tube—**Shonnard. (*See* 2961.)

**621.397.331.2:621.385.832** 2937  
**New Viewing Tube for Color TV—**A. Bronwell. (*Tele-Tech*, vol. 7, pp. 40-41, 65; March, 1948.) The "Chromoscope" cathode-ray tube contains a single electron gun and a specially designed color image screen having four parallel semitransparent screens which are electrically insulated from each other so as to permit independent control of the screen potentials. The screen nearest the gun is relatively transparent to light and electrons and is given a constant high positive potential, while the other three are coated with phosphors corresponding to the primary colors and are constructed so that one-third of the available electrons strike each screen. Fluorescence occurs on any one color screen while the others are extinguished if a high positive potential is applied to the screen which is to fluoresce and a low potential to the other two. To obtain a three-color picture, it is merely necessary to apply a high positive potential in turn to the three color screens.

Observer parallax errors exist, since the three color screens cannot coincide, but these errors would not be apparent in a projection type of television system.

As electronic switching can be used, the color interval may be made very small and synchronized with the line sweep frequency. This suppresses the two objectionable characteristics of color systems known as color flicker and color break-up. For another account see *Electronic Eng. (London)*, vol. 20, pp. 190-191; June, 1948.

**621.397.335** 2938  
**Television Field Equipment—**J. R. Smith. (*FM and Telev.*, vol. 7, pp. 30-32; December, 1947.) A synchronizing generator is described which provides all the timing impulses required to operate one or more television cameras; viz., horizontal and vertical driving signals, and synchronizing and blanking signals.

**621.397.5** 2939  
**Television D.C. Component—**K. R. Wendt. (*RCA Rev.*, vol. 9, pp. 85-111; March, 1948.) A general survey, with reference to transmitter and receiver applications. The relative merits of various restorer circuits are considered. The design of equipment for receiving the signal with the dc component present is also discussed.

**621.397.5** 2940  
**Electro-Optical Characteristics of Television Systems: Introduction and Part 1—**O. H. Schade. (*RCA Rev.*, vol. 9, pp. 5-37; March, 1948.) A general review and broad methods of analysis, with discussion of vision and visual systems.

**621.397.5:535.88** 2941  
**Large-Screen Television Projector of the Compagnie des Compteurs—**P. Mandel. (*Bull. Soc. Franc. Elec.*, vol. 8, pp. 191-200; April, 1948.) Details are first given of the high-frequency receiver and video amplifier. The projection cathode-ray tube uses a maximum voltage of 80 kv and has a mean beam current of 0.5 ma and maximum 2 ma. A special powder is used for the coating of the 20-cm screen. The image is finally projected on a screen made up of a very large number of tiny concave mirrors, whose dimensions are appreciably less than those of an element of a 450-line image. The surface of the screen is concave, the radius being 9 m; the image size is 3 m×2.25 m.

**621.397.5:535.88** 2942  
**Big Picture Practices—**(*Tele-Tech*, vol. 7, pp. 30-35, 67; March, 1948.) A survey of large-size television picture display systems in America, ranging from large direct-viewing cathode-ray tubes in metal tubes to optical projection systems and lens magnifiers. No one method seems superior to the others.

**621.397.5:535.88** 2943  
**New Projection Package for Television—**L. J. A. van Lieshout. (*Tele-Tech*, vol. 7, pp. 30-35, 56; April, 1948.) A folded adaptation of the Schmidt optical system, designed to fit into cabinets of various sizes. A sealed transformer unit using a ferroxcube core provides a 25-kv second-anode supply for the MW-6 projection tube.

**621.397.5:791.9** 2944  
**Theater Television—a General Analysis—**A. N. Goldsmith. (*Jour. Soc. Mot. Pic. Eng.*, vol. 50, pp. 95-117; February, 1948. Discussion, pp. 118-121.) A descriptive report of the present partly developed state of the art, with discussion of possible future trends.

**621.397.6** 2945  
**Film Pickup System—**H. R. Smith and G. S. Gregory. (*FM and Telev.*, vol. 8, pp. 31-33, 49; March, 1948.) Discussion of equipment for converting pictures obtained from slides or films into the form required for the program mixing facilities of standard television stations. The equipment consists of an iconoscope scanning unit, control desk, and associated power units. Provision is made for the inversion of black and white so that negatives can be used as originals. Special care has been taken to provide easy access for servicing and testing.

**621.397.6:621.385.832** 2946  
**Barrier Grid Storage Tube and Its Operation—**Jensen, Smith, Mesner, and Flory. (*See* 2986.)

**621.397.6:621.396.68** 2947  
**Television E.H.T. [extra high voltage] Supply—**A. H. B. Walker. (*Wireless World*, vol. 54, p. 215; June, 1948.) Corrections to 2390 of September.

**621.397.61** 2948  
**TV Transmitter Design—**G. E. Hamilton. (*Communications*, vol. 28, pp. 12-15, 30; May, 1948.) Discussion of design trends, with special consideration of video amplifier and modulator requirements, and modulated amplifier and Class-B linear amplifier stages. The operation of dc restorer circuits is also analyzed.

**621.397.61-182.3** 2949  
**How WABD Handles Remotes—**O. Freeman. (*Tele-Tech*, vol. 7, pp. 42-45, 85; March, 1948.) Description of apparatus and operational procedure for televising sporting and other special events. See also 3685 of 1947.

**621.397.62:621.385.1** 2950  
**Radio-Frequency Performance of Some Receiving Tubes in Television Circuits—**Cohen. (*See* 2971.)

**621.397.645:621.397.62** 2951  
**Selectivity in Television Amplifiers: Problems of Sound-Channel Rejection—**W. T. Cocking. (*Wireless World*, vol. 54, pp. 204-207; June, 1948.) To accept the full radiated bandwidth of  $\pm 3$  Mc the response curve must have a cutoff slope of at least 54 db per Mc on the side nearest the sound channel. Single-sideband working and the relative merits of superheterodyne and straight reception are discussed.

**621.397.743:621.396.65.029.64** 2952  
**Two-Way TV Relay—**Forster. (*See* 2921.)

#### TRANSMISSION

**621.316.726.078.3:538.569.4** 2953  
**Frequency Stabilization with Microwave Spectral Lines—**W. D. Hershberger and L. E. Norton. (*RCA Rev.*, vol. 9, pp. 38-49; March,

1948.) IRE 1948 National Convention paper. Absorption lines of gases at reduced pressure exhibit  $Q$  values of 100,000 in the 24,000-Mc range, and the center frequency is unaffected by pressure and temperature. Stabilization of a K-band klystron has been effected, using the 23,870.1-Mc line of ammonia contained in a short section of mismatched waveguide, both at the center frequency of the line itself and at frequencies removed from the line frequency by a controlled intermediate frequency. Indications are that the frequency stability attained compares favorably with that of quartz crystals but with the added advantages that arise from the inherent stability of spectral lines. Applications to a wide range of frequencies in the microwave range, and to a clock of high precision, are indicated.

621.396.61 2954  
**The Mighty Midget [transmitter]**—H. L. Apple. (*CQ*, vol. 4, pp. 27-30; March, 1948.) Construction, circuit, and operation details of a 35-w fixed or portable transmitter weighing only  $3\frac{1}{2}$  lb, and with over-all measurements  $3\frac{1}{2}$  inches by 5 inches by  $5\frac{1}{2}$  inches. Only standard full-size components are used.

621.396.61:621.396.41 2955  
**Medium-Power Multichannel Communication Transmitters**—B. T. Ellis. (*Elec. Commun.*, vol. 24, pp. 433-435; December, 1947.) A brief description of fractional-kilowatt transmitters for continuous service. Separate rf units are used with a common power supply and modulator to provide alternative frequency channels. Six units may be accommodated, giving three frequency bands, 200 to 540 kc, 2 to 20 Mc, and 108 to 140 Mc, on each of which two channels may be used simultaneously, provided that they are not both used for telephony.

621.396.61:621.396.712 2956  
**20-kW Broadcasting Transmitters Type TH1392**—C. Beurtheret. (*Rev. Tech. Comp.* (Franç.), pp. 41-49; April, 1948. In French.) Description, with illustrations of particular sections, of a "Monobloc" transmitter for the range 550 to 1560 kc. Within the useful modulation range of the transmitter, harmonic distortion is of the order of 1 per cent for all fundamentals from 30 to 5000 cps. Background noise is 70 db below the maximum level of modulation.

621.396.61.029.62 2957  
**Engineering a 50-kW F.M. Transmitter**—C. J. Starner. (*Tele-Tech*, vol. 7, pp. 42-45, 72; April, 1948.) Discussion of tube and circuit design developments to secure efficient operation in the range 88 to 108 Mc. Grounded-grid circuits are used with air-cooled external-anode triodes Type 7C24 and Type 5592. The exciter unit includes all the frequency-generating, modulating, and frequency-multiplying circuits of the transmitter, except the final doubler. Center-frequency stability is maintained automatically to within 1 kc by comparing a subharmonic of the modulated signal with a standard crystal-controlled frequency, using the frequency difference to operate a correcting device.

621.396.619.23 2958  
**Reducing F.M. Band-Width**—A. G. Chambers. (*Wireless World*, vol. 54, pp. 221-222; June, 1948.) Discussion and circuit diagram of a crystal-controlled reactance modulator unit.

#### VACUUM TUBES AND THERMIONICS

621.383 2959  
**The Structure of Photo-Sensitive Lead Sulphide and Lead Selenide Deposits and the Effect of Sensitization by Oxygen**—H. Wilman. (*Proc. Phys. Soc.*, vol. 60, pp. 117-132; February 1, 1948.) An investigation, by electron diffraction and photoconductivity experiments of the structure of these deposits, prepared by chemical deposition and by sublimation in vacuo or in oxygen. The PbS and PbSe crystals were found to have a lattice axial dimension which was constant to 0.1 per cent in all sam-

ples measured, even in strongly oxidized products. Oxygen treatments increase the sensitivity of PbS to wavelengths of 1 to  $3\mu$ , but do not do so for PbSe.

621.383:535.247.4 2960  
**Concerning the Local Variations of Sensitivity in Photocells**—N. Laycock and G. T. Winch. (*Compt. Rend. Acad. Sci.* (Paris), vol. 226, p. 1445; May 3, 1948.) KMV6 and RMV6 photo cells can be used for high-precision photometry in spite of the sensitivity variations observed by Terrien, Anglade, and Touvy (1814 of July), provided that the measured light is distributed always in the same manner on the cell cathode. The construction of these photo cells has recently been modified to reduce local sensitivity variations.

621.383:621.397 2961  
**Facsimile Modulator Tube**—J. R. Shonard. (*Electronics*, vol. 21, pp. 82-83; June, 1948.) A new type of photo cell with simplified bridge modulator that enables light from the facsimile scanner to produce the modulation directly without generating frequencies that must be eliminated by costly filters. The cell has two flat cathodes which act alternately as cathode and anode. High resolution is obtained, and the output range is more than sufficient for average transmission channels.

621.385.029.63/64 2962  
**The Theory of the Traveling-Wave Tube**—O. E. H. Rydbeck. (*Ericsson Tech.*, no. 46, 18 pp.; 1948. In English.) The small-signal theory is developed in detail. The variation of the amplification range of the beam velocity with beam current ( $J$ ) and diameter is discussed. For small beam currents, the gain of the amplified wave component varies as  $J^{1/2}$ , but, in general, this gain varies as  $J^{1/4}$  and is also proportional to the voltage bandwidth. The characteristic impedances of the helix waves are deduced and the total helix output voltage is computed for a particular case as a function of beam velocity. Interaction between the components of the helix waves produces an output-voltage versus beam-velocity curve with a very characteristic shape. This has been proved experimentally. A typical cro record of such a curve is reproduced. This curve was obtained for  $\lambda \approx 3$  cm with one of the traveling-wave tubes developed at the Massachusetts Research Laboratory of Electronics.

621.385.1 2963  
**Anode Current, Noise Factor, and Current Modulation of a Valve with a Nonlinear Characteristic in Class A, B, and C Operation**—H. Kanberg. (*Funk und Ton*, vol. 2, pp. 140-149, 193-207, and 227-243; March to May, 1948.) A comprehensive mathematical treatment. The amplitudes of all harmonics up to the fifth are calculated for various characteristics defined by different values of  $m$  in the formula  $I_a = KV^m$ , where  $I_a$  is the anode current and  $V$  the effective control voltage. The results are presented graphically and discussed; curves are also given for the anode-current noise factor.

621.385.1 2964  
**Reflections in Electron Tubes**—J. L. H. Jonker. (*Philips Res. Rep.*, vol. 2, pp. 331-339; October, 1947.) The effect of reflected electrons on the electric field between the electrodes is deduced from observations at low potentials. Irregularities in some tube characteristics are thus explained.

621.385.1 2965  
**Special Valves**—M. Alixant. (*Radio Tech. Dig.* (Franç.), vol. 2, pp. 95-103; April, 1948.) Operational data for a wide range of tubes particularly suitable for television, including also cathode-ray tubes, Ge and Si rectifiers, and stabilizers.

621.385.1 2966  
**Rugged Electron Tubes**—I. L. Cherrick. (*Electronics*, vol. 21, pp. 111-113; April, 1948.)

Discussion of: (a) the United States Joint Army and Navy Electron Tube Specifications for electrical and mechanical stresses that tubes must withstand, (b) an "impact machine" for testing tubes, (c) structural alterations required in Types 6L6GA, 6AC7, 2050, 6H6GT and 6AL5, (d) reduction of heater failure by using helical coil heaters, (e) the use of more rugged clips and stops.

621.385.1 2967  
**Modern Transmitting Valves under Different Operating Conditions**—F. Jenny. (*Brown Boveri Rev.*, vol. 34, pp. 139-142; June and July, 1947.) A brief general survey of properties and modes of operation. Characteristics of the ATL and ATW series of tubes, with anode dissipation up to 50 kw, are tabulated.

621.385.1 2968  
**Table of the Characteristics of New European Valves**—(*Radio Franç.*, pp. 16-17; March, 1948.) Details of the following: triode-hexode frequency changer, UCH41; high-frequency pentode with variable slope, UF41; single diode-pentode with variable slope, UAF41; output pentode, UL41; half-wave rectifiers, UY41 and UY42.

621.385.1:519.2 2969  
**Notes on the Exponential Distribution in Statistics [of valve life]**—Lewis. (*See* 2836.)

621.385.1:537.291 2970  
**The Excitation of Resonance Circuits by Electron Streams in the Transit-Time Region**—F. W. Gundlach. (*Arch. Elek. Übertragung*, vol. 1., pp. 173-183; November and December, 1947.) A method is described for determining the magnitude of the active and wattless currents arising from the excitation of oscillations in a resonator by the action of periodic electron streams. The intensity and velocity of the streams across the excitation space can depend in any way whatever on the time. Curves are provided to simplify calculation for all commonly occurring cases, including retarding-field excitation.

621.385.1:621.397.62 2971  
**Radio-Frequency Performance of Some Receiving Tubes in Television Circuits**—R. M. Cohen. (*RCA Rev.*, vol. 9, pp. 136-148; March, 1948.) Measurements of over-all gain, noise, image rejection, and oscillator frequency stability were made on a number of tubes used in the rf amplifiers, mixers, and local oscillators of television receivers. Both push-pull and unbalanced circuits are discussed. Measurements were made in the frequency bands 66 to 72 Mc and 198 to 204 Mc.

621.385.1.012.3:621.316.722 2972  
**Circuit Design for Gas-Discharge Regulator Tubes**—W. G. Hoyle. (*Tele-Tech*, vol. 7, pp. 46-47, 72; February, 1948.) Graphical methods for determining circuit parameters to ensure that tubes are operated within their normal ratings.

621.385.1.032.216 2973  
**Variation of the Spectral Emissive Power of Oxide Cathodes as a Function of Various Factors**—R. Champeix. (*Compt. Rend. Acad. Sci.* (Paris), vol. 226, pp. 1256-1257; April 19, 1948.) Experiments show that the emissive power ( $\epsilon_x$ ) decreases as the thickness of the oxide layer increases. For thin layers  $\epsilon_x$  may be 0.35, dropping to 0.05 for thick layers. For layers of the thickness normally used in small tubes, about 60 to 70  $\mu$ ,  $\epsilon_x$  is about 0.2 but varies between 0.1 and 0.3. The spectral emissive power of Ni increases rapidly with temperature, but that of oxide cathodes is little affected by temperature or activation.  $\epsilon_x$  is slightly lower after activation. See also 1010 of May (Champeix).

621.385.032.216 2974  
**Thermionic Emission from Oxide-Coated Cathodes**—F. A. Vick. (*Jour. Sci. Instr.*, vol. 25, pp. 56-60; February, 1948.) A report of the

London Summer Meeting of the Electronics Group of the Institute of Physics, June 14, 1947, at which papers describing recent work on the subject were discussed. The use of oxide cathodes for pulse work has led to speculation on the mechanism by which peak saturated current can be many times the normal saturated current at the same temperature. X-ray study of the structure of oxide cathodes shows that during life the surface layers become nearly pure SrO and rectifying barrier-layer compounds are formed at the core oxide boundary. The resistance of this latter layer has been measured and the potential difference across it at high currents could limit the emission available from the cathode. For a shorter account of the meeting see *Nature* (London, vol. 160, pp. 725-726; November 22, 1947.)

621.385.15 2975

**Electron Multiplier Tube of Large Effective Cathode Surface Area**—P. S. Faragó. (*Nature* (London), vol. 161, p. 60; January 10, 1948.) The effective area is increased by the use of an electrostatic lens to project the electron-optical image of a large-surface cathode on the first multiplying electrode of an ordinary multiplier tube.

621.385.2 2976

**Extension and Application of Langmuir's Calculations on a Plane Diode with Maxwellian Velocity Distribution of the Electrons**—A. van der Ziel. (*Philips Res. Rep.*, vol. 1, pp. 97-118; January, 1946.) Langmuir's differential equation for the potential distribution between cathode and anode is extended to the saturated and exponential regions of the characteristic. Formulas are derived relating the transconductance of a diode to the anode voltage and current and to the cathode temperature. The quantity  $C/C_0$  is also calculated for a triode, where  $C$  is the equivalent ac grid capacitance under operating conditions and  $C_0$  the capacitance when cold. Exact calculation is somewhat difficult, but approximate calculation is greatly simplified by making certain assumptions.

621.385.2 2977

**Extension of Langmuir's ( $\xi$ ,  $\eta$ ) Tables for a Plane Diode with a Maxwellian Distribution of the Electrons**—P. H. J. A. Kleynen. (*Philips Res. Rep.*, vol. 1, pp. 81-96; January, 1946.) Langmuir's tables have been extended by graphical interpolation and by calculation. Graphs show (a) the value of the potential minimum as a function of anode current at different cathode temperatures, (b) the distance  $d_m$  of this minimum from the cathode as a function of anode current at a cathode temperature of 700°C for different values of the saturation current. A table is given whereby similar curves for  $d_m$  for other temperatures can be calculated. Examples illustrate the use of the ( $\xi$ ,  $\eta$ ) tables. See also 2976 above.

621.385.3 2978

**Dimensional Analysis Applied to Very-High-Frequency Triodes**—G. Lehmann. (*Elec. Commun.*, vol. 24, pp. 391-408; September, 1947.) English version of 3821 of 1946.

621.385.3 2979

**The Dyotron Microwave Oscillator**—(*Communications*, vol. 28, pp. 24-25; May, 1948.) Summary of IRE 1948 National Convention paper by E. D. McArthur noted in 2664 of October. A new type of uhf tube, which is unusually stable, has a very wide tuning range and can be used in local oscillators. A 70-pF capacitor connects grid and cathode inside the tube, which otherwise is similar to the 2C39 triode. Experiments are described in which a single coaxial cavity with a piston tuner is used; a continuous tuning range of 370 to 3700 Mc is obtained.

621.385.3 2980

**A.C. Operated Triodes**—A. Grainge. (*Elec.*

*ronic Eng.*, vol. 20, pp. 178-180; June, 1948.) A graphical method for predicting the operating conditions of a triode which derives anode voltage from ac mains. The method is used to design a sensitive relay for the indirect control of a 2-kw load.

621.385.4.029.62/.63 2981

**500-Mc Transmitting Tetrode Design Considerations**—W. G. Wagener. (*Proc. I.R.E.*, vol. 36, pp. 611-619; May, 1948.) IRE 1947 National Convention paper. Discussion of characteristics of a power amplifier for the 30 to 500-Mc band and of the relative merits of triodes and tetrodes in this range. For tetrodes, self-neutralization occurs at a particular frequency, which can be adjusted by external circuit arrangements. Tetrodes are preferred to neutralized triodes, chiefly on the ground of greater stability. Two new transmitting tetrodes are described.

621.385.5:621.395.92 2982

**Hivac Miniature Valves**—O. P. Herrnkind. (*Funk und Ton*, vol. 2, pp. 254-259; May, 1948.) Data and characteristics of XWO 75A and B pentodes for initial stages and of XYI 4A, B and C output pentodes. These tubes are particularly suitable for use in hearing aids, on account of their small size and low current consumption.

621.385.832 2983

**An Image Storage Tube**—(*Electronics*, vol. 21, pp. 132, 134; May, 1948.) Extract from *Air Technical Intelligence. Tech. Data Digest*, p. 11; July 1, 1947. Description of the Krawinkel storage tube developed in Germany. The writing beam charges up a storage plate of small capacitors which can remain charged for three weeks. The storage surface may be scanned and an image projected on to a fluorescent screen. Leakage is minimized by incorporating in the tube a triode with a getter-coated anode, to maintain a high vacuum.

621.385.832:535.767 2984

**Stereoscopic Viewing of Cathode-Ray Tube Presentations**—H. A. Iams, R. L. Burtner, and C. H. Chandler. (*RCA Rev.*, vol. 9, pp. 149-158; March, 1948.) Discussion of: (a) two methods of presenting 3-dimensional information on cathode-ray tubes, with examples of oscillograms and radar presentations in 3 dimensions, (b) the effect of flicker on stereoscopic viewing, and (c) possible applications.

621.385.832:621.396.96 2985

**The Visibility of Signals on Radar Range Presentations**—E. R. Andrew. (*Jour. IEE* (London), part IIIA, vol. 93, no. 10, pp. 1559-1563; 1946.) An investigation of the dependence of the minimum detectable signal on parameters of the equipment, such as pulse length, bandwidth, timebase speed, and brightness of the oscilloscope trace.

621.385.832:621.397.6 2986

**Barrier Grid Storage Tube and Its Operation**—A. S. Jensen, J. P. Smith, M. H. Mesner, and L. E. Flory. (*RCA Rev.*, vol. 9, pp. 112-135; March, 1948.) Two cathode-ray tubes, one with electromotive and one with electrostatic focusing and deflection systems, have been designed for storing video signals electrostatically on an insulating screen. Methods of measurement of the tube characteristics are described and the theory of operation is discussed. After storage times of up to 100 hours, there was no evidence of distortion or decay.

621.396.615.141.2 2987

**Low-Power Resonant-Segment Magnetrons for Centimetre Waves**—J. C. Dix and E. C. S. Megaw. (*Jour. IEE* (London), part IIIA, vol. 93, no. 10, pp. 1585-1592; 1946.) The development and use of a range of small glass magnetrons having anode systems consisting of a number of interleaved segments. Characteristics of Types E1210, CV79, and CV89 are

given, together with descriptions of the associated circuits. Methods of modulation, particularly pulse-width modulation, are also discussed.

621.396.615.142.2 2988

**Multifrequency Bunching in Reflex Klystrons**—W. H. Huggins. (*Proc. I.R.E.*, vol. 36, pp. 624-630; May, 1948.) Webster's simple bunching theory is extended to include simultaneous oscillations in a reflex klystron at two or more frequencies. General expressions for the power and electronic admittance are derived that show the intermodulation effects of the oscillations upon each other.

621.314.63 2989

**Crystal Rectifiers [Book Review]**—H. C. Torrey and C. A. Whitmer (Eds.). McGraw-Hill, New York, N. Y., 1948, 443 pp., \$7.50. (*Electronics*, vol. 21, pp. 248, 250; June, 1948.) Vol. 15 of the MIT Radiation Laboratory series. The object is "to present the fund of knowledge on crystal rectifiers that accumulated during the course of World War II."

#### MISCELLANEOUS

621.3 2990

**Electrical Research**—(*Engineer* (London), vol. 185, p. 182; February 20, 1948.) A report of some of the activities of the British Electrical and Allied Industries Research Association during 1947.

621.3 (083.74) 2991

**Standard Terms and Abbreviations**—H. Jefferson and A. L. Meyers. (*Wireless Eng.*, vol. 25, p. 236; July, 1948.) Comment on 2426 to 2428 of September

621.38:519.283 2992

**Statistical Methods in the Design and Development of Electronic Systems**—L. S. Schwartz. (*Proc. I.R.E.*, vol. 36, pp. 664-670; May, 1948.) IRE 1948 National Convention paper.

621.395 2993

**Progress of Telecommunication Services in British Post Office**—(*Elec. Commun.*, vol. 24, pp. 300-309; September, 1947.) A general review of the British telephone service with brief reference to overseas radio links and ship-to-shore radiotelephone systems.

621.396 2994

**Radio Progress during 1947**—(*Proc. I.R.E.*, vol. 36, pp. 522-550; April, 1948.) This summary for 1947 covers generally, for the subjects dealt with, developments described in publications issued up to about the first of November. The material has been prepared by members of the 1947 Annual Review Committee of the Institute, with editing and co-ordinating by the Chairman. A bibliography of 689 references arranged under broad subject headings is given.

621.39 2995

**The Fundamental Research Problems of Telecommunications [Book Notice]**—Department of Scientific and Industrial Research, H. M. Stationery Office, London, March, 1948, 80 pp., 1s. 6d. (*Govt. Publ.* (London) p. 16; April, 1948.) Comprises the reports of the nine working parties set up by the Telecommunications Research Committee (chairman: Sir Stanley Angwin).

621.396(075.8) 2996

**Radio Engineering [Book Review]**—F. E. Terman. McGraw-Hill, New York, N. Y., and London, 3rd edition 1947, 969 pp., \$7.00. (*Proc. I.R.E.*, vol. 36, pp. 511-512; April, 1948.) The co-ordination and combination with older material of developments in radio engineering in the last ten years has been so accomplished that "the whole is incorporated within the covers of a single volume suitable for classroom use of engineering seniors." Fundamental principles are emphasized throughout.

D E P E N D A B I L I T Y

... can reduce your costs!

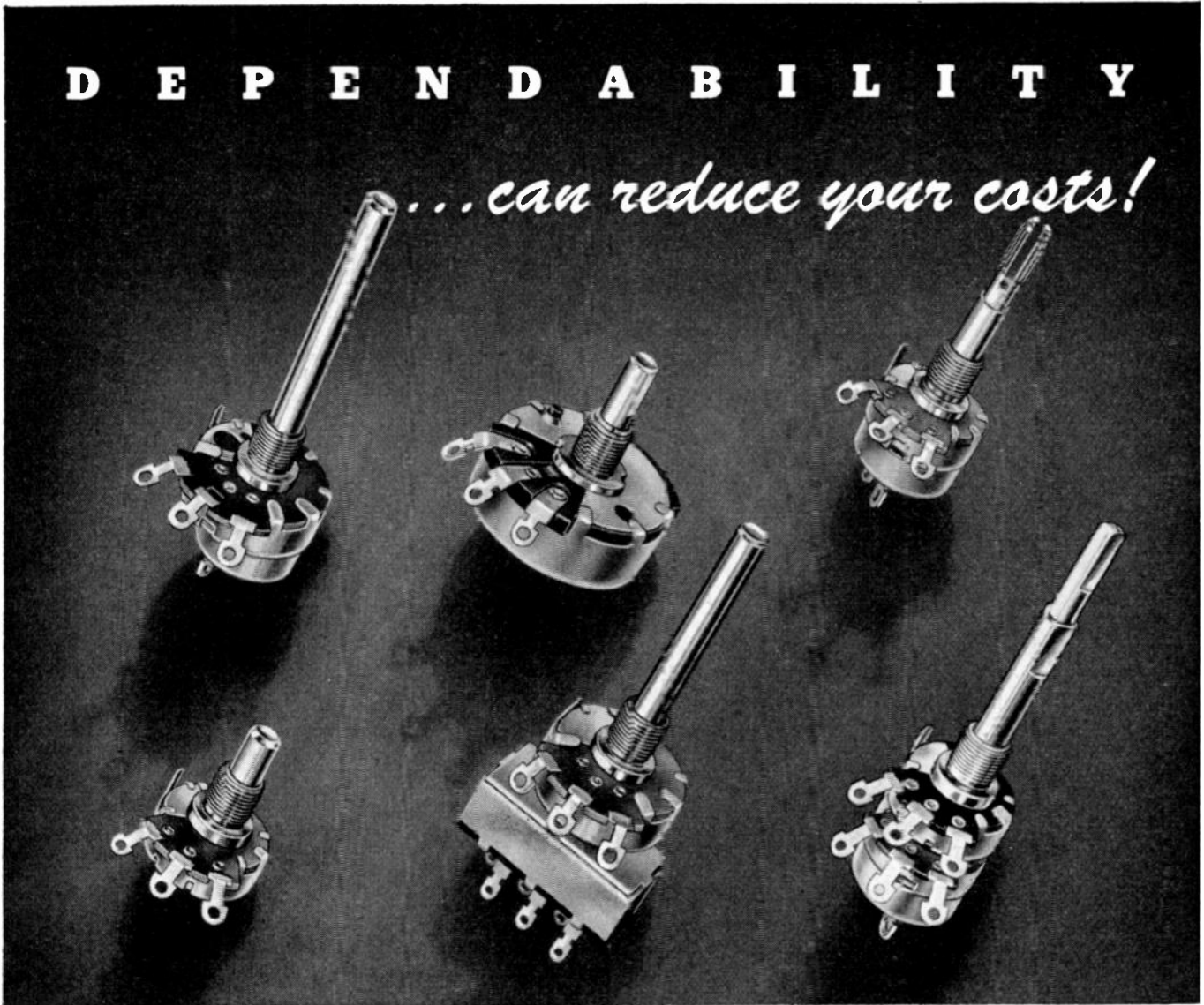

You can *depend* on Stackpole controls. Carefully supervised production means that you can depend on each unit to operate satisfactorily after it has been soldered into the circuit—and Stackpole facilities are such that you can depend, too, on *quantity deliveries* to meet *your* needs.

In both fixed and variable resistors, Stackpole is a major supplier to an im-

portant segment of the radio and electronic industries. If you are not already checking Stackpole regularly as your production releases and design requirements come up, we welcome the opportunity to cooperate on your next assignment. Write for Stackpole Control Engineering Bulletin RC-7D. The Complete Stackpole Electronic Components Catalog is also available on request.

STACKPOLE CARBON COMPANY • ST. MARYS, PA.

# STACKPOLE

RESISTORS • CONTROLS • SWITCHES • IRON CORES

# NEW SHURE "900MG"

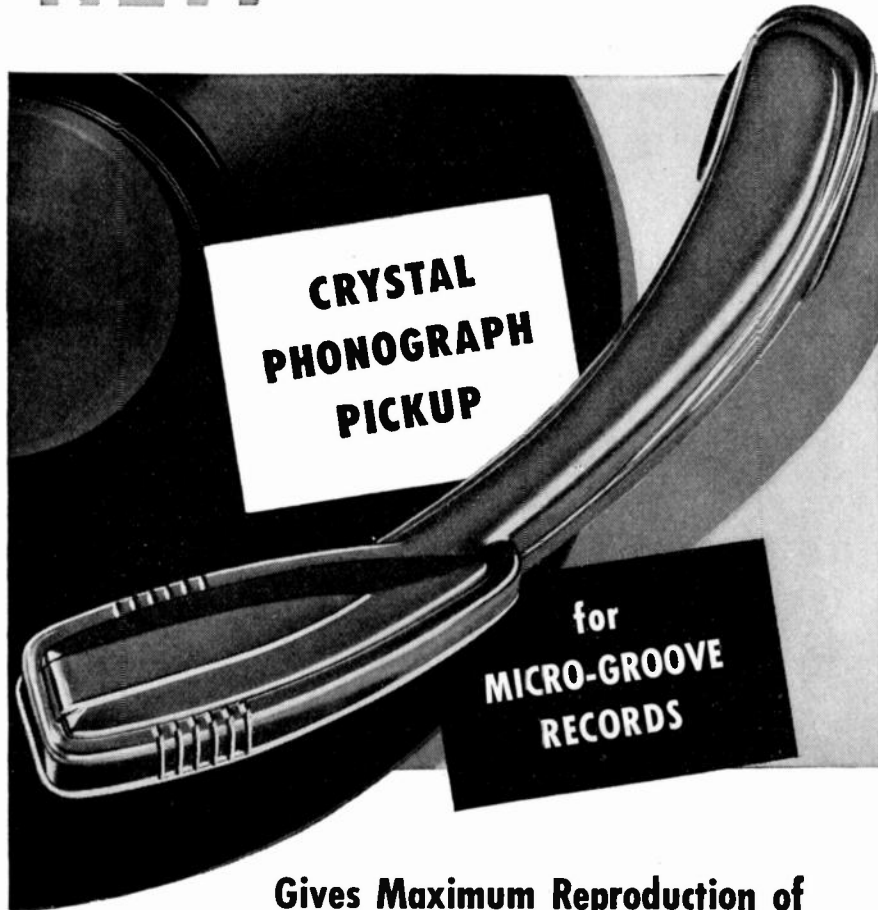

## Gives Maximum Reproduction of Micro-Groove Record Fidelity

The Shure "900MG" Pickup is an ideal instrument for tracking on the new micro-groove records. It tracks at 6 grams . . . uses a special offset osmium-tipped needle with a point radius of only .001" . . . and has an output of 1 volt! The Shure lever system has been adapted in the development of this new pickup—providing a high needle compliance. Listen to it—you will be thrilled with the results!

**Model "900MG"**

**Code: RUZUZ**

Shure Patents Issued and Pending. Licensed under the Patents of the Brush Development Co.



## SHURE BROTHERS, Inc.

*Microphones and Acoustic Devices*

225 W. HURON ST., CHICAGO 10, ILL. • CABLE ADDRESS: SHUREMICRO



### BUENOS AIRES

"Radar—Its Applications to Marine Service," by A. H. Cassiet, Argentine Navy; July 23, 1948.

"Television—Considerations on Transmitters—Agreements of Latest Television Congresses," by R. Barthélemy, Academy of Sciences (Paris); August 16, 1948.

"Measurements on Broadcast Antennas Installations—Radiation Patterns," by L. M. Malvárez, Standard Electric Argentina, August 20, 1948.

"Microwave Multiplex Transmission," by C. Baumann, Radio Corporation of America, Victor Division (Argentina); September 10, 1948.

### CEDAR RAPIDS

"Stereophonic Sound for the Home," by M. Camras, Armour Research Foundation; September 15, 1948.

### CONNECTICUT VALLEY

"Modern Loran Radio Station Equipment," by E. B. Redington, United States Coast Guard Training Station; September 16, 1948.

### DALLAS-FORT WORTH

"Radio Communications System of the KATY Railroad," by H. Kratiger, KATY Railroad; August 5, 1948.

### DAYTON

"Microwave Communications," by J. W. McRae, Bell Telephone Laboratories; September 15, 1948.

### LOS ANGELES

"Instruments for Cosmic Ray Research," by W. C. Roesch, California Institute of Technology; August 17, 1948.

"The Role of Ionization Chamber, and DC Amplifier Meters in Radiation Hazard Control," by E. Molloy, National Technical Laboratories; August 17, 1948.

### NEW MEXICO

"Thunderstorms," by E. J. Workman, New Mexico School of Mines; August 27, 1948.

"Upper Atmosphere Temperatures from Remote Sound Measurements," by E. F. Cox, Sandia Laboratory; September 24, 1948.

### NEW YORK

"A New Long Playing Disc Recording System," by P. C. Goldmark, Columbia Broadcasting System; September 8, 1948.

### PITTSBURGH

"Recent Developments in Television Receiver Design," by F. S. Kornetz, Westinghouse Electric Corporation; September 13, 1948.

### PORTLAND

"Equipment Requirements for Television Broadcast Stations," by R. J. Newman, Radio Corporation of America; September 2, 1948.

### SAN DIEGO

"Factors in Television Receiver Design," C. F. Able and B. A. Penners, Western Communications Company and Consolidated Vultee Aircraft Company, respectively; September 7, 1948.

### TORONTO

"C.B.C. International Broadcasting Service," by R. D. Calhoun, International Broadcasting Service, C.B.C.; April 5, 1948.

"Antenna Models," by G. Sinclair, University of Toronto; April 1948.

Election of Officers; April 19, 1948.

### SUBSECTIONS

#### HAMILTON SUBSECTION

"Some Aspects of Design of Panel Meters," by J. R. Bach, Bach-Simpson, Ltd.; April 16, 1948.

Election of Officers; April 16, 1948.

"Construction and Characteristics of Fixed Capacitors," by J. H. Pickett, Aerovox Canada, Ltd.; May 17, 1948.



# Ultra Sensitivity

IN  
PORTABLE FORM



MODEL  
622

(Scale length 6.1 in.)

Designed for a wide variety of laboratory measurements, especially those where high sensitivity and a long scale arc are required. Electrostatically and magnetically shielded, Model 622 is ideally suited for precise measurements of potential and current at the very low energy levels frequently encountered in nuclear physics, electronics and electro-chemical research. Microammeters, milliammeters, millivoltmeters and voltmeters are available in single and multi-range D-C types; milliammeters and voltmeters in thermo and rectifier types for RF and A-C.

Complete information on Model 622 is available from your nearest WESTON representative, or by writing . . . WESTON Electrical Instrument Corporation, 589 Frelinghuysen Avenue, Newark 5, N. J.

## WESTON

## *Instruments*

ALBANY · ATLANTA · BOSTON · BUFFALO · CHARLOTTE · CHICAGO · CINCINNATI · CLEVELAND · DALLAS · DENVER · DETROIT · HOUSTON · JACKSONVILLE · KNOXVILLE · LITTLE ROCK · LOS ANGELES · MERIDEN · MINNEAPOLIS · NEWARK  
NEW ORLEANS · NEW YORK · PHILADELPHIA · PHOENIX · PITTSBURGH · ROCHESTER · SAN FRANCISCO · SEATTLE · ST. LOUIS · SYRACUSE · TULSA · IN CANADA, NORTHERN ELECTRIC CO., LTD., POWERLITE DEVICES, LTD.



.. as putting the cap on your fountain pen .. you  
change Cartridges in Astatic's FL-33 PICKUP to  
78 RPM RECORDS

No tools needed ..  
No changing of needle pressure  
.. Nothing else to do!

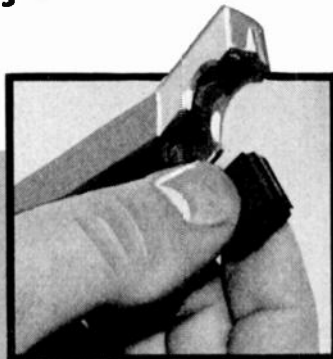

**U**NPARALLELED quality of reproduction of Columbia Microgroove Records is not the only advantage of Astatic's FL-33 Pickup. This new achievement of Astatic precision manufacture offers superior utility and convenience as well. Produced to Columbia's own specifications, its LP-33 Crystal Cartridge is easily, instantly replaceable with the new LP-78 Cartridge for playing conventional 78 RPM Records. No tools are needed, no adjusting of needle pressure, there is nothing else to be done. Identical in appearance, the cartridges are designed for insertion in the FL Arm on the same slip-in principle with which the modern fountain pen secures itself in its cap. The LP-78 Cartridge has a permanent sapphire needle with .003-inch tip radius, as compared with the .001-inch tip of the LP-33. Check the accompanying detailed features. Write for further information.

**FEATURES  
OF  
ASTATIC'S  
FL - 33  
PICKUP**

1. Five-Gram Needle Pressure.
2. Permanent Sapphire Needle with .001" Tip Radius.
3. Approximately One-Half Volt Output.
4. Frequency Range 30 to 10,000 c. p. s.
5. Novel Design at Base Eliminates Tone Arm Resonances and Assures Perfect Tracking.
6. LP-33 Cartridge for Microgroove instantly replaceable in FL Arm with LP-78 Cartridge having .003" radius needle for playing 78 RPM Records. Both simply slip into position, no tools needed, NO CHANGING OF NEEDLE PRESSURE.

**FL FILTER**—For best performance with high quality speakers. Controls high frequency response.

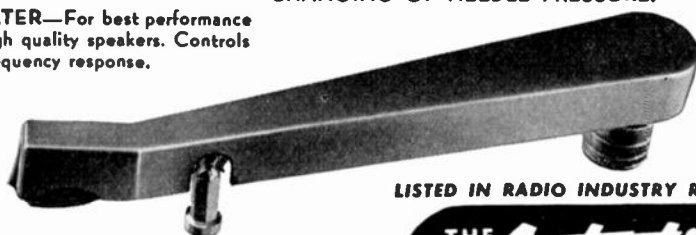

LISTED IN RADIO INDUSTRY RED BOOK



Astatic Crystal Devices Manufactured Under Brush Development Co. Patents



The following transfers and admissions were approved to be effective as of November 1, 1948

**Transfer to Senior Member**

- Bailey, L. W., 28 Browning Ave. Lenola, Moorestown, N. J.  
Lichtman, S. W., 6596 Bock Rd., S.E., Washington 20, D. C.  
Moffett, L., 9 Glenwolde Pk., Tarrytown, N. Y.  
Nibbe, G. H., 14315 Bessemer St., Van Nuys, Calif.  
Richie, S. M., 207 N. Stone Ave., La Grange, Ill.  
Stevenson, M. H., c/o Radio 2UE Sydney Pty. Ltd., 29 Bligh St., Sydney, N.S.W., Australia  
Wilkins, A. F., "Deva" Cliff Road, Felixstowe, Suffolk, England

**Admission to Senior Member**

- Barlow, E. J., 48 Roydon Dr. E. Merrick, N. Y.  
Kirkman, R. A., 1910 Oak Dr., West Belmar, N. J.  
Peixoto, E. S., S. A. Varig, Box 243, Porto Alegre, RS, Brazil  
Ponte, M. J. H., 3 Rue Villaret De Joyeuse, Paris 17, France

**Transfer to Member Grade**

- Arnold, H. H., Box 3031, Winston Salem, N. C.  
Bernstein, J., 1363 Findlay Ave., New York 56, N. Y.  
Bey, W. I., Box 1545, Fargo, N. Dak.  
Carew, S. J. H., 358 Beasborough Dr., Toronto, Ont., Canada  
Chasteen, J. W., 3717 E. 12 St., Kansas City, Mo.  
Fiske, J. J., 2031 Vista Del Mar Ave., Los Angeles 28, Calif.  
Fonda-Bonardi, G., 1723 Golden Ave., New York 60, N. Y.  
Graham, W. B., 51 St. Luke Pl., Franklin Square, L. I., N. Y.  
Hall, E. G., R.F.D. 2, County Farm Road, Lafayette, Ind.  
Haubrock, F. W., 2329 Blake St., Berkeley 4, Calif.  
Legault, E. G., 422 Mt. Royal E., Montreal, Que., Canada  
Price, R. L., 3277 Wrightwood Ave., Chicago 47, Ill.  
Subrahmanyam, G., Box 152, International House, 500 Riverside Dr., New York 27, N. Y.  
Suchard, D. G., 90 Adelaide St. S., London, Ont., Canada

**Admission to Member Grade**

- Beisel, R. W., 1421 Eagle Dr., Fort Worth 11, Tex.  
Carpenter, R. C., 2807 Blaine Dr., Chevy Chase 15, Md.  
Green, J. W. Jr., Professor of Electricity, U.S.M.A., West Point, N. Y.  
Halliday, O. T., 2415 Brazoria, Houston 6, Tex.  
Howe, D. W., Jr., 29 Chadwick St., Worcester 5, Mass.  
Johnson, D. L., 7101 E. Zion St., Tulsa 15, Okla.  
LaGrone, A. H., Box F, University Station, Austin 12, Tex.  
Shipp, R. L., Jr., 3407 Earlham Dr., Dayton 6, Ohio  
Taylor, B. M., 4661 El Cerrito Dr., San Diego 5, Calif.  
Watkins, W. B., Jr., 4015 Fairy Dr., Louisville, Ky.  
Williams, J. B., Philco Corp., Tioga & C. Sts., Philadelphia 34, Pa.

The following admissions to Associate grade have been approved and were effective as of October 1, 1948

- Allison, D. B., 835 N. Kansas, Hastings, Neb.  
Babb, J. M., Wakeeney, Kan.  
Bales, E. D., Sandia Base Branch, Albuquerque, N. M.  
Beraducci, S., 260 Union St., Brooklyn 31, N. Y.

(Continued on page 39A)





## THE LOW-LOSS, HIGH FREQUENCY INSULATION for every electrical and mechanical requirement

MYCALEX, a most versatile, low-loss insulation material, possesses unusual characteristics that ideally suit it for use in ultra high-frequency applications. It can be molded, or machined, to very close tolerances—it is impervious to water, oil or humidity; has dimen-

sional stability, high dielectric strength and will not carbonize. Metal inserts can be molded into the material giving it an almost endless number of applications in the field of electronics. It is available in the three following types:

### MYCALEX 410

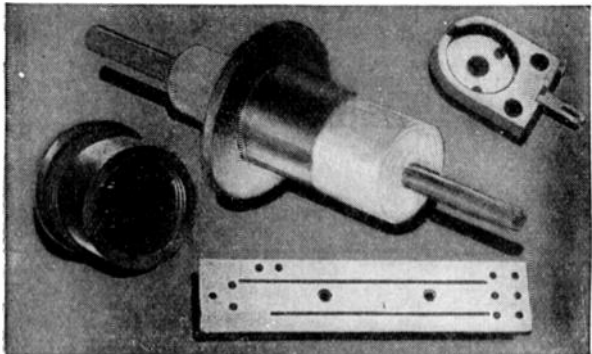

This injection-molded form of Mycalex is useful in 4 cases:  
1. When shape is too intricate to permit fabrication by machine.  
2. When quantities necessitate high production and low cost.  
3. When great dimensional stability is essential. (Mycalex 410 can be molded to very close tolerances.)  
4. When metal inserts must be incorporated into the insulator. These inserts may be made of any common metal that can withstand temperatures of about 1200° F and that has a coefficient of thermal expansion of the order of  $175 \times 10^{-7}$  per degree C. Mycalex metal seals can withstand pressure of 90 psi.

### MYCALEX 400

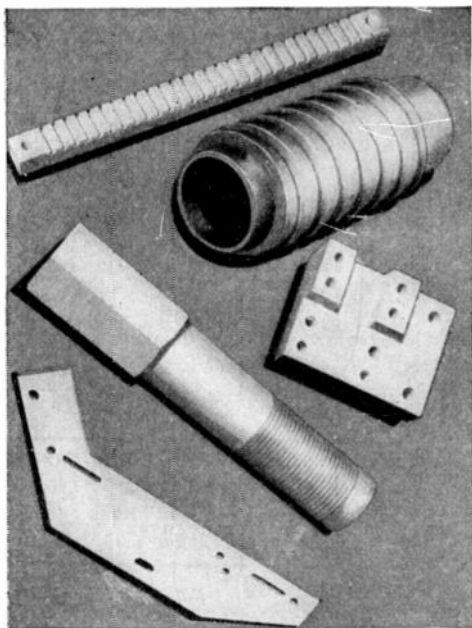

Compression molded for high-frequency applications. Its loss factor is well within requirements for operation in this portion of the electromagnetic spectrum. An outstanding characteristic is the long frequency range over which the loss factor is a minimum. Tropical climates do not impair its electrical and physical properties. It is, therefore, used for insulation in radio transmitters, radio receivers, communication panels, switchboard panels, arc shields in high tension switches, brush holders, relay contact supports, etc. Available in sheets 14 by 18 in.; thickness of  $\frac{1}{8}$  to 1 in. Rods 18 in. long, diameter  $\frac{1}{4}$  to 1 in.

### MYCALEX K series

**Ceramic Capacitor Dielectrics.** Many ceramic materials offer low power factor, negligible moisture absorption, high dielectric strength, lack of cold flow, ability to withstand high temperatures. Few, however, include a dielectric constant greater than 7 or 8 at radio frequencies. Few are available with flat surfaces of large dimensions that don't warp, or close tolerances in rods. Mycalex K capacitor dielectrics combine all of them and is available in practically any form. Power factor varies from 0.002 to 0.004 at 1 mc.

## MYCALEX FABRICATING SERVICE

Mycalex can be machined to customers' exact specifications in our new plant at Clifton, N. J. This plant is especially tooled for large volume machining of Mycalex in a wide variety of forms. This service offers the following advantages . . . **PRECISION WORKMANSHIP:** specialized equipment that assures remarkable precision and super-

vision by skilled engineers. **REDUCED COSTS:** substantial savings effected by efficient performance on a quantity basis. **RELIEF TO PLANT BOTTLENECKS. PROMPT DELIVERIES.** Consult our engineering staff for advice on the application of Mycalex to your insulating problems.

## MYCALEX CORPORATION OF AMERICA

"Owners of 'MYCALEX' Patents"

Plant and General Offices CLIFTON, N. J.

Executive Offices, 30 ROCKEFELLER PLAZA, NEW YORK 20, N. Y.



(Continued from page 36)

Bhandari, J. N., Electrical Communication Engineering, Indian Institute of Science, Bangalore 3, India  
Bisaria, J. N., E. C. Department, Indian Institute of Science, Bangalore 3, India  
Braun, A., Rousseaustr. 94, Zürich, Switzerland  
Buchtel, P. E., 2245 13 St., Akron 14, Ohio  
Busler, L. F., Jr., 60 N. Willett St., Memphis 4, Tenn.  
Chapman, L. B., 2459 Parkview Ave., Toledo 6, Ohio  
Davis, S. E., Radio Station WCNR, 38 W. Main St., Bloomsburg, Pa.  
DeBell, J. M., Jr., 5 Albion St., Passaic, N. J.  
Dilson, J., 535 E. 14 St., New York 9, N. Y.  
Dotson, E., 111 N. Metcalf, Lima, Ohio  
Dumas, K. L., 4022 Corby St., Omaha, Neb.  
Eaecher, P. H., 309 Las Casas, Pacific Palisades, Calif.  
Everhart, W. H., 136 A Eighth St., Sandia Base Branch, Albuquerque, N. M.  
Franklin, P. E., 401 Caroline, Houston 2, Tex.  
Gottschalk, M., 37 W. 52 St., New York 19, N. Y.  
Hall, R. W., c/o KFMX-KSWI, Council Bluffs, Iowa  
Hammer, W. A., Managing Director, Autophon A. G., Soleure, Switzerland  
Hennigar, N. E., Box 12, Newport Beach, Calif.  
Hodge, C. E., 1330 W. Fourth St., Winston Salem, N. C.  
Hutton, W. I., 3545 South St., Lincoln 6, Neb.  
Janardhan, N. M., Department of Electrical Communication Engineering, Indian Institute of Science, Bangalore, India  
Kimble, J. A., Radio Station KWBB, 351 N. Topeka, Wichita 2, Kan.  
Lavin, H. P., 803 N. Bellevue, Hastings, Neb.  
Ludebid, M. L., Brasil 975, 3er Piso, Buenos Aires, Argentina  
Miles, R. B., 4534 Lake Park Ave., Chicago 15, Ill.  
Molloy, G. C., 1323 Madison Ave., Baltimore 17, Md.  
Newman, L., 191 Central Ave., Newark 4, N. J.  
Phillips, P. C., 322 W. Ruscomb St., Philadelphia, Pa.  
Rappaport, R. B., 4140 Buckingham Rd., Los Angeles, Calif.  
Rector, C. V., 1617 W. Carter St., Kokomo, Ind.  
Reid, T. C., 1514 1/2 Gordon St., Hollywood 28, Calif.  
Reinach, F. J., 445 W. 118 St., Los Angeles 3, Calif.  
Robertson, A. J. L., 5540 Saylor, Lincoln 6, Neb.  
Robinson, R. J., Longhill Rd., R.F.D. 1, Little Falls, N. J.  
Ross, I. L., 228 E. Sheldon St., Philadelphia, Pa.  
Rudd, F. A., 3676 Ida St., Omaha 11, Neb.  
Sangiovanni, E. R., San Juan 2631, 1er Piso, Buenos Aires, Argentina  
Sheffrey, T. N., 1337 N. 39 St., Lincoln, Neb.  
Sibilia, L., 714 S. 38 Ave., Omaha 5, Neb.  
Sims, T. W., 54 Bluegrass, Fort Thomas, Ky.  
Skolnik, S., Milner Hotel, 131 W. Fifth St., Dayton 2, Ohio  
Smith, H. B., 467 Park Ave., Birmingham, Mich.  
Steves, P. J., 115 W. 63 St., New York 23, N. Y.  
Stropki, G. T., 3333 N. Marshfield Ave., Chicago, Ill.  
Subrahmanyam, D. L., Technical Assistant, Research Department, All India Radio, Curzon Road, New Delhi, India  
Swanson, D. A. KMMJ Transmitter, Phillips, Neb.  
Von Utfall, J. C., United Nations Sound and Recording Section CA-041, Lake Success, N. Y.  
Wallace, B. E., Jr., Randallstown, Md.  
Washburn, C. A., 203 N. Edith St., Albuquerque, N. M.

(Continued on page 40A)

## An Important Statement

by

# MYCALEX CORPORATION OF AMERICA

An explanation of the properties and advantages of Mycalex (glass bonded mica) 410, Mycalex 400, and Mycalex K are given on the opposite page.

Your attention is also called to the Mycalex 410 advertisement which appeared on pages 30 and 31 of the October 1948 issue of Proc. of I.R.E.

Constant research, improved technics, advances in the art, new, modern plant expansion, improved engineering, more efficient manufacturing equipment—now permit us to make available in increased quantities—Mycalex 410—molded—at prices comparable to other less efficient molded insulations.

## MYCALEX 410 is now priced to meet rigid economy requirements

Any interest evidenced on your part in Mycalex products and services—will receive the prompt, courteous and intelligent attention of a competent Mycalex sales engineer. He will receive the fullest backing and cooperation from other factory executives—to serve you promptly—with a quality product and at an economical and fair price.



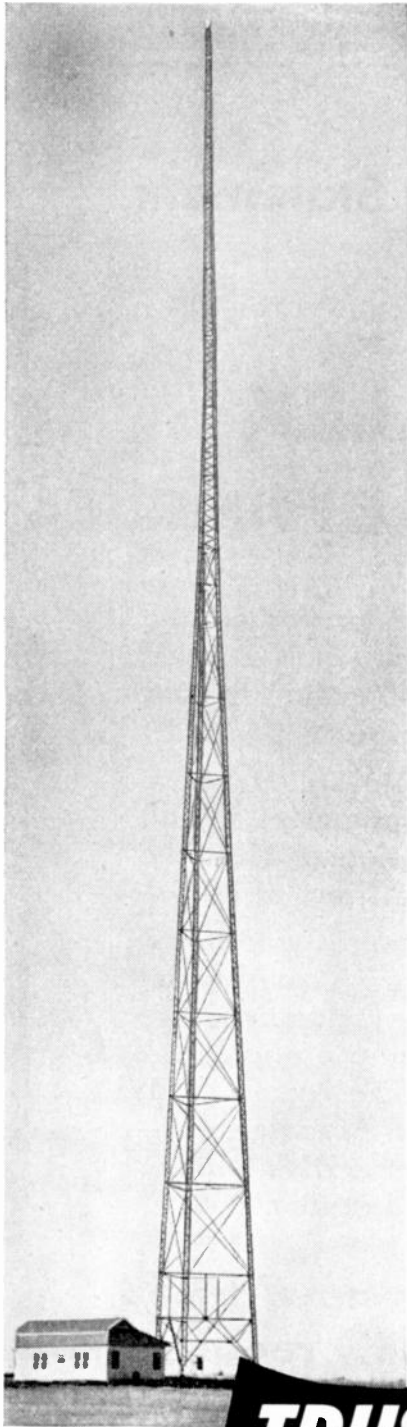

# KSAC

*Manhattan, Kansas*

On the broad, flat Kansas plains, this Truscon Radio Tower stands out as a monument of service dedicated to the people of a great area. This station is operated by the Kansas State College of Agriculture and Applied Science.

Truscon Radio Towers have a great record for service, strength and stability all over the United States and in foreign countries, operating in a wide range of wind, temperature and humidity conditions. The knowledge gained from such a diversity of installations assures you highly competent engineering service.

Truscon Radio Towers are available in guyed or self-supporting types, either tapered or uniform cross section, for AM, FM and TV broadcasting. Experienced Truscon radio tower engineers will be glad to help solve your radio tower problems of today and tomorrow.

*Radio Station KSAC, Manhattan, Kansas, uses a Truscon Self-Supporting Tower 425 feet high.*

**TRUSCON**  
 SELF-SUPPORTING  
 AND UNIFORM  
 CROSS SECTION GUYED **TOWERS**

**TRUSCON STEEL COMPANY**  
 YOUNGSTOWN 1, OHIO  
 Subsidiary of Republic Steel Corporation

Manufacturers of a Complete Line of Self-Supporting Radio Towers . . . Uniform Cross-Section Guyed Radio Towers . . . Copper Mesh Ground Screen . . . Steel Building Products.



*(Continued from page 39A)*

- Watson, R. V., 48 High St., Hoddesdon, Hertfordshire, England
- Weston, L. Y., Jr., Electronic Computer Project, Institute for Advanced Study, Princeton, N. J.

The following transfers to Associate grade were approved to be effective as of October 1, 1948

- Bennett, W. C., 5819 Kingman Blvd., Des Moines 11, Iowa
- Chang, S-H., 77 Duston St., Brighton 35, Mass.
- Gauthier, L. P., 59 Rangely Rd., West Newton, Mass.
- Guida, J. A., c/o Dr. E. B. Kent, Arlington, Vt.
- Huang, T-S., c/o Mr. C. Y. Huang, 271 Foochow Rd., Shanghai, China
- Hurwitz, M. L., 7709 Yates Ave., Chicago 49, Ill.
- King, G. L., 480 Albert St., Kingston Ont., Canada
- Lenoir, S. P., Jr., Prairie, Miss.
- McAuley, J. H., 956 Myrtle St., N.E., Atlanta, Ga.
- Normando, N. J., 600 1/2 Grove St., Jersey City, N. J.
- Pearsall, S. H., 612 Russell St., Nashville, Tenn.
- Vendeland, R. N., 711 E. 258 St., Euclid 23, Ohio

## News—New Products

These manufacturers have invited PROCEEDINGS readers to write for literature and further technical information. Please mention your I.R.E. affiliation.

*(Continued from page 30A)*

### Small Tachometer

A new, rugged, small electric tachometer, designed for continuous operation, has just been announced by **The Electric Tachometer Corp.**, 2218 Vine St., Philadelphia 3, Pa.

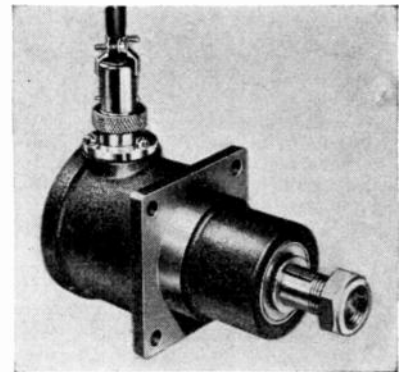

This unit, Model M-1200, measures only 2 3/4" x 5 3/4", is housed in cast bronze, and will operate in any position through a wide range of temperatures.

Various drive-shaft arrangements and a suitable assortment of indicating meters are available to cover all operating conditions.

Booklet M-120 gives complete descriptive information.

*(Continued on page 44A)*



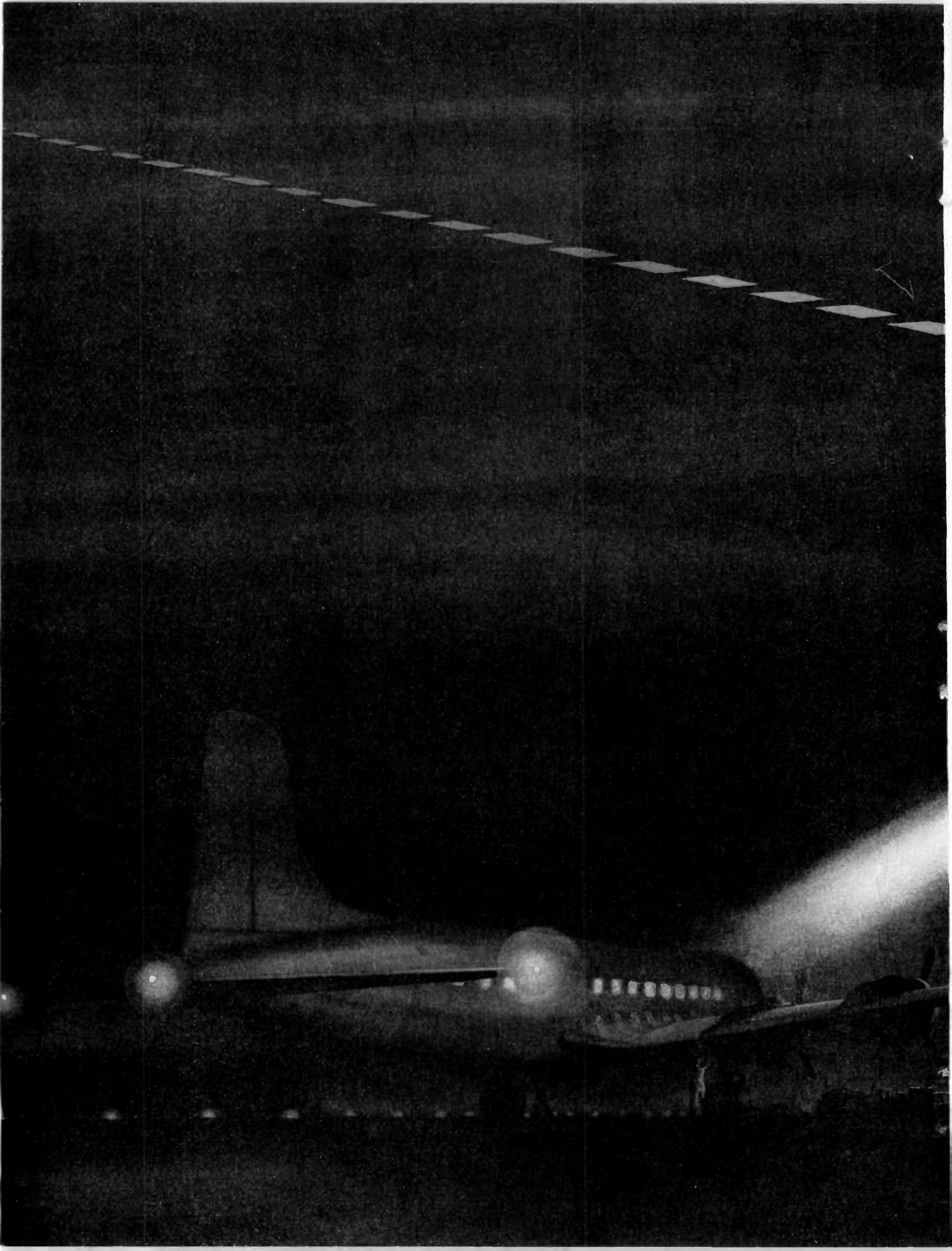





## Soup-or Duck Soup?

GCA\* makes the difference! Aviation's dread bogey—fog—has been scratched.

In 36 states, 15 foreign nations, nearly two hundred GCA-equipped airports now carry on routine transport operations in all weather. Pilots land 'instrument' . . . without incident.

As original manufacturer of the GCA radar landing system, Gilfillan has pioneered most of its refinements. Five-man, multi-scope trailer equipment has been engineered down to a trim one-man, two-scope unit in the control tower. Latest GCA self-powered military units are streamlined, air transportable.

Outstanding new GCA feature is the AZEL three-dimensional scope, which combines elevation, range and azimuth data. MTI (Moving Target Indicator) is another. Eliminating all ground clutter, it gives sharp definition to every airborne aircraft within a 30-mile radius.

GCA means pilot assurance and passenger confidence. Helping the aviation industry to achieve dependable air transportation is Gilfillan's determined objective.

*\*Ground Controlled Approach.*

***Gilfillan***  
LOS ANGELES

RCA International Division, New York, N. Y.  
Exclusive Export Distributor



# db GAIN + + +

more signal strength for greater distance  
and the best picture

with

## AMPHENOL

# STACKED ARRAY

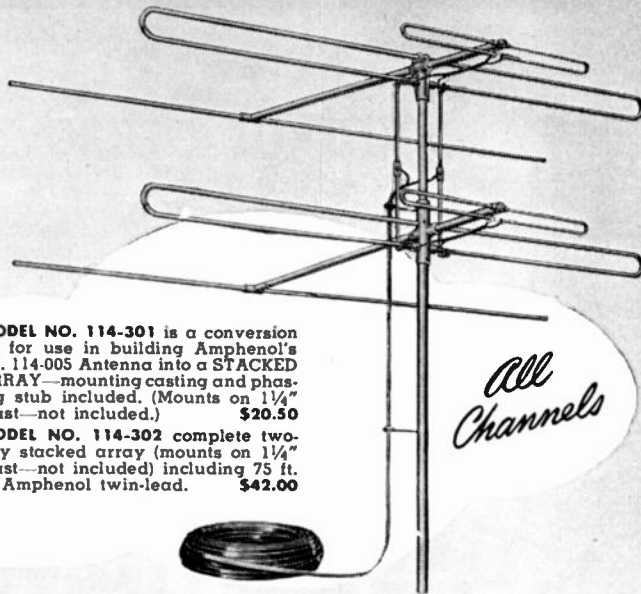

**MODEL NO. 114-301** is a conversion kit for use in building Amphenol's No. 114-005 Antenna into a STACKED ARRAY—mounting casting and phasing stub included. (Mounts on 1/4" mast—not included.) **\$20.50**

**MODEL NO. 114-302** complete two-bay stacked array (mounts on 1/4" mast—not included) including 75 ft. of Amphenol twin-lead. **\$42.00**

Stacked Array multiplies the universally acknowledged features of the Amphenol All-Channel TV Antenna (No. 114-005). Stack to provide reception at greater distances—Stack for picture brilliance and clarity—Stack for controlled TV reception. Provide the TV Receiver with the Best Antenna to Produce the Best Picture. Amphenol's Stacked Array is your assurance of top TV picture quality.

### Performance Charts Available

If you are not now receiving the monthly AMPHENOL ENGINEERING NEWS—you will want to request the September issue which included pattern and gain charts for the Stacked Array. We will be glad to mail it and to place your name on our list to receive future issues—write Dept. 13D.



## AMERICAN PHENOLIC CORPORATION

1830 SOUTH 54TH AVENUE, CHICAGO 50, ILLINOIS  
COAXIAL CABLES AND CONNECTORS • INDUSTRIAL CONNECTORS, FITTINGS AND CONDUIT • ANTENNAS • RADIO COMPONENTS • PLASTIC FOR ELECTRONICS

## News—New Products

These manufacturers have invited PROCEEDINGS readers to write for literature and further technical information. Please mention your I.R.E. affiliation.

(Continued from page 40A)

### AC, DC or Half-Way Rectified AC Relay

A new miniature relay, Type 118XBX, is now on the market from Struthers-Dunn Ind., 150 N. 13th Street, Philadelphia 7, Pa.

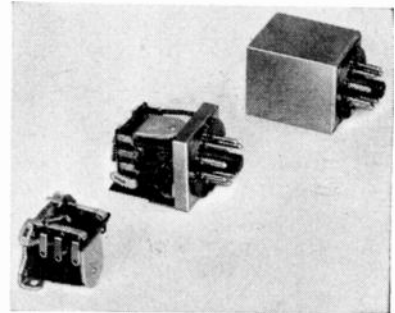

This open-type relay has double-pole double-throw contacts, rated at 2 amperes at 115 volts ac, is 1 1/2" high, 1 1/2" long, and 1" wide, and weighs approximately 2 ounces.

If required, it may be housed in a metal enclosure 1 1/2" long and wide by 1 1/2" high and equipped with a tube-type octal base. It is also adaptable to hermetic sealing.

### Phase-Sequence Indicator

A new phase-sequence indicator designed for a wide range of applications in the manufacturing, industrial, and central-station fields has been announced by the Meter and Instrument Divisions, of General Electric Co., Schenectady 5, N. Y.



This indicator is entirely static, with no moving parts, bearings, or pivots. The indicator is applicable to either 120-, 240-, or 480-volt circuits at 25, 50, and 60 cps.

It may be used to predict the directional rotation of polyphase meters for machine drivers, elevators, air-conditioning equipment, and similar devices; to determine the proper connections for paralleling generators, transformer banks, and power buses; to determine proper connections for watt-hour meters, reactive-component meters, power-factor meters, kva meters, reverse-power relays, and phase-sequence relays; to check electron-tube, thyatron, rectifier, and inverter installations; and to study vector relations of polyphase circuits.

(Continued on page 46A)

*If it's Electronic . . .*

# B&W CAN MAKE IT FOR YOU

From small electronic components up to carefully engineered test equipment and complex electronic devices, Barker and Williamson can engineer and manufacture high quality products to your specifications.

Three B&W plants, comprising 150,000 square feet, completely equipped with a competent engineering staff, machine shop, tool room (including all machines for drilling, milling, turning, stamping and forming metals and plastics), and a complete woodworking shop are at your disposal. Your inquiries are welcome. Write Department PR-118 for prompt reply.

## NOW IN PRODUCTION AT B & W

COMPLETE RADIO TRANSMITTERS • DUAL DIVERSITY CONVERTERS, CONTROL UNITS and FREQUENCY SHIFT EXCITERS FOR RADIO TELETYPE TRANSMISSION • SPECIAL TEST EQUIPMENT • REDESIGN, MODERNIZATION AND MODIFICATION OF EXISTING EQUIPMENT  
MACHINE WORK • METAL STAMPING • COILS  
CONDENSERS • OTHER ELECTRONIC DEVICES IN  
A WIDE RANGE OF TYPES

PLANT No. 2  
BRISTOL, PA.

BARKER AND WILLIAMSON

# BARKER & WILLIAMSON, Inc.

237 FAIRFIELD AVENUE

UPPER DARBY, PA.



**FREQUENCY SHIFT EXCITER**  
—Provides RF drive and frequency shift keying to transmitter.

**2 KW AMPLIFIER**—Class C R-F Amplifier. Frequency Range 1 to 25 Mc's.



**CONTROL UNIT**—Operates as an electronic repeater in teletype wire lines.

**DUAL DIVERSITY CONVERTER**—Provides diversity mixing on frequency shift circuits.

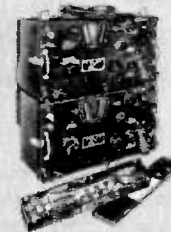

**RECEIVER ASSEMBLY**  
—Standard Army BC-342 Receivers modified for Dual Diversity Reception. Coupling Amplifier; bottom, front.

**B&W AUDIO OSCILLATOR**  
Model 200

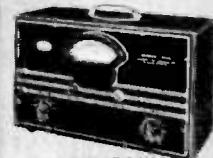

**B & W FREQUENCY METER**  
Model 300

**B & W DISTORTION METER**  
Model 400

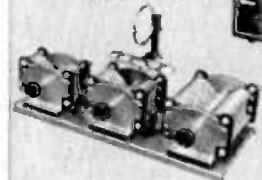

**B & W SMALL BUTTERFLY VARIABLE CAPACITORS**

**B & W TURRETS**

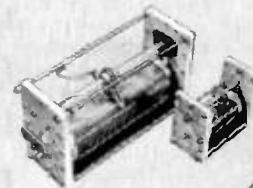

**E & W ROTARY COILS**

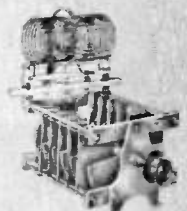

**B & W HEAVY DUTY VARIABLE CAPACITORS**



**B & W 3400 SERIES INDUCTORS**

DESIGNED FOR ONE SPECIFIC PURPOSE—

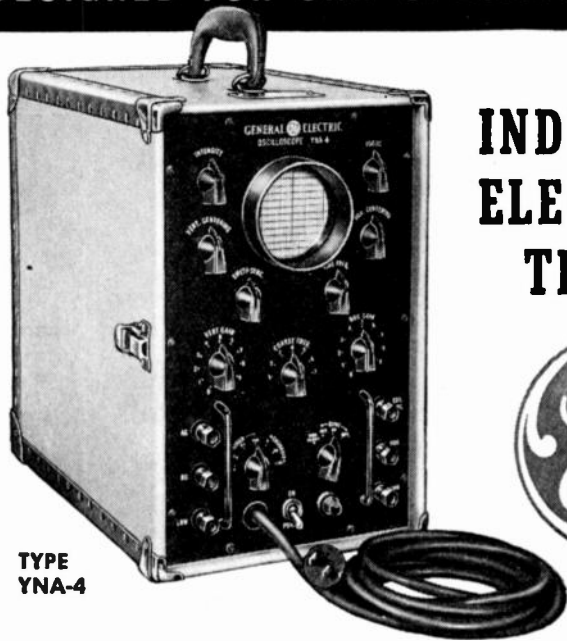

TYPE  
YNA-4

## INDUSTRIAL ELECTRONIC TESTING



# INDUSTRIAL OSCILLOSCOPE

Check—Measure—Test—with the G-E Industrial Oscilloscope.

The following partial list of uses will indicate its importance where ever electrical apparatus is employed.

For checking welding equipment, testing photo-electric circuits, checking performance of relay contacts, performance of high power rectifier tubes, measuring voltage and current relationship in motors, performance of commutators, checking audio oscillators—the YNA-4 Industrial Oscilloscope performs all these important checking and testing functions most efficiently.

**D-C Amplifiers for Horizontal and Vertical Deflection**—Give a true trace combining both the AC and DC components important for industrial purposes which is not possible with the ordinary oscilloscope used in radio work.

**Completely Insulated Case**—Since the entire unit is insulated, it may be operated as high as 550 volts above ground. Instrument may be placed on metal working surfaces, machinery, and other advantageous working spots even when connected to ungrounded circuits.

**Internal Calibrating Voltages**—The YNA-4 provides internal calibrating voltages of known value to enable the operator to set the deflection sensitivity of the oscilloscope. Functions as a vacuum tube voltmeter permitting AC and DC voltage measurements without a voltmeter.

**Flexible Input Circuits**—Vertical Amplifier—varied inputs are available to accommodate a wide range of voltages and circuit requirements. This oscilloscope may be used to

examine voltages from 1.0 volt to 500 volts and its input impedance may be switched from 1 megohm to 10 megohms or to open grid.

**Horizontal Amplifier**—direct coupled input terminals are provided or the built-in sweep generator may be used for horizontal deflection. This generator may be synchronized with the power line, the vertical amplifier or with an external source.

**Wide Sweep Frequency Range**—The YNA-4 has been designed so that the operator can observe separate cycles over a wide band of frequencies. A minimum sweep rate of 10 cycles has been established as desirable for industrial operations—this has been incorporated in YNA-4.

For complete information on the YNA-4 Industrial Oscilloscope and other precision measuring equipments write today to:  
General Electric Company,  
Electronics Park, Syracuse,  
New York.

165-66

GENERAL  ELECTRIC

## News—New Products

These manufacturers have invited PROCEEDINGS readers to write for literature and further technical information. Please mention your I.R.E. affiliation.

(Continued from page 44A)

### Powdered-Iron Transformers For Television Deflection

A core fabricated in powdered iron is being made by Henry L. Crowley & Co., Inc., West Orange, N. J., that is claimed by the manufacturer to reduce costs to less than one quarter those of equivalent laminated-sheet or strip metal types.

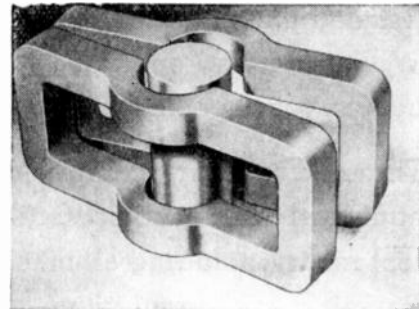

It consists of a two-piece frame and center slug assembly for television receiver deflection transformers, and with proper windings held by this transformer core structure there is provided a low-loss energy-recovery system requiring no additional electrical energy yet providing large increases in deflection capability.

Depending upon molding pressures ranging from 15 tons to upwards of 60 tons per square inch, the degree of dc saturation and again the peak amplitude of ac flux density, effective ac permeabilities of the order of 40 to 230 are available in these assemblies. High-Q systems are attainable at low cost because of the small particle thickness obtainable. The stepped-up efficiency eliminates the necessity for dissipating large amounts of energy from the transformer and deflecting-yoke structures. Furthermore, it is claimed, the molded core structure produce negligible hum noise in comparison with laminated-core structure.

A single driver tube with a single damper tube and two small rectifier tubes can provide full deflection as well as second-anode high voltage for a 50° cathode-ray tube, at accelerating voltages up to 17 kilovolts, under present tube ratings.

### Recent Catalogs

••• A 44 page booklet containing much helpful data for selecting and applying brushes for longer life and better performance on a wide variety of small motor equipment entitled "Fractional Horsepower Equipment Brush User's Guide" by Stackpole Carbon Co., St. Marys, Pa.

••• On a new capacitor type filter to control radio interference caused by fluorescent lamps, by Cornell-Dubilier Electric Corp., South Plainfield, N. J.

(Continued on page 48A)

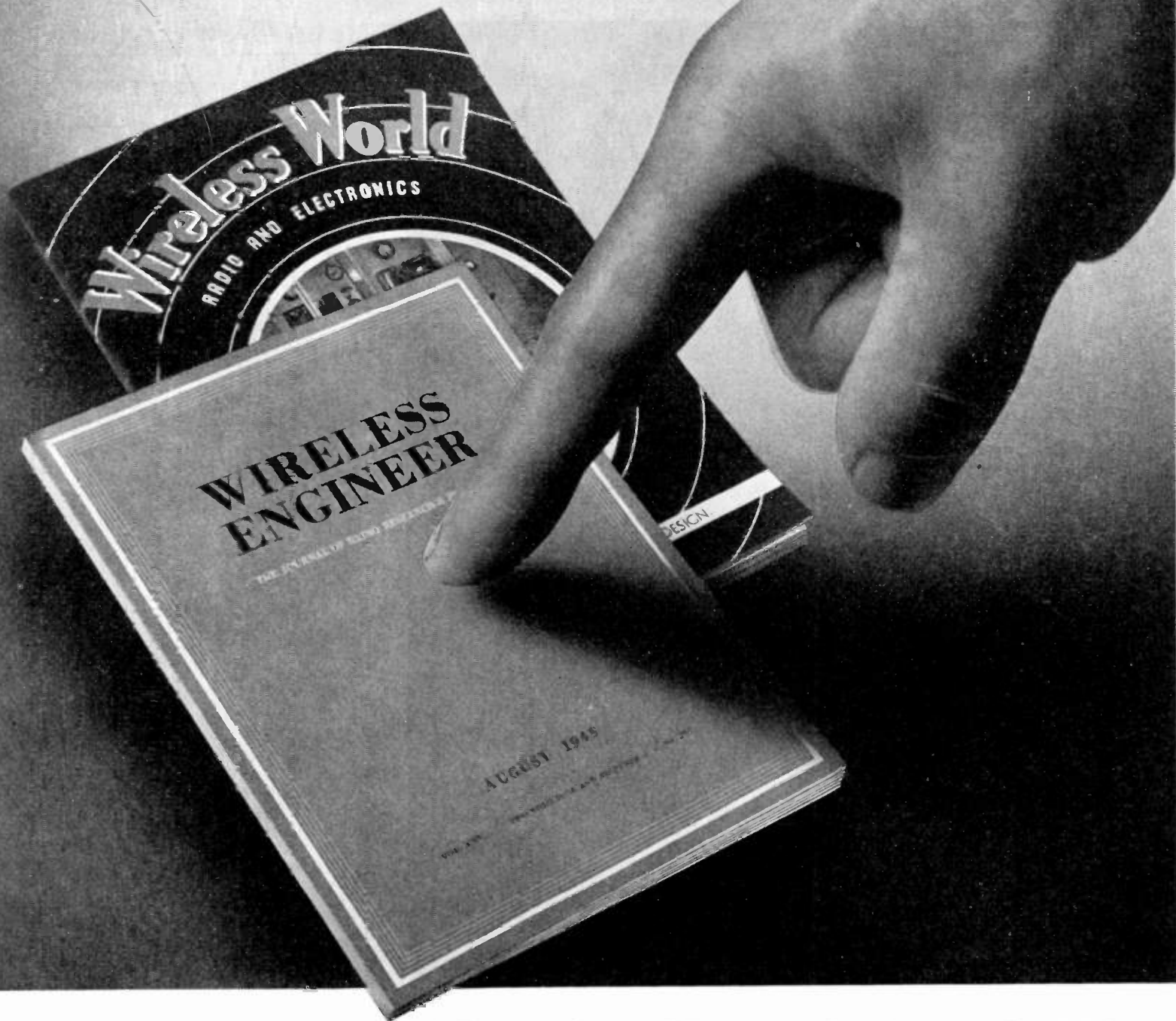

## For Accurate and Up-to-date News of Every British Development in Radio, Television and Electronics

**WIRELESS WORLD** is Britain's leading technical magazine in the general field of radio, television and electronics. For over 37 years it has consistently provided a complete and accurate survey of the newest British technique in design and manufacture. Articles of a high standard include reviews of equipment, broadcast receivers and components, while theoretical articles deal with design data and circuits for every application.

**WIRELESS ENGINEER** is read by research engineers, designers and students, and is accepted internationally as a source of information for advanced workers. The Editorial policy is to publish only original work, and representatives of the National Physical Laboratory, the British Broadcasting Corporation and the Engineering Department of the British Post Office are included on the Editorial Advisory Board.

Subscriptions can be placed with British Publications Inc., 150 East 35th Street, New York, 16, N.Y., or sent direct by



International Money Order to Dorset House, Stamford Street, London, S.E.1, England. Cables: "Iliffepres, Sedist. London."

ASSOCIATED TECHNICAL BOOKS: "Television Receiving Equipment" (2nd Edition), by W. T. Cocking, M.I.E.E. One of the most important British books on television, 13 shillings (\$2.60): "Wireless Direction Finding" (4th Edition), by R. Keen, B.Eng. (Hons.), A.M.I.E.E. An up-to-date and comprehensive work on the subject, 45 shillings (\$9.25): available from the British address above

# For TV and FM



*Standardize  
on One!*

Now, ONE crystal holder will cover your requirements for television and frequency modulation transmission. RH-7 hermetically sealed crystal units offer a frequency range from 1 to 75mc, to tolerances as close as  $\pm .0002\%$ . Space-saving, easily installed and replaced, RH-7 crystals will fit all circuits. Two pin sizes or wire leads are available.

Why not standardize now,  
on just ONE!

**REEVES**  **HOFFMAN**  
CORPORATION  
CHERRY AND NORTH STREETS • CARLISLE, PA.

## News—New Products

These manufacturers have invited PROCEEDINGS readers to write for literature and further technical information. Please mention your I.R.E. affiliation.

(Continued from page 46A)

### DC-AC Chopper

The type 222 Chopper, an electro-mechanical chopper or rectifier (demodulator) is a new product being manufactured by Stevens-Arnold Inc., 22 Elkins Street, South Boston 27, Mass.



When used as a chopper, it will convert pure dc into pulsating dc or ac so that the output of thermocouples, strain gauges, or other low-level dc sources may be amplified by means of an ac rather than a dc amplifier. As a rectifier, it will convert ac to dc. As the principal element in a square-wave generator, it may be used to produce square waves in the range of 10 to 500 cps.

The single-pole, double-throw contacts may be open or closed on either or both contacts when the armature is at rest, because there are two independent floating armatures inside the chopper. The nominal rating is 0.050 amperes, 50 volts dc. The maximum rating is  $\frac{1}{2}$  ampere, 110 volts dc.

The coil—fully shielded electrostatically—is rated at 12 volts, 10 to 500 cps, but this may be increased to 24 volts without damage.

### Recent Catalogs

••• This is a list of available bulletins and catalogs of an English firm: type No. 623 Electronic Process Timer; type No. 701 H. F. Signal Generator; type No. 702, Low Frequency Signal Generator; type No. 703 Bridge Oscillator and Amplifier Detector; type No. 704 Electronic Decade Counter; type No. 705 Stabilized Power Supply unit; type No. 708 Power Output Meter; type Nos. 707 & 713 Electronic Heat Generators; type No. 712 Valve Voltmeter; type No. 723 DC Oscilloscope; type No. 726 Frequency Meter (Tachometer); type No. 732 Electronic Ionization and Insulation Tester; type No. 734 Photocell Unit, by Airmec Laboratories, Ltd., 19 Charterhouse St., London, England.

(Continued on page 60A)

To study the simultaneous characteristics of any device

**THIS  
BIG...**

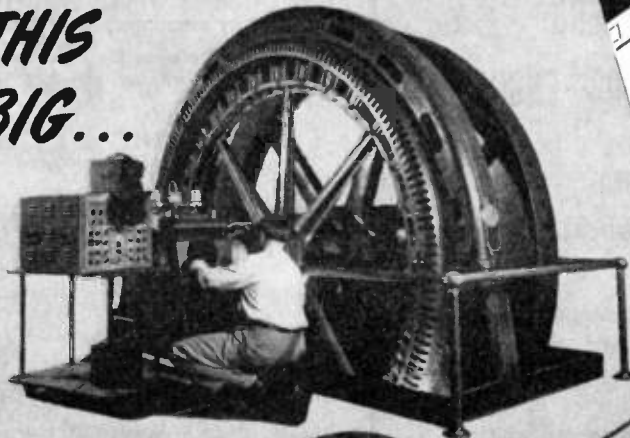

**or this  
small...**



...use the  
**DU MONT Type 5 SP-**  
*Dual-beam*  
**CATHODE-RAY  
TUBE**

Both the concomitant electrical and/or mechanical characteristics of a piece of equipment may be conveniently examined and recorded with a Du Mont Type 5SP-Dual-beam Cathode-ray Tube. Especially so if used with a Du Mont Type 279 Dual-beam Cathode-ray Oscillograph.

For example: You can compare speed and vibration, velocity and acceleration. You can observe transient voltage and current; the input and output signals of amplifiers; related phenomena on different sweep frequencies; or again the complete signal and an expanded portion thereof. And for ease of recording, there is also available the Du Mont Type 314 Oscillograph-record Camera.

Indeed, the Type 5SP- is an unique cathode-ray tube since it embodies two complete and independent electron guns and deflection plate assemblies for the production of two entirely separate electron

beams. The Type 5SP- does not produce a split electron beam. Rather it presents two separate traces on the screen. Intensifier electrodes are used for high light output at maximum deflection sensitivities. Type 5SP- is also available with any of four different screen phosphors.

And please remember this: The Du Mont Type 5SP- is the only dual-gun cathode-ray tube registered with the Radio Manufacturers Association.

Details on request.

© ALLEN B. DU MONT LABORATORIES, INC.

**DU MONT**

*for Oscillography*

ALLEN B. DU MONT LABORATORIES, INC., PASSAIC, N. J.  
CABLE ADDRESS: ALBEEDU, NEW YORK, N. Y., U.S.A.

**ELECTRONIC ENGINEERS  
PHYSICISTS  
SERVO AND COMPUTER ENGINEERS  
PROJECT ENGINEERS SENIOR ELECTRONIC ENGINEERS**

THIS IS YOUR OPPORTUNITY TO GO PLACES  
IN ELECTRONIC RESEARCH AND DEVELOPMENT

**MEN ARE ESPECIALLY NEEDED TO DO ORIGINAL WORK  
IN THE FOLLOWING FIELDS:**

- |  |   |
|--|---|
| 1. Pulse circuits including ranging, scope, video, trigger and square wave generator circuits. | 3. Micro-wave antennae, radomes, wave guides and other radio frequency components of radar systems. |
| 2. Radar type transmitters, including high voltage power supplies, receivers and modulators.   | 4. Servo-mechanism and controls.  |
|  | 5. Electronic Instrumentation.  |

Send résumé to

PERSONNEL DEPARTMENT  
THE GLENN L. MARTIN COMPANY  
Baltimore 3, Maryland

**No Housing Problem in Baltimore, Maryland**



**PHILCO**

To maintain the Philco tradition of progressive research and development in the electronic field an ever increasing staff of engineers and physicists has been employed over the last two decades. Continuing expansion of Philco's engineering and research activities is producing excellent opportunities for engineers and physicists.

The scope of the work in the Philco laboratories includes basic research on the theory of semiconductors; vacuum tube research and design, including cathode ray tubes; and the design of special circuits, radio, television, television relay and radar systems.

**IF YOU ARE INTERESTED IN YOUR OPPORTUNITY AT PHILCO,**

WRITE...      Engineering Personnel Director  
Philco Corporation  
Philadelphia 34, Pa.



The following positions of interest to I.R.E. members have been reported as open. Apply in writing, addressing reply to company mentioned or to Box No. . . .

The Institute reserves the right to refuse any announcement without giving a reason for the refusal.

**PROCEEDINGS of the I.R.E.**

1 East 79th St., New York 21, N.Y.

**MICROWAVE ENGINEERING EXECUTIVE**

Well versed in electro-magnetic theory and application, to administer currently successful microwave antenna research and development group. Moderate sized laboratory in New York City area seeking the man for this position. Box 531.

**JUNIOR ELECTRONIC ENGINEERS**

B.S. degree in radio, electronics or electrical engineering required. Experience not necessary. Outstanding opportunities in special vacuum tube development work with a small progressive organization. Box 532.

**ELECTRICAL AND AERONAUTICAL ENGINEERS**

This corporation, engaged in development of aircraft remote control and telemetering equipment, has need for engineers of several categories:

1. Young graduate electrical engineers having good background in electronics and communications.
2. Graduate electrical engineers with experience in electronics and communications.
3. Graduate electrical or mechanical engineers having background in servo-mechanism design.
4. Aeronautical engineers having experience in stability and control. Wing Engineering Corporation, Colonel Bldg., Philadelphia 7, Pa.

**JUNIOR ENGINEERS**

Microwave research and other advanced radio work, requiring college degree and natural aptitude. Opportunity for valuable experience and advancement in a small, growing organization. Suburban location on Long Island near New York City. Send personal record to Harold A. Wheeler, Wheeler Laboratories, Inc. Great Neck, N.Y.

**TECHNICAL WRITERS**

Our manual department is receiving additional orders at an increasing rate, and experienced writers with electronic engineering background are needed for registration in our files. We request applications now to facilitate assignment of jobs as they arise in the near future. Send complete resume to Mr. J. J. Roche, or phone for appointment. Boland & Boyce, 460 Bloomfield Ave., Montclair, N.J.

**ELECTRONIC ENGINEERS—ELECTRONIC TECHNICIANS**

Men with production, inspection or re-design experience preferred. Direct inquiries to SLX-1, P. O. Box 5800, Albuquerque, N.M.

*(Continued on page 52A)*





*Developed during the war, Loran projects long-distance radio beams to guide ships on lanes charted by radio-electronics.*

## **WANTED!** Design and Development Engineers

LORAN provides a new kind of road map for the sea and air, day and night, and in almost any kind of weather. With Loran, ships and planes, as far as 700 to 1400 miles offshore in the densest fog, can determine their positions with uncanny accuracy.

Continued expansion of the diversified activities at RCA have created additional opportunities for experienced design and development electronic engineers.

**WRITE TO:** **CAMDEN PERSONNEL DIVISION**  
**RCA VICTOR DIVISION**  
**CAMDEN, NEW JERSEY**

# CURTISS WRIGHT

Corp.

## PROPELLER DIVISION

Route 6 Caldwell Township  
New Jersey

Requires Experienced Graduate

## AERO DYNAMICIST ENGINEERS

to work on the design of Analog Computers, to simulate the flight characteristics of specific aeroplanes.

3 years experience in stability and control essential . . . knowledge of Servo Mechanisms, Dynamics of Free Flight and applied mathematics desirable.

## ELECTRONICS ENGINEERS

TOP FLIGHT

Must have 10 years Design and Development experience on Servo Mechanisms and Amplifiers, circuits and equipment layout.

Apply in person . . . or  
submit complete resume to  
Personnel Department

Mon. thru Fri., 8 A.M. to 4:30 P.M.

# CURTISS WRIGHT

Corp.

## PROPELLER DIVISION

Route 6,  
Caldwell Township, N.J.



(Continued from page 50A)

### TEACHER

Southwestern church-related university needs experienced teacher with Master's degree to teach radio theory and electronics in the Physics Dept. Salary \$3300 for 9 months. Write full particulars to Mr. Stewart H. Ross, Chairman, Dept. of Physics, Trinity University, San Antonio 1, Tex.

### TELEVISION ENGINEERS

Well established electronics manufacturer, located in suburban New York City area needs high grade television development engineers. Company is expanding its television activities and seeks capable men with background sufficiently complete to merit responsible positions. Send details to Chief Engineer, Box 536.

### ELECTRICAL ENGINEER

To act as field engineer in Ohio to service electronic equipment used for testing steel. Some knowledge of metallurgy preferable, but not essential. Advise qualifications, references and salary expected. Box 537.

### PROJECT ENGINEERS

Stamford firm engaged in development and research work with government agencies requires project engineer with technical and practical background in UHF radar work. Salary open depending upon background. Company is young and growing with promising future for able engineers in this kind of work. Box 538.

### ELECTRONIC ENGINEERS

College graduates with 3-5 years of development engineering experience in circuit design. Well versed in magnetic circuits, non-linear circuit operation and electronic theory. Send resume and all particulars to Personnel Department, General Precision Laboratory, Inc., Pleasantville, N.Y.

### RADIO ENGINEERS

Senior and Junior engineers to work on design and development of radio and television components. Send replies to Chief Engineer, Automatic Manufacturing Corporation, 65 Gouverneur Street, Newark 4, N.J.

### RESEARCH AND DEVELOPMENT

Engineers with considerable experience in RF and UHF circuits wanted by large, well established radio company in New York area. Send resume of education and experience to Box 539.

### GRADUATE PHYSICIST

Graduate physicist or electronic engineer with good background in gaseous conduction wanted by established New England radio tube manufacturer, for development work on gas filled tubes. Box 540.

### MATHEMATICIANS, ENGINEERS PHYSICISTS

Men to train in oil exploration for operation of seismograph instruments, computing seismic data, and seismic surveying. Beginning salary \$250.00 to \$300.00 per month depending on back-

(Continued on page 54A)

## WANTED

Middlewestern manufacturer has excellent openings for two engineers:

### CIRCUIT ENGINEER

Must be experienced in measurement work, FM and television frequencies, and have thorough knowledge of the performance characteristics and correct application of ceramic capacitors.

### CERAMIC ENGINEER

Must be experienced in all phases of the development and manufacture of high dielectric ceramic body capacitors.

★ ★ ★

Kindly give full information covering your educational background, practical experience, age, dependents, and compensation expected.

ADDRESS

Box 547

The Institute of Radio  
Engineers

1 East 79th St. New York 21, N.Y.

## ENGINEERS

Attractive positions immediately available for:

### PROJECT ENGINEERS

Experienced in design of automobile radio receivers.

### SENIOR DRAFTSMEN

Experienced in the handling of mechanical layout work and design of automobile radio receivers.

### RADIO ENGINEERS

To handle liaison work with radio and television production department.

In reply give only brief outline of work experience. Standard application blanks will be forwarded if detailed information or personal interview is desired.

Personnel Manager

BENDIX RADIO DIVISION  
Towson 4, Maryland

# GREATEST ADVANCE IN V.O.M. HISTORY

**Beautiful Streamlined Instrument.**

**Large 5 1/2 Inch Meter** in special molded case under panel.

**Resistance Scale Markings** From .2 Ohm To 100 Megohms... Zero Ohms Control Flush With Panel.

**Only one switch**... Has Extra Large Knob 2 1/2" Long... Easy To Turn... Flush With Panel Surface.

**New Molded Selector Switch**... Contacts Are Fully Enclosed... will retain lubrication without dust contamination.

**Batteries Easily Replaced**... New Double Suspended Contacts.

**All Resistors Are Precision Film Or Wire Wound Types...** Sealed For Permanent Accuracy.

**Unit Construction...** Resistors, Shunts, Rectifier, Batteries All Are Housed In A Molded Base Built Right Over The Switch... Provides Direct Connections Without Cabling... No Chance For Shorts.



Inside view cover removed...inverted



## NOTE the Sensational Improvements Model 630

**\$3750** U.S.A. Dealer Net

**Leather Carrying Case \$5.75**  
**ADAPTER PROBE FOR TV**  
**HIGH VOLTAGE TESTS EXTRA**

A completely new Volt-Ohm-Mil-Ammeter that does more... has proved components... and will give a lifetime of satisfaction.

*Precision first... to Last*



### TECH DATA

D.C. VOLTS: 0-3-12-60-300-1200-6000, at 20,000 Ohms/Volt  
A.C. VOLTS: 0-3-12-60-300-1200-6000, at 5,000 Ohms/Volts  
D.C. MICROAMPERES: 0-60, at 250 Millivolts  
D.C. MILLIAMPERES: 0-1.2-12-120, at 250 Millivolts  
D.C. AMPERES: 0-12, at 250 Millivolts  
OHMS: 0-1000-10,000; 4.4 Ohms at center scale on 1000 scale;  
44 Ohms center scale on 10,000 range.  
MEGOHMS: 0-1-100  
DECIBELS: -30 to +4, +16, +30, +44, +56, +70  
OUTPUT: Condenser in series with A.C. Volt ranges

**TRIPLETT ELECTRICAL INSTRUMENT CO. • BLUFFTON, OHIO**

In Canada: Triplett Instruments of Canada, Georgetown, Ontario

# Wanted

## Design Engineers Physicists

Men with a college degree and two to four years design experience should investigate the opportunities offered by the Collins Radio Company. This well-recognized manufacturer of radio equipment has a limited number of positions available for qualified engineers and physicists. These men will work on the design and development of broadcast, communications, radar, and electronic circuits in the design and research departments. Give present position, nature of work, experience, and education in first letter.

ADDRESS DEPARTMENT EP  
COLLINS RADIO COMPANY  
CEDAR RAPIDS, IOWA

## ENGINEERS

**Electronic  
Mechanical  
Electro-Mechanical**

Small progressive company offers excellent opportunities in electronic digital computer field to engineers with research, development, or design experience in video and pulse circuits, computers, servomechanisms, high-speed printers, or small intricate mechanical and electrical instruments.

Write full details of education, experience, and salary requirements to the

**Chief Engineer  
Eckert-Mauchly Computer  
Corporation**

Broad and Spring Garden Streets  
Philadelphia 23, Pa.



(Continued from page 52A)

ground. Excellent opportunity for advancement determined on ingenuity and ability. The work requires changes of address each year; work indoors and out; general location in oil producing locations. Send complete resume and include snapshot to National Geophysical Co., Inc. 8800 Lemmon Ave., Dallas 9, Tex.

### ELECTRONICS ENGINEER

Well known, 40 year old manufacturer of electrical and electronic instruments wants research engineer experienced in design of radio electronic apparatus at high frequencies, for the development of military and civilian test equipment. Box 542.

### PHYSICISTS—ENGINEERS

Opportunities for physicists and electronic engineers at the Naval Ordnance Test Station, P.O. China Lake, California. Applicants should have college degree or equivalent, plus professional experience. Especially desired are applications from persons with experience in design and development of microwave radar components. Send application form 57 to Placement Officer U.S.N.O.T.S., Inyokern, P.O. China Lake, Calif.

### ENGINEERS

A young rapidly expanding mid-western research laboratory has openings for the following types of personnel:

(1) **ELECTRONIC DESIGN ENGINEERS**—Experienced circuit design engineers wanted for indicator timing circuit development.

(2) **SERVO DESIGN ENGINEERS OR PHYSICISTS**—Experience required for the development airborne computer equipment.

Top pay offered to those capable of project responsibility. Local university offers graduate courses in servo and computer design, and applied mathematics. Send complete resume. Our Engineering Dept. knows of this announcement. Box 544.

### ELECTRONIC ENGINEERS—PHYSICISTS

A leading electronics company in Los Angeles, California offers permanent employment to persons experienced in advanced research and development. State qualifications fully. Box 545.

### ELECTRONIC ENGINEER

An opportunity for a man with considerable experience to head a small development and engineering group in a growing company located in Chicago. Pulse experience a necessity and a background of work with nuclear radiation instruments and nuclear detectors very desirable. Please give full details. Box 546.

### RADIO AND TELEVISION ENGINEERS

The Industry Service Laboratory (formerly License Laboratory), New York, has several positions open for Senior and Junior engineers having qualifications for development and consultation work in

(Continued on page 56A)

## Radio and Radar Development and Design Engineers

*Openings at*

**HAZELTINE ELECTRONICS  
CORPORATION**

Little Neck, L.I., N.Y.

Please furnish complete resume of experience with salary expected to:

Director of Engineering Personnel

(All inquiries treated confidentially)

## ENGINEERS - ELECTRONIC

Senior and Junior, outstanding opportunity, progressive company. Forward complete résumés giving education, experience and salary requirements to

**Personnel Department**

**MELPAR, INC.**

452 Swann Avenue  
Alexandria, Virginia

# Midget Miracles for Personal Portables

"Eveready" No. 467, 67½-volt "B" battery with "Eveready" No. 950 1½-volt "A" batteries is the standard power complement for most personal portable radios. Some new designs, however, need batteries of even smaller size. New "Eveready" batteries described below are provided to meet these requirements. Like all other "Eveready" batteries, they are available everywhere and offer users the utmost in service life and ease of replacement.



No. 724 "A" BATTERY

"Eveready" No. 724 6-volt "A" battery for tiny 3-way personal radios. 1 7/32" long, 1 7/32" wide, 2 11/32" high. weighs 2 2/3 oz. Fitted with Flashlight Type terminals.



No. 457 "B" BATTERY

"Eveready" No. 457 67½-volt "B" battery for ultra small and light personal radios. 2 13/16" long, 1 1/8" wide, 2 1/2" high. weighs 7 2/3 oz. Fitted with Snap Type terminals.



No. 736 "A" BATTERY

"Eveready" No. 736 4½-volt "A" battery for 3-way personal radios. Matches "B" battery service. 3 15/16" long, 1 5/16" wide, 4 3/32" high. weighs 1 lb. 1 oz. Terminals: Plug-in: —, +4½.



No. 490 "B" BATTERY

"Eveready" No. 490 90-volt "B" battery for increased power output in personal radios. 3 23/32" long, 1 3/8" wide, 3 45/64" high. weighs 1 lb. 1/2 oz. Terminals: Snap Type: —, +90.

For complete information on these and other "Eveready" radio batteries, send for Battery Bulletin No. 1, 1949 Revision.

The registered trade-marks "Eveready" and "Mini-Max" distinguish products of

**NATIONAL CARBON COMPANY, INC.**

30 East 42nd Street, New York 17, N.Y.

Unit of Union Carbide and Carbon Corporation

**UCC**

Division Sales Offices: Atlanta: • Chicago • Dallas • Kansas City • New York • Pittsburgh • San Francisco



(Continued from page 54A)

television and radio. Good technical education and some experience required. Interesting work, broadening experience, and wide contacts. Write fully to Director, Industry Service Lab., RCA Laboratory Division, 711 Fifth Ave., New York 22, N.Y.

#### X-RAY TUBE ENGINEER

Experienced man familiar with X-ray production and design methods. Excellent opportunity. Salary is open. Call or write Amperex Electronic Corp., 25 Washington St., Brooklyn 1, N.Y.

#### CRYSTAL ENGINEER

Manufacturer of Piezo electric crystals desires experienced engineer familiar with quartz oscillating crystals and their application to radio frequency control. Write full details. Box 548.

#### RESEARCH AND DEVELOPMENT

Wanted for advanced research and development. Should have extensive experience on analysis of electronics systems in the fields of microwaves, missiles, radar, servomechanisms communications, navigational devices. Outstanding ability in E.E. or Physics required. Please furnish complete resume, salary requirements and availability to: Personnel Manager, W. L. Maxson Corporation, 460 West 34th Street, New York, New York.

## WANTED PHYSICISTS ENGINEERS

Engineering laboratory of precision instrument manufacturer has interesting opportunities for graduate engineers with research, design and/or development experience on radio communications systems, Servomechanisms (closed loop), electronic & mechanical aeronautical navigation instruments and ultra-high frequency & microwave technique.

WRITE FULL DETAILS  
TO  
EMPLOYMENT SECTION

## SPERRY GYROSCOPE

COMPANY  
DIVISION OF SPERRY CORP.  
Marcus Ave. & Lakeville Rd.  
Lake Success, L.I.

## WESTINGHOUSE RESEARCH

Openings  
in Pittsburgh

ENGINEER having three or more years experience in radar or television for work on television systems and television receiver research.

ENGINEER or PHYSICIST with experience in underwater acoustics.

PH.D. PHYSICIST with background for working on solid state problems.

ENGINEER or PHYSICIST for work on magnetic circuits and materials.

ELECTRONIC ENGINEER to work on advanced circuit design problems.

ENGINEER or PHYSICIST with three centimeter wave guide experience.

For application address Manager, Technical Employment, Westinghouse Electric Corporation, 306-4th Avenue, Pittsburgh, Pennsylvania

## WANTED ELECTRONIC ENGINEERS AND PHYSICISTS

Excellent opportunities for graduates with research, design, and/or development experience in Communications and aerial navigation systems including direction finders, radar, FM, television, micro-wave.

Write complete details regarding education, experience and salary desired.

To Personnel manager  
Federal Telecommunication  
Laboratories

500 Washington Ave.  
Nutley, New Jersey

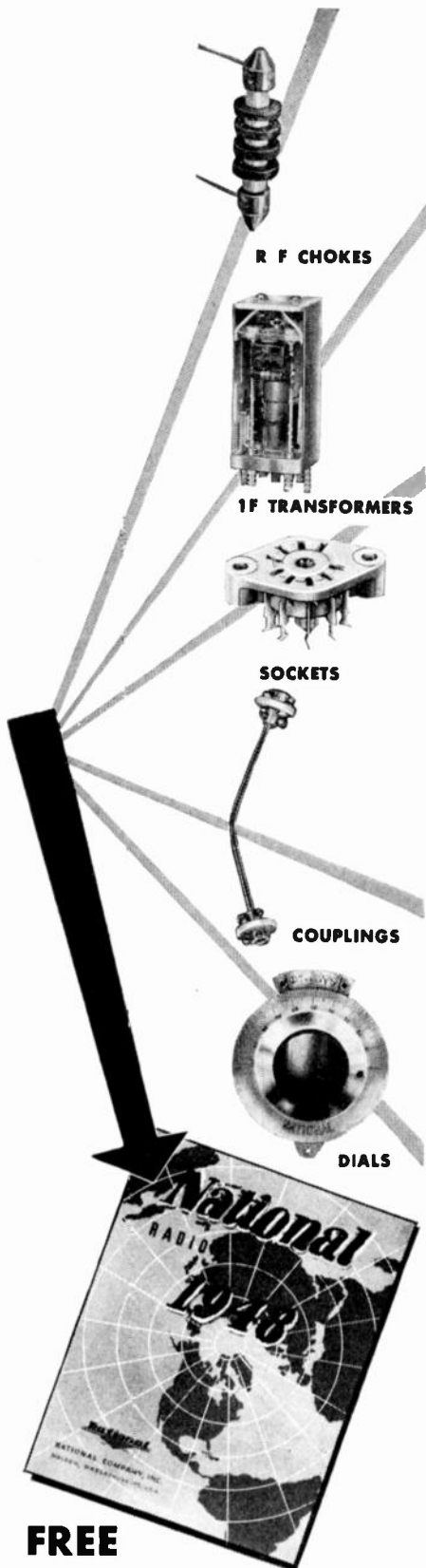

**FREE**

the new 1948 catalog of famous National precision components, parts, and communication receivers.

**WRITE TODAY TO**



Now! Specify

# KENYON



**KENYON** one of the oldest names in transformers, offers high quality specification transformers custom-built to your requirements. For over 20 years the KENYON "K" has been a sign of skillful engineering, progressive design and sound construction.

**KENYON** now serves many leading companies including: Times Facsimile Corporation, Western Electric Co., General Electric Co., Schulmerich Electronics, Sperry Gyroscope Co., Inc. Yes, *electronification* of modern industrial machinery and methods has been achieved by KENYON'S engineered, efficient and conservatively rated transformers.

For all high quality sound applications, for small transmitters, broadcast units, radar equipment, amplifiers and power supplies — Specify KENYON! Inquire today for information about our JAN approved transformers.

Now — for the first time in any transformer catalog, KENYON'S new modified edition tells the full complete story about specific ratings on all transformers. Our standard line saves you time and expense. Send for the latest edition of our catalog now!



**KENYON TRANSFORMER CO., Inc.** 840 BARRY STREET  
NEW YORK 59, N. Y.

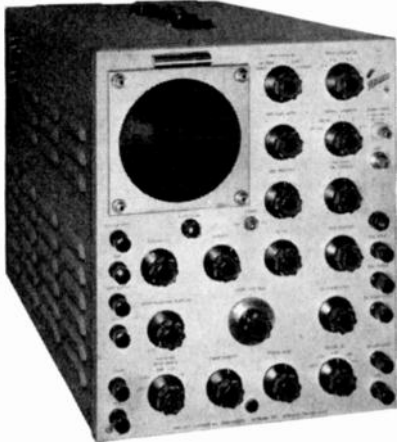

**Tektronix Type 511-A Oscilloscope**

- Wide band vertical amplifiers (10 mc. 1 stage; 8 mc. 2 stages).
- Vertical amplifiers individually adjusted for optimum transient response at high and low frequencies.
- Vertical deflection sensitivity 0.27 V to 200 V per cm. (peak to peak).
- 0.25 microsecond video delay line may be incorporated at nominal charge.

**Price \$795.00 f.o.b. Portland** Your inquiry will bring more detailed information and name of the nearest Field Engineering Representative.

Phone, EAst 6197  
Cables, TEKTRONIX



712 S. E. Hawthorne Blvd.  
Portland 14, Oregon

## AUGMENTED ACCURACY...

The Tektronix Type 511-A Oscilloscope retains all of the features that have made its predecessor, the Type 511, the universally accepted instrument in its category, **PLUS** a completely new power supply providing full regulation in all DC circuits, including the accelerating voltage. Line voltage fluctuation between 105 and 125 volts produces no noticeable effect on image intensity, sweep speed or deflection sensitivity.

The Type 511-A is a truly portable precision instrument—total weight 50 pounds and self-contained.

### TYPE 511-A FEATURES

- Continuously variable sweep speed 0.1 sec. to 1 microsec. (10 cm. deflection).
- Calibrated direct reading sweep speed dial, permitting quantitative measurement to 5% accuracy.
- Choice of triggered, recurrent or single sweeps at all speeds.
- Any 20% of normal sweep may be expanded 5 times.

**3 outstanding books from the M.I.T.**

## RADIATION LABORATORY SERIES

SEE THEM  
10 DAYS FREE

### Electronic Instruments

Vol. 21. Edited by IVAN A. GREENWOOD, JR., General Precision Laboratory, Inc.; J. V. HOLDAM, JR., Laboratory for Electronics, Inc.; and D. MACRAE, JR., Teaching Fellow, Harvard. 721 pages, illustrated, \$9.00

A detailed presentation of the theoretical background and use of electronic analogue computers, instrument servomechanisms, voltage and current regulators, and pulse test equipment. It includes many illustrative examples of practical application of design techniques. A section of the book is devoted to the design of light weight, low-power electronic servomechanisms, and examples taken from various radar and fire-control applications are included.

### Microwave Transmission Circuits

Vol. 9. Edited by GEORGE L. RAGAN, General Electric Research Laboratory. 755 pages, illustrated, \$8.50

Here is a valuable discussion of the practical techniques of power transmission at microwave frequencies. This book describes the theory of operation and complete design procedure of the various components of transmission lines, and shows what considerations are necessary for selecting proper equipment.

### Microwave Magnetrons

Vol. 6. Edited by GEORGE B. COLLINS, Department of Physics, University of Rochester. 806 pages, illustrated, \$9.00

This book includes the theoretical and practical aspects of multicavity magnetrons in the frequency range from 1000 to 24,000 Mc/s and in the power output range from 10 watts to 3,000,000 watts. It gives special attention to starting phenomena, tuning, and frequency stabilization. Practical problems of magnetron design and special applications of the magnetron principle to both pulsed and CW tubes are dealt with in full.



MAIL COUPON TODAY

McGraw-Hill Book Co., 330 W. 42nd St., N.Y.C. 18  
Send me the books checked below for 10 days' examination on approval. In 10 days I will remit total cost of books I keep, plus a few cents postage, and return unwanted books postpaid.\*

- Greenwood, Holdam, and MacRae—Electronic Instruments \$9.00
- Ragan—Microwave Transmission Circuits \$8.50
- Collins—Microwave Magnetrons \$9.00

Name .....  
Address .....  
City ..... Zone ..... State.....  
Company .....  
Position ..... IRE-11-48

\* SAVE! We pay postage and packing charges if you send cash with your order. Same return privilege.

MEASUREMENTS CORPORATION

# TELEVISION STANDARD SIGNAL GENERATOR

## MODEL 90

### SPECIFICATIONS:

#### ● CARRIER FREQUENCY

**RANGE:** Continuously variable from 20 to 250 megacycles, in eight ranges.

**ACCURACY:** Crystal frequency standard permits setting to .01%. Dial scale may be set to .1%.

**STABILITY:** Warm-up drift less than .05%.

**LEAKAGE:** Less than 10 microvolts.

#### ● MODULATION

Continuously variable from zero to 100%.

**ENVELOPE:** Sinusoidal, or composite television. Bandwidth to 3 db is 4 Mc. Rise time from 10% to 90% modulation 0.15 microsecond. Overshoot less than 5%. Slope less than 5% on 60 cycle square wave.

**INPUT IMPEDANCE:** 75 ohms  $\pm$  10% (RMA Standard).

**INPUT LEVEL:** 1.5 volts peak to peak minimum level for 100% modulation. Black negative polarity.

**MODULATION PERCENTAGE:** Zero to 110%; plate modulation.

#### ● OUTPUT

**LEVEL:** Continuously variable from 0.3 microvolt to 0.1 volt balanced to ground (measured at 100% modulation level).

**IMPEDANCE:** (a) 107 ohms line to line (balanced).

(b) 53.5 ohms line to ground (unbalanced).

(c) Suitable pads may be employed to alter these impedances.

#### ● DIMENSIONS

**OVERALL:** Height—58 $\frac{1}{2}$ "; Width—28 $\frac{1}{2}$ "; Depth—25 $\frac{1}{2}$ ".

**WEIGHT:** Model 90—302 pounds.

External Voltage Regulator 92 pounds.

**POWER SUPPLY:** 117 volts, 60 cycles.

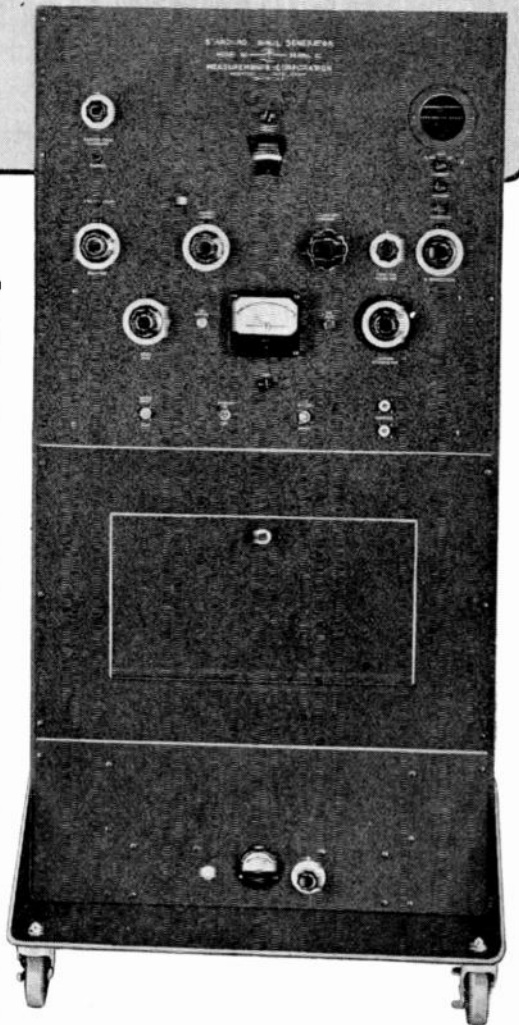

### THE FIRST COMMERCIAL WIDE-BAND, WIDE-RANGE SIGNAL GENERATOR EVER TO BE DEVELOPED

The Model 90 employs a master oscillator, buffer amplifier and modulated power amplifier. The push-pull buffer eliminates incidental frequency modulation.

**Features:** A self-contained crystal calibrator and individually calibrated dial scales permit frequency settings to a high degree of accuracy. A built-in video modulator with manual or automatic dc inserter, designed to operate from a standard RMA composite signal. Continuous monitoring is provided by built-in oscilloscope.

This signal generator meets the most exacting standards required for high definition television use.

ADDITIONAL DATA ON REQUEST

MANUFACTURERS OF  
Standard Signal Generators  
Pulse Generators  
FM Signal Generators  
Square Wave Generators  
Vacuum Tube Voltmeters  
UHF Radio Noise & Field  
Strength Meters  
Capacity Bridges  
Megohm Meters  
Phase Sequence Indicators  
Television and FM Test  
Equipment

**MEASUREMENTS CORPORATION**  
BOONTON NEW JERSEY



## Positions Wanted By Armed Forces Veterans

In order to give a reasonably equal opportunity to all applicants, and to avoid overcrowding of the corresponding column, the following rules have been adopted:

The Institute publishes free of charge notices of positions wanted by I.R.E. members who are now in the Service or have received an honorable discharge. Such notices should not have more than five lines. They may be inserted only after a lapse of one month or more following a previous insertion and the maximum number of insertions is three per year. The Institute necessarily reserves the right to decline any announcement without assignment of reason.

#### ELECTRICAL ENGINEER

McGill University B.E.E. 1948. Desires television, radio or industrial electronics work in design production or research. Canadian Army radar training. Box 180W.

#### ELECTRONIC ENGINEER

10 years experience in research, design, development and supervision with automotive and aircraft fields and guided missile projects. Seeking administrative position. Aggressive; personable. Box 188W.

#### ENGINEER

S.B.E.E. M.I.T. June 1948, major in electronics, minor in servomechanisms. Mechanical Engineering Ohio State University in Army S.T.P., Major in Internal combustion engines. Experience: 6 months Machine Shop, 1 $\frac{1}{2}$  years inspector and designer in precision bearing manufacturing. 1 $\frac{1}{2}$  years industrial engineering in Manhattan project. Age 27. Single. Prefer development work but would like to hear from any firm for which I can be an asset. Box 189W.

#### RADIO ENGINEER

English radio engineer seeks position in communications. Fully qualified by examination. 12 years experience. Leslie F. Bennett, c/o Mercantile Trust Bank, Baltimore, Md.

#### JUNIOR ENGINEER

Electrical Engineer graduate. Age 24. Single. B.S.E.E. February 1948. Some experience in television field. Seeks interesting position with good company in New York City area. Box 190W.

#### ELECTRONIC ENGINEER

Recent New York University graduate B.S.E.E. Age 27. Single. Excellent experience in electronics. Desires position in electronic circuit design and development in New York metropolitan area. Resume on request. Box 191W.

(Continued on page 59A)



## Positions Wanted

(Continued from page 58A)

### TELEVISION ENGINEER

Graduating American Television Institute of Technology November 1948 with B.S.T.E. Age 26. Married. 1st class F.C.C. license. 4 years maintenance Navy radio equipment. Trained in Operation and Maintenance of R.C.A. Image Orthicon and DuMont equipment. Desires position in television broadcasting field. Box 192W.

### JUNIOR ENGINEER

Three years electrical engineering college, major in electronics, continuing studies for B.S. in E.E. at night. Desires work as Junior Engineer in design and development of communication equipment under Senior Engineer. Prefer Long Island. Box 193W.

### ENGINEER

Graduating University of Michigan August 1948 with B.S.E.E. in communications. Age 24. Married. Two years Army radar (G.C.A.) Two years shop experience. Interested in sales or development engineering. Prefer midwest area. Box 194W.

### JUNIOR ENGINEER

Graduate R.C.A. Institutes. Age 27. Married, 1 child. Desires work West Coast in television, radio, electronics research or development. Limited Air Force experience. Ambitious, persevering. Box 195W.

### ENGINEER

Experienced in electrical, electronics and mechanical fields. Desire permanent position in management with West Coast firms. Can handle men. Age 33, B.S. in E.E. Available this fall. Interview at your expense; brochure free to interested firms. Box 202W.

### TECHNICAL EXECUTIVE

Engineering Physicist, MA, Gold medalist, 30, experienced in radio, radar and X-ray, division manager Montreal branch of European concern wants change to progressive North American concern that can use his talents not necessarily in these fields. Box 203W.

### ELECTRONIC ENGINEER

Currently engaged in production, design and development work for capacitor manufacturer, desires position in electronic industry within Chicago area. B.S.E.E. January 1948 Illinois Institute of Technology. Communications major. Age 25. Married. Two years Navy Electronic experience including supervision of Radio Teletype Station. Box 204W.

## AN ENTIRELY NEW

# *Dependable*

## AUTOMATIC DEHYDRATOR

BY

# *Andrew*



For pressurizing  
coaxial systems  
with dry air

WRITE FOR  
BULLETIN

85

Now, for the first time, here is an automatic dehydrator that operates at line pressure! This means, (1) longer life, and (2) less maintenance and replacement cost than any other automatic dehydrator.

Longer life because the compressor diaphragm operates at only 1/3 the pressure used in comparable units, vastly increasing the life of this vulnerable key part.

Reduced maintenance and replacement costs because new low pressure design eliminates many components.

Operation is completely automatic. Dehydrator delivers dry air to line when pressure drops to 10 PSI and stops when pressure reaches 15 PSI. After a total of 4 hours' running time on intermittent operation, the dry air supply is turned off and reactivation begins, continuing for 2 consecutive hours. Absorbed moisture is driven off as steam. Indicators show at a glance which operation the dehydrator is currently performing.

Output is 1/4 cubic feet per minute, enough to serve 700 feet of 6 1/8" line; 2500 feet of 3 1/8" line; 10,000 feet of 1 1/8" line or 40,000 feet of 7/8" line. Installation is simple, requiring only a few moments.

Important! Not only is this new differently designed Andrew Automatic Dehydrator completely reliable, but it is available at a surprisingly low price.

# Andrew

CORPORATION

363 E. 75th STREET, CHICAGO 19

Eastern Office:

421 Seventh Avenue, New York City

ANDREW

TRANSMISSION LINES FOR AM, FM,  
TV, DIRECTIONAL ANTENNA EQUIP-  
MENT, ANTENNA TUNING UNITS, TOWER  
LIGHTING EQUIPMENT, CONSULTING  
ENGINEERING SERVICE.

MAIL  
COUPON  
NOW!

ANDREW CORPORATION, 363 E. 75th St., Chicago 19  
Please send me Bulletin 85 describing the new Type 1900  
Andrew Automatic Dehydrator.

Name \_\_\_\_\_

Title \_\_\_\_\_

Company \_\_\_\_\_

Address \_\_\_\_\_

City \_\_\_\_\_ Zone \_\_\_\_\_ State \_\_\_\_\_

IRE 11-48

**New! All inclusive!**



**STANDARD LINE OF TRANSMITTER COMPONENTS**

FOR AM, FM AND TV—LABORATORY AND INDUSTRIAL APPLICATIONS

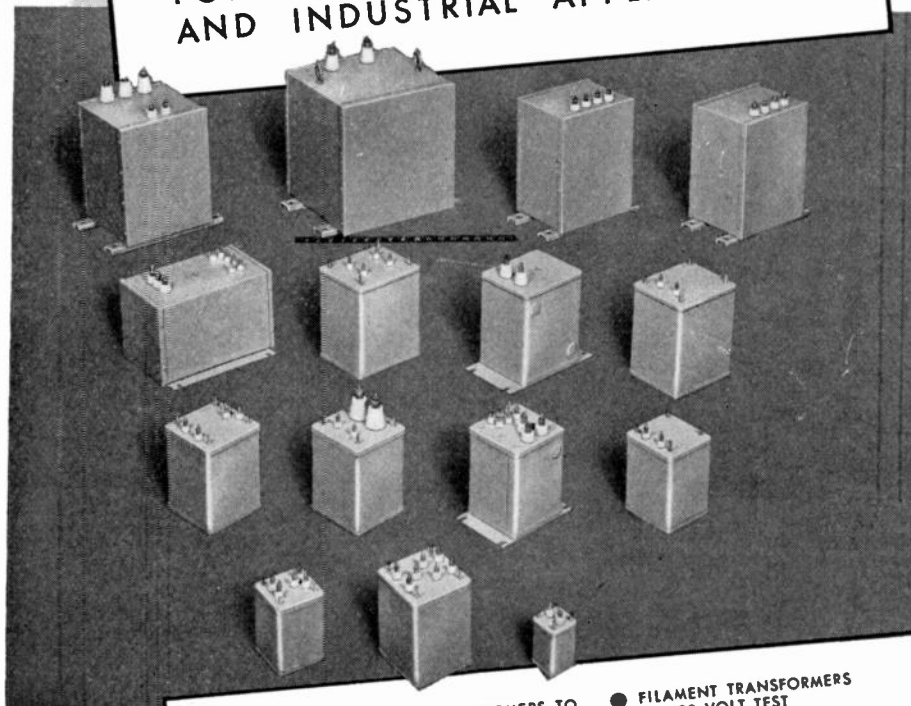

**INCLUDING —**

**FEATURING —**

- PLATE TRANSFORMERS TO 10 KVA
- FILTER REACTORS
- 115/230 VOLT, 50/60 CYCLE SUPPLY
- RUGGED INTERNAL CONSTRUCTION, SUPPORTED CORE STRUCTURE
- EYE BOLTS ON LARGE UNITS FOR EASY HANDLING
- FILAMENT TRANSFORMERS TO 15,000 VOLT TEST
- PLATE FILAMENT TRANSFORMERS LOW VOLTAGE
- AIEE SURGE TEST ON HIGH VOLTAGE UNITS
- EFFICIENT MAGNETIC AND ELECTRO-STATIC SHIELDING
- UNIFORM STREAMLINED APPEARANCE
- STURDY STEEL CASES

Here is one of the finest and most complete lines of standard transmitter components available today. Built to the same well-known high standards as N·Y·T custom-built units, they bring to the design engineer the full economy of standardized construction. Superbly constructed, inside and out, each unit fully reflects the years of experience that have made the name NEW YORK TRANSFORMER synonymous with quality, integrity and dependability wherever inductive components are used.

**WRITE FOR CATALOG**

**NEW YORK TRANSFORMER CO., INC.**  
ALPHA, NEW JERSEY

**News—New Products**

These manufacturers have invited PROCEEDINGS readers to write for literature and further technical information. Please mention your I.R.E. affiliation.

(Continued from page 48A)

**Model OL-15B Oscillosynchroscope**

The Model OL-15B Oscillosynchroscope, which is a new laboratory instrument for observation of transient and recurrent phenomena involving wide ranges of frequencies, is being manufactured by The Browning Laboratories, Inc., 742-750 Main St., Winchester, Mass.

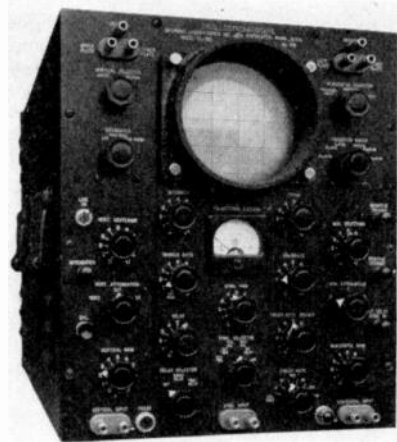

A 5-inch cathode ray tube with 4000 volts accelerating potential provides superior intensity and definition of images. Other features include a vertical amplifier bandwidth of 6 Mc, recurrent sweeps of 5 to 500,000 per second and driven sweep rates of 0.25 to 200 microseconds per inch. An internal trigger generator is also provided, as well as a variable delay circuit which may be used to provide delayed triggers or a delayed sweep either internally or externally triggered. A calibration device provides measurement of deflection sensitivity through the amplifier.

The vertical amplifier, which is linear without positive slope from 10 cps to 6 Mc, has a transient response such that a 100-kilocycle square wave which rises or falls at the rate of 500 volts per microsecond is faithfully reproduced.

Dimensions: 13 $\frac{1}{4}$ " $\times$ 14 $\frac{3}{4}$ " $\times$ 19 $\frac{3}{4}$ ", weight 95 lbs.

**Recent Catalogs**

••• On a volt-ohm-milliammeter with a direct current sensitivity of 20,000 ohms per volt. Classified as the Roto-Ranger this instrument is being manufactured by Simpson Electric Co., 5200-18 W. Kinzie St., Chicago 44, Ill.

••• A 15 page illustrated bulletin, No. CDP-578, describing molded and laminated plastics, and an 8 page illustrated bulletin, No. CDM-12 describing metallurgical products by the General Electric Co., Chemical Dept., Pittsfield, Mass.

(Continued on page 63A)

# QUICK AS AN ELECTRONIC WINK

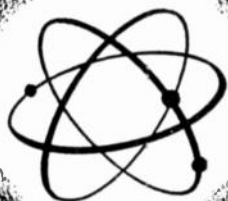

That's how fast a STABILINE Automatic Voltage Regulator corrects line voltage fluctuations. Type IE (Instantaneous Electronic) has no moving parts — is completely electronic in operation. Designed to act instantaneously— with a waveform distortion not exceeding 3 percent — and to keep output voltages stable within  $\pm 0.1$  of 1 percent of the preset value, regardless of line variations. For any load current change or load power factor change from lagging .5 to leading .9, the STABILINE Type IE will hold the output to within  $\pm 0.15$  volts of nominal. Various models available in numerous ratings.

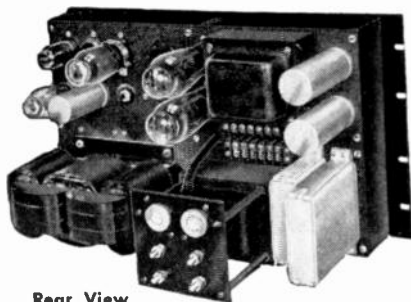

Rear View  
STABILINE Type IE

Bulletin 547 gives you information on this and other Superior Electric voltage control equipment. Write for your copy today.

THE  
**SUPERIOR ELECTRIC  
COMPANY**

811 MEADOW STREET  
BRISTOL, CONN.



## NEW . . . HIGH PRECISION 2-inch POTENTIOMETER

DESIGNED TO MEET  
HIGH STANDARDS  
DEMANDED BY COMPUTER  
AND MILITARY APPLICATIONS

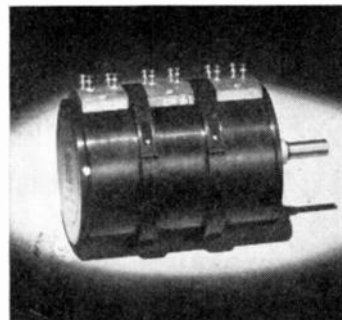

#### Mechanical Specifications

- Precision machined aluminum base and cover 2" diameter, 1" depth.
- Precision phosphor bronze bushing.
- Centerless ground stainless steel shaft.
- No set screws.
- Mechanical rotation—360°.
- Clamping method of gauging permits individual adjustment of angular position.

#### Electrical Specifications

- Winding—both linear to 0.2% and non-linear to 1% accuracies.
- Paliney contact to winding; two-brush rotor take-off assembly with precious metal contacts.
- High, uniform resolution provided by our method of winding non-linear resistances.
- Electrical rotation maximum 320°.
- All soldered connections (except sliding contacts).

This general line of precision potentiometers was developed in collaboration with the Fire Control Section of the Glenn L. Martin Company.

Write for Bulletin 2011 with complete details.



**TECHNOLOGY INSTRUMENT CORP.**  
1058 MAIN STREET, WALTHAM 54, MASS.

Midwest Office: Alfred Crocley & Associates, 540 W. Randolph St., Chicago 6, Illinois, State 7444



## PILOT LIGHT ASSEMBLIES

PLN SERIES—Designed for  
NE-51 Neon Lamp



#### Features

- THE MULTI-VUE CAP
- BUILT-IN RESISTOR
- 110 or 220 VOLTS
- EXTREME RUGGEDNESS
- VERY LOW CURRENT

Write for descriptive booklet

**The DIAL LIGHT CO. of AMERICA**

FOREMOST MANUFACTURER OF PILOT LIGHTS  
900 BROADWAY, NEW YORK 3, N. Y.

Telephone—Spring 7-1300

# SOLDERING IS A CINCH



when you know these SIMPLE TRICKS!

SEND NOW ONLY 10¢

No matter how much you know about soldering, there's always a trick that will make it easier. This little 20-page pocket guide is crammed full of such time-and-trouble savers.

Without wasting words, it covers the whole soldering operation—points out DO's and DON'T's—refreshes your memory on difficult points—suggests methods that help you work faster. Yet there's no hard studying, no tough technical talk. Every word is plain everyday English and every point is made clear by easy-to-understand illustrations.

Get this handy Soldering Guide today, and keep it on your bench for ready reference. It's a real handbook of professional soldering—not a catalog. Just mail the coupon with 10c cash or stamps and we'll send your copy at once.



When you send for your Guide to Easy Soldering, be sure to ask about the New Weller Soldering Guns. They're a handful of convenience, better from tip to grip.

## WELLER MANUFACTURING COMPANY

821 Packer Street, Easton, Penna.

Weller Mfg. Co., Easton, Pa.

Enclosed find ten cents (10c) for which please send my copy of the Weller "Soldering Tips".

I am also interested in the new Weller Soldering Guns. Please send Catalog Bulletin.

Name \_\_\_\_\_

Address \_\_\_\_\_

City \_\_\_\_\_ State \_\_\_\_\_

# Only with CO-AX

## air-spaced articulated R.F. CABLES

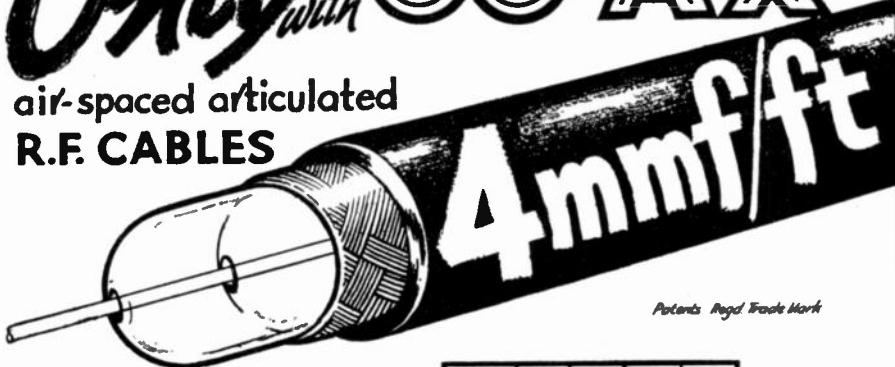

Patents Regd Trade Mark

### THE LOWEST EVER CAPACITANCE OR ATTENUATION

We are specially organised to handle direct enquiries from overseas and can give

**IMMEDIATE DELIVERIES FOR EXPORT**

*Write or cable for data sheets or deliveries to the Originators of Flexible air-spaced R.F. Cables*

**TRANSRADIO LTD**  
CONTRACTORS TO H.M. GOVERNMENT  
13 BA CROMWELL ROAD - LONDON SW7 ENGLAND  
CABLES, TRANSRAD, LONDON.

LOW ATTEN TYPES	IMPED OHMS	ATTEN db/100ft of 100 Mcs.	LOADING $K\omega$	O.D."
A 1	74	1.7	0.41	0.36
A 2	74	1.3	0.24	0.44
A 34	73	0.6	1.5	0.88

HIGH POWER FLEXIBLE

LOW CAPAC TYPES	CAPAC mmf/ft.	IMPED OHMS	ATTEN db/100ft 100Mcs.	O.D."
C 1	7.3	150	2.5	0.36
PC 1	10.2	132	3.1	0.36
C 11	6.3	173	3.2	0.36
C 2	6.3	171	2.15	0.44
C 22	5.5	184	2.8	0.44
C 3	5.4	197	1.9	0.64
C 33	4.8	220	2.4	0.64
C 44	4.1	252	2.1	1.03

PHOTOCELL CABLE

V.L.C. ★

★ Very Low Capacitance cable

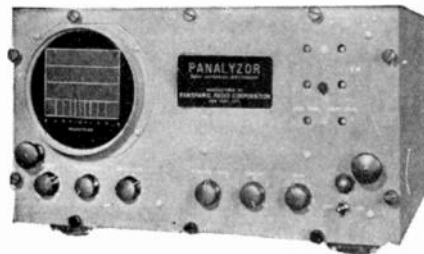

Designed for

## YOUR APPLICATION PANADAPTOR

Whether your application of spectrum analysis requires high resolution of signals closely adjacent in frequency or extra broad

spectrum scanning, there is a standard model Panadaptor to simplify and speed up your job. Standardized input frequencies enable operation with most receivers.

	MODEL SA-3 TYPES						MODEL SA-6 TYPES		
	T-50	T-100	T-200	T-1000	T-1000	T-6000	T-1000	T-10000	T-20000
Maximum Scanning Width	50KC	100KC	200KC	1MC	1MC	6MC	1MC	10MC	20MC
Input Center Frequency	455KC	455KC	455KC	5.25MC	10.2MC	30MC	5.25MC	30MC	30MC
Resolution at Maximum Scanning Width	2.5KC	3.4KC	4.4KC	11KC	11KC	25KC	11KC	75KC	91KC
Resolution at 20% of Maximum Scanning Width	1.9KC	2.7KC	4KC	9KC	7.5KC	22KC	7.5KC	65KC	75KC

Investigate these

**APPLICATIONS OF PANADAPTOR**

- \*Frequency Monitoring
- \*Oscillator performance analysis
- \*FM and AM studies

WRITE NOW for recommendations, detailed specifications, prices and delivery time.

# PANORAMIC RADIO CORP.

92 Gold St. New York 7, N. Y.

Cable Address PANORAMIC, NEW YORK

Exclusive Canadian Representative: Canadian Marconi, Ltd.

Wire drawn to  
.0004" diameter.

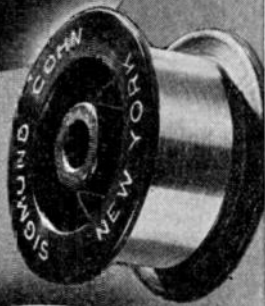

WIRE & RIBBON  
MICRODIMENSIONAL  
FOR VACUUM TUBES



Ribbon rolled to  
.0001" thickness.



Alloys for  
Special requirements.

WRITE for list  
of stock alloys.

**SIGMUND COHN CORP.**

43 GOLD ST., NEW YORK

SINCE 1901



## News—New Products

These manufacturers have invited PROCEEDINGS readers to write for literature and further technical information. Please mention your I.R.E. affiliation.

(Continued from page 60A)

### Extreme Temperature Range Capacitors

The Sprague Prokar capacitors, designed to comply with unusual temperature extremes to which military electronic equipment is subjected, are now in mass production and available from the Sprague Electric Co., North Adams, Mass.

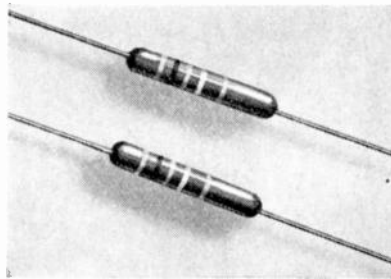

It is claimed that these small, new molded tubulars are impregnated with a new high-temperature plastic that permits a considerable size and performance advantage at high temperatures over other known impregnants and provides stable performance under all operating conditions.

They are rated for operation from  $-50^{\circ}\text{C}$  to  $+125^{\circ}\text{C}$ . Full details are available in the company's Engineering Bulletin 221.

### Fluorescent Lamp Capacitor

For use in cold-cathode fluorescent lamp equipment, the Type KX-103 capacitor is now being produced by Cornell-Dubilier Electric Corp., South Plainfield, N. J.

Three capacitor elements are combined in a rectangular case  $2\frac{1}{8}'' \times 2\frac{13}{16}'' \times 2\frac{3}{8}''$ .

The specifications are: 0.006–0.006  $\mu\text{f}$ , 750 volts ac, and 0.51  $\mu\text{f}$ , 1050 volts ac. The same type and style is available in other capacity combinations, single or multiple units, at voltages up to 1200 volts ac.

### Recent Catalogs

••• "Micro Tips," Volume 1, No. 2, has useful suggestions concerning applications of snap-action switches, published by Micro Switch, Freeport, Ill.

••• A catalog sheet describing the new series 710, electronically regulated power supplies, by Furst Electronics, 800 W. North Ave., Chicago 22, Illinois.

(Continued on page 64A)

## What are Your TRANSFORMER SPECIFICATIONS?

Would a slight change from the "standard" electrical specifications improve the performance of your finished product? If so, get in touch with Acme Electric engineers for assistance in designing a "special" transformer from standard parts.

For television, radio, and other electronic applications, Acme produces a wide variety of transformers all with different specifications from standard parts. This means better performance, better quality and often at economy prices.

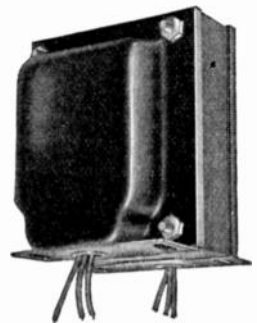

### ENCLOSED TYPES



The dies for making transformers that fit into this enclosed case, alone would cost you thousands of dollars. Acme produces to save you this expense.

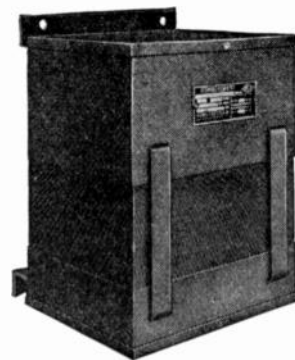

Here is a typical air-cooled design which can be produced to meet a variety of applications. Write for Bulletin 168A for further details.

**ACME ELECTRIC CORP.**

4411 WATER ST.

CUBA, N. Y.

**Acme Electric**  
TRANSFORMERS

## Save Time... Speed Assembly with CTC ALL-SET Boards!

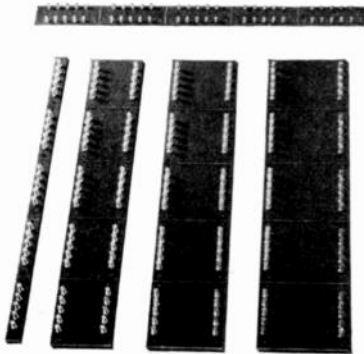

On the assembly line and in the laboratory, CTC ALL-SET Boards are valuable time-savers.

With Type 1558 Turret Lugs, a new board now offers mounting for miniature components. 1 1/16" wide, 3/32" thick, only. (Type X1401E.)

With Type 1724 Turret Lugs, boards come in four widths: 1/2", 2", 2 1/2", 3" — in 3/32", 1/8", 3/16" thicknesses.

With the addition of the new miniature board, CTC ALL-SET Boards now cover the entire range of components.

All boards are of laminated phenolic, in five-section units, scribed for easy separation. Each section drilled for 14 lugs. Lugs solidly swaged into precise position... whole board ready for your assembly line.

### SPECIAL PROBLEMS

Custom-built boards are a specialty with CTC. We're equipped to handle many types of materials including the latest types of glass laminates... many types of jobs requiring special tools... and all types of work to government specifications. Why not drop us a line about *your* problem? No obligation, of course.

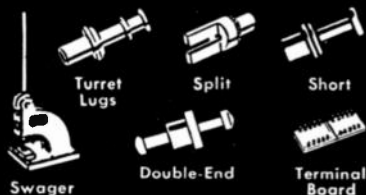

Custom or Standard  
The Guaranteed  
Components

CAMBRIDGE THERMIONIC CORPORATION

456 Concord Avenue, Cambridge 38, Mass.

## News—New Products

These manufacturers have invited PROCEEDINGS readers to write for literature and further technical information. Please mention your I.R.E. affiliation.

(Continued from page 63A)

### Studio Type Ribbon Microphone

Amperite Co., Inc., 561 Broadway, New York 12, N. Y., has announced their new high-fidelity ribbon microphone for broadcast, sound recording, and quality public address applications. Covering 40 to 14,000 cps with an output of -56 dbm, it will find acceptance for use in existing studio speech input systems.



Its smooth response will avoid feedback troubles in public address uses, and the low distortion factor claimed by the maker, 1%, makes its use suitable in FM and video sound applications.

### 10 Watt All Triode Amplifier

Brook Electronics, Inc., 34 DeHart Place, Elizabeth, N. J. in response to many requests have commenced production on a low-powered model of their well-known all-triode amplifier, rated at a normal output of 10 watts, but capable of handling transients of much greater power with the low distortion percentages obtained from triode operation.

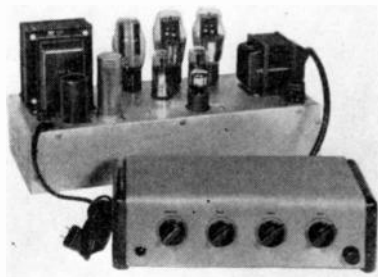

Two models are offered with the preamplifiers mounted remotely from the main amplifier chassis, or directly thereon, according to the convenience of the user and his preference. In either case, full tone controls are incorporated, working through selector switches, to afford boost or attenuation at each end of the audio spectrum. Provision is included for a radio tuner and crystal or magnetic cartridge reproducers, with the proper equalization for the latter accessories, inbuilt within the amplifier.

(Continued on page 67A)



## LINEAR AMPLIFIER

A-10-A-A

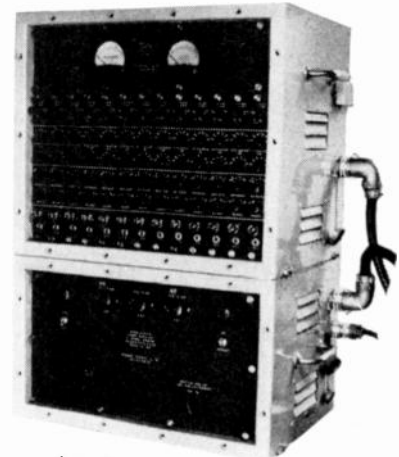

A-10-P-A

13 Channel Linear Amplifier has been specifically designed to operate low impedance type of galvanometer oscillographs. The output of the amplifier is 1.3 ohms, and full output voltage is 230 millivolts. The low output impedance and high output voltage permit loading down galvanometers of higher impedance, thus improving their frequency response. For example, if 40 ohm galvanometer with response up to 2KC be loaded down, the performance will be flat up to 5KC. The unit consists of A-10-A-A 13 channel amplifier, A-10-P-A power supply and A-10-C-A accessories (including cables, test jigs, etc.).

Each channel is a plug in unit containing all controls including metering. Spare units are available.

### ALSO MANUFACTURERS OF

#### POCKETSCOPES

Model S-10-A

Model S-10-B

Model S-11-A

#### RACK MOUNTED OSCILLOSCOPES

Model S-12-A

#### 3" RAYONIC CATHODE RAY TUBE

Model 3MP1

#### RAYONIC CATHODE RAY TUBE

ACCESSORIES

Model 3MP

For additional technical data on any of the above, please write:

**WATERMAN PRODUCTS CO., INC.**  
PHILADELPHIA 25, PA.

## PROFESSIONAL CARDS

**W. J. BROWN**  
*Consulting Engineer*  
**INDUSTRIAL ELECTRONICS  
 RADIO AND TELEVISION**  
 25 years active electronic development  
 experience  
 P.O. Box 5106, Cleveland, Ohio  
 Telephone & Telegrams Yellowstone 7771  
 Office: 501 Marshall Building

**EDWARD J. CONTENT**  
*Acoustical Consultant*  
**Functional Studio Design**  
 FM • Television • AM  
 Audio Systems Engineering  
 Roxbury Road Stamford 8-7459  
 Stamford, Conn.

**PAUL GODLEY CO.**  
*Consulting Radio Engineers*  
 P.O. Box J, Upper Montclair, N.J.  
 Offs. & Lab.: Great Notch, N.J.  
 Phone: Little Falls 4-1000  
 Established 1926

**HERMAN LEWIS GORDON**  
 Registered Patent Attorney  
 Patent Investigations and Opinions  
 1416 F Street, N.W. 100 Normandy Drive  
 Washington 4, D.C. Silver Spring, Md.  
 National 2497 Shepherd 2433

Samuel Gubin, Electronics  
 G. F. Knowles, Mech. Eng.  
**SPECTRUM ENGINEERS, Inc.**  
*Electronic & Mechanical Designers*  
 540 North 63rd Street  
 Philadelphia 31, Pa.  
 GRanite 2-2333; 2-3135

**EUGENE MITTELMANN, E.E., Ph.D.**  
*Consulting Engineer & Physicist*  
**HIGH FREQUENCY HEATING  
 INDUSTRIAL ELECTRONICS  
 APPLIED PHYSICS &  
 MATHEMATICS**  
 549 W. Washington Blvd. Chicago 6, Ill.  
 Phone: State 8021

**ARTHUR J. SANIAL**  
*Consulting Engineer*  
 Loudspeaker Design; Development; Mfg.  
 Processes. High Quality Audio Systems.  
 Announcing Systems. Test and Measuring  
 Equipment Design.  
 168-14 32 Ave. Flushing, N.Y.  
 FLushing 9-3574

ONE OF A SERIES

# Uniform Damping



## WHY BURLINGTON PANEL INSTRUMENTS PROVIDE UTMOST RELIABILITY . . .



MAGNETIC SHUNT as used by Burlington insures uniform damping characteristics. All ranges AC and DC available in 2 1/2", 3 1/2", 4 1/2" rectangular or round case styles and are fully guaranteed for one year against defects in workmanship or material. Refer inquiries to Dept. I 118.



**INSTRUMENT COMPANY**  
BURLINGTON, IOWA

# Measure Frequencies



- **INSTANTLY** . . . direct reading. No computation.
- **ACCURATELY** . . . to a frequency determination of 0.05%.
- **VISUALLY** . . . at the turn of the dial indicator knob.

Used effectively in leading laboratories, such as: Harvard University, Bell Aircraft Corp., and Hamilton Standard Propellers . . . for measuring natural frequencies or speed of rotating objects, checking or calibrating tachometers, oscillators, impulse generators, similar equipment.

**C. G. CONN LTD., DEPT. 1113  
 ELKHART, IND.**



*Write for  
Free Folder*



Please send free Strobocorr folder containing information about operation and application of this new precision instrument. I understand this places me under no obligation.

Name \_\_\_\_\_ Position \_\_\_\_\_

Company \_\_\_\_\_

Address \_\_\_\_\_

City \_\_\_\_\_ Zone \_\_\_\_\_ State \_\_\_\_\_

# INDEX AND DISPLAY ADVERTISERS

Section Meetings ..... 34A  
 Membership ..... 36A  
 Positions Open ..... 50A  
 Positions Wanted ..... 58A  
 News-New Products ..... 30A

## DISPLAY ADVERTISERS

Acme Electric Corp. .... 63A  
 Aerovox Corp. .... 26A  
 American Phenolic Corp. .... 44A  
 Ampere Electronic Corp. .... Cover II  
 Andrew Corporation ..... 59A  
 Arnold Engineering Co. .... 22A  
 Astatic Corp. .... 36A  
 Barker & Williamson ..... 45A  
 Bell Telephone Laboratories ..... 14A  
 Bendix Aviation Corp. (Scintilla Div.) ... 31A  
 Bendix Aviation Corp. (Radio Div.) ... 52A  
 Blaw-Knox ..... 28A  
 Bliley Electric Co. .... 30A  
 W. J. Brown ..... 65A  
 Burlington Instrument Co. .... 65A  
 Burnell & Co., Inc. .... 27A  
 Cambridge Thermionic Corp. .... 64A  
 Cannon Electric Development Co. .... 30A  
 Capitol Radio Engineering Inst. .... 66A  
 Centralab ..... 10A  
 Cleveland Container Co. .... 11A  
 Sigmund Cohn Corp. .... 63A  
 Collins Radio Co. .... 54A  
 Communications Equipment Co. .... 37A  
 C. G. Conn, Ltd. .... 65A  
 E. J. Content ..... 65A  
 Cornell-Dubilier Electric Corp. .... Cover III  
 Curtiss-Wright Corp. .... 52A  
 Dial Light Co. of America ..... 61A  
 Allen B. DuMont Laboratories ..... 6A, 49A  
 Eckert-Mauchly Computer Corp. .... 54A  
 Eitel-McCullough, Inc. .... 16A  
 Electrical Reactance Corp. .... 21A  
 Electro-Motive Mfg. Co., Inc. .... 13A  
 Erie Resistor Corp. .... 9A  
 Federal Telecommunication Labs. .... 56A  
 General Electric Co. .... 5A, 19A, 25A, 46A  
 General Radio Co. .... Cover IV  
 Gilfillan ..... 42A & 43A  
 Paul Godley ..... 65A  
 H. L. Gordon ..... 65A  
 Samuel Gubin ..... 65A  
 Hazeltine Electronics Corp. .... 54A  
 Hewlett-Packard Co. .... 23A  
 Iliffe & Sons ..... 47A  
 International Resistance Co. ....  
 ..... Facing 16A and 17A

Kahle Engineering Co. .... 66A  
 Kenyon Transformer Co., Inc. .... 57A  
 Kollsman Instrument Division ..... 41A  
 McGraw-Hill Book Co. .... 57A  
 P. R. Mallory & Co., Inc. .... 18A  
 Glenn L. Martin Co. .... 50A  
 Measurements Corp. .... 58A  
 Melpar, Inc. .... 54A  
 Eugene Mittelmann ..... 65A  
 Mycalex Corp. of America ..... 38A & 39A  
 National Carbon Co., Inc. .... 55A  
 National Co. .... 56A  
 Newark Electric Co. .... 67A  
 New York Transformer Co., Inc. .... 60A  
 Ohmite Mfg. Co. .... 17A  
 Panoramic Radio Corp. .... 62A  
 Philco Corp. .... 50A  
 Premax Products ..... 67A  
 Presto Recording Corp. .... 15A  
 Radio Corp. of America ..... 32A, 51A, 68A  
 Raytheon Mfg. Co. .... 24A  
 Reeves-Hoffman Corp. .... 48A  
 Revere Copper & Brass, Inc. .... 8A  
 A. J. Sanial ..... 65A  
 Sherron Electronics Co. .... 1A  
 Shure Brothers, Inc. .... 34A  
 Simpson Electric Co. .... 29A  
 Sorensen & Co., Inc. .... 12A  
 Sperry Gyroscope Co., Inc. .... 56A  
 Sprague Electric Co. .... 4A  
 Stackpole Carbon Co. .... 33A  
 Superior Electric Co. .... 61A, 67A  
 Sylvania Electric Prod. Co., Inc. .... 20A  
 Technology Instrument Corp. .... 61A  
 Tektronix, Inc. .... 57A  
 Transradio, Ltd. .... 62A  
 Triplett Elec. Inst. Co. .... 53A  
 Truscon Steel Co. .... 40A  
 United Transformer Co. .... 7A  
 Waterman Products ..... 64A  
 Weller Mfg. Co. .... 62A  
 Western Electric Co. .... 2A & 3A  
 Westinghouse Electric Corp. .... 56A  
 Weston Electrical Inst. Corp. .... 35A



**ELECTRON TUBE  
 MACHINERY OF  
 ALL TYPES**

**STANDARD  
 AND SPECIAL  
 DESIGN**

*We specialize in Equipment and  
 Methods for the Manufacture of*

- RADIO TUBES
- CATHODE RAY TUBES
- FLUORESCENT LAMPS
- INCANDESCENT LAMPS
- NEON TUBES
- PHOTO CELLS
- X-RAY TUBES
- GLASS PRODUCTS

**Production or  
 Laboratory Basis**

*Manufacturers contemplating  
 New Plants or Plant Changes  
 are invited to consult with us.*

**KAHLE**  
**ENGINEERING COMPANY**  
 1315 SEVENTH STREET  
 NORTH BERGEN, NEW JERSEY, U. S. A.

*"Where  
 Professional  
 Radiomen  
 Study"*

**CAPITOL RADIO  
 ENGINEERING INSTITUTE**

*An Accredited Technical Institute*  
 16th and Park Rd., N.W., Dept. PR-11  
 Washington 10, D.C.

**Advanced  
 Home Study and Residence  
 Courses in Practical Radio-  
 Electronics and Television.**  
*Approved for Veteran Training*



**Give..**



**Give  
 enough!**

**THROUGH YOUR  
 COMMUNITY CHEST**



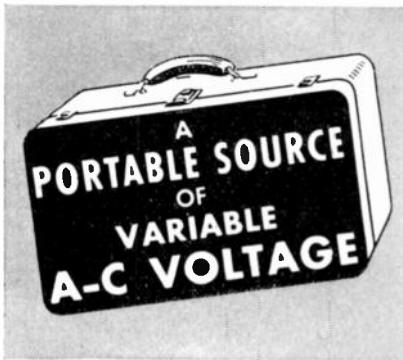

## VOLTBOX A-C POWER SUPPLY

- COMPACT
- PORTABLE
- HANDY

Operation of the Superior Electric VOLTBOX is simple. Plug into 50/60 cycle single phase source, snap "ON-OFF" switch to "ON". Snap "LINE-LOAD" switch to "LOAD", rotate knob to produce continuously adjustable output voltage, from 0 to 17 per cent above line voltage. Read line voltage by snapping "LINE-LOAD" switch to "LINE".

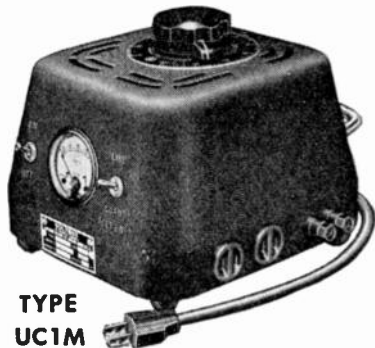

TYPE  
UC1M

INPUT: 115 volts, 50/60 cycle, single phase  
OUTPUT: 0-135 volts, 7.5 amperes, 1000 VA

Type UC2M available for 230 volt operation.

### ALL THIS IN ONE PORTABLE PACKAGE

Cast aluminum case • POWER-STAT variable transformer • Easy-to-read voltmeter • Superior 5-Way Binding Posts • Output receptacles • "ON-OFF" switch • "LINE-LOAD" switch • Renewable fuse for overload protection • Six foot cord-plug.

FOR FULL DETAILS WRITE

THE  
**SUPERIOR ELECTRIC  
COMPANY**

811 MEADOW STREET  
BRISTOL, CONN.



## News—New Products

These manufacturers have invited PROCEEDINGS readers to write for literature and further technical information. Please mention your I.R.E. affiliation.

(Continued from page 64A)

### Equalized Pre-Amplifier for Magnetic Pick-Ups

Brociner Electronic Laboratories, 1546 Second Ave., New York 28, N. Y., has announced a new equalized preamplifier to adapt magnetic pickups to a useful output voltage. The three bass roll-over frequency adjustments and six treble attenuation positions afford a combination of eighteen variable transmission curves to suit the listening choice or record-wear conditions.



Small enough to mount on a 3½ inch panel, it will fit into most phonograph cabinets and transcription turntable mounts. A companion power supply is also available, small enough to mount on the same panel, which supplies direct current for both the filament heaters as well as the plates of the tubes. Broadcasting stations will find this unit of interest, because of its incorporation of a curve very close to the NAB-recommended playback characteristics.



Tests Prove Best

## All-Channel Television Antenna

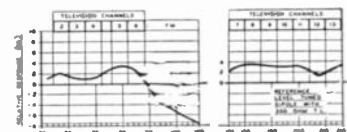

MEGACYCLES

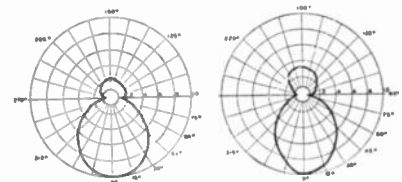

Horizontal Directivity 60 mc.

Horizontal Directivity 190 mc.

The Premax All-Channel Television Antenna No. T-448 consists of two fully adjustable arrays complete with reflectors—interconnected and licensed under AA&K Patents 2,282,292 and 2,422,458. Can be used as a 12-channel antenna or may be purchased separately for high or low frequency channels and later converted to an all-channel job.

It's simpler—lower in cost—easier to erect—has oversize elements and the famous adjustable V dipole design which permits adjustment in both vertical and horizontal planes.

List price \$20. Send for test charts, full details and discount.

**PREMAX PRODUCTS**  
DIVISION CHISHOLM-RYDER CO., INC.  
4903 Highland Ave., Niagara Falls, N.Y.

# free

1949

NEWARK

CATALOG



For EVERYONE interested in  
**TELEVISION • RADIO • ELECTRONICS  
SOUND SYSTEMS • INDUSTRIAL EQUIPMENT**  
EVERYTHING in standard brand equipment!

Professionals! Radio Hams! Television Enthusiasts! Beginners! Oldtimers! Amateurs! Hobbyists! Here's one book that's a MUST for you! Our FREE 148 page catalog jammed with over 20,000 different items. The smallest part to the most complete industrial system from one dependable source!

24-HR. MAIL ORDER SERVICE • ONE YEAR TO PAY

3 GREAT STORES: Uptown at 115 West 45th St. and Downtown at 212 Fulton St. in NEW YORK 323 W. Madison St. in the heart of CHICAGO

MAIL ORDER DIVISIONS: 242 W. 55th St., N. Y. 19 and 323 West Madison St., Chicago 6, Illinois

**NEWARK** MAIL COUPON NOW  
RADIO & TELEVISION Newark Electric Co.  
Dept. L-23, 242 W. 55th St.  
New York 19 N. Y.

Please send me FREE the Newark 1949 Catalog

NAME \_\_\_\_\_  
ADDRESS \_\_\_\_\_ CITY \_\_\_\_\_ STATE \_\_\_\_\_

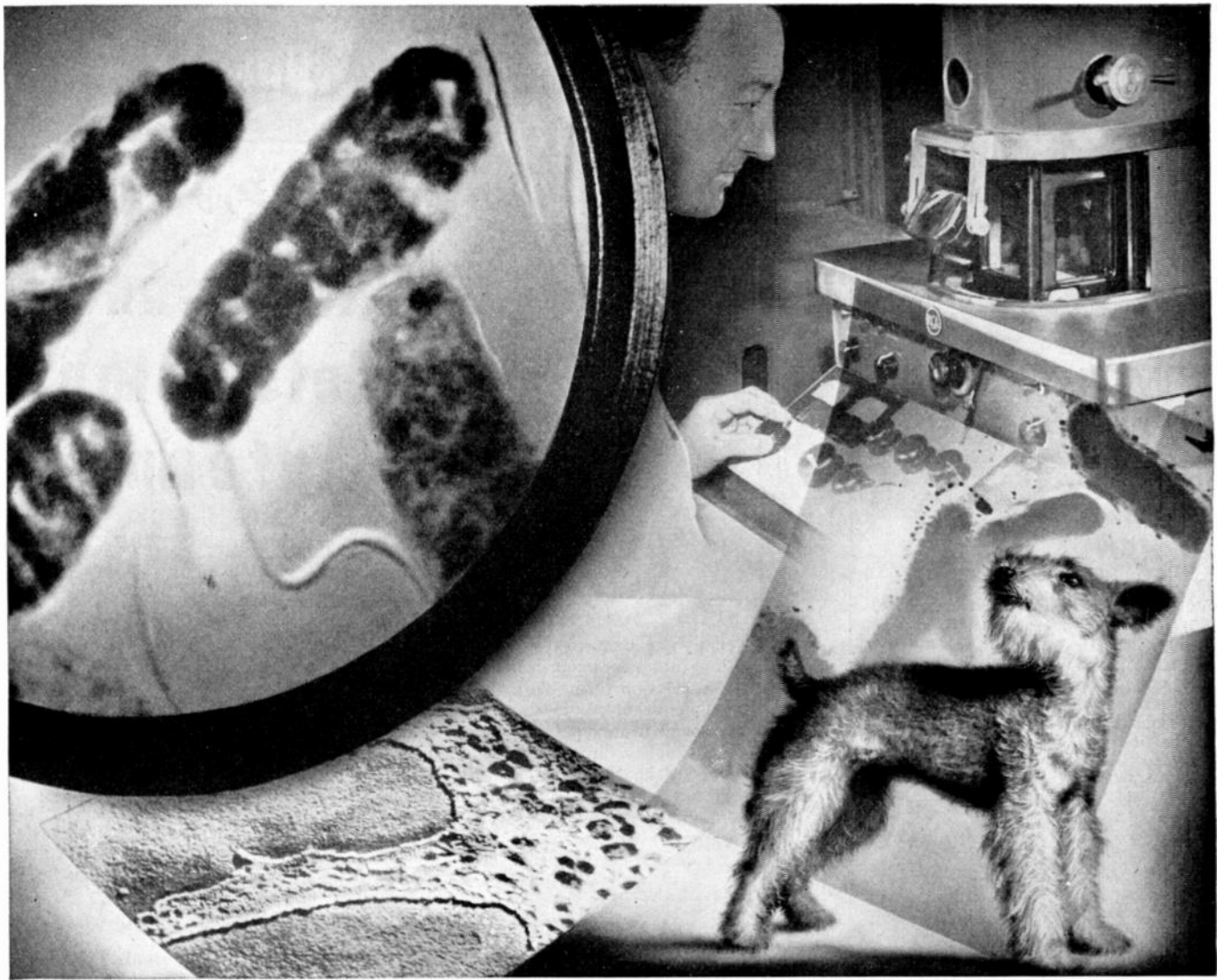

*Electron microscope, perfected at RCA Laboratories, reveals hitherto hidden facts about the structure of bacteria.*

## ***Bacteria bigger than a Terrier***

Once scientists, exploring the invisible, worked relatively "blind." Few microscopes magnified more than 1500 diameters. Many bacteria, and almost all viruses, remained invisible.

Then RCA scientists opened new windows into a hidden world—with the first commercially practical electron microscope. In the laboratory this instrument has reached magnifications of 200,000 diameters and over. 100,000 is commonplace . . .

To understand such figures, pic-

ture this: A man magnified 200,000 times could lie with his head in Washington, D. C., and his feet in New York. . . . A hair similarly magnified would appear as large as the Washington monument.

Scientists not only see bacteria, but also viruses—and have even photographed a molecule! Specialists in other fields—such as industry, mining, agriculture, forestry—have learned unsuspected truths about natural resources.

Development of the electron

microscope as a practical tool of science, medicine, and industry is another example of RCA research at work. This leadership is part of all instruments bearing the names RCA, and RCA Victor.

. . .

*When in Radio City, New York, you are cordially invited to see the radio, television and electronic wonders at RCA Exhibition Hall, 36 West 49th Street. Free admission. Radio Corporation of America, RCA Building, Radio City, New York 20.*



**RADIO CORPORATION of AMERICA**

# YOUR PRODUCT, TOO

CAN BE RADIO NOISE-PROOFED WITH C-D

*Quietones*  
Reg. U.S. Pat. Off.

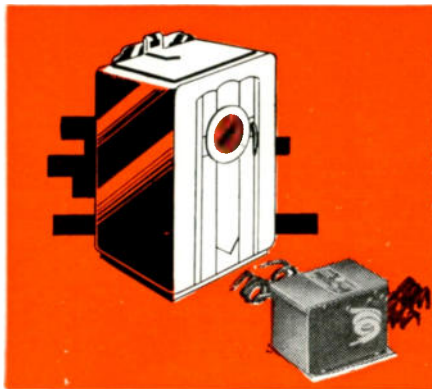
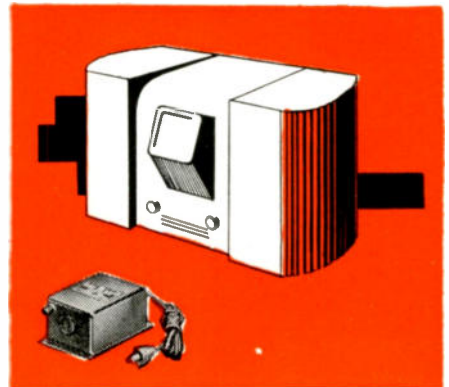
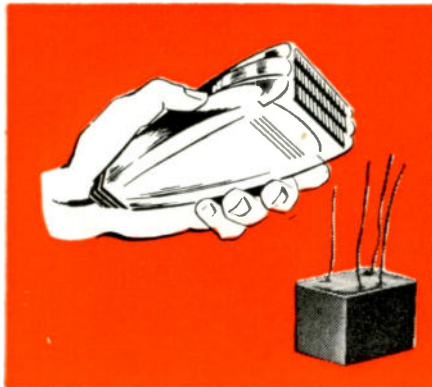
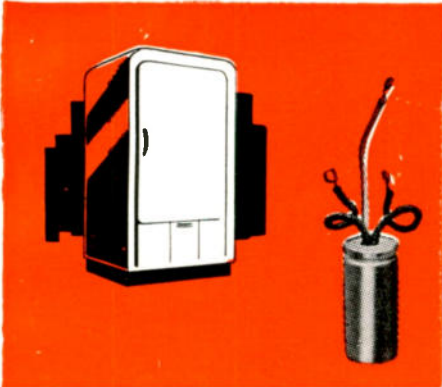

When we say Radio Noise-Proofed—we mean Radio Noise-Proofed. It's no trick at all to build a filter with high attenuation at 150 kc or 100 mc . . . but to build one which filters at 150 kc and 100 mc—as well as all points in between—is a horse of a different color. We know because we've done it. It is only one of hundreds of available types of C-D Quietones designed for all standard requirements.

Among these stock types there may be one which will bring the interference level of your product down to the level of a rabbit's bark. If not, we invite you to make full use of our Radio noise-proofing laboratory and our engineers for the development of a unit designed for your specific needs.

Your inquiries are cordially invited. Address: Cornell-Dubilier Electric Corporation, Dept. M-11, South Plainfield, N. J. Other large plants in New Bedford, Worcester and Brookline, Mass., and Providence, R. I.

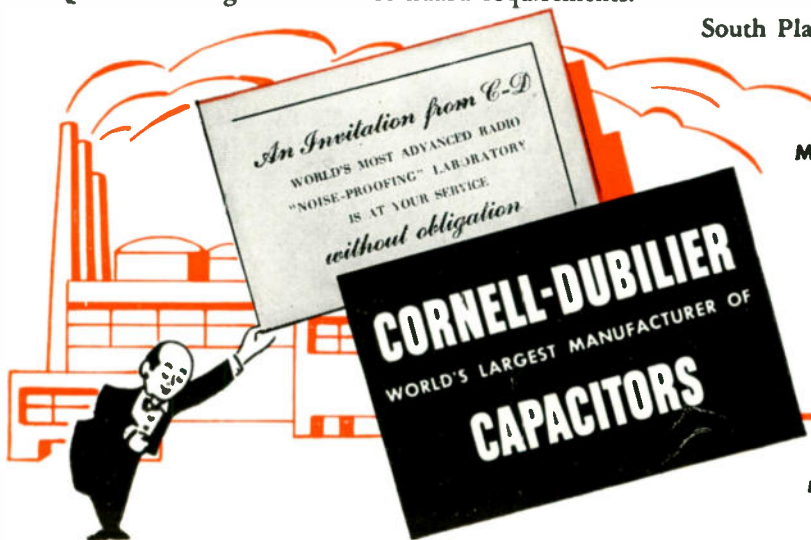

**Make Your Product More Saleable  
With C-D Quietone Radio Noise  
Filters and Spark Suppressors**



MICA • DYKANOL • PAPER • ELECTROLYTIC

# NEW



# CAPACITANCE BRIDGE



with a range of TEN BILLION to ONE

**Higher Accuracy • Greater Sensitivity • More Operating Conveniences**

**For Measuring Electrolytic Condensers • Testing Dissipation Factor of Transformer Bushings and Insulators • Measuring Dissipation Factor and Dielectric Constant of Solid and Liquid Dielectric Materials • General Electrical Machinery Insulation Testing • Product Control and Uniformity Production Checks on Materials Sensitive to Variable Electrical Properties**

This new Type 1611-A Capacitance Test Bridge has many circuit and operating conveniences which make it highly adaptable to all sorts of capacitance and dissipation-factor measurements. Its enormous range of 1 micromicrofarad to 11,000 microfarads is achieved with the unusually good accuracy of  $\pm(1\% + 1 \text{ micromicrofarad})$  over the whole range. For dissipation factor measurements the range is 0 to 60% at 60 cycles, with an accuracy of  $\pm(2\%$  of dial reading + 0.05% dissipation factor).

The bridge detector is composed of a single stage amplifier and an electron-ray visual null indicator. The detector

is designed to be very sensitive when the bridge is at or near balance, but relatively insensitive when off balance.

A new zero-compensating circuit has been developed to provide marked improvement over previous bridges of this general type when making measurements below 1000 micromicrofarads.

For measurements on electrolytic condensers, a polarizing voltage, up to 500 volts, may be applied, from a grounded power supply if desired. Terminal capacitances of the power supply do not affect the accuracy of the bridge.

The bridge and its accuracy are unaffected by temperature and humidity variations over normal room conditions (65 deg. F. and 0 to 90% RH).

The ac-voltage applied to the capacitance under test varies from approximately 125 volts at 100 micromicrofarads to less than 3 volts at 10,000 microfarads.

This bridge combines all of the principal operating features of our popular Type 740-B and Type 740-BG bridges but improves the performance of each in most of their important characteristics.

**TYPE 1611-A Capacitance Test Bridge...\$375.00**  
**WRITE FOR COMPLETE INFORMATION**

## GENERAL RADIO COMPANY

Cambridge 39,  
Massachusetts

90 West St., New York 6

920 S. Michigan Ave., Chicago 5

950 N. Highland Ave., Los Angeles 38