

Proceedings



of the I·R·E

A Journal of Communications and Electronic Engineering
(Including the WAVES AND ELECTRONS Section)

August, 1948

Volume 36

Number 8

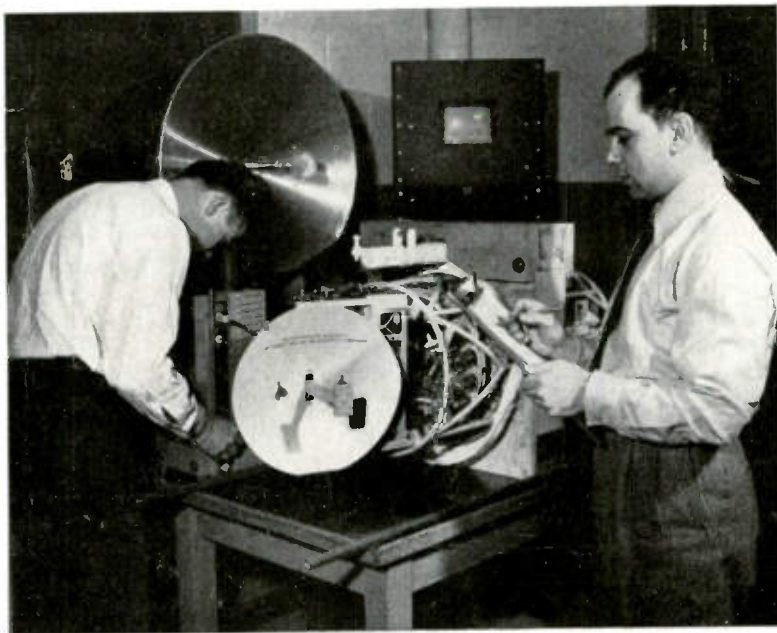

New York University

**STUDENTS TODAY—COMMUNICATIONS
ENGINEERS TOMORROW**

Air-borne radar and beamed radio relays become part of the mental "stock-in-trade" of the modern engineering students. I.R.E. Student Sections stimulate such activities.

PROCEEDINGS OF THE I.R.E.

Distributed Amplification

Netherlands PTT Single-Sideband Equipment

Investigations on High-Frequency Echoes

Passive Modes in Traveling-Wave Tubes

Antennas for Circular Polarization

Waves and Electrons Section

Surveillance Radar Deficiencies

Tunable Resonant Circuits for 300-3000 Mc

Spectral Power Distribution of Cathode-Ray
Phosphors

Megacycle Stepping Counter

Cathode-Coupled Negative-Resistance Circuit

Microphonism in Subminiature Triode

Abstracts and References

TABLE OF CONTENTS FOLLOWS PAGE 32A

The Institute of Radio Engineers



PRECISION IN PRODUCTION

Many people realize and take advantage of the fact that "the tough ones go to UTC." Many of these "tough ones," while requiring laboratory precision, are actually production in quantity. To take care of such special requirements, the UTC Laboratories have a special section which develops and produces production test equipment of laboratory accuracy. The few illustrations below indicate some of these tests as applied to a group of units used by one of our customers in one production item of equipment:



The component being checked here is a dual saturable reactor where the test and adjusting conditions necessitate uniformity of the complete slope of the saturation curve. The precision of this equipment permits measuring five widely separated points on the saturation curve with saturating DC controllable to .5% and inductance to .5%.

Servomechanisms and similar apparatus depend, to a considerable degree, on phase angle operation. The transformer adjusted in this operation requires an accuracy of .05 degrees phase angle calibration under the resonant condition of application. With wide change in voltage and temperature range from -40 to +85 degrees C., the phase angle deviation cannot exceed .2 degree. To effect this type of stability, specific temperature cycling and aging methods have been developed so that permanent stability is effected.



This test position involves two practical problems in a precision inductor. The unit shown is adjusted to an inductance accuracy of .3%, with precise (high) Q limits. It is then oriented in its case, using a test setup which simulates the actual final equipment so that minimum inductive coupling will result when installed in the final equipment.



The hermetic sealing of transformers involves considerable precision in manufacturing processes and materials. To assure consistent performance, continuous sampling of production is run through fully automatic temperature and humidity cycling apparatus. It is this type of continual production check that brings the bulk of hermetic sealed transformers to UTC.

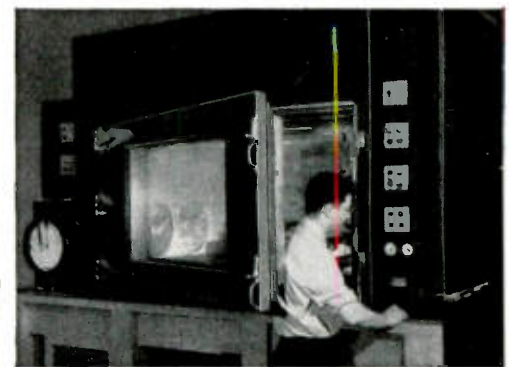

United Transformer Co.

150 VARICK STREET

NEW YORK 13, N. Y.

EXPORT DIVISION: 13 EAST 40th STREET, NEW YORK 16, N. Y.

CABLES: "ARLAB"

SHERRON SERVES YOU...

3 WAYS IN NUCLEAR RESEARCH

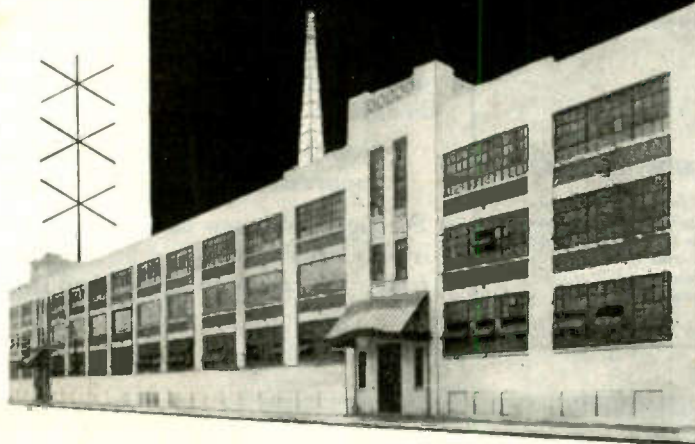

CONTROL • MEASUREMENT • POWER SOURCES

Where these three requirements are concerned in nuclear explorations, Sherron offers a comprehensive service that is at once custom-sized and confidential.

This service is based on these coordinated factors: an extensive experience in designing and manufacturing electronic equipment . . . a full complement of physicists and electronic engineers . . . thoroughly modern electronic and electro-mechanical laboratories . . . complete manufacturing facilities. Inquire!



SHERRON ELECTRONICS CO.

Division of Sherron Metallic Corporation

1201 FLUSHING AVENUE • BROOKLYN 6, N.Y.

SHERRON CAN DESIGN AND MANUFACTURE

COUNTERS: Maximum count as required. Pre-determined setting anywhere within the counting range. Resolution in the micro-second region.

COMPUTERS: Mechanical linkages. Electrical analogues of any complexity. Digital computers.

SERVO-MECHANISMS: Control to any desired accuracy. Power as desired. Linear control, logarithmic control.

AMPLIFIERS: R.F., Video, A.F., D.C. to fit any application. Particular emphasis on high gain, high stability characteristics.

OSCILLATORS: All frequencies.

POWER SUPPLIES: Electronic - Regulation $\frac{1}{2}$ % and less.

REGULATORS: Electronic - direct or through servo control. Regulation, drift, etc. to specification.

MEASUREMENT-CONTROL: Devices for measuring and control of all parameters capable of being controlled and producing proportional electrical, optical or measuring displacement. Electronic microammeters, radiation counters.

CONTROL OF ACCELERATOR ACCESSORIES: Grouping of controls, supplementary apparatus, and experimental system into a compact versatile unit.

PROCEEDINGS OF THE I.R.E., August, 1948, Vol. 36, No. 8. Published monthly in two sections by The Institute of Radio Engineers, Inc., at 1 East 79 Street, New York 21, N.Y. Price \$2.25 per copy. Subscriptions: United States and Canada, \$18.00 a year; foreign countries \$19.00 a year. Entered as second class matter, October 26, 1927, at the post office at Menasha, Wisconsin, under the act of March 3, 1879. Acceptance for mailing at a special rate of postage is provided for in the act of February 28, 1925, embodied in Paragraph 4, Section 412, P. L. and R., authorized October 26, 1927.

Table of contents will be found following page 32A

SINGLE SIDEBAND RADIO SYSTEMS . . .

How single sideband conserves power

THIS IS DOUBLE SIDEBAND

Voice modulation of carrier produces two beat frequencies—the sum and the difference of carrier and voice frequencies. Transmitter is called on to produce both sidebands in addition to carrier. This is inefficient in use of frequency spectrum and wastes power.



THIS IS SINGLE SIDEBAND (carrier reduced)

One sideband is suppressed by filters and carrier is reduced. Power thus saved is available for remaining sideband. This method of transmission conserves space in frequency spectrum, requires only a fraction of the power of double sideband, and provides an improvement of 9 db in signal-to-noise ratio.

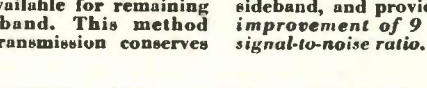

This system was originated and perfected by Bell Telephone Laboratories and Western Electric

THE RESEARCH that resulted in single sideband started at Bell Telephone Laboratories as early as 1915, when speech was first successfully transmitted overseas by radio. To improve the quality of voice reception, Bell scientists began studies of the fundamental nature of voice modulation. They proved that the radio transmitter was handling two similar versions of the voice (the sum and difference beat frequencies) in addition to the carrier.

Question: *Could one of the sidebands be suppressed—thereby increasing efficiency?*

For the answer, new tools were needed and were forged by other Bell scientists: a balanced modulator that will reduce the carrier to any desired degree; an electrical

Single Sideband is used on these Bell System overseas circuits

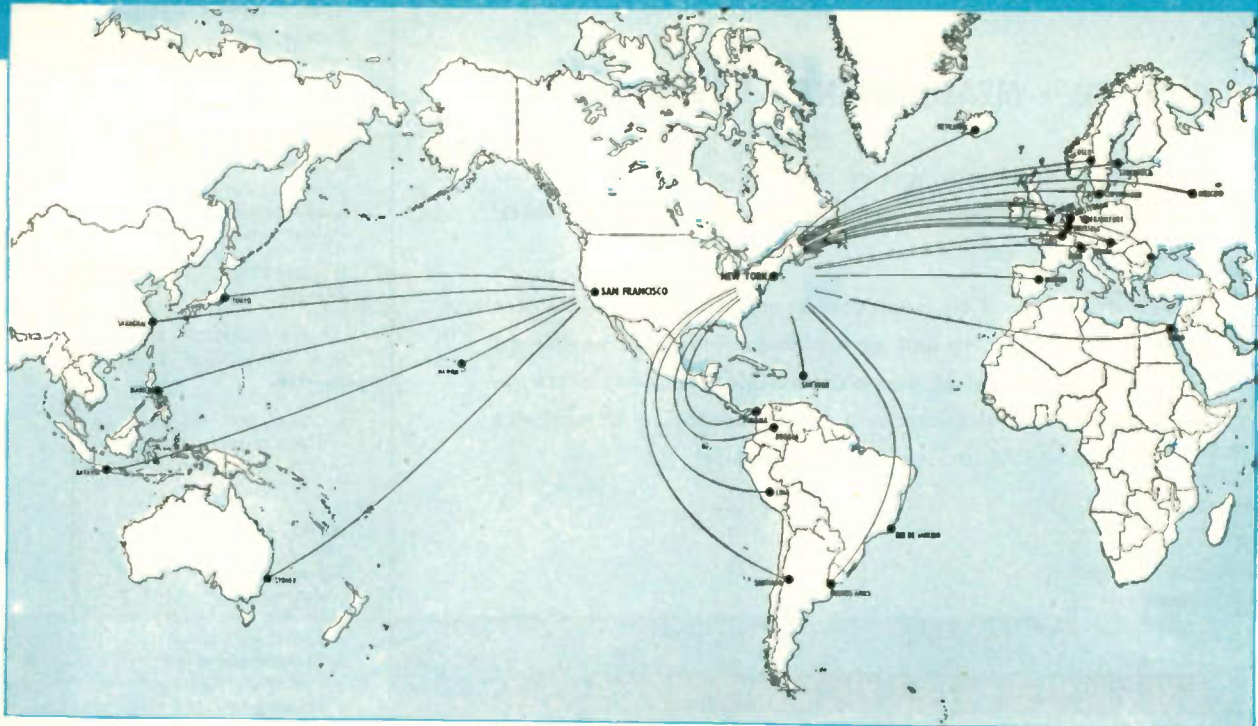

BELL TELEPHONE LABORATORIES

World's largest organization devoted exclusively to research and development in all phases of electrical communications.

.. Bell System Voice Links with the World

wave filter that could accurately select one sideband and suppress the other; a very stable carrier frequency source and many other devices were originated. This accomplished, first transatlantic test of single sideband radio was carried out January 14, 1923.

1927 marked the entry of single sideband into commercial two-way long-wave radiotelephony, and the development by Bell Laboratories of crystal-controlled oscillators soon made possible its extension to short-wave communications.

Today one single sideband transmitter can simultaneously transmit as many as three separate radiotelephone conversations, using but little more frequency space than would be required for one double sideband voice transmission. Now, single sideband equipment—originated and perfected by Bell Laboratories, built by Western Electric—joins the U. S. with practically all major points throughout the world by radiotelephone.

The birth and growth of single sideband

1915. Bell engineers analyze nature of frequency band fed into antenna in voice-modulated transmission.

1918. Bell System makes first commercial application of single sideband, in carrier telephony.

1923. Bell System makes first transatlantic single sideband voice transmission.

1927. Single sideband enters radiotelephony field with opening of long-wave U.S.—England link.

1928. First commercial short-wave transatlantic single sideband radiotelephone circuit opened.

1930-1939. Single sideband service to South America, Honolulu, Paris, Manila.

1941-1945. Single sideband equipment built by Western Electric extensively used by Armed Forces, as well as government agencies.

1945-1948. Many more Western Electric single sideband radio systems put in service throughout the world.

Now... NEWEST IN SINGLE SIDEBAND the economical, low-power LE System

LAATEST development in single sideband is the compact, low-power Western Electric LE System. Like the higher-powered LC now in wide use, the new LE is built to Bell System specifications for operation with a minimum of maintenance.

The LE System consists of three self-contained units: transmitter, receiver and control terminal. New electronic speech privacy equipment is incorporated into transmitter and receiver.

With the LE System, the Bell System now makes use of the demonstrated advantages of single sideband in the field of medium-distance radiotelephony.

—QUALITY COUNTS—



LE-T1 Transmitter LE-R1 Receiver B4 Control Terminal

LE Single Sideband equipment is distributed outside the U. S., Canada and Newfoundland by Westrex Corp., 111 Eighth Ave., New York, N. Y.

Western Electric

Manufacturing unit of the Bell System and the nation's largest producer of communications equipment.

Make it MALLORY... and Make SURE

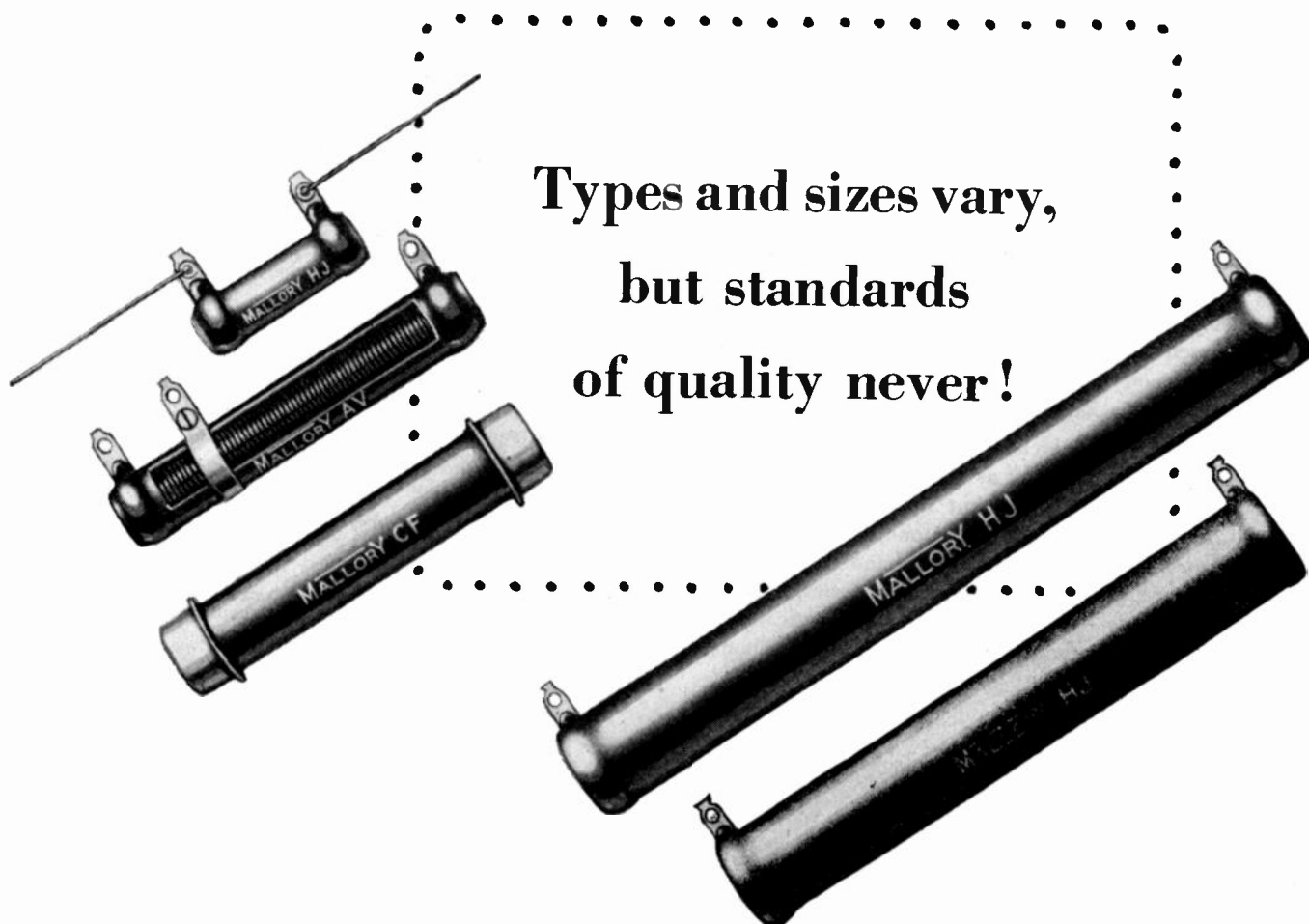

Types and sizes vary,
but standards
of quality never!

YOU don't need more than an elementary knowledge of vitreous enamel resistors to know that if they're conservatively rated to withstand severe overloads... if they're solidly constructed and strongly resistant to moisture, fumes and heat... if they're more reliable, more accurate and have a better appearance than the average... they're the kind of resistors *you* want. Mallory resistors *are* that kind, and that's why you'll find them in so many communications, industrial and laboratory applications, or whenever dependability is essential.

The Mallory line includes a large variety of standard fixed tab, adjustable and ferrule types. There are many different sizes and wattage ratings available, but the emphasis always is on premium quality. Write for our Engineering Data Folder giving full information, including charts and photographs, on all Mallory Vitreous Enamel Resistors.

P. R. MALLORY & CO. Inc.
MALLORY RESISTORS
(FIXED AND VARIABLE)
P. R. MALLORY & CO., Inc., INDIANAPOLIS 6, INDIANA



announces a new thin 3½" panel instrument

better readability
improved performance

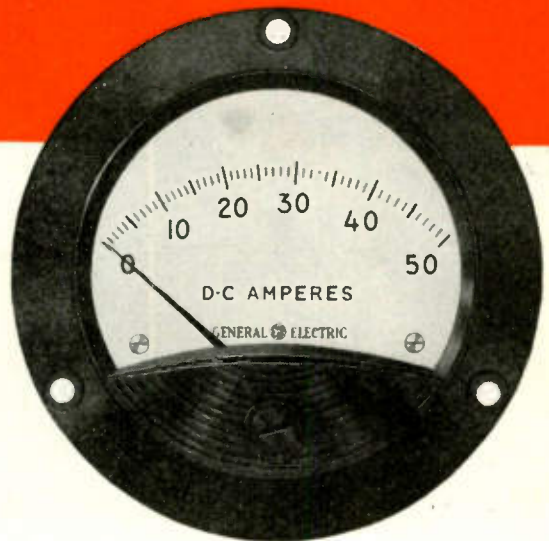

New Styling For Better Readability



The New DO-71 Panel Instruments are easy to read—correctly—because they have been designed specifically for that purpose. This new design has also resulted in a smooth, modern, appearance. Take a look at these features to see how these instruments will improve the appearance of your panels and at the same time assure you of easier more accurate readings:

- Lance type pointer for rapid, precise reading.
- Absence of arc lines make scale divisions stand out by themselves.
- Simplified scale layout for improved readability.
- Numerals shaped and sized for greater legibility.

New Engineering For Improved Performance



A new high in performance and readability has been achieved by the engineering advances in the DO-71 Panel Instruments. Depth behind the panel has been reduced to less than 1 inch. The use of high-strength Alnico magnets results in high torque, good damping, and quick response. This allows the use of larger radius pivots, giving the instrument a greater sturdiness. The large clearance between stationary and moving parts helps assure years of trouble-free performance. And, all main components are rugged integral units which mean fewer repairs and less servicing.

Now is the time to improve the quality and appearance of your products by the incorporation of these new panel instruments. And, you can do it right now, because the DO-71 line is in full production for quick delivery. Contact your nearest G-E Sales Office, or *Apparatus Dept., General Electric Company, Schenectady 5, N. Y.*

GENERAL  **ELECTRIC**

602-122

PROGRESS REPORT ON P.E.C.*

How Beltone uses Centralab's
"Printed Electronic Circuit" to design
and manufacture the
"world's smallest hearing aid"

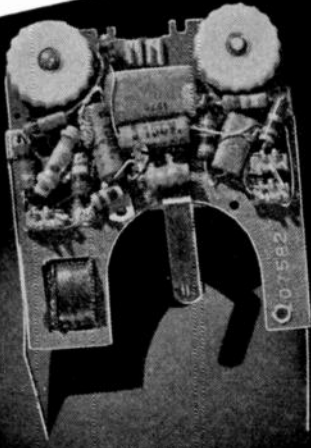

PROBLEM:

How to overcome size and weight limitations of ordinary electronic components and design a smaller, lighter Beltone hearing aid.

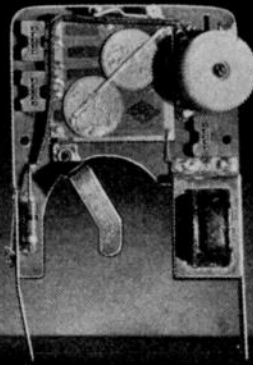

SOLUTION:

Using Centralab's "Printed Electronic Circuit", 45 parts, including capacitors and resistors, have been combined into one compact chassis.



RESULT:

The new, vastly improved 1948 Beltone Hearing Aid—smaller and lighter with improved performance and important production savings.

Models courtesy of Beltone Hearing Aid Co., Chicago

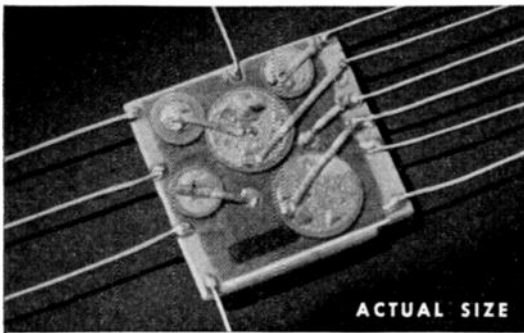

ACTUAL SIZE

REAR VIEW of Beltone PEC unit is shown above. Note ceramic disc capacitors, "printed" silver leads and resistors (black paths). See below for schematic diagram of entire Printed Electronic Circuit.

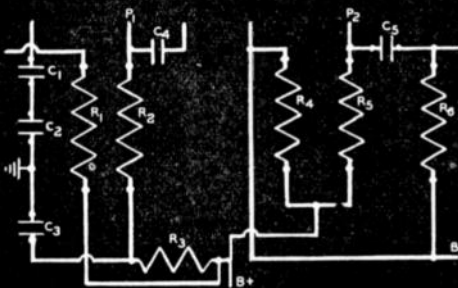

***Centralab's "Printed Electronic Circuit"**
— Industry's newest method for
improving design and manufacturing efficiency!

FOR USE where miniature size is of the utmost importance, nothing has ever been offered to manufacturers of electronic equipment which combines ruggedness, dependability and resistance to humidity and moisture in such a small unit package. That's what engineers of the Beltone Hearing Aid Co., Chicago, say about CRL's *Printed Electronic Circuit*, and that's what you will say when you have seen and tested this amazing new electronic development.

Integral ceramic construction: Each *Printed Electronic Circuit* is an integral assembly of "Hi-Kap" capacitors and resistors closely bonded to a steatite ceramic plate and mutually connected by means of metallic silver paths "printed" on the base plate. All leads are always the same length, each plate is an exact duplicate of the original or "master".

This outstanding new hearing aid development, illustrated above, was the product of close cooperation between Centralab and Beltone engineers. Working with your engineers, Centralab may be able to fit its *Printed Electronic Circuit* to your specific needs. Write for complete information, or get in touch with your nearest Centralab Representative.

LOOK TO **Centralab** IN 1948!

Division of GLOBE-UNION INC., Milwaukee



tom thumb

CAPACITOR

with "ATLAS" performance

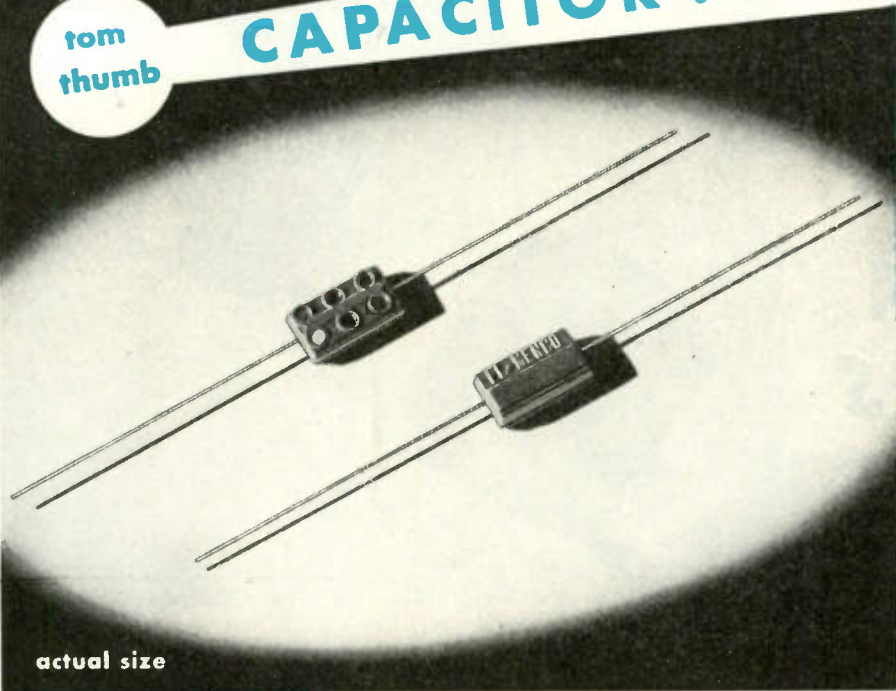

actual size

EL-MENCO'S NEW CM 15

miniature capacitor

9/32" x 1/2" x 3/16"

This tiny capacitor for radio, television and other electronic applications combines compact design with *proven* performance. Molded in low-loss bake-lite the CM 15 is famous for *dependability*. Impregnated against moisture, it delivers at maximum capacity under extreme conditions of temperature and climate.

CM 15 FEATURES

- 500 D.C. working voltage
- 2 to 420 mmf. capacity at 500v. DCA
- 2 to 525 mmf. capacity at 300v. DCA
- Temperature co-efficient 0 ± 50 parts per million per degree C. for most capacity values
- 6-dot color coded to Joint Army-Navy Standard Specifications JAN-C-5

SPECIFY EL-MENCO for your product . . .

from the Tom Thumb CM 15 to the CM 40, all El-Menco capacitors give you — and your product — dependable performance, endurance, and accuracy.

Send for catalog — Specify El-Menco Capacitors.



MOLDED MICA

THE ELECTRO MOTIVE MFG. CO., Inc.
WILLIMANTIC, CONNECTICUT

EL-MENCO

CAPACITORS

ARCO ELECTRONICS 135 Liberty St. New York, N. Y.
Sole Distributors for Jabbers and Retailers in U. S. and Canada

Foreign Radio and Electronic Manufacturers communicate direct with our Export Department at Willimantic, Conn. for information.

MICA TRIMMER

NEW

OHMITE DUMMY ANTENNA RESISTORS

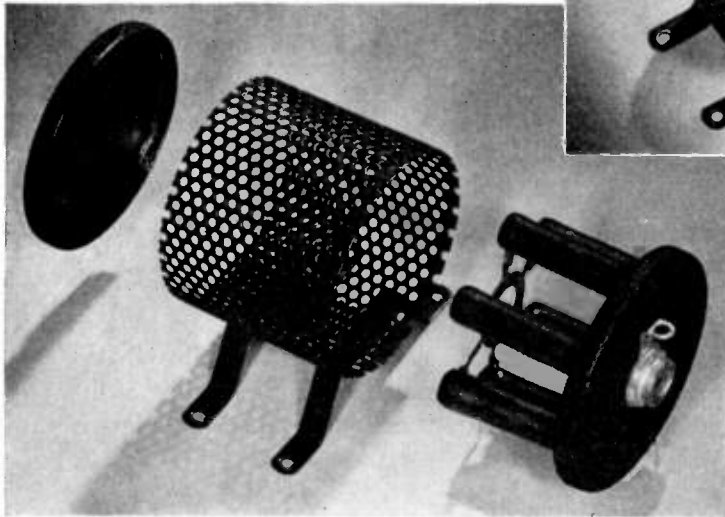

Rugged new Ohmite units consist of special non-inductively wound, vitreous-enameled resistors connected in parallel and mounted inside a sturdy, perforated steel cage.

- **IMPROVED FREQUENCY CHARACTERISTICS**
- **RUGGED VITREOUS-ENAMELED CONSTRUCTION**

Two new dummy antenna resistors, designed by Ohmite, for loading radio transmitters or other radio frequency sources, now offer improved frequency characteristics. This results from more effective proportionment of the d-c resistance, residual inductance, and distributed capacitance.

In the new units, residual inductance and distributed capacitance are kept to a minimum, making the natural resonant frequency as high as possible. For all practical purposes, these dummy antenna resistors may be considered "non-reactive" within their recommended operating frequency ranges. To make electrical connections, two types of terminations are provided, depending

upon whether the unit is intended to be used in conjunction with a coaxial cable or with a parallel transmission line.

Type D-101, 100-watt unit, is stocked in 52, 73, 300, 400, 500, and 600-ohm values; Type D-251, 250-watt unit, in 52, 73, 300, and 600 ohms. Tol. $\pm 5\%$. Get complete information on the new Ohmite Dummy Antenna Resistors.

WRITE FOR BULLETIN 136 TODAY!

OHMITE MANUFACTURING CO.
4861 Flournoy Street Chicago 44, Ill.



Be Right with

OHMITE

RHEOSTATS • RESISTORS • TAP SWITCHES • CHOKES • ATTENUATORS

For AMERICAN BOLEX....

The NEW
NORWOOD Director

..... last word in
exposure meters

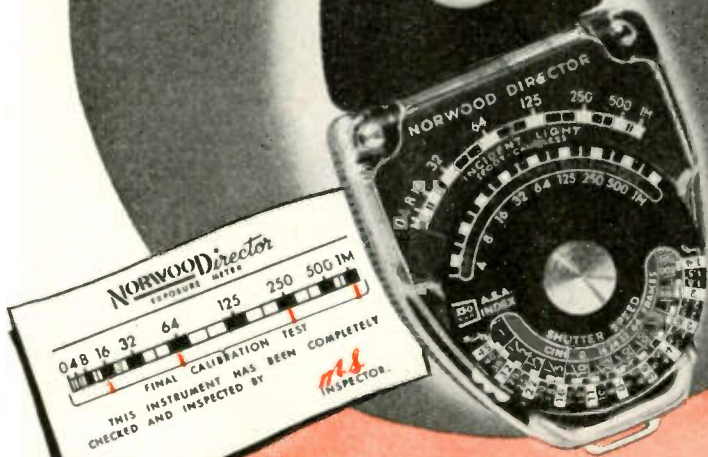

AND HERE'S REAL UNIFORMITY
Calibration inspection slips,
packaged with each Norwood
Director, show uniform high
accuracy of the product.

Engineered
and Manufactured
by
MARION



Leading photographers, both amateur and professional, have given this new American Bolex product astonishing acceptance throughout the nation. This proves that they were quick to understand the revolutionary light-gathering Principle of the Director's unique Photosphere; quick to appreciate its beauty and compactness of design, its simplicity of operation and its *unexcelled accuracy*.

Marion alone was chosen to *engineer and manufacture* this superb light measuring instrument because of Marion's recognized reputation for producing trouble-free meters.

Whether a complete product or a component part of your product, Marion "Special Instruments" offer increased sales appeal. This special Marion service can give your product real sales advantages over competition. When you want it *engineered* to the application and manufactured to *quality specifications* write, wire or telephone.

THE NAME "MARION" MEANS THE MOST IN METERS

Write for complete information



MARION ELECTRICAL INSTRUMENT COMPANY

MANCHESTER, NEW HAMPSHIRE

Export Division, 458 Broadway, New York 13, U. S. A., Cables MORHANEX

IN CANADA: THE ASTRAL ELECTRIC COMPANY, SCARBORO BLUFFS, ONTARIO

REVERE PHOSPHOR BRONZES OFFER MANY ADVANTAGES

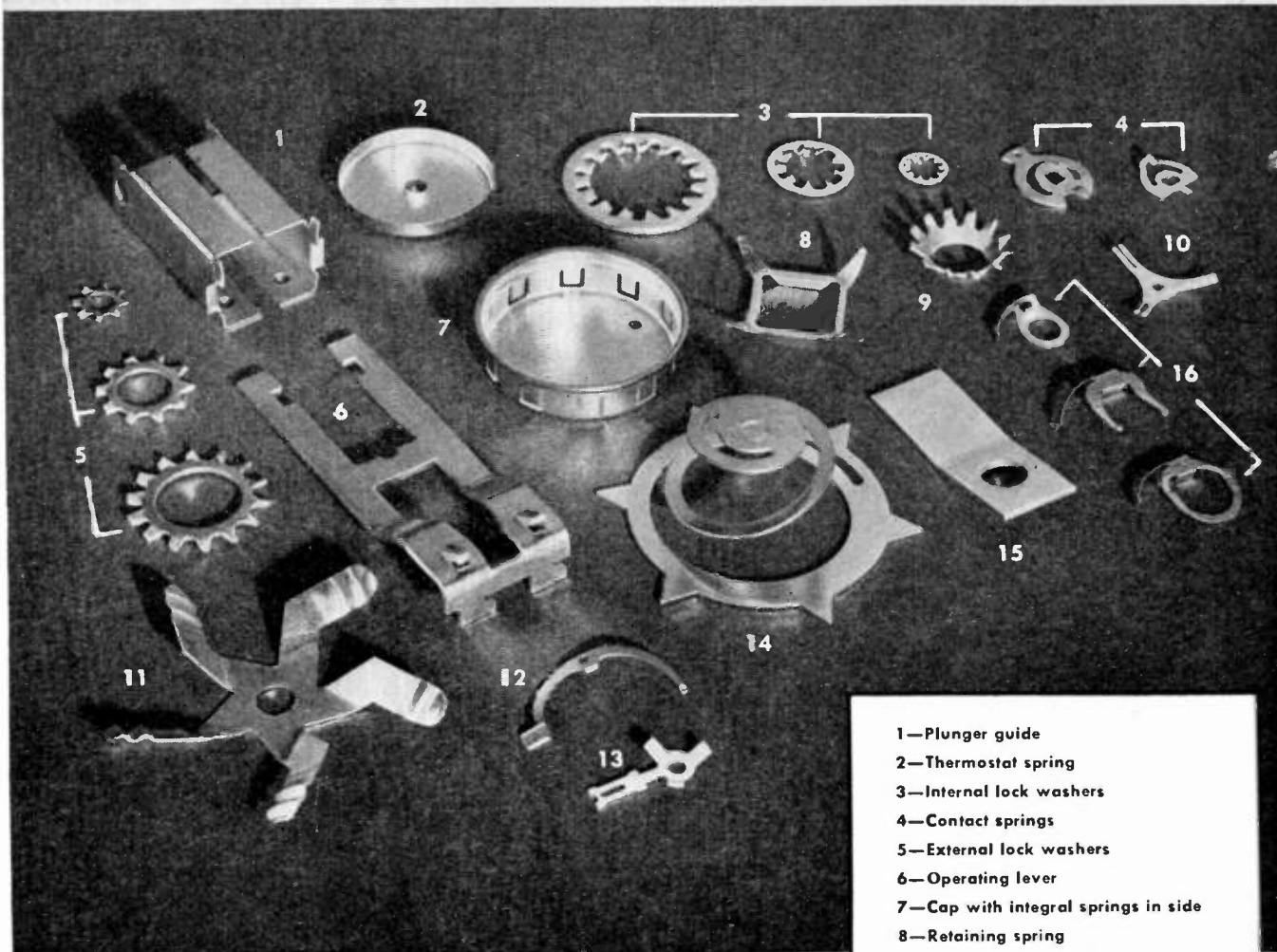

- 1—Plunger guide
- 2—Thermostat spring
- 3—Internal lock washers
- 4—Contact springs
- 5—External lock washers
- 6—Operating lever
- 7—Cap with integral springs in side
- 8—Retaining spring
- 9—Countersunk external lock washer
- 10—Pressure spring for capacitor
- 11—Five-contact spring
- 12—Contact spring for radio part
- 13—Pressure spring and terminal
- 14—Involute spring
- 15—Contact point for solenoid
- 16—Contact springs
—made of Phosphor Bronze strip supplied
by Revere

STRENGTH — Resilience — Fatigue Resistance — Corrosion Resistance—Low Coefficient of Friction—Easy Workability— are outstanding advantages of Revere Phosphor Bronzes, now available in several different alloys.

In many cases it is the ability of Phosphor Bronze to resist repeated reversals of stress that is its most valuable property. Hence its wide employment for springs, diaphragms, bellows and similar parts. In addition, its corrosion resistance in combination with high tensile properties render it invaluable in chemical, sewage disposal, refrigeration, mining, electrical and similar applications. In the form of welding rod, Phosphor Bronze has many advantages in the welding of copper, brass, steel, iron and the repair of worn or broken machine parts. Revere suggests you investigate the advantages of Revere Phosphor Bronzes in your plant or product.

REVERE

COPPER AND BRASS INCORPORATED

Founded by Paul Revere in 1801

230 Park Avenue, New York 17, New York

Mills: Baltimore, Md.; Chicago, Ill.; Detroit, Mich.;

New Bedford, Mass.; Rome, N. Y.—Sales Offices in

Principal Cities, Distributors Everywhere.



NEW! BATTERY-OPERATED!

-hp- 204A AUDIO OSCILLATOR

Range: 2 cps to 20 kc
Distortion: 1 %
Output: 5 v into 10,000 ohms
Response: Flat within ± 1 db



PRICE:
\$175
 FOB Palo Alto

-hp- 404A VACUUM TUBE VOLTMETER

Range: 2 cps to 50 kc
Voltage: .001 to 300 v, 11 ranges
Accuracy: $\pm 3\%$ to 20 kc
Input: 10 meg., 20 uufd shunt



PRICE:
\$185
 FOB Palo Alto

Portable, light-weight, completely hum-free, weather-proofed, designed for general use where power sources are not available—that's the new *-hp-* 204A Audio Oscillator and 404A Vacuum Tube Voltmeter. Now—*anywhere, anytime*—you can accurately make geophysical, remote broadcast line, carrier current, strain gauge, telemetering circuit, telephone and telegraph, motion picture sound, marine and aircraft circuit measurements. And in the laboratory, these instruments make possible completely hum-free measurements.

-hp- 204A Audio Oscillator

Like other *-hp-* oscillators, the new *-hp-* 204A is easy to use, requires no zero setting. Tuning is direct or by a 6:1 vernier control. Frequency range of 2 cps to 20 kc is covered in 4 decade ranges. Five flashlight and three 45 v "B" batteries are easily accessible, mounted in rubber-lined anti-corrosion case, balanced for over 60 hours life. In average use they need be replaced only once every three months.

Entire instrument is mounted in a welded dural case with splash-proof cover. All components are instantly accessible for servicing. Neon on-off pilot light shows when oscillator is operating. Size 10½" x 10½" x 11". Weight 24 lbs.

-hp- 404A Vacuum Tube Voltmeter

The new *-hp-* 404A battery voltmeter is designed for a-c measurements from 2 cps to 50 kc, at voltages from .001 to 300 v. The 404A is modeled after the *-hp-* 400A voltmeter, but has 10 times the sensitivity. Input impedance is high (10 megohms), and accuracy is within $\pm 3\%$, 2 cps to 20 kc, $\pm 7\%$ to 50 kc. The instrument is also useful

as a hum-free amplifier, with standardized gain up to 60 db. Operation is virtually independent of battery, temperature or humidity changes.

A linear meter reads rms sine wave values, with continuous db readings from -62 to +52 db. 11 voltage ranges selected with a single switch; no other adjustments necessary during operation. Neon on-off warning light, welded dural case, splash-proof cover. Size 7½" x 10½" x 9". Weight 14 lbs. approx.

Early Delivery! Get Full Details!

HEWLETT-PACKARD CO.

1716D Page Mill Road • Palo Alto, California
 Export Agents: Fraxar & Hansen, Ltd.
 301 Clay Street • San Francisco, Calif., U.S.A.



Power Supplies Audio Signal Generators Amplifiers Electronic Tachometers Frequency Meters
 UHF Signal Generators Square Wave Generators Audio Frequency Oscillators Attenuators
 Frequency Standards Noise and Distortion Analyzers Wave Analyzers Vacuum Tube Voltmeters

THE NEWEST ENGINEERING... BASED ON THE OLDEST MATERIALS

CARBON GRAPHITE

Seldom can any material surpass Carbon and Graphite for practical, economical solutions to a wide range of mechanical, electrical and chemical problems involving friction, temperature, corrosion, shaft sealing, arcing and similar factors. For more than a quarter of a century, Stackpole engineering has specialized in adapting these oldest, most basic of all materials to one new engi-

neering problem after another—and with outstanding success.

LET THIS BOOKLET HELP YOU!

Write for your copy of the new Stackpole Carbon-Graphite Catalog and Data Book 40. Besides describing hundreds of items regularly produced, it contains interesting evidence of the amazing versatility of Carbon and Graphite in modern design — and of the unique Stackpole facilities for producing exactly what is required for a specific application.

STACKPOLE CARBON COMPANY • ST. MARYS, PA.

STACKPOLE

CARBON GRAPHITE SPECIALTIES

BATTERY CARBONS • BEARING MATERIALS • BRAZING FURNACE BOATS • BRUSHES FOR ALL ROTATING ELECTRICAL EQUIPMENT • CARBON AND GRAPHITE CONTACTS • CARBON PILES (VOLTAGE REGULATOR DISCS) • CHEMICAL CARBONS • CLUTCH RINGS • CONTINUOUS CASTING DIES • DASH POT PLUNGERS • ELECTRIC FURNACE HEATING ELEMENTS • FRICTION SEGMENTS • GLASS MOLDS • MERCURY ARC RECTIFIER ANODES • METAL GRAPHITE CONTACTS • POWER TUBE ANODES • RAIL BONDING MOLDS • RESISTANCE WELDING AND BRAZING TIPS • SEAL RINGS (FOR GAS OR LIQUID) • SPECIAL MOLDS AND DIES • TROLLEY AND PANTOGRAPH SHOES • WATER HEATER AND PASTEURIZATION ELECTRODES • WELDING CARBONS, ETC. • ELECTROLYTIC ANODES.

For Quality and Performance Use **FREED**
INSTRUMENTS and COMPONENTS

**"Q" INDICATOR
NO. 1030 by FREED**

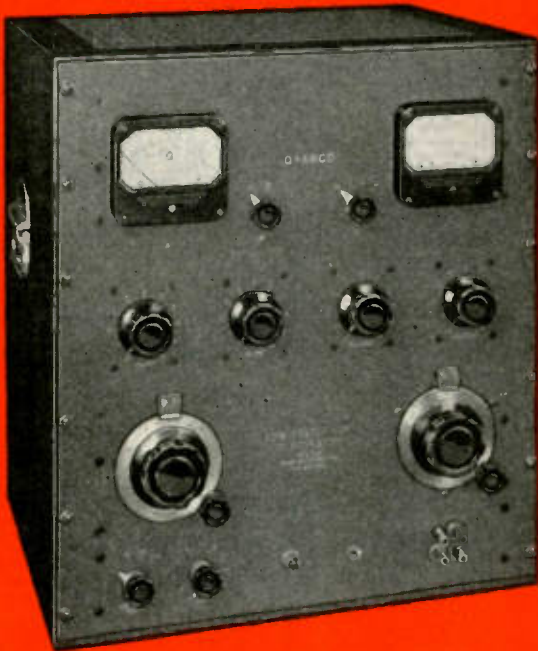

Frequency range from 20 cycles to 50 kilocycles. "Q" range from .5 to 500.

"Q" of inductors can be measured with up to 50 volts across the coil.

Indispensable instrument for measurement of "Q" and inductance of coils, "Q" and capacitance of capacitors, dielectric losses, and power factor of insulating materials.

LOW FREQUENCY HI "Q" COILS

Available from stock in the following inductance values

#1900	100 HY	#1904	10 HY
#1901	75 HY	#1905	5 HY
#1902	50 HY	#1906	1 HY
#1903	25 HY		

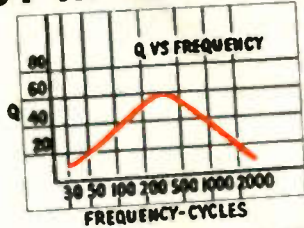

Filters

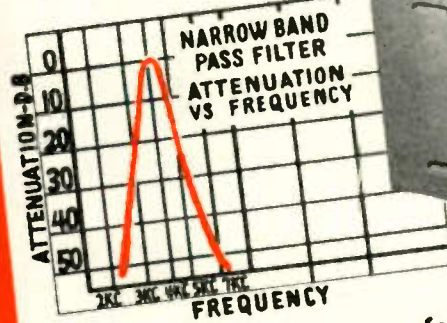

Narrow band pass filters for remote control and telemetering applications. High pass, low pass, band pass and band elimination filters for communication and carrier systems.

Discriminators

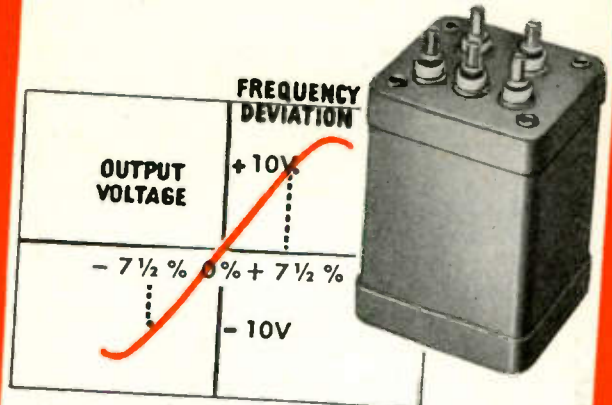

For telemetering and remote control applications using audio and supersonic frequency subcarriers.

FREED
TRANSFORMER CO., INC.
DEPT AP
72 SPRING ST.
NEW YORK 12, N. Y.

ARNOLD

Specialists and
Leaders in the

Design,

Engineering

and

Manufacture

of

PERMANENT

MAGNETS



Arnold's business is permanent magnets, *exclusively*—a field to which we have contributed much of the pioneering and development, and in which we have set peak standards for quality and uniformity of product.

Our service to users of permanent magnets starts at the design level and carries on to finish-ground and tested units, ready for your installation. It embraces all Alnico grades and other types of permanent magnet materials—any size or shape—and any magnetic or mechanical requirement, no matter how exacting.

Let us show you the latest developments in permanent magnets, and how Arnold products can step up efficiency and reduce costs in your magnet applications. Call for an Arnold engineer, or check with any Allegheny Ludlum representative.

THE ARNOLD ENGINEERING CO.

Subsidiary of

ALLEGHENY LUDLUM STEEL CORPORATION

147 East Ontario Street, Chicago 11, Illinois



Specialists and Leaders in the Design
Engineering and Manufacture of PERMANENT MAGNETS

W&D 1100

Specify
for



COMPONENTS

MINIATURIZATION

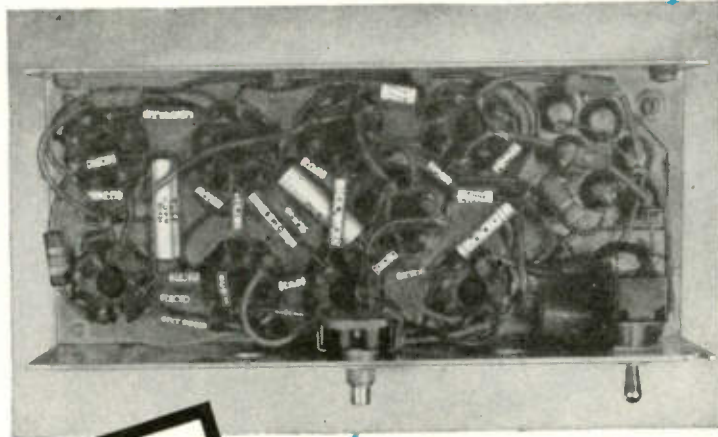

HI-Q MINIATURE G. P. TUBULARS



G. P. Miniatures providing capacities from 5 mmf to 93,000 mmf will cover the majority of your by-passing problems. By the use of our new body 41 the above extended capacity ranges are now available. These smaller units provide closer coupling of leads thus insuring the minimum of inductance and highest self resonant frequencies.
Illustration at left is actual size.

HI-Q DISK CAPACITORS

BPD Another example of accurate and dependable miniaturization is this high dielectric by-pass, blocking or coupling Hi-Q Disk Capacitor. Many applications where physical shape is more adaptable than the tubular unit. Available in two standard capacities:
Type BPD-5: .005 mfd guar. min.
Type BPD-10: .01 mfd. guar. min.
Type BPD-1.5: .0015 mfd. guar. min.
Illustration at right is actual size.



**HI-Q COMPONENTS
BETTER 4 WAYS**

- PRECISION** Tested step by step from raw material to finished product. Accuracy guaranteed to your specified tolerance.
- UNIFORMITY** Constancy of quality is maintained over entire production through continuous manufacturing controls.
- DEPENDABILITY** Interpret this factor in terms of your customers' satisfaction . . . Year after year of trouble-free performance. Our Hi-Q makes your product better.
- MINIATURIZATION** The smallest BIG VALUE components in the business make possible space saving factors which reduce your production costs . . . increase your profits.

HI-Q

Electrical Reactance Corp.

FRANKLINVILLE, N. Y.

Plants: FRANKLINVILLE, N. Y.—JESSUP, PA.
Sales Offices: NEW YORK, PHILADELPHIA, DETROIT, CHICAGO, LOS ANGELES

Announcing A NEW LINE OF SPRAGUE ELECTROLYTIC CAPACITORS



Designed For Television Use (for operation up to 450 volts at 85° C.)

With some 7 times as many components in a television receiver as in the average radio, the possibility of service calls is greatly increased. The new SPRAGUE ELECTROLYTIC line offers the first practical solution to this problem.

Designed for dependable operation up to 450 volts at 85° C. these new units are ideally suited for television's severest electrolytic assignments. Every care has been taken to make these new capacitors the finest electrolytics available today. Stable operation is assured even after extended shelf life, because of a new processing technique developed by Sprague research and development engineers, and involving new and substantially increased manufacturing facilities. More than ever before your judgment is confirmed when you *SPECIFY SPRAGUE ELECTROLYTICS FOR TELEVISION AND ALL OTHER EXACTING ELECTROLYTIC APPLICATIONS!* Sprague Electric Company invites your inquiry concerning these new units.

SPRAGUE ELECTRIC COMPANY • NORTH ADAMS, MASS.

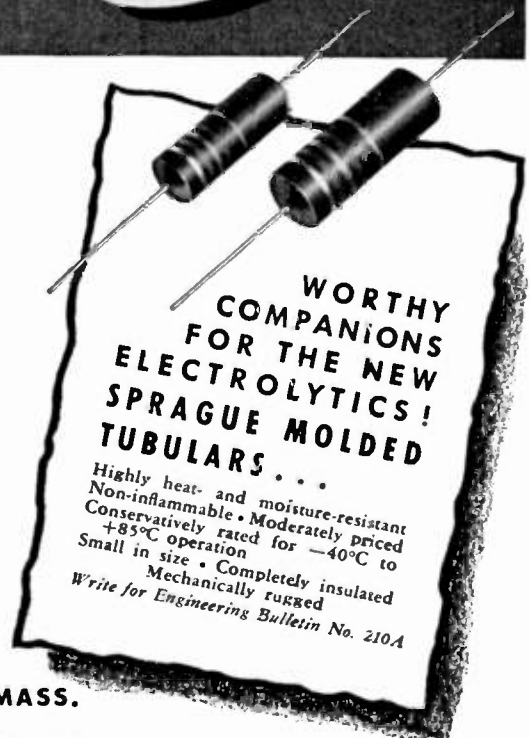

WORTHY
COMPANIONS
FOR THE NEW
ELECTROLYTICS!
SPRAGUE MOLDED
TUBULARS . . .

Highly heat- and moisture-resistant
Non-inflammable • Moderately priced
Conservatively rated for -40°C to
+85°C operation
Small in size • Completely insulated
Mechanically rugged
Write for Engineering Bulletin No. 210A

SPRAGUE

Capacitors

* Koolohm Resistors

PIONEERS OF

ELECTRIC AND ELECTRONIC PROGRESS

• Trademarks reg. U. S. Pat. Office

HERE'S THE ALL-PURPOSE SWITCH

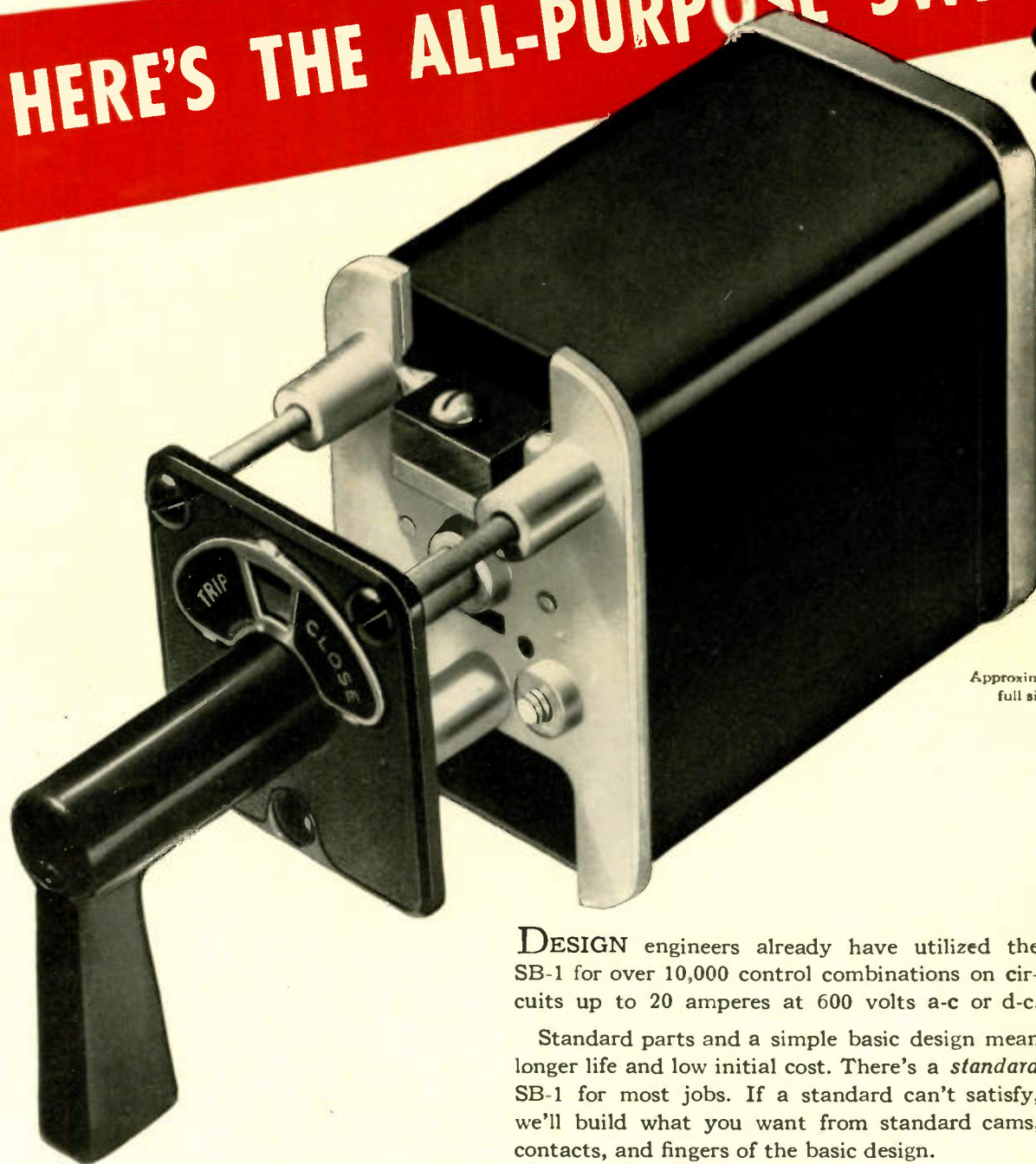

Approximately
full size

* it's the... **SB-1**
CONTROL
AND
TRANSFER
SWITCH

DESIGN engineers already have utilized the SB-1 for over 10,000 control combinations on circuits up to 20 amperes at 600 volts a-c or d-c.

Standard parts and a simple basic design mean longer life and low initial cost. There's a *standard* SB-1 for most jobs. If a standard can't satisfy, we'll build what you want from standard cams, contacts, and fingers of the basic design.

A variety of attractive switch handles, and water-tight, dust-tight, oil-immersed, fabricated-metal, or explosion-proof housings are available to fit your particular installation problems.

Your nearest G-E sales representative will be glad to assist you in the selection of an SB-1. Also, ask him for a copy of GEA-4746 which gives additional information about the SB-1, or write to *Apparatus Department, Section 856-6, General Electric Company, Schenectady 5, New York.*

GENERAL  **ELECTRIC**

SERVICE-PROVED COMPONENTS

Available Over Wide Range of Ratings

The extensive experience gained by General Electric in design and manufacture of electronic components for the Armed Forces is available to builders of commercial electronic equipments. In many cases the range of available ratings is wider than ever before.

RESONANT REACTORS, OIL-FILLED, HERMETICALLY SEALED

Resonant-charging reactors, accurately designed and constructed for radar



service. Usually required in ratings of 40 kv and below, 1 ampere and below and 300 henries and below. Higher ratings are being built, and can be considered. When required, small- and medium-size designs can be provided with 3 to 1 range of inductance adjustment.

PULSE TRANSFORMERS, OIL-FILLED, HERMETICALLY SEALED

Pulse transformers for use with either hard-tube or line-type modulators. Available in voltage ratings of 10 kv or above. These units are ideal for radar applications, stepping up or down, impedance matching, phase reversing and plate-current measurements. Also suitable for nuclear physics re-



search work, television and numerous special applications in and out of the communications field.

FILAMENT TRANSFORMERS, OIL-FILLED, HERMETICALLY SEALED

Filament transformers available with or without tube socket mounted integral with the high-voltage terminal. Low capacitance. Ratings to match any tubes; insulated to practically any required level.



For price and delivery on the above components, write your nearest General Electric Apparatus Office or direct to General Electric Company, Capacitor Sales Divisions, 16-215, Pittsfield, Mass.

GENERAL  **ELECTRIC**

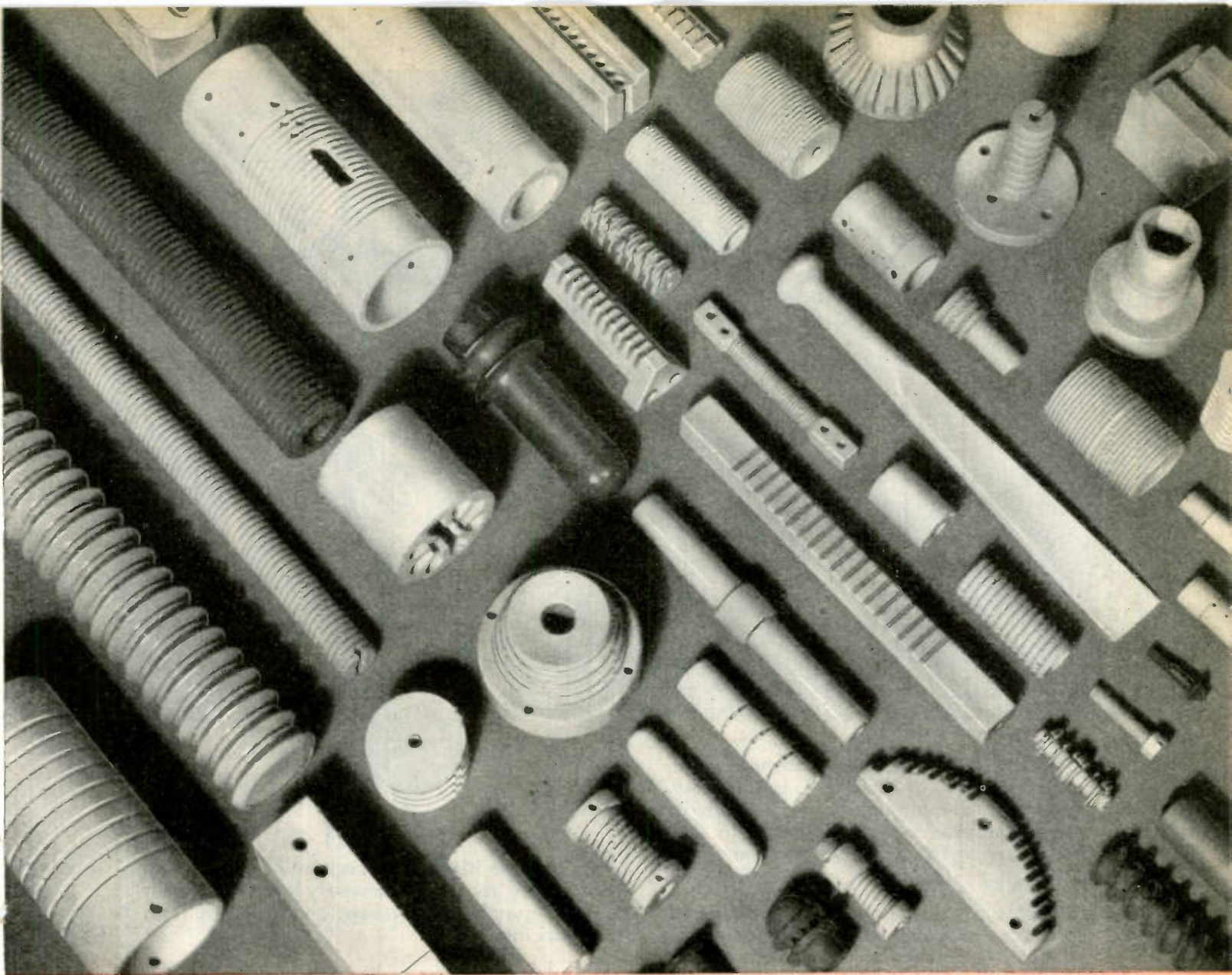

Extruded ALSIMAG offers you

TRADE MARK REGISTERED U.S. PATENT OFFICE

ECONOMY, SPEEDY DELIVERY, PRODUCTION SAVINGS

Alsimag can be extruded to almost any desired cross-section. It can then be machined to incorporate additional features before firing. This combination of extrusion and machining often permits unusually economical production of components which appear highly complex. In many instances these components can be designed to perform several functions. The result is simplified assem-

bly for you. The single Alsimag component can become virtually a sub-assembly and the focal point of your assembly operation. Alsimag's uniformity of dimensions and of physical characteristics form an ideal base on which to build a quality product with speed and economy. Our engineers will be glad to offer cost saving suggestions if you will submit details of your design and requirements.

4 7 T H Y E A R O F C E R A M I C L E A D E R S H I P
AMERICAN LAVA CORPORATION
CHATTANOOGA 5, TENNESSEE

SALES OFFICES: ST. LOUIS, MO., 1123 Washington Ave., Tel: Garfield 4959 • CAMBRIDGE, MASS., 38-B Brattle St., Tel: Kirkland 449E • PHILADELPHIA, PENNA. 1649 N. Broad St., Tel: Stevenson 4-2823
NEWARK, N. J., 671 Broad St., Tel: Michell 2-8159 • CHICAGO, 9 S. Clinton St., Tel: Central 1721 • SAN FRANCISCO, 163 2nd. St., Tel: Douglas 2464 • LOS ANGELES, 324 N. San Pedro St., Tel: Mutual 9076

FOR S.S.S.C.*

HERE'S TOP PERFORMANCE

*SINGLE SIDEBAND SUPPRESSED CARRIER

THE TREND . . . is definitely toward single-sideband operation. Advantages are obvious. Elimination of a continuously running carrier saves power and reduces interference. In fact, a signal is put on the air only when something is said.

HOWEVER . . . it does present some problems. To reproduce voice and music the equipment must handle high peaks of power even though the average power is very low. Unlike conventional AM service, where the modulation level must be held down so that the high peaks will not exceed available carrier, single-sideband modulation levels because of the absence of carrier are unrestricted by peaks and in general are limited only by the average power an r-f amplifier can produce.

TUBES . . . which can handle high peak powers in excess of normal rating are a natural for single-sideband work.

EIMAC TETRODES ARE THE ANSWER

REMEMBER . . . the universal use of Eimac tubes in radar? They were specified because of their ability to handle high peak power. Now, this ability enables them to take the lesser requirements of single-sideband service in stride. Eimac tet-

rodes handle high peaks because of their inherent ability to take momentary overloads, their reserve supply of emission, and freedom from internal insulators.

IT IS FAR EASIER . . . to produce a single-sideband signal at a low power level. Here again Eimac tetrodes fill the bill. Because of their high power-gain, this valuable low-power signal can be built up from the modulator to high power in a single amplifier stage.

IN ADDITION . . . the single-sideband driver must "see" a constant load resistance, and Eimac tetrodes with their low driving-power requirement mean a minimum of swamping action. It is even possible to run up the screen voltage until no grid current is drawn and no changing load is presented to the driver.

DATA AVAILABLE

PICTURED . . . above is the popular 4-65A tetrode. A new complete data sheet on it has been prepared. You will find SSSC ratings and suggestions in it . . . write today. Other Eimac tetrodes suited to SSSC application include 4X150A, 4-125A, 4-250A, 4-400A and the 4-1000A.

EITEL-McCULLOUGH, INC.
199 San Mateo Avenue
San Bruno, California

EXPORT AGENTS: Frazer & Hansen—301 Clay St.—San Francisco, Calif.

Follow the Leaders to

Eimac
TUBES
The Power for R-F

PRECISE VOLTAGE REGULATION FOR TESTING RELAYS

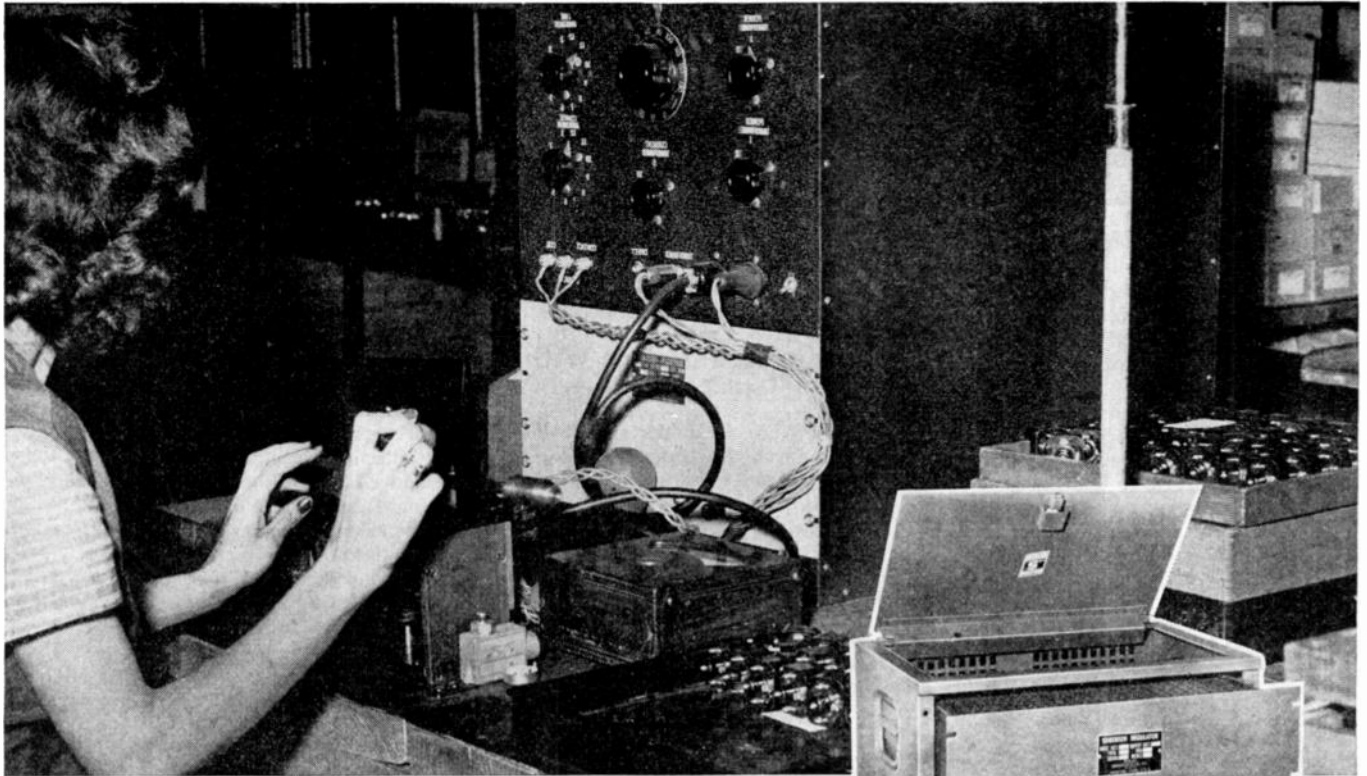

SORENSEN **PROTECTS**

Spencer Thermostat Company uses Sorensen voltage regulators to test their Klixon C-6360 motor starting relay. They say, "Sorensen regulators speed up our testing processes by providing a steady supply of current enabling us to turn out a uniform product."

Model 1000 shown provides full protection of your unit against OVER LOAD and OVER VOLTAGE.

Sorensen protects your equipment against over load and over voltage and at the same time provides regulation of 2/10 of 1% with a minimum of wave distortion and wide input ranges. Precision Klixons are themselves assembly line tested with Sorensen regulators. In turn, Klixon units installed in Sorensen equipment provide automatic shut-off of the output in case of over load. In practically all AC and DC units the Heinemann circuit breaker incorporated into Sorensen regulators insures against over voltage.

Write today and arrange to have a Sorensen engineer analyze voltage regulation requirements in your plant. He can select a standard Sorensen unit from 150 VA to 20 KVA to fit your most exacting application.

Send for your copies of the Sorensen Electronic Library



SORENSEN & COMPANY, INC.
375 FAIRFIELD AVENUE • STAMFORD, CONNECTICUT
The First Line of Standard Electronic Voltage Regulators



High-Potential Neon-Indicator Voltmeter

Covering a range from 1600 to 15,000 volts a.c., this High-Volt model 500 is intended for testing high-voltage transformers, as those used for oil-burner ignition and gas-discharge display signs, and also for television and other high-voltage electronic circuits.

In variance to the conventional meter movement, this new product of **Industrial Devices, Inc.**, Edgewater, N. J., employs a neon-lamp indicator.

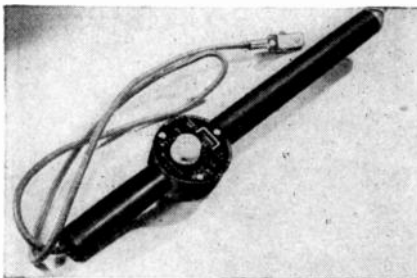

To operate, the knob is turned until the neon lamp extinguished, when the voltage is read directly from the dial.

This instrument is designed for use only with transformers having one side grounded, and is not recommended for use on high-power supplies other than those of the current-limiting type, except by persons familiar with the technique of high-voltage measurements and with the necessary precautions taken.

100-kc. to 10-Mc. RF Oscillator

The type 410-A r.f. oscillator, designed by **Technology Instrument Corp.**, 1058 Main St., Waltham, Mass, is a general-purpose laboratory instrument, and signal source for radio-frequency bridges.

It is provided with an output voltmeter, a continuously adjustable output-level control and an output-level switch which makes it possible to obtain mini-

These manufacturers have invited PROCEEDINGS readers to write for literature and further technical information. Please mention your I.R.E. affiliation.

Interlock Switch With Hold-In Feature

A new interlock door switch designed for use on high-frequency radio, radar, X-ray, and television equipment controls of all types is now being produced by **Micro Switch, Freeport, Ill.**

Positive safety is assured by this switch, as it automatically closes the circuit when the cabinet door is opened.

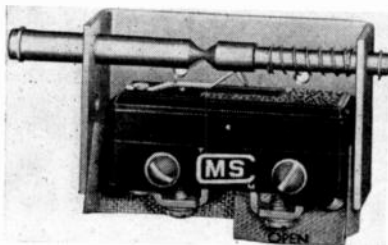

In servicing equipment the actuator may be manually moved to close the circuit without the danger of forgetting to return the switch to safe position, as the next door-closing automatically replaces the actuator in the normal position. This eliminates tying down a conventional switch or putting a jumper across the terminals which may be forgotten.

Underwriters' Laboratories list this switch at 10 amp., 25 volts, a.c.; 5 amp., 250 volts, a.c.; 3 amp., 460 volts, a.c.

mum distortion at normal levels, higher output voltage when a small amount of distortion is tolerable and a modulated output for signal identification purposes.

The circuit features a stabilized oscillator, a tuned buffer, and a low-impedance power amplifier.

The frequency range is 100 kc to 10 Mc in six bands: 100 to 216 kc, 216 to 465 kc, 465 kc to 1 Mc, 1 to 2.16 Mc, 2.16 to 4.65 Mc, 4.65 to 10 Mc.

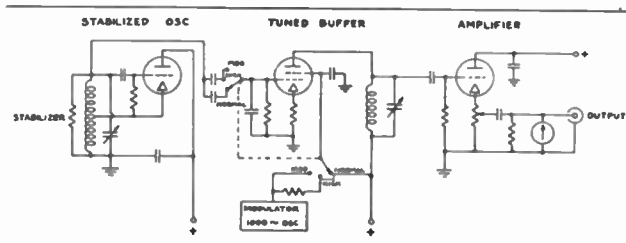

New Books

•••On a booklet entitled *Slide Rule Short Cuts*, written by **W. P. Miller**, 536 F. St., San Diego 1, Calif. This treatise is directed mainly toward short cut methods which are useful to electrical engineers and radio technicians, who desire to improve their technique with the slide rule.

It explains clearly and concisely the "how" and "why" of short-cut methods that save both time and effort in many oft-repeated calculations.

Simple rules, which apply to both the *C* and *CI* scales when used against *D*, eliminate any uncertainty as to the location of the decimal point; this, in itself, is well worth knowing.

This second edition, priced at \$1.50, may be purchased only from the author at the address listed above.

Recent Catalogs

•••For articles of general interest to those working in the field of radioactivity and descriptive literature concerning new equipment, the April "Tracerlog" by **Tracerlab Inc.**, 55 Oliver St., Boston 10, Mass.

•••On the new 1948 radio replacement speaker line, Catalog No. 100, with a simplified parts numbering system, by **Utah Radio Products**, Huntington, Ind.

•••On points of interest to contract sheet-metal fabricators, Bulletin 1001, illustrating a number of different types of parts which are being fabricated by contact shops at lower cost with standard resistance welding equipment, by **Progressive Welder Co.**, 3050 E. Outer Dr., Detroit 12, Mich.

•••On many important considerations relative to the role played by lightning arresters in radio, police alarm, fire alarm, railroad signal, telephone and telegraph circuits, with particular reference to the advantages of rare gas arresters over other mediums, by **L. S. Brach Mfg. Corp.**, Newark, N. J.

•••On a 12-page booklet describing *oscillograph photography* with the **Fairchild Oscillo-Record Camera**, by **Fairchild Camera and Instrument Corp.**, 88-06 Van Wyck Blvd., Jamaica 1, L. I., N. Y.

•••On a line of standard electronic voltage regulators, a color booklet with schematic drawings, by **Sorensen & Co.**, 375 Fairfield Ave., Stamford, Conn.

•••On a number of small, compact, space-saving relays of varied types and features, with a detailed table to enumerate the specifications of each, by **Allied Control Co., Inc.**, East End Ave., New York 21, N. Y.

(Continued on page 24A)

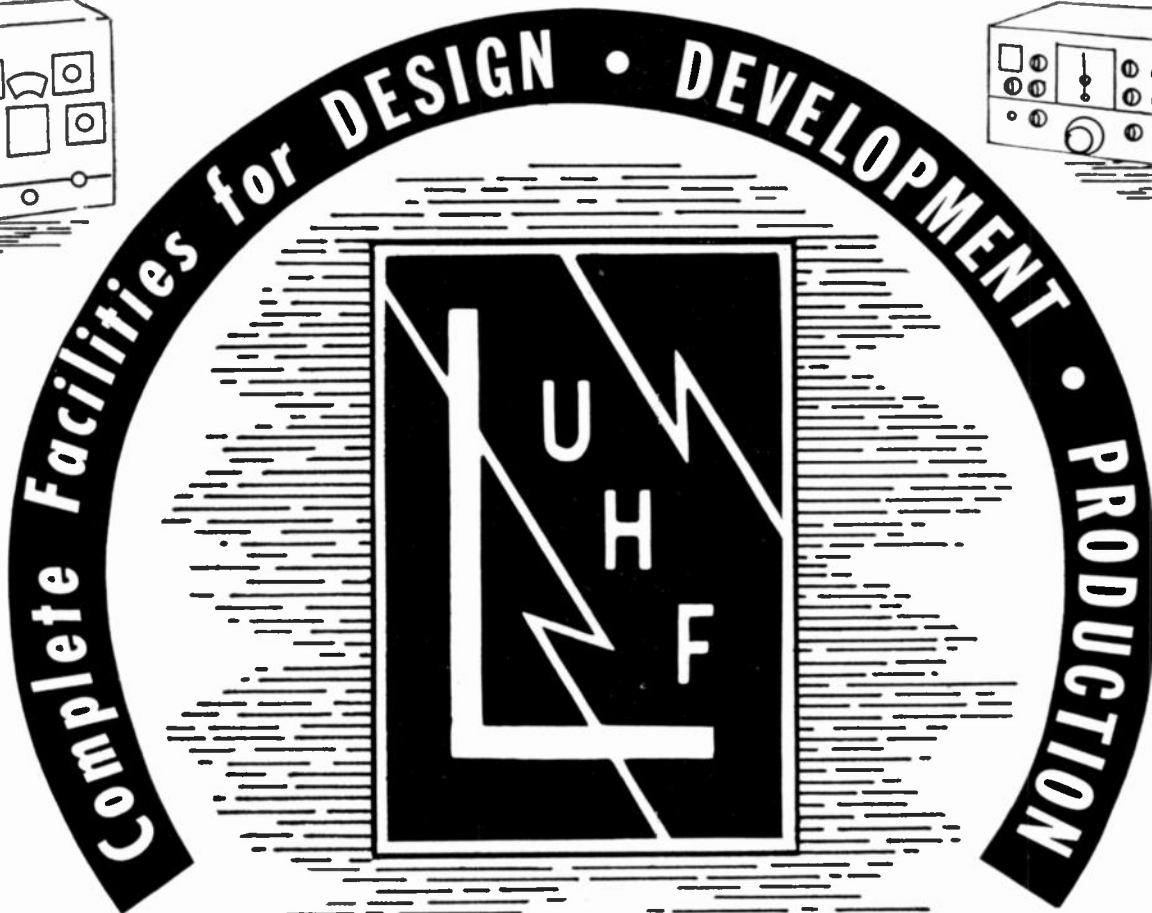
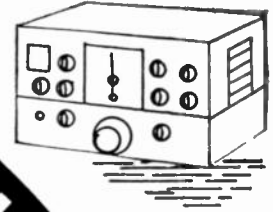
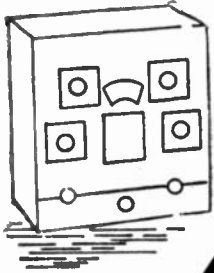

U·H·F EQUIPMENT

- ... **If** UHF design or development is a major problem with you, or...
- ... **If** low-unit manufacturing cost is essential to satisfactorily meet competition, or...
- ... **If** trustworthy, confidential collaboration is a highly necessary factor...

THEN Lavoie Laboratories can be of invaluable, practical assistance. We have the Engineering Staff—the shop techniques—and the reputation to satisfactorily meet those requirements.

● We shall be very glad to discuss any phase of UHF work with you. No cost or obligation involved. A resume of LAVOIE facilities may be had if you will address us on your letterhead.

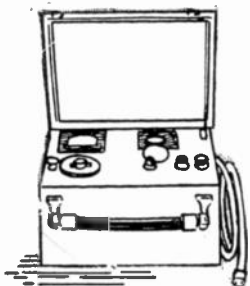

Lavoie Laboratories

RADIO ENGINEERS AND MANUFACTURERS
MORGANVILLE, N. J.

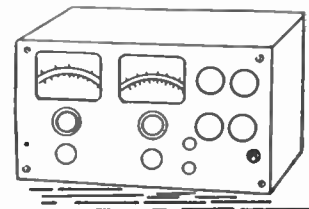

Specialists in the Development and Manufacture of UHF Equipment

File this under

A

[Two new Presto Amplifiers]

Engineers will welcome these two new additions to the PRESTO line of superior equipment.

Presto Peak Limiting Amplifier (Type 41A)

DESIGNED to control program peaks, Type 41A removes the cause of over-cutting and distortion in recording and over-modulation in broadcasting. Proper degree of peak limiting permits an appreciable increase of the average signal with consequent improvement of signal to noise ratio. Serves simultaneously as a line amplifier; its 60 db gain adequately compensates for line losses due to pads, equalizers, etc.

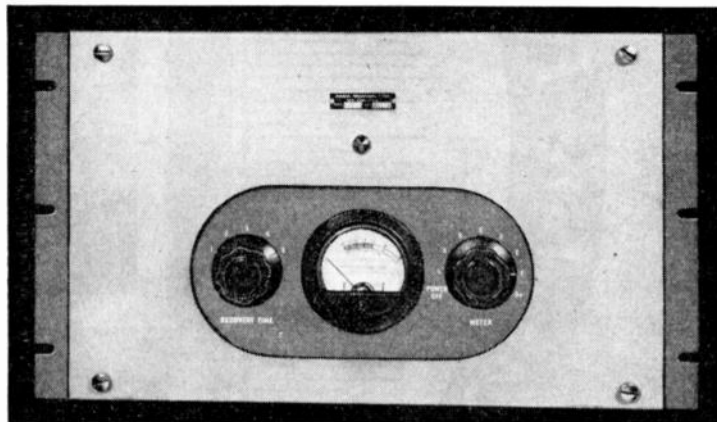

Type 41A. Chassis construction is for vertical mounting in standard racks. Removable front panel gives access to all circuits. Meter and selector switch indicate amount of limiting taking place and current readings of all tubes.

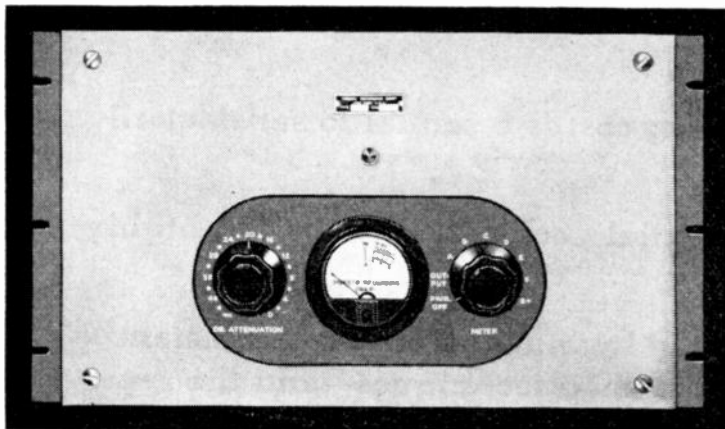

Type 89A. Chassis construction is for vertical rack mounting. Removable front panel for easy access to all circuits. Meter and selector switch provide convenient indication of output level at 1000 cps and current readings of all tubes.

Presto Power Amplifier (Type 89A)

FOR recording, or monitoring use, 89A is the perfect high fidelity, medium power unit. 25-watt output, it fills the need for an amplifier between Presto 10-watt and 60-watt units. All stages are push-pull and sufficient feedback is provided to produce a low output impedance and general performance of the type 807 tubes which is superior to that of triodes.

PRESTO

RECORDING CORPORATION

Paramus, New Jersey

Mailing Address: P.O. Box 500, Hackensack, N. J.

In Canada: WALTER P. DOWNS, Ltd., Dominion Sq. Bldg., Montreal

FULL SPECIFICATIONS OF THESE TWO NEW AMPLIFIERS WILL BE SENT ON REQUEST.

WORLD'S LARGEST MANUFACTURER OF INSTANTANEOUS SOUND RECORDING EQUIPMENT & DISCS



WILCOX - *First Choice of*

PIONEER *Air Lines*

PIONEER EQUIPS GROUND *STATIONS WITH
Wilcox Type 378A Package Radio

PACKAGE DESIGN SPEEDS YOUR INSTALLATIONS

The Type 378A is complete from microphone to antenna, ready for connection to power mains. It is designed for aeronautical VHF ground-air communications at smaller traffic centers.

PROVEN COMPONENTS INSURE QUALITY AND PERFORMANCE

—The Type 305A VHF Receiver and Type 364A VHF Transmitter (50 watts) are the principal components of the 378A. Long used separately and field-tested by leading airlines, these units are now available in package form.

NEW AIDS TO CONVENIENT OPERATION

The telephone handset with its convenient push-to-talk button, serves as both headphone and microphone, with an auxiliary loudspeaker for incoming calls. The 378A includes desk front, message rack, and typewriter space—there are no accessories to be added.

LOCAL OR REMOTE CONTROL

—If desired, the control panel can be removed and the 378A remotely controlled, either by re-installing the panel at the operating position or by simple adaptation to your existing control equipment.

*Pioneer aircraft are also 100% equipped with the new WILCOX Type 361A Airborne VHF Communication System.

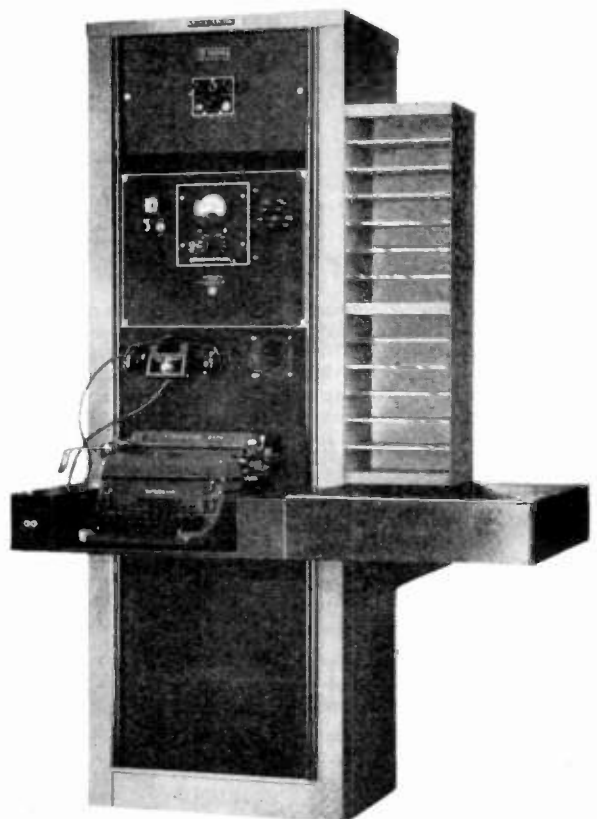

WILCOX ELECTRIC COMPANY
KANSAS CITY 1, MISSOURI
WILCOX Means Dependable Communication

Write today for complete information

BENDIX-SCINTILLA

the finest ELECTRICAL CONNECTORS
money can build or buy!

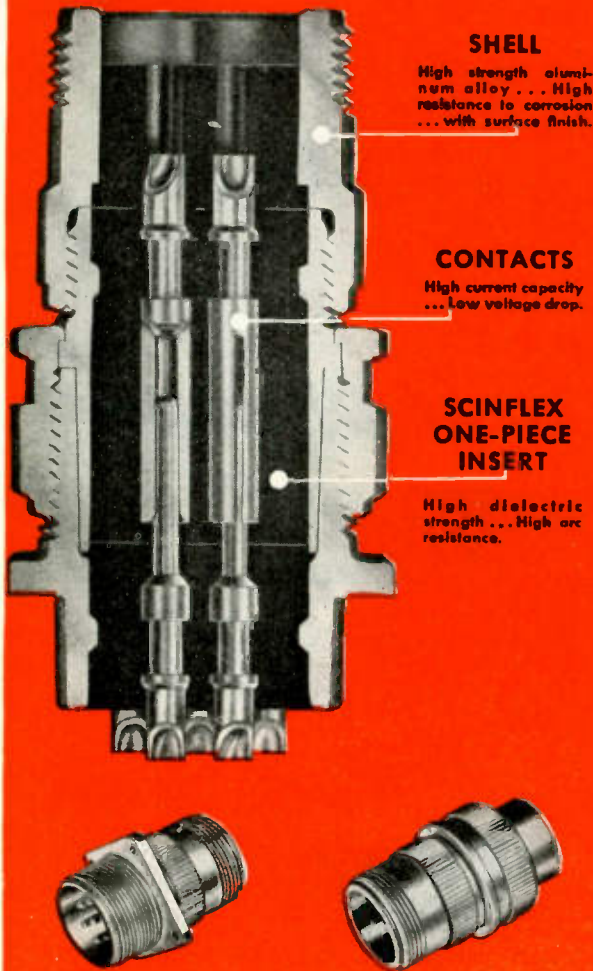

SHELL

High strength aluminum alloy... High resistance to corrosion... with surface finish.

CONTACTS

High current capacity... Low voltage drop.

SCINFLEX ONE-PIECE INSERT

High dielectric strength... High arc resistance.

AND THE SECRET IS SCINFLEX!

Bendix-Scintilla* Electrical Connectors are precision-built to render peak efficiency day-in and day-out even under difficult operating conditions. The use of "Scinflex" dielectric material, a new Bendix-Scintilla development of outstanding stability, makes them vibration-proof, moisture-proof, pressure-tight, and increases flashover and creepage distances. In temperature extremes, from -67° F. to $+300^{\circ}$ F., performance is remarkable. Dielectric strength is never less than 300 volts per mil.

The contacts, made of the finest materials, carry maximum currents with the lowest voltage drop known to the industry. Bendix-Scintilla Connectors have fewer parts than any other connector on the market—an exclusive feature that means lower maintenance cost and better performance.

*REG. U.S. PAT. OFF.

Write our Sales Department for detailed information.

- Moisture-proof, Pressure-tight • Radio Quiet • Single-piece Inserts
- Vibration-proof • Light Weight • High Arc Resistance • Easy Assembly and Disassembly • Less parts than any other Connector

Available in all Standard A.N. Contact Configurations

**BENDIX
SCINTILLA**

SCINTILLA MAGNETO
SIDNEY, N. Y.
DIVISION OF



News—New Products

These manufacturers have invited PROCEEDINGS readers to write for literature and further technical information. Please mention your I.R.E. affiliation.

(Continued from page 20A)

Standards of Very Small Capacitance Set by N.B.S.

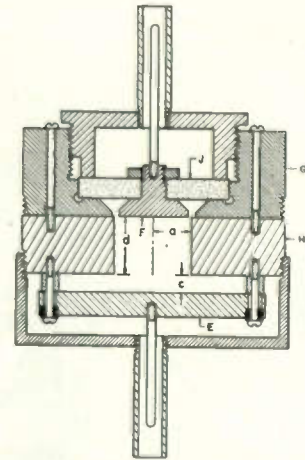

Under the direction of Dr. Charles Moon a new type of guarded-electrode capacitor has been designed at the National Bureau of Standards to provide primary standards of capacitance from 0.1 down to 0.001 micromicrofarad. The high-voltage electrode (E), is held at a fixed distance from the smaller measuring electrode (F), which is separated by a small gap from the guard ring (G). Increases in thickness of the additional guard (H), by reducing the flux to (F), decreases the measured capacitance to as low values as may be desired. The measured electrode is accurately centered in the guard ring by means of a Pyrex-glass collar (J). Capacitance is computed from measurements of the lengths *a*, *c*, and *d*.

The formula for computing the capacitance was derived by Dr. Chester Snow of the Bureau on the assumption that the clearance between the island and the guard ring is infinitely small, that the edges of the hole in the guard ring are not rounded, and that the guard ring and voltage plates extend to infinity.

However, measurements on an experimental model have shown that the clearance between the island and the guard ring can be as large as several thousandths of an inch without appreciably altering capacitance, and that the high-voltage plate need extend over the edge of the guard ring for a distance only three or four times the space between the high-voltage plate and the ring. Further increase in the size of the high-voltage electrode has no measurable effect but is undesirable because it increases its capacitance to ground.

Recent Catalogs

••• On f.m. limiters and detectors by Jas. H. Canning, in the April issue of "Sylvania News," Technical Section, from Sylvania Electric Products Inc., P. O. Box 431, Emporium, Pa.

(Continued on page 47A)

HOW MANY OF THESE PRODUCTION PROBLEMS ARE YOURS



RADIO INSULATION

Looking for high insulation resistance, low radio-frequency losses, high mechanical strength, resistance to extremes of temperature or humidity? Note the following properties of Taylor Grade XXXP-1.

24 hour water absorption—1/16" thickness . . .	0.35%
Loss Factor 10 ⁶ cycles—after 24 hours in water . . .	0.12
Dielectric Strength—1/16" thickness (V.P.M.)	690
short time test	640
step by step test	
Insulation Resistance 4 days at 90% R.H.,	500,000
96°F. (megohms)	

ARC RESISTANCE

Have you experienced equipment breakdowns due to tracking or arcing? Taylor Vulcanized Fibre, Melamine Laminates, and combinations of Taylor Vulcanized Fibre and Phenol Fibre Grades XP-2 and C-2 have proved very satisfactory for many applications. Where high temperatures prevail, Taylor Glass Base Melamine Laminates, Grades G-5 and G-6, are particularly recommended.

HIGH STRENGTH PLUS HEAT RESISTANCE

Taylor Grade AAA asbestos mat laminate is offered for applications requiring high heat resistance plus high mechanical strength, at a low cost.

Note these properties of Grade AAA:

Tensile Strength—Lengthwise 20,000 p.s.i.
Crosswise 13,000 p.s.i.
Flexural Strength—Lengthwise 25,000 p.s.i.
Crosswise 19,000 p.s.i.
Compressive Strength—Flatwise 50,000 p.s.i.
Heat Resistance—Continuous 300°F.—Intermittent 350°F.

FORMING TO INTRICATE SHAPES

Taylor Phenolastic Fibre, Grade C-7, adapts easily to compound curves, and other intricate shaping operations . . . yet retains all the desirable physical properties of Taylor Grade C. Among these properties: high tensile, flexural, and impact strength; good resistance to wear; dimensional stability.

CORROSION RESISTANCE

For applications requiring high resistance to the chemical action of acids and alkalis, plus high mechanical strength . . . such as barrels for plating solutions . . . Taylor Grades C-5 and L-5 (fabric base Melamine Laminates) are outstanding. For moderate concentrations of acids or weak alkalis, Taylor Grades C-4 and L-1 (fabric base Phenol Laminates) are equally effective and cost less.

INSULATION OF ARMATURE SLOTS, FIELD COILS

High in dielectric strength, Taylor Insulation (Fish-paper) withstands severe bending without cracking, resists abrasion from contact with rough spots in machined slots. Available in sheets, continuous rolls, and ribbon rolls.

Regardless of the problem . . . if Laminated Plastics can help solve it, Taylor Fibre engineers are at your service. Please make your inquiry as specific as possible.

TAYLOR FIBRE COMPANY

LAMINATED PLASTICS: PHENOL FIBRE • VULCANIZED FIBRE • Sheets, Rods, Tubes, and Fabricated Parts
 NORRISTOWN, PENNA. Offices in Principal Cities Pacific Coast Plant: LA VERNE, CAL.

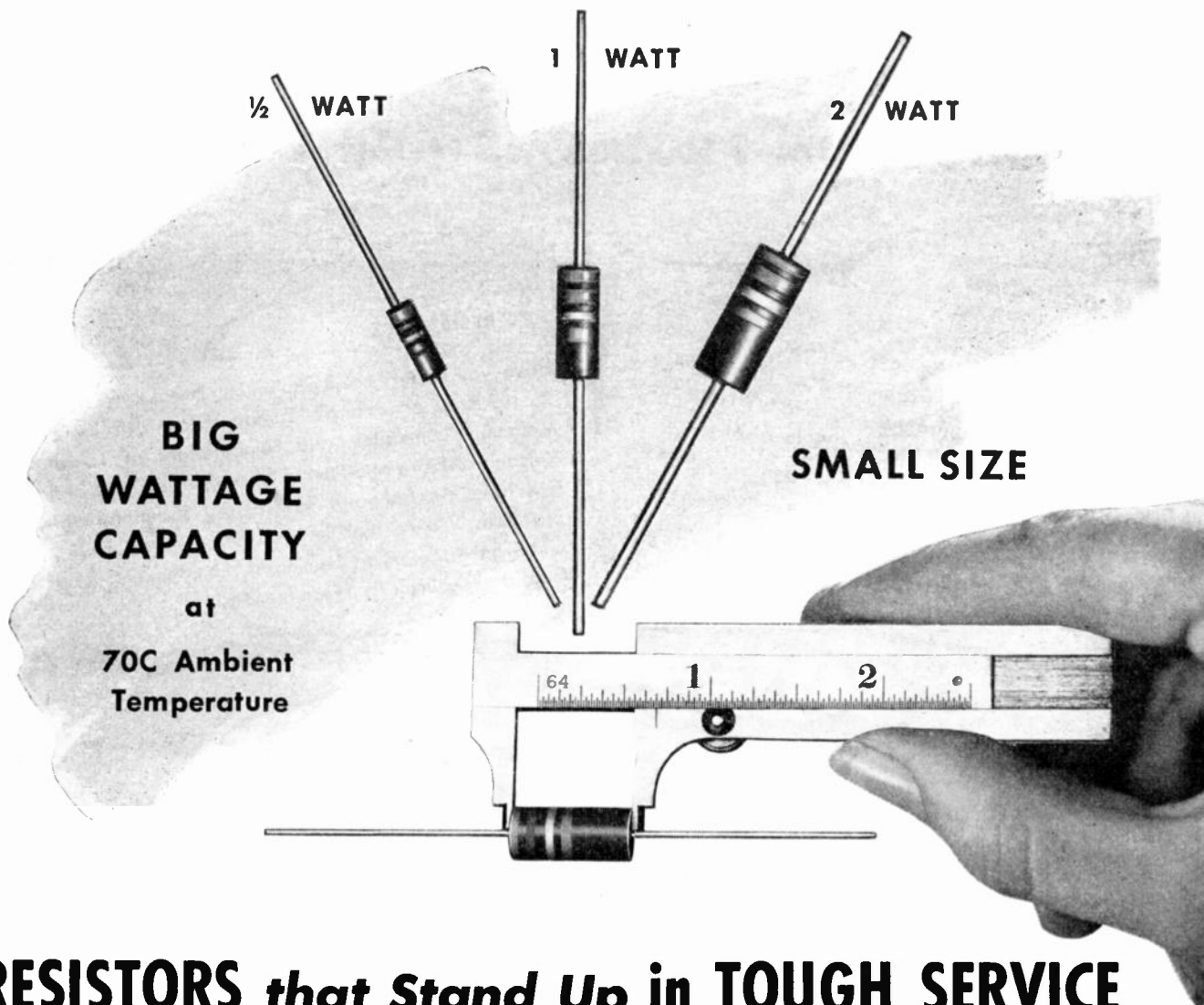

RESISTORS *that Stand Up* in TOUGH SERVICE

Fixed resistors are usually rated at ambient temperatures of 40C. But Bradleyunit resistors are rated at 70C ambient temperature. At this high temperature, Bradleyunits . . . in 1/2-watt, 1-watt, and 2-watt ratings . . . operate at full rating for 1000 hours with less than 5% resistance change.

Bradleyunits require no wax impregnation to pass salt water immersion tests, and have high mechanical strength and permanent electrical characteristics.

Available in all standard R.M.A. values as follows: 1/2-watt and 2-watt sizes from 10 ohms to 22 megohms; 1-watt size from 2.7 ohms to 22 megohms. We shall be glad to send you an A-B resistor chart.

Allen-Bradley Co., 114 W. Greenfield Ave., Milwaukee 4, Wis.

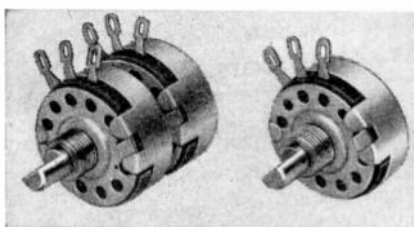

TYPE J BRADLEYOMETERS
in 1, 2, and 3 section types

For continuously adjustable resistors—in 1, 2, or 3 section types—specify Type J Bradleyometers. They meet any resistance-rotation curve specification . . . and, being solid-molded, there is no change due to age or use. Furnished with line switch if desired.

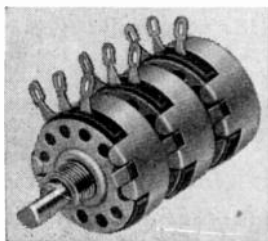

ALLEN-BRADLEY
FIXED & ADJUSTABLE RADIO RESISTORS
QUALITY

The "core" of Electronics

G. A. & F.

Carbonyl Iron Powders

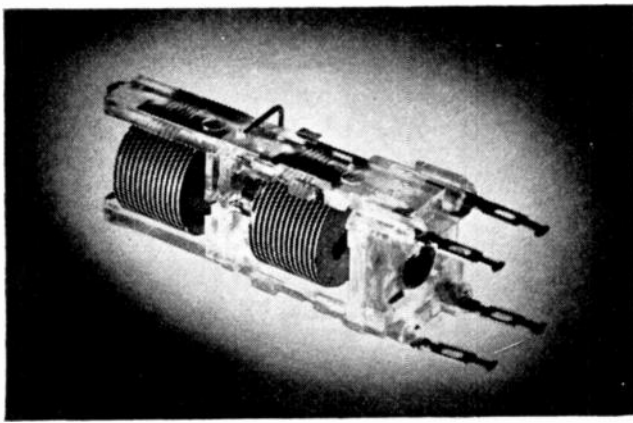
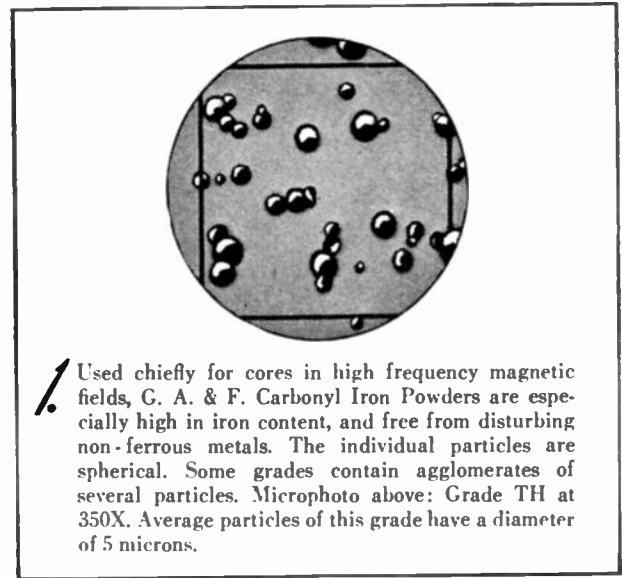

2. I-F and H-F applications of G. A. & F. Carbonyl Iron Powders include: I-F transformer cores, H-F adjusting cores, AM inductance tuning cores, TV wave trap cores, short-wave transmitter tank coil cores, direction finder loop antenna cores, carrier telephony cores and cups. Photo above: "K-Tran," revolutionary top quality I-F transformer, only possible with cores of G. A. & F. Carbonyl Iron Powder.

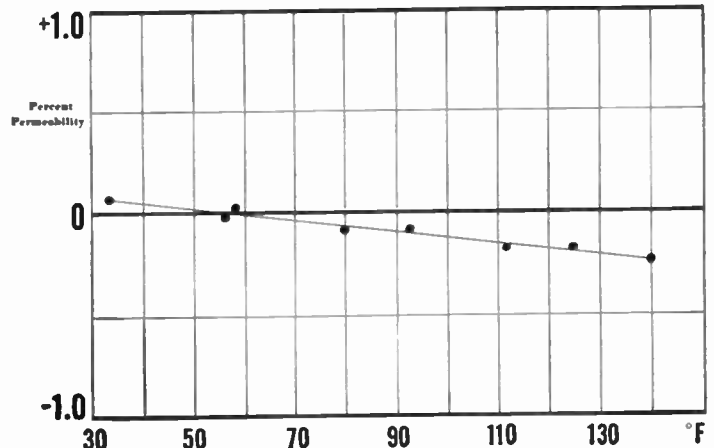

3. G. A. & F. Carbonyl Iron Powder advantages: Low eddy current, residual, hysteresis losses (resulting in higher Q). Excellent temperature and magnetic stability. Savings (as against air-cored coils) in volume, weight, wire length. Graph above: the small permeability change due to temperature of uncompensated toroids of G. A. & F. Carbonyl Iron Powders, Grades E, TH and SF.

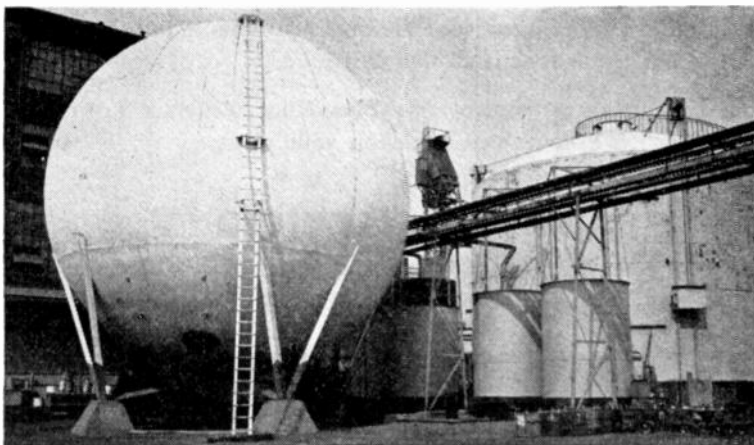

4. Made by exclusive carbonyl process: CO gas and iron ore form liquid iron penta carbonyl. Decomposed by heat into powdered iron, CO gas. Two unique results: *chemically pure* iron penta carbonyl and *spherical* iron powder particles. Photo above: Hortonsphere for storing CO under pressure.



Ask your core manufacturer about Carbonyl Iron Powders. Or write to:

ANTARA PRODUCTS

444 Madison Avenue

New York 22, N. Y.

Department 83

Carbonyl Iron Powders are an Antara® Product of General Aniline & Film Corporation

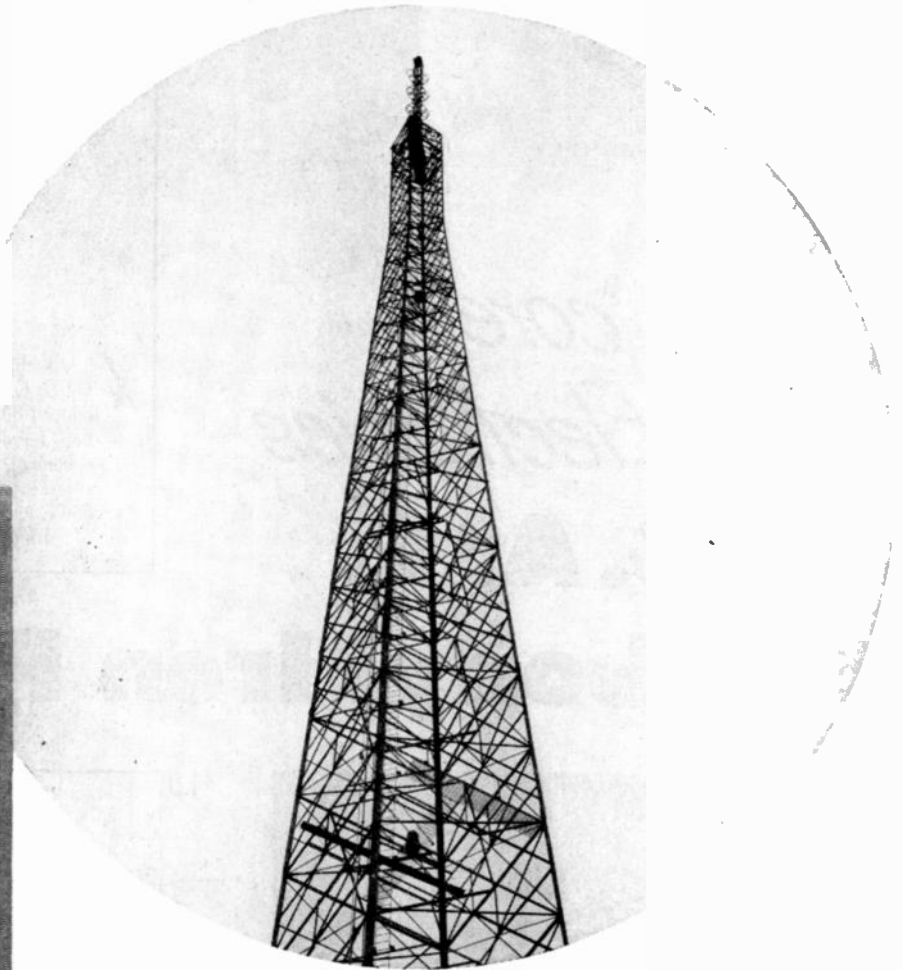
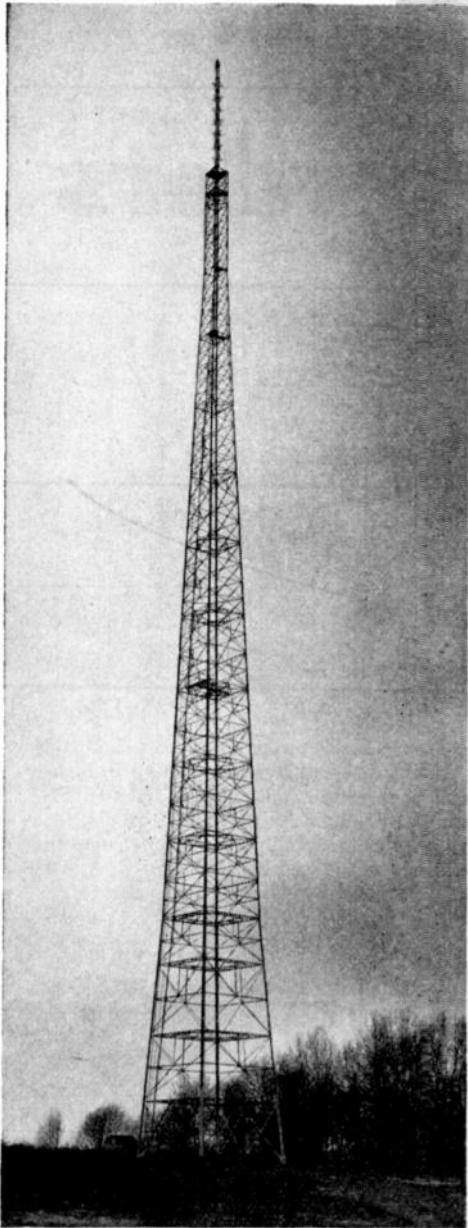

Performance—PLUS Maintenance—MINUS

Add hot-dip galvanizing to Blaw-Knox construction, and you've got the utmost in tower performance with maintenance costs close to zero. Illustrated is a new Blaw-Knox Heavy Duty H 40 Tower with "lifetime" protection of a heavy zinc coating on all members as well as on inside climbing ladder and Electroforged Grating platforms. Painting to conform with CAA regulations is all that is required.

Hot-dip galvanizing is available on Blaw-Knox Antenna Towers of any height . . . We invite discussion on your plans for future station improvement.

BLAW-KNOX DIVISION
of Blaw-Knox Company
2037 Farmers Bank Building • Pittsburgh 22, Pa.

BLAW-KNOX TOWERS

For Quality and Performance

BURNELL offers

High Q

TOROIDAL COILS

The solution of filter network problems, has been greatly simplified through the use of toroidal coils wound on molybdenum permalloy cores. Design engineers have learned to depend upon them since discovering that only these toroids possess all the necessary qualities of a good high "Q" coil.



Of the 30 different items now being manufactured, the most available types now being supplied are:

TYPE	RANGE
TC-1	Any Ind. up to 10 HYS
TC-2	Any Ind. up to 30 HYS
TC-3	Any Ind. up to 750 MHYS

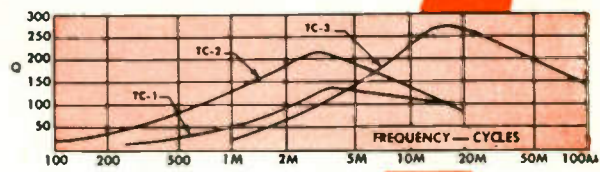

TOROIDAL COIL FILTERS



Our toroid filters have become a by-word in every phase of electronics where only the best results are acceptable. Toroidal coils wound on MOLYBDENUM PERMALLOY DUST CORES are the primary basis for our success in producing filters unexcelled in performance. We are producing toroidal coil filters which consistently demonstrate the value of toroidal coils. These filters cannot be matched in stability, accuracy and sharpness by filters made with the usual laminated type of coil.

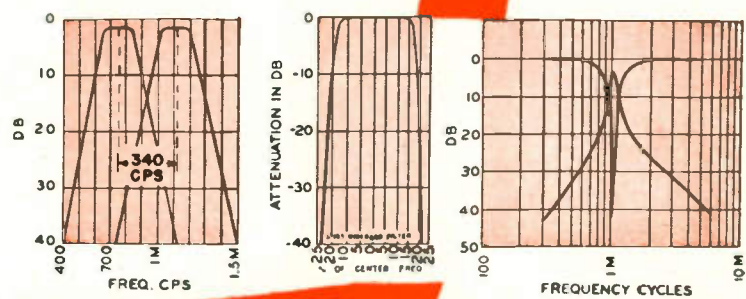

Burnell & Company
 DESIGNERS AND MANUFACTURERS OF ELECTRONIC PRODUCTS
 45 WARBURTON AVE., YONKERS 2, N. Y.
 CABLE ADDRESS "BURNELL"



Memo to... DESIGN ENGINEERS about... MYCALEX 410 - MOLDED

In the design of components or complete equipment for industrial controls or communications—where insulation qualities are of critical importance—where mechanical precision must be a fixed factor—where strength is essential—where electrical characteristics must accurately meet high frequency circuit needs... then remember MYCALEX 410 as the insulation that designs-in with your most exacting requirements.

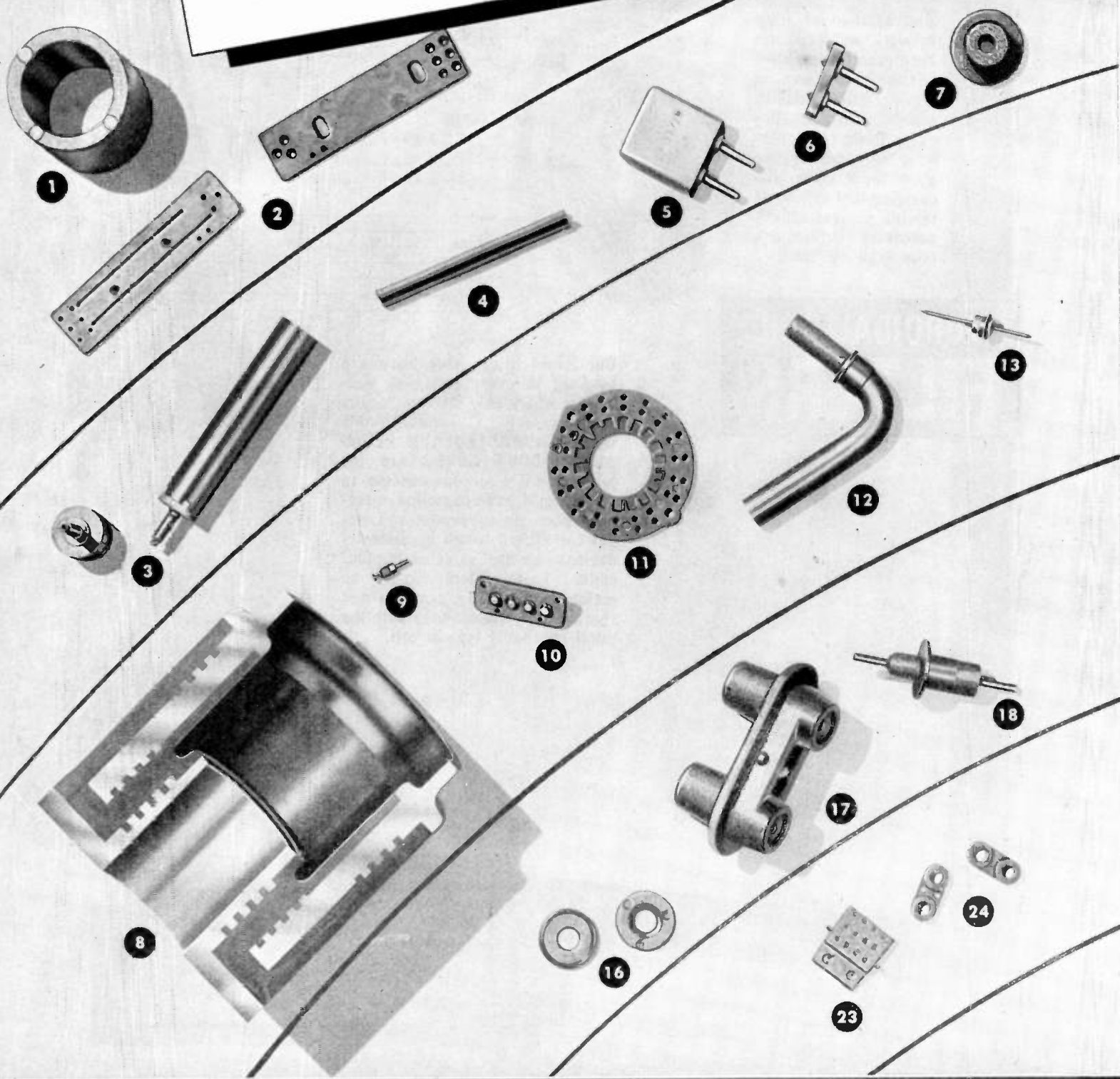

MYCALEX is today's improved insulation — designed to meet the exacting demands of all types of high-frequency circuits. MYCALEX is unusual in that it possesses a combination of peculiar characteristics that make it ideally suited for insulation in all types of electronic circuits. In tomorrow's designs for communications and industrial control equipment, MYCALEX 410 will be specified more than ever

before because of its... Low dielectric loss • High dielectric strength • High arc resistance • Dimensional stability over wide humidity and temperature changes • Resistance to high temperatures • Mechanical precision • Mechanical strength • Ability to mold metal inserts in place. If you have any insulation problems, our engineers will be glad to help you in their solutions.

MYCALEX CORP. OF AMERICA

"Owners of 'MYCALEX' Patents"

Plant and General Offices: Clifton, N. J. Executive Offices: 30 Rockefeller Plaza, New York 20, N. Y.

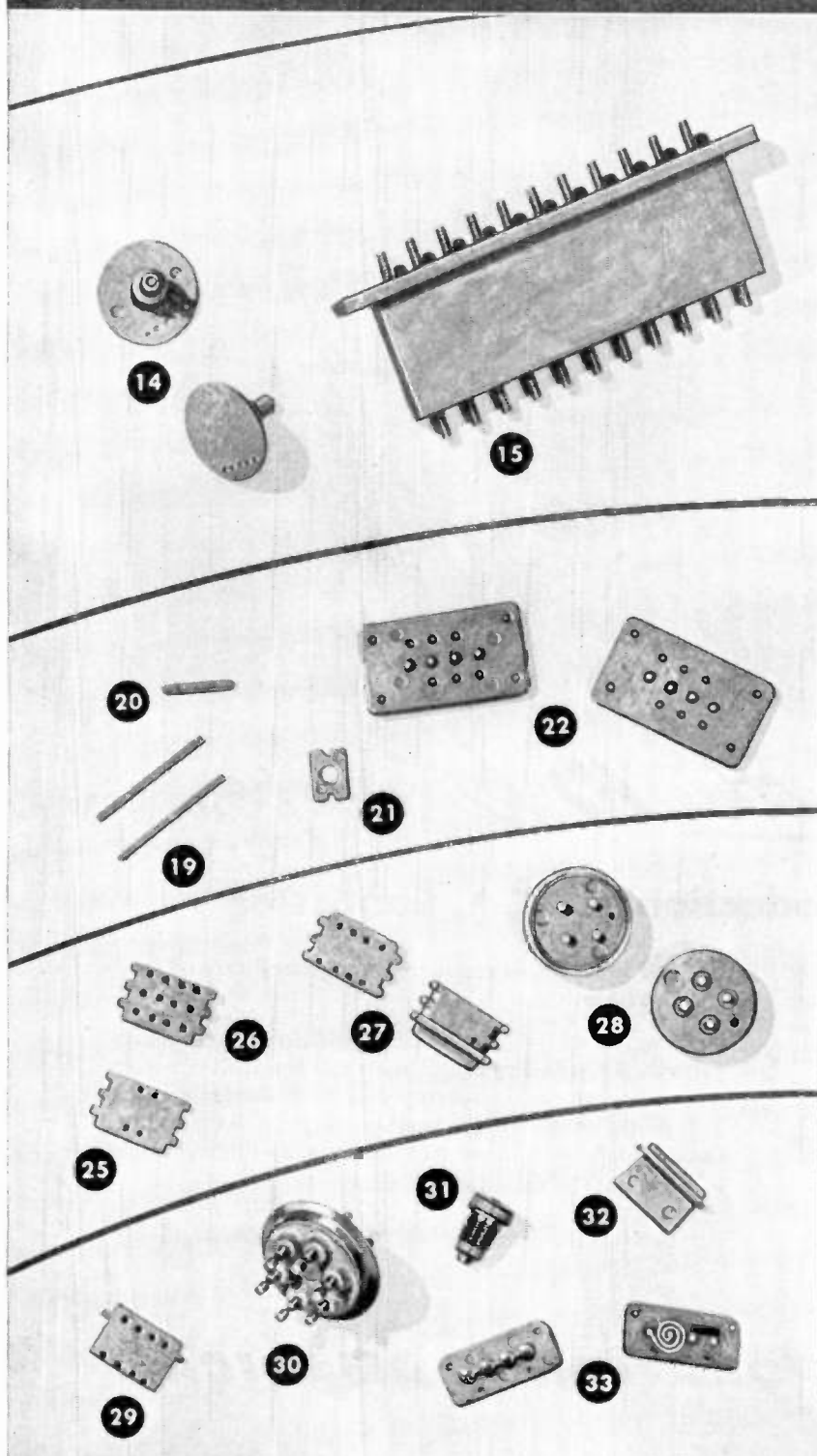

PART NAME	APPLICATION	INSERTS	MAX. DIMEN.
1 Bushing	Motor Generator	None	1.75"
2 Insulator	Electrical Instrument	None	3.18
3 End Seal	Thermostat Shell	Stainless Steel	3.75
4 Insulator	Electrical Instrument	None	3.00
5 Hermetic Seal	Crystal housing	Nickel and Copper	0.88
6 Hermetic Seal	Crystal housing	Copper	1.09
7 Insulator	Automobile Antenna	None	1.06
8 Bushing	Ignitron	Steel	4.50
9 Stand-Off Insulator	Electronics circuit	Brass	0.56
10 Panel	Television Selector Switch	Silver	1.38
11 Switch Wafer	Television Selector Switch	None	2.31
12 Elbow	Aircraft ignition	Steel and Brass	2.75
13 Lead	Transformer	Monel	1.75
14 Insulator	Polarizing relay	None	1.09
15 Lead through block	Oscillator	Brass	4.69
16 Insulator	Telephone Transmitter	None	0.88
17 Dual Bushing	Oil Burner Transformer	None	3.00
18 Lead	Transformer	Monel	2.50
19 Actuating Bar	Telephone relay	None	1.44
20 Actuating Bar	Telephone relay	None	0.78
21 Spacer	Radio vibrator	None	0.56
22 Panel	Television Selector Switch	None	1.75
23 Spacer	Telephone relay	None	1.00
24 Spacer	Relay	None	0.91
25 Spacer	Telephone relay	None	1.00
26 Spacer	Telephone relay	None	1.00
27 Clamping Plate	Telephone relay	None	1.00
28 Electrode Mounting	Level Indicator	Brass	1.13
29 Spacer	Telephone relay	None	1.00
30 Six Terminal Header	Transformer	Monel	1.42
31 Test jack body	High Frequency Circuits	Monel	0.75
32 Clamping Plate	Telephone relay	None	1.00
33 Printed Circuit Base	Experimental	Silver	1.38

The world's most modern tube plant...

RCA, LANCASTER, PA.



Every minute... another 10" kinescope...

by automatic mass production at RCA, Lancaster

THE STORY OF LANCASTER focuses dramatically on an elaborate array of automatic tube machinery for the mass production of television kinescopes. These intricate machines were conceived, designed, and built by RCA engineers as the answer to the problem of producing the vast quantities of kinescopes, at progressively lower cost, that are so vital to the rapid expansion of television.

Today this highly automatic equipment—unique in the tube manufacturing industry—is turning out *better*

10-inch kinescopes at the unprecedented rate of more than one a minute!

Now, in anticipation of television's continued growth, RCA is embarked on a million-dollar expansion program at Lancaster that will *double* present kinescope output . . . another step in RCA's continued leadership in the development and manufacture of high quality tubes at low cost.

THE FOUNTAINHEAD OF MODERN TUBE DEVELOPMENT IS RCA



TUBE DEPARTMENT

RADIO CORPORATION of AMERICA

HARRISON, N. J.

BOARD OF DIRECTORS, 1948

- Benjamin E. Shackelford
President
- R. L. Smith-Rose
Vice-President
- S. L. Bailey
Treasurer
- Haraden Pratt
Secretary
- Alfred N. Goldsmith
Editor
- Frederick B. Llewellyn
Senior Past President
- W. R. G. Baker
Junior Past President

1948-1949

- J. B. Coleman
Murray G. Crosby
Raymond A. Heising

- T. A. Hunter
H. J. Reich
F. E. Terman

1948-1950

- J. E. Shepherd
J. A. Stratton

1948

- A. E. Cullum, Jr.
Virgil M. Graham
Raymond F. Guy
Keith Henney
J. V. L. Hogan
F. S. Howes
J. A. Hutchesson
I. J. Kaar
D. B. Sinclair

- Harold R. Zeamans
General Counsel

- George W. Bailey
Executive Secretary

- Laurence G. Cumming
Technical Secretary

- E. K. Gannett
Assistant Secretary

BOARD OF EDITORS

- Alfred N. Goldsmith
Chairman

PAPERS REVIEW COMMITTEE

- Murray G. Crosby
Chairman

PAPERS PROCUREMENT COMMITTEE

- John D. Reid
General Chairman

PROCEEDINGS OF THE I.R.E.

(Including the WAVES AND ELECTRONS Section)

Published Monthly by

The Institute of Radio Engineers, Inc.

VOLUME 36

August, 1948

NUMBER 8

PROCEEDINGS OF THE I.R.E.

John V. L. Hogan	954
Invention Lloyd Espenschied	955
3098. Distributed Amplification Edward L. Ginzton,	
William R. Hewlett, John H. Jasberg, and Jerre D. Noe	956
3099. Modern Single-Sideband Equipment of the Netherlands Postals	
Telephone and Telegraph C. T. F. van der Wyck	970
3100. Investigations of High-Frequency Echoes H. A. Hess	981
3101. Effect of Passive Modes in Traveling-Wave Tubes J. R. Pierce	993
3102. Antennas for Circular Polarization W. Sichak and S. Milazzo	997
Contributors to the PROCEEDINGS OF THE I.R.E.	1002
Correspondence:	
981. "Circuit Relations in Radiating Systems and Applications to Antenna Problems"	
Reviewed by W. A. Cole	1003
981. "Mr. Carter's Reply" P. S. Carter	1003

INSTITUTE NEWS AND RADIO NOTES SECTION

Board of Directors	1004
Industrial Engineering Notes	1006
Sections	1008
Books:	
3103. "Russian-English Technical and Chemical Dictionary" by Ludmilla Ignatiev	
Callahan Reviewed by R. M. Page and D. C. Harkin	1009
3104. "Elementary Manual of Radio Propagation" by Donald H. Menzel	
Reviewed by Harold O. Peterson	1009
3105. "Radar Beacons" edited by Arthur Roberts Reviewed by Irving Wolf	1010
3106. "Crystal Rectifiers" by Henry C. Torrey and Charles A. Whitmer	
Reviewed by C. F. Edwards	1010
3107. "The Radio Amateur's Handbook" by the American Radio Relay League	
Reviewed by Harold A. Wheeler	1010
3108. "Fluorescent and Other Gaseous Discharge Lamps" by W. E. Forsythe and E. Q. Adams	1010
3109. "The American Year Book" edited by William M. Schuyler	1010
I.R.E. People	1011

WAVES AND ELECTRONS SECTION

N. W. Mather, Past Chairman, Princeton Subsection, and A. V. Bedford,	
Current Chairman	1014
3110. Surveillance Radar Deficiencies and How They Can Be Overcome	
. J. Wesley Leas	1015
3111. A New Approach to Tunable Resonant Circuits for the 300- to	
3000-Mc Frequency Range Frank C. Isely	1017
3112. Spectral Power Distribution of Cathode-Ray Phosphors	
. R. M. Bowie and Alfred E. Martin	1023
3113. Megacycle Stepping Counter C. B. Leslie	1030
3114. Cathode-Coupled Negative-Resistance Circuit Peter G. Sulzer	1034
3115. Microphonism in a Subminiature Triode	
. V. W. Cohen and A. Bloom	1039
Contributors to Waves and Electrons Section	1049
3116. Abstracts and References	1051
News—New Products 20A	Student Branches 38A
Section Meetings 34A	Positions Open 50A
Membership 42A	Positions Wanted 55A
Advertising Index	63A

EDITORIAL DEPARTMENT

Alfred N. Goldsmith
Editor

Clinton B. DeSoto
Technical Editor

Mary L. Potter
Assistant Editor

William C. Copp
Advertising Manager

Lillian Petranek
Assistant Advertising Manager

Responsibility for the contents of papers published in the PROCEEDINGS OF THE I.R.E. rests upon the authors. Statements made in papers are not binding on the Institute or its members.

Changes of address (with advance notice of fifteen days) and communications regarding subscriptions and payments should be mailed to the Secretary of the Institute, at 450 Ahnaip St., Menasha, Wisconsin, or 1 East 79 Street, New York 21, N. Y. All rights of republication, including translation into foreign languages, are reserved by the Institute. Abstracts of papers, with mention of their source, may be printed. Requests for republication privileges should be addressed to The Institute of Radio Engineers.





John V. L. Hogan

DIRECTOR, 1916-1920, 1932-1936, 1948

John V. L. Hogan was born in Philadelphia, Pa., on February 14, 1890. From 1906 until 1907 Mr. Hogan was a laboratory assistant to Lee de Forest in experimental radio telephone and vacuum-tube work, leaving the following year to study electrical engineering at the Sheffield Scientific School. In 1910 he became an electrical engineer on the staff of the National Electric Signaling Company, where he was associated with Professor R. A. Fessenden in a number of research projects. In 1912 Mr. Hogan supervised the erection of the Bush Terminal Station in New York City. A year later he was placed in charge of the test operations between the Navy's first high-power station at Arlington, Va., and the U.S.S. *Salem* in 1913.

Mr. Hogan was appointed chief research engineer of the National Electric Signaling Company in 1914. In 1917 the company's name was changed to the International Signaling Company, and he was made commercial manager. The following year he became manager of the company then known as the International Radio Telegraph Company, leaving in 1921 to become

a consulting radio engineer in New York City. He is president of Radio Inventions, Inc., and is responsible for many inventions in the television and facsimile fields. In 1934 he founded radio station WQXR (then W2XR), which the *New York Times* acquired ten years later. As president of the Interstate Broadcasting Company, he still directs the operation of WQXR and its sister station WQXR-FM.

Mr. Hogan is author of "The Outline of Radio," and has been a prolific contributor to radio literature. One of the three original founders of the Institute, he helped to combine the Society of Wireless Telegraph Engineers and the Wireless Institute into the IRE. At the Institute's formation in 1912 he was elected to full membership. Three years later he was transferred to Fellow Grade. Since 1913 he has frequently served as a member of the Board of Directors. From 1916 until 1919 he served as Vice-President, and he was elected President of the Institute in 1920. Mr. Hogan has also been Chairman of a number of Institute Committees, including Membership, Publicity, and Standardization.

Invention—often born of urgent necessity, and itself the parent of progress—is here analyzed in an inspiring guest editorial. This has been written by a pioneer radio worker who himself has contributed major novel thoughts and methods to the communications field. As a Fellow of the Institute, a recipient of its Medal of Honor, a former Chairman of its New York Section, and a member of the Bell Telephone Laboratories, the writer of this editorial has offered guidance and a stimulus to enthusiasm among the readers of these PROCEEDINGS.—*The Editor*

Invention

LLOYD ESFENSCHIED

Radio and electronics are good examples of industries that have arisen out of scientific discovery through the act of invention, and that in turn have stimulated the further acquiring of knowledge.

Invention is a rather broad term. Generally, today in technology we mean approximately what the Patent Office tells us invention is: namely, something that is original in the sense of being not ordinarily arrived at, and that is useful. A patentable invention is not the original idea *per se*, but the embodiment of it in a device or method that is useful.

In the approach to invention, the lead or major motivation may be from either or both of two directions: it may come from the discovery of a new phenomenon or a new material so radically different as to give unexpected results, whereupon one seeks useful embodiments of the principle. Or the lead may come from a problem or need (hence the familiar adage that necessity is the mother of invention). One then searches the realm of physical knowledge to find a phenomenon or arrangement that can be adapted in a novel way to serve the purpose. If the combination of means and application involve ingenuity, originality beyond the ordinary, then an invention has been made.

Frequently the desire is present, the problem exists, but no means are known for accomplishing the result. Then one must await the further exploring of research. Often many years elapse before the appropriate discovery is made; and then, likely as not, it may prove to have come up from a little-expected area, perhaps from a branch of physics not previously related to the problem at issue.

In general, the more fundamental inventions are those that flow from the more fundamental physical discoveries. Thus, electric communications followed naturally after the discovery of electricity and its properties. One simply would not have known enough to have wished for this new medium in advance, for swift communication purposes, and then gone out and found it! As it was, from the time that electric communication was first contemplated until the time when it could be practically realized took a full century, because many additional discoveries and inventions had to be made before this subtle force could be harnessed.

Inventive progress seems to proceed as a sort of recurring feedback action, whereby a given step in knowledge leads to a step in application, and the additional practice thus brought about calls for more knowledge, and so forth. The cycle continues in an enlarging spiral until great new sectors of technical knowledge and industry are opened, and parallel avenues of advance are found to become confluent, opening into still greater territory. Invention is essentially a *growth* process in terms of physical knowledge and means, in analytical and measuring methods, in expectation, desire, realization, and, in turn, search for still more knowledge.

Thus man acts through physical discovery to produce a new result, feeds that new result back into his experience in order to be able to climb another rung of Nature's ladder, and so continues upward. It is a grand phenomenon, as difficult to understand as it is satisfying to both mind and body. Obviously, inventing itself is inexhaustible. But not so the inventor, for with advancing years he loses energy, and experiences a degree of technical obsolescence in these days of rapid advance. Individual inventors come and go, but invention itself, like Tennyson's Brook, goes on forever. In invention, where there is life there is hope, and in the young men of the day there is always much life!

Distributed Amplification*

EDWARD L. GINZTON†, SENIOR MEMBER, IRE, WILLIAM R. HEWLETT‡, FELLOW, IRE,
JOHN H. JASBERG†, ASSOCIATE, IRE, AND JERRE D. NOE††, STUDENT, IRE

Summary—This paper presents a new principle in wide-band amplifier design. It is shown that, by an appropriate distribution of ordinary electron tubes along artificial transmission lines, it is possible to obtain amplification over much greater bandwidths than would be possible with ordinary circuits. The ordinary concept of "maximum bandwidth-gain product" does not apply to this distributed amplifier. The high-frequency limit of the distributed amplifier appears to be determined by the grid-loading effects.

The distributed amplifier provides means for designing amplifiers either of the low-pass or band-pass types. The low-pass amplifiers can be made to have a uniform frequency response from dc to frequencies as high as several hundred Mc using commercially available tubes.

The general design considerations included in this paper are: The effect of improper termination of transmission lines; methods for controlling the frequency response and phase characteristic; the design which provides the required gain with fewest possible number of tubes; and a discussion of high-frequency limitations. The noise factor of the amplifier is evaluated.

Practical amplifiers, designed according to the principles described in this paper, have been built and have verified the theoretical predictions. Experimental work will be described in a forthcoming paper.

I. INTRODUCTION

WITH THE EXPANSION of the electronic art, there has been a steadily increasing demand for still wider-bandwidth amplifiers. The conventional techniques of cascading amplifier stages have been explored thoroughly in the recent years, and it has been shown¹⁻³ that there is a maximum "bandwidth-gain product" for a given tube type, no matter how complex is the coupling system between stages. Aside from the practical difficulties of attaining this maximum, this basic limitation determines the maximum bandwidth that can be obtained with conventional tubes and circuits.

The introduction of the traveling-wave concepts^{4,5} has provided a new technique for wide-band amplification at microwave frequencies. In principle, it is possible to build traveling-wave tubes which will amplify low frequencies as well as microwaves; on the other hand, the traveling-wave tube must be electrically long, and practical limitations make it improbable that such tubes will be available for frequencies much below 1000 Mc.

* Decimal classification: R363.4. Original manuscript received by the Institute, January 5, 1948. Presented, 1948 National IRE Convention, March 23, 1948, New York, N. Y.

† Stanford University, Stanford, Calif.

‡ Hewlett-Packard Company, Palo Alto, Calif.

¹ H. A. Wheeler, "Wide-band amplifiers for television," *PROC. I.R.E.*, vol. 27, pp. 429-438; July, 1939.

² W. W. Hansen, "Maximum gain-bandwidth product in amplifiers," *Jour. Appl. Phys.*, vol. 16, pp. 528-534; September, 1945.

³ Hendrick W. Bode, "Network Analysis and Feedback Amplifier Design," D. Van Nostrand Co., Inc., New York, N. Y., 1945, chap. XVII.

⁴ J. R. Pierce and L. M. Field, "Traveling-wave tubes," *PROC. I.R.E.*, vol. 35, pp. 108-111; February, 1947.

⁵ R. Kompfner, "The traveling-wave tube as amplifier at microwaves," *PROC. I.R.E.*, vol. 35, pp. 124-128; February, 1947.

To date, no practical solution for extremely broadband "video" amplifiers has been found.

The distributed amplifier to be described below provides means for designing amplifiers which have flat frequency response from low audio frequencies (and dc if necessary) to frequencies as high as several hundred Mc. This is accomplished by applying traveling-wave concepts to the "video" frequency region. By this method, as will be shown, the conventional restrictions on bandwidth are completely removed, the high-frequency limit being determined entirely by high-frequency effects within the tube proper, and not by the circuit effects outside of the tubes.

It should be pointed out that the basic idea described in this paper is not new, being first disclosed by Percival.⁶ However, for reasons which are not clear to the authors, there does not seem to be further discussion of this idea in the literature. The name "distributed amplifier" is due to the authors of this paper.

II. BASIC PRINCIPLES

It has been shown by Wheeler¹ and others that the frequency limit of a conventional video amplifier is determined by a factor which is proportional to the ratio of the transconductance G_m of the tube to the square root of the product of the input and output capacitances. Clearly, it does not help matters simply to parallel tubes; the resulting increase in G_m is compensated for by the corresponding increase in the combined capacitances. The distributed amplifier about to be described overcomes this difficulty by paralleling the tubes in a special way, in which the capacitances of the tubes may be separated while the G_m of the tubes may be added almost without limit and not affect the input or output impedance of the device. In its simplest form, this result is achieved by using the tube capacitances as the shunting elements in an artificial transmission line.

Fig. 1 shows the structure of the distributed amplifier.

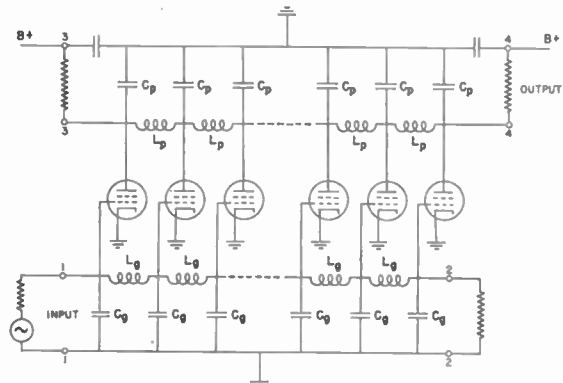

Fig. 1—Basic distributed amplifier.

⁶ W. S. Percival, British Patent Specification No. 460,562, applied for, July 24, 1936.

Between the input terminals 1-1 and terminals 2-2 there is an artificial transmission line, which consists of the grid-cathode capacitance of the tubes C_g , and the inductance between tubes (or sections) L_g . Then the characteristic impedance of the grid line is

$$Z_0 = \sqrt{\frac{L_g}{C_g}} \tag{1}$$

If the proper terminating impedance is connected to terminals 2-2, and if this transmission line is assumed to be dissipationless, then it can be shown that the driving-point impedance at terminals 1-1 is *independent of the number of tubes so connected*. In a like fashion, a second transmission line is formed by making use of the plate-to-cathode capacitances to shunt another set of coils L_p . The impedance of the plate line is similarly independent of the number of tubes (sections). Impedances connected to terminals 3-3 and 4-4 are intended to be equal to the characteristic impedance of the plate line. The impedance connected to terminals 2-2 will be called the *grid termination*; that connected to terminals 3-3 will be called the *reverse termination*; and the impedance connected to terminals 4-4 will be called the *plate termination*. Terminals 4-4 are the *output terminals*.

The two transmission lines so formed are made (by design) to have identical velocities of propagation.

A generator connected to the *input terminals 1-1* will cause a wave to travel along the grid line. As this wave arrives at the grids of the distributed tubes, currents will flow in the plate circuits of the tubes. Each tube will then send waves in the plate line in both directions. If the reverse termination is perfect, the waves which travel to the left in the plate line will be completely absorbed, and will not contribute to the output signal. The waves which travel to the right in the plate line all add *in phase*, as can be verified by examining the various possible paths between the input and output terminals. Thus, the output voltage is directly proportional to the number of tubes. The net result is that the effective G_m of this distributed "stage" may be increased to any desired limit. Thus, no matter how low the gain of each tube (section) is (even if it is less than unity), as long as the gain per section is greater than the transmis-

sion-line loss of the section, the signal in the plate line will increase and can be made to be as large as one desires by merely using a sufficient number of tubes.

When sufficient gain has been accumulated in one distributed-amplifier stage, then such stages can be cascaded in the normal manner as shown in Fig. 2.

III. CASCADING OF STAGES

It can be easily shown that there is an optimum method of dividing the tubes into groups. Appendix I shows that the least number of tubes that is required to produce a desired total gain G results when each stage⁷ has a gain of ϵ (the Napierian logarithmic base, equal to 2.72). Each such stage has n sections, and the stages are cascaded m times. Thus, there are mn tubes in such an amplifier.

If a total gain G is required, then the number of cascaded stages that should be used is m (see Appendix I).

$$m = \log_{\epsilon} G \tag{2}$$

The total number of sections that must be used in each stage must be large enough to provide a gain of ϵ for the stage. The number n obviously depends upon the bandwidth desired and upon the type of tube to be used. It is convenient to express the high-frequency figure of merit of a tube as a *bandwidth index frequency*¹; i.e., the maximum bandwidth over which unity gain may be obtained. The number of sections in each stage will then be a simple function of the ratio of the desired bandwidth to this index frequency. It is

$$n = 2 \frac{f_c}{f_0} \epsilon \tag{3}$$

where

f_c = high-frequency cutoff of the amplifier

f_0 = Wheeler's bandwidth-index frequency = $\frac{G_m}{\pi \sqrt{C_g C_p}}$

$\epsilon = 2.72$.

The number of sections required to produce a gain of ϵ is plotted in Fig. 3 for the case under discussion, and also for the conventional cascade amplifier. It is evident from this figure that the distributed amplifier is the *only* means available for amplification when the maximum frequency desired is greater than the bandwidth index frequency of the tube being used. Further, it is usually found that it is impractical to achieve much more than 50 per cent of the theoretically available bandwidth with conventional circuits; this is so because the theoretical limit requires the use of extremely complex coupling circuits, which can hardly be considered practical and

⁷ The following nomenclature will be used in this paper: Each electron tube with its section of transmission line will be called a *section*; the gain of the section will be called A_0 . n such sections form a *stage*, with a gain A . When such stages are cascaded in the conventional manner, they are called *cascaded stages*, with a gain G .

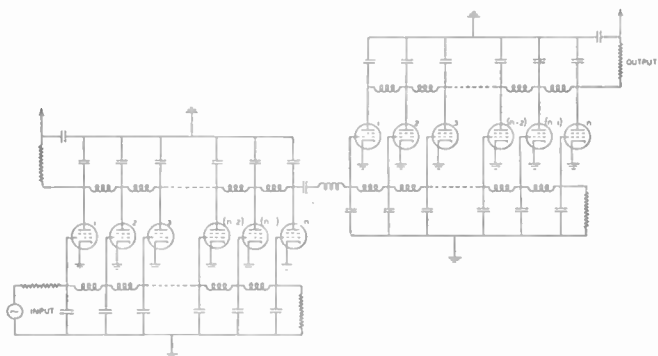

Fig. 2—Two-stage distributed amplifier, having n tubes per stage.

which increase the stray capacitance to ground. This is not the case in the distributed amplifier.

The basic ideas presented in the above discussion were in terms of the low-pass filter structure. It is obvious that the principle is equally applicable to band-pass filters. The distributed amplifier can be made to operate even in cascaded form at frequencies down to dc by utilizing well-known dc amplifier techniques.⁸

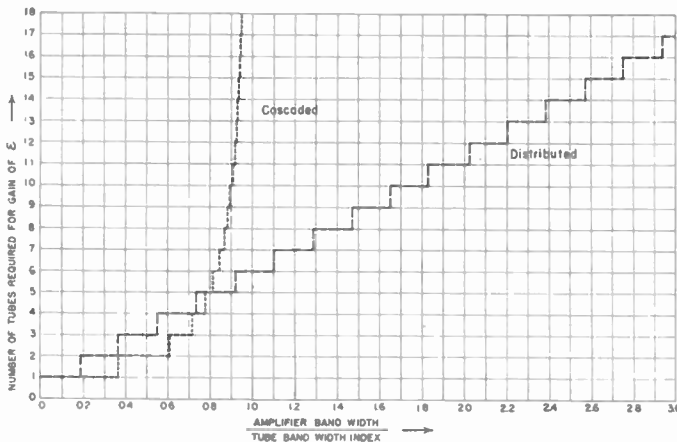

Fig. 3—Number of tubes required to produce a gain of ϵ in cascaded and in distributed amplifiers.

IV. FREQUENCY-RESPONSE CHARACTERISTICS

The following discussion of the frequency-response characteristics of the distributed amplifier will be carried out in terms of the low-pass structure of the type shown in Figs. 1 and 2. Several of the equations below are of a general type, however, and only simple modifications need to be made to make the analysis applicable to other possible structures.

The voltage gain of the amplifier consisting of n sections per stage and m cascaded stages is

$$G = \left[\frac{nG_m}{2} \sqrt{Z_{01}Z_{02}} \right]^m \tag{4}$$

where the symbols are, as before,

G = total gain

Z_{02} = characteristic impedance of the plate line

Z_{01} = characteristic impedance of the grid line.

For the case shown in Figs. 1 and 2, and assuming that the two transmission lines are identical,

$$Z_{01} = Z_{02} = \frac{R}{\sqrt{1 - x_k^2}} \tag{5}$$

where

$$x_k = \frac{f}{f_c}$$

$$R = \frac{1}{\pi f_c C}$$

⁸ E. L. Ginzton, "D-c amplifier design technique," *Electronics*, vol. 17, pp. 98-102; March, 1944.

f = frequency

f_c = cutoff frequency of the transmission lines.

Under these conditions, the gain of the distributed amplifier becomes

$$G = \left[\frac{nG_m}{2} \cdot R \right]^m (1 - x_k^2)^{-m/2} \tag{6}$$

The second factor of this equation shows that the gain of the simple structures shown in Figs. 1 and 2 will be a function of frequency. This is due to the fact that the mid-shunt characteristic impedance of a constant- K filter section (these lines obviously are constant- K sections) rises rapidly as the cutoff frequency is approached. This, in turn, causes the gain of the amplifier to increase sharply near cutoff, producing a large undesired peak. In principle, this peak can be equalized, but this becomes increasingly difficult as the number of cascade stages increases.

There are cases where the peak at the high-frequency end is not harmful and may be even beneficial. However, there are several methods which can be used to eliminate this peak. Three of these methods are discussed below.

(a) Paired-Plate or Paired-Grid Connection

Fig. 4 (a) shows a somewhat different arrangement of electron tubes along the transmission lines from those previously discussed. The grids of the tubes are still

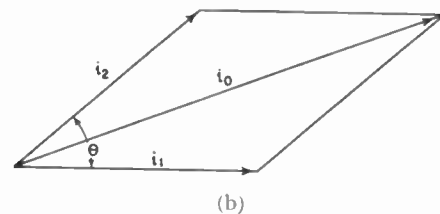
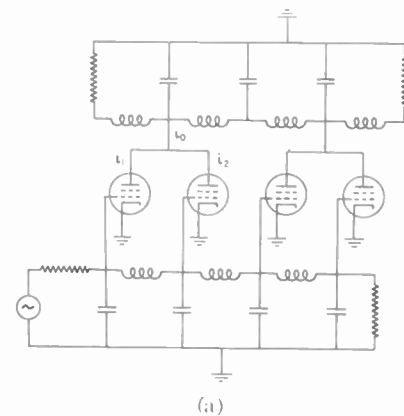

Fig. 4—(a) Paired-plate type of distributed amplifier; (b) current phase relations in paired plate amplifier.

connected periodically along the grid line, but the plates are paired as shown, with a dummy capacitance being placed at the point where the plate capacitance is now missing. This particular arrangement of tubes will be called the *paired-plate* connection. It is possible to pair grids and leave the plates arranged periodically. This is

called the *paired-grid* connection. The action of the two circuits is similar, and only the paired-plate connection will be discussed below.

The operation of this paired-plate circuit can be understood by referring to the vector diagram of the plate currents at the common junction, shown in Fig. 4 (b). Let i_1 be the current in one of the tubes, and i_2 the current in the other. The phase angle between i_1 and i_2 is determined by the phase shift between the grids of the two tubes⁹ and is given by

$$\theta = 2 \sin^{-1} x_k \tag{7}$$

where x_k is the normalized frequency of the section, as defined above. The resultant current vector is a function of x_k , and is

$$i_0 = 2\sqrt{1 - x_k^2} \tag{8}$$

It is evident that this factor is the reciprocal of the characteristic-impedance function of the section. Thus, the voltage developed in the plate line, being the product of i_0 and Z_{02} , will be constant over the pass band of the filter.

By leaving some of the plates unpaired, the gain of a stage can be made to have a frequency response which is intermediate between the flat characteristic of the completely paired stage and the rising characteristics of the constant- K sections. The control of the degree of rise in gain is a very valuable feature of this circuit. This increase in gain can be used to compensate for the decrease in gain which is due to attenuation in the transmission line at high frequencies.

Since the plate-to-cathode capacitance of most pentodes is about one-half of the grid-to-cathode capacitance, the addition of extra capacitance in the plate line does not reduce materially the design cutoff frequency.

(b) *Negative Mutual-Inductance Circuit*

The method of improving the frequency response about to be described is slightly more complicated from the original design viewpoint, but has several desirable features which are believed to be of great importance. The basic connection is shown in Fig. 5 (a), which differs from Fig. 1 only in that the adjacent coils are wound on

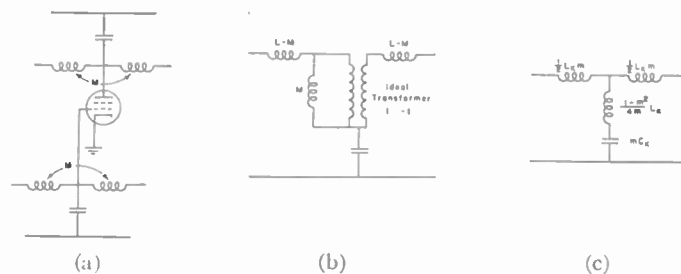

Fig. 5—(a) Circuit using mutual coupling between coils; (b) circuit equivalent to (a) by transformer theory; (c) m -derived filter circuit equivalent to (a) and (b).

⁹ E. A. Guillemin, "Communication Networks," vol. II, McGraw-Hill Book Co., Inc., New York, N. Y., 1935, p. 316.

the same form and in the same direction, and have a large coefficient of coupling. Each section can be resolved by conventional transformer theory into Fig. 5 (b). By proper design, this can be equated to the usual m -derived section shown in Fig. 5 (c). If the mutual inductance is negative, as it is in the case being discussed, the constant m will be greater than unity. This has two very desirable features. First, m greater than unity leads to a more linear phase shift through the stage. This becomes particularly important if a large number of stages are to be cascaded. Secondly, $m > 1$ leads to a larger value of capacitance C than would be called for if constant- K sections were to be used instead. For a given capacitance C , then, it is possible either to increase the gain per section for the same bandwidth, or to increase the bandwidth for the same gain.

Equation (9) shows the grid-to-plate gain, and (10) the phase shift for a stage with n tubes connected as shown in Fig. 6. This equation is derived in Appendix II.

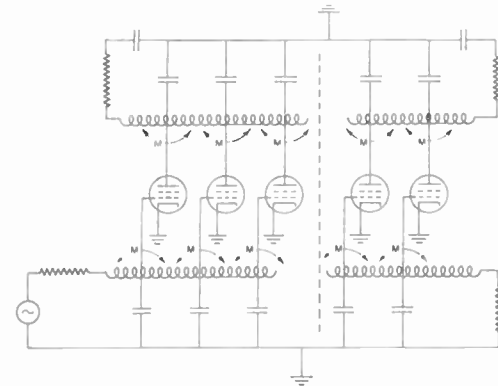

Fig. 6—An n -stage distributed amplifier using mutual coupling between coils.

$$G = \frac{R_0 G_m}{2} \frac{nm^3}{[m^2 - (1 - m^2)x_k^2] \sqrt{m^2 - x_k^2}} \tag{9}$$

$$\phi = 2n \tan^{-1} \frac{mx_k}{\sqrt{m^2 - x_k^2}} \tag{10}$$

where

$$R_0 = \frac{K}{\pi f_m C_p} \tag{11}$$

$$L_k = \frac{C_p R_0^2}{m} \tag{12}$$

$$L = \frac{1 + m^2}{4m^2} L_k, \quad M = \frac{1 - m^2}{4m^2} L_k \tag{13}$$

in which

f_m = maximum frequency required with amplitude or phase tolerance ϵ

K = coverage factor, to be determined from Fig. 9 for a desired value of tolerance ϵ

$x_k = f/f_0 = (f/f_m)K$ normalized frequency function

m = design parameter selected from Fig. 9 for desired ϵ .

The time delay through the stage is the derivative of the phase shift with respect to angular frequency, and is

$$\tau = \frac{nd\phi}{d\omega} = \frac{nd\phi}{dx_k} \cdot \frac{1}{\omega_0}$$

$$= \frac{nm^3}{[m^2 - (1 - m^2)x_k^2][m^2 - x_k^2]^{1/2}\pi f_0} \text{ seconds. (14)}$$

It is interesting to observe that both the gain and delay functions are the same except for numerical constants. Figs. 7 and 8 show the relative gain, time delay, and phase shift as a function of normalized frequency x_k for four values of m .

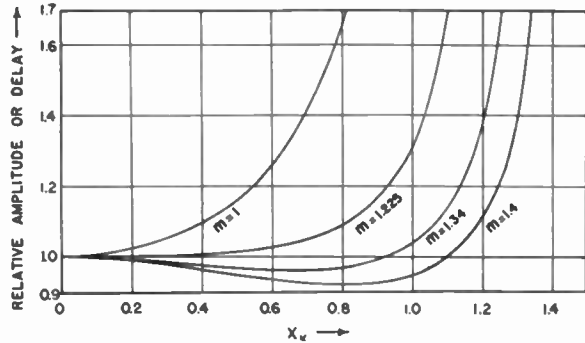

Fig. 7—Relative gain and time delay of amplifier with mutual coupling versus normalized frequency.

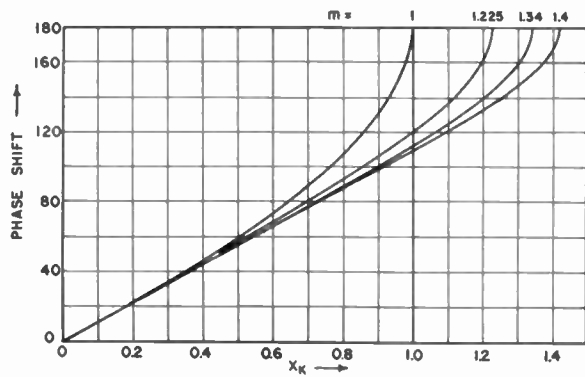

Fig. 8—Phase shift of amplifier using mutual coupling versus normalized frequency.

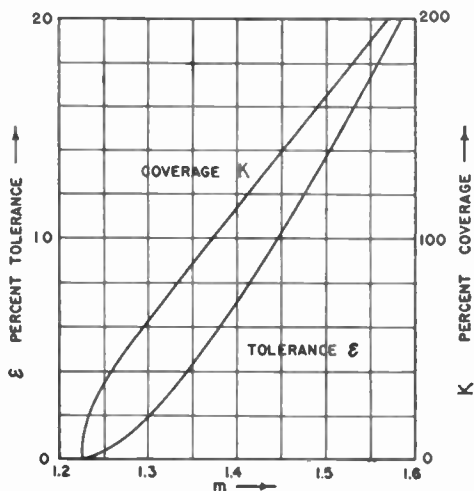

Fig. 9—Per cent tolerance or phase linearity and per cent of band covered for amplifier with mutual coupling.

Fig. 9 is designed to permit the selection of any desired tolerance in either phase or amplitude linearity as a function of per cent band coverage K over which tolerance may be maintained.

(c) The Bridged-Tee Connection

The third method of equalizing the frequency response is by means of the bridged-tee connection shown in Fig. 10 (a). By simple transformer theory this is equivalent to the circuits shown in Figs. 10 (b) and 10 (c). Fig. 10 (c) corresponds to a line having mutual coupling between coils and shunted by an impedance Z_c . If Z_c is the capacitance C_1 and Z_d is C_0 , the tube capacitance, then, using Fig. 10 (d), the circuit may be

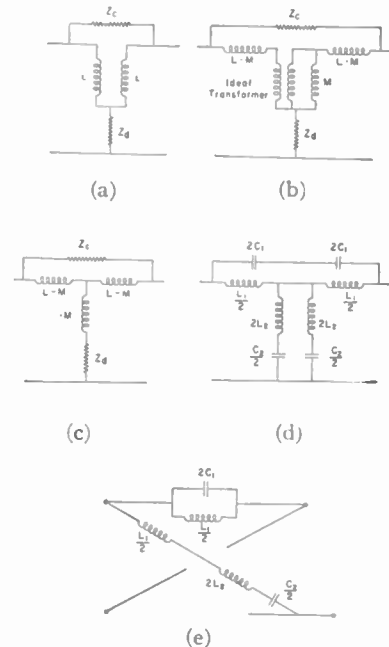

Fig. 10—Equivalent circuits for bridged-tee connection.

converted into a lattice (Appendix III) having the arms

$$Z_a = \frac{1}{4} \frac{L_1}{C_1}$$

$$= \frac{1}{2} \frac{1}{j\omega L_1} + \frac{1}{2j\omega C_1}$$

$$Z_b = \frac{1}{2} j\omega L_1(1 + \alpha) + \frac{2}{j\omega C_0}$$

(15)

where

$$\alpha = 4 \frac{L_2}{L_1}$$

This lattice is shown in Fig. 10 (e). Its characteristic impedance is

$$Z_0 = \sqrt{\frac{L_1}{C_0} \frac{1 - \omega^2 \frac{L_1 C_0}{4} (1 + \alpha)}{1 - \omega^2 L_1 C_1}}$$

(16)

If $C_0(1+\alpha)/4=C_1$, this equation is independent of frequency and the impedance becomes

$$Z_0 = \sqrt{\frac{L_1}{C_0}} = R_0. \tag{17}$$

If x_k is defined as before, the phase shift θ and the time delay τ per section become

$$\theta = 2 \tan^{-1} \frac{x_k}{1 - x_k^2(1 + \alpha)} \tag{18}$$

$$\tau = \frac{\partial \theta}{\partial \omega} = \frac{1}{\pi f_p} \frac{1 + x_k^2(1 + \alpha)}{[1 - x_k^2(1 + \alpha)]^2 + x_k^2} \text{ seconds.} \tag{19}$$

The stage gain A for n sections will be

$$A = n \frac{R_0 G_m}{2} \frac{1}{[1 - x^2(1 + \alpha)]^2 + x^2}$$

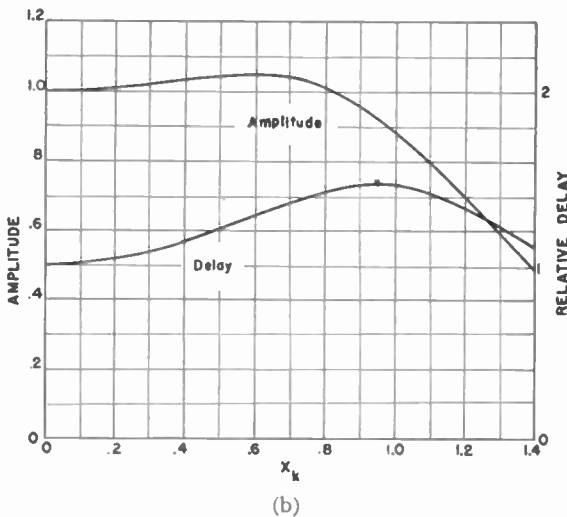
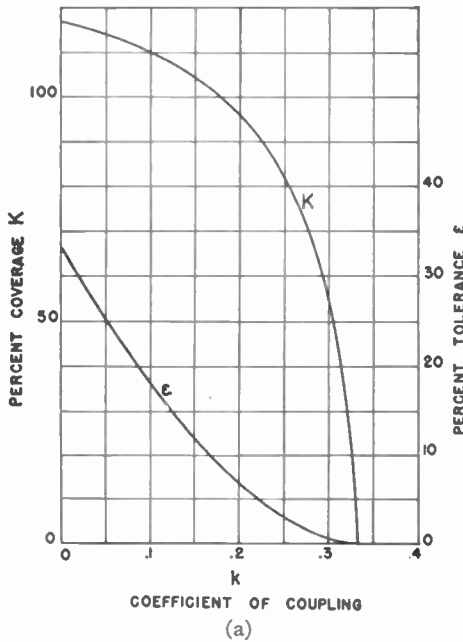

Fig. 11—(a) Coverage and tolerance for bridged-tee amplifier; (b) gain and time delay for bridged-tee amplifier.

$$R_0 = \frac{1}{\pi C_0 f_m} K. \tag{20}$$

The parameters L and C_1 are given by

$$L = 1/2 C_0 R_0^2 \frac{1}{1 - k} \tag{21}$$

$$C_1 = 1/4 \left(\frac{1 - k}{1 + k} \right) C_0 \tag{22}$$

in which k, f_m, x_k are defined previously, but being selected in this case from Fig. 11 (a), which gives ϵ and K as a function of coefficient of coupling k .

The gain and time delay for a typical case of $k=0.215$ are shown in Fig. 11 (b).

V. THE EFFECT OF IMPROPER TERMINATIONS OF LINES

In all of the discussion above, it was assumed that the lines were perfectly terminated. In the first place, it should be pointed out that, in general, the artificial lines need to be terminated by proper half-sections and resistors equal to the characteristic impedance of the lines. This is done in a conventional way, and will not be described in detail. In any practical situation, however, the terminations cannot be perfect; there can be reflections from all four sets of terminals. The effect of these reflections may be understood by reference to Fig. 12 (a), which is a schematic diagram of one stage of a distributed amplifier. It shall be assumed that the

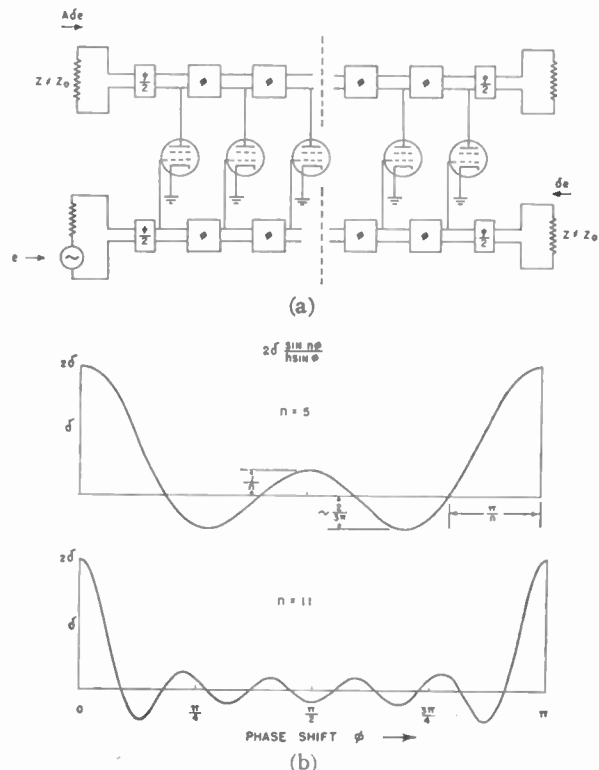

Fig. 12—(a) Diagram of distributed amplifier showing phase shift and reflection from terminations; (b) ratio of signal to reflected voltages.

lines are dissipationless, and that all sections are identical. Each stage has a phase shift of ϕ degrees, and each end of each line is terminated by a terminal half-section. The terminal half-sections will be assumed to have a phase shift of $1/2\psi$ degrees. If a signal e is introduced into the grid line, then a portion of that signal will be reflected from the grid termination. If δ is the reflection coefficient, then the reflected wave will have an amplitude δe , where $\delta = (Z_L - Z_0)/(Z_L + Z_0)$. For the sake of simplicity, it will be assumed that secondary reflections from the input and from the plate termination are negligible. The reflected voltage δe will appear at the grids of the various tubes and will add vectorially to the original wave. In a similar fashion, reflections may be expected from the reverse termination in the plate line. The net voltage at the output of the distributed amplifier is then a vector sum of all of these voltages. The net voltage due to reflections alone is

$$E_r = 2A_0e\delta \left[e^{j[2\psi + (n-1)\phi]} + e^{j[2\psi + (n+1)\phi]} + \dots + e^{j[2\psi + (2k+n-1)\phi]} + \dots + e^{j[2\psi + 3(n-1)\phi]} \right] \quad (23)$$

The voltage due to the signal at the output terminals, neglecting reflections, is

$$E_s = A_0e\epsilon^{j[\psi + (n-1)\phi]} \quad (24)$$

where

- A_0 = amplification per section
- e = input signal
- n = number of tubes per stage.

The ratio of the reflected voltage to the signal voltage is then given by (E_r/E_s) , and it is

$$\frac{E_r}{E_s} = \frac{2\delta}{n} \sum_{k=0}^{k=n-1} \epsilon^{j[\psi + 2k\phi]} \quad (25)$$

$$= 2\delta \frac{\sin n\phi}{n \sin \phi} \epsilon^{j[\psi + (n-1)\phi]} \quad (26)$$

This equation predicts the importance of the reflections. The magnitude of this function is plotted in Fig. 12(b) for $n=5$ and $n=11$. It is evident from (26) and from Fig. 12(b) that the relative magnitude of the reflected voltages near the center of the band depends upon $(2\delta/n)$ and that the larger peaks are displaced toward the edges of the band.

From a practical standpoint, the reflection factor for low values of ϕ , i.e., at the lower frequencies, may be made nearly zero. The larger peaks as ϕ approaches π tend to move toward the edges of the useful range of the amplifier. Furthermore, the concave phase characteristic of the normal constant- K section will still further crowd these larger peaks toward the upper end of the frequency band. It is evident, then, that as the number of sections n is increased, the seriousness of small mismatches is reduced.

The actual output voltage is the vector sum of the

nominal output signal and the reflected signal. Fig. 13 shows the magnitude of the variations in the output voltage for $n=5$ and $n=11$ when it is assumed that δ is

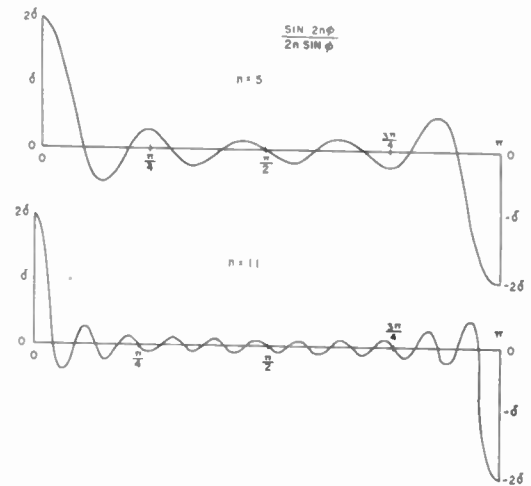

Fig. 13—Variations in output voltage.

small compared to 1 and $\phi = \psi$. If ψ is less than ϕ , as is usually the case, the effect on the curve as shown in Fig. 13 will be to crowd it toward the right and displace it slightly downward in accordance with (27).

$$E_{out} \sim E_s \left[1 + 2\delta \left(\frac{\sin(2n\phi + \psi - \phi)}{2n \sin \phi} - \frac{\sin(\psi - \phi)}{2n \sin \phi} \right) \right] \quad (27)$$

When the number of sections is small, i.e., less than four, the value of m in the terminal half-section may be so selected that the characteristic impedance and the terminating resistance will be equal ($\delta=0$) at a frequency coinciding with one of the maxima of Fig. 12(b). This will further tend to reduce the reflection effect from an imperfect termination.

VI. TAPERED PLATE LINES

In cases where it is desired to operate a distributed amplifier into a lower impedance than the optimum design impedance of the plate line, the so-called tapered line sections in the plate circuit may be used. Referring to Fig. 14, the first tube operates into a section of line

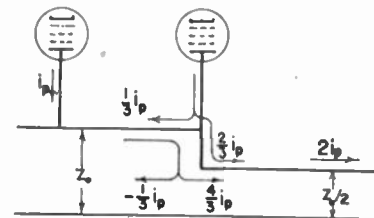

Fig. 14—Current distribution in tapered line.

with a characteristic impedance of Z_0 which is unterminated, and all the plate current i_p will flow down this section. If the next section has a characteristic impedance $1/2 Z_0$, there will be a reflected current from this

discontinuity of $-1/3 i_p$ and, in accordance with Kirchhoff's law, a current will flow into the new section of $4/3 i_p$. However, the current flowing into this junction from the second tube will produce a current of $1/3 i_p$ back down the line exactly cancelling the reflected current, and a forward current of $2/3 i_p$ which, added to the forward current of the first tube, will give $2 i_p$ flowing in the new section. At the next junction, the third section should have a characteristic impedance equal to $2/3$ of the preceding section, or $1/3 Z_0$. It is evident, then, that the output impedance of the line will be Z_0/n , where Z_0 is the initial impedance and n is the number of sections per stage. The entire current of the output tubes may thus be effectively used in the load without the necessity of half the current flowing in the load and half the current flowing in the reverse termination.

VII. HIGH-FREQUENCY EFFECTS

When an attempt is made to build an amplifier embodying the principles of the distributed amplifier and operating at frequencies above 100 Mc, the effect of lead inductance, grid loading, and line loss must be taken into account.

(a) Incidental Dissipation

It is well known that series resistance and shunt conductance will produce attenuation in a filter. Equation (28) is a good approximation of the effect of such dissipation. It is to be noted from this equation,¹⁰

$$\alpha = \frac{x_k}{2} \left(\frac{1}{Q_c} + \frac{1}{Q_L} \right) \frac{d\phi}{dx_k} \quad (28(a))$$

$$= \left(\frac{G}{2c} + \frac{R}{2L} \right) \frac{d\phi}{d\omega} \quad (28(b))$$

where

- α = attenuation in nepers
- Q_c = the Q of the capacitors
- Q_L = the Q of the coils
- x_k = the normalized frequency function
- G = the shunt conductance across the capacitance C
- R = the resistance in series with inductance L
- ϕ = the phase shift of the section in radians,

that dissipation produces an attenuation in the pass band proportional to the sum of the reciprocals of the Q 's of the coils and capacitors and proportional to the normalized slope of the phase function times the normalized frequency function x_k . As the phase function of a constant- K section is concave and rises sharply near cutoff, a marked increase in attenuation will occur near the cutoff frequency. The advantage of a linear phase function such as that obtained from sections utilizing negative mutual impedance is also immediately evident when considering the effects of incidental dissipation.

¹⁰ See p. 447 of footnote reference 9.

(b) Lead Inductance

Lead inductance in the grid and plate circuits has the effect of reducing the cutoff frequency and producing a peak near cutoff. The use of negative mutual inductance can completely compensate for this effect. The constants L and M of the negative-mutual-inductance circuit as previously discussed need to be modified to correct for the presence of the lead inductance. The following equations are given without proof, and show how L and M need to be modified to compensate for the grid (or plate) lead inductance.

$$L = \left(\frac{m^2 + 1}{4m} - \gamma \right) L_k \quad (29)$$

$$M = \left(\frac{m^2 - 1}{4m} + \gamma \right) L_k \quad (30)$$

where

$$\gamma = \frac{\text{lead inductance}}{L_k}$$

The effect of the cathode lead inductance is much more serious. This inductance, in conjunction with the grid-to-cathode capacitance, produces an input grid conductance which is equal to¹¹

$$G = G_m \omega^2 L_c C_g \quad (31)$$

The effect of this conductance is discussed in the following section.

(c) The Effect of Grid Losses

At high frequencies, there are two sources of grid loading. One of these was mentioned above, and is due to currents flowing through the grid-to-cathode capacitance and cathode lead inductance. The second of these is the transit-time effect, which also produces resistive loading of the grid circuit. Both of these loading conductances are approximately proportional to frequency squared. The relative importance of the two effects depends upon the tube geometry.

Thus, at the high frequencies, the input resistance approaches the characteristic impedance of the grid line, and the attenuation will rise rapidly. This is shown in (32) which gives the fractional loss of gain due to a grid loading conductance of G in terms of the G_m of the tube, the gain of the stage A , and the normalized slope of the phase function $d\beta/dx_k$.

$$\frac{E_{\text{out with grid losses}}}{E_{\text{out without grid losses}}} = 1 - \frac{A}{4} \frac{G}{G_m} \frac{d\beta}{dx_k} \quad (32)$$

$d\beta/dx_k$ is equal to $2/\sqrt{1-x_k^2}$ for a constant- K section, and is approximately equal to 2 for properly designed sections with negative mutual inductance. The derivation for (32) is given in Appendix IV.

¹¹ F. E. Terman, "Radio Engineering," McGraw-Hill Book Co., New York, N. Y., 1947; pp. 369-371.

VIII. NOISE IN DISTRIBUTED AMPLIFIER

There are four sources of noise of basic and unavoidable nature that need to be considered in any amplifier which extends to high frequencies. These are:

- (a) Thermal noise in the input impedance.
- (b) Shot-effect noise generated by the electron stream in the electron tubes.
- (c) Induced grid noise, which is associated with transit time effects at the high frequencies.
- (d) Thermal noise in the equivalent grid-loading impedance which is developed between the cathode and grid of an electron tube as a result of grid-to-cathode capacitance and the cathode lead inductance.

The ideal amplifier would be one in which the only noise in the output terminal was due to the thermal noise in the input impedance of the amplifier. The thermal noise in the input impedance can be used as a comparison standard and all other noises can be measured in terms of it.

The manner in which these various noises appear in the output of the distributed amplifier will be considered below. The analysis will be carried out for a single-stage distributed amplifier, shown in Fig. 1.

(a) Thermal Noise

The grid line is terminated with resistances on each end, and both of these act as generators of thermal noise. The noise generated in the input termination will cause a noise voltage to appear at the output terminals in exactly the same way as if it were a signal. The noise due to the grid termination produces a noise wave on the grid line which is amplified by the tubes, the noise signals adding in the plate line in a way which depends upon the phase shift per section. The addition of the noise voltages in the plate line due to the backward-going wave is the same mathematical problem as was considered in the case of reflections in Section IV. Calling the noise power in the output due to the input impedance N_1 and noise power due to grid termination N_2 ,

N_T = total thermal noise output in a band Δf cycles

wide at frequency f

$$\begin{aligned} &= N_1 + N_2 \\ &= N_0 \frac{Z_{01}}{Z_{02}} A_0^2 n^2 \left[1 + \left(\frac{\sin n\phi}{n \sin \phi} \right)^2 \right] \end{aligned} \quad (33)$$

where

$N_0 = 4kT\Delta f$ watts

k = Boltzman's constant

T = temperature of the terminations, °K

Δf = bandwidth in cps in which noise is to be measured

f = frequency

A_0 = amplification of each section = $G_m Z_{02} / 2$

ϕ = phase shift per section

n = number of sections per stage.

The first term in (33) is the amplified noise arising in the

input impedance. The second term is due to the noise originating in the grid termination; it can have a value of unity when $\phi = 0, \pi$, etc., but is, in general, smaller than unity. The functional dependence of this noise power upon the phase shift per section is identical with the square of the voltage reflections from the grid termination shown plotted for $n=5$ and $n=11$ in Fig. 12(b). As can be seen from (33) and Fig. 12(b), the thermal noise due to the *grid termination* is usually small compared with the noise due to the input impedance. Only at dc and at cutoff do the two terms become equal.

(b) Shot-Effect Noise

The shot-effect noise is due to the random emission of electrons from the cathode. The effect of this noise can be represented by a resistor in the grid circuit which is assigned a value such that this fictitious resistance generates as much noise as is actually observed in the plate circuit of the tube. If the impedance, looking back from the grid toward the input terminals, can be made much higher than this noise resistance, then the noise due to the shot effect will be small compared with the thermal noise. At low frequencies and in narrow-band amplifiers, the input impedance can be made high and, consequently, the shot-effect noise can be made to be negligible. In wide-band amplifiers, including the distributed amplifier, the input impedance cannot be made high, and as a result, the noise generated by the shot effect cannot be neglected.

However, in the case of the distributed amplifier, the shot-effect noise can be made negligibly small in spite of the fact that the grid-to-ground impedance is not high when compared to the equivalent noise resistance. This can be seen from the following considerations. Each tube develops random noise current in its plate circuit independently of the other tubes used in the distributed amplifier. The noise currents cause voltages to appear on the plate line, and these voltages add in the output terminals in a random manner. The random addition of voltages can be obtained by taking a sum of the noise power produced by the individual tubes; thus, if the tubes are alike, the total noise power will be proportional to the number of tubes. On the other hand, the signal at the output terminals is proportional to the number of tubes, and the signal power is proportional to the number of tubes squared. Hence, the signal to noise ratio will be proportional to n , where n is the number of tubes. Thus, by using a sufficient number of sections, it is possible to make the signal as large as one desires compared to the shot-effect noise.

The effect of shot noise can be computed in the usual manner. The following results are given without proof. The shot-effect noise power N_s in the output of the distributed amplifier is

$$N_s = n N_0 A_0^2 \frac{R_{eq}}{Z_{02}} \quad (34)$$

where A_0 is the amplification per section. Thus, for a given tube and desired bandwidth, N_0 , A_0 , R_{eq} , and Z_{02} are known constants.

(c) High-Frequency Noise

The transit-time effects and cathode lead inductance can both be taken into account by representing them as shunt resistances from grid to ground in each tube. Associated with this equivalent resistance there is a noise, which can be evaluated in a standard manner.¹²

The behavior of this noise in the output of the distributed amplifier is very complicated. In the first place, the magnitude of the noise is a rapid function of frequency (the noise power per cycle is approximately proportional to frequency squared). In the second place, each tube generates noise voltages which propagate in both direction from the tube. Thus, noise generated by one tube is amplified by all the other tubes. Moreover, this amplification depends upon the particular position of the tube in the distributed amplifier.

Fig. 15 shows a single section of distributed amplifier, indicating the sources of high-frequency noise. While the discussion of the relative magnitudes of the two sources of noise is not within the scope of this paper, it should be pointed out that both effects are determined by the geometric factors within the tube itself. For the purpose of this discussion, it shall be assumed that an equivalent

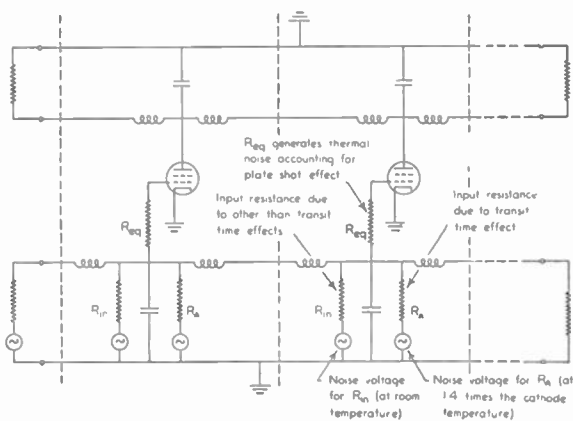

Fig. 15—Sources of noise in section (symbols after Terman).

resistance R_A and an accompanying voltage can be found which accounts for the existing noise. If the noise power that R_A can deliver is N_T , then it can be shown that the total noise power N_A due to high-frequency effects in the output is given by

$$N_A = \frac{N_T R_A A_0^2 Z_{01}^2}{Z_{02} (Z_{01} + 2R_A)^2} \cdot P \tag{35}$$

¹² See pp. 579–584 of footnote reference 11.

where P is a constant which depends upon ϕ and n . Near dc and near cutoff,

$$\phi \rightarrow 0 \text{ or } \pi, \text{ and } P \rightarrow n^3. \tag{36}$$

Near midband,

$$\phi \rightarrow \frac{\pi}{2}, \text{ and } P \rightarrow \frac{n^3}{3}. \tag{37}$$

Thus, it can be seen that the noise power in the output due to grid loading effects is proportional to n^3 , whereas the signal voltage is proportional to n^2 . Hence, should the noise from this source be at all appreciable, increasing the number of stages decreases the signal-to-noise ratio. However, for reasons having to do with attenuation, this noise is not too important. This will be discussed below.

(d) The Noise Factor of the Distributed Amplifier

The noise in the output of the amplifier is the sum of the three noises given above:

$$\text{Total noise power} = \text{thermal noise} + \text{shot noise} + \text{grid-loading noise}$$

or

$$N_{\text{total}} = N_T + N_S + N_A. \tag{38}$$

The noise factor $N.F.$ can be defined as the ratio of the total noise in the output terminals to the noise due to the input impedance. Thus,

$$N.F. = \frac{N_T + N_S + N_A}{N_1} \tag{39}$$

where the notation is as used above. Substituting values of these terms from (33), (34), and (35), and simplifying,

$$N.F. = 1 + \left(\frac{\sin n\phi}{n \sin \phi} \right)^2 + \frac{1}{n} \frac{R_{eq}}{Z_{01}} + n \frac{Z_{01}}{R_A} \frac{\alpha}{4} \tag{40}$$

in which it has been assumed that

- (1) $Z_{01} = Z_{02}$, for reasons of simplicity
- (2) $R_A \gg Z_{01}$, for reasons to be explained below
- (3) α is a numerical factor, equal to about 5, which takes into account the experimentally observed values of noise associated with R_A .

It should also be remembered that R_A is a function of frequency:

$$R_A \propto \frac{1}{f^2}.$$

From (40) it will be seen that noise factor of the amplifier depends upon competing factors of $(1/n)$ and n . Thus, one would think that there should be an optimum value of n for minimum noise. Actually, such a choice would have little physical meaning. In the first place, R_A is a function of frequency; and in the second place,

if frequency response is to be at all uniform, one must choose tubes in which $R_A \gg Z_{02}$ at the highest frequency of interest *in order to avoid attenuation*. Under these conditions, the associated high-frequency noise will also be small. Therefore, by using a sufficient number of sections, the shot noise can be made negligibly small and the resulting noise factor can be made to approach unity except at low and high frequencies where it approaches 2 due to the noise arising in the grid termination.

IX. CONCLUSIONS

The amplifier described in this paper utilizes the principle of distributing amplification in space, and to this extent bears some relation to the traveling-wave tube. However, it is basically different in its principle of operation and in its field of application. It will permit the construction of wide-band amplifiers with top cutoff frequencies far in excess of those previously obtainable by conventional means. New tubes will undoubtedly be developed specifically for this application and should be characterized by good physical separation between grid and plate terminals, preferably with a ground plane in-between, to which the screen, cathode, and heater may be by-passed. The gain versus bandwidth index of such a tube should be as high as possible, and tubes should present a minimum of grid loading. Present tubes do, in part, meet these requirements, but it is felt that if tubes are specifically designed for this purpose, improved performance can be obtained. The techniques herein outlined, although presented in specific detail, are capable of much broader applications. It does not appear necessary to confine the principle of the distributed amplifier to tetrodes alone but should be applicable to other types of amplifier tubes, such as velocity-modulation devices.

Experiments have been conducted which have verified the predictions given in this paper. For example, a two-stage amplifier, using seven 6AK5 tubes per stage with a frequency response of essentially 0 to 200 Mc, had a gain of 18 db. Several such amplifiers will be described in a forthcoming paper which will present experimental confirmation of the principles presented here.

APPENDIX I

Gain Relations

Fig. 1 shows the basic circuit of a distributed amplifier of the low-pass type. The purpose of this Appendix is to prove the gain relations stated in Sections III and IV.

It will be assumed that it is possible to match impedances between the generator and the grid transmission line and between stages.

If the voltage that is applied to the grid line is e , then the current that will flow in each plate circuit will be eG_m . The impedance that appears between the plate and cathode of each tube is $Z_{02}/2$. Thus, the voltage developed by a single tube is $eG_m Z_{02}/2$. Hence, the gain of the stage is

$$.A = \frac{nG_m Z_{02}}{2} \quad (41)$$

However, if such stages are to be cascaded, then, in general, a transformer must be provided to match the plate line to the grid line of the next stage. Thus, the voltage at the grid of the next stage will be $neG_m Z_{02}/2 \cdot \sqrt{Z_{01}/Z_{02}}$. Hence, the gain of a single stage *measured from grid line to grid line* is

$$.A = \frac{nG_m}{2} \sqrt{Z_{02}Z_{01}} \quad (42)$$

If such stages are cascaded m times, then the resultant gain of the cascaded stages will be

$$G = .A^m = \left(\frac{nG_m}{2} \sqrt{Z_{01}Z_{02}} \right)^m \quad (43)$$

This is (4), given in Section IV.

One can now make use of the fact that Z_{01} and Z_{02} are not really independent variables. More fundamental parameters are: grid-to-cathode capacitance C_g , plate-to-cathode capacitance C_p , and the desired cutoff frequency f_c . Using these, the characteristic impedance of the transmission lines can be written in terms of f_c , C_p , and C_g . It then follows that

$$.A = \frac{n}{2f_c} \cdot \frac{G_m}{\pi \sqrt{C_g C_p}} \quad (44)$$

Wheeler's bandwidth index frequency f_0 was defined in Section III. Using this definition, (43) and (44) become

$$.A = n \frac{f_0}{2f_c} \quad (45)$$

$$G = \left(n \frac{f_0}{2f_c} \right)^m \quad (46)$$

The total number of electron tubes in a cascaded amplifier is $N = mn$. It is desired to determine the least number of tubes required to produce a given gain. This can be done as follows:

If the gain per stage is

$$G^{1/m} = n \frac{f_0}{2f_c} \quad (47)$$

solving for n ,

$$n = \frac{2f_c}{f_0} G^{1/m}$$

Hence,

$$= mG^{1/m} \cdot \frac{2f_c}{f_0} \quad (48)$$

Differentiating (48) with respect to m and setting the resultant to zero, one finds that the smallest N is obtained when

$$m = \log_e G \quad (49)$$

$$\frac{E}{e_0} = \frac{G_m R_0}{2} \frac{m^3}{[m^2 - (1 - m^2)x_k^2] \sqrt{m^2 - x_k^2}} \angle -\theta_2 \quad (60)$$

$$\theta = 2 \tan^{-1} \frac{m x_k}{\sqrt{m^2 - x_k^2}} \quad (61)$$

$$\tau = \frac{1}{\pi f_c} \frac{m^3}{[m^2 - (1 - m^2)x_k^2] \sqrt{m^2 - x_k^2}} \quad (62)$$

where f_c in (62) is equal to

$$f_c = \frac{1}{\pi R_0 C_0}$$

APPENDIX III

The Bridged-Tee Connection

The bridged-tee structure shown in Fig. 19(a) may, by Bartlett's bisection theorem,¹³ be equated to the lat-

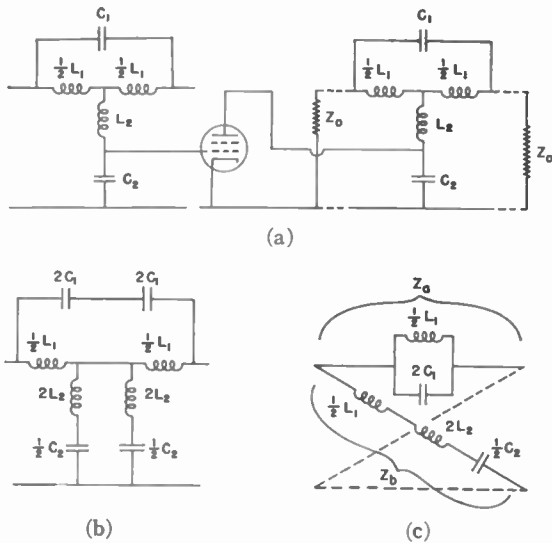

Fig. 19—Bridged-tee connection and symbols.

tice section shown in Fig. 19(c). The characteristic impedance Z_0 is, however, given by

$$Z_0 = \sqrt{Z_a Z_b} = \sqrt{\frac{L_1}{C_2} \frac{1 - \omega^2 \frac{L_1 C_2}{4} (1 + \alpha)}{1 - \omega^2 L_1 C_1}} \quad (63)$$

where

$$\alpha = 4 \frac{L_2}{L_1}$$

If $C_2(1 + \alpha) = 4C_1$, Z_0 is independent of frequency and equal to $\sqrt{L_1/C_2}$.

The propagation function γ of a lattice is defined as

¹³ Bartlett's bisection theorem states that any symmetrical network may be represented by an equivalent lattice network in which one arm of the lattice is equal to the bisected symmetrical section open-circuited on the bisected end and the other arm of the lattice is equal to the bisected symmetrical section short-circuited.

$$\gamma = \log_e \left[\frac{1 + \sqrt{Z_a/Z_b}}{1 - \sqrt{Z_a/Z_b}} \right] = 2 \tanh^{-1} \sqrt{Z_a/Z_b} \quad (64)$$

but when

$$C_2(1 + \alpha) = 4C_1, \quad \sqrt{Z_a/Z_b} = \frac{j x_k}{1 - x_k^2(1 + \alpha)}$$

where x_k is defined as before as $\pi f R_0 C_0$, recognizing that $C_2 \equiv C_0$.

As $\sqrt{Z_a/Z_b}$ is always imaginary, the propagation function γ is imaginary and thus represents only a phase shift with no attenuation, i.e., an all-pass section. The phase shift θ is then

$$\theta = 2 \tan^{-1} \frac{x_k}{1 - x_k^2(1 + \alpha)}, \quad (65)$$

and the delay τ is

$$\tau = \frac{d\theta}{d\omega} = \frac{1}{\pi f_c} \frac{1 + x^2(1 + \alpha)}{[1 - x_k^2(1 + \alpha)]^2 + x_k^2} \text{ seconds.} \quad (66)$$

The grid drive is calculated in the same fashion as in Appendix II with the exception that part of the input

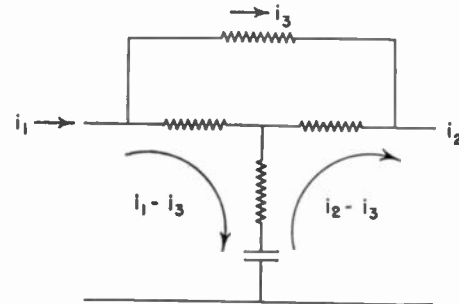

Fig. 20—Bridged-tee current connection.

current flows in the bridging arm as shown in Fig. 20. Thus, the net current through the capacitors is

$$(i_1 - i_3) - (i_2 - i_3) = (i_1 - i_2)$$

And so

$$e_g = (i_1 - i_2) \cdot \frac{1}{j\omega C_2} \quad (67)$$

or

$$\frac{e_g}{e_0} = \frac{1}{j\omega C_2 Z_0} (1 - e^{-i\theta}) \quad (68)$$

or

$$\frac{e_g}{e_0} = \frac{1}{\sqrt{[1 - x_k^2(1 + \alpha)]^2 + x_k^2}} \angle -\tan^{-1} \frac{x_k}{1 - x_k^2(1 + \alpha)} \quad (69)$$

The voltage developed per section of plate line may

be readily calculated from the redrawn plate circuit shown in Fig. 21. As no voltage difference exists across

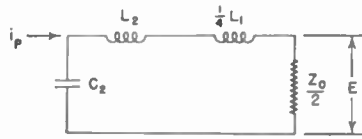

Fig. 21—Equivalent plate circuit of the bridged-tee connection.

the two ends of the bridging arm due to the current i_p , it may be omitted, allowing the series arms and terminating resistors to be combined in parallel. Thus,

$$E = i_p \cdot \frac{\frac{Z_0}{2} \cdot \frac{1}{j\omega C_2}}{\frac{Z_0}{2} + \frac{1}{j\omega C_2} + \frac{1}{j\omega L_1(1+\alpha)}} = \frac{i_p R_0}{2} \frac{1}{\sqrt{[1 - x_k^2(1+\alpha)]^2 + x_k^2}} \angle -\tan^{-1} \frac{x_k}{1 - x_k^2(1+\alpha)}$$

but

$$i_p = e_0 G_m \tag{70}$$

Thus, the transfer characteristic is given by

$$\frac{E}{e_0} = \frac{G_m R_0}{2} \frac{1}{[1 - x_k^2(1+\alpha)]^2 + x_k^2} \angle -\theta \tag{71}$$

Equating the physical structure against the desired structure as shown in Fig. 22, it is evident that $L+M = \frac{1}{2}L_1$ and $-M = L_2$. Therefore,

$$L = L_1/2 + L_2 = L_1/2 \left(1 + \frac{\alpha}{2}\right) \text{ as } L_2 = \alpha L_1/4,$$

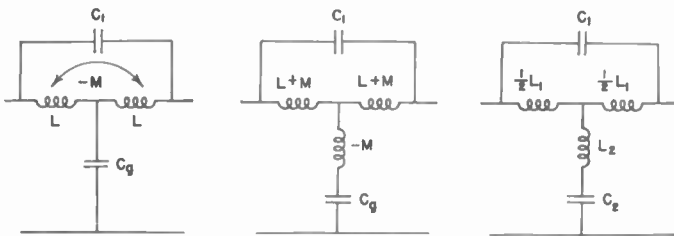

Fig. 22—Bridged-tee connection and its equivalents.

the coefficient of coupling k is

$$k = \frac{M}{L} = -\frac{\alpha}{2 + \alpha} \tag{72}$$

or

$$\alpha + 1 = \left(\frac{1 - k}{1 + k}\right) \tag{73}$$

$$C_1 = C_2 \frac{1 + \alpha}{4} = \frac{1 + \alpha}{4} C_0 = \frac{1}{4} \left(\frac{1 - k}{1 + k}\right) C_0 \tag{74}$$

Thus, the transfer characteristic may be given as,

$$\frac{E}{e_0} = \frac{G_m R_0}{2} \frac{1}{\left[1 - x_k^2 \left(\frac{1 - k}{1 + k}\right)\right]^2 + x_k^2} \angle -\theta \tag{75}$$

$$\theta = 2 \tan^{-1} \frac{x_k}{1 - x_k^2 \left(\frac{1 - k}{1 + k}\right)} \tag{76}$$

and the delay τ as,

$$\tau = \frac{1}{\pi f_c} \frac{1 + x_k^2 \left(\frac{1 - k}{1 + k}\right)}{\left[1 - x_k^2 \left(\frac{1 - k}{1 + k}\right)\right]^2 + x_k^2} \text{ seconds.} \tag{77}$$

From these equations, curves may be plotted as a function of x_k for various values of the design parameter k , the coefficient of coupling.

APPENDIX IV

Attenuation Due to Grid Losses

The effect of a shunting conductance G across the shunt capacitor C will introduce an attenuation per section given by

$$\alpha \approx \frac{G}{4\pi f_c C} \frac{d\theta}{dx_k} \tag{78}$$

where

- θ = the phase shift per section
- f_c = the cutoff frequency
- x_k = the normalized frequency function.

If the voltage e_0 is applied to the first section of the grid line, the output voltage E of an n -section stage will be given by

$$E = e_0 \frac{G_m R_0}{2} [1 + \epsilon^{-\alpha} + \epsilon^{-2\alpha} \dots \epsilon^{-(n-1)\alpha}] = e_0 \frac{G_m R_0}{2} \frac{1 - \epsilon^{-n\alpha}}{1 - \epsilon^{-\alpha}} \approx e_0 \frac{G_m R_0 n}{2} \left(1 - \frac{n\alpha}{2}\right) \tag{79}$$

R_0 is, however, equal to $1/\pi f_c C$, and thus

$$n = \frac{2A}{G_m R_0} = \frac{2\pi f_c C A}{G_m} \tag{80}$$

where A is the stage gain, neglecting losses.

Thus the fractional loss in gain $n\alpha/2$ is given by

$$\frac{n\alpha}{2} = \frac{A}{4} \frac{G}{G_m} \frac{d\theta}{dx_k} \tag{81}$$

Modern Single-Sideband Equipment of the Netherlands Postals Telephone and Telegraph*

C. T. F. VAN DER WYCK†

Summary—After an introduction, a short description is given of the equipment developed before 1940, followed by a survey of the principles of the modern equipment. The way in which the automatic tuning in the receiver is accomplished is described in detail. A summary is given of the advantages of the modern equipment with respect to the earlier art. In an appendix, some theoretical considerations are given with respect to the automatic tuning control; particularly, the conditions for a stable circuit are derived.

INTRODUCTION

SINGLE-SIDEBAND TELEPHONY on the Netherlands long-distance radio transmissions started in 1933, preparatory work having been carried out in the years before. Owing to the initiative of the late N. Koomans and the late W. F. Einthoven, the Postal and Telecommunication Services of the Netherlands and the Netherlands East Indies were among those who first put to commercial use a four-channel single-sideband system on a commercial link. Apart from many modifications important from a practical point of view, the original scheme of the apparatus did not change until 1940. In 1938, Koomans gave a description of this equipment.¹

After extensive experimental work, carried out during the occupation of the Netherlands and continued after the war, the construction of new single-sideband equipment was started. In preparation for commercial production, a few prototypes have been constructed at the PTT laboratories, these equipments being in operation on the U.S.A.-Netherlands link.

One of the outstanding features of this new equipment, in comparison with the former, is the introduction of carrier telephone equipment. Moreover, many improvements, made in the earlier days and suggested by the requirements of communication, have been included from the beginning in our design, thus leading to further simplicity and efficiency. An extensive use of crystals in filters and oscillators, the avoidance of switches in signal circuits, and a different way of accomplishing automatic tuning control in the receiver are some salient points in our new apparatus. Special attention has been paid to the stability of the first oscillators.

As to the transmitting part, we shall limit ourselves to the "premodulator." In the premodulator, the low-frequency telephone channels are transformed to a higher frequency level and are grouped together in their

correct positions. At this point, the energy is still low, the actual amplification taking place in the "transmitter." At the transmitting center of Kootwijk, the premodulators are placed in a separate building, the "studio," at 1 kilometer from the transmitter buildings.

GENERAL ADVANTAGES OF THE SINGLE-SIDEBAND SYSTEM

The general advantages of the single-sideband system may be summarized as follows: In an AM system, the energy of the carrier forms a large part of the total radiated energy, whereas, in the single-sideband system, this carrier and one sideband are eliminated at the transmitter, a local carrier being added again in the receiver. Consequently, an energy reduction (or a more economical use of the energy), a reduction of the bandwidth, and, by applying a local carrier, a noticeable reduction of fading is obtained.

In view of the necessity to fix the channels relative to the local carriers in the receiver, a pilot frequency, which has a definite position with regard to the suppressed carriers, is transmitted simultaneously.

FORMER EQUIPMENT (KOOMANS)

In the premodulator, the low-frequency band of each channel is modulated on a definite carrier, different for each channel, after which selection of the upper or the lower band takes place by means of a filter network, varying in frequency for each channel. The *A* channel is modulated on 10 kc (or 7 kc); this modulation is followed by selection of the 7- to 10-kc band. The *B* channel is modulated on 10 kc (or 13 kc), after which selection of the 10- to 13-kc band takes place. Similarly, the modulation frequencies of the *C* and *D* channels are 14 and 20 kc, and the frequency bands 14 to 17 kc and 17 to 20 kc. (Fig. 1).

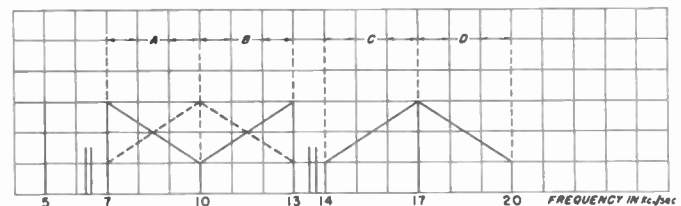

Fig. 1—Arrangement of channels in former equipment.

This arrangement of these four channels with a pilot frequency at 5 or 10 kc and with two channels for double-tone telegraphy (mark and space), covering in total the frequency band 5 to 20 kc, is characteristic for the "Indies link." This frequency band is converted

* Decimal classification: R423.5. Original manuscript received by the Institute, September 22, 1947.

† Radio Laboratory of the Dutch Postal Telephone and Telegraph, The Hague, Holland.

¹ N. Koomans, "Single-sideband telephony applied to the radio link between the Netherlands and the Netherlands East Indies," Proc. I.R.E., vol. 26, pp. 182-207; February, 1938. Discussion, H. J. J. M. de Bellescize and N. Koomans, Proc. I.R.E., vol. 26, pp. 1299-1301; October, 1938.

successively to the band 65 to 80 kc and to the band 465 to 480 kc in two steps, the final frequency transformation and the amplification of the energy taking place in the transmitter.

Testing apparatus for observing the excitation of the transmitter, the mutual interference, and nonlinear distortion are provided for.

In the receiver, the high-frequency spectrum, by an analogous process, is converted to the frequency band 5 to 20 kc and, by means of oscillators of 7, 10, 13, 14, 20 kc, to the low-frequency *A, B, C, and D* channels.

In our original equipment, the automatic frequency control is substantially electric; in a discriminator, the frequency variations of the pilot frequency are converted into voltage variations (+ or - voltage); these voltage variations operate the second oscillator in the receiver. This second oscillator contains a reactance tube coupled to the oscillator tube.

MODERN EQUIPMENT

In the low- and medium-frequency parts of our modern equipment, carrier telephone equipment, as normally used by the Netherlands PTT Administration, has been applied.

Premodulator (Block Diagram, Fig. 2).

The low-frequency band of *each* channel is modulated on 60 kc and the upper band (60.3 to 63.4 kc) is se-

having the frequency range of 266 to 286 kc by means of a (crystal) oscillator, unique for each channel ($60+x$ oscillator).² After this second modulation process, the relative positions of the channels are such as are required for a particular correspondent (Fig. 8).

By choosing the frequencies of the oscillators properly, we can, in a simple way, obtain frequency arrangements required by the different correspondents. In our first equipment, a change in the relative position of the channels necessitated a change of filters.

A band-pass filter 266 to 286 kc, with high attenua-

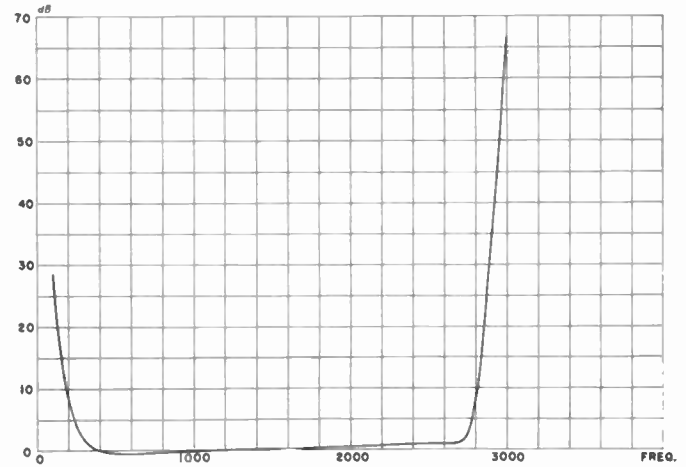

Fig. 3—Attenuation curve of a telephone channel in the premodulator.

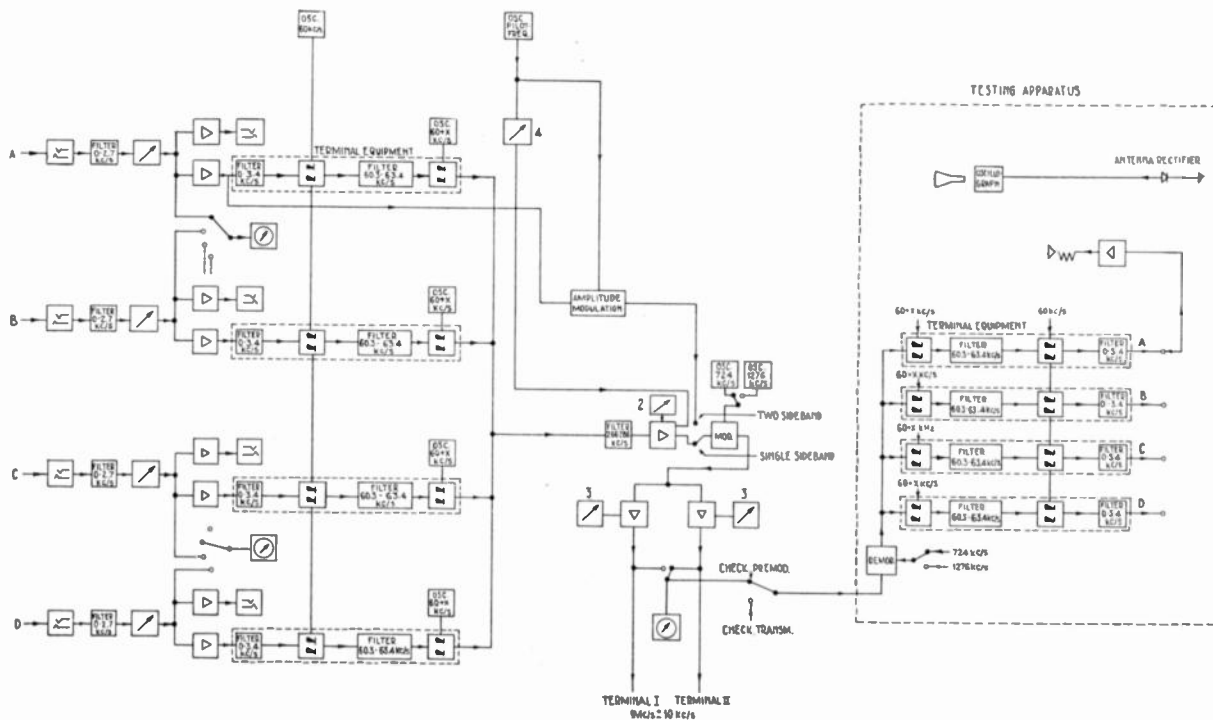

Fig. 2—Premodulator for the single-sideband transmitter.

lected. A low-pass filter, 0 to 2800 cps, confines the frequency range to the usual "3000-cps" band on radio links. This upper band is converted into a band

² In the expression $60+x$ oscillator, taken from the terminology of carrier telephony, x is the (suppressed) carrier in the second conversion process. As there are two ways for converting the 60.3- to 63.4-kc band, we could say in our case: $x \pm 60$ oscillator.

tion, prevents radiation of modulation products outside this range.

Practice has proved the necessity of transmitting a given channel band, as formed in the second process (266 to 286 kc), both in the "right" position, in which the sequence of the channels as transmitted in sense of increasing frequency does not change, and in the "inverted" position, in which this sequence is inverted, as well.

The output terminals of the premodulator are provided, so that two transmitters can be operated simultaneously (the maximum output voltage is 10 volts and the impedance of the cable from premodulator to transmitter is 130 ohms).

In view of correspondents using a different channel arrangement, a number of $60+x$ oscillators are available; the description of our receiver contains a table of these oscillators.

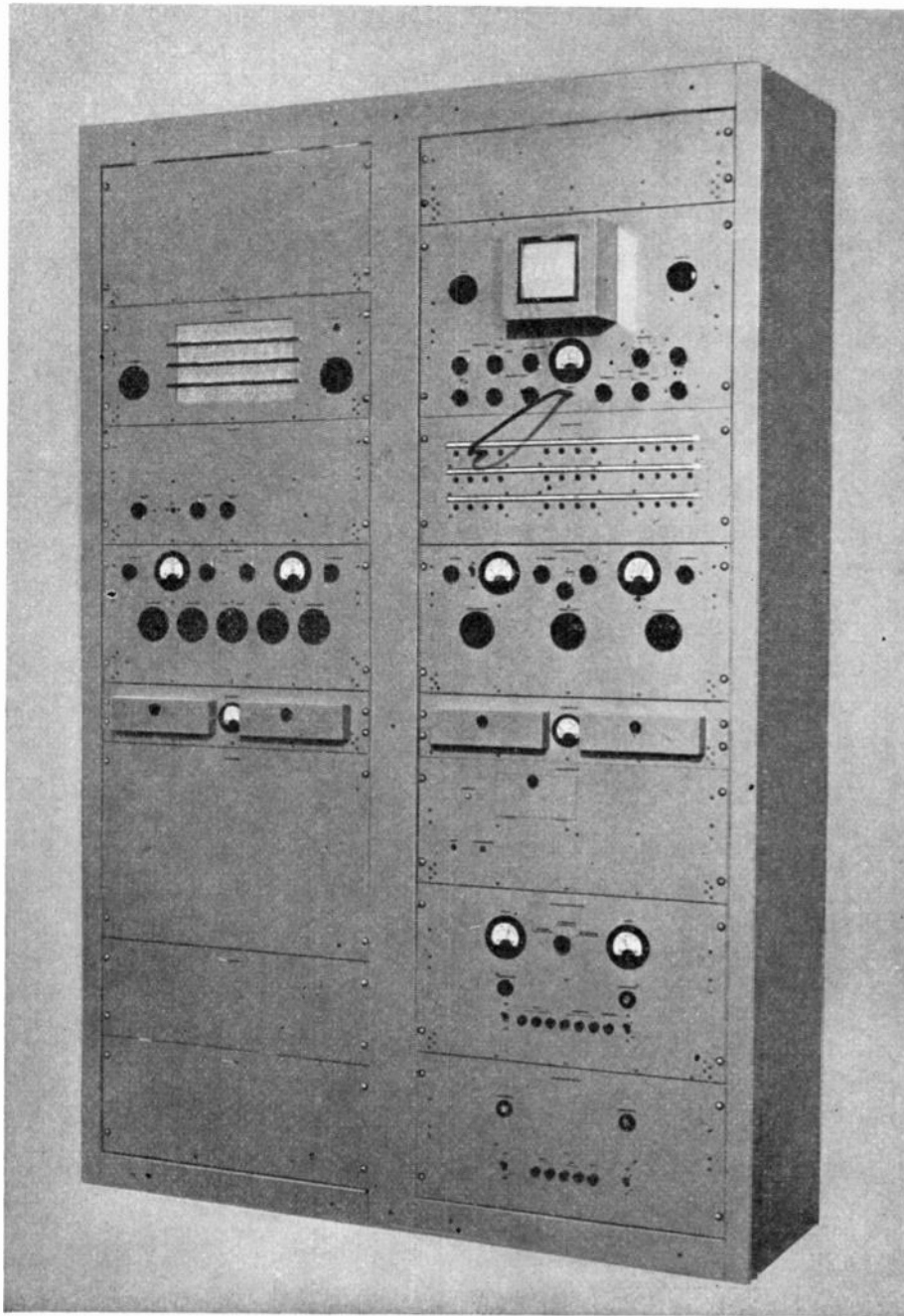

Fig. 4—Front view of the premodulator.

In a third converter stage, the frequency band is raised to $1 \text{ Mc} \pm 10 \text{ kc}$. In view of the foregoing, there are two crystal oscillators, 724 kc and 1276 kc corresponding with the "right" and the "inverted" position.

Fig. 3 shows the frequency characteristic of one channel; this curve is determined by the band-pass filter, 60.3 to 63.4 kc, the low-pass filter, 0 to 2800 cps, and a couple of correction elements compensating the atten-

uation in the lower frequencies. Between 300 and 2700 cps, such variations are slight. At full modulation of a channel, the "suppression" of the 60-kc carrier, achieved in the filter and the balanced modulator (ring-type modulator), amounts to at least 60 db. The attenuation of the 266- to 286-kc filter at the frequency of the $60+x$ oscillators is better than 85 db. This high order of attenuation is necessary for an adequate suppression of the $60+x$ frequencies in the radiated spectrum.

The possibility of using normal double-sideband transmissions (AM) is provided for. A frequency of 276 kc (in single-sideband transmissions used as a pilot) is modulated by the Heising method. The frequency spectrum, 273 to 279 kc, is further raised to 1 Mc by mixing with 724 kc.

The testing apparatus, forming an important part of the premodulator, permits observation of the linear and nonlinear distortion of every channel, the degree of modulation, and the mutual interference of the channels; deficiencies of premodulator and transmitter can be measured separately.

The following devices are used:

1. A test "receiver"; in order to observe the mutual interference and distortion, the spectrum of all channels can be separated again in this receiver, using the $60+x$ oscillators and a set of 60.3- to 63.4-kc filters.

(a) For checking the premodulator, the 1-Mc band is converted to 276 ± 10 kc. Applying the $60+x$ oscillators already available, each of the set of channels is converted to 60.3 to 63.4 kc and, after applying 60 kc, the low frequencies are again obtained.

(b) For checking the transmitter, the high-frequency band is converted to the 1-Mc band and passed to the studio. The separation of the channels takes place as in (a).

2. An oscillograph with dc amplifier (cutoff frequency, 1 Mc) measures the rectified antenna current; for this purpose the transmitter contains a rectifier, the output of which is fed to the oscillograph. This arrangement permits a supervision of the excitation of the final stage. The oscillograph can also be used for a visual observation of the signal in the different stages of the premodulator. The time-base frequency can be varied over a range covering frequencies up to 100 kc.

3. Low-frequency amplifier (with loudspeaker). For an over-all check, the equipment contains a low-frequency amplifier with loudspeaker; using the arrangement 1(a) or 1(b), the quality of each channel at the input and at the output terminals of the premodulator and of the transmitter can be checked.

4. Vacuum-tube voltmeters for measuring peak voltages indicate input and output voltages of the premodulator. An important device, not described in detail, is a wave analyzer for the 1-Mc band, provided with a crystal filter for 100 kc (bandwidth 100 cps), bringing about the separation of the frequencies in the 1-Mc band. This instrument, useful for laboratory tests in the studio, is not a part of the premodulator. A schematic diagram of the premodulator is given in Fig. 2. Transformation of a channel from the low-frequency band to a band in the 266- to 286-kc range takes place in the normal "carrier-terminal equipment." The carrier-terminal apparatus, containing no tubes, comprises a low-pass filter, a ring-type modulator (for 60-kc modulating frequency), a band-pass filter 60.3 to 63.4 kc, and a second modulator ($60+x$ kc modulating frequency); the absence of tubes permits the use of carrier terminal equipment in both directions (the "receiver" direction being used in 1). All four carrier-terminal sets are connected to the band-pass filter 266 to 286 kc.

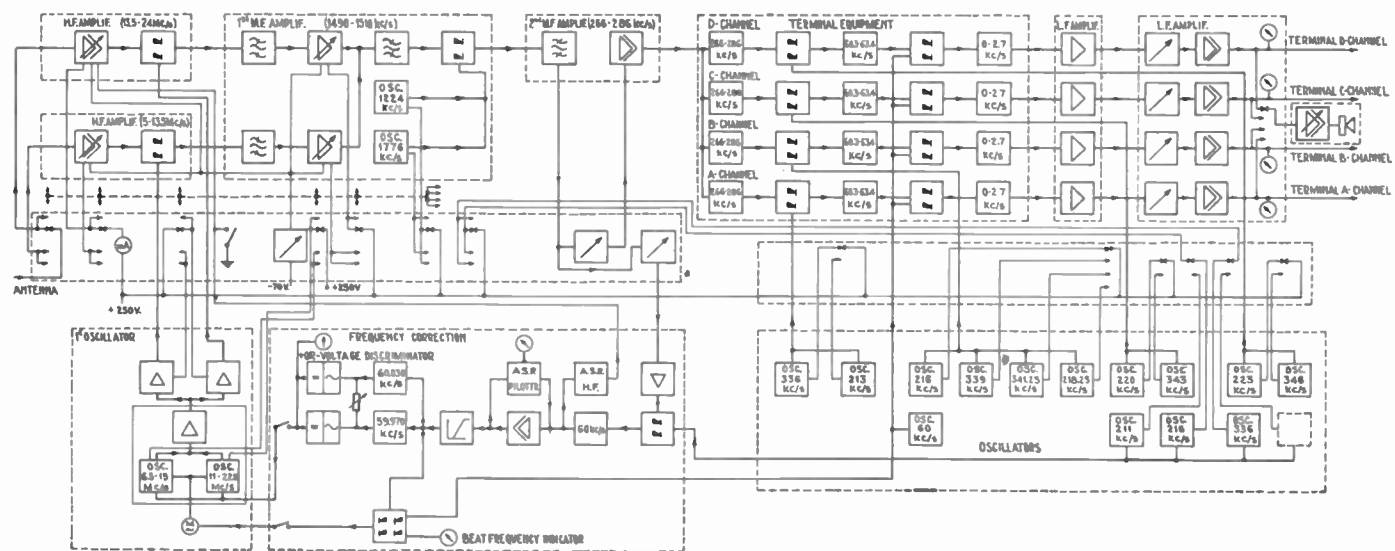

Fig. 5—Block schematic wiring diagram of the receiver with carrier mixing.

Volume Controls. (See Block Diagram, Fig. 2 and Front View, Fig. 4.)

For an adjustment of the level of each channel, the equipment is provided with four volume controls 1, the level of the channel band being adjusted with a volume control 2. Independently of 2, volume control 4 controls the amplitude of the pilot frequency, and 3 controls the output voltages to the transmitters.

variable oscillators. All other oscillators are crystal oscillators. The frequency range 5 to 23.5 Mc is split into a range of 5 to 13 Mc and 13 to 23.5 Mc. For each range, the receiver is provided with a high-frequency amplifier. In the lower range, the frequency of the first oscillator is *above*, and in the higher range it is *below* the signal frequency. In both frequency ranges, the second-oscillator frequency can be taken higher or lower than

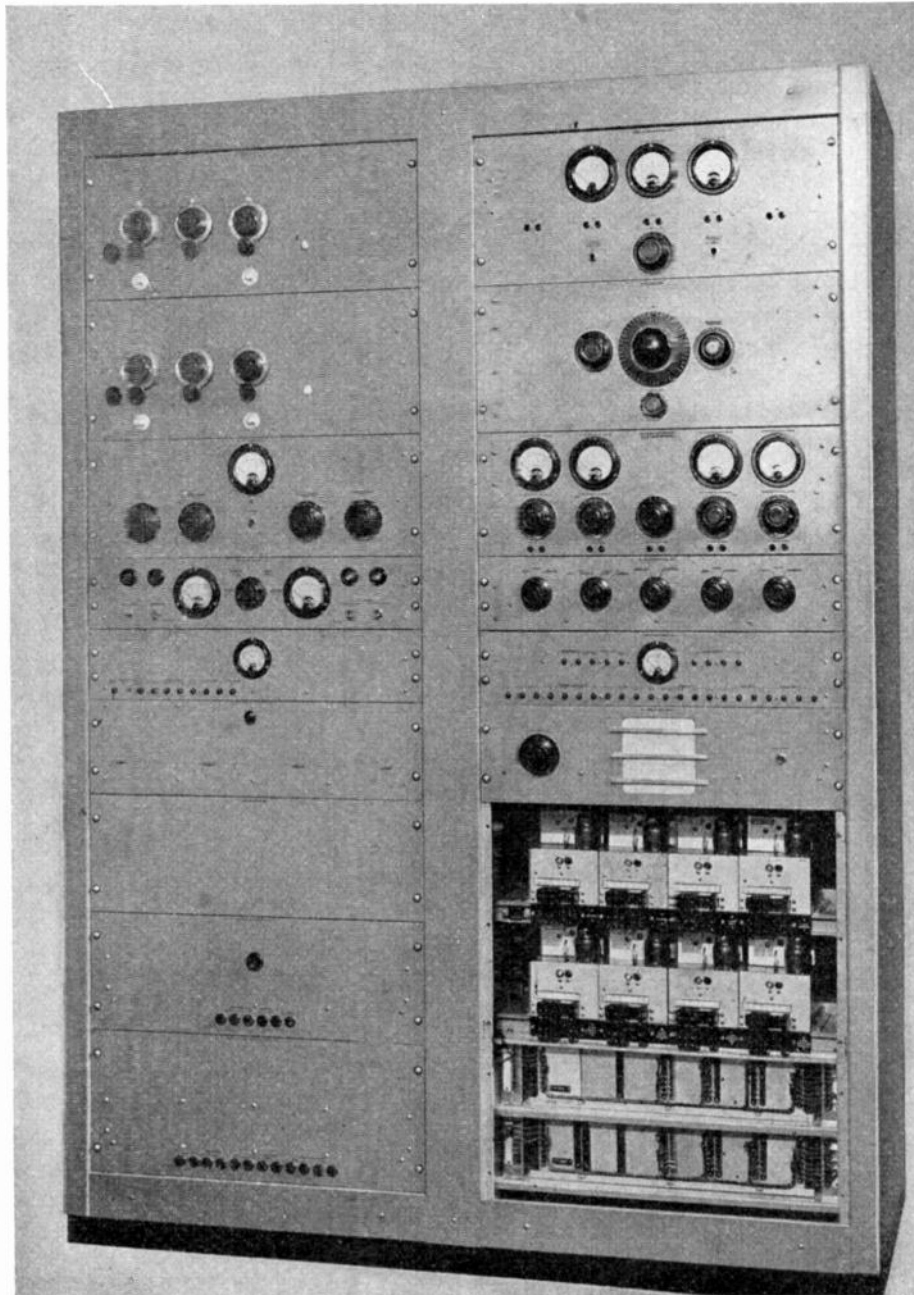

Fig. 6—Front view of the single-sideband receiver.

Receiver. (Block Diagram, Fig. 5, and Front View, Fig. 6.)

The receiver consists of a high-frequency, a medium-frequency, and a low-frequency part. In contrast with the older types of equipment, automatic tuning control takes place in the first oscillators, these being the only

the first medium frequency; thus one can receive a certain channel in the "right" or in the "inverted" arrangement. In this connection, we refer to what was said of the premodulator.

The first medium frequency is 1.5 Mc; the band-

width of the first medium-frequency amplifier is 20 kc. In the following mixer stage, conversion to the second medium-frequency band, 276 ± 10 kc, takes place after modulation with $1500 - 276$ or $1500 + 276$ kc (second-oscillator frequencies). Here, each channel, after modulation with a $60+x$ oscillator, characteristic for this channel (Table I), is converted to 60.3 to 63.4 kc and after modulation with 60 kc to the low-frequency bands; a low-pass filter limits this band to 2800 cps. These last demodulation processes are carried out in the "carrier-terminal equipment" consisting of a ring-type demodulator ($60+x$ kc), a band-pass filter 60.3 to 63.4 kc, a ring-type demodulator (60 kc) and a low-pass filter. In order to eliminate mutual interference between

special set of these oscillators being available for each correspondent.

The different volume controls permit an adjustment of the high frequency, of the first and second medium frequencies, of the low-frequency amplification, and of the pilot-frequency amplification. The receiver contains an amplifier and a loudspeaker for monitoring purposes.

Automatic Tuning Control

The automatic tuning control forms an important part of the receiver. The purpose of an automatic tuning control is to keep the pilot frequency, and with it the band of channel frequencies, accurately in their appointed positions in the 266- to 286-kc band.

A transmitted "pilot frequency," having a fixed relative position to the channels, controls the frequency of the first oscillator. If a change in the pilot frequency takes place, caused by the transmitter or during its transmission, the frequency of the first oscillator is automatically changed in such a way that the medium frequencies are maintained.

An electric automatic tuning system, as used in our older equipment, is quite satisfactory for rapid fre-

TABLE I

FREQUENCIES OF THE CHANNELS AND THEIR CHARACTERISTIC $60+x$ OSCILLATORS IN Mc

A-band	B-band	B-band (displaced)	C-band	D-band
(273-276)	(276-279)	(278.25-281.25)	(280-283)	(283-286)
273-60=213	276-60=216	278.25-60=218.25	280-60=220	283-60=223
276+60=336	279+60=339	281.25+60=341.25	283+60=343	286+60=346

the channels, it is necessary to place a band-pass filter, 266 to 286 kc, before each carrier-terminal set. The input terminals of these filters are connected together (see Fig. 5).

Fig. 7 shows a low-frequency attenuation curve of a channel; the variation between 300 and 2700 cps being negligible. The image discrimination for frequencies

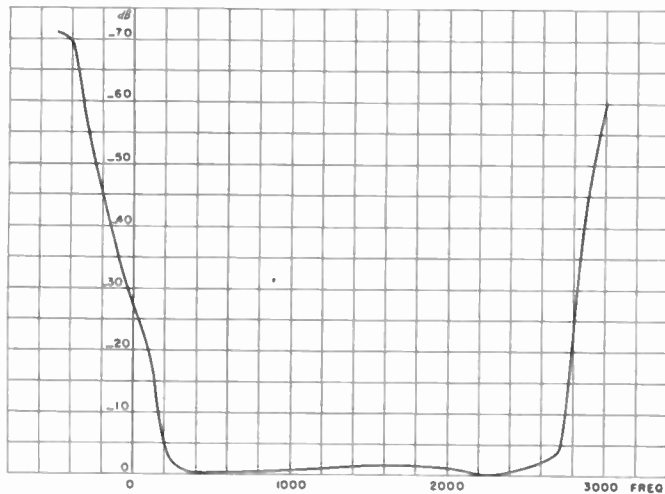

Fig. 7—Attenuation curve of the terminal equipment plus line repeater with wide-band corrector in the receiver.

>325 kc is better than 60 db; the attenuation of the lower frequencies in the transmission band, caused by the band-pass filter 60.3 to 63.4 kc, is compensated by correction elements.

As mentioned before, the receiver and the premodulator are provided with a number of $60+x$ oscillators; a

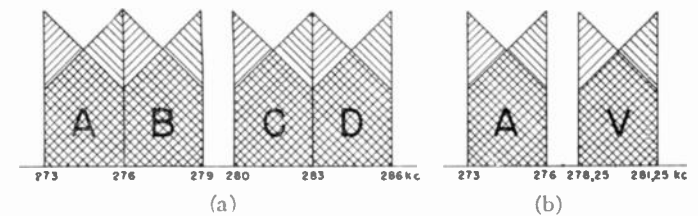

Fig. 8—(a) The position of the channels on the Indies link; (b) the position of the channels in the so-called "displaced-band" configuration. The different shadings apply to both possibilities with regard to the position of a specific channel.

quency variations; such a device is not suitable for a slow variation in one direction. These variations may not only occur in the transmitter and because of the ionosphere, but also by temperature changes in the first oscillator of the receiver. In an electrical system, a regulating voltage (+ or - voltage) produced by the deviation of the pilot frequency from the correct frequency (in the 266- to 286-kc band), accomplishes the necessary correction of the first oscillator (or second oscillator in our older equipment). The frequency deviation of the first oscillator is only maintained as long as the regulating voltage is present; fading in reception may cause an interruption. Furthermore, the frequency adjustment is not complete; a certain difference has to be maintained for producing the necessary regulating voltage. These effects will be more pronounced as the oscillator is detuned more by the regulating voltage.

An electromechanical system produces a change in frequency by a modification of the mechanical arrangement (self-induction, or capacitance) of the oscillator; the oscillator obtaining a new equilibrium. A short sur-

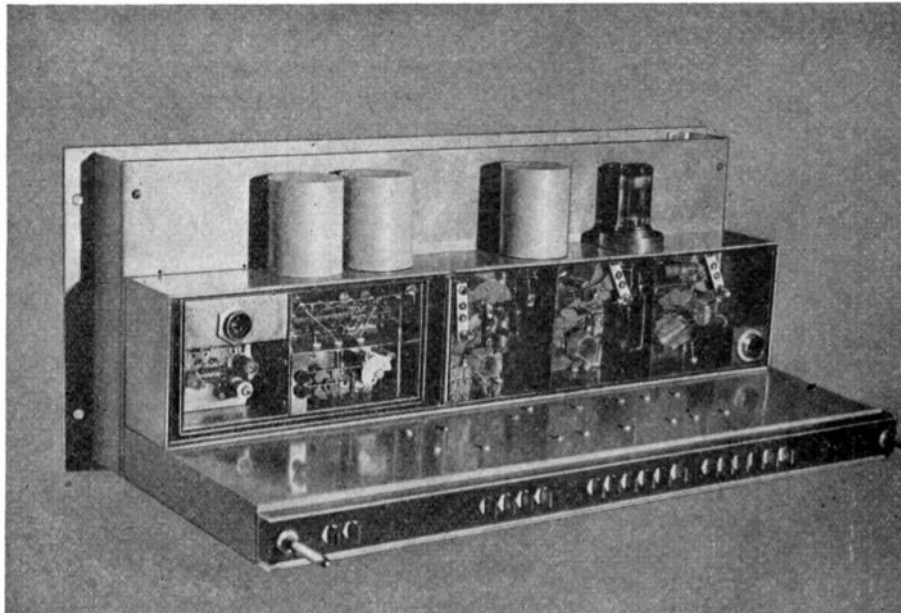

Fig. 9—High-frequency repeater (rear side opened).

vey of the automatic tuning devices in the receiver is given in the following paragraphs (Fig. 5).

Following the second frequency conversion (266 to 286 kc), the pilot frequency is converted to 60 kc, by the use of $60+x$ oscillators. If, as is usual now, the pilot frequency is 276 kc, these oscillators are 216 or 336 kc, for the "right" or "inverted" channel arrangement, respectively.

In accordance with the position of the pilot on the former Indies link on four channels (Fig. 1), an oscillator of 211 kc is provided. The 60-kc pilot, after selection in a crystal filter (bandwidth 100 cps), amplification and limitation, operates a discriminator, converting the frequency deviations from 60 kc into voltage variations (+ or -), these voltages operating a first-oscillator suppressor grid (Fig. 10). This design was developed by Prins, engaged in laboratory work at the Radio Laboratory of the PTT.

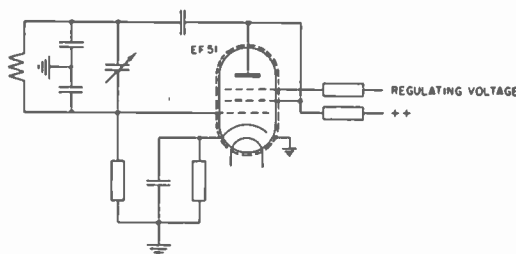

Fig. 10—Block schematic of the first oscillator.

The discriminator contains two crystals ($60 \text{ kc} \pm 20 \text{ cps}$). A change in suppressor-grid potential causes a change in space charge and, accordingly, a frequency

change. Between the discriminator and the suppressor grid an RC network is fitted for the purpose of stabilizing the electrical frequency-adjustment circuit, preventing, at the same time, a rapid fall of the voltage during fading.

Our mechanical frequency adjustment is essentially that of the Western Electric single-sideband receiver.^{3,4} The 60-kc pilot and a 60-kc stabilized frequency (crystal oscillator) are applied to the grids of four tubes (two pairs), and each pair is balanced with regard to one of these frequencies; with regard to the other frequency, these pairs are shifted 90 degrees. The plate current of each tube flows through the windings of one of four stator poles of a motor; a frequency difference produces a rotating field in a direction depending on the sense of frequency deviation. As the four grids are biased, the four poles are in fact magnetized in turn. The rotor consists of a magnetic wheel provided with a number of teeth (11), not being a multiple of the number of poles; a magnetized pole will turn the rotor in a position most suitable to the magnetic flux. The successive magnetization of the poles produces a rotation of the rotor; a trimmer coupled with the axis of the motor varies the frequency of the first oscillator.

To avoid large differences in trimmer frequency variation over the frequency range of one oscillator, coupling of trimmer and tank capacitances is by means of a network.

³ F. A. Polkinghorn and N. F. Schlaack, "A single sideband short-wave system for transatlantic telephony," *PROC. I.R.E.*, vol. 23, pp. 701-718; July, 1935.

⁴ A. A. Roetken, "A single sideband receiver for short-wave telephone service," *PROC. I.R.E.*, vol. 26, pp. 1455-1465; December, 1938.

The tuning capacitors and the trimmer of both oscillators are of the twin type. Thus one tuning knob and one motor are sufficient for both first oscillators and both frequency ranges. In this equipment, the electric tuning control is designed for control of rapid frequency variations and the mechanical for the slower variations.

In contrast with an electrical frequency adjustment, the frequency difference is completely neutralized.

Stability and Instability in Automatic Tuning Systems

In a system for automatic frequency adjustment, as in any feedback circuit, stability or instability may

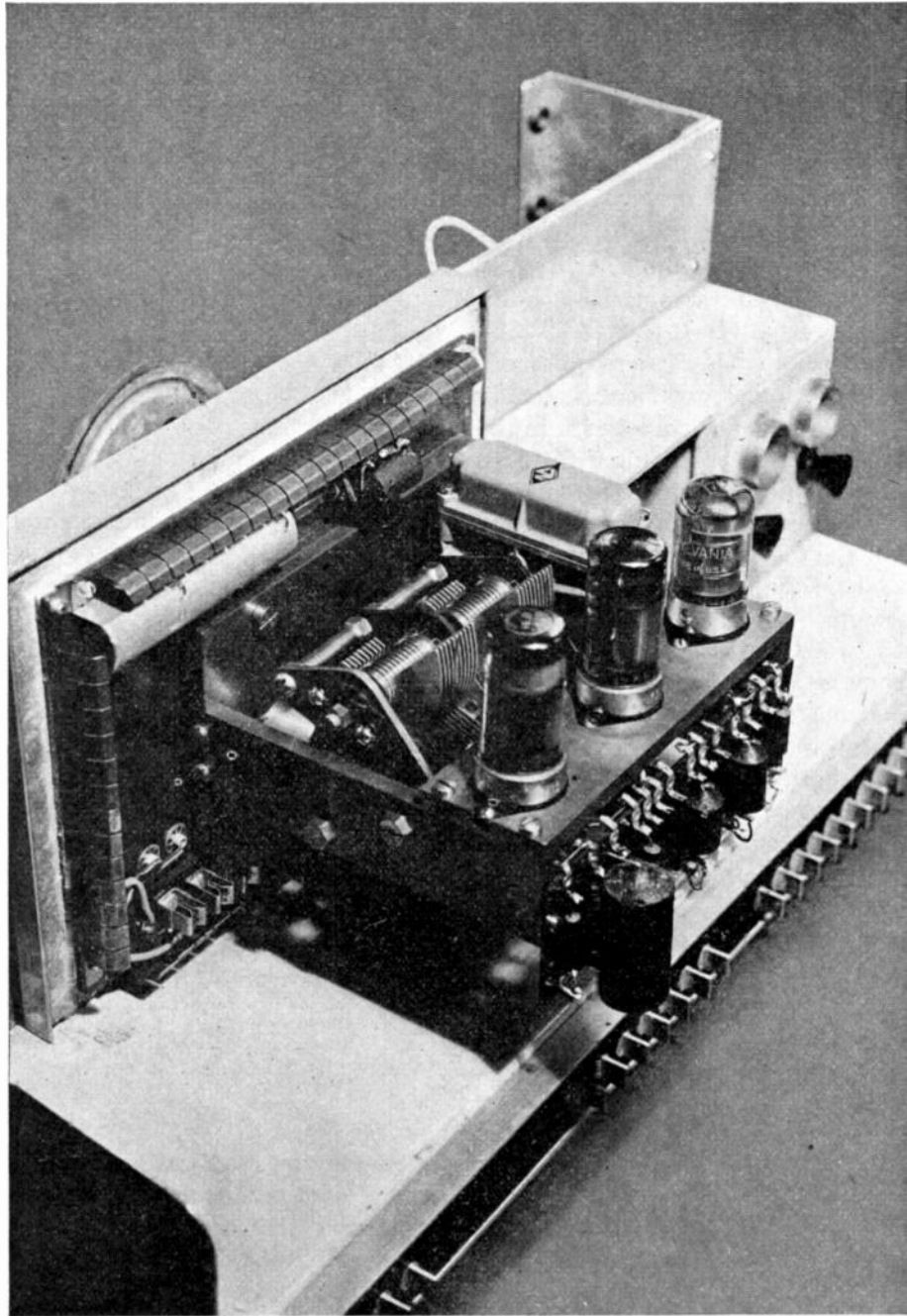

Fig. 11—Rear view of the first oscillator with thermostat and double screening removed.

(This does not mean that a mechanical correction is essentially "slow.")

Frequency difference of the pilot and the 60-kc standard causes a rotation of the motor and a change of the first-oscillator frequency through the trimmer capacitor.

exist.

The conditions for stability, which must be fulfilled in the receiver, will be deduced in the theoretical part of this paper.

For the purpose of a stabilization of the electrical fre-

frequency adjustment, an RC network is inserted between the discriminator and the oscillator.

With regard to stability, the lowest value of RC is determined by the amplification in the circuit and the delay of the 60-kc filter, the stability of the mechanical adjustment being given by the frequency variation of the motor for one rotation.

Temperature Control of the First Oscillator (Fig. 11)

In order to minimize the influence of the temperature on the frequency, the first oscillators, together with a coupling tube, are placed in a thermostatically controlled oven.

Résumé

The advantages of the newest equipment in comparison with the older one may be summarized as follows:

1. The introduction of normal cable carrier equipment results, in addition to sharing all experiences already gained in the development of such equipment, in the application of one uniform type of filter (60.3 to 63.4 kc) for the formation of the single sideband. A change in the relative positions of the channels only involves a change of the $60+x$ frequencies.
2. The first and second medium-frequency filters may be comparatively simple. (In a receiver of the older type, the filter 465 to 480 kc is a derived type of filter (with frequency of ∞ attenuation) for a sufficient suppression of image response below 455 kc).
3. By applying electrical and mechanical adjustment, we take advantage of both systems.
4. The use of crystals in the pilot-frequency network and in the discriminators makes routine checks of these important parts superfluous.
5. The first oscillators are stable from an electrical and a mechanical point of view and are placed in thermostatically controlled ovens.

APPENDIX

SOME THEORETICAL CONSIDERATIONS ABOUT FREQUENCY ADJUSTMENT

1. Electrical Adjustment

ω_i = input frequency

ω_0 = oscillator frequency

ω_u = output frequency

Δ_ω = deviation of these magnitudes.

The frequency adjustment may be shown diagrammatically according to Fig. 12.

M = modulator. O = oscillator. D = discriminator.

$$\omega_u = \omega_i - \omega_0 \quad \Delta\omega_u = \Delta\omega_i - \Delta\omega_0. \quad (1)$$

With ω_i variable, ω_u will have to remain as constant as possible. The operation of the adjusting mechanism may be represented by

$$\Delta\omega_0 = m\Delta\omega_u. \quad (2)$$

From (1) and (2), and because $m \gg 1$, it follows that

$$\Delta\omega_u = \frac{\Delta\omega_0}{m+1} \approx \frac{\Delta\omega_0}{m}. \quad (3)$$

Equation (3) gives the degree of control; i.e., the deviation of ω_u as a result of the deviation of ω_0 . The adjusting mechanism has been considered as being static; this system, however, which is closed in itself, can, under certain circumstances, be in an unstable condition. The

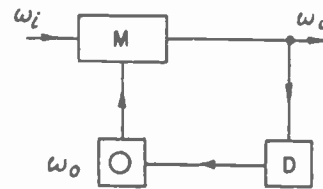

Fig. 12

conditions for stability and instability will now be considered.

† *Stability.* The circuit for the adjustment is again shown in diagram in Fig. 13, with the addition of the pilot-frequency filter F and an RC network. These ele-

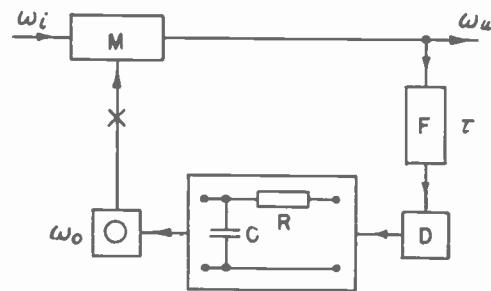

Fig. 13

ments play an essential part when considering the frequency fluctuations which can occur in this circuit. It is supposed that these frequency fluctuations are small and remain limited to the frequency area of the filter F ; the effect of F on the transmission of these "frequency waves" is given by a "time delay" τ . This time delay is determined by $d\phi/d\omega$ in the passing range, wherein ϕ = phase angle between the input and output voltages; the value of τ will be estimated.

By applying the Nyquist theorem,⁵ a stability condition may be obtained in a simple way.

For that, we disconnect the circuit at x and trace the

⁵ R. E. Graham, "Linear servo theory," *Bell Sys. Tech. Jour.*, vol. 25, pp. 616-651; October, 1946.

variations of ω_0 , while ω_i is periodically varied with a frequency ω .

From the following equations,

$$\Delta\omega_u = \Delta\omega_i - \Delta\omega_0 \tag{1}$$

$$\Delta\omega_0 = \frac{m}{\sqrt{(\omega CR)^2 + 1}} e^{-i(\omega\tau + \arctg \omega CR)} \Delta\omega_u \tag{3a}$$

where in (3a) the argument is determined by τ and RC and the modulus by RC , it follows

$$\frac{\Delta\omega_0}{\Delta\omega_u} = \frac{m}{\sqrt{(\omega CR)^2 + 1}} e^{-i(\omega\tau + \arctg \omega CR)} \tag{4}$$

According to Nyquist, (4) will not contain the point -1 , if plotted in the complex plane as $f(\omega)$ for a stable situation.

We can limit ourselves to positive values of ω ; since the modulus of the function concerned decreases as ω increases, the Nyquist condition may be formulated thus:

If

$$\omega\tau + \arctg \omega CR = \pi, \tag{5}$$

then

$$\frac{m}{\sqrt{(\omega CR)^2 + 1}} < 1. \tag{6}$$

Because $m \gg 1$, it follows from (5) and (6): $\omega CR \gg 1$ and $\omega\tau = \pi/2$ and, in connection with (6), the stability condition is

$$\frac{m\tau}{RC} < \frac{\pi}{2} \tag{7}$$

This condition can also be obtained from the oscillation equation of the adjustment circuit in Fig. 13.

Supposing that $\omega_i = \text{constant}$, it follows that $\Delta\omega_i = 0$ and, according to (1), $\Delta\omega_u = -\Delta\omega_0$.

In Fig. 14 the RC network is shown; U_i and U_u are the input and output voltages, respectively.



Fig. 14

From the following equations (Fig. 13),

$$U_{i_t} = \kappa \Delta\omega_{u_t-\tau} = -\kappa \Delta\omega_{0_t-\tau} \tag{8}$$

$$U_{u_t} = \lambda \Delta\omega_{0_t} \quad \text{where in} \quad \frac{\kappa}{\lambda} = m \quad \text{and} \tag{9}$$

$$U_u = U_i - RC \frac{dU_u}{dt}, \tag{10}$$

the oscillation equation follows as

$$\Delta\omega_{0_t} = -m \Delta\omega_{0_t-\tau} - RC \left\{ \frac{d\Delta\omega_0}{dt} \right\}_t \tag{11}$$

Substituting

$$\Delta\omega_0 = e^{\gamma t} \tag{12}$$

$$\gamma = \alpha + j\beta \tag{12a}$$

into (11), the two equations (13) will be obtained, after splitting up into real and imaginary parts, as follows:

$$1 + \alpha RC = -m e^{-\alpha\tau} \cos \beta\tau \tag{13a}$$

$$m e^{-\alpha\tau} \sin \beta\tau = \beta RC. \tag{13b}$$

The limit of stability, the transition from oscillations with increasing amplitude to those with decreasing amplitude, is given by $\alpha = 0$; because of $m \gg 1$, it follows from (13a): $\beta\tau \approx \pi/2$ and, after substitution into (13b), the stability condition is obtained.

This result was found in 1932; a solution of the transcendental equations (13) by graphical methods is given in considerations by de Cock Buning,⁶ which have not been made public. In these, the condition for a nonperiodical oscillation equation is also laid down. The deduction of this condition will be indicated briefly.

Substitution of (13b) into (13a) leads to the equation

$$1 + \frac{RC}{\tau} \left[\frac{\beta\tau}{\text{tg } \beta\tau} - \ln \frac{RC}{m\tau} \frac{\beta\tau}{\sin \beta\tau} \right] = 0 \tag{14}$$

and because RC/τ is usually big, the following equation is obtained:

$$\frac{\beta\tau}{\text{tg } \beta\tau} - \ln \frac{\beta\tau}{\sin \beta\tau} = \ln \frac{RC}{m\tau} \tag{15}$$

From equation (15) the various solutions for $\beta\tau$ can be obtained. It appears that for $\ln(RC/m\tau) > 1$ no solution for $\beta\tau$ between 0 and 2π is possible. (Since the solutions for values of $\beta\tau > 2\pi$ imply a large attenuation, we can limit ourselves to the cases where $\beta\tau < 2\pi$.)

The condition for a nonperiodical solution is evidently more stringent than the condition for an oscillation with a decreasing amplitude and is, therefore,

$$\ln \frac{m\tau}{RC} < -1 \quad \text{or} \quad \frac{m\tau}{RC} < e^{-1}.$$

In the newest single-sideband receiver, $m \approx 200$ and $\tau \approx 50$ milliseconds and $RC = 35$.

II. Mechanical Adjustment

A schematic wiring diagram of the mechanical adjustment is shown in Fig. 15.

S.M. = motor for the frequency adjustment

θ_d = angle of rotating field in motor

θ_r = angle of rotor in motor.

⁶ Unpublished data.

The following relations exist:

$$\Delta\omega_u = \Delta\omega_i - \Delta\omega_0 \tag{16}$$

$$\frac{d\theta_d}{dt} = \Delta\omega_u \tag{17}$$

$$\frac{d\Delta\omega_0}{dt} = m \frac{d\theta_r}{dt}, \tag{18}$$

while the differential equation of the motor is as follows:

$$I \frac{d^2\theta_r}{dt^2} + R \frac{d\theta_r}{dt} + A(\theta_r - \theta_d) = 0 \tag{19}$$

I = mass momentum of inertia of the motor

R = coefficient of resistance

A = force of rotating field on the rotor.

For a motor with negligible mass and resistance, $\theta_r = \theta_d$.

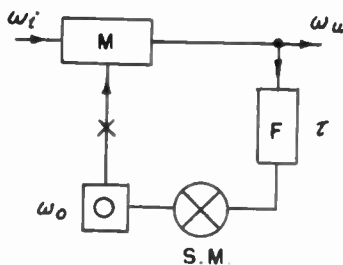

Fig. 15

Stability. When interrupting the circuit at x , it follows, as in the previous case, from equations (16), (17), and (18) for a motor without mass and resistance

$$\frac{\Delta\omega_0}{\Delta\omega_u} = \frac{m}{\omega} e^{-i(\omega\tau + \pi/2)}. \tag{20}$$

Application of the Nyquist theorem, as has been done in I , gives us the stability condition:

$$\frac{m}{\omega} < 1 \quad \omega\tau + \frac{\pi}{2} = \pi \quad \text{or} \quad \boxed{m\tau < \frac{\pi}{2}} \tag{21}$$

In the general case, it follows from (16)–(19) instead of (20):

$$\frac{\Delta\omega_0}{\Delta\omega_u} = \frac{m}{\omega^2 \sqrt{R^2 + (\omega I - A/\omega)^2}} e^{-i(\omega\tau + \pi + \arctg[(\omega I - A/\omega)/R])} \tag{22}$$

(for $I = R = 0$, equation (22) changes into equation (20).

If $R^2 > AI$, in other words, if the resistance element is sufficiently big to make the motor “nonperiodical,” the modulus of (22) will decrease with ω increasing. The stability condition may then be derived from

$$\omega\tau + \pi + \arctg \frac{\omega I - A/\omega}{R} = \pi \quad \text{or} \quad \text{tg } \omega\tau = \frac{A/\omega - \omega I}{R} \tag{23}$$

$$\frac{m}{\omega^2 \sqrt{R^2 + (\omega I - A/\omega)^2}} < 1. \tag{24}$$

From (23) and (24) it follows that

$$m\tau < \frac{R}{A} \frac{\omega^2\tau}{\cos \omega\tau}. \tag{25}$$

From (23) it also follows that

$$0 < \omega\tau < \frac{\pi}{2}, \dots \tag{26}$$

and if, in (23), ωI is small with regard to A/ω , $\text{tg } \omega\tau = A/\omega R$ and (25) changes into

$$m\tau < \frac{\omega\tau}{\sin \omega\tau}$$

and because of (26),

$$\boxed{m\tau < 1}. \tag{27}$$

Although reliable tests have not yet been carried out, it seems likely that the suppositions on which equation (27) is based are fulfilled.

In our case, $m \approx 10$ and $\tau \approx 50$ milliseconds.

CONCLUSION

With the exception of a part of the carrier equipment, the receiver as well as the premodulator have been constructed as prototypes at the Radio Laboratories of the Netherlands PTT.

With regard to the carrier equipment, the Transmission Laboratories of the PTT have been very helpful in the design, as well as during the construction.

Of all the contributors, we would like to mention in particular the engineers van den Berg, Bicknese, and Verhoef, as well as the technicians Bennink, van Maanen, Philippens, van der Hoeven, and van Hal.

Investigations of High-Frequency Echoes*

H. A. HESS†

Summary—A method of measurements of high accuracy has been developed for investigations of telegraph signals from high-frequency stations. Very exact time-interval measurements were obtained at echo signals on distant high-frequency transmitters within the frequency range between 10 and 20 Mc, presuming definite ionospheric conditions which are limited to a few hours daily. The time interval of a signal circulating completely around the earth manifests itself as a constant value of 0.13778 seconds. It seems to be quite independent from the radio frequency used, and further, from the daily and seasonal conditions; and no changes could be perceived during the course of three years. By the occurrence of the indirect signals which reach the recording place along the opposite great-circle path after a measurable time interval later than the direct signals, exact measurements have been possible on such high-frequency transmitters more than 1000 kilometers away. For these cases, the errors were ± 25 kilometers from the true values of the geographical distances. A strange multiple-path phenomenon occurred on telegraph signals at less-distant stations regarding the principal signal, which is split into the signal which arrives first, the so-called direct signal, and into one or more retarded signals. It has been found and explained that no exact determination of distances is possible for transmitting stations which are less than about 1000 kilometers from the recording place. These facts resulted from numerous measurements made during the years 1941 to 1944, and further comparisons of the amplitudes of signals circulating repeatedly around the globe caused the assumption of an important law of nature by which ionospheric high-frequency propagation may be explained. The theory of a so-called "sliding-wave propagation" along an ionospheric limit layer, which is always 204 kilometers above the earth's surface, is compared to the opinion considering the occurrence of a high-frequency propagation by multiple reflections in single hops between the ionosphere and the earth's surface.

I. INTRODUCTION

THE OCCURRENCE of so-called multiple signals in high-frequency propagation has been known since 1926. Early investigations were performed in this field by Quaeck and Moegel (Germany),¹ Eckersley (England),² and Taylor and Young (United States).³ The results of these scientists did not coincide in all points. Moegel found values for the measured time intervals which varied at least 1 per cent from each other. These results stood in remarkable contrast to those of the echo-pulse measurements on the ionospheric layers at vertical incidence, which are marked by strong daily and seasonal variations. Taylor and Young found essentially greater deviations of about 5 per cent on the measured time intervals of the multiple signals. The results of Moegel, therefore, have been generally doubted as to their accuracy.

* Decimal classification: R112.4. Original manuscript received by the Institute, June 3, 1947.

† Schad-Str. 24, 14a-ULM (Donau), Germany.

¹ E. Quaeck and H. Moegel, "Neues ueber die Ausbreitung von Kurzwellen," *Jahr. für Draht. Teleg.*, 28, s. 177; 1926; "Weitere Mitteilungen ueber die Ausbreitung von Kurzwellen," *Jahr. für Draht. Teleg.*, 30, s. 41; 1927; "Doppel und Mehrfachzeichen bei Kurzwellen," *Elek. Nach. Tech.*, 6, s. 45; 1929.

² T. L. Eckersley, "Short-wave wireless telegraphy," *Jour. I.E.E.* (London), p. 600; 1927.

³ A. H. Taylor and L. C. Young, "Studies of high-frequency radio-wave propagation," *PROC. I.R.E.*, vol. 16, pp. 561-578; May, 1928.

A new theory of high-frequency propagation has been developed by von Schmidt⁴ on the basis of Moegel's measurements. At the Institute of Physics in Berlin-Gatow, measurements of this kind were started in 1941, under his direction. It was the special purpose of these investigations to clear up whether the existence of the earth-round high-frequency signals could be explained by multiple reflections occurring in single hops between the ionospheric layers and the earth's surface, or by a propagation of a so-called sliding wave along an ionospheric limit layer. The first measurements performed at Gatow in September and October, 1941, with essentially improved apparatus, showed surprising results at stations from Europe, East Asia, and South America; so that, for all cases, an exact determination of distances on such high-frequency stations seemed to be possible with a high accuracy, if their distances were greater than 1000 kilometers.

A simple theoretical consideration indicated a much better and longer echo-activity period on high-frequency signals at more northern geographical latitudes. Therefore, it seemed to be necessary to transfer the recording arrangements to a position of a higher geographical latitude. On December 6, 1941, the transportation of the apparatus from Berlin-Gatow to Frederikshavn (Denmark) (geographical position, 57°26' N, 10°29' E) began. On December 12, 1941, the arrangements were completed. On this day, at 09^h04 Central European time, the signals of the Japanese commercial station JUM, Tokyo, on 13,705 kc, were recorded as the first experiment. The expedition remained at Frederikshavn until April 1, 1944, and then was transferred to Randers (geographical position, 56°31' N, 10°02' E), where the scientific group remained until January 20, 1945.

II. TECHNICAL EQUIPMENT

Fig. 1 shows the arrangement of the apparatus which was used to perform the signal investigations at

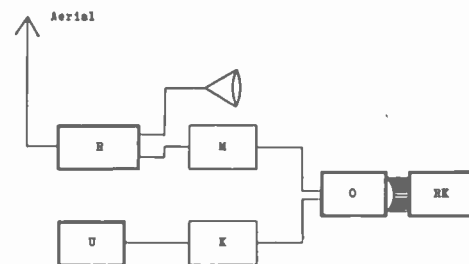

Fig. 1—Arrangement of the apparatus.

⁴ Oswald von Schmidt, "Neue Erklarung des Kurzwellenumlaufes um die Erde," *Zeit. für Tech. Phys.*, vol. 17, s. 443; 1936.

Frederickshavn. R is a normal high-frequency superheterodyne receiver (Philips CR 101). The intermediate frequency of this receiver, about 750 kc, goes to the mixer stage M by way of a small capacitor, where it combines with the signal from a variable oscillator to form a second if, which could be varied between 50 and 100 kc according to the kind of photographic records. This second if was called the "writing frequency" for the film rolls, and was conducted to one ray of the two-ray oscillograph O . On the other ray of the oscillograph, a 500-cps surveying frequency was derived from a tuning-fork generator U . An accuracy of 10^{-7} cycle at this frequency was obtained by a thermostat. The ac sinusoidal curve of the normal frequency being unsuited for the measurements, it was distorted by the apparatus K . The peaks, with a distance of 2 milliseconds, allowed a measurement with an accuracy of $1/100$ mm by the microscope. The recording apparatus RK made photographs of the radio signals and of the normal-frequency peaks on the passing paper-film rolls with an extremely good reproduction with regard to the modulation and the amplitudes of the radio signals. The films generally had a length of 10 meters.

For the measurements at Berlin-Gatow, the 1000-cps normal frequency of the Physikalische Technische Reichsanstalt was applied, conducted to Gatow by a special cable, with an accuracy of 10^{-9} cycle.

Directional antennas were employed for the reception of the high-frequency signals. The so-called long-wire antennas⁵ were found most suitable because of their radiation characteristics. Such antennas radiate power in two opposite directions, which are given approximately by considering the straight wire as the axis. They were arranged horizontally to receive the direct and indirect signals coming from opposite directions.⁶ Four long-wire antennas, each with a length of 100 meters (5λ on 20 meters wavelength), were employed at Frederikshavn for the following directions: north to south, southwest to northeast, east to west, northwest to southeast; and at Randers for the following directions: south to north, northeast to northwest, east to west, and southwest to northeast.

The apparatus used for the recordings of the high-frequency signals had been improved essentially with regard to the accuracy of the measurements and the photographic reproductions as compared with those used by Moegel during the years 1927 to 1934. The following essential improvements had been obtained:

1. The frequency on the oscillograph tube which is responsible for the reproduction of the radio signals was raised from 50 to 100 kc. Moegel used a sinusoidal frequency of 1000 cps on a slip-knot oscillograph.

⁵ W. S. Potter and H. C. Goodman, "More on the practical operation of transmitting antennas," *QST*, vol. 19, pp. 21-26; April, 1935.

⁶ However, a better solution would be to apply V-antenna systems. This could not be realized because of the greater cost.

2. The velocity of the paper on the film rolls was raised from 40 to 400 centimeters per second.

3. The accuracy of the time measurements was increased from 1 to $1/100$ per cent.

4. Suitable antenna systems were used for the reception of the echo signals.

III. THE TYPES OF THE ECHO SIGNALS AND MATHEMATICAL RELATIONS FOR DISTANCE MEASUREMENTS

The signal of a high-frequency transmitter in the frequency range between 10 and 20 Mc may arrive on two paths from the transmitter to the receiver, either along the direct great-circle line (called the *direct signal*), or along the same great-circle line but in the opposite direction (called the *indirect signal*). There are such signals circulating around the earth. For the case where the direct signal travels completely around the globe, it is called the *direct circulating signal*, and a complete circuit of the indirect signal is called the *indirect circulating signal*. There are cases in which a signal circulates two or three times around the globe. They occur more seldom, however, and require best conditions for reception.

An equation can be derived easily from the measured time intervals on high-frequency signals which enables an exact determination of the distances of high-frequency stations. There exists the following ratio

$$\frac{t_u - t_i}{t_i} = \frac{2d}{u}$$

where t_u is the time of a complete circuit around the globe (measurable as the time interval between the direct signal and the direct circulating signal at the receiving position), t_i is the time interval between the arrival of the direct signal and the indirect signal, d is the distance between transmitter and receiver along the earth's surface, and u is the circuit around the globe along the earth's surface.

The earth circuit is $u = 40,024$ kilometers (average value), and the time interval of a complete circulation around the earth has been found by many measurements to be the very constant number of 0.137788 second. The following equation may be obtained for the distance along the earth's surface:

$$d = \frac{40,024}{2} \left(1 - \frac{t_i}{0.137788} \right) \text{ kilometers.}$$

IV. RESULTS OF THE INVESTIGATIONS

a. Definition of the Echo-Activity Period by Systematically Performed Ionospheric Observations

The first investigations of Quaeck and Moegel during the years 1926 to 1933 showed that the occurrence and the intensity of the indirect signals and especially of the circulating signals depends on daily and seasonal conditions. Even changes extending through several years had been recognized to be connected with the eleven-

year sun-spot cycle. These authors proceeded to the conclusion that the indirect signals and circulating signals occurred exclusively during the twilight time. The twilight girdle surrounding the earth's globe has been regarded as the zone of best propagation for such echo signals.

These conclusions have been confirmed by recent investigations. Sometimes, however, greater deviations from the great-circle line of the twilight zone have been established. In the course of the present investigations, the occurrence and the relative strength of the echoes has been recorded for a period of one year at Frederikshavn, Denmark. Fig. 2 shows the daily times and the intensity of the echo signals from distant high-frequency stations in all parts of the world during several months. The drawn-in curves of the echo

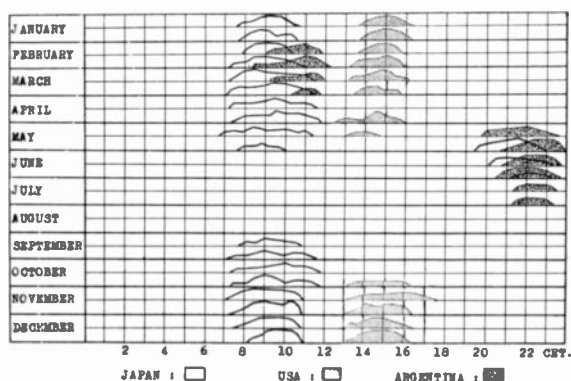

Fig. 2—Daily and seasonal variations of the echo-activity period.

strength always represent the average value of 15 days. For each diagram, the one axis shows the relative strength of the echoes. The other axis contains the time (Central European time). It can be shown that the echo activity occurs at different times of day; for instance, for East Asia and South America it is always in the morning during the winter half-year, and for North America, in the afternoon. During May, June, July, and August, the echoes occurred on stations from East Asia and South America only during the evening. No regular observations took place between 00^h00 and 06^h00 CET. At these hours, echoes occur generally on North American stations. Therefore, the data in Fig. 2 cannot be considered as complete. During May, however, the echo activity lasted in the morning as well as in the evening for some hours. Direct signals and indirect circulating signals have been perceived at stations from East Asia in the evening, while the indirect circulating signals were missing completely at stations from South America and also from North America. Only the direct signals and the corresponding direct circulating signals could be observed for these cases.

Systematical investigations took place from May to August, 1943, during the evening hours on the signals of the high-frequency stations from East Asia and South America, examining the results of Moegel which indi-

cated that the indirect circulating signals should fall off during the evening of the summer months and only the direct signals and the direct circulating signals should be received. These investigations showed that in more than 80 single cases only the direct signals and the indirect circulating signals were registered on Japanese stations during the summer evening, and that the direct signals, the indirect circulating signals, and the direct circulating signals were present only in two cases. A determination of distances was always possible, therefore, during the summer nights on stations in East Asia. On stations in Argentina and Brazil, however, only direct signals, and the corresponding direct circulating signals, could be recorded. In no case was an indirect circulating signal ever seen on the film records. On a few records of North American stations during June, 1943, at about 02^h00 CET, direct circulating signals were received, but no indirect circulating signals could be established. Therefore, no determinations of distances were possible.

b. Ionospheric Studies about the Zone of the Echo Activity

The echo activity on high-frequency signals depends, according to the present investigations, on the following factors: the time of day, the season, and the ionospheric variations during the course of the years, as well as the radio frequency used and the geographical latitude.

It has been explained that the echo signals propagate best around the earth along a great-circle line which has nearly the same direction as the earth's surrounding twilight zone. Vertically to the twilight zone, no occurrence of high-frequency echoes was established.

Regarding the results in Fig. 2, it is evident that the observed times of the echo occurrences lasted between two and four hours at stations from East Asia and South America, as well as at stations from North America. Thus it may be shown that extraordinarily suitable conditions for high-frequency propagation exist inside of a broad girdle surrounding the earth. The direction of this good propagation will be given nearly by the great-circle line of the twilight girdle.

Two principal different directions on the earth's globe in which echo activity occurs, according to the observations, are represented in Fig. 3(a) and (b). During the morning in winter and the late evening in summer, the earth's surrounding twilight zone is characterized by the direction: northeast to southwest (see Fig. 3(a)). During the afternoon in winter and the early morning hours in summer, the twilight zone is characterized by the direction: northwest to southeast, as shown in Fig. 3(b). The echoes occur on all stations within the marked zone, and into the direction of the great-circle line inside of the zone; for instance, in Fig. 3(a): London, Frederikshavn, Berlin, Rio de Janeiro, Buenos Aires, (and Tokyo); and in Fig. 3(b): London, Frederikshavn, Berlin, and Tananarive. Vertically to the echo zone, no activity of echo signals can be perceived for distant stations; for instance, in Fig. 3(a): New York, Cape-

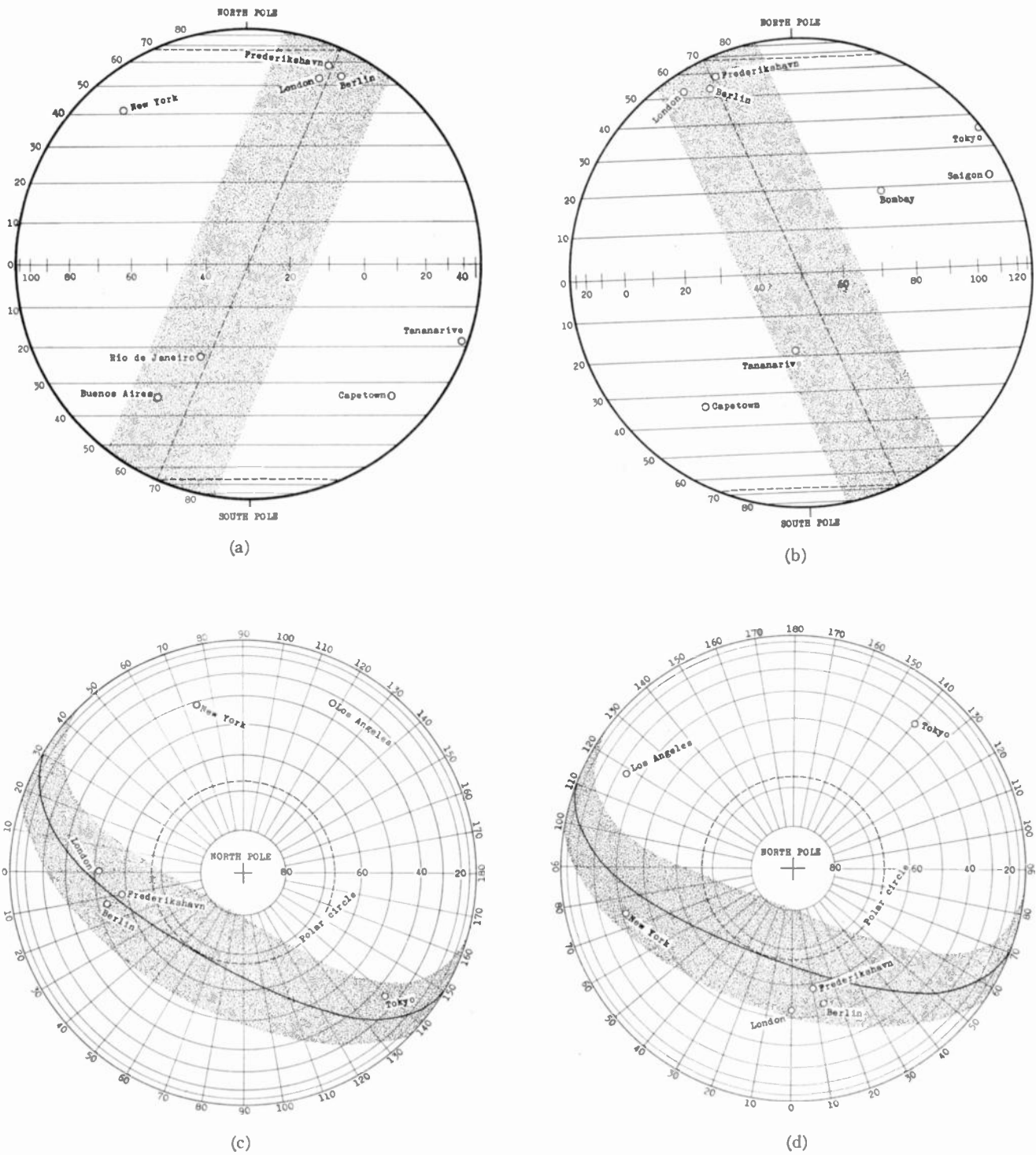

Fig. 3—Direction of the echo zone; (a) in winter at 09^h00^m and in summer at 21^h00^m CET; (b) in winter at 15^h40^m and in summer at 03^h40^m CET; (c) in winter at 09^h00^m and in summer at 21^h00^m CET; (d) in winter at 14^h20^m and in summer at 02^h20^m CET.

town, and Tananarive, and in Fig. 3(b): Tokyo, Bombay, Saigon (and Buenos Aires). The echo girdle across the polar regions is illustrated especially in Fig. 3(c) and (d) for the summer and winter conditions. It is apparent that the occurrence of echoes in higher geographical latitudes lasts over more daily hours. Observations performed simultaneously at Frederikshaven and at Berlin-Gatow during the months of September to November,

1943, showed that echo signals from Japan were first observed on September 4, at Frederikshavn, and in the early part of October, at Gatow. Echo signals from the United States were first observed on October 15, at Frederikshavn, and in the early part of November, at Gatow. The width of the echo zone or the time of the echo activity including the affected radio frequencies depends on the general ionospheric conditions. They are

subject to disturbances of the ionosphere as well as to the changes of the 11-year sun-spot cycle.

Fig. 4 represents the results of observations during the echo-activity period on the German commercial high-frequency station DGO, Nauen, 13,225 kc, and

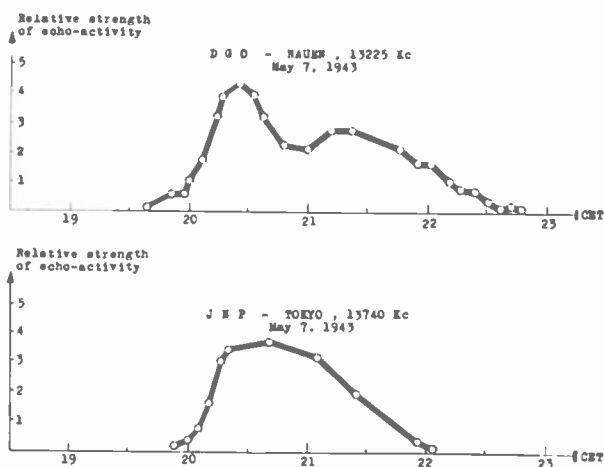

Fig. 4—Echo-activity period on two stations of different positions.

the Japanese high-frequency station JNP, Tokyo, 13,740 kc, on May 7, 1943, when the conditions of the echo zone were of the kind shown in Fig. 3(a) and (c). The relative strength of the echo signals has been estimated according to the FRAM code signal strength 1 to 5. The signals of both stations were synchronized on the oscillograph tube and the ratio of the amplitudes between direct signals and echo could easily be investigated and measured. A radio operator was instructed to observe stations having echo signals, and to note the relative strength for every 10 minutes. Fig. 4 shows that the occurrence of the echo signals on both these stations covers nearly the same period. The maximum of the relative echo strength occurred on about 20^h30 CET.

c. Records on Signals Circulating around the Earth

A direct signal circulating around the earth in its original direction arrives twice at the receiving position after the time $t_u = 0.137788$ second. This value represents the arithmetic average value of 218 good measurable circulations obtained at Frederikshavn during the year 1942. Later measurements at Randers, during the year 1944, resulted in an average value of $t_u = 0.137772$ second. These investigations were performed with special care only on stations whose distances were greater than 1000 kilometers from the recording place. For these cases, the single measured values showed maximum divergences between 0.13760 and 0.13805 second. Such signals which were most measurable always gave values of 0.13770 second. In the measurements made at Frederikshavn, some few values were included from stations nearer than 1000 kilometers. These values often showed essential divergences (see Section IV-g).

Fig. 5 shows the film record of direct signals and direct circulating signals at the South American commercial station, LQB2, Monte Grande, Argentina, on

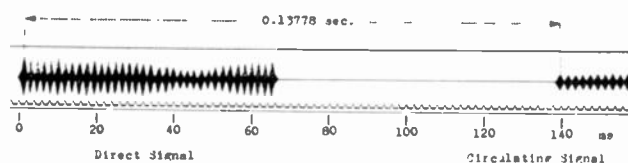

Fig. 5—Signals of LQB2, Monte Grande, Argentina, 17,570 kc.

17,570 kc. The signals are strongly modulated, facilitating exact measurements. On the basis of the applied accuracy of the measurements, the time t_u must be a constant value. It has been shown that this value is not dependent on the frequency of the transmission, as first might be supposed. In the same way, no diurnal and seasonal variations were observed. Similarly, the investigations did not lead, as yet, to any results tending to establish a declination between the t_u values obtained from the north-south direction and those from the east-west direction. In case such declinations should occur, they would be rather unimportant and would never surpass the applied accuracy of the errors in the measurements.

Under particularly good ionospheric conditions, signals may travel repeatedly around the earth. As many as three circuits around the globe were recorded. (See Section IV-g.)

d. Records on Indirect Signals and Measurements of Distances

Film rolls showing both direct and indirect high-frequency signals made possible a determination of distances with surprising accuracy by measuring the time interval between the direct signals and the indirect signals. In the equation above, the value of the measured time difference t_i only need be used, taking the complete circulation time around the globe to be the value of $t_u = 0.13778$ second.

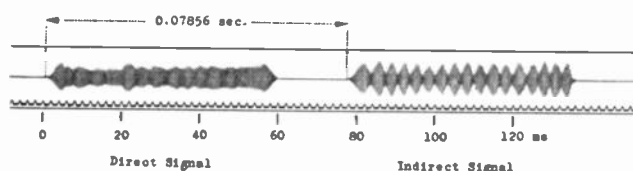

Fig. 6—Signals of JUP/JUD, Tokyo-Oyama, Japan, 13,065 kc; distance, 8598 kilometers.

The great number of stations recorded at Frederikshavn show direct and indirect signals on the film rolls. Forty-seven different high-frequency transmitters in all parts of the world were measured. The measurements include distances between 2000 and 17,000 kilometers. The frequencies of the received stations were in the range between 10 and 19 Mc. Altogether, there were 785

measured values between the direct signals and the indirect signals.

Fig. 6 shows the signals of the Japanese station JUP/JUD, Tokyo-Oyama, on 13,065 kc. It is especially striking to observe that the indirect signal arrives with a larger amplitude and has a sharper curve, while the direct signal is distorted in its modulation by a so-called multiple-path phenomenon. The direct signal is formed by different signals arriving nearly simultaneously with different phases. Fig. 7 represents a record of the North American station WQL, New Brunswick, on 14,815 kc, and Fig. 8 is a record of the South American station LQB, Monte Grande, Argentina, on 17,570 kc. In this case, the direct signals and the indirect signals are interfering. The signal is strongly modulated and consists of 33 peaks.

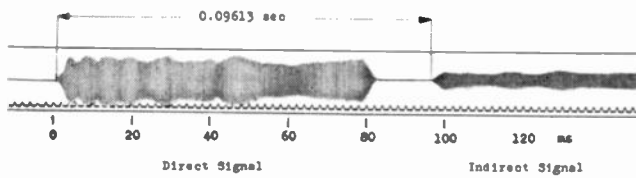

Fig. 7—Signals of WQL, New Brunswick, N.J., United States, 14,815 kc; distance, 6052 kilometers.

e. Measurements on Repeated Circulating Signals

During the whole period of the observations, short-signal transmissions were given five times by the German commercial high-frequency transmitters DLO, 19,947 kc, DLN, 17,670 kc, DLK, 15,075 kc, and DLJ,

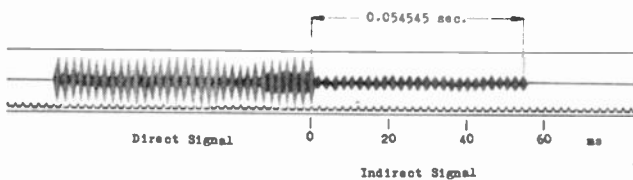

Fig. 8—Signals of LQB2, Monte Grande, Argentina, 17,570 kc; distance, 12,105 kilometers.

13,925 kc, at different times of the day. These transmissions first took place at Frederikshavn on June 29, 1942, and on July 27, 1942. Further extensive investigations were performed at Randers on November 6,

1944, on November 19, 1944, and on December 14, 15, and 17, 1944. The length of the transmitted signals was 10 milliseconds. Two signals were sent within one second. The signal intervals were adapted in such a way that repeated circulating signals could be investigated without interference.

Especially good results were obtained by records on November 19, 1944, receiving station DLO, Rehmate, on 19,947 kc. These records were limited to the time between 07^h55 to 08^h00, 08^h25 to 08^h30, 08^h55 to 09^h00, 09^h25 to 09^h30, 09^h55 to 10^h00, 10^h25 to 10^h30, 10^h55 to 11^h00, and 11^h25 to 11^h30 CET. Four or five film rolls, 10 meters long, could be recorded during these 5-minute schedules. It may be remarked that DLO employed an antenna directional toward Japan for these transmissions (direction to northeast), thus suppressing the indirect signal in the opposite direction. At the receiving position at Randers, a directional long-wire antenna was used. Extraordinarily good conditions for multiple-echo signals were obtained during the recording period between 09^h25 to 09^h30, 09^h55 to 10^h00, and 10^h25 to 10^h30 CET. These rolls show the principal signal, and the first, second, and third circulating signals. Such a

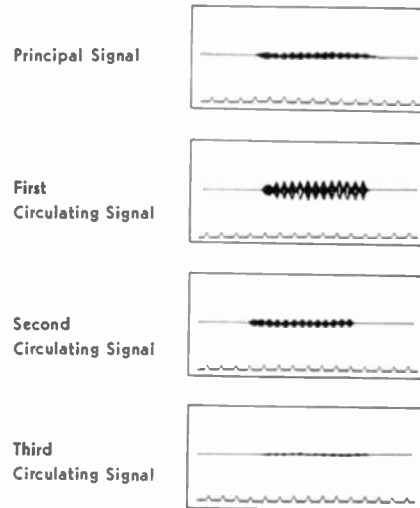

Fig. 10—Amplitudes on repeated circulating signals.

case is illustrated in Fig. 9. A reproduction of the individual echoes is given in Fig. 10. The principal signal

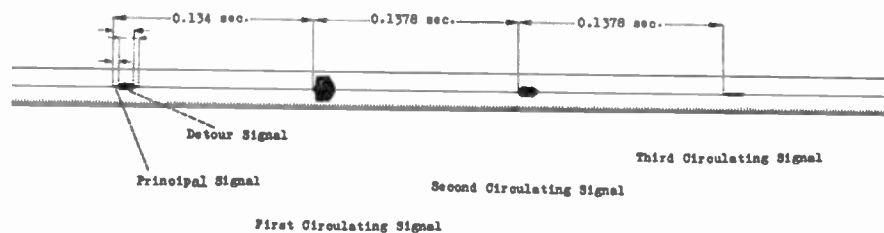

Fig. 9—Measurements of a circulating signal, repeated around the globe.

consists of several interfering parts which arrived within short time intervals. The signal of the highest field strength is the first direct circulating signal. The second direct circulating signal appeared often with a greater strength than the principal signal, and showed one-third of the field strength of the first direct circulating signal, and the third direct circulating signal showed one-third of the field strength of the second direct circulating signal. The third circulating signal has traveled a path which has a distance of more than 120,000 kilometers.

f. Cleft Signals

Interesting phenomena occurred on signals when the great-circle path passed near the earth's magnetic poles. These conditions were found at Frederikshavn for signals from California and for signals in the opposite direction from Madagascar. In Fig. 11(a) and (b) film records

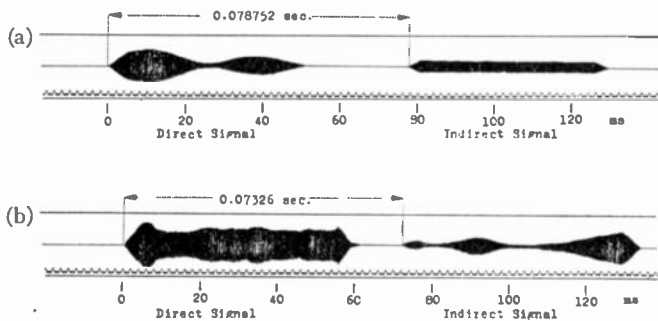

Fig. 11—(a) Signals of KPH, Bolinas, California, United States, 12,735 kc; distance, 8571 kilometers. (b) Signals of FZT, Tananarive, Madagascar, 17,690 kc; distance, 9370 kilometers.

of such signals are illustrated. It may be seen that the direct signal from California has been cleft while the indirect signal arrived clearly, and that the indirect signal from Madagascar has been cleft while the direct signal arrived clearly.

g. Special Investigations on Signals of Stations Distant Less than 1000 Kilometers

The great-circle distance between Frederikshavn, Denmark, and the transmitters at Nauen and at Rehmate is nearly 500 kilometers. It is obvious that the skip distances of these stations in the frequency range between 10 and 20 Mc must be greater than this short distance. Thus it would be supposed that no signal from those transmitters would reach the recording position at Frederikshavn on the direct path if rather high transmitting frequencies are employed. For these reasons, extensive investigations took place at all times of the day and seasons, observing DLO, 19,947 kc, DLN, 17,670 kc, DGR, 17,395 kc, DLK, 15,075 kc, DLJ, 13,925 kc, and DGO, 13,225 kc.

All the film rolls on transmitters nearer than 1000 kilometers from Frederikshavn and Randers showed a strange multiple-path phenomenon for the signal which arrived first. The signal was split, in most cases, into two or more single signals arriving successively within short time intervals. A film record realizing this problem is shown in Fig. 12. The transmitter DLN, Rehmate, on 17,670 kc, has been recorded on any day during the morning hours in November, 1942, working with an antenna directional toward Japan, or the Far East. The ionospheric conditions represented in Fig. 3(a) and (c) concerning the direction of the echo zone are applicable to this case. The principal signal is split in two signals A-C and B-D. The length of the signal which arrives first, or direct signal, has been measured to be 0.05624 second, and that of the second part, the signal B-D, is 0.05616 second. The direct circulating signal, arriving after the time interval $t_u' = 0.13432$ second, is also recorded on the film roll, and the length of this signal is measured to be 0.05653 second. The principal signal is not always shaped so sharply, as shown in Fig. 12. It is often very indistinct, caused by the multiple-path phenomenon and the different phases of the successively ar

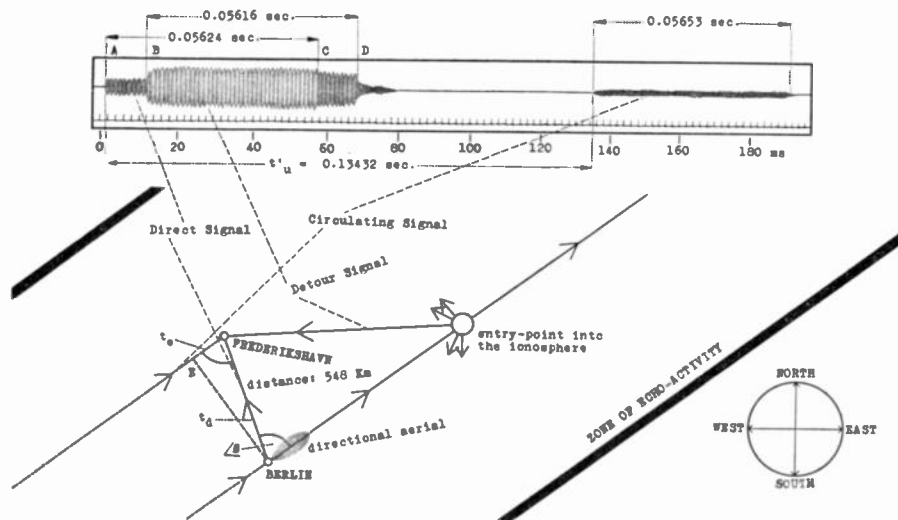

Fig. 12—Records on the German transmitter DLN, Rehmate, 17,670 kc.

ringing multiple signals. Measurements and separations of the single parts, therefore, are often very difficult. Thorough investigations and studies about the radio signals with the affecting phenomena were performed and collected for a period of more than two years. A great amount of the data was lost by war influence.

In the lower part of Fig. 12, an attempt is made to explain the cause of the multiple-path phenomena by which the principal signal is affected. Within the zone of the echo activity, the two positions Berlin and Frederikshavn are marked. DLN employed an antenna system directional toward Japan or the Far East, thereby suppressing the indirect signal to the opposite direction. The high-frequency power from DLN was radiated in a nearly flat angle toward the horizon. Table 1 gives data concerning the proportion between the angles and the distances for a ray reaching the ionosphere at a height of about 200 kilometers.

TABLE 1

Angles	Distances
0°	1600 km
5	1200
10	950
15	750
20	600
25	500

It may be supposed that, at the point where the signal enters the ionosphere, a dispersion will be caused under certain ionospheric conditions, and that the power will be scattered to any definite direction. The retarded or detour signal *B-D* should be explained in the light of this assumption. The signal *A-C* arriving at the recording place, obviously along the nearest path, may be called the direct signal. The time interval between the direct and the retarded signal is about 10 milliseconds for this case. This value corresponds to a path of about 3000 kilometers.

The direct signal usually has a much lower field strength than the retarded signals. In many cases, this signal is often so weak that its field strength is at the limit of sensitivity of the receiver, and, therefore, this signal was missing completely on many film rolls.

The direct circulating signal, traveling around the

earth, reaches the transmitting position of DLN again after the time interval of $t_u = 0.13778$ second. During this time, the signal arrives simultaneously at the point *E*. Frederikshavn will be reached, however, a little later, after the time interval t_e . The following relation exists

$$t_u = t_u + t_e.$$

According to Fig. 12, it is $t_e = t_d \cos \beta$.

The direct signal arrives at Frederikshavn after the time interval t_d . The value t_u' , which can be measured as the time interval on the film rolls, will be obtained by

$$t_u' = t_u + t_e - t_d, \text{ or } t_u' = t_u + t_d (\cos \beta - 1)$$

where $t_u = 0.13778$ second, and β is the angle between the line connecting the transmitter-receiver and the direction of the echo zone.

These investigations at Frederikshavn and Randers, Denmark, were performed primarily with the intention of studying the t_u' values for different times of the day and seasons. These values often vary considerably, and it may be supposed, therefore, that they depend on the angle of the echo zone with regard to the position of the recording place. Some widely varying values do not seem to be t_u' values, but manifest themselves to be apparently the corresponding t_i' values of the indirect signals received. It may not be surprising that the t_u' values found for the transmitters from London and Paris show no very extensive deviation from the true t_u value of 0.13778 second. This probably is because London and Paris were lying in the direction of the echo zone during the period of the observations and β in the above derived equation is nearly zero. Moreover, in many cases indirect signals were observed side by side with direct circulating signals.

Extended and thorough studies on signals of DLN, 17,670 kc, and DLO, 19,947 kc, both at Rehmate, were performed at all times of the day and seasons to investigate the time intervals between the single parts of the principal signal. These seemed to show that the time-interval values by which the retarded signals are affected depend on the frequency. The retarded signals on DLO seemed to have longer time intervals than those of DLN. On many film rolls, the multiple-path

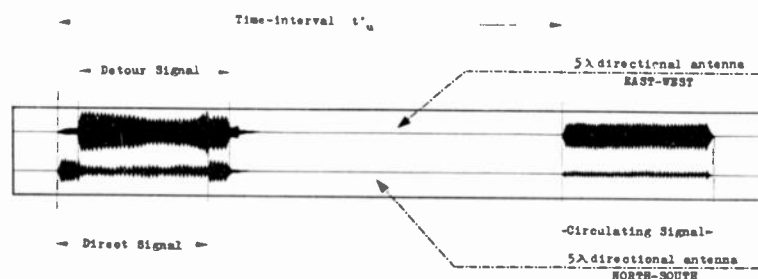

Fig. 13—Two ray-oscillographic records on the German transmitter DLN, Rehmate, 17,670 kc, using two different directional antennas.

phenomena were so involved that no more certain measurements could be performed. For these reasons, it was impossible to establish hourly variations in the time intervals on the retarded signals. Exact investigations can only be realized by the application of very short pulse signals.

A series of film records was made at Frederikshavn to obtain important conclusions about the celestial direction of the single parts of the principal signal. Film records were made employing two directional 5λ long-wire antennas for two different directions (for instance, north to south, or east to west) to study, simultaneously, the signals on stations at shorter distances. Such antennas radiate at a rather flat angle (22.5°) with regard to the horizontally straight wire as axis. These records were not suitable for measurement of time intervals, because no normal frequency could be recorded on the film rolls. The velocity of the film rolls was known, however, and thus time intervals could be obtained. It was intended, as the principal purpose, to compare the amplitudes of the single multiple signals on a two-ray oscillograph.

Fig. 13 shows such two-ray oscillographic records on DLN, Rehmate, 17,670 kc, employing two 5λ directional antennas, the one for the east-west, and the other for the north-south direction. These recordings were performed during the morning hours of a day in November, 1942. The ionospheric conditions, with regard to the direction of the echo-activity zone illustrated in Fig. 3(a) and (c), correspond with the conditions represented in Fig. 12. The direct signal is very weak on the east-west antenna. The so-called detour, or retarded, signal is much stronger on the east-west antenna than on the north-south antenna. This fact may be regarded as reason for the assumption that the retarded signals cannot arrive from the usual great-circle direction connecting the transmitter with the recording position. The circulating signal which travels around the whole earth is weak on the north-south antenna and arrives rather strongly from the east-west direction. The assumption illustrated in Fig. 12, by which the cause of the occurrence of the multiple-path phenomena may be explained, is confirmed by the results of the investigations demonstrated in Fig. 13.

These investigations offer a contribution to the important problem of skip distance in the frequency range

between 10 and 20 Mc. It may further be considered how these found and measured time intervals of the multiple-path phenomena would stand in any casual connection to the known scattered reflections, which are observed within the skip-distance zone on transmitters using a high radio frequency. According to these results, no sure distance measurements seem to be possible on near-by stations.

h. Special Cases of Distance Measurements on Near-By Transmitters.

There are many cases which also admit distance measurements on near-by transmitters. The conditions of Fig. 3(a) and (c) may be considered when, for instance, London and Frederikshavn are located on the same great-circle line of the echo zone and the skip distance of the direct signal is smaller than the true distance between these two positions. Another case which occurs often manifests itself when no direct signal can be received from near-by stations but the indirect signal and the direct circulating signal travel around the globe and arrive successively on the recording position. The time interval t_d between these two signals can be measured, and the distance d may be determined according to the simple equation:

$$d = \frac{t_d}{2} \times c$$

where ($c=299,776$ kilometers per second, velocity of the electromagnetic waves).

Fig. 14 represents an interesting film record of the British transmitter MIB/GPB, 15,070 kc, on February 10, 1943, at 10^h05 Central European time. During this time, the ionospheric conditions were as shown in Fig. 3(c). The record shows the direct signal, the indirect signal, and the direct circulating signal.

Considering the t_i value shown, the distance from the recording position, Frederikshavn, is given by

$$d = \frac{u}{2} \left(1 - \frac{t_i}{t_u} \right) \text{ kilometers, or}$$

$$d = \frac{40,020}{2} \left(1 - \frac{0.13124}{0.13772} \right) \text{ kilometers,}$$

$$d = 964 \text{ kilometers.}$$

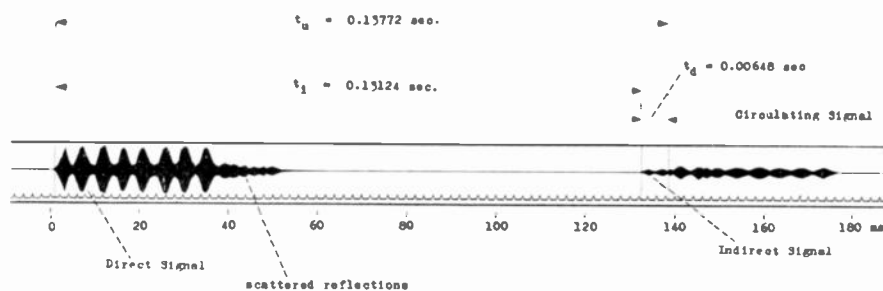

Fig. 14—Time-interval measurements on MIB/GPB, England, 15,070 kc, February 10, 1943, 10:05 CET.

An interesting argument would be the value obtained by the time-interval measurements between the indirect signal and the direct circulating signal, employing the equation for the distances:

$$d' = \frac{t_d}{2} \times c \text{ (kilometers), } t_d = 0.00648 \text{ second, or}$$

$$d' = \frac{0.00648}{2} \times 299,776 \text{ kilometers per second}$$

$$d' = 971 \text{ kilometers.}$$

The difference between these two measurements is only 7 kilometers.

i. Arithmetical Definition of the t_u Values

When the distance is known between the transmitter and the receiver and when the time interval between the direct signal and the indirect signal can be measured as a t_i value, the t_u value for every case can be calculated by putting the values in the equation derived under Section III.

These calculations performed for 785 values are given for $t_u=0.137767$ second as an average value, while the value as found on the 218 good measurable circulating signals is $t_u=0.137788$ second. The difference from these values is 0.000021 second, or 6.3 kilometers.

k. Definition of Possible Errors on the Measured Time Intervals

Errors in the measurements are possible, especially where the amplitudes of the measured signals and the echo signals are very different from each other. When a signal is unmodulated and is received with a slow rising characteristic for the beginning point, as shown in Fig. 15, errors always occur if the field strength of the echo signal is weak. The exact beginning point of the echo

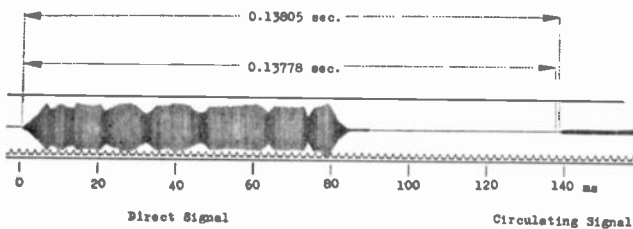

Fig. 15—Explanation of the errors in the measurements.

signal can not be reproduced, and the values obtained from the measurements are too large. For such cases, values of about 0.1381 seconds were obtained. It may be considered, therefore, that the average value, $t_u=0.137788$ seconds, may be too high for the direct circulating signal, and it seems to be possible that later measurements, which were made with better equipment, may show values a little smaller. This concerns, how-

ever, the fifth or the sixth decimal figure. It is evident, also, that measured indirect signals which are too weak in their amplitudes always result from too small ionospheric distances. Measurements on modulated signals generally led to better results with regard to accuracy, especially if the time intervals between the corresponding peaks could be measured.

l. Irregularities and Disturbances of the Ionosphere

During the period of the observations, irregularities in high-frequency propagation were frequently perceived. For one or several days, the echo signals from distant high-frequency transmitters would be missing completely. Such phenomena may be linked to ionospheric disturbances which are accompanied nearly simultaneously with the occurrence of the polar light.⁷ Also, perturbations occur in the earth's magnetic field, as shown. Days of unusually strong echo activity on short waves are usually followed by such disturbances, so that a prediction of magnetic storms seems to be possible within 10 or 12 hours before their occurrence.

Conditions with regard to abnormal *E*-layer propagation also were investigated at Frederikshavn and at Randers. The records show enormous field strengths for the *E*-reflected signals and, therefore, an analysis of the single-arriving signals was very difficult and could never be realized.

V. THEORETICAL ANALYSIS

Sliding-Wave Theory

Fig. 16 depicts the sliding-wave propagation theory of von Schmidt. The ray rising from the transmitter *T* to the ionosphere propagates on the ionospheric limit layer with a constant velocity, and radiates continuously from this later to the earth at a definite angle. Measurements performed at the Telefunken Co., Berlin, by Kotowski and Schuettloeffel⁸ of the angles of incidence

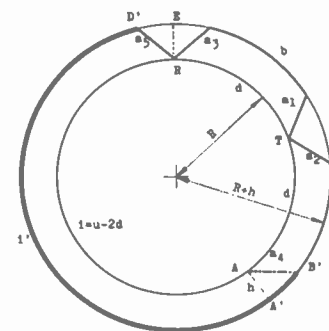

Fig. 16—Sliding-wave propagation around the earth; direct path, $a_1 + b + a_3$, indirect path, $a_2 + b + i' + a_4$.

⁷ S. S. Kirby, N. Smith, and T. R. Gilliland, "The nature of the ionospheric storm," *Phys. Rev.*, vol. 54, p. 234; August, 1938.

⁸ Kotowski, Schuettloeffel, and Vogt, "Kurzwellen-Anlagen mit steuerbarer Richtcharakteristik," u. ihre Anwendung zur Messung von Einfallswinkeln Mitteilungen aus dem Telefunken-Laboratorium (1940).

at distant short-wave transmitters resulted in values between 15° and 25° toward the horizon in the frequency range between 10 and 20 Mc. The ionospheric path $a_1 + b + a_3$ from the transmitter to the receiver corresponds to the opposite path $a_2 + b + a_4$ from the transmitter to the point A . For the moment the direct signal arrives at the receiver, the sliding wave stays simultaneously near A' . It travels from there to D' , reaching the receiver later than the direct signal after the time interval t_i . During the time t_i , the path i' will be traveled. Only by considering the fact that the ascending and the descending rays a_1 , a_2 , a_3 , and a_5 can be eliminated, can the extraordinary accuracy of the t_i and the t_u values be explained. An eventual curvature of these rays is unimportant.

Assuming that the waves travel on the circle of radius $R + h$ with the velocity of light, the following proportion exists:

$$\frac{R + h}{R} = \frac{c}{(u - 2d)/t_i} = \frac{c}{u/t_u}$$

The possibility of calculating the layer height h is given herewith. From 785 good measurable values on the film rolls, the average value

$$w_i = \frac{u - 2d}{t_i} = 290,515 \text{ kilometers per second,}$$

and from 218 good measurable circulations, the average value

$$w_u = \frac{u}{t_u} = 290,476 \text{ kilometers per second, was obtained.}$$

These values, together with $R = 6370$ kilometers and $c = 299,776$ kilometers per second, in the relation

$$h = R \left(\frac{c}{w_{i,u}} - 1 \right) \text{ (kilometers),}$$

result in $h = 203$ kilometers (w_i), and $h = 204$ kilometers (w_u).

These two values obtained from different kinds of measurements show a remarkable coincidence for the height of the ionospheric limit layer, differing only by 1 kilometer.

Von Schmidt envisioned two possible conditions of ionospheric propagation, as shown in Fig. 17(a) and (b). According to the theory of multiple reflections between the ionosphere and the earth's surface (Fig. 17(a)), the velocity v may be smaller than the velocity c of light within the reflecting E layer or within the reflecting F layer. Between these layers and between the E layer and the earth's surface, the velocity v will be equal to c . The propagation (Fig. 17(b)) consists of a continuous radiation of a sliding or head wave which travels along an ionospheric limit layer 204 kilometers above the

earth's surface. The velocity v between the E and the F layers is smaller than the velocity c of light. In the limit

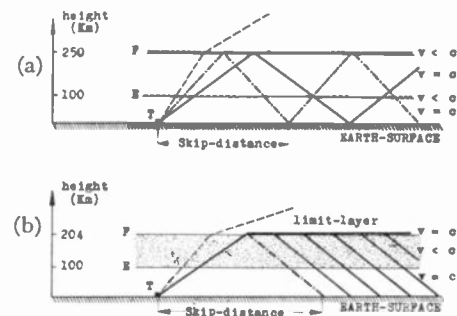

Fig. 17—High-frequency propagation (a) by reflections between ionosphere and earth surface, and (b) by a sliding wave according to von Schmidt.

layer and between the earth's surface and the E layer, the velocity v is equal to c .

According to the general theory of radio wave propagation, which is assumed to occur as multiple reflections in single hops between an ionospheric layer at a height of 250 kilometers and the earth's surface, an angle of incidence of 3° toward the horizon is obtained with regard to the measured value of $t_u = 0.13778$ second. The circulation around the earth should occur in 12 to 14 hops. Actually, however, the values measured by Kotowski and Schuettloeffel varied between 15° and 25° . von Schmidt derived a remarkable contrast to the results of the automatic echo recordings at vertical incidence according to these experimentally established facts. These general perceptions, which resulted from the echo registrations, have been applied to high-frequency propagation over long distances. Since a system of high-frequency propagation caused by repeated reflections in single hops between the ionosphere and the earth's surface could not be maintained, according to the results of his research, the fact of a surprising exact and highly constant value of a complete earth's circulation gave von Schmidt the occasion to relate it, together with other experimentally found results, to his theory of a so-called sliding or head wave.

VI. CONCLUSION

The principal result of these investigations manifests itself in the important fact that exact measurements of distances are possible on distant high-frequency stations within the frequency range between 10 and 20 Mc. The ionospheric conditions under which echo signals occur depend on the earth's surrounding twilight zone, and are limited to a few hours during the day.

Essential points of the study, which are based only on experimentally found data, are summarized in the following:

1. The reproductions of the indirect signal, direct circulating signal, indirect circulating signal, and the

the repeated circulating signals revealed on the film records are of an exceptional clearness and sharpness, and no important distortions by multiple-path phenomena were perceived. The indirect signals and the circulating signals had a much sharper curve than the direct signals. The longer the distance, the sharper the signal seems to be shaped on the films.

2. Comparisons between the measured amplitudes on the direct signals, indirect signals, indirect circulating signals, direct circulating signals, and especially between the repeated circulating signals have been performed. Measurements of the amplitudes between the direct signals and direct circulating signals on South American stations resulted that the circulating signals reached an average value of 20 per cent of the direct signal. Measurements between circulating signals and repeated circulating signals showed values up to 30 per cent.

3. Numerous measurements and investigations over a period of more than three years yielded 0.13778 second for the time interval of a complete circuit. This value seems to be quite independent of the frequency, and of the time of day and the season. No changes occurred with regard to the value of this time interval during the course of three years. Changes of the high-frequency propagation appearing during the 11-year sun-spot cycle effect a variation of the frequency band inside of which high-frequency echoes occur, and cause an increase or a diminution of the daily echo period. The time of a complete circuit around the globe, however, manifests itself as a constant value, subject to proof by later investigations that the divergence of the values is caused only by errors in the measurements.

4. According to von Schmidt's theory, there is a layer 203 kilometers above the earth's surface in which the signals propagate. From the theory assuming a propagation in single hops between the earth's surface and ionosphere, an angle of radiation at 3° toward the horizon and a layer height of 250 kilometers results for the measured complete circulation of 0.13778 second. Actually, angles of 20° have been measured as average values. This would mean a contradiction of the general opinion by which high-frequency propagation is explained.

5. Strongly marked distortions of the direct signals occur on stations which are less than 1000 kilometers from the recording place. For these cases, a multiple-path phenomenon is caused by single signals arriving successively after time intervals of some milliseconds,

and different phases. Distance measurements are mostly uncertain considering such conditions. Some experimentally developed methods seem to be helpful in searching for the true causes of multiple-path phenomena. These investigations may also be of importance to the problems of the deviation in radio navigation methods employing direction-finding systems. An interesting case of time-interval measurements is presented in this work on the recorded signals of a British station. Two different ways allowed a determination of the distance for this case.

All of these studies on radio signals took place on geographical latitudes between 53° and 58° . High geographical latitudes seem to be suitable for these echo studies with regard to the longer daily period for the occurrence of the echo signals because of the longer twilight conditions. Other positions on the earth's globe are supposed to have other conditions. A world-wide investigation of this field would be necessary to clear up all these problems.

A recent publication⁹ indicates that the highly constant time intervals on signals which travel completely around the globe can well be explained with a high-frequency propagation occurring by multiple reflections between the *F* layer and the earth's surface. According to calculations which presume low angles of incidence, circulating signals are probably reflected in 12 to 17 hops between the earth's surface and the ionosphere. Measurements of angles of incidence at North American high-frequency transmitters in 1944¹⁰ resulted in angles of 6° on 19 Mc, and 9° on 15 Mc. The early measurements in 1939 at the Telefunken Company with values between 15° and 25° are applicable to the conditions during the maximum of the sun-spot cycle.

ACKNOWLEDGMENT

The author wishes to express his gratitude to the late Oswald von Schmidt, whose original ideas for the explanation of ionospheric propagation by the sliding-wave theory have been discussed in this paper.

The support of Irvin L. Harlow, executive officer of the United States Military Government in Germany, is gratefully acknowledged. Through his help in May, 1945, important notes were saved from destruction.

⁹ L. Hamberger and K. Rawer, "Zur Fernausbreitung der Kurzwellen," *Z. Naturforsch.*, vol. 2a, no. 9, pp. 521-527; 1947.

¹⁰ H. Neyer, "Einfallswinkelmessungen nordamerikanischer Kurzwellensender," *Report Zentralst. Funk.*, reportedly published in *L'Onde Electrique*.

Effect of Passive Modes in Traveling-Wave Tubes*

J. R. PIERCE†, FELLOW, IRE

Summary—As the beam current in a traveling-wave tube is increased, the local fields due to the bunched beam become appreciable compared with the fields propagating along the circuit. The effect is to reduce gain, to increase the electron speed for optimum gain, to introduce a lower limit to the range of electron speeds for which gain is obtained, and to change the initial loss.

IN AN EARLIER PAPER¹ a theory of the beam-type traveling-wave tube was presented. The most important properties of such tubes can be understood in terms of the electronic parameters, dc beam current I_0 and voltage V_0 , and the parameters of the one mode of propagation along the circuit which gives unattenuated or slightly attenuated transmission with a phase velocity very near to the electron velocity. The purpose of this paper is to discuss the effect on the operation of traveling-wave tubes of the part of the field which is not associated with this particular mode of propagation of the circuit.

The analysis was formulated in terms of the active and passive² modes of propagation of the circuit in order that it might apply to traveling-wave tubes which have circuits other than helices, as well as to the particular form of traveling-wave tube previously described.³ In the analysis certain assumptions are made, among them that there is no effect of transverse electron motion, and that all electrons in the flow are acted on by substantially the same longitudinal electric field. The writer believes that, within these assumptions, the equations derived are substantially correct for any traveling-wave type of tube which has but one active mode with a phase velocity near to the electron speed. Thus, the expansion in terms of modes may, if one wishes, be regarded as an artifice in obtaining (2), and the writer believes that (2) is substantially correct even when the expansion in modes is of doubtful validity.⁴

It is important to define clearly what is meant by passive modes. Consider a transmission system whose properties do not vary in the direction of propagation (the z direction). It may be assumed that, at a given frequency, there is a set of solutions of Maxwell's equations satisfy-

ing the boundary conditions of the system which vary in the z direction as $\exp \pm \Gamma_n z$. We assume that the boundary conditions will be satisfied for certain discrete values of Γ_n only, and the subscript n is to be regarded as an integer labeling these values. Ordinarily, for each value Γ_n there will be a given variation of field in directions normal to the axis. Each permissible value of Γ_n and the field corresponding to it will be regarded as a mode of propagation. If Γ_n is predominantly real, so that the field chiefly decays exponentially with distance, the mode will be a passive mode.⁵

An excitation of the transmission system by current elements can be expanded in terms of the various modes of propagation. If we assume the z component of electric field to have a magnitude E over the area A occupied by current, and let the current in the z direction have a magnitude q and vary as $\exp -\Gamma z$, the field E is found to be (see Appendix):

$$E = q \left(\sum_n \frac{\Gamma_n}{\Psi_n^* (\Gamma^2 - \Gamma_n^2)} + \frac{j}{\omega \epsilon A} \right). \quad (1)$$

This field, of course, varies as $\exp -\Gamma z$. The quantity Ψ_n^* is twice the complex power flow in the n th mode when the field component associated with the n th mode has unity peak amplitude at the position of q .

Often a transmission system, such as the helix, does vary physically in the z direction. Generally, the fields of a solution of Maxwell's equations for such a system will not vary simply as $\exp -\Gamma_n z$ along a line parallel to the z axis. For instance, if the system has a physical variation periodic over the distance d , each transmission mode will involve components varying as $\exp (-\Gamma_n \pm 2m\pi/d)z$. The component for which $m=0$ can be regarded as the fundamental component and those for which $m \neq 0$ as spatial harmonics. These are sometimes called Hartree harmonics. The calculations presented here apply strictly only to smooth systems without such harmonics. When such harmonics are small in amplitude compared with the fundamental, or when they have phase velocities very different from the electron velocity, it probably is safe to neglect their effect.

As used in traveling-wave tubes, helices have only one slow active mode. For this $n=0$ mode, which propagates with small attenuation, the imaginary component of Ψ_0^* is very small compared with its real component for the losses usually encountered.⁶ The real component of Γ_0 is very small compared with its imaginary component. Also, in traveling-wave tubes the real compo-

* Decimal classification: R339.2. Original manuscript received by the Institute, September 9, 1947; revised manuscripts received, February 9, 1948, and March 22, 1948.

† Bell Telephone Laboratories, Inc., New York 14, N. Y.

¹ J. R. Pierce, "Theory of the beam-type traveling-wave tube," *Proc. I.R.E.*, vol. 35, pp. 111-123; February, 1947.

² These passive modes were called "cutoff" modes in the previous paper.¹

³ J. R. Pierce and L. M. Field, "Traveling-wave tubes," *Proc. I.R.E.*, vol. 35, pp. 108-111; February, 1947.

⁴ From conversations with R. G. Hutter, it appears to the writer that a helically conducting sheet with no surrounding conducting cylinder has no passive modes, while a helically conducting sheet with a concentric shield, however large, has passive modes and may have fast active modes. Experimentally, an outer conductor does not affect the operation of a helix-type traveling-wave tube, even when the outer conductor is quite close to the helix.

⁵ Ordinarily, Γ_n for a passive mode will have an imaginary component only if the transmission system has loss.

⁶ Ψ_0^* would be entirely real for a lossless helix.

ment of Γ is small compared with its imaginary component, and the imaginary components of Γ and Γ_0 differ by a small fraction of themselves. Thus, $\Gamma^2 - \Gamma_0^2$ is a quantity of small magnitude compared with Γ_0 , and this quantity is very sensitive both in magnitude and in phase angle to the small variations which occur in Γ as electron speed, electron current, and circuit attenuation are varied over the useful range.

As may be seen from (1), the component of field due to this active mode, which is nearly in synchronism with the impressed current, does not contribute all of the field excited by the current, but the writer believes that it does contribute the only part of the field which (1) is strongly sensitive to small changes in Γ , and (2) has an appreciable in-phase component.

Hence, the term $j/\omega\epsilon A$, plus the summation for all passive modes and for active modes with phase velocities differing very widely from the electron velocity, will be regarded as a purely imaginary constant, and (1) will thus be rewritten:

$$E = q \left[\frac{\Gamma_0}{\psi_0^*(\Gamma^2 - \Gamma_0^2)} + \frac{j}{m_1\beta} \right]. \quad (2)$$

Here m_1 is a real quantity having the dimensions of admittance, and $\beta = \omega/u_0$ where u_0 is the dc electron velocity. The velocity u_0 is assumed to differ by a small fraction only from the phase velocity of the 0 mode, and hence is treated as a constant.

The important thing about (2) is that it expresses the circuit properties in terms of three important parameters, Ψ_0^* , Γ_0 , and $m_1\beta$. Of these, Ψ_0^* and Γ_0 are truly constants. $m_1\beta$ is strictly a function of Γ , but it is assumed to vary little over the range of Γ which is of interest, and to be purely real.⁷

The first term in (2) represents a field having the spatial pattern, normal to the z direction, of the unforced 0 mode. At a given z position this field component is largely due to energy which has been transferred to the 0 mode by the convection current q at remote points.

It turns out that, the smaller is the beam current I_0 , the smaller is the fractional difference between Γ and Γ_0 , and hence the greater is the first term of (2) in comparison with the second term. However, as the beam current is made larger, the second term becomes important.

According to the foregoing analysis, this second term should be thought of as representing the field contribution of the term $j/\omega\epsilon A$, the nonpropagating or passive modes, and perhaps the effects of any active modes having phase velocities very different from the electron velocity. This term represents a field with a spatial pattern very different from the 0 mode. The field of the 0 mode tends to be strong near the circuit (the helix, for instance), while the field of the other term tends to be strong near the electrons. Thus, for large beam currents

the variation of field normal to the z direction can be quite different from that for the 0 mode.

The field at a given z position represented by the second term of (2) is due largely to excitation by electrons very near to that position. Thus, we can consider this as the field due to the local *space charge* in contrasting it with the 0-mode field, which represents energy which has traveled along the circuit from remote points of excitation. This distinction indicates that we can estimate the magnitude of the parameter m_1 in another way than by summing over the passive modes. For instance, an estimate of this parameter has been made¹ by assuming a tubular electron beam of radius a in free space so bunched as to constitute a convection current of magnitude q varying with distance and time as $\exp(-j\beta z + j\omega t)$. The longitudinal electric field at the radius a was computed. This field and the current q were then identified with E and q in (4), the first term in the brackets being omitted because the circuit was not present. The assumption involved was that the fields due to local space charge would be much the same in the presence of the circuit as in the absence of the circuit. The writer believes this will be substantially true unless the beam is quite close to the conductors constituting the circuit.

This previously published curve giving $(1/m_1\beta^2)$ (u_0/c) as a function of γa , where a is the *beam radius* (Fig. 8 of reference (1)), can be used in connection with Fig. 10 of the same reference in predicting the performance of a helix-type tube.⁸ Through an unfortunate oversight, a means beam radius in Fig. 8 and helix radius in Fig. 10.

For small signals, the convection current q can be expressed as a linear function of the field E^1 . When this is done and the expression is substituted in (1), the following equation is obtained:

$$1 = \left[\frac{\Gamma_0}{\psi_0^*(\Gamma^2 - \Gamma_0^2)} + \frac{j}{m_1\beta} \right] \frac{j\beta I_0}{2V_0(-\Gamma + j\beta)^2}. \quad (3)$$

It is assumed that the imaginary part of Ψ_0^* is so small that this quantity can be treated as purely real, and Ψ_0 will be used interchangeably with Ψ_0^* .

It is convenient to use parameters

$$C^2 = \frac{I_0}{4\psi_0\beta^2 V_0} \quad (4)$$

$$Q = \frac{\psi_0}{2m_1}. \quad (5)$$

We further write

$$-\Gamma_0 = -j\beta - j\beta Cb. \quad (6)$$

$$-\Gamma = -j\beta + (x + jy)\beta C. \quad (7)$$

Here b is a parameter which can be thought of as specifying the relative speeds of the electrons and the undis-

⁸ The results presented in this paper give a variation of Γ with electron speed of substantially the same form as that deduced by Chu and Jackson by quite a different method. Using values from the figures referred to, a fairly close numerical agreement is obtained.

⁷ As a further refinement, one could of course replace the term $j/m_1\beta$ by a constant plus a term proportional to $\Gamma - \Gamma_0$.

turbed wave. For positive values of b , the electrons travel faster than the undisturbed wave; for negative values of b , the electrons travel slower than the undisturbed wave. From (6) we see that we have now assumed the circuit to be lossless, and hence to propagate without attenuation.

The quantities x and y tell about the attenuation and the speed of the actual wave. For x positive, the wave increases as it travels. For y positive, the wave goes faster than the electrons; for y negative, the wave goes slower than the electrons.

We assume that

$$|\Gamma - \Gamma_0| \ll \Gamma_0 \quad (8)$$

$$|\Gamma - \beta| \ll \Gamma_0 \quad (9)$$

Neglecting higher-order terms, we obtain

$$(x^2 - y^2)(b + y) + 2x^2y + 4QC(b + y) + 1 = 0 \quad (10)$$

$$x[(x^2 - y^2) - 2y(y + b) + 4QC] = 0. \quad (11)$$

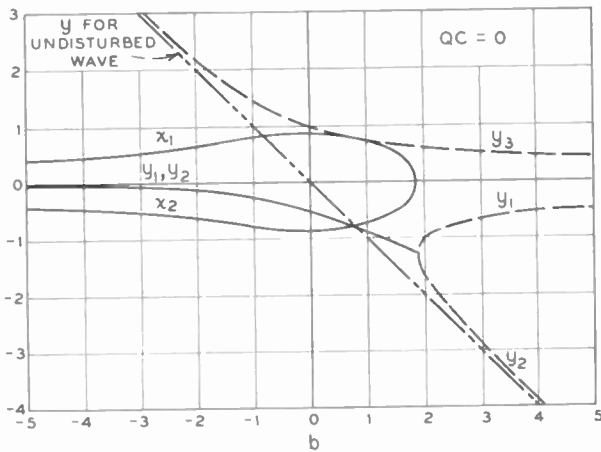

Fig. 1—Curves showing properties of the three forward waves versus b , a parameter which increases with electron speed. x is positive for increasing waves; y is negative for waves slower than the electron speed and positive for waves with greater than electron speed. These curves are for a passive-mode or space-charge parameter $QC=0$.

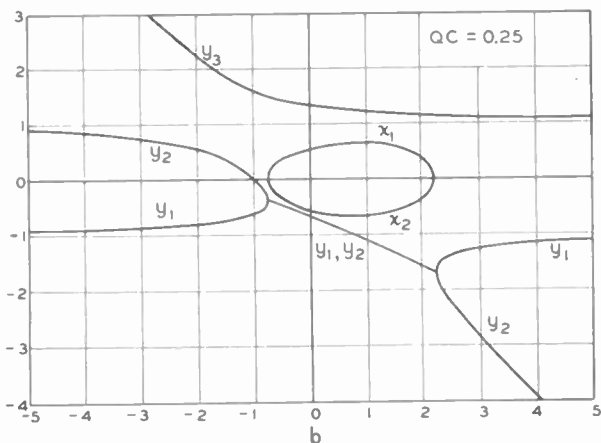

Fig. 2—Curves showing properties of the three forward waves for $QC=0.25$.

and 1 in Figs. 1, 2, 3, and 4. For $QC=0$, $x_1=0$ for values of b greater than $3/2^{2/3}$. However, for $QC>0$, $x_1=0$ for b less than a critical value, as well. This absence of gain for electron velocities below a certain minimum value is one outstanding feature of the effect of passive modes. Another is the fact that the maximum value of x_1 occurs at greater values of b (greater electron speeds) as QC is increased (by increasing the current, for instance).

It may be seen that for large and small values of b there are a "circuit" wave in which $y \approx b$, which travels with almost the speed of the wave in absence of electrons, and two "space-charge" waves, one traveling faster than the mean electron speed and the other slower. This is in accord with the work of Hahn⁹ and Ramo.¹⁰ They treated a case in which the electron stream traveled in a waveguide. At frequencies above cutoff, the waveguide mode has a velocity of propagation much greater than the beam speed ($b \ll 0$ in our terms), so that

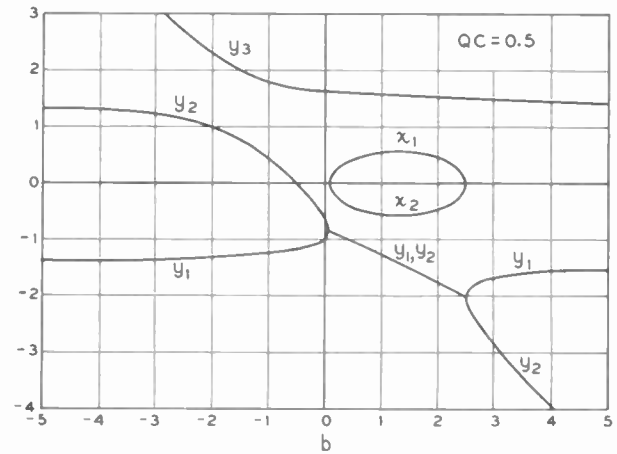

Fig. 3—Curves showing properties of the three forward waves for $QC=0.5$.

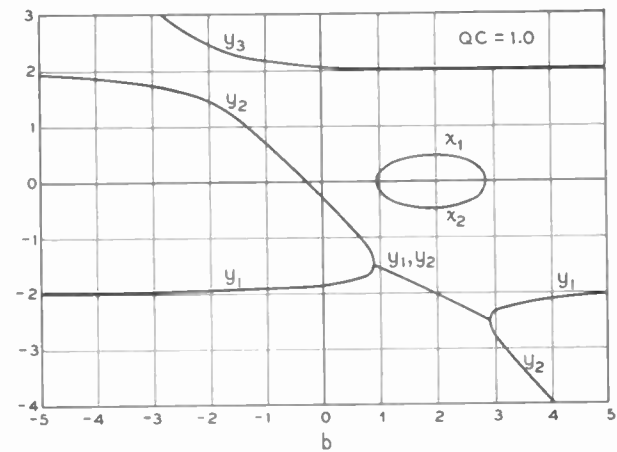

Fig. 4—Curves showing the properties of the three forward waves for $QC=1.0$.

These equations yield three pairs of x, y . The values of x and y have been plotted versus b for $QC=0, 0.25, 0.50,$

⁹ W. C. Hahn, "Small signal theory of velocity modulated electron beams," *Gen. Elec. Rev.*, vol. 42, pp. 258-270; June, 1939.

¹⁰ Simon Ramo, "Space charge and field waves in an electron beam," *Phys. Rev.*, vol. 56, pp. 276-283; August, 1939.

in this case there is a virtually undisturbed "circuit" wave ("field wave") and two unattenuated "space-charge" waves. In most cases where the "space-charge" waves are of interest, the "circuit" waves are cut off.

We see from (10) that, when $b \ll 0$, the "space-charge" waves are given by

$$x = 0 \quad (12)$$

$$v = \pm 2\sqrt{QC} \quad (13)$$

$$-\Gamma = -j(\beta \pm 2\beta\sqrt{QC^3})$$

$$-\Gamma = -j(\beta \pm \sqrt{I_0/2m_1V_0}) \quad (14)$$

Thus, under these circumstances, even in the presence of an active mode, the space-charge waves are dependent only on the parameter m_1 , and not at all on the active mode parameters Ψ_0 and Γ_0 .

The rate at which the increasing wave increases with distance is given by x_1 . When $QC=0$, the maximum value of x_1 is $\sqrt{3}/2$. An idea of one effect of local space-charge fields on gain can be obtained by plotting the maximum value of $2x_1/\sqrt{3}$ versus QC . This has been done in Fig. 5. It should be noted from Figs. 1 through 4 that the maximum value of x_1 occurs at increasing values of b as QC increases. Thus, as the effect of local space-charge fields increases, the optimum electron speed with respect to the speed of the undisturbed wave

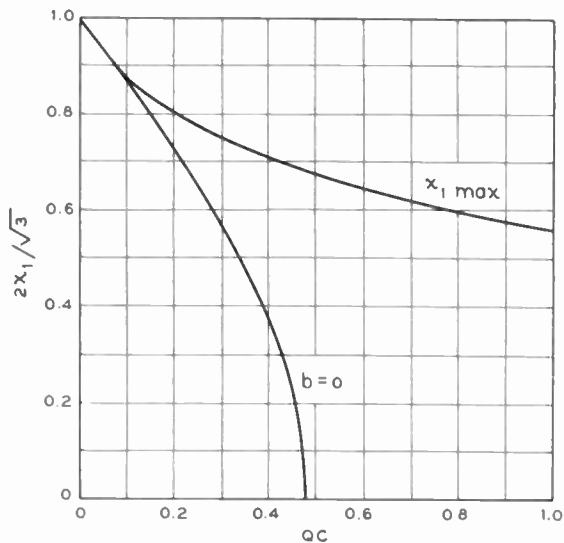

Fig. 5—Relative rate of increase of the increasing wave versus QC . The curve $x_{1\max}$ is for optimum electron velocity, and the curve marked $b=0$ is for an electron velocity equal to the phase velocity of the undisturbed wave.

becomes greater. For comparison, the value of $2x_1/\sqrt{3}$ for $b=0$ (electron speed same as speed of unperturbed wave) is shown in Fig. 5. This is a curve which was given in the earlier paper.¹

There is another effect of local space-charge fields on over-all gain. How much increasing wave is excited by a given applied field or power? We can no longer proceed in quite the same way as when $QC=0$.

In the first place, we observe that the impressed field

should be equal to the sum of the field components representing power flow in the circuit, excluding the field components due to passive modes. However, one of our boundary conditions at the input ($z=0$) is that the sum of the convection currents for the three modes is zero:

$$q_1 + q_2 + q_3 = 0. \quad (15)$$

Now, we see from (2) that the coefficient $j/m_1\beta$ is independent of Γ , and hence is the same for all three waves. Thus, from (15) we see that setting the sum of the total fields E_1, E_2, E_3 of the three waves at $z=0$ equal to E_0 , the impressed field, is equivalent to setting the sum of the three power-carrying components, which we can call E_{p1}, E_{p2}, E_{p3} , equal to E_0 , so as before we can write at $z=0$

$$E_1 + E_2 + E_3 = E_0. \quad (16)$$

Thus, we get the same relation for E_1 in terms of E_0 as in the earlier paper:

$$E_1 = \frac{E_0}{\left(1 + \frac{x_2 + jy_2}{x_1 + jy_1}\right) \left(1 + \frac{x_3 + jy_3}{x_1 + jy_1}\right)}. \quad (17)$$

The actual electromagnetic energy associated with the increasing wave alone, which we can extract at the end of the tube, is specified not by E_1 but by the component associated with the 0, or active mode, E_{1p} . The E of (4) is the total field, and the left-hand term of the right side is that associated with the 0 mode. Hence, we see from (3), (4), and (5) that

$$E_{1p} = [1 + 4QC(b + y_1 - jx_1)]E_1. \quad (18)$$

Using (17) and (18) and the values of x_1, y_1 and b for maximum gain from Figs. 1 through 4, we can evaluate E_{1p} in terms of E_0 . In Fig. 6 the quantity

$$A = 20 \log_{10} |E_{1p}/E_0| \quad (19)$$

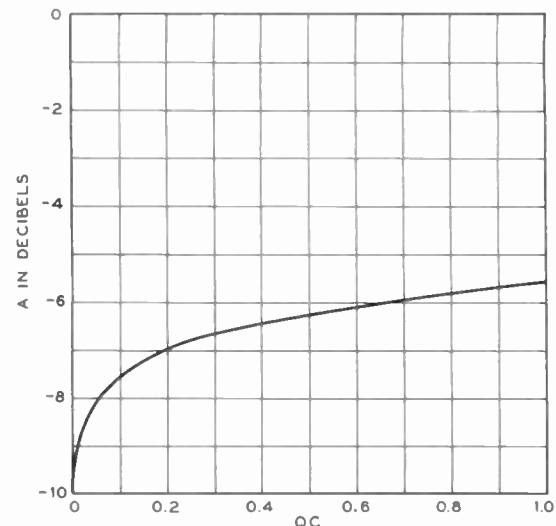

Fig. 6—Initial loss in setting up the increasing wave versus QC ; b is adjusted to make x_1 a maximum.

has been plotted versus QC . This can be regarded as the db loss in setting up the power-carrying component of the increasing wave.

APPENDIX

In a previous paper¹ the writer gave an expression like (1), except that the term $j/\omega\epsilon A$ was missing. This gave the field *outside* of the current correctly, but it is not correct in the space occupied by the current flow.

In the derivation previously given, the propagation in the $+z$ and $-z$ directions away from a current I flowing over some elementary distance l in the z direction was correctly evaluated. This gives the correct field outside of the space l long, but not the complete field inside of the space where the current flows. It is physically necessary that when current flows in the z direction between two planes a distance l apart, and not beyond those planes, charges must accumulate at the planes, and this results in a discontinuity in the field at the planes. The extra component of field inside the short region of current flow must be such that the displacement current is equal and opposite to the convection current. Thus, if J is the impressed current density in the z direction, the extra field inside the flow must be

$$E = \frac{j}{\omega\epsilon} J. \quad (20)$$

If the current density is constant over the area A , and the impressed current is called q , the extra field component is

$$E = \frac{j}{\omega\epsilon A} q. \quad (21)$$

This is the extra term which appears in (1) and did not appear in the writer's previous paper.¹ The correct expression is given in a somewhat different form by Bernier.¹¹ It has also been called to the attention of the writer by several other workers.

If we wish to take into account currents flowing over a broad region over which the field varies considerably, (1) must be replaced by a more general expression. Suppose that the z component of the electric field of the n th mode of transmission¹² varies as $\Phi_n(x, y)$ normal to the z direction, where

$$\Phi_n(0, 0) = 1. \quad (21)$$

Let Ψ_n be twice the power carried by the n th mode across a plane normal to the z axis in one direction for unit peak field in the n th mode on the z axis ($x=y=0$). Let the impressed current density be a function of x and y as well as of z , and be

$$J(x, y)e^{-\Gamma z}.$$

Let

$$I_n = \int_{-\infty}^{\infty} \int_{-\infty}^{\infty} \Phi_n(x, y) J(x, y) dx dy. \quad (22)$$

Thus, I_n is a component of current in the spatial pattern of the n th normal mode.

We obtain, for the complete field excited by the impressed current,

$$E(x, y)e^{-\Gamma z} = \left[\frac{jJ(x, y)}{\omega\epsilon} + \sum_n \frac{I_n \Gamma_n \Phi_n(x, y)}{\Psi_n^* (\Gamma^2 - \Gamma_n^2)} \right] e^{-\Gamma z}. \quad (23)$$

¹¹ J. Bernier, "Essai de théorie du tube électronique à propagation d'onde," *Ann. de Radioelect.*, vol. 2, no. 7, pp. 87-104; January, 1947.

¹² We deal here with transverse magnetic modes, which have a z component of electric field, and disregard transverse electric modes, which are not excited by the current.

Antennas for Circular Polarization*

W. SICHAK†, MEMBER, IRE, AND S. MILAZZO†, MEMBER, IRE

Summary—A formula is derived to give the variation in received voltage when an elliptically polarized antenna is rotated in a plane transverse to the direction of propagation of the incident elliptically polarized wave. It is shown that a circularly polarized antenna will not receive any of its transmitted energy which is reflected from a highly conducting smooth surface. Conditions that must be satisfied to obtain an omnidirectional circularly polarized pattern are derived. Experimental results are given.

1. INTRODUCTION

THE AIM OF THIS PAPER is to examine some aspects of circularly polarized antennas, and more generally the case of elliptically polarized sys-

* Decimal classification: R120. Original manuscript received by the Institute, July 14, 1947; revised manuscript received, March 5, 1948. Presented, 1947 IRE National Convention, March 6, 1947, New York, N. Y.

† Federal Telecommunication Laboratories, Inc., Nutley, N. J.

tems. If a system of co-ordinates is chosen as shown in Fig. 1, the electric field of an elliptically polarized plane wave traveling in the positive z direction is given by

$$E = \epsilon_x \mathcal{E}[j(\omega t - \beta z)] + \epsilon_y \mathcal{E}[j(\omega t - \beta z + \theta)] \quad (1)$$

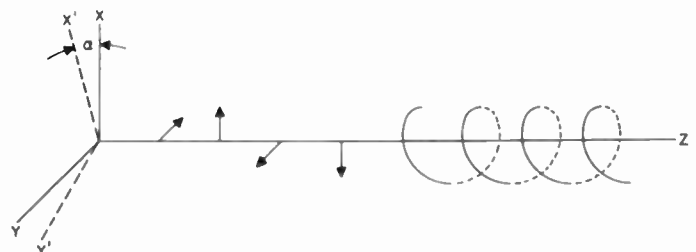

Fig. 1—Electric field of an elliptically polarized wave traveling from left to right.

where

$$\begin{aligned} \epsilon_x \text{ and } \epsilon_y &= \text{unit vectors in } x \text{ and } y \text{ directions} \\ \beta &= 2\pi/\lambda \\ \lambda &= \text{wavelength} \\ \theta &= \text{phase difference between } x \text{ and } y \text{ components.} \end{aligned}$$

The actual field varies as the real part of this expression, each component being of unit amplitude. If $\theta = \pm\pi/2$, circular polarization is obtained. If the sign of $\pi/2$ is positive, the field is said to be right-handed circularly polarized; if the sign is negative, the field is left-handed circularly polarized. Fig. 1 shows the sense of rotation of a right-handed circularly or elliptically polarized field at a fixed instant of time. Viewed from the origin, the electric field vector rotates clockwise around the z axis in the direction of propagation (in the same sense as a nut rotating on a right-handed screw thread). At a fixed value of z , however, the field vector rotates counterclockwise around the z axis as a function of time, looking again in the direction of propagation. The essential difference between elliptical and circular polarization is that the amplitude of the field vector for elliptical polarization varies in such a way that it describes an ellipse as it rotates about the z axis, whereas for circular polarization the amplitude remains constant. A circularly polarized field that is right-handed with respect to space is left-handed with respect to time. Confusion is avoided by specifying the sense in only one co-ordinate, the space co-ordinate.

An expression is derived in the Appendix which gives the absolute magnitude of voltage V induced in an elliptically polarized receiving antenna located in the field of an elliptically polarized wave. The expression is

$$V = K \left(1 \mp \frac{2r_2}{r_2^2+1} \frac{2r_1}{r_1^2+1} + \frac{r_2^2-1}{r_2^2+1} \frac{r_1^2-1}{r_1^2+1} \cos 2\alpha \right)^{1/2} \quad (2)$$

where

- K = a constant
- r_1 = ratio of maximum to minimum amplitudes in the receiving antenna as it is rotated in a plane transverse to the direction of propagation of a linearly polarized plane wave. It is also the ratio of maximum to minimum amplitudes of the field vector in the elliptically polarized wave that would be radiated by the receiving antenna if it acted as a transmitter
- r_2 = ratio of maximum to minimum amplitudes of the field vector of the incident elliptically polarized wave
- α = angle between the direction of maximum amplitude of the electric-field vector in the incident elliptically polarized wave and the direction of maximum amplitude of the electric-field vector that would be produced by the receiving antenna if it were radiating. It is assumed that the latter electric-field vector always lies in a plane normal to the direction of propagation of the incident wave.

The \mp sign will be read as $+$ if both the receiving antenna and the transmitting antenna produce the same handedness or screw sense of polarization, and as $-$ if they have opposing senses of polarization.

2. EXAMPLES

Let us now consider two particular cases.

Case A

A circularly polarized wave is incident on a circularly polarized receiving antenna.

Then $r_1 = r_2 = 1$, and (2) becomes

$$\left. \begin{aligned} V &= K\sqrt{1 \mp 1} \\ &= K\sqrt{2} \text{ or } 0 \end{aligned} \right\} \quad (3)$$

Thus, the receiving antenna will absorb energy if it has the same handedness of polarization as the incident wave. If the antenna has the opposite screw sense to that of the incident wave, it will be completely "blind" to such radiation and will absorb no power. This holds for all angles around the z axis in the xy plane, Fig. 1, at which the receiving antenna can be inclined, (3) being independent of α . One conclusion is that, if circular polarization is to be used for communication, the transmitting and receiving antennas must produce the same handedness of polarization when each is used as a radiator.

One can go further and predict the behavior of a circularly polarized antenna as a receiver of energy reflected back to it from a highly conducting smooth surface. This system has the property that, if the wave incident on the reflector is right-handed, the reflected wave will be left-handed, since both of the mutually perpendicular components of electric field in the incident wave are shifted 180° in phase on reflection, but the direction of propagation in the reflected wave is reversed. This analysis does not apply to metallic reflectors made of parallel thin wires, because such surfaces will reflect mainly the component of polarization parallel to the wires. The fact that a circularly polarized antenna will not receive energy reflected from a metallic object can be useful in many ways; for instance, the impedance of a circularly polarized antenna does not change when it is used to excite a parabola. During the war, considerable trouble was encountered in matching radiators associated with full paraboloids having focal lengths a few wavelengths long, even over relatively narrow frequency bands, because of the reflection introduced into the transmission line by the paraboloid. The voltage reflection coefficient in such a case is given¹ by

$$\Gamma = \frac{G\lambda}{4\pi F} \quad (4)$$

¹ S. Silver, Report No. 422, Radiation Laboratory, Massachusetts Institute of Technology, Cambridge, Mass.

where

- Γ = voltage reflection coefficient
- G = gain of antenna in direction of vertex (not the gain of the whole antenna)
- λ = wavelength
- F = focal length.

This formula was derived for linear polarization. For elliptical polarization, by use of (2), (4) becomes

$$\Gamma = \frac{G\lambda}{4\pi F} \frac{r^2 - 1}{r^2 + 1} \quad (5)$$

where r has the same meaning as r_1 in (2).

The reflection coefficient at 2200 Mc due to a paraboloid having a 24-inch diameter by 9-inch focal length was measured with an antenna that could be changed to produce circular, elliptical, or linear polarization. For each polarization, the antenna was matched with a double-stub tuner to give a standing-wave ratio less than 1.05 in free space. The antenna was then moved back and forth on a line between the vertex and the focus, and the maximum and minimum standing-wave ratios were measured. From these measurements, the reflection coefficients were obtained for the case where the antenna and paraboloid reflections add, and for the case where one subtracts from the other. From these two reflection coefficients, the true reflection coefficient is obtained. Table I summarizes the data.

TABLE I
MATCHING BETWEEN ANTENNA AND PARABOLOID

Polarization	Reflection coefficient	
	Calculated	Observed
Circular	0.00	0.01
Elliptical	0.06	0.07
Linear	0.08	0.10

Case B

Consider now an elliptically polarized wave incident on an elliptically polarized antenna, so that r_1 is not equal to r_2 . Inspection of (2) shows that the power received will depend on the angle α at which the receiving antenna is oriented. Also, more energy will be absorbed when the screw senses of polarization are the same than when they are not, although there will be no orientation for which the received power will be zero.

TABLE II
RECEIVED VOLTAGE BETWEEN ELLIPTICALLY POLARIZED ANTENNAS

	Same Sense of Polarization		Opposite Sense of Polarization	
	Maximum voltage	Minimum voltage	Maximum voltage	Minimum voltage
Calculated	1	0.775	0.638	0.040
Observed	1	0.708	0.600	0.037

Table II gives confirming experimental data. Measurements were made at 1000 Mc, using two turnstile antennas so that the screw sense could be easily changed. The transmitting antenna was placed about four wavelengths away from the receiving antenna. The receiving antenna was rotated in the plane transverse to the direction of propagation (xy plane, Fig. 2), and the maximum and minimum received power were measured. One dipole was then rotated 180° to change the screw sense (i.e., in Fig. 2, connections to arms B and B' were reversed while leaving the connections to dipole AA' unchanged), and maximum and minimum received powers were again measured. Ratios r_1 and r_2 were measured by replacing one of the antennas with a dipole and measuring the maximum and minimum powers received as the dipole was rotated. All values are normalized with respect to the greatest value of induced voltage; values of ratios r_1 and r_2 were 2.0 and 2.24, respectively.

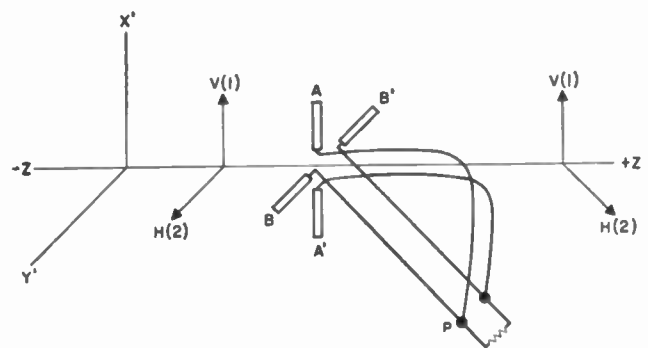

Fig. 2—Use of turnstile antenna to demonstrate effect of screw sense of polarization between elliptically polarized wave and the receiving antenna.

A circularly polarized antenna can, of course, be used to receive a linearly polarized wave, or a linearly polarized antenna to receive power from a circularly polarized wave.

3. METHODS OF PRODUCING CIRCULAR POLARIZATION

A simple circularly polarized antenna with a field pattern similar to that of a dipole has been described.²

The antenna consists of a horizontal loop with a ver-

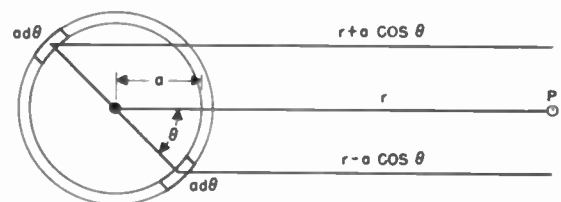

Fig. 3—Production of a circularly polarized wave by means of a horizontal loop antenna with a vertical dipole placed at the center.

² A. G. Kandoian, "Three new antenna types and their applications," Proc. I.R.E., vol. 34, pp. 70W-75W; February, 1946. Also, Elec. Commun., vol. 23, pp. 27-34; March, 1946.

tical dipole at its center placed normal to the plane of the loop, Fig. 3. Although actual loops are built in the form of triangles or squares, the loop will be considered to be a circle for this discussion. In the plane of the loop, the field dE_h from two diametrically opposite elements $d\theta$ on the periphery of the loop³ is

$$\begin{aligned} dE_h &= C_1 \left\{ \mathcal{E}[j(\omega t - k_1 b - kr + ka \cos \theta)] \right. \\ &\quad \left. - \mathcal{E}[j(\omega t - k_1 b - kr - ka \cos \theta)] \right\} \cos \theta d\theta \\ &= 2jC_1 \mathcal{E}[j(\omega t - k_1 b - kr)] \sin(ka \cos \theta) \cos \theta d\theta, \end{aligned} \quad (6)$$

where

- $C_1 = \text{constant}$
- $k_1 = 2\pi/\lambda_1$
- $\lambda_1 = \text{wavelength in transmission line}$
- $k = 2\pi/\lambda$
- $\lambda = \text{free-space wavelength}$
- $b = \text{length of transmission line}$
- $a = \text{radius of loop}$
- $r = \text{distance from center of loop.}$

The loop is considered to be made of infinitesimal elements, each excited uniformly by a separate transmission line. The total field is obtained by integrating (6) from 0 to π .

$$E_h = jC_2 \mathcal{E}[j(\omega t - k_1 b - kr)] J_1(ka) \quad (7)$$

where $J_1 =$ Bessel function of the first order. Equation (7) shows that the phase of the distant field, referred to the center of the loop, has undergone a shift of a quarter-wavelength, which is independent of the transmission-line length b , or the distance r . The distant field of the vertical dipole at the center of the loop is

$$E_v = C_3 \mathcal{E}[j(\omega t - kr)]. \quad (8)$$

The factors C_2 and C_3 in (7) and (8) contain all parameters that affect the magnitude but not the phase of the distant field. To obtain circular polarization, two conditions must be satisfied:

$$C_2 J_1(ka) = C_3,$$

and

$$\mathcal{E}[-jk_1 b] = \pm 1.$$

The first condition must be satisfied to produce equal horizontal and vertical fields. The loop diameter must be less than about 0.6 wavelength to obtain a pattern that is roughly equivalent to that from a vertical dipole.³ The second condition must be satisfied if the phase of the horizontal field is to differ by a quarter-wavelength from the vertical field. This condition is satisfied by making length b of the transmission line connected to the loop elements an integral number of half-wavelengths long. Another way of stating this is that the current in the loop must be exactly in-phase or exactly out-of-phase with the current in the dipole.

There are certain types of circularly polarized antennas that produce both right-handed and left-handed circular polarization simultaneously in different directions. The antenna shown in Fig. 2, the well-known turnstile,⁴ which is used mainly to obtain a horizontally polarized omnidirectional pattern, is one of these. In Fig. 2 is shown the orientation of the field at one instant of time and a quarter-cycle later. At time t , the field at two points on the z axis on opposite sides of, and equidistant from, the turnstile is vertical; the horizontal component is zero. A quarter-cycle later the field is horizontal. The field traveling along the plus- z axis rotates clockwise in time, or to the left hand in space. The field traveling along the minus- z axis rotates counterclockwise in time, or right-handedly in space. This means that, with a 180° rotation of the turnstile antenna about an axis transverse to the direction of propagation, the received power will go from a maximum to zero when received on a circularly polarized fixed receiving antenna.

A turnstile antenna can be made more directive by placing a reflector a quarter-wavelength behind it, because the reflected field will then have the same screw sense as the direct field. A plane reflector cannot be used with an antenna like that described in footnote reference 2 (which produces the same screw sense in all directions) because the reflected field will have the opposite screw sense from the direct field.

APPENDIX

Consider the second system of co-ordinates, x' , y' , and z' obtained from those of Fig. 1 by a rotation about the z axis through an angle α .

Referred to this system, the value of E given by (1) becomes

$$\begin{aligned} E &= \mathbf{e}_{x'} \left\{ \mathcal{E}[j(\omega t - \beta Z)] \cos \alpha + \mathcal{E}[j(\omega t - \beta Z + \theta)] \sin \alpha \right\} \\ &\quad + \mathbf{e}_{y'} \left\{ -\mathcal{E}[j(\omega t - \beta Z)] \sin \alpha + \mathcal{E}[j(\omega t - \beta Z + \theta)] \cos \alpha \right\} \\ &= \mathbf{e}_{x'} (1 + \cos \theta \sin 2\alpha)^{1/2} \\ &\quad \cdot \mathcal{E} \left\{ j[\omega t + \arctan(\sin \theta \sin \alpha / \cos \alpha + \cos \theta \sin \alpha) - \beta Z] \right\} \\ &\quad + \mathbf{e}_{y'} (1 - \cos \theta \sin 2\alpha)^{1/2} \\ &\quad \cdot \mathcal{E} \left\{ j[\omega t + \arctan(\sin \theta \cos \alpha / -\sin \alpha + \cos \theta \cos \alpha) - \beta Z] \right\} \\ &= \mathbf{e}_{x'} E_A + \mathbf{e}_{y'} E_B. \end{aligned} \quad (9)$$

In general, the difference in phase between the x' and y' components of the field will depend on the value chosen for α . When $\alpha = 45^\circ$, (9) assumes the especially simple form

$$\begin{aligned} E &= \mathbf{e}_{x'} (1 + \cos \theta)^{1/2} \mathcal{E}[j(\omega t - \beta Z + \theta/2)] \\ &\quad + \mathbf{e}_{y'} (1 - \cos \theta)^{1/2} \mathcal{E}[j(\omega t - \beta Z + \theta/2 - 90^\circ)]. \end{aligned} \quad (10)$$

Hence, we see that any wave of the form given by (1) or (9) is equivalent to one of the form (10), where we have two mutually perpendicular components in space of am-

³ D. Foster, "Loop antennas with uniform current," *Proc. I.R.E.*, vol. 32, pp. 603-607; October, 1944.

⁴ G. H. Brown, "The turnstile antenna," *Electronics*, vol. 9, p. 15; April, 1936.

plitudes $(1 + \cos \theta)^{1/2}$ and $(1 - \cos \theta)^{1/2}$ and in phase quadrature.

Now suppose a receiving antenna placed at the point $z = z_0$ on the z axis, consisting of two mutually perpendicular half-wave dipoles AA' and BB' , Fig. 2, both parallel to the xy plane, and with their axes coinciding with those of the x' and y' axes.

Assume also that dipole A is fed by a line that is Δl longer or shorter than the line supplying power to dipole B . If the sign of Δl is $+$, this antenna of Fig. 2 is right-handed elliptically polarized in the negative- z direction. If the sign is $-$, the antenna is left-handed elliptically polarized in the negative- z direction.

When the wave described by (9) reaches this antenna, voltages will be induced in dipoles A and B as a result of the x' and y' components of E , respectively. Assuming that mutual impedance effects are zero, voltages V_A and V_B induced by dipoles A and B , respectively, at the common junction are

$$\left. \begin{aligned} V_A &= k_A E_A \mathcal{E}^{-j\beta(1 \pm \Delta l)} \\ V_B &= k_B E_B \mathcal{E}^{-j\beta l} \end{aligned} \right\} \quad (11)$$

where k_A and k_B are proportionality constants, which, in general, differ from one another.

At point P , Fig. 2, the equivalent circuit is as in Fig. 4. Here, Z_A and Z_B are the impedances at point P looking into the lines leading to antennas A and B , respec-

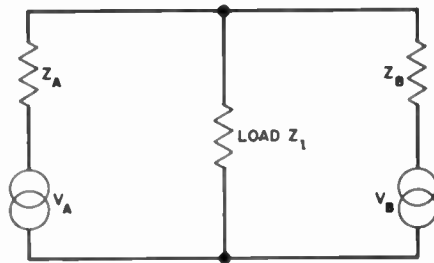

Fig. 4—Equivalent circuit at point P of Fig. 2.

tively. By Thevenin's theorem, we obtain for the voltage drop V across the load,

$$\begin{aligned} V &= \frac{(V_A Z_B + V_B Z_A)}{Z_L(Z_A + Z_B) + Z_A Z_B} Z_L \\ &= \frac{\{k_A E_A Z_B \mathcal{E}^{-j\beta(1 \pm \Delta l)} + k_B E_B Z_A \mathcal{E}^{-j\beta l}\}}{Z_L(Z_A + Z_B) + Z_A Z_B} Z_L \quad (12) \end{aligned}$$

when relations (11) are used.

One special case which covers a variety of situations is considered. Assume that both dipoles have the same input impedance and that both are matched to their respective transmission lines. Also assume that the load impedance Z_L is real. Then,

$$k_A = k_B = k,$$

$$Z_A = Z_B = R,$$

$$Z_L = R_L.$$

Equation (12) then takes the following form, after substituting for E_A and E_B from (9):

$$\begin{aligned} V &= \frac{k}{2 + R/R_L} \mathcal{E}^{j(\omega t - \beta z - \beta l)} \{ (1 + \cos \theta \sin 2\alpha)^{1/2} \\ &\quad \cdot \mathcal{E}^{j[\text{arc tan}(\sin \theta \sin \alpha / \cos \alpha + \cos \theta \sin \alpha) \mp \beta \Delta l]} \\ &\quad + (1 - \cos \theta \sin 2\alpha)^{1/2} \\ &\quad \cdot \mathcal{E}^{j[\text{arc tan}(\sin \theta \cos \alpha / -\sin \alpha + \cos \theta \cos \alpha)]} \}, \quad (13) \end{aligned}$$

and the absolute value of this complex quantity is

$$\begin{aligned} |V| &= \frac{k}{2 + R/R_L} [1 \mp \sin(\beta \Delta l) \sin \theta \\ &\quad + \cos(\beta \Delta l) \cos \theta \cos 2\alpha]^{1/2}. \quad (14) \end{aligned}$$

Further defining the ratio r_2 as equal to the maximum amplitude of the field vector divided by the minimum amplitude in our elliptically polarized plane wave, we have, from (10),

$$r_2 = \frac{(1 + \cos \theta)^{1/2}}{(1 - \cos \theta)^{1/2}}$$

whence

$$\left. \begin{aligned} \sin \theta &= \frac{2r_2}{r_2^2 + 1} \\ \cos \theta &= \frac{r_2^2 - 1}{r_2^2 + 1} \end{aligned} \right\} \quad (15)$$

Similar expressions for the quantities $\sin(\beta \Delta l)$ and $\cos(\beta \Delta l)$, which appear in (14), can be obtained. For, if the receiving antenna were made to transmit, it would radiate an elliptically polarized wave such that the phase difference between the component due to dipole AA' and that due to dipole BB' would be $\beta \Delta l$. So that, exactly as above, if r_1 is defined as equal to the ratio of maximum-to-minimum amplitudes in the elliptically polarized wave that the receiving antenna could radiate, we have

$$\left. \begin{aligned} \sin \beta \Delta l &= \frac{2r_1}{r_1^2 + 1} \\ \cos \beta \Delta l &= \frac{r_1^2 - 1}{r_1^2 + 1} \end{aligned} \right\} \quad (16)$$

Then, (14) becomes

$$V = K \left(1 \mp \frac{2r_2}{r_2^2 + 1} \frac{2r_1}{r_1^2 + 1} + \frac{r_2^2 - 1}{r_2^2 + 1} \frac{r_1^2 - 1}{r_1^2 + 1} \cos 2\alpha \right)^{1/2}, \quad (17)$$

which is (2).

Contributors to the Proceedings of the I.R.E.



EDWARD L. GINZTON

Edward L. Ginzton (S'39-A'40-SM'46) was born in Russia on December 27, 1915, and came to the United States in 1929. He received the B.S. degree in electrical engineering from the University of California in 1936, and the M.S. degree from the same institution in 1937. Continuing graduate study at Stanford University, he received the E.E. degree in 1938, and the Ph.D. degree in 1940.

From 1937 until 1939 Dr. Ginzton acted as assistant in teaching and research at Stanford University, and in 1940 he became a research associate in the physics department.

From 1940 until 1947 he was employed in the research laboratories of the Sperry Gyroscope Company, where he was successively in charge of the microwave research and klystron research and development departments. Since 1946, Dr. Ginzton has been an assistant professor of applied physics at Stanford University. He is a member of Sigma Xi, Tau Beta Pi, and Eta Kappa Nu.



WILLIAM R. HEWLETT

H. A. Hess was born on June 15, 1910, at Kirchheim-Teck, Wuerttemberg, Germany. He attended the Technische Hochschule, Stuttgart, from 1930 to 1933, and the University of Jena from 1933 to 1935. From 1936 to 1937, he was a scientific assistant at the Heinrich Hertz Institute, Berlin, and received the Dr. Phil. Nat. degree from the Friedr. Schiller University of Jena in 1937.

During the period from 1938 to 1940, he was employed in the research laboratories of the Telefunken Co., at Berlin, and was a contributor to the periodical *Funktechnische Monatshefte* from 1937 to 1940. From May to July, 1941, Dr. Hess was a technical assistant at the German Patent Office, Berlin, and after his dismissal as a government official, he was obliged to serve as a civilian employee of the Luftwaffe. He performed research works in the field of high-frequency propagation in Denmark from 1942 to 1945, together with the geophysicist, Oswald von Schmidt, now deceased.

Dr. Hess was an associate member of IRE in 1939, and a member of ARRL from 1935 to 1939. In May, 1946, the ICD of the United States Military Government in Germany gave him a recommendation as author of technical publications.



HANNS A. HESS



William R. Hewlett (S'35-A'38-SM'47-F'48) was born in 1913 at Ann Arbor, Mich. He received the A.B. degree from Stanford University in 1934, and the M.S. degree from the Massachusetts Institute of Technology in 1936. In 1939 he received the E.E. degree from Stanford University, after spending the period from 1936 to 1938 in Palo Alto, Calif., engaged in electromedical research.

In 1939 Mr. Hewlett joined David Packard in starting the Hewlett-Packard Company in Palo Alto. During the war he was on active duty with the Army, first assigned to the office of the Chief Signal Officer, and then to the New Developments Division of the War Department's Special Staff in Washington, D.C. Since 1946, he has been



JOHN H. JASBERG



associated with the Hewlett-Packard Company.

Mr. Hewlett is a member of Sigma Xi and the American Institute of Electrical Engineers. He received the IRE Fellow award "for his initiative in the development of special radio measuring techniques."



John H. Jasberg (S'42-A'45) was born on November 3, 1917, in Telluride, Colo. He received the B.S. degree in electrical engineering from the University of Idaho in 1943, and was employed by the Radio Research Laboratory at Harvard University from 1943 until 1946. Since then, he has been a graduate student at Stanford University, Calif., as well as research assistant in the Microwave Laboratory of that institution.



Salvatore Milazzo (M'47) was born in New York, N. Y., in 1917. He received the B.A. degree from Brooklyn College in 1943. He has been with the Federal Telecommunication Laboratories since 1943, engaged in development of microwave antennas.



SALVATORE MILAZZO



JERRE D. NOE

Jerre D. Noe (S'43) was born at McCloud, Calif., on February 1, 1923. He received the B.S. degree in electrical engineering from the University of California in 1943. From 1943 to 1946 he was employed as a research associate by the Radio Research Laboratory of Harvard University. During 1944 and part of 1945 he worked in England at the American British Laboratory, associated with the Radio Research Laboratory of Harvard University.

Since 1946, Mr. Noe has been a graduate student in electrical engineering at Stanford University, during which time he has been employed on a part-time basis in the development laboratory of Hewlett-Packard Company, Palo Alto, Calif. He is a member of Sigma Xi, Eta Kappa Nu, and Tau Beta Pi.



J. R. PIERCE

J. R. Pierce (S'35-A'38-SM'46-F'48) was born at Des Moines, Iowa, on March 27, 1910.

He received the B.S. degree in electrical engineering from the California Institute of Technology in 1933, and the Ph.D. degree in 1936. Since 1936 he has been a member of the technical staff of the Bell Telephone Laboratories, where he has worked on various vacuum-tube problems.

Dr. Pierce received the IRE Fellow award in 1948 for his "many contributions to

the theory and design of vacuum tubes." He is also the recipient of the Eta Kappa Nu "Outstanding Young Electrical Engineer" award for 1942, and the IRE Morris Liebman Memorial Prize for 1947. He has served on the IRE Papers Procurement Committee.



WILLIAM SICHAK

William Sichak (M'46) was born on January 7, 1916, at Lyndora, Pa. He received the B.A. degree in physics from Allegheny College in 1942. From May, 1942, to November, 1945, he was at the Radiation Laboratory, MIT, engaged in developing microwave radar antennas. Since November, 1945, he has been with the Federal Telecommunication Laboratories, Nutley, N. J., working on microwave antennas and allied subjects.



C. T. F. van der Wyck was born in Djocjakarta, Dutch East Indies, on June 7, 1903. He received a degree in electrical engineering in 1929 and the degree of technical sciences in 1946 from the Technical University of Delft. In 1929, he joined the staff of the Radio Laboratory of the Dutch Postal Telephone and Telegraph.



C. T. F. VAN DER WYCK

Correspondence

Circuit Relations in Radiating Systems and Applications to Antenna Problems*

In connection with some work on directional antenna design, the author recently had occasion to refer to a paper by P. S. Carter.¹

Several typographical errors were discovered in the body of the paper, and since no subsequent errata announcement could be found, it seemed advisable to bring them to your attention.

In the paragraph covering the mutual impedance of parallel wires in echelon, equation (17), page 1011, there is an error in the last term inside the first square bracket of the resistive component preceded by $-15 \cos mh[\dots]$. The term is given as $Cih - (h+1)$, whereas it should be $Ci - (h+1)$.

In the last term inside the second square bracket of the resistive component of the same equation, the term is given as $Ci - (h+1)$, but it should be $Si - (h+1)$.

The following paragraph, on page 1011, concerning the mutual impedance of collinear wires, has a misplaced square bracket following the second term of the resistive component in equation (18). The bracket is placed at the right of the minus sign, whereas it should be placed at the left.

The above equations are correctly given in Appendixes 3 and 4, respectively, pages 1039 and 1040.

W. A. COLE
Ground Radio Engineer
Trans-Canada Air Lines
Dorval, Quebec

* Received by the Institute, February 16, 1948.
¹ P. S. Carter, "Circuit relations in radiating systems and applications to antenna problems," Proc. I.R.E., vol. 20, pp. 1004-1041; June, 1932.

Mr. Carter's Reply*

The typographical errors in the paper "Circuit relations in radiating systems and applications to antenna problems," had, with one exception, escaped my notice. I appreciate Mr. Cole's having called attention to them. Since equations (54) and (60) in Appendixes 3 and 4 are correct, they should be used, rather than (17) and (18) on page 1011.

Equations (17) and (18) contain the typographical errors mentioned. Otherwise these equations should be identical with (54) and (60).

P. S. CARTER
RCA Laboratories
Rocky Point, L. I., N. Y.

* Received by the Institute, March 31, 1948.

Institute News and Radio Notes

Board of Directors

May 5, 1948

Recommendations of Executive Committee. The Executive Committee, at its April 6 meeting, voted to recommend to the Board of Directors "the general policy that Institute Headquarters sponsor only one National Convention a year, that convention to be held in New York City, and that Regions be encouraged to hold Regional Conventions during other times of the year."

In support of the recommended policy, Dr. Goldsmith pointed out that, so far as the membership is concerned, if the National Convention is held in New York, more members can arrange to have business activities or other duties which would justify their coming to the National Convention, in addition to the convention itself, than if the convention were held in any other city. From the standpoint of the Institute fiscal considerations, it is important to maintain the continuity of the convention in New York.

During discussion, it was suggested that a basic policy be formulated to maintain the holding of the National Convention in New York each year. Therefore, Dr. Terman moved that the Board go on record as approving the recommendation of the Executive Committee as stated above. (Unanimously approved.)

Calendar of COMING EVENTS

1948 West Coast Convention of the IRE, Los Angeles, Calif., Sept. 30-Oct. 2, 1948

Society of Motion Picture Engineers Convention, Washington, D. C., Oct. 25-29

1948 Conference on Electrical Insulation, National Research Council, Washington, D. C., Oct. 27-29

National Electronics Conference, Chicago, Ill., Nov. 4-6, 1948

American Physical Society Meeting, Chicago, Ill., Nov. 26-27

IRE-RMA Rochester Fall Meeting, Rochester, N. Y., Nov. 8-10, 1948

American Physical Society Meeting, New York City, Jan. 27-29, 1949

1949 IRE National Convention, New York City, Mar. 8-11, 1949

President Shackelford suggested that the following additional note with regard to the above action be placed in the Minutes:

Note: This action takes no position with respect to national sponsorship of Regional Conventions, which is a subject elsewhere under discussion.

Report of Policy Development Committee. Mr. S. L. Bailey, Chairman of the Policy Development Committee, reported that the first meeting of the committee was held Wednesday morning, May 5, and was for the most part an orientation meeting to familiarize the members of the committee with the details of the Institute framework. The following two subcommittees were formed:

a. *Subcommittee on Public Relations.* W. N. Tuttle was appointed Chairman of a subcommittee of the Policy Development Committee to study the aims and problems attendant upon an Institute Public Relations Program. Messrs. Van Dyke, Graham, and Laport have been appointed members of the subcommittee, and two additional members will be added.

b. *Subcommittee on Regions, Sections, and Student Branches.* A subcommittee of the Policy Development Committee was formed to study the inter-relationships and problems arising in three divisions of the membership: Regions, Sections, and Student Branches. Their most immediate problem will be to set forth the aims and requirements of the Regional Directors in addition to their normal duties as Board members.

Resolution of Board of Editors. With reference to a resolution voted by the Board of Editors at their meeting on March 24, 1948, Dr. Llewellyn moved that the resolution, as quoted below, be included in these Minutes, and that the President extend the commendation to the Editor, as requested in the resolution:

*RESOLVED:

That the Board of Editors hereby commend the Editor and the members of the Headquarters Editorial Staff for the superior work they have performed and are performing, that a copy of this resolution be sent to each officer of the Institute and to each member of the Board of Directors, and that the President be asked to extend this commendation to the Editor and the members of the Editorial staff.*

(Unanimously approved)

Sections Constitution Amendment. Dr. Llewellyn moved that the Board of Directors, in conformance with Bylaw Section 63, approve the amendment of Article 8, Section 3, of the Sections Constitution, which was unanimously approved at the Annual Sections Committee Meeting on March 22, 1948, and which is quoted below:

(Unanimously approved.)

The amended Article 8, Section 3, reads: "The start of the fiscal year of the Sections shall coincide with the start of any one of the quarters of the fiscal year of the Institute."

The original Article 8, Section 3, read: "The fiscal year of the Section shall correspond with the fiscal year of the Institute. (Calendar year)"

CINCINNATI SPRING CONFERENCE

The Cincinnati Section of the IRE presented its annual spring technical conference on television in Cincinnati, Ohio, on April 24. The moderator for the morning session was W. C. Osterbrock, and for the afternoon session, L. M. Clement, who also acted as toastmaster at the official banquet held in the Hotel Alms in the evening.

Five papers were presented: "Cathode Compensation of Video Amplifiers," by A. B. Bereskin; "Television Test Equipment for the Receiver Designer," by Jerry B. Minter; "Television Transcription by Film," by T. T. Goldsmith and Harry Millholland; "Microwave Radio Relay Facilities of the Bell System," by J. Harold Moore; and "Over-All Problems in Improving Television Quality," by Robert E. Shelby. A symposium on television tuners featured five different approaches in solving tunable input circuit design of television receivers, as presented by Sarkes Tarzian, J. A. Stewart, John Rankin, Charles T. Carroll, and M. F. Melvin.

B. E. Shackelford, President of the IRE, was the speaker at the banquet. On the morning of Sunday, April 25, an inspection trip to WLWT, the new high-power television transmitter and studios of the Crosley Broadcasting Corporation, was held.

SINGLE NOMINATIONS FOR IRE PRESIDENT AND VICE- PRESIDENT

Nominations for highest offices in the IRE are in the nature of a professional recognition of the nominee, and constitute a type of honor conferred on him.

It has been found that those nominated are willing and desirous of serving the Institute. However, they are generally much averse to a contest of personalities, somewhat in the nature of a political campaign. While they are usually indifferent to possible defeat in an electoral competition, they are nevertheless disinclined to enter into a public determination of the relative popularities of several candidates. They are convinced that election to highest offices in a learned society should be a dignified recognition of the professional standing of the nominees.

It is for these reasons that single nominations are presented for such offices. It should be added that the Constitution of the Institute provides that the membership, wherever they desire, may nominate additional candidates.

—The Editor

NOTICE

Three new IRE standards are now available:

Standards on Television: Methods of Testing Television Transmitters, \$1.00.

Standards on Antennas, Modulation Systems, and Transmitters: Definitions of terms, \$0.75.

Standards on Abbreviations, Graphical Symbols, Letter Symbols, and Mathematical Terms, \$0.75.

Orders may be sent to The Institute of Radio Engineers, Inc., 1 East 79 Street, New York 21, N. Y., enclosing remittance.

IRE-URSI
JOINT MEETING

A joint technical meeting of the American Section of the International Scientific Radio Union (URSI) and The Institute of Radio Engineers was held in Washington, D. C., from May 3 through May 5. The registered attendance at this meeting was 565.

The meeting was made up of eight sessions, at which 57 papers covering a large variety of the more fundamental and scientific aspects of radio were presented. Monday morning L. V. Berkner headed a group on Ionospheric Propagation, and in the afternoon of the same day Martin Katzin was chairman of the meeting on Tropospheric Propagation and Radio Noise. On the evening of May 3, A. C. Omberg led the session on Microwave Systems, which was continued in the evening, since a few papers required a longer presentation. The following morning, L. C. Van Atta headed a group on Antennas, followed by Microwave Techniques under Harold Lyons in the afternoon. On Wednesday, May 5, H. H. Beverage was the chairman of the morning group on Theory of Systems, and Harry Diamond was the chairman of the afternoon group on Circuits.

Abstracts of the papers presented have been prepared in pamphlet form. A few copies of this booklet are still available, and may be obtained from Newbern Smith, National Bureau of Standards, Central Radio Propagation Laboratory, Washington, D. C.

The International Scientific Radio Union itself is one of several world scientific unions organized in 1919 under a parent organization now called the International Council of Scientific Unions. Commonly designated as the URSI, from its French name, *Union Radio Scientifique Internationale*, the group's aims are threefold: to promote the scientific study of radio communication; to aid and organize radio research requiring co-operation on an international scale and to encourage the discussion and publication of the results; and to facilitate agreement upon common methods of measurement and the standardization of measuring instruments. In itself, URSI is an organizational framework designed to assist in promoting these

objectives, with the actual technical work done for the most part by the sections in the various countries. Its headquarters in Belgium, the Union is financed by small contributions from the governments of the member countries, but its work is necessarily carried on to a great extent through voluntary services.

CANADIAN IRE
CONVENTION

Nearly 650 persons, hailing from all parts of Canada, the United States, and England, attended the Canadian IRE Convention held in the Roof Garden of the Royal York Hotel, Toronto, on April 30 and May 1. The first technical session was held shortly after the convention's official opening on the morning of the thirtieth, and the following papers were presented: "A Direct-Reading Phase Monitor," by D. F. Wright; "FM Field-Intensity Measurement," by J. E. Hayes; and "Narrow-Beam Radar Recording Altimeter," by B. J. McCaffrey. The second technical session, held the afternoon of the same day, featured "Industrial Electronics," by J. T. Thwaites; "25-Cycle Operation of Television Receivers," by Orrin Dakin; and "Theater Television in England," by H. Goldin.

On the evening of April 30 the official banquet took place, at which R. A. Hackbush presided, while Benjamin E. Shackelford, President of the Institute, was the guest speaker. On Saturday morning the third technical session opened, and the following papers were offered: "Frequency Allocations," by G. C. W. Browne; "The Reproduction of Sound," by E. O. Swan; and "New Measuring Equipment in the Radio Industry," by B. DeF. Bayly.

The final technical session was held the afternoon of May 1. John F. Hinds presented "Some Quality Control Problems in the Manufacture of Miniature Tubes"; and George Sinclair offered "Directional Antennas for FM."

"Know the Canadian Radio Industry" was the official slogan of the convention, and 31 exhibitors arranged displays which showed the numerous products. The plaque awarded for the most educational exhibit was won by the Canadian Signals Research and Development Establishment of the Canadian Army, which had an exceptionally fine display of military equipment and systems. A center of attraction was a weather-proof radio in operating condition, completely submerged in a glass aquarium with fish swimming around it.

NAB CONFERENCE
DRAWS 352

A total of 352 broadcast engineers attended the engineering conference portion of the twenty-sixth Annual National Association of Broadcasters Convention in Los Angeles from May 20 through May 22. The major meetings were given over to panel discussions of subjects of primary interest to engineers, and to technical papers prepared by the nation's leading broadcast engineers.

Television was the subject under discussion at the first morning session, on

Thursday, May 20, J. R. Poppele presiding. Chief of the problems studied were the elimination of costly equipment breakdowns by the erection of adequate lighting ground on mountain-top locations, and the introduction of equipment facilitating "interconnection of metropolitan and community stations and point-to-point applications." Speakers were James D. McLean, John L. Seibert, J. A. Waldschmitt, Raymond F. Guy, M. A. Trainer, F. E. Carlson, and Richard Blount. In the afternoon session on the same day, representatives of radio's four major networks—ABC, CBS, MBS, and NBC—outlined their plans for the future. Frank Marx, William B. Lodge, Robert Clark, Ernst H. Schrieber, Edward Edison, R. H. Ranger, H. W. Pangborn, and W. C. Eddy spoke.

At the Friday morning session, Everett Dillard presented a paper on the economics of coverage in FM broadcasting. A studio-to-transmitter relay radio system was described by W. G. Broughton, while David Packard offered a paper on measuring equipment and techniques for FM and AM broadcast transmitters. Factors affecting the performance of directional antenna systems were outlined by A. Earl Cullum, and Robert A. Fox spoke on a newly developed system for measuring co-channel interference. At the luncheon session, a newly perfected method of reproducing stereophonic sound was demonstrated by Haldon A. Leedy.

The FCC-Industry round table discussion on Friday brought the statement from George E. Sterling, FCC Commissioner, that the Commission is tightening up on people who have FM licenses but who have not yet gone on the air, thus, according to industry complainants, letting those already on the air bear the brunt of the promotional and development costs of the new broadcast medium. Other FCC representatives on the round table were John A. Willoughby, Cyril M. Braum, J. A. Barr, and Hart S. Cowperthwait. Those representing industry were Neal McNaughten, Orrin W. Towner, Frank Marx, and E. M. Johnson.

On Friday evening the engineers toured the new Mutual-Don Lee studios and Warner Brothers' studios, where a large-screen television demonstration was given. Tours of the Mount Wilson FM and television installations and visits to the observatory on Saturday were the culminating features of the engineering conference.

RCA INDEX AVAILABLE

It has been announced that the RCA Technical Papers Index, Volume II (b) 1947 is available, without charge, upon request to the RCA Review at the RCA Laboratories Division in Princeton, N. J. This booklet contains a chronological index, an alphabetical index, an index by authors, and a classified subject index, as well as an errata sheet for Volumes I and II (a) of prior Indexes covering the periods 1919 to 1945, and 1946, respectively.

ELECTRONIC COMPUTER GROUP

The Technical Committee on Electronic Computers is interested in forming a Professional Group on Electronic Computers, which would elect its own officers, form its own committees, and hold special conferences. In addition, it would be expected to take charge of one or more programs at national and regional conventions, and would also provide a means for insuring proper coverage of the computer field in the publications of the Institute. Limited distribution of papers of special interest would be organized by the Group, and special honors could be developed for its membership. Before proceeding further with the plan, however, the Technical Committee would like to know just how many IRE members would be interested in joining such a group. All interested members are, therefore, asked to communicate with J. R. Weiner, Eckert-Mauchly Computer Corporation, Broad and Spring Garden Streets, Philadelphia 23, Pa.

NEW ENGLAND MEETING

The second annual New England Radio Engineering Meeting was held this May under the auspices of the North Atlantic Region of the IRE at the Hotel Continental in Cambridge, Mass. Registered attendance for the one-day meeting was nearly 600.

Six technical papers, 30 manufacturers' exhibits, a luncheon, and a banquet were featured. Paul K. McElroy was the banquet toastmaster, and the banquet speaker was Jerrold R. Zacharias. Among the special events were four trips to points of current electronic interest, a demonstration of ultrahigh-speed motion-picture technique, and a demonstration of a television studio monitor loop. Details of the program will be found on page 635 of the May, 1948, issue of the PROCEEDINGS OF THE I.R.E.

UNIVERSITY OF MICHIGAN STUDENT BRANCH FIELD TRIP

The Joint IRE-AIEE Student Branch of the University of Michigan, in conjunction with Eta Kappa Nu, sponsored a field trip during the spring vacation, April 2 to April 11. The group chartered a bus and visited the following places: Jones & Laughlin Steel Mills, and Radio Station KDKA, Pittsburgh, Pa.; RCA Laboratories, Princeton, N. J.; Bell Telephone Laboratories, Murray Hill, N. J., and New York, N.Y.; Westinghouse Lamp Division, Bloomfield, N. J.; General Electric Co., Schenectady, N. Y.; Eastman Kodak Co., Rochester, N. Y.; and Niagara Falls Power Co., Niagara Falls, N. Y. Plans have been made to sponsor a similar trip next year.

NEW TABLE OF COEFFICIENTS

A 20-page "Table of Coefficients for Obtaining the First Derivative without Differencing (NBS Applied Mathematics Series 2)" has been prepared by the National Bureau of Standards, and may be obtained

from the Superintendent of Documents, U. S. Government Printing Office, Washington 25, D. C., for 15 cents.

This Table, permitting the calculation of the derivative at a point within a tabular interval by a single machine operation, will be of value in many fields of applied mathematical computation, where it is desirable to find the derivative of a function that is tabulated at uniform intervals. It will be particularly useful in the location of maxima and minima, in thermodynamic calculations where many functions are found as derivatives of other known functions, and in ballistic computations for slopes of trajectories.

Industrial Engineering Notes¹

ELECTRICAL SAFETY CODE

A revised edition of the "National Electrical Safety Code," published by the Bureau of Standards, may now be obtained from the Superintendent of Documents, U. S. Government Printing Office, Washington 25, D. C., for \$1.25. Contents of the 408-page book include installation and maintenance rules for electric supply stations, electric supply and communication lines, and electric utilization equipment; safety rules for operation of electric equipment and lines; rules for radio installations; and an index to all five parts.

TWO NEW BRITISH REPORTS

The Telecommunication Research Committee, formed by the British Department of Scientific and Industrial Research "to determine the basic research problems in telecommunications," has published its findings in a report divided into nine topics: wave propagation, line propagation, valve fundamentals, properties of materials, contact phenomena, circuitry, luminescence, photoemission, and television appraisal. Copies may be obtained from the Department of Scientific and Industrial Research at 1s. 6d. each.

A new series of comprehensive reports on German technology, including one on telecommunications and equipment, is being made available to American businessmen. Detailed information on the 50 planned reports may be obtained from the sales section of the British Information Services, 30 Rockefeller Plaza, New York 20, N. Y.

SIGNAL CORPS EQUIPMENT MINIATURIZATION

Efforts of the Signal Corps to miniaturize its signal equipment to fit the task of communications into an Army geared for speed and mobility were described by Col.

¹ The data on which these NOTES are based were selected, by permission, from "Industry Reports," issues of May 14 and 21, and June 4 and 11, published by the Radio Manufacturers' Association, whose helpful attitude in this matter is hereby gladly acknowledged.

E. R. Petzing, Chief of the Engineering and Technical Division of the Signal Corps.

The Signal Corps has already succeeded in reducing a radar set, once requiring five two-and-one-half ton trucks to transport, to the size of a standard office desk, thus making it easily transportable in a single truck; and has also produced midget storage batteries weighing only five and one-half ounces, but able to produce enough electrical energy when used, four to a pack, to operate a transmitter up to 100,000 feet above the earth's surface; a complete telephone switchboard weighing only two and one-half pounds, in place of the Army's standard 60-pound instrument; and radio tubes a fraction of an inch in length.

ELECTRON-OPTICAL DEVELOPMENT

Electron-microscope experiments conducted by the National Bureau of Standards have developed a valuable tool for the quantitative study of electrostatic or magnetic fields that are not susceptible to any other type of investigation. Extension of the principle provides a powerful means of broadening present knowledge concerning space-charge fields, fields produced by contact potentials, waveguide problems, and the microstructure of metals. A detailed report may be obtained for ten cents from the Superintendent of Documents, U. S. Government Printing Office, Washington 25, D. C.

RECENT FCC RULINGS

The FCC has issued an order (Mimeograph No. 20770) liberalizing its rules to permit the use of a common antenna by two or more stations, provided that "one of the licensees accepts responsibility for maintaining, painting, and illuminating the structure." Previously, the use of a common antenna by stations not licensed to the same licensee had been prohibited . . . The FCC order (Public Notice 22087) concerning the use of recording devices in connection with telephone service has been modified. The order still requires that the related automatic tone-warning device be furnished, installed, and maintained by the organization responsible for furnishing the telephone service, but permits a greater variance in the frequency of recurrence of each signal produced by the warning device: once during every 12 to 18 seconds instead of once during every 12 to 15 seconds . . . The FCC has also amended its rules and regulations governing the ship service with respect to qualifications of ship radio operators. Under this order (Mimeograph No. 218425), the provisions requiring a radar operator to hold a radio license are waived, provided the unlicensed operator does not make any adjustments on the radar equipment . . . Copies of Public Notice 22087 and Mimeograph No. 21845 may be obtained from the Secretary of the FCC, Washington, D. C. . . The rules and regulations governing the amateur services have been modified, clarifying the types of radio communications which are prohibited, and adding a new section which defines certain types of one-way communication which may be transmitted.

LOUDSPEAKER REGULATION HELD UNCONSTITUTIONAL

The U. S. Supreme Court ruled unconstitutional an ordinance of Lockport, N. Y., which forbids the use of sound-amplification devices, except with permission of the chief of police. In an opinion written by Justice Douglas, the highest court held that the ordinance "is unconstitutional on its face, for it establishes a previous restraint on the right of free speech in violation of the First Amendment."

"Loudspeakers are today indispensable instruments of effective public speech," he said. "The sound truck has become an accepted method of political campaigning." To allow the police to "bar the use of loudspeakers because their use can be abused is like barring radio receivers because they, too, make a noise."

MILITARY GUIDE FOR INDUSTRY ISSUED

The Munitions Board has issued a 46-page booklet entitled "Military Procurement, a Guide for Joint Industry-Military Procurement Planning," which may be obtained from the Superintendent of Documents, U. S. Government Printing Office, Washington 25, D. C., for 25 cents. Designed to help management plan for mobilization in the event of war, the guide includes a detailed list of purchasing offices of the Army, Air Force, and Navy, and the items each office purchases. Other chapters in the booklet are: "Meaning of Industrial Mobilization," "A Checklist for Mobilization of Industry," "Military Plans for Supply Sources," "Materials and Components Essential in War," and "Who Plans for Emergency Procurement in the Armed Services."

LATEST TELEVISION DEVELOPMENTS

NBC was granted a construction permit for a new experimental television broadcast station to test the feasibility of television broadcasting in the high bands. The new station will be located at Washington, and will be operated on 504-410 Mc with 5000 watts power.

Regular television stations now on the air have increased to 27, with 101 construction permits outstanding, and 269 applications still pending. Construction permits for new television stations have been applied for in the following states: *Ariz.*, Phoenix; *Calif.*, Los Angeles; *Iowa*, Davenport; *Ill.*, Rock Island; *Neb.*, Omaha; *Mass.*, Boston (WBZ-TV); *N. Y.*, Buffalo (WBON); *N. C.*, Greensboro; *Okla.*, Oklahoma City, Tulsa; *Tex.*, San Antonio; *Utah*, Salt Lake City (KDYL-TV); and *Wash.*, Seattle.

COMMERCIAL FACSIMILE APPROVED ON FM BAND

The FCC has announced rules and regulations which will enable FM broadcast stations also to render commercial facsimile service, because practically all present facsimile development, operation, and interest is in the FM band. Since the war, facsimile equipment and techniques have improved,

and facsimile interests have agreed on recommended standards for regular service. Limited quantities of facsimile transmitting and receiving equipment now are in production, and more will be available as the service develops. At the present time 11 stations are authorized to engage in experimental facsimile broadcasting. Facsimile has also been employed to some extent by common carriers, such as the telegraph, and by police, aeronautical, and other specialized services. Facsimile may be authorized for such services, provided that the emissions are confined to the band assigned to the particular service.

Simplex facsimile transmissions, because they interrupt the aural programs during facsimile transmission on the same channel, will be limited to one hour between seven A.M. and midnight, with no limit for the hours between midnight and seven A.M. Multiplex facsimile, on the other hand, may be transmitted for a maximum of three hours between seven A.M. and midnight, as well as any time between midnight and seven A.M.

Purchasers of different types of facsimile receivers should be able to receive programs from all stations transmitting "fax" within broadcast range. Consequently, a single standard is authorized, providing a recording width of 8.2 inches for the usual number of scanning lines per inch (105), but other paper widths may be employed where desired, with appropriate numbers of lines per inch under the one set of standards.

Copies of this order (Mimeograph No. 21960) may be obtained from the Secretary of the FCC, Washington 25, D. C.

552 FM STATIONS ON AIR

A total of 552 FM stations and 21 non-commercial educational FM outlets are now in operation. A number of FM stations have recently begun broadcasting in the following states: *Ala.*, Birmingham (WJLD-FM); *Calif.*, Los Angeles (KMGM), Monterey (KDON-FM), San Jose (KRPO); *Conn.*, New Haven (WNHC-FM and WEMI); *D. C.*, Washington (WMAL-FM); *Fla.*, Fort Lauderdale (WGOR), Tampa (WFLA); *Ga.*, Columbus (WDAK-FM); *Ill.*, Carbondale (WCIL-FM), Chicago (WOAK), Quincy (WQDI); *Iowa*, Des Moines (KSO-FM and (KRNF-FM); *Ky.*, Queensboro (WVJS); *La.*, Baton Rouge (WAFB-FM); *Mass.*, Greenfield (WHA1-FM), Springfield (WSFL); *Mich.*, Detroit (WJAR-FM); *Mo.*, Poplar Bluff (KWOC-FM); *N. Y.*, Albany (WROW-FM); *N. C.*, Charlotte (WSOC-FM); *Ore.*, Portland (KPOJ); *Pa.*, Altoona (WFBG-FM); Johnstown (WJKT, WARD-FM), Pittsburgh (WCAE-FM); *S. C.*, Greenville (WFBC-FM), Greenwood (WCRS-FM); *Tex.*, San Antonio (KONO-FM), Wichita Falls (KWFT-FM); *Va.*, Roanoke (WJJB-FM); and *Wis.*, Oshkosh (WOSH-FM).

VHF RECEIVER FOR PRIVATE FLIERS

Low-cost vhf radio navigation receivers for private pilots will be available by the end of this year under a "competitive-bid development contract" announced by the CAA

this week. The receivers will allow private fliers to navigate visually, using indications from the new CAA-developed omnidirectional radio ranges soon to become standard airway equipment throughout the U. S. The sets also will receive vhf communications from the ground, and will receive the localizer indications of the CAA instrument landing systems.

A contract was signed between CAA and the National Aeronautical Corporation of Ambler, Pa., for development of the sets at a complete cost to private fliers of less than \$500, or about one-fourth the price of any previously available omnirange receiver.

1947-'48 TELEVISION SET DISTRIBUTION

A total of 162,181 television receivers were shipped to 21 states and the District of Columbia during 1947, an RMA survey revealed in the first authoritative industry report on the distribution of television sets among television broadcasting areas. About half of the sets were shipped to the New York-Newark area.

During the first quarter of 1948, the shipments of 106,136 receivers brought the total distribution since January 1, 1947, to 268,317. The District of Columbia and 27 states have now received various numbers of television sets, although some shipments have been only a handful in areas where there is no regular broadcasting service.

AMPLIFIER DIVISION PLANS NEW STATISTICAL SERVICE

Plans for a new RMA industry statistics service, embracing several types of amplifying and sound equipment, were recently approved by members of the RMA Amplifier and Sound Equipment Division. Chairman Fred D. Wilson said that arrangements will be made through RMA headquarters for the quarterly collection of reports on the dollar volume sales to jobbers on amplifiers, intercommunication equipment, microphones, loudspeakers, and recorders.

Amplifier sales will be broken down into the following classes: under \$25, \$25 to \$50, \$50 to \$100, and over \$100. Intercommunication equipment will be classified as master, substation, and cable; loudspeakers will be grouped under those used in public address systems and those used for replacements in radios; and recording equipment will be divided into disk, tape, and wire types.

NEW STANDARDS APPROVED ON RADIO COMPONENTS

Director W. R. G. Baker of the RMA engineering department has announced that eight engineering standards proposals, most of which concern radio components, have been approved by the general standards committee and are now recommended RMA standards. They are: Molded Mica Capacitors; Battery Socket Patterns; Pin Alignment Gauges GB11-1 and GB14-1; Audio Facilities for Radio Broadcast Systems; Electric Performance Standards for Television Relay Facilities; Color Codes, Numerical Values, and Preferred Values; Fixed Wire-Wound Resistors; and Fixed Composition Resistors.

Sections

Chairman		Secretary	Chairman		Secretary
W. A. Edson Georgia School of Tech. Atlanta, Ga.	ATLANTA	M. S. Alexander 2289 Memorial Dr., S.E. Atlanta, Ga.	O. W. Towner Radio Station WHAS Third & Liberty Louisville, Ky.	LOUISVILLE	D. C. Summerford Radio Station WHAS Third & Liberty Louisville, Ky.
	BALTIMORE	J. G. Hammond 13 Beaumont Ave. Baltimore 28, Md.	E. T. Sherwood Globe-Union Inc. Milwaukee 1, Wis.	MILWAUKEE	J. J. Kircher 2450 S. 35th St. Milwaukee 7, Wis.
John Petkovsek 565 Walnut Beaumont, Texas	BEAUMONT— PORT ARTHUR	C. E. Laughlin 1292 Liberty Beaumont, Texas	K. R. Patrick RCA Victor Div. 1001 Lenoir St. Montreal, Canada	MONTREAL, QUEBEC	S. F. Knights Canadian Marconi Co. P.O. Box 1690 Montreal, P. Q., Canada
R. W. Hickman Cruft Laboratory Harvard University Cambridge, Mass.	BOSTON	A. F. Coleman Mass. Inst. of Technology 77 Massachusetts Ave. Cambridge, Mass.	L. A. Hopkins, Jr. 629 Permanent Quarters Sandia Base Branch Albuquerque, N. M.	NEW MEXICO	T. S. Church 637 La Vega Rd. Albuquerque, N. M.
G. E. Van Spankeren San Martin 379 Buenos Aires, Arg.	BUENOS AIRES	A. C. Cambre San Martin 379 Buenos Aires, Arg.	J. W. McRae Bell Telephone Labs. 463 West Street New York 4, N. Y.	NEW YORK	R. D. Chipp 99 Morse Ave. Bloomfield, N. J.
J. F. Meyers 249 Linwood Ave. Buffalo 9, N. Y.	BUFFALO-NIAGARA	R. F. Blinzler 558 Crescent Ave. Buffalo 14, N. Y.	C. G. Brennecke Dept. of Electrical Eng. North Carolina State Col- lege Raleigh, N. C.	NORTH CAROLINA- VIRGINIA	C. M. Smith Radio Station WMIT Winston-Salem, N. C.
G. P. Hixenbaugh Radio Station WMT Cedar Rapids, Iowa	CEDAR RAPIDS	W. W. Farley Collins Radio Co. Cedar Rapids, Iowa	W. L. Haney 117 Bourque St. Hull, P. Q.	OTTAWA, ONTARIO	G. A. Davis 78 Holland Ave. Ottawa, Canada
K. W. Jarvis 6058 W. Fullerton Ave. Chicago 39, Ill.	CHICAGO	Kipling Adams General Radio Co. 920 S. Michigan Ave. Chicago 5, Ill.	P. M. Craig 342 Hewitt Rd. Wyncote, Pa.	PHILADELPHIA	J. T. Brothers Philco Radio and Tele- vision Tioga and C Sts. Philadelphia 34, Pa.
C. K. Gieringer 3016 Lischer Ave. Cincinnati, Ohio	CINCINNATI	F. W. King RR 9 Box 263 College Hill Cincinnati 24, Ohio	E. M. Williams Electrical Engineering Dept. Carnegie Institute of Tech. Pittsburgh 13, Pa.	PITTSBURGH	E. W. Marlowe 560 S. Trenton Ave. Wilkinburgh PO Pittsburgh 21, Pa.
F. B. Schramm 1764 Wickford Rd. Cleveland 12, Ohio	CLEVELAND	J. B. Epperson Scripps-Howard Radio Inc. 306 Prospect St. Berea, Ohio	O. A. Steele 1506 S.W. Montgomery St. Portland 1, Ore.	PORTLAND	F. E. Miller 3122 S.E. 73 Ave. Portland 6, Ore.
C. J. Emmons 158 E. Como Ave. Columbus 2, Ohio	COLUMBUS September 10	L. B. Lamp 846 Berkeley Rd. Columbus 5, Ohio	A. V. Bedford RCA Laboratories Princeton, N. J.	PRINCETON	L. J. Giacoletto 9 Villa Pl. Eatontown, N. J.
L. A. Reilly 989 Roosevelt Ave. Springfield, Mass.	CONNECTICUT VALLEY	H. L. Krauss Dunham Laboratory Yale University New Haven, Conn.	K. J. Gardiner 111 East Ave. Rochester 4, N. Y.	ROCHESTER	Gerrard Mountjoy Stromberg-Carlson Co. 100 Carlton Rd. Rochester, N. Y.
J. G. Rountree 4333 South Western Blvd. Dallas 5, Texas	DALLAS-Ft. WORTH	J. H. Homsy Box 5238 Dallas, Texas	E. S. Naschke 1073-57 St. Sacramento 16, Calif.	SACRAMENTO	W. F. Koch California Div. of Forestry Sacramento 14, Calif.
George Rappaport 132 East Court Harshman Homes Dayton 3, Ohio	DAYTON	C. J. Marshall 1 Twain Place Dayton 10, Ohio	G. M. Cummings 7200 Delta Ave. Richmond Height 17, Mo.	ST. LOUIS	C. E. Harrison 4530A W. Papin St. St. Louis, Mo.
C. F. Quentin Radio Station KRNT Des Moines 4, Iowa	DES MOINES- AMES	F. E. Bartlett Radio Station KSO Old Colony Bldg. Des Moines 9, Iowa	C. L. Jeffers Radio Station WOAI 514 W. Lynwood San Antonio, Texas	SAN ANTONIO	H. G. Campbell 233 Lotus Ave. San Antonio 3, Texas
A. Friedenthal 5396 Oregon Detroit 4, Mich.	DETROIT	N. C. Fisk 3005 W. Chicago Ave. Detroit 6, Mich.	C. N. Tirrell U. S. Navy Electronics Lab. San Diego 52, Calif.	SAN DIEGO September 7	S. H. Sessions U. S. Navy Electronics Lab. San Diego 52, Calif.
E. F. Kahl Sylvania Electric Prod- ucts Emporium, Pa.	EMPORIUM	R. W. Slinkman Sylvania Electric Prod- ucts Emporium, Pa.	L. E. Reukema Elec. Eng. Department University of California Berkeley, Calif.	SAN FRANCISCO	W. R. Hewlett 395 Page Mill Rd. Palo Alto, Calif.
W. H. Carter 1309 Marshall Ave. Houston 6, Texas	HOUSTON	J. C. Robinson 1422 San Jacinto St. Houston 2, Texas	W. R. Hill University of Washington Seattle 5, Wash.	SEATTLE September 9	W. R. Triplett 3840—44 Ave. S.W. Seattle 6, Wash.
R. E. McCormick 3466 Carrollton Ave. Indianapolis, Ind.	INDIANAPOLIS	Eugene Pulliam 931 N. Parker Ave. Indianapolis, Ind.	F. M. Deerhake 600 Oakwood St. Fayetteville, N. Y.	SYRACUSE	S. E. Clements Dept. of Electrical Eng. Syracuse University Syracuse 10, N. Y.
Karl Troegen KCMO Broadcasting Co. Kansas City 6, Mo.	KANSAS CITY	Mrs. G. L. Curtis 6005 El Monte Mission, Kan.	W. M. Stringfellow Radio Station WSPD 136 Huron St. Toledo 4, Ohio	TOLEDO	M. W. Keck 2231 Oak Grove Pla. Toledo 12, Ohio
R. W. Wilton 71 Carling St. London, Ont., Canada	LONDON, ONTARIO	G. H. Hadden 35 Becher St. London, Ont., Canada			
Walter Kenworth 1427 Lafayette St. San Gabriel, Calif.	LOS ANGELES July 20	R. A. Monfort L. A. Times 202 W. First St. Los Angeles 12, Calif.			

Sections

Chairman		Secretary		Chairman		Secretary	
C. A. Norris J. R. Longstaffe Ltd. 11 King St., W. Toronto, Ont., Canada	TORONTO, ONTARIO	C. G. Lloyd 212 King St., W. Toronto, Ont., Canada		G. P. Adair 1833 "M" St. N.W. Washington, D. C.	WASHINGTON	H. W. Wells Dept. of Terrestrial Magnetism Carnegie Inst. of Washington Washington, D. C.	
O. H. Schuck 4711 Dupont Ave. S. Minneapolis 9, Minn.	TWIN CITIES	B. E. Montgomery Engineering Department Northwest Airlines Saint Paul, Minn.		J. C. Starks Box 307 Sunbury, Pa.	WILLIAMSPORT	R. G. Petts Sylvania Electric Products, Inc. 1004 Cherry St. Montoursville, Pa.	

SUBSECTIONS

Chairman		Secretary		Chairman		Secretary	
P. C. Smith 179 Ido Avenue Akron, Ohio	AKRON (Cleveland Sub-section)	J. S. Hill 51 W. State St. Akron, Ohio		L. E. Hunt Bell Telephone Labs. Deal, N. J.	MONMOUTH (New York Subsection)	G. E. Reynolds, Jr. Electronics Associates, Inc. Long Branch, N. J.	
S. C. Ferguson Farnsworth Television & Radio Co. 3700 E. Pontiac St. Fort Wayne, Ind.	FORT WAYNE (Chicago Subsection)	S. J. Harris Farnsworth Television and Radio Co. 3702 E. Pontiac Fort Wayne 1, Ind.		J. B. Minter Box 1 Boonton, N. J.	NORTHERN N. J. (New York Subsection)	A. W. Parkes, Jr. 47 Cobb Rd. Mountain Lakes, N. J.	
F. A. O. Banks 81 Troy St. Kitchener, Ont., Canada	HAMILTON (Toronto Sub-section)	E. Ruse 195 Ferguson Ave., S. Hamilton, Ont., Canada		A. R. Kahn Electro-Voice, Inc. Buchanan, Mich.	SOUTH BEND (Chicago Subsection) June 17	A. M. Wiggins Electro-Voice, Inc. Buchanan, Mich.	
A. M. Glover RCA Victor Div. Lancaster, Pa.	LANCASTER (Philadelphia Subsection)	C. E. Burnett RCA Victor Div. Lancaster, Pa.		R. M. Wainwright Elec. Eng. Department University of Illinois Urbana, Illinois	URBANA (Chicago Subsection)	M. H. Crothers Elec. Eng. Department University of Illinois Urbana, Illinois	
H. A. Wheeler Wheeler Laboratories 259-09 Northern Blvd. Great Neck, L. I., N. Y.	LONG ISLAND (New York Subsection)	M. Lebenbaum† Airborne Inst. Lab. 160 Old Country Rd. Box 111 Mineola, L. I., N. Y.		W. A. Cole 323 Broadway Ave. Winnipeg, Manit., Canada	WINNIPEG (Toronto Subsection)	C. E. Trembley Canadian Marconi Co. Main Street Winnipeg, Manit., Canada	

Books

Russian-English Technical and Chemical Dictionary, by Ludmilla Ignatiev Callaham.

Published (1947) by John Wiley and Sons, Inc., 440 Fourth Ave., New York 16, N. Y. 794 pages, xvii pages. 5½ × 8 inches. \$10.00.

The evaluation of a technical dictionary from the radio engineer's viewpoint suggests comparison with A. S. Litvinenko's 1937 classic "Dictionary of Radio Terminology in the English, German, French, and Russian Languages." The rapidly advancing radio art has created a need for bringing that work up to date, particularly in the high-frequency field. Any new dictionary professing to cover the radio field is likely to be judged on the basis of the extent to which it fills this need.

A very great number of technical words in Russian are exact or nearly exact phonetic equivalents of the English counterpart of an almost universal scientific vocabulary. In the case at hand, perhaps something like half of the words having uniquely technical significance in mathematics and radio fall within this category. As such, they form a very good exercise in learning the sounds of the 32 letters in the Russian alphabet. This, plus familiarization with the common Russian word endings conveniently listed in the introduction, puts a sizable technical vocabulary within easy grasp.

As to originally nontechnical words which have acquired a uniquely technical usage, again limiting our observations to mathematics and radio, we find the technical trans-

lation is sometimes omitted, leaving the translator to guess the technical terminology from the context and the nontechnical equivalents. A proper English mathematical usage, for example, of "sluchainost" (случайность) is "contingency," but only "chance, accident, emergency" are given. The Russian equivalent of "transconductance," "krutizna" (крутизна) is translated in the dictionary only as "steepness, sharpness."

This work, however, can not be judged fairly on the basis of its coverage of mathematics and radio. It was originally intended, according to the author's preface, as "a convenient reference for chemists and chemical engineers." As this remained its main purpose, "inorganic and organic chemistry, chemical technology, and chemical engineering are naturally given the most complete coverage," while the coverage of certain other fields, including radio technology and mathematics, is restricted to "the more frequently used terms." It does not, therefore, meet the need for modernizing the Russian section of Litvinenko.

On the other hand, after a year of proving in as a chemical dictionary, the work stands out as superb. The completeness of coverage and the technical accuracy of translation in this field leave nothing to be desired. It not only has filled a real need, but it has set a standard of perfection to challenge future attempts in other fields.

The reviewers are pleased to acknowledge the helpful suggestions of Mrs. Jeanne

Schwartz and Miss Antoinette Pingell, both of the Naval Research Laboratory.

ROBERT M. PAGE AND D. C. HARKIN
United States Naval Research Laboratory
Washington 20, D. C.

Elementary Manual of Radio Propagation, by Donald H. Menzel.

Published (1948) by Prentice-Hall, Inc. 70 Fifth Ave., New York, N. Y. 220 pages, 2-page index, xii pages. 164 figures. 9½ × 11½. \$7.65.

The manual presents graphic methods that enable rapid calculation of field strength for various conditions of distance, time, frequency, geographic locations, and topography. It includes sections on the determination of maximum usable frequencies, the absorption problem and radio noise, calculation of lowest useful high frequencies, variability of the sun, ionospheric variations, groundwave transmission, and sections pertaining to very-high-frequency propagation for which effects of atmospheric refraction, diffraction, and local reflections are important considerations. The treatment of the frequency range from 3 to 30 Mc is particularly comprehensive, and includes the evaluation of absorption in the auroral zones. This book should be of particular value to those concerned with the choice of frequencies and evaluation of power requirements for various radio communications services.

HAROLD O. PETERSON
RCA Laboratories
Riverhead, N. Y.

Radar Beacons, edited by Arthur Roberts.

Published (1947) by McGraw-Hill Book Co., 330 W. 42 St., New York 18, N. Y. 474 pages. 9-page index, 2-page list of symbols, 3-page glossary, xx pages. 245 figures. 6½ × 9½ inches. \$6.00.

This volume is number three of the series of books reviewing the work done at the Massachusetts Institute of Technology's Radiation Laboratory during the war. In addition, the theory and practice underlying the use of radar beacons is thoroughly covered. Now that beacons are being used as an accurate aid to surveying and map making, as in the Shoran equipment; and now that they have become an integral part of the present air navigation system, as in DME, and of the airborne equipment of the target air navigation system covered by the SC31 report of the RTCA, a knowledge of their operation has become very important to many radio engineers. This book is undoubtedly the best reference now in existence for gaining such information.

Approximately one-quarter of the book is devoted to a discussion of basic considerations, such as the uses of beacons; and items governing general performance, such as maximum range, propagation effects, and the effect of frequency and coding. Two-thirds of the book deal with details of design of both the beacon and interrogator, and the remainder covers the operation of beacons in the field.

Although a good job of editing has been done, the continuity of the book suffers from the fact that more than a dozen authors have contributed to the preparation of the manuscript. The subject matter in general, however, is treated with reasonable fullness and clarity, and the book should be simple reading for any engineer with a good knowledge of the fundamentals of communication engineering.

IRVING WOLFF
RCA Laboratories
Princeton, N. J.

Crystal Rectifiers, by Henry C. Torrey and Charles A. Whitmer.

Published (1948) by the McGraw-Hill Book Co., 330 W. 42 St., New York 18, N. Y. 432 pages, 218 figures. 9½ × 6½ inches. \$6.00.

This book, Volume 15 of the Massachusetts Institute of Technology's Radiation Laboratory series, is a scholarly and comprehensive account of the work done during the war in the development of silicon and germanium point-contact rectifiers. The account is particularly interesting, since it covers a period in the development of these devices when they advanced from a very obscure state to one of virtual indispensability in the development of the microwave art.

The volume has three main divisions. Part I, headed "General Properties," discusses semiconductors and the semiconductor-to-metal contact in terms of the energy band theory. The treatment is based on the modern solid-state theory of electron conduction. Part II, which occupies more than half the book, is headed "The Crystal Converter," and gives extensive mathematical treatment of the general problem of frequency conversion by a nonlinear impedance. Expressions are derived for the conversion loss, and the terminal impedances of the converter and their dependence on the image-frequency impedance are shown. The

cases in which full and "weak" reciprocity hold are discussed. A chapter is devoted to noise in crystal rectifiers and succeeding chapters discuss measuring methods, test equipment, and manufacturing techniques. Part III, headed "Special Types," discusses low-level detection, high-inverse-voltage rectifiers, and welded-contact germanium rectifiers. These latter devices exhibit negative conductance properties and are capable of self-oscillation, and a theory, postulated by Torrey, of this anomalous behavior is given.

A large portion of the book is devoted to theoretical discussion, and, as is usual in a growing field, the disparities between theory and experience are not few. This is especially true in the case of the noise generated in a crystal rectifier by the passage of direct current through it. A phenomenon similar to that found in carbon microphones exists, and its explanation, as well as the explanation of many of the other properties of the crystal rectifier, awaits further advances in our knowledge of the solid state of matter.

The conversion theory, given in Part II of the book, is especially good, and the authors have paid full attention to the practical aspect of the problem in formulating the theoretical treatment. The problem is especially difficult in that a rigorously complete mathematical treatment would be almost hopelessly complicated, so that some sacrifice in generality is necessary. This loss is evidenced by the brief space allotted to harmonic effects which, although small, need to be considered in some practical cases.

C. F. EDWARDS
Bell Telephone Laboratories
Holmdel, N. J.

The Radio Amateur's Handbook, by the Headquarters Staff of the American Radio Relay League.

Published (1948) by the American Radio Relay League, Inc., West Hartford, Conn. 760 pages, 8-page index. 1712 figures, including 83 charts and tables and 79 basic formulas. 6½ × 9½ inches. \$2.00 in the U. S., its possessions, and Canada; \$2.50 elsewhere.

Written for the radio amateur by his own organization, this annual has attained a high standing also among engineers who are confronted with practical problems within the scope of the book. The soundness of its principles and the accuracy of its information are recognized by the profession.

According to the foreword, "this twenty-fifth edition of the Handbook is featured by the complete rewriting of most of the material. The textbook style . . . has been replaced by a simpler and more understandable discussion of those basic facts that an amateur should know to get the most out of designing and using his apparatus . . . The over-all plan of the book has been changed—achieving, we believe, the object of segregating the material so that it can be most conveniently used . . . As always, the object has been to show the best of current technique through equipment designs proved by thorough testing . . . New chapters on ultra-high frequencies, station assembly, and the elimination of interference to broadcasting have been added to round out the treatment of all phases of amateur radio. The material on operating has likewise been greatly expanded."

The alleviation of wartime shortages has permitted a noticeable improvement in the quality of materials, along with the 30

per cent increase in the number of pages of text. Much of the added space is devoted to new models of amateur equipment for all purposes, described in the experienced manner that has long characterized this handbook. The usual excellent index makes the material conveniently available for reference.

The most notable technical expansion is found in the 50 per cent increase to 72 pages on antennas and lines over the previous treatment of 48 pages. This indicates the greater attention to performance efficiency and the progress of frontiers to higher frequencies. The description of standing-wave indicators (based on the reflection coefficient in the transmission line) is outstanding in the literature.

Characteristic of the scientific pioneering of amateurs is the attention to the detection of meteor trails and the applications of higher frequencies. Jumping from 235 Mc in the previous edition, there is described a simple superregenerative receiver for 420 Mc.

This annual continues to improve in its value to amateurs for getting results and also in its value to practicing engineers for getting a perspective, and useful ideas in the field of the transmission and reception of code and speech.

HAROLD A. WHEELER
Consulting Radio Physicist
259-09 Northern Boulevard
Great Neck, L. I., N. Y.

Fluorescent and Other Gaseous Discharge Lamps, by William E. Forsythe and Elliot Q. Adams.

Published (1948) by Murray Hill Books, Inc., 232 Madison Ave., New York 16, N. Y. 271 pages, 18-page index, xi pages. 142 figures. 6 × 9½. \$5.00.

Although the phenomenon of fluorescence has been known for many centuries, it was not until the early thirties of this century that a commercially feasible fluorescent lamp was developed, because many of the integral parts that go to make up the complete lamp, as it is now known, were slow in developing and because the light had to be produced at a total cost per lumen-hour such that it could compete with existing light sources. Causes of delays in development, and some of the developments that helped to make the present-day fluorescent lamp possible are related in this book. Many of the characteristics of the lamp and of its constituent parts are described, together with some of its advantages and disadvantages, all with attention to experimental laboratory results and helpful design and engineering data.

The American Year Book: A Record of Events and Progress, 1947, edited by William M. Schuyler.

Published (1948) by Thomas Nelson and Sons, 385 Madison Ave., New York 17, N. Y. 1088 pages, 37-page index, xxiii pages. 8 × 5½. \$15.00.

This volume of general facts contains three sections, or slightly over thirteen pages in all, of especial interest to IRE members. The section on "Electrical Engineering" by Harry Sohon comprises a summary of electrical engineering progress and achievement for the year 1947. G. L. Beers' article on "Radio" does the same for that field, as does W. J. Morlock's piece on "Technical Progress in Sound Equipment."

IRE People

JOHN MILLS

John Mills (M'16-F'30), who retired in 1945 after 20 years as director of publication at the Bell Telephone Laboratories, died recently.

Born in Morgan Park, Ill., Mr. Mills attended the University of Chicago, the University of Nebraska, and the Massachusetts Institute of Technology. He was an instructor of physics at Western Reserve University from 1903 to 1907 and at MIT from 1907 to 1909, leaving to become professor of physics at Colorado College. In 1911 he joined the American Telephone and Telegraph Company in New York as a transmission engineer to work on overseas telephone service. Five years later he was transferred to the Western Electric Company's research department, which later became the Bell Laboratories of the AT&T. From 1921 until 1925 he was director of personnel at the laboratories. In the latter year he was appointed director of publication, and he wrote many articles for the layman on scientific discoveries and methods. He was also the author of many engineering and science papers, and published a dozen books.

Mr. Mills held 29 patents relating to wire and telephonic communication. Since his retirement he had been an adviser to undergraduates at the California Institute of Technology. He was a member of Phi Beta Kappa, Sigma Xi, Delta Upsilon, and a Fellow of the AIEE and the American Physical Society.

A. M. SKELLETT

A. M. Skellett (M'44), recently appointed vice-president in charge of the Research Division of National Union Radio Corporation, Orange, N. J., joined the research division of National Union as chief engineer in 1944.

Dr. Skellett is a consultant to the Research and Development Board in the Department of National Defense of the Government. Before joining National Union, he was for 15 years a member of the technical staff of the Bell Telephone Laboratories.



A. M. SKELLETT

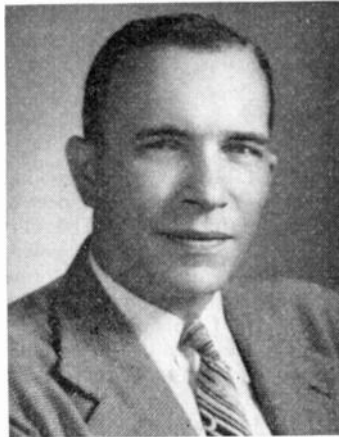

HERBERT C. FLORANCE

HERBERT C. FLORANCE

Herbert C. Florance (M'45), formerly associated with Finch Telecommunications, Inc., as chief engineer at WGHF-FM, New York, has been appointed director of engineering at radio station KDFC.

Mr. Finch was at one time a member of the staff of the National Broadcasting Company. During the war, he served in the Navy Department, Bureau of Ships, with the rank of warrant officer.



KARL SPANGENBERG

Karl Spangenberg (A'34-VA'39-M'45-SM'45), professor of electrical engineering at Stanford University, will be granted a year's leave of absence in order to head the electronics activities of the Office of Naval Research.

Dr. Spangenberg received the B.S. degree in 1932 and the M.S. degree the following year, both from the Case School of Applied Science. In 1937 he was given the Ph.D. degree by Ohio State University, and, in that year, he became a member of the Stanford University faculty, where he has remained officially ever since. During the war, however, he left temporarily to become technical consultant with the Office of Scientific Research and Development. He



KARL SPANGENBERG

also worked at the wartime radio research laboratory at Harvard, and still holds an Office of Naval Research contract to continue a project on the properties of receiver oscillator tubes and circuits of types used in microwave radio and radar, which he started under Harvard's auspices. Dr. Spangenberg is the author of a volume on vacuum tubes, recently published by the McGraw-Hill Book Company.

HARRY DIAMOND

Harry Diamond (A'26-M'30-SM'43-F'43), chief of the electronics division of the National Bureau of Standards, and one of the chief developers of the proximity fuze for shells—a vitally important ordnance discovery of World War II—died recently in Washington.

Born in Quincy, Mass., in 1900, Mr. Diamond received the B.S. degree from the Massachusetts Institute of Technology in 1922, and, upon his graduation, engaged in research work in mechanical engineering with the General Electric Company. In 1923 he left to become an instructor in electrical engineering at Lehigh University, from which he received the M.S. degree in electrical engineering in 1925. Appointed an associate radio engineer at the National Bureau of Standards in 1927, he remained with that organization until his death.

Mr. Diamond's activities included work on aviation radio, radio meteorological observation, radio direction finding, electric ordnances, and electronics. The inventor of the instrument landing system in aviation, he also had a major part in the development of radiosonde. He received awards for his brilliant scientific work from the Washington Academy of Sciences in 1940, the U. S. Navy in 1940, and the War Department, also in 1940.

Mr. Diamond was a fellow of the AIEE and a member of the Washington Academy of Sciences, the educational board of the National Radio Institute, the American Ordnance Association, the Joint Research and Development Board, and the National Defense Research Committee.



HARRY DIAMOND



JOHN F. McALLISTER

JOHN F. McALLISTER

John F. McAllister (A'42) has become designing engineer of General Electric's specialty division, in which capacity he will be responsible for the design of the division's products for radio servicemen, precision testing units, and other electronic application developments.

Born in Philadelphia, Pa., Mr. McAllister holds the degrees of B.A. in physics and B.S. in electrical engineering, both from the University of Pennsylvania. He joined the General Electric Co. in 1939, and, in the course of his service there, worked during the war on a number of government equipment projects.



IRVIN R. WEIR

Irvin R. Weir (A'25-M'41-SM'43), designing engineer of the transmitter division of the General Electric Co. at Electronics Park, has been active in the radio industry since 1923.

Mr. Weir was born in Prairie Creek, Ind., and holds the degrees of B.S. and E.E. from Rose Polytechnic Institute. He joined the General Electric Co. in June, 1921, when he was assigned to the test department in Schenectady. In March, 1923, he was transferred to the transmitter division of what was then the Radio (now Electronics) Department. With the exception of the year

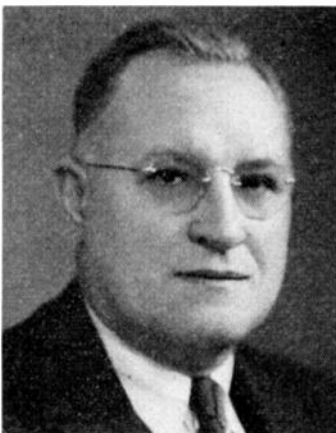

IRVIN R. WEIR

1924, when he was sent to Central America to install and adjust high-power radio equipment for the United Fruit Company, he has worked in the Division ever since, and during the war had complete responsibility for engineering and drafting activities at the Syracuse plant.



LESTER L. LIBBY

Lester L. Libby (A'41-SM'46) has accepted the position of chief engineer of the Ohmega Laboratories, Inc. The Ohmega Laboratories, Inc., is a new development engineering corporation recently formed as an outgrowth of the expanded activities of the Kay Electric Company.

Mr. Libby was born in Hartford, Conn., on January 26, 1914, and received the B.S. degree in E.E. from the Worcester Polytechnic Institute in 1935 and the M.S. degree in E.E. from W.P.I. in 1936. He was a radio-tube design engineer with RCA and Tung-Sol from 1936 to 1941, and a project engineer on receivers and direc-



LESTER L. LIBBY

tion finders with Federal Telephone and Radio Corporation from 1941 to 1944. From 1944 to the end of 1947 he was a senior project engineer at the Federal Telecommunication Laboratories. He was an instructor in uhf techniques at the Newark College of Engineering from October, 1944, to February, 1945, and is a member of Sigma Xi.



THOMAS B. JACOCKS

Thomas B. Jacocks (A'36), formerly manager of the Philadelphia office of the electronics department, General Electric Co., has been appointed manager of the department's Washington, D. C. office.

Mr. Jacocks was born in Tarboro, N. C., and was graduated from the University of North Carolina with the degree of B.S. in electrical engineering in 1924. He joined the General Electric Co. the same year, and, after a year of study in the student test course, was assigned to what was then the radio department (now electronics), where he remained until 1927.



THOMAS B. JACOCKS

From 1927-1931, he was associated with the department's commercial division. In 1931, he was sent to Washington, D. C., as a representative of the radio department, handling government and commercial radio equipment. From 1940-1945 he was engaged in government contract negotiations, and was then appointed manager of the department's Atlantic district, with headquarters in Philadelphia, Pa.



DALE POLLACK

Dale Pollack (J'30-S'35-SM'43), consulting radio engineer of New London, Conn., has been appointed research associate in the department of applied mathematics of the Weizmann Institute of Science at Rehovoth, Palestine, where he will organize and direct the work of the Institute's Electronics Laboratory.

Dr. Pollack studied at Columbia and the Massachusetts Institute of Technology, receiving the Sc.D. degree from the latter in 1940. He has worked for the Radio Corporation of America, the Bell Telephone Laboratories, and the Templetone Radio Manufacturing Corporation, where he was vice-president in charge of engineering. Chairman of the Connecticut Valley Section from 1946 to 1947, Dr. Pollack is a member of the Modulation Systems and Radio Receivers IRE Technical Committees.



DALE POLLACK



MARCUS A. ACHESON

MARCUS A. ACHESON

Marcus A. Acheson (A'29-M'37-F'41), formerly manager of the Sylvania Electric Products' Central Engineering Laboratories, has been named chief engineer for the same company's radio tube division.

A native of Denison, Texas, Mr. Acheson received the B.S. degree in electrical engineering from the Rice Institute in 1924. After serving as a member of the research staff of the General Electric Co., he joined Sylvania in 1934 as a division engineer. During the war he directed the Sylvania development of proximity-fuze tubes for the Navy Bureau of Ordnance, later receiving an award for exceptional service from the Bureau. Mr. Acheson holds about thirty patents on radio transmitter circuits, water-cooled power tubes, and tubes for television transmission.



RAYMOND K. McCLINTOCK

Raymond K. McClintock (A'37-M'41-SM'43), formerly engineering manager for Sylvania Electric Products' International Division, was recently appointed assistant to the chief engineer of the same company's radio tube division.

Mr. McClintock received the B. A. degree in electrical engineering from Pennsylvania State College in 1933. After serving briefly with the Philco Radio and Television



RAYMOND K. McCLINTOCK

Corporation's radio laboratory and the test bureau of the New York Consolidated Edison Company, in 1936 he joined Sylvania, and has been with that company ever since.

Mr. McClintock is an associate member of the Illuminating Engineering Society, and has been granted several patents in the radio tube field.



FRANK G. MARBLE

FRANK G. MARBLE

Frank G. Marble (A'36-SM'44) has been appointed sales manager of the Kay Electric Company, Pine Brook, N. J. After his graduation from the Massachusetts Institute of Technology with the degree of S.M. in electrical engineering, Mr. Marble served with the Television Research Department of Philco, the Western Electric Company, the Bell Telephone Laboratories, and Pratt and Whitney Aircraft.



OTIS W. PIKE

OTIS W. PIKE

Otis W. Pike (A'26-M'29-SM'43), division engineer of the General Electric Company's tube division, has been awarded a distinguished service plaque in recognition of his work as first chairman of the Joint Electronic Tube Engineering Council during its formative years, from 1944 until 1948. J.E.T.E.C. handles standardization of electronic tubes for the RMA and NEMA.



ROBERT M. MORRIS

ROBERT M. MORRIS

Robert M. Morris (A'26-M'32-SM'43), who will supervise the American Broadcasting Company's television operations in Chicago and Detroit, has been active in radio engineering since 1924. He has been associated with the National Broadcasting Company since 1928, except during the war, when he was chief radio engineer, and chief of the communications branch of the Signal Security Agency, for the United States Army.

Mr. Morris attended Western Reserve University and the Case School of Applied Science in Cleveland, Ohio. He is chairman of the executive committee of the National Association of Broadcasters' recording and reproducing standards committee, and a member of the Acoustical Society of America.



C. P. GADE

C. P. Gade (M'48) has been appointed head of the Navy section of the government division of the General Electric Company's electronics department.

A native of Guilderland, N. Y., Mr. Gade was graduated from Union College in 1922 with the degree of B.S. in chemical engineering. That same year he joined the General Electric Co., and he has been with it ever since, working as draftsman and design engineer.



C. P. GADE

N. W. MATHER

PAST CHAIRMAN, PRINCETON SECTION

Norman W. Mather was born on April 29, 1914, at Ontario, Calif. Awarded the B.S. degree from the University of California in 1936, he entered the employment of the Otis Elevator Company in the same year, working until 1942, when he joined the U. S. Naval Reserve. After attending radar courses at Harvard University and the Mas-



sachusetts Institute of Technology, Mr. Mather became a Naval instructor, teaching at Harvard for four months and at Princeton University for eighteen months. In 1945 he became a construction superintendent in the electronics division of the assistant industrial manager's office of the Mare Island Navy Yard.

The following year he was released from active duty, and matriculated as a graduate student at Princeton University, from which he received the M.S. degree in 1947. The previous year he had been appointed visiting assistant professor of electrical engineering at Princeton's Engineering School, and, upon securing the higher degree, he was appointed associate professor.

Although Mr. Mather had been an Associate Member of the IRE some ten years previous, he re-enrolled as an Associate in 1946, becoming a Member the year following. Elected vice-chairman of the Princeton Subsection of the IRE, he became, at the expiration of his term in 1947, Chairman of the Princeton Section, to which the Subsection had become upgraded. His term expired in July of this year. Mr. Mather is also an associate of the AIEE, and a member of Eta Kappa Nu and Sigma Xi.

A. V. BEDFORD

CURRENT CHAIRMAN, PRINCETON SECTION

Alda V. Bedford was born in Winters, Tex., on January 6, 1904. While he was attending the University of Texas, from which he received the B.S. degree in electrical engineering in 1925, he spent one summer with the Dallas Power and Light Company, and was engaged as a laboratory assistant in that University's physics department during one session.

After graduation, Mr. Bedford joined the General Electric Company at Schenectady, starting in the general engineering department, and later transferring to the testing department and the research laboratory. He worked on sound recording by film and disk, audio amplifiers, loudspeakers, sound printers for film, and television. While in Schenectady, he obtained the M.S. degree in electrical engineering from Union College. Since 1929 he has been employed in the RCA Laboratories, first on disk sound recording and then on television.

Mr. Bedford received a "Modern Pioneer" award from the National Association of Manufacturers in February, 1940, for inventions in television. At present he holds 80



patents. He has been active in various committees of NTSC, the Radio Technical Planning Board, and the IRE, in standardizing broadcast television. Mr. Bedford became an Associate of the IRE in 1931 and a Senior Member in 1946. He is the current Chairman of the Princeton Section, having served in the preceding years as secretary-treasurer and vice-chairman.



Surveillance Radar Deficiencies and How They Can Be Overcome*

J. WESLEY LEAS†, MEMBER, IRE

GROUND SURVEILLANCE radar is being investigated today to determine how it can be integrated into the present air traffic-control system. Sets are installed at certain airports, and many more are planned for installation. Every effort will be made to use the radars to the fullest extent in increasing safety and expedition in controlling traffic.

Based on wartime experience, on studies made by Airborne Instruments Laboratory, and on considerable operational thinking, surveillance radar alone—or primary radar, as it is called—can be used *only as a monitor* in civil operations. It has certain technical and operational limitations that must be overcome before it can be used as a primary aid in controlling traffic. It is the purpose of this paper to explore the limitations and determine if and how they may be overcome. Such improvements and additions as are practical will be pointed out in an effort to show how the maximum utility and highest performance can be realized from ground surveillance radar.

TECHNICAL PROBLEMS

There are three major technical difficulties in the operation of surveillance radar. These are:

1. "Seeing" moving targets in the presence of fixed targets.

Since the radio energy is reflected back to the radar, regardless of whether the reflecting object is fixed or moving, the problem of distinguishing moving targets from fixed targets must be overcome if the radar is to be used effectively as a traffic-control aid.

2. "Seeing" aircraft in the presence of storm clouds.

Because of the water content of storm clouds, the radio energy at certain frequencies is reflected back to the radar. These cloud reflections can be strong enough to mask the echoes from aircraft.

3. "Seeing" aircraft with very small cross-sectional areas at desired operational ranges.

High-speed, small, streamlined aircraft do not present much of a cross section to reflect radio energy. It is often impossible to track such aircraft to ranges required operationally.

OPERATIONAL LIMITATIONS

The operational limitations are:

1. Communication with aircraft.

Lack of adequate communication with aircraft could easily make use of the radar data almost impossible. Although the ground controller would have the information, he would be powerless in controlling traffic for lack of communication.

* Decimal classification: R537. Original manuscript received by the Institute, March 31, 1948. Presented, 1948 National IRE Convention, March 22, 1948, New York, N. Y.

† Air Transport Association of America, Washington, D. C.

2. Determination of altitude.

Surveillance radar gives only plan-position data, such that within the limits of coverage of the radar there is no differentiation in altitude. Flight plan and position reports give this data, but correlation with the radar display can be difficult. This limitation becomes very evident when there is stacking, and when the traffic density is high in the area.

3. Determination of identity.

Since all aircraft appear approximately alike on the radar display, identification can be troublesome. Correlation of flight plan and position reports with the actual radar presentation can be used, but careful tracking of the aircraft echo is required to follow a particular aircraft. This becomes particularly difficult where courses cross, where there is stacking, and where traffic is heavy.

4. Use of ground radar data.

Methods of handling the data collected by the radar must be worked out. Among the operational problems are PPI scope reading under daylight conditions, correlation of radar data with flight plans and position reports, and formulation of radar procedures for controlling traffic. As traffic control is performed essentially manually today, use of radar data could run the risk of providing too much information and so add to the controller's already manifold and complex duties.

SOLUTIONS TO TECHNICAL PROBLEMS

Let us see first how the technical difficulties could be resolved.

The ability to see moving targets in the presence of fixed targets could be attained to varying degrees as follows:

1. By placing the radar in a low spot on the ground.

This, of course, depends on the terrain conditions, but it can considerably reduce permanent echoes as the antenna beam tends to clear near-by objects. Low-angle cover may be sacrificed, but no special circuits need be added to the radar.

2. By improvement of the radar.

(a) By use of fast-time-constant (FTC) circuits.

Such circuits will reduce the amount of clutter caused from permanent echoes as their width is reduced. Aircraft can be tracked through most permanent echoes by this means, but constant attention is required as the echoes are often masked by the permanent echoes.

(b) By use of an antenna which can be tilted in elevation.

This has the same effect as placing the radar in a low spot, but permits near-by objects to be cleared even though the antenna is quite high above the ground. Low-angle coverage is sacrificed, the amount being dependent upon the angle of elevation of the antenna and the sight of the radar.

(c) By use of MTI (moving target indication).

This essentially cancels all fixed returns so that only moving targets are shown. Low-angle coverage is not lost. Tracking is easier than in the above cases, but there are certain blind spots—aircraft flying a tangential course to the radar, and aircraft flying through a region of heavy ground echoes—when a moving target may be lost.

3. By use of an airborne transponder or beacon.

This responds to the radar, or separate interrogator associated with the radar, and transmits a reply on a different frequency from the ground transmission; hence, all echoes are tuned out by the ground receiver for the transponder. This co-operating system of ground interrogation and airborne reply is known as secondary radar. Low-angle coverage depends on radio frequencies used, and blind spots associated with MTI are not present. Continuous tracking can be accomplished readily, providing satisfactory signals are received from the transponder during the maneuvering of the aircraft. The replies can be displayed alone, put together with the radar echoes, or gated with the radar echoes such that only aircraft with equipment failures, or unequipped aircraft, are shown.

As concerns the second technical difficulty—that of seeing through storm clouds—there are three lines of attack:

1. Improve radar performance.

Regardless of operating frequency, decreasing the pulse width and the horizontal and vertical beamwidths of the antenna will help to reduce cloud return. This simply reduces the volume of cloud that can give a return and makes the ratio of aircraft return to cloud return more favorable. Since it is the ratio of two quantities, changes in receiver sensitivity and power output will not affect it. In addition to pulse-width and beam-width reductions, fast-time-constant circuits and MTI are helpful. However, if the radar operates on a frequency that is well reflected by clouds, these changes bring only partial improvement.

2. Use the optimum radio frequency.

It is known that radar operating at 3000 Mc is bothered by storm-cloud return. This condition is aggravated with increase in the radio frequency. It is also known that radars at 200 Mc are not troubled by storm clouds. Because this frequency is low, definition is also low, so that a higher radio frequency is desirable, but this must be balanced against increased cloud return. Considerable tests, calculations, and study have indicated that a compromise frequency around 1300 Mc is optimum.

3. Use airborne transponders.

Since the transponder reply is on a different frequency from the radar, normal echoes from clouds can be tuned out. While the improvements in radar performance and

use of optimum radio frequency may not be practical to incorporate in available radars, the use of transponders can make cloud effects nonexistent, just as fixed echoes can be eliminated. The use of transponders could enable available radars to be used more effectively.

The third technical difficulty—seeing aircraft with small cross-sectional areas—can be eliminated to a great extent by improving the over-all signal-to-noise ratio in the radar. This can be accomplished by:

1. Radar improvements
 - a. Higher pulse power
 - b. Narrower beam widths
 - c. Higher receiver sensitivity
 - d. Higher pulse-repetition frequency
 - e. Slower scanning speed.

These improvements must be balanced against the possible slower rate of obtaining data, shorter search range, and greater difficulty in reading the display. The amount of signal-to-noise improvement has practical limits which could still leave this difficulty only partially solved.

2. Use of an airborne transponder.

This overcomes the variation in signal return due to varying cross-sectional areas of aircraft, but the problem of line-of-sight shadow must be overcome by proper location of the antenna on the aircraft, or by use of diversity antennas. If this problem can be solved, the pickup range of the radar will also be increased materially.

To overcome these technical difficulties, it appears that all surveillance radars now being built for civil use will have MTI, or at least provisions for adding it, and some form of FTC circuits. Necessary provisions for transponder operation will be made. The radars will probably operate on about 3000 Mc in the immediate future, as the design is further advanced than on 1300 Mc, but it seems very likely that the surveillance sets in the future will operate at a frequency around 1300 Mc. Radars on both frequencies are now in operation to obtain more technical and operational data. Transponders to improve the range on search and precision of the GCA are now being developed. Transponders will be installed on certain commercial aircraft so that operational procedures can be devised.

SOLUTIONS TO OPERATIONAL LIMITATIONS

Let us now see how the operational shortcomings can be handled.

1. The first is communication with aircraft.

Today, communication with aircraft is handled entirely by voice. This method is already saturated in heavy-traffic-density areas. If the ground controller can have more accurate position and identity information than at present, he will want to make the maximum use of it. But he will not be able to do this without a more efficient means of communication with the aircraft.

The airborne transponder could be used as a direct aid in ground-to-air communication. It could have a receiver which would provide a channel for transmission of traffic data from the ground to the aircraft. The transponder could also relieve the strain of air-to-ground voice communication by automatically reporting position, identity, making requests, and acknowledging clearances.

To illustrate the communication possibilities, transmission of the following data can be accomplished. Since the ground has positional data of all aircraft by primary and secondary radar, fixed blocks of practically any size and configuration that traffic would demand could be laid out. Once this is set up, occupancy of these blocks could then be made to transmit automatically appropriate block signals to each aircraft. For flow or rate control, the ground has data on the rate of progress of each aircraft and its identity such that this could be compared to the desired rate of progress to get time and position differentials. These differentials could be transmitted to each aircraft and displayed as indicator signals, such as speed up, slow down, go up, go down, go left, go right, etc.

Special Committee 31 of the Radio Technical Commission for Aeronautics, which was formed to study the traffic control problem and to set down operational requirements and means of implementing them, recommended that the transponder and automatic air-ground communication be integrated into one airborne equipment. This will enable the ground controller to obtain not only the position and identity of equipped aircraft, but to communicate on a selective or private line basis with every aircraft in the area, sending up block and flow data and receiving clearance requests and acknowledgments from each aircraft. (Development and operational groups are now being established within the government to implement the RTCA common integrated air traffic-control system.)

The second operational shortcoming in using primary radar alone is lack of altitude information.

Altitude data are obtained from flight plan and position reports in present-day operations.

Height-finding radars can be used to check the altitude of aircraft. The accuracy is not all that is desired operationally, for the absolute accuracy at around 30 miles is only the order of ± 750 feet with a relative accuracy of about ± 250 feet. With a height finder, only one aircraft can be checked at a time, and a period of 10 to 20 seconds is usually required to take a reading. Like primary radar, it requires no equipment in the aircraft, but suffers from the same technical shortcomings.

However, to obtain altitude essentially instantaneously and continuously with available techniques, a transponder is necessary. By using a sealed aneroid capsule, absolute altitude accuracy above a datum plane can be the order of plus or minus 250 feet with relative accuracy around plus or minus 100 feet. Display can be by altitude laminae, and the height data are available at a glance, and can be renewed with every rotation of the antenna. By using a transponder in the aircraft, the technical difficulties of primary radar are overcome.

The RTCA Air Traffic Control Committee has recommended that this method be used for obtaining aircraft altitude data for traffic control use.

The third operational shortcoming with primary radar alone is lack of identity.

Today identity can be obtained by flight plan and reporting over fixes. Matching this with the radar display can be difficult.

Vhf (ground) ADF on the voice position reports can be of assistance. With the vhf ADF only the bearing of the aircraft from the station is given; this can be viewed separately or superimposed optically or electronically on the radar display. Of course, ambiguity can exist when two aircraft are at the same bearing from the station, or when two aircraft both report at once. All aircraft reporting must be on the same vhf channel, as presently available equipment can receive only on one channel at a time. No equipment except a vhf transmitter is required in the aircraft. As an interim device, vhf ADF should aid the traffic controller materially. Its use is recommended by RTCA.

A more exact, positive, and efficient method of identity is to make use of a transponder in the aircraft. This transponder would give a particular signal or code to identify a particular flight, the flight and aircraft type, or the particular aircraft. This means of obtaining identity ensures instantaneous and essentially continuous reports. It can provide both bearing and distance with altitude segregation. It can be superimposed electronically or optically on the radar display, or mechanically on a "veeder counter" type of indicator. More than one aircraft can be handled simultaneously and a very striking identity signal can be shown on the radar display to call attention to the particular aircraft reporting. Such provisions for identity from the transponder have been recommended by the RTCA Air Traffic Control Committee.

The fourth operational shortcoming is lack of co-ordination of radar data into the traffic control system on the ground.

It is all very well to supply the ground control agency with the required traffic-control data, but it is also highly important to make provisions for efficient handling of these data by the agency. Normal PPI displays are not bright enough for use under daylight conditions. Television scanning and Schmidt projection is a known means to overcome this deficiency. Such an installation is now being completed by Airborne Instruments Laboratory at the Washington National Airport.

The Civil Aeronautics Authority, in conjunction with the Air Force and Airborne Instruments Laboratory, is working out a sector correlation scheme at Washington National Airport, such that the posting boards covering a particular sector are located alongside the PPI covering the same sector. In conjunction with this, the first civil-controlled radar area is going into effect around Andrews Field near Washington. The CAA and Air Force are co-operating to establish this area for operational test purposes. Much remains to be done to be able to use radar data effectively in the ground control agency. Actual experience at Washington, New York, Chicago, and Gander, Newfoundland, where surveillance radars are operating, should do much to speed up the integration of radar data in traffic control procedures.

CONCLUSION

While it is evident that the technical shortcomings can be overcome to a marked degree by improvement in the primary radar itself, many of these improvements are of

such a nature that they would require major redesign of existing equipment. In some cases, even with this redesign, or with the incorporation of the new design in new radars, the trouble would not be cured completely. By using airborne transponders these technical deficiencies can be circumvented in both presently available radars and radars now being built. The airborne transponder complements the primary radar. It is not proposed that the trans-

ponder is the cure-all or the complete replacement of primary radar. However, it can perform certain functions not possible with primary radar alone.

Looking at the operational shortcomings, it at once becomes evident that the bottlenecks are overload of voice channels and lack of identity. Primary radar cannot perform either one of these functions. The airborne transponder, in addition to assisting the radar in altitude determination, can furnish

identity and provide automatic communication between ground controllers and aircraft.

Ground surveillance radar will be the only new major traffic control tool available for civil use in the next two to four years. *With the aid of co-operating airborne transponders, secondary radar, backed up by primary radar, can become a primary aid in traffic control.* It can mean increased flow of air traffic, while providing for safe separation of all aircraft.

A New Approach to Tunable Resonant Circuits for the 300- to 3000-Mc Frequency Range*

FRANK C. ISELY†, SENIOR MEMBER, IRE

Summary—The development of the use of distributed constants and of discontinuities, in lines of fixed length, for the design of resonant circuits at frequencies between 300 and 3000 Mc is discussed. Various types of these circuits and their characteristics are shown with an indication of their advantages and disadvantages when used as variable frequency elements.

INTRODUCTION

TUNED CIRCUITS for wide-frequency-range coverage in the band of 300 to 3000 Mc are still in the experimental stage. As has been pointed out by Karplus,¹ the lumped circuit is useful only at lower frequencies; at frequencies above this range, the noncontacting plungers operate fairly satisfactorily. Several papers have appeared in the last several years describing different resonant circuits,¹⁻³ all of which have certain limitations, as shown in Table I.

The need for wide-coverage circuits springs from the demand by the armed forces for wide-frequency-coverage receivers and transmitters and for signal generators. A 5-to-1 range would be desirable if it could be made to meet the demand of accurate frequency calibration; however, a 2-to-1 range is at present hoped for. Band-switching is not at present possible and even a turret assembly does not appear feasible, leaving plug-in units as the acceptable method even with the extra space requirements. A logarithmic scale normally is used for signal generators; but for receivers a straight-line-fre-

quency scale is desirable, which usually reduces the available frequency range. In a receiver, these circuits are needed for the whole preselector; i.e., the amplifier, oscillator, and mixer.

The desired circuit would have no sliding contacts, would be easily ganged, would include one or more rf sections, would have at least 180° rotation for accurate frequency setting, would preferably be self-shielded with high Q and satisfactory impedance values, would have no spurious responses and no harmonic modes within its range, and would also be rugged, stable, and not heavy or bulky.

An added difficulty in the development of useful circuits is the lack of suitable small vacuum tubes. Of the "acorn" tubes, only the 6F4 is usable up to 1000 or 1200 Mc, and for wide-range circuits this is difficult to obtain except with the cylindrical circuit. Though the "lighthouse" type 2C40 will oscillate to above 3000 Mc, it is bulky and the gain as a stable amplifier at the higher frequencies is not believed to be large. The klystron is available as an oscillator for concentric- and cavity-type circuits and tubes with coverages of 2-to-1 are available; however, again the tube is "bulky."

At the Naval Research Laboratory it has been felt that a new attack on resonant circuits should be made, and that the starting point should be from fundamental theory. The circuits herein discussed have come out of this work, and though no finished product meeting all the desired circuit requirements has been produced, several circuits and ideas have been developed.

THE DISTRIBUTED-CAPACITANCE LINE

First there was considered a line in which only the distributed capacitance is varied. Normally, in a two-wire or concentric line, the spacing and size of the conductors, when varied, produce a change in both distributed capacitance and distributed inductance but in opposite

* Decimal classification: R141.2. Original manuscript received by the Institute, December 24, 1947; revised manuscript received, February 27, 1948. Presented, Joint Meeting, International Scientific Radio Union, American Section, and The Institute of Radio Engineers, Washington, D. C., May 6, 1947.

† Naval Research Laboratory, Washington, D. C.

¹ E. Karplus, "Wide range tuned circuits," *Proc. I.R.E.*, vol. 33, pp. 426-441; July, 1945.

² W. H. Huggins, "Broad band noncontacting short circuits for coaxial lines," *Proc. I.R.E.*, vol. 35, pp. 906-913; September, 1947; pp. 1085-1091, October, 1947; pp. 1324-1328, November, 1947.

³ F. C. Everett, "Tuned circuits for the UHF and SHF bands," *Communications*, vol. 16, pp. 21; June, 1946.

TABLE 1

Circuit	Frequency Limits	Tubes Used	Advantages	Disadvantages
Coil and capacitor	Up to 400 Mc	Miniature Acorn	Ganging not too difficult 270° rotation possible	Inductance appears in capacitor Not usable above 400 Mc
Butterfly	100 to 1000 Mc 3000 Mc possible in some cases	Acorn Doorknob	Symmetrical circuit 3-to-1 frequency coverage L and C both change	Spurious modes Tube mounting difficult Ganging difficult 90° effective rotation
Semibutterfly	100 to 700 Mc	Miniature Acorn Doorknob	L and C both change 180° rotation Tube mounting not difficult	Spurious modes Frequency range limited Nonsymmetrical
Cylindrical circuit	100 to 1000 Mc?	Lighthouse 6F4	Ganging not difficult Ganging probably not too difficult 180° rotation	Requires shielding Requires external shielding Limited as to tube types usable
Coaxial line	Upper limit above 3000 Mc	Lighthouse Klystron	Constant Z_0 Excellent Q's possible Wide range Self shielding	Sliding contacts or else noncontacting plungers make for bulkiness at lower frequencies Ganging difficult Harmonics possible

directions, so that the resonant frequency of the line remains practically constant. A commercial variable capacitor, such as those used in low-frequency receivers, can be considered as a two-wire line, the stator supports being one wire and the rotor shaft the other, as shown in Fig. 1. With rotation of the rotor plates, the dis-

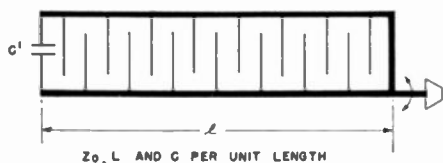

Fig. 1—A variable capacitor as a two-wire line.

cretely distributed capacitance per unit length is varied, producing frequency versus rotation characteristics arising from the $\frac{1}{4}$, $\frac{3}{4}$, $\frac{5}{4}$, $\frac{7}{4}$, $\frac{9}{4}$, etc., modes, depending on whether the ends are shorted or open, just as in the normal line.

The operation of a capacitor at high frequency was first described by King,⁴ although his approach was different from the present and was more rigorous in that he included the inductance of the capacitor plates. In a transmission line

$$v = \frac{1}{\sqrt{LC}} \text{ and } f\lambda = v, \text{ so that } f = \frac{1}{\lambda\sqrt{LC}}$$

where λ in this case is fixed and depends on the mode of operation. The variables are now C instead of length and v and f instead of λ and f . The calculation of the length of such a line can easily be made from transmission-line theory:

$$Z_1 = Z_0 j \tan \beta l, \quad Z_0 = \sqrt{\frac{L}{C}}, \quad \beta = 2\pi f \sqrt{LC}$$

$$Z_{C^1} = -j \left(\frac{1}{2\pi f C^1} \right), \text{ and } Z_1 + Z_{C^1} = 0.$$

Then

$$\frac{1}{2\pi f C^1} = \sqrt{\frac{L}{C}} \tan 2\pi f l \sqrt{LC}$$

or

$$\tan 2\pi f l \sqrt{LC} = \frac{1}{2\pi f C^1} \sqrt{\frac{L}{C}}$$

and

$$l = \left(\frac{1}{2\pi f \sqrt{LC}} \right) \left(\tan^{-1} \frac{1}{2\pi f C^1 \sqrt{\frac{L}{C}}} \right).$$

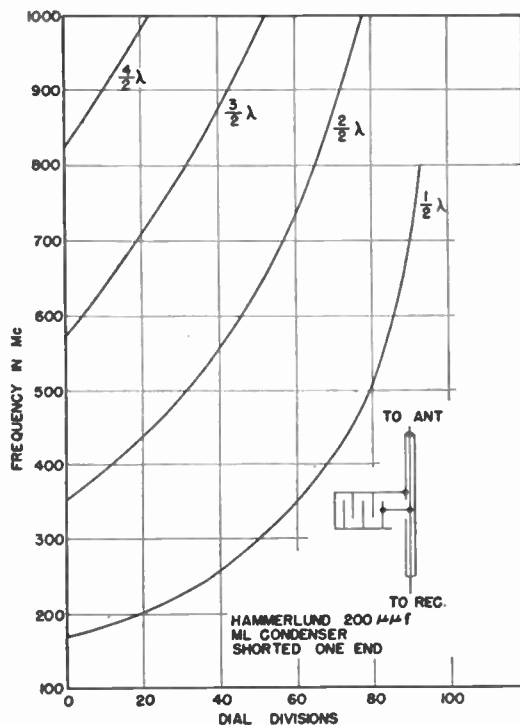

Fig. 2—A distributed-capacitance line as a wave trap.

⁴ Ronold King, "Capacitance at ultra-high frequencies," *Phil. Mag.*, vol. 25, pp. 339-363; February, 1938.

For higher modes $n\pi$ must be added to the \tan^{-1} term, where $n=0, 1, 2$, etc.

Such a capacitor has been used as a wave trap when shorted at one end and connected to the transmission-line input to a receiver (see Fig. 2). This gives the general picture of the action of such a capacitor used as a resonant circuit. The velocity of propagation may be reduced as much as ten to fifteen times.

In order to determine the effect of the plate spacing (that is, how much the distributed capacitance can be concentrated), a run was made on a capacitor, after which some of the plates were removed to increase the spacing by ten times, keeping the length the same. Fig. 3 shows that, though the frequency coverage was reduced, the curves follow those previously obtained.

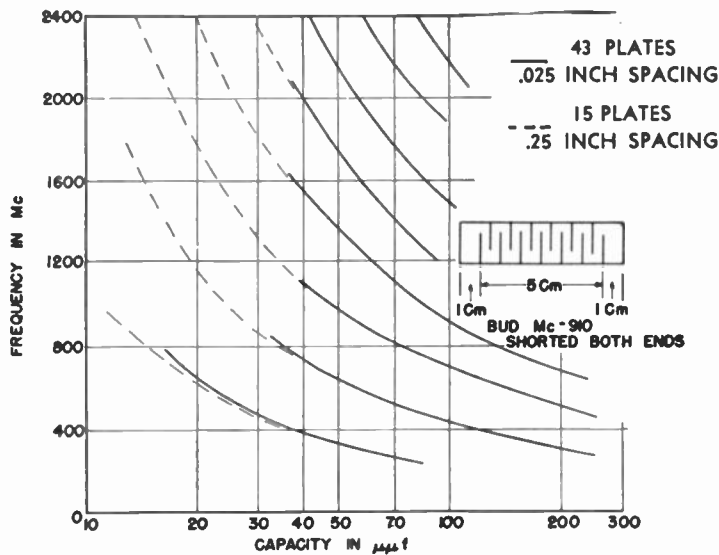

Fig. 3—The effect of plate spacing in a distributed-capacitance line.

Sliding or rotating contacts are not desirable in an rf circuit, so a split-stator capacitor of the type in which the rotor plates operate between opposing stator plates was used. Confusing spurious responses were quite pronounced, as shown in Fig. 4. It was soon realized that these spurious responses came from the introduction of a new line, formed by the rotor in conjunction with either of the stators. If the capacitances from rotor to each stator were not exactly equal, there could, in effect, be three lines, two of which were undesired. By insulating each rotor plate from the others and from the shaft, the spurious responses could be eliminated and only the desirable resonance mode retained.

In this connection, it may be worth while to point out that, in normal use of split-stator capacitors, spurious responses that have been found may very likely come from this effect, and if the circuit is used as an oscillator or amplifier a "dead" spot due to absorption may occur. Continuing in this same line of thought, spurious responses in butterfly circuits may well be due to this cause. For example, the General Radio wavemeter, type 754A, shows two peaks at about 440 and 470 Mc when brought close to a 1220-Mc oscillator, the two peaks

probably being due to a difference in capacitance between the rotor and the two sets of stator plates. Such a wavemeter was modified by insulating the rotor plates one from the other, and the double peaks previously found were gone. However, another spurious peak appeared that probably had been damped out by the short-circuiting straps described by Karplus. On further investigation, it appeared possible for the stator plates, even though connected together by a strap, to be a "line." Coupling the same wavemeter to a 1000-Mc oscillator, a spurious response was found at a point giving

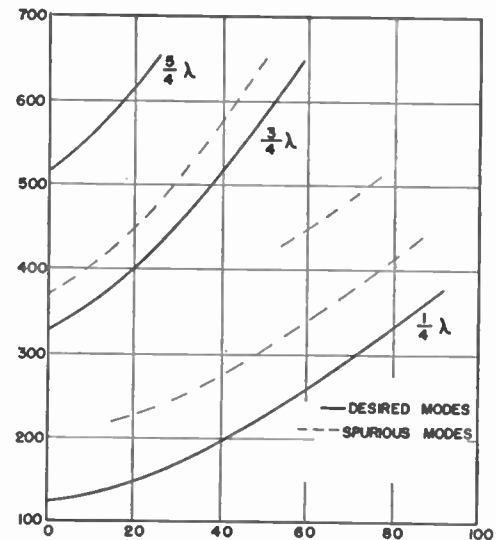

Fig. 4—Spurious modes in a split-stator line.

a capacitance of $10 \mu\mu f$ or $8.3 \mu\mu f$ per centimeter (GR data). Substituting this value, and a value of $0.012 \mu h$ per centimeter estimated from other work, into the formulas for the $\frac{1}{4}$ -wavelength line, a value of 1.5 centimeters for the length was obtained. Since the actual value was 1.2 centimeters and considering the rough estimate of the inductance and the neglected connecting ring, it was felt that a satisfactory correlation was obtained and that these spurious responses are due to this "line" operation.

Further consideration should also be given to the use of lumped inductance in series with a variable capacitor. Fig. 5 illustrates this in connection with a wave trap, showing the normal operation as well as the high-frequency "line" mode obtained. This same effect has been found also in low-frequency wavemeters where there was a response to a high-frequency signal that was quite misleading. The inductively loaded line has a formula similar to that of the capacitance-loaded line:

$$l = \frac{1}{2\pi f \sqrt{LC}} \tan^{-1} \frac{2\pi f L^1}{\sqrt{\frac{L}{C}}}$$

where L^1 is the loading inductance.

Actually, a two-wire-line type of circuit is practically limited to frequencies below 200 Mc for wide frequency

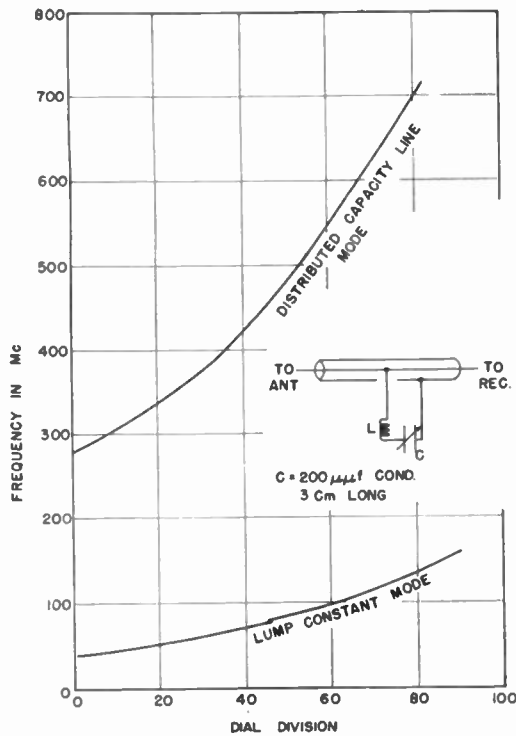

Fig. 5—Wavetrap modes of operation.

coverage. A concentric-line type, Fig. 6, is much more useful because of the reduction in inductance, and has been made to oscillate over the range of 700 to 1150 Mc with a 2C40 tube. Provisions were made for variable feed back from plate to cathode in order to smooth out the variations in grid current. Also, the rotor plates were mounted on a bakelite shaft in order to insulate them from each other, which is one of the more difficult steps in building this circuit. Approximately 1200 Mc is the upper limit for a single-tuned wide-coverage oscillator,

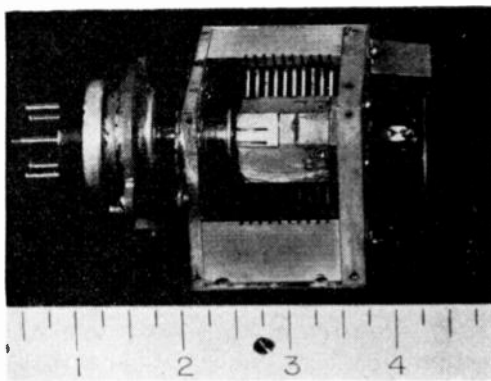

Fig. 6—A concentric distributed-capacitance line.

because of the increased loading on the circuit. A tuned-plate tuned-cathode circuit is needed for the higher frequencies, and the lighthouse tube is “bulky” for a double-tuned circuit of this sort.

Fig. 7 illustrates a distributed-capacitance line in which the capacitance from the rotor to the center con-

ductor is secured only by the fringe capacitance of the rotor plates, while the capacitance to the outer plates is secured normally by the meshing of the plates. Fringe capacitance, though difficult of accurate calculation, can be estimated closely enough, since the plate spacing is small, by assuming the rotor to be solid and calculating the capacitance as between two plates, the center con-



Fig. 7—A concentric distributed-capacitance line by fringe effect.

ductor and the adjacent periphery along the rotor. Another way of calculating both the inductance and capacitance is from the characteristic impedance of the line, where $C = 33.45Z_0$ in $\mu\mu\text{f}$ per centimeter and $L = 33.45 Z_0$ in $\mu\mu\text{h}$ per centimeter. The calculated and actual frequency range check fairly well, as shown in Table II, which gives these values as well as the values

TABLE II
CHARACTERISTICS OF LINE OF FIG. 7

L (calculated)	C (calculated)	f (calculated)	f (measured)	Q (measured)
2500 $\mu\mu\text{h/cm}$	1.9 $\mu\mu\text{f/cm}$	1200 Mc	1300 Mc	250
2500	0.63	2090	2100	194

of Q of the circuit. This circuit is not very useful for, when loaded by a tube of, say, 2 $\mu\mu\text{f}$ capacitance, the tuning range is reduced from 1.6 to 1 to about 1.3 to 1. However, the use of fringe capacitance has pointed the way to the development of the distributed-inductance line.

THE DISTRIBUTED-INDUCTANCE LINE

Fringe capacitance from the edge of parallel plates, as seen from the line discussed above, is comparable to the capacitance of a peripheral plate along these edges. Con-

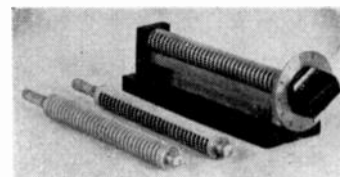

Fig. 8—A distributed-inductance line.

sequently, it would appear possible to obtain a variable inductance by means of a slotted cylinder with only a portion of the cylinder wall solid, the inductance variation being obtained by the variation of the mutual inductance when this solid portion approaches or recedes from an adjacent fixed member, and the capacitance remaining constant. Fig. 8 is such a two-wire line, consisting of a slotted rotor and an adjacent plate milled to give a 1/32-inch spacing between the two.

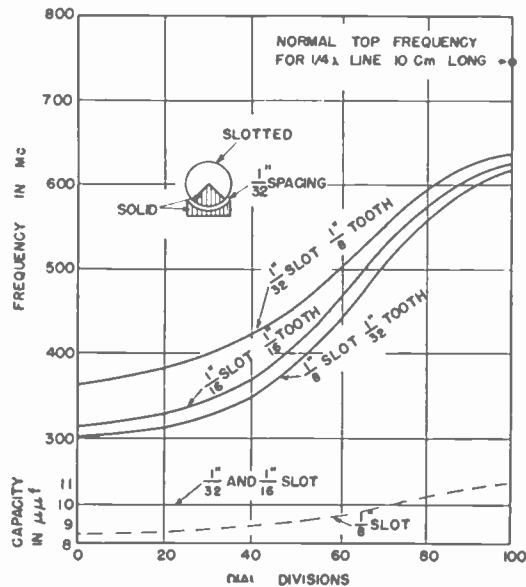

Fig. 9—Characteristics of the distributed-inductance line shown in Fig. 8.

Fig. 9 is a curve of frequency versus rotation for different slot and tooth widths. It was made in order to determine the limits of the fringe-capacitance effect and the best proportions for maximum frequency range. The lower curve shows that the fringe capacitance maintains the capacitance of the rotor constant for the 1/32-inch slot and 1/8-inch tooth and for the 1/16-inch slot and tooth, but falls off when the slot becomes 1/8 inch. The frequency coverage is slightly greater for the 1/8-inch slot and 1/32-inch tooth, presumably due to the reduced inductive effect in the teeth; however, the increase is only slight and 1/16-inch teeth and slots are easier to machine, so that further work has been carried on with these proportions.

The theoretical top frequency of this two-wire line, if

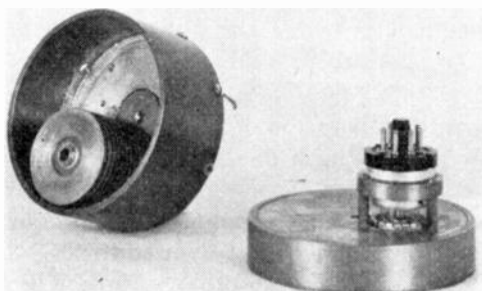

Fig. 10—Another distributed-inductance line.

made of the solid rotating portion and the stationary section, should be about 750 Mc, whereas actually it is around 625 Mc due to the extra capacitance of the toothed part of the rotating portion. Unfortunately, there is a current flow in the toothed portion, as well as the solid portion, which reduces the effective maximum inductance by about 35 to 40 per cent, and consequently reduces the maximum frequency coverage. This line, of course, has rotating contacts, and is mostly of interest in developing the fundamental facts concerning variable inductance. A concentric line using this variable distributed inductance has been built, as shown in Fig. 10, in which the cross section is as sketched in Fig.

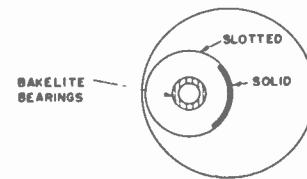

Fig. 11—Cross section of the distributed-inductance line.

11. The design of this line, which covers a frequency of 600 to 900 Mc, was calculated by using curvilinear squares⁵ and by loaded-line theory. In calculating the size of this line, the inner cylinder is made about one-half the diameter of the outer, with the closest spacing between about 1/32 inch. At the minimum-inductance position, the inductance is obtained which, combined with the capacitance, gives the characteristic impedance. The product of this Z_0 and the capacitance of the tube loading will allow the foreshortened 1/4-wavelength of a normal line to be determined. The ratio of the square root of the inductance of an unslotted line to that of a slotted line will determine the reduction in velocity of propagation, and, consequently, the length of the line. The square root of the ratio of maximum to minimum inductance will give the frequency-coverage ratio; however, the maximum inductance must be modified to include the inductive effect in the teeth.

In Fig. 11, the shaded ring represents a bakelite bearing to eliminate metallic sliding contacts between the rotating cylinder and the center shaft, which is the plate connection to the vacuum tube. This shaft is insulated from the outer conductor by a mica washer. A test was made with brass bearings in place of bakelite, and the frequency coverage and oscillator performance were unchanged, indicating that there is sufficient capacitance coupling (1/32-inch spacing) to allow the rotor and shaft to operate at the same potential. For rotation, a gear was soldered at the bottom of the rotating member. This meshed with an offset bakelite gear operated on a shaft through the bottom plate of the line. The difficulty with this type of line is to secure close-enough spacing to ob-

⁵ E. O. Willoughby, "Application of field plotting," *Jour. I.E.E.* (London), part III, vol. 93, pp. 275–293; July, 1946.

tain a large frequency coverage, as a 1/32-inch spacing gave only 600 to 900 Mc or 1½ to 1 when used as an oscillator with a 2C40 tube. The Q at 900 Mc, when unloaded was approximately 200. It is also interesting to note that, if the inner cylinder had been made to rotate

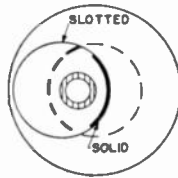

Fig. 12—Cross section of the distributed-capacitance line.

off center (Fig. 12), a distributed-capacitance line would be had. Such a line has approximately the same characteristics as the distributed-inductance line.

THE DISCONTINUITY LINE

One other type of line investigated is the so-called discontinuity line of Fig. 13. This is a ¼-wavelength line

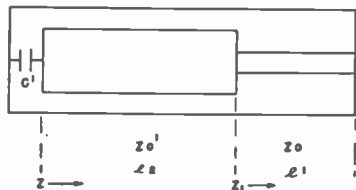

Fig. 13—Diagram of the discontinuity line.

which normally operates only in the ¼-wavelength mode. l1 is ¼ wavelength and l2 is ½ wavelength for an unloaded line. The discontinuity in the characteristic impedance is made to be about 3 to 1, as it would appear that such a value would minimize the ¼-wavelength mode. Again, from transmission-line theory, l2 may be calculated:

$$Z_1 = jZ_0 \tan \frac{2\pi l_1}{\lambda}, \quad Z = Z_0^1 \frac{Z_1 + jZ_0^1 \tan \frac{2\pi l_2}{\lambda}}{Z_0^1 + jZ_1 \tan \frac{2\pi l_2}{\lambda}}$$

and

$$Z_{C^1} = -j \frac{5.3\lambda}{C^1}$$

where C¹ is in μμf. Then

$$\frac{5.3\lambda}{C^1} = Z = Z_0^1 \frac{Z_0 \tan \frac{2\pi l_1}{\lambda} + Z_0^1 \tan \frac{2\pi l_2}{\lambda}}{Z_0^1 - Z_0 \tan \frac{2\pi l_1}{\lambda} \tan \frac{2\pi l_2}{\lambda}}$$

and

$$\tan \frac{2\pi l_2}{\lambda} \left(-Z_0 \frac{5.3\lambda}{C^1} \tan \frac{2\pi l_1}{\lambda} - Z_0^1 \right)$$

$$= Z_0 Z_0^1 \tan \frac{2\pi l_1}{\lambda} - Z_0^1 \frac{5.3\lambda}{C^1}$$

or

$$l_2 = \frac{\lambda}{2\pi} \tan^{-1} \frac{\frac{5.3\lambda}{C^1} - Z_0 \tan \frac{2\pi l_1}{\lambda}}{\frac{Z_0}{Z_0^1} \frac{5.3\lambda}{C^1} \tan \frac{2\pi l_1}{\lambda} + Z_0^1}$$

It would appear that Z₀¹ could either be greater or smaller than Z₀; however, in practice only in the case where Z₀¹ is smaller will the circuit operate with a tube as an oscillator, for in the other case the ¼-wavelength portion appears to be a load on the ½-wavelength portion which acts as a ¼-wavelength element. The lower ¼ wavelength does not need to be strictly a quarter-wavelength, and in fact does not need to be tuned even for a 2-to-1 frequency coverage, though by tuning it would give a greater coverage than is obtainable without it.

Fig. 14 is a circuit that covers a range of 600 to 1000

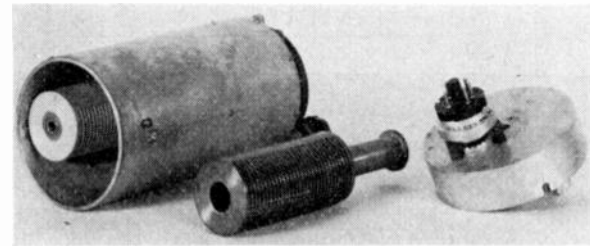

Fig. 14—A discontinuity line.

Mc, when using distributed inductive tuning with the solid portion of the rotor being 90°. As would be expected, a reduction in the solid portion lowers the resonant frequency and increases the frequency coverage slightly. A 45° solid portion gives a frequency range of 450 to 780 Mc. This line has the same cross-sectional dimensions as that of Fig. 10 but a somewhat greater frequency coverage, which is one advantage of this type of line. The reason for this added coverage is the fact that the tube loading does not reduce the percentage length of the tuned circuit as much. On the other hand, the circuit is longer and, consequently, more useful at much higher frequencies where the ¼-wavelength line would become too short to be usable. The circuit Q is about 300.

In the actual operation of an oscillator, using a 2C40 tube, the ¼-wavelength mode did not appear unless a very great amount of capacitance feedback was used. It also appeared as if the normal feedback for the ¾-wavelength mode did not need to be varied to cover the range although there was considerable variation in grid current.

Spectral Power Distribution of Cathode-Ray Phosphors*

R. M. BOWIE†, FELLOW, IRE, AND ALFRED E. MARTIN†, MEMBER, IRE

Summary—This paper embodies some of the results of a study undertaken because of the lack of substantial agreement among colorimetric determinations made from cathode-ray-tube screens by television manufacturers in the United States. The ICI (International Commission on Illumination) system of color specification is described, and is applied to the visible light produced by cathode-ray screens. A survey was made of the principal colorimetric methods now in use by television manufacturers. These methods have been evaluated in terms of how closely their inherent characteristics meet the criteria of the 1931 ICI Standard Observer. The necessity for standardization of colorimetric measuring equipment is pointed out. Suggestions are offered as to the manner in which such standardization might be achieved.

THE COMMERCIALIZATION of television has now brought to the public a new form of entertainment presented as the play of highlights and shadows across the face of a cathode-ray tube (crt). The radio industry has thereby entered the field of commercial production of light. With its advent into that field has come the necessity for defining and standardizing the appropriate attributes of that light. It is scarcely conceivable that commercialization can expand to any great volume, involving many set, component, and tube manufacturers, without industry-wide standardization of output performance characteristics of the crt. Though much television technology has to do with the transmission and reproduction of geometric configurations, this paper deals with the nongeometric aspects of the screen output; namely, brightness and color.

As is often the case in new and expanding fields, the art is ahead of the specifications and the methods of measurement. That this is true is evidenced by the fact that cathode-ray tubes have been rejected by customers because those customers did not approve the screen colors when examined visually. Tubes have also been rejected for color shift with beam current change on the basis of visual inspection. Although these customers may have been right, the point is rather that no *accepted* methods of measurements exist in the radio industry by which to judge screen quality.

Brightness and color are, in reality, human evaluations of the light output of the screen. The eye, however, is notably poor in direct evaluation, although it is quick to detect color and brightness differences. Thus an objective, rather than a subjective, method of measuring these attributes must be used. To understand what an instrument must do to make such objective measurements, it is first necessary to inquire regarding the mechanism of seeing.

The ear is essentially an harmonic analyzer. With a

* Decimal classification: R138.31. Original manuscript received by the Institute, February 4, 1948.

Presented, Rochester Fall Meeting, Rochester, N. Y., November 18, 1947.

† Sylvania Electric Products Inc., Bayside, L. I., N. Y.

little training, most people can tell what frequencies make up a tone or chord. Each frequency is detected as such. The eye, however, is an integrating device. It cannot even tell a line spectrum from a continuous one. The range in which the eye performs the integrations is defined as the visible spectrum.

The visible spectrum extends approximately from 400 to 700 $m\mu$ (750 to 430 mega-megacycles). A crt screen emits light power distributed in various ways throughout this range.¹ The spectral power distributions for three crt screens are shown in Fig. 1. The ordinate is

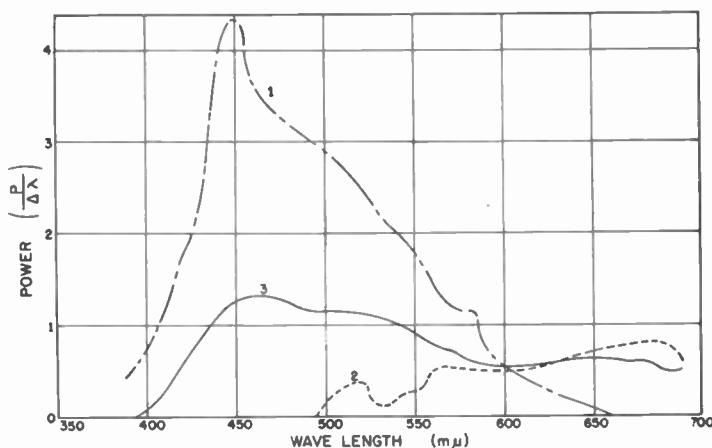

Fig. 1—Spectral power distribution of ZnS·Ag, (Zm, Cd)S·Cu, and a blend thereof.

- (1) ZnS·Ag
 - (2) (Zm, Cd)S·Cu
 - (3) ZnS+(Zm, Cd)S
- E screen = 6000 V.
Power density = 10 mW/cm.²

expressed as $P/\Delta\lambda$ where P is power received for fixed viewing conditions in the narrow wavelength interval $\Delta\lambda$. Two of the curves are for sulfides blended to make the screen of the third tube. For the purpose of this discussion, consider one of these curves; say, that for the blend. Define the shape of this curve as $E(\lambda)$. The eye, however, does not respond equally well to all wavelengths, but has the spectral response curve of Fig. 2. This curve was adopted as standard by The International Commission on Illumination (ICI) in 1924 after measurements on many people.² Let the spectral response be $R(\lambda)$. The ordinate of this plot is defined in a similar manner to that of Fig. 1. The eye then performs the integration³

$$\text{brightness} = \int_{400}^{700} E(\lambda) \cdot R(\lambda) \cdot d\lambda. \quad (1)$$

¹ 1 millimicron ($m\mu$) = 10 Angstrom units = 10^{-9} meter.

² "IES Lighting Handbook," Illuminating Engineering Society, New York, N. Y., pp. 1-4, 1947.

³ W. E. Forsythe, "Measurement of Radiant Energy," McGraw-Hill Book Co., Inc., New York, N. Y., p. 409; 1937.

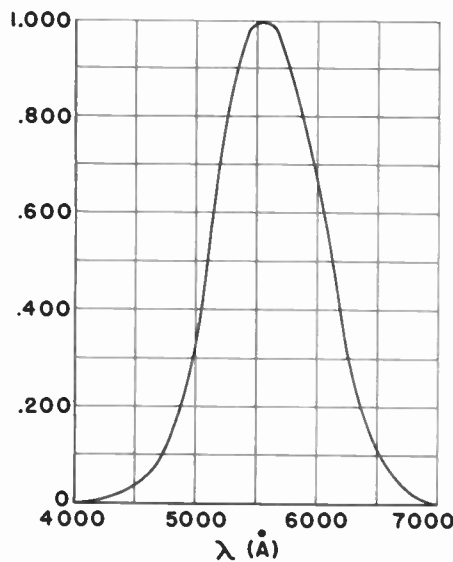

Fig. 2—ICI luminosity curve for the human eye.

Visual specification of the color of light perceived depends upon the fact that, by mixing three primary lights (e.g., red, green, and blue) of suitable character in the correct proportions, light of almost any given color can be reproduced. The perception of color necessarily implies that, as the quality of the physical stimulus incident on the retina of the eye is changed, so the quality of the response transmitted from the retina to the brain must change also. There is good reason to believe, however, that the number of types of response thus initiated is limited to three, and that the totality of color sensations is produced solely by variations among the relative magnitudes of these three responses.

It may therefore be said that color results from the performance by the eye of three integrations such as (1). That there are three integrals comes as no surprise, in view of the extensively reported use of three primary colors in color television.^{4,5} These three integrals may be written:

$$X = \int_{400}^{700} E(\lambda) \cdot \bar{x} \cdot d\lambda \quad (2)$$

$$Y = \int_{400}^{700} E(\lambda) \cdot \bar{y} \cdot d\lambda \quad (3)$$

$$Z = \int_{400}^{700} E(\lambda) \cdot \bar{z} \cdot d\lambda \quad (4)$$

X , Y , and Z are defined as the tristimulus values of the light.⁶

The shapes of the three distribution functions \bar{x} , \bar{y} , and \bar{z} have been the subject of much study. Upon examining the data for a large number of observers, an interrelation among \bar{x} , \bar{y} , and \bar{z} was found, but their

magnitudes could not be uniquely determined. If, however, the magnitude of one were fixed by arbitrary choice, then the other two were also fixed. The ICI in 1931 chose to make \bar{y} agree with $R(\lambda)$, thus yielding the three functions \bar{x} , \bar{y} , \bar{z} ,^{7,8} called the tristimulus values of the spectrum. These are shown in Fig. 3.

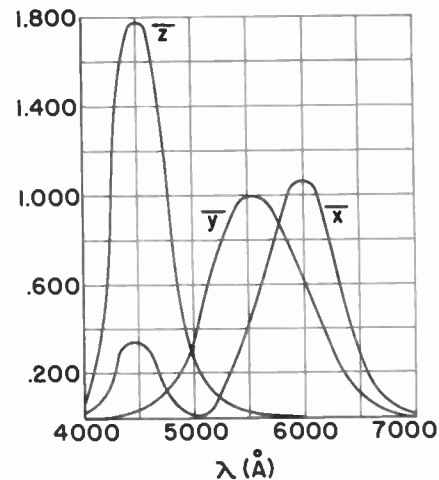

Fig. 3—Tristimulus values of spectrum colors (1931 ICI Standard Observer).

It is obvious that the tristimulus values, X , Y , and Z , all depend on brightness as well as color. To eliminate brightness one merely defines the trichromatic coefficients x and y as follows:

$$x = \frac{X}{X + Y + Z} \quad (5)$$

$$y = \frac{Y}{X + Y + Z} \quad (6)$$

$$z = \frac{Z}{X + Y + Z} \quad (7)$$

The third trichromatic coefficient is redundant, as $x + y + z \equiv 1$. Thus, x , y , and Y express both the color and brightness of a light for the standard ICI observer. That Y is identical with brightness results directly from the decision of the ICI to make \bar{y} the same as $R(\lambda)$. If, now, x and y for the pure spectral colors are plotted in Cartesian co-ordinates, one obtains the spectrum locus of Fig. 5, inside of which all real colors lie.⁹ This is then a convenient way of indicating a color by its co-ordinates.

An objective way of measuring and specifying color and brightness therefore exists as just described. That way is to measure the spectral power distribution, and subsequently to perform graphically or numerically the indicated integrations. These integrations are performed numerically or graphically, in practice, as shown

⁴ "Color TV demonstrations reveal engineering progress," *Tele-Tech*, vol. 6, p. 66; March, 1947.

⁵ A. Bronwell, "New viewing tube for color TV," *Tele-Tech*, vol. 7, p. 40; March, 1948.

⁶ A. C. Hardy, "Handbook of Colorimetry," The Technology Press, Cambridge, Mass., p. 49; 1936.

⁷ See page 416 of footnote reference 3.

⁸ D. B. Judd, "The 1931 ICI standard observer and coordinate system for colorimetry," *Jour. Opt. Soc. Amer.*, vol. 23, pp. 359-374; 1933.

⁹ W. D. Wright, "The Measurement of Colour," Adam Hilger Ltd., London, p. 75; 1944.

pictorially in Fig. 4. Thus, to obtain X , each ordinate in $E(\lambda)$, such as that marked $E(i)$, is multiplied by the ordinate $\bar{x}(i)$ for the same wavelength, $\lambda=i$. The re-

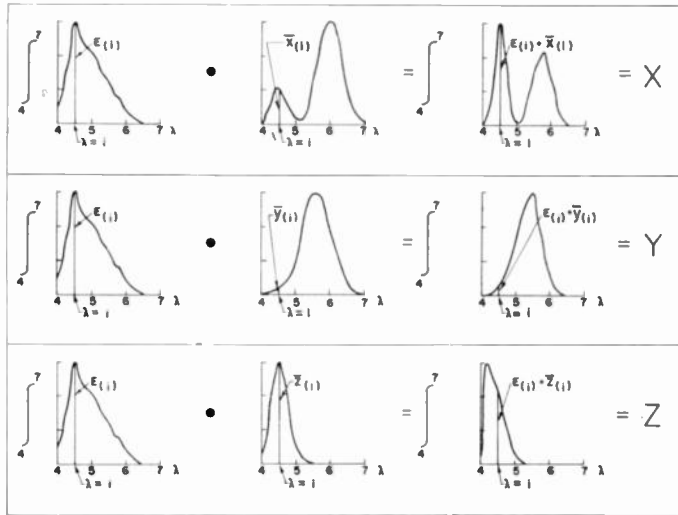

Fig. 4—Graphic representation of method of obtaining ICI tristimulus values.

sulting products are plotted to obtain the $E(\lambda) \cdot \bar{x}(\lambda)$ curve. The area under that new curve is the integral X . Similarly, the integrals for Y and Z may be obtained.

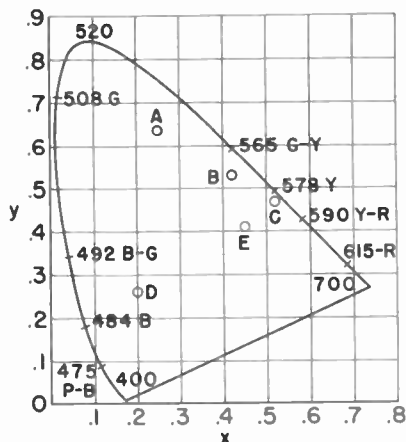

Fig. 5—ICI spectrum locus. Willemite = A ; $Zn-Bc$ silicate = B ; blue sulfide = D ; illuminant $A = E$; orange sulfide = C .

The making of spectral-power-distribution measurements can be done automatically or manually. Fig. 6 shows an automatic spectroradiometer developed by the Sylvania Research Department for the Lamp Engineering Department at Salem. It automatically scans through the spectrum and records power per wavelength interval against wavelength. Its cams provide: (1) linear wavelength drive; (2) compensation for the spectral response curve of the photocell; and (3) slit width adjustment for constant-wavelength pass band, $\Delta\lambda$. Cams could also have been provided to perform the

integrations yielding the tristimulus values X , Y , and Z , but were not wanted on this instrument. Such an instrument costs many thousands of dollars, and is not likely to find its way into the plants of many crt customers. Other crt manufacturers have developed similar instruments.^{10,11} The spectral power distribution can be found with less elaborate, manually operated equipment, but it requires about an hour of time of a trained engineer for each tube. This is scarcely attractive to a television set manufacturer, nor is it feasible for crt manufacturing control.



Fig. 6—Sylvania recording spectroradiometer.

The question arises, therefore, as to whether or not there are less tedious or less expensive ways of determining screen color. Certainly with the plethora of colored objects on our markets, this problem must have received much attention. It has, and many solutions have been proposed.¹²⁻¹⁵ Some have met with considerable success under limited conditions.

One of the most obvious ways is to compare the crt screen visually with a white surface illuminated by red, green, and blue lights in just the right proportions to give the specified color.¹⁶ Dr. Edith Fehr at the 1947 National Electronics Conference discussed colorimetry of crt screens, at which time she demonstrated this method and pointed out that it is suitable only for approximation. This is due primarily to the rather large

¹⁰ F. J. Studer, "A method for measuring the spectral energy distribution of low brightness light sources," *Jour. Opt. Soc. Amer.*, vol. 37, pp. 288-291; 1947.

¹¹ A. E. Hardy, "Combination Phosphorometer and Spectroradiometer for Luminescent Materials," The Electrochemical Society, Preprint 91-8, 1947.

¹² R. S. Hunter, "Photoelectric Tristimulus Colorimetry with Three Filters," National Bureau of Standards Circular C429; 1942.

¹³ Parry Moon, "Color determination," *Illum. Eng.*, vol. 36, pp. 315-335; 1941.

¹⁴ B. T. Barnes, "A Four-Filter Photoelectric Colorimeter," *Jour. Opt. Soc. Amer.*, vol. 29, pp. 448-452; 1939.

¹⁵ B. T. Barnes, "A direct-reading photoelectric colorimeter," *Rev. Sci. Instr.*, vol. 16, pp. 337-339; 1945.

¹⁶ See page 5 of footnote reference 6.

differences among human eyes. Not only do eyes differ, but the same eye will differ with changing conditions of viewing. Numerous instruments employing this comparison principle have been described in the literature but none has met with wide acceptance.¹⁷

Probably the most promising approach is the filter-photocell colorimeter. The criteria to be met by such an instrument can best be seen in connection with Fig. 3. If the standard observer is specified as having the three response functions \bar{x} , \bar{y} , and \bar{z} , then one merely needs three receptors made to have these responses. They will then perform the same three integrations and yield the three tristimulus values, X , Y , and Z . To use language more familiar to electronic engineers, each receptor is an analogue computer.

A number of such instruments have been described in the literature. Only two will be discussed here, as they are sufficiently typical and represent actual practice.¹²⁻¹⁵ Both comprise essentially a barrier-layer photoelectric cell, in front of which either three or four filters are placed in succession. A typical instrument of this kind is shown in Fig. 7. Knowing the spectral response of the photocell, one filter is so chosen that the

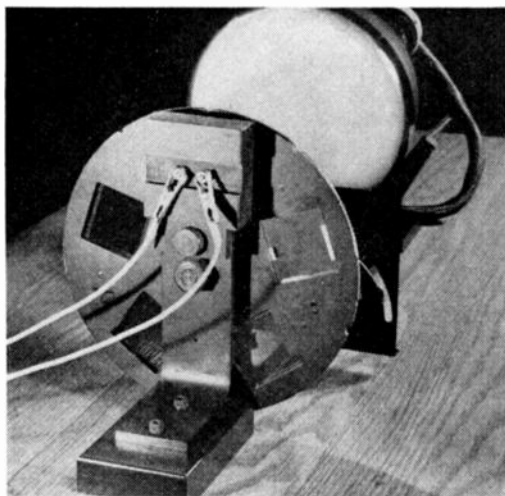

Fig. 7—Photoelectric tristimulus colorimeter.

cell and filter together have a response curve agreeing closely with \bar{y} . It is greenish. A second filter is so chosen that the combined response curve agrees with \bar{z} . This one is blue. A third filter is so chosen as to give agreement with the right lobe of \bar{x} . It is amber. Barnes¹⁴ chose a fourth filter to yield the left lobe of the \bar{x} curve. Hunter¹² chose to use the \bar{z} filter for the left lobe of the \bar{x} curve. Of course, the photocell current had to be multiplied by a suitable constant to account for the size difference. There is an appreciable shape difference also which others¹⁸ have been quick to point out. However,

¹⁷ See chapter 4 of footnote reference 9.

¹⁸ J. A. Van den Akker, "Chromaticity limitations of the best physically realizable three-filter photoelectric colorimeter," *Jour. Opt. Soc. Amer.*, vol. 27, pp. 401-407; 1937.

this discrepancy appears to be of negligible importance if the instrument is used as directed by Hunter.

Theoretically, the four-filter colorimeter could be used as a primary standard, but practically this is far from possible, because filters and cells cannot be found which fit the standard curves with sufficient accuracy. The Barnes-type instrument is, however, used extensively in the lamp industry for measuring the color of fluorescent lamps.¹⁹ Its fallibility is evident, however, from a recent experience in the Sylvania lamp plant. Two lamps which read the same on the Barnes colorimeter looked appreciably different to all observers. The two spectral energy curves are shown in Fig. 8. It is obvious that the lamps were made with different powders.

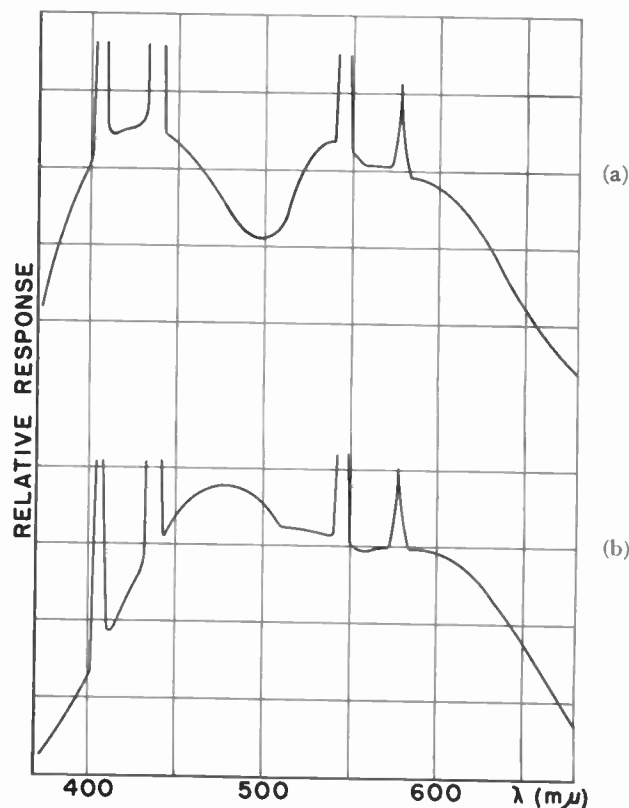

Fig. 8—Spectroradiometric comparison of two fluorescent lamps.
(a) $x=0.314$, $y=0.323$
(b) $x=0.313$, $y=0.324$.

This leads directly to the conditions under which filter-photocell colorimeters may be used. Both Hunter and Barnes, as well as designers of other similar colorimeters,²⁰ have pointed out that these instruments are well suited to detect the difference between two samples which are supposed to be identical. It is essential that the two samples have nearly the same spectral power distribution. In other words, they should be isospectroradiometers.²¹ Isospectroradiometers may be defined as lights having substantially the same spectral power dis-

¹⁹ W. F. Little and E. H. Salter, "The measurement of fluorescent lamps and luminaires," *Illum. Eng.*, vol. 42, pp. 217-233; 1947.

²⁰ See page 3 of footnote reference 12.

²¹ The word "isospectroradiometers" has been coined here for the purpose of emphasis.

tribution. It is obvious that the two fluorescent lamps mentioned earlier were not isospectroradiometers. They contained different powders, yet looked much alike.

It is obvious, therefore, that a filter-photocell colorimeter is ideally suited to the measurement of color shift such as may be caused by changing the beam current in a crt. However, in measuring color, it should be used to make comparison with an isospectroradiometric standard. Such a standard would, very likely, have to be another crt of almost identical manufacture.

Before going into further detail as to how this might be accomplished, consider the sources of filter-photocell colorimeters. To the best of the authors' knowledge, there is no source of complete Barnes-type colorimeters, although the filters are obtainable from the Corning Glass Works, and the cells from the General Electric Company. However, no one takes the responsibility for a complete instrument. Thus, one who buys the components and assembles his own instrument has no assurance of accuracy, unless he has spectroradiometric equipment of his own. That some form of over-all responsibility is needed can be seen from the following figures.

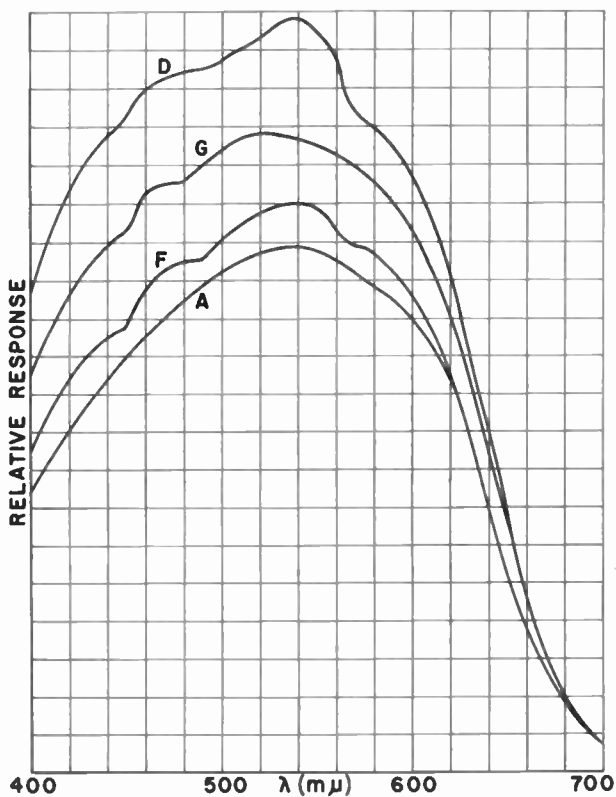

Fig. 9—Equal power response curves of four General Electric photocells per unit slit width.

Four photocells of the type required for the Barnes colorimeter were purchased as a lot, and measured for spectral response. These data appear in Fig. 9. When these curves are normalized at 560 $m\mu$, the curves of Fig. 10 result. This represents rather good manufacturing uniformity. If, however, curve *F* is chosen as stand-

ard, and the deviations of the others from it are computed, the curves of Fig. 11 result. It should be pointed

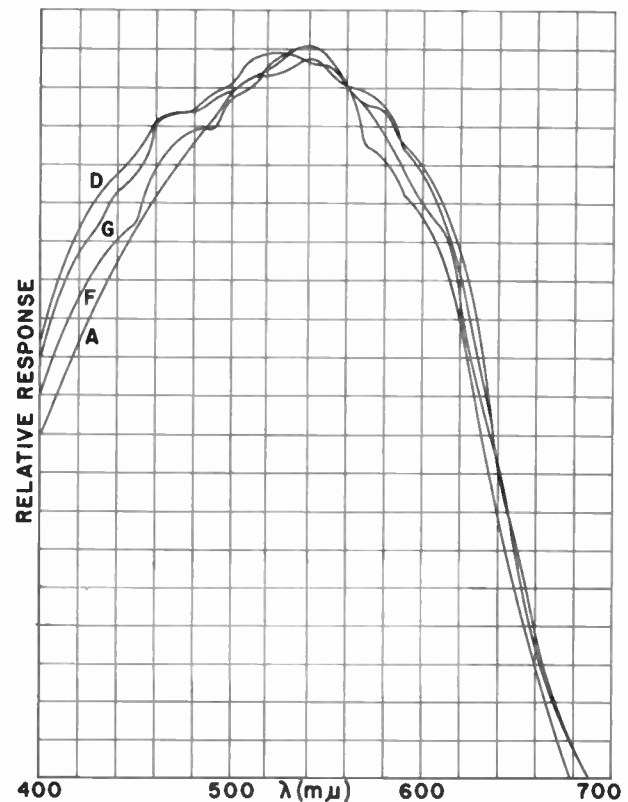

Fig. 10—Equal power response curves of four General Electric photocells per unit slit width (normalized at 560 $m\mu$).

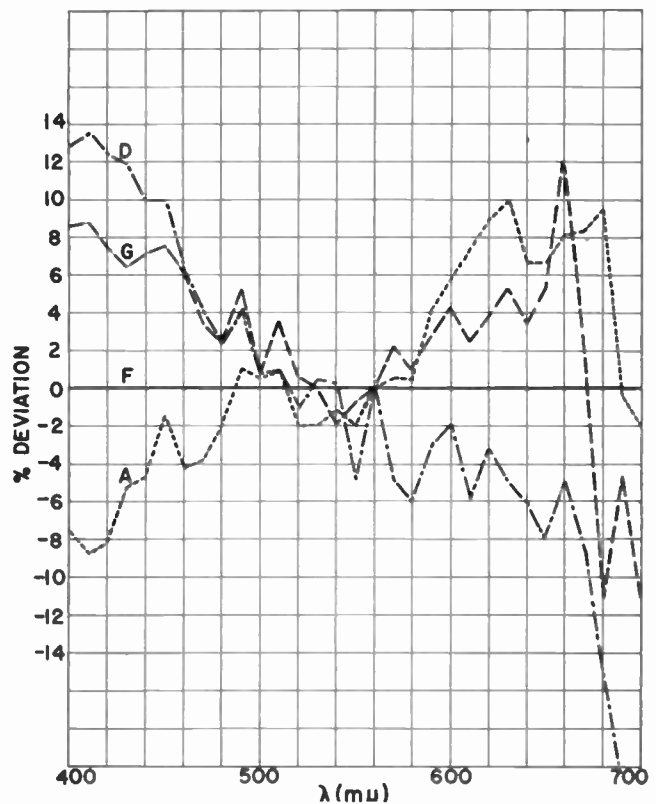

Fig. 11—Deviation of response curves from that of photocell *F*.

out that the manufacturer made no claim regarding the suitability of these cells for colorimetry. These curves cannot be regarded as critical of quality, but should be an indication of the problem which a colorimeter manufacturer must face.

Just as it is not possible to reproduce exactly the spectral response curve of a photocell, so it is not possible to obtain identical filters. The transmissions of two filters of the type required for the \bar{y} response are shown in Fig. 12, together with the typical curve for the glass

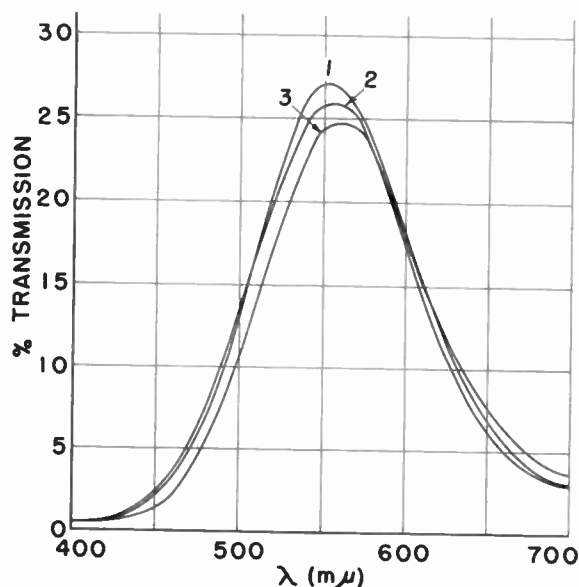

Fig. 12—Transmission curves—*B* filters for Barnes colorimeter.

batch from which the filters came. Deviations for the other three filters are similar, but are not shown.

It is interesting to note the small error which would result, however, were one to measure the color of a black body at 6500°K when using a Barnes-type colorimeter comprising cell *F* and the set of filters of which 3 of Fig. 12 is a part. See Table I. The trichromatic coeffi-

TABLE I
CALCULATED TRICHROMATIC COEFFICIENTS—
BLACK BODY AT 6500° K.

	x	y
True ICI Values	0.313	0.324
Four-Filter Colorimeter	0.313	0.325
Three-Filter Colorimeters		
(a) Photocell <i>P</i>	0.313	0.327
(b) Photocell <i>Q</i>	0.313	0.328
(c) Photocell <i>R</i>	0.317	0.325

cients were computed. Included also are computed trichromatic co-ordinates for three Hunter-like colorimeters using the same set of filters for each, but with three different makes of photocell. These rather good agreements result from the smooth energy-distribution curve

for a black body at 6500°K. A less regular distribution could yield greater discrepancies. Note, however, the better agreement for the four-filter colorimeter.

It is obvious that the selection of filters and cells to form a set should not be left to chance. There is, therefore, room for a reliable manufacturer to place on the market a complete Barnes-type meter.

The Photovolt Corporation offers a three-filter Hunter-like colorimeter with which this laboratory has had but recent experience. It should be noted that it is a three-filter colorimeter, and therefore subject to the faults pointed out by Hunter¹² and others.¹⁸ However, it should be satisfactory for measuring the extent to which a substantially white screen deviates from an isospectroradiometric standard.²²

It is interesting to consider the colorimetric methods being used at present by various crt manufacturers in this country. Table II shows the results of a survey con-

TABLE II
COLORIMETRIC EQUIPMENT USED BY CRT
MANUFACTURERS IN U.S.

Manu- facturer	Spectro- radiometer	Barnes Colorimeter	Hunter Colorimeter
1	<i>L</i>	<i>L-P</i>	<i>L</i>
2	<i>L-P</i>		
3	<i>L</i>	<i>L-P</i>	
4			<i>L</i>
5	<i>L</i>	<i>P</i>	
6		<i>L-P</i>	
7		<i>P</i>	

L: Used in Engineering Laboratory.
P: Used in Production.

ducted by A. E. Martin, co-author of this paper. Note that but one company uses a spectroradiometer in production control, while five use Barnes-type colorimeters, and none use Hunter-like instruments. It is believed that most of the filter-photocell colorimeters are used without benefit of an isospectroradiometric standard. Laboratory tests involve more types of instruments per company, although no standardization exists. That further work remains to be done on colorimeters can be seen from the plot of Fig. 13. This is an expanded view of a portion near the center of the horseshoe-shaped curve shown in Fig. 5. The polygon *ABCDE* defines the tentative limits for color for P4 screens as considered by a subcommittee of the Joint Electron Tube Engineering Council (JETEC) on December 12, 1946. The other lettered points are the results of measurements made on the same tube by crt manufacturers. Those marked *W* and *S* were made by means of spectroradiometers, while the others were made with Barnes-type colorimeters. Note that *T* falls outside the acceptable area.

²² It has recently come to the attention of the authors that there is available a set of three tristimulus filters for use with a General Electric photocell to make up a Hunter-like colorimeter. These filters are reported to be similar to those described in footnote reference 12. They are for sale by the Henry A. Gardner Laboratory, Bethesda, Md.

Note, further, that the instrument errors are comparable with the width dimension of the acceptable area. Even the spectroradiometrically determined points deviate appreciably.

The gist of what has already been presented can be stated as follows:

1. Television has reached the state of commercialization at which standards for, and methods of, measurement of crt screen color should be established.

2. The theory of color specification is well worked out, and has been standardized by the ICI.

3. Measuring instruments now in use give widely differing readings. Secondary standard instruments are used in many cases without adequate calibration procedure.

4. Some attempt is being made through JETEC to set up specifications and tolerances for screen color, although the methods of measurement are still at such variance as to make this of questionable value.

At the Rochester Fall Meeting on November 18, 1947, at which this paper was presented, the authors made the following proposals relative to standardization of methods of colorimetry and specifications for the light output of crt screens.

First, that The Institute of Radio Engineers should define the appropriate attributes of the light from crt screens and evaluate systems of measurement. As has been pointed out, the necessary theory is already well established. It remains for IRE to pick out those parts of the existing standards and theory which properly apply to crt screens.

Second, that the Radio Manufacturers Association (RMA), or, through it, JETEC, should carry on suitable investigations leading to the specification of methods of measurement.

Third, RMA or JETEC should carry out subjective tests leading to crt screen-color specifications.

The Subcommittee on Phosphors, Committee on Cathode-Ray Tubes JTC6, Joint Electron Tube Engineering Council, has been studying the problem of crt light output specifications. This has been mentioned in connection with Fig. 13. The work to date on methods of measurement has been primarily correlative. It appears to the authors that the differences between readings of primary colorimeters will first have to be resolved and procedures standardized before conditions for use of secondary instruments can be prescribed. It was suggested at Rochester that advantage be taken of the

services of some independent laboratory, such as the National Bureau of Standards, in achieving these ends.

The work of the committee in setting specifications for P4 color has been hampered, of course, by lack of agreement among measuring instruments. Further, the subjective reactions upon which the suggested limits have been based were derived through the independent efforts of the various companies represented. Because of the need of the broadest possible base, sampled under controlled conditions to obtain a reliable measure of subjective reaction, it was proposed at Rochester that RMA, or through it JETEC, set up and conduct controlled tests leading to crt screen-color specifications. Ultimately, the screen colors of cathode-ray tubes sold on the market must become matters of customers'

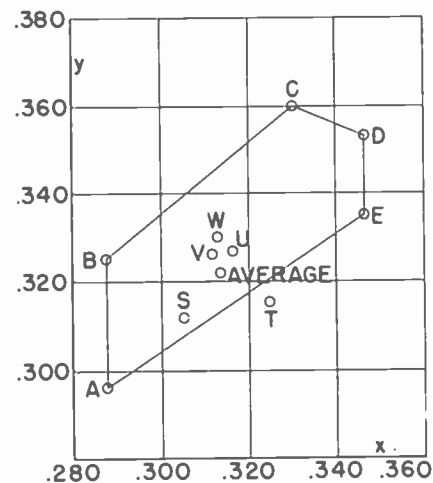

Fig. 13—JETEC proposed tentative color limits for P4 television white cathode-ray-tube screens.

preference. In other competitive merchandising fields where color enters into the design of consumer goods, it is the established practice to survey the color preferences of consumers in various lines, in order to achieve merchandise color co-ordination. For example, a report on such a study, made by Montgomery Ward and Company, was given at a recent meeting of the Inter-Society Color Council. On the grounds that "sauce for the goose is sauce for the gander," the importance of final subjective color approval by the customer of television picture screens must now be evident. However, this work can scarcely be done until satisfactory objective methods of measurement have been established.

Correction

In the paper, "500-Mc. Transmitting Tetrode Design Considerations," by W. G. Wagener, which appeared on page 611 of the May, 1948, issue of the PROCEEDINGS OF THE I.R.E., the decimal classification reads: R399.2. This classification should read: R339.2.

Megacycle Stepping Counter*

C. B. LESLIE†, ASSOCIATE, IRE

Summary—This paper describes the development and construction of a modified ring- or stepping-type counter capable of operating at a megacycle rate. Two special features are described: the input-pulse commutator, and the method of interstage coupling. Application to electronic digital computing work is discussed briefly.

THE PROPOSED DEVELOPMENT and design of a high-speed electronic digital computing machine at the Naval Ordnance Laboratory created a number of problems which had never been solved. A prerequisite for the solution of a group of these problems was a ring- or stepping-type counter capable of operating at a megacycle input pulse rate. Probably the most important use for this counter was as a practical "word source." In electronic computing machines, numbers as well as controlling instructions are transmitted, stored, and acted upon in the form of coded groups of pulses or "words." In this computer it was proposed to have a positive pulse either present or absent at each microsecond interval throughout the group. The information would then be contained in the arrangement of the pulses and blanks. The "word source" should be of such a design as to make it capable of being extended to handle up to 50 pulse positions in one word. It should also be able to put out a single word, or else repeat the same word at regular intervals so that operations may be viewed on a cathode-ray oscilloscope. The arrangement of pulse positions should be easily controlled. For the early work it was desirable to have a row of switches, and to set up the desired "word" by hand presetting a switch for each pulse position. Thus, if the word to be used consisted of pulses in the first-, fourth-, and thirty-ninth-microsecond positions, the corresponding switches would be turned to "on," and that "word" would be available until the switch arrangement was changed.

Conventional counter circuits offer very little help on this problem. Normally, all counting speeds of more than 100 kc are handled with binary-type counters.^{1,2} A binary counter, however, is not applicable to this problem, because it does not provide points where a pulse output may be obtained for each microsecond position independent of the other positions. For example, if a circuit point is selected to give a pulse at the eighth position, it will automatically give the sixteenth also. While it would be possible to use coincidence devices to overcome this, the system would become extremely complex for a 50-position source. Consequently,

* Decimal classification: 621.375.2. Original manuscript received by the Institute, August 27, 1947; revised manuscript received, March 10, 1948.

† Naval Ordnance Laboratory, U. S. Naval Gun Factory, Washington 25, D. C.

¹ I. E. Grosdoff, "Electronic counters," *RCA Rev.*, vol. 7, pp. 438-47; September, 1946.

² H. Lifschutz, "A complete Geiger-Muller counting system," *Rev. Sci. Instr.*, vol. 10, pp. 21-26, January, 1939.

we are forced to work with ring- or stepping-type counters. Those stepping-type counters which are capable of operating with up to 50 stages are usually of the general type shown schematically in Fig. 1. The megacycle pulses are fed continuously into each stage (some form of flip-flop circuit with two input channels and two stable states, each state corresponding to input pulses on one channel). This tends to keep all the stages in one of their two stable conditions, which will be termed the normal state. If something happens to put stage 1 into its other, or odd, state, the next regular megacycle input pulse will flop stage 1 back to normal. This change of state puts out a special pulse which flips stage 2 over to its odd state to be returned to normal by the next regular input pulse. Thus, it may be seen that the odd state advances systematically down the string of stages, moving one stage each regular input pulse.

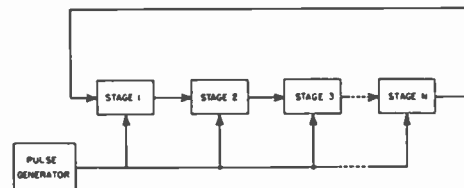

Fig. 1—Block diagram of a conventional ring counter.

The difficulty with this type of stepping counter is easily seen. The special pulse from the preceding stage, which should serve to flip a given stage over to its odd state, will arrive at the stage almost simultaneously with the regular input pulse which tends to keep the stage in its normal state. This leads to an uncertainty of operation and consequent failure of the counter. At relatively low frequencies, it is possible to have the regular input pulses short enough, and the time constants of the stages long enough, so that the flipping action pulse will be delayed a part of a cycle until the regular input pulse has passed. There is, then, no interference, and the counter operates properly. This is impractical, however, at a megacycle rate.

Fig. 2 shows schematically a method of overcoming this difficulty by eliminating the nearly simultaneous application of opposing pulses to the same stage. The binary counter essentially commutates the megacycle input between the two outputs, applying the first, third, and fifth pulses to line 1, and the second, fourth, and sixth pulses to line 2. If stage 1 is supposed to have been put into its odd state at some instant, the next pulse on line 1 switches this stage back to normal, sending a special pulse along the interconnection line to stage 2 and flipping that stage into an odd state. One micro-

second later, a pulse comes on line 2 and changes stage 2 back to normal, thereby setting up stage 3, etc. The operation, therefore, is that each stage in succession flips over to its odd state for 1 microsecond and then goes back to normal. It may easily be seen that the addition of the binary counter eliminates the regular input pulse which would go to stage 2, for instance, at almost the same instant that the opposing special pulse arrived

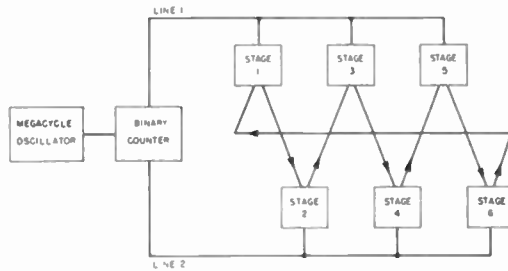

Fig. 2—Block diagram of the proposed megacycle ring counter.

from stage 1. Each stage in this system will consist of a flip-flop circuit with two stable states and two control input channels such that signals on the first input keep it in its normal state and signals on the second input put it into its odd state.

The idea of operating this type of counter as a true ring counter was dropped for two reasons. The first was that ring-type operation of the device used as a "word source" did not adapt itself to generation of a single word. The second objection was that, if the circuit ever generated a second special pulse anywhere in the chain, there was nothing to eliminate this second pulse, and two odd states would continue to circulate, giving two possible pulse outputs for each position. Therefore, it was decided to operate the chain as a stepping-type counter in which the action is initiated by tripping the first stage over to its odd state each time it is desired to generate a word, and the action halts when each stage has operated once.

While recycling of this device can be accomplished in several ways, any satisfactory solution must, in general, be capable of taking a random pulse and putting out a resultant recycling pulse that is fixed in phase relative to the timing pulse input to the counter (binary counter output). The means chosen for accomplishing this synchronization is outlined in block diagram form in Fig. 3.

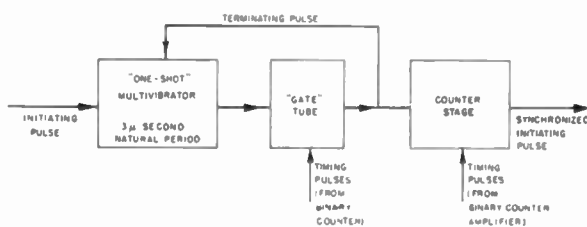

Fig. 3—Block diagram of the pulse synchronizer.

The principle of operation is quite simple. The initiating pulse trips the one-shot multivibrator which puts out a positive pulse of 3 microseconds normal duration (a trigger circuit with one stable state which flips over to its unstable state for a limited period of time upon the application of a triggering pulse). The 3-microsecond pulse is applied to the suppressor grid of the coincidence or gate tube. To the control grid of this tube is fed the positive pulse output from one side of the binary counter (not the output of its inverter-buffer amplifier). Since one of the binary pulses appears every 2 microseconds, there is bound to be at least one, and there may be two, timed pulses arriving during the 3-microsecond period the gate is open. In order to eliminate the possible second pulse output, part of the gate-tube output is fed back to the one-shot multivibrator, shutting it off as soon as one timing pulse has been gated. Since, supposedly, the pulse synchronization has already been accomplished, the addition of the counter stage is merely a refinement.

However, because all the pulses concerned are somewhat rounded in shape instead of square, there will be an appreciable uncertainty in the amplitude, phase, and shape of the gated pulse. In addition, the phase of the output of the gate tube will differ from that of a regular counter stage. Hence, the first stage of the actual counter circuit would operate slightly differently from succeeding stages. The addition of the extra counter stage to the pulse synchronizer eliminates this uncertainty and difference in operation.

The pulse-synchronizer circuit as actually built and operated in conjunction with the megacycle counter was somewhat different from the block diagram. The original initiating pulse was derived from a scale-of-eight binary counter driven by the megacycle timing oscillator. This scheme allowed the period of the one-shot multivibrator to be reduced to just under two microseconds, and thus eliminated the possibility of two pulse outputs. It also tended to fix the phase of the original initiating pulse and thereby gave greater certainty of operation. The circuit diagram is shown in Fig. 4. The final timed pulse comes from output C. It will be noted that a two-stage pulse-sharpening amplifier was included to standardize the waveform of the initiating pulse. The megacycle binary counter is also included in this chassis, together with a two-stage limiter input amplifier and two output inverter-buffer amplifiers. The binary-counter stage is of fairly standard form, being essentially the same as that used in the RCA commercial megacycle counter.¹

The circuit diagram for the counter chassis is shown in Fig. 5. It consists of six identical stages with coupling networks between them and a mixer unit to give the desired word source. Each counter stage consists of a pentode and one-half of a double triode, or a tube complement of one and one-half tubes per stage. The plates of the tubes are cross-connected to the control grid of the triode and the suppressor grid of the pentode, so that

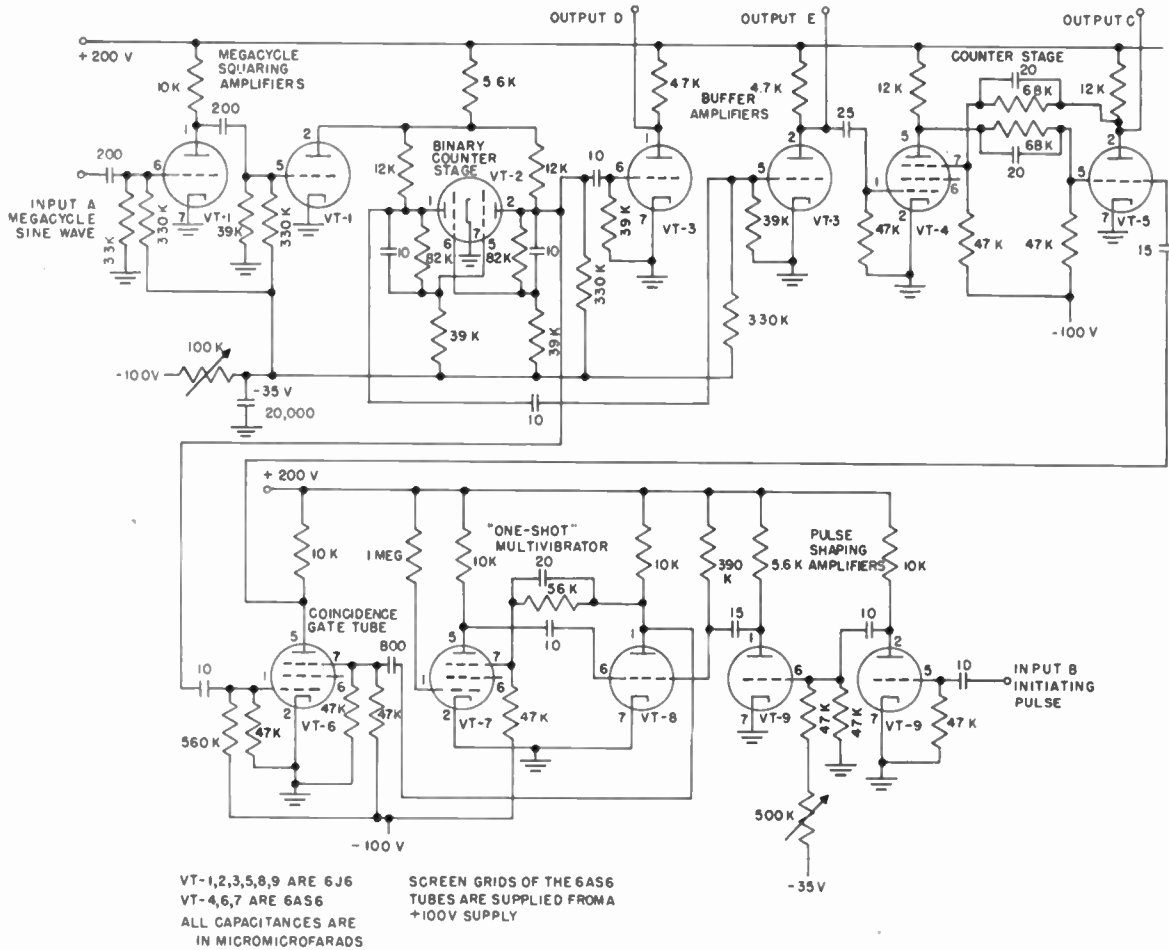

Fig. 4—Circuit diagram of the pulse-synchronizer chassis.

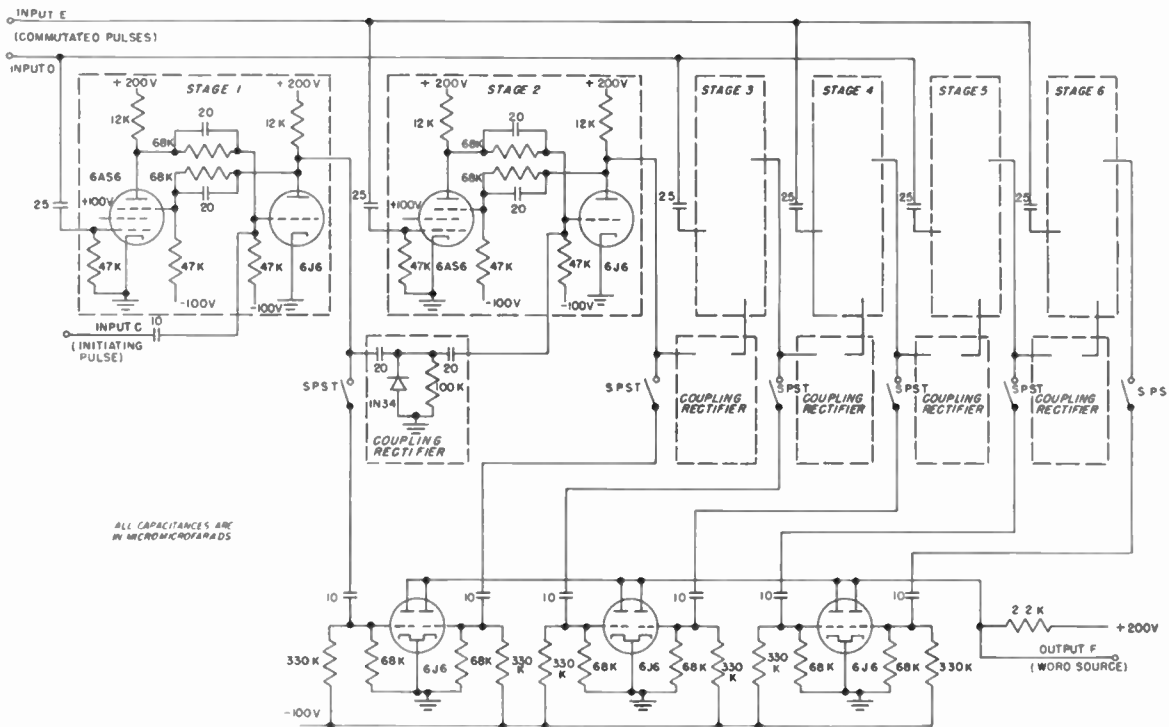

Fig. 5—Circuit diagram of the counter chassis.

whichever tube is conducting will hold the other cut off. The half-megacycle negative timing pulses are fed onto the control grid of the pentode, and keep that tube normally cut off. The special pulse that sets a stage into its odd state is a positive pulse, coupled through a capacitor to the triode grid, which rises in voltage one microsecond and falls the next. Since the triode grid is already conducting, it cannot rise much higher, so the coupling capacitor charges up through the low-impedance grid. Then, when the pulse starts dropping, the grid is driven negative, and conduction is transferred from the triode to the pentode. The next timing pulse arrives one microsecond later and turns the pentode off and the triode on. The triode output, therefore, is a voltage rise for one microsecond and a drop the next. This output is used as the special pulse fed to the triode grid of the next stage to set it into its odd state, and is also fed to the mixer.

The mixer consists of six identical triode units with a common plate load. Each grid has a negative bias that normally keeps it cut off, but it is coupled to the output of one of the counter stages. The triode unit will conduct, therefore, whenever the counter output pulse exceeds the negative bias. The switches between the counter stages and the mixer allow a selection of the pulses which are to be mixed without interfering with the action of the counter.

Originally, single 10- μf capacitors were used to couple between the stages. This arrangement, however, was found to lead to the introduction of undesired odd states into the counter. The means by which this was accomplished may be understood by a study of the somewhat idealized waveforms shown in Fig. 6. In analyzing Fig. 6, it is necessary to remember two things. The first is that the output from each stage forms the input for the next stage. The second point is that, even

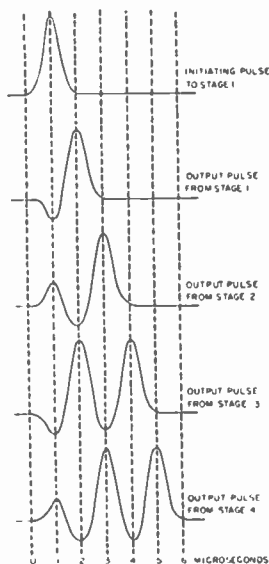

Fig. 6—Idealized counter waveforms without rectifiers between stages.

though a tube is limiting itself by drawing grid current, a positive pulse applied to the grid will cause even more plate current to flow. It is this second point which caused the difficulties. In the first stage, for instance, the rising input voltage overdrives the 6J6 and thus gives the small negative peak in the output. Then, as the input drops, the tube is cut off and the plate voltage rises rapidly to its maximum, only to drop again the next microsecond as the regular timing pulse switches the other half of the stage off and the 6J6 on again. Considered only by itself, this waveform would cause no trouble; but when it is fed into later stages, it does. In the second stage the initial drop in the input starts to cut the tube off. The signal is so small that only partial cutoff is achieved before the input voltage rises again and overdrives the tube. From here on the process is the same as that for the first stage. From the output of the second stage, however, we have a voltage drop exactly 2 microseconds ahead of the desired main drop, and approximately 40 per cent as large. It may be seen that this spurious signal produces a full-size signal 2 microseconds later. As stated before, once this spurious signal is generated, it will continue down the rest of the chain of stages.

The problem, therefore, is to find some means of eliminating the small negative peak of voltage which may be seen in the output of the first stage. A number of possible solutions were tried, the one which was finally adopted being to break the 10- μf coupling capacitor between stages into two 20- μf capacitors in series. A type 1N34 crystal rectifier, connected in parallel with a resistor, was placed from the midpoint to ground with polarity such as to short out any negative voltage. The parallel resistor normally maintains the high side of the diode at ground potential.

Fig. 7 shows oscilloscope tracings of the output waveform of the counter used as a word source for three different combinations of stages connected to the mixer. They were obtained with a Du Mont 248 oscilloscope with probe input and driven sweep. The breaks in the traces represent 1-microsecond timing marks.

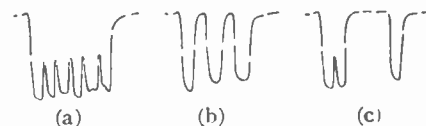

Fig. 7—Counter output with various combinations of stages connected to the mixer:
 (a) Stages 1, 2, 3, 4, 5, 6;
 (b) Stages 1, 3, 5;
 (c) Stages 1, 2, 6.

The counter was built up with randomly selected components comprising resistors of 10 per cent tolerance and capacitors of 20 per cent tolerance. No difficulties were observed due to these tolerances, however. As a check on the stability and reliability of the counter, the nega-

tive bias supply was varied from -80 to -115 volts before operation failed. This is quite an extended range for a device employing a large number of high-frequency multivibrator circuits. With a negative bias supply of -100 volts, the frequency was varied from 0.5 to 1.3 Mc. before the operation failed. At higher frequencies, cutoff was due to failure of the binary counter stage, while at lower frequencies, the pulse synchronizer stopped operating properly. This is to be expected, since this particular synchronizer is designed to operate only at 1 Mc.

Unfortunately, the computing machine project at the Laboratory was dropped before this megacycle-counter

project was fully completed. The principles of operation, however, should be useful in many applications where high-frequency ring-counter circuits are desired. The stepping counter also offers interesting possibilities as an electrical delay or storage device with the length of delay variable over a wide range. An accurately timed delay is available by using that number of stages; and if the timing-oscillator frequency is varied, the periods themselves may be varied. Such a delay device also has the advantage that the pulse is regenerated each cycle, so that the waveform remains good and is independent of the length of delay or number of outputs taken from the device.

Cathode-Coupled Negative-Resistance Circuit*

PETER G. SULZER†, ASSOCIATE, IRE

Summary—The cathode-coupled negative-resistance circuit is considered at medium, low, and high frequencies. The effects of supply-voltage variations are also treated. It is found that the more common types of dual triodes are capable of developing a negative resistance of the order of 1000 ohms. It is also found that these tubes are useful as oscillators well into the vhf range with this circuit. The assumption is made that amplitudes are sufficiently small to permit the use of linear tube parameters. It should be noted that frequently this is not the case unless some means of amplitude control is provided.

INTRODUCTION

THE PURPOSE of this paper is to present an analysis of the negative-resistance circuit shown in Fig. 1(a). Although it has been described before¹ and its applications demonstrated,^{2,3} there has not been, to the writer's knowledge, a complete investigation of its potentialities. An analysis would seem desirable because of the great utility of the device.

MEDIUM FREQUENCIES

Medium frequencies are defined here as those at which the reactances of all capacitances can be neglected. Under these conditions, an equivalent circuit, Fig. 1(b), may be drawn. The circuit will be considered as a feedback amplifier.

* Decimal classification: R139.2. Original manuscript received by the Institute, September 22, 1947; revised manuscript received, January 19, 1948. The work reported in this paper was done under a research contract, W28-099-ac-143, between the Pennsylvania State College and the Watson Laboratories, Air Materiel Command, Red Bank, N. J.

† Pennsylvania State College, State College, Pa.

¹ G. C. Sziklai and A. C. Schroeder, "Cathode-coupled wide-band amplifiers," *Proc. I.R.E.*, vol. 33, pp. 701-703; October, 1945.

² Keats A. Pullen, Jr., "The cathode-coupled amplifier," *Proc. I.R.E.*, vol. 34, pp. 402-406; June, 1946.

³ Murray G. Crosby, "Two-terminal oscillator," *Electronics*, vol. 19, pp. 136-137; May, 1946.

If a voltage E is applied to the input of an amplifier whose voltage gain is $A < \theta$, where θ is the phase angle of A , its output will be $EA < \theta$. The amplifier has an internal impedance Z_i in the absence of feedback. If the output is now connected back to the input, a single-loop circuit results. It is apparent that the current i in this loop will be

$$i = \frac{E - EA < \theta}{Z_i} = \frac{E(1 - A < \theta)}{Z_i} \quad (1)$$

The impedance Z seen by source E will be

$$Z = \frac{e}{i} = \frac{Z_i}{1 - A < \theta} \quad (2)$$

Z_i and A may have any magnitude and phase angle, so Z may have positive or negative resistance and reactance components. At medium frequencies Z is a pure positive resistance, and A may have a phase angle of 0 or 180 degrees. As may be readily seen, the cathode-coupled amplifier of Fig. 1(b) has its output voltage in phase with its input voltage, so that $A < \theta = A < 0$, or simply A .

Z will then be the negative resistance,

$$R = \frac{R_i}{1 - A} \quad (3)$$

where R_i is Z at medium frequencies, and when $A > 1$, which is the case of interest here.

The amplifier of Fig. 1(b) may be considered as a cathode follower V_1 driving a grounded-grid stage V_2 through a coupling resistor R_K . The two tubes are taken as identical, each having an amplification factor μ and a plate resistance R_P . Considering V_2 ,

$$I_P = \frac{E_g + \mu E_g}{R_P + R_L}$$

where E_g is the ac voltage between grid and cathode of V_2 , I_P is the ac plate current, and R_L is the load resistance.

Thus,

$$R_1 = \frac{E_g}{I_P} = \frac{R_P + R_L}{\mu + 1}$$

where R_1 is the impedance seen looking into the cathode circuit of V_2 .

The gain of the cathode follower V_1 is

$$ACF = \frac{1}{\frac{\mu + 1}{\mu} + \frac{R_P}{\mu R_K}} = \frac{1}{\frac{\mu + 1}{\mu} \left[1 + \frac{R_P}{R_P + R_L} \right] + \frac{R_P}{\mu R_K}}$$

since R_2 is R_1 in parallel with R_K .

The gain of the grounded-grid stage V_2 is

$$A_{ggs} = \frac{\mu + 1}{1 + \frac{R_P}{R_L}}$$

and hence the over-all gain

$$A = A_{cf} \times A_{ggs} = \frac{1}{\frac{\mu + 1}{\mu} \left[1 + \frac{R_P}{R_P + R_L} \right] + \frac{R_P}{\mu R_K}} \times \frac{\mu + 1}{1 + \frac{R_P}{R_L}}$$

which can be written

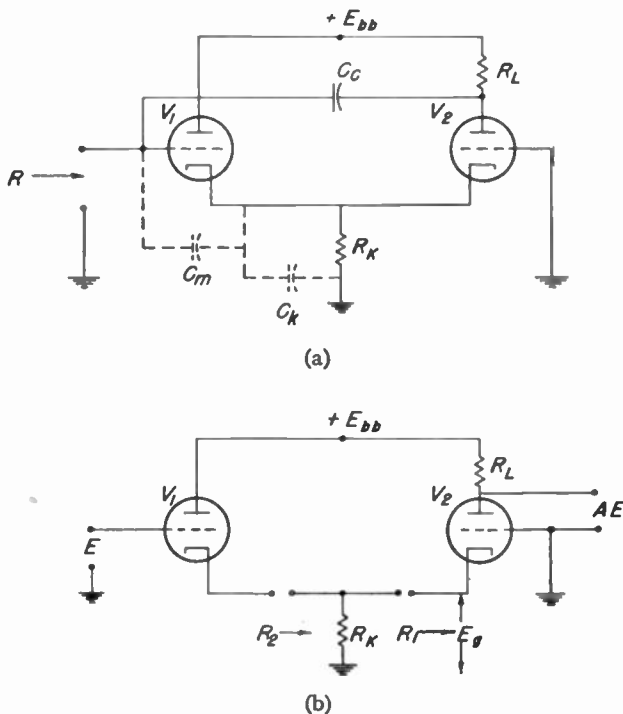

Fig. 1—(a) Negative-resistance circuit; (b) equivalent circuit.

$$A = \frac{\mu R_L}{R_P \left[2 + \frac{R_P + R_L}{R_K(1 + \mu)} \right] + R_L} \quad (4)$$

This value of A is now to be substituted in (3) to determine the magnitude of the negative resistance appearing between the grid of V_1 and ground, Fig. 1(a).

It is first necessary to evaluate R_i . By Thevenin's theorem, R_i will be the resistance looking back into the amplifier with all voltage sources shorted out. This will be R_L in parallel with the effective plate resistance of V_2 . The effective plate resistance of V_2 is higher than R_P because of the impedance inserted in its cathode circuit. This impedance will be R_K in parallel with the output impedance of the cathode follower V_1 .

The output impedance of the cathode follower is $R_P/\mu + 1$.

The effective plate resistance of V_2 is $R_P + (1 + \mu)$ (cathode impedance)

$$= R_P + \frac{(1 + \mu)R_P R_K}{R_P + (1 + \mu)R_K}$$

R_i will be this resistance in parallel with R_L .

$$R_i = \frac{R_P^2 R_L + 2R_P R_K R_L(1 + \mu)}{R_P(R_P + R_L) + (1 + \mu)(2R_P R_K + R_K R_L)} \quad (5)$$

Substituting (4) and (5) in (3) yields

$$R = \frac{R_i}{1 - A} = R_L \frac{\frac{R_P^2}{R_K} + 2(1 + \mu)R_P}{R_L \left[\frac{R_P}{R_K} + 1 - \mu^2 \right] + \frac{R_P^2}{R_K} + 2(1 + \mu)R_P} \quad (6)$$

Fig. 2 is a plot of R versus R_K for four representative dual-triode types, the 6SN7GT, 6J6, 12AU7, and 2C51. To obtain these results it was necessary to measure μ and R_P for each value of cathode resistor R_K .

LOW FREQUENCIES

At low frequencies, the reactance of C_c , Fig. 1(a), must be considered. Therefore, R_i must be replaced by

$$Z_i = R_i + \frac{1}{j\omega C_c} \quad (7)$$

Since the frequency is low, A will have zero phase angle. Substituting (7) and (4) in (2) yields

$$Z = R_L \frac{\frac{R_P^2}{R_K} + 2(1 + \mu)R_P}{R_L \left[\frac{R_P}{R_K} + 1 - \mu^2 \right] + \frac{R_P^2}{R_K} + 2(1 + \mu)R_P} + \frac{1}{j\omega C_c} \frac{(1 + \mu)(2R_P R_K + R_K R_L) + R_P(R_P + R_L)}{R_K R_L(1 - \mu^2) + 2R_P R_K(1 + \mu) + R_P(R_P + R_K)} \quad (8)$$

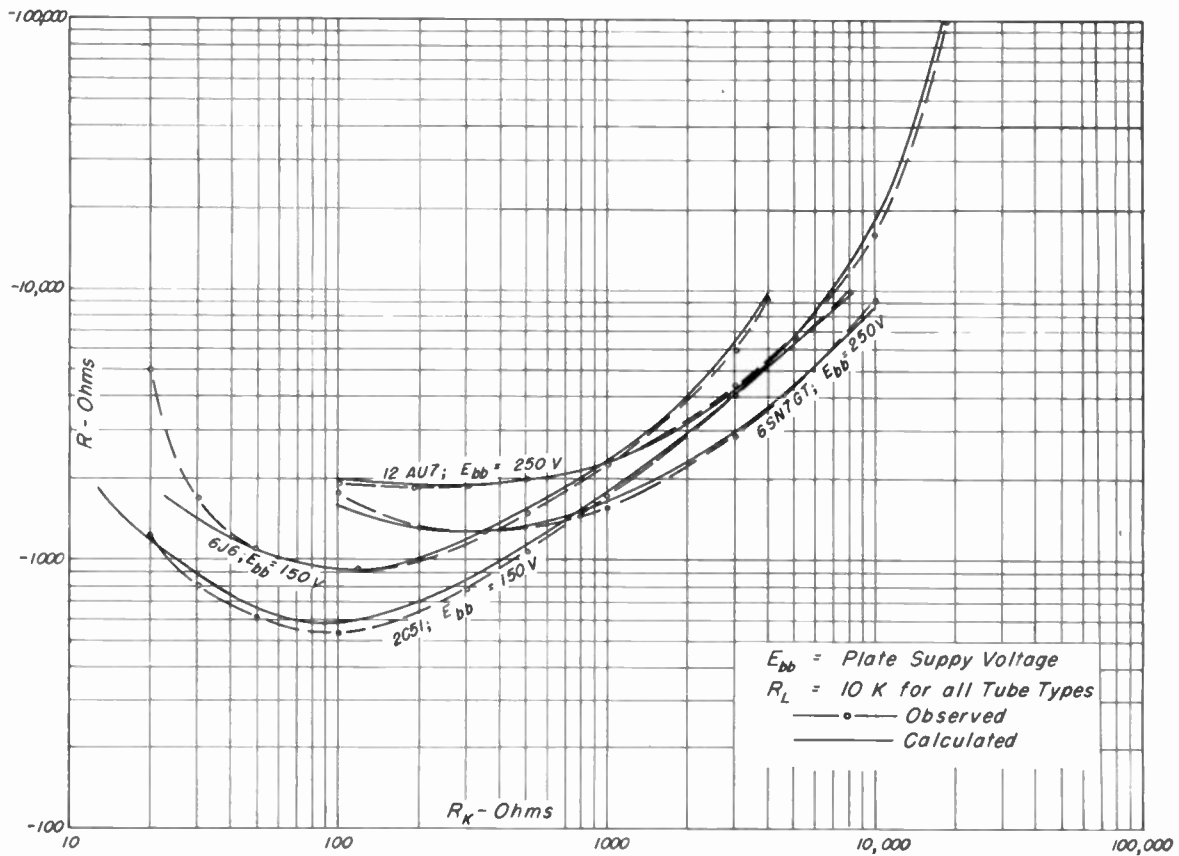

Fig. 2—Negative resistance as a function of cathode resistance; tube types 6SN7GT, 6J6, 12AU7, and 2C51.

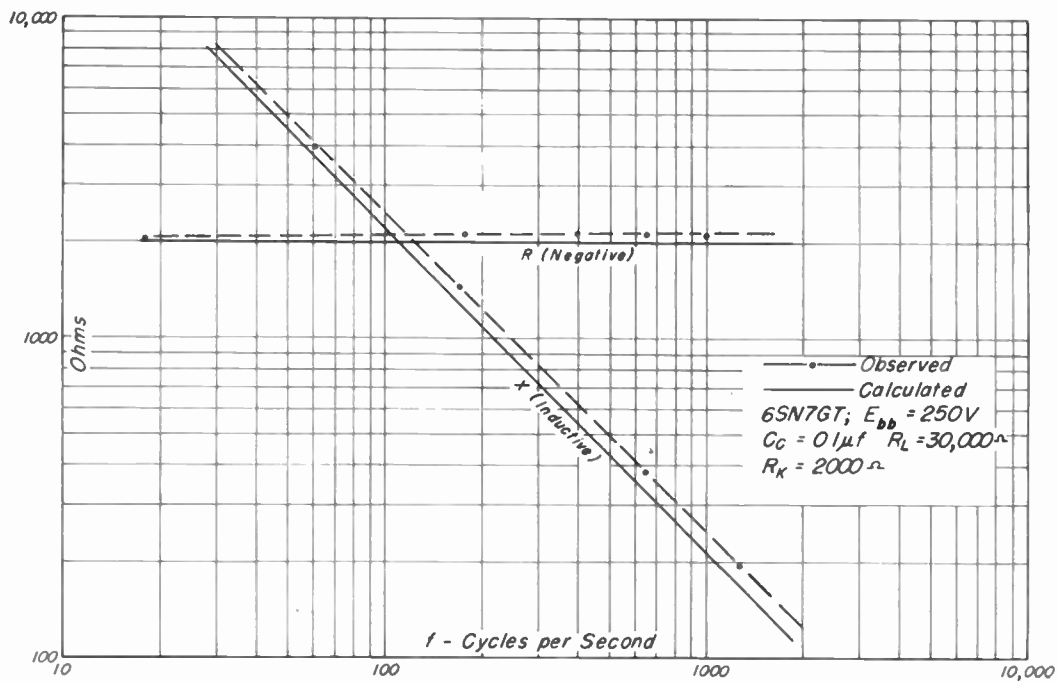

Fig. 3—Low-frequency case. Series components of impedance versus frequency.

The first term is the original expression for R , in (6), while the second involves a multiplier times $1/J\omega C_c$. If the denominator of this multiplier is negative, which it is for normal circuit values, Z is of the form $Z = R + JX$, indicating that, at low frequencies, the circuit appears as a negative resistance in series with an inductive reactance. However, since the magnitude of the reactance is inversely proportional to frequency, the circuit can be considered as a negative resistance in series with a negative capacitance. Fig. 3 is a plot of R and X versus frequency for the conditions given in the figure.

HIGH FREQUENCIES

At high frequencies, the reactance of C_c , Fig. 1(a), can be neglected, but the reactance of C_K and C_M must be considered. The capacitance across R_L is neglected since in most applications it would be tuned out. It is convenient to consider C_K and C_M separately.

To allow for C_K , R_K in (6) must be replaced with

$$Z_K = \frac{R_K}{1 + J\omega C_K R_K},$$

the impedance of C_K and R_K in parallel. This yields

$$Z = R_L \left\{ \frac{(3 + 2\mu - \mu^2)R_L + 4R_P(1 + \mu)}{R_K} + \frac{R_P(R_P + R_L)}{R_K^2} + 4(1 + \mu)^2 + 2(1 + \mu)(1 - \mu^2) \frac{R_L}{R_P} + \omega^2 C^2 R_P(R_P + R_L) - J\omega C(1 + \mu)^2 R_L \right\} \left[\frac{R_P + R_L}{R_K} + 2(1 + \mu) + (1 - \mu^2) \frac{R_L}{R_P} \right]^2 + \omega^2 C^2 (R_P + R_L)^2 \quad (9)$$

in rationalized form. Z is now of the form $R - JX$ in the practical case, where the values of both R and X depend on frequency. Therefore, at high frequencies the circuit appears as a negative resistance in series with a capacitive reactance.

Fig. 4 is a plot of R and X versus frequency, calculated from (9). A large value of C_K was used to facilitate measurements, as described below.

It is difficult to determine from (9) the frequency range in which C_K becomes effective. It can be stated,

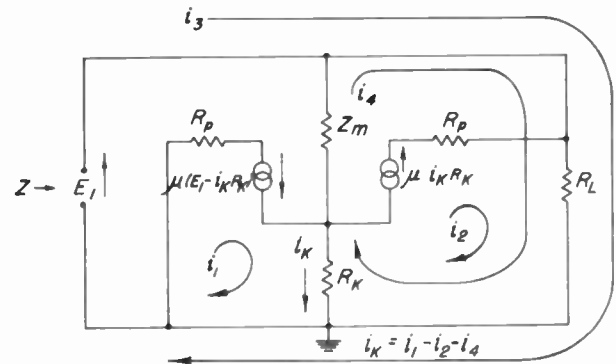

Fig. 5—Network for considering C_M .

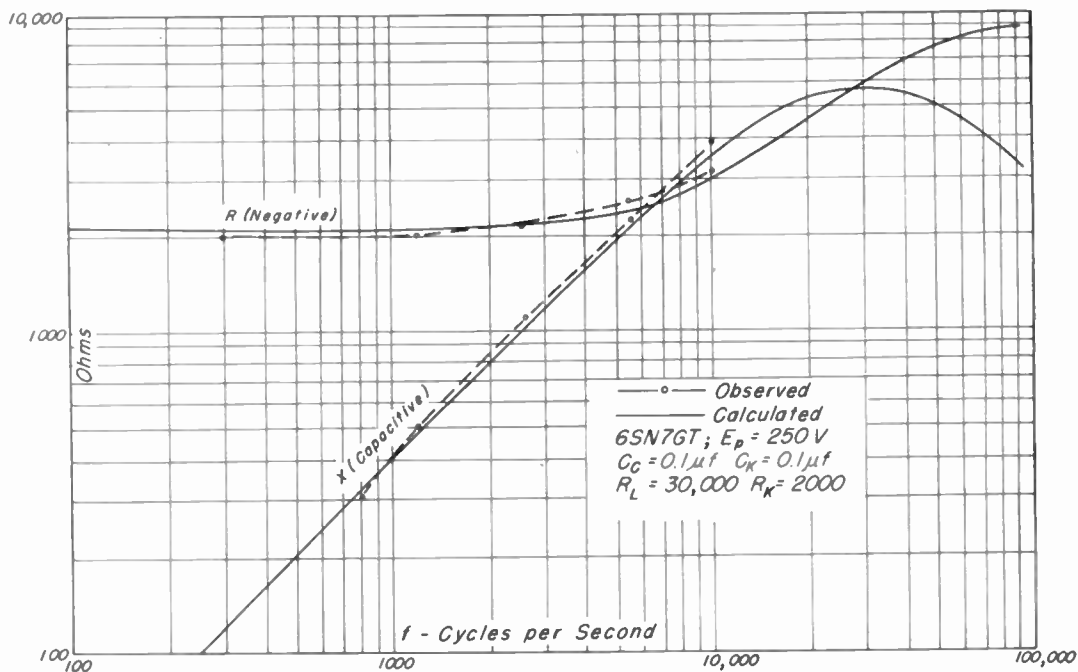

Fig. 4—High-frequency case considering C_K . Series components of impedance versus frequency.

however, that, since the main effect of C_K is to load the cathode follower, $1/J\omega C_K$ must be large compared with the total impedance from cathodes to ground, which is R_K in parallel with the output impedance of the cathode follower and the input impedance of the grounded-grid stage.

In considering C_M , it is convenient to set up the network shown in Fig. 5. Writing the loop equations,

$$\left. \begin{aligned} \mu(E_1 - i_K R_K) &= i_1(R_P + R_K) - i_2 R_K && + i_3 0 - i_4 R_K \\ \mu i_K R_K &= -i_1 R_K && + i_2(R_P + R_K + R_L) + i_3 R_L + i_4(R_K + R_L) \\ e_1 &= i_1 0 && + i_2 R_L && + i_3 R_L + i_4 R_L \\ 0 &= -i_1 R_K && + i_2(R_K + R_L) && + i_3 R_L + i_4 \left(R_K + R_L + \frac{1}{J\omega C_M} \right) \end{aligned} \right\} \quad (10)$$

where the current variables are defined in Fig. 5. Solving for i_3 , and letting $Z = E_1/i_3$, we obtain

$$Z = R_L \left[\frac{AD + BE\omega^2 C^2}{D^2 + E^2\omega^2 C^2} + J \frac{(BD - AE)\omega C}{D^2 + E^2\omega^2 C^2} \right] \quad (11)$$

in rationalized form. The parameters A , B , D , and E are defined by the relations

$$A = R_P^2 + 2(1 + \mu)R_P R_K$$

$$B = R_P^2 R_K$$

$$D = R_P^2 + R_P[R_L + 2(1 + \mu)R_K] + (1 - \mu^2)R_K R_L$$

$$E = R_P^2(R_K + R_L).$$

Fig. 6 is a plot of the components R and X of the impedance Z plotted against frequency.

If C_K had been $20 \mu\mu\text{f}$, a practical value, R would be about -4000 ohms at 100 Mc. If C_M had been $5 \mu\mu\text{f}$,

R would have been negative at frequencies as high as 70 Mc; thus, the circuit is capable of functioning as an oscillator in the vhf range. It has been found by experiment that the 6J6 and 2C51 will oscillate well at frequencies as high as 300 Mc.

SUPPLY-VOLTAGE VARIATIONS

It is possible to determine the effects of supply-volt-

age variations if μ and R_P are known at the different supply voltages. These values, when substituted in (6), will give R for the desired conditions.

Fig. 7 is a plot of R versus E_{bb} for typical operating conditions with a type-6SN7GT tube. In drawing this curve, it was necessary to measure μ and R_P for each point calculated. The rate of change of R decreases as E_{bb} is increased, indicating that good negative-resistance stability can be obtained by choosing the correct circuit parameters.

EXPERIMENTAL RESULTS

Fig. 2 shows a comparison of calculated and experimental values of R for the medium-frequency case. It can be seen that there is close agreement under most conditions. The negative resistance was measured by decreasing the value of a positive resistance, placed in

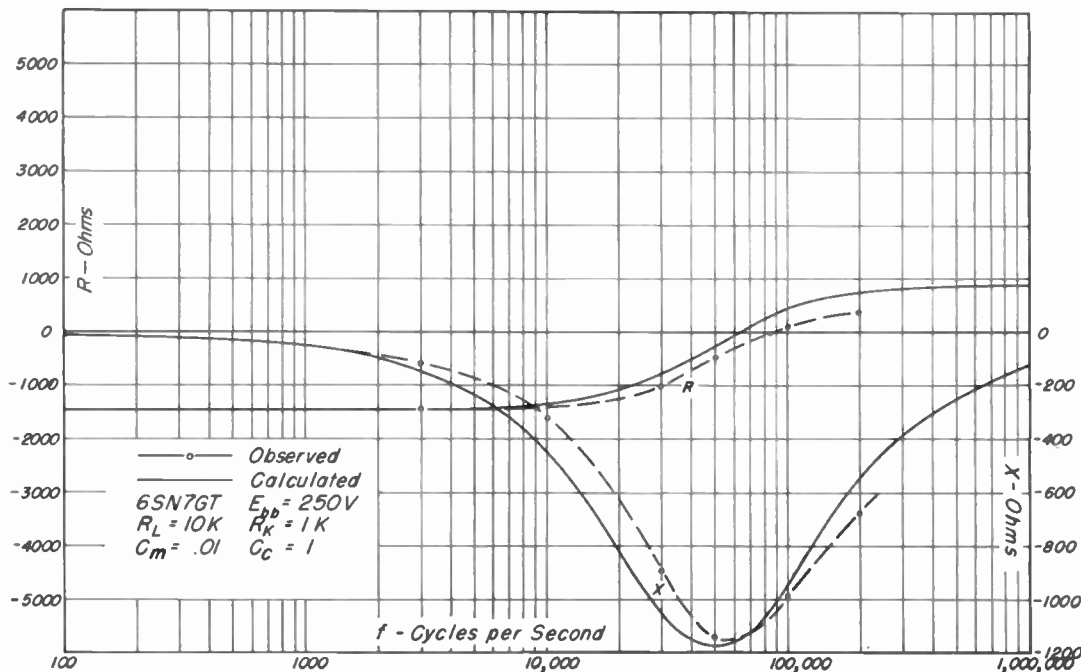

Fig. 6—High-frequency case considering C_M . Series components of impedance versus frequency.

parallel with the circuit, until relaxation oscillations ceased. At this point, the positive resistance equals the negative resistance.

The results of Fig. 3 indicate a close agreement between the calculated and observed components of impedance for the low-frequency case. These measurements were made by shunting a positive damping resistance and a capacitance across the circuit. By adjusting the damping resistance so that oscillations are of extremely small amplitude, the condition is obtained that the equivalent series impedance, made up of positive R and C , is almost exactly equal in magnitude to the internal impedance of the circuit, which is made up of negative R and negative C .

Experimental results for the high-frequency case are plotted in Figs. 4 and 6. Measurements were difficult to make because of the lack of a suitable variable inductance; however, reasonably good results were obtained. To obtain the data shown in Fig. 4, a 0.1- μ fd capacitor was shunted across R_K so that measurements could be made at audio frequencies. For Fig. 6, C_M was 0.01 μ fd. As in the low-frequency case, measurements were made by a resonant device; however, parallel inductance and capacitance were used.

Fig. 7 requires little comment, except that R was measured by means of an external positive resistance, as at medium frequencies.

CONCLUSION

It has been shown that the circuit under discussion is a useful source of negative resistance over a wide frequency range.

The effects of tube and circuit parameters, supply voltage, and frequency have been fully considered.

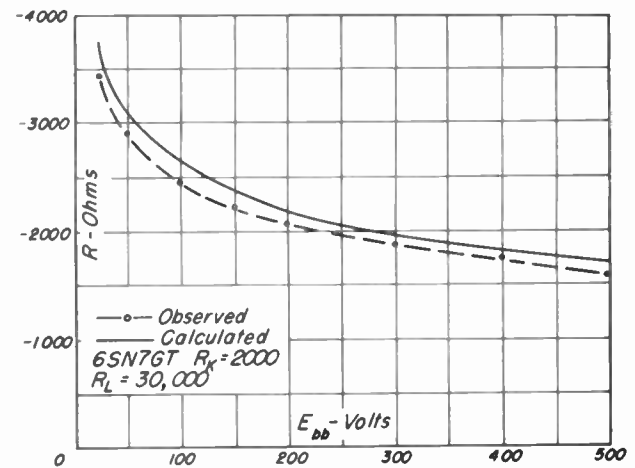

Fig. 7—Negative resistance versus plate-supply voltage.

Although the main application of the circuit has been as a two-terminal oscillator, there are other applications which are enumerated briefly:

- (1) By placing the input across a tuned circuit, its resonant impedance can be measured.
- (2) When shunted across the load impedance of an amplifier, the net impedance may be made very high. With pentode amplifiers, gain exceeding the amplification factor of the tube can be obtained.
- (3) If the circuit is connected as an oscillator, output being taken across R_L , and R_K is adjusted for cessation of oscillation, a very selective amplifier is obtained. The input is applied to the normally grounded grid of the stage.
- (4) Several other applications are noted in footnote reference 3.

Microphonism in a Subminiature Triode*

V. W. COHEN†, AND A. BLOOM†, ASSOCIATE, IRE

Summary—The simple theory of the symmetrical plane triode has been applied to the calculation of the change in plate current as a function of motion of the grid and cathode. For perfect symmetry, the first-order approximation gives zero change in current. The second-order expressions are evaluated and show that an output signal may be expected having twice the vibration frequency. A description is given of equipment for vibrating a tube for test, measuring the amplitude of vibration, detecting very small resonances of tube parts, and studying the wave form of the electrical output.

Experimental studies have been made on tubes to determine the mechanical origin of several different forms of electrical output. In some cases, individual tubes which exhibited particular forms of microphonism have been opened up, the structure altered, and the tube operated under vibration in an evacuated bell jar. In this way, the mechanical origin of particular forms of microphonism were determined quite definitely. A few general comments are given regarding tests for microphonism, and the design of tubes.

INTRODUCTION

THE SUBJECT of microphonics has been discussed only briefly in the literature, and then chiefly in regard to special problems. This report gives

* Decimal classification: R262.9. Original manuscript received by the Institute, December 15, 1947; revised manuscript received, April 1, 1948.

† National Bureau of Standards, Washington, D. C.

some of the results of a study made on a special-purpose triode, somewhat similar to a QF556, in a T2X3 bulb. The methods used, together with the observations made, should serve as indications of what might be looked for in more common tube types.¹⁻³

The principal objective of the study was to arrive at a more general understanding of the processes of microphonism. The tests made were of necessity on a very small statistical sample of the tube type.

In this paper, microphonism is considered to mean any change in plate current of a tube due to vibration of a tube element.

Microphonic variations in plate current have been ascribed to a number of different causes:

1. Variations caused by changes in the interelectrode spacing, produced by mechanical or acoustical excitation of the bulb or base.

2. Intermittent contacts in the tube, caused either by poor welds or by other defects in design or workmanship.

3. Fluctuating electrical leakage, due either to getter material on the mica, or to cathode sputtering of the mica.

4. Charging of the dielectric as a result of pressure.

The first type of microphonism lends itself to a simple theoretical calculation which can be checked roughly by experiment, as will be shown below. The second and third have been observed, and will be discussed in later sections of this paper. The fourth has been suggested and looked for, but has not been observed with the techniques used.

I. THEORY OF THE TRIODE

The tube studied was roughly a symmetrical filamentary triode with approximately plane grid and plate structures. It is illustrated in Figs. 1 and 2.

The microphonic output will be derived for the following three types of vibration for the idealized tube of Fig. 1:

1. The filament vibrating with other elements fixed.
2. The entire grid structure moving as a rigid body.
3. The plate moving as a rigid body.

Numerous well-known equations have been derived relating the space-charge-limited current in a triode to the interelectrode spacings. It is, therefore, relatively simple to express the modulation or change in plate current in terms of the changes in the spacing. If more than one element vibrates, the modulation will be the sum of the modulations due to the separate moving elements, so long as the amplitudes of vibrations are small

¹ A. C. Rockwood and W. R. Ferris, "Microphonic improvements in vacuum tubes," *Proc. I.R.E.*, vol. 17, pp. 1621-1633; September, 1929.

² D. B. Penick, "The measurement and reduction of microphonic noise in vacuum tubes," *Bell. Sys. Tech. Jour.*, vol. 13, pp. 614-633; October, 1934.

³ A. H. Waynick, "The reduction of microphonics in triodes," *Jour. Appl. Phys.* vol. 18, pp. 239-246; February, 1947.

enough to treat the microphonism as a perturbation effect.

With this assumption, only a rough approximation of plate current is necessary.

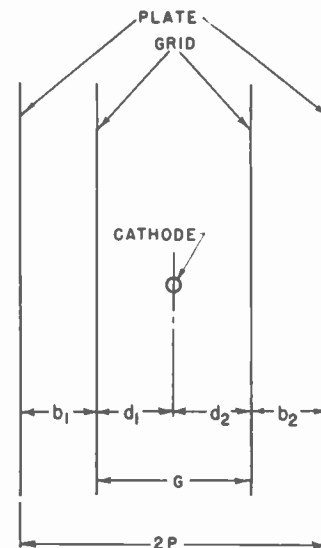

Fig. 1—Schematic arrangement of triode.

A formula in common use for the approximate plate current of a triode of plane elements is:^{4,5}

$$I = \frac{2.336 \times 10^{-6} A (E_g + DE_p)^{3/2}}{d^2 (1 + D)} \quad (1)$$

where

$$D = \frac{1}{\mu} = \frac{\log\left(\frac{1}{2\pi \rho n}\right)}{2\pi n b_1} \quad (2)$$

D = the penetration factor $\frac{1}{\text{amplification factor}}$

E_g = grid bias

E_p = plate voltage

n = number of grid turns per cm

ρ = radius of the grid wire

A = cathode emitting area.

b_1 , d_1 are shown in Fig. 1. Since $D \ll 1$, $(1 + D)$ can be replaced by 1. We can then write:

⁴ E. L. Chaffee, "Theory of Thermionic Vacuum Tubes," McGraw-Hill Book Co., 1933, New York, N. Y.

⁵ Y. Kusunose, "Calculation of characteristics and the design of triodes," *Proc. I.R.E.*, vol. 17, pp. 1706-1750; October, 1929. This paper considers the filamentary nature of the cathode using the formula:

$$I = \frac{2.336 \times 10^{-6} A (E_g + DE_p)^{3/2}}{d (1 + D)}$$

A similar analysis has been made using this formula with results which are similar in character.

$$I = \frac{c}{d^2} \left(E_G + \frac{KE_p}{b} \right)^{3/2} \quad (3)$$

where

$$c = 2.336 \times 10^{-6} A \quad (4)$$

$$K = \frac{1}{2\pi n} \log \left(\frac{1}{2\pi\rho n} \right). \quad (5)$$

For a complete triode, as illustrated in Fig. 1, the plate current will be the sum of two terms, one due to each side.

$$I = I_1 + I_2 = \frac{c}{d_1^2} \left(E_G + \frac{KE_p}{b_1} \right)^{3/2} + \frac{c}{d_2^2} \left(E_G + \frac{KE_p}{b_2} \right)^{3/2}. \quad (6)$$

Consider first the motion of the cathode only. In this case

$$b_1 = \text{constant} \quad (7)$$

$$b_2 = \text{constant} \quad (8)$$

$$d_1 + d_2 = \text{constant}. \quad (9)$$

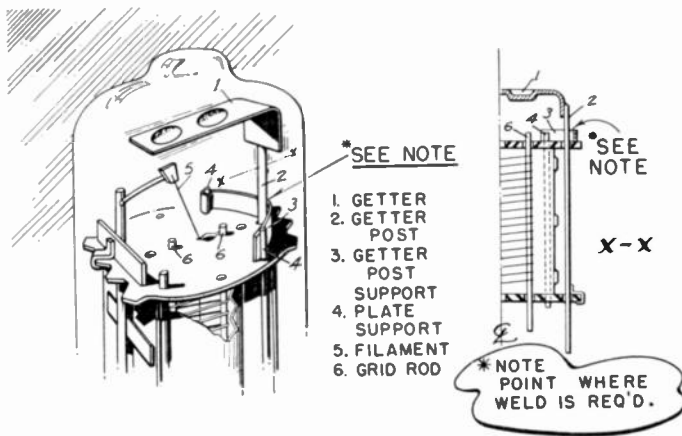

Fig. 2—Pictorial view of the triode, showing loose getter post.

Equations (7), (8), and (9) enable us to reduce (6) to an equation in only one variable, say d_1 .

The plate current can then be evaluated in a McLaurin series of the form:

$$I = I_{01} + \Delta d_1 \frac{\partial I_{01}}{\partial d_1} + \frac{(\Delta d_1)^2}{2} \frac{\partial^2 I_{01}}{\partial d_1^2} + \dots + I_{02} + \Delta d_2 \frac{\partial I_{02}}{\partial d_2} + \frac{(\Delta d_2)^2}{2} \frac{\partial^2 I_{02}}{\partial d_2^2} + \dots \quad (10)$$

From equations (8) and (9), it follows that

$$\Delta d_2 = -\Delta d_1. \quad (11)$$

Then, by evaluating (10) from (5), a general expression for the change in plate current, assuming E_p to remain constant, can be written:

$$I - (I_{01} + I_{02}) = \Delta I = c\Delta d_1 \left[-\frac{2}{d_1^3} \left(E_G + \frac{KE_p}{b_1} \right)^{3/2} + \frac{2}{d_2^3} \left(E_G + \frac{KE_p}{b_2} \right)^{3/2} \right] + c(\Delta d_1)^2 \left[\frac{3}{d_1^4} \left(E_G + \frac{KE_p}{b_1} \right)^{3/2} + \frac{3}{d_2^4} \left(E_G + \frac{KE_p}{b_2} \right)^{3/2} \right]. \quad (12)$$

If condition (6) obtains and $(d_1 - d_2)$ is appreciable, the term in Δd_1 will be the most important term in the series. If, however, the tube is exactly symmetrical, i.e., $d_1 = d_2$, and $b_1 = b_2$, then all odd terms of the expansion in (12) will vanish.

If we suppose the vibration to be harmonic, that is

$$\Delta d = a \sin \omega t, \quad (13)$$

then

$$\Delta d^2 = a^2 \sin^2 \omega t = \frac{a^2}{2} - \frac{a^2}{2} \cos 2\omega t. \quad (14)$$

This implies that, if the triode is symmetrical, its output will have a constant shift and a component of the second harmonic of the vibration frequency.

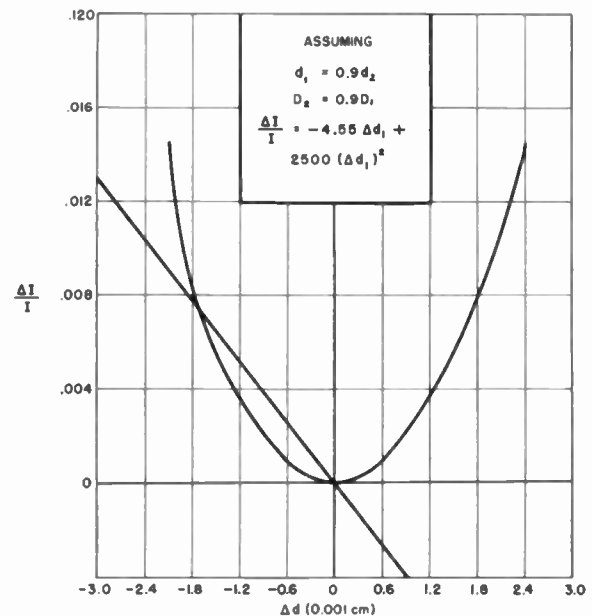

Fig. 3—First- and second-order output variation resulting from filament shift on the triode.

For the special case in which $E_G = 0$, (6) and (12) can be combined in a form more convenient for computation:

$$\frac{\Delta I}{I} = \frac{2\Delta d_1}{d_1} \left[\frac{-1 + \left(\frac{d_1}{d_2}\right)^3 \left(\frac{b_1}{b_2}\right)^{3/2}}{1 + \left(\frac{d_1}{d_2}\right)^2 \left(\frac{b_1}{b_2}\right)^{3/2}} \right] + \frac{3(\Delta d_1)^2}{d_1^3} \left[\frac{1 + \left(\frac{d_1}{d_2}\right)^4 \left(\frac{b_1}{b_2}\right)^{3/2}}{1 + \left(\frac{d_1}{d_2}\right)^2 \left(\frac{b_1}{b_2}\right)^{3/2}} \right] + \dots \quad (15)$$

or, inserting the numerical values for the particular tube under discussion,

$$d_1 = 0.033 \text{ cm} \quad \frac{d_1}{d_2} = 0.9, \quad \frac{b_2}{b_1} = 0.9 \quad (16)$$

$$\frac{\Delta I}{I} = -4.55\Delta d_1 + 2500(\Delta d_1)^2 \quad (\Delta d_1 \text{ in cm}).$$

A plot of these two terms is given in Fig. 3. The straight line represents the first-order term, while the parabola represents the second-order term. Clearly, the greater the asymmetry of the tube, the greater the slope of the straight line.

A similar argument may be applied to the motion of the grid, assuming it to move laterally as a rigid body. In this case, (7), (8), and (9) are replaced by

$$d_1 + d_2 = \text{constant} \quad (17)$$

$$b_1 + b_2 = \text{constant} \quad (18)$$

$$b_1 + d_1 = \text{constant} \quad (19)$$

and, hence,

$$\Delta d_1 = -\Delta d_2 = -\Delta b_1 = \Delta b_2. \quad (20)$$

Differentiation of (6) and substitution of (18) leads to the following formula for the variation in plate current:

$$\begin{aligned} \Delta I = \Delta d_1 \left\{ \frac{c}{d_1^2} \left[-\frac{2}{d_1} \left(E_G + \frac{KE_p}{b_1} \right)^{3/2} + \frac{3}{2} \left(E_G + \frac{KE_p}{b_1} \right)^{1/2} \frac{KE_p}{b_1^2} \right] \right. \\ \left. - \frac{c}{d_2^2} \left[-\frac{2}{d_2} \left(E_G + \frac{KE_p}{b_2} \right)^{3/2} + \frac{3}{2} \left(E_G + \frac{KE_p}{b_2} \right)^{1/2} \frac{KE_p}{b_2^2} \right] \right\} \\ + \frac{(\Delta d_1)^2}{2} \left\{ \frac{c}{d_1^2} \left[\frac{6}{d_1^2} \left(E_G + \frac{KE_p}{b_1} \right)^{3/2} + \frac{3KE_p}{b_1^2} \left(\frac{1}{b_1} - \frac{2}{d_1} \right) \left(E_G + \frac{KE_p}{b_1} \right)^{1/2} + \frac{3}{4} \frac{K^2 E_p^2}{b_1^4} \left(E_G + \frac{KE_p}{b_1} \right)^{-1/2} \right] \right. \\ \left. + \frac{c}{d_2^2} \left[\frac{6}{d_2^2} \left(E_G + \frac{KE_p}{b_2} \right)^{3/2} + \frac{3KE_p}{b_2^2} \left(\frac{1}{b_2} - \frac{2}{d_2} \right) \left(E_G + \frac{KE_p}{b_2} \right)^{1/2} + \frac{3}{4} \frac{K^2 E_p^2}{b_2^4} \left(E_G + \frac{KE_p}{b_2} \right)^{-1/2} \right] \right\}. \quad (21) \end{aligned}$$

As in the case of cathode motion with $E_g = 0$, (21) and (6) can be put into the form:

$$\begin{aligned} \frac{\Delta I}{I} = \frac{\Delta d_1}{d_1} \left[\frac{-2 + \frac{3}{2} \left(\frac{d_1}{b_1}\right) + 2 \left(\frac{d_1}{d_2}\right)^3 \left(\frac{b_1}{b_2}\right)^{3/2} - \frac{3}{2} \left(\frac{d_1}{d_2}\right)^2 \left(\frac{b_1}{b_2}\right)^{3/2} \left(\frac{d_1}{b_2}\right)}{1 + \left(\frac{d_1}{d_2}\right)^2 \left(\frac{b_1}{b_2}\right)^{3/2}} \right] \\ + \left(\frac{\Delta d_1}{d_1}\right)^2 \left[\frac{3 - 3 \frac{d_1}{b_1} + \frac{15}{8} \left(\frac{d_1}{b_1}\right)^2 + 3 \left(\frac{d_1}{d_2}\right)^4 \left(\frac{b_1}{b_2}\right)^{3/2} - 3 \left(\frac{d_1}{d_2}\right)^3 \left(\frac{d_1}{b_2}\right) \left(\frac{b_1}{b_2}\right)^{3/2} + \frac{15}{8} \left(\frac{d_1}{d_2}\right)^2 \left(\frac{d_1}{b_2}\right)^2 \left(\frac{b_1}{b_2}\right)^{3/2}}{1 + \left(\frac{d_1}{d_2}\right)^2 \left(\frac{b_1}{b_2}\right)^{3/2}} \right]. \quad (22) \end{aligned}$$

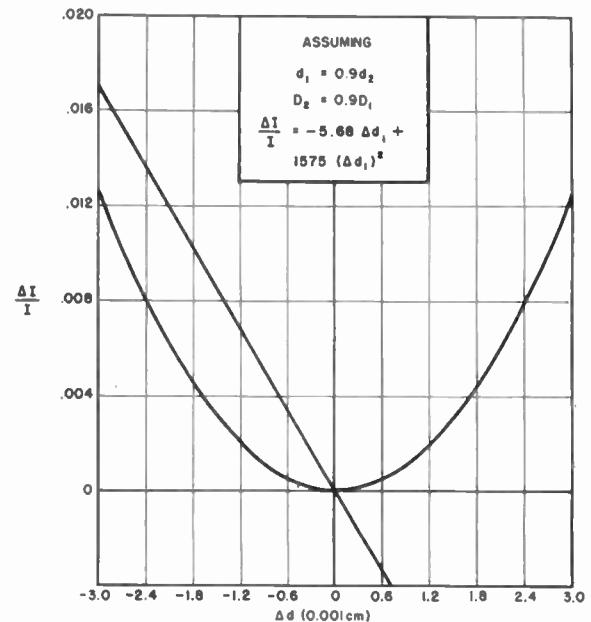

Fig. 4—First- and second-order output variation resulting from grid shift in the triode.

For the numerical values of the tube under discussion, this equation reduces to

$$\frac{\Delta I}{I} = -5.68\Delta d_1 + 1575(\Delta d_1)^2 \quad (\Delta d \text{ in cm}). \quad (23)$$

The terms of this equation are plotted in Fig. 4. They are similar in character to those for the case of cathode motion.

For plate motion a similar analysis has been made with results which indicate the same type of relationship.

Waynick³ has called attention to the dependence of microphonic output upon grid bias. This effect may be studied by examining (12) and (21) for dependence upon E_g . For simplicity, let us limit the equations to only one side of the tube.

The first-order term for (12) can be written:

$$\Delta I \left(\frac{-d_1^3}{2c\Delta d_1} \right) = \left(E_g + \frac{KE_p}{b_1} \right)^{3/2}. \quad (24)$$

The only term dependent upon E_g is on the right-hand side. This implies that I drops to zero at

$$E_g = -\frac{KE_p}{b_1} = -\frac{E_p}{\mu}$$

which is the normal grid cutoff. In the calculations that follow, cutoff is assumed at -10 volts. The plot of (24) is shown in Fig. 5, curve A.

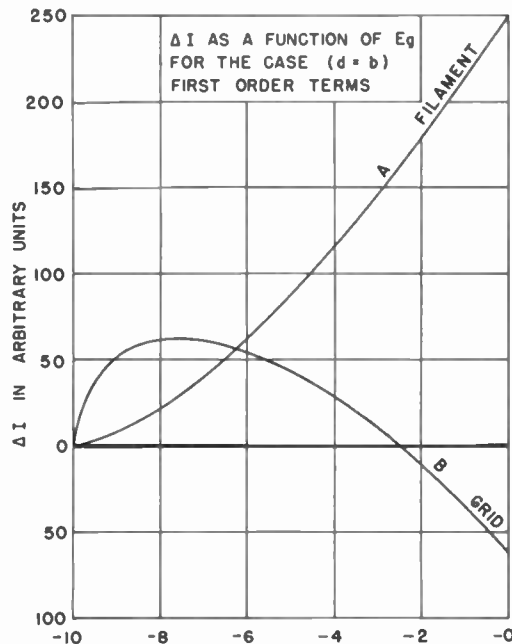

Fig. 5—Variation of microphonic output with grid bias, first-order terms only.

Similarly, the second-order term can be written:

$$\Delta^2 I \left(\frac{d_1^4}{3c\Delta d_1^2} \right) = \left(E_g + \frac{KE_p}{b_1} \right)^{3/2} \quad (25)$$

which is plotted in Fig. 6, curve A.

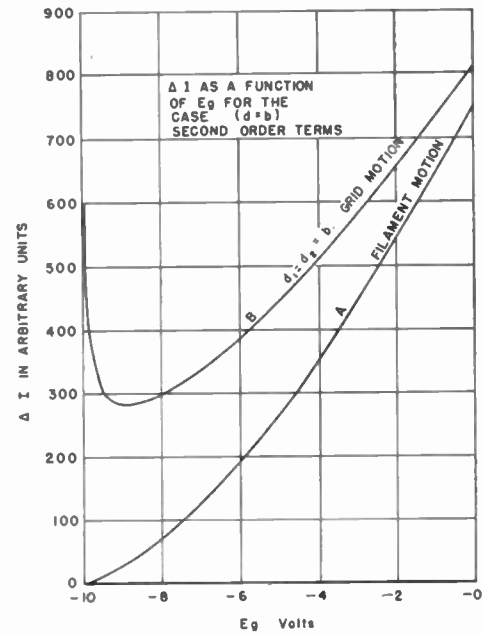

Fig. 6—Variation of microphonic output with grid bias, second-order terms only.

For grid motion, the first-order term may be written:

$$\Delta I \left(\frac{d_1^3}{\Delta d_1 c} \right) = -2X^{3/2} + 3/2X^{1/2} \frac{E_p}{\mu} \left(\frac{d_1}{b_1} \right)$$

where

$$X = \left(E_g + \frac{E_p}{\mu} \right). \quad (26)$$

In the tube under discussion, as well as in many low- μ types, d_1 is approximately b_1 and we can write

$$\Delta I \left(\frac{d_1^3}{\Delta d_1 c} \right) = 15X^{1/2} - 2X^{3/2} \quad (27)$$

which is plotted in Fig. 5(b). This function passes through zero for a particular value of grid bias, and represents the term calculated by Waynick.³

The second-order term, considerably more complicated than the others, can be written:

$$\begin{aligned} \Delta^2 I \left(\frac{1}{(\Delta d_1)^2} \frac{2d_1^4}{c} \right) &= \left\{ 6X^2 + X \left[-\frac{6E_p}{\mu} \frac{d_1}{b_1} + \frac{3E_p}{\mu} \left(\frac{d_1}{b_1} \right)^2 \right] \right. \\ &\quad \left. + 3/4 \left(\frac{E_p}{\mu} \right)^2 \left(\frac{d_1}{b_1} \right)^2 \right\} X^{-1/2}. \quad (28) \end{aligned}$$

This term is plotted in Fig. 6, curve *B*, for the tube under discussion.

Equation (28) can be examined for the range of values for which the curve for $\Delta^2 I$ will pass through zero. This will occur when the bracket term = 0. Since this is a simple quadratic expression, the conditions that the roots of

$$6X^2 + X \left[-\frac{6E_p}{\mu} \frac{d_1}{b_1} + \frac{3E_p}{\mu} \left(\frac{d_1}{b_1} \right)^2 \right] + 3/4 \left(\frac{E_p}{\mu} \right)^2 \left(\frac{d_1}{b_1} \right)^2 = 0$$

be real are given by

$$\left[\frac{-6KE_p}{b} \frac{d}{b} + \frac{3KE_p}{b} \left(\frac{d}{b} \right)^2 \right]^2 - 18 \frac{K^2 E_p^2}{b^2} \left(\frac{d}{b} \right)^2 \geq 0$$

or

$$\frac{d}{b} \geq 2 + \sqrt{2}$$

or

$$\frac{d}{b} \leq 2 - \sqrt{2}.$$

In practically any commercial tube there will be some departure from any design symmetry, as well as several possible modes of vibration of the tube structure. One can, therefore, expect to observe several components of the microphonic output, some of which may have a minimum at a particular grid bias, while others may not.

While these arguments imply that a tube could be designed for low microphonism by suitable choice of the ratio d/b , such considerations will usually be outweighed by the requirements that the tube have particular values of mutual conductance, plate resistance, and amplification factor.

II. MECHANICS OF THE TUBE STRUCTURE

In order to understand the behavior of a complex vibrating system, one must first know the modes of vibration, and second, the response in each mode as a function of excitation frequency and amplitude. The most obvious modes of vibration, illustrated in Fig. 7, are as follows:

1. The entire mount vibrating as a cantilever structure supported by the stem leads (see Fig. 7(a)).
2. The filament vibrating as a stretched string (see Fig. 7(b)).
3. The grid side rods vibrating essentially as a bar clamped at one end with the added complication that the side rods may have some "rattle" in the mica holes (see Fig. 7(c)).
4. The grid turns vibrating as curved bars clamped at each end to the side rods (see Fig. 7(d)).

5. The plate structure vibrating as a stiff diaphragm.

The entire mount will generally vibrate at a much lower frequency than will the other members. If the amplitude is appreciable, the mount will strike the bulb, producing a shock which will excite many natural modes of the structure. Such a repeated excitation of any one mode will result in an electrical output which will contain many harmonics of the striking frequency.

If the tube is subjected to a complex vibration containing sharp peak components, such as might arise from a vibration machine with a knock or rattle in the driving system, the shock will be transmitted to the tube, and many vibrational modes will be excited in their harmonics, as well as their fundamental frequencies.

The fundamental frequency of the filament vibration is given by the well-known formula:

$$f_0 = \frac{1}{2l} \sqrt{\frac{T}{m}} \text{ in cps}$$

where

$$\begin{aligned} T &= \text{tension in dynes} \\ l &= \text{length in cm} \\ m &= \text{density in } g_m/\text{cm}. \end{aligned}$$

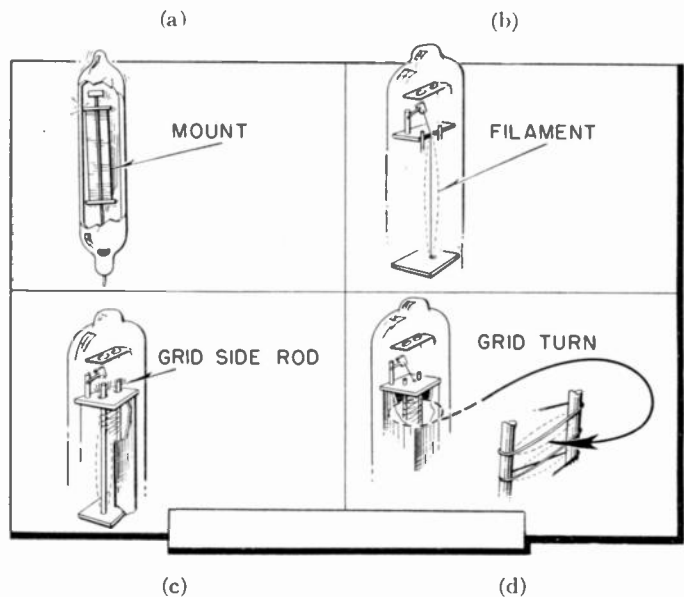

Fig. 7—Four possible modes of vibration.

This equation neglects the flexural stiffness of the filament, which, for nickel or tungsten of 1 mil or less in diameter, is quite small.

Vibration in modes 3 and 4 was not detected with any of the techniques used, which are described below. No attempt was made to calculate accurately their resonant frequencies. However, it would appear that these frequencies are very high compared with those for modes 1 and 2.

III. METHODS OF TEST

The triode was vibrated with an electromagnetic vibrator which could be driven at a frequency which was continuously variable. The tube could be operated electrically while under vibration, and its output studied with either an oscilloscope or a wave analyzer.

Vibrator

The electromagnetic vibrator is illustrated in Fig. 8. A loudspeaker magnet *A* furnished a field in which a single-layer driving coil *B* is free to move vertically. The coil is carried on a plastic table *C* which has, as a restoring spring, a disk of soft sponge rubber *D*. The tube

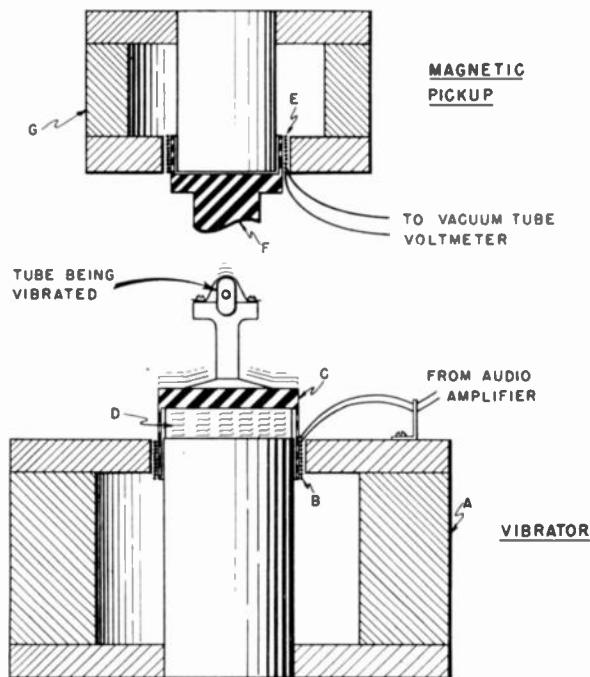

Fig. 8—Electromagnetic vibrator.

can be clamped to the vibrating member as shown in the figure. Since the restoring spring is relatively soft, the principal resonant frequency of the unloaded shake table is only about 250 cps. Several minor resonances are present, but between 300 and 7000 cps the response is reasonably free from irregularities (see Fig. 9).

Magnetic Calibrating Pickup

In order to calibrate the shaker, a magnetic pickup was constructed which is essentially the inverse of the shaker (see Fig. 8). It consists of a coil *E* rigidly connected to the shaker through a post *F*, and moving in the field of a speaker magnet *G*. The coil output, fed to a vacuum-tube voltmeter, gives a measure of the velocity of vibration.

A calibration curve of the shaker obtained with the magnetic pickup is shown in Fig. 9. The pickup was

calibrated by measuring the output voltage corresponding to a given amplitude of vibration. The amplitude of vibration was measured by a microscope with an ocular micrometer. Since the internal impedance of the pickup coil was low compared to the voltmeter, the calibration would be expected to be constant over the range of frequency studied, 200 to 20,000 cps.

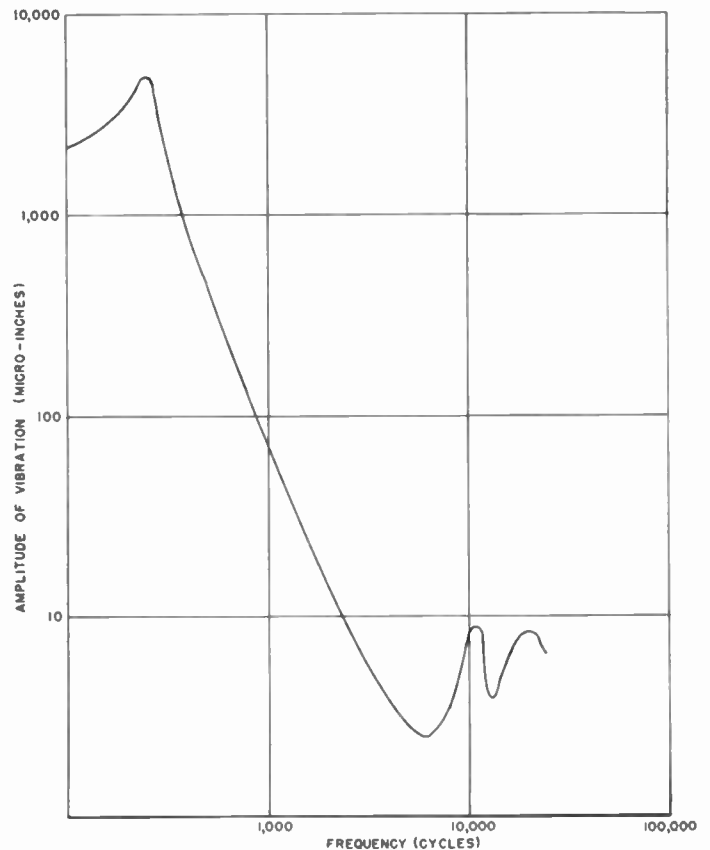

Fig. 9—Response of the vibrator with $\frac{1}{4}$ ampere flowing through the driving coil.

Electrical Test Circuit

Fig. 10 shows a block diagram of the electrical test circuit. A voltage amplifier with a gain of approximately 250 was usually used ahead of the cro amplifier to get an appreciable deflection on the screen. In certain cases where it was necessary to preserve the wave form of the signal a video amplifier, which had a flat frequency response up to 4 Mc, was used. The harmonic analyzer could measure the signal contained in a band 10 to 300 cps wide with center at any frequency between 150 and 16,000 cps.

By synchronizing the cro sweep with the oscillator furnishing the shaker signal, it is possible to relate the details of the electrical output with the phase of the vibration cycle. If the electrical output appears to be harmonic, and in a fixed phase with respect to the vibration signal, one would expect the output to be due to relative motion of some part of the system at vibra-

tion frequency. If, on the other hand, the output appears as a "hash" or as sharp "spikes," one might expect either an intermittent contact or a "knocking" between two parts of the tube.

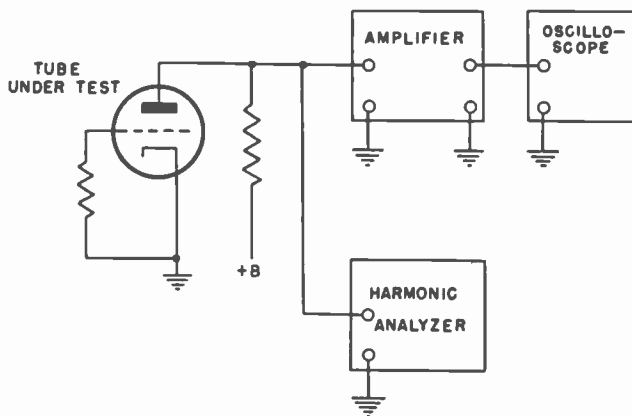

Fig. 10—Electrical test circuit block diagram.

Visual Observation

By examining the vibrating tube under a binocular microscope using stroboscopic light, it was possible to see the relative motion of some of the parts and to locate frequencies at which certain components would resonate. Magnification of $10\times$ to $36\times$ was used; higher magnification would give no advantage because of lack of adequate stroboscopic illumination. This type of observation gives a good picture of the modes of vibration and resonant frequencies, as long as the amplitude does not go much below 0.001 inch.

RF Vibration Indicator

In order to detect resonances of vibrating elements where the amplitude was too small to be visible under a microscope, a high-frequency pickup was developed which utilized the change in capacitance between a stationary probe *A* (Fig. 11) and the vibrating element.



Fig. 11—High-frequency capacitance pickup.

This capacitance was shunted across the plate tank capacitance of a high-frequency tuned-plate tuned-grid oscillator (see Fig. 11). As the spacing between the probe and the moving element changed, the frequency and amplitude of the oscillator likewise changed. Being self-biasing, the oscillator develops a grid bias dependent upon the amplitude of oscillation. This grid bias has the wave form of the motion, and can be amplified and measured on a cro.

As long as the change in the capacitance is small compared to the tank capacitance, the change in amplitude of oscillation will be linear with change in capacitance. Since this indicator is used principally for detection of vibrations which are small compared with the separation between the vibrating part and the probe, the relative change in capacitance will be small.

The high-frequency pickup, while it could be calibrated for absolute measurements, was used in this work only to indicate the occurrence of resonances. By using a probe 2 mm in diameter and 2 cm in length, approximately 1 mm from a part such as a grid, oscilloscope deflections of the order of 1 inch for vibration amplitudes of 0.0002 inch can be obtained. Since there is no mechanical coupling to the moving section of the tube, the motion is not perturbed by the pickup. The device can be used either with the tube disassembled, or with one tube element used as a probe to detect the relative motion of another element.

Fig. 11 shows a view of the pickup lead *A* connected to the triode grid as a vibrating element, and one side *I* of the plate structure as a probe.

The oscillator frequency is of the order of a hundred Mc, and the tank capacitance is approximately $2\ \mu\text{mf}$.

Bell Jar Tests

By use of a combination of the techniques just described, it is possible to relate many features of the electrical output spectrum to modes of vibration of the tube elements. In order to confirm any conclusions with regard to mechanisms of generation of particular components of microphonic output, it is naturally desirable to test tubes in which the vibrating structures have been altered and the suspected vibrations either reduced or eliminated. As a rule, the presence or absence of undesirable vibrations of a given type follow a statistical law, and in order to draw a definite conclusion regarding the effect of a structural change, a number of tubes must be constructed and the results of the tests examined statistically.

Since it was impractical to build a number of these tubes in the laboratory under conditions resembling those of manufacture, a technique was used which enabled an inference to be drawn from a single tube. A system was arranged so that an individual tube could be modified and retested.

For this purpose, a tube shaker was built similar to the one illustrated in Fig. 8, but using materials which could be placed inside a bell-jar vacuum system without

poisoning an oxide cathode. The procedure used was first to cut off the end of the glass bulb above the top mica, leaving the remainder of the glass intact where it confines the mica. It was then possible to make small changes in the tube structure, such as eliminating the rattle of a grid side rod in its hole in the mica. The tube could then be placed on the shaker and the whole assembly placed in the bell-jar vacuum system and evacuated. It was an easy matter to reactivate the cathode after three or four successive exposures to the atmosphere. In this way, an individual tube known to produce a certain form of microphonic output could be modified, and that particular output could be removed and restored again, by three successive structural modifications.

IV. RESULTS

While properties of the particular tube investigated are not of general interest, the results indicate the nature of information which can be obtained by these methods.

The most important vibrating component of the tube is the filament, which is resonant at about 5000 cps. The motion of the filament at resonance could be observed very easily by eye, and when vibrated at double the fundamental frequency, the center-node vibration was visible.

The wave form of the tube output when subject to vibration at this frequency is shown in the oscillogram of Fig. 12. The fundamental component and the second

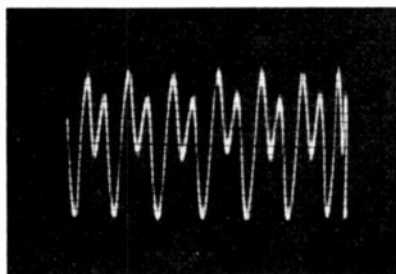

Fig. 12—Wave form of tube output at filament resonance.

harmonic, called for by the theory, are clearly shown. The amplitude of the microphonic output at filament resonance was at least 1000 times that observed at other frequencies.

One important factor to be considered while studying the output spectrum is that the motion of the shaker usually has some harmonic content which will cause the filament to be excited by a shake frequency which is actually a submultiple of the fundamental filament frequency.

At a vibration frequency of about 240 cps, the entire mount structure resonated; this could be observed very readily through the binocular microscope when illuminated by stroboscopic light. As the vibration ampli-

tude became high enough for the mount to strike the glass bulb, a sharp rise in output was observed. This output was rich in harmonics of the vibration frequency. In one tube type, different from that described above, examined in this way, ten integral multiples of the vibration frequency could be measured by examining the output in a harmonic analyzer. This complex output spectrum showed quite an appreciable signal even at frequencies as high as 50 to 75 kc.

The resonances of the grid structure occurring at several frequencies between 1000 and 18,000 cps were not of great importance, these amplitudes being of the order of 10^{-4} inches.

In another type of subminiature tube, some microphonic noise was observed to persist after the filament power was turned off. This current was of extremely irregular form and was believed to be due to electrical leakage over the mica surface augmented by particles of getter material. In this tube, the effect disappeared after the getter was relocated and the micas were sprayed with magnesium hydroxide.

One type of microphonism which was particularly baffling for some time was a "hash" that set in over a wide range of frequencies, usually 3000 to 7000 cps, at a critical value of the vibration amplitude. The signal did not vary appreciably as the vibration amplitude was increased above this value.

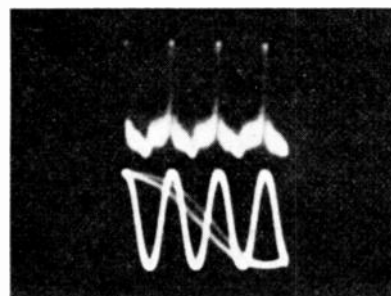

Fig. 13—Oscillogram illustrating hash type of microphonism.

The "hash" was analyzed in an oscilloscope, using a video amplifier to preserve the high-frequency components of the wave form. One of the oscillograms is reproduced in the upper trace of Fig. 13. It shows a fundamental with some second harmonic and a very sharp spike occurring once each cycle. The duration of the spike was clearly short compared to the vibration period. The lower trace of Fig. 13 shows the wave form of the voltage driving the shaker. In order to get a better estimate of the pulse duration, the output was examined, using a triggered sweep with a filter cutting off below 20,000 cps. The wave pattern obtained is shown in Fig. 14.

The dark marker to the right indicates a time of 100 microseconds. The damped oscillatory pattern following the initial pulse is the sort of distorted wave which would

be expected to result from a square wave of about 10 microseconds duration passing through a low-cutoff filter.

This spike output was traced to those tubes in which the getter post had not been properly welded to the support (part No. 3 of Fig. 2) as required. The getter post, as it vibrated, touched the support once each cycle, rising to plate potential. After breaking contact, it was isolated electrically, attracted electrons from the cathode, and dropped in potential. As it struck the sup-

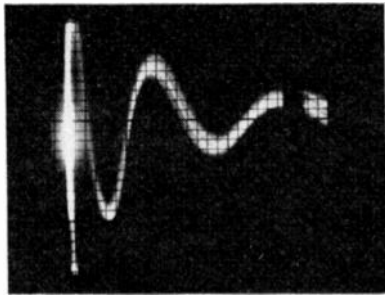

Fig. 14—Wave pattern resulting from spike passing through high-pass filter.

port again, it discharged to the plate, causing a negative pulse. The confirmation of this mechanism was made by using the bell jar described above, and making an electrical contact between the getter post and the plate without affecting the motion. This contact eliminated the effect completely.

V. DISCUSSION

While no attempt has been made in this paper to propose an acceptance test suitable for industrial standardization, the need for such a test deserves serious consideration. The specification of such a test must be based upon two classes of data: (a) the causes of microphonism found to be of general importance, and (b) the frequency components in the output which are disturbing for various fields of service.

Clearly, modes of resonance which may give an output at, say, 7000 cycles would be of importance to a high-fidelity audio amplifier, but not in a narrow-band communication system. In applications in electronic instrumentation, a narrow-band tuned amplifier may be shock-excited into transient oscillation by sharp sawtooth aperiodic pulses. In narrow-band supersonic applications, serious difficulties may arise from tubes with natural frequencies in the audio range.

The theory described in this paper may be applied to examine a microphonic test used to some extent in industry and adopted as a standard test in the Joint Army-Navy Specification.⁶

⁶ JAN-IA. Sec. F-6c. (3).

The test consists of placing a tube in the sound field of a speaker and feeding the tube output, through an amplifier, back to the speaker. If the system sustains oscillations after the tube is tapped, the tube is rejected.

Such a test, in effect, may do no more than sort out tubes with right- from left-hand asymmetry.

Consider the tube with a positive sound pressure on the side nearest the speaker. This will result in a motion of one tube element, say the grid, in one direction. If the tube is slightly asymmetrical, this motion may either increase or decrease the plate current, depending upon which side has the greater cathode-grid spacing. If the phase relations are such that oscillations of the grid can be sustained in this position, a rotation of the tube through 180° will reverse the phase of the grid displacement relative to the sound pressure, and no further oscillation will take place.

To demonstrate this effect, a type 1H5 tube, a standard-size filamentary triode, was mounted on a swivel base with its axis horizontal about 8 inches above a speaker. The tube output was fed back to the speaker through an audio amplifier of variable gain. At a certain orientation, the system would oscillate at the filament resonant frequency when the tube was tapped. Rotating the tube 180° quenched the oscillation, and even though the gain was increased appreciably no further oscillation would set in.

While the primary objective of this paper is to clarify the understanding of the microphonic processes, some inferences which bear upon their elimination can be drawn. Since it is not possible to avoid elastic deflections in the tube structure, it is important to control these deflections by proper design. One should, therefore, consider the following possibilities:

(a) Design of the components so as to provide high relative damping in order that the amplitude at resonance will be low. While this is desirable it is certainly difficult to realize.

(b) Design of the most prominent vibrating components so that the resonant frequencies are above the range of application; an example of this would be to increase the filament tension.

(c) Elimination of sources of rattle or knock so that the higher harmonics of the vibrating frequency will not be excited; an example is the use of flexed mica to cushion the mount from impact against the glass bulb.

(d) Careful design to keep the tube symmetrical.

(e) Design and construction to insure that tube elements are not "floating" electrically at any time.

ACKNOWLEDGMENT

The authors wish to express their appreciation of many helpful discussions on this subject with W. G. Dow, consultant to the Tube Laboratory, R. D. Huntoon, Chief of the Electronics Section, National Bureau of Standards, and Si Lackenbruch, also of the National Bureau of Standards.

Contributors to Waves and Electrons Section



A. BLOOM

A. Bloom (A'43) was born in New York, N. Y., in 1913. He was graduated from the City College of New York in 1932 with the B.S. degree, specializing in mathematics and physics. In 1941 he joined the staff of the National Bureau of Standards, working on the development of special subminiature tubes. In 1943 he became associated with the Signal Corps, setting up a tube testing laboratory at the Camp Evans Signal Laboratory.

Mr. Bloom returned to the Bureau of Standards in 1944, and was in charge of the subminiature tube work there until the end of the war. He has since been connected with the newly organized Tube Laboratory at the Bureau, and has been working on problems of ruggedization and microphonics of vacuum tubes.



ROBERT M. BOWIE

Robert McNeil Bowie (A'34-M'37-SM'43-F'48) was born in Table Rock, Neb., on August 24, 1908, and was educated at Iowa State College, where he received the bachelor's degree in chemistry. His graduate work at the same institution was in physics, for which he was awarded the degrees of M.S. and Ph.D.

In 1933 Dr. Bowie joined the engineering department of Sylvania Electric Products Inc., at Emporium, Pa., and a short time later he established the company's research department, of which he is the present manager.

He has served on the following IRE committees: Admissions, Board of Editors, Papers Review, Nuclear Studies, Papers Procurement, National Electronics Conference, and Research.



V. W. COHEN

V. W. Cohen was born on July 18, 1911, in New York, N. Y. He received the B.S. degree from College of the City of New York in 1931, and the Ph.D. degree from Columbia University in 1936. From September, 1934, to January, 1937, he was employed by the State University of Iowa to carry out original research work in its physics department.

From June, 1937, to February, 1939, Dr. Cohen conducted original research in nuclear physics at Columbia University; and from September, 1938, to February, 1940, he assisted in the design and construction of a cryogenic laboratory, including research in the production of liquid air, hydrogen, and helium. From July, 1939, to August, 1940, Dr. Cohen instructed at the evening summer sessions in college physics, lectured, supervised laboratory, and performed demonstration experiments at the College of the City of New York.

From September, 1940, to October, 1944, Dr. Cohen was employed as a physicist by Navy Department, Bureau of Ordnance, Washington, D. C., in work which involved research development, and from November, 1944 to October 7, 1947, he served as chief of a section charged with furnishing engineering on research and quality control for unexpended, air-borne, ordnance electronic equipment at the National Bureau of Standards.

Since October 7, 1947, Dr. Cohen has been with the Brookhaven National Laboratory, engaged in research in the field of the application of electronics to problems in nuclear physics. He is the author of numerous papers which have been published in the *Physical Review*.



FRANK C. ISELY

Frank C. Isely (SM'48) was born in Wichita, Kan., on December 20, 1898. He received the A.B. degree from the University of Wichita in 1921, and the M.A. degree from the University of Kansas in 1924. From 1924 to 1927, he was an instructor in physics at the College of Wooster; and from 1927 to 1931, he did graduate work and was an instructor in physics at Harvard University. In 1935, he became a member of the engineering staff of the Radio Division of the Naval Research Laboratory, where he has been in charge of a number of naval radio problems.

During the war, Mr. Isely originated the Echo Box for use in testing radar equipment. He has been actively interested in the problem of uhf and shf resonant circuits. He is a member of Sigma Xi.

Contributors to Waves and Electrons Section



J. WESLEY LEAS

J. Wesley Leas (M'45) was born on June 14, 1916, at Delaware, Ohio. He received the B.S. degree in electrical engineering from the Ohio State University in 1938. From 1938 to 1941 he was engaged in sales engineering work with the Armstrong Cork Company in Chicago and New York.

In January, 1942, Mr. Leas, then a member of the Electronics Training Group of the U. S. Signal Corps, was sent to England to study early-warning radars, and was selected to join the staff at the Telecommunications Research Establishment in England. After a year as group leader in charge of the design and development of production and field test equipment for a beacon navigation system, he was ordered back to the United States in May, 1943, and assigned to the Combined Research Group at the Naval Research Laboratory, Washington, D. C., as Commanding Officer of the Army Section. He was also assistant head for engineering of the Combined Research Group with technical and administrative direction of the project engineering section. He designed the first distance-measuring equipment ever built to operate at 1000 Mc, and supervised the first flight tests.

On termination of active service in January, 1946, Mr. Leas went with the Airborne Instruments Laboratory, Inc., at Mineola, L.I., N. Y., in their air navigation and traffic control group. He was placed in charge of the section engaged in flight testing of air-borne radar. Later in the year he was made the representative of AIL and Aeronautical Radio, Inc., at the PICAQ demonstrations in England, New York, and

Indianapolis. He served as technical advisor to the U.S. delegation at the PICAQ sessions in Montreal. In February, 1947, Mr. Leas joined the air Navigation and Traffic Control Group of the Air Transport Association in Washington, D. C., and has been associated with them ever since then. He has been active in the Radio Technical Commission for Aeronautics special committees, including SC-31, which set up the operational requirements for a common integrated traffic control system for military, commercial, and private aircraft.

Mr. Leas is a lieutenant colonel in the USAF reserve. He is a member of Eta Kappa Nu, the Institute of Navigation, and the Army Signal Association, and an associate of the American Institute of Electrical Engineers.



CHARLES B. LESLIE

Charles B. Leslie (S'42-A'45) was born at Minneapolis, Minn., on June 16, 1922. He received the degree of B.E.E. in 1943 from the University of Minnesota. Since then he has been employed by the Naval Ordnance Laboratory in Washington, D. C. During 1945 he held a commission as ensign in the Naval Reserve.

Mr. Leslie has been engaged in the development and design of electronic circuits and laboratory measuring equipment for several underwater ordnance programs of the Laboratory. At present he is an electronic engineer for the acoustic division of the Laboratory. He is a member of Eta Kappa Nu, Tau Beta Pi, and the AIEE.

Alfred E. Martin (S'40-A'43-M'47) was born in New York, N. Y., in September, 1911, and received the bachelor's degree in physics at the College of the City of New York in 1932, and the master's degree at the University of Michigan in 1933. From 1933 to 1942 he taught physics at Shaw University and at Fisk University, except for the period of 1938-1940, when he held a General Education Board Fellowship in physics at the University of Michigan.

In 1942 Mr. Martin joined the Signal Corps Laboratories at Eatontown, N. J., where he specialized in meteorological microwave radar problems. After the war he worked on microwave test equipment development at the Engineering Laboratory of the Allen D. Cardwell Manufacturing Corporation, Brooklyn, N. Y.

In 1946, Mr. Martin joined Sylvania Electric Products Inc., in Flushing, L. I., N. Y., where he is engaged in research work on colorimetry and spectroradiometry.

For a biography and photograph of PETER G. SULZER, see page 426 of the March, 1948, issue of the PROCEEDINGS OF THE I.R.E.



ALFRED E. MARTIN



Abstracts and References

Prepared by the National Physical Laboratory, Teddington, England, Published by Arrangement with the Department of Scientific and Industrial Research, England, and *Wireless Engineer*, London, England

NOTE: The Institute of Radio Engineers does not have available copies of the publications mentioned in these pages, nor does it have reprints of the articles abstracted. Correspondence regarding these articles and requests for their procurement should be addressed to the individual publications and not to the IRE.

Acoustics and Audio Frequencies.....	1051
Antennas and Transmission Lines.....	1051
Circuits and Circuit Elements.....	1052
General Physics.....	1054
Geophysical and Extraterrestrial Phenomena.....	1055
Location and Aids to Navigation.....	1056
Materials and Subsidiary Techniques ..	1057
Mathematics.....	1057
Measurements and Test Gear.....	1057
Other Applications of Radio and Electronics.....	1060
Propagation of Waves.....	1060
Reception.....	1061
Stations and Communication Systems..	1062
Subsidiary Apparatus.....	1063
Television and Phototelegraphy.....	1063
Transmission.....	1063
Vacuum Tubes and Thermionics.....	1063
Miscellaneous.....	1064

The number in heavy type at the upper left of each Abstract is its Universal Decimal Classification number and is not to be confused with the Decimal Classification used by the United States National Bureau of Standards. The number in heavy type at the top right is the serial number of the Abstract. UDC numbers marked with a dagger (†) must be regarded as provisional.

ACOUSTICS AND AUDIO FREQUENCIES

- 534.132** **1845**
On the Radiation of Sound from an Unflanged Circular Pipe—H. Levine and J. Schwinger. (*Phys. Rev.*, vol. 73, pp. 383–406, February 15, 1948.) Full paper. Summary abstracted in 628 of April.
- 534.321.9** **1846**
On the Measurement of Ultrasonic Wave-lengths using Two Beams of Progressive Waves—A. Giacomini. (*Rend. Accad. naz. Lincei*, vol. 2, pp. 791–794, June 1947. Reprint.) The method is a modification of that of Bachem, Hiedemann, and Asbach (1934 Abstracts, *Wireless Eng.* p. 273). It is based on the fact that a system of stationary waves is equivalent to the superposition of two systems of progressive waves of equal frequency and amplitude moving in opposite directions. A parallel beam of light is passed through the cell containing the liquid under test and an image of the stationary-waves system is projected on to a screen.
- 534.321.9:621.391.63** **1847**
Ultrasonic Cell of Large Area for the Modulation of Light—A. Giacomini. (*Alla Frequenza*, vol. 12, pp. 409–416; October to December, 1943.) In Italian, with English, French, and German summaries.) A linear mosaic of quartz down the center of a rectangular glass cell con-

The Institute of Radio Engineers has made arrangements to have these Abstracts and References reprinted on suitable paper, on one side of the sheet only. This makes it possible for subscribers to this special service to cut and mount the individual Abstracts for cataloging or otherwise to file and refer to them. Subscriptions to this special edition will be accepted only from members of the IRE and subscribers to the Proc. I.R.E. at \$15.00 per year. The Annual Index to these Abstracts and References, covering those published from February, 1947, through January, 1948, may be obtained for 2s. 8d. postage included from the *Wireless Engineer*, Dorset House, Stamford St., London S. E., England.

taining xylol generates ultrasonic waves in the liquid. These waves, of frequency 5 Mc or more, can be used to modulate a beam of light passing through the cell. Applications to phototelephony and phototelemetry are described, with experimental results.

534.756 **1848**
The Relaxation Theory of Hearing—Ya. I. Frenkel. (*Compt. Rend. Acad. Sci. (URSS)*, vol. 59, pp. 679–681, February 1, 1948. In Russian.)

621.395.61/.62:621.392.51 **1849**
Characteristic Quantities of Electromechanical Transducers—I. Barducci. (*Atti Accad. naz. Lincei*, vol. 2, pp. 190–196; February, 1947. Reprint.) P. G. Bondoni (*ibid.*, vol. 1, p. 1324; 1946) introduced a new type of mixed electromechanical coupling impedance, defined as the ratio between a mechanical force and an electric current. Using this quantity, the behavior of any transducer can be expressed by a single set of equations.

Starting from the general equations thus obtained, dynamic impedance transfer, sensitivity, and efficiency are calculated and a coupling factor is derived which is real, dimensionless, has values between 0 and 1, and is independent of the sense of the transformation. This coupling factor seems to be an improved means of estimating the goodness of electromechanical coupling and of comparing various types of coupling.

The characteristic quantities for electromechanical resistance and capacitance coupling are tabulated and it is shown that short-circuit dynamic impedances satisfy a reciprocity theorem that has the same form for electric circuits, mechanical systems, or electromechanical transducers.

621.395.623.8 **1850**
Two-Way Speaker System: Parts 1–3—C. G. McProud. (*Audio Eng.*, vol. 31, pp. 18–22 and 17–19, 35; November and December, 1947; and vol. 32, pp. 21–23, 38; February, 1948.) Details of the construction and assembly of a high-frequency unit and horn, a low-frequency speaker, and a suitable enclosure for it, and a dividing network to pass the appropriate frequencies to the two sections of the system. See also 3816 of January.

621.395.625.3 **1851**
Review of the Present Status of Magnetic Recording Theory: Parts 1–3—W. W. Wetzel. (*Audio Eng.*, vol. 31 and vol. 32, pp. 14–17, 39, pp. 12–16, 37, and pp. 26–30, 47; November, 1947 to January, 1948.) Part 1 describes a hysteresis loop tester and the measurements that can be made with it. The residual induction in a recorded tape may be expected to decrease with decreasing wavelength. The residual induction is governed mainly by the coercivity of the material at short wavelengths and by the remanence at long wavelengths. Part 2 discusses current theories of erasing, recording, and reproduction, particular attention being given to recording theory. Part 3 summarizes the above and gives practical illustrations. Noise and distortion phenomena are examined from the experimental point of view, since the relevant theories are far from complete.

621.395.625.3:534.76 **1852**
Arrangement for Note Location on Magnetophon Tape—H. Gunka and W. Lippert. (*Funk. und Ton*, no. 3, pp. 125–134; March, 1948.) A reproducing head follows a circular path formed by a section of the tape, which can be easily marked or cut when a particular note is heard. The device includes provision for periodic sampling. Possible applications are suggested.

621.395.625.6 **1853**
A Newly Developed Light Modulator for Sound Recording—G. L. Dimmick. (*Jour. Soc. Mot. Pic. Eng.*, vol. 49, pp. 48–57; July, 1947.) Very low distortion and greatly improved performance are claimed. The modulator is of the magnetic type and is mechanically and optically interchangeable with existing RCA sound-recording galvanometers. The power required for 100 per cent modulation is 1.25 w. Distortion characteristics, frequency-response curves, and impedance data are discussed, and the effect of bias upon performance is considered.

ANTENNAS AND TRANSMISSION LINES

621.315.212:621.392.43 **1854**
The Series Reactance in Coaxial Lines—H. J. Rowland. (*Proc. I.R.E.*, vol. 36, pp. 65–69; January, 1948.) The effect of reactance in

series with the inner conductor is investigated; such reactance can be used for direct impedance matching without the protruding stubs necessary for parallel compensation. The reactors take the form of step discontinuities in the diameter of the inner conductor. See also 736 of 1945 (Whinnery et al.).

621.392.029.64 1855
A New Type of Waveguide Directional Coupler—H. J. Riblett and T. S. Saad. (Proc. I.R.E., vol. 36, pp. 61–64; January, 1948.) The coupler has been measured for $\lambda 3.1$ to 3.5 cm. It has high directivity, low input SWR, is easy to design and has many applications. Theory, design, and performance curves are given. A system of pairs of slots at right angles is cut in the wall common to two waveguides. These slots have compensating frequency characteristics so that directional couplers with very flat coupling characteristics can be produced. See also 1007 of 1947 (Early) and 2007 of 1947 (Mumford).

621.392.029.64:621.317.78 1856
The Enthakometer, an Instrument for the Measurement of Power in Rectangular Wave Guides—Collard. (See 2020.)

621.392.029.64:621.396.662.029.64 1857
Note on Wave-Guide Attenuators—Miller, Crowley-Milling, and Saxon. (See 1892.)

621.396.67 1858
Theory of the Circular Diffraction Antenna—A. A. Pistolkors. (Proc. I.R.E., vol. 36, pp. 56–60; January, 1948.) The e.m. field produced by an antenna in the form of a circular gap in a conducting plane is investigated. The method is based on the classical diffraction theory of Fresnel and Kirchhoff. The electric field intensity at a distance is calculated from the expressions obtained for E and H , the directional patterns are plotted and an expression for gap admittance is obtained.

621.396.67 1859
Wavelength Lenses [polyrod aerials]—G. Wilkes. (Proc. I.R.E., vol. 36, pp. 206–212; February, 1948.) A mathematical analysis of a system consisting of a dielectric block in front of a horn or open-ended waveguide. The theory is approximate, but fair agreement is obtained with experimental determinations of lens patterns and gain.

621.396.67:[538.311+538.32 1860
Currents Excited on a Conducting Plane by a Parallel Dipole—Dunn and King. (See 1910.)

621.396.671 1861
Determination of Aerial Gain from Its Polar Diagram—J. A. Saxton. (Wireless Eng., vol. 25, pp. 110–116; April, 1948.) On the assumption that the field-strength distribution in the main forward lobe of a highly directive antenna may be represented by an ellipsoid, and that only a very small fraction of the total energy is radiated in side lobes, it is shown that the power gain of the antenna, compared with a doublet radiator, is $(8\phi^2/3)$. Here ϕ is the ratio of the major to the minor axis of the ellipsoid. The validity of this approximation in certain circumstances has been demonstrated by measurements of the polar diagrams and gains of some antennas used for centimeter wavelengths.

621.396.671 1862
Radiation Resistance of Ring Aerials—H. Page. (Wireless Eng., vol. 25, pp. 102–109; April, 1948.) Radiation resistance formulas are derived. Systems with anti-fading properties, consisting of vertical antennas equally spaced around a circle whose radius is comparable with λ , are considered. The currents in the

antennas have the same amplitude, but the phase changes progressively round the ring, the total phase change being an integral multiple of 2π radians. A special case of in-phase ring currents with a central antenna is also discussed.

621.396.671:518.4 1863
Calculation of Small Horizontal Rhombic Aerials—B. van Dijn. (Tijdschr. ned. Radio-genoot, vol. 13, pp. 23–31; January, 1948.) [In Dutch, with English summary.] A family of curves is given to facilitate calculation of radiation patterns.

621.396.677 1864
An Automatic Contour Plotter for the Investigation of Radiation Patterns of Directive Antennae—J. Dyson and B. A. C. Tucker. (Jour. I.E.E. (London), part IIIA, vol. 93, no. 9, pp. 1403–1406; 1946.) The directional characteristics of the receiver antenna system under test are presented as a family of received-signal contours. A Cartesian plot is used with azimuth and elevation angles forming the respective axes. For lecture summary see *ibid.*, part IIIA, vol. 93, no. 9, pp. 214–215; 1946.

CIRCUITS AND CIRCUIT ELEMENTS

531:621.392 1865
Contribution to the Study of Electromechanical Analogies—M. Nuovo. (Mem. Accad. naz. Lincei, vol. 1, pp. 26–50; 1946. Reprint.) A general discussion of the correct application of both the "classical" analogy, due originally to Maxwell, and the "modern" one, due to Firestone and Hecht, starting in both cases either from a given circuit or a given set of differential equations. Matrix algebra is used, and some illustrative examples are appended.

621.3.018.4 1866
On the Concept of Negative Frequency—G. B. Madella. (Alta Frequenza, vol. 13, pp. 31–38; March, 1944. In Italian, with English, French, and German summaries.) The concept has a definite application to polyphase systems but not to monophasic systems. The phenomena of frequency conversion are examined and it is shown that this idea permits a very simple representation of the results by means of expressions in which both the magnitudes and the signs of the frequencies in question are taken into account. See also 1867 and 2013 below.

621.3.018.4 1867
Positive and Negative Frequencies—N. F. Barber. (Wireless Eng., vol. 25, p. 98; March, 1948.) Comment on 669 of April (Madella). The new points of view regarding negative frequencies have been more fully discussed by Madella (1866 above and 2013 below.)

621.314.2+621.396.619.23 1868
Rectifier Resistance Laws—D. G. Tucker. (Wireless Eng., vol. 25, pp. 117–128; April, 1948.) Discussion of an exponential relationship

$$R = R_0 + \kappa e^{-qV}$$

between the resistance R of a rectifier and the voltage V across it, where R_0 , κ and q are constants for any particular rectifier. For forward and small backward voltages, the relationship agrees well with experimental results; for large backward voltages, the agreement is not as good, but R is so large compared with R_0 that the usefulness of the relationship is little affected, at any rate for the ring, Cowan, and constant-impedance modulator circuits to which it is here applied. The agreement is best for diodes and least good for crystal tubes; its adaptation to measured rectifier characteristics is discussed fully. The relationship applies

to dc or ac resistance. It is assumed throughout that rectifier capacitance is small, and that the amplitude of the ac signal is sufficiently small for dV/dI to be taken as the ac resistance, I being the rectifier current.

621.314.3† 1869
The Transductor [or magnetic amplifier]—H. B. Rex. (Instruments, vol. 20, pp. 1102–1109; December, 1947.) Based on a series of articles in *Arch. Für Elektrotech.*, 1942 to 1944. A complete theoretical analysis of the transductor: (a) with natural magnetization, i.e., with sinusoidal voltages in the control windings, (i) without self-excitation, (ii) with self-excitation under various feedback conditions, which are analyzed and their effect upon the performance discussed; (b) with constrained magnetization, where only dc flows in the control windings.

621.316.82 1870
Rheostat Trigger Circuits—S. A. Drobov. (Radiotekhnika (Moscow), vol. 3, pp. 40–50; January and February, 1948. In Russian.)

621.392 1871
Resistor-Transmission-Line Circuits—P. I. Richards. (Proc. I.R.E., vol. 36, pp. 217–220; February, 1948.) Necessary and sufficient conditions are derived for a function to be the driving-point impedance of a physically realizable network consisting (essentially) of lumped resistors and lossless transmission lines. The circuits so developed are thoroughly practical for pure reactances and in many other special cases, but, in general, ideal transformers are sometimes required. A rigorous correspondence between lumped-constant circuits and line-resistor circuits is established.

621.392 1872
Response of Circuit to an E.M.F. of Sawtooth Waveform—F. Bedeau. (Rev. Tech. Comp. (Franc) Thomson-Houston, no. 7, pp. 39–45; May, 1947. In French with English summary.) Carson's formulas for the response of a circuit to an e.m.f. of any waveform are often difficult to apply. Graphical methods permit considerable simplifications and Nerken's method (3190 of 1937) can be further simplified for sawtooth waveforms, so that the response can be obtained by simple planimetry. A similar method is applicable to rectangular signals.

621.392:621.314.25 1873
The Conversion of Two Potentials (or Currents) of Different Phases to Two Potentials (or Currents) of the Same Phase with an Amplitude Ratio determined by the Phase Difference—H. Thiede. (Funk. und Ton, pp. 111–118; March, 1948.) Suitable circuits for this transformation are described. Applications discussed include the display of phase difference on a c.r.o.

621.392:621.396.96 1874
Introduction to Circuit Techniques for Radiolocation—F. C. Williams. (Jour. I.E.E. (London), part IIIA, vol. 93, no. 1, pp. 289–308; 1946.) The words "circuit technique" have come to have a special meaning in radar. Roughly, this field may be said to include the generation of waveforms, both sinusoidal and otherwise, and their manipulation to meet specific needs. It includes also servomechanisms of the instrument type and their associated special amplifiers. The particular aspects of these processes which radar has mainly affected have been precision, reliability, and producibility, since vast numbers of similar equipments have been called upon to operate under singularly adverse conditions, and have been required to give visual or other indications to a high degree of precision.

The paper deals mainly with the question

of waveform generation and manipulation, and "the aim has therefore been to explain the basic circuit elements, and their use, and to show by example how the necessary design calculations are undertaken."

621.396.611 1875

Trigonometric Components of a Frequency-Modulated Wave—E. Cambi. (Proc. I.R.E., vol. 36, pp. 42-49; January, 1948.) The exact solution of the differential equation of a resonant circuit having either variable capacitance or inductance is given in a form having a clear physical meaning and allowing accurate numerical computation. Results are compared with those of approximate formulas. Approximate expressions, valid for small percentage changes of L or C , are deduced from the rigorous solution.

621.396.611.1 1876

Universal Impedance Diagrams for Parallel Resonant Circuits—A. Madella-Lucarelli. (*Alla Frequenza*, vol. 12, pp. 366-370; July to September, 1943. In Italian, with English, French, and German summaries.) Diagrams with non-dimensional co-ordinates applicable to circuits comprising a capacitor shunted by an inductor and resistor in series. Diagrams are given for various values of Q for the inductor at the ideal resonance frequency and also for constant ratio between the actual frequency and the ideal resonance frequency.

621.396.611.21:549.514.51 1877

High-Frequency Plated Quartz Crystal Units—R. A. Sykes. (Proc. I.R.E., vol. 36, pp. 4-7; January, 1948.) Discussion of development problems, mounting methods, and frequency adjustment by means of evaporated gold. See also 3222 and 3224 of 1944.

621.396.615 1878

A Tunable Vacuum-Contained Triode Oscillator for Pulse Service—C. E. Fay and J. E. Wolfe. (Proc. I.R.E., vol. 36, pp. 234-239; February, 1948.) A tunable push-pull triode oscillator is described in which the oscillatory circuit is contained in an evacuated envelope with the tube components. A pulse peak power output of more than $\frac{1}{2}$ Mw is delivered through a 50- Ω line in the frequency range 390 to 435 Mc.

621.396.615 1879

Theory and Practice of the Transitron Oscillator—R. Lemas. (*Télev. Franç.*, pp. 12-15; March, 1948.) Families of curves are given which show how the negative-resistance portion of the transitron characteristic depends on the various circuit parameters. Transitron circuits give a good waveform with very good frequency stability. Operation for pulse generation will be discussed later.

621.396.615 1880

On the Operation of a Blocking Oscillator—D. M. Levitas and V. V. Migulin. (*Zh. Tekh. Fiz.*, vol. 17, pp. 1171-1180; October, 1947. In Russian.)

621.396.615 1881

Resistance-Capacitance Oscillator—G. Francini. (*Alla Frequenza*, vol. 13, pp. 5-17; March, 1944.) In Italian, with English, French, and German summaries.) The use of a negative-transconductance tube enables a simple oscillator to be constructed with a single tube instead of the usual two or three. An equation is given which takes account of the nonlinearity of tube characteristics and is analogous to that for the inductance-capacitance oscillator. Design criteria are established, frequency limits determined, and a practical circuit described.

621.396.615:549.514.51 1882

Negative-Resistance Crystal Oscillators—

A. Pincioli. (*Alla Frequenza*, vol. 13, pp. 18-30; March, 1944. In Italian, with English, French, and German summaries.) Theoretical discussion, based on equivalent circuits, of pentode oscillators differing essentially from the normal Pierce circuits. The quartz crystal is connected between the suppressor and screen grids and the screen voltage is much higher than the anode voltage. Curves show the relation between frequency and the variations of the various circuit parameters. With proper choice of these parameters, a high degree of frequency stability is possible.

621.396.615:621.316.72 1883

Theory of Amplitude-Stabilized Oscillators—P. R. Aigrain and E. M. Williams. (Proc. I.R.E., vol. 36, pp. 16-19; January, 1948.) The performance of generalized amplitude-stabilized oscillators is analyzed in terms of a stability factor. Theoretical calculations are made for stabilization with various types of nonlinear control elements, whose properties are tabulated. The circuit of an improved stabilized oscillator is described.

621.396.615.17 1884

The Degenerative Positive-Bias Multivibrator—S. Bertram. (Proc. I.R.E., vol. 36, pp. 277-280; February, 1948.) The operation of a multivibrator with positive grid supply and cathode degeneration is described. It is shown that, for suitable circuit parameters, the frequency of the multivibrator is very nearly a linear function of the applied grid voltage. Since the grid voltage can be controlled with relatively simple auxiliary circuits, the positive-bias multivibrator becomes a useful variable-frequency source.

621.396.615.18 1885

Negative-Transconductance Frequency Divider—A. Bressi. (*Alla Frequenza*, vol. 12, pp. 417-427; October to December, 1943. In Italian, with English, French, and German summaries.) The behavior as multivibrator of a sawtooth relaxation oscillator with a single negative-transconductance tube is examined. Applications to the construction of frequency dividers for a quartz clock are discussed.

621.396.619.13 1886

Distortion of F.M. Signals in Passage through Electrical Networks—F.L.H.M. Stumpers. (*Tijdschr. ned. Radiogenoot.*, vol. 13, pp. 1-21; January, 1948. In Dutch, with English summary.) Full account of part of the work described in 2221 of 1947.

621.396.645 1887

The Cathode Amplifier—W. Geyger. (*Funk. und Ton*, pp. 119-124; March, 1948.) General theory and a summary of the particular advantages of this type of amplifier.

621.396.645 1888

Harmonic-Amplifier Design—R. H. Brown. (Proc. I.R.E., vol. 36, p. 84; January, 1948.) Discussion on 61 of February.

621.396.645 1889

Design of Wide-Band Amplifiers—J. Harman. (*Funk. und Ton*, pp. 72-80; February, 1948.) A design method is developed for amplifiers comprising a number of detuned circuits. The conditions necessary for the amplifiers to have approximately square frequency/amplification curves are also determined.

621.396.645:621.396.615.142 1890

Application of Velocity-Modulation Tubes for Reception at U.H.F. and S.H.F.—M. J. O. Strutt and A. van der Ziel. (Proc. I.R.E., vol. 36, pp. 19-23; January, 1948.) When such tubes are used as preamplifiers, a special arrangement of three electrode pairs spaced along the electron stream is recommended. The noise factor

can thereby be reduced from several thousand to about ten, with no loss of gain. The first pair of electrodes is connected to a resonant line or cavity and constitutes a preselector circuit; the second is connected to the input and the third to the output circuit. It is suggested that experiments by E. Barlow (IRE Electron-Tube Conference, New Haven, Conn., June, 1946) which failed to realize such noise reduction should be repeated under conditions conforming to this analysis.

621.396.645.36 1891

Class-A Push-Pull Amplifier Theory—H. L. Krauss. (Proc. I.R.E., vol. 36, pp. 50-52; January, 1948.) Two tubes operating in push-pull, class-A, have more than twice the power output of a single tube operating at the same voltages; optimum load values are assumed in each case. This is demonstrated analytically, and explained in terms of the change in load impedance seen from one tube caused by coupling to the other. Experimental data confirm the theory.

621.396.662.029.64:621.392.029.64 1892

Note on Wave-Guide Attenuators—C. W. Miller, M. C. Crowley-Milling, and G. Saxon. (*Jour. I.E.E.* (London), part IIIA, vol. 93, no. 9, pp. 1477-1478; 1946; summary, *ibid.*, part IIIA, vol. 93, no. 1, p. 227; 1946.) A practical paper describing the design of fixed and variable attenuators. For operation at low power levels, a carbon-loaded absorbing material is used, and at higher levels, the power is absorbed in flowing water.

621.396.662.33.029.62 1893

A 35 Mc/s High-Pass Filter—P. F. Cundy. (*RSGB Bull.*, vol. 23, pp. 174-175; March, 1948.) Details of a filter, consisting of one constant- K and one m -derived section, designed to eliminate, in television reception, second-channel interference from transmissions in the 28-Mc amateur band.

621.396.69 1894

Printed-Circuit Techniques—C. Brunetti and R. W. Curtis. (Proc. I.R.E., vol. 36, pp. 121-161; January, 1948.) A comprehensive discussion, with a bibliography of 60 references. See also 1913 of 1947 (Sargrove).

621.396.69 1895

A Review of the Radio Component Industry's Activities—E. M. Lee. (*Jour. I.E.E.* (London), part IIIA, vol. 94, no. 11, pp. 221-230; 1947; summary, *ibid.*, part I, vol. 94, pp. 487-488; October, 1947.) History of development, production, and standardization work from 1934 to 1947, with an estimate of the post-war value of war-time experience in component production.

621.396.69:06.064 1896

R.C.M.F. [Radio Component Manufacturers Federation] Exhibition—(*Elec. Times*, vol. 113, pp. 283-284; March 4, 1948; and *Electrician*, vol. 140, p. 722; March 5, 1948.) A short account of the opening ceremony and of some of the exhibits.

621.396.69:06.064 1897

The International Components Exhibition [Paris, Feb. 1948]—G. Sequeille (*Télev. Franç.*, pp. 16-18; March, 1948.) A general discussion of the exhibits. The exhibition was international only in name. Another account in *Onde Elec.*, vol. 28, pp. 115-118; March, 1948; see also 1898 below.

621.396.69:06.064 Paris 1898

Components Exhibition, Paris, 1948—(*Radio Prof.* (Paris), vol. 17, pp. 18-21, 26; February, 1948.) A review of the exhibits, with a short account of the special features of items of particular interest or novelty. For other ac-

counts see *Toute la Radio*, vol. 15, pp. 112–115; March–April, 1948; and 1897 above.

621.396.69:389.6 1899
Standardization of Components in France—Radionyme. (*Toute la Radio*, vol. 15, pp. 85–88; February, 1948.) Discussion of proposals for standard tests for the various components used in radio receivers and similar apparatus, to ensure good quality.

621.396.69:623.6 1900
Component Development for War-Time Service Applications—I. M. Ross. (*Jour. I.E.E.* (London), part IIIA, vol. 94, no. 11, pp. 231–243; 1947; and summary, *ibid.*, part I, vol. 94, pp. 493–494; October, 1947.) Discussion of co-ordination arrangements and organization, and of reliability, miniaturization, tropicalization, and other special factors influencing design. Important developments in individual classes and types of components are considered, and future trends and some of the problems still unsolved are briefly reviewed.

621.396.813:621.392.015.3 1901
Phase and Amplitude Distortion in Linear Networks—M. J. Di Toro. (PROC. I.R.E., vol. 36, pp. 24–36; January, 1948.) The behavior of practical communication networks is examined and relations are deduced which show the conditions necessary to avoid transient response overshoot caused by phase distortion. Graphs are given from which design data such as transient overshoot and effective bandwidth of networks in cascade may be obtained. Applications to delay lines with lumped and distributed constants, a stagger-tuned if amplifier, and uncompensated and series-peaked compensated video amplifiers are given.

GENERAL PHYSICS

537.52 1902
Theory of High Frequency Gas Discharges: Part 1—Methods for Calculating Electron Distribution Functions—H. Margenau. (*Phys. Rev.*, vol. 73, pp. 297–308; February 15, 1948.)

537.52 1903
Theory of High Frequency Gas Discharges: Part 2—Harmonic Components of the Distribution Function—H. Margenau and L. M. Hartman. (*Phys. Rev.*, vol. 73, pp. 309–315; February 15, 1948.)

537.52 1904
Theory of High Frequency Gas Discharges: Part 3—High Frequency Breakdown—L. M. Hartman. (*Phys. Rev.*, vol. 73, pp. 316–325; February 15, 1948.)

537.52 1905
Theory of High Frequency Gas Discharges: Part 4—Note on the Similarity Principle—H. Margenau. (*Phys. Rev.*, vol. 73, pp. 326–328; February 15, 1948.)

537.525 1906
Starting Potentials of High-Frequency Gas Discharges at Low Pressure—E. W. B. Gill and A. von Engel. (*Proc. Roy. Soc. A.*, vol. 192, pp. 446–463; February 18, 1948.) A study of h.f. electrodeless discharges in H, He, air, and Hg vapor at pressures of the order of 10^{-3} mm Hg. The starting field strength is found to be independent of the gas and only slightly dependent on the pressure. As the wavelength is increased from 4 m, the starting field first varies as λ^{-1} , then becomes constant, and at a critical value rises discontinuously, probably to infinity. The cutoff wavelength depends on the size of the containing vessel. A theory based on

secondary emission from the glass walls agrees well with the experimental results.

537.533:621.385.032.216 1907
A Method of Studying the Thermionic Emission of Oxide-Coated Cathodes in Gaseous Conduction Devices.—W. F. Hodge. (*Phys. Rev.*, vol. 73, p. 95; January 1, 1948.) Summary of Amer. Phys. Soc. paper.

537.56:621.385.1.016.4.029.63 1908
Production of High-Frequency Energy by Ionized Gases—J. L. Steinberg. (*Nature* (London), vol. 160, pp. 833–834; December 13, 1947.) A description of measurements made for λ 1.30 to 2.60 m using a cold cathode discharge in pure nitrogen. The effects of applying a transverse magnetic field across chosen portions of the discharge path are discussed. A complete account is to be published in *Rev. Sci.* (Paris). See also 715 of 1947 (Thomemann and King.)

538.3 1909
The Experimental Basis of Electromagnetism: Part 2—Electrostatics—N. R. Campbell and L. Hartshorn. (*Proc. Phys. Soc.*, vol. 60, pp. 27–52; January 1, 1948.) Continuation of 3091 of 1947. The basis of electrostatics is found in alternating currents and the laws of capacitance which lead to the concept of electric potential energy. The experiments on mechanical forces between electrified bodies fit in with this conception. The soundest procedure in the investigation of any system of conductors and dielectrics is to represent the system by its equivalent capacitance network.

This method is applied to such problems as the measurement of mutual capacitance, the effect of screening, and the properties of a complex capacitor.

538.311+538.32]:621.396.67 1910
Currents Excited on a Conducting Plane by a Parallel Dipole—B. C. Dunn, Jr. and R. King. (PROC. I.R.E., vol. 36, pp. 221–229; February, 1948.) An analysis of the distribution of magnetic field and of current on the plane surface of a perfectly conducting infinite sheet, due to a driven half-wave dipole parallel to the sheet. With certain assumptions regarding current distribution in the dipole, it is found that the tangential magnetic field is everywhere perpendicular to the axis of the dipole while the current is everywhere parallel to this axis. The distributions of field and current are presented graphically and the assumptions regarding current distribution are discussed and shown to be substantially correct for the usual physical systems.

538.569.4.029.64 1911
Ultra-Short Waves in the Millimetre Region—H. H. Klinger. (*Funk. und Ton*, pp. 135–139; March, 1948.) A review of the special properties of mm waves, including their absorption by water vapor, hydrogen, and oxygen. Some possible applications are examined.

538.569.4.029.64+537.226.2]:546.212 1912
The Anomalous Dispersion of Water at Very High Radio Frequencies: Part 1—Experimental Determination of the Dielectric Properties of Water in the Temperature Range 0° C to 40° C for Wave-Lengths of 1.24 cm and 1.58 cm—J. A. Saxton and J. A. Lane. (*Physical Society Special Report on Meteorological Factors in Radio Wave Propagation*, pp. 278–292.) A free-wave method of determining the refractive index and absorption coefficient of water by measuring the reflection coefficient of a thin film and the attenuation of e.m. radiation passing through it. For λ 1.24 cm, the absorption coefficient increases from 2.11 at 40° C to a maximum of 2.92 at 10° C and then falls to 2.73 at 0° C; the refractive index decreases steadily from 7.47 at 40° C to 4.67 at 0° C. For λ 1.58 cm, the absorption coefficient increases

from 1.80 at 40° C, to a maximum of 2.97 at 5° C and falls to 2.90 at 0° C; the refractive index decreases steadily from 7.81 at 40° C to 5.24 at 0° C. Similar results are obtained for sea water. Accuracy is within about 1 per cent for the absorption coefficient and about 2 per cent for the refractive index. Evidence is given of anomalous dispersion due to permanent polarity of the molecules. The results are in qualitative agreement with Debye's theory. See also 1913–1915 below.

538.569.4.029.64+537.226.2]:546.212 1913
The Anomalous Dispersion of Water at Very High Radio Frequencies: Part 2—Relation of Experimental Observations to Theory—J. A. Saxton. (*Physical Society Special Report on Meteorological Factors in Radio Wave Propagation*, pp. 292–306.) Recent theories of the dielectric constant of a pure polar liquid are discussed. The Debye theory as modified by Onsager is used as a basis for the examination of the relation to theory of the measurements described in 1912 above. The form of the equations is verified; the results compare well with existing data on wavelengths up to 10 cm, but a higher value of atomic polarization ($\epsilon_0 \approx 5.5$) must be assumed than has hitherto been used.

Curves are calculated on this basis to show the variation of dielectric properties for λ 0.2 to 10 cm and for temperatures of 0° to 40° C. The relaxation time and atomic polarization are discussed, and the relation between relaxation time and viscosity is examined briefly.

538.569.4.029.64+537.226.2]:546.212 1914
The Anomalous Dispersion of Water at Very High Radio Frequencies: Part 3—The Dipole Relaxation Time and Its Relation to the Viscosity—J. A. Saxton. (*Physical Society Special Report on Meteorological Factors in Radio Wave Propagation*, pp. 306–316.) The experimental results described in 1912 above are examined on the basis of Eyring's theory of absolute reaction rates. A fundamental similarity exists between the mechanisms of dipole rotation and viscous flow, and the dielectric properties under consideration can be determined from a knowledge of the viscosity, the atomic polarization, and static dielectric constant. A single relaxation time, dependent on temperature, seems adequate to account for dipolar dispersion in water.

538.569.4.029.64+537.226.2]:546.331.31+546.212 1915

The Anomalous Dispersion of Water at Very High Radio Frequencies: Part 4—A Note on the Effect of Salt in Solution—J. A. Saxton. (*Physical Society Special Report on Meteorological Factors in Radio Wave Propagation*, pp. 316–325.) The dielectric properties of an aqueous salt solution at vhf are in agreement with the supposition that the salt produces a structural change in the water analogous to that produced by an increase in temperature. Calculations, based on this hypothesis and actual absorption measurements, have been made of the dielectric properties of solutions for other wavelengths, and they agree well with experimental determinations.

538.569.4.029.64:546.171.1 1916
Pressure Broadening of the Inversion Spectrum of Ammonia: Part 2—Disturbance of Thermal Equilibrium at Low Pressures—B. Bleaney and R. P. Penrose. (*Proc. Phys. Soc.*, vol. 60, pp. 83–98; January 1, 1948.) The absorption coefficient at the center of the line (3, 3) of the centimeter wavelength inversion spectrum of ammonia gas was measured at pressures between 1.5 and 0.01 mm Hg. The coefficient is constant at the higher pressures, as would be expected for a single line whose width is determined solely by pressure broadening. At lower pressures, the absorption coefficient

falls by an amount dependent on the energy density in the resonator. This is due to disturbance of thermal equilibrium by absorption of rf energy. A theory is developed from which the thermal relaxation time can be calculated by comparison with experimental values of the absorption coefficient. See also 3507 of 1947 and 3870 of January.

530.145 1917

The Principles of Quantum Mechanics [Book Review]—P.A.M. Dirac. International Series of Monographs on Physics, Clarendon Press, Oxford and Oxford University Press, London, 3rd edition 1947, 312 pp., 25s. (*Nature*, (London), vol. 160, p. 812; December 13, 1947.) The book "is the standard work in the fundamental principles of quantum mechanics, indispensable both to the advanced student and the mature research worker."

GEOPHYSICAL AND EXTRA-TERRESTRIAL PHENOMENA

016:550.38 1918

List of Recent Publications [on terrestrial and cosmical electricity and magnetism, and allied subjects]—H. D. Harradon. (*Terr. Mag. Atmo. Elec.*, vol. 52, pp. 558-565; December, 1947.)

523.7+550.3851"1947.04/.09" 1919

Solar and Magnetic Data. April to September, 1947, Mount Wilson Observatory—S. B. Nicholson. (*Terr. Mag. Atmo. Elec.*, Vol. 52, no. 4, pp. 451-452; December, 1947.)

523.72.029.6:621.396.822 1920

Metre and Centimetre Waves from the Sun—K. O. Kiepenheuer. (*Funk. und Ton*, pp. 165-170; April, 1948.) A general discussion of the correlation between s.w. radiation from the sun and the occurrence of sunspots, flares, etc., and of the magnitude of the solar temperatures and magnetic fields which would account for the observed effects.

523.72.029.63"1946.06/1947.05" 1921

Solar Intensity at 480 Mc—G. Reber. (*Proc. I.R.E.*, vol. 36, p. 88; January, 1948.) Noon solar intensity values obtained at Wheaton, Illinois, are plotted for June, 1946, to May, 1947, and discussed.

523.746"1946" 1922

Final Relative Sunspot-Numbers for 1946—M. Waldmeier. (*Terr. Mag. Atmo. Elec.*, vol. 52, pp. 493-495; December, 1947.)

523.746"1947.07/.09" 1923

Provisional Sunspot-Numbers for July to September, 1947.—M. Waldmeier. (*Terr. Mag. Atmo. Elec.*, vol. 52, p. 448; December, 1947.)

523.78"1940.10.01":551.510.535 1924

The Ionospheric Eclipse of October 1, 1940—J. A. Pierce. (*Proc. I.R.E.*, vol. 36, pp. 8-15; January, 1948.) Values of critical frequencies, obtained for the various layers during the total eclipse at Queenstown, South Africa, are discussed and compared with observations made under normal conditions. A theory of the formation of the E layer is proposed to account for some of the results. Processes of recombination and diffusion cannot explain completely the behavior of the F₂ region; cooling of the atmosphere as a result of the eclipse probably plays an important part. Some of the results are compared with those obtained in the USSR in 1936. The Russian results were not published as it was thought that a severe magnetic storm might have made them unreliable.

523.78"1945.07.09":551.510.535 1925

Some Experimental Results Obtained by Ionospheric Investigations in Sweden during the Total Solar Eclipse of July 9, 1945—S. Gejer and P. Åkerlind. (*Terr. Mag. Atmo. Elec.*, vol. 52, pp. 479-491; December, 1947.) The critical frequencies were measured during the eclipse and on several days before and after it. The greatest decreases in the ionization densities for the E, F₁, and F₂ regions were respectively 57 per cent, 63 per cent, and 33 per cent below the estimated undisturbed values. During the eclipse, the signal strength of a North American station on 15 Mc fell by about 20 db at totality. The signal strength of two medium-wave Swedish stations showed no important change, indicating that D-region absorption remained high. See also 1777 or 1947 (Rydbeck).

523.854:621.396.822.029.62 1926

An Investigation of Galactic Radiation in the Radio Spectrum—J. S. Hey, S. J. Parsons, and J. W. Phillips. (*Proc. Roy. Soc. A*, vol. 192, pp. 425-445; February 18, 1948.) An investigation of the distribution of the sources of galactic radiation at 64 Mc is described. Methods are discussed for measuring the characteristics of the receiving antenna and estimating the magnitude of the received galactic power by reference to the noise from a saturated diode. Possible sources of error are considered; an accuracy better than 1.2 db (30 per cent) is expected for the regions of highest radiation intensity. Comparison of the derived distributions of galactic radiation with other astronomical data does not clearly favor any one theory. Neither a simple theory in terms of a distributed source in interstellar gas nor one in terms of discrete centers of radiation analogous to sunspots appears adequate to account for the observed phenomena. It is suggested that sources of both types contribute to the observed radiation and that, in general, they must be very distant and associated with the main body of the galaxy. See also 402 of 1947, 3511 of January, and 413 of March.

538.12:521.15 1927

On Magnetism of Celestial Bodies—J. Mariani. (*Phys. Rev.*, vol. 73, pp. 78-79; January 1, 1948.) An interpretation of the proportionality of magnetic moment to angular momentum in the case of celestial bodies is suggested. The electrical density is found to be of the order assumed by Blackett (3112 of 1947) for the production of cosmic magnetism. Also, the charge associated with the gravitational field energy is of the same order as the negative charge at the earth's surface. See also 2115 of 1947, 1634 and 1635 of July and back references.

550.38(515) 1928

Preliminary Report on the Magnetic Results of a Journey to Sikkim and Southern Tibet—K. Wienert. (*Terr. Mag. Atmo. Elec.*, vol. 52, pp. 505-521; December, 1947.) The declination, horizontal intensity, and dip for 55 stations in the area, reduced to the epoch 1939.0, are tabulated. Methods of reduction and apparatus used are discussed.

550.38"1946" 1929

Mean K-Indices from Thirty Magnetic Observatories and Preliminary International Character-Figures C for 1946—W. E. Scott. (*Terr. Mag. Atmo. Elec.*, vol. 52, pp. 497-503; December, 1947.)

550.38"1947.07/.09" 1930

Cheltenham [Maryland] K-Indices for July to September, 1947—W. E. Wiles. (*Terr. Mag. Atmo. Elec.*, vol. 52, p. 522; December, 1947.)

550.38"1947.07/.09" 1931

K-Indices and Sudden Commencements, July to September, 1947, at Abinger—H. Spen-

cer Jones. (*Terr. Mag. Atmo. Elec.*, vol. 52, pp. 495-496; December, 1947.)

550.384 1932

Note on "Sudden Commencements" and Other Small Characteristic Impulses [of the earth's field]—H. W. Newton. (*Terr. Mag. Atmo. Elec.*, vol. 52, pp. 441-447; December, 1947.) The close correspondence in time and character of certain impulses recorded in England and North America is mentioned. Tracings are included for comparison in other countries.

550.384.3(498) 1933

Magnetic Measurements at Jassy from 1941 to 1947—S. Procopiu. (*Bull. Éc. Polyt. (Jassy)*, vol. 2, pp. 193-196; July to December, 1947. In French.) Tables of D and H.

550.384.3(498) 1934

Magnetic Measurements at Jassy from 1941 to 1947—N. Calinicenco. (*Bull. Éc. Polyt. (Jassy)*, vol. 2, pp. 197-199; July to December, 1947. In French.) Tables of the magnetic inclination I.

550.384.3 (498) 1935

Values of the Magnetic Elements and Secular Variations at Jassy, during 16 Years, from 1931 to 1947—S. Procopiu. (*Bull. Éc. Polyt. (Jassy)*, vol. 2, pp. 207-220; July to December, 1947. In French.) Tables, for July 1 in each year, of D, H, and I, dD, dH and dI, also of Z and F. The variations at Bucharest and at Jassy from 1772 to 1947 are shown graphically and discussed.

550.384.4 1936

The Magnetic Diurnal Variation of the Horizontal Force near the Magnetic Equator—J. Egedal. (*Terr. Mag. Atmo. Elec.*, vol. 52, pp. 449-451; December, 1947.) If ΔH is plotted against magnetic inclination for stations near the equator, a smooth curve can be drawn which passes through the points for Kodaikanal and Huancayo. The curve is discussed briefly.

550.385 "1947.07/.09" 1937

Principal Magnetic Storms [July-September, 1947]—(*Terr. Mag. Atmo. Elec.*, vol. 52, pp. 540-557; December, 1947.)

551.510.5:525.624 1938

Atmospheric Oscillations and the Resonance Theory—K. Weekes and M. V. Wilkes. (*Proc. Roy. Soc. A*, vol. 192, pp. 80-99; December 23, 1947.) A description of the circumstance under which tidal energy supplied to the atmosphere through the action of tide-producing forces can be trapped between a certain stratum (usually where the temperature has a minimum) and the ground. The results are applied to discuss, in general terms, the types of free oscillation which an atmosphere with a given temperature distribution may possess. Results of numerical calculations are given which determine to what extent the requirements of the resonance theory restrict the possible temperature variation in the atmosphere.

551.510.52:621.396.11 1939

The Structure and Refractive Index of the Lower Atmosphere—P. A. Sheppard. (*Physical Society Special Report on Meteorological Factors in Radio Wave Propagation*, pp. 37-79.) Data on the vertical gradients of temperature and humidity in the lowest kilometer of atmosphere, which largely determine the gradient of the refractive index, are assembled and discussed. Profiles measured over land and sea are examined in detail with reference to diurnal and seasonal effects, advection, and subsidence. The effect of turbulence on these profiles in certain conditions is discussed briefly.

551.510.52:621.396.11 1940

Refraction in the Lower Atmosphere and its Applications to the Propagation of Radio Waves—A. C. Stickland. (*Physical Society Special Report on Meteorological Factors in Radio Wave Propagation*, pp. 253–267.) The variation with height of the refractive index of the lower atmosphere is studied from available meteorological data, and a law is deduced for the average bending of short radio waves by the atmosphere. Empirical formulas for the variation of refractive index with height are examined; world-wide variations are also considered. Finally, the application of the results to propagation problems is discussed.

551.510.52:621.396.11 1941

Note on Errors in Measurement of the Refractive Index of the Air for High-Frequency Radio Waves Consequent upon Errors in Meteorological Measurements—G. A. Bull. (*Physical Society Special Report on Meteorological Factors in Radio Wave Propagation*, pp. 273–278.)

551.510.52:621.396.11 1942

A Standard Radio Atmosphere for Microwave Propagation—Best. (See 2045.)

551.510.52:621.396.812 1943

Radio Climatology—C. S. Durst. (*Physical Society Special Report on Meteorological Factors in Radio Wave Propagation*, pp. 193–212.) "Meteorological conditions as regards temperatures and humidity are examined for certain regions of the globe in certain seasons. These conditions are related to the occurrence of abnormal refraction of radio waves. From this examination it is shown how the regions of abnormal refraction can be mapped for much of the world, provided maps are available of (a) the contrast of sea and air temperature, (b) humidity, (c) horizontal air flow near the surface, and (d) vertical air flow at some comparatively low height."

551.510.53:537.591.8 1944

The Basic Reactions in the Upper Atmosphere. Part 2—The Theory of Recombination in the Ionized Layers—D. R. Bates and H. S. W. Massey. (*Proc. Roy. Soc. A*, vol. 192, pp. 1–16; December 23, 1947.) The results of recent work make the ionic recombination theory very difficult to maintain. Two possible alternatives are here discussed, the dust recombination theory and the molecular recombination theory. It is concluded that only the second of these is at all promising. According to this theory, nonradiative combination of an electron with a molecular positive ion can occur, the energy released by the capture producing dissociation of the oxygen molecule. Confirmation of the theory must await proper determination of the appropriate reaction rates, but the modified molecular recombination theory appears capable of giving a plausible explanation of the ionized layers. Part 1: 414 of 1947.

551.510.535+550.385 1945

Differential Penetration and Magnetic Storms—T. L. Eckersley. (*Terr. Mag. Atmo. Elec.*, vol. 52, pp. 433–440; December, 1947.) Magnetic and ionospheric storms are attributed to neutral streams of charged particles which enter the earth's field; the behavior of such streams has been examined (726 of April). The observed increase in abnormal-*E* is due to penetration of positive particles to the *E*-region; the negative particles do not penetrate below the *F*-region, where they drift westward, causing the observed increase in *H* and decrease in *F*-region ionization density.

621.396.11.029.52:551.510.535 1946

On the Measurement of Ionospheric Virtual Height at 100 Kilocycles—R. A. Helliwell. (*Phys. Rev.*, vol. 73, p. 77; January 1, 1948.) An

antenna is charged to 100 kv and allowed to discharge through a sphere gap. About 500 w is radiated vertically in pulses of time constant 200 μ s. At night in October, 1947, in California, reflections were obtained from virtual heights of 91 to 98 km. These echoes were sometimes weaker than the first-order multiple reflections.

551.510.535:621.396.11 1947

On Magneto-Ionic Splitting [of Radio Waves] in the Sporadic E Layer—Driatski. (See 2051.)

551.510.535:621.396.11 1948

The Influence of Wave-Propagation on the Planning of Short-Wave Communication—Tremellen and Cox. (See 2050.)

551.510.535:621.396.11 1949

The Investigation and Forecasting of Ionospheric Conditions—Appleton. (See 2048.)

551.510.535:621.396.11 1950

Developments in Radio Sky-Wave Propagation Research and Applications During the War—Dellinger and Smith. (See 2049.)

551.594.21 1951

On the Electricity of Thunderstorms—V. I. Arabadzhi. (*Priroda*, no. 7, pp. 12–15; 1947. In Russian.) Various theories of the electrification of clouds are surveyed and preference is given to the contact theory as originally expounded by Luvini and Sohnke.

551.594.5 1952

A Proposed Auroral Index-Figure—I. L. Thomsen. (*Terr. Mag. Atmo. Elec.*, vol. 52, pp. 453–467; December, 1947.) A new numerical scale with 15 degrees of intensity is proposed, and compared with existing scales. Auroral form or activity as well as brightness is considered in determining the new scale number.

551.594.5 1953

Notes on the Aurora Australis—I. L. Thomsen. (*Terr. Mag. Atmo. Elec.*, vol. 52, pp. 469–477; December, 1947.) Continuous records of aurora seen in New Zealand for nearly 1½ sunspot cycles are available at the Carter Observatory. Auroral phenomena in the southern hemisphere are believed to be generally similar to those of the northern, but scientifically reliable data are scanty.

523.746 1954

Sunspots in Action [Book Review]—H. T. Stetson. Ronald Press Co., New York, 1947, 227 pp., \$3.50. (*Proc. I.R.E.*, vol. 36, p. 254; February, 1948.) "Collects into a highly informative and thoroughly readable form a wealth of information covering various aspects of sunspot phenomena."

LOCATION AND AIDS TO NAVIGATION

621.396.93 1955

Fundamental Problems in Radio Direction-Finding at High Frequencies (3–30 Mc/s)—W. Ross. (*Jour. I.E.E.* (London), part IIIA, vol. 94, no. 11, pp. 154–165; 1947; and summary, *ibid.*, part I, vol. 94, pp. 479–480; October, 1947.) A survey paper that discusses instruments and propagation. Wave interference effects from two rays arriving from different directions may give rise to considerable errors for systems of the Adcock type in which the antenna spacing is comparable with λ . Wide spacing of the antennas eliminates interference but may give ambiguous bearings. Various forms of display are discussed and the specification of the performance of the Adcock type d.f. is considered. The directions of propagation of ground and ionospheric waves are examined and a summary is given of the present knowledge of devi-

ations of ionospheric rays from the great-circle path and of methods developed to overcome this. Methods of assessing the probable accuracy of individual bearings are discussed, though there is still no fully satisfactory solution; the determination of the most probable transmitter location is also considered. Possible future development of mechanical and electronic devices for carrying out the necessary operations automatically are mentioned.

621.396.932.2 1956

Naval Radio Direction-Finding—C. Cramp-ton. (*Jour. I.E.E.* (London), part IIIA, vol. 94, no. 11, pp. 132–153; 1947; and summary, *ibid.*, part I, vol. 94, no. 82, pp. 477–478; October, 1947.) A brief account of land-based d.f. systems used by the Admiralty and of the German Wullenweber steerable-lobe system.

Shipborne systems for m.f., h.f. and v.h.f. are described, with particular attention to the position of the antenna system for optimum accuracy. The effect of reradiation by various structures is considered in detail and curves for estimating the probable errors are given, together with typical calibration curves for h.f. and v.h.f. systems. The sensitivity of a crossed-loop h.f. system is examined; the probable range of a transmitter may be estimated from the strength of the signal received. Curves are given showing how a spaced-loop system can give increased accuracy at h.f.

621.396.933+621.396.96 1957

Radar Equipment manufactured in Hungary and Abroad—E. Istvánffy. (*Elektrotechnika* (Budapest), vol. 40, pp. 1–12; January, 1948.) A review of war-time developments, including British and American types and a few navigation systems.

621.396.933 1958

The Development of C.W. Radio Navigation Aids, with Particular Reference to Long-Range Operation—R. V. Whelpton and P. G. Redgment. (*Jour. I.E.E.* (London), part IIIA, vol. 94, no. 11, pp. 244–254; 1947; and summary, *ibid.*, part I, vol. 94, pp. 489–490; October, 1947.) Considerations governing the choice of system and the selection of optimum frequency in relation to reliability and range, with some details of various methods involving phase of amplitude measurement, and discussion of their relative merits. Pulse techniques are only reviewed briefly.

621.396.933 1959

Radar Navigation—R. A. Smith. (*Jour. I.E.E.* (London), part IIIA, vol. 93, no. 1, pp. 331–342; 1946.) Full paper: summary noted in 3144 of 1947.

621.396.933 1960

A Survey of Continuous-Wave Short-Distance Navigation and Landing Aids for Aircraft—C. Williams. (*Jour. I.E.E.* (London), part IIIA, vol. 94, no. 11, pp. 255–266; 1947; and summary, *ibid.*, part I, vol. 94, pp. 491–492; October, 1947.) Requirements for navigation and landing aids are discussed and the importance of the method of display of information is stressed. Principal features of several different types of system are described briefly. Principles and applications of radio altimeters, and methods of distance measurement, are also considered.

621.396.933 1961

Radio and Aerial Navigation in Civil Aviation—F. Penin. (*Onde Élec.*, vol. 28, pp. 87–98; March, 1948.) Discussion of general problems and short descriptions of various navigation systems.

621.396.96 1962

Precision Radar—W. A. S. Butement, B. Newsam, and A. J. Oxford. (*Jour. I.E.E.* (Lon-

don), part IIIA, vol. 93, no. 1, pp. 114-126; 1946.) Measurements of ranges up to 20 miles were required to an over-all accuracy of ± 25 yd. Pulse technique was used; the leading edge of an echo was found the most satisfactory as a ranging point. The necessary accuracy in frequency was achieved by means of crystal-controlled tube oscillators. For high accuracy in measuring angles, narrow split beams were used; this technique is discussed fully. Calibration, sources of error, and possible future developments are considered; three typical equipments are described briefly.

621.396.96:551.594.6 1963

Radar Storm Detection: Part 1—F. L. Westwater. (*Physical Society Special Report on Meteorological Factors in Radio Wave Propagation*, p. 190.) Brief discussion, with photographs, of typical echoes. For theory see 2062 below.

621.396.96:551.594.6 1964

Radar Storm Detection: Part 2—K. G. Ross. (*Physical Society Special Report on Meteorological Factors in Radio Wave Propagation*, pp. 190-193.) Brief discussion, with illustrative example, of the use of radar storm observations for short-term local weather forecasting.

621.396.96:621.385.832 1965

The Visibility of Small Echoes on Radar PPI Displays—R. Payne-Scott. (*Proc. I.R.E.*, vol. 36, pp. 180-196; February, 1948.) A discussion of the mathematical basis of visibility on a c.r. tube PPI display, with experimental confirmation and nomograms for the rapid calculation of the minimum visible signal under any set of conditions.

621.396.96:621.392 1966

Introduction to Circuit Techniques for Radiolocation—Williams. (See 1874.)

621.396.96:621.396.61 1967

Radar Transmitters: A Survey of Developments—Ratsey. (See 2095.)

621.396.96:621.396.621 1968

Radar Receivers—Lewis. (See 2067.)

621.396.96:621.396.812(931) 1969

Observations of Unorthodox Radar Vision in the Vicinity of New Zealand and Norfolk Island—F. E. S. Alexander. (*Physical Society Special Report on Meteorological Factors in Radio Wave Propagation*, pp. 242-249.) Observations based on records of war-time operational stations. [Note. More recently a scientific expedition was sent to study propagation and meteorological conditions in the Christchurch district, but results have not yet been published.]

621.396.96:621.396.812.029.64 1970

The Attenuation and Radar Echoes Produced at Centimetre Wave-Lengths by Various Meteorological Phenomena—Ryde. (See 2062.)

621.396.96:621.396.932 1971

Problems in Shipborne Radar—A. W. Ross. (*Jour. I.E.E.* (London), part IIIA, vol. 93, no. 1, pp. 236-244; 1946.) Information from any one receiver must be distributed to several positions; displays must be interchangeable, and often well separated from the set; there may be up to 30 radar sets in addition to many communications equipments in a ship; stabilization to compensate for the motion of the ship must be arranged; side lobes must be very small; sea clutter effects, transmitter instability due to long antenna feeders, and interference effects must be reduced to a minimum; reliability and ease of maintenance are important considerations. Methods of meeting these requirements as far as possible are discussed. The design of shipborne navigation aids is also considered briefly.

MATERIALS AND SUBSIDIARY TECHNIQUES

533.5:621.3.032.53 1972

New Techniques in Glass-to-Metal Sealing—J. A. Pask. (*Proc. I.R.E.*, vol. 36, pp. 286-289; February, 1948.) The new techniques enable seals to be made by controlled processes on a mass-production basis. The metal is first oxidized to obtain a film of a definite thickness. The glass is powdered, applied to the surface as a suspension in a liquid, and finally fused. Other additions can then be made by glass-to-glass seals. Critical factors in the process are defined, and theories of the baking, adhering, and oxidation processes are suggested.

535.37.001.8 1973

Applications of Luminescent Substances—F. A. Kröger. (*Philips Tech. Rev.*, vol. 9, no. 7, pp. 215-221; 1947.) A general discussion of the most suitable luminescent substances for use with electron beams, X-rays, ultraviolet rays, and infrared rays.

538.221 1974

The Theory of the Ferromagnetism of Binary Alloys—S. V. Vonsovski. (*Zh. Tekh. Fiz.*, vol. 18, pp. 131-144; February, 1948. In Russian.)

538.221:669.14 1975

Magnetic Properties of Cr-Ni-Mo Steel after Various Thermal Treatments—P. N. Zhukova and M. N. Mikheev. (*Zh. Tekh. Fiz.*, vol. 18, pp. 187-196; February, 1948. In Russian.)

546.161-1:621.3.015.5 1976

Gaseous Insulation for High-Voltage Apparatus—G. Camilli and J. J. Chapman. (*Gen. Elec. Rev.*, vol. 51, pp. 35-41; February, 1948.) Description of an investigation of a group of halogenated gaseous compounds to determine their impulse ($1\frac{1}{2}\times 40$ microsecond wave) and 60-cps alternating voltage strength in uniform and nonuniform fields at pressures of one, two and three atmospheres.

Results show that SF₆ is superior to the freon gases. It reaches a dielectric strength comparable to that of mineral oil, at pressures low enough to prevent the gas from condensing over the expected ambient temperature range. SF₆ is stable at high temperatures and non-inflammable. As no carbon is contained in its molecular structure, it does not leave a conducting deposit after slight decomposition by breakdown.

621.3.017.22 1977

Investigation of the Eddy-Current Anomaly in Electrical Sheet Steels—F. Brailsford. (*Jour. I.E.E.* (London), part II, vol. 95, pp. 38-48; February, 1948.)

621.3.042.2 1978

The Effects of Overlapping Joints in Laminated Magnetic Cores on the M.M.F. and Power Required for Their A.C. Magnetization—O. I. Butler and C. Y. Mang. (*Jour. I.E.E.* (London), part II, vol. 95, pp. 15-24; February, 1948.)

621.3.042.2:621.317.4 1979

The Predetermination of the Magnetic Properties of Ferromagnetic Laminae at Power and Audio Frequencies—O. I. Butler and C. Y. Mang. (*Jour. I.E.E.* (London), part II, vol. 95, pp. 25-37; February, 1948.)

621.315.61 1980

Work Function and Energy Levels in Insulators—D. A. Wright. (*Proc. Phys. Soc.*, vol. 60, pp. 13-22; January 1, 1948.) An estimate is made for several insulators of the energies of the highest filled energy band and of the empty conduction band. For BaO, SrO, CaO, MgO and BeO, the bottom of the conduction band is

near the zero level. It is considerably lower in AgBr, ZnO and ZnS. The bearing of the results on thermionic emission, secondary emission, and photoconductivity is discussed briefly, with special reference to BaO and SrO. See also 1981 below.

621.315.61:621.3.032.216 1981

Energy Levels in Oxide Cathode Coatings—D. A. Wright. (*Proc. Phys. Soc.*, vol. 60, pp. 22-27; January 1, 1948.) The energy level diagram is considered in the case of a Ba/SrO emissive cathode coating, and it is concluded from the results of the paper noted in 1980 above that the process of activation consists in building up a concentration of free barium in the coating, and in providing barium at the interface between core and coating. The work function of the activated coating without adsorbed barium on its outer surface cannot be much greater than the observed value of 1 eV, and may be no greater, so that such an adsorbed layer, if present, has only a small effect on the work function. The possibility of increase in emission under the influence of ultraviolet light or electron bombardment is discussed briefly.

621.316.993 1982

The High-Voltage Characteristics of Earth Resistances—G. M. Petropoulos. (*Jour. I.E.E.* (London), part II, vol. 95, pp. 59-70; February, 1948.)

621.318.22 1983

The Effect of Rust and Recrystallization on the Magnetic Properties of Soft Magnetic Materials—V. I. Drozhzhina, M. G. Luzhinskaya, and Ya. S. Shur. (*Zh. Tekh. Fiz.*, vol. 18, pp. 167-174; February, 1948. In Russian.)

621.318.322 1984

The Effect of Heat Treatment on the Shape of Magnetization and Magnetostriction Curves of AlsiFer Alloys—Ya. S. Shur and A. A. Lukshin. (*Compt. Rend. Acad. Sci. URSS*, vol. 59, pp. 693-695; February 1, 1948. In Russian.)

669.717:621.315.22 1985

Aluminium-Sheathed Cables—(*Elec. Rev.* (London), vol. 142, pp. 629-630; April 23, 1938.) Some details of the manufacturing process and illustrations of joints. The light-weight sheath is far superior to any lead alloy in tensile strength and resistance to creep and is better able to endure fatigue and vibration. The higher permissible service temperatures for Al-sheathed cables may enable Cu-core size to be reduced.

MATHEMATICS

517.564.2:518.3 1986

Nomograms of Complex Hyperbolic Functions [Book Review]—J. Rybner. J. Gjellerups Forlag, Copenhagen, 24 kroner. (*Wireless Eng.*, vol. 25, p. 129; April, 1948.) The text is in both English and Danish.

MEASUREMENTS AND TEST GEAR

531.764+621.3.018.4(083.74):621.396.7 1987

Centre for the Emission of Standard Frequencies and Time Signals—A. Pincioli. (*Alta Frequenza*, vol. 13, pp. 150-154; September, 1944. In Italian, with English, French, and German summaries.) Discussion of experiments with a view to the creation of such a center near the Galileo Ferraris National Electrotechnical Institute. The equipment used is described briefly. Negative-transconductance multivibrators are used for frequency division. The rhythmic time signal is obtained by means of a rotating disk furnished with a suitable system of slots through which a beam of light passes to a photo cell.

- 621.317.029.6 1988
Ultra-High-Frequency Measurements—C. W. Oatley. (*Jour. I.E.E.* (London), part IIIA, vol. 93, no. 1, pp. 199–206; 1946.) A survey paper covering, in general terms only, the techniques of measurements at frequencies exceeding 50 Mc. The discussion includes the measurement of frequency, voltage, current, and power at kilowatt and milliwatt levels. Methods of measuring attenuation, impedance, field strength, and antenna gain are also considered.
- 621.317.083.7 1989
Design Principles of Amplitude-Modulated Subcarrier Telemeter Systems—C. K. Stedman. (*Proc. I.R.E.*, vol. 36, pp. 36–41; January, 1948.) The problems of multichannel overload, cross talk, filter design, and signal-to-noise ratio are discussed. A new criterion is obtained for multichannel overload which is easy to use and simply related to single-signal overload. Nothing is gained by spacing filter midband frequencies in such a way that harmonics of lower subcarriers fall outside the pass bands of higher-frequency channel filters.
- 621.317.3.011.5+538.569.4.029.64:546.212 1990
The Anomalous Dispersion of Water at Very High Radio Frequencies: Part I—Experimental Determination of the Dielectric Properties of Water in the Temperature Range 0°C to 40°C for Wave-Lengths of 1.24 cm and 1.58 cm—Saxton and Lane. (*See* 1912.)
- 621.317.3.011.5:621.396.611.4.029.64 1991
The Cavity Resonator Method of Measuring the Dielectric Constants of Polar Liquids in the Centimetre Band—C. H. Collie, J. B. Hasted, and D. M. Ritson. (*Proc. Phys. Soc.*, vol. 60, pp. 71–82; January 1, 1948.) The resonance curve of an H_{01} resonator with an axial capillary of liquid is measured. The value deduced for the refractive index n of water at 21°C is $n = 6.30 \pm 1$ per cent.
- 621.317.3.011.5.029.63/.64 1992
A Method for the Measurement of the Dielectric Properties of Liquids in the Frequency Range 600–3200 Mc/s (50–9.4 cm)—R. Duns-muir and J. G. Powles. (*Phil. Mag.*, vol. 37, pp. 747–756; November, 1946.) The liquid is contained in a thin-walled bottle of fused quartz placed inside a cylindrical cavity resonator. The permittivity and power factor of the liquid are obtained from measurements of the resonant frequencies and Q -factors of the system. The relevant theory is given.
- 621.317.3.011.5.029.63/.64 1993
On Measurements of the Dielectric Constants of Solid Dielectrics at Centimetre Wavelengths—A. I. Starobinski. (*Zh. Tekh. Fiz.*, vol. 17, pp. 1209–1214; October, 1947; In Russian.)
- 621.317.3.011.5.029.63 1994
Dielectric Measurements at Centimetre Wavelengths—C. N. Smyth and R. G. Roach. (*Jour. I.E.E.* (London), part IIIA, vol. 93, no. 9, pp. 1462–1466; 1946; and summary, *ibid.*, part IIIA, vol. 93, no. 1, pp. 232–233; 1946.) Design principles are discussed and coaxial instruments operating in the frequency band 600 to 3000 Mc are described. With disk samples, an accuracy within 1 per cent for permittivity and within 5 per cent for power factor is achieved. For tubular specimens, the accuracy is lower—within 10 per cent—but the variation of dielectric properties with temperature may be examined with such samples.
- 621.317.3.011.5.029.64 1995
Dielectric Measurement at Wavelengths around 1 cm by means of an H_{01} Cylindrical-Cavity Resonator—J. Lamb. (*Jour. I.E.E.* (London), part IIIA, vol. 93, no. 9, pp. 1447–1451; 1946.) The changes in resonant length and Q -factor caused by introducing the specimen are used respectively to derive the permittivity and loss factor. Liquid or solid materials may be examined. The accuracy of the method is discussed and measured values for certain substances are tabulated.
- 621.317.3.011.5.029.64:546.212 1996
The Dielectric Properties of Water Vapour at Very High Radio Frequencies—J. A. Saxton. (*Physical Society Special Report on Meteorological Factors in Radio Wave Propagation*, pp. 215–238.) Measurements of the dielectric constant and absorption coefficient of water vapor by resonant cavity methods. The values of dielectric constant obtained at 76 cm pressure and 100°C. are 1.0056, 1.0051 and 1.0056 for 9, 3.2 and 1.6 cm respectively. Comparison with the static value of 1.0060 shows some evidence of dispersion; this is discussed. The absorption coefficient at 100°C. was greatest for the highest frequency used, its value then being 1.8×10^{-4} . The experimental results are used to estimate the attenuation due to atmospheric water vapor, for uhf propagation through the troposphere. See also 2845 of 1947 (Lamb).
- 621.317.33/.34:029.64 1997
The Two-Point Method of Measuring Characteristic Impedance and Attenuation of Cables of 3000 Mc/s—W. T. Blackband and D. R. Brown. (*Jour. I.E.E.* (London), part IIIA, vol. 93, no. 9, pp. 1383–1386; 1946.) The cable parameters are measured from two observations of the SWR in a slotted line, under specified conditions. A description of the apparatus is given, together with results of measurements in the frequency band 2300 to 3300 Mc. The method is suitable for detecting irregularities in the cable.
- 621.317.331:621.396.611 1998
Application of the Falling Characteristic to the Measurement of the Loss- and Resonance-Resistance of Oscillatory Circuits—H. Fröhlich. (*Funk. und Ton*, pp. 81–87; February, 1948.) A simple method for which no elaborate apparatus is required. Only resistors, capacitors, batteries, and a single tube are used, with two moving-coil instruments.
- 621.317.332.029.64 1999
Resistance Comparison at 3300 Mc/s by a Novel Method—C. J. Milner and R. B. Clayton. (*Jour. I.E.E.* (London), part IIIA, vol. 93, no. 9, pp. 1409–1412; 1946; and summary, *ibid.*, part IIIA, vol. 93, no. 1, pp. 226–227; 1946.) The uhf resistance of specimens of wire form is deduced from changes in Q of a $3\lambda/4$ concentric-line resonator in which the specimen forms a $\lambda/2$ section of the inner conductor. The apparatus is calibrated with Cu and Mo specimens of calculated uhf resistance ratio.
 Q measurements are made by a novel method in which the resonator is compared with a standard one. Both resonators are coupled to a FM oscillator and the difference in output of crystal detectors in the two resonators is displayed on a c.r. tube against the FM voltage. A null indication is obtained when a triple balance is secured, (a) for resonant frequency, (b) for Q , and (c) for peak height of the resonance curves.
- 621.317.335 2000
Sensitive Capacitance Measurements with Double-Valve Voltmeter and Voltage Divider—R. Mecke and R. L. Schupp. (*Funk. und Ton*, pp. 171–174; April, 1948.) With stabilized supply voltages for the double voltage divider (1075 of May), a sensitivity $\Delta C/C_{\max}$ of 3×10^{-6} is possible, using as indicator a mirror galvanometer with sensitivity 10^{-8} A/scale division. When the double-tube voltmeter is used as indicator, the maximum sensitivity with the circuit given is $\Delta C/C_{\max} \approx 2 \times 10^{-6}$.
- 621.317.336 2001
On a Method of H.F. Impedance Measurement, using Transmission-Line Resonance Curves—P. Abadie. (*Compt. Rend. Acad. Sci.* (Paris), vol. 226, pp. 474–475; February 9, 1948.) A constant e.m.f. is applied to the short-circuited end of a transmission line of variable length and a detector circuit is coupled loosely to the same end. The impedance to be measured is connected to the other end of the line and its value is determined from the resonance curve by means of simple formulas.
- 621.317.35 2002
L. F. Cinematic Analyser—R. Aschen and R. Gosmand. (*Toute la Radio*, vol. 15, pp. 80–84; February, 1948.) Principles of operation, general description, and complete circuit details of an instrument with c.r. tube display and covering the frequency range 20 to 19,000 cps.
- 621.317.35 2003
Explanation of the Principle of the L.F. Analyser—E. A. (*Toute la Radio*, vol. 15, pp. 76–77; February, 1948.)
- 621.317.361+621.317.763 2004
Frequency Measurement for Metre and Decimetre Waves—G. Ioppolo. (*Alla Frequenza*, vol. 13, pp. 217–233; December, 1944. In Italian, with English, French, and German summaries.) Discusses methods using tuned circuits, and transmission lines, and their frequency limits and accuracy. The method in which the unknown frequency beats with one of the harmonics of a stable oscillator is considered and a wavemeter of this type is described for the frequency range 30 to 800 Mc.
- 621.317.372.029.64 2005
A Q -Factor Comparator for Echo Boxes in the 10-cm Band—L. W. Shawe and C. M. Burrell. (*Jour. I.E.E.* (London), part IIIA, vol. 93, no. 9, pp. 1443–1446; 1946; and summary, *ibid.*, part IIIA, vol. 93, no. 1, pp. 231–232; 1946.) The method involves measurement of the time taken for the amplitude of the free oscillations generated by a p.m. signal to fall from one fixed level at the trailing edge of the pulse to another fixed level.
- 621.317.4 2006
Alternating-Current Measurements of Magnetic Properties—H. W. Lamson. (*Proc. I.R.E.*, vol. 36, pp. 266–277; February, 1948.) Full paper; summary abstracted in 2173 of 1947.
- 621.317.72 2007
The Measurement of Voltage at Centimetre Wavelengths—J. Collard. (*Jour. I.E.E.* (London), part IIIA, vol. 93, no. 9, pp. 1393–1398; 1946.) The equipment includes a gold-leaf electroscope for establishing a standard of voltage; test connectors for the circuit to be measured; broad-band crystal holders for measuring the voltage, and amplifying equipment used with the crystal holders for measuring small voltages. Two sets of equipment are described, one for the range 8.5 to 11.0 cm and the other for the range 3.0 to 3.5 cm.
- 621.317.725 2008
Thermionic Valve Voltmeters for Direct Voltages—E. Tommasini. (*Alla Frequenza*, vol. 13, pp. 95–119; June, 1944. In Italian, with English, French, and German summaries.) Discussion shows that, for greatest stability, a triode must be operated at constant anode rest-current. Negative feedback can be used to increase stability and input differential resistance and to decrease output voltage distortion. Constant anode rest-current and negative feedback can both be obtained with a bridge circuit. Theory of such circuits is given, with a practical example.

- 621.317.729:537.291:621.385 2009
Automatic Tracer for Electron Trajectories—J. Marvaud. (*Compt. Rend. Acad. Sci.* (Paris), vol. 226, pp. 476-478; February 9, 1948.) A semiautomatic method using an electrolyte bath, a single probe, and two calibrated potentiometers.
- 621.317.733 2010
On the Sensitivity of Bridges for Impedance Measurement—G. Montalenti. (*Alta Frequenza*, vol. 13, pp. 234-247; December, 1944. In Italian, with English, French, and German summaries.) For bridges with constant supply voltage and infinite detector impedance, the sensitivity is given by the product of two factors, one depending on the type of bridge and the other on the nature and value of the impedance which is varied to obtain a balance. Expressions are derived for (a) the maximum sensitivity near balance when the bridge contains no reactive elements, and (b) the total sensitivity of a bridge with a galvanometer as detector.
- 621.317.733:621.317.755 2011
On the Use of a Cathode Ray Oscillograph for Indicating the Balance of a Bridge—V. S. Troitski. (*Radiotekhnika* (Moscow), vol. 3, pp. 66-73; January and February, 1948. In Russian.)
- 621.317.733:621.317.784 2012
A Method of Determining and Monitoring Power and Impedance at High Frequencies—N. F. Morrison and E. L. Younker. (*Proc. I.R.E.*, vol. 36, pp. 212-216; February, 1948.) The rf wattmeter described consists of a bridge circuit which is first balanced and then changed slightly to yield a meter reading of transmitted power. The meter dial, calibrated on a circuit with a matched load, is substantially correct for a wide range of unmatched loads. Details of design and construction are given, suitable for frequencies of the order of 100 Mc.
- 621.317.75 2013
Heterodyne Wave Analyzer with Polyphase Search Voltage—G. B. Madella. (*Alta Frequenza*, vol. 13, pp. 132-149; September, 1944. In Italian, with English, French, and German summaries.) The characteristics of harmonic analyzers with h.f. and l.f. filters respectively are surveyed. The l.f. method is modified by using a polyphase search voltage which enables the sign of the beat frequency to be taken into account and avoids image-frequency troubles. Similar modification of the double heterodyne system, which uses both h.f. and l.f. filters, gives more complete suppression of the image frequency and permits the choice of a very low frequency for the second filter. A single unit can thus be produced which combines the advantages of the h.f. and l.f. methods. Such an instrument is described and experimental results are given to show its capabilities. See also 1866 and 1867 above.
- 621.317.755:621.396.645.36 2014
A Cathode-Ray Oscillograph with Two Push-Pull Amplifiers—E. E. Carpenter. (*Philips Tech. Rev.*, vol. 9, no. 7, pp. 202-210; 1947.) The oscillograph incorporates a push-pull amplifier for each pair of deflecting plates. At maximum sensitivity, the amplification is constant within 3 db for a frequency range 10 to 460,000 cps, and with reduced sensitivity this range can be extended beyond 10^6 cps. A sawtooth voltage is available for purposes extraneous to the oscillograph; its frequency can be regulated between 10 and 150,000 cps. The new oscillograph is smaller and lighter than the older types.
- 621.317.76.029.64 2015
The Measurement of Frequencies in the Range 10,000 to 50,000 Mc/s—G. H. Aston and L. Essen. (*Jour. I.E.E.* (London), part IIIA, vol. 3, no. 9, pp. 1374-1377; 1946; and summary, *ibid.*, part IIIA, vol. 93, no. 1, pp. 217-218; 1946.) The unknown frequency is compared with that of a harmonic of an auxiliary oscillator whose frequency is adjustable to values near 3000 Mc. The oscillator frequency can be measured by the method described in 679 of 1946 (Essen and Gordon-Smith). A heterodyne signal is obtained by mixing the signal and the auxiliary oscillation in a crystal converter and passing the output to a wide-band if amplifier. The method is capable of an accuracy of 1 part in 10^4 but is at present limited to 5 parts in 10^4 by the instability of the source. The apparatus has been used to investigate the properties of a resonant-cavity absorption wavemeter designed for frequencies in the region of 25,000 Mc. The wavemeter is described and the results obtained with it for low-power 25,000-Mc oscillators are discussed briefly.
- 621.317.761.029.4/.54 2016
Direct-Reading Frequency-Meters—C. Egidi. (*Alta Frequenza*, vol. 12, pp. 324-346; July to September, 1943. In Italian with English, French, and German summaries.) Meters are classified according to their electrical, mechanical, or electromechanical principles. Descriptions are given of many types for sonic and ultrasonic frequencies.
- 621.317.763+621.392.43 2017
A 3-cm R.F. Spectrometer and Mismatching Impedance Unit—E. Kettlewell, W. A. Bourne, and C. Chilton. (*Jour. I.E.E.* (London), part IIIA, vol. 93, no. 9, pp. 1431-1435; 1946; and summary, *ibid.*, part IIIA, vol. 93, no. 1, p. 224; 1946.) Details are given of the design and operation of apparatus suited for use in the production of 3-cm magnetrons of the type demanding adjustment of load coupling in manufacture. The function of this equipment is to give a quick indication of the frequency pulling figure for magnetrons, in particular, types CV191 and CV214.
- The apparatus consists of a mechanically scanned transmission-type cavity wavemeter, with associated rectifier and signal amplifier, together with a mechanically driven mismatching impedance unit for use with standard $\frac{1}{2}$ -inch \times 1-inch waveguide.
- 621.317.763 2018
Direct-Reading Centimetre Wavemeters—L. W. Shawe and C. M. Burrell. (*Jour. I.E.E.* (London), part IIIA, vol. 93, no. 9, pp. 1479-1486; 1946.) "An account of the design and performance of wavemeters developed for Army use in the 3-, 6-, 10-, and 25-cm wavebands. Each wavemeter consisted of a resonator, together with a tuning indicator and suitable connectors. The resonators, which are described in some detail, were designed to have scales reading in wavelength, with accuracies which varied between ± 1 in 500 and ± 1 in 1000."
- 621.317.763.029.63/.64 2019
The Design, Calibration and Performance of Resonance Wavemeters for Frequencies between 1000 and 25,000 Mc/s—L. Essen. (*Jour. I.E.E.* (London), part IIIA, vol. 93, no. 9, pp. 1413-1425; 1946.) Discussion is restricted to instruments using the principal coaxial mode, the E_{010} -EH hybrid mode and the E_{010} , H_{011} and H_{11a} cylindrical waveguide modes. Non-ambiguous ranges of frequency variation of approximately 6 per cent and 12 per cent are obtained with the H_{011} mode and H_{11a} mode respectively; with the E_{010} mode, a range of the order of 10 per cent is obtained with radial plungers, and a range of 3 to 1 with an axial plunger, the mode of vibration in this case being the E_{010} -EH hybrid. Under carefully controlled conditions, the frequency of resonance of a fixed-frequency wavemeter resonating in the E_{010} mode was measured with a precision of ± 2 parts in 10^4 . The accuracy of the wide-range instruments was of the order of 1 part in 10^4 , while that of the intermediate category (H_{011} and H_{11a} types) was about 1 part in 10^3 , the limitation in the latter category being, in general, the temperature coefficient of the instrument. It is estimated that a careful comparison of the measured and calculated values of the frequencies of resonant wavemeters would yield a value for the speed of propagation of e.m. waves accurate to about 1 part in 10^4 . The paper includes a schedule of tests which should be made on instruments intended for precision work.
- 621.317.78:621.392.029.64 2020
The Enthrakometer, an Instrument for the Measurement of Power in Rectangular Wave Guides—J. Collard. (*Jour. I.E.E.* (London), part IIIA, vol. 93, no. 9, pp. 1399-1402; 1946.) "The instrument consists essentially of a resistive film, forming one wall of the guide, whose change in resistance, due to the absorption of a small fraction of the power passing through the guide, is used as a measure of that power. The instrument is self calibrating, is extremely broad-banded and can be used for any wavelength for which rectangular guide is employed." For lecture summary see *ibid.*, part IIIA, vol. 93, no. 1, pp. 209-211; 1946.
- 621.317.78:621.396.67 2021
Aerial Power Meters for Radio Transmitters—L. Palieri and A. Piccinini. (*Alta Frequenza*, vol. 12, pp. 379-408; October to December, 1943. In Italian, with English, French, and German summaries.) A method of checking such meters is described which involves only rf current measurements. Experimental results for different types of meter are given. In a new type of calorimeter, the expansion of the liquid instead of its increase of temperature is measured, giving an accuracy within 1 per cent at the highest frequencies.
- 621.317.78.029.63/.64 2022
The Measurement of Power at Centimetric and Decimetric Wavelengths—M. C. Crowley-Milling, D. S. Gordon, C. W. Miller, and G. Saxon. (*Jour. I.E.E.* (London), part IIIA, vol. 93, no. 9, pp. 1452-1456; 1946.) Equipments are described for the measurement of mean powers of the order of 1 to 100 w for λ 3 to 50 cm. The factors influencing the design of water calorimeters for absolute measurements are discussed and the equipments evolved are described. "Feed-through" wattmeters suitable for relative measurements and which distinguish between the forward-traveling and reflected powers are also described.
- 621.317.78.029.64 2023
Balanced Calorimeters for 3000 and 10,000 Mc/s with Tapered Water Loads for H_{01} Rectangular Pipes—L. B. Turner. (*Jour. I.E.E.* (London), part IIIA, vol. 93, no. 9, pp. 1467-1476; 1946.) Discussion of the design of calorimeters in which the rf power is balanced against a controllable and measured l.f. power. The effects of heat losses are discussed theoretically, and means for introducing self-compensation are indicated. Practical instruments are described, with which powers of the order of 500 w at 3000 Mc or 50 w at 10,000 Mc can be measured to within about 1 per cent. Auxiliary apparatus for the measurement of the conductivities of sea, tap, and distilled water at 300 Mc is described in an appendix, and results for these liquids are tabulated.
- 621.317.78.029.64 2024
A Wide Band Calorimeter for R.F. Power Measurements at 3 cm—E. Kettlewell. (*Jour. I.E.E.* (London), part IIIA, vol. 93, no. 9, pp. 1407-1408; 1946; and summary, *ibid.*, part IIIA, vol. 93, no. 1, p. 223; 1946.) A calorim-

eter consisting of a water load and thermocouple unit, for use where the mean power range involved is 5 to 200 w.

621.317.78.029.64:621.317.794 2025
Radio-Frequency Power Measurement by Bolometer Lamps at Centimetre Wavelengths—B. Bleaney. (*Jour. I.E.E.* (London), part IIIA, vol. 93, no. 9, pp. 1378–1382; 1946; and summary, *ibid.*, part IIIA, vol. 93, no. 1, pp. 218–219; 1946.) A description of the construction and application of bolometer lamps for the measurement of oscillator power output, and for association with transmission-line and waveguide feeders. A theoretical treatment is given of the effect of using heater wires of length comparable with λ ; the theory applies only for small power inputs $< 10^{-4}$ w.

621.317.79:621.396.615.14 2026
The Design of Signal Generators for the Measurement of Receiver Noise Factor at 10- and 3-cm Wavelengths—B. Bleaney, J. H. E. Griffiths, and D. Roaf. (*Jour. I.E.E.* (London), part IIIA, vol. 93, no. 9, pp. 1387–1392; 1946.) "... the monitor and attenuator are made integral parts of the signal generator; the signal emerges through a length of Pyrotenax cable of over 10 db attenuation, giving a resistive output. The signal generator is calibrated by measurement of the power output when the piston attenuator is set to low attenuation but still obeys the theoretical law. Known power outputs of the order of 10^{-14} w may thus be obtained with an accuracy of ± 1 db. The screening is such that no leakage can be detected with the most sensitive receivers.

621.317.79:621.396.615.14 2027
The Design of Signal Generators for Centimetre Wavelengths—D. C. Rogers. (*Jour. I.E.E.* (London), part IIIA, vol. 93, no. 9, pp. 1457–1461; 1946; and summary, *ibid.*, part IIIA, vol. 93, no. 1, pp. 230–231; 1946.) The problems encountered in the design of the component parts of cm- λ signal generators are discussed from a practical standpoint. Particular attention is given to various forms of output monitor, to output piston attenuators of the H_1 and E_0 types and to screening and filtering arrangements. A description of a direct-reading power meter of the bolometer type is included in a discussion of calibration techniques. Finally a 6-cm instrument, based on these principles is described.

621.396.81.08 2028
Radio Technique and Apparatus for the Study of Centimetre-Wave Propagation—H. Archer-Thompson and E. M. Hickin. (*Jour. I.E.E.* (London), part IIIA, vol. 93, no. 9, pp. 1367–1373; 1946; and summary, *ibid.*, part IIIA, vol. 93, no. 1, pp. 215–216; 1946.) Describes the apparatus and associated techniques for the experimental investigation whose results were discussed in 517 of 1947 (Smith-Rose) and 518 of 1947 (Megaw). The point-to-point method is used; a measured power is transmitted along the path under observation and the signal received at a distant point is recorded by a receiver calibrated with a signal generator.

621.396.81.08 2029
A Field-Strength Meter and Standard Radiator for Centimetre Wavelengths—J. A. Saxton and A. C. Grace. (*Jour. I.E.E.* (London), part IIIA, vol. 93, no. 9, pp. 1426–1430; 1946.) The meter is suitable for operation at a wavelength of about 9 cm and takes the form of an electromagnetic-horn receiver in which the received power is measured directly by means of a bolometer. A modified form of Wheatstone bridge is used. The magnitude of field strengths covered is limited by the bolometer to the range 0.1 to 50 v/m. A similar e.m. horn is used as the

standard radiator. The application of the instruments to the determination of the power radiated by a transmitter and to the measurement of the over-all sensitivity of a receiver is discussed.

621.317.3 2030
High-Frequency Measuring Techniques using Transmission Lines [Book Review]—E. N. Phillips, W. G. Sterns and N. J. Gamara. J. F. Rider, New York, 58 pp., \$1.50. (*Wireless Eng.*, vol. 25, p. 130; April, 1948.) For two- and four-terminal networks at frequencies over 100 Mc. A 7-ft slotted coaxial line is used to determine the voltage SWR and the positions of the voltage nodes. Other characteristics are deduced by calculation.

OTHER APPLICATIONS OF RADIO AND ELECTRONICS

535.37.001.8 2031
Applications of Luminescent Substances—Kröger. (*See* 1973).

539.16.08 2032
Some Experiments with Geiger-Müller Counters—J. D. Craggs, W. Bosley, and A. A. Jaffe. (*Jour. Sci. Instr.*, vol. 25, pp. 67–71; March, 1948.) Describes a simple counting circuit and various types of G-M counter. Representative plateau curves are given for normal cylindrical counters and for parallel-plate/wire counters. The latter have directional response if a suitable thin window is provided. A simple method for the suppression of delayed cathode emission (Paetow effect) is also outlined.

539.16.08 2033
Photoelectric Effect in Self-Quenching Geiger-Müller Counters—M. V. Scherb. (*Phys. Rev.*, vol. 73, pp. 86–87; January 1, 1948.)

539.16.08 2034
On the Resolving Time and Genuine Coincidence Loss for Geiger-Müller Counters—C. E. Mandeville and M. V. Scherb. (*Phys. Rev.*, vol. 73, pp. 90–91; January 1, 1948; Correction, vol. 73, p. 639; March 15, 1948.)

621.365.5 2035
Induction Heating Applications—N. R. Stansel. (*Gen. Elec. Rev.*, vol. 51, pp. 44–50; February, 1948.) Discussion of practical applications of formulas relating flux distribution, eddy currents, temperature, and electrical efficiency.

621.365.92 2036
Electronic Heating of Dielectrics—L. Thourel. (*Téltv. Franç.*, Supplement *Électronique*, pp. 4–9; March, 1948.) Theory, and applications to the joining of thermoplastics, treatment of rubber, drying, sterilization, and cooking.

621.384.6 2037
The One Million-Volt Accelerating Equipment of the Cavendish Laboratory, Cambridge—W. E. Burcham. (*Nature* (London), vol. 160, pp. 316–318; September 6, 1947.) A general description of the apparatus and of its performance during the past 10 years, with a short list of papers describing work carried out with it.

621.384.6 2038
Equipment for Automatic Synchronization of the Cyclotron—P. Debraine and Č. Šimáně. (*Compt. Rend. Acad. Sci.* (Paris), vol. 226, pp. 648–650; February 23, 1948.) A description of apparatus which stabilizes the magnetic field and also controls the displacement of the magnetic field by an arrangement governed by the intensity of the beam of accelerated ions.

Stabilization is thus effected at the instant when exact synchronism is realized.

621.385.833 2039
An Experimental Electron Microscope for 400 Kilowatts—A. C. van Dorsten, W. J. Oosterkamp, and J. B. le Poole. (*Philips Tech. Rev.*, vol. 9, no. 7, pp. 193–201; 1947.) The advantages of high acceleration voltage are discussed, and each part of the instrument is described. The best possible contrast in the image is ensured by using an objective aperture with four different openings, which can be adjusted from outside. Measures are discussed for the protection of the observer against the X-radiation excited in the microscope.

621.385.833 2040
The Aberration of an Electrostatic Objective with [slightly] Elliptical Central Hole—H. Bruck, R. Remillon, and L. Romani. (*Compt. Rend. Acad. Sci.* (Paris), vol. 226, pp. 650–652; February 23, 1948.)

621.385.833 2041
The Design and Construction of a New Electron Microscope—M. E. Haine. (*Jour. I.E.E.* (London), part 1, vol. 94, pp. 447–459; October, 1947. Discussion, pp. 459–462.) Full paper. Summary abstracted in 211 of February.

PROPAGATION OF WAVES

523.78 "1940.10.01":551.510.535 2042
The Ionospheric Eclipse of October 1, 1940—Pierce. (*See* 1924.)

523.78 "1945.07.09":551.510.535 2043
Some Experimental Results obtained by Ionospheric Investigations in Sweden during the Total Solar Eclipse of July 9, 1945—Gejer and Åkerlind. (*See* 1925.)

621.396.11:518.61 2044
Practical Methods for the Solution of the Equations of Tropospheric Refraction—D. R. Hartree, J. G. L. Michel, and P. Nicholson. (*Physical Society Special Report on Meteorological Factors in Radio Wave Propagation*, pp. 127–168.) Calculations of propagation in a stratified medium can be carried out: (a) by a ray treatment, supplemented by the concept of interference when two or more rays pass through a single point and by diffraction theory in the neighborhood of caustics of geometrical rays; or (b) by a wave treatment in which the field is expressed as a sum over a set of discrete modes of propagation which depend only on the refractive index structure of the atmosphere and which can be superposed in different ways to give the radiation field of a source. The differential analyzer has been used in the ray treatment for evaluating ray trajectories, and in the wave treatment for evaluating height-gain functions for the normal modes. See also 2892 of 1947 (Booker and Walkinshaw).

621.396.11:551.510.52 2045
A Standard Radio Atmosphere for Microwave Propagation—A. C. Best. (*Physical Society Special Report on Meteorological Factors in Radio Wave Propagation*, pp. 267–273.) The sea-level pressure and temperature and the vertical temperature gradient of the I.C.A.N. (International Commission for Air Navigation) standard atmosphere are adopted without change. Three alternative humidity conditions are considered: (a) 80 per cent relative humidity at all heights below 1.5 km; this corresponds closely to average conditions in England; (b) 60 per cent relative humidity at all heights below 1.5 km; this is suggested by some USA workers; (c) humidity defined by a particular

linear variation of vapor pressure with height, which gives a uniform ray curvature at all heights up to 1.5 km. Values of modified refractive index and ratio of ray curvature to earth curvature are tabulated for all three atmospheres to 1.5 km, the effects of pressure, temperature, and humidity being shown separately.

621.396.11:551.510.52 2046

Refraction in the Lower Atmosphere and Its Applications to the Propagation of Radio Waves—Stickland. (See 1940.)

621.396.11:551.510.52 2047

The Structure and Refractive Index of the Lower Atmosphere—Sheppard. (See 1939.)

621.396.11:551.510.535 2048

The Investigation and Forecasting of Ionospheric Conditions—E. V. Appleton. (*Jour. I.E.E.* (London), part IIIA, vol. 94, no. 11, pp. 186–199; 1947; and summary, *ibid.*, part I, vol. 94, pp. 483–484; October, 1947.) An account of work on ionospheric exploration conducted by vertical-incidence radio sounding and a discussion of the use of data thus obtained to estimate the maximum radio frequencies at which a wave would return to the ground at any given range from a sending station. The connection between ionospheric-layer electron densities and heights and solar and seasonal phenomena is described and the anomalous behavior of the F_2 layer is discussed with reference to longitude effect and geomagnetic control of ionization densities. Ionospheric irregularities are mentioned and methods are indicated for forecasting the ionospheric conditions affecting m.u.f. and the attenuation of radio waves by absorption.

621.396.11:551.510.535 2049

Developments in Radio Sky-Wave Propagation Research and Applications during the War—J. H. Dellinger and N. Smith. (*Proc. I.R.E.*, vol. 36, pp. 258–266; February, 1948.) Discussion of: work done by the Interservice Radio Propagation Laboratory (IRPL); the circumstances leading to its establishment; the problems facing it, methods of solution, and some results; and some specific services for the military and civil authorities.

621.396.11:551.510.535 2050

The Influence of Wave-Propagation on the Planning of Short-Wave Communication—K. W. Tremellen and J. W. Cox. (*Jour. I.E.E.* (London), part IIIA, vol. 94, no. 11, pp. 200–219; 1947; and summary, *ibid.*, part I, vol. 94, pp. 485–486; October, 1947.) A review of the principal features of the various ionosphere layers, and details of the methods of calculation and presentation of ionospheric data, together with necessary corrections to m.u.f. factors. Fluctuations occurring in the various layers are discussed with reference to difficulties in predicting ionospheric data. Formulas governing the attenuation of the sky-wave and a description of noise and noise curves are given. As an example, data for two specific transmissions of different path-lengths are included. Irregularities, fade-outs, magnetic disturbances, and the prediction of magnetic storms are also discussed.

621.396.11:551.510.535 2051

On Magneto-Ionic Splitting [of Radio Waves] in the Sporadic E Layer—V. M. Driatski. (*Compt. Rend. Acad. Sci. URSS*) vol. 58, no. 5, pp. 775–778; 1947. In Russian.) A brief report on several years' observations at Bay Tiksi ($71^{\circ}35' N$, $128^{\circ}55' E$). The main conclusions are: (a) magneto-ionic splitting of radio waves is observed not only on reflection from regular F_2 , F_1 and E layers but also from the sporadic E layer; (b) the differences in critical frequencies of the components of the

waves indicate the presence of a considerable number of free electrons in the sporadic E layer; (c) the sporadic E layer has apparently a grid-like structure. These conclusions, however, do not diminish the importance of ions in the formation of the sporadic E layer.

621.396.11.018.41:551.510.535 2052

Effect of the Vertical Displacement of the Ionized Layers on the Frequency of Radio Waves—D. Romell. (*Compt. Rend. Acad. Sci.* (Paris), vol. 226, p. 1007; March 22, 1948.) The results obtained by Decaux (1725 of July) can be explained by vertical displacement of the ionosphere reflecting layer at about 10 m/s. The diurnal variations of the height of the F_2 layer account satisfactorily for the diurnal frequency variations observed by Decaux.

621.396.11.029.58 2053

Short-Wave Echoes—H. A. Hess. (*Funk. und Ton*, pp. 57–65; February, 1948.) Description of experiments carried out at Frederikshavn and Randers (Denmark) during 1941 to 1945, using frequencies between 10 and 20 Mc. Measurements of the path-time difference between direct and reverse transmissions gave a mean value of 0.137767 second for a complete circuit of the earth.

621.396.81.08 2054

Radio Technique and Apparatus for the Study of Centimetre-Wave Propagation—Archer-Thompson and Hickin. (See 2028.)

621.396.812+538.566.3 2055

Gyro-Interaction of Radio-Waves Obtained by the Pulse Method—M. Cutolo. (*Nature* (London), vol. 160, p. 834; December 13, 1947.) Description of observations of the effect on 630-m and 1250-m transmissions of a p.m. transmitter operating in the wavelength range 265 to 285 m. For earlier work see 513 of 1947 (Cutolo, Carlevaro, and Gherghi).

621.396.812:551.510.52 2056

The Influence of Tropospheric Conditions on Ultra-Short-Wave Propagation—E. V. Appleton. (*Physical Society Special Report on Meteorological Factors in Radio Wave Propagation*, pp. 1–17.) A general introductory survey of recent advances in the subject. The troposphere is regarded as a nonhomogeneous medium, and the factors determining the atmospheric refractive index are considered. Both the refractive and reflective properties of atmospheric inhomogeneities can cause increased fields beyond the optical horizon; experimental results are given from early and recent papers on anomalous propagation. The action of ducts, the origin of superrefracting conditions, and scattering by raindrops are discussed briefly.

621.396.812:551.510.52 2057

Radio Climatology—Durst. (See 1943.)

621.396.812:621.396.96 2058

The Vertical Distribution of Radar Field Strength over the Sea under Various Conditions of Atmospheric Refraction—J. A. Ramsay. (*Physical Society Special Report on Meteorological Factors in Radio Wave Propagation*, pp. 238–242.)

621.396.812 (931):621.396.96 2059

Observations of Unorthodox Radar Vision in the Vicinity of New Zealand and Norfolk Island—Alexander. (See 1969.)

621.396.812.029.63/.64 2060

Meteorological Effects on the Propagation of Very Short Waves—J. Vogé. (*Onde Elec.*, vol. 28, pp. 99–107; March, 1948.) A general review of the atmospheric conditions which affect the propagation of decimeter and centimeter waves. Particular reference is made to horizontal stratification, variation of refractive

index with height, temperature, humidity, clouds and rain, and many experimental results are discussed. See also 516 of 1947 (Booker).

621.396.812.029.64 2061

An Experimental Study of the Effect of Meteorological Conditions upon the Propagation of Centimetric Radio Waves—R. L. Smith-Rose and A. C. Stickland. (*Physical Society Special Report on Meteorological Factors in Radio Wave Propagation*, pp. 18–37.) Continuous observations of field strength at frequencies above 3000 Mc were made for a period of two years over a land path of 61 km and a sea path of 92 km. Four separate links, with different terminal heights, were used over the sea path; three of these extended beyond optical range.

The effects of fog and frontal passages on signal strengths are described for the land and sea paths. Except for slight fading in anticyclonic conditions, transmission over the optical sea path showed comparatively little variation. From aircraft observations of temperature and humidity made over the path of propagation, the refractive index gradient was calculated for the first few hundred meters of atmosphere. The field strength deduced from this gradient agrees closely with that observed. See also 2892 of 1947 (Booker and Walkinshaw).

621.396.812.029.64:621.396.96 2062

The Attenuation and Radar Echoes Produced at Centimetre Wave-Lengths by Various Meteorological Phenomena—J. W. Ryde. (*Physical Society Special Report on Meteorological Factors in Radio Wave Propagation*, pp. 169–188. Discussion, pp. 188–189.) "The attenuation and the intensity of radar echoes produced by fog, cloud, rain, hail, and snow are computed on the basis of electromagnetic theory for wavelengths in the cm band; due account is taken of the particle size distributions. In general, the particles are not small enough for the simple Rayleigh law to hold. Tables and curves are given which enable the attenuation and echo intensity to be readily calculated for any given case. In general, both effects increase rapidly as the wavelength diminishes and their magnitudes may be considerable with rain, hail, or snow. For completeness, a brief summary of Van Vleck's results on the attenuation produced by the atmospheric gases is included." See also 515 of 1947.

621.396.812.4.029.63/.64 2063

Results of Microwave Propagation Tests on a 40-mile Overland Path—A. L. Durkee. (*Proc. I.R.E.*, vol. 36, pp. 197–205; February, 1948.) Wavelengths in the range 1.25 to 42 cm were used. The tests at each wavelength extended over periods of 2 to 20 months. Various types of fading are analyzed statistically to show diurnal and seasonal variations, and the correlation with meteorological phenomena is discussed.

RECEPTION

621.396.619.13 2064

Distortion of F.M. Signals in Passage through Electrical Networks—F. L. H. M. Stumpers. (*Tydschr. ned. Radiogenoot.*, vol. 13, pp. 1–21; January, 1948. In Dutch, with English summary.) Full account of part of the work described in 2221 of 1947.

621.396.621 2065

Premodyne F.M. Receivers—A. A. McK. (*Electronics*, vol. 21, pp. 83–87; January, 1948.) Circuit details of this low-cost mass-produced receiver are discussed. Tests of sensitivity, quieting-sensitivity, distortion, relative audio

response, selectivity, and radiated interference were conducted for two fremodyne receivers, one fremodyne adaptor, and two conventional types of FM receiver. Interfering signals on neighboring channels which "captured" the conventional receivers merely produced increased interference with the fremodyne receivers. Radiation interference had a maximum value of 20 to 30 mv on one channel for each fremodyne receiver. Audio output distortion is of the order of 6 to 8 per cent for a 1-mv signal.

621.396.621 2066
Trends in Mass Production of Radio Receivers—M. Chauvierre. (*Radio Franç.*, pp. 9-17; February, 1948.) Discusses printed circuits, Sargrove's E.C.M.E. (1913 of 1947), and the UA-55 all-stage tube (1203 of May). Circuits and characteristics are given for the UA-55 as grid detector, as fixed- μ or variable- μ tube, and as frequency changer, together with the circuit of superheterodyne receiver using only UA-55 tubes.

621.396.621:621.396.96 2067
Radar Receivers—W. B. Lewis. (*Jour. I.E.E.* (London) part IIIA, vol. 93, no. 1, pp. 272-279; 1946.) Survey of: requirements for radar receivers and the bearing of these requirements on research; noise factor and its relation to internal noise, input noise and source temperature; design of rf and if amplifiers, and of mixers for cm λ ; methods of a.f.c. and a.g.c.; common-antenna working; special types such as superregenerative and search receivers.

621.396.621.2 2068
Input Circuits for Broadcasting Radio Receivers—L. de Valroger. (*Rev. Tech. Comp. Franç. Thomson-Houston*, pp. 5-37; May, 1947. In French with English summary.) A study of the characteristics of receiving antennas and a comprehensive treatment of receiver input circuits, from which are deduced the circuits giving optimum results for medium and long waves. The effects of the various circuit elements on receiver performance are analyzed and suitable numerical values are assigned for each element. Practical rules are given, based on theory and confirmed experimentally. To be continued.

621.396.662:621.396/.397].62 2069
Inductive Tuning System for F.M. Television Receivers—P. Ware. (*Proc. Radio Club Amer.*, vol. 23, pp. 9-16; May, 1946.) Illustrated description of a 3-section tuning unit with which tuning ratios as high as 7 can be obtained for frequencies up to 1000 Mc. The associated motor-driven push-button tuning mechanism is described. For basic principles see 2293 of 1938.

621.396.81:621.317.755 2070
On the Evaluation of the Signal/Noise Ratio in Oscillographic Receivers—U. Tiberio. (*Alta Frequenza*, vol. 12, pp. 316-323; July to September, 1943. In Italian, with English, French, and German summaries.) Theory based on the Boltzmann statistic. A formula is derived for the probability of confusion between the true signal image and an occasional irregularity in the oscillogram.

621.396.813 2071
On the Summation of Nonlinear Distortions—M. A. Sapozhkov. (*Zh. Tekh. Fiz.*, vol. 17, pp. 1187-1194; October, 1947. In Russian.)

621.396.822 2072
Thermal Noise in Resistors—S. Rodda. (*Wireless Eng.*, vol. 25, p. 131; April, 1948.) The consequences of suddenly placing a unit charge in a small cavity in the material of a resistor are considered. Such effects may be produced

by electrons and afford a better explanation of noise voltage than that of Bell (1038 of 1946.)

621.396.822:621.385.2 2073
The Transmission-Line Diode as Noise Source at Centimetre Wavelengths—P. Kompfner, J. Hatton, E. E. Schneider, and L. A. G. Dresel. (*Jour. I.E.E.* (London), part IIIA, vol. 93, no. 9, pp. 1436-1442; 1946; and summary, *ibid.*, part IIIA, vol. 93, no. 1, pp. 225-226; 1946.) After a short survey of existing methods of absolute calibration of receivers in the centimeter waveband, the transmission-line noise diode is described and its operation explained. The available noise power is calculated on the assumption of arbitrary terminations of the "active" line; i.e., of the part of the line across which emission current is flowing. Two special cases are considered in detail, the case when the active line is "matched" at both ends, particularly suitable for absolute calibrations of receivers, and the case when the line is "resonant," giving increased noise output, and particularly suitable as a relative source of noise or as a transfer standard.

Results of experiments on the absolute noise output, on the electronic attenuation, on the influence of transit-time and on space-charge smoothing are given, the last showing that some mechanism of noise-reduction exists even at frequencies as high as 3000 Mc. Details are given of applications of the resonant diode in practice.

621.396.621 2074
Ultra- and Extreme-Short Wave Reception [Book Review]—M. J. O. Strutt. D. Van Nostrand, New York N. Y.; Macmillan, London, 387 pp., 37s. 6d. (*Wireless Eng.*, vol. 25, pp. 128-129; April, 1948.) "Dr. Strutt has performed a useful service to the practical designer . . . by providing a balanced review, which also incorporates much of his own practical experience in this field. . . The theoretical background is provided by verbal explanations rather than formal proofs. Advanced mathematical ability is not required of the reader." Over 400 references are listed.

621.396.621.001.4 2075
Philips Manual of Radio Practice for Servicemen [Book Review]—E. G. Beard. Philips Electrical Industries of Australia, Sydney, 495 pp., 22s. 6d. (Australian). (*Wireless Eng.*, vol. 25, p. 129; April, 1948.) The treatment is descriptive and nonmathematical, and of an elementary nature. It covers most of the circuits commonly used in broadcast receivers and they are described well, but briefly

STATIONS AND COMMUNICATION SYSTEMS

621.391.63:534.321.9 2076
Ultrasonic Cell of Large Area for the Modulation of Light—Giacomini. (*See* 1847.)

621.394/.396 2077
Long-Distance Point-to-Point Communication—A. H. Mumford. (*Jour. I.E.E.* (London), part IIIA, vol. 94, no. 11, pp. 23-43; 1947. Discussion, *ibid.*, part IIIA, vol. 94, no. 12, pp. 397-400; 1947. Summary, *ibid.*, part I, vol. 94, pp. 465-466; October, 1947.) Advances in technique during the war years and expansion of the network maintained by the Post Office are discussed. The relative advantages of commercial single-sideband as compared with double-sideband operation have been found to outweigh its disadvantages of increased complexity of equipment and the high degree of frequency stability required. Rhombic and multielement arrays and their conflicting ad-

vantages are analyzed. Forecasting of ionospheric data forms an important part in the planning and operation of a long-distance network. An increasing use of multichannel voice-frequency telegraph equipment working into single-sideband transmitting and receiving equipment may be expected. Only by compression of the bandwidth for speech below that normally considered the minimum for satisfactory reproduction can the frequency spectrum available for long-distance telephony be made nearly adequate.

621.395.43:621.392.029.64 2078
Multiplex Links using Waveguides—A. V. J. Martin. (*Toute la Radio*, vol. 15, pp. 72-75; February, 1948.) A résumé of the main points of a paper by H. Barlow (257 of February).

621.396.619.16 2079
Pulse Communication. Parts 1-3—D. Cooke; Z. Jelonek, E. Fitch, and A. J. Oxford. (*Jour. I.E.E.* (London), part IIIA, vol. 94, no. 11, pp. 83-105; 1947; and summary, *ibid.*, part I, vol. 94, pp. 471-472; October, 1947.) Part I is a general review of amplitude, length, phase, and frequency p.m., including a comparison between time-allocation and frequency-allocation multiplex and considerations of pulse shape, repetition frequency, signal-to-noise ratio, and privacy. P.m. is compared with c.w. modulation for a v.h.f. radio link and its use on cables and in omnidirectional broadcasting is examined. A keyed pulse train can reduce fading effects in long-distance h.f. communication.

In part 2 the results of theoretical and experimental analyses of technical problems are presented graphically. The spectrum of modulated pulses is used to estimate the intelligibility of received speech with reference to minimum repetition frequency. The pulse systems are compared amongst themselves and with conventional AM and FM systems. Examination of a spongy locking system is followed by the determination of the optimum length and shape of the transmitted pulse.

Part 3 discusses the relative merits of various circuit techniques used for synchronization, demodulation, and the production of multiplex systems, and future trends.

621.396.65 2080
Résumé of V.H.F. Point-to-Point Communication—F. Hollinghurst and C. W. Sowton. (*Jour. I.E.E.* (London), part IIIA, vol. 94, no. 11, pp. 115-130; 1947; and summary, *ibid.*, part I, vol. 94, pp. 475-476; October, 1947.) An outline of British developments during and before the war, with brief reference to similar developments abroad. Engineering aspects of the planning, provision, and operation of v.h.f. radio links are discussed, with particular reference to British Post Office practice. A typical multichannel radiotelephone link and some special war-time applications of v.h.f. transportable radiotelephone equipment are described. Possible future developments are discussed.

621.396.65 2081
Ultra-High-Frequency Techniques applied to Mobile and Fixed Communication Services—J. Thomson, J. D. Denly, I. J. Richmond, F. Pugliese, and H. Borg. (*Jour. I.E.E.*, (London), part IIIA, vol. 94, no. 11, pp. 107-114; 1947; and summary, *ibid.*, part I, vol. 94, pp. 470-471; October, 1947.) A statement of the advantages of u.h.f. for short-range communication within the optical range, with a review of: (a) the available tubes, (b) the various forms of crystal and resonator control of v.m. oscillators, (c) AM, FM, and p.m. of u.h.f. signals, and (d) amplifiers, detectors, and antennas.

- 621.396.7+621.397.2 2082
Engineering Arrangements for Broadcasting the Royal Wedding—L. Hotine. (*BBC Quart.*, vol. 3, pp. 52-58; April, 1948.) A detailed description of the technical equipment used to provide the necessary facilities for television and for broadcasting both in Great Britain and throughout the world.
- 621.396.931 2083
Military Radio Communications—J. B. Hickman. (*Jour. I.E.E.* (London), part IIIA: vol. 94, no. 11, pp. 60-73; 1947; and summary, *ibid.*, part I, vol. 94, pp. 469-470; October, 1947.) The importance of radio communication in the modern army is stressed. The principal field radio equipments and war-time developments are described. V.h.f. military equipment is now preferred to h.f.; possible future developments are considered.
- 621.396.932 2084
Low-, Medium- and High-Frequency Communication to and from H.M. Ships—W. P. Anderson and E. J. Grainger. (*Jour. I.E.E.* (London), part IIIA, vol. 94, no. 11, pp. 46-58; 1947. Discussion, *ibid.*, part IIIA, vol. 94, no. 12, pp. 437-440; 1947. Summary, *ibid.*, part I, vol. 94, pp. 467-468; October, 1947.) An outline is given of naval communication requirements and the development of equipment and control systems from 1934 to 1939, together with tabulated details of transmitters, receivers, and wavemeters in use at the outbreak of war. The extension of equipment to meet war-time needs is described and the problems of providing suitable antenna arrangements are discussed with reference to the restricted space available and the necessity for providing antenna trunks for most transmitter antennas. A diagram illustrates antenna arrangements on a modern battleship. New equipment mentioned based on war-time experience includes the "600 Series" transmitters, designed to cover 200 to 500 kc and 1500 to 24,000 kc with different power outputs up to 2 kw, and two receivers designed to work over a combined range of 14.7 to 30,000 kc.
- 621.396.933 2085
Aeronautical Communications—B. G. Gates (*Jour. I.E.E.* (London), part IIIA, vol. 94, no. 11, pp. 74-81; 1947; and summary, *ibid.*, part I, vol. 94, pp. 473-474; October, 1947.) Operational requirements are outlined and the special conditions to which airborne apparatus is exposed are discussed. The effect of these requirements and conditions on broad design principles is considered, and typical examples are quoted of equipments which meet the requirements. Probable future developments are forecast.
- 621.396.97 2086
The War-Time Activities of the Engineering Division of the B.B.C.—H. Bishop. (*Jour. I.E.E.* (London), part IIIA, vol. 94, no. 11, pp. 169-185; 1947; and summary, *ibid.*, part I, vol. 94, pp. 481-482; October, 1947.) Regrouping and extensive expansion of BBC services during the war years involved an increase of 97 transmitters as compared with the 1939 total of 24, and an increased radiated power of 5040 kw. The grouping of several high-power transmitters on one wavelength made enemy direction finding impossible except within 25 miles of any station; Fighter Command ordered a close-down when necessary. High-accuracy crystal-drive equipment achieved the required close synchronization between transmitters without the use of line links. High-powered transmissions were achieved by operating transmitters in parallel, with horizontal polarization to prevent enemy direction finding. Development of apparatus and techniques in emergency studio centers greatly assisted the con-

tinuity and quality of post-war broadcasting. Intricate land-line and radio networks between studios and transmitters ensured that the most violent enemy action did not interrupt programs. Monitoring of world broadcasting enabled a constant check to be kept on the position of enemy transmitters; anti-jamming measures were taken when required. Broadcasting to enemy and enemy-occupied countries was useful for guiding aircraft, for countermeasure work against raiding aircraft, and for broadcasting code-messages to paratroops.

- 621.396.619.13 2087
Frequency Modulation [Book Review]—P. Güttinger. Gebr. Leemann, Zürich, 183 pp. (*Wireless Eng.*, vol. 25, p. 129; April, 1948.) For radio engineers and students of h.f. technology. The treatment is necessarily mathematical. Principles of FM and p.m. and their application to transmitters and receivers are considered. Each of the 36 sections is complete in itself; the complete bibliography contains 295 references.

SUBSIDIARY APPARATUS

- 621.526 2088
A Variable-Radio-Frequency-Follower System—R. F. Wild. (*Proc. I.R.E.*, vol. 36, pp. 281-285; February, 1948.) In the servo-system described, the mechanical changes of the leader and follower vary the tuning of an oscillator and a discriminator, balance always being achieved when the two circuits are tuned to the same frequency. Several methods of applying this technique are discussed, with details of design and performance of typical circuits.

TELEVISION AND PHOTOTELEGRAPHY

- 621.397.335 2089
Synchronization in Television—H. Delaby. (*Télev. Franç.*, pp. 23-27; March, 1948.) Basic principles and a short account of methods used in America, England, France, and Germany.
- 621.397.5:535.88 2090
Projection Television—I. G. Maloff. (*Proc. Radio Club Amer.*, vol. 23, pp. 5-8; May, 1946.) Long summary. The use of moulded aspherical correcting lenses is considered.
- 621.397.5:621.396.67 2091
Television Installation—W. W. Wayne. (*Radio News*, vol. 38, pp. 52-54, 128; December, 1947.) The location of antennas for good television reception in urban districts is discussed. The reasons for weak pictures and ghost images are explained and methods of eliminating these faults by directive antennas and correct orientation are given. Installation procedure for any type of television antenna is tabulated.
- 621.397.6:621.385.832 2092
Modern Electromagnetic Sweep Technique—A. de Saint-Romain. (*Radio Franç.*, pp. 35-43; February, 1948.) A detailed discussion based on the work of Schade (574 of March) and Schlesinger (573 of March).
- 621.397.6:621.396.67 2093
A New Wide Band WSW Aerial for Television—B. V. Braude. (*Radiotekhnika* (Moscow), pp. 8-21; September to October, 1947. In Russian.) It is suggested that the construction of a turnstile antenna can be simplified if flat ribbon conductors are used instead of those with a circular cross-section. Accord-

ingly, an antenna has been developed in which the elements are made in the shape of two grids lying in the same plane and short-circuited at the end opposite to the input terminals (Figs. 1z and 13). A detailed report is presented of experiments with these antennas and approximate theory of operation is given. Experiments were also conducted with multistack antennas. Finally, these antennas are compared with American types of turnstile antenna.

- 621.397.7 2094
Alexandra Palace Television Centre—H. Sassoon. (*Télev. Franç.*, pp. 10-13; February, 1948.) A short account of BBC studio facilities and transmitter and antenna equipment.

TRANSMISSION

- 621.396.61:621.396.96 2095
Radar Transmitters: A Survey of Developments—O. L. Ratsey. (*Jour. I.E.E.* (London) part IIIA, vol. 93, no. 1, pp. 245-261; 1946. Discussion, *ibid.*, part IIIA, vol. 93, no. 7, p. 1302; 1946.) Beginning with the first 12-meter transmitters adapted from ionospheric research equipment, the history of the extension toward shorter and shorter wavelengths is traced over the decade 1935 to 1945, concluding with an indication of the elements of a 3-cm rf unit. The major Service equipments are described with special reference to the technical advances they exhibited, particularly on the modulation side. The circuit fundamentals of the duplexing devices (t. r. switches), which may normally be regarded as part of the transmitter, are also given.
- 621.396.61.029.54 2096
50-Watt Broadcast Transmitter, Type T.H. 1163—C. Beurtheret. (*Rev. Tech. Comp. Franç. Thomson-Houston*, pp. 47-51; May, 1947. In French with English summary.) A high-quality transmitter for the medium waveband (550 to 1500 kc.).
- 621.396.611.33:621.396.671 2097
The Matching Ranges of Transmitters—P. Mourmant. (*Radio Franç.*, p. 8; February, 1948.) Corrections to 595 of March.
- 621.396.82 2098
Unwanted Radiations from Medium-Wave Broadcast Transmitters—J. B. Webb. (*BBC Quart.*, vol. 3, pp. 59-64; April, 1948.) A discussion of the production of harmonic radiation on multiples of the fundamental carrier frequency, and of combination frequencies due to the interaction of two or more transmitters. Methods of identifying and suppressing such unwanted radiations are also considered.
- 621.3.032.216:621.315.61 2099
Energy Levels in Oxide Cathode Coatings—Wright. (*See* 1981.)
- 621.383 2100
Photoelectron Multipliers with an Sb-Cs Cathode—S. M. Feinstein. (*Zh. Tekh. Fiz.*, vol. 18, pp. 39-48; January, 1948. In Russian.)
- 621.385 2101
The Development of Radio Valves—J. H. E. Griffiths. (*Jour. I.E.E.* (London), part IIIA, vol. 93, no. 1, pp. 173-179; 1946.) A brief survey for m- and cm- λ transmitting and receiving tubes, mixers, gas-filled switches, and modulators. Because of its low power output and

efficiency, the klystron was superseded by the magnetron, whose stability and efficiency were increased by "strapping" alternate segments. The scaling-down of magnetrons for 3-cm operation, magnetron-to-waveguide couplings, and cathode design are also discussed.

621.385:621.317.729:537.291 2102

Automatic Tracer for Electron Trajectories—J. Marvaud. (*Compt. Rend. Acad. Sci. (Paris)*, vol. 226, pp. 476-478; February 9, 1948.) A semiautomatic method using an electrolyte bath, a single probe, and two calibrated potentiometers.

621.385.029.63/.64 2103

Small-Signal Analysis of Traveling-Wave Tube—C. Shulman and M. S. Heagy. (*RCA Rev.*, vol. 8, pp. 585-611; December, 1947.) Optimum design curves are obtained for an idealized tube consisting of a cylindrical shell electron beam moving parallel to the axis of a free-space perfectly conducting helix wound with small-diameter wires. The beam may be inside or outside the helix. The method is based on Hahn's theory (3521 of 1939). For maximum gain the helix should be small and close to the beam, and an optimum pitch and beam voltage exist for a given λ and helix diameter. For minimum noise factor, the beam should not be close to the helix, and no optimum pitch and beam voltage for a given λ and helix diameter exist; both should be as small as possible.

621.385.032.216:537.533 2104

A Method of Studying the Thermionic Emission of Oxide-Coated Cathodes in Gaseous Conduction Devices—W. F. Hodge. (*Phys. Rev.*, vol. 73, p. 95; January 1, 1948.) Summary of Amer. Phys. Soc. paper.

621.385.1.012 2105

Determination of Static Valve Characteristics by Extrapolation—G. Gregoretti. (*Alla Frequenza*, vol. 13, pp. 195-216; December, 1944.) In Italian, with English, French, and German summaries.) A method for obtaining the characteristics for normal cathode heating voltage from measurements at reduced voltage.

621.385.1.016.4.029.63:537.56 2106

Production of High-Frequency Energy by Ionised Gases—Steinberg. (*See* 1908).

621.385.2:621.396.822 2107

The Transmission-Line Diode as Noise Source at Centimetre Wavelengths—Kompfner, Hatton, Schneider, and Dresel. (*See* 2073.)

621.385.38 2108

Grid-Controlled Hot-Cathode Gas-Discharge Valves—H. Hertwig. (*Funk. und Ton*,

pp. 175-182; April, 1948.) Explanation of the operation of thyratrons and short account of their practical applications.

621.385.4 2109

Potential Distributions in Screen-to-Anode Space of Beam Tetrodes—S. Rodda. (*Wireless Eng.*, vol. 25, p. 33; January, 1948.) According to Gill (*Phil. Mag.*, pp. 993-1005; May, 1925), over a range of current densities there are apparently two steady-state solutions for this potential distribution. Discussion of the transient conditions shows that one of Gill's two voltage distributions is impossible as a final steady state.

621.396.615.142.2 2110

Electronic Tuning of Reflection Klystrons—B. Bleaney. (*Wireless Eng.*, vol. 25, pp. 6-11; January, 1948.) A simple theory of the electronic frequency control of a reflection klystron is developed by which it is possible to calculate the frequency deviation $\pm(\Delta f)m$ over which the power output does not fall below a certain fraction m of the power output at zero frequency deviation. It is shown that for a simple resonator of high impedance $(\Delta f)m = \pm A\beta^2 I_0^2 C W_1$ where β = modulation factor of resonator gap, I_0 = beam current, C = resonator capacitance, W_1 = power drawn from the beam, and A is a Bessel function expression whose maximum value is derived as a function of m . In particular, the frequency range from half-power to half-power has a maximum value of $(\Delta f)\frac{1}{2} = \pm 52 \beta^2 I_0^2 / C W_1$ Mc (I_0 in ma, C in μmf , and W_1 in mw) which occurs when the tube is loaded to deliver its maximum output. When the tube is used with a lightly coupled load, such as a crystal mixer, the resonator may require to be loaded with some extra loss to obtain the maximum value of $(\Delta f)\frac{1}{2}$.

MISCELLANEOUS

002:778.1 2111

Science Museum Photostat Service—The service is available to purchasers of special requisition forms which can be obtained singly for 3s. or in pads of 50 for £5. They may be obtained from the Director, Science Museum, South Kensington, London, S.W. 7; applications should be accompanied by a remittance payable to Science Museum, London, S.W. 7, and crossed "A/c H.M. Paymaster-General." The "value" of one requisition form is from six to ten photostat sheets, according to the nature of the publication. A declaration must be signed

with each requisition to comply with the Copyright Act.

016:621.396 2112

Bibliography of [1947 I.E.E.] Radiocommunication Convention Papers—(*Jour. I.E.E.* (London), part I, vol. 94, pp. 494-496; October, 1947.) A list of supporting papers. Summaries of all but a few of these papers are given, *ibid.*, part IIIA, vol. 94, no. 11, pp. 44-45, 59, 82, 105-106, 114, 131, 166-168, 220, 243, and 267-268; 1947. For abstracts of survey papers read at the Convention, see other sections; all survey papers appear in full, *ibid.*, part IIIA, vol. 94, no. 11, 1947; and summarized, *ibid.*, part I, vol. 94; October, 1947.

061.3 URSI-IRE 2113

URSI-I.R.E. Meeting—(Proc. I.R.E., vol. 36, pp. 103-104; January, 1948.) Titles and authors of 50 papers read at the meeting in Washington, D.C. October, 1947.

621.39 "1939/1945" 2114

Telecommunications in War—A. S. Angwin. (*Jour. I.E.E.* (London), part IIIA, vol. 94, no. 11, pp. 7-15; 1947; and summary, *ibid.*, part I, vol. 94, pp. 463-464; October, 1947.) Other summaries noted in 2644 and 4094 of 1947.

621.396 2115

Summarizing Review [of trends in radio communication]—C. C. Paterson. (*Jour. I.E.E.* (London), part IIIA, vol. 94, no. 11, pp. 16-22; 1947; and summary, *ibid.*, part I, vol. 94, p. 464; October, 1947.) Other summaries noted in 2649 of 1947 and 4096 of January.

621.396.1.029.64 2116

Physics and Technics of Microwaves—H. H. Klinger. (*Funk. und Ton*, pp. 183-192; April, 1948.) A review of the principal properties of microwaves and discussion of waveguides, cavity resonators, magnetrons, and propagation phenomena, including anomalous dispersion and absorption.

621.396.029.6 2117

Very High-Frequency Techniques. [Book Review]—Staff of the Radio Research Laboratory, Harvard, Conn., McGraw-Hill Publishing Co., London, 1057 pp., 84s. (*Wireless Eng.*, vol. 25, pp. 87-88; March, 1948.) Represents a summary of the methods, theories and circuits used by the Radio Research Laboratory that it is believed will be of general interest to radio engineers and physicists. . . . Should be invaluable to all concerned with frequencies of over 100 Mc. There is also a good deal in it of application to somewhat lower frequencies.

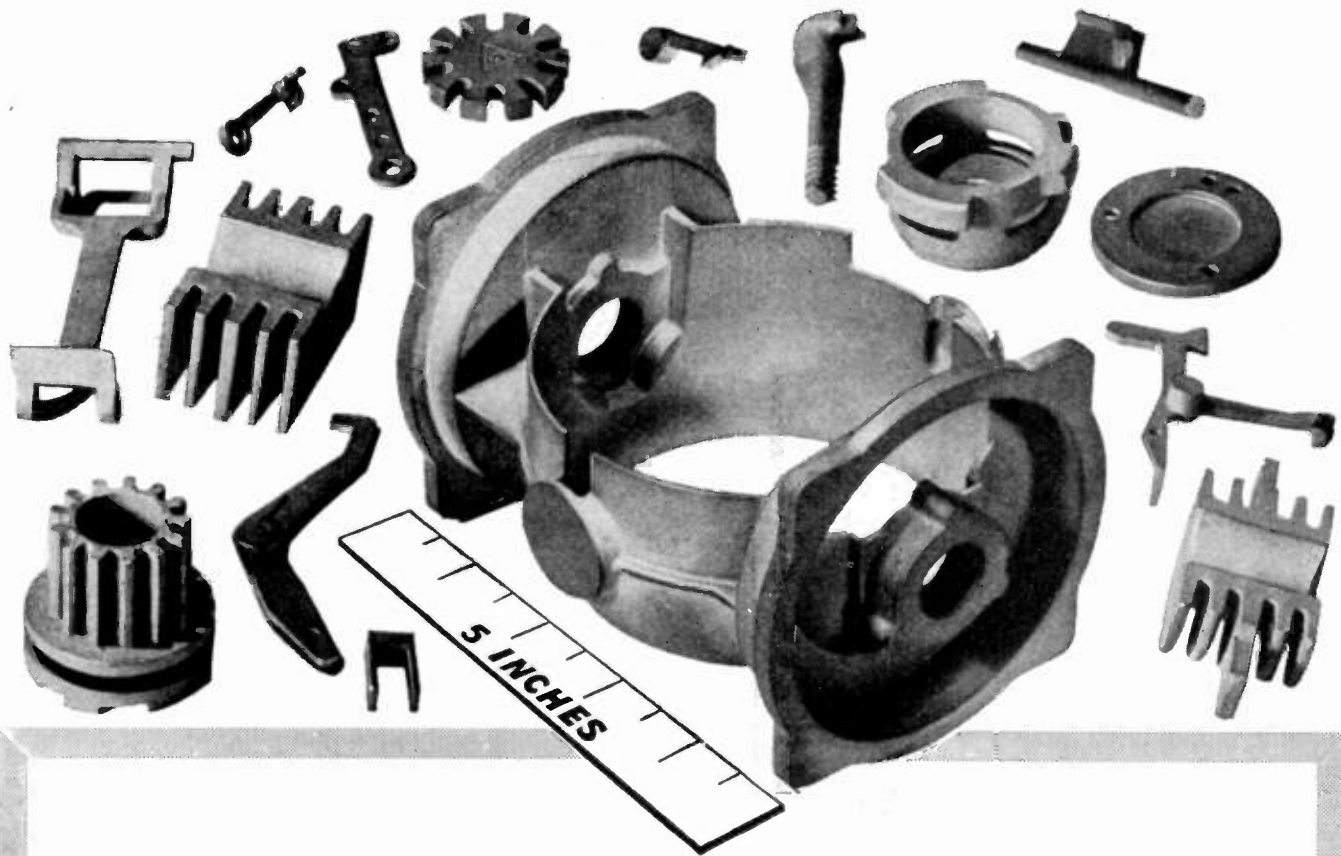

Cast to $\pm.005$ " accuracy!

Lower production costs, design flexibility, resistance to rust and corrosion...you get them ALL when you use INCO Nickel Alloy precision castings!

Casting, instead of forging, forming or machining saves shop time and tool costs. INCO precision castings of Monel*, Nickel, and Inconel* can usually be used *just as they come from the foundry*. The sand blast finish is so fine that additional machining is rarely required.

And as for accuracy... $\pm.005$ " per inch is the *common* production tolerance. Even closer limits can often be maintained when needed. Add to *accuracy* the fact that intricate contours are more easily produced by casting than by any other method—and you have a combination that will solve many a tough design problem.

Another important advantage...Inco Nickel Alloys can be used to greatly extend the life of

a product. These rustless, strong materials are highly resistant to heat, corrosion, abrasion and fatigue.

Check with INCO if your machining costs are running high. If modern precision casting techniques can solve your problems, you will be assured of mass-production economies *plus* a dependable source of supply.

Simply send a print and a sample, if available, with the quantities needed. We will be glad to tell you whether or not precision casting is practical for your problem.

Meanwhile, perhaps you have other metal problems. Our newest publication "66 PRACTICAL IDEAS FOR METAL PROBLEMS IN ELECTRICAL PRODUCTS" shows how other manufacturers have solved scores of tough design questions. Send for it today.

*Reg. U. S. Pat. Off.

The International Nickel Company, Inc.

67 Wall Street • New York 5, N. Y.

EMBLEM OF SERVICE
NICKEL  **ALLOYS**

MONEL* • "K" MONEL • "S" MONEL • "R" MONEL • "KR" MONEL • INCONEL* • NICKEL • "L" NICKEL • "Z" NICKEL



Simple, positive protection for 9 Type Reproducers ...Inexpensive... Easy to Install

Here's how the new Western Electric 706A Guard eliminates the three major causes of damage to 9 Type Reproducers and greatly facilitates their handling.

First, it serves as an automatic latch-type support for the reproducer arm when not in use—taking the place of the armrest from which the arm may be accidentally jarred with damage to the reproducer.

Second, the 706A Guard *positively prevents any contact* between the reproducer stylus and the felt surface of the turntable and prevents the stylus from riding into the label and drive-hole area of the transcription.

Third, with the 706A Guard it is *impossible* for the stylus to hit the edge of a 16-inch transcription.

To place your order, call your local Graybar office or write Graybar Electric, 420 Lexington Ave., New York 17, N. Y.

—QUALITY COUNTS—

DISTRIBUTORS: IN THE U. S. A.—Graybar Electric Company. IN CANADA AND NEWFOUNDLAND—Northern Electric Company, Ltd.

Western Electric



ATLANTA

"Problems of Television," by B. E. Shackelford, President, The Institute of Radio Engineers; April 7, 1948.

"Automatic Time Announcement Equipment," by J. L. Franklin, J. O. McCarty, and T. B. Franklin, Audichron Company; May 28, 1948.

BALTIMORE

"Low Temperature High-Frequency Phenomena," by J. V. Le Bacqz, Johns Hopkins University; April 27, 1948.

"Design of Current Television Receivers," by F. Norton, Bendix Radio Division; May 25, 1948.

BOSTON

"Bandwidth Reduction in Communication Systems," by W. G. Tuller, Melpar, Inc.; May 27, 1948.

BUFFALO-NIAGARA

"Underwater Surveys at Bikini by Television," by R. E. Frazier, Cornell Aeronautical Research Laboratories; April 21, 1948.

"Gas Tube Relay," by R. G. Rowe, Carborundum Company; "Electric Timer," by W. Bergeron, Electric Instrument Laboratories; "Phonograph Noise Suppression," by N. Nickolson, Colonial Radio Corporation; Election of Officers; May 19, 1948.

CEDAR RAPIDS

"Design and Application of Reflex Oscillators," by W. G. Shepherd, University of Minnesota; May 19, 1948.

CHICAGO

"New Developments in Television Transmitting Equipment," by H. Smith, Allen B. DuMont Laboratories, Inc.; Annual Business Meeting and Election of Officers; May 21, 1948.

CINCINNATI

"Permeability Tuned Oscillators and General Applications of Permeability Tuning," by T. A. Hunter, Hunter Manufacturing Company; May 18, 1948.

"Dinner Meeting," A. F. Knoblauch, Master of Ceremonies; Election of Officers; June 15, 1948.

CLEVELAND

"Institute Matters," and "Television Progress," by B. E. Shackelford, President, The Institute of Radio Engineers, Election of Officers; May 27, 1948.

CONNECTICUT VALLEY

New England Radio Engineering Meeting; May 22, 1948. Social Meeting; June 12, 1948.

DALLAS-FORT WORTH

"Factors Affecting Performance of Directional Antennas," by A. E. Cullum, Jr., Consulting Radio Engineer; June 3, 1948.

DAYTON

"Communication Systems for Aircraft," by J. E. Wilson and I. H. Bowker, Communication & Navigation Laboratory; May 13, 1948.

"Television Ghosts," by A. Alford, Andrew Alford Associates; May 27, 1948.

DES MOINES-AMES

"Methods of Frequency Control," by T. A. Hunter, Hunter Manufacturing Company; May 20, 1948.

(Continued on page 36A)

"Communications"



TS159 TPX

Measures frequency between 150-200 Mc. by heterodyne method. Pwr. output of XMTR can be measured directly. Measures DC voltages up to 500 V. Operates on 110 V. 400 cy. Complete with tubes, crystal, calibration chart, and conversion kit for 60 cy. \$29.95

MICROWAVE TEST EQUIPMENT

W. E. I. 138 A. Signal generator, 2700 to 2900 Mc range. Lighthouse tube oscillator with attenuator & output meter. 115 VAC input. req. Pwr. supply. With circuit diagram \$50.00
 TS-238 GP. 10 cm. Echo box with resonance indicator and micrometer adjust cavity. 2700 to 2900 Mc calibrated \$65.00
 3 cm. wavemeter: 9200 to 11,000 mc transmission type with square flanges \$15.00
 3 cm. stabilizer cavity, transmission type. \$20.00
 3 cm. Wavemeter. Micrometer head mounted on X-Band guide. Freq. range approx. 7900 to 10,000 Mc. \$75.00

"X" BAND AN/AP5-15A: Compl RF head and modulator, incl. 725-A magnetron & magnet, two 723A/B klystrons (local osc & beacon), 1B24 tr. rcvr-ampl. duplexer, HV supply, blower, pulse xfmr, 1k Pwr out; 45 KW apx. input; 115V. 400 cy. Modulator pulse duration 5 to 2 microsec. apx. 15 KV. PK. pulse. Compl with all tubes, incl. 715 B, 829 B, 1KR 73, two 72. Compl. pkg. new \$210.00
COMPLETE PKG., as above, less Mfr. \$150.00

MICROWAVE PLUMBING

10 CENTIMETER
 "S" BAND MIXER assembly with crystal mount, pick up loop, tunable output \$3.00
MAGNETRON TO WAVEGUIDE coupler with 721-A duplexer cavity, gold plated \$45.00
10 CM. WAVEGUIDE SWITCHING UNIT, switches 1 input to any of 3 outputs. Standard 1 1/2" x 3" guide with square flanges. Complete with 115 vac or dc arranged switching motor. Mfr. Raytheon. New and complete \$135.00
721-A TR CAVITY WITH TUBE. Complete with tuning plungers \$5.50
WAVEGUIDE SECTION, MC 445A, rt. angle bend, 5 1/2 ft. OA. 8" slotted section \$21.00
10 CM. OSC. PICKUP LOOP, with male homedell output 7/8" rigid coax—3/4" I.C. \$3.50
RIGHT ANGLE BEND, with flexible coax output pickup loop \$8.00
SHORT RIGHT ANGLE bend, with pressurizing nipple \$2.00
30 FT. FLEXIBLE SECTION, 3/4" rigid to 7/8" rigid \$7.50
RIGID COAX to flex coax connector \$3.50
STUB-SUPPORTED rigid coax, gold plated, 5' length. Per length \$5.00
TR ANGLES for above \$2.50
3/4" COAX, rotary joint \$8.00
RT. ANGLE bend 15" L. OA. \$2.00
FLEXIBLE SECTION, 15" L. Male to female \$4.25
MAGNETRON COUPLING to 3/4" rigid coax, 3/4" I.C. line. Less "M" nut \$7.50



3 CM. PLUMBING (STD. 1" x 1/2" GUIDE UNLESS OTHERWISE SPECIFIED)

TR CAVITY for 724-A TR tube, transmission or absorption types \$3.50
 724-A TR tube (41-TR-1) \$2.50
WAVEGUIDE SECTION, CG 251/AP8-15A, 28" long choke to cover, with 180 deg. bend of 2 1/2" rad at one end \$4.00
ROTARY JOINT with slotted section and type "N" output pickup \$8.50
WAVEGUIDE SECTION, 12" long choke to cover, 45 deg. twist & 2 1/2" radius, 90 deg. bend \$4.50
STABILIZER CAVITY feeding waveguide section, with filtered output and attenuating slugs \$20.00
SLUG TUNER/ATTENUATOR, W.E. guide, gold plated \$3.75
TR/ATR DUPLEXER section with iris flange \$4.00
RIGHT ANGLE ELBOW, 5 1/2" choke to cover, 2 1/2" radius E or H plane \$5.00
TWIST, 90 deg., choke to cover w/press. nipple \$5.00
WAVEGUIDE SECTIONS 2 1/2" long, all silver plated, with choke flange \$4.50
WAVEGUIDE, 90 deg., 5" band E plane, 18" long \$4.00
ROTARY JOINT choke to choke \$6.00
ROTARY JOINT, choke to choke, with deck mounting \$6.00
S-CURVE WAVEGUIDE, 8" long cover to choke \$2.50
DUPLEXER SECTION for 1B24 \$10.00
3 CM. WAVEGUIDE, 1" x 1/2", per ft. \$1.50
CIRCULAR CHOKE FLANGES, solid brass \$1.55
"T" SECTION (TR-ATT) choke to choke, supplied with circ. or sq. flanges \$3.50
DIRECTIONAL COUPLER CG 124 AP5-15A on 16" section cover to cover 15 deg. bend \$5.00
FEEDBACK DIPOLE with 90 deg. twist, 7 1/2" \$3.50
2 1/2" FLEXIBLE SECTION, cover to cover \$4.00
SHORT ARM "T" section, with additional choke output on vertical section \$4.00

1.25 CENTIMETER

WAVE GUIDE Section 1" cover to cover \$2.00
 T SECTION choke to cover \$4.50
 MITRED ELBOW cover to cover \$3.00
 MITRED ELBOW and "S" sections choke to cover \$3.50
FLEXIBLE SECTION 1" long choke to choke \$3.00
K-BAND ROTARY Joint \$45.00

2K25/723AB, X band local oscillator mount with (1) choke coupling to beacon reference cavity; (2) choke coupling to TIT and receiver; (3) Iris coupling with APC attenuator to antenna waveguide; (4) Radar APC crystal mount; (5) Receiver crystal mount; (6) Attenuating slug. Mfr. DeMornay Budd \$22.50
 TR/ATR Duplexer section for above \$4.00

LABORATORY ACCESSORIES

REACTOR: .01HY, 2.5 amp. 1500 v ins "Kenyon" \$3.50
BROAD BAND S THRU X themistor mount with type "N" input \$8.00
SPERRY KLYSTRON TUNER Mod. 12 \$2.00
SINE POTENTIOMETERS, GE251x98 or W.E. \$3.50
 SKS 15188 LOI \$3.50
CG 27 TYPE "N" CABLE ASSY, 3' long, male to female \$2.50
PH-SHIFTING CAP., 180 deg. W.E. 2D-150734 \$2.50
KLYSTRON SOCKETS for 723 A.B. and similar types, 2 for \$1.00
10 CM. McNALLY CAVITY TYPE SG. From \$3.00-\$3.50
LINE INSERTION ATTENUATOR, type OAX 10-20 dB, attention with 3-contact plug and socket (amphenol 168-5) \$2.25
TS 115/AP5-2F 10 CM ANTENNA in lucite ball, with type "N" fitting \$4.50
OAJ NAVY TYPE CYT66ADL ANTENNA in lucite ball, with Sperry fitting \$4.50
10 CM. FEEDBACK DIPOLE ANTENNA, in lucite ball, for use with parabolic antenna \$8.00
DECADE RESISTANCE BOX, 0-1250 ohms in 250-ohms steps \$2.50
DECADE CAPACITOR, .0054 mfd in 8 steps, 2500 v. ins. CD 5 PL 1185-120, 8" x 5 1/4" diam. \$6.50
"PPI", ROTATING YOKE TYPE, complete with all necessary oscillator circuits, CR tube 5P77, complete with tubes. Used with SO radar \$100.00
RT39/AP8-15, Transmitter-receiver, 2200-2700 mc APX. Complete with 2C43 lighthouse plumbing, TR, 30 mc, I.F., all enclosed in compact pressurized housing. New, less tubes \$100.00
CP 14 AP5-15A COMPUTER, Compiles slant range-ground range against altitude \$15.50
CURSOR DIAL ASSEMBLY for 7" CR tube. Azimuth bearing to 360 deg. roller bearing mech. \$12.50
BC 701-A RADAR RECEIVER, Part of SCR 521 and ASE eqpt. 176 mc operation, receives holoed search and homing patterns. Complete with tubes and antenna switching motor \$37.00
BC 704-A SCOPE, part of SCR 521 and ASE equipment. "L" scope with linear range sweep. With all tubes, including 5B71 \$17.50
YAGI ANTENNA SWITCHING MOTOR for ASF and SCR 521 sets. Operates on 24 v.d.c. at 1800 RPM. DPDT \$2.00

COAXIAL CONNECTORS

831R \$0.35 UG 21/50 \$1.85
 831SP \$0.35 UG 86 U \$0.95
 831AP \$0.35 UG 254/U \$0.75
 831P \$0.15 UG 255/U \$0.85
 Homedell male to type "N" male adapter \$1.25
 RT ANGLE Sperry fittings \$1.00

THERMISTORS

(\$95 ea.)
 D-167332 (Beard)
 D-170306 (Beard)
 D-168391 (Buton)
 D-166228 (Buton)
 D-167018 (Tubet)

VARISTORS

(\$95 ea.)
 D-167178
 D-170225
 D-168687
 D-171121
 D-171631

CROSS POINTER INDICATOR

Two 0-200 microamp. movements in 3" case. Each movement brought out to 6-term. receptacle at rear. Originally used in ILS equipment. \$2.50



5J30 THE NEWEST THING IN UHF. 10-350 MC. MAGNETRON IN GLASS ENVELOPE. NEW, COMPLETE WITH DATA SHEET \$39.50

TUBE	FRQ. RANGE	PK.	PWR.	OUT.	PRICE
2131	2820-2860 mc.		265 KW.		\$15.00
2124A	9345-9405 mc.		50 KW.		\$25.00
2122	3267-3333 mc.		265 KW.		\$15.00
2126	2092-3019 mc.		275 KW.		\$15.00
2127	2065-2092 mc.		275 KW.		\$15.00
2132	2780-2820 mc.		285 KW.		\$15.00
2138	Pkg. 3249-3265 mc.		5 KW.		\$25.00
2139	Pkg. 3267-3333 mc.		8.7 KW.		\$25.00
2155	Pkg. 9345-9405 mc.		50 KW.		\$25.00
8311	24,000 mc.		50 KW.		\$17.00
7144Y					\$15.00
720BY	2800 mc.		1000 KW.		\$25.00

KLYSTRONS: 723A/B \$7.75 707B W/CAVITY \$20.00

MAGNETS

For 2121, 725-A, 2122, 2126, 2127, 2131, 2132, and 3131 \$2.00 Each \$8.00
 4850 Gauss, 3/4" bet. pole faces, 3/4" pole diam. \$8.00
 1500 Gauss, 1 1/2" bet. pole faces, 1 1/2" pole diam. \$8.00
 1000 Gauss, electromagnet, adjustable 2 1/2" to 3" bet. pole faces, 2 1/2" pole diam. \$12.00

TUNABLE PKG'D "CW"

MAGNETRONS

QK59 2675-2900 Mcs. QK61 2975-3200 Mcs.
 QK60 2800-3025 Mcs. QK62 3150-3375 Mcs.
 .. New-\$45 each .. New-\$55 each

WATER COOLED TUBES

GL697 GL623 GL562
GUARANTEED \$75.00 EA.

PULSE EQUIPMENT

APQ-13 PULSE MODULATOR, Pulse Width. 5 to 1.1 Micro Sec. Rep. rate 624 to 1348 Pps. Pwr. out. 35 KW. Energy 0.018 Joules \$49.00
 TPS-3 PULSE MODULATOR, Pk. power 50 amp. 24 KV (1200 KW pk); pulse rate 200 PPS, 1.5 microsec; pulse line impedance 50 ohms. Circuit—series charging version of DC Resonance type. Uses two 705-A's as rectifiers. 115 v. 400 cycle input. New, with all tubes \$49.50

PULSE TRANSFORMERS

G. E. EK2731 \$19.50 W. E. D166173 \$12.50
 K2450A \$15.00 KS9948 \$8.50
 K2748A \$12.00 KS9800 \$2.00
 W. E. D169271 \$9.95 Utah 9318 or 9280 \$1.25
 705A \$1.95 715B \$8.50
 Sockets for 705A, 715B \$0.69 ea.

CONDENSER DRIVE

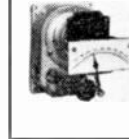

Rotates any coupled condenser by means of motor thru 90 deg. at rate of 5 deg. per min. Operates on 55-110 vac. 60 cy. Manual knob permits rough adjustment. WE 21401020-G1. New, complete with cover and 0-90 deg. indicator scale \$12.50

DYNAMOTORS

Type	Input Volts	Input Amps	Output Volts	Output Amps	Radio Set	Price*
BD 77KM	14	40	1000	350	BC 191	\$12.00 N \$7.95 LN
DM 73	28	19	1000	350	BC 375	\$8.95 N
DM 21	14	3.3	235	000	BC 312	\$3.45 LN
DM 21CX	28	1.6	235	000	BC 312	\$3.45 LN
DM 25	12	2.3	250	050	HC 367	\$2.49 LN
DM 28R	28	1.25	275	070	HC 348	\$5.75 N
DM 33	28	7	540	250	BC 456	\$5.50 N
DM 42	14	46	515	110	SCR 508	\$6.50 LN
					1030, 050	
PE 55	12	25	500	400	SCR 245	\$5.25 LN
PE 86 N	28	1.25	250	060	IC 36	\$3.95 N
PE 101 C	13/26	12.6/7	500	135	SCR 515	\$5.25 N
					9 AC 1.12	
BD AR 93	28	3.25	375	150		\$4.95 N
23350	27	1.75	285	075	APN-1	\$3.50 N
35X045B	28	1.2	250	080		\$3.50 N
ZA .0515	12/24	4/2	500	050		\$3.95 N
ZB .0516	12/24	8/4	275	110		\$2.25 N
B-19 pack	12	6.4	275	110	Mark II	\$9.95 N
					600, 050	

*N—New.

LN—Like New.

POWER EQUIPMENT

STEP DOWN TRANSFORMER: Pri: 440/220/110 volts a.c. 60 cycles, 3 KVA. Sec: 115 v. 2500 volt install. Size 12" x 12" x 7" \$40.00
PLATE TRANSFORMER, Pri: 117 v. 60 cy. Sec: 17,000 v. @ 114 ma, with choke. Oil immersed. Size: 20" x 29" x 13". Amertran \$65.00
FIL. TRANSFORMER, Pri: 220 v.a.c., 60 cy; .05KVA. Sec. 5 v.c.t., 34,000 v. test \$24.50
FIL. TRANS. UX6R00, Pri: 115 V. 60 cy. Sec: Two 5 v.c. 6.5 amp w/20K TUBE \$24.50
PLATE TRANSFORMER, Pri: 115/230 v.a.c. 50-60 cy. Sec: 21,000 v. 100 ma \$145.00
LINE VOLTAGE REG PR: 92-138 v 57/63 cy. 1ph15A Sec 115 v 7.15 A .82 Kw 98% PF \$99.50
"TRANSTAT" VOLTAGE REG, 11.5 KVA, 0-115 vac. 60 cy. 100 amps \$75.00
VOLTAGE REG Transtat. Amertran type RH 2 KVA load input: 90/130 v. 50-60 cy output 115 v. \$40.00
ITE CIRCUIT BREAKER, 115 A. 600 V \$15.00

400 CYCLE TRANSFORMERS

PLATE XFMR: Pri: 115 v. 400 cy. Sec: 9800 v or 8600 v @ 32 ma dc \$12.50
 12033, Plate Xfmr: Pri: 115 v. 800 cy. Sec: 4550 vct. 250 ma. \$4.60
 KS 9445, Pwr Xfmr, Pri: 115 v. 400-2400 cy. Sec: 592 vct. 120 ma. 6.3v. 8 amp. 5v. Sec: 5,000 v. 290 ma; \$3.50
PLATE XFMR, Pri: 115 v. 400-2400 cy. Sec: 4500 v. 6 ma \$6.50
 27143, Pri: 115 v. 400 cy. Sec: 6.3 v. 7 amp. 8.3 v. 8.8 amp; 6.3 v. 1.3 amp \$2.50
FIL XFMR, Pri: 115 v. 400 cy. Sec: 6.3 v. 9 amp; 6.3 vct. 65 amp; 2.5 v. 3.5 amp; 2.5 v. 3.5 amp \$3.25
 KS 9584, Pri: 115 v. 400 cy. Sec: 5,000 v. 290 ma; 5 v. 10 amp. size: 7" x 10" x 6" \$15.00
 Pri: 115 v. 380-2800 cps. Sec: 2200 v. 350-VA. open frame \$3.95
PLATE XFMR, Pri: 115 v. 400 cy. Sec: 1150-0-1150 v. 40 ma. GE. 68G631 \$1.75

INVERTERS

PE 206-A. Input: 28 VDC @ 38 amp. Output: 80 volts @ 500 volt-amps. 800 cycles. Leland. New, complete with enclosed relay, filter, instruction book \$12.50
 PE 218: Input: 25-28 VDC @ 92 amps. Output: 115 volts @ 1500 volt-amps. 380-500 cycles. Poor physical but good running condition \$12.50
DBM ANTENNA, Dual, back-to-back parabolas with dipoles. Freq. coverage, 1,000-4,500 mc. No drive mechanism \$65.00
AS-125/APR Cone type receiving antenna, 1000 to 3200 megacycles, New \$4.50

30 FT. MAST SETS

Heavy duty rugged plywood. Crated in 3 sections with coupling material. Two masts for ideal flat-top antenna. Unused \$40.00 per set

PURCHASING AGENTS—MFRS.

SEND FOR OUR LISTING OF PLUGS, RELAYS, CONDENSERS—IN PRODUCTION QUANTITIES.

All merchandise guaranteed. Mail orders promptly filled. All prices, F.O.B. New York City. Send Money Order or Check. Shipping charges sent C.O.D. Rated Concerns send P.O.

COMMUNICATIONS EQUIPMENT CO.

131-R Liberty St., New York, N.Y.

Digby 9-4124



AROUND SAN FRANCISCO

IT'S KGO WHEREVER YOU GO...

Three Truscon Steel Radio Towers Serve this Popular Station

On the edge of San Francisco Bay, these three 304-foot Truscon Radio Towers enable KGO to GO and GO with high efficiency.

KGO is a 50,000 watt station, owned by American Broadcasting Company, and reaches beyond Northern California into the Oregon and Nevada area. The three Truscon Steel Radio Towers shown here were designed from a location and structural standpoint to best assure continuous service to this large audience.

Field experience and manufacturing facilities make it possible for Truscon to meet adequately the individual requirements of every broadcasting installation. This assures satisfactory, trouble-free operation and ability to meet changing conditions in the AM, FM and TV fields.

Truscon engineering consultation is yours without obligation. Write or phone our home office at Youngstown, Ohio, or any of the numerous and conveniently located district sales offices.

TRUSCON STEEL COMPANY
YOUNGSTOWN 1, OHIO

TRUSCON SELF-SUPPORTING AND UNIFORM CROSS SECTION GUYED **TOWERS**



(Continued from page 34A)

EMPORIUM

"Secondary Emission as a Function of Temperature," by G. Hees, Sylvania Electric Products Inc.; June 3, 1948.

HOUSTON

"Atomic Physics, Detection of Subatomic Particles," by J. H. Stewart, Industrial Radiography Laboratory; Election of Officers; May 17, 1948

LONDON (CANADA)

"Applications of Electronics to Bio-Physics," by A. Burton, University of Western Ontario; Election of Officers; April 23, 1948.

"Magnetic Tape Recording," by T. E. Lynch, Brush Development Company; May 14, 1948.

LOS ANGELES

"Remote Control Television Lighting," by W. C. Eddy, WBKB, Balaban & Katz; "Stereophonic Magnetic Recorder," by M. Camras, Armour Research Foundation; "Television Studio Systems," by M. A. Tralner, Radio Corporation of America; May 20, 1948.

LOUISVILLE

"The Baldwin Electronic Organ," by J. F. Jordan, Baldwin Company; Election of Officers; May 14, 1948.

MONTREAL

"Transmission Considerations in Radio Systems for Telephone Service," by S. T. Fisher and C. B. Fisher, F. T. Fisher's Sons, Ltd.; April 28, 1948. Field Trip to RCAF Station; Election of Officers; May 15, 1948.

NEW MEXICO

"Television Progress," by P. J. Larsen, Los Alamos Scientific Laboratories; May 14, 1948.

"Application of Electronics in Nuclear Research," by H. G. Weiss, Los Alamos Scientific Laboratories; June 18, 1948.

NEW YORK

"A New 15-Kw Transmitter for Standard Band Broadcasting," by T. J. Boerner, Radio Corporation of America; April 22, 1948.

PRINCETON

"Reproduction of Sound," by H. F. Olson, Radio Corporation of America; Election of Officers; Annual Business Meeting; May 13, 1948.

ROCHESTER

"Simultaneous AM-FM Communication," by J. C. O'Brien, General Railway Signal Company; Election of Officers; May 27, 1948.

SACRAMENTO

"Our Interesting Universe," by L. E. Reukema, University of California; Annual Meeting; May 18, 1948.

"Stub Matching of RF Transmission Lines," by W. E. Evans, Jr., McClatchy Broadcasting Company; Election of Officers; June 15, 1948.

ST. LOUIS

"Telephones on Wheels," by M. W. Waggoner, Southwestern Bell Telephone Company; May 27, 1948.

SAN DIEGO

"An Analysis of Linear Modulation in a Diode," by M. W. Alnutt, U. S. Navy Electronics Laboratory; May 4, 1948.

(Continued on page 38A)

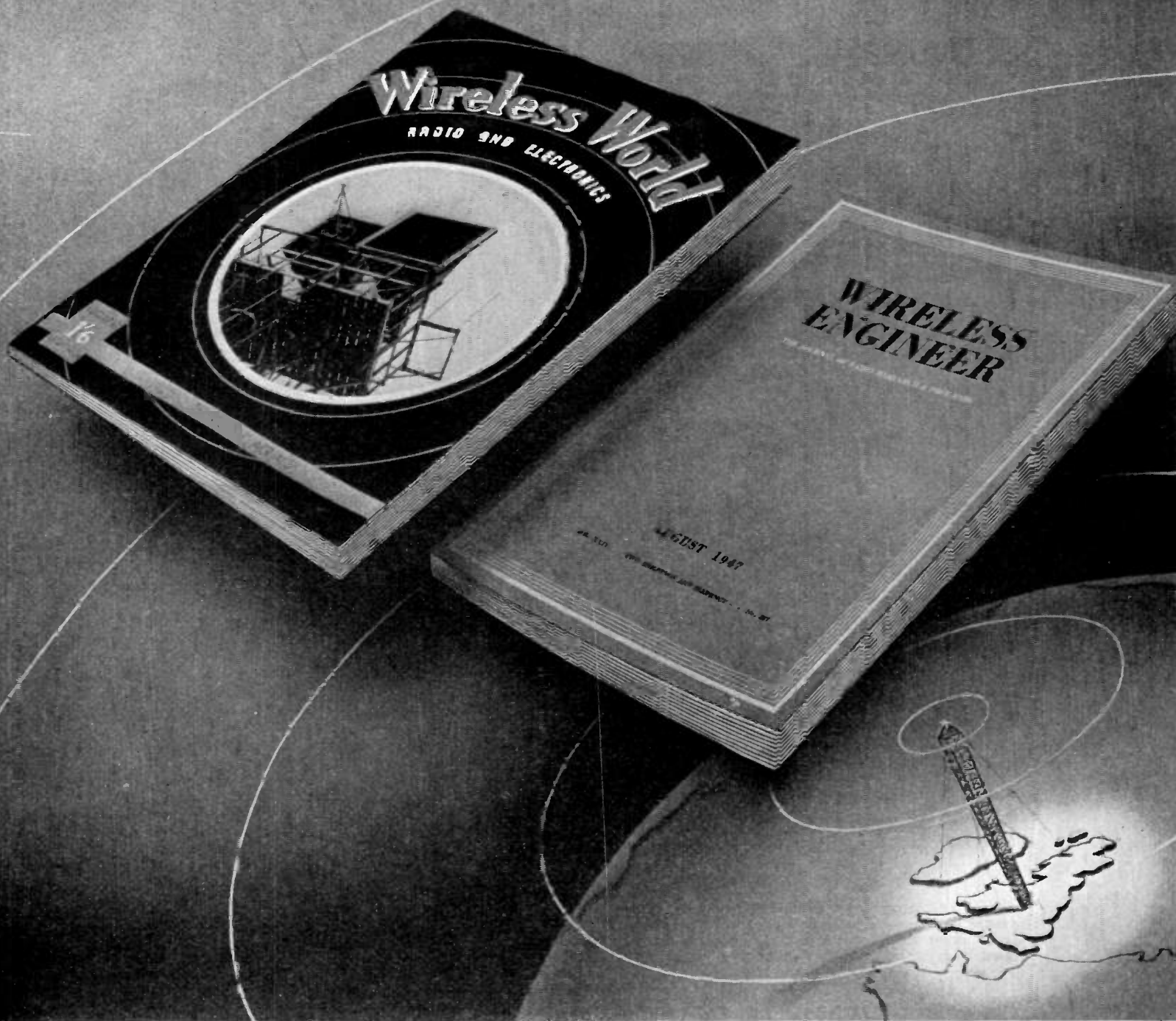

FOR ACCURATE & UP-TO-DATE NEWS OF EVERY BRITISH DEVELOPMENT IN RADIO, TELEVISION & ELECTRONICS

WIRELESS WORLD is Britain's leading technical magazine in the general field of radio, television and electronics. For over 35 years it has consistently provided a complete and accurate survey of the newest British technique in design and manufacture. Articles of a high standard include reviews of equipment, broadcast receivers and components, while theoretical articles deal with design data and circuits for every application.

WIRELESS ENGINEER is read by research engineers, designers and students, and is accepted internationally as a source of information for advanced workers. The Editorial policy is to publish only original work, and representatives of the National Physical Laboratory, the British Broadcasting Corporation and the Engineering Department of the British Post Office are included on the Editorial Advisory Board.

Subscriptions can be placed with British Publications Inc., 150 East 35th Street, New York 16, N.Y., or sent direct by International Money Order to



The Subscription Dept., Iliffe & Sons Ltd., Dorset House, Stamford Street, London, S.E.1, England. Cables "Iliffres, Sedist, London"

ASSOCIATED TECHNICAL BOOKS: "Television Receiving Equipment" (4th Edition), by W. T. Cocking, M.I.E.E. One of the most important British books on television 13 shillings (£2.60): "Wireless Direction Finding" (4th Edition), by R. Keen, B.Eng. (Hons.), A.M.I.E.E. An up-to-date and comprehensive work on the subject, 45 shillings (\$9.25): available from the British address above.

ASTATIC PIONEERED THE FIRST CRYSTAL DEVICES

Again Astatic Takes the lead
with MICROPHONES and
PHONOGRAPH PICKUPS
employing the
AMAZING PIEZOELECTRIC
CERAMIC
ELEMENTS

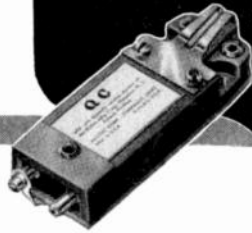

ASTATIC again assumes a pioneer role . . . in making available, for the first time, the unique physical advantages of the amazing piezoelectric ceramic element, in a microphone and phonograph pickup cartridge of advanced quality and fidelity. Unaffected by heat, moisture or dryness, they can go virtually anywhere . . . provide transcription quality reproduction, troublefree service, in tropical climates, under exposure to direct sunlight, heat from klieg lights or automotive interiors, when subjected to the many other conditions that threaten damage or impaired performance to other type instruments. These, plus other important advantages, combine to assure an immediate, enthusiastic reception for Astatic ceramic devices.

NOW AVAILABLE

Astatic has incorporated ceramic elements in two of its most popular product designs—the convertible "Velvet Voice" microphone and the "Quiet Talk" series pickup cartridges. Now moving through Astatic production lines, they are immediately available.

**MODEL "QC"
PICKUP CARTRIDGE**

- (1) Transcription quality reproduction.
- (2) Frequency response unaffected throughout wide temperature range.
- (3) Unaffected by heat, moisture or dryness.
- (4) A new level of physical ruggedness.
- (5) Extended service life, free from trouble and diminishing quality of reproduction.
- (6) Adaptable, without changes, to standard circuits, because impedance is comparable to that of standard crystal cartridges.
- (7) Needle pressure, 1 oz.
- (8) Frequency range, 50 to 10,000 c.p.s.

**MODEL "VC"
MICROPHONE**

- (1) Available with substantially flat response or rising characteristics in the voice range.
- (2) Unaffected frequency response, throughout a wide temperature range, suggests use for laboratory applications.
- (3) Unaffected by heat, moisture or dryness.
- (4) Amazingly rugged against physical shocks and stresses.
- (5) Peak service life assured by resistance to both climatic and operational abuses.
- (6) Comparatively low impedance opens up new fields of application, heretofore limited to costly and heavy units.
- (7) Frequency response, 30 to 10,000 c.p.s.

Write for prices, specifications



(Continued from page 36A)

SAN FRANCISCO

"Television—Its Mechanism and Promise," by W. L. Lawrence, Radio Corporation of America; May 12, 1948.

"Television Receiver Installation and Servicing Problems," by E. Edison, RCA Television Receiver Installation Shop; June 9, 1948.

TOLEDO

"Miniature Tubes," by G. H. Floyd, General Electric Company; May 25, 1948.

TWIN CITIES

"Components and Tubes for Television Receivers," by H. E. Hafker, Radio Corporation of America; May 5, 1948.

"Atomic Energy," by A. O. C. Nier, University of Minnesota; May 26, 1948.

WASHINGTON

"Reproduction of Sound," by H. F. Olson, Radio Corporation of America; May 10, 1948.

"Projection Television Receiver Design Features," by E. L. Clark, Radio Corporation of America; June 14, 1948.

SUB-SECTIONS

LANCASTER

"The Engineer and the Community," by D. A. Distler, Franklin & Marshall College; May 14, 1948.

LONG ISLAND

"Fundamental Limitations of Wide-Band Amplifiers," by H. A. Wheeler, Wheeler Laboratories; April 14, 1948.

"Pulse Multiplex System for Distance Measuring Equipment," by C. Hirsch and Lois Stewart, Hazeltine Electronics Corporation; Election of Officers; May 12, 1948.

MONMOUTH

"Maxially Flat Filters in Waveguides," by W. W. Mumford, Bell Telephone Laboratories, Inc.; "A New Microwave Filter," by J. R. Pierce, Bell Telephone Laboratories, Inc.; Election of Officers; June 16, 1948.

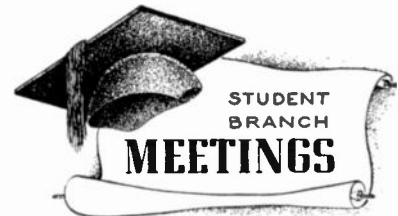

**ALABAMA POLYTECHNIC INSTITUTE,
I.R.E. BRANCH**

Election of Officers; May 17, 1948.
"Electronic Computers," by Mr. Sayre, Alabama Polytechnic Institute; June 21, 1948.

UNIVERSITY OF ARKANSAS, I.R.E. BRANCH
Election of Officers; May 19, 1948.

**POLYTECHNIC INSTITUTE OF BROOKLYN,
I.R.E. BRANCH**

"My Experiences in the E.T.O.," by C. A. Hachemeister, Polytechnic Institute of Brooklyn; May 11, 1948.

(Continued on page 40A)

"NOFLAME-COR"

the TELEVISION hookup wire

by



approved by
Underwriters' Laboratories of

90° CENTIGRADE _____ **600** VOLTS

For transformer use in television, F-M, quality radio and all exacting electronic applications. Immediate delivery in all sizes, solid and stranded. Over 200 color combinations. Demonstrating anew the Efficiency and Economy of *CORNISH WIRES AT WORK.*

- Flame Resistant
- Heat Resistant
- High Insulation Resistance
- High Dielectric
- Easy Stripping
- Facilitates Positive Soldering
- Also Unaffected by Heat of Impregnation
Therefore Ideal for Coil and Transformer Leads

COMPLETE ENGINEERING DATA AND SAMPLES ON REQUEST

RUBBER	75°
PLASTIC	80°
"NOFLAME-COR"	90°

"made by engineers for engineers"



CORNISH WIRE COMPANY, Inc.

605 North Michigan Avenue,
Chicago 11

15 Park Row, New York 7, N.Y.

1237 Public Ledger Bldg.,
Philadelphia 6

MANUFACTURERS OF QUALITY WIRES AND CABLES FOR THE ELECTRICAL AND ELECTRONIC INDUSTRIES

For Unusual and Difficult Requirements

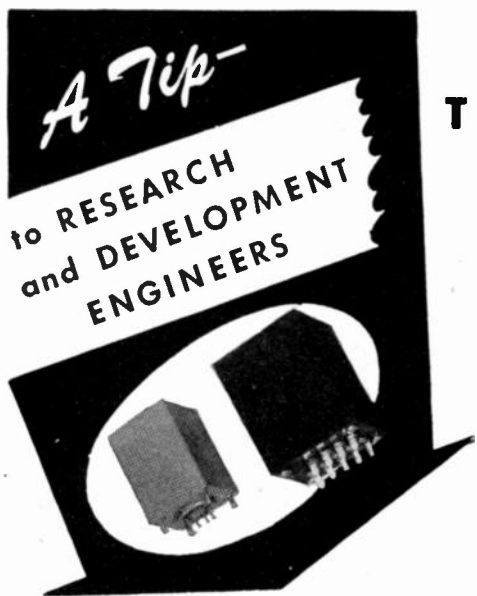

USE **ADC** TRANSFORMERS

- Research
- Models
- Testing

STEEL When a steel company engineer was presented with a problem of testing steel with an application of variable frequency, an oscillator output impedance as low as 0.01 ohms was required over a wide frequency range.

Through the aid of **ADC** engineers and the use of special **ADC** designed transformers a regular oscillator was equipped to perform the test satisfactorily with great savings in time and money to the steel company. Remember **ADC** as a transformer source for unusual and difficult assignments as well as for high quality and dependable production transformers.

Research

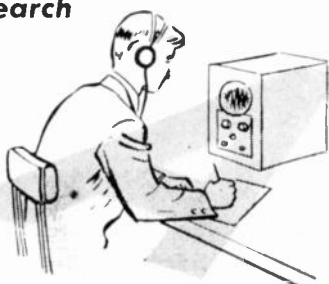

Models



Development

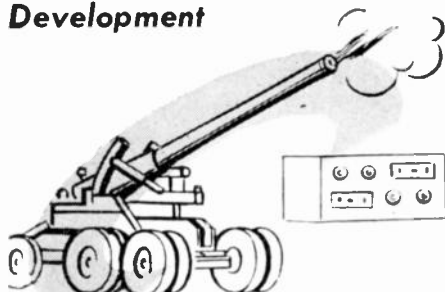

COMMUNICATIONS Today a large utility company has a satisfactory communication system between its central location and its mobile units because **ADC** engineers worked out technical transformer applications for the maker of a power line carrier telephone. From model stage to production this company depended upon the skill of **ADC** transformer design and production. You, too, will find **ADC** helpful in all unusual model work as well as production.

ENGINEERING The development of a computer to check the muzzle velocity of a cannon with greater accuracy required many special transformer applications. This job is typical of scores of development tasks presented to **ADC** engineers from university laboratories, communication developments, guided missile programs and developmental engineers everywhere. **ADC** supplies transformer "know how" with excellent transformer production to assure you a reliable source of dependable transformers.

Have an **ADC** catalog in your file for ready reference. Write us about your special problems.

Foreign Inquiries Solicited. Cable address: AUDEVCO MINNEAPOLIS



ADC *Audio* **DEVELOPMENT CO.**
 "Audio Develops the Finest!"
 2833 13th AVE. SOUTH · MINNEAPOLIS 7, MINN.

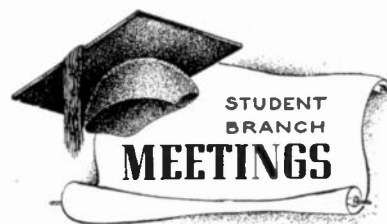

(Continued from page 38A)

CALIFORNIA INSTITUTE OF TECHNOLOGY,
 I.R.E. BRANCH
 Business Meeting; May 17, 1948.

UNIVERSITY OF CALIFORNIA, I.R.E.—
 A.I.E.E. BRANCH
 "The California Engineer's Registration Act,"
 by A. Tittes, PG&E; May 13, 1948.

CALIFORNIA STATE POLYTECHNIC COLLEGE,
 I.R.E. BRANCH
 "Operational Analysis of a 2000-Cycle Class-C,
 Amplifier," by H. Engwicht, San Jose State Col-
 lege; May 20, 1948.

UNIVERSITY OF ILLINOIS, I.R.E.—
 A.I.E.E. BRANCH
 Business Meeting; April 29, 1948.

MANHATTAN COLLEGE, I.R.E. BRANCH
 Election of Officers; May 19, 1948.

UNIVERSITY OF MICHIGAN, I.R.E.—
 A.I.E.E. BRANCH
 Spring Vacation Field Trip; April 2 to April 11,
 1948.
 "Plants versus Engineers," by W. C. Steere,
 University of Michigan; Election of Officers; May
 19, 1948.

COLLEGE OF THE CITY OF NEW YORK,
 I.R.E. BRANCH
 Election of Officers; May 11, 1948.

NORTH CAROLINA STATE COLLEGE,
 I.R.E. BRANCH
 Election of Faculty Representative; May 12,
 1948.
 "Radar Waveguide Transmission Techniques,"
 by R. Peters, Western Electric Company; May 26,
 1948.

NORTHWESTERN UNIVERSITY, I.R.E.—
 A.I.E.E. BRANCH
 Discussion of Field Trip; April 8, 1948.
 Field Trip and Dinner; April 15, 1948.
 "The Business Physician—A Consultant Engi-
 neer," by H. F. Fruth; April 29, 1948.
 "After Commencement, What Next?" by T. G.
 LeClair, Commonwealth Edison Company; May
 13, 1948.
 "The Art of Selling Technical Knowledge," by
 O. Eisenchlm, Scientific Oil Compounding Com-
 pany; May 21, 1948.
 Business Meeting; May 27, 1948.

PRINCETON UNIVERSITY, I.R.E.—
 A.I.E.E. BRANCH
 Election of Officers; May 11, 1948.

ST. LOUIS UNIVERSITY, I.R.E. BRANCH
 "The Proximity Fuse," by F. W. Bubb, Washing-
 ton University.
 Election of Officers; May 11, 1948.

STANFORD UNIVERSITY, I.R.E.—
 A.I.E.E. BRANCH
 "Basic Problems of Vacuum-Tube Construc-
 tion," by R. H. Gordon, Stanford University; Elec-
 tion of Officers; May 19, 1948.

(Continued on page 42A)

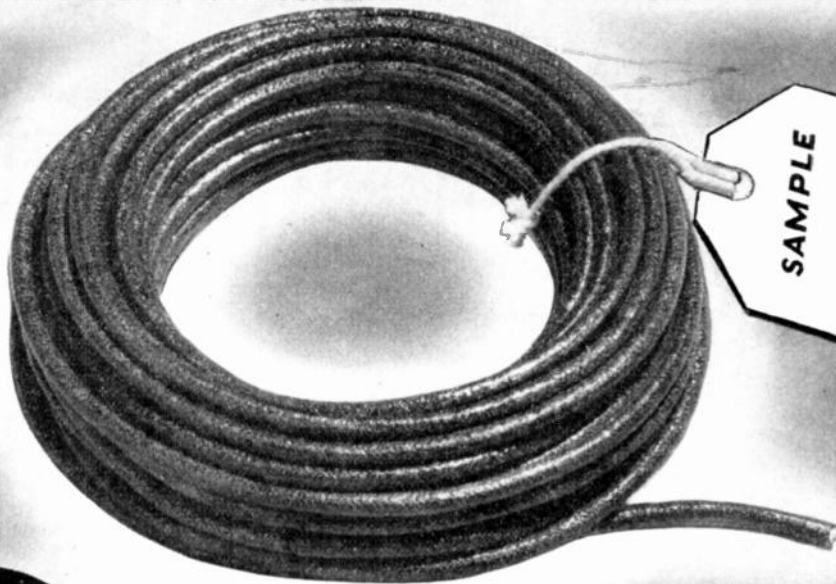

SAMPLE
LENZ POWTRAN
Submitted to
Coil Manufacturers



powtran

FOR POWER TRANSFORMER LEADS

- ◆ **Withstands coil impregnation temperatures without electrical or mechanical deterioration**
- ◆ **Textile Insulation rated at 90° operating temperature**
- ◆ **4100 volts breakdown one foot immersed in Mercury**
- ◆ **Available in RMA Transformer Lead Color Code— Sizes 22 to 14**
- ◆ **Flame Resistant**
- ◆ **Easy Stripping**

LENZ ELECTRIC MANUFACTURING CO.
1751 N. Western Ave., Chicago 47, Illinois
Please send me sample and specifications of POWTRAN.

Name..... Title.....
Company.....
Address.....
City..... State.....

Mail This Coupon for FREE Sample and Specifications

in business since 1904



LENZ ELECTRIC MANUFACTURING CO.

WGN-TV SELECTS ANDREW TELEVISION TRANSMISSION LINE *and* ANDREW INSTALLATION SERVICE

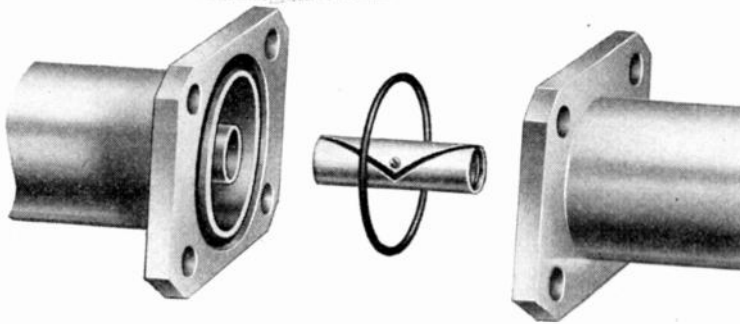

Many of America's new television stations are selecting Andrew equipment because of the efficiency of Andrew's flanged coaxial transmission line and the added advantage of having Andrew consulting engineers install it.

Because each television installation poses its own different, individual problem, those stations selecting Andrew have two big advantages: 1) they obtain transmission line and accessories *specially designed for television*, and 2) specialized Andrew consulting engineers are available to direct the installation. These engineers have both the special instruments and the experience to engineer all or any part of the construction of a television station. **NO OTHER TRANSMISSION LINE MANUFACTURER OFFERS YOU THIS COMPLETE INSTALLATION SERVICE!**

Andrew TV transmission line meets official RMA standards and is specially designed for television. Mechanically, it's held to close television tolerances assuring an essentially "flat" transmission line system.

Fabricated in twenty foot lengths with brass connector flanges silver brazed to the ends, sections can be easily bolted together with only a couple of small wrenches. Flanges are fitted with gaskets so that a completely solderless, gas-tight installation results. Markings on the outer conductor indicate where twenty foot sections may be cut to maintain the characteristic 51.5 ohm impedance.

WANT A TELEVISION STATION DESIGNED AND BUILT—FROM THE GROUND UP? LET ANDREW DO IT!

Write today for full details. Andrew will get you on the air.

Television antenna of WGN-TV — Chicago's newest and most powerful television station—showing Andrew 1-5/8" flanged television transmission line.

Andrew
CORPORATION
363 EAST 75th STREET • CHICAGO 19
TRANSMISSION LINES FOR AM, FM, TV • DIRECTIONAL ANTENNA EQUIPMENT • ANTENNA TUNING UNITS • TOWER LIGHTING EQUIPMENT • CONSULTING ENGINEERING SERVICE

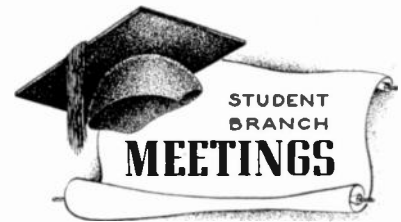

(Continued from page 40A)

UNIVERSITY OF TEXAS, I.R.E.—
A.I.E.E. BRANCH

"Report on Regional Meeting," by D. Spence, Student; April 26, 1948.
Social Meeting; May 8, 1948.
Election of Officers; May 10, 1948.

UNIVERSITY OF UTAH, I.R.E.—
A.I.E.E. BRANCH

"Mk 16 Radar," by G. Wade, J. E. Edwards, R. W. Grow, C. L. Alley, D. R. McAllister, and W. R. Tate, Students; May 3, 1948.

UNIVERSITY OF WASHINGTON, I.R.E.—
A.I.E.E. BRANCH

Nomination of Officers; May 21, 1948.
Election of Officers; June 3, 1948.

WORCESTER POLYTECHNIC INSTITUTE,
I.R.E.—A.I.E.E. BRANCH

"Broadcasting," by E. Browning, WTAG & WTAG-FM; Election of Officers; May 11, 1948.
Business Meeting; May 18, 1948.



The following transfers and admissions were approved on July 7, 1948, to be effective as of August 1, 1948:

Transfer to Senior Member

Carlisle, R. W., Box 107, Elmsford, N. Y.
Clarke, J. R., School of Electrical Engineering, Purdue University, Lafayette, Ind.
Fancher, H. B., 178 Hickok Ave., Syracuse 6, N. Y.
Hinsdale, E. M., Jr., 2025 S. Randolph St., Arlington, Va.
Holmes, L. C., Stromberg-Carlson Co., 100 Carlson Rd., Rochester 3, N. Y.
Olson, H. F., Acoustical Research Laboratory, RCA Laboratories Division, Princeton, N. J.
Powles, F. T., 5030 Benning Rd., S.E., Washington 19, D. C.
Rhys-Jones, J. E., Three Ways, Sykecluan, Iver, Bucks, England
Waldock, D. A. G., c/o Directorate of Armament Development, Army Headquarters, Ottawa, Ont., Canada
Wallace, J. W., Radio KPQ, Wenatchee, Wash.
Wells, F. H., Atomic Energy Research Establishment, T.R.E., Malvern, Worcs., England

Admission to Senior Member

Arenstein, G. H., 29 Colin Kelly Dr., Dayton 3, Ohio
Edwards, M. A., 805 Sanders Ave., Scotia, N. Y.
Harden, J. G., 240 N. Meridian St., Indianapolis 9, Ind.
Koch, R., 72 Via del Mascherino, Rome, Italy
Krause, R. A., 536 Huron Ave., Cambridge 38, Mass.
Rutelli, G., Via Sturla 39-B/6, Istituto Di Elettrotecnica, Universita Di Genova, Genova, Italy
Wankel, F. A., 30 Rockefeller Plaza, New York 20, N. Y.

(Continued on page 44A)

NOW!

.. LARGE PROJECTED PICTURE

perfected by



PROTELGRAM



The 2½" magnetic projection triode 3NP4 has a face as small as a compact and is only 10½" long.

A VAST NEW MARKET OPPORTUNITY FOR MANUFACTURERS OF TELEVISION RECEIVERS

NOTE THESE 10 SIGNIFICANT FEATURES

- | | |
|--|--|
| <ol style="list-style-type: none"> 1 Flat 16" x 12" non-reflecting picture provides fatigueless viewing from less than 5 feet up. 2 Wide-angle visibility - square corners. 3 True photographic black and white picture quality - no color distortion. 4 Compact unit - even fits table model cabinets. 5 Long-life, low-cost picture tube. | <ol style="list-style-type: none"> 6 Standard chassis for 10" direct-viewing tube system can be easily adapted for use with PROTELGRAM. 7 Easy to service. 8 High contrast ratio and broad gray tone range. 9 Simple optical adjustment system. 10 Quality built after more than 10 years of development. |
|--|--|

NORELCO PROTELGRAM consists of a projection tube, an optical box with focus and deflection coils, and a 25 kv regulated power supply unit, making possible large-size home projection. More than ten years of exhaustive research led to the determination of the ideal system for reproducing a 525-line projected picture. The optical components were designed to produce perfected projection for a 16" x 12" image as the optimum picture size for steady, distant observation and also for *proper viewing at less than 5 feet.*

- Other NORELCO products include standard 10" direct-viewing tubes and special-purpose cathode-ray tubes for many applications.

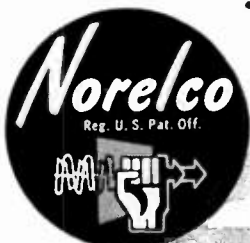

PROTELGRAM IS PICTURE PERFECTION IN PROJECTION

NORTH AMERICAN PHILIPS COMPANY, INC.

DEPT. TP-9, 100 EAST 42nd STREET, NEW YORK 17, N. Y. ★ IN CANADA: PHILIPS INDUSTRIES LTD., 1203 PHILIPS SQUARE, MONTREAL
EXPORT REPRESENTATIVE: PHILIPS EXPORT CORPORATION, 100 EAST 42ND STREET, NEW YORK 17, N. Y.

Now It's Easy To BUILD VOLTAGE STABILITY RIGHT INTO YOUR EQUIPMENT

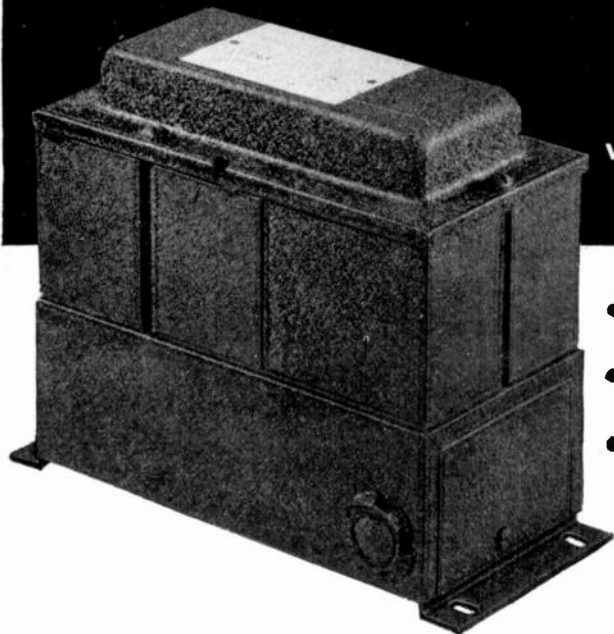

RAYTHEON
VOLTAGE STABILIZER
HEADQUARTERS
Since 1927

- New
- Lighter
- More Compact

RAYTHEON VOLTAGE STABILIZERS Insure Peak Performance At Low Cost

Don't leave your product's reputation for accuracy and reliability at the mercy of fluctuating line voltage. Raytheon Voltage Stabilizers make it easy—and economical—to build voltage control right into your equipment. New, lighter, more compact models are easy to install, require little space, never need adjustment or maintenance. It costs so little to be sure your product will never fall short of top performance, due to varying power supply. Why not look into it? The New Raytheon line includes a wide choice of performance-engineered standard types—or special models can be custom-built to suit your needs. Get the complete story from "Voltage Stabilizer Headquarters" today.

BUILD THESE ADVANTAGES INTO YOUR EQUIPMENT

- Positive stabilization of output voltage to within $\pm \frac{1}{2}\%$.
- Stabilization at any load within rated capacity.
- Quick response. Stabilizes varying input voltage within 1/20 second.
- Entirely automatic. No adjustments. No moving parts. No maintenance.
- Many designs available with low harmonic distortion of the output voltage wave at any load.
- Single or multiple output voltages.
- Stabilizers can be supplied with frequency compensation.
- Wide range of designs including hermetically-sealed types.

RAYTHEON MANUFACTURING COMPANY Waltham 54, Massachusetts

Gentlemen: Please send me copy of your new Voltage Stabilizer Bulletin DL-V-304F.

Name Position.....
Company.....
Street Address.....
City.....Zone No.....State.....



(Continued from page 42A)

Transfer to Member

- Alterman, F. J., 25-40-31 Ave., Long Island City, L. I., N. Y.
- Anspach, K. E., Sylvania Electric Products Inc., 40-22 Lawrence St., Flushing, L. I., N. Y.
- Braude, A. N., c/o Hong Kong Telephone Company Ltd., Hong Kong, China
- Brooks, F. E., Jr., 702 W. 25 St., Austin 21, Texas
- Brown, D. R., 115 Hemenway St., Apt. 16, Boston 15, Mass.
- Danziger, A., 910 Park Pl., Brooklyn 16, N. Y.
- Dasburg, A. V., 55 Stonybrook Dr., Rochester 10, N. Y.
- Dorrell, R. E., Electron Tube Laboratory, National Bureau of Standards, Washington 20, D. C.
- Farrell, F. X., 105 Tobey St., Providence 9, R. I.
- Gossland, R. D., G. M. Giannini & Company, 285 W. Colorado St., Pasadena 1, Calif.
- Grobecker, A. J., 2395 Woodlyn Rd., Pasadena 7, Calif.
- Hauser, W. H., 112 Warren St., Newton Center 59, Mass.
- Holmboe, L. W., 1400 Packard St., Ann Arbor, Mich.
- Huntley, K. L., Radio Division III, Naval Research Laboratory, Washington 20, D. C.
- Jackson, A., Box 101, Hollyburn, B. C., Canada
- Jullan, R. S., University of Illinois, Champaign, Ill.
- Kirkland, G. I., 8006 Piney Branch Rd., Silver Spring, Md.
- Korin, S. B., 129 Wadsworth Ave., New York 33, N. Y.
- Lawton, B. E., 1942 Birchwood Ave., Chicago 26 Ill.
- Lee, L. K., 284 Ninth St., Oakland 7, Calif.
- Leifer, M., 632 Leonard St., Brooklyn 22, N. Y.
- MacKechnie, H. K., 146 Langley Rd., Newton Center, Mass.
- Managan, W. W., 3800 Perkins Ave., Cleveland 14, Ohio
- McCallum, D. M., The Rectory, Bathgate, West Lothian, Scotland
- Miller, J. L., 2416 S. Dinwiddie St., Arlington, Va.
- Nasmyth, P. W., 73 Renfrew Ave., Ottawa, Ont., Canada
- O'Connor, D. G., 6823 Ridge Blvd., Brooklyn 20, N. Y.
- Onyskin, M., Sperry Gyroscope Co., Great Neck, L. I., N. Y.
- Pritchard, W. L., 287 Newbury St., Boston 15, Mass.
- Rehkopf, C. L., 6308-23, N.E., Seattle 5, Wash.
- Rosenbaum, J., 44 S. Madison Ave., Spring Valley, N. Y.
- Russell, J. D., Radio Station WHIR, Danville, Ky.
- Russell, J. H., 2914 S. Buchanan St., Arlington, Va.
- Skerrey, C. E., 8 Wyver Crescent, Coventry, Worces., England
- Southwell, J. D., 371 Forrest St., Beaumont, Texas
- Stanton, I. W., 4078 Ninth Ave., Los Angeles 43, Calif.
- Trotter, G. C., 134-A Brattle, Cambridge 38, Mass.
- Wilson, D. G., EEL 203, University of Kansas, Lawrence, Kan.
- Zimmerman, S., 135 Prospect Park, S.W., Brooklyn 18, N. Y.

Admission to Member

- Ames, B. C., 7504 Nestle Ave., Reseda, Calif.
- Beier, L. W., 600 S. Michigan Ave., Chicago 5, Ill.
- Behrend, W. L., 564 S. Main St., Hightstown, N. J.
- Bergquist, P., 982 National Press Bldg., Washington 4, D. C.
- Bloom, M. S., 1058 W. Loyola Ave., Chicago 26, Ill.
- Brown, V. A., 3929 Newdale Rd., Chevy Chase 15, Md.
- Bruning, J. M., New York Group, Atlantic Reserve Fleet, U. S. Navy, Bayonne, N. J.
- Coles, D. K., Westinghouse Research Laboratories, Pittsburgh, Pa.



- Devine, G. F., R.F.D. 1, Bishop Hill Rd., Marcellus, N. Y.
- Feldman, B., Farnsworth Tel. and Radio Corp., Fort Wayne 1, Ind.
- Greeff, C. E., 1010 Cameron Ave., Lancaster, Pa.
- Harrison, S. W., 37-41-79 St., Jackson Heights, L. I., N. Y.
- Hidalgo, M. T., Box 332, Carnegie Institute of Technology, Pittsburgh, Pa.
- Iversen, J., c/o Hewlett-Packard Co., 395 Page Mill Rd., Palo Alto, Calif.
- Knoop, I. L., 340 Baldwin Rd., Akron 6, Ohio
- Larsen, J., 321 W. Cortland St., Jackson, Mich.
- Metcalf, D., 4404 Ramsey Ave., Austin, Texas
- Morrin, T. H., 194 Islington Rd., Auburndale 66, Mass.
- Morrison, R. T., 1423 Tower Rd., Winnetka, Ill.
- Morton, H. B., 2, Lawn Ave., West Drayton, Middlesex, England
- Myers, M. C., Jr., 14 Columbus Ave., Montclair, N. J.
- Ransom, D. H., R.D. #1, Paterson, N. J.
- Roe, J. N., 5 Gloucester Rd., Hampton-on-Thames, Middlesex, England
- Ryan, W. R., Weaskum Wood Rd., Riverside, Conn.
- Saari, L. V., 722 N. Broadway, Milwaukee 2, Wis.
- Savage, L. E., 1033 W. Van Buren St., Chicago 7, Ill.
- Schrank, H. E., 1611 Maple St., Fort Lee, N. J.
- Sharma, S. B., Asst. Wireless Officer, U.P. Police Wireless, Dilkooaha Rd., Lucknow, U.P., India
- Stolaroff, M. J., 235 McEvoy St., Redwood City, Calif.
- Torrey, B. M., 50 Churchill St., Milton 87, Mass.
- Vollenweider, A. D., 205 Halstead Ave., Mamaroneck, N. Y.
- West, C. F., 4 Pilgrim Rd., Watertown, Mass.
- Wiley, C. A., 213 S. College St., W., Yellow Springs, Ohio
- Wood, G. V., 1097 Green St., San Francisco 11, Calif.

The following admissions to Associate grade have been approved and will be effective as of July 1, 1948:

- Adams, C. E., Jr., 2114 Reading Rd., Cincinnati 2, Ohio
- Adler, D. P., 2604 Rosewood Ave., Baltimore 15, Md.
- Bennett, N., 37 Pulaski St., Brooklyn 6, N. Y.
- Benson, H. H., Box 2175, Houston 1, Texas
- Biasbalg, H., 24 W. Rosemont Ave., Alexandria, Va.
- Blevins, E. L., 9134 S. 53 Ave., Oak Lawn, Ill.
- Brittle, D. F., Jr., 319 Bond Bldg., Washington 5, D. C.
- Brown, E. B., 4922 W. 58 St., Mission, Kan.
- Channon, K. F., Jr., 54 Rhode Island Ave., N.W., Washington, D. C.
- Collins, B. G., "Winchmore," Ashurst Rd., Cockfosters, Herts., England
- Collins, P. B., c/o Pan American Airways, Box 257, San Juan, Puerto Rico
- Curta, O., 6934 Narcissus, Houston 17, Texas
- Dellinger, J. T., 3846 Central Ave., San Diego 5, Calif.
- deSouza, F. X., 1434 Monroe St., N.W., Washington 10, D. C.
- Earp, T. N., 115 N Ave. 52, Los Angeles 42, Calif.
- Fehlmann, H. Soneggstr. 27, Zürich 6, Switzerland
- Feldman, H., 3306 W. Eastwood Ave., Chicago 25, Ill.
- Ferreira, H. M., Av. Pasteur 458, Rio de Janeiro, Brazil
- Fisher, P. A., 400 Golfview Ave., Dayton 6, Ohio
- Funk, H. N., 2122 E. Pontiac Blvd., Fort Wayne 5, Ind.
- Ghose, R. N., India 15 R. B. Saha 1st. Bye Lane, Howrah, Bengal, India
- Gordon, S. H., 1841 Summit Pl., N.W., Washington 9, D. C.

(Continued on page 46A)

Simplify WITH S.S. WHITE FLEXIBLE SHAFTS

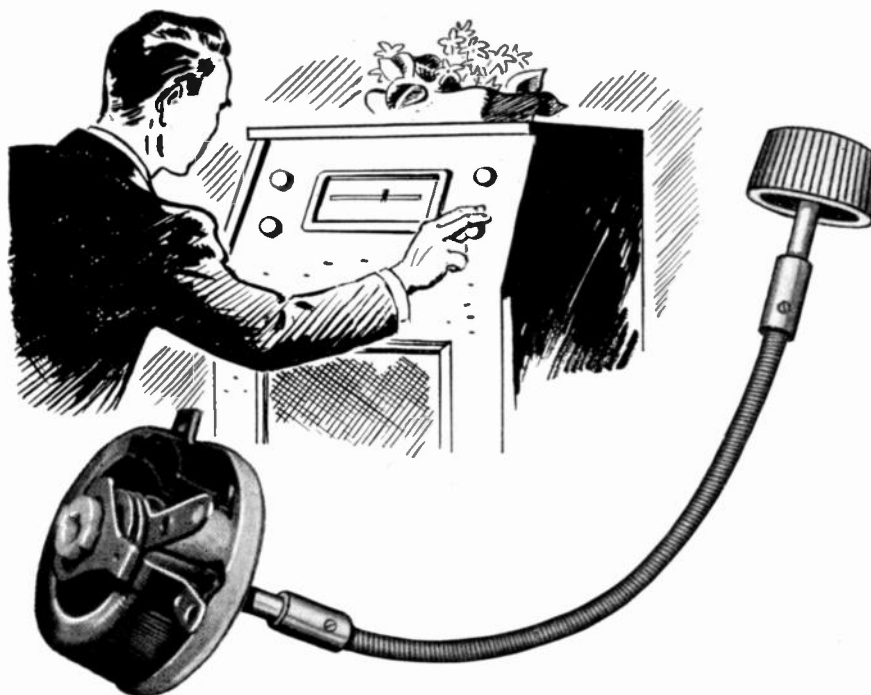

HOW TO MEET 6 "MUSTS" IN EQUIPMENT DESIGN

Certain electrical and physical requirements must be met in creating radio and electronic equipment that will be satisfactory from the standpoint of both production and use. The 6 principal "musts" are these

- | | |
|--|---|
| 1 <u>Optimum circuit efficiency</u> | 4 <u>Convenient operation</u> |
| 2 <u>Easy assembly and wiring</u> | 5 <u>Accessibility for servicing</u> |
| 3 <u>Space saving</u> | 6 <u>Orderly panel arrangement</u> |

With respect to variable elements, you can satisfy all six by coupling such elements to their control knobs with S.S.White remote control flexible shafts, because this *allows you to locate both elements and controls in their most advantageous positions*. And you sacrifice nothing in the quality of control, because, with proper application, S.S.White remote control shaft operation is every bit as smooth, easy and sensitive as a direct connection.

THIS 260-PAGE FLEXIBLE SHAFT HANDBOOK WILL GIVE YOU FULL DETAILS—

A free copy will be mailed, if you write for it on your business letterhead and mention your position.



S.S. WHITE INDUSTRIAL
 THE S. S. WHITE DENTAL MFG. CO. DEPT. G 10 EAST 40TH ST., NEW YORK 16, N. Y.



FLEXIBLE SHAFTS • FLEXIBLE SHAFT TOOLS • AIRCRAFT ACCESSORIES
 SMALL CUTTING AND GRINDING TOOLS • SPECIAL FORMULA RUBBERS
 MOLDED RESISTORS • PLASTIC SPECIMENS • CONTRACT PLASTICS HOLDING

One of America's AAAA Industrial Enterprises

PREMAX

Better Reception



**COVERS
ALL TV
BANDS**

Lower cost! Easy to erect! Gets all 13 channels! The answer to a definite demand for one antenna that will handle all television jobs. Two separate arrays, each of a dipole and reflector insure maximum signal pickup on all 13 bands. Rugged, serviceable, easily assembled, fully adjustable in horizontal and vertical planes.

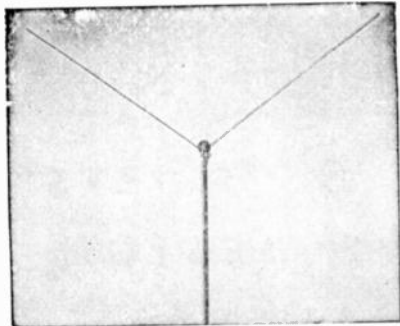

Perfect for All FM

The successful FM Antenna that can be adjusted to bring in ALL the stations. Available in dipole type as illustrated or with reflectors. Low in cost! Easy to install! Gives three dimensional reception.

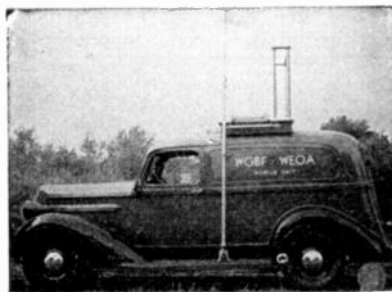

Mobile Antennas

A 35-foot collapsible Antenna that is fully adjustable—for heavy mobile duty. Available in steel, aluminum or monel. Easily installed. Perfect for transmitting or receiving.

A complete line of whip type Antennas with mountings to meet every type of installation.

Contact your radio jobber. If he cannot supply you, write direct.

PREMAX PRODUCTS
DIVISION CHISHOLM-RYDER CO., INC.

4811 Highland, Niagara Falls, N.Y.



(Continued from page 45A)

- Hall, R. T., 82 Peterborough St., Boston 15, Mass.
 Hames, A. L., 212 King St. W., Toronto, Ont., Canada
 Herbin, L., 1140 Anderson Ave., Bronx 52, N. Y.
 Herbst, J. J., 178 Ash St., Valley Stream, N. Y.
 Jackson, J. E., Woute 1, Philpot, Ky.
 Jones, C. T., 327 Trust Co. of Georgia Bldg., Atlanta 2, Ga.
 Kassner, M. H., 2, Soudan Rd., London S.W. 11, England
 Krishnamurthy C. R., Sound Section, National Bureau of Standards, Washington 25, D. C.
 Lantz P. A., 521 Oakwood St., S.E., Washington, 20, D. C.
 Leslie, E. E., Jr, 50 Shore Dr., Plandome, L. I., N. Y.
 Matheson, R. M., Box 2-98, R.F.D. 2, Princeton, N. J.
 Matovich, J., 202 First Ave., New York 3, N. Y.
 McHale, K. S., 3313 17 St. N.W., Washington 10, D. C.
 Meaney, M. H., Jr., National Broadcasting Co., 30 Rockefeller Plaza, New York, N. Y.
 Medkeff, D. D., 2114 Reading Rd., Cincinnati 2, Ohio
 Merritt, N. A., R.F.D. 1, Noank Rd., Mystic, Conn.
 Mitchum, M. M., Radio Station KTRR, Rolla, Mo.
 Naybor, E. V., 53 Nassau Ave., Malverne, N. Y.
 Parnes, J. J., 1922 Crotona Pkwy., Bronx 60, N.Y.
 Quinn, C. E., 245 Glendale, Highland Park 3, Mich.
 Rautio, R. W., 87 W. Loop, Port Clinton, Ohio
 Richards, E. L., 1646 N. 73 Ct., Elmwood Park, Chicago, Ill.
 Rodey, F. W., Jr., 1843 S. Ridgeland Ave., Berwyn, Ill.
 Rupke, E., 1830 Independence Blvd., Ann Arbor, Mich.
 Rusche, C. L. H., 5233 Petty St., Houston 7, Texas
 Russell, W. H., 209 Eighth Ave., Haddon Heights, N. J.
 Simpson, R. L., 2021 Kalorama Rd. N.W., Washington 9, D. C.
 Smith-Vaniz, W. R., Jr., 3903 Walnut Grove Rd., Memphis, Tenn.
 Stewart, J., 398 Georges River Rd., Enfield, Sydney, N.S.W., Australia
 Sund, H. E., Jr., 2316 Chelsea Terr., Baltimore 16, Md.
 Sweeney, C. W., 827 N. 7 St., Camden, N. J.
 Thomas, A. G., 1642 Mineral Spring Rd., Reading, Pa.
 Thomas, W. D., Crawshay House, Highbridge Rd., Burnham-On-Sea, Somerset, England
 Urman, B. S., 3550 Cochran Ave., Los Angeles 16, Calif.
 Waller, S. L., Box 577, Howard Air Force Base, Canal Zone
 Weaver, S. E., 35 Elm, Huntington, L. I., N. Y.
 Webb, E. M. G., 4049 N. Sheridan Rd., Chicago 13, Ill.
 Williams, C. E., 94 1/2 Red River St., Austin, Texas
 Zambarelon, J. T., Box 1628, Glendale, Calif.

When writing to these
advertisers please mention
Proceedings of the
I.R.E.

Laboratory Standards

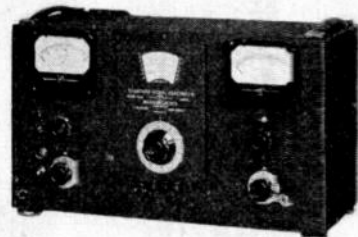

STANDARD SIGNAL GENERATOR

Frequency range: 75 kc. to 30 mc. Output 0.1 microvolt to 2.2 volts. MODEL 65B

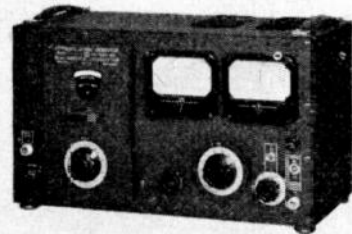

STANDARD SIGNAL GENERATOR

Frequency range: 2 mc. to 400 mc. Output 0.1 microvolt to 0.1 volt. MODEL 80



SQUARE WAVE GENERATOR

5 to 100,000 cycles. Recommended for AM, FM and television testing. MODEL 71

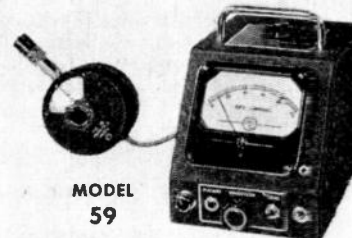

MODEL 59

MEGACYCLE METER

MANUFACTURERS OF
Standard Signal Generators
Pulse Generators
FM Signal Generators
Square Wave Generators
Vacuum Tube Voltmeters
UHF Radio Noise & Field
Strength Meters
Capacity Bridges
Megohm Meters
Phase Sequence Indicators
Television and FM Test
Equipment

A versatile grid-dip oscillator covering the frequency range of 2.2 mc. to 400 mc.

CIRCULARS ON REQUEST

MEASUREMENTS CORPORATION
BOONTON NEW JERSEY

News—New Products

These manufacturers have invited PROCEEDINGS readers to write for literature and further technical information. Please mention your I.R.E. affiliation.

(Continued from page 24A)

Miniature Drag Cup Motor

Two new products of Kollsman Instrument Div., Square D Co., 80-08 45th Ave., Elmhurst, L. I., N. Y., are two miniature drag-cup motors. Generally used as follow-up motors, these instruments may serve as dynamometers for low-value torque measurements. They are also used in various control mechanisms to obtain variable speed and torque through voltage control. By simply having the motor apply a constant torque, objectionable backlash in a train of gears can be reduced.

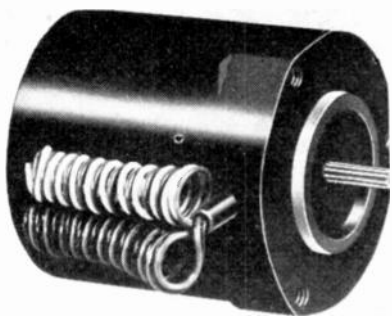

Dimensions are: 7.6 ounces, 1.922" length, 1.719" diameter. There are two standard types: one develops 3000 r.p.m. and operates at 115 volts, 400 cps.

In both cases maximum stall torques of 0.32 to 0.41 ounce-inches are produced.

Custom motors for other voltages and frequencies can be supplied on order.

Plug-In Type DC Relay

Illustrated is the new Type "J" Relay manufactured by C. P. Clare & Company, 4719 West Sunnyside Avenue, Chicago 30, Illinois. It features independent twin contacts, high current carrying capacity, large armature bearing area, and is made with a standard octal base plug. Overall length of relay and plug is 3 3/8".

It is designed for installation where quick removal and easy replacement are desired, and is claimed to offer efficient magnetic structure, high operating speed and large contact spring pileups.



(Continued on page 48A)

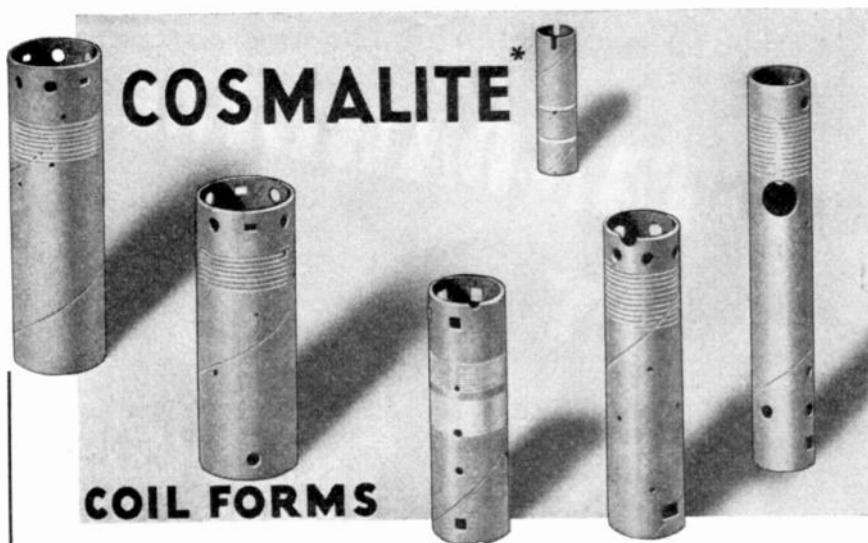

for RADIO and Television receivers . . .

punched, threaded, notched or grooved to meet individual specifications with nominal tooling costs.

These spirally laminated paper base phenolic coil forms and tubes give exceptional performance with the added advantage of lower material costs. Note: We also have available numerous stock punching dies.

Partial list of Radio and Television Receivers in which Cosmalite is used:

Admiral
Arvin
Belmont
Bendix Radio
Colonial
Farnsworth
General Electric
Howard
Magnavox
Motorola
Sentinel
Stewart Warner
Warwick
Wells Gardner
Zenith

Your inquiry will receive immediate and intelligent attention.

Ask also about other Cosmalite types . . . #96 COSMALITE for coil forms in all standard broadcast receiving sets. SLF COSMALITE for permeability tuners. COSMALITE deflection yoke shells, cores and rings.

• • •

Spirally wound kraft and fish paper Coil Forms and Condenser Tubes.

* Trade Mark Registered

The CLEVELAND CONTAINER Co.

6201 BARBERTON AVE. CLEVELAND 2, OHIO

- All-Fibre Cans • Combination Metal and Paper Cans
- Spirally Wound Tubes and Cares for all Purposes
- Plastic and Combination Paper and Plastic Items

PRODUCTION PLANTS also at Plymouth, Wisc., Ogdensburg, N.Y., Chicago, Ill., Detroit, Mich., Jamesburg, N.J.
PLASTICS DIVISION at Plymouth, Wisc. • ABRASIVE DIVISION at Cleveland, Ohio
SALES OFFICES: Room 5632, Grand Central Term. Bldg., New York 17, N.Y., also 647 Main St., Hartford, Conn.
CARIBBIAN PLANT: The Cleveland Container Canada, Ltd., Prescott, Ontario



**STANDARDIZE
ON
ONE!**

Now, one crystal holder for your new applications. A development of many years, this hermetically sealed, miniature crystal holder is designed to cover a frequency range from 1 to 75 Mc and can be made to tolerances as close as plus or minus .002%. Supplied with either pins or wire leads, this new crystal holder will supplant the multitude of holders now used in your circuits. Standardize with the RH-7!

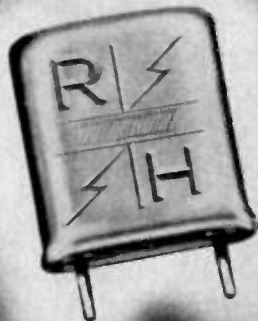

**REEVES  HOFFMAN
CORPORATION
CHERRY AND NORTH STREETS • CARLISLE, PA.**

News—New Products

These manufacturers have invited PROCEEDINGS readers to write for literature and further technical information. Please mention your I.R.E. affiliation.

(Continued from page 47A)

Wide-Frequency-Range Wattmeter

This new meter, designated as the Model 101 VAW, is in production by Anderson-Fluke Engineering Co., Box 815 B, Springdale (Stamford), Conn.

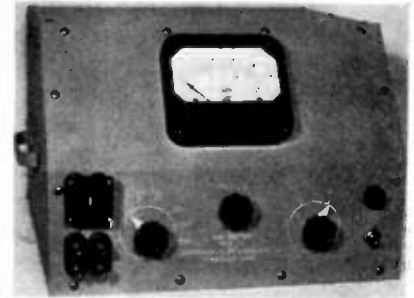

The instrument is capable of measuring volts, amperes, and watts over a frequency range of 20 to 200,000 cps. Eight voltage ranges of 0.1 to 300 volts and ten current ranges of 0.001 to 30 amperes provide full-scale wattage readings of 100 microwatts to 9 kilowatts, giving the reading ranges of 1 to 60,000 for volts, 1 to 600,000 for amperes, and the extremely wide range of 1 to 1,800,000,000 for watts. The input resistance is 1 megohm in parallel with 25 μf , and the full-scale shunt drop is only 5 millivolts. Powered by 117 volts, 60 cps, the electronically regulated power supply and the feedback amplifiers result in exceptional stability of calibration.

The instrument is housed in an aluminum case 12" \times 12" \times 10" high and weighs only 20 pounds. Accuracy is within 3 per cent on all scales. Literature available on request.

Recent Catalogs

••• On nonfraying varnished tube insulation, and a product listing by Insulation Mfrs. Corp., 565 W. Washington Blvd., Chicago 6, Ill.

••• On a leaflet explaining the construction and advantages of Tri-core "Leak-Pruf" acid-filled solder, by Alpha Metals Inc., 363 Hudson Ave., Brooklyn 1, N. Y.

••• On a tricolored 32-page catalog covering the thirteen major type series of multi-contact electric connectors for radio aircraft, communications, etc.; dc solenoids and signal equipment and miscellaneous products, by Cannon Electric Development Co. Humbolt St., and Ave. 33, Los Angeles 31, Calif. Request C-47 from Catalog Dept.

••• On a 32-page booklet entitled "Stainless Plates (Solid and Clad) and their Fabrication," with charts, tables, and photographs designed to supply fabricators with late and authentic information on selection and fabrication of these products, by Allegheny Ludlum Steel Corp., Pittsburgh 22, Pa.

(Continued on page 49A)

Airtron

FLEXAGUIDE

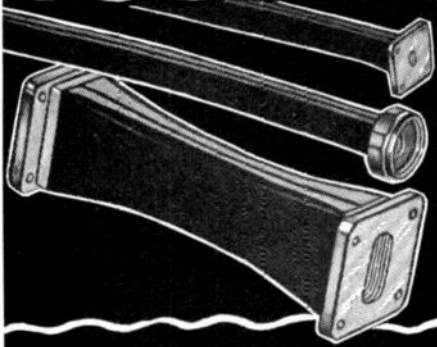

Improved, Extra Durable
FLEXIBLE MICRO-WAVE PLUMBING

Built to satisfy extreme flexing requirements. Specified and used in latest aircraft and ship-board applications. Useful in the elimination of standard rotary and swivel joints.

YOUR INQUIRIES INVITED

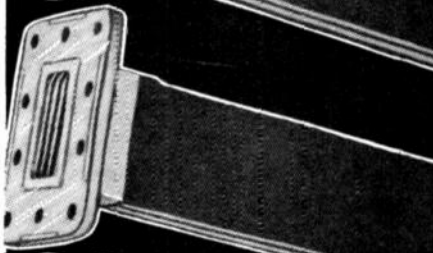
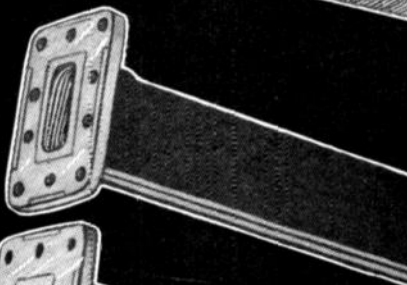
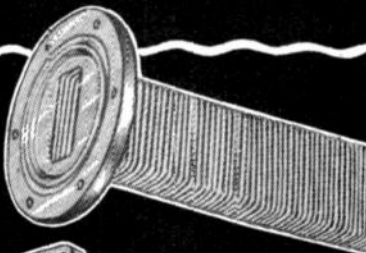

Airtron

DESIGNS and PRODUCES
Electronic and Aircraft Components

650 Bloomingdale Road, Pleasant Plains
Staten Island 9 New York

BRANCH OFFICES

Baltimore Detroit Los Angeles

News—New Products

These manufacturers have invited PROCEEDINGS readers to write for literature and further technical information. Please mention your I.R.E. affiliation.

(Continued from page 48A)

An Improved Autoscaler

A new-model improved Autoscaler, designated the SC-1A, with an extended range from 500 to 2200 volts; and regulated to 0.01% change in line voltage, is announced by Tracerlab Inc., 55 Oliver St., Boston 10, Mass.



The SC-1A is a complete unit for supplying the operating voltage for a G-M tube, counting the impulses, and measuring the time required for collecting a given number of impulses.

When the preselected number of impulses has been determined, the timer automatically stops. There is no need to read neon interpolating lights, because a rapid, accurate reading of the timer is all that is necessary.

The over-all resolving time of the input amplifier and scaling circuits is approximately 5 microseconds. Pulse height sensitivity is approximately 250 millivolts. Also included with the SC-1A is a P-4 pre-amplifier suitable for use with either the plug-in type TGC-1/1B83 or TGC-2/1B84 Tracerlab Geiger tubes or those which require clip leads.

Interesting Abstract

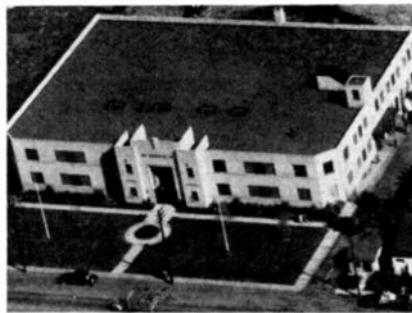

New Servo Plant

Henry Blackstone, president of the Servo Corp. of America, 294 N. Fulton Ave., Lindenhurst, N. Y. has recently acquired space in the Wedemeyer Bldg., in New Hyde Park, L. I., N. Y. This expansion inaugurated Plant No. 2 of this company, and provides for increased production of their numerous products to the radio and electronic industry.

(Continued on page 57A)

TECHNICAL MANUALS

**CUSTOM DESIGNED TO
YOUR SPECIFICATIONS**

Planned, written and illustrated by a select staff . . . experts in creating radio and electronic manuals for civilian and military use.

When you call upon Boland & Boyce to create your manuals you are relieved of every detail in their preparation. The entire operation is taken over and completed by a specialized staff with years of experience in publishing books and manuals.

First the requirements for your manual are completely surveyed. The working conditions to which they will be put are studied and the operations or equipment described in the manual are thoroughly analyzed. A complete outline is then prepared and submitted for your approval, along with a dummy of the manual as it will appear when finished. Upon your approval the job is completed and delivered with your satisfaction guaranteed.

Boland & Boyce manuals incorporate only the most modern editorial and illustrative style. Each project is treated with individual attention in technique of presentation and editorial approach. The Boland & Boyce military and civilian manuals now in use throughout the world are our best recommendations.

U. S. Navy

U. S. Signal Corps

Sylvania Electric Products, Inc.

The National Company

Western Electric Co.

Bell Telephone Laboratories

Maguire Industries, Inc.

Allen B. Dument Laboratories, Inc.

General Electric Co.

Mine Safety Appliances Co.

*Write or wire Boland & Boyce
today for more information*

Radio Maintenance
Technical Manuals

Radio Data Book
Video Handbook

BOLAND & BOYCE INC., PUBLISHERS

**MANUAL DIVISION M-2 MONTCLAIR, N.J.
CHICAGO: 228 North LaSalle Street**

★

BOEING AIRPLANE COMPANY

Experienced Control and Servomechanism Engineers Needed

Development of: Electronic Control Circuits
High Performance Servo Actuators • Automatic Computers

Analytical Studies of: Dynamical Systems
Aerodynamic Control Techniques • Computation Systems

Problems are related to commercial and military aircraft and guided missiles. Employment is stable and offers opportunity for advancement to those able to assume responsibility. Present staff includes highly qualified physicists, engineers and mathematicians, and insures a stimulating professional environment. Imaginative and original design thinking is particularly encouraged. Liberal patent and publication policy. Apply through Personnel Manager, Boeing Airplane Company, Seattle 14, Washington.

TELEVISION ENGINEERS

The Crosley Division, Avco Manufacturing Corporation, is expanding its Television Receiver Activities on a long term basis, creating a few positions for qualified Supervisory and Senior Engineers.

Requirements: College Degrees. Three or more years experience in Television and Radar Design and Development of which at least two years have been spent in advanced or product development of television receivers. Specialists in circuit elements will be considered.

Ideal working conditions in well equipped modern laboratories with unlimited opportunities for advancement. Forty hour week, insurance, hospitalization and pension plans. Responsibilities and salary based on experience and ability.

Replies (which will be kept confidential) stating age, experience, education and salary requirements should be addressed to:

Director of Research and Engineering
Crosley Division—Avco Manufacturing Corporation
1329 Arlington St., Cincinnati 25, Ohio



The following positions of interest to I.R.E. members have been reported as open. Apply in writing, addressing reply to company mentioned or to Box No.

The Institute reserves the right to refuse any announcement without giving a reason for the refusal.

PROCEEDINGS of the I.R.E.
1 East 79th St., New York 21, N.Y.

TELEVISION ENGINEER

Chief Engineer of television broadcast station located in midwest city. Please state fully experience and qualifications. Box 516.

RADIO RECEIVER ENGINEERS

Radio Receiver Engineers. Various types of qualifications. Please state experience and salary requirements in first letter. Box 517.

ENGINEERS

Allen B. DuMont Laboratories, Inc. have several openings in their Clifton plant for Intermediate and Senior Engineers. Must have B.S. degree in physics or electrical engineering and experience in V.H.F., television deflection or general circuit development. Apply Personnel Dept., 1000 Main Ave., Clifton, New Jersey. 9:00 A.M. to 3:00 P.M.

ELECTRONIC DESIGN ENGINEER— PRODUCTION ENGINEER

(1) **ELECTRONIC DESIGN ENGINEER**—Boston firm developing electronic instruments for radioactivity detection and measurement. Offers excellent opportunity for high calibre design engineer. Write full details.

(2) **PRODUCTION ENGINEER**—Boston firm manufacturing electronic radioactivity instruments has opening for qualified man experienced in engineering production models from prototype designs. Position also entails responsibility for component and production quality control. Write full details. Box 518.

TELEVISION INSTRUCTOR

Television instructor wanted by a television training institution of long standing in Hollywood; must be well versed in the principles and practice underlying television transmitting and receiving. Minimum \$3,200. State particulars, including educational and experience background. Box 521.

MATHEMATICIANS, ENGINEERS, PHYSICISTS

Men to train in oil exploration for operation of seismograph instruments, computing seismic data, and seismic surveying. Beginning salary—open depending upon background; excellent opportunity for advancement determined on ingenuity and ability. Nature of work requires several changes of address each year; work indoors and out; general locations in oil producing states. To apply, write giving scholastic and employment background, age, nationality, marital status and include recent snapshot to National Geophysical Co., Inc. 8800 Lemon Ave., Dallas 9, Texas.

(Continued on page 52A)

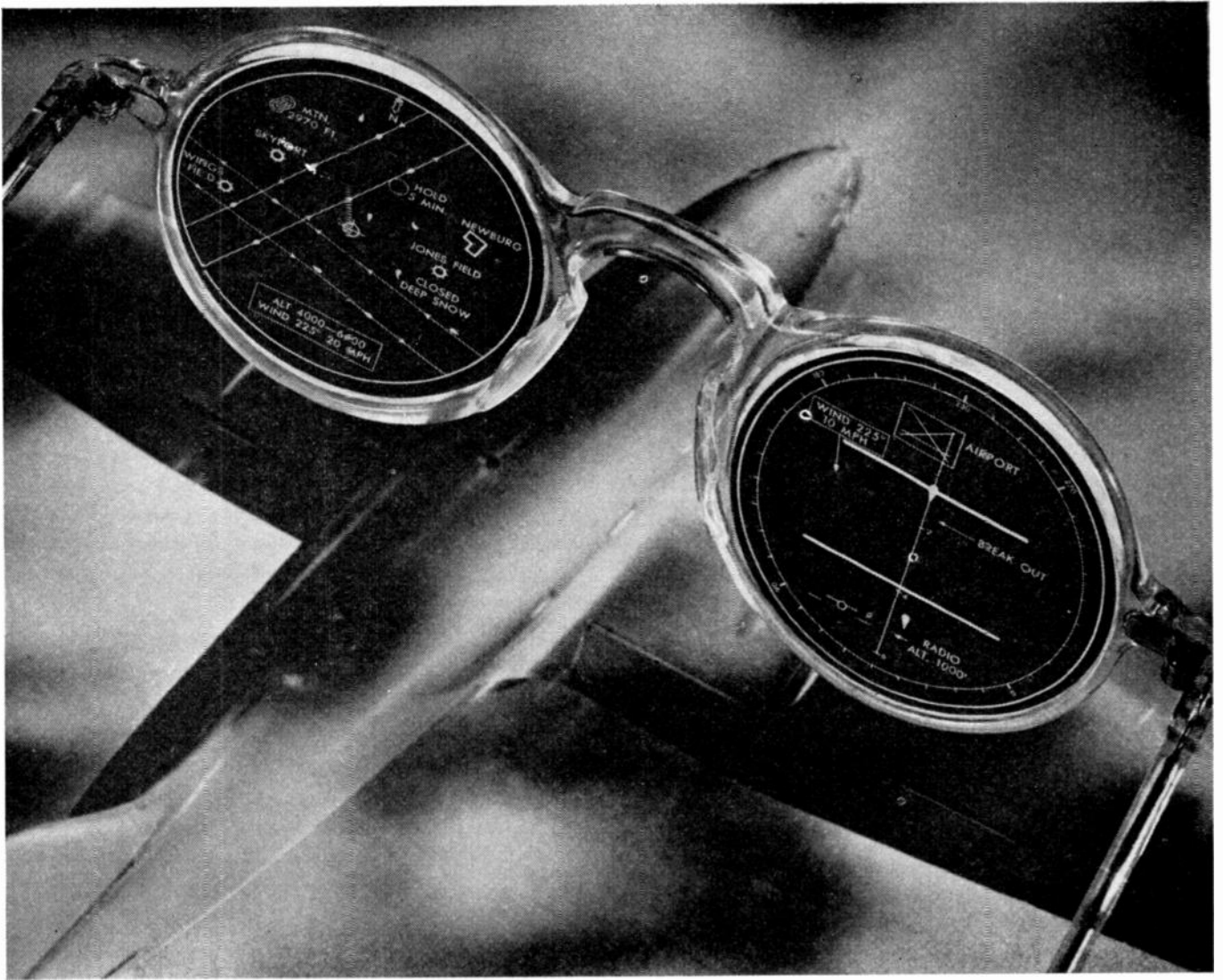

Teleran pictures — air traffic control by radar plus television

TELERAN — “Radio Eyes” for blind flying!

• Teleran (a contraction of TELEvision — Radar Air Navigation) collects all of the necessary information on the ground by radar, and then instantly transmits a television picture of the assembled

data to the pilot aloft in the airplane.

RCA Victor, endless source of history-making developments in radio and electronics, has openings for qualified engineers in:

**Radar Aviation Equipment Television Receiver Mobile Equipment
Audio, Ultra-sonic and Infra-red Communications Equipment**

Write in detail to:

**Camden Personnel Division
RCA Victor Division
Camden, New Jersey**



(Continued from page 50A)

ELECTRONIC ENGINEERS

Salaries \$3021 to \$4149 per annum. In charge of major field communication installation projects including electronic, radio and teletype equipment system. Contact Civil Aeronautics Administration, 385 Madison Ave., New York 7, N.Y.

Positions Open for

PHYSICISTS

SENIOR ELECTRONIC ENGINEERS

SENIOR MECHANICAL ENGINEER

CHEMIST FOR PROBLEMS ASSOCIATED WITH TUBE DEVELOPMENT

Experienced in radar development, servomechanisms and computers to fulfill the requirements of an expanding airborne radar project, research in electron optics and tubes, and production engineering.

Salary commensurate with experience and ability—insurance plan—paid vacations—excellent opportunity for suitably qualified personnel.

Please furnish complete resume of education, experience and salary required to:

Industrial Relations & Personnel Department, Farnsworth Television & Radio Corporation, Fort Wayne 1, Indiana

PROFESSOR OF COMMUNICATION ENGINEERING

Professor of communication engineering needed for fall 1948 by southeastern university. Will be in charge of graduate work and research activities. \$6000 for nine months with extra income for summer teaching. Must have Ph.D. or D.Sc. degree. Write Box 522.

PROJECT ENGINEER

Electronic Engineer with practical background in television is required by small television manufacturer to act as project engineer on television distribution systems. Metropolitan New Jersey. Box 523.

DEVELOPMENT ENGINEER

West coast organization has openings for creative electronic engineers with several years research and development experience. Work involves highly interesting, essential projects in fields of audio-video circuits; magnetic circuits; electronic, mechanical, and optical apparatus. An outstanding opportunity with a small aggressive development and manufacturing concern in San Francisco area. Reply in detail, giving education, experience and salary requirements. Berkeley Scientific Company, Sixth and Nevin Ave., Richmond, California.

SCR—584 TECHNICIANS

Unusual opportunity for engineers and technicians familiar with the SCR—584 radar. Many advantages offered. For application forms write Route 1, Box 118, Oxnard, California.

CATHODE RAY TUBES TEST ENGINEER

Test experimental models of television cathode ray tubes in cooperation with the design engineers and carry out the modification of test equipment for the testing of such special tubes. Experience in the design of television video and scanning circuits desirable. Position includes responsibilities with maintenance of cathode ray test tubes equipment but not for its initial design or construction. Apply: Supervisor of Employment, Industrial Relations Dept., Sylvania Electric Products, Inc. 500 Fifth Ave., New York, N.Y.

GLASS ENGINEER

A progressive New England radio tube manufacturing company is in need of a glass engineer for development work. This man must have considerable industrial experience in general glass work. Must be familiar with modern practices of metal to glass seals. Box 524.
(Continued on page 53A)

Are You
An
Experienced
Electronics
Engineer
Or
Applied
Mathematician



There is a good position for you at RAYTHEON provided you can qualify for development and design work or analytical studies in the fields of radar and general electronic circuits, computers, servomechanisms, microwave components and antennas, or radar systems.

In your reply, please give full particulars regarding qualifications, salary expected, age, and family situation:

Employment Manager

Raytheon Manufacturing Co.
Foundry Avenue, Waltham, Mass.

WANTED PHYSICISTS ENGINEERS

Engineering laboratory of precision instrument manufacturer has interesting opportunities for graduate engineers with research, design and/or development experience on radio communications systems, Servomechanisms (closed loop), electronic & mechanical aeronautical navigation instruments and ultra-high frequency & microwave technique.

WRITE FULL DETAILS
TO
EMPLOYMENT SECTION

**SPERRY
GYROSCOPE
COMPANY**

DIVISION OF SPERRY CORP.
Marcus Ave. & Lakeville Rd.
Lake Success, L.I.

Bachelors, Masters, Ph.D.'s in PHYSICS or E.E.; Experienced Electronic Engineers; Recent Graduates; and Technicians: **OPPORTUNITY ON LONG ISLAND**

offers attractive working conditions, salary commensurate with ability, access to graduate schools, first-rate research and plant facilities; other advantages.

Projects underway in fields of microwave receivers, transmitters, antennas; radar, air traffic control; servos, motor-control systems; general electronics.

Write **PERSONNEL MANAGER**

Airborne Instruments Laboratory
INCORPORATED

160 OLD COUNTRY ROAD · MINEOLA, N.Y.



(Continued from page 52A)

ELECTRONICS RESEARCHER

Ph.D. in Electrical Engineering, with background in antenna theory, for research work at University of California, Berkeley, Calif. Possibility of part-time faculty appointment. Salary dependent on qualifications. Write to Professor T. C. McFarland, Chairman, Division of Electrical Engineering, giving full details regarding education and experience.

ELECTRONIC ENGINEER

Wanted by electronic laboratory in New York City, electronic engineer with practical experience VHF receiver design. Must also be well versed in mechanical design aspects. State experience and salary requirements in first letter. Box 526.

DRAFTSMAN

Wanted by electronic laboratory in New York City, draftsman with thorough experience in mechanical and electrical phases of radio drafting. State experience and salary requirements. Box 527.

ENGINEERS—PHYSICISTS

The Naval Ordnance Laboratory located just outside of Washington, offers many advantages to engineers and physicists. Openings exist in the fields of electronics and complex mechanisms. The laboratory is provided with the best equipment. Men capable of developing complex electronic circuits or with experience in electronic instrument design are particularly desired. Salaries range from P-4—\$4902 and higher, to P-2 \$3397.20. Interested applicants are urged to communicate with Engineering Dept. Naval Ordnance Laboratory, White Oak, Maryland.

ELECTRICAL ENGINEER

Graduate electrical engineer with several years experience in audio development work, preferably magnetic recording, wanted for design work. Unusual opportunity for permanent position for the right person with long established company. Vicinity New York City. Reply giving resume of personal data, educational background, experience and salary desired. Write I.R.E. 1699, 113 West 42 Street, New York 18, N.Y.

ENGINEERS

Scientific research, development and engineering positions at the National Bureau of Standards, Washington, D.C. are available in the fields of physics, electronics engineering, radio engineering, mechanical engineering and mathematics. Salary range from \$3397 per annum through \$8179, depending upon qualifications. Qualified scientists are invited to communicate with Personnel Officer, Division 13, National Bureau of Standards, Washington 25, D.C.

(Continued on page 54A)

Investigate this Opportunity

To join the staff of one of the largest research organizations in the country devoted exclusively to

VACUUM TUBE RESEARCH

Working conditions are ideal in these laboratories which are located in the New York Suburb of Orange, New Jersey. Your associates will include men of many years experience in vacuum tube research and development.

This rapidly expanding organization is devoted to both commercial and military research. It is a division of one of the oldest vacuum tube manufacturers in America. Security and stability for the years to come are assured. You will have an opportunity to gain experience with the different kinds of vacuum tubes, receiving, power, cathode ray, sub-miniature, micro-wave, radial beam and various special types.

If you can qualify as a

PHYSICIST
MATHEMATICIAN
ELECTRICAL ENGINEER
CIRCUIT TECHNICIAN
VACUUM TUBE TECHNICIAN

write at once to

**DIRECTOR OF RESEARCH
RESEARCH DIVISION
NATIONAL UNION RADIO CORPORATION**

350 Scotland Rd.
Orange, New Jersey

ENGINEERS - ELECTRONIC

Senior and Junior, outstanding opportunity, progressive company. Forward complete résumés giving education, experience and salary requirements to

Personnel Department
MELPAR, INC.
452 Swann Avenue
Alexandria, Virginia

Radio and Radar Development and Design Engineers

Needed by

HAZELTINE ELECTRONICS CORPORATION

Please furnish complete resume of experience with salary expected to:

Director of Engineering Personnel
HAZELTINE ELECTRONICS CORPORATION
Little Neck, L.I., N.Y.
(All inquiries treated confidentially)

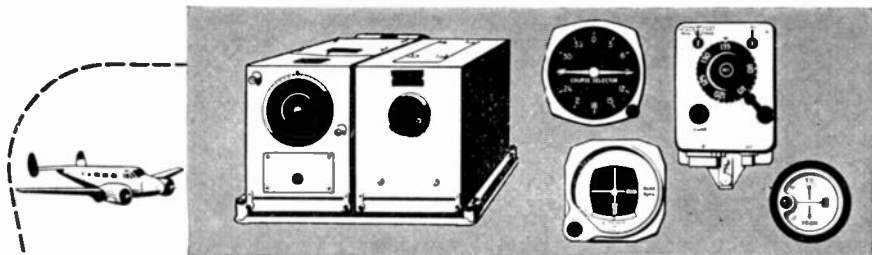

The Magic of VHF

Airborne Equipment for:
 OMNI-DIRECTIONAL RANGES
 RUNWAY LOCALIZERS
 VISUAL-AURAL RANGES
 SIMULTANEOUS VOICE
 GCA VOICE RECEPTION

The Type 15A VHF Navigational Receiving Equipment (illustrated) provides for reception on the new Omni-Directional Ranges as well as operation on both types of VHF Runway Localizers, and the VHF Visual-Aural Airways Ranges. Simultaneous voice feature is included on these ranges. The *tunable* A.R.C. Receiver permits selection of any VHF aircraft frequency.

The A.R.C. Type 17 or A.R.C. Type 18 is the companion communication equipment normally associated with the Type 15A. The Type 17 VHF Communication Equipment adds independent two-way VHF communication facilities. The Type 18 adds VHF Transmitting Equipment only. All Type 17 and 18 units are type-certificated by the CAA.

The dependability and performance of these VHF Communication and Navigation Systems spells increased safety in flight. Specify A.R.C. for your next installation.



Aircraft Radio Corporation
 BOONTON, NEW JERSEY
 DEPENDABLE ELECTRONIC EQUIPMENT SINCE 1928

NEY Precious Metals . . . in Industry

VERY SUCCESSFULLY USED AS Slip Ring Brush Contacts

NEY-ORO #28, a precious metal alloy, was developed especially to meet requirements in precision electrical apparatus for brush contacts operating against coin silver slip rings. Our laboratory tests, confirmed by reports from users, have shown service life of better than ten million revolutions with no electrical noise.

Slip ring brushes in NEY-ORO #28 are available in a range of standard forms and sizes sufficient to meet most operating conditions efficiently and economically. Special shapes can be supplied for unusual applications.

A NEY TESTED INDUSTRIAL ALLOY

NEY-ORO #28

PHYSICAL PROPERTIES

Brinell Hardness	90
Tensile Strength p.s.i.	57,700
Resistivity ohms per C.M.F.	60
Specific Gravity	16



Other Ney precious metal products include sliding contacts for precision wire wound potentiometers (both nickel-chrome and copper base windings); fine size resistance wire (bare or enameled); special make-break contacts; gold solders.

Our engineering and research laboratory will welcome the opportunity of working with you in meeting your requirements.

Write or phone (HARTFORD 2-4271) our Research Department

THE J. M. NEY COMPANY 171 ELM ST. • HARTFORD 1, CONN.
 SPECIALISTS IN PRECIOUS METAL METALLURGY SINCE 1812



(Continued from page 53A)

RESEARCH SCIENTISTS

Scientific research and development positions at the Naval Research Laboratory, Washington, D.C. are open in the fields of physics, mathematics, engineering (including electronics, radio, electrical, mechanical, chemical, metallurgical, etc.). AB.S. degree in the appropriate field from an accredited college or university is essential. Advanced academic standing and pertinent research experience is desirable. Opportunities for graduate study are offered at NRL. Qualified scientists are invited to communicate with Employment Officer, Code 1811 (I) Naval Research Laboratory, Washington 20, D.C.

ELECTRONIC ENGINEER

Experienced in development and product design of electro-mechanical precision instruments. Capable of full responsibility for development of timing and control circuits, servo mechanisms, associated equipment. Ingenuity, imagination and theoretical inclinations suitable for Research Lab work desired. Top salary for qualified person. Send resume to Box 528.

ELECTRONIC ENGINEER

Graduate engineer with major in electronics is required for development of industrial and medical electronic equipment. Must have good scholastic record and have ability to do original work. Salary open. Send full details of education and experience. Write Perkin-Elmer Corporation, Glenbrook, Conn.

ENGINEERS

Condenser engineers—electrolytic, paper, ceramic, for both production and development work. Needed by leading manufacturer. Excellent working conditions. Please send full details. Box 529.

PROJECT ENGINEER, SENIOR

Electronic engineers with outstanding academic and practical background for responsible positions. Will carry on projects under their own direction in modern, fully-equipped, owner-managed plant in southeast New Jersey one hour from New York City. Send resume of education, experience, age and salary requirements. Our Engineering Dept. knows of this announcement. Box No. 530.

6 NEW



TERMINALS JOIN THE CTC LINE

Hollow lugs speed wiring from top or bottom of terminal board.



Lugs shown actual size. Notice the midjet split lug for hearing aids and other small-space applications. Ask for prices by code number.

These new CTC terminal lugs for quick, easy, neat connections are typical of the broad line in midjet, short, turret, double-end and split types... in sizes to meet widely varying needs. They're all strongly made of quality brass, heavily silver plated; yet they're free from surplus metal that would draw heat and slow down soldering. Their tolerances are uniform enough for automatic swaging. And, of course, like all CTC components and hardware, they're guaranteed for materials and workmanship!

CUSTOM SERVICE

Chances are you'll find the terminal lugs you need in the CTC standard line. It's wise to check first. If not, CTC will custom-engineer lugs to your specifications. A discussion of your requirements will not obligate you in any way.

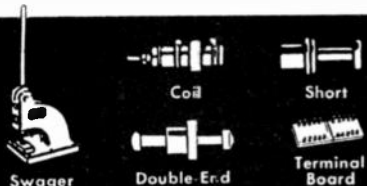

Custom or Standard
The Guaranteed
Components

CAMBRIDGE THERMIONIC CORPORATION
456 Concord Avenue, Cambridge 38, Mass.



Positions Wanted By Armed Forces Veterans

In order to give a reasonably equal opportunity to all applicants, and to avoid overcrowding of the corresponding column, the following rules have been adopted:

The Institute publishes free of charge notices of positions wanted by I.R.E. members who are now in the Service or have received an honorable discharge. Such notices should not have more than five lines. They may be inserted only after a lapse of one month or more following a previous insertion and the maximum number of insertions is three per year. The Institute necessarily reserves the right to decline any announcement without assignment of reason.

ENGINEER

Ph.D. (Physics) completing second year scholastic requirements by May. Available June 1 for employment in metropolitan area. Vacuum tube, electronics etc. B.S., M.S. physics. Strong minor in chemistry. Captain, radar A.U.S. Graduate Harvard, M.I.T. Electronic Training Center. Box 153 W.

EXECUTIVE ENGINEER

Desires administrative position in Los Angeles area. Extensive administrative and electronic engineering experience. M.S. degree Harvard. Box 155 W.

JUNIOR ENGINEER

Graduated University of Michigan June 1948 with B.S.E.E. (Communications) and B.S.E.E. (Mathematics). Tau Beta Pi, Eta Kappa Nu. One year experience Navy electronics. Interested in television broadcasting, production or development. Details on request. Box 156 W.

JUNIOR ENGINEER

B.E.E. January 1948 Cooper Union. Age 23. Two years experience as electronic technician. U. S. Navy. Graduate work at Columbia University. Prefer circuit development in television or radio in vicinity of New York City. Box 157 W.

JUNIOR ENGINEER

B.S.E.E. from University of Illinois 1948. Navy experience in radar and sonar. Seeks position as Junior Engineer in electronics. Prefers vicinity around New York City. Box 158 W.

ADMINISTRATIVE ENGINEER

Business administration plus engineering training. M.B.A. Harvard Business School, June 1948. B.E.E. Rensselaer, 1942. Tau Beta Pi, Sigma Xi. Age 26. Navy radar and patent experience. Desires job in small to medium size concern. Box 159 W.

(Continued on page 56A)



MICRODIMENSIONAL
WIRE & RIBBON
FOR VACUUM TUBES

WOLLASTON PROCESS WIRE

drawn as small as .00010";

Made to your specifications for
diameter and resistance . . .

WRITE for list of products.



SIGMUND COHN CORP.

44 GOLD ST., NEW YORK

SINCE 1907



Crystals for the Critical

LET US SOLVE YOUR CRYSTAL PROBLEMS

The James Knights Co. is equipped to build "Stabilized" crystals to your exact specifications. A special production system meets your needs for short runs . . . and the price is right! Whether you need one, ten, or several thousand crystals, The James Knights Co. can deliver quickly and at modest cost.

In addition, The James Knights Co. fabricates a complete line of "Stabilized" crystals to meet every ordinary need—precision built by the most modern methods and equipment.

If you want quality—speed—price, contact The James Knights Co.

*New James Knights Co. Catalog
On Request*

An ENGINEER wanted three crystals on approximately 90 kc in one hermetically sealed holder. The James Knights Co. made delivery in 72 hours, our Type H18.

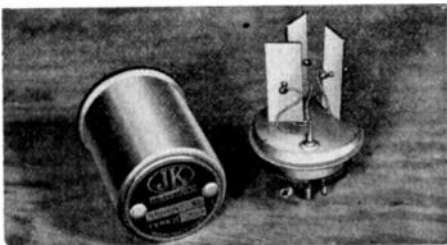

The JAMES KNIGHTS Co.

SANDWICH, ILLINOIS



CRYSTALS

Positions Wanted

(Continued from page 55A)

PATENT ENGINEER

B.E.E. Illinois Institute of Technology. Now enrolled graduate Law School patent course. 10 years diversified experience—research, production, Army radio instructor, radar, etc. Desires patent position. New York or Chicago area preferred. Box 170 W.

RADIO ENGINEER

Interested in going abroad. Graduated in June with B.S.E.E. Have also a degree in radio engineering. Age 23. Single. Willing to locate in almost any country. Box 171 W.

ENGINEER

B.S.E.E. June 1948 Columbia University. Age 28. Married, two children. Officer, Army Signal Corps, 2½ years administrative and communication experience. Desires sales engineering or administrative position in New York area. Occasional travel possible. Box 172 W.

JUNIOR ENGINEER

B.E.E. June 1948. Tau Beta Pi, Eta Kappa Nu. Prefer metropolitan area of New York, anywhere near a graduate school. Box 173 W.

ELECTRICAL ENGINEER

B.S.E.E. Illinois Institute of Technology 1948. Age 27. Married. 2½ years Signal Corps. Installation and maintenance of radio equipment. 2 years electronic instrument experience. 1st class Radiotelephone license. Desires position with opportunity for advancement. Box 176 W.

JUNIOR ENGINEER

Graduate west coast radio and television school. Single. Age 28. 1st class phone. 2½ years AAF as VHF specialist. Now employed Navy Guided Missile base. Desires position with television station, preferably maintenance. Will work anywhere in U. S. Box 177 W.

JUNIOR ENGINEER

B.S.E.E. (communications) June 1948 University of Michigan. Tau Beta Pi, Eta Kappa Nu, 21 months experience in Navy Electronics program. Desires position in production, design or development of electronic equipment. New York City area or southwestern U. S. Box 181 W.

ENGINEER

Engineer. Age 28. B.S.E.E. Columbia, also business degree. 3 years responsible business experience. Best references. New York area preferred. Call Lu 8-9164 mornings or write Box 182 W.

JUNIOR ELECTRICAL ENGINEER

June 1948 B.E.E., summa cum laude, electronics major. Desires research and development position electronics or electrical measurements. Member Tau Beta Pi, Sigma Xi, Eta Kappa Nu. Married, no children. Prefer New York City area or east. Box 183 W.

(Continued on page 57A)

FASTER, SIMPLER AUDIO ANALYSIS with Model AP-1



PANORAMIC SONIC ANALYZER

Reduce time, complexity and cost of making audio measurements with the unusual advantages offered by the Panoramic Sonic Analyzer. By resolving a complex audio wave into a spectrograph showing the frequency distribution and voltage amplitude of the components, Model AP-1 . . .

- Eliminates slow point-by-point frequency checks • Provides a quick overall view of the audio spectrum
- Enables determination of changes in waveform content while parameters are varied • Furnishes simple presentations for production line testing.

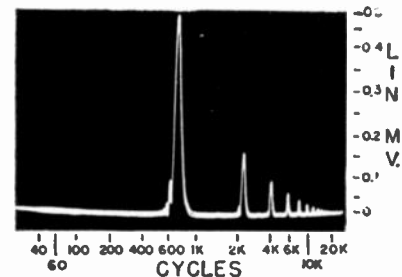

Panoramic Sonic Spectrograph of
750 cps square wave.

Use Model AP-1 for analyzing . . .

- Harmonics • Intermodulation • Vibration • Noise • Acoustics • Materials

Features . . . Continuous scanning from 40-20,000 cps in one second • Wide input voltage range • Linear and log voltage scale • Closely logarithmic frequency scale • Built-in voltage and frequency calibrator • Simple operation.

WRITE for detailed specs, price and delivery.



Positions Wanted

(Continued from page 56A)

RADIO ENGINEER

Radio Engineer, currently employed in commercial engineering division of metropolitan tube manufacturer, desires change to permanent position in midwest. Age 27, married, 1 child. B.S. physics, graduate Army Electronic Training Center, M.I.T., Harvard, 3 years military experience, special roving radar officer US and ETO, 2 years commercial circuit work in present position. Minimum salary \$5,500. Box 184 W.

ENGINEER

B.S.R.E. August 1948. Age 24. Married, 1 child. 3 years U. S. Navy electronics technician. 2nd class Radio Telephone. Considerable servicing experience. Desires position with opportunity for advancement. Box 185 W.

JUNIOR ELECTRONIC ENGINEER

B.E.E. June 1948. Cornell University (Top third of class). Two years Navy experience as electronics technician, including 8 months sea duty with responsibility. Seeking permanent position with opportunity, preferably within commuting distance of New York City. Box 186 W.

SALES ENGINEER OR EXECUTIVE ASSISTANT

Young, aggressive, hard-hitting design and development engineer invites inquiries from firms having need for addition to sales engineering staff or assistant to top executive. Thorough background of research design and supervision in measurement apparatus, receivers, transmitters and audio equipment. Capable of handling engineering, purchasing, production, inspection and personnel. Prefer New York City location. Box 187 W.

News—New Products

These manufacturers have invited PROCEEDINGS readers to write for literature and further technical information. Please mention your I.R.E. affiliation.

(Continued from page 49A)

Recent Catalogs

• • • On up-to-the-minute facts and figures which have been compiled on the use of stainless steels in a booklet entitled "Allegheny Metal in Chemical Processing," by Allegheny Ludlum Steel Corp., 2020 Oliver Bldg., Pittsburgh 22, Pa.

• • • On many practical applications, and arguments for the use of magnesium, in "The Magazine of Magnesium," by Brooks & Perkins Inc., 2457 Woodward Ave., Detroit 1, Mich.

• • • On a self-starting synchronous timing motor, in Bulletin No. 10A, by the R. W. Cramer Co. Inc., Centerbrook, Conn.

(Continued on page 58A)

IF IT'S ELECTRONIC... B&W CAN MAKE IT FOR YOU!

NOW IN PRODUCTION AT B & W

COMPLETE RADIO TRANSMITTERS • DUAL DIVERSITY CONVERTERS, CONTROL UNITS and FREQUENCY SHIFT EXCITERS FOR RADIO TELETYPE TRANSMISSION • SPECIAL TEST EQUIPMENT

- REDESIGN, MODERNIZATION AND MODIFICATION OF EXISTING EQUIPMENT • MACHINE WORK
- METAL STAMPING
- COILS • CONDENSERS
- OTHER ELECTRONIC DEVICES IN A WIDE RANGE OF TYPES

From small electronic components up to carefully engineered test equipment and complex electronic devices, Barker & Williamson can engineer and manufacture high quality products to your specifications.

Three B&W plants, comprising 150,000 square feet, completely equipped with a competent engineering staff, machine shop, tool room (including all machines for drilling, milling, turning, stamping and forming metals and plastics), and a complete wood-working shop are at your disposal. Your inquiries are welcome. Write Department PR 88... for prompt reply.

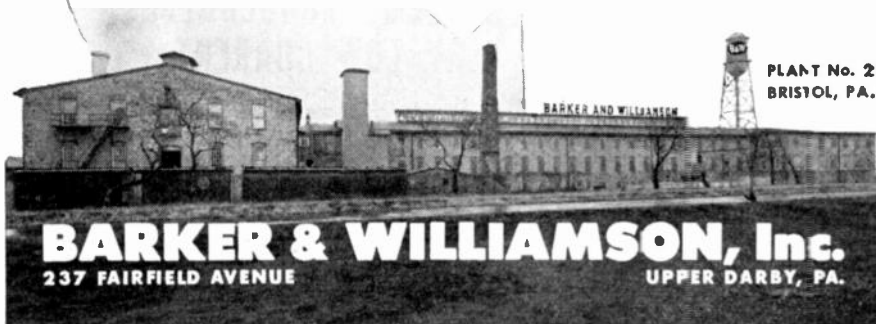

PLANT No. 2
BRISTOL, PA.

BARKER & WILLIAMSON, Inc.
237 FAIRFIELD AVENUE
UPPER DARBY, PA.

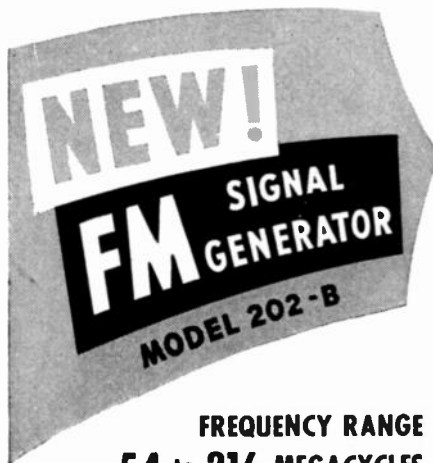

FREQUENCY RANGE 54 to 216 MEGACYCLES

The model 202-B is specifically designed to meet the needs of television and FM engineers working in the frequency range from 54-216 mc. Following are some of the outstanding features of this instrument:

RF RANGES—54-108, 108-216 mc. \pm 0.5% accuracy.
VERNIER DIAL—24:1 gear ratio with main frequency dial.
FREQUENCY DEVIATION RANGES—0-80 kc; 0-240 kc.
AMPLITUDE MODULATION—Continuously variable 0-50%; calibrated at 30% and 50% points.

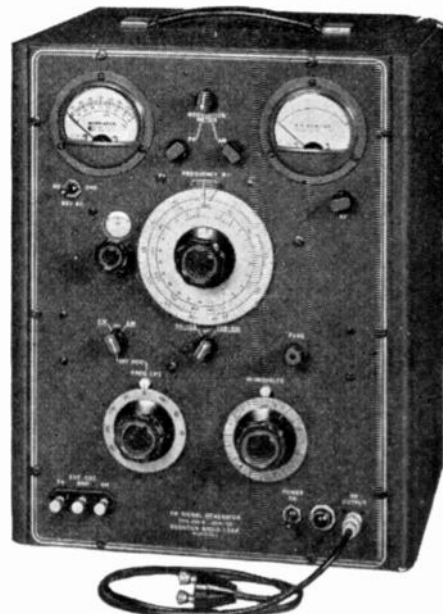

MODULATING OSCILLATOR—Eight internal modulating frequencies from 50 cycles to 15 kc., available for FM or AM.

RF OUTPUT VOLTAGE—0.2 volt to 0.1 micro-volt. Output impedance \approx 26.5 ohms.

FM DISTORTION—Less than 2% at 75 kc deviation.

SPURIOUS RF OUTPUT—All spurious RF voltages 30 db or more below fundamental.

Write for Catalog D

BOONTON RADIO Corporation
BOONTON - N.J. - U.S.A.



DESIGNERS AND MANUFACTURERS OF
THE Q METER • QX CHECKER
FREQUENCY MODULATED SIGNAL GENERATOR
BEAT FREQUENCY GENERATOR
AND OTHER DIRECT READING INSTRUMENTS



PILOT LIGHT ASSEMBLIES

PLN SERIES—Designed for NE-51 Neon Lamp



Features

- THE MULTI-VUE CAP
- BUILT-IN RESISTOR
- 110 or 220 VOLTS
- EXTREME RUGGEDNESS
- VERY LOW CURRENT

Write for descriptive booklet

The DIAL LIGHT CO. of AMERICA

FOREMOST MANUFACTURER OF PILOT LIGHTS
900 BROADWAY, NEW YORK 3, N. Y.
Telephone—Spring 7-1300

News—New Products

These manufacturers have invited PROCEEDINGS readers to write for literature and further technical information. Please mention your I.R.E. affiliation.

(Continued from page 57A)

Rotary Tap Switch

The Tesco Rotary Tap Switch has been developed by the Eastern Speciality Co., Philadelphia 40, Pa., for use in circuits whose requirements cannot be fully met by existing types of switches.

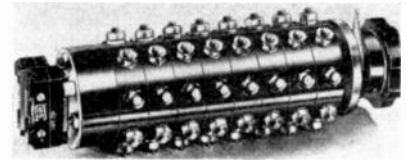

Each switch section, with seven active positions and one off position, is rated at 50 amperes continuous duty, with an overload capacity of 75 amperes. As many as twelve switch sections in tandem may be operated in parallel to handle a maximum current of 600 amperes.

A current interrupter consisting of one or two microswitches, rated at 10 amperes, and operated by the detent action, opens the source of power when the switch is rotated toward a new position, so that no arcing occurs at the switch contacts. Due to this nonarcing feature, the circuit in which the switch is used may be at high voltage, carrying an inductive load.

Individual switch sections measure 2½" diameter over the housing, 3¼" over the terminal studs, length ¾". Request Bulletin No. 57 for complete operating data.

Sensitive Relay with Split Armature

A relay with a split armature classified as the "24" is now on the market from Kurman Electric Co., 35-18 37th St., Long Island City 1, N. Y.

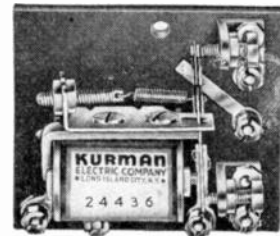

Used for automatic controls, keying antenna changeover, burglar alarms, and closed-circuit applications, this relay has a rated sensitivity of 0.014 watts dc. or 0.3 va ac. It adjusts to operate at 0.005 watts, and from 0.01 to 115 volts dc or ac.

(Continued on page 59A)

Measure Frequencies

- **INSTANTLY** ... direct reading. No computation.
- **ACCURATELY** ... to a frequency determination of 0.05%.
- **VISUALLY** ... at the turn of the dial indicator knob.

Used effectively in leading laboratories, such as: Harvard University, Bell Aircraft Corp., and Hamilton Standard Propellers... for measuring natural frequencies or speed of rotating objects, checking or calibrating tachometers, oscillators, impulse generators, similar equipment.

C. G. CONN LTD., DEPT. 813
ELKHART, IND.



Write for Free Folder



Please send free Stroboconn folder containing information about operation and application of this new precision instrument. I understand this places me under no obligation.

Name _____ Position _____
 Company _____
 Address _____
 City _____ Zone _____ State _____



PROFESSIONAL CARDS

W. J. BROWN
Consulting Engineer
INDUSTRIAL ELECTRONICS
RADIO AND TELEVISION
 25 years active electronic development
 experience
 P.O. Box 5106, Cleveland, Ohio
 Telephone & Telegrams Yellowstone 7771
 Office: 501 Marshall Building

EDWARD J. CONTENT
Acoustical Consultant
Functional Studio Design
 FM - Television - AM
 Audio Systems Engineering
 Roxbury Road Stamford 3-7459
 Stamford, Conn.

STANLEY D. EILENBERGER
Consulting Engineer
INDUSTRIAL ELECTRONICS
 Design—Development—Models
 Complete Laboratory and Shop Facilities
 6309-13—27th Ave.
 Kenosha, Wis. Telephone 2-4213

PAUL GODLEY CO.
Consulting Radio Engineers
 P.O. Box J, Upper Montclair, N.J.
 Offs. & Lab.: Great Notch, N.J.
 Phone: Little Falls 4-1000
 Established 1926

HERMAN LEWIS GORDON
*Engineering Consultant—Registered
 Patent Attorney*
 Product Development and Design
 Electronics — Mechanical Devices — Optics
 100 Normandy Drive 1416 F Street, N.W.
 Silver Spring, Md. Washington 4, D.C.
 Shepherd 2433 National 2497

Samuel Gubin, Electronics
 G. F. Knowles, Mech. Eng.
SPECTRUM ENGINEERS, Inc.
Electronic & Mechanical Designers
 540 North 63rd Street
 Philadelphia 31, Pa.
 Granite 2-2333; 2-3135

EUGENE MITTELMANN, E.E., Ph.D.
Consulting Engineer & Physicist
HIGH FREQUENCY HEATING
INDUSTRIAL ELECTRONICS
**APPLIED PHYSICS &
 MATHEMATICS**
 549 W. Washington Blvd. Chicago 6, Ill.
 Phone: State 8021

ARTHUR J. SANIAL
Consulting Engineer
 Loudspeaker Design; Development; Mfg.
 Processes. High Quality Audio Systems.
 Announcing Systems, Test and Measuring
 Equipment Design.
 168-14 32 Ave. Flushing, N.Y.
 FLushing 9-3574

News—New Products

These manufacturers have invited PROCEEDINGS readers to write for literature and further technical information. Please mention your I.R.E. affiliation.

(Continued from page 58A)

“Multivue” Cap Pilot Light Effective with Neon Lamp

A new type of pilot light with a “Multi-vue” cap, which is said to be highly effective with neon lamps, in being manufactured by Dial Light Co. of America, Inc., 900 Broadway, New York 3, N. Y.



Primarily intended to obtain new effectiveness for the NE-S1 neon glow lamp, a radically new principle was employed. Instead of being scattered by facets or concentrated by a lens, the light from the glowing electrodes is refracted in such a way that a multiple image is seen from any viewing angle.

The necessary resistor for the lamp is built in. With voltages of 110 or 220 or higher a small additional resistor must be included.

Powerful Rotary Solenoids

Two powerful Ledex rotary solenoids are now being produced by G. H. Leland, Inc., 135 Webster St., Dayton 2, Ohio.



The Ledex No. 7 is 2 3/4" in diameter, weighs less than 2 1/2 lbs, and develops a starting torque of 25 pound-inches with a 45° rotary stroke.

(Continued on page 60A)

Attention Associate Members!

Many Associate Members can qualify for higher membership grades and should certainly do so. Members are urged to keep membership grades up in pace with their present development.

An Associate over 24 years of age who is occupied as a radio engineer or scientist, and is in this active practice three years may qualify for Member Grade.

An Associate who has taught college radio or allied subjects for three years may qualify.

Some may possibly qualify for Senior Grade. But transfers can be made only upon your application. For fuller details request transfer application-form in writing or by using the coupon below.



Coupon

Institute of Radio Engineers
 1 East 79th St.,
 New York 21, N.Y. 8-48

Please send me the Transfer Application Membership-Form.

Name

Address

Place

State

Present Grade

Engineers... like to SHOP at 'NEWARK'

**for ALL Their Needs in
RADIO and ELECTRONIC
• EQUIPMENT • COMPONENTS • ACCESSORIES**

RECORDERS



For all your personal or professional needs in Radio and Electronic equipment — save time, save MONEY, by shopping 'Newark' FIRST!

TELEVISION SETS



Engineers, who "live by the clock" have learned to depend on Newark's speedy, efficient service . . . our high geared organization of technically trained personnel know how important YOUR order is to YOU . . . mail and phone orders shipped same day! All standard makes of Tubes, Components, Receiving, Transmitting, Public Address, and Recording Equipment, in stock.

TUBES



F-M TUNERS



WIRE & TAPE RECORDERS — all makes now on demonstration at any of our THREE GREAT STORES, centrally located in New York and Chicago.

P.A. SYSTEMS

TRANSMITTING and RECEIVING EQUIPMENT

NEW YORK
Offices & Warehouse
242 W. 55th St., N.Y. 19

NEWARK
ELECTRIC COMPANY, INC.

CHICAGO
323 W. Madison St.
Chicago 6, Ill.

New York City Stores: 115-17 W. 45th St. & 212 Fulton St.

Speedy, Efficient Service
AS NEAR AS YOUR PHONE!
in **NEW YORK**
Phone: **CL. 6-4060**
in **CHICAGO**
Phone: **STAtc 2950**

News—New Products

These manufacturers have invited PROCEEDINGS readers to write for literature and further technical information. Please mention your I.R.E. affiliation.
(Continued from page 59A)

The Ledex No. 8 is 3 3/4" in diameter, weighs slightly over 4 lbs, and develops a starting torque of 50 pound-inches with a rotary stroke similar to the No. 7. Both units are of similar construction.

A choice of wire sizes from Nos. 13 to 35 represents dc operation from 6 to 550 volts.

Dynamotor for Mobile Transmitters

A new type of dynamotor, developed in the laboratories of Gothard Mfg. Co., 2110 Clear Lake Ave., Springfield, Ill., is now being marketed.

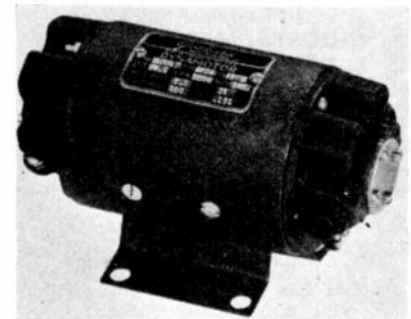

Styled as Model GP-26, its primary use is for mobile transmitters, but it is also suited to many marine and aircraft applications.

This model is available in a range of capacities to meet various requirements, with power output ranging up to 80 watts continuous duty, and 150 watts intermittent duty. Voltage regulation averages 19%, with the unit efficiency about 61%.

Dimensions are: height, 4", length 7 1/2", frame diameter 3 1/2", weight, 8 1/2 lbs.

Recent Catalogs

• • • An illustrated 24-page catalog, listing over 400 Stancor stock items, and various charts on transmitting tubes, driver-modulator combinations, and matched power supplies, by Standard Transformer Corp., Elston, Kedzie and Addison Sts., Chicago 18, Ill. Request Catalog 140-H from Dept. K.

• • • Bulletin No. 133, which describes the Model 450 series hi-meg multitesters, by Radio City Products Co., 152 W. 25 St., New York 1, N. Y.

• • • A wall chart which gives a complete selection of resistors, controls, and resistance devices by Clarostat Mfg. Co., Inc., 130 Clinton St., Brooklyn 2, N. Y.

• • • On a new liquid wire stripper, "Formula 21", for removing Formex, Formovar, enamel, and similar wire insulating coatings, request catalog section 71, Aircraft Marine Products Co., 1613 N. 4th St., Harrisburg, Pa.

(Continued on page 61A)

STATION WHKC ... **Selects TECH LABS**
VERTICAL ATTENUATORS

for new **CONSOLE INSTALLATION**



The flick of a finger operates the patented "Gove" Vertical Attenuator. Representing the very latest in broadcast components, these units are suitable for every type of sound equipment from elaborate broadcast stations to the simplest P.A. system. Unit gives smooth easy operation and can be cleaned from front of panel by removing escutcheon. Completely shielded and dust proof.

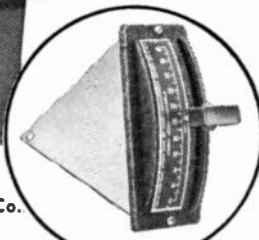

Write for Descriptive Bulletin

Courtesy of WHKC, United Broadcasting Co.

TECH
LABORATORIES, INC.

Manufacturers of Precision Electrical Resistance Instruments
337 CENTRAL AVE. • JERSEY CITY 7, N. J.

News—New Products

These manufacturers have invited PROCEEDINGS readers to write for literature and further technical information. Please mention your I.R.E. affiliation.

(Continued from page 60A)

5-Kw Air-Cooled and Water-Cooled Triodes

Two new high-frequency triode amplifier and oscillator tubes, one water-cooled and one air-cooled, have been announced by **Amperex Electronic Corp.**, 79 Washington St., Brooklyn 1, N. Y.

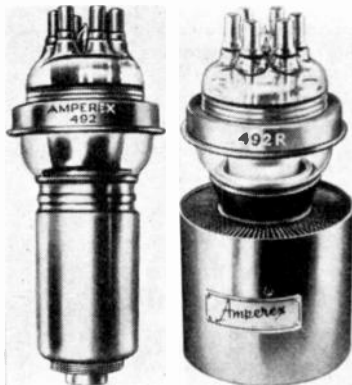

The maximum rating of 5 kw plate dissipation applies up to a frequency of 150 Mc. The 492-R radiator is capable of dissipating full power with an air flow of 170 cfm. The 492 anode is capable of dissipating 5 kw of power with a water flow of 3 to 5 gallons of water per minute. The water jacket is an integral part of the tube, and a separate adaptor is provided for connection to external water lines. For high-frequency coaxial circuits, the water jacket is readily adaptable for extension into standard 2" copper tubing of any desired length to permit adjustment for a particular frequency.

Television Components Made Available by GE

A new line of television components, for use with 10" picture tubes requiring 50° magnetic deflection at an accelerating voltage of 9000 volts, has been announced by the **Receiver Division of the General Electric Co.**, Electronics Park, Syracuse, N. Y.

The components consist of a horizontal output transformer, horizontal size control, horizontal linearity control, deflection yoke, focus control, centering device, mounting bracket, and ion trap.

The permanent-magnetic centering device is the only one on the market today, according to R. S. Fenton, sales manager for the division's component parts section. The focus coil is a combination of permanent and electromagnets, and the horizontal transformer is polyethylene molded and hermetically sealed. The new ion trap may be slipped on to the tube without removal of the socket.

Over-all length of the deflection yoke, centering device, and focus coil assembly is $4\frac{1}{8}$ ". Maximum diameter of the assembly is $3\frac{1}{8}$ ".

(Continued on page 62A)

NEW...

High Precision 2-inch Potentiometer

Designed to meet the high standards demanded by computer and military applications

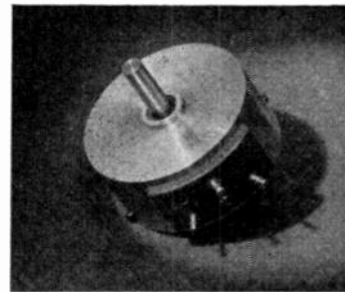

Mechanical Specifications

- Precision machined aluminum base and cover 2" diameter, 1" deep.
- Precision phosphor bronze bushings.
- Centerless ground stainless steel shaft.
- No set screws.
- Mechanical rotation—360°.
- Basic design permits use in ganged assemblies.

Electrical Specifications

- Winding—both linear to 0.5% and non-linear to 1% accuracies.

- Paliney contact to winding; two-brush rotor take-off assembly with precious metal contacts.
- High, uniform resolution provided by our method of winding non-linear resistances.
- Electrical rotation maximum 320°.
- All soldered connections (except sliding contacts).

This general line of precision potentiometers was developed in collaboration with the Fire Control Section of the Glenn L. Martin Company. Send us detailed information on your requirements for prompt quotation on large or small quantities.

TE TECHNOLOGY INSTRUMENT CORP.

1058 MAIN STREET, WALTHAM 54, MASS.

Midwest Office: Alfred Crossley & Associates, 549 W. Randolph St., Chicago 6, Illinois, State 7444

Only with **CO-AX**
air-spaced articulated
R.F. CABLES
4mmf/ft

Patents Regd Trade Mark

THE LOWEST EVER CAPACITANCE OR ATTENUATION

We are specially organised to handle direct enquiries from overseas and can give

IMMEDIATE DELIVERIES FOR EXPORT

Write or cable for data sheets or deliveries to the Originators of Flexible air-spaced R.F. Cables

TRANSRADIO LTD
CONTRACTORS TO H.M. GOVERNMENT
138A CROMWELL ROAD LONDON SW7 ENGLAND
CABLES: TRANSRAD LONDON.

LOW ATTEN TYPES	IMPED OMMS	ATTEN db/100ft at 100 Mcps	LOADING $\frac{A_w}{A_m}$	O.D."
A 1	74	1.7	0.31	0.36
A 2	74	1.3	0.24	0.44
A 34	73	0.6	1.5	0.88
LOW CAPAC TYPES	CAPAC mmf/ft	IMPED OMMS	ATTEN db/100ft 1000 Mcps	O.D."
C 1	7.3	150	2.5	0.36
PC 1	10.2	132	3.1	0.36
C 11	6.3	173	3.2	0.36
C 2	6.3	171	2.15	0.44
C 22	5.5	184	2.8	0.44
C 3	5.4	197	1.9	0.64
C 33	4.8	220	2.4	0.64
C 44	4.1	252	2.1	1.03

HIGH POWER FLEXIBLE

PHOTOCELL CABLE

V. L. C. ★

★ Very Low Capacitance cable

How to Solder Around Corners...and Between Wiring...



FLEXITIP—loop tip easily formed—no re-tinning.

LONGER REACH—8" from housing to tip, gives greater reach.

BUILT-IN TRANSFORMER—compact, complete and safe

SOLDERLITE—spotlights the work.

5 SECOND HEATING—no waiting; saves power.

DUAL HEAT—single heat 100 watts, dual heat 100/135 watts, 110 volts, 60 cycles.

Here's a tip from Weller—a *Flexitip* that is, attached to a "longer-reach" Weller Soldering Gun. Form that flexible loop tip into any shape you want and see how it slides around corners, between wiring, into the tightest spots. Even when the job's buried deep, *Flexitip* and the 8" Weller Gun will reach it.

But that isn't the only advantage of the Weller Soldering Gun. Just check the 6 features and see why it's called the "handful of soldering convenience."

Solderlite and 5-second heating means hours and dollars saved—your Weller Gun will pay for itself in a few months. And because the transformer is built in—not separate—the Weller Gun is a complete, compact unit, safer and easier to use. There's no need to unplug the gun when not in use; heat comes "on" only when the trigger is pulled.

For laboratory and maintenance work, we recommend the efficient 8" model—DX-8 with dual heat; or 4" types S-107 single heat and D-207 dual heat. Order from your distributor or write for bulletin direct.

WELLER MFG. CO.
821 Packer Street • Easton, Pa.

News—New Products

These manufacturers have invited PROCEEDINGS readers to write for literature and further technical information. Please mention your I.R.E. affiliation.

(Continued from page 61A)

Wherever possible, permanent magnets supply the dc magnetic fields in the components, eliminating much of the wiring and space consideration normally given to these parts.

Recent Catalogs

••• A new 4-page catalog covering the company's "Time-Saver Templates" for engineers, designers, draftsmen, and architects, by **Rapidesign Inc.**, P.O. Box 592, Glendale, Calif. Each type of template is pictured, designated by number and briefly described. Copy may be obtained from address given above.

••• A television control replacement manual which will be made available to firms writing on their business stationery, by **Clarostat Mfg. Co.**, 130 Clinton St., Brooklyn 2, N. Y.

••• A product list of electrical insulating materials, by **Insulation Mfrs. Corp.**, 565 W. Washington Blvd., Chicago 6, Ill.

••• A 7-page catalog describing standard microwave equipment and components, by **Waveguide Mfg. & Equipment Co., Inc.**, 125 E. 23 St., New York 10, N. Y.

••• Folder CX39A describes filter engineering that has opened up new spectrum space for use either as a narrow-band voice circuit, or with a nine-channel FM or AM telegraph system specially designed for this application, by **Lenkurt Electric Co.**, 1134 County Rd., San Carlos, Calif.

••• Three new bulletins of interest to the recording and broadcast fields: (1) Bulletin No. 139, on improved Cardyne cardioid dynamic microphones; (2) Bulletin No. 140 on replacement "Mobil-Mikes" for Motorola, RCA, GE, and similar communications equipment; (3) Bulletin No. 141 on a new torque-drive crystal pickup cartridge, by **Electro-Voice, Inc.**, Buchanan, Mich.

••• A catalog describing a new line of custom-engineered automatic voltage stabilizers, for precise ac line-voltage stabilization, by **Raytheon Mfg. Co.**, 60 E. 42 St., New York 17, N. Y.

••• A description of a new high-speed general-purpose electronic computer, entitled, "The UNIVAC System," by **Eckert-Mauchly Computer Corp.**, Broad and Spring Garden Sts., Philadelphia 25, Pa.

••• On a line of resistors, rheostats, and relays; catalog D-130, by the **Radio & Electronic Distributor Div.**, **Ward Leonard Electric Co.**, 53 W. Jackson Blvd., Chicago 4, Ill.

••• A concise 4-page illustrated booklet, No. CDM-16, describes GE permanent-magnet sub-assemblies; by the **Metallurgy Div.**, **General Electric Co.**, Pittsfield, Mass.

Kahle

ELECTRON TUBE MACHINERY OF ALL TYPES STANDARD AND SPECIAL DESIGN

We specialize in Equipment and Methods for the Manufacture of

RADIO TUBES
CATHODE RAY TUBES
FLUORESCENT LAMPS
INCANDESCENT LAMPS
NEON TUBES
PHOTO CELLS
X-RAY TUBES
GLASS PRODUCTS

Production or
Laboratory Basis

Manufacturers contemplating
New Plants or Plant Changes
are invited to consult with us.

KAHLE
ENGINEERING COMPANY
1315 SEVENTH STREET
NORTH BERGEN, NEW JERSEY, U. S. A.

WANTED ELECTRONIC ENGINEERS AND PHYSICISTS

Excellent opportunities for graduates with research, design, and/or development experience in Communications and aerial navigation systems including direction finders, radar, FM, television, micro-wave.

Write complete details regarding education, experience and salary desired.

To personnel manager
Federal Telecommunication
Laboratories

500 Washington Ave.

Nutley, New Jersey

INDEX AND DISPLAY ADVERTISERS

Section Meetings	34A
Student Branch Meetings	38A
Membership	42A
Positions Open	50A
Positions Wanted	55A
News—New Products	20A

DISPLAY ADVERTISERS

Acme Electric Corporation	YB
Aircraft Radio Corp.	YB 54A
Airborne Instruments Laboratory	52A
Airtron, Inc.	YB 49A
Allied Radio Corporation	YB
American Electrical Heater Co.	YB
American Lava Corp.	YB 17A
American Television & Radio Co.	YB
Amperite Co.	YB
Andrew Corporation	YB 42A
Applied Science Corp. of Princeton	YB
Arlington Elec. Prod.	YB
Arnold Engineering Co.	14A
Astatic Corp.	38A
Atlantic India Rubber Works	YB
Audio Development Co.	40A
Audio Devices, Inc.	YB
Ballantine Laboratories	YB
Alfred W. Barber Laboratories	YB
Barker & Williamson	YB 57A
Barry Corporation	YB
Bead Chain Mfg. Co.	YB
Bell Telephone Laboratories	2A & 3A, 34A
Bendix Aviation Corp. (Pacific Div.)	YB
Bendix Aviation Corp. (Scintilla Div.)	24A
Beta Electronics	YB
Biwax Corporation	YB
Blaw-Knox Company	28A
Bliley Electric Co.	YB
Boeing Airplane Co.	50A
Boland & Boyce, Inc.	49A
Boonton Radio Corp.	YB 57A
W. H. Brady Co.	YB
W. J. Brown	59A
Burnell & Co.	YB 29A
Bussman Mfg. Co.	YB
Cambridge Thermionic Corp.	YB 55A
Cannon Electric Development Co.	YB
Capitol Radio Engineering Inst.	63A
Centralab	YB 6A
Chatham Electronics	YB
Chicago Transformer	YB
Clark Crystal Co.	YB
Clark-Reiss Distributors	YB
Clarostat Mfg. Co.	YB
Cleveland Container Co.	47A
Cohan-Epner Co.	YB
Sigmund Cohn Corp.	YB 55A
Collins Radio Co.	YB
Communications Equipment Co.	35A
Concord Radio Corp.	YB
C. G. Conn	YB 58A
E. J. Content	59A
Cornell-Dubilier Electric Corp.	Cover III
Cornish Wire Company	YB 39A
R. W. Cramer Co., Inc.	YB
Crosley, Div. Avco Mfg. Co.	50A
Daven Co.	YB
DeJur Amsco Corp.	YB
Dial Light Co. of America	YB 58A
Drake Mfg. Co.	YB
Allen B. DuMont Laboratories	YB
Stanley D. Eilenberger	59A
Eitel-McCullough, Inc.	18A
Electric Soldering Iron Co.	YB
Electrical Reactance Corp.	YB 15A
Electro Engineering Works	YB
Electro Motive Mfg. Co.	YB 7A
Electro-Seal Corp.	YB
Electro-Tech Equipment Co.	YB
Erie Resistor Corp.	YB

Those firms coded "YB" in the above index are providing additional product data in advertisements in the I.R.E. Yearbook coming out this summer. I.R.E. Members will find these ads provide working facts.

Farnsworth Television & Radio	52A
Federal Telecommunications, Inc.	62A
Federal Telephone & Radio Corp.	YB
Ferranti Electric, Inc.	YB
Field Electrical Inst. Co.	YB
A. W. Franklin Mfg. Co.	YB
Freckel & Nelson	YB
Freud Transformer Co., Inc.	YB 13A
Furst Electronics	YB
General Aniline & Film Corp.	YB
General Electric Company	5A, Facing 16A and 17A
General Radio Company	YB Cover IV
Paul Godley Company	YB 59A
Herman Lewis Gordon	59A
Samuel Gubin	59A
Alexander Hamilton Institute	YB
Harvey Radio Co.	YB
Hawley Products	YB
Hawley Products	YB
A. W. Haydon Co.	YB
Hazeltine Electronics	53A
Helipot Corp.	YB
Hewlett-Packard Co.	11A
Hughey & Phillips	YB
Hunt Corporation	YB
Illiffe & Sons	37A
Illinois Condenser Co.	YB
Indiana Steel Products Co.	YB
Inductive Equipment Co.	YB
Industrial Products Co.	YB
Industrial Television	YB
International Nickel Co.	33A
Insulation Manufacturers Corp.	YB
Insuline Corp. of America	YB
Jennings Radio Mfg. Co.	YB
Kahle Engineering Company	62A
Kay Electric Co.	YB
Kenyon Transformer Co., Inc.	YB
James Knights Co.	56A
Kollsman Instrument Division	YB
Lavoie Laboratories	YB 21A
Lehigh Structural Steel Co.	YB
Lenz Electric Mfg. Co.	YB 41A
Legri-S Company	YB
Linde Air Products Co.	YB
Machlett Laboratories	YB
Macmillan Company	YB
Magnetic Core Corp.	YB
George J. Maki	YB
P. R. Mallory & Co., Inc.	4A
Marion Electrical Inst. Co.	YB 9A
McGraw-Hill Book Co.	YB
Measurements Corp.	YB 46A
Melpar, Inc.	53A

Mepco, Inc.	YB
J. W. Miller Co.	YB
Eugene Mittelmann	59A
Mueller Electric Co.	YB
Mycalex Corp. of America	YB 30A & 31A
National Carbon Co.	YB
National Union Radio Corp.	53A
Newark Electric Co., Inc.	YB 60A
J. M. Ney Co.	54A
Northern Radio Co.	YB
North American Philips Co.	43A
J. P. O'Donnell & Sons	YB
Ohmite Mfg. Co.	YB 8A
Panoramic Radio Corp.	YB 56A
Par-Metal Products Corp.	YB
Precision Paper Tube Co.	YB
Premax Products	YB 46A
Presto Recording Corp.	YB 22A
Radio Corporation of America	YB 32A, 51A, 64A
RCA Review	YB
Radio Receptor Co.	YB
Raytheon Mfg. Co.	44A, 52A
Reeves-Hoffman Corp.	48A
Revere Copper & Brass, Inc.	10A
Howard W. Sams & Co., Inc.	YB
Arthur J. Sanial	59A
Hermon Hosmer Scott	YB
Shallcross Mfg. Co.	YB
Sherron Electronics Co.	YB 1A
Shure Brothers, Inc.	YB
Sorensen & Co., Inc.	19A
Sperry Gyroscope Co., Inc.	YB 52A
Sprague Electric Co.	YB 16A
Stackpole Carbon Co.	12A
Standard Piezo	YB
Stephens Mfg. Corp.	YB
Superior Electric Company	YB
Sylvania Electric Prod. Co., Inc.	YB
TAB	YB
Taylor Fibre Co.	25A
Tech Labs.	60A
Technology Instrument Corp.	61A
Times Facsimile Corp.	YB
Transradio, Ltd.	61A
Truscon Steel Co.	36A
Turner Company	YB
United Transformer Corp.	YB Cover II
V-M Corporation	YB
Valpey Crystal Corp.	YB
Vitroseal Corp.	YB
Waterman Products	YB
W. M. Welch Mfg. Co.	YB
Weller Mfg. Co.	62A
Western Electric Co.	2A & 3A, 34A
S. S. White Dental Mfg. Co.	YB 45A
Wilcox Electric Co.	23A
John Wiley & Sons	YB
C. K. Williams & Co.	YB
Zophar Mills, Inc.	YB

"Where Professional Radiomen Study"

CAPITOL RADIO ENGINEERING INSTITUTE

An Accredited Technical Institute
16th and Park Rd., N.W.
Washington 10, D.C.

Advanced
Home Study and Residence
Courses in Practical Radio-
Electronics and Television.
Approved for Veteran Training.



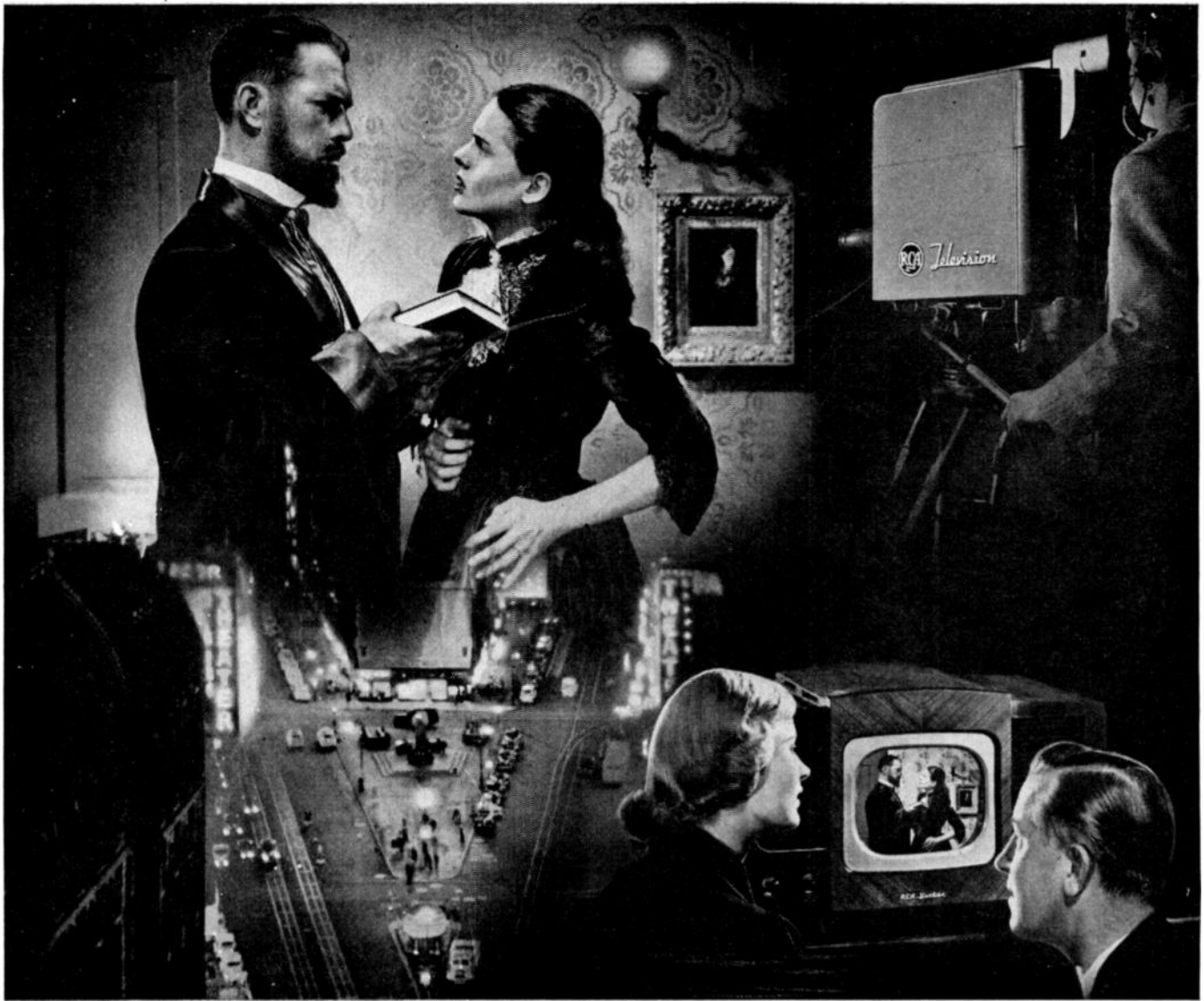

Great drama comes to television in NBC telecasts of Theatre Guild presentations.

How wide is "Broadway"?

To all the world "Broadway" means the theatre. So when NBC, in October, 1947, introduced regular telecasts of Theatre Guild productions, an expansion of "Broadway" began—and some day it will be nation-wide.

Today, if you live in a television area almost anywhere from Boston to Richmond, the new "Broadway" of television runs past your door. Now you can see great plays, pro-

fessionally performed by noted actors. That's news, exciting news, to lovers of the theatre.

Celebrated artists run through lines and action before keen-eyed RCA Image Orthicon television cameras. At *your* end of the picture, on an RCA Victor home television receiver, action is sharp, clear, detailed . . . and voices flawless.

That television can make so im-

portant a contribution to American entertainment is in good part the result of pioneering and research at RCA Laboratories. Such research enters every instrument bearing the name RCA or RCA Victor.

When in Radio City, New York, be sure to see the radio, television and electronic wonders at RCA Exhibition Hall, 36 West 49th Street. Free admission. Radio Corporation of America, RCA Building, Radio City, N. Y. 20.



RADIO CORPORATION of AMERICA

quiet

as a

goldfish



with **C-D Quietones***

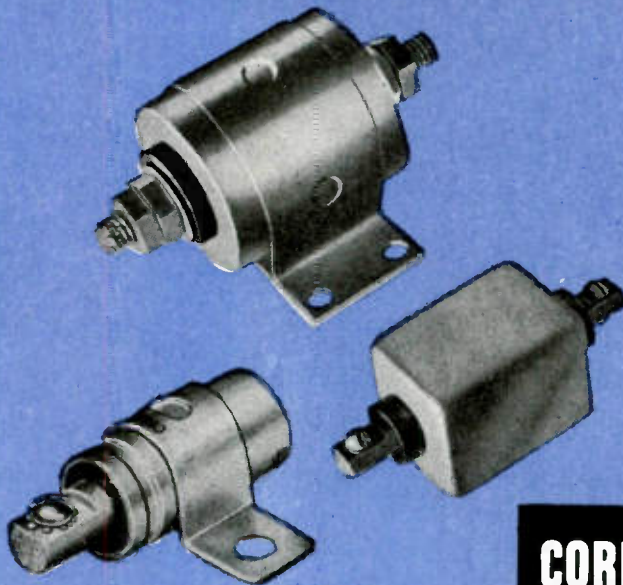

MICA • DYKANOL • PAPER • ELECTROLYTIC

A lot of electronic and electrical equipment is going to sea these days. But it won't stay there long—in fact, it won't even stay sold—unless it is Noise-Proofed against radio interference.

To you—the manufacturer—this means that your product should include C-D Quietones in its basic design. With safety at sea—as well as listening pleasure—at stake, your marine customers demand the kind of interference-free equipment operation C-D Quietones are designed to give. Of the hundreds of Quietone types available, there may be one which will fit your needs to a "T"; if not, our sleeves are rolled up and we're ready in our modern and complete Radio Noise-Proofing Laboratory—to design the specific filter you need. C-D Quietones will solve your radio noise and spark suppression problems speedily, permanently and effectively. Your inquiry is invited. Cornell-Dubilier Electric Corporation, Dept. M8, South Plainfield, New Jersey. Other large plants in New Bedford, Worcester, and Brookline, Massachusetts, and Providence, R. I.

Make Your Products More Saleable with C-D Quietone Radio Noise Filters and Spark Suppressors.

An Invitation from C-D
WORLD'S MOST ADVANCED RADIO
"NOISE-PROOFING" LABORATORY
IS AT YOUR SERVICE
without obligation



*Reg. U.S. Pat. Off.

CORNELL-DUBILIER
WORLD'S LARGEST MANUFACTURER OF
CAPACITORS

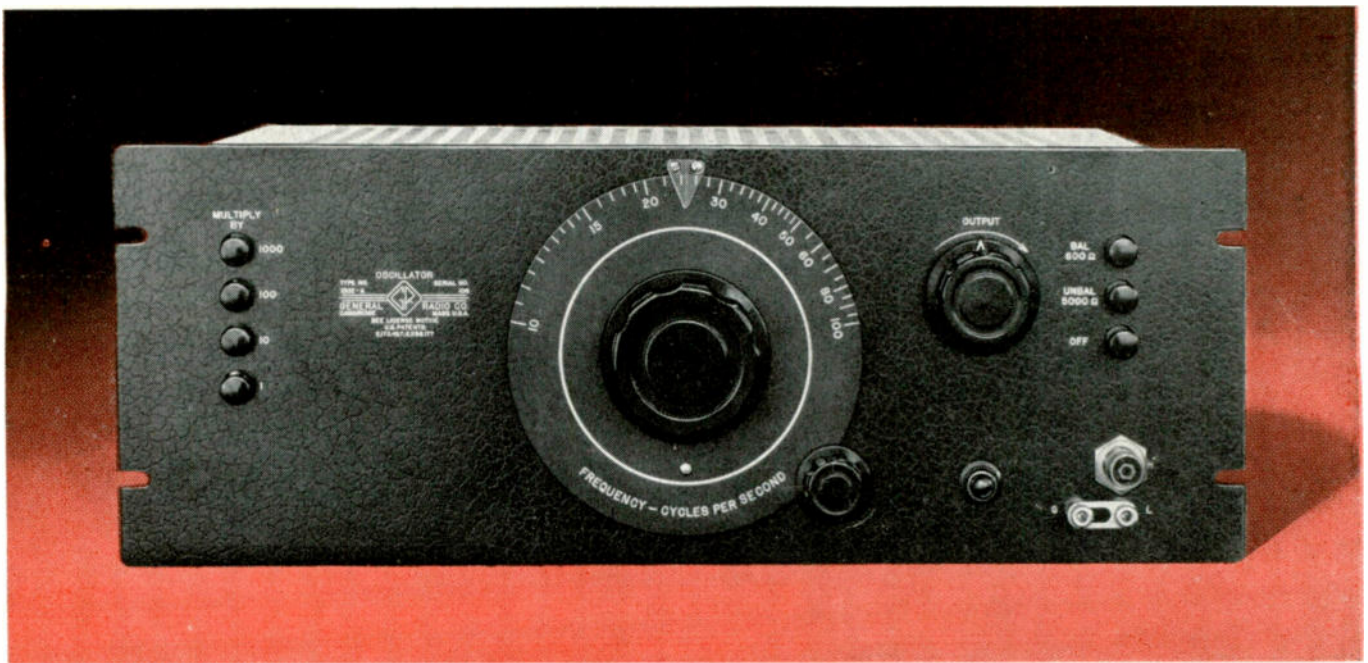

AUDIO and ULTRASONIC OSCILLATOR

with Low Distortion • Uniform Output • Excellent Stability

THIS oscillator was designed to fill the need for a wide range, continuously adjustable instrument for laboratory measurements of gain, distortion, impedance and frequency response at frequencies well above the audio range.

With a single calibrated dial and four push-button-controlled multipliers the Type 1302-A Oscillator covers the range of 10 to 100,000 cycles. Because of its wide frequency range, high stability and flat output this oscillator is particularly suited to taking frequency response characteristics on amplifiers, telephone lines, filters and other such circuit elements.

FEATURES

- **WIDE FREQUENCY RANGE** — 10 to 100,000 cycles — 180 degree rotation of dial covers the 10 to 100 cycle decade, panel push buttons add in decade steps
- **ACCURATE CALIBRATION** — adjusted within $\pm (1\frac{1}{2}\% + 0.2 \text{ cycle})$
- **LOW DISTORTION** — less than 1% at any frequency
- **SMALL FREQUENCY DRIFT** — less than 1% in first 10 minutes; less than 0.2% per hour thereafter
- **FREQUENCY DRIFT CONSTANT PERCENTAGE OF OPERATING FREQUENCY** — particularly helpful with bridge measurements at low frequencies
- **CONSTANT OUTPUT VOLTAGE** — within $\pm 1.0 \text{ db}$ over whole range; 20 volts open circuit on 5,000-ohm output, 10 volts on 600 ohms
- **STABILIZED SUPPLY** — compensated for transient line voltage surges and average line voltage variations between 105 and 125 (210 and 250) volts
- **VARIABLE CONDENSER FREQUENCY CONTROL** — avoiding contact difficulties often found in variable resistance control
- **TWO SEPARATE OUTPUT CIRCUITS** — balanced 600 ohm and unbalanced 5,000 ohm

TYPE 1302-A OSCILLATOR . . . \$365.00

GENERAL RADIO COMPANY

Cambridge 39,
Massachusetts

90 West St., New York 6

920 S. Michigan Ave., Chicago 5

950 N. Highland Ave., Los Angeles 38