

Proceedings



of the I·R·E

A Journal of Communications and Electronic Engineering
(Including the WAVES AND ELECTRONS Section)



Westinghouse Electric Corporation

ELECTRONIC TRAPS TO SNARE ATOMIC RAYS

Aids in counting the rays thrown off by exploding atoms are shown in this assortment of atomic counters. A metallurgist who studies the structure of metals with the aid of radioactive materials, holds a detector especially designed to locate "tagged atoms" in liquid solutions. The "glass-tower" counter at left traps beta particles, or high-speed electrons, and is of the kind medical men now use to trace radioactive substances injected into the human body. In the foreground can be seen a gamma-ray counter covered with black plastic material to keep out beta rays. After the rays are captured by any of these counters, they are recorded on the receiver in the background, which "announces" the passage of each ray over a loudspeaker and ticks off its number on a meter.

September, 1947

Volume 35

Number 9

PROCEEDINGS OF THE I.R.E.

Simultaneous Color Television
Electrical Noise Generators
Design of Speech Systems
3- and 9-Cm. Duct Propagation
Broad-Band Noncontacting Short Circuits for Coaxial Lines
Velocity-Modulated Reflex Oscillator
Wave-Guide-to-Coaxial-Line Junctions

Waves and Electrons
Section

Liberal Education for Engineers
Rating Microphones and Loudspeakers
F.M. Receiver I.F. Amplifiers
Microwave Frequency Standard
Loop-Antenna Coupling Transformers
Resistance-Tuned F.M. Oscillator for Audio-Frequency Applications
Calibrating Microwave Wavemeters
Graphical Analysis of Cathode-Degenerated Amplifiers
Abstracts and References

TABLE OF CONTENTS PAGE FOLLOWS PAGE 32A

The Institute of Radio Engineers

the **LITTLE**
differences

We know that our brazing techniques are as good as can be . . . but we also know that you can't always be sure of perfect heat conduction through the brazed metals.

For that reason, we've developed a method of cutting our radiators for the 8002-R out of a solid chunk of metal; giving us a perfect heat conducting path between the core and its fins. This prevents "spot heating" of the tube's copper anode.

It's quite a trick to slice those cooling fins so that they radiate equally from the center and do not vary in thickness. But we mastered it!

And we have hundreds of other "little differences" in the design and construction of the many, many types of transmitting, rectifying and special purpose tubes that comprise the extensive Amperex line.

It's these little differences that combine to make the **BIG** difference when you

re-tube with Amperex

make the
BIG
difference

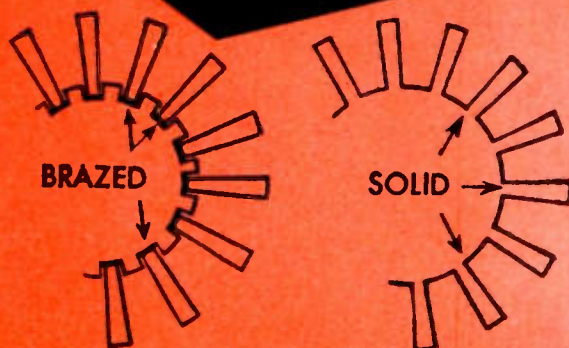

**AMPEREX
ELECTRONIC
CORPORATION**



25 WASHINGTON STREET, BROOKLYN 1, N. Y.
In Canada and Newfoundland: Rogers Majestic Limited
11-19 Brentcliffe Road, Leaside, Toronto, Ontario, Canada

New SILICONE* BUSHINGS..

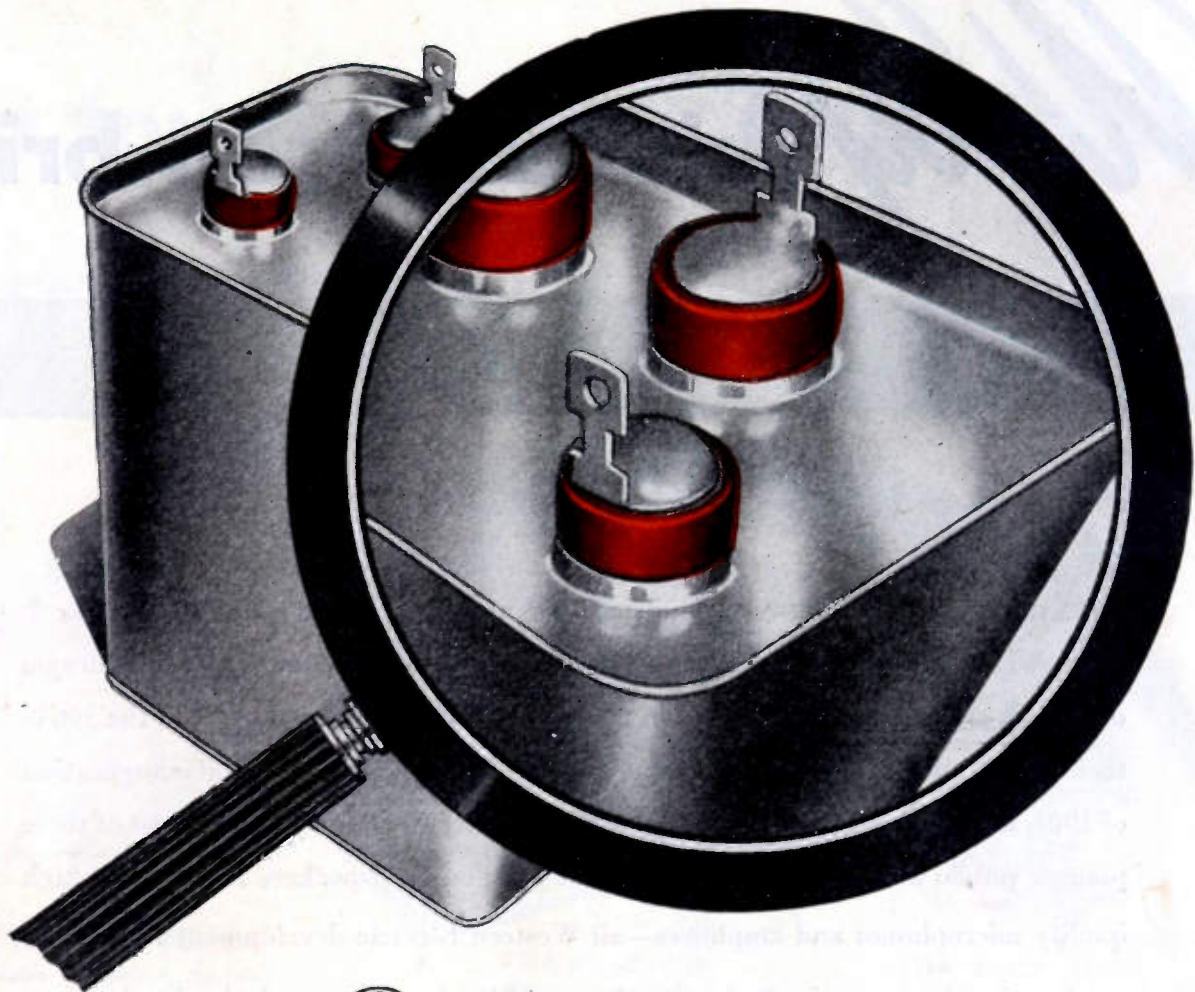

add to reliability of CAPACITORS

Here is a new development of importance to all users of specialty capacitors. It is General Electric's new silicone bushing—available only on G-E capacitors.

This new bushing gives greater dependability and longer life for capacitors. Being elastic, it is self-sealing—permanent, for all practical purposes, in both physical and dielectric properties. Inserted through the openings in the top of the capacitor casing, it seals by compression—without adhesives or gaskets. It retains its elasticity over a wide range of temperatures and will not shrink, pull away, or loosen during the life of the capacitor.

This bushing has other advantages—all of which add to the reliability of

G-E capacitors. The single piece construction provides permanently high dielectric strength and insulation resistance. It is highly resistant to oils, alkalis, and acids; it will not support fungus growth.

Silicone bushings will be used on all General Electric Pyranol* capacitors having solder-lug terminals. This new G-E first is one more reason for selecting General Electric capacitors. Others, all adding to dependability and long life, include the positive sealing of casings by double rolling or roll-crimping and soldering, the use of highest grade materials and superior processing methods, with strict quality control. Apparatus Dept., General Electric Company, Schenectady 5, N. Y.

*Reg. U.S. Pat. Off.

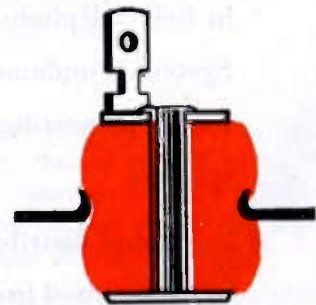

This bushing represents one of the newest uses for the recently developed G-E family of chemicals called silicones. Permanently elastic, formed to close tolerances, it seals itself by compression to the capacitor casing.

GENERAL ELECTRIC

407-142

PROCEEDINGS OF THE I.R.E., September, 1947, Vol. 35, No. 9. Published monthly in two sections by The Institute of Radio Engineers, Inc., at 1 East 79 Street, New York 21, N.Y. Price \$1.50 per copy. Subscriptions: United States and Canada, \$12.00 a year; foreign countries \$13.00 a year. Entered as second class matter, October 26, 1927, at the post office at Menasha, Wisconsin, under the act of March 3, 1879. Acceptance for mailing at a special rate of postage is provided for in the act of February 28, 1925, embodied in Paragraph 4, Section 412, P. L. and R., authorized October 26, 1927.

Table of contents will be found following page 32A

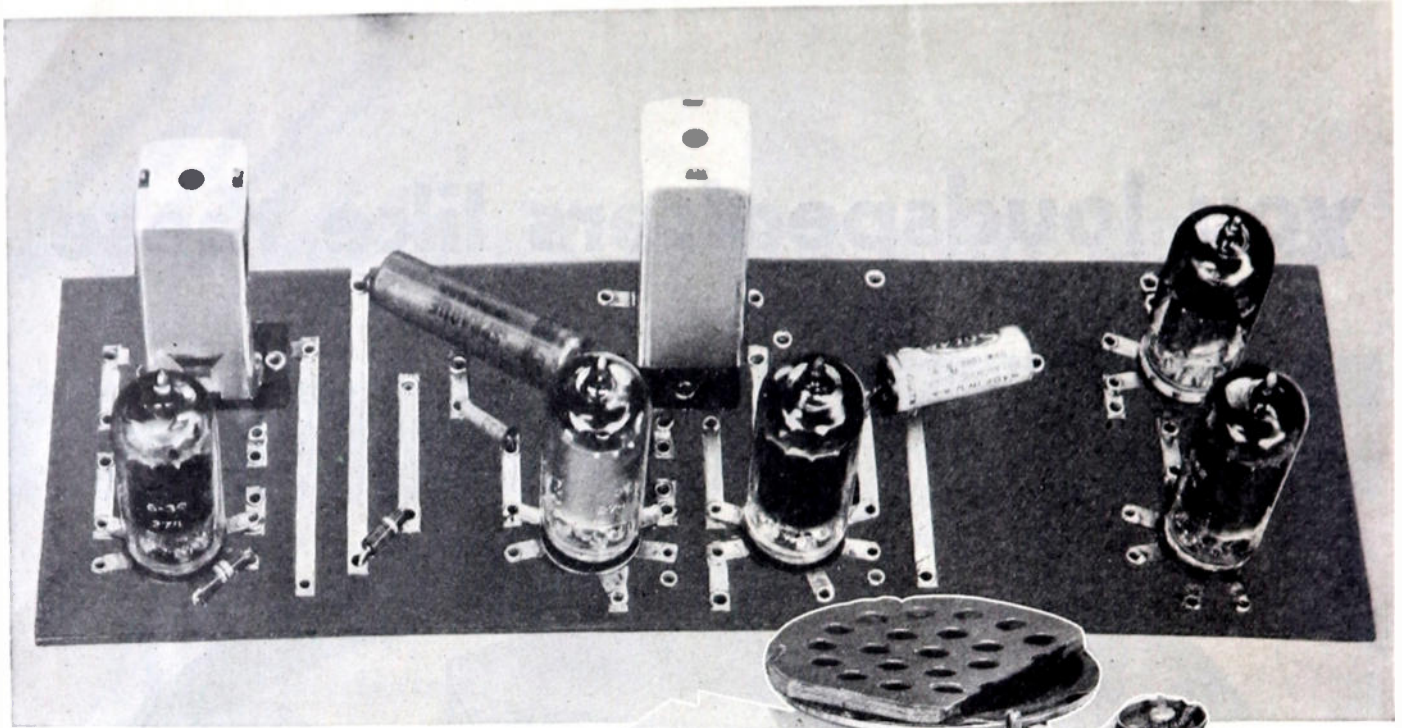

Stamped wiring deck, with tubes, transformers, capacitors and resistors, ready for assembly in metal chassis. This is a development of the Franklin Airloop Corp., New York City.

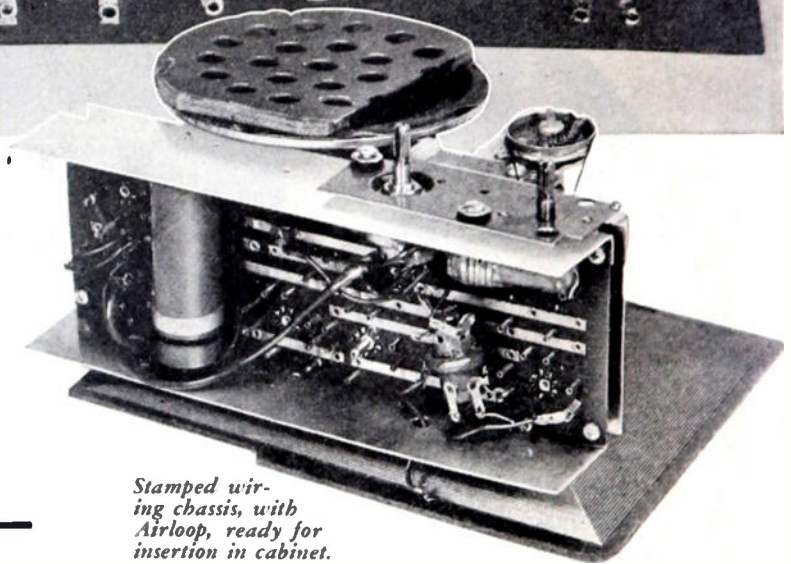

Stamped wiring chassis, with Airloop, ready for insertion in cabinet.

**Once again,
REVERE says—**

"Copper is the Metal of INVENTION"

STAMPED wiring offers new proof of the complete adaptability of copper to the development of new ideas. In this type of wiring, copper strips are stamped into both sides of an insulating sheet, the strips on one side running at right angles to those on the other. Connections between the two sides can be made by eyelets, pins, or other simple methods. It is estimated that with this system it should be possible to stamp about 90% of the wiring in the average radio or other electronic device. Thus many operations such as cutting, skinning, cabling and soldering wires should be almost completely eliminated. This new idea, though still in the development stages, will also make possible large economies in the telephone and communications fields, and for measuring instrument panelboards of airplanes, ships, and automobiles. The copper used is Revere OFHC.

Revere produces many metals, and is glad to collaborate with the electronic industry in such matters as

selection and fabrication. These metals are available in mill products, as follows: *Copper and Copper Alloys:* Sheet and Plate, Roll and Strip, Rod and Bar, Tube and Pipe, Extruded Shapes, Forgings; *Aluminum Alloys:* Tube, Extruded Shapes, Forgings; *Magnesium Alloys:* Sheet and Plate, Rod and Bar, Tube, Extruded Shapes, Forgings; *Steel:* Electric Welded Steel Tube.

• • •

REVERE

COPPER AND BRASS INCORPORATED

Founded by Paul Revere in 1801

230 Park Avenue, New York 17, New York

Mills: Baltimore, Md.; Chicago, Ill.; Detroit, Mich.; New Bedford, Mass.; Rome, N. Y.—Sales Offices in Principal Cities, Distributors Everywhere.

Put This Formula To Work For You

$$I = \frac{E}{IRC}$$

The formula $I = \frac{E}{IRC}$ is a favorite and easily-remembered solution to resistance problems. Radio and electronic Engineers know that IRC offers the most complete line of resistance products in the industry... a fixed or variable resistor for most every requirement... with uniform dependability proved by years of rigorous laboratory and field tests. Purchasing Agents and material control executives like IRC's service... "on-time" deliveries... factory stock-piles of the most popular types and ranges from which they can draw in emergency... IRC's distributor network, providing speedy, 'round-the-corner service for small order requirements.

Put this formula to work for you... check below the catalog bulletins in which you are interested—tear out this page, and mail it to us today with your letterhead, giving your name and title. International Resistance Company, 401 N. Broad Street, Philadelphia 8, Pennsylvania. In Canada: International Resistance Company, Ltd., Toronto, Licensee.



INSULATED COMPOSITION WIRE WOUND RESISTORS
IRC types BT & BW



FINGER-TIP CONTROLS AND SWITCHES
IRC types H & SH



WIRE WOUND RESISTORS
IRC type MW



MATCHED PAIR RESISTORS



POWER RESISTORS



FLAT POWER RESISTORS
IRC type FRW



VOLUME CONTROLS
IRC type DS



WIRE WOUND POTENTIOMETERS
IRC type W



VOLTMETER MULTIPLIERS
IRC types MFA & MFB



POWER RHEOSTATS
IRC types PR & PRT



WATER-COOLED RESISTORS
IRC type LP



PRECISION RESISTORS



HIGH VOLTAGE RESISTORS
IRC type MV



HIGH POWER RESISTORS
IRC type MP

INTERNATIONAL RESISTANCE COMPANY

Wherever the circuit says

Power Resistors • Precisions • Insulated Composition Resistors • Low Wattage Wire Wounds • Rheostats • Controls • Voltmeter Multipliers • Voltage Dividers • MP and High Voltage Resistors

TWO-POINT FASTENING

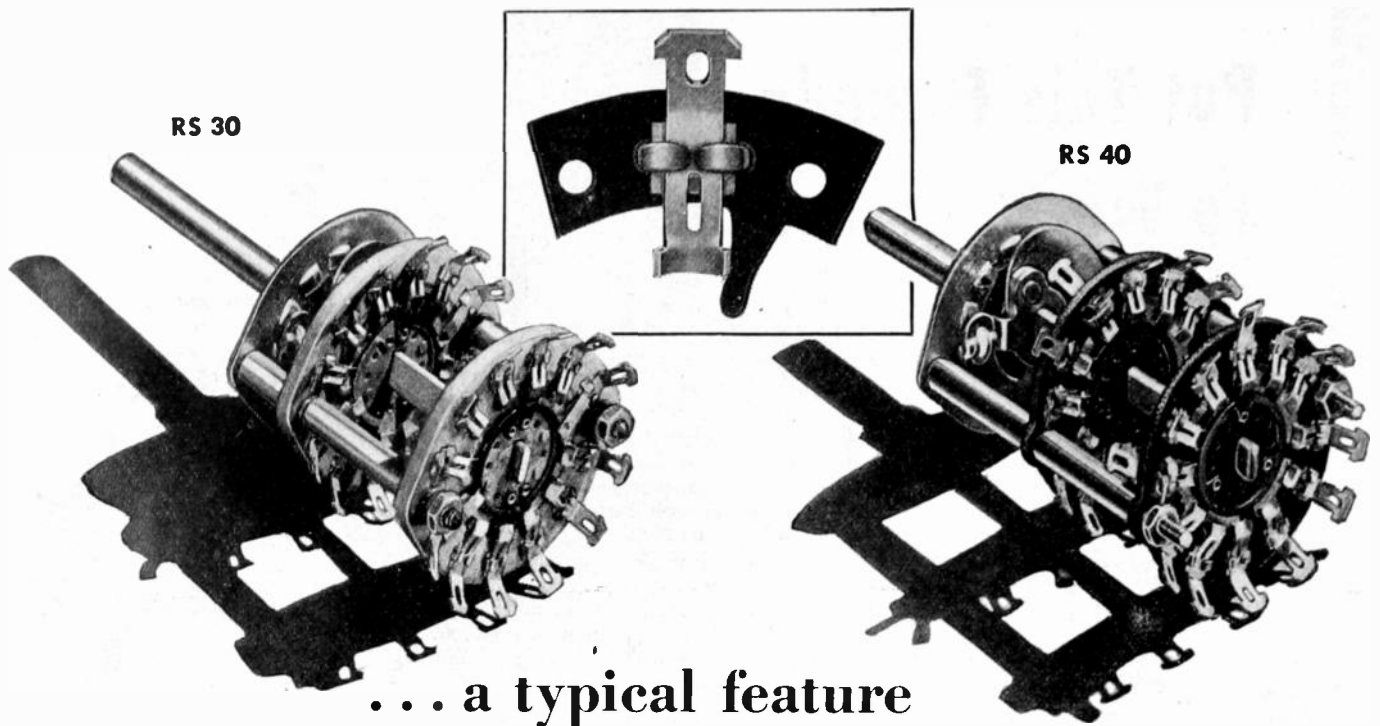

... a typical feature that insures accuracy, dependability and long life

ONE thing you'll like about the RS 30 and RS 40 is the Mallory method of fastening the terminals. By means of heavy staples and round hole stator design, terminals are held securely at two different points so they can't twist or work loose. Proper contact alignment is thus also assured.

There are lots of other features you'll like, including: the unlimited circuit possibilities . . . the improved stator design embracing adequate rotor supports to assure proper rotor and contact alignment . . . new silver-to-silver double wiping contacts, formed to maintain high contact pressure . . . where desired, the exclusive Mallory silver-indium process may be applied to rotor segments, permitting higher contact pressure with smooth operating torque and a minimum of contact resistance with extremely low noise level and long life.

Both switches have high torque definite snap indexing, and both permit 12 terminals on either side per section. Insulation is different, however—the RS 30 featuring high grade ceramic, and the RS 40 having low loss phenolic. Write for RS engineering data folder. Many standard circuit combinations in Mallory RS 30 switches are obtainable from convenient Mallory distributors under catalog numbers 160C, 170C and 180C series.

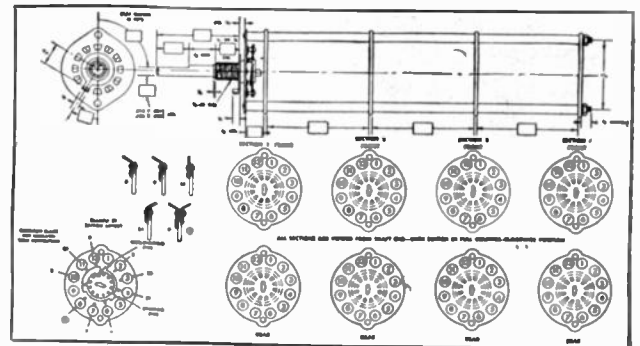

Ask for RS Specification Sheets

Printed on thin paper to permit blueprinting, these sectional drawings indicate standard and optional dimensions—make it easy for you to specify Mallory RS switches built to meet your specific circuit and mechanical requirements.

P. R. MALLORY & CO. Inc.

MALLORY SWITCHES

(ELECTRONIC, INDUSTRIAL and APPLIANCE)

P. R. MALLORY & CO., Inc., INDIANAPOLIS 6, INDIANA

SYLVANIA RESEARCH NEWS



SEPT. Prepared by SYLVANIA ELECTRIC PRODUCTS INC., Bayside, L. I. 1947

HIGHLY SPECIALIZED TESTING AND INSPECTING OPERATIONS ASSURE SYLVANIA RADIO TUBE PERFECTION

Sylvania laboratories are constantly on the trail of newer and better methods and materials to further assure radio tubes of unsurpassed quality.

For instance, research in alloys, tungsten, other metals is constantly being carried on — raising higher and higher the famous Sylvania standard of quality.

One of the instruments used in this work is the electron microscope (shown), with magnifications up to 100,000 diameters. *Sylvania Electric Products Inc., 500 Fifth Ave., New York 18, N. Y.*

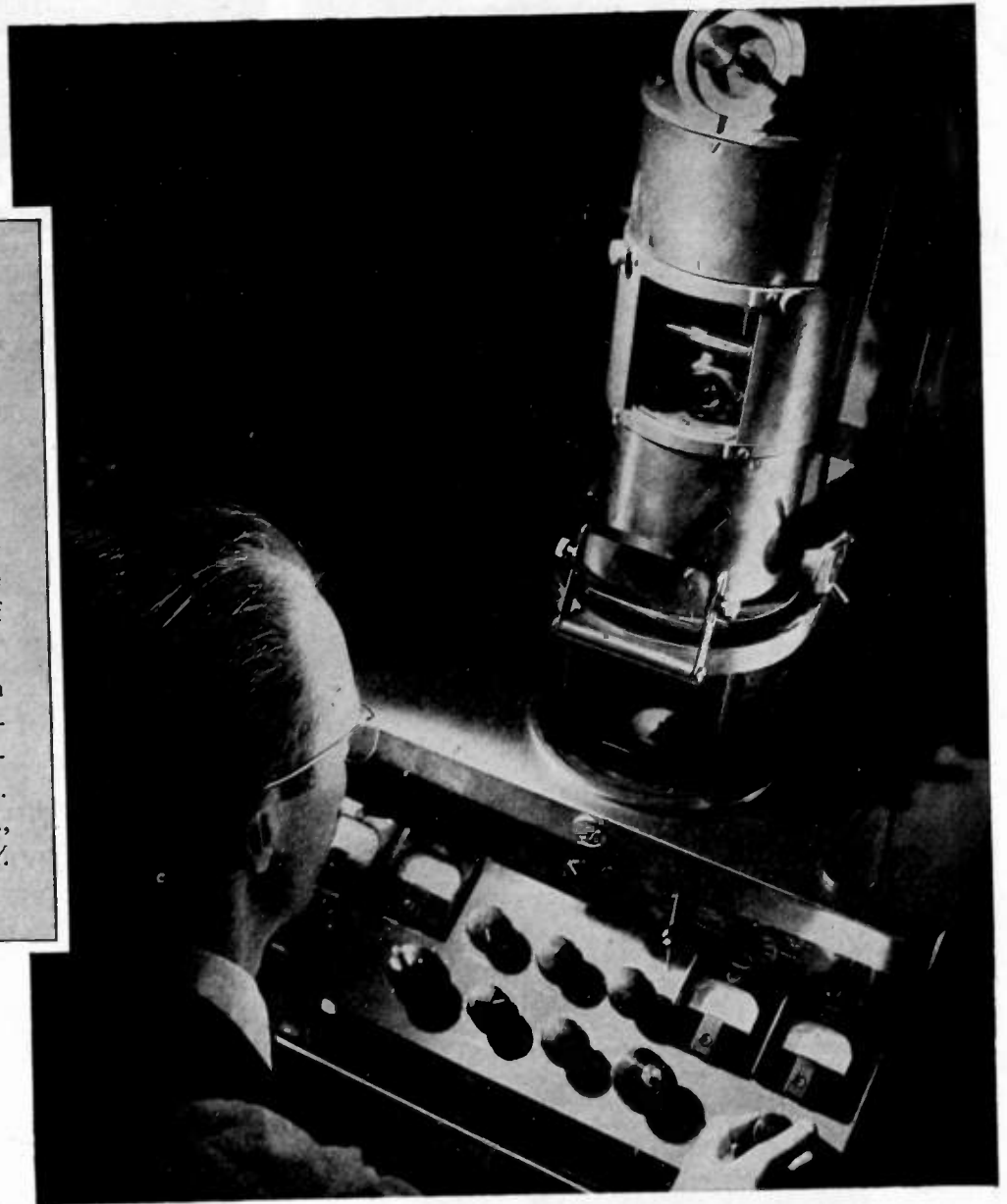

SYLVANIA ELECTRIC

MAKERS OF RADIO TUBES; CATHODE RAY TUBES; ELECTRONIC DEVICES; FLUORESCENT LAMPS, FIXTURES, WIRING DEVICES; ELECTRIC LIGHT BULBS

Want to simplify production?

See how Centralab's model "M" Radiohm gives you wide range of possible mechanical variations . . . helps keep down your inventory, step up your production of electronic equipment.

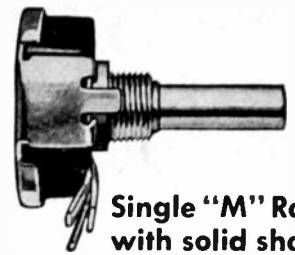

Single "M" Radiohm with solid shaft

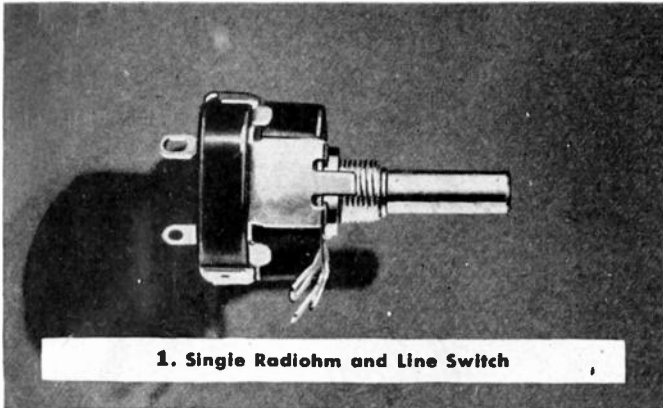

1. Single Radiohm and Line Switch

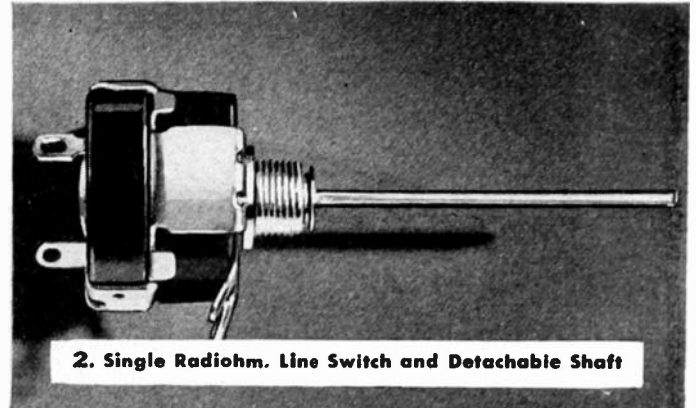

2. Single Radiohm. Line Switch and Detachable Shaft

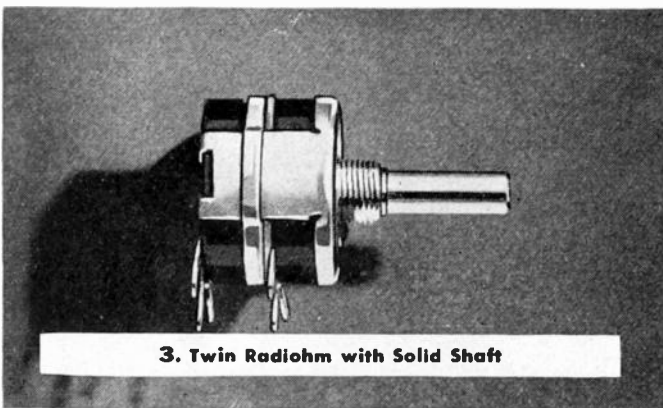

3. Twin Radiohm with Solid Shaft

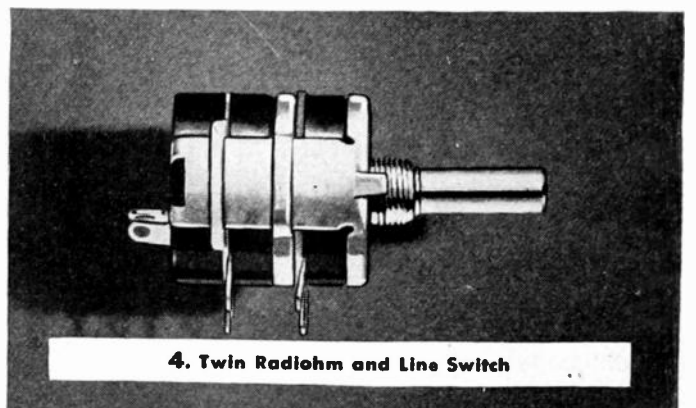

4. Twin Radiohm and Line Switch

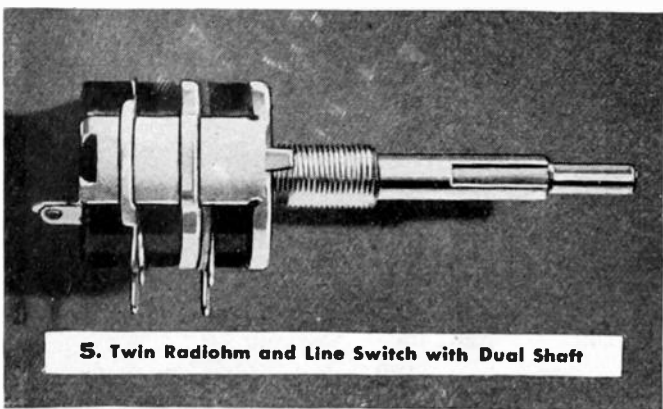

5. Twin Radiohm and Line Switch with Dual Shaft

Your choice of detachable and dual shafts gives you new versatility, maximum convenience!

ONE LOOK at the many variations you can have from Centralab's single model "M" Radiohm, and you'll see why it's one of the most popular controls on the market today for cost-conscious manufacturers! Added to this: fine CRL engineering and research have given it a guaranteed minimum life test of 10,000 cycles (control resistance that is) . . . an average life expectancy of 20,000-25,000 cycles. Available with shaft and bushing lengths to meet your needs. For complete facts, send for Bulletin R697-A.

LOOK TO CENTRALAB IN 1947! First in component research that means lower costs for the electronic industry . . . pioneer manufacturer of Radiohms, switches, capacitors and ceramics.

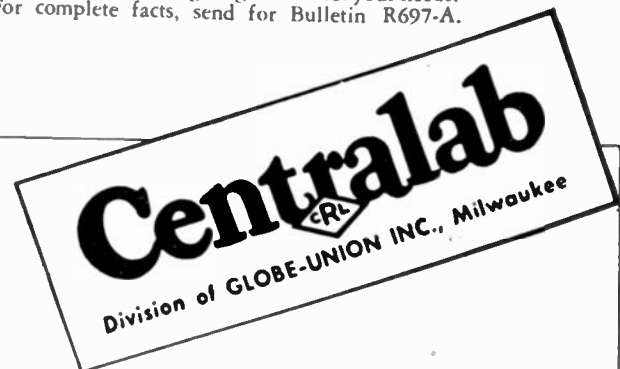

LINKING FUNCTION

TO DESIGN

Engineers and Designers who insist on dependable components have adapted SCA Selenium Rectifiers into their circuits. They are specifying SCA products, and are submitting their rectifier problems to us. Our greatly expanded plant facilities, plus the recognized dependability of SCA products, make it possible for us to offer the most complete line of Selenium Rectifiers and self-generating Photoelectric Cells.

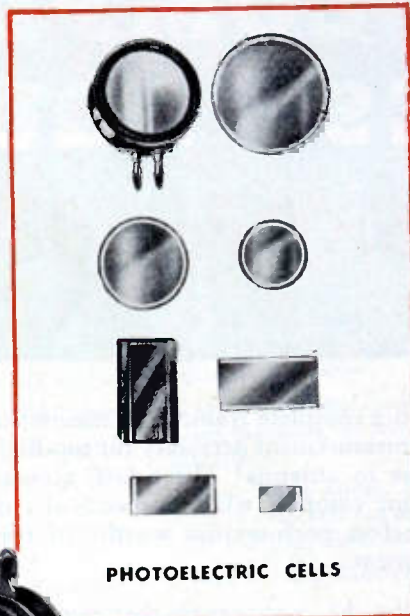

PHOTOELECTRIC CELLS

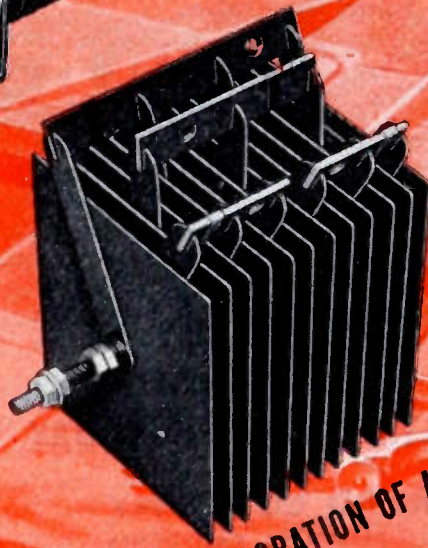
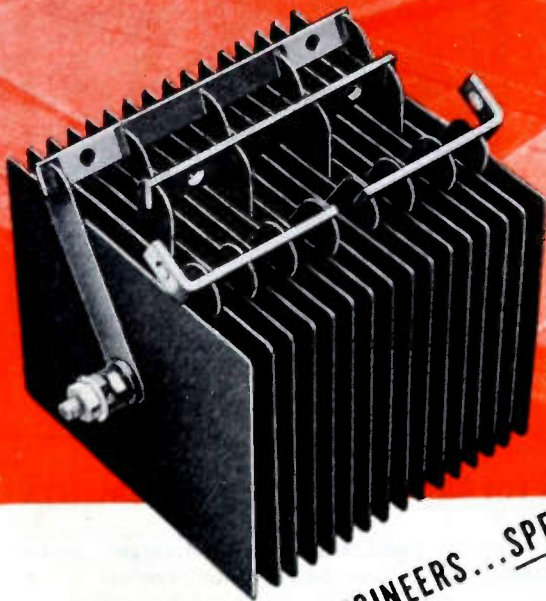

FOLLOW THE ENGINEERS... SPECIFY... SELENIUM CORPORATION OF AMERICA



SELENIUM CORPORATION OF AMERICA

Affiliate of **VICKERS** Incorporated
 2160 EAST IMPERIAL HIGHWAY • EL SEGUNDO, CALIFORNIA
 EXPORT: Frazar & Hansen, Ltd., 301 Clay St., San Francisco 11, Calif.
 Canada: Powerironic Equipment Ltd., 494 King St., E. Toronto 2, Canada

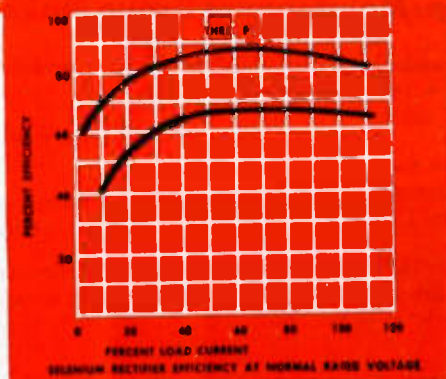

47-J



Announces...

COMPLETE FM TEST EQUIPMENT For Broadcast Stations



Here is a complete transmitter maintenance group—providing every measurement necessary for top-flight operation from microphone to antenna! Three fast, accurate precision instruments in one compact whole—specifically designed for years of trouble-free performance worthy of the finest FM broadcast equipment.

These are the *-hp-* instruments that comprise this group.

1. **-hp- 335B Frequency and Modulation Meter.**
Continuous measurement of carrier frequency and modulation swing. Low distortion audio output for measuring and monitoring.
2. **-hp- 206A Audio Signal Generator.**
Provides continuously variable audio frequency voltage having a total wave form distortion of less than 0.1% from 50 cps to 20 kc.
3. **-hp- 330C Noise and Distortion Analyzer.**
Measures harmonic distortion and noise level from demodulated carrier or audio channels. Built-in-vacuum-tube-voltmeter measures audio level, frequency response and gain.

All instruments have identical panel sizes for convenient mounting in relay racks. Can be delivered in colors and finishes to match your equipment.

GET FULL INFORMATION...WRITE TODAY

HEWLETT-PACKARD COMPANY

1481 D PAGE MILL ROAD • PALO ALTO, CALIFORNIA



This *-hp-* Maintenance Group Makes These Essential FM BROADCAST MEASUREMENTS

Carrier Frequency: Continuously monitored with accuracy well within F.C.C. limits.

Modulation Swing: Continuously measured at instrument installation and at control console.

Modulation Limit: Alarm lamp flashes on instrument and console when pre-set level is exceeded.

Aural Monitor: Demodulated signal provides listening check for operator.

Harmonic Distortion: Measured from r-f carrier or audio channel.

Noise: Measured accurately from FM carrier or audio channel.

Frequency Response: Overall response, microphone to antenna, of individual units in transmitter set-up.

Audio Transmission: Accurately measures gain of audio channels.

Audio Level: Measured over range from +50 db to -60 db at 600 ohm level.

Equalizer Circuits: Characteristics of circuits and lines can be checked accurately, swiftly.

Oscilloscope Connections: Facilitates visual study of noise and distortion.



NEW! -hp- 335B

FM Monitor

Accurate, Stable, Easy to Operate

BRIEF SPECIFICATIONS

Frequency Range: Any single frequency, 88 to 108 mc.

Deviation Range: +3 kc to -3 kc.

Accuracy: Better than ± 1000 cps.

Modulation Range: Modulation swing 100 kc. Scale calibrated 100% at 75 kc.

Audio Output: Supplied with 75 microsecond de-emphasis circuit, flat within $\frac{1}{2}$ db of standard curve, 20 cps to 20 kc.

Monitoring Output: 1 milliwatt into 600 ohms, balanced, at 100% modulation.

Size: Panel $10\frac{1}{2}$ " x 19". Depth 13".

Precision accuracy, unique stability, new convenience and compact size—those are but a few of the reasons why this -hp- 335B is the finest instrument ever developed for FM broadcast monitoring. Here are additional advantages that help make this new -hp- instrument an ideal component of the -hp- FM group.

Simple to Operate. No adjustments required during operation.

Independent of Signal Level. Readings of frequency or modulation meter are unaffected by variations in transmitter level.

Unusual Stability. Low temperature co-efficient crystal in temperature-controlled oven combined with specially developed

electronic linear counter circuits provides accuracy far beyond that required. Measurements do not depend on accuracy of conventional discriminator circuits.

Remote Modulation Meter. Modulation may be monitored at control console or other remote point.

Low Distortion. Audio output for measuring purposes has less than .25% residual distortion.

Low Noise Level. Residual noise and hum in audio output are at least 75 db below 100% modulation.

Meets F.C.C. Requirements.

This instrument is small in size, easy to install, suitable for cabinet or rack panel mounting. Can be furnished to match your transmitter color scheme.



NEW! -hp- 206A

Audio Signal Generator

Distortion Less Than 0.1%

BRIEF SPECIFICATIONS

Frequency Range: 20 cps to 20 kc, 3 bands.

Output: +15 dbm to matched resistive loads. 10 volts available for open circuit.

Output Impedance: 50, 150, 600 ohms center-tapped and balanced. 600 ohms single-ended.

Frequency Response: Better than 0.2 db beyond output meter at all levels.

Distortion: Less than 0.1% above 50 cps. Less than 0.25% from 20 cps to 50 cps.

Hum Level: At least 70 db below output signal, or more than 100 db below 0 level, whichever is larger.

Size: Panel $10\frac{1}{2}$ " x 19". Depth 13".

The -hp- 206A Audio Signal Generator provides a source of continuously variable audio frequency voltage having a total distortion of less than 0.1%. This feature, combined with high stability, flat frequency response, and great accuracy of output voltage, makes it an ideal component for FM station maintenance. Here are some of this instrument's unusual advantages:

Distortion less than 0.1% between 50 cps and 20 kc.

Continuously variable frequency range, covered in 3 bands, micro-controlled dial,

effective scale length 47", ball-bearing smoothness for tuning ease.

Output meter monitors output voltage signal with accuracy of at least 0.2 db.

Special low temperature co-efficient frequency determining elements provide high stability and excellent accuracy over long periods of time.

Precision attenuators vary output signal level in 0.1 db steps over 111 db range.

This new -hp- generator is convenient to use, compact in size. It can be provided for rack or cabinet mounting, in colors matching your installation.

hp laboratory instruments
FOR SPEED AND ACCURACY

*They Lick Humidity and Vibration
at High Frequencies*

STACKPOLE Polytite TRIMMER ELECTRODE CORES

Placed in fitted metal sleeves, Stackpole Polytite Trimmer Electrode Core Forms serve as variable capacitors that assure honest-to-goodness capacity stability in high-frequency circuits where humidity and vibration must be considered. The molded Polytite has a high dielectric constant. Cores are moisture repellent and carry a heavy dielectric coating that establishes a path of high leakage resistance between the electrodes. Since these electrode surfaces have short, symmetrical current paths, the inductance may be kept low enough for use in the 200-megacycle range. Standard types provide easy capacity adjustment with a maximum from 20 to 40 mmf., depending on the size.

Write for Stackpole Polytite Trimmer Data Bulletin

STACKPOLE CARBON COMPANY
Electronic Components Division • St. Marys, Pa.

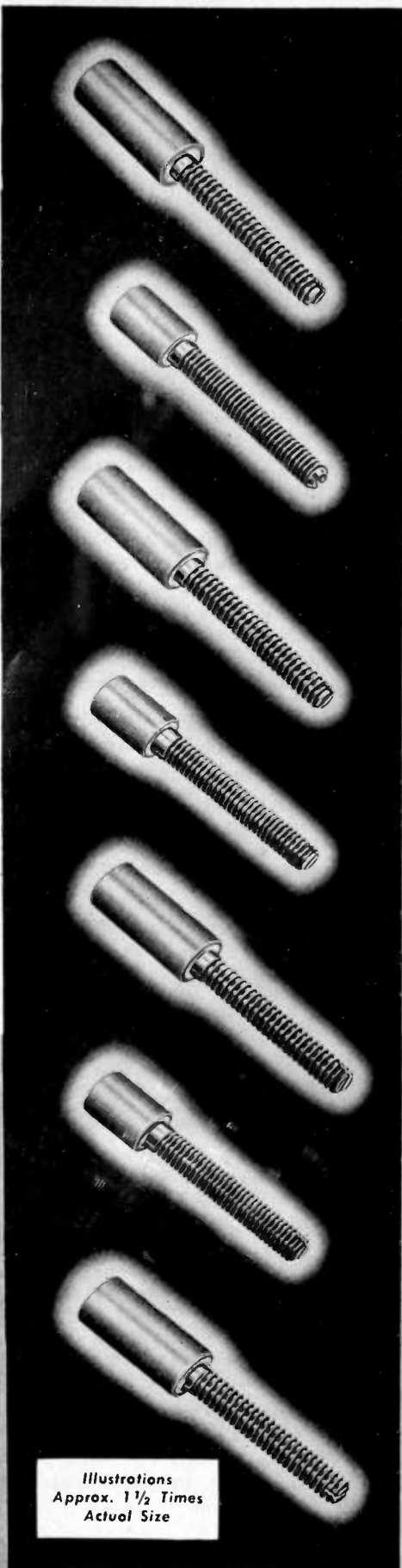

Illustrations
Approx. 1 1/2 Times
Actual Size

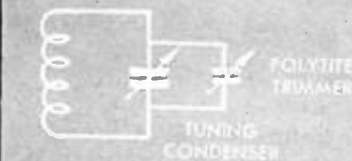

Stackpole Polytite Trimmer Electrode Capacitors are well suited for minimum capacity adjustments in tuned circuits, installed across the tuning capacitor as in Figure 1 or across the tuning inductance as in Figure 2. Trimmers may be mounted directly to the tuning capacitor.



A typical application using two Polytite Trimmer Electrode Capacitors in a circuit where band-spread tuning is desired. Various bands may be covered by the switching of coils and preadjusted trimmers.

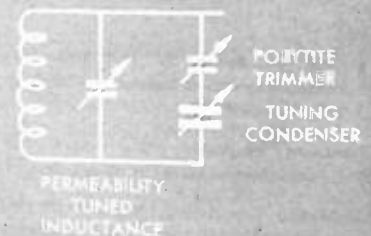

RESISTORS • IRON CORES • SWITCHES

NEW ITEMS AT



New designs and products are in continuous development at the U.T.C. Research Laboratory. While most of these items are specific to customer's unusual requirements, units having general application are added to the New U.T.C. catalogue.

UNIVERSAL RESONANT EQUALIZER

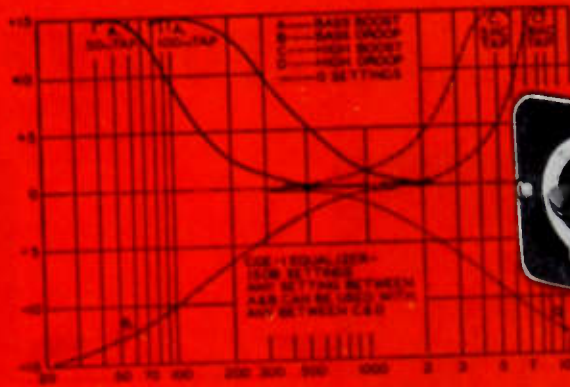

This new U.T.C. unit is the ideal, simple device for any application requiring frequency response correction. Designed to be connected between two triode audio stages or to match a high impedance (5000 to 30000 ohms) source to grid.

The COE-1 equalizer is not a simple R-C tone control, but employs resonant circuits to permit low or high end equalization without affecting mid-frequencies. With controls in center, no equalization is effected. Moving one control to left increases bass; to right, drops bass. Moving other control to left increases high; to right drops high. Controls are independent so that bass may be raised and high dropped simultaneously, etc. Amount of equalization is continuously adjustable, up to 15 dB, panel calibrated in dB. The insertion loss effected is equal to the combined low frequency and high frequency settings plus \pm dB. Unless existent gain of equipment to which COE-1 is added is high, an additional audio stage may be required.

This unit comes complete so that controls with etched panel may be mounted on a chassis (2 1/2 inch minimum) or a panel with case containing the electrical elements held by etched panel screws.

COE-1 Panel Dim. 2 1/2 x 4. Wt. 3 lbs.

List Price \$25.00

PHOTO FLASH TRANSFORMERS

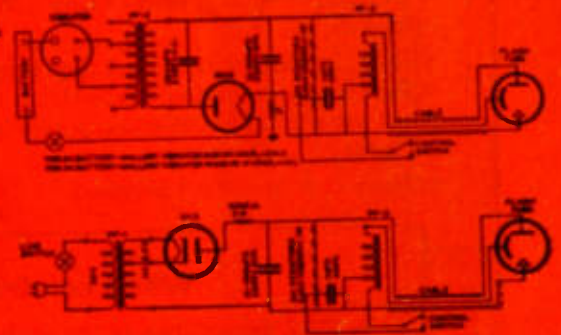

The three basic U.T.C. items described below cover all medium power multiple photo flash applications using trigger type or non trigger type tubes. PF-1 is for AC line units . . . PF-2 is for portable units . . . PF-3 is used for tubes employing trigger electrode.

PF-1 Primary for 115 volts, 50/60 cycles. Secondaries for power supply delivering 2200 volts DC to condenser up to 100 Mfd. (30 Mfd. charges in 8 Sec.) Compound sealed in G-3 case 2 1/2 x 2 1/4 x 2 1/2 inches high. Weight 3 lbs. List Price . . . \$10.00

PF-2 For portable photo flash service. Primary tapped for 4 volt or 6 volt battery (full wave vibrator). Secondary for power supply delivering 2200 volts DC to condenser up to 60 Mfd. (30 Mfd. charges in 30 Sec. with 6 volts or 28 Sec. with 4 volts). Compound sealed in G-3 case. Weight 2 lbs. List Price . . . \$10.00

PF-3 Trigger Transformer 15 KV peak List Price . . . \$4.50

For further circuit details, write for sheet (PF).

For Full Listings of U.T.C. Items, Write for Catalogue PS-407

United Transformer Corp.
150 VARICK STREET NEW YORK 13, N.Y.

EXPORT DIVISION: 13 EAST 40th STREET, NEW YORK 16, N.Y.

CABLES: "ARLAB"

FOR SPECIALIZED APPLICATIONS...

THE NEW BASIC CATHODE-RAY INDICATOR Type 281



Type 281 as an independent unit

- A basic instrument for needs too specialized or advanced for equipment hitherto available.
- Choice of 4 kv or 8 kv accelerating potential; self-contained power supplies.
- Recordable writing rates of single transients exceed 4 in./ μ s.
- No amplifiers or time base, but coupling to all deflection plates, grid and cathode on front panel; direct connection to deflection plates on top of instrument.
- Relay-rack or cabinet mounted.

ITS NEW SUPPLEMENTARY HIGH-VOLTAGE POWER SUPPLY Type 286



Type 286 as an independent unit

- Exceptionally safe for operator.
- Output potential continuously variable between + 18 kv and + 25 kv.
- Regulation within 5% for $\pm 10\%$ line voltage change or 0 to 500 ma. load variation.
- Direct-reading output voltmeter accurate within $\pm 2\%$ of full scale.
- Used in standard relay-rack or own dust-proof cabinet.
- May be fastened to Du Mont Type 281.

When combined

- FULL capabilities of the high-voltage Type SRP-A Cathode-Ray Tube are realized.
- Excels the cold-cathode continuously-evacuated type tubes for photographic recording.
- Writing rate for the Type SRP-A Tube now exceeds 400 in./ μ s.! Note unretouched photo of single transient containing writing rates of 400 in./ μ s. at right.

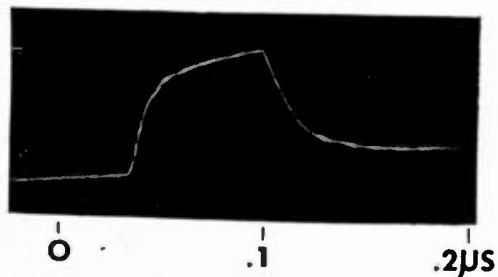

► Details on request

© ALLEN B. DUMONT LABORATORIES, INC.

DUMONT

Precision Electronics & Television

ALLEN B. DUMONT LABORATORIES, INC., PASSAIC, NEW JERSEY • CABLE ADDRESS: ALBEEDU, PASSAIC, N. J., U. S. A.

MAKING TUBES IS EASY..

76
YOU KNOW HOW!

GLASS—FLAME—SEAL

Glass — flame — seal. Sounds easy. Just slip a glass bulb down over the mount assembly. Then by cleverly directed gas flames seal bulb and stem flare together.

Yes, there is a catch in it. A directed flame applied to glass may cause severe thermal shock. Local expansion and contraction then result in strain or fracture. Such thermal shock must be avoided by gradually raising the temperatures of both bulb and stem before hitting them with intensely hot flames. Without scientific control, permanent strains would be set up which might cause cracks — immediately or at some future time. The finished tube would become an "air leaker" and useless.

As this multihead rotary sealing machine indexes, fingers of gas flame — mixed with air delicately proportioned to achieve the proper temperature — warm, shape, and seal bulb to flare. Because it is shielded from the flames by the bulb, the stem is preheated before loading. This preheat temperature is maintained throughout sealing by hot air blown up under the flare. The continual stream of hot air also shapes the seal. Concentrated flames cut off the bulb cullet. In high speed operations, the sealing and subsequent exhaust operations are performed on the same machine.

A precision machine carefully controlled by the glass expert makes this working with glass easy. Gives you a combination which assures you once again of trouble-free performance from your Hytron tubes.

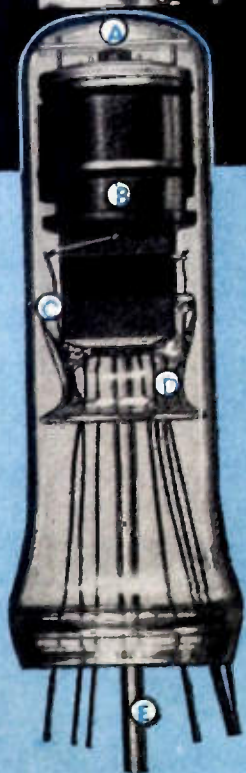

- A Outer bulb
- B Mount
- C Stem
- D Flare
- E Exhaust tube

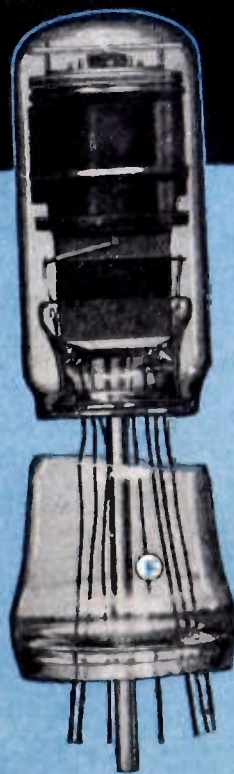

Sealed-in mount ready for exhaust. Cullet (F) cut off by gas flames is discarded.

SPECIALISTS IN RADIO RECEIVING TUBES SINCE 1921

HYTRON

RADIO AND ELECTRONICS CORP.

MAIN OFFICE: SALEM, MASSACHUSETTS



NOW - A SIXTY-FIVE WATT

EIMAC TETRODE

TYPE

4-65A



- **Hard Glass**
- **Non-Emitting Grids**
- **Instant Heating Filament**
- **Low Drive**
- **Low Voltage**
- **Low Feed-Thru Capacitance**
- **Low Cost**

\$14.50

THE ANSWER TO THE TRANSMITTER-MAN'S PRAYER

Available now, type 4-65A is a small radiation cooled, instant heating tetrode. Devoid of internal insulating hardware, the 4-65A was designed as a transmitting tube . . . not a blown-up receiving tube. This rugged new Eimac tetrode really performs at low voltage, and its instant heating thoriated tungsten filament makes it ideally suited for mobile installations. The 4-65A operates well into the VHF, beyond the 160-Mc. band, and is capable of delivering relatively high-power with a plate voltage range from 400 to 3000 volts. As do other Eimac tetrodes, type 4-65A embodies the inherent characteristics of low grid drive, low feed-thru capacitance, and general stability of operation.

Type 4-65A's versatility of operation is demonstrated in the adjacent data showing typical operation at 400, 1000, and 2000 volts. Additional data on the 4-65A are now available, write direct.

EITEL-McCULLOUGH, Inc.
1771 San Mateo Ave., San Bruno, California

Follow the Leaders to **Eimac** THE POWER OF R-F **TUBES**

EXPORT AGENTS: FRAZAR AND HANSEN, 301 CLAY STREET
SAN FRANCISCO 11, CALIFORNIA, U.S.A.

PROCEEDINGS OF THE I.R.E.

September, 1947

TYPE 4-65A			
ELECTRICAL CHARACTERISTICS			
Filament: Thoriated tungsten			
Voltage	-	-	6.0 v
Current	-	-	3.5 amp
Grid-Screen Amp. Factor (Av.)	-	-	5
Direct Inter-Electrode Capacitances (average)			
Grid-Plate	-	-	0.08 μuf
Input	-	-	8.0 μuf
Output	-	-	2.1 μuf
TYPICAL OPERATION			
Class C Telephony or FM Telephony (Key Down Conditions, 1 Tube)			
D-C Plate voltage	-	400 1000 2000 v	
D-C Screen voltage	-	250 250 250 v	
D-C Grid voltage	-	-40 -50 -70 v	
D-C Plate current	-	100 125 125 ma	
D-C Screen current	-	40 37 35 ma	
D-C Grid current	-	13 16 16 ma	
Peak R-F grid input voltage	-	135 155 180 v	
Driving power (approx)	-	1.8 2.5 2.9 w	
Screen dissipation	-	10.0 9.2 8.8 w	
Plate power input	-	40 125 250 w	
Plate dissipation	-	12 30 50 w	
Plate power output	-	28 95 200 w	

Gates Radio Company
QUINCY, ILLINOIS, U. S. A.

Electronic Equipment
June 10, 1947

American Lava Corporation,
Chattanooga 5, Tennessee.

Gentlemen:

We would like to report to you the excellent performance and electrical characteristics we are obtaining in the field with your part E-16898 transmission line insulator. You will recall that after we covered the field quite thoroughly about two years ago we decided to use this particular design and insulator because of superior performance that we expected.

This particular insulator is used as the center support on broadcast frequency transmission lines. At times these insulators are subject to considerable electrical and mechanical overload due to lightning hits, ice formations and a number of other unpredictable factors. To this date we have not had one single field failure and the performance both electrically and mechanically has been up to and exceeding expectations.

We wish to thank your company for the close cooperation in the design of such an outstanding electrically and mechanically product and assure you that on future developments of this type we will first request your valued engineering and production assistance.

Yours very truly,

GATES RADIO COMPANY

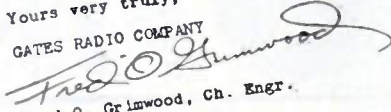

Fred O. Grimwood, Ch. Engr.

FOG/nh

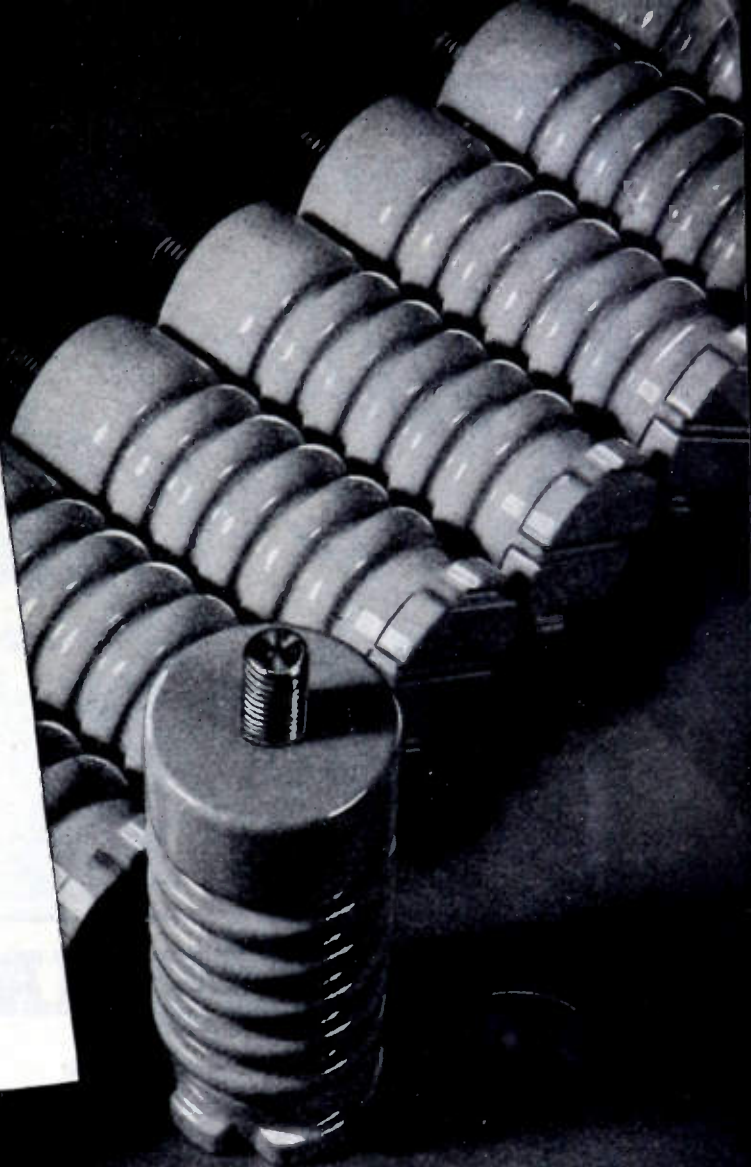

ALSiMAG TRANSMISSION LINE INSULATORS WITH METAL STUDS

Low loss AISiMag Insulators with metal studs solve many installation problems . . . permit a variety of transmission line characteristics.

The Feed Through insulator illustrated is mounted in the center of an open wire transmission line bracket by means of a 2" metal stud sunk 1" into the insulator. This stud is accurately placed and is engineered to be a strong joint resistant to all types of weather.

The letter reproduced above outlines the experience of one user of this type of AISiMag steatite insulator.

The physical characteristics of the principal AISiMag technical ceramic compositions are shown on the AISiMag Property Chart, sent free on request. Our engineers will gladly cooperate with you in developing the design most advantageous to your requirements.

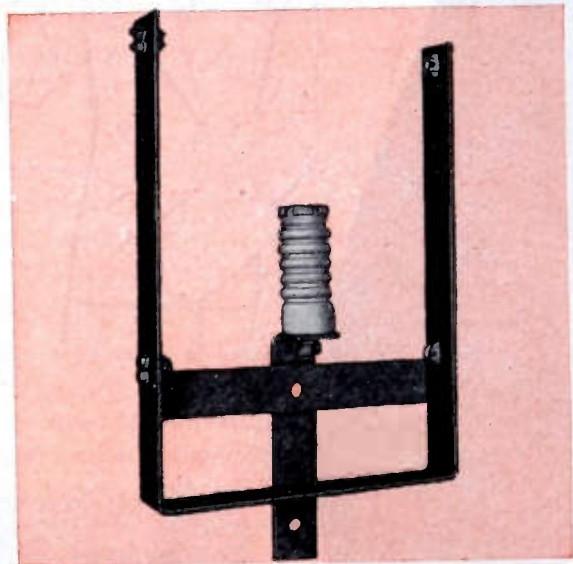

COURTESY GATES RADIO CO., QUINCY, ILL.



46TH YEAR OF CERAMIC LEADERSHIP
AMERICAN LAVA CORPORATION
CHATTANOOGA 5, TENNESSEE

SALES OFFICES: ST. LOUIS, MO., 1123 Washington Ave., Tel: Garfield 4959 • CAMBRIDGE, MASS., 38-B Brattle St., Tel: Kirkland 4498 • PHILADELPHIA, 1649 N. Broad St., Tel: Stevenson 4-2823
NEWARK, N. J., 671 Broad St., Tel: Mitchell 2-8159 • CHICAGO, 9 S. Clinton St., Tel: Central 1721 • SAN FRANCISCO, 163 2nd. St., Tel: Douglas 2464 • LOS ANGELES, 324 N. San Pedro St., Tel: Mutual 9076

Wherever you Employ Magnets,
Check with us on the
Advantages of using

ARNOLD

PERMANENT MAGNETS



As electrical constituents go, permanent magnets are relatively new. They made tremendous advances within the past decade, especially in the communications and aviation industries, and in the general fields of instruments, controls, meters and mechanical holding devices.

Many of these uses were problems that just couldn't be solved until permanent magnet materials were developed to do the job—a work of pioneering to which Arnold contributed a heavy share. Many other applications were those where permanent magnets supplanted older materials because of their inherent ability to save weight, size and production time, as well as greatly improve the performance of the equipment.

To these advantages, Arnold Permanent Magnets add another very important value—standards of quality and uniformity that are unmatched within the industry. Arnold Products are 100% quality-controlled at every step of manufacture. What's more, they're available in all Alnico grades and other types of magnetic materials, in cast or sintered forms, and in any shape, size or degree of finish you need.

● Let's get our engineers together on *your* magnet applications or problems.

THE ARNOLD ENGINEERING CO.



Subsidiary of

ALLEGHENY LUDLUM STEEL CORPORATION

147 East Ontario Street, Chicago 11, Illinois

Specialists and Leaders in the Design, Engineering and Manufacture of PERMANENT MAGNETS

W&D 1296

**They started at the bottom
to make Karp service TOPS**

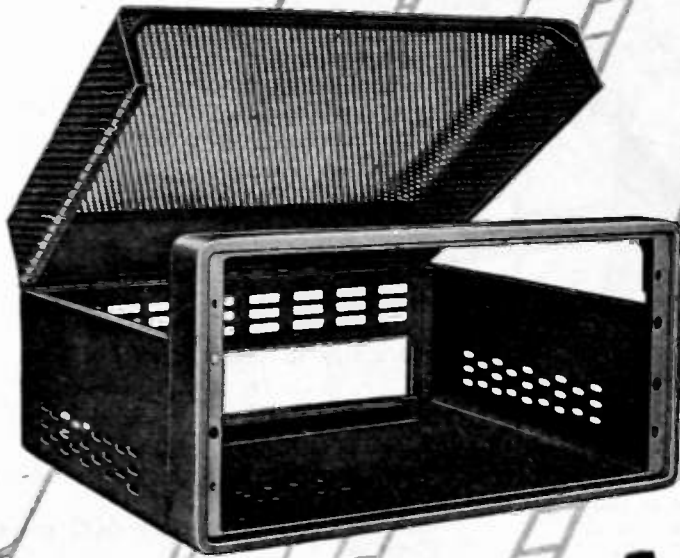

One reason why Karp craftsmanship offers extra quality and value, is that our key employees, from the president to department heads, literally came up from the ranks. They learned their valuable "know how" at the bench or machine, and their specialized experience is long.

91% of our supervisory personnel started in the shop. 80% of these men have each served the company for a period of 15 years or more. 10 of them have served a combined total of 178 years. 3 were with us 22 years ago when the organization was founded by a small group of perfectionists.

This outstanding combination of knowledge, skill and long experience builds extra (though often unseen) quality features into your finished products. It assures you of finest materials and exceptional workmanship in every detail. It means accuracy and uniformity in production, which will save you time and money in assembling. It guarantees handsome appearance, careful finishing and ruggedness for long service life.

KARP METAL PRODUCTS CO., INC.

117 - 30th STREET, BROOKLYN 32, NEW YORK

Custom Craftsmen in Sheet Metal

CONDENSERS...

... BASIC TUNING UNITS

These transmitting condensers should be the basic tuning units of your transmitter designs.

Compact assembly, steatite insulation, sturdy construction, and conservative ratings will enable National condensers to prove their superiority in your transmitter.

Send for your copy of the 1947 National catalog, containing a complete list of variable condensers and some 600 other parts, today.

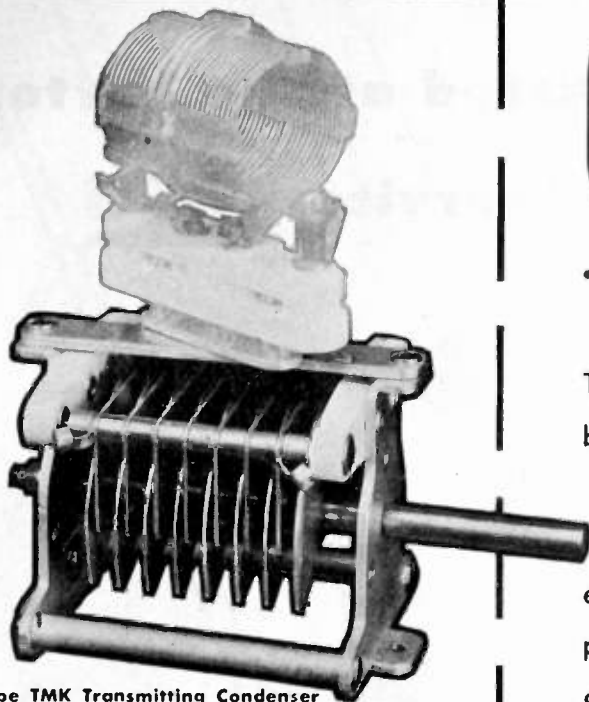

Type TMK Transmitting Condenser

An ideal condenser for exciters and low power transmitters. Available in single and double stator models. Steatite insulation. Special provision has been made for mounting AR-16 exciter coils in a swivel plug-in mount on either the top or rear of the condenser if desired. Over-all width 2-11/16", height 2-23/32".

Capacity (max.-min.)	Air Gap	Peak Voltage	Length	Catalog
35 mmf.-7.5	.047"	1500v.	2-7/32"	TMK-35
50 -8	.047"	1500v.	2 3/8"	TMK-50
100 -10	.047"	1500v.	3"	TMK-100
DOUBLE STATOR MODELS				
35/35 mmf.-7.5/7.5	.047"	1500v.	3"	TMK-35D
100/100-10/10	.047"	1500v.	4 1/8"	TMK-100D

Complete List in Catalog

National Company, Inc.

Dept. No. 10
Malden, Mass.



Type TMC Transmitting Condenser

Designed for use in the power stages of transmitters where peak voltages do not exceed 3,000. The frame is extremely rigid. Insulation is steatite. The stator in the split stator models is supported at both ends. Over-all width 3-9/16", height 3-5/8".

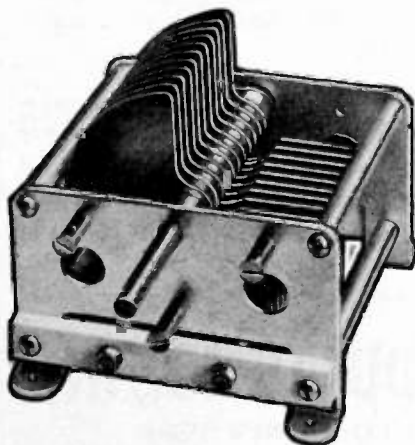

Capacity (max.-min.)	Air Gap	Peak Volt.	Len.	Cata.
50 mmf.-10	.077"	3000v.	3"	TMC-50
100 -13	.077"	3000v.	3 1/2"	TMC-100
250 -23	.077"	3000v.	6"	TMC-250
DOUBLE STATOR MODELS				
50/50 mmf.-9/9	.077"	3000v.	4 3/8"	TMC-50D
100/100-11/11	.077"	3000v.	6 3/8"	TMC-100D

Complete List in Catalog

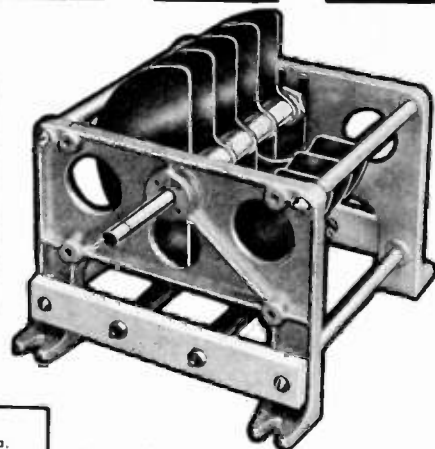

Type TML Transmitting Condenser

This is a 1 KW job throughout. Special steatite Insulators prevent arc-covers. Sturdy cast aluminum end frames and dural tie bars permit an unusually rigid structure. Precision end bearings insure smooth turning and permanent alignment of the rotor. Over-all width 7", height 7-1/8".

Capacity (max.-min.)	Air Gap	Peak Volt.	Len.	Cata.
75 mmf.-25	.719"	20,000v.	18 1/8"	TML-75E
50 -22	.469"	15,000v.	8 3/8"	TML-50D
500 -55	.219"	7,500v.	18 1/8"	TML-500A
DOUBLE STATOR MODELS				
30/30 mmf.-12/12	.719"	20,000v.	18 1/8"	TML-30DE
60/60-	.469"	15,000v.	18 1/8"	TML-60DD
100/100-	.344"	10,000v.	18 1/8"	TML-100DB

Complete List in Catalog

MAKERS OF LIFETIME RADIO EQUIPMENT

available **NOW**

THE NEW 1947

THORDARSON

Transformer Catalog



ACCLAIMED EVERYWHERE AS THE FINEST YET TO APPEAR,

the new 1947 Edition of the Thordarson Catalog is now available. Describing the complete Thordarson line of transformers and chokes for replacement and amateur purposes, this up-to-date catalog also contains circuit diagrams, charts and curves

showing applications for Audio, Power, Modulator, Output and Plate Transformers and Chokes . . . as well as complete circuit diagrams and application notes for photo-flash power supplies. Compiled by the engineering staff of America's oldest transformer manufacturing company, it is a worthy addition to your technical library.

SEND FOR YOUR FREE COPY TODAY

**ELECTRONIC DISTRIBUTOR & INDUSTRIAL SALES DEPT.
MAGUIRE INDUSTRIES INC., 936 N. MICHIGAN AVE., CHICAGO 11, ILL.**

PLEASE SEND MY FREE COPY OF THE NEW 1947
THORDARSON CATALOG, POSTPAID, TO THE ADDRESS BELOW.

THORDARSON

ELECTRONIC DISTRIBUTOR &
INDUSTRIAL SALES DEPARTMENT

MAGUIRE

INDUSTRIES, INC.

936 N. MICHIGAN AVENUE, CHICAGO 11, ILLINOIS

EXPORT: SCHEEL INTERNATIONAL, INCORPORATED
4237 N. LINCOLN AVENUE, CHICAGO 18, ILLINOIS, CABLE HARSHEEL.

NAME _____

STREET _____

CITY _____ STATE _____

Wherever you Employ Magnets,
Check with us on the
Advantages of using

ARNOLD

PERMANENT MAGNETS



As electrical constituents go, permanent magnets are relatively new. They made tremendous advances within the past decade, especially in the communications and aviation industries, and in the general fields of instruments, controls, meters and mechanical holding devices.

Many of these uses were problems that just couldn't be solved until permanent magnet materials were developed to do the job—a work of pioneering to which Arnold contributed a heavy share. Many other applications were those where permanent magnets supplanted older materials because of their inherent ability to save weight, size and production time, as well as greatly improve the performance of the equipment.

To these advantages, Arnold Permanent Magnets add another very important value—standards of quality and uniformity that are unmatched within the industry. Arnold Products are 100% quality-controlled at every step of manufacture. What's more, they're available in all Alnico grades and other types of magnetic materials, in cast or sintered forms, and in any shape, size or degree of finish you need.

● Let's get our engineers together on *your* magnet applications or problems.

THE ARNOLD ENGINEERING CO.



Subsidiary of

ALLEGHENY LUDLUM STEEL CORPORATION

147 East Ontario Street, Chicago 11, Illinois

Specialists and Leaders in the Design, Engineering and Manufacture of PERMANENT MAGNETS

W&D 1296

**They started at the bottom
to make Karp service TOPS**

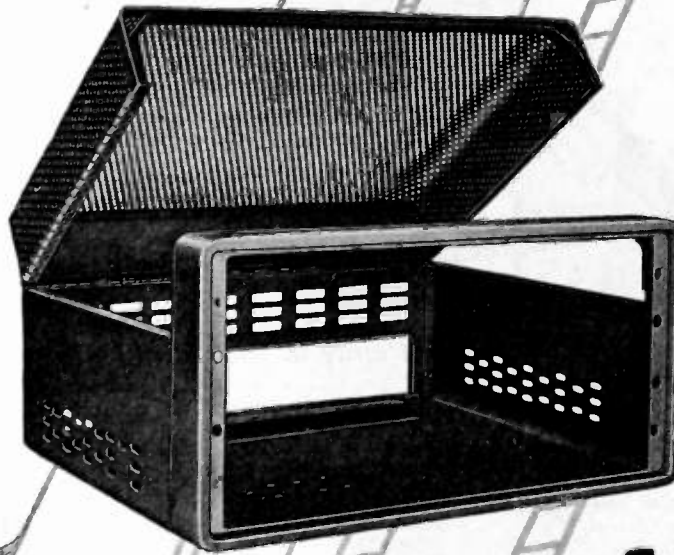

One reason why Karp craftsmanship offers extra quality and value, is that our key employees, from the president to department heads, literally came up from the ranks. They learned their valuable "know how" at the bench or machine, and their specialized experience is long.

91% of our supervisory personnel started in the shop. 80% of these men have each served the company for a period of 15 years or more. 10 of them have served a combined total of 178 years. 3 were with us 22 years ago when the organization was founded by a small group of perfectionists.

This outstanding combination of knowledge, skill and long experience builds extra (though often unseen) quality features into your finished products. It assures you of finest materials and exceptional workmanship in every detail. It means accuracy and uniformity in production, which will save you time and money in assembling. It guarantees handsome appearance, careful finishing and ruggedness for long service life.

KARP METAL PRODUCTS CO., INC.

117 - 30th STREET, BROOKLYN 32, NEW YORK

Custom Craftsmen in Sheet Metal

CONDENSERS...

... BASIC TUNING UNITS

These transmitting condensers should be the basic tuning units of your transmitter designs.

Compact assembly, steatite insulation, sturdy construction, and conservative ratings will enable National condensers to prove their superiority in your transmitter.

Send for your copy of the 1947 National catalog, containing a complete list of variable condensers and some 600 other parts, today.

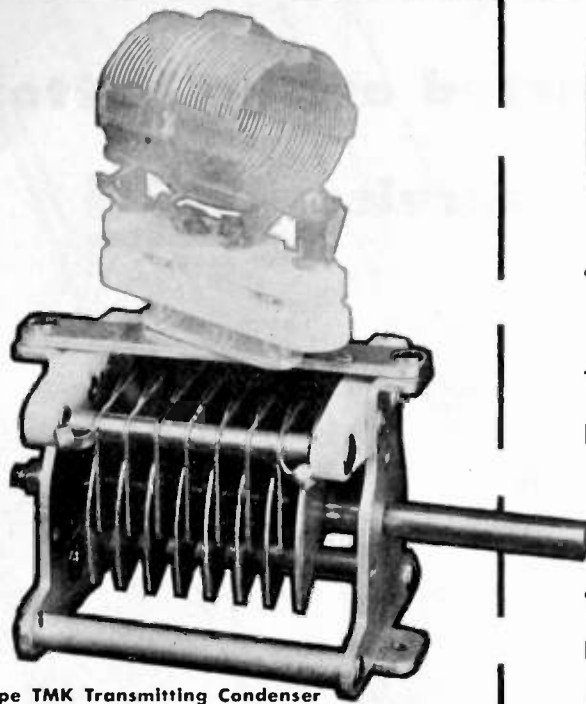

Type TMK Transmitting Condenser

An ideal condenser for exciters and low power transmitters. Available in single and double stator models. Steatite insulation. Special provision has been made for mounting AR-16 exciter coils in a swivel plug-in mount on either the top or rear of the condenser if desired. Over-all width 2-11/16", height 2-23/32".

Capacity (max.-min.)	Air Gap	Peak Voltage	Length	Catalog
35 mmf.-7.5	.047"	1500v.	2-7/32"	TMK-35
50 -8	.047"	1500v.	2 3/8"	TMK-50
100 -10	.047"	1500v.	3"	TMK-100
DOUBLE STATOR MODELS				
35/35 mmf.-7.5/7.5	.047"	1500v.	3"	TMK-35D
100/100-10/10	.047"	1500v.	4 1/4"	TMK-100D

Complete List in Catalog

National Company, Inc.

Dept. No. 10
Malden, Mass.



Type TMC Transmitting Condenser

Designed for use in the power stages of transmitters where peak voltages do not exceed 3,000. The frame is extremely rigid. Insulation is steatite. The stator in the split stator models is supported at both ends. Over-all width 3-9/16", height 3-5/8".

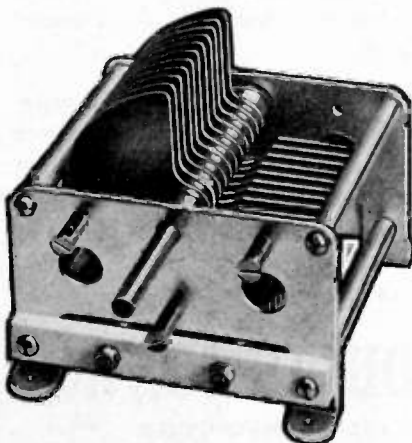

Capacity (max.-min.)	Air Gap	Peak Volt.	Len.	Cata.
50 mmf.-10	.077"	3000v.	3"	TMC-50
100 -13	.077"	3000v.	3 1/2"	TMC-100
250 -23	.077"	3000v.	6"	TMC-250
DOUBLE STATOR MODELS				
50/50 mmf.-9/9	.077"	3000v.	4 3/8"	TMC-50D
100/100-11/11	.077"	3000v.	6 3/4"	TMC-100D

Complete List in Catalog

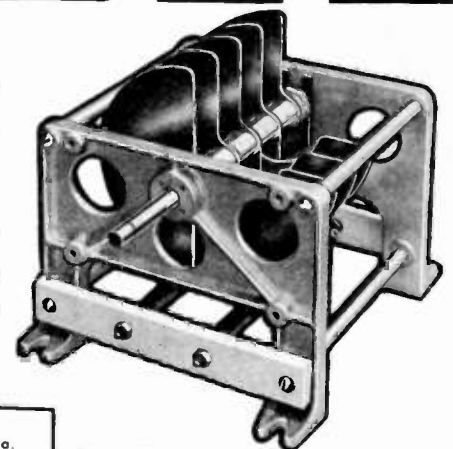

Type TML Transmitting Condenser

This is a 1 KW job throughout. Special steatite insulators prevent arc-overs. Sturdy cast aluminum end frames and dural tie bars permit an unusually rigid structure. Precision end bearings insure smooth turning and permanent alignment of the stator. Over-all width 7", height 7-1/8".

Capacity (max.-min.)	Air Gap	Peak Volt.	Len.	Cata.
75 mmf.-25	.719"	20,000v.	18 1/8"	TML-75E
50 -22	.469"	15,000v.	8 3/8"	TML-50D
500 -55	.219"	7,500v.	18 1/8"	TML-500A
DOUBLE STATOR MODELS				
30/30 mmf.-12/12	.719"	20,000v.	18 1/8"	TML-30DE
60/60 -26/26	.469"	15,000v.	18 1/8"	TML-60DD
100/100-27/27	.344"	10,000v.	18 1/8"	TML-100DB

Complete List in Catalog

MAKERS OF LIFETIME RADIO EQUIPMENT

available **NOW**

THE NEW 1947

THORDARSON

*Transformer
Catalog*

**ACCLAIMED EVERYWHERE AS
THE FINEST YET TO APPEAR,**

the new 1947 Edition of the Thordarson Catalog is now available. Describing the complete Thordarson line of transformers and chokes for replacement and amateur purposes, this up-to-date catalog also contains circuit diagrams, charts and curves showing applications for Audio, Power, Modulator, Output and Plate Transformers and Chokes . . . as well as complete circuit diagrams and application notes for photo-flash power supplies. Compiled by the engineering staff of America's oldest transformer manufacturing company, it is a worthy addition to your technical library.



SEND FOR YOUR FREE COPY TODAY

ELECTRONIC DISTRIBUTOR & INDUSTRIAL SALES DEPT.
MAGUIRE INDUSTRIES INC., 936 N. MICHIGAN AVE., CHICAGO 11, ILL.

PLEASE SEND MY FREE COPY OF THE NEW 1947
THORDARSON CATALOG, POSTPAID, TO THE ADDRESS BELOW.

THORDARSON

ELECTRONIC DISTRIBUTOR &
INDUSTRIAL SALES DEPARTMENT

MAGUIRE

INDUSTRIES, INC.

936 N. MICHIGAN AVENUE, CHICAGO 11, ILLINOIS

EXPORT: SCHEEL INTERNATIONAL, INCORPORATED
4237 N. LINCOLN AVENUE, CHICAGO 18, ILLINOIS, CABLE HARSHEEL.

NAME _____

STREET _____

CITY _____ STATE _____

ELECTRONIC

EQUIPMENT

BARGAINS

JOBBERS

WHOLESALEERS

MANUFACTURERS

Large inventories of valuable electronic tubes, devices and equipment are being offered by the WAA Approved Distributors listed herewith for your convenience. Alert commercial buyers are taking advantage of this big bargain opportunity. Why not fill *your* present and future requirements from these available stocks. Act now—while inventories still permit wide selection.

Purchase of this surplus equipment has been greatly simplified. The Approved Distributors appointed by WAA were selected on a basis of their technical background and their ability to serve you intelligently and efficiently. Write, phone or visit your nearest Approved Distributor for information concerning inventories, prices and delivery arrangements. You'll find you can "Save with Surplus."

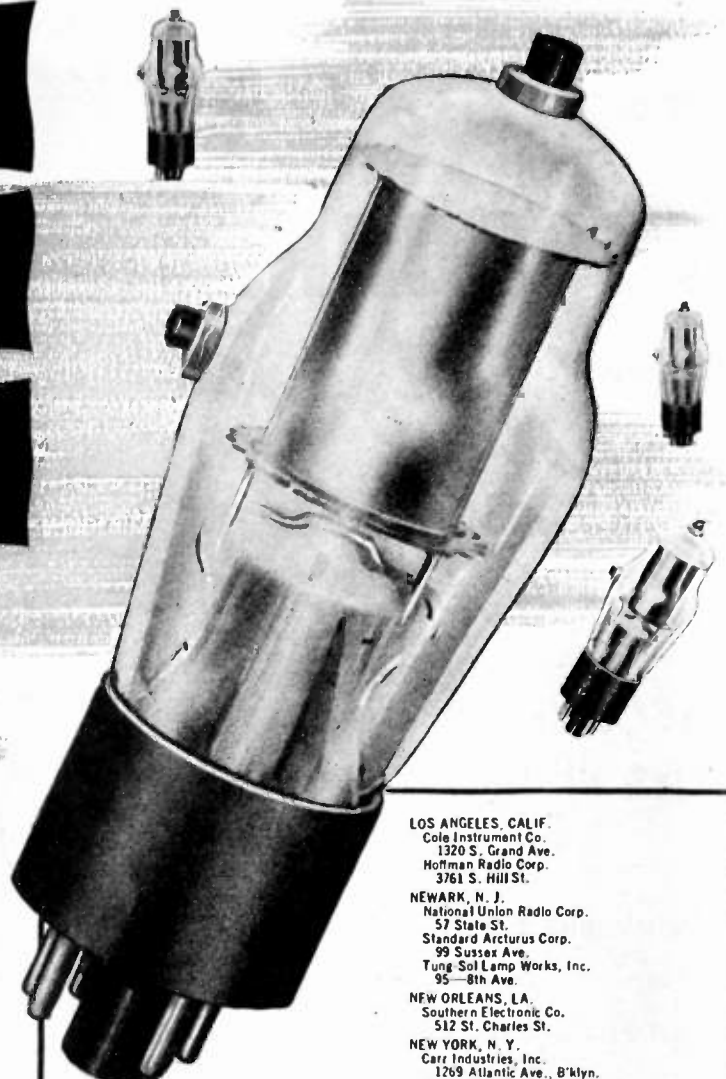

LOS ANGELES, CALIF.
Cole Instrument Co.
1320 S. Grand Ave.
Hoffman Radio Corp.
3761 S. Hill St.

NEWARK, N. J.
National Union Radio Corp.
57 State St.
Standard Arcturus Corp.
99 Sussex Ave.
Tung-Sol Lamp Works, Inc.
95—8th Ave.

NEW ORLEANS, LA.
Southern Electronic Co.
512 St. Charles St.

NEW YORK, N. Y.
Carr Industries, Inc.
1269 Atlantic Ave., B'klyn.
Electronic Corp. of America
353 W. 48th St.

Emerson Radio & Phonograph Corp.
75—9th Ave.
General Electronics, Inc.
1819 Broadway
Hammarlund Mfg. Co., Inc.
460 W. 34th St.
Johanns & Keegan Co., Inc.
52 Pearl St.
Newark Electric Co., Inc.
242 W. 55th St.
Smith-Meeker Engineering Co.
125 Barclay St.

NORFOLK, VA.
Radio Parts Distributing Co.
128 W. Olney Road

ROCHESTER, N. Y.
W. & H. Aviation Corp.
Municipal Airport

SALEM, MASS.
Hylton Radio & Electronics Corp.
76 LaFayette St.

SCHENECTADY, N. Y.
General Electric Co.
Bldg. 257, 1 River Road

WASECA, MINN.
E. F. Johnson Co.
206 2nd Ave., S. W.

BOSTON, MASS.
Automatic Radio Mfg. Co., Inc.
122 Brookline Ave.
Technical Apparatus Co.
165 Washington St.

BUCHANAN, MICH.
Electro-Voice, Inc.
Carroll & Cecil Sts.

CANTON, MASS.
Tobe Deutschmann Corp.
863 Washington St.

CHICAGO, ILL.
American Condenser Co.
4410 N. Ravenswood Ave.
Belmont Radio Corp.
3633 S. Racine Ave.

EMPORIUM, PENNA.
Sylvania Electric Products, Inc.

FORT WAYNE, IND.
Essex Wire Corp.
1601 Wall St.

HOUSTON, TEXAS
Navigation Instrument Co., Inc.
P. O. Box 7001, Heights Station

OFFICE OF AIRCRAFT AND ELECTRONICS DISPOSAL

WAR ASSETS ADMINISTRATION



Offices located at: Atlanta • Birmingham • Boston • Charlotte • Chicago • Cincinnati • Cleveland
Dallas • Denver • Detroit • Fort Worth • Helena • Houston • Jacksonville • Kansas City, Mo. • Little Rock
Los Angeles • Louisville • Minneapolis • Nashville • New Orleans • New York • Omaha • Philadelphia
Portland, Ore. • Richmond • St. Louis • Salt Lake City • San Antonio • San Francisco • Seattle • Spokane • Tulsa

1284

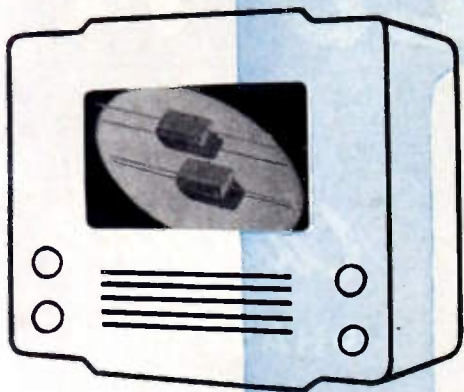

A GOOD TRADEMARK
is
BUT A REFLECTION OF
Many **OTHERS**

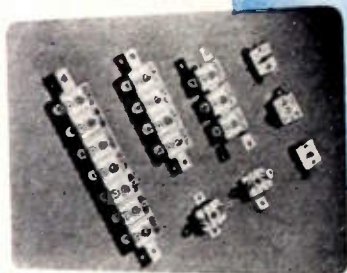
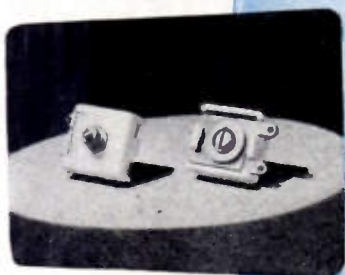

WHEN a manufacturer puts his trademark on a product, he not only expresses pride in his own workmanship, but also his confidence in the trademarks of those who have contributed vital parts to its manufacture. For instance — on capacitors he recognizes the El-Menco branding as his assurance of trustworthy performance under all operating conditions.

JOBBERS & DISTRIBUTORS
 Arco Electronics,
 135 Liberty St., New York, N. Y.
 is Sole Agent for El-Menco Products

Foreign Radio and Electronic Manufacturers
 communicate direct with our Export Department
 at Willimantic, Conn., for information.

THE ELECTRO MOTIVE MFG. CO., Inc., Willimantic, Conn.



Write on firm letterhead
 for samples and
 catalog.



MOLDED MICA

El-Menco
CAPACITORS

MICA TRIMMER

THIS PROVES IT!

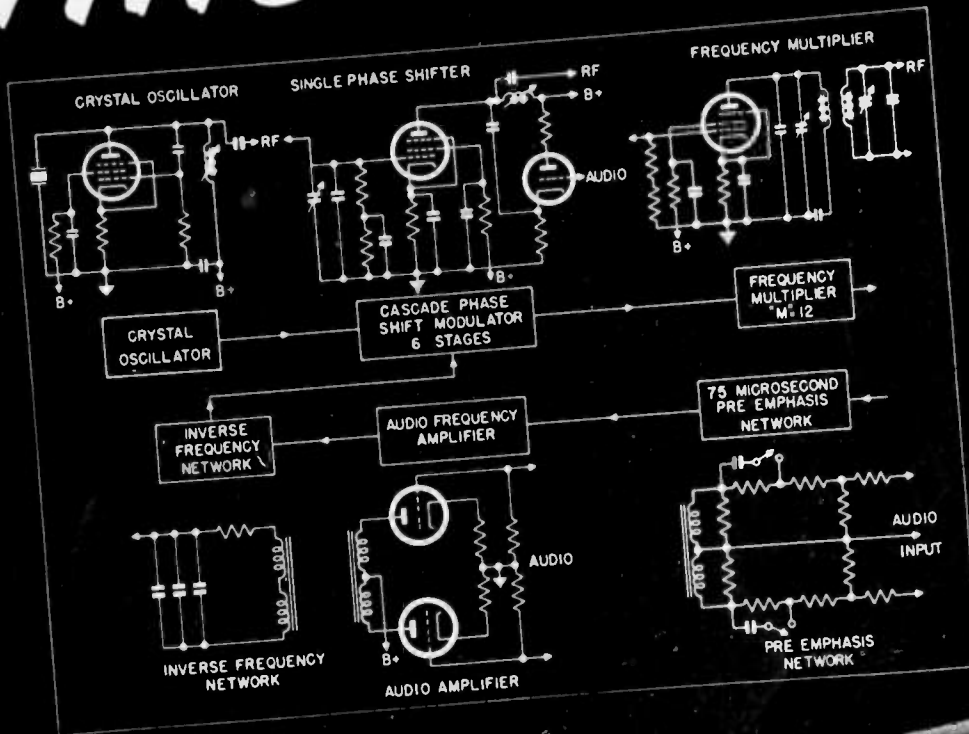

Cascade
**PHASE
 SHIFT
 MODULATION**

RAYTHEON FM

IS BETTER...

12 Ways



Excellence in Electronics

BECAUSE IT:

1. Features direct crystal control
2. Gives the most desirable electrical characteristics
3. Contains fewest circuits, fewest tubes
4. Has the simplest circuits
5. Is easiest to tune and maintain
6. Has *inherently* the lowest distortion level

AND ELIMINATES ALL:

7. High orders of multiplication
8. Complex circuits
9. Expensive special purpose tubes
10. Discriminator frequency control circuits
11. Pulse counting circuits for frequency control
12. Motor frequency stabilizing devices

See your consulting engineer and write for fully illustrated booklet giving complete technical data and information. Write today to:

RAYTHEON MANUFACTURING COMPANY

COMMERCIAL PRODUCTS DIVISION, WALTHAM 54, MASSACHUSETTS

Industrial and Commercial Electronic Equipment, Broadcast Equipment, Tubes and Accessories

Sales offices: Boston, Chattanooga, Chicago, Dallas, Los Angeles, New York, Seattle

Check first with **ERIE RESISTOR**

- ✓ **YOU CAN SAVE SPACE**
- ✓ **YOU CAN CUT COSTS**
- ✓ **YOU CAN INCREASE EFFICIENCY**

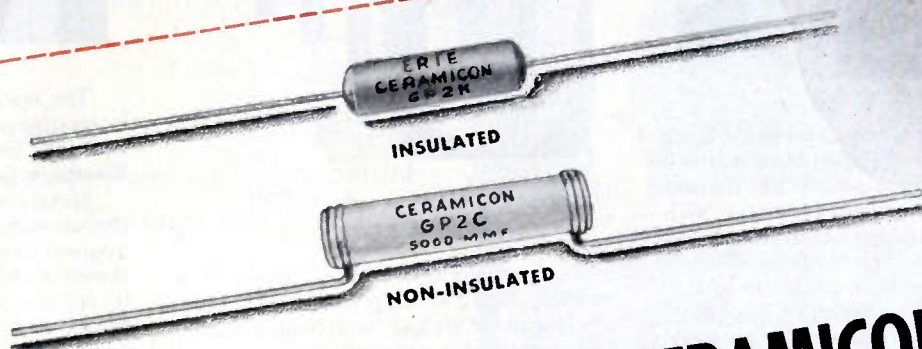

✓ **by using ERIE "GP" CERAMICONS***
for general purpose applications

THE low price of ERIE "GP" Ceramicons is not attained by sacrifice of quality, but by mass production methods; and mass production methods are possible because of the wide field of application—wherever the condenser is not directly frequency determining.

But the economy of ERIE "GP" Ceramicons is not due alone to their low price. They save space because high capacities are available in extremely compact sizes, and because the tubular shape is in itself space-saving

compared to condensers of rectangular shape in equal capacity. ERIE "GP" Ceramicons also speed up production, because they are easy to handle in the assembly line.

These Ceramicons have excellent electrical properties, with higher resonant frequencies, a factor of increasing importance with the trend to FM and Television.

ERIE "GP" Ceramicons are made in insulated styles in popular capacity values up to 5000 MMF., and in non-insulated styles up to 10,000 MMF. Write for details and samples.

*Ceramicon is the registered trade name of silvered ceramic condensers made by Erie Resistor Corporation.



Electronics Division
ERIE RESISTOR CORP., ERIE, PA.
LONDON, ENGLAND • • TORONTO, CANADA



September 1947

Turntable Console

Greater efficiency in handling, cueing, and playing of transcriptions has been achieved by Detroit's radio station WJR in cooperation with Fairchild Camera & Instrument Corp., of Jamaica, N. Y. This has resulted in a perfected turntable console said to be capable of meeting the most exacting reproduction problems with utmost flexibility.

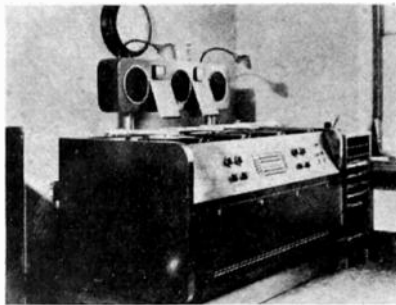

Two operators are assigned to the bank of four turntables equipped with vertical-lateral pickups. Each pickup has its own filter network and built-in cue circuit with separate cueing loudspeaker. Because of the system of playing recordings of music as well as spot announcements from this blind position, the operators also have built in talkback equipment connected directly to the announcers' stand-by and spot studios. The console is so designed that each table can be fed to a different circuit or mixed on one channel. Two separate amplifiers have been wired in, one handling the left two tables, the other the right pair.

Frequently all four tables will be in use, one possibly feeding an audition to a client, one for a chain-break spot, another for a delayed network program, and the fourth feeding into the cutting circuit for re-dubbing purposes.

According to the designers, this centralization of all waxed activities decreases the percentage of damaged or misplaced disks, and allows for better over-all operating efficiency.

The illustration shows push-button controls and attenuators as well as filter controls giving the operator full fingertip jurisdiction over two outgoing channels. Additional channels will be patched in upon a moment's notice.

Such a bank of turntables is most useful during disk-jockey programs where frequent 33½-r.p.m. commercial spots are inserted between live patter and 78-r.p.m. recorded music.

The Fairchild console incorporates ideas of the entire engineering staff of Detroit's CBS affiliate.

These manufacturers have invited PROCEEDINGS readers to write for literature and further technical information. Please mention your I.R.E. affiliation.

Television Capacitors

Television set manufacturers will be interested in the new series of television capacitors recently announced as an addition to the line of capacitors manufactured by Cornell-Dubilier Electric Corp., South Plainfield, N. J.

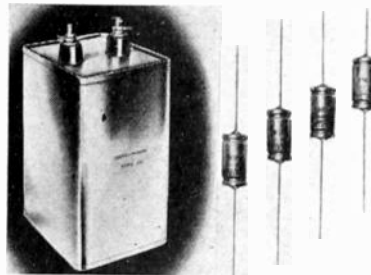

Type G.C.

Type TMC

Impregnated and filled with Dykanol, a dielectric liquid which provides exceptionally long life at high ambient temperatures, and hermetically sealed, the capacitors are made in various capacitance and voltage ranges to meet specific needs.

Type GC1A00, pictured here, is an example of these high-voltage units designed specifically for filter applications in television receiver circuits.

Type TMC is extremely compact in size, moderate in cost, and ruggedly built to exacting standards. It is housed in tubular, hermetically sealed containers of seamless drawn-metal tubing. The capacitors are self-supporting, as one lead is brought out from each end. Available capacitance range from 0.005 to 0.05 Mfd., d.c. voltage ratings from 2,000 to 5,000.

NOTICE

Information for our News and New Products section is warmly welcomed. News releases should be addressed to Mrs. Harriet P. Watkins, I.R.E. Industry Research Division, Room 707, 303 West 42nd St., New York 18, N. Y. Photographs, and electrotypes if not over 2" wide, are helpful. Stories should pertain to products of interest specifically to radio engineers.

Degassing Chambers

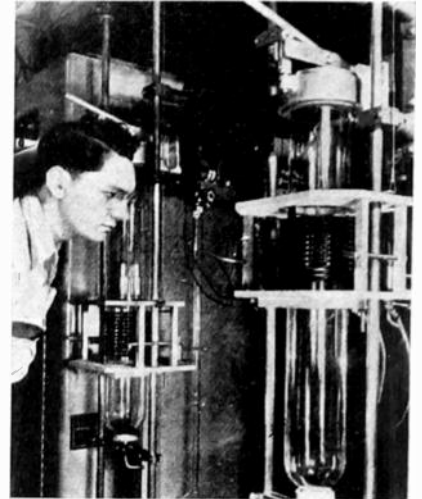

The operator watches progress of an interesting phase in the production of electron-tube parts at the plant of Amperex Electronic Corporation in Brooklyn, N. Y.

Metal components which are placed in the vacuum jars get white-hot then high-frequency current passes through the coils shown in the photo. This forces the metal to release occluded gas, which is then drawn off by the oil-diffusion pump used in the exhausting process.

New Aluminum Solder



Prolyt, the new aluminum solder from Switzerland, manufactured and distributed in the United States by Aluminum Solder Corp., 10 East 52nd St., New York 17, N. Y., is used to join an aluminum cable with a standard copper lug. Soldering technique, as shown in the picture, is simple and no flux or flux substitute is required. Recent tests at the New York Testing Laboratories have shown that such a joint when soldered with Prolyt has greater vibration strength than the wire itself. Electrical resistance at the joint is in the range of 20 microhms. Even after a 250-hour salt spray, the resistance increased only a negligible amount.

(Continued on page 48A)

IF IT'S UHF EQUIPMENT

WE CAN

- DESIGN
- DEVELOP
- PRODUCE IT!

LAVOIE LABORATORIES are specialists in high frequency work. We can begin with your own ideas — design, develop and produce; or we can manufacture (in any quantity) from your blue-prints.

In either event, we can do a business-like job because we have the personnel and equipment for precision work plus a background of practical experience.

A few typical examples of LAVOIE-produced equipment are shown, including Frequency Standards—Frequency Meters—Receivers, etc.

Complete information and detailed estimates of LAVOIE service are available promptly without obligation.



Lavoie Laboratories

RADIO ENGINEERS AND MANUFACTURERS
MORGANVILLE, N. J.



Specialists in the Development and Manufacture of UHF Equipment

DEFLECTION COIL
SHELL CYLINDER

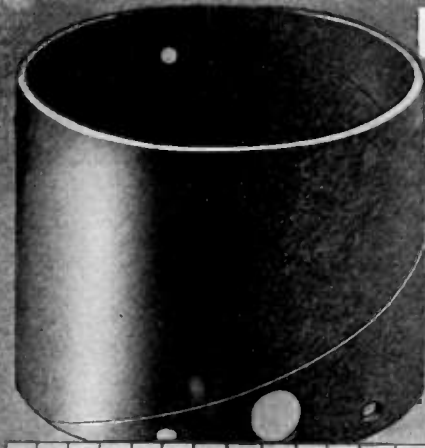

DEFLECTION
COIL CORE

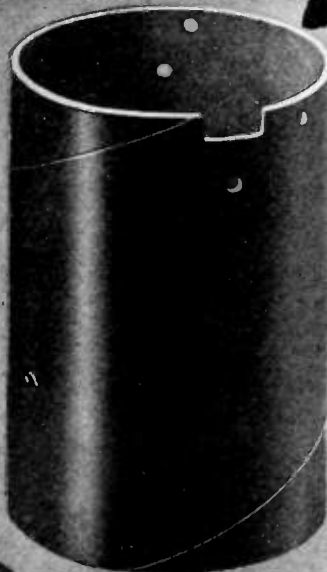
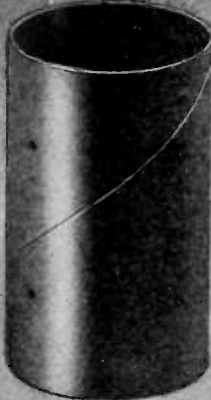

SHELL

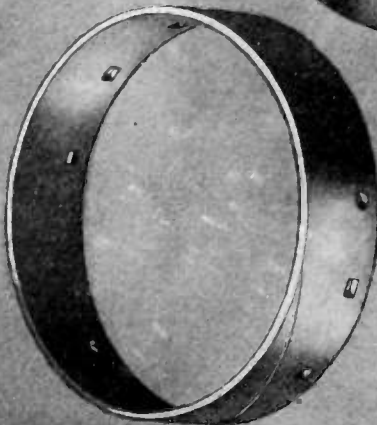

DEFLECTION COIL
TERMINAL RING

RETAINING RING



HALF SHELL

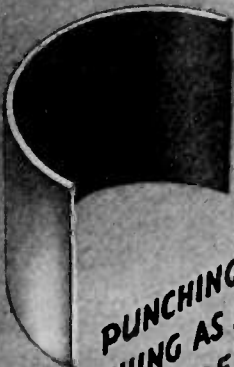

**PUNCHING AND
NOTCHING AS MAY BE
DESIRED.**

*Trade Mark Registered

The CLEVELAND CONTAINER Co.
6201 BARBERTON AVENUE
CLEVELAND 2, OHIO

PRODUCTION PLANTS also at Plymouth, Wisc., Ogdensburg, N. Y., Chicago, Ill., Detroit, Mich., Jamesburg, N. J.,
PLASTICS DIVISIONS at Plymouth, Wisc., Ogdensburg, N. Y. • ABRASIVE DIVISION at Cleveland, Ohio
New York Sales Office—1186 Broadway, Room 223

IN CANADA—The Cleveland Container Canada Ltd., Prescott, Ontario

PUNCHED COSMALITE*
COIL FORMS FOR..

Television RECEIVERS

A new and further step in the ever increasing use of these spirally laminated paper base, Phenolic Tubes. Performance based upon approximately seven years of research.

Other Cosmalite Types—

#96 COSMALITE for coil forms in all standard broadcast receiving sets.
SLF COSMALITE for Permeability Tuners.

Spirally wound kraft and fish paper Coil Forms and Condenser Tubes.

Attractive prices.
Fast deliveries.

Inquiries given specialized attention



Accent on

MOTION

The famous Model 80 Even Speed Alliance Phonomotor operating on 110 or 220 volts is made for 40, 50 or 60 cycles, 16 watts input, 78 RPM. It has no gears—runs at an even speed—has a smooth, quiet, positive friction-rim drive. Ample proportioned bearings with large oil reservoirs assure long life. A slip-type fan gives cool operation—avoids any possible injury.

The Alliance Model K Phonomotor, a 25 cycle companion to the Model 80, operates on 110 volts, 25 cycles at 12 watt input. Motor and idler plate on Alliance phonomotors are all shock mounted to the cabinet mounting plate, to minimize vibration.

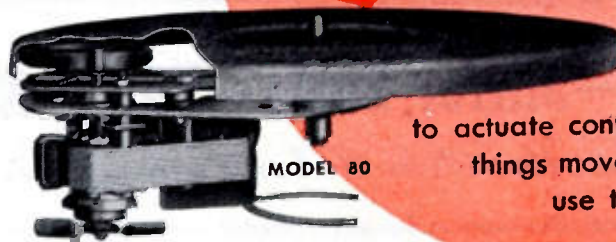

The trend is to make things move!

Designs will call for more action—movement! Flexible product performance needs power sources which are compact, light weight! Alliance Powr-Pakt Motors rated from less than 1-400th on up to 1-20th h.p. will fit those "point-of-action" plates! Alliance Motors are mass produced at

low cost—engineered for small load jobs!

For vital component power links

to actuate controls...to make things move...plan to use them!



WHEN YOU DESIGN—KEEP

alliance

MOTORS IN MIND

ALLIANCE MANUFACTURING COMPANY • ALLIANCE, OHIO

NOW

625 NA* VOLT-OHM-MIL-AMMETER

RANGES

- Six D.C. Volts to 2,500 at 20,000 Ohms per Volt.
- Six D.C. Volts to 5,000 at 10,000 Ohms per Volt.
- Six A.C. Volts to 5,000 at 10,000 Ohms per Volt.
- Six Current Ranges: 0-50 Micro-amperes to 0-10 Amperes.
- Three Resistance 0-2000-200,000 Ohms; 0-4 Megohms.
- Six Decibel Ranges: -30 to +69.
- Six Output Ranges to 5,000 Volts.

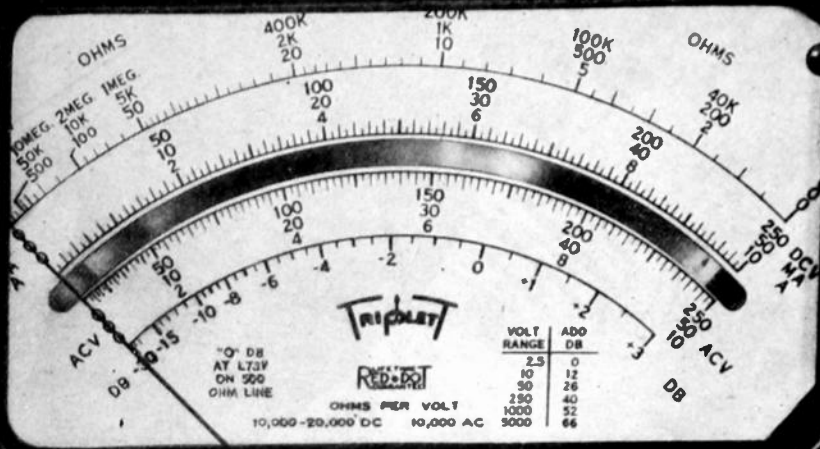

CAUTION ON HIGH VOLTS



* High Ohms—Mirror Scale—Thirty-Nine Ranges

For the Man Who Takes Pride in His Work

The new Model 625NA, with 39 ranges and many added features, is the widest range tester of its type. Note the long mirror scale on the large 6" meter for easier more accurate reading. Resistance ranges to 40 megohms give you all the ranges

needed for general servicing, plus Television and FM. And with 10,000 ohms per volt A. C. you can check many audio and high impedance circuits where a Vacuum Tube Volt meter is ordinarily required. A proven super-service instrument

Write for details today about Model 625NA and the many other new Triplet testers. Address Dept. H97.



Triplet

ELECTRICAL INSTRUMENT CO. BLUFFTON, OHIO



BOOST KVA RATING BY FIVE OR MORE . . .

CUT PRESENT SIZES OF POWER CAPACITORS . . .

AEROVOX SERIES 1780

Water-cooled **MICA CAPACITORS**

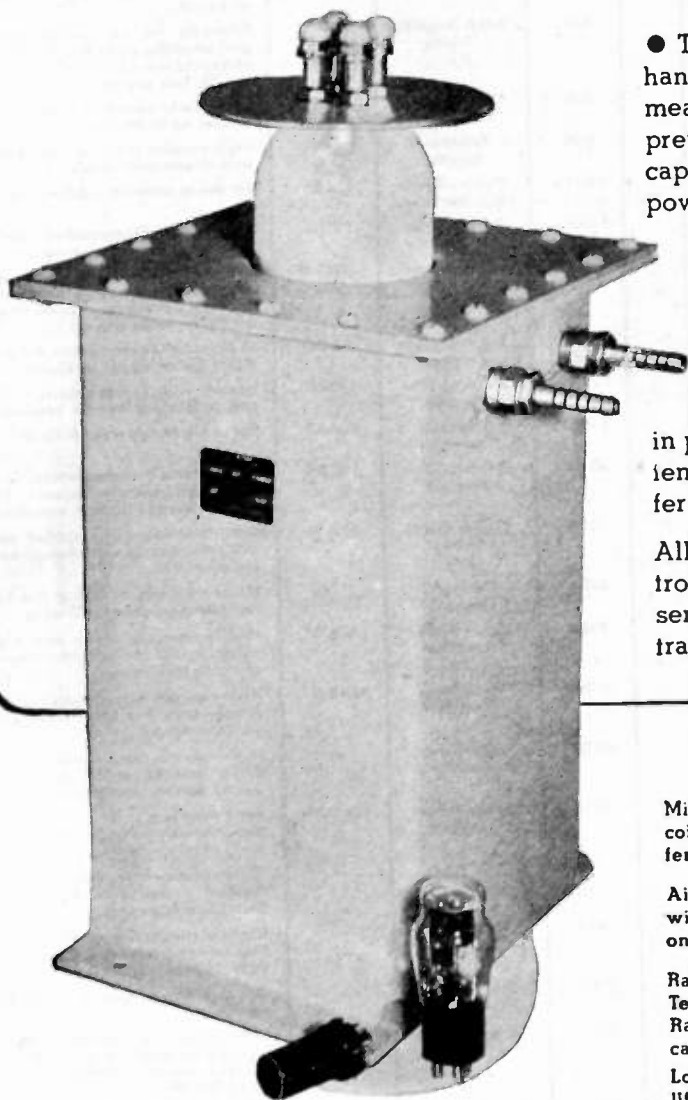

● This new water-cooled oil-filled mica capacitor handles exceptional KVA loads for its size. This means that more power can be handled than with previous capacitors of similar size or, conversely, capacitor size can be greatly reduced for given power ratings.

Series 1780 capacitors attain their higher KVA ratings in two ways: (1) By exceptional design such as critical arrangement and location of sections; choice of materials; specially-plated parts; large cross-section of conductors; careful attention to details and true craftsmanship in production. (2) By the use of a water-cooling system so designed as to provide maximum heat transfer from capacitor section to cooling coils.

All in all, here is a sturdy, compact, hard-working, trouble-free mica capacitor for extra-heavy-duty service, such as induction furnaces and high-power transmitters.

Featuring...

Mica stacks in oil bath. Cooling coils in oil bath for efficient transfer of heat.

Air-cooled operation, 200 KVA; with water-cooling, 1000 KVA—a one-to-five ratio.

Ratings up to 25,000 volts A.C. Test. Capacitances up to .01 mfd. Rated loads up to 1000 KVA. Typical unit: 20,000 V. at .01 mfd.

Lower power factor (.01%). Long life and large factor of safety.

Provisions for making connections with high-current-capacity conduc-

tors. Four-stud terminal. Grounded case.

Heavy welded metal case, hermetically sealed. Exceptionally sturdy construction.

Series-parallel mica stack designed for uniform current distribution throughout.

Silver-plated hardware for minimum skin resistance. To minimize or eliminate corona, terminals are finished with large radii of curvature. Steatite insulator shaped to hold gradients below corona limits.

TECHNICAL DATA ON REQUEST

FOR RADIO-ELECTRONIC AND INDUSTRIAL APPLICATIONS

AEROVOX CORPORATION, NEW BEDFORD, MASS., U.S.A.

SALES OFFICES IN ALL PRINCIPAL CITIES • Export: 13 E. 40th St., NEW YORK 16, N. Y.

Cable: 'ARLAB' • In Canada: AEROVOX CANADA LTD., HAMILTON, ONT.



RCA QUICK-REFERENCE CHART MINIATURE TUBES

RCA Miniatures make practical, compact, lightweight designs. Often, they provide superior performance at less cost.

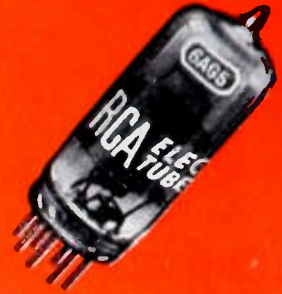

Type No.	Class	Performance Equivalent	Applications
OA2	Voltage Regulator	OD3/VR150	Cold-Cathode Glow-Discharge Type.
IA3	H-F Diode	—	Heater-Cathode type. Discriminator for battery-operated FM receivers; portable h-f measuring equipment. Resonant frequency about 1000 Mc.
IL4	R-F Amplifier Pentode	IU4	Filamentary type. Sharp cutoff characteristic. For battery-operated portables.
IR5	Pentagrid Converter	—	Filamentary type. Mixer tube and oscillator in superheterodyne circuits. For portable receivers.
IS4	Power Amplifier Pentode	3S4	Filamentary type. For battery receivers.
IS5	Diode-Pentode	—	Filamentary type. High voltage gain. For broadcast receivers.
IT4	Super-Control R-F Amplifier Pentode	—	R-F or I-f amplifier in battery-operated receivers.
IU4	R-F Amplifier Pentode	INS-GT	Sharp cutoff characteristic. For low-drain battery-operated receivers.
2D21	Thyatron Tetrode	2050	Relay tube and grid-controlled rectifier. Will operate directly from high-vacuum phototube.
3A4	Power Amplifier Pentode	—	Filamentary type. A-F output of 700 milliwatts, or r-f output of 1.2 watts at 10 Mc.
3A5	H-F Twin Triode	—	Filamentary type. For use in h-f applications. Class C output about 2 watts at 40 Mc.
3Q4	Power Amplifier Pentode	3Q5-GT	Filamentary type. For 3-way battery portable receivers.
3S4	Power Amplifier Pentode	IS4	Filamentary type. For battery portable equipment.
3V4	Power Amplifier Pentode	3Q4	Filamentary type. Similar to 3Q4, but has preferable biasing arrangement. For 3-way battery portable receivers.
6AG5	R-F Amplifier Pentode	—	Sharp cutoff characteristic. High transconductance and low input and output capacitance. I-F video amplifier or r-f amplifier up to 400 Mc.
6AK5	R-F Amplifier Pentode	—	Sharp cutoff characteristic. High transconductance, low input and output capacitance, and low input conductance at high frequencies.
6AK6	Power Amplifier Pentode	6G6-G	Singly or in push-pull in output stage. A-F power output 1.1 watts per tube.
6AL5	H-F Twin Diode	—	High permeance makes it particularly useful as an F-M detector.
6AQ5	Beam Power Amplifier	6V6	For automobile and ac-operated receivers.
6AQ6	Duplex-Diode High-Mu Triode	6S27	Combined detector, a-f amplifier, and avc tube.
6AT6	Duplex-Diode High-Mu Triode	6SQ7	Combined detector, amplifier, and avc tube.
6AU6	R-F Amplifier Pentode	6SH7	Sharp cutoff characteristic. High transconductance and low grid-plate capacitance. Limiter for FM receivers.
6BA6	R-F Amplifier Pentode	6SG7	Remote cutoff characteristic. High transconductance and low grid-plate capacitance. For r-f and I-f stages of FM and AM receivers.
6BE6	Pentagrid Converter	6SA7	Mixer tube and oscillator in superheterodyne circuits. For FM and AM receivers.

Type No.	Class	Performance Equivalent	Applications
6BF6	Duplex-Diode Triode	6SR7	For use as a combined detector, amplifier, and avc tube. For auto and ac-operated receivers.
6C4	V-H-F Power Triode	—	Class C amplifier and oscillator. Class C output about 5.5 watts at moderate frequencies, 2.5 watts at 150 Mc.
6J4	U-H-F Amplifier Triode	—	Primarily for use as grounded-grid amplifier up to 500 Mc. Transconductance 12000 micromhos, $\mu\mu$ 55, low capacitances.
6J6	Twin Triode	—	Particularly useful as mixer or oscillator up to 600 Mc.
6X4	Full-Wave Rectifier	6X5	High-vacuum type. For use in auto and ac-operated receivers.
12AT6	Duplex-Diode High-Mu Triode	12SQ7	For use in compact ac/dc receivers.
12AU6	R-F Amplifier Pentode	12SH7	Sharp cutoff characteristic. Limiter tube for ac/dc FM receivers.
12AU7	Twin Triode Amplifier	12SN7-GT	Separate terminals for each cathode, and mid-tapped heater for 6.3- or 12.6-volt operation. Mixer oscillator, multivibrator.
12AW6	R-F Amplifier Pentode	6AG5	Sharp cutoff characteristic. R-F amplifier for ac/dc FM receivers.
12BA6	R-F Amplifier Pentode	12SG7	Remote cutoff characteristic. For use in compact ac/dc receivers.
12BE6	Pentagrid Converter	12SA7	For use in compact ac/dc receivers.
26A6	R-F Amplifier Pentode	12BA6	Remote cutoff characteristic. Features high transconductance. For 12-cell storage-battery operation.
26C6	Duplex-Diode Triode	12AT6	Combined detector, amplifier, and avc tube. For 12-cell storage-battery operation.
26D6	Pentagrid Converter	12BE6	Mixer tube and oscillator. For 12-cell storage-battery operation.
35B5	Beam Power Amplifier	35L6-GT	High power sensitivity and high efficiency for use in output stages of ac/dc receivers.
35W4	Half-Wave Rectifier	35Z5-GT	High-vacuum type. Heater tap for panel lamp. For use in compact ac/dc receivers.
45Z3	Half-Wave Rectifier	—	High-vacuum type. Heater rating, 0.075 ampere at 45 volts. For 3-way battery portable receivers.
50B5	Beam-Power Amplifier	50L6-GT	For output use in ac/dc receivers. Maximum-signal power output, 1.9 watts.
117Z3	Half-Wave Rectifier	—	High-vacuum type. For supplying rectified power to 3-way battery portable equipment.
1654	Half-Wave Rectifier	—	High-vacuum, filamentary type. Maximum peak inverting 7000 volts, filament current 0.05 ampere.
9001	Sharp Cutoff U-H-F Pentode	—	R-F amplifier or detector in U-H-F service.
9002	U-H-F Triode	—	U-H-F detector and amplifier. May be used as oscillator in superheterodyne receivers at frequencies up to 500 Mc.
9003	Remote Cutoff U-H-F Pentode	—	Useful as a mixer or as an r-f or I-f amplifier in U-H-F service.
9006	U-H-F Diode	—	For U-H-F service as rectifier, detector, or measuring device. Resonant frequency, about 700 Mc.

For additional technical data on these types, refer to the RCA HB-3 Handbook, or write RCA, Commercial Engineering, Section R-521, Harrison, N.J.

THE FOUNTAINHEAD OF MODERN TUBE DEVELOPMENT IS RCA



TUBE DEPARTMENT

RADIO CORPORATION of AMERICA

HARRISON, N. J.

BOARD OF DIRECTORS, 1947

Walter R. G. Baker
President

Noel Ashbridge
Vice-President

Raymond F. Guy
Treasurer

Haraden Pratt
Secretary

Alfred N. Goldsmith
Editor

William L. Everitt
Senior Past President

Frederick B. Llewellyn
Junior Past President

1945-1947

Stuart L. Bailey
Keith Henney
B. E. Shackelford

1946-1948

Virgil M. Graham
Frederick R. Lack
Donald B. Sinclair

1947-1949

Murray G. Crosby
Raymond A. Heising
William C. White

1947

J. E. Brown
Jack R. Poppele
David Smith

Harold R. Zeamans
General Counsel

George W. Bailey
Executive Secretary

Laurence G. Cumming
Technical Secretary

BOARD OF EDITORS

Alfred N. Goldsmith
Chairman

PAPERS REVIEW COMMITTEE

Murray G. Crosby
Chairman

PAPERS PROCUREMENT COMMITTEE

Dorman D. Israel
General Chairman

PROCEEDINGS OF THE I.R.E.

(Including the WAVES AND ELECTRONS Section)

Published Monthly by

The Institute of Radio Engineers, Inc.

VOLUME 35

September, 1947

NUMBER 9

PROCEEDINGS OF THE I.R.E.

J. R. Poppele, Board of Directors, 1947.....	859
Science Legislation and National Progress.....	
..... Frederick Emmons Terman	860
2851. An Experimental Simultaneous Color-Television System, Part I—Introduction.....	R. D. Kell 861
2852. Part II—Pickup Equipment.....	
..... G. C. Sziklai, R. C. Ballard, and A. C. Schroeder	862
2853. Part III—Radio-Frequency and Reproducing Equipment.....	
..... K. R. Wendt, G. L. Fredendall, and A. C. Schroeder	871
2854. Electrical Noise Generators.....	
..... J. D. Cobine and J. R. Curry	875
2855. The Design of Speech Communication Systems... ..	Leo L. Beranek 880
2856. 3- and 9-Centimeter Propagation in Low Ocean Ducts.....	Martin Katzin, Robert W. Bauchman, and William Binnian 891
2857. Broad-Band Noncontacting Short Circuits for Coaxial Lines. Part I.—TEM-Mode Characteristics.....	William H. Huggins 906
2858. Velocity-Modulated Reflex Oscillator.....	J. M. Lafferty 913
2859. Design of Simple Broad-Band Wave-Guide-to-Coaxial-Line Junctions.....	Seymour B. Cohn 920
2717. Discussion on "The Maximum Range of a Radar Set" by Kenneth A. Norton and Arthur C. Omberg.....	Jerome Freedman and Kenneth A. Norton 927
2551. Discussion on "The Transverse Electric Modes in Coaxial Cavities" by Robert A. Kirkman and Morris Kline.....	William H. Huggins, Morris Kline and Robert A. Kirkman 931
Contributors to PROCEEDINGS OF THE I.R.E.....	935
Correspondence:	
2860. "Report on Professional Standing to the Canadian Council".....	E. G. Cullwick 938
2762. "A Source of Error in Radio Navigation Systems which Depend on the Velocity of a 'Ground-Wave'".....	J. A. Ratcliffe 938

EDITORIAL DEPARTMENT

Alfred N. Goldsmith
Editor

Clinton B. DeSoto
Technical Editor

Mary L. Potter
Assistant Editor

William C. Copp
Advertising Manager

Lillian Petranek
Assistant Advertising Manager

Responsibility for the contents of papers published in the PROCEEDINGS OF THE I.R.E. rests upon the authors. Statements made in papers are not binding on the Institute or its members.

Changes of address (with advance notice of fifteen days) and communications regarding subscriptions and payments should be mailed to the Secretary of the Institute, at 450 Ahnaip St., Menasha, Wisconsin, or 1 East 79 Street, New York 21, N. Y. All rights of republication, including translation into foreign languages, are reserved by the Institute. Abstracts of papers, with mention of their source, may be printed. Requests for republication privileges should be addressed to The Institute of Radio Engineers.

(Table of Contents continued on page 858)

Copyright, 1947, by The Institute of Radio Engineers, Inc.



BOARD OF EDITORS

Alfred N. Goldsmith,
Chairman

- F. W. Albertson
- J. S. Allen
- G. M. K. Baker
- W. L. Barrow
- R. R. Batcher
- A. E. Bowen
- R. M. Bowie
- Ralph Bown
- R. S. Burnap
- O. H. Caldwell
- C. W. Carnahan
- L. W. Chubb
- L. M. Clement
- J. D. Cobine
- M. G. Crosby
- R. B. Dome
- W. G. Dow
- E. W. Engstrom
- W. L. Everitt
- W. G. H. Finch
- D. G. Fink
- H. C. Forbes
- I. A. Getting
- G. W. Gilman
- P. C. Goldmark
- A. W. Graf
- F. W. Grover
- L. B. Headrick
- E. W. Herold
- J. A. Hutcheson
- C. M. Jansky, Jr.
- J. K. Johnson
- L. F. Jones
- H. S. Knowles
- J. D. Kraus
- J. B. H. Kuper
- J. T. Lawson
- D. G. Little
- F. B. Llewellyn
- S. S. Mackeown
- Nathan Marchand
- E. D. McArthur
- Knox McIlwain
- J. W. McRae
- L. A. Meacham
- G. F. Metcalf
- E. L. Nelson
- D. O. North
- H. F. Olson
- R. M. Page
- H. O. Peterson
- G. W. Pickard
- Haraden Pratt
- C. A. Priest
- J. R. Ragazzini
- Simon Ramo
- H. J. Reich
- J. D. Reid
- F. X. Rettenmeyer
- P. C. Sandretto
- S. W. Seeley
- V. W. Sherman
- L. C. Smeby
- C. E. Smith
- J. A. Stratton
- W. C. Tinus
- K. S. Van Dyke
- E. K. Van Tassel
- E. C. Wente
- H. A. Wheeler
- J. R. Whinnery
- W. C. White
- L. E. Whittemore
- G. W. Willard
- William Wilson
- I. G. Wolff
- V. K. Zworykin

TABLE OF CONTENTS (Continued)

INSTITUTE NEWS AND RADIO NOTES

SECTION

A Statement to the Membership Concerning Publication Plans and Problems.....	939
Minutes of Institute Committee Meeting.....	939
Constitution.....	940
West Coast I.R.E. Convention.....	942
Industrial Engineering Notes.....	942
Sections.....	944
Books:	
2861. "Radar Engineering," by Donald G. Fink...Reviewed by Kenneth A. Norton	946
2862. "Theory and Application of Radio-Frequency Heating," by George H. Brown, Cyril N. Hoyler, and Rudolph A. Bierwirth.....Reviewed by T. P. Kinn	946
2863. "Electricity—Principles, Practice, Experiments," by Charles S. Siskind.....Reviewed by J. D. Ryder	946
2864. "Standard FM Handbook," edited by Milton B. Sleeper.....Reviewed by Murray G. Crosby	946
I.R.E. People.....	947

WAVES AND ELECTRONS

SECTION

Officers, Princeton Subsection.....	949
Standards.....A. B. Chamberlain	950
2865. Liberal Education for the Engineering Profession.....H. S. Rogers	951
2866. Proposed Method of Rating Microphones and Loud Speakers for Systems Use..... Frank F. Romanow and Melville S. Hawley	953
2867. Intermediate-Frequency Amplifiers for Frequency-Modulation Receivers...J. J. Adams..	960
2868. A Microwave Frequency Standard..... ...Richard G. Talpey and Harold Goldberg	965
2869. A Note on Coupling Transformers for Loop Antennas.....M. J. Kobilsky	969
2870. A Resistance-Tuned Frequency-Modulated Oscillator for Audio-Frequency Applications Henry S. McGaughan and Charles B. Leslie	974
2871. A Method for Calibrating Microwave Wavemeters.....Lloyd E. Hunt	979
2872. A Method of Graphically Analyzing Cathode-Degenerated Amplifier Stages.....E. M. Lonsdale and W. F. Main	981
Contributors to Waves and Electrons Section....	985
2873. Abstracts and References.....	987
News—New Products.....	26A
Section Meetings... 35A Positions Open....	50A
Membership..... 36A Positions Wanted..	56A
Advertising Index.....	78A

PAPERS PROCUREMENT COMMITTEE

Dorman D. Israel,
Chairman

- | | |
|-------------------|-------------------|
| Andrew Alford | W. P. Mason |
| B. B. Bauer | Pierre Mertz |
| R. M. Bowie | B. J. Miller |
| A. B. Bronwell | I. E. Mouromtseff |
| J. W. Butterworth | A. F. Murray |
| I. F. Byrnes | J. R. Nelson |
| T. J. Carroll | L. L. Nettleton |
| Madison Cawein | G. M. Nixon |
| K. A. Chittick | D. E. Noble |
| B. J. Chromy | T. M. Odarenko |
| J. T. Cimorelli | H. F. Olson |
| Harry Diamond | W. E. Reichle |
| E. Dietze | J. D. Reid |
| G. V. Eltgroth | F. X. Rettenmeyer |
| M. K. Goldstein | H. W. G. Salinger |
| H. Grossman | Robert E. Shelby |
| R. C. Guthrie | W. P. Short |
| D. E. Harnett | P. L. Smith |
| J. R. Harrison | J. Q. Stansfield |
| J. V. L. Hogan | G. R. Town |
| F. V. Hunt | L. G. Trolese |
| T. A. Hunter | H. J. Tyzzer |
| Hans Jaffe | K. S. Van Dyke |
| J. J. Jakosky | W. L. Webb |
| Martin Katzin | J. R. Whinnery |
| C. E. Kilgour | W. C. White |
| A. V. Loughren | G. S. Wickizer |
| I. G. Maloff | R. H. Williamson |
| H. B. Marvin | R. J. Wise |
| | C. J. Young |

PAPERS REVIEW COMMITTEE

Murray G. Crosby,
Chairman

- | | |
|-------------------|--------------------|
| H. A. Affel | C. V. Litton |
| E. W. Allen | H. R. Lubcke |
| C. F. Baldwin | Louis Malter |
| B. de F. Bayly | W. P. Mason |
| F. J. Bingley | R. E. Mathes |
| H. S. Black | H. F. Mayer |
| F. T. Bowditch | H. R. Minno |
| H. A. Chinn | R. E. Moe |
| J. K. Clapp | R. M. Morris |
| I. S. Coggeshall | F. L. Mosely |
| S. B. Cohn | I. E. Mouromtseff |
| J. M. Constable | G. G. Muller |
| F. W. Cunningham | A. F. Murray |
| H. D. Doolittle | J. R. Nelson |
| O. S. Duffendack | K. A. Norton |
| R. D. Duncan, Jr. | H. W. Parker |
| I. E. Fair | L. J. Peters |
| E. H. Felix | A. P. G. Peterson |
| V. H. Fraenckel | W. H. Pickering |
| R. L. Freeman | A. F. Pomeroy |
| Stanford Goldman | S. O. Rice |
| W. M. Goodall | T. H. Rogers |
| W. C. Hahn | H. E. Roys |
| G. L. Haller | M. W. Scheldorf |
| O. B. Hanson | Samuel Seely |
| A. E. Harrison | Harner Selvidge |
| J. R. Harrison | C. M. Slack |
| T. J. Henry | J. E. Smith |
| C. N. Hoyler | P. L. Smith |
| F. V. Hunt | E. E. Spitzer |
| Harley Iams | E. K. Stodola |
| D. L. Jaffe | H. P. Thomas |
| Hans Jaffe | Bertram Trevor |
| W. R. Jones | Dayton Ulrey |
| D. C. Kalbfell | A. P. Upton |
| A. G. Kandoian | G. L. Usselman |
| J. G. Kreer, Jr. | L. Vieth |
| Emil Labin | S. N. Van Voorhies |
| V. D. Landon | R. M. Wilmotte |
| H. C. Leuteritz | J. W. Wright |
| | H. R. Zcamans |



J. R. Poppele

Board of Directors, 1947

J. R. Poppele was born on February 4, 1898, in Newark, N. J. He received his education in electrical engineering at Newark Technical School, and studied wireless at the Marconi Wireless School in New York City. During the first World War he served as a radio operator, and upon termination of service was associated for a year with the Radio Corporation of America.

In 1922, when WOR was established, Mr. Poppele became its chief and only engineer. Today he heads a staff of eighty technicians, and is vice-president and secretary of the board of directors of the station, in charge of all a.m., f.m., television, and facsimile engineering projects for the Bamberger Broadcasting Service, and the service departments of that organization.

He is known as one of America's leading engineers, both in vision and in practice. During his association with WOR he has instituted and maintained a research laboratory in which many devices now in common use have been developed to help the advance of broadcasting. Much of the equipment of the 50,000-watt transmitter in Carteret, New Jersey, was specially designed under his direction.

In the early days of radio, Mr. Poppele was instrumental in staging many broadcasting "firsts." He superintended the first transatlantic communication test to London, the first play-by-play sports description of a remote football game, and was responsible for broadcasting the first on-the-scene golf tournament using intricate electronic equipment in 1926. In 1924 he helped guide back the dirigible

Shenandoah with radio direction, after it had broken away from its mooring mast in Lakehurst, N. J. In 1926, he began television experiments, pioneered in f.m., and developed the directional antenna which concentrates 135,000 watts to a designated area.

Mr. Poppele has also been active in many outside groups. He makes frequent appearances before technical bodies, engineering societies, and other groups, for addresses on the varied phases of radio. He serves as radio consultant to the New Jersey State Police and helped that body in planning the State's radio system. He also aided the Newark, N. J., police in creating its radio car system. During World War II he served as a member of the Board of War Communications and helped develop station synchronization to create enemy deception for radio ranging.

Mr. Poppele joined The Institute of Radio Engineers in 1930 as an Associate, transferred to Member in 1939, and to Senior Member in 1943. He is a member of the board of directors of the Mutual Broadcasting System and is one of the founders, as well as a director and now president, for a third term, of the Television Broadcasters Association, Inc. He was also a founder of the original Frequency Modulation Broadcasters Association. He is a member of the board of directors of the Veteran Wireless Operators Association and chairman of its scholarship committee, a Fellow of the Radio Club of America, a member of the Acoustical Society of America, and a member of the Society of Motion Picture Engineers.

It is generally admitted that scientific research is a source from which may spring better human health and enhanced individual effectiveness, new products and processes of social value, and a strong system of national defense.

Pure and applied research have, however, proven in many instances to be costly and long-term enterprises. Differences of opinion exist as to the most desirable and dependable sources of the funds necessary for the prosecution of research, together with safeguards of the freedom of the research workers against unsuitable outside control of their activities.

The PROCEEDINGS OF THE I.R.E. accordingly presents below a forceful expression of one viewpoint on these topics from a prominent educator, author, and research administrator, now Dean of the School of Engineering of Stanford University, and also a Past President of The Institute of Radio Engineers.—
The Editor.

Science Legislation and National Progress

FREDERICK EMMONS TERMAN

It is now generally appreciated that scientific research is the foundation on which our complex technological civilization rests, and that it is furthermore the basis of our national security.

We also have learned that money spent on scientific research is a highly profitable investment when the benefit that society as a whole receives is balanced against the expenditure involved. Thus, the several hundred million dollars that went into wartime electronic research has resulted in an unprecedented expansion of the radio industry. This is taking the form of rapid exploitation of higher frequencies, the development of new types of communication systems, acceleration in the application of electronic aids to air navigation, and many other activities. The return to society in the next two decades, in the form of increased standards of living and increased safety to life, will undoubtedly be many times the entire cost of the wartime electronic research program.

It is now clear that the prewar level of scientific research, not only in radio but in many other fields, was far below the level that would have been most profitable from the point of view of balancing cost against all the values involved. Moreover, because of the inadequacy of prewar funds, it was almost the rule rather than the exception for universities and similar institutions to concentrate their research largely on problems that called for a minimum of expenditure, rather than on problems most in need of being solved.

In the past, the principal support for fundamental research came from nonprofit organizations, such as universities and foundations. Industrial research, while an indispensable factor in national development and large in magnitude, is largely confined to activities that have a high probability of producing an early profit, and of improving the competitive position of the organization spending the money. Corporations obviously cannot justify to their stockholders the expenditure of large sums on activities that make socially desirable additions to general knowledge, but which have little possibility of bringing a financial return to the corporation within a reasonable number of years, or which will produce results that will be of equal or greater benefit to competitors that do not carry any of the expense involved. Moreover, the important values of fundamental research are frequently of a very long-range type, and it is commonly impossible to foresee what particular industrial groups will be the chief ultimate beneficiaries of any particular research.

National science legislation is intended to provide federal support for the type of research that is needed by society, and yet which industry cannot be expected to

finance, and it is also designed to assist in the training of the additional research workers so badly needed by the country. While nonprofit institutions meet part of these needs, their resources are hopelessly inadequate to meet the requirements of the country as they are now understood. The cost of such a program is readily justified by the fact that money put into research is not a burden on society, but rather can be a highly profitable investment.

Objection has been raised in these pages to federal support of research on the basis that, if the government pays the bill, it will dictate the program.¹ Examination of the actual situation fails to support this viewpoint, however. Thus, state-supported institutions have a good record of carrying on research in the engineering, physical, and biological sciences without political domination. Moreover, there is nothing in the record indicating that the federal government would be more restrictive in the conditions under which it would support research than are private and corporate donors of funds to nonprofit institutions. The experience of the past is, in fact, quite the contrary. An individual donor normally specifies how his gift is to be spent, and frequently desires a building or a fellowship that, while serving a useful purpose, does not provide for the technicians, mechanics, and materials that are needed in laboratory research. As a result, university researchers, both faculty and student, commonly spend a large part of their research time being radio technicians, poor glass blowers, and the like. Similarly, corporate contributors to research quite naturally require that the research they sponsor be in a field that is of direct interest to the corporation, and in addition often expect the university carrying on the research to supply supervision and overhead from its own funds. Many parts of the present program of military-sponsored research are free of these objections. It is expected that a National Science Foundation with broader objectives than the military will evolve a method of operation that is at least as satisfactory.

The close connection between research and radio practice makes the success of national science legislation of direct concern to every radio engineer. Such legislation deserves support, and when a National Science Foundation comes into being, the radio engineer should interest himself in its activities and co-operate fully, so that the scientific foundation for electronics and other technological phases of our civilization will become steadily broader and stronger.

¹R. W. King, "The engineer and science legislation," *Proc. I.R.E.*, vol. 35, p. 339; April, 1947.

An Experimental Simultaneous Color-Television System

Part I—Introduction*

R. D. KELL†, FELLOW, I.R.E.

Summary—During 1945 and 1946 a complete sequential television system was constructed and tested. This was followed by the development of a simultaneous system, compatible with the present commercial monochrome television. This paper is the introduction to a group of two papers which describe the transmitting and receiving apparatus used in the simultaneous system.

WITH THE RESUMPTION of peacetime research and development, color television became a major item in the research program of RCA Laboratories.

A color-television receiver of the simultaneous type had been constructed in 1939. The circuit and tube limitations at that time were such that satisfactory registration of the three-color images could not be obtained.

In 1941 a sequential color system had been used by the National Broadcasting Company to broadcast television pictures. With this work as a background, the first step of our new research program consisted of building, and putting into operation, a complete sequential type of color-television system.¹ The camera made use of the new image orthicon for direct studio pickup. The associated sound was carried by variable-width pulses occurring during the horizontal-return-line time.² The result of this work was demonstrated on December 13, 1945. In some of the tests, the radio transmitter operated on 288 megacycles, with a power output of approximately 5 kilowatts. In other tests, radio-relay-type equipment was used, operating on approximately 9000 megacycles. With this work as a background it was possible to evaluate more accurately the technical difficulties more or less inherent in such a system.

In parallel with this work, a study was being made of the possibilities of a simultaneous color system. The important fact that the simultaneous color system could be made an integral part of the expanding black-and-white television service made such a system extremely attractive. Because the three primary pictures are transmitted at the same time in the simultaneous system, each of the three primary color pictures can have the same number of lines per picture, the same number of fields per second, and the same other standards as the present monochrome system. If they are so chosen, the

present monochrome and the simultaneous color systems are identical in all basic respects, except that the color system transmits three independent monochrome signals at one time. This condition results in the enormously important fact that, with only the addition of a radio-frequency converter, and without any alterations, a present monochrome receiver will receive the programs transmitted by the simultaneous color method (reproducing them in monochrome). The radio-frequency signal, corresponding to the green picture, contains information as to picture detail and values of light and shade which, when translated into black and white in the monochrome receiver, is capable of producing an excellent picture. By associating the frequency-modulated sound channel with the green picture, at the same spacing as in the present monochrome standards, the tuning of the converter to the green-picture radio-frequency channel not only makes possible the reception of a black-and-white image from the color transmission, but also makes possible the reception of the associated sound. The red- and blue-picture signals may be transmitted on separate radio-frequency carriers and vestigial sidebands located adjacent to the green signal. Without regard for compatibility, visual observations alone indicate that the properties of flicker and resolution of images containing red and green components are sufficiently similar to monochrome images that the same standards should also apply. With reference to the blue component, observations have indicated that an appreciable reduction in the bandwidth of the blue video is possible without degradation of the color image. This is due to the eye having lower acuity for blue light than for red and green light at brightnesses which are considered desirable and at the relative brightnesses which produce subjective white. A simple confirmation of the lower acuity may be made by observation of the blue component of a black-and-white test pattern of satisfactory brightness at the normal viewing distance. It is found that the apparent resolution in the blue image is definitely inferior to the resolutions of red, green, or black-and-white images. From the point of view of economy of bandwidth in channel allocation for color television, this is a fortunate condition. A satisfactory blue video bandwidth for the experimental system was 1.3 megacycles.

The transmission standards used are the following:

525 scanning lines	} green, red, and blue components
Odd-line interlacing	
60 fields	

* Decimal classification: R583. Original manuscript received by the Institute, June 10, 1947.

† Radio Corporation of America, RCA Laboratories Division, Princeton, N. J.

¹ R. D. Kell, G. L. Fredendall, A. C. Schroeder, and R. C. Webb, "An experimental color television system," *RCA Rev.*, vol. 7, pp. 141-154; June, 1946.

² G. L. Fredendall, K. Schlesinger, and A. C. Schroeder, "Transmission of television sound on the picture carrier," *PROC. I.R.E.*, vol. 34, pp. 49-61; February, 1946.

Standard synchronizing wave form on the green video signal

4.5-megacycle bandwidth for green and red signals

1.3-megacycle bandwidth for the blue signal.

In the color receiver, the three signals are separated by means of intermediate-frequency circuits and used to control the brightness of the three color images, which are optically superimposed.

Preliminary attempts at producing pictures using the simultaneous method involved the use of a single cathode-ray tube having three electron guns with a single deflecting yoke. The three scanning rasters were at different positions on the face of the cathode-ray tube. Preliminary results with this tube were sufficiently promising to justify the design and construction of a color-slide scanner capable of generating the three color signals of the simultaneous system.³ The limitations in a system in which different areas of a single cathode-ray tube are scanned soon became evident. Work was then concentrated on the construction of a projection-type receiver having a 15- by 20-inch screen where three small cathode-ray tubes simultaneously projected the three color images on the viewing screen.⁴ The reproduction of a picture by this receiver using signals transmitted by coaxial cables was demonstrated to the press and others on October 30, 1946.⁵

At a later demonstration, on January 29, 1947, receivers of this type were operated over a radio-frequency circuit. At this time a simple radio-frequency converter connected in the antenna circuit of a standard black-and-white receiver made possible the reception of the green component of the simultaneous color picture, along with the associated sound. To illustrate the optical efficiency of a simultaneous color system, the next step in the development program was the construction of a projection-type receiver capable of producing a picture 7½ by 10 feet. This picture had a brightness of

³ G. C. Sziklai, R. C. Ballard, and A. C. Schroeder, Part II, "Pickup equipment," *PROC. I.R.E.*, this issue, pp. 862-871.

⁴ K. R. Wendt, G. L. Fredendall, and A. C. Schroeder, Part III, "Radio-frequency and reproducing equipment," *PROC. I.R.E.*, this issue, pp. 871-875.

⁵ A progress report, "Simultaneous all-electronic color television," *RCA Rev.*, vol. 7, pp. 459-468; December, 1946.

approximately 10 foot lamberts. The receiver was demonstrated at the Franklin Institute on April 30, 1947, using color slides and 16-millimeter motion-picture film as subject material.

Several major technical items remain before color television can be considered for a commercial service. Among these items may be included studio and outdoor cameras. One of the major remaining problems is the field testing of the complete system. This will involve the construction and installation of high-power television transmitters with the associated terminal facilities for film and studio transmission. Propagation measurements must be made to determine the broadcast coverage possible in the new range of ultra-high frequencies required for color. The preliminary indications are that much higher effective radiated powers will be required for color transmissions in the 500- to 900-megacycle region than are at present required in the commercial television channels. Tests on various types of receivers under actual operating conditions must be made to determine the practicability of the receiver design when placed in the hands of the layman. The tests of the simultaneous color system have been sufficiently complete to indicate that there are no serious fundamental technical difficulties. The work with the system has indicated, directly or as a result of analysis, the objectives of further research and development.

It is the purpose of this group of papers to describe the system, the experimental apparatus, and the tests that have been made. The description is divided into two parts: "Pickup Equipment," and "Radio-Frequency and Reproducing Equipment."

ACKNOWLEDGMENT

The authors of this group of papers wish to acknowledge the interest and encouragement of E. W. Engstrom and V. K. Zworykin. The flying-spot tubes and color kinescopes used were developed by D. W. Epstein and his associates, with phosphors supplied by H. W. Leverenz. The dichroic mirrors were made by M. E. Widdop. Credit should also go to all the other members of the RCA Laboratories organization who participated in the work.

Part II—Pickup Equipment*

G. C. SZIKLAI†, SENIOR MEMBER, I.R.E., R. C. BALLARD†, SENIOR MEMBER, I.R.E.,
AND A. C. SCHROEDER†, SENIOR MEMBER, I.R.E.

Summary—The technical development of the present flying-spot-type color-television pickup equipment is described. The use of a high-voltage kinescope with a short persistence phosphor, of the multiplier-type photo-tubes and dichroic filters, permit the construction of apparatus for flying-spot scanning of color slides and color motion picture film providing excellent color video signals. The cir-

cuit equalization for the phosphor persistence is described in detail. The use of the simple flying-spot scanner for studio pickup is described.

I. INTRODUCTION

ONCE a careful study of the technical aspects of color-television systems reached a point where a systematic development of a particular system could be scheduled, the first part of the program was to

* Decimal classification: R583. Original manuscript received by the Institute, June 10, 1947.

† Radio Corporation of America, RCA Laboratories, Princeton, N. J.

develop terminal equipment with the greatest flexibility and reliability. For the initial adjustments of the first simultaneous-color-television image reproducers, a monoscope signal was divided by three parallel-input amplifiers, and thus the three grids of the reproducer were controlled by the same signal. This type of signal was perfectly adequate to check resolution, registration, and proper balance of control voltages to produce a good black-and-white picture. By adjusting the balance of the picture signals, a monochrome picture in a choice of colors could be obtained. The registry obtained with three identical simple signals was sufficiently encouraging to justify undertaking the development of a signal source providing a complete color picture.

The use of the monoscope as a source set the standards high, since it could be relied on for good resolution, perfect registration, high signal-to-noise ratio, freedom from spurious signals, etc. In order to obtain a similarly high-quality color signal, a special slide scanner was developed, to be used with Kodachrome transparencies to provide the desired high-quality color video signals from a wide variety of subjects.¹

II. THE SLIDE PROJECTOR

A signal-generation method using a cathode-ray-tube flying-spot scanner, with beam splitters and multiplier phototubes, was chosen because of the inherent registry and natural freedom from spurious signals of such a system. The concept of cathode-ray-tube flying-spot scanning is old. It was attempted both in this country and abroad several years ago, but due to the lack of satisfactory components for the system, several times it was tried and abandoned.

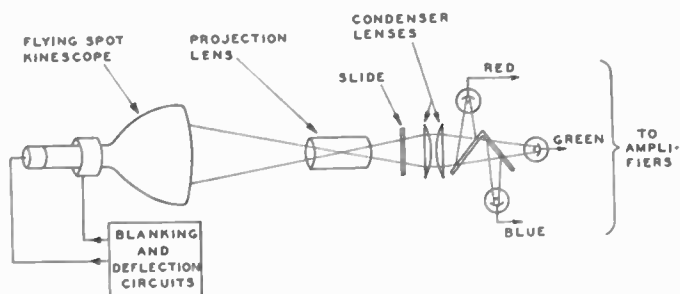

Fig. 1—Diagram of the color-slide scanner.

A re-examination of the problem in the course of the development revealed that improved and new tools were available which made the flying-spot scanning not only practical, but, from many respects, superior to other known methods of picture-signal generation, even for black-and-white transmission.

With the use of very-short-persistence phosphors in the flying-spot cathode-ray tube, the problem of equalization has been considerably simplified. The use of multiplier phototubes provides high video input to the am-

¹ The slide and motion picture scanners, as well as the color receivers, have been described briefly in a progress report; see "Simultaneous all-electronic color television," *RCA Rev.*, vol. 7, pp. 459-468; December, 1946.

plifiers, thus minimizing the usual difficulties in shielding to eliminate spurious signals. In spite of the equalization for the phosphor characteristic, the amplifier is very simple and the amplifier noise is negligible.

The schematic diagram of the color-slide scanner is shown in Fig. 1. As shown, the optics of a conventional slide projector are used in reverse. The screen of a short-persistence-phosphor kinescope replaces the projection screen, and the projection lamp of the slide projector is replaced by the light-dividing assembly and the phototubes. The scanning raster is imaged by the projection lens onto the slide. The transmitted light is then collected by the condensing-lens system and then divided by dichroic mirrors which reflect one color of light and pass the other colors. The divided light beams are further filtered by color-absorption filters, then collected by multiplier phototubes which convert the varying light intensity of the spot as transmitted by the slide into video signals corresponding to the three primary colors of the slide.

A photograph of the complete flying-spot color video signal generator is shown in Fig. 2. The synchronizing, blanking, and deflecting circuits for the flying-spot

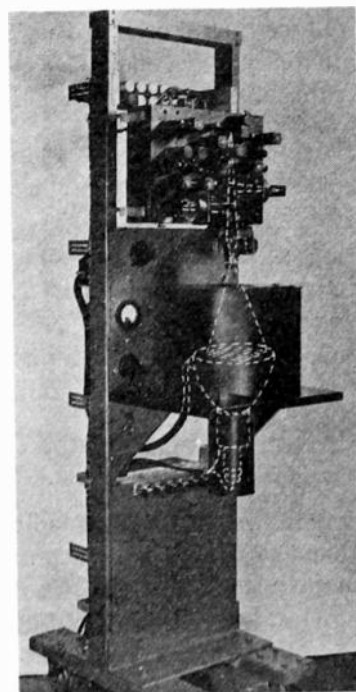

Fig. 2—The color-slide scanner.

kinescope are at the bottom of the rack. The anode supply is in the center and the video amplifiers are at the top. The location of the cathode-ray tube and light paths are shown by the dotted lines.

The flying-spot kinescope utilizes a zinc-oxide phosphor² which decays to less than 5 per cent of its original intensity in 1 microsecond. The kinescope is operated at 30 kilovolts and 400 microamperes. The first-anode focusing potential is variable around 7 kilovolts. The raster has a brightness of approximately 200 foot lam-

² H. W. Leverenz, "Luminescence and tenebrescence as applied in radar," *RCA Rev.*, vol. 7, pp. 199-239; June, 1946.

berts. In order to have a definite black-level reference, the return lines of the scanning raster are blanked out by applying blanking pulses to the kinescope grid.

The objective lens is an $f/1.9$ high-quality color-corrected lens in a focusing mount. Lenses with a lesser degree of color correction were tried and were found to provide satisfactory signals, but the change of lenses is definitely noticeable; and since the slide scanner is relied upon as a standard signal generator, the lens with the best color correction was chosen. The whole optical assembly is mounted on the same chassis with the three video amplifiers.

III. THE DICHOIC MIRRORS

The use of dichroic mirrors for a light-splitter, instead of half-silvered mirrors and color filters, reduces the light losses and therefore provides a signal with a higher signal-to-noise ratio. If semitransparent mirrors were used in the arrangement, as shown in Fig. 1, the light flux would be divided in three parts, and thus only 33 per cent of the red, blue, or green light of the total would reach the phototube even if the semitransparent mirrors were 100 per cent efficient. Actually, the efficiency of a chromium mirror drops rapidly when the transmission is reduced, as shown in Fig. 3. Considering that the first mirror would reflect 17 per cent of the light to the red tubes, and transmit 58 per cent, and the

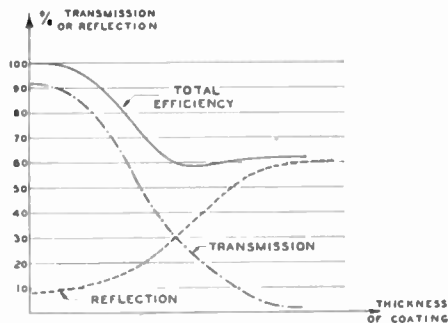

Fig. 3—Transmission and reflection of chromium mirrors.

second mirror would divide the transmitted light by providing 30 per cent of the 58 per cent, or 17.4 per cent, of the original light, the light flux would be divided equally, but the over-all efficiency would be reduced by a factor of approximately 6.

Dichroic mirrors which reflect one color light and transmit others have been known for some time, and were made with certain crystals, aniline dyes, or thin metallic films. A thin film of gold transmits green light and reflects the lights in the red spectral region. The dichroic mirrors used in the present color-television terminal equipment are the quarter-wave dielectric-film type.³ This type of dichroic mirror is made by evaporating alternate layers of insulators with high and low index of refraction of predetermined thickness on glass. The mirrors have no appreciable absorption, and if both sides are properly coated to eliminate undesirable reflection, they may be considered 100 per cent

³ G. L. Dimmick, "A new dichroic reflector," *Jour. Soc. Mot. Pic. Eng.*, vol. 38, pp. 36-44; January, 1942.

efficient. Fig. 4 shows the spectral characteristics of two dichroic mirrors, the ordinate representing the transmission at various frequencies within the visible range of the spectrum. The complementary percentage is reflection. By using a dichroic mirror with a characteristic as shown in curve A of Fig. 4 as the first beam divider, practically all the red component of the light flux is reflected to the phototube of the red channel, while the remaining portion of the spectrum is transmitted to the second dichroic mirror, having a characteristic as shown in curve B of Fig. 4, reflecting substantially the total blue portion of the light and transmitting the whole green component. Thus it may be readily seen that, by the use of dichroic mirrors, a light-flux input about six times higher is available than with the use of semitransparent mirrors.

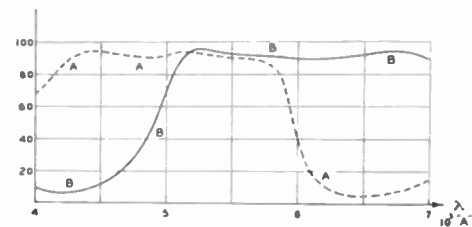

Fig. 4—Spectral characteristic of two dichroic mirrors.

Another compact beam-splitting arrangement available with dichroic filters is shown in Fig. 5. The light beam, after passing the transparency, falls upon the crossed dichroic mirrors. While both mirrors pass the green component, the combination will not pass the red and blue components of the light, which are reflected to their proper phototubes.

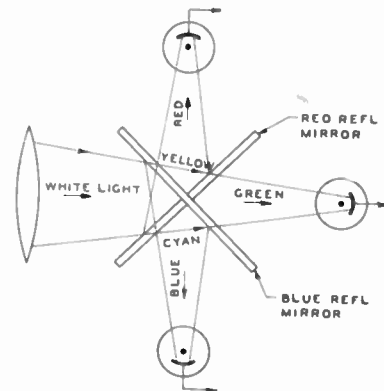

Fig. 5—Crossed dichroic beam-splitter.

Due to the fact that the dichroic mirrors used did not have the ideal spectral response for the three chromatic separations of the picture, thin absorption filters were used in front of the phototubes to improve upon the spectral selectivity of the dichroic mirrors.

IV. THE AMPLIFIER CIRCUITS

In some of the literature on flying-spot scanning⁴ it was assumed that a different frequency compensation

⁴ Kurt Bruckersteinkuhl, "The persistence of phosphors and its meaning for flying-spot scanning with cathode-ray tubes," *Fernseh A.G.*, vol. 1, pp. 179-186; August, 1939.

would be needed for the transition from black to white than for the change from white to black. This was based on the known rise-and-decay characteristic of the phosphor. The assumption would be correct if a pulse corresponding to the video signal appeared on the grid of the flying-spot kinescope, since the phosphor excitation is practically instantaneous, while the decay is exponential. However, when a transition from black to white is scanned, the spot in time has an exponential shape and a changing position. Thus it delivers to the phototube through the front edge of the transition its maximum brightness; then, as it moves, it still provides the maximum instantaneous brightness *plus* the decaying brightness. The light input to the phototube is thus proportional to the integral of the original light-decay characteristic. Since the decay curve is an e^{-z} type of function, its integral is also of the e^{-z} form. As the scanning spot moves from white to black, the light falling on the phototube decreases according to $(1 - e^{-z})$, both the rise and fall signals following the same law. Fig. 6 shows an oscillogram at line frequency of the voltage generated in the scanning of a vertical white bar. The shape is

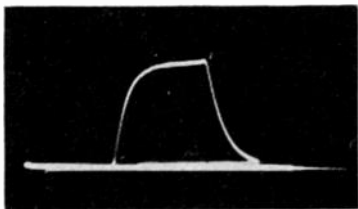

Fig. 6—Oscillogram of the signal from a white bar.

typical of the square-wave response of a circuit in which the high frequencies are deficient. The fact that the light decay characteristic of the phosphor is exponential simplifies the equalization. The equalization required is of the type supplied by simple resistance-capacitance combinations. Fig. 7 shows the same signal after equalization. The sides of the wave are now square within the accuracy of the measurement.

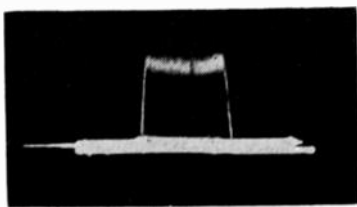

Fig. 7—Oscillogram of the corrected signal from a white bar.

The oscillogram is a composite of all the 525 lines of the scanning raster. The irregularities across the top of the wave are due to the random grain structure of the phosphor.

The circuit constants used to correct for the phosphor are much the same as those used to correct for the capacitance across the input circuit of a conventional television-camera amplifier. However, it was found from

observation of the square-wave response of the flying-spot scanner that the decay characteristic of the phosphor is only to the first approximation a simple exponential.

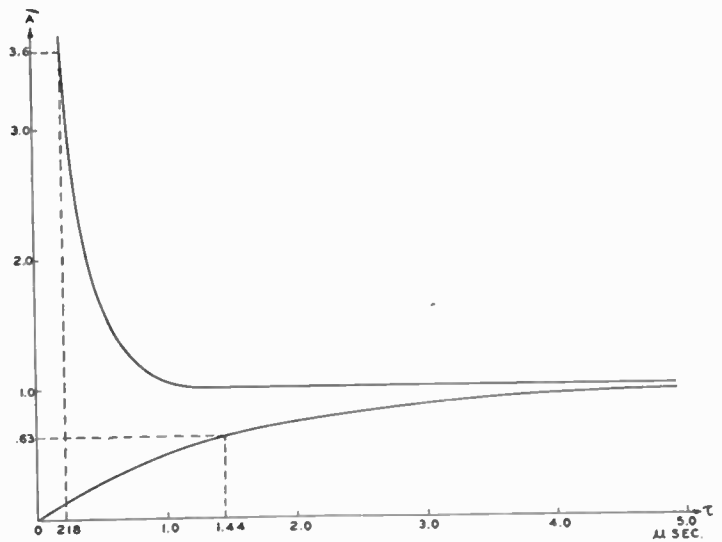

Fig. 8—Unit-function responses of the flying-spot scanner.

The square-wave response of the flying-spot scanner is shown again with time and amplitude co-ordinates as the bottom curve in Fig. 8. The experimental determination of the required equalization time constant indicated that it was about 1.5 microseconds. With this correction applied, however, it was found that there was a large residual transient overswing response to the square wave, as shown in the top curve. An additional circuit having a time constant of 0.2 microsecond was experimentally determined as being required to make the response to the square wave come within the accuracy of measurement.

The circuit diagram of the equalized amplifier is shown in Fig. 9. The 120,000-ohm resistor shunted by the 25-micromicrofarad variable capacitor in the plate circuit of the first stage is adjusted to the time constant of 1.5 microseconds. The 560 ohms in series with the 390-micromicrofarad capacitor across the output of the phototube is the other circuit having the time constant of 0.2 microsecond.

It may be interesting to note that some of the multiplier dynodes and the photocathode of all three phototubes are supplied by a grounded positive supply, while the last stages are connected to the regulated B supply of the amplifier. This circuit arrangement minimizes the high-voltage requirements with respect to the ground, as well as the feedback and crosstalk due to the varying current drain of the last dynode stages. The voltage of the first seven dynodes of all three tubes may be controlled by the variable D (dynode) supply, and by this means the video levels of all three channels may be varied simultaneously to compensate for the different densities of the slides. Three variable shunt resistors between dynodes 5 and 7 of each phototube can also be

used for adjusting the video level, and with control each channel may be varied individually to provide the desired color balance. Optionally, the potentiometer in the

of the input to the output light linear. Since this amplifier attempts to make the over-all gamma unity, it is called the "gamma-correction amplifier." There are, of

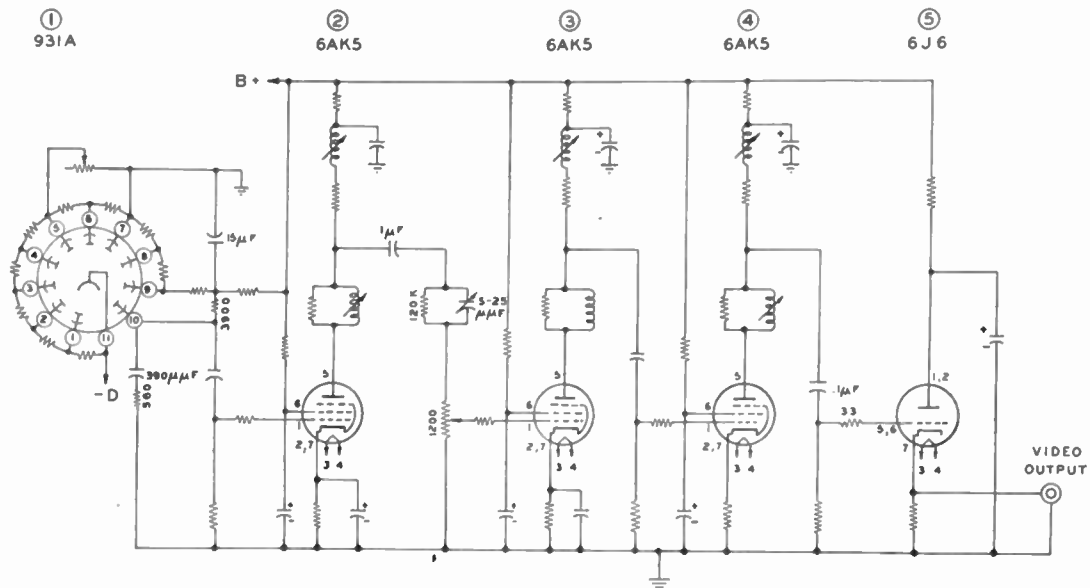

Fig. 9—The circuit diagram of the equalizing amplifier.

grid circuit of the second video amplifier may also be used for color balance. Due to the low impedance of the controls, the high-frequency response of the signal is not affected. The output of the four-stage video amplifiers at normal brightness level is in the order of 1 volt peak-to-peak.

V. GAMMA-CORRECTION CIRCUIT

For maximum fidelity of color reproduction, the light output of the receiver should be directly proportional to the light input to the photosensitive device. In other words, the gamma of the system should be unity.

Since, in the flying-spot type of pickup, the voltage output is directly proportional to the light input, the video signal with linear amplifiers will have voltage proportional to light input.

course, three separate amplifiers required, one for each color. In these amplifiers the kinescope blanking is added to all three signals and the RMA synchronizing signal is added to the green signal.

Fig. 10 shows a block diagram of the green part of the amplifier. The other two are identical, except that the synchronizing amplifier is omitted.

The blanking and video signals are mixed in the common plate load of two 6AC7 tubes. Most of the blanking is clipped off by the clipping circuit to leave a small amount of setup. Since the black level in a color synchronizer must be accurately controlled, the clipper must be linear down to clipping level, and the clipping level must be accurately controlled. For this reason a special type of clipper is used, and a clamp circuit is used to set the direct current on the grid of the clipper.

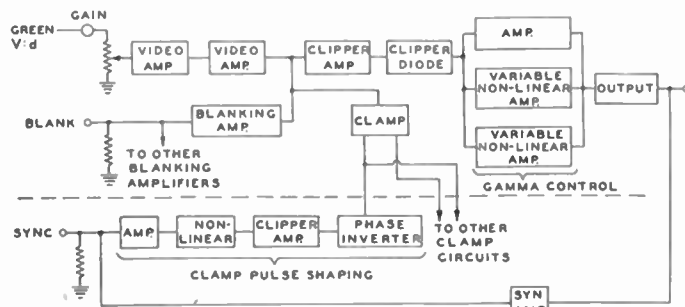

Fig. 10—Block diagram of the green channel of the gamma-control amplifier.

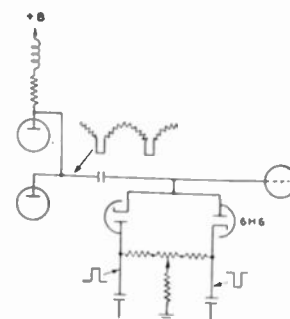

Fig. 11—Detail of the clamp circuit.

However, the kinescope is not linear, since it takes more volts to give the same change in light output at low light than at high lights. A nonlinear amplifier must, therefore, be provided, with the reciprocal of the kinescope characteristic, in order to make the relation

Fig. 11 shows the clamp circuit in detail. Equal pulses of opposite polarity are applied to the plate and to the cathode of two diodes with the indicated polarity. During the time of these pulses, the clamp circuit may be considered as a short circuit to a point halfway between

the plate and cathode. The direct voltage of this point with respect to ground and cutoff voltage of the clipper is obtained by grounding the proper point of the resistor between the plate and cathode. Since the pulses are at horizontal frequency and occur during horizontal blanking, the black level in the picture is held at a constant direct voltage, which is so chosen that it is very close to the cutoff level of the clipper.

The pulses for the clamp circuit, which must occur immediately after each synchronizing pulse, are derived from the RMA synchronizing signal by a nonlinear differentiating circuit, as shown in Fig. 12. Due to the high positive bias on the grid resistor of the first half of the

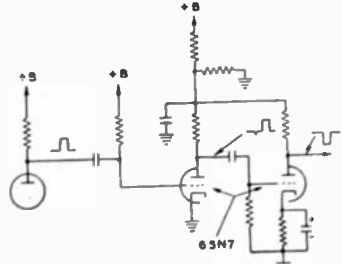

Fig. 12—Detail of the nonlinear differentiating circuit for making clamping pulses of RMA synchronizing signals.

6SN7, the tube draws considerable grid current and holds the grid at zero bias. When the output of the amplifier driving this tube attempts to swing the grid positive, the grid draws slightly more current, but holds the zero bias so that there is no change in the plate current. However, at the back edge of the input pulse there is nothing to stop the grid from swinging far below cutoff. Due to the very small coupling capacitor, the grid immediately starts to charge up to +300 volts at a rate determined by this capacitor and the grid resistor until it reaches zero bias again. By adjusting the time constant of this input circuit and the amplitude of the driving signal pulses, any desired width can be obtained, starting at the back edge of the synchronizing pulses.

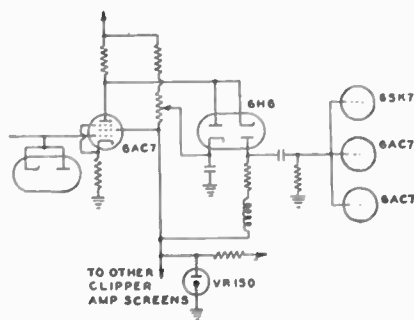

Fig. 13—Detail of the clipper circuit.

After some further clipping, these pulses are fed to the grid of a phase inverter with equal plate and cathode resistors. These push-pull pulses are then fed to the three clamp circuits.

Fig. 13 shows the clipper circuit. The plate load resistor is fed through a diode so that, when the plate voltage is higher than a certain value, no signal will pass.

This, however, changes the plate load to a higher value, and the signal is then so high that some of the high frequencies get across the diode capacitance. To eliminate this, a second diode shorts out the high-frequency plate load soon after the first diode opens up.

The output of the clipper is fed to the three grids of the nonlinear gamma-correcting circuit shown in Fig. 14. Black is positive on the grids and is held at zero bias by the grid current of the three tubes.

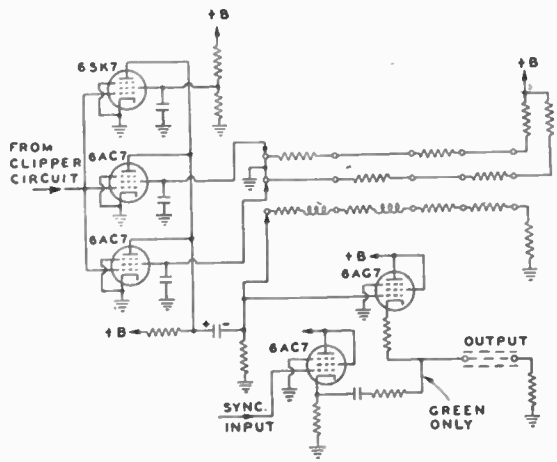

Fig. 14—Detail of the gamma-control circuit.

The screen voltages of two of the tubes are variable in steps by a five-position switch. When this switch is in the first position, both screen voltages are at 0 and these tubes are inoperative, only the 6SK7 passing the signal. On the second position one of the tubes has some screen voltage, but its cutoff is low so that only the blacks are amplified. Going to the third, fourth, and fifth positions, the blacks are amplified more, and thus the gamma is further reduced. In order to keep the peak-to-peak signal constant, the plate load resistor is also switched, being lowered for each successive position. The signal is then fed to the cathode follower output of the amplifier, where the RMA synchronizing signal is added in the case of the green signal.

VI. MOTION-PICTURE-FILM SCANNER

Essentially the same scheme was utilized in a motion-picture-film scanner with the film gate replacing the slide holder. Since a 30-frames-per-second reproduction of the film was both acceptable and expedient, the job at hand was a simple one. The film moving mechanism of a standard RCA 16-millimeter home sound-film projector was altered by substituting a synchronous-motor drive. The arrangement of the motion-picture scanner is shown in Fig. 15. The flying-spot raster on the kinescope replaced the projection screen, and it is imaged by the $f/1.65$ lens on the film. The transmitted light is treated in the same manner as described for the slide scanner. Under this condition each frame is scanned twice to give the required 60 fields per second. The pull-down mechanism may be speeded up considerably; otherwise, it is necessary to blank approximately 30 per cent of the field time to avoid showing the distorted

picture produced during the film pull-down time. The proper 24-frames-per-second operation may be obtained by any of the schemes utilized in the past with non storage pickup devices.

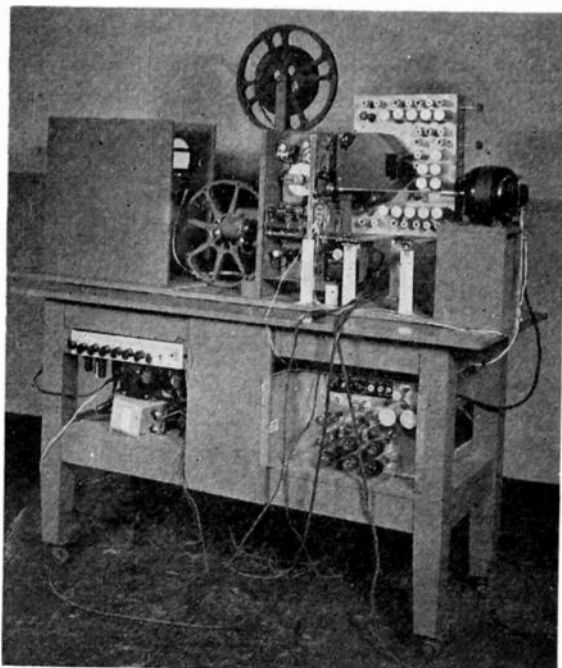

Fig. 15—The motion-picture scanner.

VII. THE FLYING-SPOT "LIVE" PICKUP

The equipment used for scanning of opaque objects, shown in Fig. 16, is similar to that used for the slide scanning. The flying-spot kinescope is mounted hori-

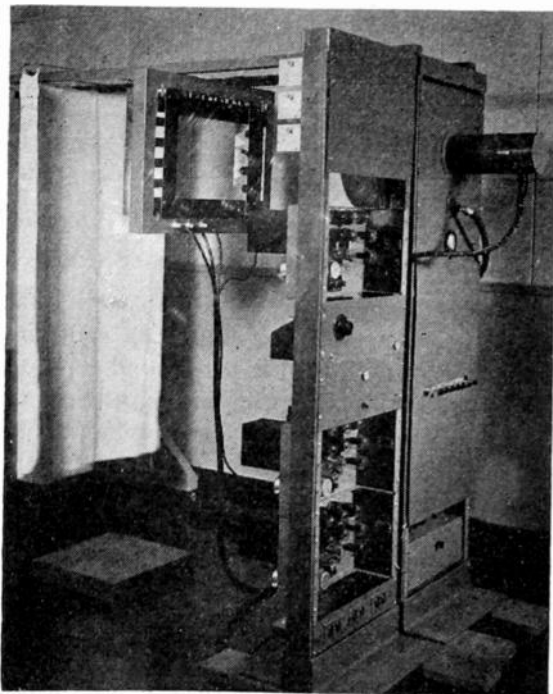

Fig. 16—The live-pickup scanner.

zontally to project the raster by means of a 5-inch focal-length projection lens of $f/1.5$ aperture to an area approximately 18 by 24 inches, about 12 inches behind

the rectangular phototube assembly frame, and at a convenient height from the floor. Illumination from any source other than that from the kinescope contributes only a noise component to the picture signal and is, therefore, to be avoided. The meter beneath the kinescope indicates the beam current. Directly below is the video-amplifier chassis, the circuit of which is quite similar to that of the slide-scanner amplifier. Beneath this is the synchronizing, blanking, and deflection chassis, which is identical to that of the slide scanner. At the bottom of the rack is the kinescope anode supply. This unit is a recently developed regulated radio-frequency direct-current supply which delivers approximately 1 milliamperes beam current at 30 to 40 kilovolts.

The three similar uncovered units on the adjacent rack are regulated direct-current supplies. The panel with the control at the left is a 2000-volt phototube supply with grounded positive. Just below is a heater supply and the main control panel. The amplifier strips at the top were added for future development work.

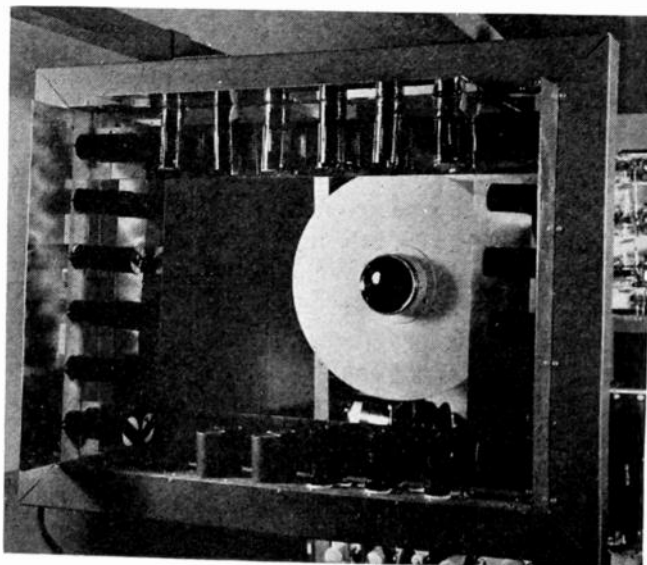

Fig. 17—The phototube assembly.

The phototube assembly used in the opaque pickup is shown in detail in Fig. 17. It consists of a hollow metal frame on three inside edges of which are mounted a series of type 931A phototubes. These are arranged so that along the frame there is a succession of red-, green-, and blue-filtered phototubes. Additional red tubes are used to compensate for lack of sensitivity in the long wavelengths. All phototubes of each color were paralleled to feed into common load resistors.

It may be pointed out that, with flying-spot scanning, each phototube picking up light reflected from the scanned area produces in the reproduced picture an effect the same as though a light source were at that location. Since, with color-selective individual phototubes, the effect is as though the subject were illuminated by colored lights, to avoid separation of colors it is desirable to have the phototubes collect light of all three colors at the same point. An auxiliary spot pickup (provid-

ing an effect similar to a spotlight) was added to supplement the flat lighting effect of the phototube frame. This was conveniently accomplished by the use of three phototubes and the crossed dichroic mirror system. Fig. 18 shows the essential parts. A condenser lens was used in front to increase the efficiency.

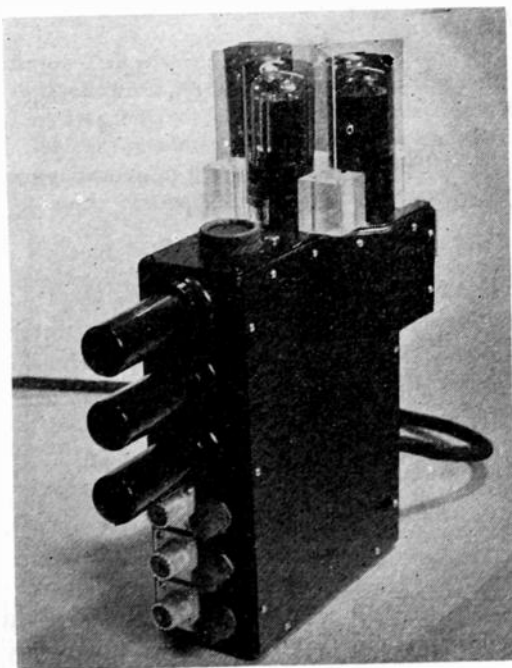

Fig. 18—The phototube "spot" assembly.

Since the 931-A type of phototube does not lend itself readily to high-aperture optical systems, new experimental multiplier phototubes have been developed. Fig. 19 compares these with the 931-A type. In the new phototubes the whole front end serves as the photocathode, which in the large tube shown is 5 inches in diame-

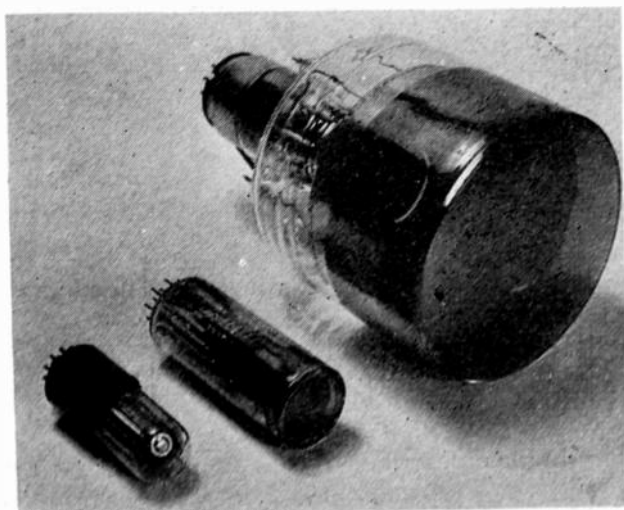

Fig. 19—Larger-aperture phototubes.

ter. This tube has a stacked-ring dynode assembly of the turbine-blade type. Due to the large sensitive area, it greatly outperforms the 931-A type in signal-to-noise ratio at low light levels. For color it must be used at some distance from the subject, or be provided with a light-mixing system to avoid the color separation previously mentioned.

The smaller phototube is of similar construction. Its 1½-inch diameter makes it suitable either for close grouping or for use with a dichroic mirror system. In either case, a lens may be added to increase the pickup.

These new phototubes make it possible to exceed the performance of the human eye at low light levels. An observer standing beside the phototube is unable to distinguish details of the subject which are reproduced satisfactorily by the system.

VIII. PERFORMANCE

The amplifiers have a flat response up to 5.5 megacycles, and a resolution of 400 lines or better can be obtained in both directions. The pictures are free from shading and other spurious signals and have excellent halftone gradations. The registration of the three signals is inherently correct.

With the electron-multiplier phototube operating at the light levels involved in the flying-stop-scanning arrangement, the noise output of the phototube is proportional to the light input. As a result, the noise is a constant percentage of the signal, giving the equivalent in appearance to grain in motion-picture film. This is a very desirable condition, as contrasted with the conventional camera tube where the noise is of constant amplitude, independent of the picture brightness.

By removing the light-splitter and using a single phototube and amplifier, an excellent black-and-white signal generator may be obtained. The freedom from noise, shading, and other spurious signals provides a contrast range and picture quality not yet attained, even for black and white, by any other means than a monoscope. The simplicity and excellence of performance of the arrangement is such that it has much to recommend it as a source of television signals for general laboratory and factory test use. Its flexibility is such that it will find application in the television studio as a very convenient method for televising titles, special effects, and as a flexible substitute for the monoscope.

APPENDIX

If the light on some spot on the screen is a function of time, and the movement of the spot is a linear function of time, as in the case of linear deflection, the spot may be considered to have a shape along a line given by the original function of time.

When the spot moves from behind a mask into an opening, at first only the light from the spot being hit by electrons strikes the phototube. A little later, as the spot moves farther into the opening, the light from the spot being hit by the electrons has the light from the spots which had been hit a short time before added to it, since they are still emitting some light. In other words, the light output as a function of time as the spot moves into an opening is the integral of the light output with respect to time of the phosphor.

Assume that the light output as a function of time rises instantaneously and decays according to the function

$$L(t) = a\epsilon^{-\lambda_1 t} + b\epsilon^{-\lambda_2 t}.$$

Then the signal will be

$$S = \int_0^t L(T) dT = \int_0^t (a\epsilon^{-\lambda_1 T} + b\epsilon^{-\lambda_2 T}) dT$$

$$S = \frac{a}{\lambda_1} + \frac{b}{\lambda_2} - \frac{a}{\lambda_1} \epsilon^{-\lambda_1 t} - \frac{b}{\lambda_2} \epsilon^{-\lambda_2 t} \quad (1)$$

so that, when the spot is completely in the opening ($t = \infty$),

$$S = \frac{a}{\lambda_1} + \frac{b}{\lambda_2}.$$

Starting from this level of signal, when the spot goes behind a mask,

$$S = \frac{a}{\lambda_1} + \frac{b}{\lambda_2} - \int_0^t L dt$$

$$= \frac{a}{\lambda_1} + \frac{b}{\lambda_2} - \int_0^t (a\epsilon^{-\lambda_1 t} + b\epsilon^{-\lambda_2 t}) dt$$

$$S = \frac{a}{\lambda_1} \epsilon^{-\lambda_1 t} + \frac{b}{\lambda_2} \epsilon^{-\lambda_2 t}.$$

The correcting networks for the $Z_n0-(Z_n)$ phosphor in the amplifier described are shown in Fig. 20.

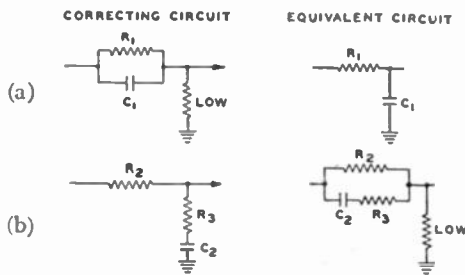

Fig. 20—Correcting networks.

The unit-function response of the network for which (a) is the correction is

$$f_1 = 1 - \epsilon^{-t/R_1 C_1},$$

and for which (b) is the correction,

$$f_2 = \frac{R_3}{R_2 + R_3} + \left(1 - \frac{R_3}{R_2 + R_3}\right) \epsilon^{-t/R_3 C_2}.$$

This means that the flying-spot in passing a boundary gives a signal as though a unit function had gone through two networks, one having the unit-function response f_1 and the other f_2 . In order to find the unit-function response after going through both these networks, we use the superposition theorem, which states that

$$F(t) = f_1(0)f_2(t) + \int_0^t f_1'(t-T)f_2(T) dT$$

since

$$f_1(0) = 0$$

$$F(t) = \int_0^t \frac{1}{R_1 C_1} \epsilon^{-t-T/R_1 C_1} \left[\frac{R_3}{R_2 + R_3} \right.$$

$$\left. + \left(1 - \frac{R_3}{R_2 + R_3}\right) \epsilon^{-T/R_3 C_2} \right] dT$$

$$= \frac{R_3}{R_2 + R_3} \times \frac{1}{R_1 C_1} \epsilon^{-t/R_1 C_1} \int_0^t \epsilon^{T/R_1 C_1} dT + \frac{R_2}{R_2 + R_3}$$

$$\times \frac{1}{R_1 C_1} \epsilon^{-t/R_1 C_1} \int_0^t \epsilon^{T/R_1 C_1 - T/R_3 C_2} dT$$

$$= \frac{1}{R_1 C_1} \epsilon^{-t/R_1 C_1} \left[\frac{R_3}{R_2 + R_3} (R_1 C_1 \epsilon^{t/R_1 C_1} - R_1 C_1) \right.$$

$$\left. + \frac{R_2}{R_2 + R_3} \times \frac{R_1 R_3 C_1 C_2}{R_3 C_2 - R_1 C_1} (\epsilon^{t/R_1 C_1 - t/R_3 C_2} - 1) \right]$$

$$= \frac{R_3}{R_2 + R_3} (1 - \epsilon^{-t/R_1 C_1}) + \frac{R_2}{R_2 + R_3}$$

$$\times \frac{R_3 C_2}{R_3 C_2 - R_1 C_1} (\epsilon^{-t/R_3 C_2} - \epsilon^{-t/R_1 C_1})$$

$$F(t) = \frac{R_3}{R_2 + R_3} \left[1 - \left(1 + \frac{R_2 C_2}{R_3 C_2 - R_1 C_1}\right) \epsilon^{-t/R_1 C_1} \right.$$

$$\left. + \frac{R_2 C_2}{R_3 C_2 + R_1 C_1} \epsilon^{-t/R_3 C_2} \right],$$

which is the unit-function response of the flying-spot system without correction. The phosphor-decay characteristic is the derivative of the above:

$$\frac{dF(t)}{dt} = \frac{R_3}{R_2 + R_3} \left[\frac{R_3 C_2 - R_1 C_1 + R_2 C_2}{R_3 C_2 - R_1 C_1} \right.$$

$$\left. \times \frac{1}{R_1 C_1} \epsilon^{-t/R_1 C_1} - \frac{R_2}{(R_3 C_2 - R_1 C_1) R_3} \epsilon^{-t/R_3 C_2} \right]$$

$$= \frac{R_3}{(R_2 + R_3)(R_3 C_2 - R_1 C_1)} \left[\frac{R_3 C_2 - R_1 C_1 + R_2 C_2}{R_1 C_1} \epsilon^{-t/R_1 C_1} \right.$$

$$\left. - \frac{R_2}{R_3} \epsilon^{-t/R_3 C_2} \right]$$

or

$$= -K \left[\left(\frac{(R_2 + R_3) C_2}{R_1 C_1} - 1 \right) \epsilon^{-t/R_1 C_1} - \frac{R_2}{R_3} \epsilon^{-t/R_3 C_2} \right]$$

(the $-K$ since $R_1 C_1$ is larger than $R_3 C_2$). Therefore, the phosphor delay characteristic is

$$D = K \left[\frac{R_2}{R_3} \epsilon^{-t/R_3 C_2} - \left(\frac{(R_2 + R_3) C_2}{R_1 C_1} - 1 \right) \epsilon^{-t/R_1 C_1} \right].$$

In the amplifier described it was found that, for best correction, $R_1 = 120,000$ ohms, $C_1 = 12$ micromicrofarads, $R_2 = 3900$ ohms, $R_3 = 560$ ohms, and $C_2 = 390$ micromicrofarads. Substituting, we find for the phosphor decay

$$D = 6.98 \epsilon^{-t/0.218} - .21 \epsilon^{-t/1.44},$$

and for the apparent square-wave response,

$$F = 1 + .247 \epsilon^{-t/1.44} - 1.245 \epsilon^{-t/0.218}.$$

Part III—Radio-Frequency and Reproducing Equipment*

K. R. WENDT†, FELLOW, I.R.E., G. L. FREDENDALL†, SENIOR MEMBER, I.R.E., AND A. C. SCHROEDER†, SENIOR MEMBER, I.R.E.

Summary—Two possible types of transmission, the three-carrier system and subcarrier system, are outlined. Radio-frequency and intermediate-frequency receiving equipment is discussed for both systems. Several reproducing devices and the associated deflecting and video equipment for the trinoscope are described. The solutions of some problems encountered in registration are set forth.

SIMULTANEOUS COLOR TRANSMITTERS

SINCE RED, green, and blue video signals exist simultaneously, the transmission problem may be solved on the basis of frequency division. The subcarrier system and the three-carrier system are possible choices. Since a subcarrier transmitter involved much less development work this system was used, but the choice was one of expediency. Fig. 1(a) shows the essential components of the subcarrier transmitter in which the three color signals are multiplexed, as in the practice of carrier telephony. One subcarrier at a frequency of 8.25 megacycles is modulated by the red video signal and the lower sideband is partially suppressed. The frequency of the blue subcarrier is 6.25 megacycles and the blue upper sideband is partially suppressed. The term "mixer" indicates that a composite signal is formed, which is the direct addition of the green video signal and the two modulated subcarriers (Fig. 1(b)). A substantially linear mixer is required if cross modulation of the color signals is to be avoided.

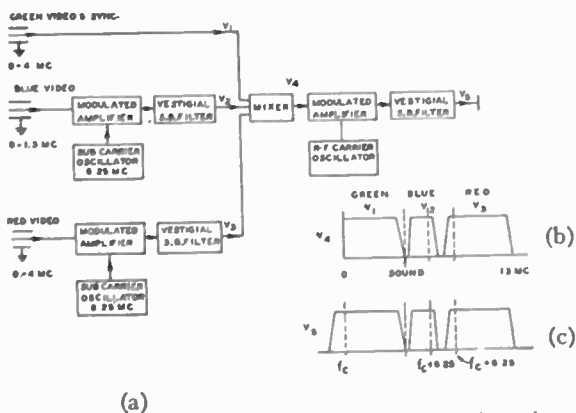

Fig. 1—Simultaneous color transmitter of the subcarrier type.

Finally, the composite signal modulates the radio-frequency carrier. The lower sideband of carrier is partially suppressed, which results in the radiated spectrum in Fig. 1(c). Thus, including guard bands, a total channel width of approximately 14.5 megacycles is called for. All radio-frequency circuits were designed for this bandwidth.

* Decimal classification: R583. Original manuscript received by the Institute, June 10, 1947.
† Radio Corporation of America, RCA Laboratories, Princeton, N. J.

As in other multiplex arrangements, the maximum amplitude of the principal carrier must exceed the maximum amplitude of a subcarrier by an amount that depends upon the number of subcarriers. The ratio of amplitudes is 5 to 1 here.

The three-carrier system illustrated in Fig. 2(a) embodies three substantially independent transmitters feeding through a suitable coupling device or "triplexer" into a common antenna. One sideband of each transmitter is partially suppressed by a vestigial-sideband filter, as in monochrome transmission. Fig. 2(b) illustrates one of the many dispositions possible of the three carriers in the color channel. The arrangement in Fig. 2(b) appears to be especially suitable for reception of the green signal by a monochrome receiver, because the red and blue signals act as guard bands against adjacent color channels.

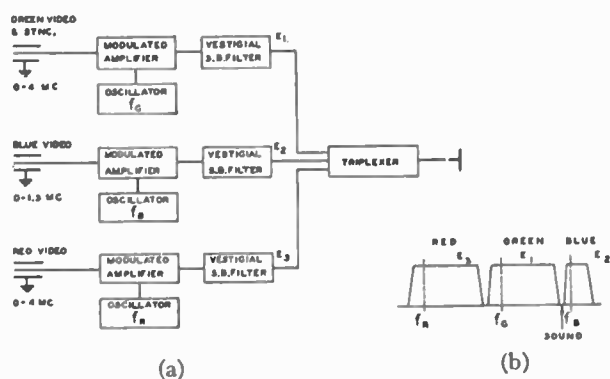

Fig. 2—Simultaneous color transmitter of the three-carrier type.

Only the antenna must cover the full channel of approximately 14.5 megacycles. The red and green transmitters have a bandwidth approximately equal to 6 megacycles, the standard width for monochrome television, while the bandwidth of the blue transmitter may be restricted as dictated by the acuity of the eye for blue light.

SIMULTANEOUS COLOR RECEPTION

The signal circuits of a subcarrier receiver for simultaneous color reception are shown in block form in Fig. 3(a). Attenuation of the main radio-frequency carrier by 6 decibels as required for detection in a vestigial sideband system is provided in the broad-band radio-frequency and intermediate-frequency amplifiers. The composite video signal T_2 in Fig. 3(a) is present in the output of the linear detector in the same form as the mixed signal in Fig. 1(b). Attention must be given to assure linearity of detection, if cross-modulation of the color signals is reduced to an imperceptible amount. A

low-pass filter selects the green video signal, including the synchronizing signal, and rejects the red and blue subcarriers and sidebands. The red and blue subcarrier spectrums are isolated, as T_4 and T_5 in Fig. 3(d), by band-pass amplifiers which also attenuate the subcarriers by 6 decibels. T_6 and T_7 indicate the desired video signals obtained by demodulation of T_4 and T_5 .

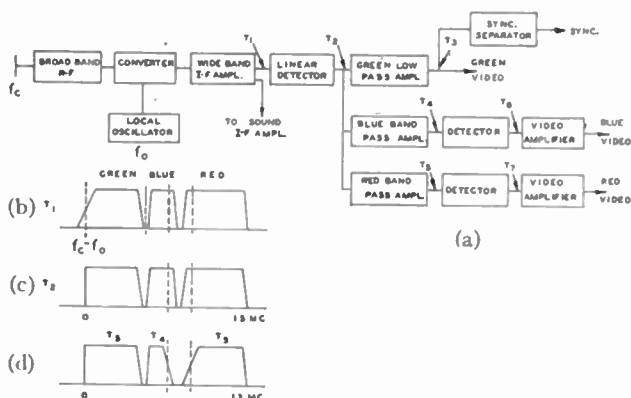

Fig. 3—Simultaneous color receiver for subcarrier reception.

Fig. 4(a) is a block diagram showing the essential signal circuits of a simultaneous receiver which is operable on the signals of both types of transmission, subcarrier or three-carrier. The radio-frequency spectrum shown by S_1 in Fig. 4(b) may represent both transmissions, since the distinction is only the difference between the relative amplitudes of the carriers. A bandwidth equal

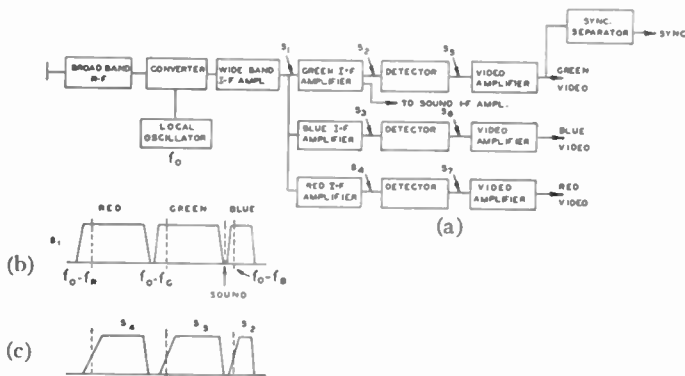

Fig. 4—Simultaneous color receiver for three-carrier or subcarrier reception.

to the channel width must be covered by the radio-frequency and common intermediate-frequency amplifiers, but subsequent amplifiers which isolate a particular color signal are 6 megacycles or less in width. Attenuation of the carriers by 6 decibels is accomplished in the individual amplifiers. Subsequent detection in each of the chains gives the required video signal.

TRANSMISSION OF SOUND

In the subcarrier system, television sound may be transmitted either as a subcarrier centered at a point 4.5 megacycles from the main carrier, or as a separate radio-frequency carrier at the same point. Such a spac-

ing is required by the principle of compatibility. A radio-frequency sound carrier at the final frequency at a spacing of 4.5 megacycles from the green carrier would be used in the three-carrier color transmitter.

THE REPRODUCTION OF THE COLOR IMAGE

The kinescope shown in Fig. 5 is the three-gun single-neck tube mentioned in Part I. The photograph also shows the yoke and the optical system used for registration of the three images. In this tube the three cathode-ray beams cross inside the yoke and thus are deflected by the same field. The three rasters then appear opposite the three guns on different areas of the tube face. The tube face has a curvature whose center is at the center of the yoke. The three images are filtered to produce the three colors, and are combined by a system of mirrors and the lens to form a registered color image. It is possible with this tube to register the three images

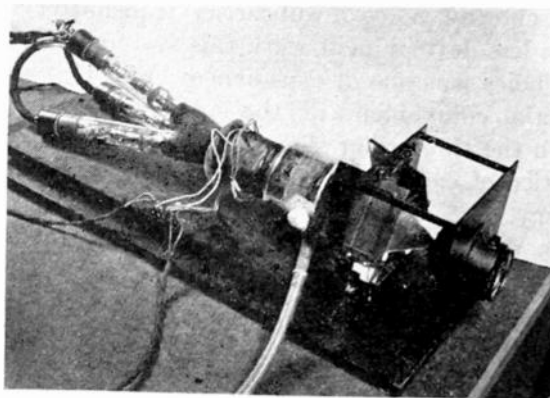

Fig. 5—Three-gun single-yoke tube.

quite satisfactorily, and experience gained with it indicated that registration might also be achieved with three separate tubes and lenses. Such an arrangement appears to be more straightforward, and at the same time leads to improved resolution and brighter images. This device has been denoted by the convenient term "trinoscope."

THE TRINOSCOPE

The term "trinoscope" is a designation for an assembly of three kinescopes, three lenses, and three deflection yokes which are energized from a common sawtooth deflection generator.

An ideal trinoscope having identical yokes and tubes is probably not realizable in an experimental setup. Hence provision was made for adjusting each yoke separately. Equalization of the horizontal size was obtained by moving a yoke slightly along the axis of a tube, thus obviating a complicated size-control circuit containing a variable inductance with approximately the same Q and self-resonant frequency as the yoke. The vertical sizes are adjusted through a small range, or trimmed by variable resistors in series with each vertical winding, to produce three rasters of equal size. Each yoke could be rotated slightly by a mechanical adjustment for angular alignment of the scanning rasters.

On first thought, it would seem best that the same current flow through each yoke, a condition which should be insured by a series connection of yokes. However, identical fields are desired, rather than identical currents, and since there is a variation between individual yokes, different currents are required to produce identical fields. If the variation between yokes is caused by a variation in the number of turns, then parallel operation is particularly advantageous, since the yoke having the larger number of turns requires the smaller current, which is actually the case due to the higher impedance. At any rate, trimming is necessary, and a method of connection should not be chosen to minimize trimming if other difficulties are introduced. There are at least two serious difficulties in series operation which are not encountered with the parallel connection. First, individual centering and trimming of the three yokes becomes exceedingly cumbersome for the series connection, but quite simple for the parallel connection. Second, and most important, in the series connection, capacitance to ground of the yokes remote from alternating-current ground appears as a shunt capacitance across the yokes nearer ground. These capacitances are of such magnitude in the horizontal deflection circuit that considerable current is by-passed around the yokes nearer ground. Also, high- Q series resonances occur in both the horizontal and vertical coils as a result of these capacitances. These circuits are shock-excited by the return-line pulse and cause objectionable transients on the left side of the picture that are different in the three yokes.

Fig. 6 shows a simplified diagram of the horizontal-deflection system. It is a normal power-feedback circuit using the 6AS7G damper tube except that three yokes and centering circuits connected in parallel are substituted for the usual single yoke and centering circuit. Fig. 7 shows the vertical circuit. In the absence of a suitable transformer, a direct-coupled circuit with feedback

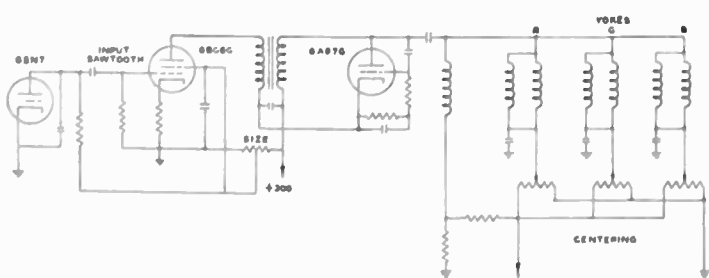

Fig. 6—Horizontal-deflection circuit.

was used. Although this arrangement is wasteful of power, it gives ample and good deflection with a minimum of time spent on adjustment. The linearity control is unusual in that excellent linearity is achieved without either changing the size or bouncing the raster when the control is varied.

The yokes for the trinoscope must be carefully designed and built. They should have high efficiency and should be as nearly alike as possible. They should pro-

duce a rectangular raster with neither pincushion nor barrel distortion. Such distortion will produce misregistry at the edges or corners of the image, if the assembly is not mechanically correct. For example, pincushion distortion occurs commonly when tubes with flat faces, as in the trinoscope, are deflected. The amount of distortion at any one point depends upon the total deflection there, including that from both the sawtooth and

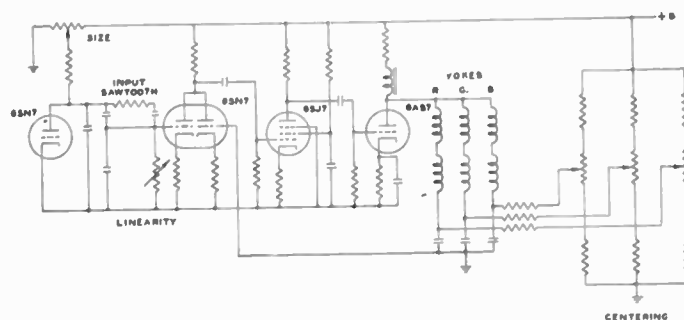

Fig. 7—Vertical-deflection circuit.

the direct-current, or shifting, source. If, then, due to poor mechanical alignment in the trinoscope assembly, appreciable electrical shifting of one or two of the rasters is required to register them, additional distortion will be introduced. The important point is that the distortion will be different on the three rasters since the shifting in each must necessarily be in a different direction to bring them together.

The inductance of the horizontal yoke winding is 8 millihenries, or approximately the same as a normal one-yoke deflection circuit, and the circuit is designed to supply three times normal current. Presumably, yokes having three times the normal inductance could be operated in parallel in order to give normal circuit impedance. Such an arrangement would reduce the current in the circuit, but raise the voltage. Experience, however, has shown that a yoke with an inductance above 8 millihenries requires voltages which occasionally may cause breakdown within the yoke. The two coils of a horizontal pair within a yoke are connected in parallel. However, the two vertical coils are connected in series in order to obtain an impedance as high as possible, since here the impedance is limited by a practical size of wire. With a given size of wire the impedance for the series connection is four times that for the parallel connection.

The kinescopes for the trinoscope assembly must be aluminized.¹ A thin layer of aluminum completely covers the phosphor and those inside surfaces of the tube which are held at second-anode potential. This layer is transparent to the high-voltage electrons, but opaque to light. The coating also has high conductivity, which insures that the three phosphors will be at the same potential, thus obviating any difference in raster size due to different beam voltages in the three kine-

¹ D. W. Epstein and L. Pensak, "Improved cathode-ray tubes with metal-backed luminescent screens," *RCA Rev.*, vol. 7, pp. 5-10; March, 1946.

scopes. Furthermore, the entire volume inside the bulb beyond the second anode is equipotential, and no distortion can be caused by spurious wall charges or potential drops. The kinescope guns should be as well-centered and mechanically stable as possible, since any variation contributes to misregistry.

The choice of phosphors for the red, green, and blue kinescopes was guided by a consideration of the over-all light efficiencies of the phosphors in combination with any light filters required for color correction. Thus, an orange phosphor in combination with a red filter yielded more light than available red phosphors.

The trinoscope optical system included three separate lenses. The three tubes were assembled at the corners of a triangle, as shown in Fig. 8, with their faces in

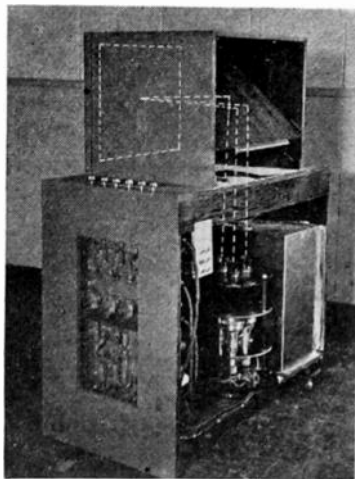

Fig. 8—Receiver showing trinoscope assembly.

the same plane. The axis of each lens in front of a tube is perpendicular to the tube face, but is offset from the tube axis toward the center of the assembly by an amount sufficient to register the three images. If the lenses are rectilinear, no distortion will result from such a displacement. Fig. 9 shows the principle of this registration with two tubes. The principle is the same as that used in photography where, by means of the rising front, tall buildings may be photographed from the ground without distortion. The image and object, or film and scene, are simply made parallel and the lens axis perpendicular to them, the center of the lens being

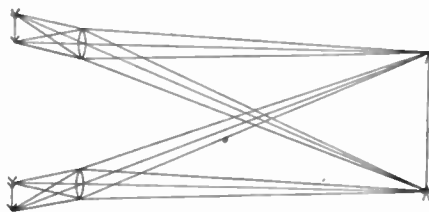

Fig. 9—Method of optical registration.

on the line joining the center of the image and object to make the image distortionless, or rectilinear. This, of course, requires a larger field, or increased covering power from the lens. Any noticeable falling off of light towards the edge of the lens will result in color shading

in the registered picture, since the shading will be different in the three colors. The lenses for the trinoscope need not be color-corrected, since each passes only one color.

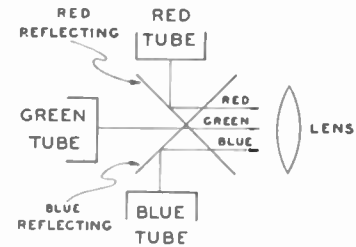

Fig. 10—Registration with three dichroic mirrors and one lens.

Another optical method of registry was tried in which ordinary mirrors were used to direct the light from the three tubes into one lens, but the arrangement was rejected as impracticable. Half-silvered mirrors, though feasible, waste much light. Dichroic mirrors,² however, provide an excellent solution to this problem. Fig. 10 shows the arrangement of the three tubes and the two dichroic mirrors, which are cut in the middle and crossed. One mirror reflects red, and passes green and blue, and the other reflects blue, and passes red and green. While this arrangement is still in the experimental stage, it offers great promise for a simple and economical method of registration.

THE VIDEO SYSTEM

The video system consists essentially of three identical video amplifiers of two stages each, with cathode-follower outputs. Approximately 75 volts peak-to-peak is available. The frequency response is flat to 5 megacycles. Two controls, the gain and background, are provided in each channel. Eventually, of course, simpler arrangements would be used, and individual gain controls dispensed with. The gain controls here, however, are useful for demonstrating color balance, and in making experimental adjustments. The background controls must be set accurately. Controls would be necessary even in the simplest receivers, although, once set, they would require adjustment only if the cutoff of a kinescope changed due to aging. Accurate setting of the "blacks," or background, is extremely important in any additive color system. That is, the black portions of the reproduced image must correspond with the blacks of the original scene, and, even more important, the blacks of the three colors must agree with each other. If one of the colors were incorrect, such that zero light were produced when a low value were needed, all of the reproduced colors requiring low levels of that color would receive none, and wrong colors would be obtained.

Therefore, the picture direct current is reinserted by the double-diode clamp, one of the best restorers. The direct current is reinserted on the grid of the cathode

² See Part II of this series.

follower. Delayed pulses, obtained from separated synchronizing signal, operate the clamp circuits during the back-porch interval. Such a circuit can restore the correct picture back level and maintain it regardless of picture content, incorrect or spurious low frequencies, or switching transients. Restoration is also independent of synchronizing-signal height, which means that the red and blue backgrounds remain correct when these channels are switched to the green signal, as when reproducing a black-and-white picture from a low-band station.

The synchronizing signal is separated from the green-channel signal. Fig. 11 is a block diagram of the green video amplifier and the synchronizing-signal circuits.

Safety circuits are provided for protection of the kinescopes in the event of deflection or power failure.

Protection against power failure, such as a blown fuse or disconnected cable, is necessary since the deflection would cease before the accelerating voltage, and an un-

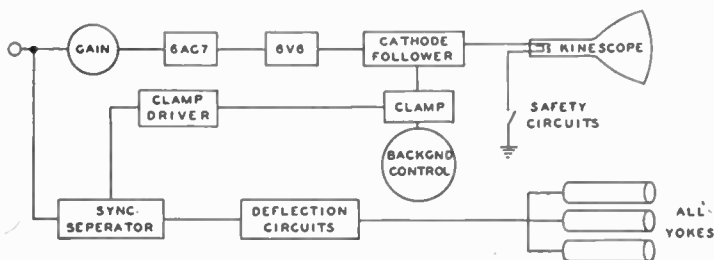

Fig. 11—Video block diagram of green channel.

deflected spot would remain long enough to damage the kinescope screen.

Electrical Noise Generators*

J. D. COBINE†, SENIOR MEMBER, I.R.E., AND J. R. CURRY‡, ASSOCIATE, I.R.E.

Summary—A new noise source consisting of a gas tube in a transverse magnetic field has been developed. Characteristics of the noise source are presented, together with some consideration of the problems in the amplification of noise. Typical noise-amplifier circuits are given for frequency bandwidths from 0.1 to 2.5 and 5 megacycles, respectively.

INTRODUCTION

AS PART of a noise-application program a study was made of various noise sources capable of providing high-level random-noise signals. In general, it was necessary to have signals consisting of random noise having frequency components extending over wide bandwidths. In addition, it was desirable to have no oscillations present in the signal. Obviously, it was desirable to have a high level of random-noise voltage available to simplify problems of amplification. In the course of this study a gas-tube noise source was developed with random noise output much higher than could be obtained from thermal noise,¹ shot noise,¹ or even photomultiplier² tubes. The noise output of the tube was amplified in order to provide sufficient noise power for modulation. The design of noise amplifiers

presents special problems not ordinarily encountered in video-amplifier design.

The noise measurements recorded in this paper were made by two spectrum analyzers. One of these³ measured the noise in a 33-kilocycle bandwidth in the frequency range 100 kilocycles to 10 megacycles. The other⁴ permitted measurements from 25 cycles to 1 megacycle. Both spectrum analyzers were designed to present a high impedance to the noise source and to minimize distortion of the spectrum due to clipping.⁵ The noise spectra were assumed flat over the bandwidth of the analyzers. Thus the noise was measured in units of root-mean-square volts/ $(\Delta f)^{1/2}$, where Δf was an arbitrarily chosen small bandwidth. In studying a wide range of noise sources and generators it was generally found convenient to refer the spectral data in decibels to the arbitrary level of 10 microvolts per (kilocycle)^{1/2}. The level of the shot-noise voltage developed by a diode with a plate current of 10 milliamperes and a 3000-ohm plate load is 26 decibels below this reference level. The root-mean-square voltage obtained by integrating an experimentally determined spectrum of irregular shape agreed well with the value obtained with a wide-band thermocouple voltmeter.

GAS-TUBE NOISE SOURCE

The noise source developed consisted of a 6D4 miniature gas triode placed in a transverse magnetic field pro-

* Decimal classification: R355.913.21×R537.9. Original manuscript received by the Institute, May 28, 1946; revised manuscript received, September 4, 1946.

This work was done in whole or in part under Contract No. OEMsr-411 between the President and Fellows of Harvard College and the Office of Scientific Research and Development.

† Formerly, Radio Research Laboratory, Harvard University; now, Research Laboratory, General Electric Company, Schenectady, New York.

‡ Formerly, Radio Research Laboratory, Harvard University; now, Thompson Chemical Laboratory, Williams College, Williamstown, Massachusetts.

¹ E. B. Moullin, "Spontaneous fluctuations of voltage," Clarendon Press, 1938.

² W. Shockley, and J. R. Pierce, "A theory of noise for electron multipliers," Proc. I.R.E., vol. 26, pp. 321-332; March, 1938.

³ G. P. McCouch, and P. S. Jastram, "Video spectrum analyzer," Harvard Radio Research Laboratory Report, OEMsr 411; p. 96.

⁴ J. D. Cobine and J. R. Curry, "Range extender for General Radio 760 A sound analyzer," R.S.I., vol. 17, pp. 190-194; 1946.

⁵ D. Middleton, "The response of biased saturated linear and quadratic rectifiers to random noise," Jour. Appl. Phys., vol. 17, pp. 778-801; October, 1946.

duced by a small permanent magnet (Fig. 1).⁶ The magnetic field has the property of eliminating undesirable oscillations characteristic of gas tubes, and at the same time increasing the level of the high-frequency noise.^{7,8}

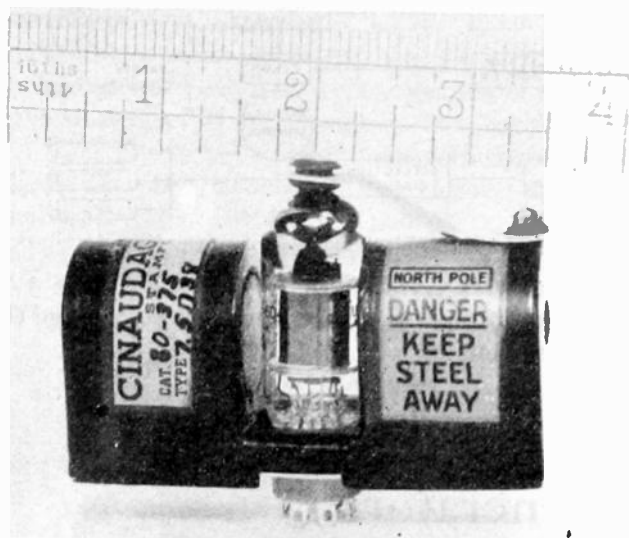

Fig. 1—6D4 permanent-magnet noise source.

The 6D4 tube was chosen because it combined the desirable features of small size, low power drain, and great uniformity from tube to tube.

The values of the magnetic field, load resistance, and operating current were chosen after a systematic study of the effects of these variables on the noise spectrum. The effect of the magnetic field on the spectrum is shown in Fig. 2. A flux density of 375 gauss was chosen to give

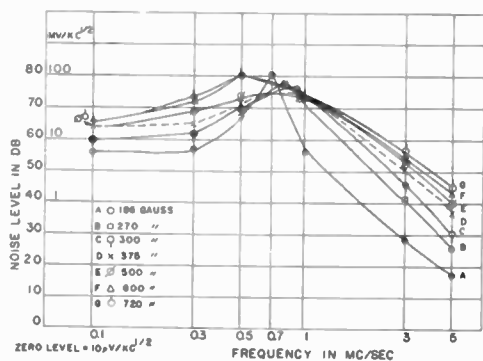

Fig. 2—Effect of magnetic field strength on the 6D4 noise spectrum. Electromagnet used. Load resistance = 20,000 ohms. Anode current = 5 milliamperes.

the maximum high-frequency noise consistent with the requirements of a readily equalized spectrum and compact construction of the permanent magnet. The mag-

⁶ Special design, made by Cinadagraph Corporation, as Catalog No. 80-375.

⁷ J. D. Cobine, and C. J. Gallagher, "Noise and oscillations in hot cathode arcs," *Phys. Rev.*, vol. 80, p. 113, 1946. Also, *Jour. Frank. Inst.*, vol. 243, pp. 41-54; 1947.

⁸ C. J. Gallagher, and J. D. Cobine, "Effect of magnetic field on noise and oscillations in hot cathode arcs," *Phys. Rev.*, vol. 70, p. 113, 1946. Also, *Jour. Appl. Phys.*, vol. 18, pp. 110-116; January, 1947.

net itself consisted of two short alnico bar magnets supported in an aluminum casting. No magnetic return path was necessary. The field was directed transverse to the normal flow of current and polarized to deflect the arc to the top of the tube.

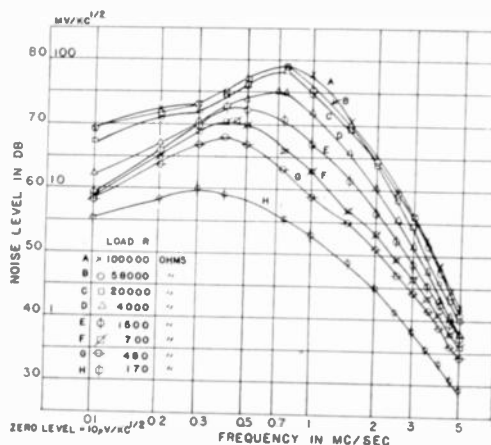

Fig. 3—Effect of load resistance on the 6D4 noise spectrum. Standard permanent magnet used; $B = 375$ gauss. Anode current = 5 milliamperes.

The gas tube requires a high nonreactive load resistance in order to develop the highest-level high-frequency noise. The effect of load resistance is shown by Fig. 3. It was found desirable to use a load resistance of about 20,000 ohms, since the higher values have little effect on the noise spectrum and lower values reduce the level and shift the maximum in the spectrum to lower frequencies. Fig. 4 shows the noise spectra for various anode currents within the range practical for the 6D4. The effect of anode current is greatest at the high fre-

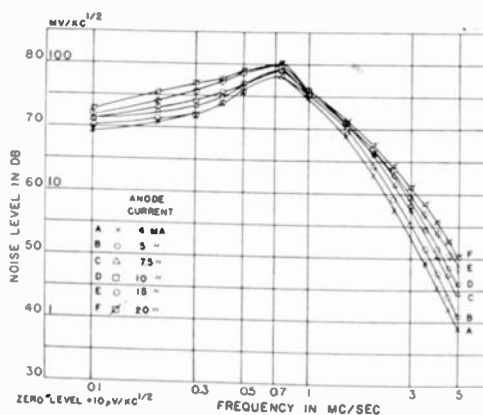

Fig. 4—Effect of anode current on the 6D4 noise spectrum. Standard permanent magnet used; $B = 375$ gauss. Load resistance = 20,000 ohms.

quencies, and negligible at the peak. The low-frequency spectrum (not shown in the figure) is substantially flat down to 25 cycles at the level indicated for 100 kilocycles in Fig. 4. The root-mean-square voltage for the band 25 cycles to 5 megacycles is 2.5 volts with a peak-to-peak voltage of 18 volts. The 6D4 tube was found to operate stably in the magnetic field for at least 600 hours with no appreciable change in noise output. The

standard deviation of the noise level for a large number of these units was 1.3 decibels. Thus, the 6D4 noise unit is a suitable primary noise source capable of generating a continuous spectrum of any bandwidth in the range 25 cycles to 5 megacycles.

DESIGN AND EQUALIZATION OF WIDE-BAND NOISE GENERATORS

Although the noise spectrum of the Sylvania 6D4 tube falls off rapidly at frequencies higher than 700 kilocycles, it is possible to build a high-level noise generator that gives as an output a noise spectrum that is flat up to 5 megacycles if suitable equalizing circuits are used in the various amplifying stages.

The following discussion summarizes the principles involved in designing and building wide-band noise amplifiers. Ordinarily, all or some of the following characteristics of the output of a noise amplifier should be specified: (1) cutoff frequencies, (2) shape of spectrum, (3) peak-to-peak voltage, (4) type and degree of clipping, and (5) power output.

It is important to keep in mind that the spectrum is an integrated measurement. The grid of a tube "sees" the instantaneous noise voltage which cannot be determined from the root-mean-square voltage as given by the spectrum. The peak-to-peak voltage, which determines the degree of clipping, must be obtained by other measurements. The method of measuring the spectrum has been discussed in the first part of this paper. The most convenient way to measure the peak-to-peak voltage is to put the noise on the horizontal plates of a calibrated wide-band oscilloscope and make the horizontal deflection zero. Observation of the noise voltage on an oscilloscope will also show to what extent the positive and negative peaks are clipped. Often the clipping is unsymmetrical, so in the general case the peak-to-peak voltage cannot be determined by means of a positive-peak-reading voltmeter. Power output may be determined from the root-mean-square current flowing through a known noninductive resistor. It should be pointed out that a statement of power output alone is deceptive unless the output spectrum is also defined.

In broad outline, wide-band noise amplifiers bear a considerable resemblance to ordinary video amplifiers but in detail they differ in many respects, particularly if a high level or a clipped output is desired. In ordinary video amplifiers the tubes use class- A_1 linear operation (i.e., there is no nonlinear distortion) and frequency and phase distortion are eliminated by properly designed coupling circuits. Where high power output is required, noise amplifiers are overdriven because of the high peak-to-root-mean-square ratio of the noise from the noise source. This ratio may be as high as 5 to 1, compared to 1.4 to 1 for sine wave. High power output requires high root-mean-square voltage, not high peak voltage. Overdriving the amplifier results in a clipped noise signal, which is usually permissible and increases the power output. Thus, the dynamic operation of a

noise amplifier is different from that of an ordinary video amplifier. In a noise amplifier, nonlinear distortion will be present. On the negative swing the grid voltage goes beyond cutoff, and on the positive swing grid current is drawn. The positive grid swings may even cause the tube to operate in the saturated region. Thus r_p and g_m of the tube change constantly, as does the load impedance which the tube sees because of grid current drawn by the following stage. The clipping that occurs when an amplifier is overdriven causes a change in the spectrum. The general effect is to increase both high-frequency and low-frequency components, with the greater increase in the low frequencies.⁵ Thus, the equivalent-plate-circuit theorem cannot be used in designing equalizers. Also, it is not possible to determine the nature of the output noise spectrum by measuring the frequency response of the amplifier with a sine wave. The only completely satisfactory way to adjust the output spectrum is to excite the amplifier with the operating noise signal and adjust the circuit constants while observing the noise output with a spectrum analyzer.

The drop-off in the spectrum of the 6D4 at high frequencies is caused by phenomena taking place inside of the tube. It is not a result of the ordinary shunting effect of interelectrode capacitances. Thus the spectrum cannot be made flatter by reducing the load into which the 6D4 works.

It has been found that it is impractical to put an equalizing circuit, particularly one for the high frequencies, between the 6D4 tube and the first amplifying tube. The reason for this is twofold. First, such a circuit has relatively little effect because the 6D4 has such a high internal impedance that high- Q circuits cannot be obtained. The other reason is that such circuits may cause the 6D4 to oscillate as a relaxation oscillator. It was found best to insert equalizing circuits in the plate circuits of the amplifying tubes.

First, consider the problem of obtaining a flat noise spectrum. For convenience, assume in the following discussion that the spectrum is to be flat to 5 megacycles. It will be noted that at 5 megacycles the spectrum of the 6D4 unit is about 30 decibels below the maximum, which is at 700 kilocycles. In order to bring up this high-frequency portion, a shunt-peaking circuit is the most satisfactory. The peaking circuit acts as a parallel-resonant circuit, the capacitance between tubes forming one arm. The circuit should resonate at 5 megacycles and the Q of the circuit is determined primarily by the load resistance. If the following tube draws grid current, as it usually does, the Q of the circuit is lowered and it may be impossible to obtain the desired elevation of the high-frequency end of the spectrum in one stage.

A sine-wave signal and a vacuum-tube voltmeter can be used to adjust the inductance of the peaking coil so that the resonant frequency of the circuit is at the proper point, e.g., 5 megacycles in this case. (For experimental use it is convenient to use coil forms provided with adjustable powdered iron slugs.) It is not very

practical to calculate in advance the most advantageous size of the load resistor. It must be adjusted more or less by trial and error, using the analyzer to determine the noise spectrum.

It should be remembered that the chief purpose of the first amplifying tube is to amplify differentially, i.e., it should bring up the 5-megacycle region by a factor of 30 over that of the 700-kilocycle region. This means that a very small value (50 to 200 ohms) of load resistor R_L will be used in the shunt-peaking circuit. Little success has been experienced in using a series-peaking circuit to raise the higher-frequency portion of the 6D4 spectrum to such an extent. A minor advantage of the

achieved very well by using series-peaking circuits. They have the advantage of having a greater over-all amplification compared to the shunt types of peaking circuit.

For low-frequency compensation it usually suffices to put a parallel RC circuit in series with the load resistor. It may be put in the same stage as the shunt-peaking coil. In this case the capacitance of the RC circuit and the high-frequency peaking coil will show series resonance and a dip in the spectrum may occur at medium frequencies. Sometimes advantage may be taken of this by adjusting these circuits so that the dip occurs at 700 kilocycles and is of the proper magnitude. Thus the two

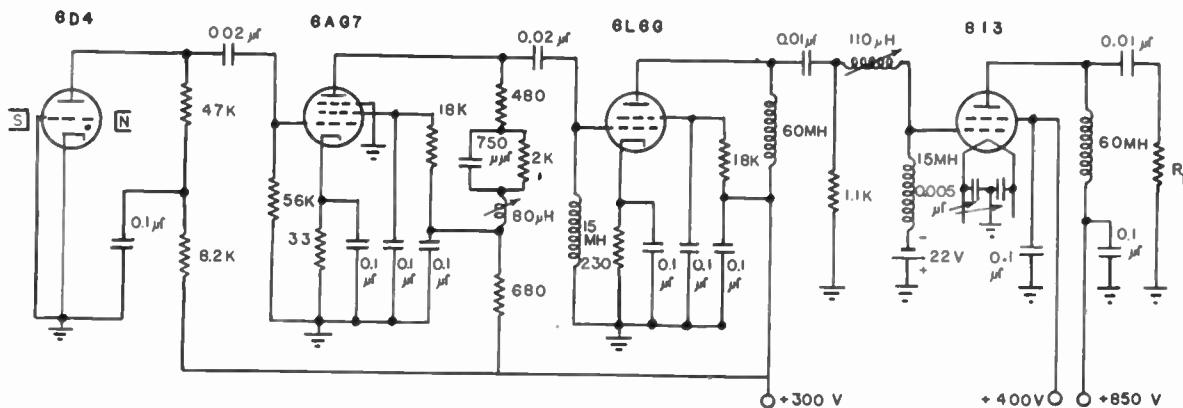

Fig. 5—High-level wide-band (0.1 to 2.5 megacycles) noise generator. R_L either 2000 or 4000 ohms.

shunt-peaking circuit is that it is far easier to adjust.

Usually it is impossible to raise the high-frequency portion of the spectrum sufficiently in one stage. Even when this is possible, intertube capacitance must be compensated for in the later stages. The slight addi-

compensating circuits achieve a flat spectrum by raising the ends and lowering the hump.

Sometimes it is necessary to pull down either the hump in the 6D4 spectrum or a new peak that may appear in the spectrum at some later stage. A convenient

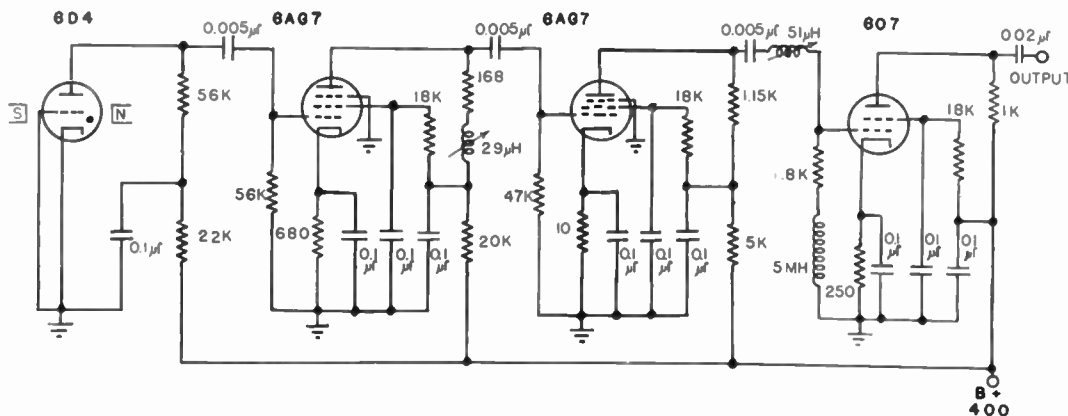

Fig. 6—Wide-band (0.1 to 5 megacycles) noise generator.

tional peaking that is required, and the compensation that is necessary on account of capacitance, can be

way to do this is to put, at the appropriate point, a series-resonant circuit to ground. L and C are made to

resonate at the frequency at which the dip is desired, and the amount of the dip is adjusted by means of a resistance in series with L .

It must be remembered that in any one stage the equalizing circuits for the various portions of the spectrum are usually not independent of one another. Thus it is not possible to make the final adjustment on each one separately. For example, if a shunt-peaking circuit is adjusted to raise the high-frequency portion of the spectrum, and then a series-resonant circuit is put into the same stage to pull down a low-frequency hump that is present, the latter circuit will have an effect on the high-frequency portion of the spectrum.

A few attempts have been made to equalize by means of cathode degeneration. These have not been very successful. The general effect of cathode degeneration is to lower the level of the entire spectrum.

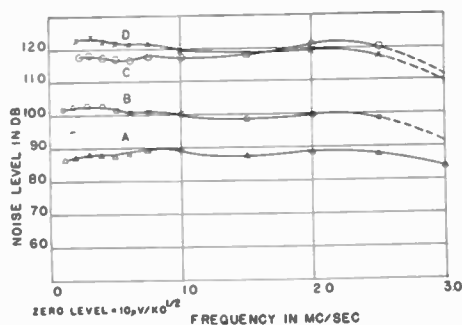

Fig. 7—Noise spectrum for circuit of Fig. 5.

Curve	Voltage		Power output, watts
	Peak-to-peak	R.M.S.	
D—Plate, 813, $R_L=4000$ ohms,	1800	590	87
C—Plate, 813, $R_L=2000$ ohms,	1400	400	80
B—Grid, 813	300	55	—
A—Grid, 6L6G	92	—	—

The amount of clipping can often be adjusted by changing the grid bias. In special cases a resistor can be put in series with the grid so that clipping occurs when grid current is drawn, or diode clippers may be used. An important phenomenon connected with clipping is that, if the noise is clipped severely in one of the intermediate stages of a multistage amplifier, it will not as a rule appear clipped to the same extent in later stages. Sometimes it even becomes practically unclipped. This action has been observed many times and its practical importance is that if one desires a clipped output from the final stage, one cannot simply arrange things so that the clipping occurs at an earlier stage and then expect the

clipped signal to be transmitted through the later stages with the usual voltage inversions. This phenomenon is probably caused by phase distortion. In clipped noise a completely random distribution of the phases of the noise components does not exist. Phase distortion restores the randomness in the phase relations.

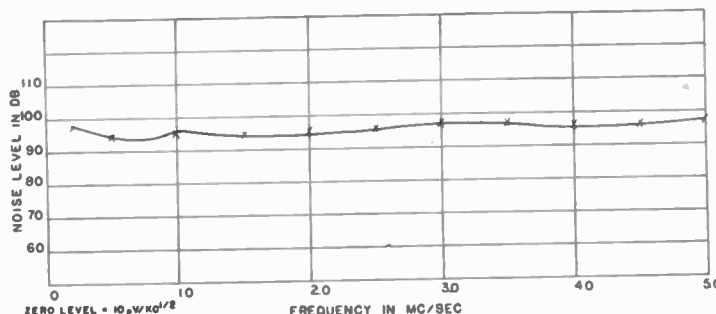

Fig. 8—Noise spectrum at plate of 807 for circuit of Fig. 6. Peak-to-peak voltage = 285 volts.

Both low-pass and high-pass filters have been used when it has been desired to obtain spectra with special characteristics. As a rule they are not very successful when they are used in intermediate stages. The effect, of the filter is partially counteracted by later clipping, which tends to raise the level of the low- and high-frequency components. However, filters work very well on the output of the amplifier. They can be calculated from ordinary circuit theory. In this connection, Rice has shown that, if clipped noise is fed into a narrow-pass filter, the noise coming out of the filter will be unclipped.⁹

Typical amplifiers designed according to the foregoing principles are shown in Figs. 5 and 6. These amplifiers were designed to give substantially uniform noise spectra extending from 100 kilocycles to 2.5 and 5 megacycles, respectively. The output spectra are shown in Figs. 7 and 8. In additions the spectra obtained at the intermediate stages of the 2.5 megacycles amplifier are shown in Fig. 7. Although these amplifiers were designed to modulate high-frequency oscillators, it was not possible to determine the equivalent "impedance" presented to the modulator by the oscillator. The spectra were obtained with the last amplifier working into a pure resistance load.

ACKNOWLEDGMENT

The authors wish to acknowledge the generous assistance of C. J. Gallagher.

⁹ S. O. Rice, "Mathematical analysis of random noise," *Bell Sys. Tech. Jour.*, vol. 24, pp. 46-156; January, 1945.



The Design of Speech Communication Systems*

LEO L. BERANEK†, SENIOR MEMBER, I.R.E.

Summary—A method is presented for calculating the ability of a communication system to transmit speech intelligibly in the presence of noise. The total speech arriving at the ear of a listener is determined by adding the orthotelephonic gain of the system to the speech spectrum which would be produced by a talker at the eardrum of a listener at a distance of 1 meter. The total noise arriving at the ear is determined in terms of its spectrum level from measurements of the noise pickup of the microphone and the acoustic attenuation of the earphone cushions. The area lying between the spectrum level of the peaks of the speech and the spectrum level of the total noise arriving at the eardrum when plotted on a distorted frequency scale determines a quantity called articulation index which can be correlated with articulation scores. Methods for determining the maximum gain permissible in the system are discussed. The validity of the method is established by comparison of calculated with carefully measured articulation scores.

I. INTRODUCTION

VOICE COMMUNICATION using microphones, earphones, or telephone receivers has risen to a new level of importance as modern transport has increased in complexity and tempo. No longer is it adequate to communicate by radiotelegraph signals between aircraft and the ground or by messages handed from the engineer to the station master. These slow methods, by which only a minute quantity of information can be exchanged while the vehicle moves into sight and out again, have had to give way to the efficiency of the spoken word. Furthermore, as the number of vehicles has increased, and as the time allotted for an exchange of vital information has decreased, speech as we ordinarily know it has had to be replaced by a group of code words such as "angels" for "height in thousands of feet," "mattress" for "bottom of a cloud layer in thousands of feet," and "wilco" for "message received, understood, and will be acted on." As airplanes increase in speed and number, landing operations at air terminals may require the use of even more condensed language, each word of which would convey the meaning contained normally in a sentence or even a paragraph.

The more information that each word conveys, the more significant becomes the loss of a word, and the more nearly perfect the communication system must be. As a result, the radio engineer finds himself called on today to design equipment which will transmit and receive the most difficult words and syllables in an atmosphere of noise so loud that two people are unable to hear each other even when shouting.

* Decimal classification: 621.385×534. Original manuscript received by the Institute, June 13, 1946; revised manuscript received, September 30, 1946. Presented, National Technical Meeting of the Acoustical Society of America, New York, N. Y., May, 1946.

This research, begun under Contract No. OEMsr-658 between Harvard University and the Office of Scientific Research and Development, is continuing under contract with the U. S. Navy, Office of Naval Research.

† Formerly, Harvard University, Cambridge, Massachusetts; now, Massachusetts Institute of Technology, Cambridge, Massachusetts.

Through the pioneering efforts of the Bell Telephone Laboratories, considerable data had been accumulated by 1941 on what constitutes an effective communication system for the transmission of speech over telephone circuits. Their data apply primarily to the design of systems for operation at low signal levels in reasonably quiet surroundings with the talker speaking in a normal tone of voice. Their findings were succinctly summarized by Fletcher¹ when he wrote in 1942 that "substantially complete fidelity for the transmission of speech is obtained by a system having a frequency range from 100 to 7000 cycles per second and a volume range of 40 decibels." This statement, although conclusive, gives the design engineer no guidance on how far it is safe to depart from these specifications.

More recently French and Steinberg have presented a method for calculating the performance of voice communication systems in environs in which the ambient noise is moderate.² Their findings, and data obtained at the Electro-Acoustic and Psycho-Acoustic Laboratories (Harvard) during the past five years, form the basis of the procedure for calculating the performance of voice communication systems in any environment of noise which is presented in this paper.

II. THE ARTICULATION TEST

The articulation test has been used^{3,4} as a quantitative measure of the intelligibility of speech transmitted over communication systems. In performing the test, an announcer reads carefully prepared lists of syllables or words to a group of listeners, and the percentage of items correctly recorded by these listeners is called the articulation score. Differences in talkers, listeners, or word material profoundly affect the score, hence only those tests which are performed under identical conditions can be compared. In order to determine how a particular communication system is likely to perform it must be subjected, during the articulation test, to those stresses which it will encounter in use, such as interfering noise, reduced atmospheric pressure at altitude, method of holding or facing the microphone, etc.

During the initial stages of design, articulation testing is costly and slow. Hence, the need arises for a method of calculating the effect on speech intelligibility brought about by changes in the physical characteristics of the system or the ambient noise in which it will oper-

¹ H. Fletcher, "Hearing, the determining factor for high-fidelity transmission," *Proc. I.R.E.*, vol. 30, pp. 266-277; June, 1942.

² N. R. French and J. C. Steinberg, "Factors governing the intelligibility of speech sounds," *Jour. Acous. Soc. Amer.*, vol. 19, pp. 90-119; January, 1947.

³ H. Fletcher and J. C. Steinberg, "Articulation testing methods," *Bell Sys. Tech. Jour.*, vol. 8, pp. 806-854; October, 1929.

⁴ J. P. Egan and F. M. Wiener, "On the intelligibility of bands of speech in noise," *Jour. Acous. Soc. Amer.*, vol. 18, pp. 435-441; October, 1946.

ate. It is not implied that the articulation test can be dispensed with, for in the final analysis it is the only way one can make certain that all possible variables have been taken into account.

III. THE CHARACTER OF SPEECH

The average spectrum of speech, produced at a distance of one meter by typical young male voices in an anechoic (echo-free) chamber⁵ and measured by a microphone compensated to be flat over the frequency range indicated, is shown by the upper curve of Fig. 1.⁶ Some

of the frequency range between 500 and 4000 cycles per second shows that the contour lines are essentially parallel. Hence, taking the 1000- to 1400-cycle-per-second

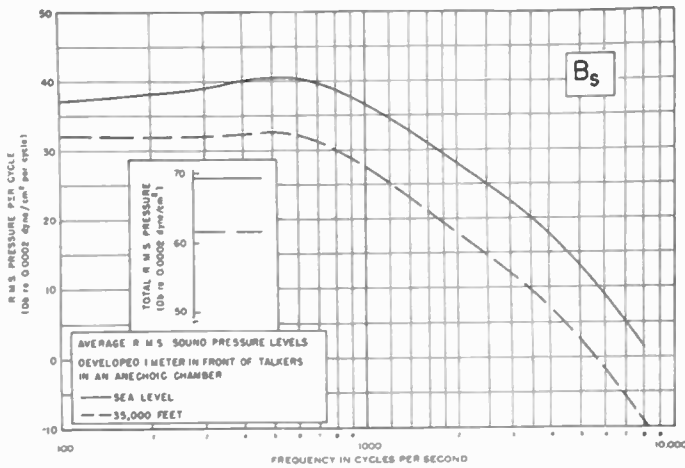

Fig. 1—Average spectrum level of speech measured in one-cycle band-widths in decibels versus frequency for young male voices talking at a level six decibels below the maximum they could sustain without straining their voices. Microphone placed one meter in front of talkers in an anechoic (echo-free) chamber. Upper curve taken at sea level; lower at 35,000 feet simulated altitude. One decibel has been added to remove the effect of pauses between words in the total spectrum level.

voices were considerably stronger than others; the maximum spread of the data obtained on seven subjects was of the order of ± 7 to ± 10 decibels. It is seen that the average total sound pressure level at one meter for half-effort is about 68 decibels.

Oscillographic records⁶ showed that about 20 to 25 per cent of the total talking time was consumed by the space between words. Hence, approximately one decibel was added into the spectrum level of Fig. 1 to yield the average level of the speech itself. These curves, at sea level and 35,000 feet of altitude will be referred to as B_s versus frequency in later use.

Dunn and White published data showing the root-mean-square pressures developed by the voice in successive $\frac{1}{8}$ -second intervals in fourteen contiguous frequency bands.⁷ An extension of their findings, taken from footnote reference 2, is shown in Fig. 2. Inspection

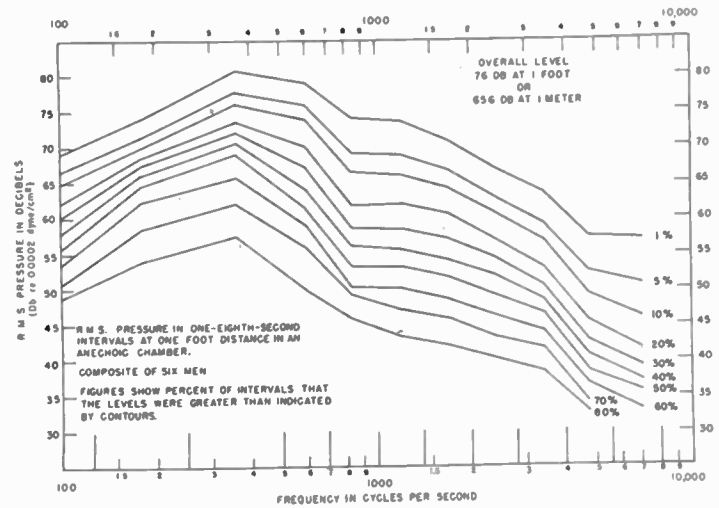

Fig. 2—Root-mean-square sound-pressure levels measured in successive $\frac{1}{8}$ -second-long intervals at one-foot distance in an anechoic chamber (from French and Steinberg). Contours show percentage of intervals in which the level exceeded the values shown on the ordinate at different frequencies.

band as typical of all bands in this region, a plot was made of cumulative level distribution in the $\frac{1}{8}$ -second intervals. (See Fig. 3.) The long time average sound pressure for that band was 62 decibels. Now as was just stated, about 20 per cent of the intervals of speech

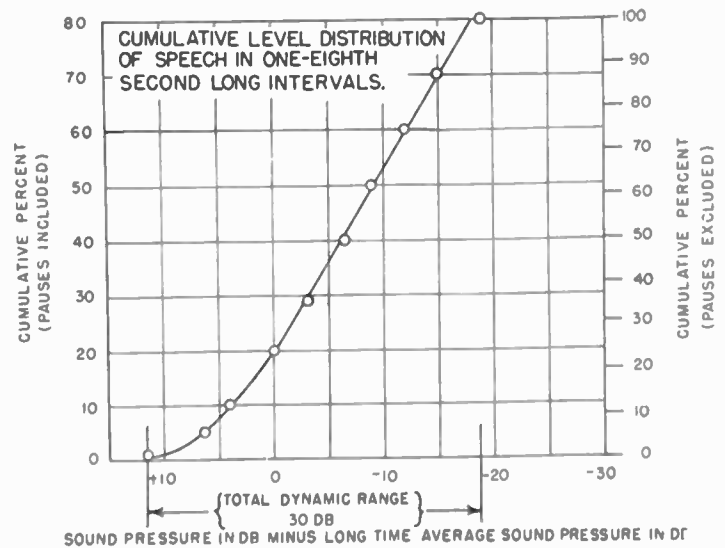

Fig. 3—Curve showing cumulative level distribution of speech in an octave band in $\frac{1}{8}$ -second-long intervals versus the sound-pressure level in decibels minus long-time average sound-pressure level in decibels. The right-hand ordinate has been added to the original graph of French and Steinberg.

⁵ L. L. Beranek and H. P. Sleeper, Jr., "Design and construction of anechoic sound chambers," *Jour. Acous. Soc. Amer.*, vol. 18, pp. 140-150; July, 1946.

⁶ H. W. Rudmose, K. C. Clark, F. D. Carlson, J. C. Eisenstein, and R. A. Walker, "The effects of high altitude on speech and hearing," Paper No. 31, 31st Meeting, Acoustical Society of America, New York, N. Y., May 11, 1946.

⁷ H. K. Dunn and S. D. White, "Statistical measurements on conversational speech," *Jour. Acous. Soc. Amer.*, vol. 11, pp. 278-288; January, 1940.

are consumed by pauses between words and breathing. If the right-hand side of the graph is observed the important conclusion is reached that, the total dynamic range of speech is about 30 decibels in any one band.

IV. THE NATURE OF HEARING

Extensive data have been taken to determine the average threshold of hearing for the population of the United States. The threshold curve for young people most commonly published⁸ and later found to hold for acute young ears⁹ is shown in (a) of Fig. 4. Another type of threshold curve derived recently¹⁰ by adding a correction curve to the American Standards Association curve for the difference between pressure in the free-field and at the eardrum is shown as (b) of Fig. 5. It gives the threshold levels in terms of the pressure produced at the eardrum.

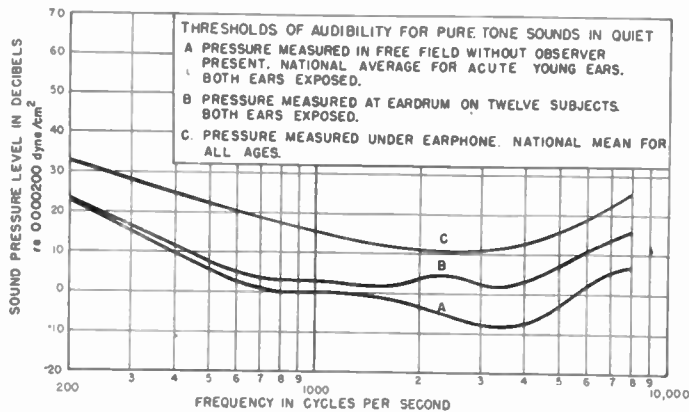

Fig. 4—Thresholds of audibility for pure tone sounds with subjects in quiet.

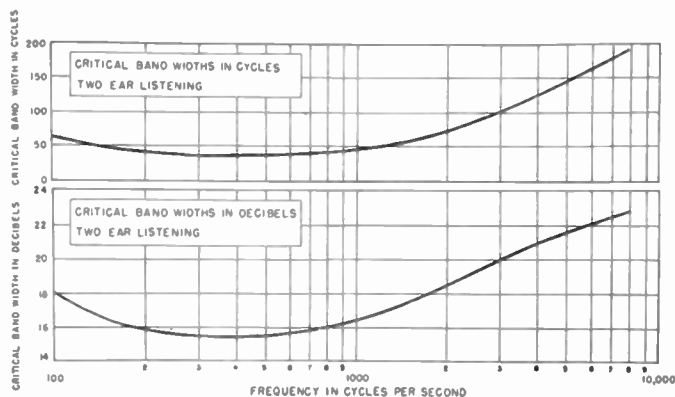

Fig. 5—Widths of critical masking bands plotted as a function of frequency. The upper curve gives the critical bandwidths in cycles per second and the lower curve is ten times the logarithm to the base ten of the upper.

At the other extreme we need to know the maximum intensity of a pure tone or speech which the ear can tolerate without discomfort or injury. Recent unpublished data obtained at the Central Institute for the Deaf, St. Louis, Missouri, have shown that three different upper thresholds for pure tones or speech will be

⁸ Acoustical Society of America—American Standard for Noise Measurements Z24.2-1942, *Jour. Acous. Soc. Amer.* vol. 14, pp. 102-110; July, 1942.

⁹ J. C. Steinberg, H. C. Montgomery, and M. B. Gardner, "Results of the world's fair hearing tests," *Bell Sys. Tech. Jour.*, vol. 19, pp. 533-562; October, 1940.

¹⁰ F. M. Wiener and D. A. Ross, "The pressure distribution in the auditory canal in a progressive sound field," *Jour. Acous. Soc. Amer.*, vol. 18, pp. 401-408; October, 1946.

determined by a group of listeners depending upon how much exposure to intense noises they have had previously. These thresholds are essentially constant as a function of frequency and are known as thresholds of (a) discomfort, (b) tickle, and (c) pain; and for listeners who have not been exposed to high noise levels the values for pure tones are approximately 110, 132, and 140 decibels respectively, re 0.000200 dyne/cm². These three thresholds will be approximately 10 decibels higher for people who have been exposed to loud noises for several hours daily over a period of several days.

Of interest in communication at high altitudes is the variation of hearing acuity with decreasing atmospheric pressures. Data taken at the Electro-Acoustic Laboratory⁶ indicate that there is no measurable change in the average threshold of hearing between sea level and 35,000 feet.

One needs only to turn to everyday experience to know that a sound which is faintly audible is "drowned out" or *masked* when even a moderately loud noise is produced nearby. By definition, the *masking* of a pure tone by noise is equal to the difference between the new and the old threshold levels of the tone, i.e., $M = T - T_0$ where M is the masking, T_0 is the threshold level of the pure tone in quiet, and T is the level of the pure tone when it is just audible with the noise present. All three values are expressed in decibels.

Of great importance in understanding the ability of the ear to interpret transmitted speech is the way in which various noises mask desired sounds. Extensive tests have shown that for noises with a continuous spectrum, it is the noise in the immediate frequency region of the masked tone which contributes to the masking.¹¹ For example, if a band of noise with a continuous spectrum is used to mask a tone of 800 cycles per second, it will be found that after the band (centered about 800 cycles per second) is made increasingly wider than 50 cycles per second, the same amount of masking will be obtained as was attained for a band exactly 50 cycles wide. For narrower bands the masking decreases in proportion to the logarithm of the bandwidth. The bandwidth at which the masking just reaches its stable value is known as a "critical band." Most noise produced in aircraft, locomotives, tanks, engine or boiler rooms, wind tunnels, and near spinning or weaving machines is of a continuous spectrum type although the spectrum may slope upward or downward. Bands of speech appear to be masked by continuous-spectra noises in much the same way as pure tones are masked by them. For this reason it is possible to divide the speech spectrum into narrow bands and study each band independently of the others.

Published data^{11,12} indicate that the critical bandwidth is a function of frequency, and curves are shown in

¹¹ H. Fletcher, "Auditory patterns," *Rev. Mod. Phys.*, vol. 12, pp. 47-65; January, 1940.

¹² Psycho-Acoustic Laboratory, Harvard University, "The masking of signals by noise," O.S.R.D. Report No. 5387; October 1, 1945.

two ways in Fig. 5.² Observations indicate that when a critical band of frequencies is at a just-audible level the total energy in the band is the same as the energy of a just-audible pure tone located at the center of the band.

A relation between the masking of a pure tone whose frequency lies between 200 and 8000 cycles per second and the level of a masking noise of the continuous spectrum type is shown in Fig. 6.¹² This curve shows that the masking increases linearly with noise level.

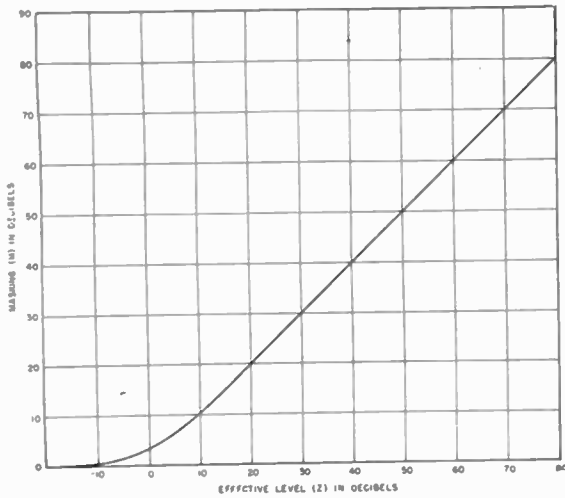

Fig. 6—Relation between masking and the effective level of a critical band width. M is the change in the threshold of a pure tone due to the noise. Z is the number of decibels that the total energy in a critical band is above its threshold level.

V. ORTHOTELEPHONIC GAIN

Before proceeding farther, a definition of a perfect communication system will be made. Although subject to proof by test, it is obvious that two intelligent people with normal hearing, speaking in loud, clear tones could understand each other nearly perfectly if placed in an absolutely quiet room, free from reflecting surfaces and facing each other at a distance apart of one meter. With this condition as a reference, a perfect communication system is defined as one which produces exactly the same sounds at the ear of a listener as would be produced in the above-described situation. The same talker would need to be used in both cases. Orthotelephonic gain¹³ is now defined as

$$\text{Orthotelephonic Gain} = 20 \log_{10} (p_2/p_1) \quad (1)$$

where p_1 is the pressure produced by the talker in a free sound field at a distance of one meter and p_2 is the pressure measured in a free sound field which produces with the listener present the same loudness in his ear as that produced by the communication system under test. These data must be taken in narrow frequency bands as a function of frequency. Alternatively, p_1 is the pressure produced at the eardrum of a listener seated facing a talker in an anechoic chamber at a distance of one meter, and p_2 is the pressure at the eardrum produced

by the communication system under test. That is to say, the orthotelephonic gain can be measured either *subjectively*, i.e., by the loudness produced, or *objectively*, by using a small probe microphone to determine the pressures at the eardrum. Actually these two measurements of orthotelephonic gain appear not to be equivalent. For reasons still obscure, it seems that to produce the same sensation of loudness about 6 or 7 decibels more sound pressure must be produced at the eardrum by an earphone than by a loudspeaker at a meter's distance.¹⁴ Hence the orthotelephonic gain obtained using the loud-

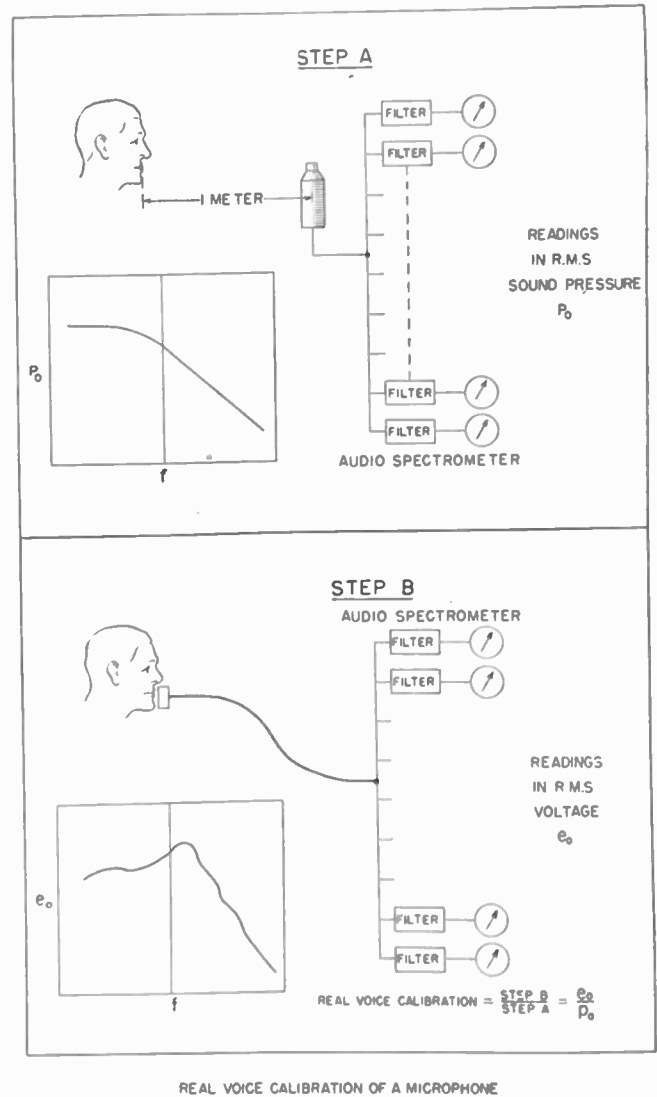

Fig. 7—Procedure for obtaining the real-voice calibration of a microphone. Upper step shows measurement of speech spectrum; lower shows measurement of voltage output of microphone.

ness-balance technique described later will be 6 or 7 decibels less than that determined by measuring pressures at the eardrum with a probe tube. The method of handling this difficulty will be described later.

¹⁴ Recent data demonstrating this point were taken by F. M. Wiener at Harvard. Reference should also be made to L. J. Sivian and S. D. White, "On minimum audible sound fields," *Jour. Acous. Soc. Amer.*, vol. 4, pp. 288-321; April, 1933. (The difference between curves B and C may, in part, be due to this effect.)

¹³ A. H. Inglis, "Transmission features of the new telephone sets," *Bell Sys. Tech. Jour.*, vol. 17, pp. 358-380; July, 1938.

From a physical standpoint, it is difficult to measure the orthotelephonic response in one step. It is customary, therefore, to perform the measurement in two steps, first by measuring the "real-voice" response of the microphone and secondly, by measuring the "real-ear" response of the earphone. Then the two are added together to yield the orthotelephonic response, taking into account the loss or gain of the interconnecting amplifier or transmission line.

The first step in the determination of the real-voice response of a microphone (see Fig. 7) is to measure the speech spectrum of the particular talker and word material used. A standard microphone is placed before the talker in an anechoic chamber at a distance of one meter. Then speaking at half-effort, the talker produces a voltage at the output of the microphone which is analyzed¹⁶ by a group of parallel filters to yield the root-mean-square sound pressure p_0 . The second step is to replace the standard microphone with the microphone under test and to repeat the measurement. The ratio of the root-mean-square voltage produced by the microphone under test across its load resistor e_0 to the root-mean-square pressure obtained in step A (p_0) for each of the frequency bands yields the real-voice calibration. If pressure at the eardrum is desired, a transfer curve from free field to eardrum is necessary. Such a curve for an average of twelve subjects is given as (A) in Fig. 16(f).¹⁰

the procedure for subjective calibration is given. In step A, a loudspeaker, located at a distance of one meter from a standard microphone, is energized by an oscillator whose output voltage is adjusted to a value of E_1 for which a convenient sound level is indicated by the microphone. Next, a high-fidelity earphone, known as the transfer standard, is placed over one ear of an observer whose head replaces the microphone. In step B the switch is thrown to connect the transfer standard to the output of the attenuators, and the voltage E_1 is reduced by an attenuation of A_1 until the earphone produces a sound which the listener judges to be as loud as that produced by the loudspeaker with a voltage E_1 across it. Then, in step C, the earphone under test is placed on the opposite ear and the attenuator A_2 is adjusted until the same loudness is produced by the unknown as is produced by the transfer standard. Automatic, frequent switching of the voltage E_1 between the two sources of sound being compared in each of the two cases leads to results which are repeatable to a satisfactory degree. For results typical of a population, a number of human subjects must be used and the data averaged at each frequency. The real-ear calibration then is expressed as being the voltage required to produce the same loudness at the ear as is produced by a sound field measured before the listener enters it.

The orthotelephonic gain is now found by either (2) or (3) below:

O.T. Gain (Subjective Method)

$$= 20 \log (e_0/p_0) + 20 \log (E_2/e_0) + 20 \log (P_1/E_2) \quad (2)$$

where P_1 is the free-field pressure necessary to produce the same loudness in the ear as was produced by the earphone with a voltage E_2 across it; E_2/e_0 is the voltage amplification of the amplifier; and e_0 is the voltage produced by the microphone across the input resistor of the amplifier by a voice which produces a pressure p_0 at a distance of one meter in a free field. Alternatively,

O.T. Gain (Objective Method)

$$= 20 \log (e_0/p_0) + 20 \log R + 20 \log (e_2/e_0) + 20 \log (p_e/c_2) \quad (3)$$

where R is the ratio of the pressure produced at the eardrum of a listener by a source of sound to the pressure which would be produced by the same source at the listener's head position if he were removed from the field (see Fig. 16(f), curve A), p_e is the pressure produced at the eardrum of a listener by the earphone with a voltage e_2 across it, and the other quantities are the same as before.

VI. MICROPHONE AND EARPHONE NOISE PICKUP

To measure the noise-pickup characteristics of a microphone, a person holding the microphone in a normal manner is immersed in a diffuse noise field having a reasonably flat spectrum. The voltage e' produced by the microphone across its load resistor is determined by

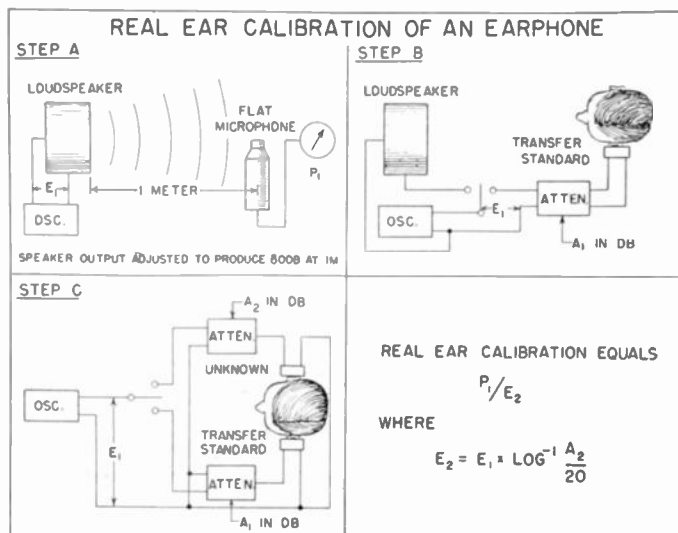

Fig. 8—Subjective procedure for measuring the real-ear calibration of an earphone by a loudness-balance method.

As stated before, the real-ear calibration of an earphone can be determined either objectively or subjectively. The procedure necessary for measuring the pressure directly at the eardrum involves the use of a very small probe tube attached to a capacitor microphone and is a delicate and physiologically dangerous measurement. Reference should now be made to Fig. 8, where

¹⁶ H. W. Rudmose, K. C. Clark, F. D. Carlson, J. C. Eisenstein, and R. A. Walker, "An integrating audio-spectrometer," Paper No. 42, 31st Meeting, Acoustical Society of America, May 11, 1946.

the audio spectrometer. Then the spectrum of the noise p' is measured by the spectrometer at the position where the person's head was located, using a standard microphone. The ratio e'/p' as a function of frequency as just measured is the noise pickup characteristic of the microphone.

The amount of ambient noise reaching the ear through the earphone cushion is dependent on the noise attenuation properties of the cushion. The cushion attenuation can be measured either subjectively or objectively. To measure the attenuation subjectively, a person is seated in a diffuse noise field having a continuous spectrum bandwidth of about 20 cycles per second. The level of the noise is adjusted by means of an attenuator in the noise amplifying circuit so that the noise sounds equally loud with the cushion on as it did before adjustment of the noise with the cushion off. The change of the setting of the attenuator in decibels is a measure of the cushion attenuation at that frequency. Alternatively, the cushion attenuation is measured objectively by determining the change in pressure at the eardrum when the cushion is placed on the ear with the person seated in a diffuse sound field from its value with the cushion off. Similar to the results obtained for determination of orthotelephonic gain, the cushion attenuation seems to be greater for the subjective than that for the objective type of measurement by about 6 or 7 decibels.

The important conclusion is now drawn that it is necessary, to avoid ambiguity of results, *always to pair objective orthotelephonic gain with objective cushion attenuation measurements and subjective orthotelephonic gain with subjective measurements in the method of calculation which follows.*

VII. CONCEPT OF ARTICULATION INDEX

The concept of *articulation index* advanced by French and Steinberg and the basis of both their calculation scheme and the one given in this paper was introduced by Harvey Fletcher many years ago. The articulation index A is defined as a number obtained from articulation tests using nonsense syllables under the assumption that any narrow band of speech frequencies of a given intensity in the absence of noise carries a contribution to the total index, which is independent of the other bands with which it is associated, and that the totals of all the bands is the sum of the contributions of the separate bands.² It is necessary to prove that there is a unique function relating syllable or word articulation to A for any given articulation crew and choice of word list. In determining an articulation index (A) under the conditions stated above, there are essentially two parameters of a linear communication system that can be varied: (a) the level of the speech above the threshold of hearing, and (b) the frequency response of the system. Linear systems free from noise are assumed.

The procedure necessary for determining the relationships between syllable articulation, articulation index

(A), gain and frequency response for a given articulation crew have been presented by French and Steinberg² and will not be repeated here. From those data they derived a curve of articulation index (A) versus cut-off frequency of a group of low pass filters (see Curve B of Fig. 9) under the special condition of optimal loudness

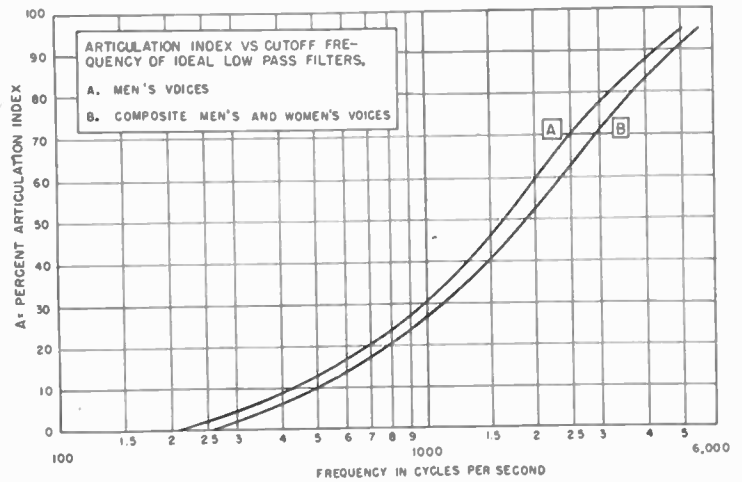

Fig. 9—Articulation index versus cutoff frequency of ideal low-pass filters as determined by French and Steinberg.

at the ear and negligibly low noise levels for combined men's and women's voices. Curve A of this graph, for men's voices alone, is based on an estimate, but will be used as the basis of discussion here. From Curve A , several things can be perceived:

1. Extending the frequency range of a communication system below 200 or above 6000 cycles per second contributes almost nothing to the intelligibility of speech.
2. Each of the following frequency bands makes a 5 per cent contribution to the articulation index (A), provided the orthotelephonic gain of the system is optimal (about +10 decibels) and there is no noise present. Male voices are assumed.

TABLE I
FREQUENCY BANDS OF EQUAL CONTRIBUTION TO ARTICULATION INDEX

No.	Limits	Mean	No.	Limits	Mean
1	200 to 330	270	11	1660 to 1830	1740
2	330 to 430	380	12	1830 to 2020	1920
3	430 to 560	490	13	2020 to 2240	2130
4	560 to 700	630	14	2240 to 2500	2370
5	700 to 840	770	15	2500 to 2820	2660
6	840 to 1000	920	16	2820 to 3200	3000
7	1000 to 1150	1070	17	3200 to 3650	3400
8	1150 to 1310	1230	18	3650 to 4250	3950
9	1310 to 1480	1400	19	4250 to 5050	4650
10	1480 to 1660	1570	20	5050 to 6100	5600

Throughout the following discussion a distorted frequency scale based on Table I and plotted as shown in Fig. 10 will be used. On this graph is shown the information of Section III of this paper, namely, the total dynamic range of speech in each of the bands (Fig. 3) plotted as 12 decibels above and 18 decibels below the

average root-mean-square spectrum of speech of Fig. 1. If the ear is able to hear all the region represented by the shaded area, speech should be perfectly intelligible

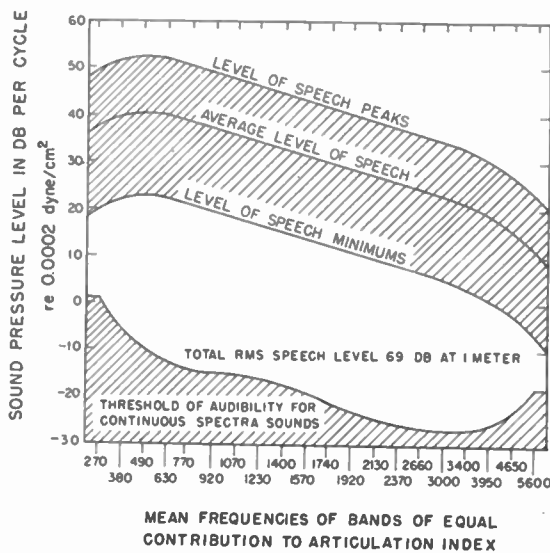

Fig. 10—Total speech spectrum and threshold of audibility for continuous spectrum sounds plotted versus frequency on distorted frequency scale.

and the per cent articulation index A should be equal to one hundred. The premises now made and to be proven are that *the articulation index A is (a) linearly related to the per cent of the shaded area of Fig. 10 which can be heard by the listeners, and is (b) uniquely related to articulation scores for any given syllable, word, or sentence list and crew of talkers and listeners used during the test.*

The following nomenclature will now be introduced:

$$A = \sum_n W_n \cdot (\Delta A)_{\max} = \sum_n 0.05 W_n \quad (4)$$

where

A = total articulation index = sum of contributions of all bands

(ΔA) = contribution of any one band

$(\Delta A)_{\max}$ = maximum contribution of any one band = 0.05

W_n = per cent of maximum contribution contributed by any band.

Fletcher¹ states that studies at the Bell Telephone Laboratories show that the ear integrates such varying sounds as speech over about $\frac{1}{4}$ -second intervals. For example, the integrated sound energy in a critical bandwidth over a $\frac{1}{4}$ -second interval will sound as loud as a pure tone in the same frequency band which produces the same energy in each $\frac{1}{4}$ -second interval. The $\frac{1}{8}$ -second intervals of the data of Figs. 2 and 3 are short enough so that this statement applies to them. Hence, if a critical bandwidth of speech is expressed as root-mean-square sound pressure level (in decibels) in $\frac{1}{8}$ -second intervals, the resulting 30-decibel spread in levels can be plotted as a function of frequency on the same graph along with a continuous spectrum masking noise, provided the

latter is expressed as sound pressure level in decibels for *critical bandwidths*. The difference between the upper side of the 30-decibel spread and the noise curve will be equal to the level by which the peak levels of speech exceed the masking level of the noise (by virtue of Fig. 6). Also, the threshold of hearing (A , Fig. 4) can be plotted on the same graph to show the level of the speech above the threshold level for the cases when no noise is present.

It is generally customary to express noises in terms of their *spectrum levels*, i.e., in terms of energy contained in one-cycle-wide bands. To convert levels in a critical bandwidth to levels in one-cycle-wide bandwidths, the lower curve of Fig. 5 should be subtracted from the speech, noise, and threshold curves just described. The curves of Fig. 10 are already plotted in this way. Noise, expressed in terms of its spectrum level, can be plotted directly on that graph and the difference between the upper edge of the shaded region and the spectrum level of the noise will be equal to the level of the speech peaks above the masking level of the noise.

If assumptions (a) and (b) stated in italics above are valid, W_n for each band of equal contribution to speech intelligibility can be written

$$W_n = \frac{(\text{level of speech peaks}) - (\text{level of noise})}{30}, \quad (5)$$

where W_n is limited to unity as a maximum value.

VIII. EXPERIMENTAL VALIDATION OF THE CONCEPT OF ARTICULATION INDEX

To demonstrate that the concept of articulation index is useful it is necessary first to show that a given area

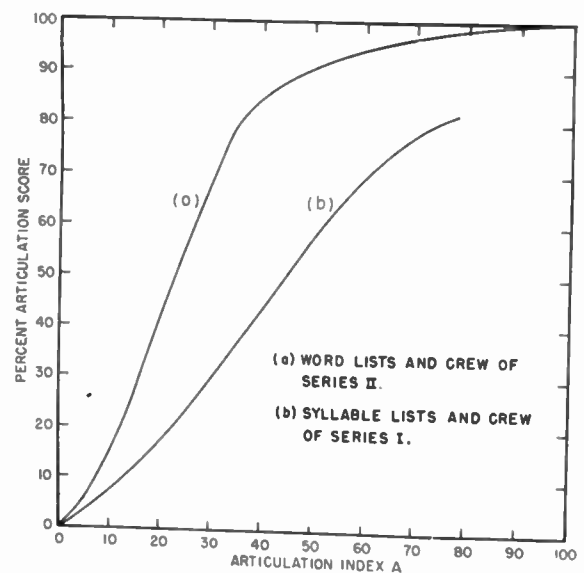

Fig. 11—Experimentally determined relations between word or syllable articulation and articulation index A .

of Fig. 10 is uniquely related to measured articulation scores, regardless of whether the area is spread over a wide frequency range with a small speech-noise difference in each band or over a narrow frequency range in

tremes of what are usually found in practice, the results will be generally better for practical situations.

Similar results are shown in Table III for a second series of tests performed on three types of aircraft interphones. The curve of articulation score versus A is shown as (a) in Fig. 11 and the calculated versus measured scores are shown in Fig. 14. Because words rather

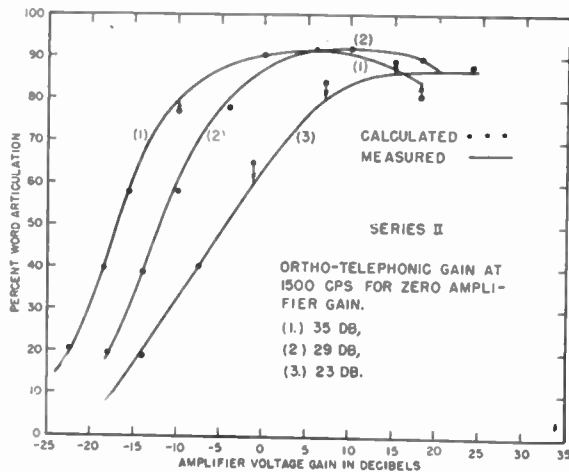

Fig. 14—Comparison of experimentally determined and calculated articulation scores for three types of interphone systems in an untreated bomber.

than syllables were used in the Series II tests, the relation between articulation score and A is different from that for Series I tests as would be expected.

TABLE III
COMPUTED ARTICULATION INDEXES FOR SERIES II TESTS

Per Cent Articulation	System Number			Average A
	1	2	3	
20	0.125	0.123	0.114	0.121
40	0.187	0.177	0.185	0.183
60	0.252	0.254	0.280	0.262
80	0.324	0.336	0.385	0.348

IX. MAXIMUM GAIN SETTINGS

Inspection of the data in Fig. 14 shows that, for the particular articulation crew used in Series II experiments, the scores reached a maximum and then turned down again as the gain was increased. It is believed that no estimates have been made before on what constitutes the maximum gain to which an audio system can be adjusted before no further contribution to speech intelligibility is obtained.

On the basis of the average articulation-index data versus per cent articulation of Table III and of additional datum points computed for the cases where the speech peak curves did not exceed 90 decibels, but where the word-articulation scores approached 90 per cent, a fairly well-defined relationship between A and the per cent word articulation was established (see (a) of Fig. 11). Then, for the three systems just described, articulation indices were computed for a number of points in the region where the gain curves had flattened off, or

started to bend downward, utilizing one of four assumptions successively: (a) setting no upper limit beyond which no contribution to A would be permitted; (b) setting the limit at 100 decibels; (c) at 95 decibels, and (d) at 90 decibels. The results are shown in Table IV in terms of the deviations of A from the value it should have to lie on the per cent word articulation versus A relationship of Fig. 10(a).

TABLE IV
DEVIATION OF COMPUTED ARTICULATION INDEXES FROM PER CENT WORD ARTICULATION VERSUS A RELATION OF FIG. 14.

System	Amplifier Gain	Ceiling Value			
		Unlimited	100	95	90
1	18	0.195	0.087	-0.009	-0.111
1	10	0.062	0.047	-0.001	-0.080
1	0	*	*	0.000	-0.017
2	22	0.177	0.084	-0.006	-0.102
2	18	0.108	0.071	0.010	-0.089
2	6	*	*	-0.004	-0.025
3	24	0.125	0.080	0.026	-0.087
3	15	*	0.168	0.052	0.010
Average Deviation		0.133	0.089	0.008	-0.063

* Speech peaks did not rise above level of following column.

A limiting value of 95 decibels yields values of A more nearly correct than for any one of the other three. It is concluded, then, that the region above 95 decibels per cycle should not be considered as contributing to A . A speech level of 95 decibels per cycle corresponds to an over-all speech level of about 125 decibels, which approximates the region of "tickle" in the ear. For this reason, if for no other, the speech peaks should not be amplified beyond this point.

A complete graph is shown in Fig. 15 for System 2 of Series II with an amplifier gain of +6 decibels. The

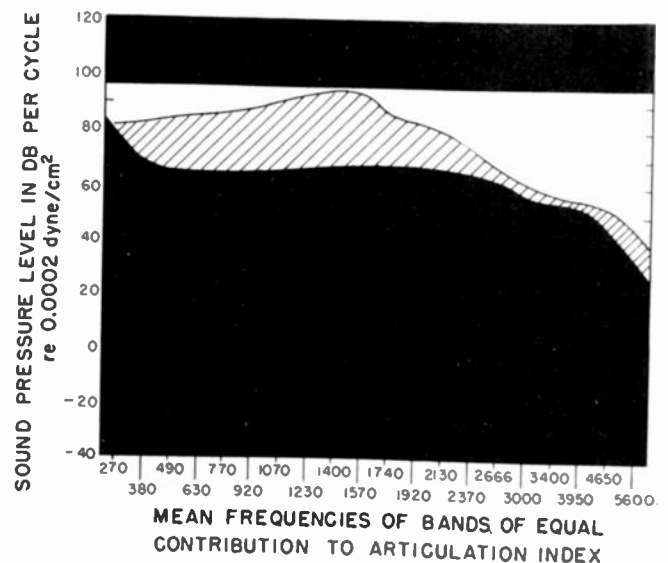

Fig. 15—Chart demonstrating the calculation of articulation index. Upper black region shows probable area of no contribution to articulation index. Lower black area shows masking effect of noise. Shaded region shows speech area presented to ear of a listener in the presence of the noise and is equal to the articulation index A .

lower black region is the total root-mean-square noise level arriving at the eardrum from the microphone and through the earphone cushions. The shaded region shows the area of speech which is not masked out by the interfering noise. The upper black area is the region of no contribution to A . The articulation index A is about 0.5 in this example.

X. DETERMINATION OF SYSTEMS PERFORMANCE

In order to calculate the articulation index of a voice communication system, data of the type described in Sections V and VI are needed. These data are often tedious to obtain. As an alternative, use of response data taken on artificial voices or ears (couplers) will sometimes permit the computation of approximate articulation indices.¹⁶

The articulation index for a particular interphone system will now be calculated to demonstrate the method in detail. Both the talker and the listener will be assumed to be in the same noise field. It is further assumed that the system is substantially free from nonlinear distortion, and hence, amenable to treatment by this procedure. Articulation scores have previously been obtained so that the accuracy of the results can be checked.

1. The *real-voice response of the carbon microphone* is shown in Fig. 16(a) as the root-mean-square voltage produced across a 100-ohm resistor by a human voice which, without the microphone to interfere, would produce a root-mean-square sound pressure level of 74 decibels at a distance of one meter in an anechoic chamber.

2. An *objectively measured real-ear response of an ANB-II-1A headset* in the doughnut-type cushions is shown in Fig. 16(b). The curves are plots of sound pressure in decibels re 0.000200 dyne per centimeter squared produced in the *outer ear canal* of an average listener as a function of frequency by the headset with one volt impressed across the terminals of the two earphones of the headset in series.

3. The *response characteristic of the amplifier* is assumed to be flat and the voltage gain at 1000 cycles per second is expressed as:

$$\text{Amplifier Gain} = 20 \log E_2/E_1$$

where

E_1 = voltage developed by the microphone across a 200-ohm load resistor

E_2 = voltage delivered by the amplifier across its load measured at 1000 cycles per second.

4. The *noise pickup characteristic of the microphone* is given in Fig. 16(c).

5. The *objectively measured noise-exclusion characteristics of the doughnut type of earphone cushions* are given in Fig. 16(d).

6. The *ambient noise spectrum* used for the articulation tests is shown in Fig. 16(e).

7. The *real-ear and real-voice curves* along with the response of the amplifier, are combined to yield the *orthotelephonic gain of the over-all system*. Two decibels were added to the microphone response to account for the difference between the 100-ohm test resistor used with the microphone and the amplifier input impedance of 200 ohms.

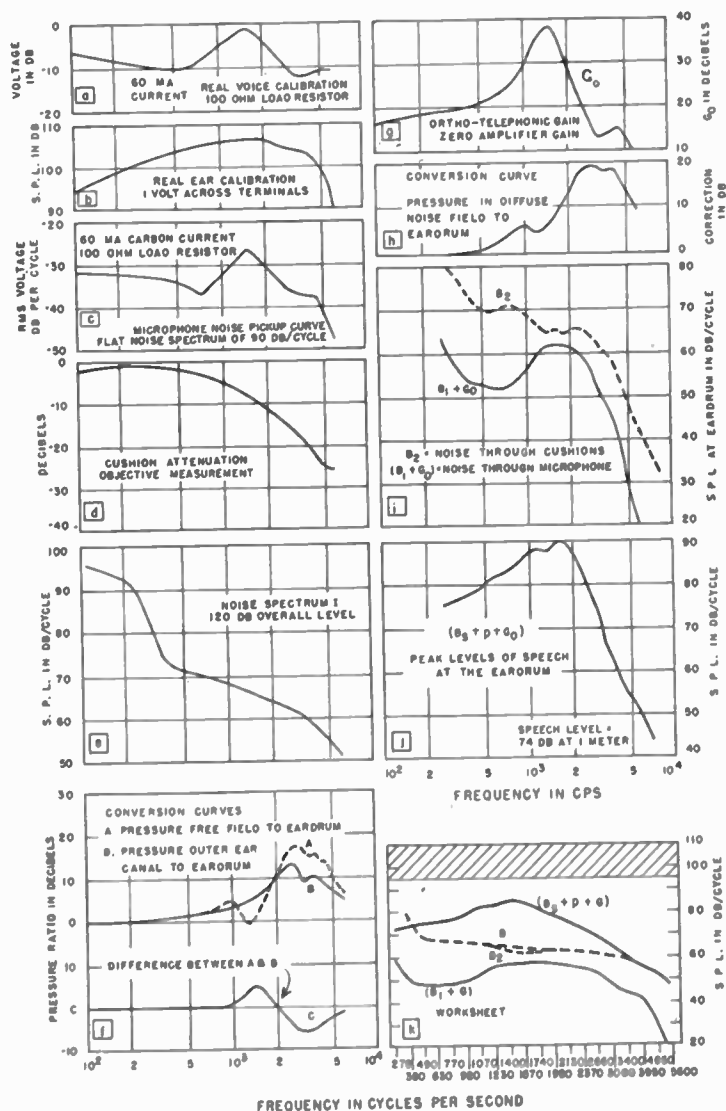

Fig. 16—Detailed steps in calculation of articulation index. The procedure is outlined in the text.

A correction must be added to the data of curves (a) and (b) above if they are to be used in the calculation of the orthotelephonic gain. The curve for converting free-field pressure to pressure at the eardrum is given as (a) in Fig. 16(f). This curve should be *subtracted* from Fig. 16(a) to convert the real-voice calibration curve of the microphone to give the voltage produced by the microphone for a constant sound pressure of 74 decibels at the eardrum of an average listener.

The curve for converting the pressure in the outer ear, under the cushion, over to the pressure at the eardrum is

¹⁶ Specifications on acceptable artificial voices and ears are being drawn up by Sub-Committee Z-24-B of the American Standards Association at this time.

average root-mean-square spectrum of speech of Fig. 1. If the ear is able to hear all the region represented by the shaded area, speech should be perfectly intelligible

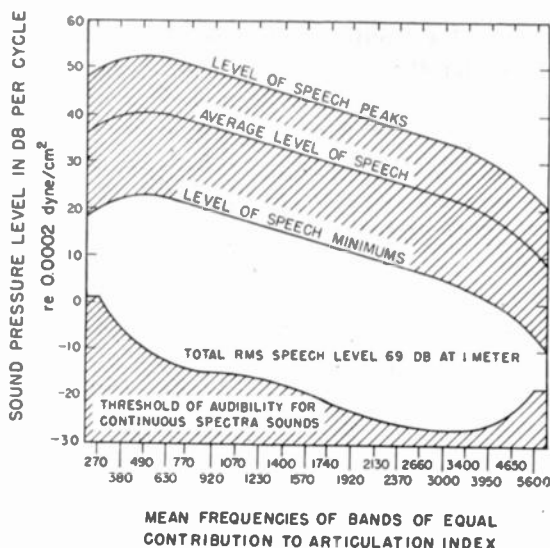

Fig. 10—Total speech spectrum and threshold of audibility for continuous spectrum sounds plotted versus frequency on distorted frequency scale.

and the per cent articulation index A should be equal to one hundred. The premises now made and to be proven are that the articulation index A is (a) linearly related to the per cent of the shaded area of Fig. 10 which can be heard by the listeners, and is (b) uniquely related to articulation scores for any given syllable, word, or sentence list and crew of talkers and listeners used during the test.

The following nomenclature will now be introduced:

$$A = \sum_n W_n \cdot (\Delta A)_{\max} = \sum_n 0.05 W_n \quad (4)$$

where

A = total articulation index = sum of contributions of all bands

(ΔA) = contribution of any one band

$(\Delta A)_{\max}$ = maximum contribution of any one band = 0.05

W_n = per cent of maximum contribution contributed by any band.

Fletcher¹ states that studies at the Bell Telephone Laboratories show that the ear integrates such varying sounds as speech over about $\frac{1}{4}$ -second intervals. For example, the integrated sound energy in a critical bandwidth over a $\frac{1}{4}$ -second interval will sound as loud as a pure tone in the same frequency band which produces the same energy in each $\frac{1}{4}$ -second interval. The $\frac{1}{8}$ -second intervals of the data of Figs. 2 and 3 are short enough so that this statement applies to them. Hence, if a critical bandwidth of speech is expressed as root-mean-square sound pressure level (in decibels) in $\frac{1}{8}$ -second intervals, the resulting 30-decibel spread in levels can be plotted as a function of frequency on the same graph along with a continuous spectrum masking noise, provided the

latter is expressed as sound pressure level in decibels for critical bandwidths. The difference between the upper side of the 30-decibel spread and the noise curve will be equal to the level by which the peak levels of speech exceed the masking level of the noise (by virtue of Fig. 6). Also, the threshold of hearing (A , Fig. 4) can be plotted on the same graph to show the level of the speech above the threshold level for the cases when no noise is present.

It is generally customary to express noises in terms of their spectrum levels, i.e., in terms of energy contained in one-cycle-wide bands. To convert levels in a critical bandwidth to levels in one-cycle-wide bandwidths, the lower curve of Fig. 5 should be subtracted from the speech, noise, and threshold curves just described. The curves of Fig. 10 are already plotted in this way. Noise, expressed in terms of its spectrum level, can be plotted directly on that graph and the difference between the upper edge of the shaded region and the spectrum level of the noise will be equal to the level of the speech peaks above the masking level of the noise.

If assumptions (a) and (b) stated in italics above are valid, W_n for each band of equal contribution to speech intelligibility can be written

$$W_n = \frac{(\text{level of speech peaks}) - (\text{level of noise})}{30}, \quad (5)$$

where W_n is limited to unity as a maximum value.

VIII. EXPERIMENTAL VALIDATION OF THE CONCEPT OF ARTICULATION INDEX

To demonstrate that the concept of articulation index is useful it is necessary first to show that a given area

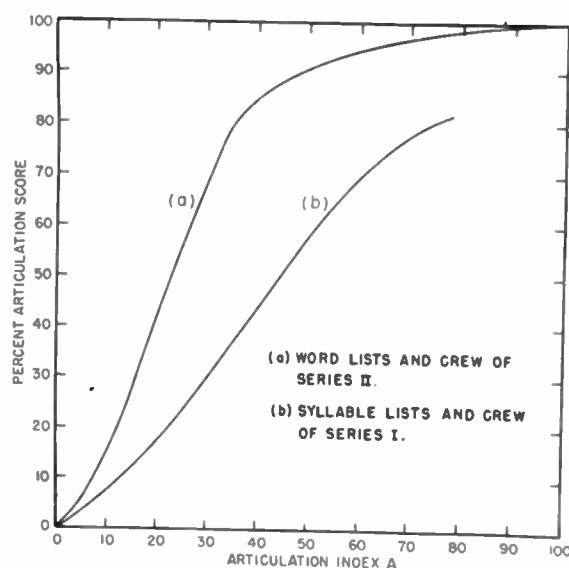

Fig. 11—Experimentally determined relations between word or syllable articulation and articulation index A .

of Fig. 10 is uniquely related to measured articulation scores, regardless of whether the area is spread over a wide frequency range with a small speech-noise difference in each band or over a narrow frequency range in

tremes of what are usually found in practice, the results will be generally better for practical situations.

Similar results are shown in Table III for a second series of tests performed on three types of aircraft interphones. The curve of articulation score versus A is shown as (a) in Fig. 11 and the calculated versus measured scores are shown in Fig. 14. Because words rather

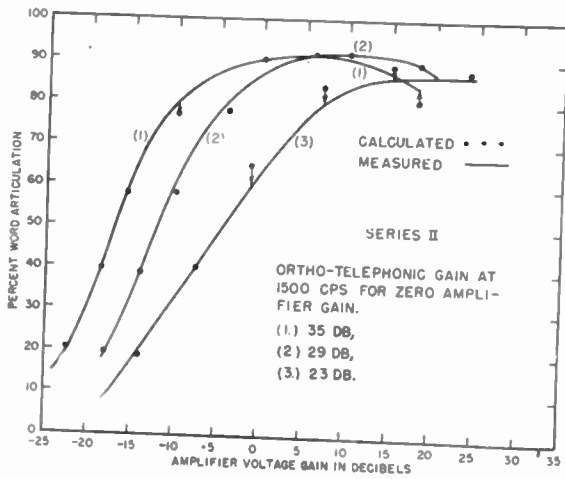

Fig. 14—Comparison of experimentally determined and calculated articulation scores for three types of interphone systems in an untreated bomber.

than syllables were used in the Series II tests, the relation between articulation score and A is different from that for Series I tests as would be expected.

TABLE III
COMPUTED ARTICULATION INDEXES FOR SERIES II TESTS

Per Cent Articulation	System Number			Average A
	1	2	3	
20	0.125	0.123	0.114	0.121
40	0.187	0.177	0.185	0.183
60	0.252	0.254	0.280	0.262
80	0.324	0.336	0.385	0.348

IX. MAXIMUM GAIN SETTINGS

Inspection of the data in Fig. 14 shows that, for the particular articulation crew used in Series II experiments, the scores reached a maximum and then turned down again as the gain was increased. It is believed that no estimates have been made before on what constitutes the maximum gain to which an audio system can be adjusted before no further contribution to speech intelligibility is obtained.

On the basis of the average articulation-index data versus per cent articulation of Table III and of additional datum points computed for the cases where the speech peak curves did not exceed 90 decibels, but where the word-articulation scores approached 90 per cent, a fairly well-defined relationship between A and the per cent word articulation was established (see (a) of Fig. 11). Then, for the three systems just described, articulation indices were computed for a number of points in the region where the gain curves had flattened off, or

started to bend downward, utilizing one of four assumptions successively: (a) setting no upper limit beyond which no contribution to A would be permitted; (b) setting the limit at 100 decibels; (c) at 95 decibels, and (d) at 90 decibels. The results are shown in Table IV in terms of the deviations of A from the value it should have to lie on the per cent word articulation versus A relationship of Fig. 10(a).

TABLE IV
DEVIATION OF COMPUTED ARTICULATION INDEXES FROM PER CENT WORD ARTICULATION VERSUS A RELATION OF FIG. 14.

System	Amplifier Gain	Ceiling Value			
		Unlimited	100	95	90
1	18	0.195	0.087	-0.009	-0.111
1	10	0.062	0.047	-0.001	-0.080
1	0	*	*	0.000	-0.017
2	22	0.177	0.084	-0.006	-0.102
2	18	0.108	0.071	-0.010	-0.089
2	6	*	*	-0.004	-0.025
3	24	0.125	0.080	0.026	-0.027
3	15	*	0.168	0.052	0.010
Average Deviation		0.133	0.089	0.008	-0.063

* Speech peaks did not rise above level of following column.

A limiting value of 95 decibels yields values of A more nearly correct than for any one of the other three. It is concluded, then, that the region above 95 decibels per cycle should not be considered as contributing to A . A speech level of 95 decibels per cycle corresponds to an over-all speech level of about 125 decibels, which approximates the region of "tickle" in the ear. For this reason, if for no other, the speech peaks should not be amplified beyond this point.

A complete graph is shown in Fig. 15 for System 2 of Series II with an amplifier gain of +6 decibels. The

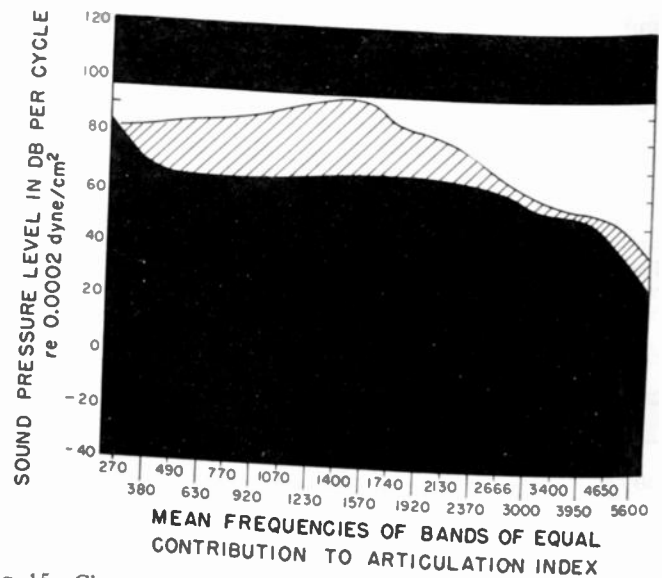

Fig. 15—Chart demonstrating the calculation of articulation index. Upper black region shows probable area of no contribution to articulation index. Lower black area shows masking effect of noise. Shaded region shows speech area presented to ear of a listener in the presence of the noise and is equal to the articulation index A .

lower black region is the total root-mean-square noise level arriving at the eardrum from the microphone and through the earphone cushions. The shaded region shows the area of speech which is not masked out by the interfering noise. The upper black area is the region of no contribution to *A*. The articulation index *A* is about 0.5 in this example.

X. DETERMINATION OF SYSTEMS PERFORMANCE

In order to calculate the articulation index of a voice communication system, data of the type described in Sections V and VI are needed. These data are often tedious to obtain. As an alternative, use of response data taken on artificial voices or ears (couplers) will sometimes permit the computation of approximate articulation indices.¹⁶

The articulation index for a particular interphone system will now be calculated to demonstrate the method in detail. Both the talker and the listener will be assumed to be in the same noise field. It is further assumed that the system is substantially free from nonlinear distortion, and hence, amenable to treatment by this procedure. Articulation scores have previously been obtained so that the accuracy of the results can be checked.

1. The *real-voice response of the carbon microphone* is shown in Fig. 16(a) as the root-mean-square voltage produced across a 100-ohm resistor by a human voice which, without the microphone to interfere, would produce a root-mean-square sound pressure level of 74 decibels at a distance of one meter in an anechoic chamber.

2. An *objectively measured real-ear response of an ANB-II-1A headset* in the doughnut-type cushions is shown in Fig. 16(b). The curves are plots of sound pressure in decibels re 0.000200 dyne per centimeter squared produced in the *outer ear canal* of an average listener as a function of frequency by the headset with one volt impressed across the terminals of the two earphones of the headset in series.

3. The *response characteristic of the amplifier* is assumed to be flat and the voltage gain at 1000 cycles per second is expressed as:

$$\text{Amplifier Gain} = 20 \log E_2/E_1$$

where

E_1 = voltage developed by the microphone across a 200-ohm load resistor

E_2 = voltage delivered by the amplifier across its load measured at 1000 cycles per second.

4. The *noise pickup characteristic of the microphone* is given in Fig. 16(c).

5. The *objectively measured noise-exclusion characteristics of the doughnut type of earphone cushions* are given in Fig. 16(d).

6. The *ambient noise spectrum* used for the articulation tests is shown in Fig. 16(e).

7. The real-ear and real-voice curves along with the response of the amplifier, are combined to yield the *orthotelephonic gain of the over-all system*. Two decibels were added to the microphone response to account for the difference between the 100-ohm test resistor used with the microphone and the amplifier input impedance of 200 ohms.

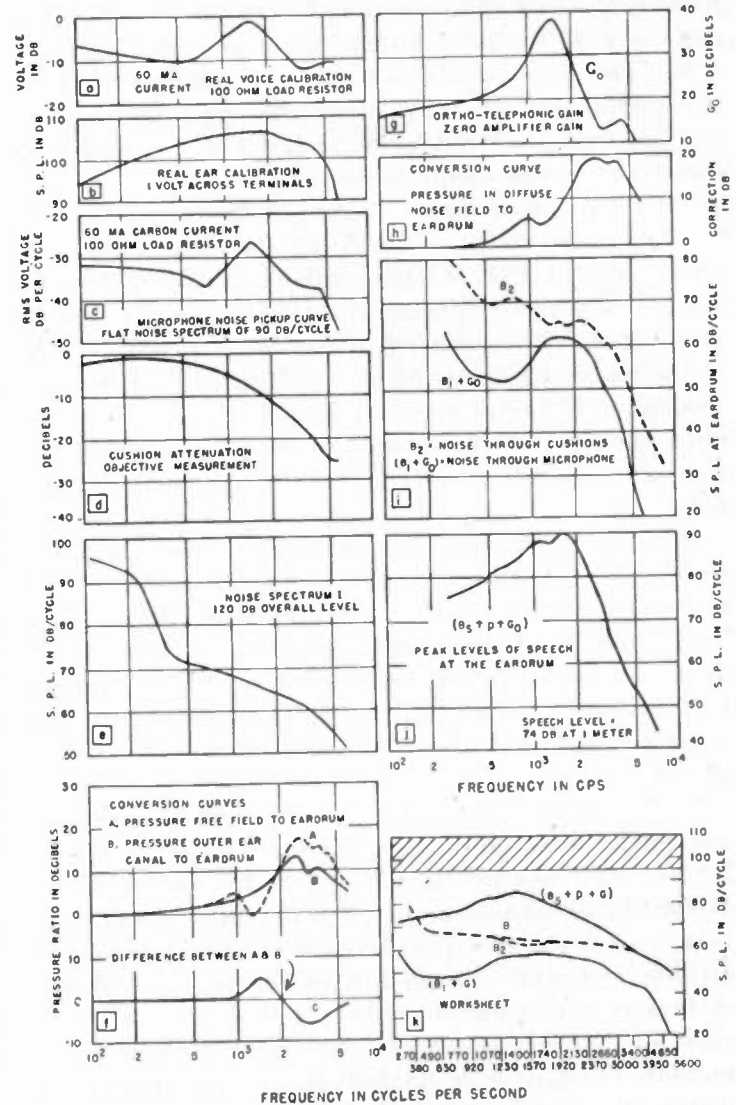

Fig. 16—Detailed steps in calculation of articulation index. The procedure is outlined in the text.

A correction must be added to the data of curves (a) and (b) above if they are to be used in the calculation of the orthotelephonic gain. The curve for converting free-field pressure to pressure at the eardrum is given as (a) in Fig. 16(f). This curve should be *subtracted* from Fig. 16(a) to convert the real-voice calibration curve of the microphone to give the voltage produced by the microphone for a constant sound pressure of 74 decibels at the eardrum of an average listener.

The curve for converting the pressure in the outer ear, under the cushion, over to the pressure at the eardrum is

¹⁶ Specifications on acceptable artificial voices and ears are being drawn up by Sub-Committee Z-24-B of the American Standards Association at this time.

average root-mean-square spectrum of speech of Fig. 1. If the ear is able to hear all the region represented by the shaded area, speech should be perfectly intelligible

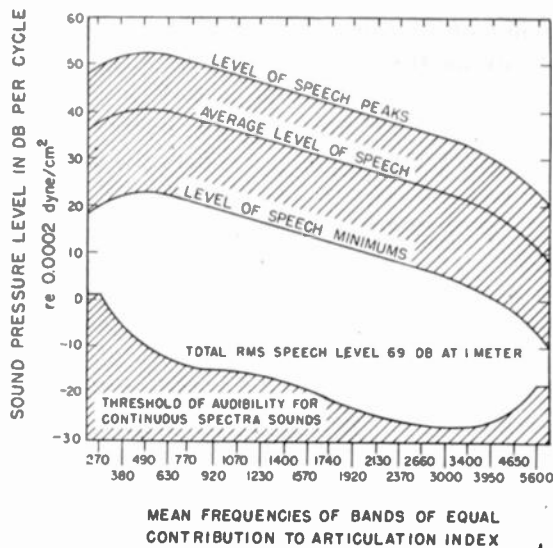

Fig. 10—Total speech spectrum and threshold of audibility for continuous spectrum sounds plotted versus frequency on distorted frequency scale.

and the per cent articulation index A should be equal to one hundred. The premises now made and to be proven are that the articulation index A is (a) linearly related to the per cent of the shaded area of Fig. 10 which can be heard by the listeners, and is (b) uniquely related to articulation scores for any given syllable, word, or sentence list and crew of talkers and listeners used during the test.

The following nomenclature will now be introduced:

$$A = \sum_n W_n \cdot (\Delta A)_{\max} = \sum_n 0.05 W_n \quad (4)$$

where

A = total articulation index = sum of contributions of all bands

(ΔA) = contribution of any one band

$(\Delta A)_{\max}$ = maximum contribution of any one band = 0.05

W_n = per cent of maximum contribution contributed by any band.

Fletcher¹ states that studies at the Bell Telephone Laboratories show that the ear integrates such varying sounds as speech over about $\frac{1}{4}$ -second intervals. For example, the integrated sound energy in a critical bandwidth over a $\frac{1}{4}$ -second interval will sound as loud as a pure tone in the same frequency band which produces the same energy in each $\frac{1}{4}$ -second interval. The $\frac{1}{8}$ -second intervals of the data of Figs. 2 and 3 are short enough so that this statement applies to them. Hence, if a critical bandwidth of speech is expressed as root-mean-square sound pressure level (in decibels) in $\frac{1}{8}$ -second intervals, the resulting 30-decibel spread in levels can be plotted as a function of frequency on the same graph along with a continuous spectrum masking noise, provided the

latter is expressed as sound pressure level in decibels for critical bandwidths. The difference between the upper side of the 30-decibel spread and the noise curve will be equal to the level by which the peak levels of speech exceed the masking level of the noise (by virtue of Fig. 6). Also, the threshold of hearing (A , Fig. 4) can be plotted on the same graph to show the level of the speech above the threshold level for the cases when no noise is present.

It is generally customary to express noises in terms of their spectrum levels, i.e., in terms of energy contained in one-cycle-wide bands. To convert levels in a critical bandwidth to levels in one-cycle-wide bandwidths, the lower curve of Fig. 5 should be subtracted from the speech, noise, and threshold curves just described. The curves of Fig. 10 are already plotted in this way. Noise, expressed in terms of its spectrum level, can be plotted directly on that graph and the difference between the upper edge of the shaded region and the spectrum level of the noise will be equal to the level of the speech peaks above the masking level of the noise.

If assumptions (a) and (b) stated in italics above are valid, W_n for each band of equal contribution to speech intelligibility can be written

$$W_n = \frac{(\text{level of speech peaks}) - (\text{level of noise})}{30}, \quad (5)$$

where W_n is limited to unity as a maximum value.

VIII. EXPERIMENTAL VALIDATION OF THE CONCEPT OF ARTICULATION INDEX

To demonstrate that the concept of articulation index is useful it is necessary first to show that a given area

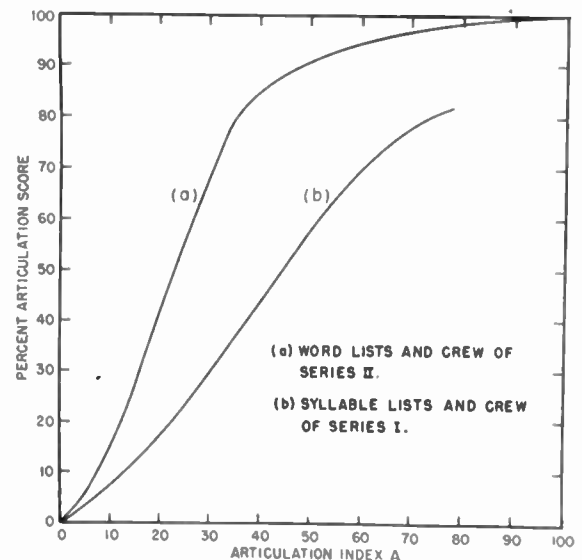

Fig. 11—Experimentally determined relations between word or syllable articulation and articulation index A .

of Fig. 10 is uniquely related to measured articulation scores, regardless of whether the area is spread over a wide frequency range with a small speech-noise difference in each band or over a narrow frequency range in

tremes of what are usually found in practice, the results will be generally better for practical situations.

Similar results are shown in Table III for a second series of tests performed on three types of aircraft interphones. The curve of articulation score versus A is shown as (a) in Fig. 11 and the calculated versus measured scores are shown in Fig. 14. Because words rather

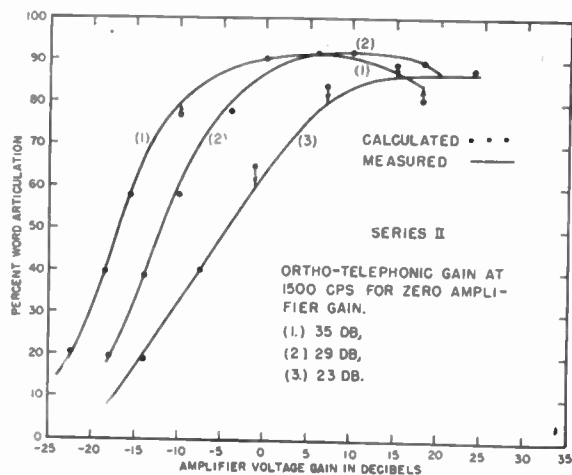

Fig. 14—Comparison of experimentally determined and calculated articulation scores for three types of interphone systems in an untreated bomber.

than syllables were used in the Series II tests, the relation between articulation score and A is different from that for Series I tests as would be expected.

TABLE III
COMPUTED ARTICULATION INDEXES FOR SERIES II TESTS

Per Cent Articulation	System Number			Average A
	1	2	3	
20	0.125	0.123	0.114	0.121
40	0.187	0.177	0.185	0.183
60	0.252	0.254	0.280	0.262
80	0.324	0.336	0.385	0.348

IX. MAXIMUM GAIN SETTINGS

Inspection of the data in Fig. 14 shows that, for the particular articulation crew used in Series II experiments, the scores reached a maximum and then turned down again as the gain was increased. It is believed that no estimates have been made before on what constitutes the maximum gain to which an audio system can be adjusted before no further contribution to speech intelligibility is obtained.

On the basis of the average articulation-index data versus per cent articulation of Table III and of additional datum points computed for the cases where the speech peak curves did not exceed 90 decibels, but where the word-articulation scores approached 90 per cent, a fairly well-defined relationship between A and the per cent word articulation was established (see (a) of Fig. 11). Then, for the three systems just described, articulation indices were computed for a number of points in the region where the gain curves had flattened off, or

started to bend downward, utilizing one of four assumptions successively: (a) setting no upper limit beyond which no contribution to A would be permitted; (b) setting the limit at 100 decibels; (c) at 95 decibels, and (d) at 90 decibels. The results are shown in Table IV in terms of the deviations of A from the value it should have to lie on the per cent word articulation versus A relationship of Fig. 10(a).

TABLE IV
DEVIATION OF COMPUTED ARTICULATION INDEXES FROM PER CENT WORD ARTICULATION VERSUS A RELATION OF FIG. 14.

System	Amplifier Gain	Ceiling Value			
		Unlimited	100	95	90
1	18	0.195	0.087	-0.009	-0.111
1	10	0.062	0.047	-0.001	-0.080
1	0	*	*	0.000	-0.017
2	22	0.177	0.084	-0.006	-0.102
2	18	0.108	0.071	-0.010	-0.089
2	6	*	*	-0.004	-0.025
3	24	0.125	0.080	0.026	-0.087
3	15	*	0.168	0.052	0.010
Average Deviation		0.133	0.089	0.008	-0.063

* Speech peaks did not rise above level of following column.

A limiting value of 95 decibels yields values of A more nearly correct than for any one of the other three. It is concluded, then, that the region above 95 decibels per cycle should not be considered as contributing to A . A speech level of 95 decibels per cycle corresponds to an over-all speech level of about 125 decibels, which approximates the region of "tickle" in the ear. For this reason, if for no other, the speech peaks should not be amplified beyond this point.

A complete graph is shown in Fig. 15 for System 2 of Series II with an amplifier gain of +6 decibels. The

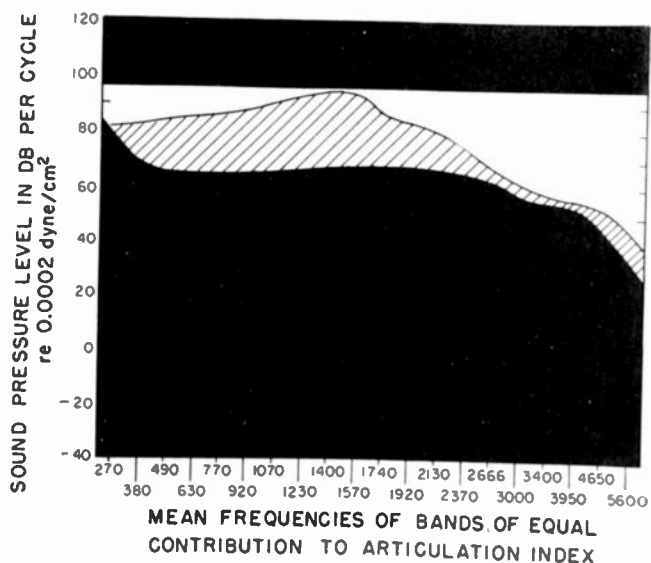

Fig. 15—Chart demonstrating the calculation of articulation index. Upper black region shows probable area of no contribution to articulation index. Lower black area shows masking effect of noise. Shaded region shows speech area presented to ear of a listener in the presence of the noise and is equal to the articulation index A .

lower black region is the total root-mean-square noise level arriving at the eardrum from the microphone and through the earphone cushions. The shaded region shows the area of speech which is not masked out by the interfering noise. The upper black area is the region of no contribution to A . The articulation index A is about 0.5 in this example.

X. DETERMINATION OF SYSTEMS PERFORMANCE

In order to calculate the articulation index of a voice communication system, data of the type described in Sections V and VI are needed. These data are often tedious to obtain. As an alternative, use of response data taken on artificial voices or ears (couplers) will sometimes permit the computation of approximate articulation indices.¹⁶

The articulation index for a particular interphone system will now be calculated to demonstrate the method in detail. Both the talker and the listener will be assumed to be in the same noise field. It is further assumed that the system is substantially free from nonlinear distortion, and hence, amenable to treatment by this procedure. Articulation scores have previously been obtained so that the accuracy of the results can be checked.

1. The *real-voice response of the carbon microphone* is shown in Fig. 16(a) as the root-mean-square voltage produced across a 100-ohm resistor by a human voice which, without the microphone to interfere, would produce a root-mean-square sound pressure level of 74 decibels at a distance of one meter in an anechoic chamber.

2. An *objectively measured real-ear response of an ANB-II-1A headset* in the doughnut-type cushions is shown in Fig. 16(b). The curves are plots of sound pressure in decibels re 0.000200 dyne per centimeter squared produced in the *outer ear canal* of an average listener as a function of frequency by the headset with one volt impressed across the terminals of the two earphones of the headset in series.

3. The *response characteristic of the amplifier* is assumed to be flat and the voltage gain at 1000 cycles per second is expressed as:

$$\text{Amplifier Gain} = 20 \log E_2/E_1$$

where

E_1 = voltage developed by the microphone across a 200-ohm load resistor

E_2 = voltage delivered by the amplifier across its load measured at 1000 cycles per second.

4. The *noise pickup characteristic of the microphone* is given in Fig. 16(c).

5. The *objectively measured noise-exclusion characteristics of the doughnut type of earphone cushions* are given in Fig. 16(d).

6. The *ambient noise spectrum* used for the articulation tests is shown in Fig. 16(e).

7. The *real-ear and real-voice curves* along with the response of the amplifier, are combined to yield the *orthotelephonic gain of the over-all system*. Two decibels were added to the microphone response to account for the difference between the 100-ohm test resistor used with the microphone and the amplifier input impedance of 200 ohms.

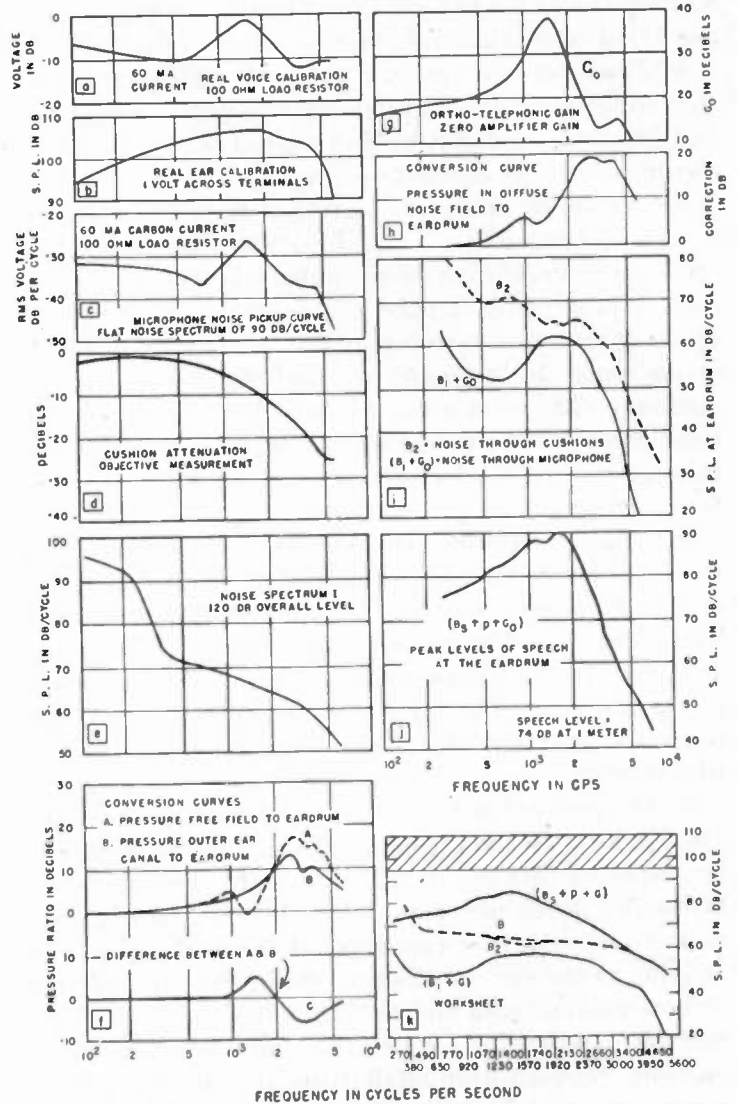

Fig. 16—Detailed steps in calculation of articulation index. The procedure is outlined in the text.

A correction must be added to the data of curves (a) and (b) above if they are to be used in the calculation of the orthotelephonic gain. The curve for converting free-field pressure to pressure at the eardrum is given as (a) in Fig. 16(f). This curve should be *subtracted* from Fig. 16(a) to convert the real-voice calibration curve of the microphone to give the voltage produced by the microphone for a constant sound pressure of 74 decibels at the eardrum of an average listener.

The curve for converting the pressure in the outer ear, under the cushion, over to the pressure at the eardrum is

¹⁶ Specifications on acceptable artificial voices and ears are being drawn up by Sub-Committee Z-24-B of the American Standards Association at this time.

given as (b) in Fig. 16(f). This curve then should be added to those of Fig. 16(b) for the real-ear calibrations of the headsets to convert them to sound pressure produced at the eardrum for a constant voltage of 1 volt across the headset. Because the curves (b) and (a) are subtracted to yield the orthotelephonic gain, their difference given as the smoothed curve (c) can be used.

The orthotelephonic response of the system with a gain control setting of zero is given in Fig. 16(g) (see (3)) and will be designated as G in the remainder of this section. It was found by adding together curves (a), (b), and (c) of (f) minus a constant factor of 74 decibels.

8. *Three noises arrive at the ear*, (1) that entering at the microphone, (2) that entering through the cushion, and (3) that produced by amplifier. For this problem, the amplifier was adequately quiet.

To determine the noise entering at the ear via the microphone, curves (b), (c), and (e), the gain of the amplifier, and curve (b) of (f) are added together. If the gain control is adjusted during the experiment, the curve showing the noise arriving at the ear from the microphone must be adjusted upward or downward accordingly. The total noise arriving at the ear from the microphone will be designated as (B_1+G) , to show that the values must be changed when the gain of the amplifier is changed.

The noise entering the system at the earphone through the cushion is designated as B_2 and is determined by adding together the curves of (d) and (e). These data must be corrected to produce the pressure at the eardrum. An approximate curve for this purpose is shown in (h). The values of (B_1+G_0) for zero gain control setting and B_2 for our illustrative problem are shown in (i).

9. The peaks of speech lie about 12 decibels above the average level and so the curve of Fig. 2 called B_s should be displaced upward by 12 decibels for our purposes. We shall call the new curve (B_s+p) , where $p=12$ decibels. To get the spectrum level of the peaks of speech arriving at the ear, we need to add in the curve for the orthotelephonic gain and the correction curve A of (f), thereby yielding (B_s+p+G) . For talking levels which measure different from 68 decibels at a distance of one meter, the value of B_s should be corrected accordingly. The values of (B_s+p+G) with zero gain control setting for our illustrative examples are shown in Fig. 16(j).

10. *To calculate the articulation index*, the first step in the process of determining the articulation index is to plot (B_s+p+G) , B_2 and (B_1+G) on a graph with the distorted frequency scale of Fig. 10. The value of each of

these quantities at the mean frequency of the band is plotted in the center of the band as shown.

To determine the total noise produced at the ear, an energy summation of the noises (B_1+G) and B_2 must be made. This can be done easily on the graph by plotting a new curve B which lies 3 decibels above (B_1+G) and B_2 if the two have the same value, i.e., cross each other; 2 decibels above the larger if the larger lies 2 decibels above the lesser; 1 decibel above the larger if it lies 6 decibels above the lesser; and on the larger if it lies greater than 7 decibels above the lesser (see Fig. 16(k)). The useable area for contributing to intelligible speech lies between (B_s+p+G) and B and is similar to the shaded region of Fig. 15. In case B should lie so low that it crosses over the threshold of hearing at the bottom of the graph, an energy summation of B and the threshold curve should be made as though the threshold curve was determined by a noise having a continuous spectrum. The discovery of the identity of the threshold curve with a continuous spectrum noise is to be attributed to the Bell Telephone Laboratories. For each of the bands $(\Delta A)=0.05 W_n$ (see (4) and (5)), and can easily be determined by using a small scale marked from 0 to 0.05 with each 0.01 division being equal in length to 6 decibels on the graph. The total articulation index equals the sum of the (ΔA) values for the twenty different bands. If the (B_s+p+G) and the B curves lie more than 30 decibels apart, a value of 0.05 should be assigned to that band as being its maximum contribution. If (B_s+p+G) lies above 95 decibels, only the contribution up to 95 should be counted. For this example, A is 0.495. The measured articulation score was 88 per cent using words.

In general, an entirely satisfactory system for a given ambient noise is one for which the articulation index is greater than 0.5, while an unsatisfactory system will have an A of less than 0.3. For values of A between 0.5 and 0.3, the system should be viewed with suspicion and subjected to an actual articulation test using the exact ambient noise spectrum if possible. Approximate values of word or syllable articulation scores can be obtained from Fig. 11, but it must be remembered that those relationships are valid only for a particular test crew and lists of speech material.

ACKNOWLEDGEMENT

The author wishes to express his appreciation to the Bell Telephone Laboratories and the Psycho-Acoustic and Electro-Acoustic Laboratories at Harvard for making available the foundation material for this study.



3- and 9-Centimeter Propagation in Low Ocean Ducts*

MARTIN KATZIN†, SENIOR MEMBER, I.R.E., ROBERT W. BAUCHMAN‡, AND
WILLIAM BINNIAN§

Summary—One-way radio propagation measurements on 9 and 3 centimeters between ship and shore, coupled with meteorological measurements on ship and ashore, were made in the Atlantic trade-wind area off the east coast of Antigua, British West Indies, early in 1945. Persistent low-level ducts, averaging 20 to 50 feet in height, with an effective strength of 5 to 10 M units, were found to exist all the time. The height and strength of the duct appears to depend on the wind speed, low winds producing low ducts of moderate strength while higher winds result in higher but weaker ducts.

Various antenna-height combinations were explored to determine the optimum heights for utilization of the duct. Very effective trapping was found on 3 centimeters, the optimum height being between 6 and 15 feet, depending on duct conditions. On 9 centimeters the degree of trapping was only partial, and the strongest signals were obtained with the highest heights available (46 feet transmitting and 94 feet receiving). Rates of decrease of signal averaged 0.85 decibel per nautical mile on 9 centimeters up to about 80 miles, and 0.45 decibel per nautical mile on 3 centimeters for all ranges. Beyond 80 miles the rate of decrease of signal on 9 centimeters was much less, about 0.2 decibel per nautical mile. Rain squalls had no observable effect on the strength of received signals.

Measurements inland from the shore site showed that the duct is destroyed within one-quarter mile from the water's edge, but that effective radio transmission can be obtained with installations up to at least a mile inland if the terrain is flat and low-lying. The duct reforms on the leeward side within a distance of 2 miles offshore.

Radar measurements of 3 centimeters gave results substantiating the one-way measurements. Ranges up to 47 miles on a small vessel were obtained with the antenna at 6 feet, lower maximum ranges being obtained with higher heights of radar antenna, in agreement with the findings of the one-way measurements.

INTRODUCTION

INTEREST HAS been drawn during the past few years to low-lying ducts¹ formed close to the surface of the sea, particularly in those areas where the

* Decimal classification: R113. Original manuscript received by the Institute, June 10, 1946; revised manuscript received, January 27, 1947. Presented, 1946 I.R.E. Winter Technical Meeting, January 26, 1946, New York, N. Y.

† Naval Research Laboratory, Washington, D. C.

‡ Formerly, Naval Research Laboratory, Washington, D. C.; now, Idaho Falls Electric Company, Idaho Falls, Idaho.

§ Formerly, Naval Research Laboratory, Washington, D. C.; now, Pan American World Airways, New York, N. Y.

¹ In a nonhomogeneous atmosphere whose index of refraction decreases with height, rays of sufficiently small initial elevation angle are refracted downward with a curvature proportional to the rate of decrease of the index of refraction with height. If the radius of curvature is less than the radius of the earth, such rays reach a maximum height and are confined, or trapped, between this height and the earth's surface. This process is referred to as trapping, and the region of the atmosphere within which it occurs is called a duct, because of the analogy of wave-guide propagation.

It is convenient to represent the variation of refractive index with height by a quantity M , defined by

$$M = n - 1 + h/a) \cdot 10^{-6}$$

n being the index of refraction of the atmosphere at a height h over the earth of radius a . M is thus the excess over unity of the modified index of refraction, in parts per million. It is customary to plot this relation in rectangular co-ordinates with M as abscissa and h as ordinate, resulting in the so-called M curve. For trapping to be possible, it can be shown that the M curve must have a region of negative slope.

trade winds prevail. The existence of these ducts was first discovered by the British through meteorological measurements made over the Irish Sea late in 1943. These measurements showed that a rapid decrease in the humidity, accompanied by a superadiabatic lapse rate of temperature, occurred very close to the surface, resulting in a duct of height 20 to 50 feet. Calculations indicated that 1-centimeter waves should be strongly trapped by these ducts, and 3-centimeter waves trapped to some extent. The importance of such trapping in radar applications and in inter-island communications was also pointed out.

Further meteorological measurements which verified the existence of these ducts were made in the Caribbean off Panama early in 1944 by a Washington State College (WSC) group, in conjunction with the Naval Research Laboratory.² Still further meteorological measurements³ were made by the WSC group off the northeastern coast of New Guinea and off the island of Saipan which showed the presence of these ducts in every case. Duct heights were found to vary between about 20 and 50 feet, apparently being a function of wind speed, higher wind speeds producing higher ducts. M curves¹ calculated from the soundings indicated that 3-centimeter transmissions could be trapped, and possibly 10 centimeters to some extent as well.

In order to obtain experimental verification of the predicted trapping, an experiment in the Atlantic trade-wind region was undertaken. It was decided that one-way transmission measurements between a shore station on the windward side of an island and a ship off shore, providing a transmission path over the ocean, would yield suitable quantitative data. In order to determine optimum antenna heights, antennas installed at heights of approximately 100, 50, 25, and 15 feet at the shore station, and 50 and 25 feet on the ship, were proposed. Two frequencies were chosen for the experiment, their wavelengths being 9.1 and 3.2 centimeters. These will be referred to as 9 and 3 centimeters, respectively, for conciseness. Duplicate facilities for 9- and 3-centimeter transmissions were to be provided. Meteorological measurements were to be made both ashore and aboard ship. A 173-foot patrol vessel of 350 tons displacement was assigned for the experiment, although a larger vessel would have been more suitable.

² K. E. Fitzsimmons, S. T. Stephenson, and R. W. Bauchman, "Low level meteorological soundings and radar correlations for the Panama Canal Zone," Department of Physics, Washington State College, Report No. 6; June 12, 1944.

³ P. A. Anderson, K. E. Fitzsimmons, G. M. Grover, and S. T. Stephenson, "Results of low-level atmospheric soundings in the Southwest and Central Pacific Oceanic areas," Department of Physics, Washington State College, Report No. 9; February 27, 1945.

OUTLINE OF EXPERIMENT

After extensive examination of available climatological data of the Caribbean area, the island of Antigua (latitude 17° 08' N, longitude 61° 48' W), British West Indies, one of the Leeward Islands of the Lesser Antilles chain, was chosen for the site of the experiment. The shore station was located on the northeastern shore of the island, affording a clear, unobstructed view into the prevailing northeasterly winds. The air over the path was thus of long ocean trajectory, unmodified by passage over any intervening land mass. At this point of the island, the ground was very low—only a few feet above sea level—and flat for some distance inland. Tide variations amounted to only about one foot.

Most of the receiving and transmitting equipment used during the experiments was loaned by the Radiation Laboratory of the Massachusetts Institute of Technology. The transmitters, which were installed on the ship, were composed largely of radar components. The magnetrons of the transmitters were mounted in a water-tight box on the signal bridge, in order to keep the transmission lines to the antennas short, and connected by pulse cable to modulators installed below decks. The magnetrons were pulsed at a repetition rate of 600 cycles per second, with a pulse width of 1 microsecond. The power output was monitored by means of directional couplers and thermistors connected in the radio-frequency lines leading to the antennas. Peak power outputs averaged 42 kilowatts on 9 centimeters, and 31 kilowatts on 3 centimeters. Fig. 1 is a view of the ship after the installation was completed.



Fig. 1—Ship used in experiments.

The shipboard antennas were full parabolic dishes of 36-inch diameter for 9 centimeters and 18-inch diameter for 3 centimeters. For the higher of the two heights, antennas were installed on either side of the yardarm at an elevation of 46 feet above the water. The lower-level antennas were at a height of 16 feet, obtained by installation of the dishes off the deck of the signal bridge on either side of the ship. In each case duplicate antennas were mounted facing fore and aft, to enable measurements to be made when the ship was running either way over the path.

The 9-centimeter antennas were fed with $\frac{7}{8}$ -inch stub-supported coaxial line, while $\frac{1}{2}$ - by 1-inch wave

guide was used with the 3-centimeter antennas. The coaxial line and wave guide were pressurized. A radio-frequency switching arrangement was associated with the magnetron installation to allow connection of the output to any one of the four antennas for each band.

Near the end of the one-way transmission experiments, after it had been found that low antenna heights gave the strongest signals on 3 centimeters, an additional 3-centimeter antenna was installed at a height of 8 feet on the ship, aimed forward. Only two runs were made using this antenna.

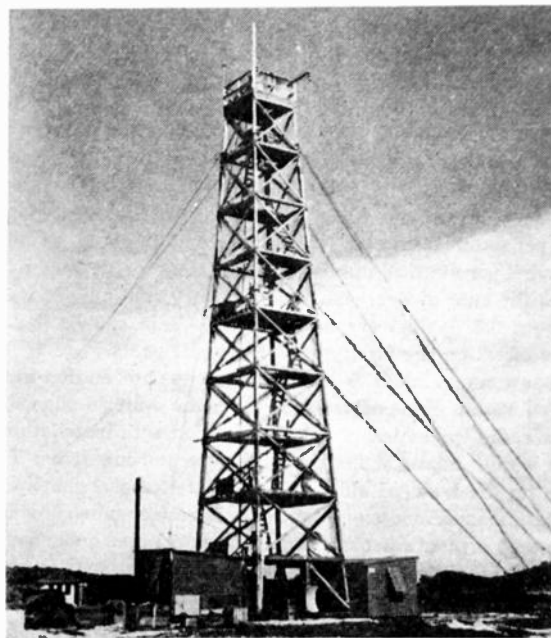

Fig. 2—90-foot tower with 9- and 3-centimeter receiving antennas.

The receiving antennas were mounted on a 90-foot wooden tower installed on a concrete foundation 60 feet from the water's edge. Two wooden buildings, approximately 10 by 14 feet, were installed at the base of the tower, one for the one-way receiving equipment, the other for meteorological work. Four antennas for each band were installed on the tower (Fig. 2), one each at heights of 94, 54, 24, and 14 feet above mean sea level. On 9 centimeters, 48-inch full parabolic dishes were used. The 3-centimeter antennas were 48-inch dishes cut to 2 feet in the horizontal dimension to broaden the horizontal beam. This was done to allow minor deviations of the ship from a radial course to occur without undue loss in signal strength. Midway in the experiment another 3-centimeter antenna was mounted at the base of the tower at a height of 6 feet, since results up to that time indicated that the lowest available antenna height gave the strongest signals on 3 centimeters. All antennas were mounted on swivels to allow alignment on any course over a 40-degree arc. Wave guide for 3 centimeters and stub-supported coaxial line for 9 centimeters were also used on the shore installation.

Two 9-centimeter and two 3-centimeter receivers were used, their outputs feeding recording milliameters. The 9-centimeter receivers had a minimum sensitivity of 110 decibels below 1 watt, while the minimum sensitivity of the 3-centimeter receivers was 105 decibels below 1 watt. It was necessary to use automatic frequency control on the 3-centimeter receivers, but manual tuning was employed for the most part on the 9-centimeter receivers, because of the greater dynamic range that could be obtained without automatic frequency control. This was possible by virtue of the good frequency stability of the 9-centimeter magnetron and local oscillator. The receivers were calibrated with standard test sets before and after each run. Since only two receivers on each band were available, it was necessary to use a radio-frequency patching arrangement, similar to that used on the ship, for connecting the receivers to the antennas.

Two-way voice communication between the ship and shore station was maintained at all times for coordination of operations. The facilities of a radio direction-finding station on the island were available to obtain bearings on the ship.

In order to determine the effect on the received signal of moving the receiving antenna inland, a mobile unit, consisting of a 3-centimeter receiver, test set, recorder, and 18-inch parabolic dish, was mounted in a truck and operated from a gasoline-driven generator. During the course of runs made on March 24 to 27, 1945, this unit was operated at points up to one mile inland from the tower site.

Coupled with the inland radio measurements, meteorological soundings were made inland to determine the destruction of the duct back from the shore. Additional soundings were made on the leeward side of the island to determine how rapidly the duct reformed. A discussion of this work is given in the meteorological section.

In an attempt to determine the direct effect of these ducts on radar, and to verify the results indicated by the one-way measurements, a 3-centimeter aircraft search radar was set up at the tower site and a series of measurements made. This system had a peak power output of about 30 kilowatts, with a 29-inch parabolic antenna. The installation was mounted at the base of the tower. This placed the antenna elevation at approximately 6 feet above sea level. Measurements of received signal strength versus range using the test ship as a target were made. The effect of the duct upon the height of the system was evaluated by placing the unit on a truck and operating along a coastal road at heights of 15, 50, and 90 feet above sea level.

ONE-WAY RADIO PROPAGATION MEASUREMENTS

A typical procedure was to align the ship at a point about 7 miles off shore (closer ranges were not feasible because of reefs lying off the northeastern coast of the

island) and commence a run on a prescribed bearing away from the tower. This bearing was predetermined by the ship from observations of the current wind and sea directions. The receiving antennas were aligned for maximum received signals and secured in this position by clamping to the platforms. The ship operating speed was usually around 10 knots, depending somewhat on the current sea conditions. While the ship was moving on course, antenna heights on the transmitting end were switched every two hours. After making several runs using this procedure, results showed that there was no discernible diurnal variation of signal strength. Therefore, in the subsequent runs the antennas at the transmitting end were switched only at the conclusion of the outward run. Periodic changes of the receiving antenna heights were made in order to obtain records for all possible antenna combinations during each run. The ranges of these runs extended up to a maximum of 190 miles.

Sixteen one-way transmission runs, consisting of round trips to maximum ranges of 70 to 190 miles, were made in a seven-week period during February and April, 1945. During each run, signal records of all antenna combinations were taken, using the radio-frequency switching arrangement described previously. Each of the 9-centimeter receivers was switched periodically between two of the four 9-centimeter antennas. The same was done on 3 centimeters for the first half of the experiment until the extra antenna at 6-foot elevation was added, after which one of the receivers was rotated between three antennas.

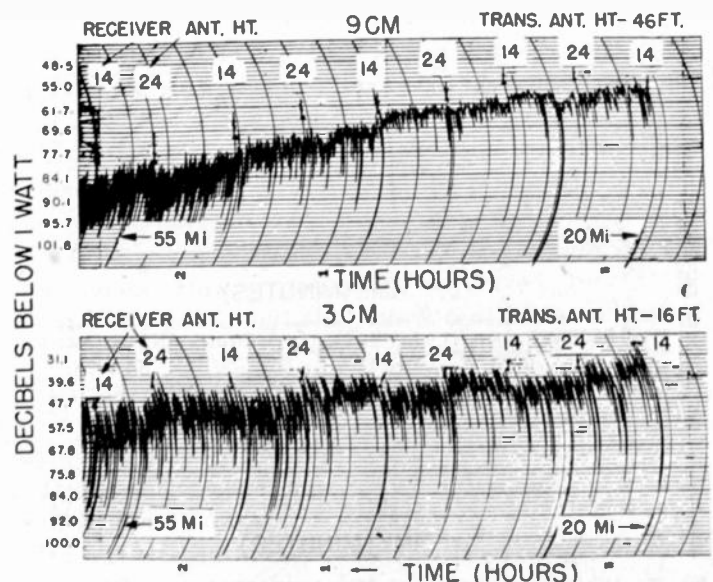

Fig. 3—Portion of 9- and 3-centimeter records of March 13, 1945, range of 20 to 50 miles.

The receiver outputs were recorded on strip charts, with a chart speed of 3 inches per hour. Fig. 3 shows portions of typical 9- and 3-centimeter records, taken during the run of March 13, 1945. This figure shows the signals received between ranges of 20 and 55 miles.

Fig. 4 shows the records of the same run for ranges of 150 to 190 miles, indicating the manner in which the signal faded out at the end of a run. The rapid fluctua-

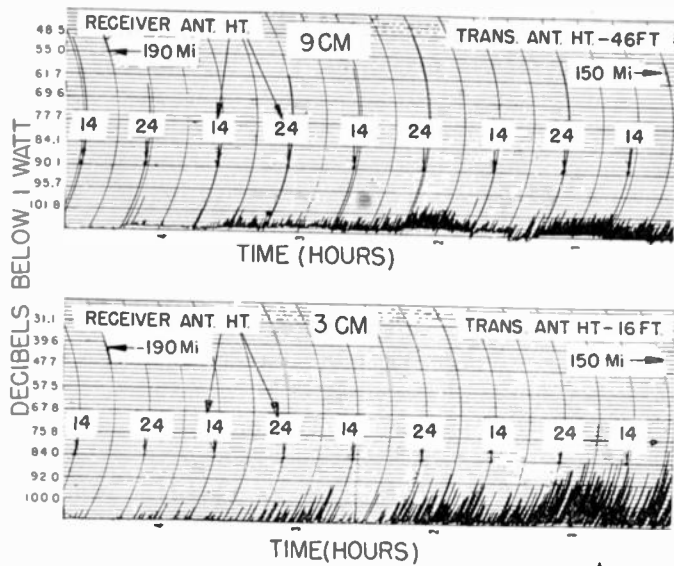

Fig. 4—Portion of 9- and 3-centimeter records of March 13, 1945, range of 150 to 190 miles.

tion of the received signal over wide limits is quite apparent. Presumably this was due principally to the pitching and tossing of the ship in the heavy prevailing swells. To check this, the recorder charts were speeded up to 60 times normal speed (to 3 inches per minute) and the fluctuations on all four recorder charts compared. Fig. 5 shows sections out of one 9- and one 3-centimeter record, taken on March 20, at a range of 34 miles. At the shorter ranges the variations were

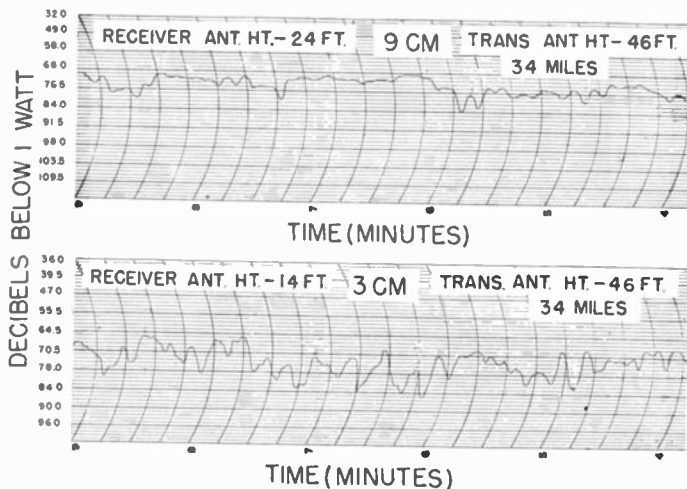

Fig. 5—High-speed records of March 20, 1945, range of 34 miles.

simultaneous on all records, indicating that the signals were fluctuating because of ship's motion. At greater ranges the fluctuations were more severe and random, particularly on the 9-centimeter records. This is illustrated by Fig. 6, taken on March 20 at a range of 90 miles.

To allow the measurements to be reduced to quantita-

tive terms, calibrations of the over-all transmission losses between transmitting and receiving equipments were made. This was done by removing the transmitting

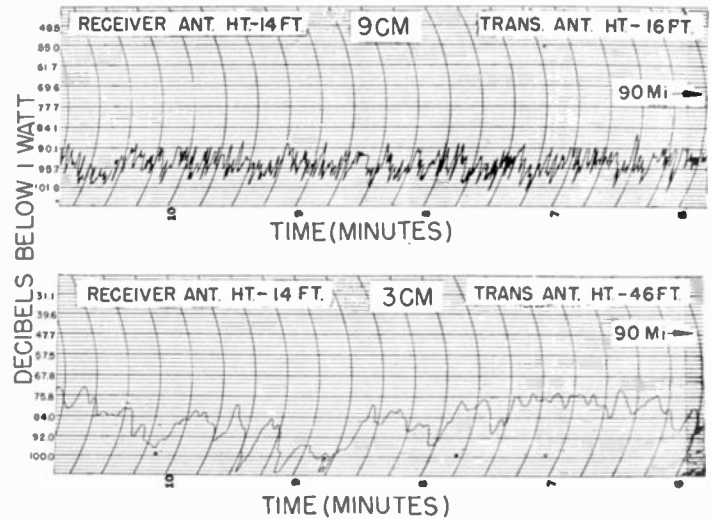

Fig. 6—High-speed records of March 20, 1945, range of 90 miles.

antennas from the ship, setting them up on shore at close range, energizing them from test sets, and determining the ratio of transmitted to received power on each frequency. In this way, the data could be converted into absolute values of attenuation. The over-all accuracy of these calibrations is believed to be within 2 decibels. The results of these calibrations have been taken into account in the computation of the data presented in this paper.

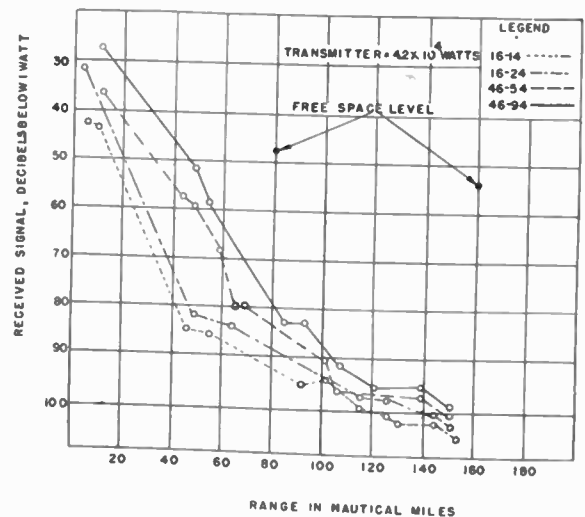

Fig. 7—Received power versus range at 9 centimeters, March 15, 1945.

Results

The one-way transmission records have been analyzed by plotting the peaks of the signal versus range. Figs. 7 and 8 show the results of the run of March 15, 1945, during which normal winds prevailed. The curves for some of the height combinations have been omitted

from these figures to avoid confusion. It can be seen that for the 3-centimeter link, in particular, the very lowest combination of 16-foot transmitting and 6-foot receiving

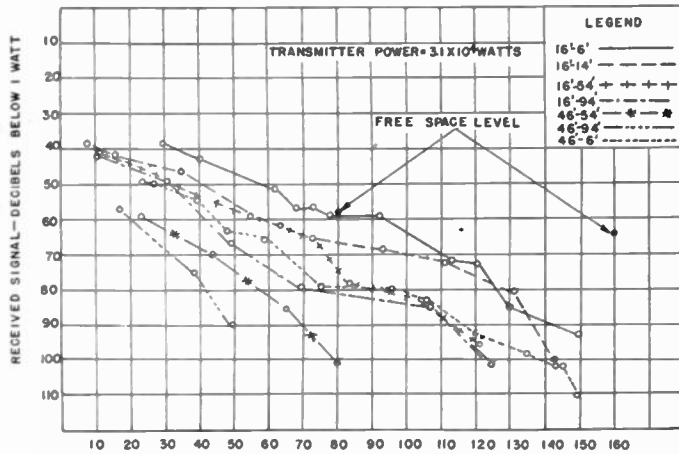

Fig. 8—Received power versus range at 3 centimeters, March 15, 1945.

antennas shows the highest signal level. The 9-centimeter records indicate the reverse to be true, with the 46- to 94-foot antenna combination giving the highest average signal level. On 9 centimeters, the signal level decreases steadily with decreasing antenna height, while on 3 centimeters the highest heights give the weakest signals. This run was made out to 150 miles and back. The 3-centimeter receiving antennas were alternated every 15 minutes for both the run out and back, while on the 9-centimeter receivers the 54- and 94-foot heights were recorded continuously going out, and the 14- and 24-foot heights coming back.

Closer examination of the 3-centimeter records shows that the curves for the 6- and 14-foot receiving-antenna heights lie fairly close together. This was found to be the case on most runs. Although the 6-foot antenna height more often gave a slightly higher signal level, the 14-foot height was the higher on several runs. For this run, which is rather typical of the average results, the average slopes of the curves are 0.4 decibel per nautical mile for the lower height combinations, while the higher heights show an average attenuation of 0.5 decibel per nautical mile.

The finite value of the attenuation constant found for the 9-centimeter transmissions is to be expected, since this wavelength is not completely trapped by the duct. On 3 centimeters, however, the first mode should be completely trapped,⁴ so that its attenuation should be zero. The fact that an appreciable attenuation does exist may be attributable to scattering of the radio waves at the surface of the sea. If this takes place, rays of sufficiently small vertical angle to be trapped within the duct will be partially scattered to steeper vertical angles, some of which can no longer be trapped, and hence

⁴ C. L. Pekeris, "Wave theoretical interpretation of propagation of 10-centimeter and 3-centimeter waves in low-level ocean ducts," *Proc. I.R.E.*, vol. 35, pp. 453-462; May, 1947.

escape from the duct. This is equivalent to a loss of power from the duct, and thus would result in a higher attenuation than expected on the basis of a theory which assumes a perfectly reflecting surface. If such a scattering process does indeed occur, its magnitude should increase with frequency. This suggests that there may be an optimum frequency for utilization of these ducts for long-range surface transmission.

The order of gain of the lowest-height combination over the highest used was often greater than 30 decibels, although sometimes as low as 10 decibels, depending on conditions. Free-space levels have been indicated on the figures at 80 and 160 miles. Out to ranges of 80 miles, the low 3-centimeter antennas receive signals 2 to 20 decibels above this level. High antennas, meanwhile, may receive signals as much as 25 decibels below this level at 80 miles.

For the 3-centimeter records, a straight line may be fitted fairly well to the plots of received signal (in decibels) versus range. In the 9-centimeter records, however, there is a marked change in the slope at a range which varies from 70 to 90 miles. The 9-centimeter records show an average slope of 0.7 decibel per nautical mile for the high height combinations out to 90 miles, and a slope of 1.1 decibels per nautical mile for the lower height combinations out to 50 miles. Beyond these points the slopes of all combinations are nearly the same, being about 0.2 decibel per nautical mile to the maximum range. This decrease of slope was found to be a distinctive characteristic of all the 9-centimeter signal records. The difference in received power between the two extremes of antenna heights used is in the order of 25 to 30 decibels out to the region where the slope changes, after which point the records become intermingled, and the height gain with the higher antennas is never over 5 decibels. This is characteristic of all runs, although the limits of height gain over the entire operating period may vary plus or minus 10 decibels from the 30-decibel figure given above.

A possible explanation of the change in slope of the 9-centimeter curves has been suggested by C. L. Pekeris.⁴ He points out that the 9-centimeter record of Fig. 6 looks like a scattered type of signal. If this is indeed the case, then the rate of attenuation of the signal will depend on the mechanism by which the scattering sources are illuminated. Why scattering of this type should take place on 9 centimeters but not on 3 centimeters, however, is not clear.

From the 3-centimeter curves, it is strikingly evident that the lowest combination of antenna heights—16-foot transmitting and 6-foot receiving—give the highest received powers. Since the increasingly higher heights yield successively lower signals, it would seem likely that a lower transmitting height than 16 feet would produce a higher signal level. It further indicates that the optimum height for antenna location may exist at a lower height. To determine this optimum height, an 8-foot 3-centimeter transmitting antenna was located on

the ship and used during the last two runs made. Midway through the first of these runs, the antenna broke loose because of the heavy pounding from the seas at such a low elevation. The record for the second run with this low antenna was obtained without mishap, and the results obtained are shown in Fig. 9.

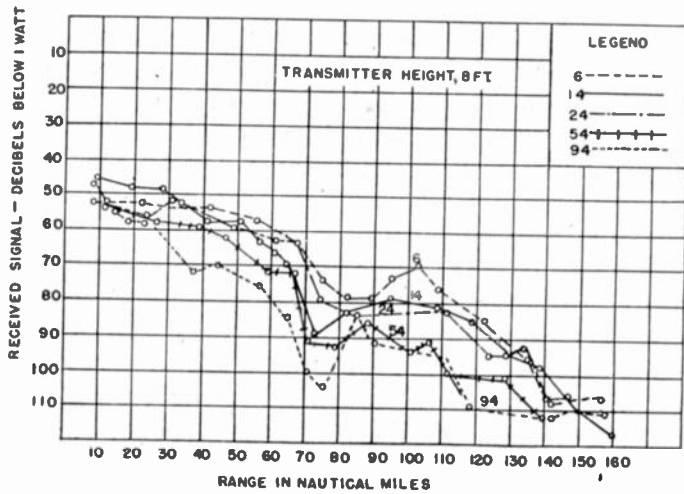

Fig. 9—Received power versus range at 3 centimeters, April 10 and 11, 1945; transmitting antenna height, 8 feet.

Further plots have been made to show a composite picture of the variations between the various antenna-height combinations over the entire period in which observations were made. Fig. 10 is one of these plots showing how the received signal for the 46- to 94-foot 9-centimeter antenna combination changed from run to run. Differences of 30 to 35 decibels with varying meteorological conditions are noted. Fig. 11 shows a similar composite plot of the results for the 16- to 6-foot 3-centi-

meter antenna combination. Differences in the order of 30 to 35 decibels occurring at the same periods of time as the changes on 9 centimeters are noted. Further references to these and similar plots will be made in

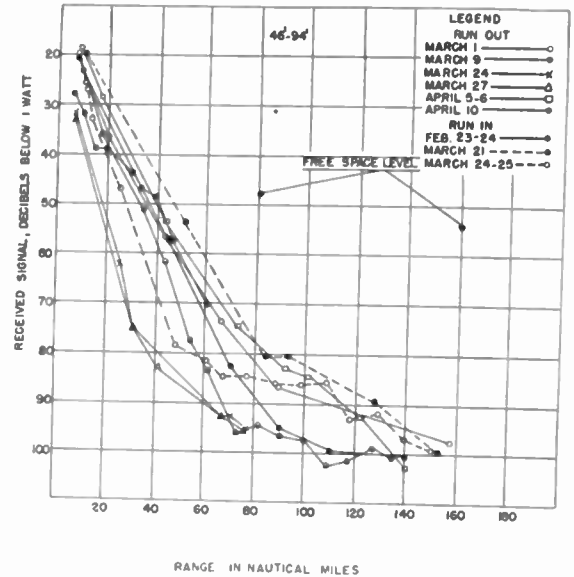

Fig. 10—Received power level versus range at 9 centimeters. Composite of all runs with 46- to 96-foot antennas.

the discussion of the radio and meteorological correlations.

Analysis of Results

The most important information that was sought from the experiment was the rate of attenuation of the signals and the optimum antenna heights. In order to extract quantitative information on these points from

TABLE I
ATTENUATION SLOPES FOR ALL ANTENNA COMBINATIONS, FEBRUARY 21, 1945, TO APRIL 11, 1945

Date	9 Centimeters								3 Centimeters									
	Transmitting Antenna 16 Feet				Transmitting Antenna 46 Feet				Transmitting Antenna 16 Feet					Transmitting Antenna 46 Feet				
	Receiving Antenna Height, Feet				Receiving Antenna Height, Feet				Receiving Antenna Height, Feet					Receiving Antenna Height, Feet				
	14	24	54	94	14	24	54	94	6	14	24	54	94	6	14	24	54	94
2-21	0.80	0.80			0.65	0.65												
2-23	1.15			1.10		0.43		0.92		0.35	0.25				0.57			
2-27	0.92	0.80	1.15	1.50			1.07	1.26		0.27	0.49				0.25	0.57	1.62	1.95
2-28	0.43	1.04	1.61	1.96			1.27	1.03		0.28	0.28	0.87	0.74				2.19	1.61
3-1	0.83	1.26	0.97	1.00	0.86	0.58	1.36	1.53		0.19	0.41	0.72	0.63					
3-3	1.03	1.15	1.04	1.00	1.15	0.97	1.15	1.32		0.40	0.59	0.48	0.40		0.47	0.57	0.51	0.42
3-9	0.86	1.07	0.78	1.06		0.92	1.06	1.07		0.42	0.64	0.72	0.86		0.40	0.48	0.49	0.87
3-13	0.83	0.86	0.84		1.15	1.09	1.38	1.15		0.43	0.46	1.00	0.89		0.42	0.65	0.83	1.11
3-15	1.23	1.26	0.78				0.78	0.78	0.43	0.40	0.48	0.49	0.57	0.63	0.30	0.42	0.72	0.57
3-19	0.80	0.87	0.88	0.77	0.95	0.87	0.97	0.92	0.63	0.51	0.61		0.69	0.51	0.45	0.55		1.15
3-24	1.09	1.09	1.55	0.86	1.96	2.07	1.84	1.61	0.49	0.97	2.30	1.84		0.28	0.75	0.76	0.86	
3-27	1.38	1.49	1.45	1.29	2.42	2.30	1.84	1.84	0.17	0.34			0.59	0.31	0.30			0.80
3-28	0.69	0.69	0.80	0.84	2.40	2.19	1.95	1.38	0.84	0.75	0.92		0.71	0.72	0.63	0.75		0.77
3-30	0.51	0.58	0.57	0.55	0.81	0.86	1.01	0.88	0.51	0.80	0.81	0.92	0.89	0.63	0.54	0.63	0.64	0.64
4-5	1.03	0.95	0.88	0.91	0.81	0.80	0.86	0.94	0.21	0.51	0.40	0.46	0.52	0.63	0.54	0.63	0.64	0.64
4-10	0.94	1.11	1.11	1.15	1.15	1.72	1.26	1.95	0.23	0.14	0.23	0.26	0.47	0.53	0.40	0.46	0.61	0.36

the experimental data, the signal plots, such as those given on Figs. 10 and 11, have been analyzed to obtain the slopes and height gains.

The slopes were determined from straight lines giving the best fits to the plots of received signal versus range. Since the data plotted are received power in decibels

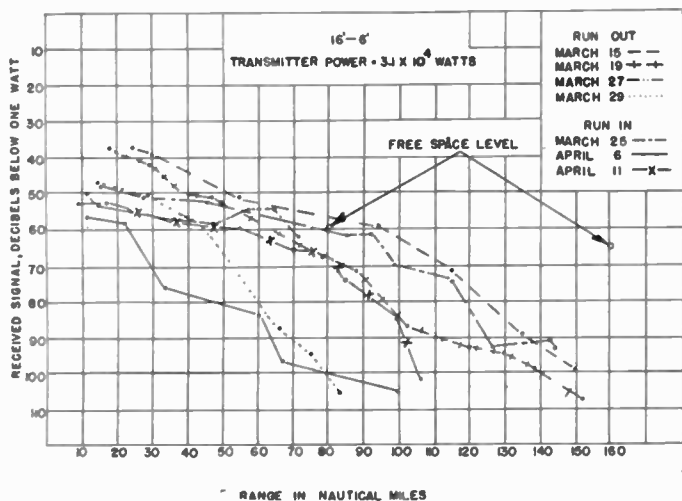

Fig. 11—Received power level versus range at 3 centimeters. Composite of all runs with 16- to 6-foot antennas.

versus range on a linear scale, these straight lines represent exponential rates of signal decay.⁵ The slopes of the 9-centimeter plots which are given are for the initial 80 miles or so, before the characteristic change of slope mentioned previously occurs. Table I gives the 9- and 3-centimeter slopes for the individual runs. These were then divided into three groups, corresponding to periods

of low, normal, and high winds. It was during these periods of distinct variation in prevailing winds that the most marked changes in the signal occurred, other changes being only of a secondary nature. The resulting values, as well as the general average for all the runs, are given in Table II. From this tabulation, it can be seen that the lowest attenuations were associated with high winds.

TABLE III
HEIGHT GAIN DISTRIBUTION IN DECIBELS (NORMALIZED AT 16- FEET TO 6- FEET FOR 3 CENTIMETERS AND 46- FEET TO 94- FEET FOR 9 CENTIMETERS)

Antenna Height Combination (in feet)	Height Gain	
	$\lambda = 3$ centimeters (in decibels)	$\lambda = 9$ centimeters (in decibels)
16-6	0	24.0
16-14	2.5	24.0
16-24	6.5	16.0
16-54	3.0	10.0
16-94	5.0	10.0
46-6	0	
46-14	4.0	14.0
46-24	8.5	6.0
46-54	4.0	2.0
46-94	7.5	0

In order to show the height-gain relations, the values of received power at 20 miles have been taken from the smoothed curves for each combination of transmitting and receiving antenna height, and averaged over all the runs. These were then normalized by taking ratios (decibel differences) to the height combination which was best, on the average. That is, the reference height combination was 46 feet to 94 feet for 9 centimeters,

TABLE II
AVERAGE ATTENUATION RATES FOR VARIOUS WIND CONDITIONS

Condition	9 Centimeters								3 Centimeters									
	Transmitting Antenna 16 Feet				Transmitting Antenna 46 Feet				Transmitting Antenna 16 Feet					Transmitting Antenna 46 Feet				
	Receiving Antenna Height, Feet				Receiving Antenna Height, Feet				Receiving Antenna Height, Feet					Receiving Antenna Height, Feet				
	14	24	54	94	14	24	54	94	6	14	24	54	94	6	14	24	54	94
General Ave.	0.84	1.00	1.03	1.07	1.31	1.10	1.26	1.24	0.44	0.44	0.61	0.76	0.66	0.51	0.51	0.55	0.91	0.82
Low Wind	1.38	1.49	1.55	1.44	2.42	2.30	1.96	1.84	0.80	0.97	2.30	1.84	0.74	0.71	0.86	0.74	0.86	1.95
Normal	0.86	0.92	0.86	0.97	0.86	0.80	0.97	0.97	0.42	0.34	0.51	0.69	0.69	0.46	0.51	0.51	0.74	0.74
High Wind	0.46	0.57	0.57	0.57	0.69	0.46	0.80	0.80	0.23	0.17	0.23	0.34	0.46	0.51	0.34	0.28	0.46	0.40

⁵ It should be noted that this attenuation rate applies to a relation of the form

$$W = W_0 \cdot e^{-0.400\alpha(R-R_0)} \quad (a)$$

where W is the received power density at the range R nautical miles, W_0 is the received power density at a range R_0 nautical miles, and α is the attenuation rate given in Tables I and II. For cylindrical propagation such as takes place in a duct, a relation of the form

$$W = W_0 \cdot \frac{R_0}{R} e^{-0.400\alpha'(R-R_0)} \quad (b)$$

would be expected, the factor R_0/R accounting for horizontal divergence of the beam. It was found, however, that relation (a) yielded a much better fit to the data than relation (b).

and 16 feet to 6 feet for 3 centimeters. These differences are tabulated in Table III, and have been plotted against the antenna heights on Figs. 12 and 13. In this way, a representation of the average height-gain distribution is obtained for the two frequencies used.

From Fig. 12, which shows the distribution of 9-centimeter signal level with height, it can be seen that the gain increased continually with height up to the 94-foot level, which was the highest height available. The gain obtained using the 46-foot transmitting antenna

instead of the 16-foot antenna is in the order of 10 decibels. The fact that the signals continue to increase all the way up to the highest height shows that the 9-centimeter waves are not strongly trapped in the duct, but leak rather badly. From this, it follows also that only a single mode is propagated in the duct.

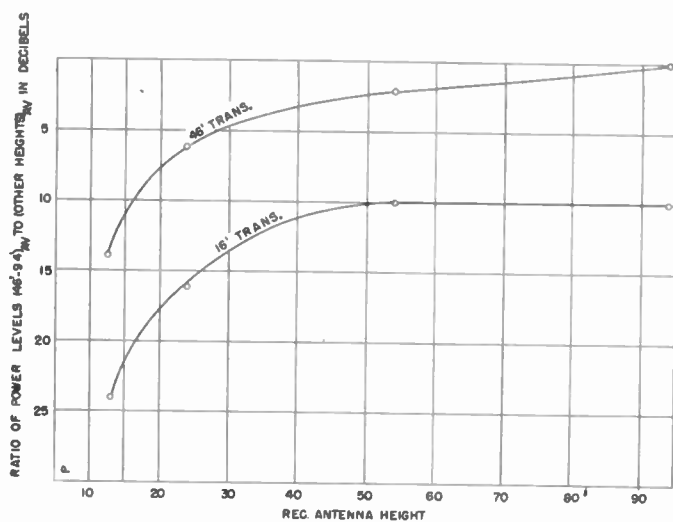

Fig. 12—Average height gain, 9 centimeters.

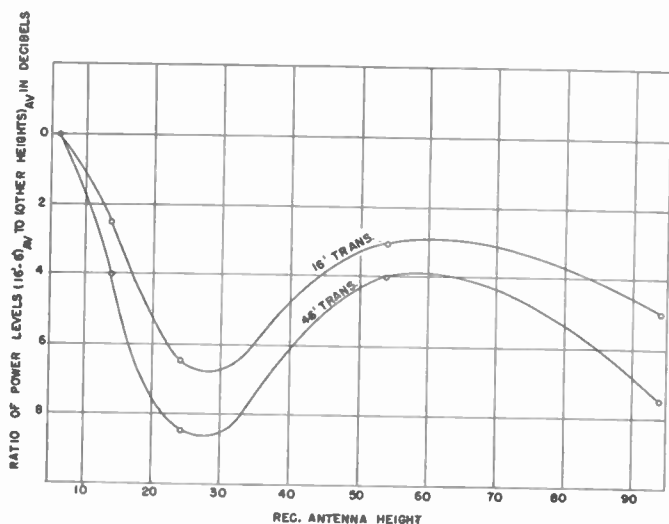

Fig. 13—Average height gain, 3 centimeters.

The 3-centimeter average height-gain curves on Fig. 13 show quite a different behavior. Here the effect of more complete trapping is rather clearly evident. The saddle-shaped curve having two maximums, one at 6 feet, the other around 60 feet, indicates that at least two modes are trapped. The optimum height is 6 feet (or below) on the average, while a pessimum height is indicated at about 30 feet. These are average results, of course, and on individual runs deviations from this behavior were observed. It has already been pointed out that on some occasions the 14-foot height gave the strongest signals. In one case the strongest signals occurred at the 24-foot height. In general, these conditions were associated with periods of low wind.

The 8-foot-height transmitting antenna has not been drawn into the comparisons on the height-gain plots

because so few data were available. In order to judge the performance of this height relative to the others, the received power levels at two ranges, 40 and 70 miles, have been tabulated for the various transmitting heights. Table IV gives a summary of the levels, expressed in decibels below the free-space levels, at the 40- and 70-mile ranges. The variations in received signal, referred to this level, for the 8-, 16-, and 46-foot antennas transmitting to the 6-, 14-, 24-, 54-, and 94-foot receiving antennas indicate the increase in gain of the very low heights over the 46-foot height. However, there is only one point where the 8-foot combination affords any advantage over the 16-foot combination, and the gain in that case is so small as to be within experimental error. Other comparisons between the two agree within the same limits. A summary of all the combinations

TABLE IV

POWER LEVELS IN DECIBELS ON $\lambda=3$ CENTIMETERS FOR 8- AND 16-FOOT TRANSMITTING HEIGHTS NORMALIZED TO FREE SPACE

Receiving Antenna Height, Feet	Power Level in Decibels Above Free-Space Level				
	April 10, 11, 1945 Transmitting Antenna Height		Transmitting Antenna Height		
	8 feet	16 feet	8 feet	16 feet	46 feet
<i>R=40 miles:</i>					
6	+ ½	- 2½	+ 3½	+ 4½	
14	- 1	- 1½	+ 7½	+ 7½	
24	- 2½	- 1	- 3½	- 2½	
54	- 8½	- 5½	- 13½	- 1½	
94	- 16	- 9½	- 6½	- 6½	
<i>R=70 miles:</i>					
6	- 3½	- 5	+ 2	+ 3	- 2
14	- 5	- 2	- 2	- 1	- 5
24	- 7	- 4½	- 7	- 5	- 6
54	- 19	- 10	- 15	- 13	- 18
94	- 21½	- 16	- 17	- 16	- 21

shown, therefore, seems to indicate that the optimum height for 3-centimeter transmitting antennas lies between 8 and 16 feet, for the particular conditions then prevailing.

In interpreting these results, it is important to bear in mind that the heights of the transmitting antennas actually were not constant, due to the rolling motion of the ship. The average amount of roll was between 15 and 30 degrees, depending on the roughness of the sea, with peaks as high as 50 degrees. Since signal peaks were scaled from the records, the height of transmitting antenna yielding these peak values may actually be somewhat less than the nominal values stated.

RADAR MEASUREMENTS

In the observations which were made with the 3-centimeter airborne search radar, the normal sector scan was not used, the antenna being trained manually through a rope-and-pulley arrangement. Thus the radar measurements apply to "searchlighting" illumination of the target.

With the radar set up at the base of the tower, several runs were made to determine maximum ranges and the

variation of echo level with range. The echo strength was measured by means of a test set which injected an artificial echo into the receiver through a directional coupler. Then, by matching the target and test-set echoes on the A scope (which displays echoes on a linear range scale), the received signal strength was evaluated. Because of the violent fading of the echo, it was difficult to do the echo-matching, and the method gave rather rough data. In making the signal strength measurements, the ship was maneuvered on an S-shaped course so as to present broadside aspects at periodic intervals of range out from the tower.

In order to verify the one-way results on the effect of antenna height on received signal, observations of received-echo-level variation with range were made with radar antenna heights of 15, 50, and 90 feet above sea level. All these observations were restricted to the test ship, which was the only target available at the time. At the same time, maximum range of sea return, or "clutter," was determined at each height. The sea-clutter observations were made on the plan-position-indicator and A scopes. During one of these runs, measurements were made with a 48-inch dish replacing the regular radar antenna, in the hope that greater ranges would be obtained.

On the leeward side of the island, the radar truck was stationed at four different positions, with various heights above sea level. Observations on islands and available ship traffic from heights of 10, 15, 75, and 100 feet were possible. During the period of observation, several small islands and only one ship were detected from the vantage points selected. The locations available were disadvantageous because of the island's topography on the leeward side.

Calibrations similar to those made on the one-way antennas were made using the radar antenna. These included measurements of antenna gain, test-set calibration, and insertion loss of the directional coupler.

The values of received echo from the ship were plotted against range and average attenuation rates smoothed therefrom, as was done in the one-way measurements. The results are shown in Table V.

TABLE V
MAXIMUM RANGE AND ATTENUATION RATES ON
3-CENTIMETER RADAR

Radar Antenna Height (feet)	dP/dR (decibels per nautical mile)	Maximum Range (in nautical miles)
90	1.2	26.5
50	1.4	28.0
16	0.8	34.0
6	0.8	47.5

Although the radar measurement was quite difficult and gave somewhat rough results, the slopes of the curves for the lower heights were definitely lower than for the higher heights. Also, the maximum ranges were in

the order of decreasing height. These results are in general accord with the results of the one-way transmission measurements.

The observations on the leeward (west) side of the island gave scanty information, due to the scarcity of ship traffic at the time. They did serve to show, however, that the duct is reformed on the leeward side, as evidenced by the detection of a ship at 45 miles. This was obtained with the radar at approximately 75 feet above the water. In this instance, a lower site from which to make the same observation was not available, because the island's topography provided limited low-elevation sites.

Echoes from islands lying to the west of Antigua were the chief results of the observations on the west side of the island. At a 15-foot height an island at 37.5 miles was detected with a very strong signal, but at a 100-foot height the same island gave only a weak echo.

METEOROLOGY

As an introduction to the low-level meteorology of the Atlantic tradewind region, the following paragraph is included as a description of the climate in question.

The significant feature of the climate at Antigua during the late winter is its persistence. The weather is determined largely by the position and strength of the Bermuda High, a large, semipermanent high-pressure area covering the Atlantic from 10 to 30 degrees north latitude. The northeast trade winds blow around and out of the southern rim of this high-pressure area. With a few exceptions, the wind direction at Antigua during the period of the experiment was east-northeast. Once, for a period of three days, it went around to north-northeast, and on two separate occasions it blew from the east. Average daily surface wind speed was 16 knots, with occasional variations between 8 knots and 27 knots. Representative air temperatures varied between 74 and 78 degrees Fahrenheit; relative humidities between 60 and 80 per cent. The sea-water temperature was reasonably constant at 77.5 degrees Fahrenheit, with occasional variations between 76.5 and 78 degrees. No significant horizontal gradients of sea temperature were found. Precipitation was wholly in the form of showers, with a maximum frequency of occurrence around sunrise. Periods of relatively dry weather followed by periods of relatively showery weather and accompanying transitions were experienced. It is felt that these variations were caused by fluctuations in the intensity and position of the Bermuda High, or by the trough effects ahead of dissipating cold fronts.

Low-level meteorological measurements were made principally at two locations; namely, aboard the ship and at the receiving tower. Aboard ship, soundings were taken at the rate of approximately one per hour by two methods; the first, by means of a halliard which ran from the outboard end of the main yardarm to a 15-foot boom extending out from the ship's side approximately

amidships; the second, by means of a captive balloon flow from the fantail. Halliard soundings were used to make detailed measurements of temperature and humidity at levels below 44 feet. It was found that measurements below 14 feet were impracticable because of the heavy seas and the accompanying ship's roll and large amounts of spray. With winds averaging around 15 knots, all types of soundings were out of the question when the ship was moving into the seas with a speed of 10 knots; the spray and, in many cases, solid water and the motion of the ship made low-level soundings impossible. It was found, however, that with proper precautions against the effects of radiation from the ship and the sun and against salt spray, psychrometric observations could be obtained on the signal bridge at an elevation of 20 feet. These observations, together with wind-speed measurements made with a hand anemometer which would be moved to the optimum location for the particular attitude of the ship, and measurements of the sea temperature, were taken hourly on all outgoing runs. Sea temperatures and winds were, of course, recorded inbound as well.

All soundings were made with Washington State College equipment.² Due to the large sensitivity of the temperature and humidity elements, most of the turbulent short-time variations in temperature and relative humidity were indicated on the meters. Wide fluctuations of the order of plus or minus one-half a degree Fahrenheit for the temperature and plus or minus three per cent for the relative humidity were observed at a given height above the water. These fluctuations were, in some cases, greater than the average total change between the lower and upper heights of the halliard soundings. Consequently, one was faced with the problem of obtaining the average temperature and humidity from observations which showed wide variations of temperature and humidity over a period of several minutes. The most satisfactory method seemed to be the recording of six to ten meter readings at each level and taking the arithmetic average.

Since ship soundings were impractical except when running with the wind, aeration of the elements in the radiation shield proved difficult when the relative wind became small. Balloon soundings proved equally rough.

Meteorological measurements ashore consisted first of soundings made on a halliard rig which ran from a pole at the top of the tower to a point at the water's edge. Readings at about one foot were made by holding the instrument over the water. Kite soundings made beside the tower furnished temperature and humidity information up to heights averaging 600 feet, with occasional soundings to over 1000 feet. Tower soundings were made every two hours, kite soundings every eight to twelve hours. Other equipment included two anemometers mounted on the windward side of the towers, one at 10 feet, the other at 100 feet; hygrothermographs were installed on the tower at the 10-, 20-, 50-, and 90-foot levels. For a short period of time, a halliard rig was

installed on a 50-foot windmill about three-quarters of a mile inland from the beach.

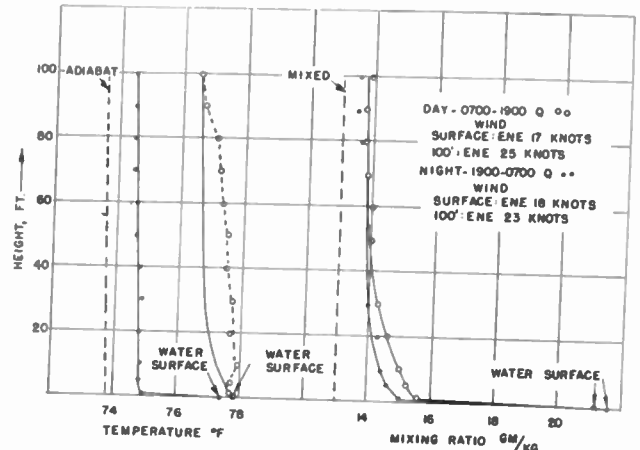

Fig. 14—Day and night temperature and mixing-ratio curves from mean soundings of March 9, and 10, 1945.

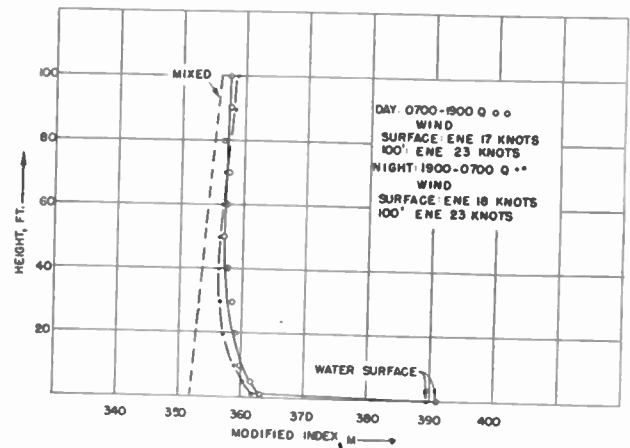

Fig. 15—Day and night *M* curves of March 9 and 10, 1945, sounding.

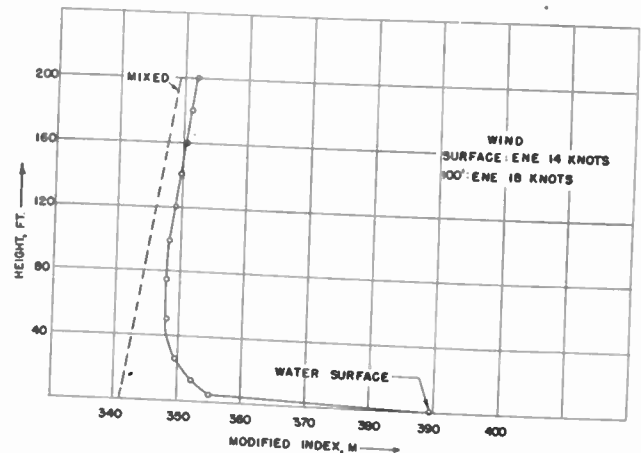

Fig. 16—Sample *M* curve for March 2, 1945, sounding.

The same turbulent fluctuations in temperature and humidity were observed on the tower soundings that were found at sea. The data were taken in a similar manner. Effects of the radiation from the narrow strip of ground between the tower and the water were noted, particularly in the daytime. Individual soundings showed a tendency to give much warmer temperatures in the region between 20 and 50 feet in the daytime than

at night. The lower and upper portions were not affected as severely. Unreasonable variations of tempera-

time permitted between runs, at various locations and with several techniques. On one occasion a sounding from 10 feet down to 1 foot was taken 100 feet out from the shore in front of the tower with the sounding instrument attached to a pole. Another site chosen for special low-level work was the end of a dock which extended about 200 feet out from the windward shore of the island. The third type of very low measurements was conducted from the bow of the ship while anchored in the lee of submerged reefs a mile or so to windward of the tower. The radiation shield was held out on the end of a long pole ahead of the ship and various heights from 20 feet on down were investigated. The results of these independent measurements will be given later.

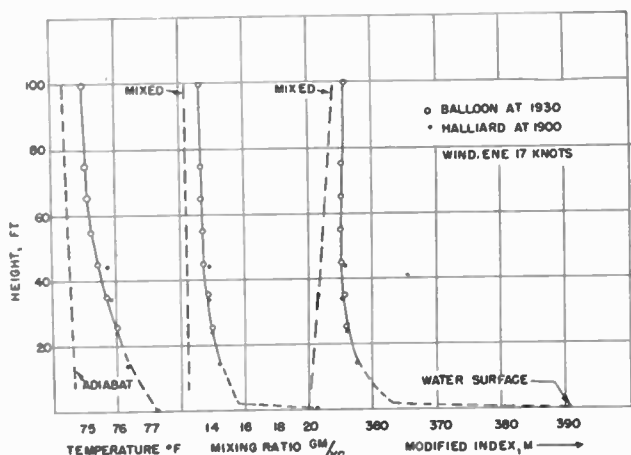

Fig. 17—Sample temperature, mixing-ratio, and *M* curves for February 28, 1945, 1900 ship sounding.

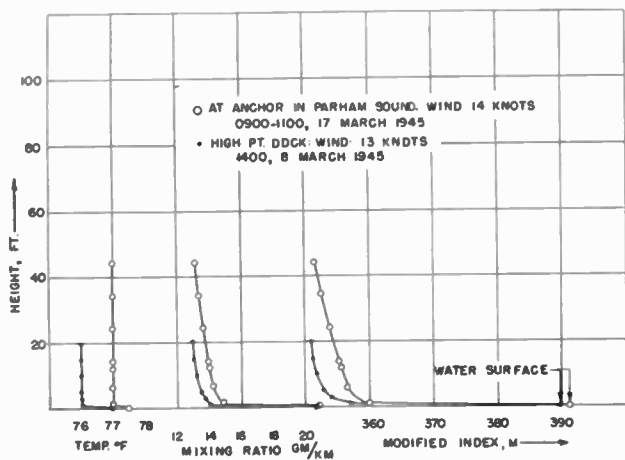

Fig. 18—Very-low-level soundings of March 8 and 17, 1945.

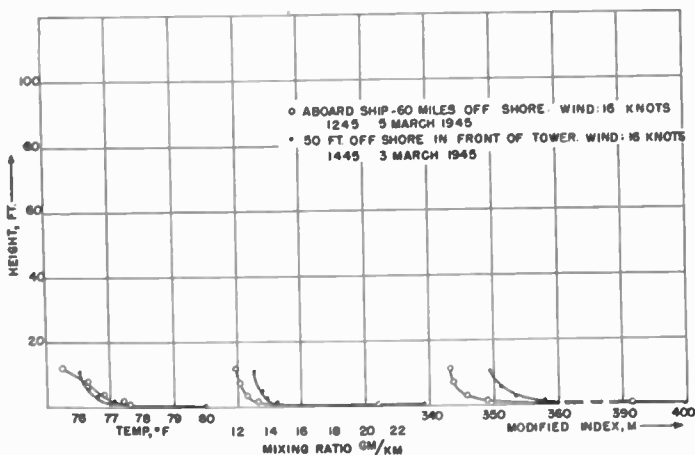

Fig. 19—Very-low-level soundings of March 3 and 5, 1945.

ture with height were found to be common, particularly in the daytime. Unreasonable humidity curves were not as prevalent, probably because the humidity drop with height was more pronounced than the temperature drop. Also, the sounding equipment allows only a second-order effect of temperature on mixing ratio.

In addition to the schedule of soundings given above, a number of very-low-level soundings were taken, when

The weather regimes encountered fall into a number of categories; the soundings have been examined accordingly. During the entire period of observations, a simple surface duct was found to exist over the water. From the second week in February through the third week in March, and again in the first week of April, synoptic and duct conditions appeared reasonably constant. Surface winds during these periods were of the order of 15 knots from the east-northeast, the trades being well developed. This condition will henceforth be referred to as the normal condition. Figs. 14 through 19 show typical and mean soundings for this condition; Figs. 14 through 16 are soundings made ashore; Fig. 17 was made aboard ship; and Fig. 18 consists of two very low-level soundings, one made at the dock, the other aboard ship while anchored off shore. Fig. 19 shows other very low-level data. The sounding made 60 miles off shore is of doubtful validity due to poor aeration.

In order to minimize the roughness of the soundings, and for the purpose of correlation with the radio data, the recorded temperatures and humidities at each height have been averaged and used to compute the corresponding values of modified index of refraction, or *M*, from the averages. All water surface temperatures and the derived mixing ratio and *M* values at the sea surface were taken from water temperature as measured aboard the ship. Examination of the sea-temperature records indicated no significant horizontal gradients except within 50 to 100 feet from the beach. Temperatures inside the submerged reefs which lay about five miles off shore were not found to differ from those at sea.

Certain features of the normal case may be pointed out. The duct height (the height of the minimum value of *M*, or "nose" of the *M* curve) appears to be at about 40 feet. The gradients of both temperature and mixing ratio, particularly the latter, are extreme in the first foot above sea level. Reference to Figs. 18 and 19 will show that the kink at the one-foot level is not confined to soundings made at the tower site. Undoubtedly the roughness of the water plays a large part in determining the shape of the lower portions of the temperature and mixing-ratio curves. The waves at both the dock and anchorage position of the ship were about 1½ to 2 feet

high, while at the beach they were somewhat less. In the open ocean, of course, the seas were considerably higher, running from 4 to 8 feet, depending on the wind speed.

The important quantity in determining the extent of trapping is not the value of M , but the total decrease of M in the portion of the M curve of negative slope. This total decrease of M is called the M deficit. In the light of the sharp gradients found below one foot and the lesser gradients above, it was found convenient to divide the temperature, humidity, and M deficits into two portions: *total* deficits are the values at the sea surface minus the values at the nose of the M curve; *effective* deficits are the values at one foot minus the values at the nose.

The effects of the heating from below by the land between the tower and the water's edge are shown on the temperature plots in Fig. 14. The circles are the average of the measured values for the daytime period. A curve joining these points appears utterly unreasonable for a simple unstable case over water, and it is felt that such a curve as is described by the points is the result of localized heating. The temperature curve obtained after sundown appeared plausible.

Considerable help in evaluating the representativeness of the shore data was derived from the psychrometric measurements made aboard ship when running into the wind. These showed that the air at 20 feet was colder than the water. An examination of the diurnal variations of air and sea temperatures was made. The air temperatures were measured with care to avoid heating of the thermometer by the sun or by radiation from the ship. It appears that despite all the precautions that were taken, the diurnal variation of air temperature, both over a two-month period and over one 24-hour period, was larger than current belief calls for.

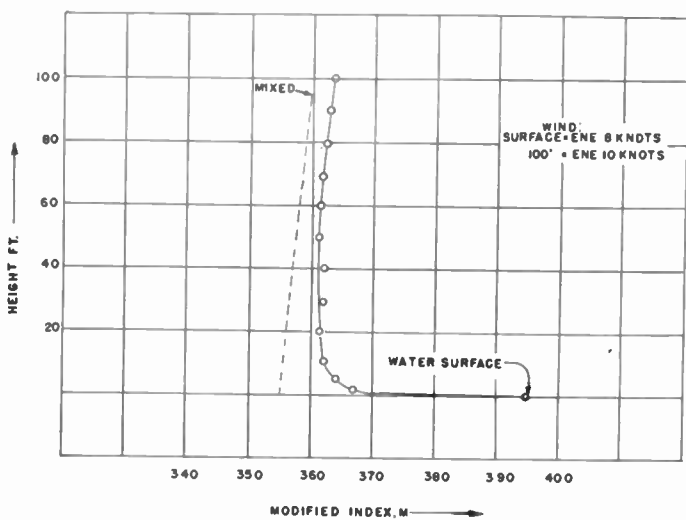

Fig. 20—Modified index curve for 0700-1900, March 24 and 25, 1945.

Soundings made to heights in the vicinity of 600 feet, both on the ship and ashore, show no evidence of the existence of any higher ducts. The tradewind inversion, with its accompanying sharp decrease in moisture

through the inversion, was shown by radiosonde observations to be present at all times at heights between 5000 and 10,000 feet, depending on the synoptic condition.

Turning to variations from the normal conditions, the qualitative effect on the low-lying duct of changes in wind speed will now be discussed. Fig. 20 is an example of the low-wind condition. The change in duct height is not too clear, but the heights appear to be lower for the lower winds. In addition, while there is little change in the total M deficit, the effective M deficit has increased.

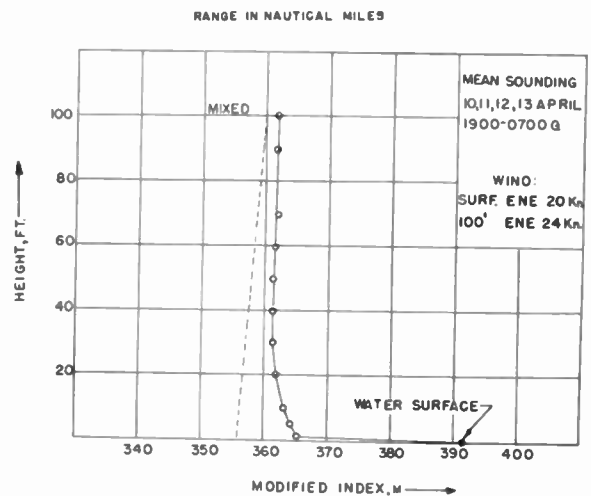

Fig. 21—Modified index curve, average for 1900-0700, April 10 to 13, 1945.

High winds produced further changes in the M curve. Fig. 21 shows a pronounced decrease in the effective M deficit, a less pronounced increase in duct height, and little change in total M deficit when compared with the curves for the normal condition.

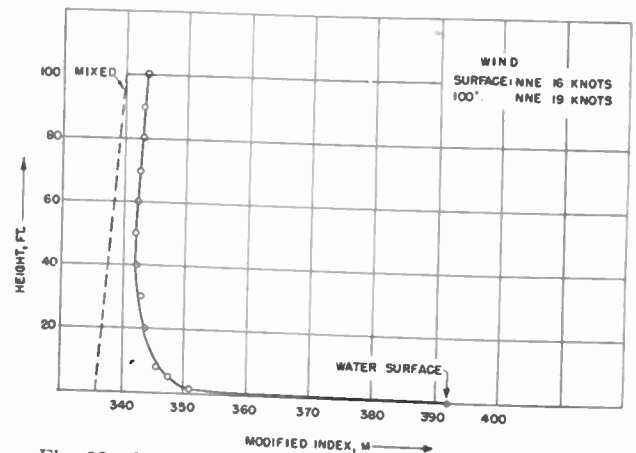

Fig. 22—Modified index curve, average for 1900-0700, March 27 to 29, 1945.

The other major change in the weather was the influx of air which was either dryer or more moist than under the normal condition. Fig. 22 is an example of the M curve under dry conditions, Fig. 23 under moist conditions. The principal difference between the two is the large increase in total M deficit when the air was dry. This, of course, is to be expected.

During several periods of measurements, rain squalls, which varied in intensity from heavy showers to light intermittent rainfall, were present over the radio transmission path. These squalls at times covered a large part of the path, as evidenced from the precipitation echoes present on the radar. Soundings taken just prior to their development and almost immediately following their dispersion showed great similarity of duct conditions. On one occasion a storm at sea was present

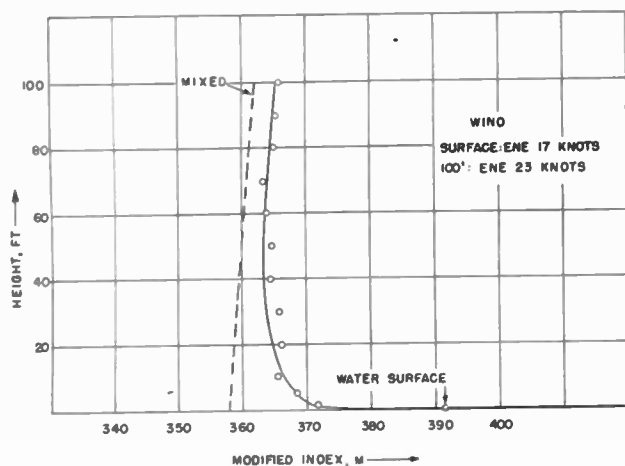

Fig. 23—Modified index curve for 1900, April 11, 1945.

over the path and observed to be moving in over the island. At this time a sounding happened to be in progress. The expected increase in moisture content of the air developed with the presence of falling rain drops, which at first were not heavy enough to prevent completion of the sounding. The sun was intermittently obscured, thus causing a fluctuation of readings, in particular of temperature, probably due to radiation effects. However, smoothing over this effect by using the averaging method, normal lapse rates of temperature and mixing ratio, and resulting M curve, were found.

In order to evaluate the effect of the island on the low-lying duct, soundings were made inland from the tower, and aboard ship to leeward of the island. These soundings showed that the duct was destroyed within the first one-quarter to one-half mile from shore (in the daytime), but was completely restored at two miles off shore on the leeward side. Unfortunately, shallow water prevented the ship from coming in closer to the leeward side of the island to check restoration of the duct in detail.

Analysis of Meteorological Data

In the following paragraphs there is presented a number of plots of various meteorological parameters relating to the formation and behavior of low-lying ducts over the ocean. The validity of the results of such an analysis is dependent primarily on the validity or representativeness of the data used. In the light of observed influences which are disturbing the representativeness of the measurements, such as radiation effects, the

presence of salt spray, and poor judgment in the use of equipment or in evaluating average values of temperature and humidity of a medium whose properties are turbulent, the analyst of such data faces many obstacles. Suffice it to say that the data were the best obtainable under circumstances which were at times adverse to the meteorologist. For example, the values of temperature and humidity at a height of one foot above the water surface are difficult to obtain over the open sea. When such measurements are made in smoother water the immediate reaction is to condemn them as nonrepresentative of rough water conditions, a perfectly justifiable remark. However, as a first-order approximation, it is believed that measurements made over relatively calm water are better than no measurements at all.

Because of the dimensions of the ship available, reasonably accurate soundings above 44 feet were not made. The necessity of maintaining a heading either directly into the wind or directly with the wind for purposes of obtaining radio data, together with the state of the sea, confined shipboard soundings to those times when proper aeration of the radiation shield and proper sampling of representative ocean air were hindered by low relative winds and sometimes large effects of the ship on the air being sampled. Thus, the ship data, with the exception of the psychrometer observations made at one level while heading into the wind, and sea-water temperature and wind-speed measurements, are of limited accuracy.

Ashore, the air sampled at the tower was most certainly modified by the land immediately in front of the tower and probably by the smoother water that lay along the shore. Turbulent variations in temperature and humidity were correspondingly large at the tower site. On the other hand, the operational advantages of a shore-based sounding station are obvious. Attempts to obtain very-low-level measurements over the water were a compromise between questionable measurements at the tower or near-by sites and no measurements over the open sea.

Turning to the plots, it was found that the most successful results were obtained by using the average of a number of observations under a given weather regime. The use of individual soundings in the raw or unsmoothed form turned out to be hopeless. Attempts at smoothing the M curves directly would, in many cases, mask the existence of temperature and humidity roughnesses which were out of phase. Therefore, the temperature and mixing-ratio curves were smoothed separately and the corresponding M curve computed. Such a practice is subject to considerable human judgment in determining the smooth curves. Furthermore, slight changes in the slope of the mixing-ratio curves would manifest themselves in significant changes in the slope of the M curve. The evaluation of the height of the duct by the smoothing method was subject to considerable guesswork on the part of the analyst, as changes of the

same order of magnitude as the sensitivity of the measurement of mixing ratio at a given height, introduced by smoothing, would often determine whether the slope of the M curve was positive or negative.

In estimating the accuracy of the psychrometric measurements made aboard ship, one must remember that the procurement of dry- and wet-bulb temperatures accurate to one-tenth of a degree Fahrenheit is most difficult and not easily checked. The tolerance for these readings is probably of the order of plus or minus three-tenths of a degree Fahrenheit, and plus or minus one- to two-tenths of a gram per kilogram for mixing ratio. The tolerances of the temperatures and mixing ratios obtained from the Washington State College sounding equipment are at best plus or minus two-tenths of a degree Fahrenheit for temperature and plus or minus one- to two-tenths of a gram per kilogram for mixing ratio, neglecting entirely the disturbing influences of turbulence and radiation. It is clear, therefore, that for measuring differences of temperature and mixing ratio of the order of a few tenths of a degree or a few tenths of a gram per kilogram, respectively, the sounding equipment is somewhat inadequate. It is with the above remarks in mind that the correlation plots must be examined.

An attempt was made to determine whether the difference between the sea temperature and that of the air above was connected with the force of the wind. A plot versus wind speed of sea temperature minus the air temperature at 20 feet showed no correlation. A similar scattering appeared when a plot of sea-air mixing-ratio difference versus wind speed was made. These plots did show, however, that there appears to be a critical wind speed above which the humidity deficit takes a sudden jump for a small increase in wind speed. The critical wind speed becomes greater as one approaches the condition of neutral equilibrium, where the temperature deficit is zero. At all wind speeds, the larger the temperature deficit, the larger the humidity deficit. The critical wind speed appears in each case to lie between 15 and 20 knots. It might be noted that this is about the wind speed at which waves in the open sea begin to break.

The remaining plots are the result of an analysis of the soundings themselves. In most cases, the data are taken from the soundings made on the tower. It was necessary to confine the analysis to these soundings because most of the shipboard soundings did not reach above the duct, and it was impossible to obtain very low measurements at sea. It was found to be advisable to use the values of duct height, effective M deficit, total M deficit, and derived parameters averaged over a 2- to 2½-day period. Some of the plots contain values of the parameters obtained from individual soundings which were smoothed in the manner mentioned earlier in the paper.

The variation of effective M deficit (the difference between the values of M at one foot and the minimum M) with wind speed is shown in Fig. 24. In general, the two tend in opposite directions. Fig. 25 presents a plot of

the ratio of duct height to effective M deficit versus wind speed. Here a trend in the same direction is indicated. The scatter in this diagram can be attributed largely to the difficulty in obtaining an exact value of the height of the duct due to the rather gradual recurvature of the M curve at the nose. In Fig. 26 plots of the variations of effective M deficit with duct height and wind speed show that there appears to be a critical value of wind speed of about 15 knots at which, for a given duct height, the variation of effective M deficit with wind speed changes sign.

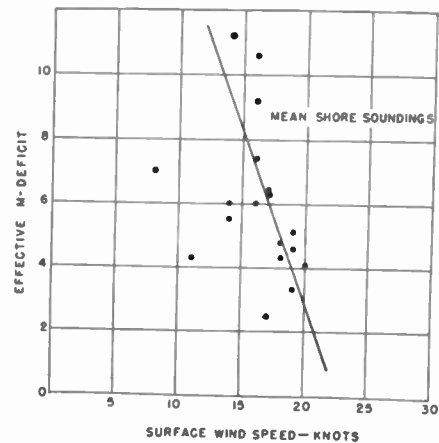

Fig. 24—Effective M deficit versus wind speed.

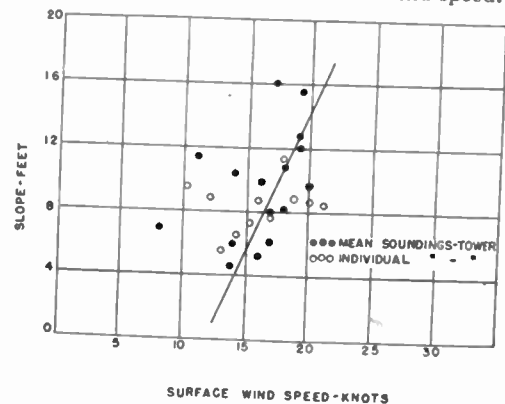

Fig. 25—Effective M slope versus wind speed.

Figs. 24 and 25 should prove useful for evaluating such quantities as duct height, effective M deficit, and total M deficit for purposes of prognosticating the dimensions of a simple surface duct found over water. It must be remembered, however, that any extrapolation of the data to regions of the world where the sea-air temperature difference is large is likely to prove unwise. When the sea-air temperature difference is significant, conditions of neutral equilibrium no longer hold, and the stability of the boundary layer plays an increasingly important role in the vertical distribution of M in the boundary layer.

CORRELATIONS

In the analysis of the radio and meteorological data, attempts have been made to draw what correlation may be present from the averaged results. In establishing a basis for such an analysis, it was evident that an average of the recorded observations had to be made if any

pertinent information was to be drawn out of the comparison. The data in the unsmoothed form offered too many variations caused by indeterminate factors in the methods of making both the radio and meteorological observations. Even after taking the smoothed data and comparing plots of meteorological information possibly related to the radio plots for the same period, the problem of making any correlation is somewhat complex. However, the available data have been analyzed with a view toward determining what quantitative or qualitative information is present.

the nose, using both the effective and total M deficit, and the wind speeds as measured on the ship and shore were compared with these signal records. From the results of these comparisons, it appears that the only possible meteorological factor which can be expected to show clear interdependence with attenuation rates and signal level is the wind speed. Figs. 26 and 27 show such comparisons. These are chronological plots of signal strength at 20 miles, slope in decibels per nautical mile, and wind speed. It is apparent that, on the whole, both signal strength and slope show correlations with wind speed, higher winds giving stronger signals and lower slopes.

CONCLUSIONS

Several significant deductions are apparent from the results obtained during these experiments. A summary of the more important of these is given below.

An extremely low-lying surface duct, averaging in height between 20 and 60 feet over the sea, persists in the trade-wind regions. The height and strength of this duct vary with wind speed, the lower wind speeds (8 to 15 knots) producing a low, moderately strong duct, while higher winds (20 to 30 knots) produce a higher but weaker (smaller M deficit) duct. Changes in wind speed have no clear effect on *total M* deficit, which is determined essentially by the temperature and humidity of the air mass as a whole. Passing squalls and rain showers do not wipe out the duct or decrease the received signal strength. The duct is not present over land, but is destroyed within about one-quarter mile in from the windward shore. The duct is reformed on the leeward side of small land masses, such as small islands within several miles beyond the coast line.

Transmissions of sufficiently high frequency can be trapped within such ducts, so that it is possible to transmit such frequencies successfully to far beyond the horizon with appropriately located antennas. Signal strength and attenuation rate appear to be related to wind speed, stronger winds resulting in stronger signals and lower attenuation rates, in general. On 9 centimeters, stronger signals are obtained with higher antennas, up to at least 100 feet. On 3 centimeters, however, antenna heights of very low elevation (6 to 15 feet) give stronger signals and greater ranges. Radar performance is in accord with the results of the one-way transmission measurements. The effect of the duct in trapping these waves can be utilized with installations inland up to at least a mile from the shore, provided the terrain is low-lying.

Measured rates of attenuation give higher values on 3 centimeters than expected on the basis of theory, possibly due to scattering caused by the roughness of the sea. This suggests that there may be an optimum range of frequencies for utilization of these low ducts. On 9 centimeters, a marked, and as yet unexplained, decrease in attenuation rate takes place for distances beyond about 80 miles.

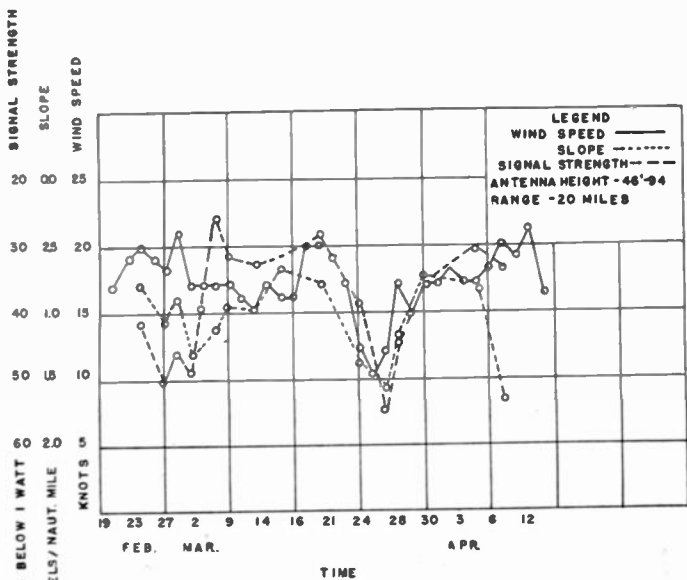

Fig. 26—Chronological plots of 9-centimeter signal level, attenuation, and wind speed.

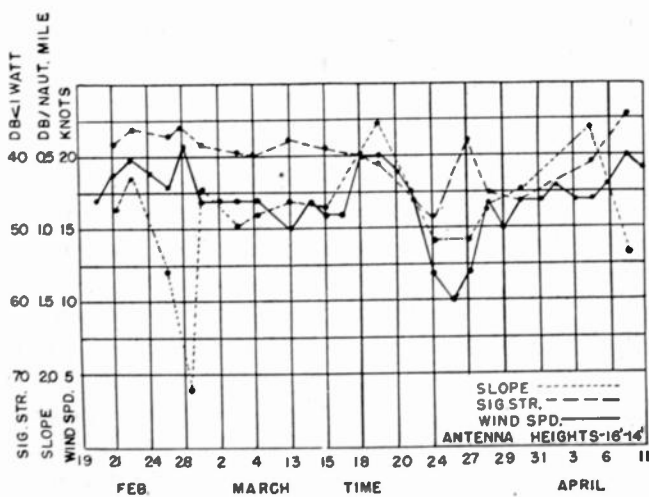

Fig. 27—Chronological plots of 3-centimeter signal level, attenuation, and wind speed.

With this in mind, plots of the rates of attenuation in decibels per nautical mile for each antenna combination for both 9 and 3 centimeters over the seven-week period were made from the radio data. Similar plots showing the variation in the power level at 20 miles over this period were made. To correlate with the meteorological findings, the variation of the average values of effective M deficit, total M deficit, slope of the M curve below

Broad-Band Noncontacting Short Circuits for Coaxial Lines

Part I. TEM-Mode Characteristics*

WILLIAM H. HUGGINS†, ASSOCIATE, I.R.E.

Summary—This paper discusses the factors that must be considered in the design of an S-type noncontacting plunger, which will present an effective short circuit to the TEM-mode in a circular coaxial line over a frequency tuning ratio of 3 to 1 or more. Since there are no sliding contacts, a coaxial resonator may be tuned an unlimited number of times with this type of plunger and still remain free from physical wear, "finger noise," and mechanical hysteresis and drag. It was the use of this type of plunger that made possible the development of local oscillators which can be tuned an unlimited number of times over a microwave frequency range as great as 2 to 1.

Subsequent Parts II and III of this paper will deal with the analysis and methods of controlling the parasitic resonances which may occur in a noncontacting plunger when the operating wavelength is less than the circumference of the outer coaxial line.

INTRODUCTION

THE CIRCULAR coaxial-line section is an extremely useful circuit element in the design of microwave circuits which must be tunable over a large frequency ratio. Applications of such coaxial-line sections to oscillator resonators, radio-frequency preselectors, and tunable filters have been reported elsewhere.¹

The principal advantage of the circular coaxial-line section over other wave-guide shapes is that it possesses a principal (TEM) mode which allows operation at frequencies much lower than those required for propagation of the higher-order TE and TM modes. Hence, tuning ratios of 2 to 1 or more are practicable in a coaxial line, whereas in a rectangular wave-guide section, for example, the allowable tuning range is considerably less than 2 to 1.²

However, to fully realize the wide-tuning-ratio feature of the coaxial-line section, it is necessary to provide a short circuit, the position of which can be varied mechanically. The simplest form of short circuit is a ring (or plunger) having spring fingers which make a sliding metallic contact between the inner and outer coaxial conductors. While a plunger of this type is probably satisfactory for applications requiring only a few tuning operations, when the coaxial-line section is to be tuned roughly 1,000,000 times the unavoidable mechanical wear is almost certain to produce erratic performance, a change in frequency calibration, and tuning

* Decimal classification: R141XR310. Original manuscript received by the Institute June 19, 1946; revised manuscript received, September 18, 1946.

† Communications Laboratory, Cambridge Field Station, Air Materiel Command, Cambridge 39, Massachusetts. This paper is based in part upon work done for the OSRD under Contract No. OEMsr-411 with the President and Fellows of Harvard College.

¹ Radio Research Laboratory Staff, "Very-High-Frequency Techniques," McGraw-Hill Book Co., New York, N. Y., 1947.

² Greater tuning ratios may be obtained, however, by using a ridged wave guide.

"noise." Furthermore, the contact resistance may be so great as to prohibit this type of short circuit, particularly at the very short wavelengths where line dimensions are necessarily small and the surface resistivity is large. The finger-contact power loss may be reduced by incorporating appropriate transmission-line sections ahead of the fingers to transform the contact resistance to a much smaller value. Although choke joints incorporating this principle have been used extensively in equipments tuning over a narrow range, there is a widespread notion that such circuits are inherently narrow-band devices and that tuning ratios in the order of 3 to 1 are impossible to obtain.

It is the purpose of this paper to present a discussion of the factors that must be considered in the design of a noncontacting plunger which can simulate an effective short circuit to the TEM mode over a frequency range of 3 to 1 or more. Since there are no sliding electrical contacts, a coaxial line may be tuned an unlimited number of times with complete freedom from physical wear, tuning noise, and mechanical hysteresis and drag.

This paper will be divided into three parts: (I) TEM-Mode Characteristics; (II) Parasitic Resonances in the Unslotted Plunger; and (III) Control of Parasitic Resonances. The plunger theories were evolved during the development of wide-tuning-range reflex oscillators, and the examples presented herein relate for the most part to that application.

TEM-MODE CHARACTERISTICS

The principal function of the plunger is to close off the coaxial line and reflect completely all energy in the incident wave which impinges upon it. Actually, a plunger can only approximate this ideal behavior because there will always be some loss of power. This power loss is of two kinds: the surface power loss that arises from the surface resistance of the conductors forming the coaxial line and plunger, and the leakage power loss due to energy which escapes past the plunger into the rear cavity. The practical design of the plunger is such that these two losses are more or less independent of each other, and it is therefore possible to calculate each by ignoring the other and then to combine the losses thus calculated to obtain the total power loss.

In order to treat the plunger as a circuit element, it is convenient to consider the plunger as presenting a plunger input impedance, $Z_p = R_p + jX_p$, at its "face." The plunger input resistance R_p is simply equal to the total power loss divided by the square of the effective

current at the plunger face. Hence, the plunger input resistance may itself be expressed also as the sum of two components: that due to "surface" energy losses, and that arising from rear-cavity leakage losses. As usual, it has been found convenient to normalize the plunger impedance with respect to the characteristic impedance R_0 of the coaxial line. The *normalized* plunger impedance will hereafter be designated by lower-case symbols, $Z_p/R_0 = z_p = r_p + jx_p$.

Actually, for satisfactory performance the plunger need not simulate a perfect short circuit. It is only necessary that the power loss (i.e., R_p) be negligible; the plunger reactance simply alters the position of the equivalent short circuit. Thus the effect of a reactance x_p measured at the face of the plunger is equivalent to that of a short circuit located θ_p electrical degrees *behind* the face of the plunger, where

$$\theta_p = \tan^{-1}(x_p). \tag{1}$$

The total power loss in the plunger may be expressed in terms of a *power-absorption coefficient* σ which is defined as the ratio of the power absorbed by the plunger to the power in the incident traveling wave. In terms of the voltage reflection coefficient r at the plunger, this is

$$\sigma = 1 - |r|^2, \tag{2}$$

and in terms of the normalized plunger impedance $r_p + jx_p$,

$$\sigma = \frac{4r_p}{(1 + r_p)^2 + x_p^2}. \tag{3}$$

THE S-TYPE PLUNGER

The type of plunger that seems to offer the greatest rear-cavity isolation over the widest tuning ratio may have any of the forms shown in Fig. 1. These plungers

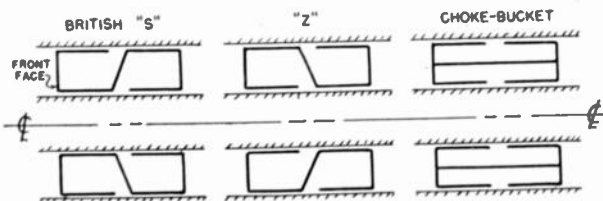

Fig. 1—Cross sections of equivalent forms of the S-type plunger.

are all equivalent electrically in their behavior with respect to the principal (*TEM*) coaxial mode and as a class will hereafter be referred to as S-type plungers.³

These plungers do not touch either the inner or outer coaxial conductors and hence they must be supported from the rear by some sort of carriage which will maintain accurate alignment. For proper operation the clearance between the plunger and the outer and inner con-

ductors must be kept very small (0.010 inch being a common clearance) and sporadic contact between plunger and cavity must be avoided if proper operation is to be obtained.

Transmission-line techniques may be applied in analyzing the performance of these plungers, but first the following assumptions will be made in order to simplify the analysis:

1. The discontinuity effects are neglected and the various parts of the plunger are replaced by sections of simple coaxial line. These line sections are all assumed to be equal in length.
2. The spacing of each low-impedance gap is negligible compared to the spacing between the inner and outer conductors of the main coaxial line. The characteristic impedances of all low-impedance gaps are identical.
3. The thickness of the plunger walls is assumed to be negligible. Hence, the characteristic impedances of the "internal" line sections are equal to that of the main line.
4. The section of coaxial line to the rear of the plunger is terminated in its characteristic impedance. This is equivalent to assuming that the coaxial line is semi-infinite in length, so that any energy that "leaks" past the plunger is not reflected back to the plunger. (Although this assumption is not fulfilled in practice, this assumption is necessary if the plunger characteristics are to be independent of those of the rear cavity.)

On the basis of these assumptions, then, the equivalent circuit for the S-type plunger appears as shown in

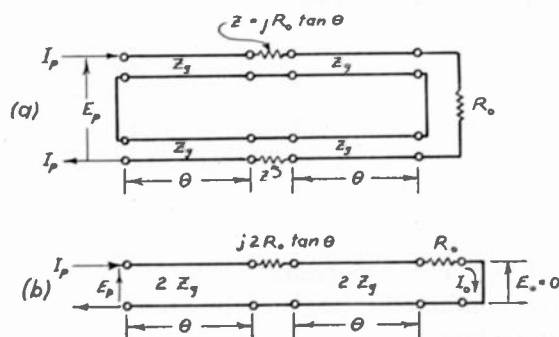

Fig. 2—Equivalent circuits for the plungers shown in Fig. 1.

Fig. 2. In this diagram, the following nomenclature applies:

- I_p = current at front face of plunger
- I_0 = current at rear face of plunger
- θ = electrical length of transmission-line sections
- E_p = transverse voltage at front face of plunger
- R_0 = characteristic impedance of main coaxial line
- Z_g = characteristic impedance of low-impedance gaps
- Z = impedance presented by internal section of plunger.

The input impedance of the transmission-line circuit shown in Fig. 2(b) may now be calculated using conventional methods. It would be possible to include the

³ The choke-bucket configuration may have a slightly greater internal power loss. For a comparison of the S-type plunger with other possible types, see footnote reference 1, chapter 32.

internal losses due to the resistivity of the plunger and conductor surfaces by introducing the appropriate propagation factor for each transmission-line section. This, however, would lead to a very complicated solution and, furthermore, would not indicate the *division* of the power losses. Therefore, we shall make two calculations. The first calculation will be for the energy that leaks past the plunger and is absorbed by the rear of the cavity (i.e., by R_0). The slight losses in the transmission-line section may be neglected in making this calculation since they will have only a negligible effect on the current in R_0 . Finally, the internal losses will be calculated from the idealized current distribution over the conductor surfaces.

$$r_p = \frac{R_p}{R_0} = \frac{1}{[\cos 2\theta - m \tan \theta \sin 2\theta]^2 + m^2[\sin 2\theta - m(1 - \cos 2\theta) \tan \theta]^2} \quad (8)$$

INPUT REACTANCE AND REAR-CAVITY POWER LEAKAGE

The input impedance of the circuit of Fig. 2(b) may be most easily obtained by multiplication of the matrices for the individual four-terminal networks.⁴

$$\begin{bmatrix} E_p \\ I_p \end{bmatrix} = \begin{bmatrix} \cos \theta & j2Z_0 \sin \theta \\ \frac{j}{2Z_0} \sin \theta & \cos \theta \end{bmatrix} \cdot \begin{bmatrix} 1 & j2R_0 \tan \theta \\ 0 & 1 \end{bmatrix} \cdot \begin{bmatrix} \cos \theta & j2Z_0 \sin \theta \\ \frac{j}{2Z_0} \sin \theta & \cos \theta \end{bmatrix} \cdot \begin{bmatrix} 1 & R_0 \\ 0 & 1 \end{bmatrix} \cdot \begin{bmatrix} 0 \\ I_0 \end{bmatrix} \quad (4)$$

Multiplying out these matrices, and performing various algebraic and trigonometric simplifications, one obtains:

$$\begin{bmatrix} E_p \\ I_p \end{bmatrix} = \begin{bmatrix} R_0[\cos 2\theta - m \tan \theta \sin 2\theta] + jR_0 \left[\frac{1}{m} \sin 2\theta + (1 + \cos 2\theta) \tan \theta \right] \\ [\cos 2\theta - m \tan \theta \sin 2\theta] + j[m \sin 2\theta - m^2(1 - \cos 2\theta) \tan \theta] \end{bmatrix} \cdot I_0 \quad (5)$$

where m is the *gap-impedance ratio*, $R_0/2Z_0$. The two equations contained in (5) may be used to calculate the input impedance of the plunger (assuming, of course, perfect conductors). Since with perfect conductors the tangential voltage drop across the face of the plunger is zero, the transverse voltage at the plunger is simply the gap voltage E_p , and the plunger impedance is the ratio E_p/I_p . By using (5), the plunger impedance is expressible in terms of gap-impedance ratio m and the parameter $\psi = \tan \theta$ as

$$\frac{Z_p}{R_0} = \frac{[1 - (1 + 2m)\psi^2] + j\left[\frac{2}{m} + 2\right]\psi}{[1 - (1 + 2m)\psi^2] + j2m[1 - m\psi^2]} \quad (6)$$

Equation (6) may be used to calculate the reactance x_p

of the plunger and also the plunger resistance r_p . Practically, however, it is found that $r_p \ll x_p$, and for calculation of r_p the accuracy of (6) is not good. An expression for the plunger resistance which yields much better accuracy may be obtained as follows:

Since the internal losses are zero, all net energy flowing into the plunger must eventually be dissipated in the rear-cavity termination. Hence,

$$R_p |I_p|^2 = R_0 |I_0|^2 \quad (7)$$

But the second row of (5) expressed I_p in terms of I_0 . Substituting this relation into (7) and dividing out $(I_0)^2$ gives

$$r_p = \frac{R_p}{R_0} \approx \frac{1}{m^2[m \tan \theta(1 - \cos 2\theta) - \sin 2\theta]^2} \quad (8a)$$

For the practical case where $m \gg 1$, the first term in the denominator of (8) may be neglected over the useful range of operation and a good approximation is

The resistance and reactance characteristics of a typical noncontacting S-type plunger as calculated from (6) are shown in Figs. 3 and 4. As these functions are

even- and odd-symmetric, respectively, about $\theta = 90$ degrees, they have been plotted only for the interval $0 < \theta < 90$ degrees. Equation (8a) has been found to give excellent accuracy over the useful frequency range of the plunger. The plunger becomes antiresonant, however, at a very low frequency (corresponding to the electrical length, $\theta_b = 1/\sqrt{m}$ radian) and (8a) does not apply in this region (see Fig. 3). (Fig. 10 shows how the leakage resistance as calculated from 8(a) varies with the gap-spacing parameter m for several different values of electrical length θ .)

Experimental measurements of the plunger reactance have yielded data that compare quite closely with the calculated values shown in Fig. 4. The principal discrepancy between calculated and experimental values is that, because of the capacitive-loading effect of the discontinuities inside the plunger, the zero-resistance condition apparently occurs at about $\theta = 80$ degrees, instead of $\theta = 90$ degrees.

⁴ Paul I. Richards "Applications of matrix algebra to filter theory," Proc. I.R.E., vol. 34, pp. 145-150P; March, 1946.

SURFACE-RESISTANCE POWER LOSS

Throughout the normal operating range of the S-type plunger, the input impedance of each of the rear low-impedance gaps is negligible compared to the high-impedance Z of the internal line section, and for the

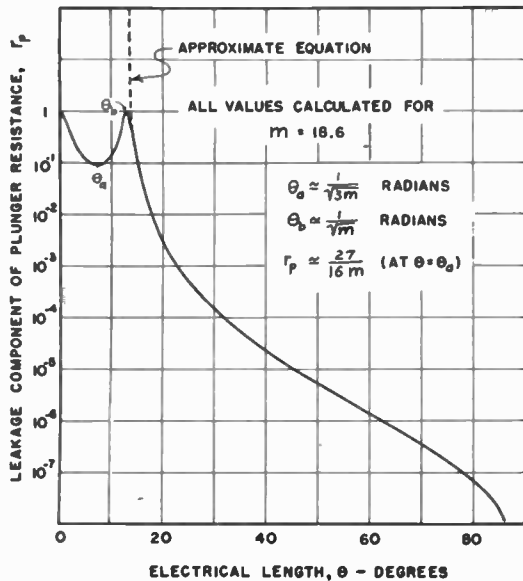

Fig. 3—Typical plunger leakage as a function of frequency (θ is proportional to frequency).

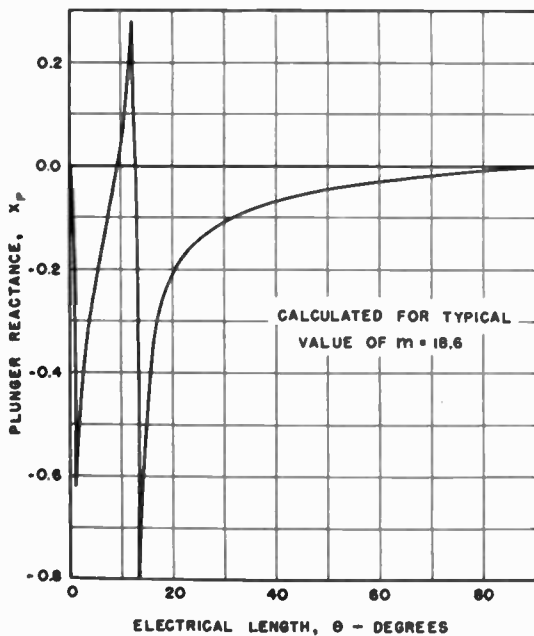

Fig. 4—Typical plunger reactance as a function of frequency (θ is proportional to frequency).

practical purpose of estimating the current distribution over the plunger surfaces, we may assume that the rear low-impedance gaps are equivalent to perfect short circuits. Hence, if the internal high-impedance line section were unfolded, both inner and outer plunger gaps when viewed from the face of the plunger would have equivalent circuits such as that shown in Fig. 5.

In terms of the current I_2 at the short-circuited end

of the internal high-impedance line section, the current and voltage at any distance x from the short circuit are

$$e_x = jR_0 I_2 \sin \frac{\theta x}{l} \tag{9a}$$

$$i_x = I_2 \cos \frac{\theta x}{l} \tag{9b}$$

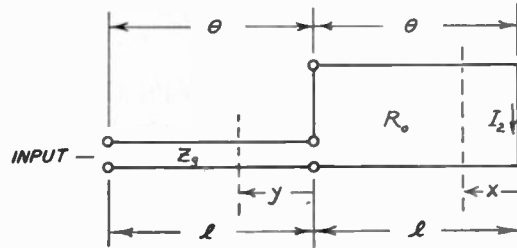

Fig. 5—Equivalent circuit for approximating the current and voltage distribution.

At the junction of the high-impedance with the low-impedance line sections, the current and voltage are

$$E_m = jR_0 I_2 \sin \theta \tag{10a}$$

$$I_m = I_2 \cos \theta \tag{10b}$$

and at any distance y from this junction into the low-impedance line, the current and voltage are

$$e_y = (jR_0 I_2 \sin \theta) \cos \frac{\theta}{l} y + jZ_0 (I_2 \cos \theta) \sin \frac{\theta y}{l} \tag{11a}$$

$$i_y = \frac{j}{Z_0} (jR_0 I_2 \sin \theta) \sin \frac{\theta}{l} y + (I_2 \cos \theta) \cos \frac{\theta y}{l} \tag{11b}$$

From (11b) the plunger input current is found to be

$$I_p = [\cos^2 \theta - 2m \sin^2 \theta] I_2 \tag{12}$$

Since $m \gg 1$, ordinarily, we shall use the approximation

$$I_2 \approx \frac{-I_p}{m(1 - \cos 2\theta)} \tag{12a}$$

If we now calculate the total power loss occurring over all surfaces in the plunger region, the power loss thus obtained when divided by I_p^2 will be equal to the component of plunger resistance arising from the surface losses. We shall first calculate the power loss in the coaxial cylindrical surfaces and then in the radial surfaces. In the following derivations, let

R_s = surface resistivity = $0.087/\sqrt{\lambda}$ for brass (λ in centimeters)

a = radius of inner coaxial conductor

b = radius of outer coaxial conductor

R_0 = characteristic impedance of main coaxial line

Z_0 = characteristic impedance of gap sections

$m = R_0/2Z_0$ = gap-impedance ratio

$\eta = 377$ ohms = intrinsic impedance.

Cylindrical Sections

Both surfaces of the outer gap section are assumed to have the same radius b , and both surfaces of the inner

section are assumed to have the same radius a . The total resistance per unit length for the low-impedance gaps is, therefore,

$$R = R_0 2 \left(\frac{1}{2\pi a} + \frac{1}{2\pi b} \right). \quad (13)$$

The power loss in the low-impedance sections is, therefore,

$$P_o = \int_0^l R i_v^2 dy \quad (14)$$

where i_v is given by (11b). Evaluating (14); using (12a); and dropping terms that are negligibly small for $m \gg 1$, one finds that

$$P_o \approx Rl \cdot \frac{\left[1 - \frac{\sin 2\theta}{2\theta} \right]}{[1 - \cos 2\theta]} \cdot I_p^2. \quad (15)$$

The total resistance per unit length of the high-impedance sections is also given by (13). Hence, the power loss is obtained from the current distribution given by (9b) and the integral

$$\begin{aligned} P_c &= \int_0^l R i_x^2 dx \\ &= \frac{R}{2} l \left[1 + \frac{\sin 2\theta}{2\theta} \right] \cdot I_2^2. \end{aligned} \quad (16)$$

Using equation (12a),

$$P_c \approx \frac{Rl}{2m^2} \frac{\left[1 + \frac{\sin 2\theta}{2\theta} \right]}{[1 - \cos 2\theta]^2} \cdot I_p^2.$$

Of the two losses, we see that P_c is smaller than P_o roughly by the factor $1/m^2$, and that most of the loss, therefore, occurs in the low-impedance line sections.

Radial Sections

There are five radial surfaces that also contribute to the power dissipation. These are shown in Fig. 6. The

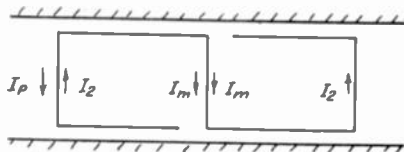

Fig. 6—Currents in radial surfaces.

resistance of a radial disk which short circuits a coaxial line having a characteristic impedance Z_0 is simply

$$\frac{Z_0}{\eta} \cdot R_s = \frac{R_0}{377} \cdot R_s. \quad (17)$$

Hence, the total power loss in the radial sections is

$$\begin{aligned} P_r &= (I_p^2 + 2I_2^2 + 2I_m^2) \frac{R_0}{377} \cdot R_s \\ &\approx \left[1 + \frac{(3 + \cos 2\theta)}{m^2(1 - \cos 2\theta)^2} \right] \frac{R_0}{377} \cdot R_s \cdot I_p^2. \end{aligned} \quad (18)$$

Here also we find that power loss across the front face of the plunger is roughly m^2 times greater than the power losses in the other (internal) radial segments forming the plunger.

Total Surface Power Loss

The total internal power loss is the sum of the component losses given by (15), (16), and (18). It is significant that for the practical case of $m \gg 1$, nearly all of the power loss occurs in the low-impedance gaps and across the face of the plunger. Both of these losses are substantially independent of the gap parameter m . In fact, if we assume that the conductors are brass, the total power loss may be approximated by

$$P_o + P_r \approx \frac{231 \times 10^{-6}}{\sqrt{\lambda}} R_0 \left[1 + 2\chi \cdot \frac{1 - \frac{\sin 2\theta}{2\theta}}{1 - \cos 2\theta} \right] I_p^2 \quad (19)$$

where the geometrical parameter χ is defined as

$$\chi = \frac{l}{\ln(b/a)} \left(\frac{1}{a} + \frac{1}{b} \right). \quad (20)$$

The component of the normalized plunger resistance due to the surface losses of the brass conductors is, therefore,

$$r_p \approx \frac{231 \times 10^{-6}}{\sqrt{\lambda}} \left[1 + 2\chi \cdot \frac{1 - \frac{\sin 2\theta}{2\theta}}{1 - \cos 2\theta} \right]. \quad (21)$$

Obviously, the surface losses for conductors other than brass may be obtained by direct proportion of the surface resistivities of the conductor.

TOTAL POWER ABSORPTION

We now have sufficient data to calculate the power-absorption coefficient of the plunger. The leakage resistance given by (8a) is added to the surface-loss resistance given by (21) to obtain the total plunger resistance. The plunger reactance is known from (6). These values when substituted into (3) give the power absorption coefficient σ .

Fig. 7 shows the power-absorption coefficient for a typical S plunger designed to operate from 7 to 14 centimeters in a $1\frac{3}{4}$ - by $1\frac{5}{16}$ -inch coaxial-line resonator. The length l of the plunger sections is 1.7 centimeters and the gap parameter m is 18.6. The operating range of this particular plunger corresponds to electrical length θ ranging from 45 to 90 degrees.

The data of Fig. 7 illustrate several important points. First, it is apparent that the lowest loss will occur when the electrical length θ is considerably less than 90 degrees. Hence, the minimum surface loss does not occur at $\theta=90$ degrees (where the leakage loss is the least) but, in the practical case, the minimum internal loss will occur at the long-wavelength limit of the tuning range. Except for the change due to variation in surface resistivity with frequency, the internal loss is nearly con-

stant for electrical lengths less than $\theta=90$ degrees. But for electrical lengths greater than $\theta=90$ degrees and approaching $\theta=180$ degrees, the internal loss rapidly increases because of internal resonance effects. This asymmetrical behavior of the internal loss characteristic is a very important consideration since it shows that, to

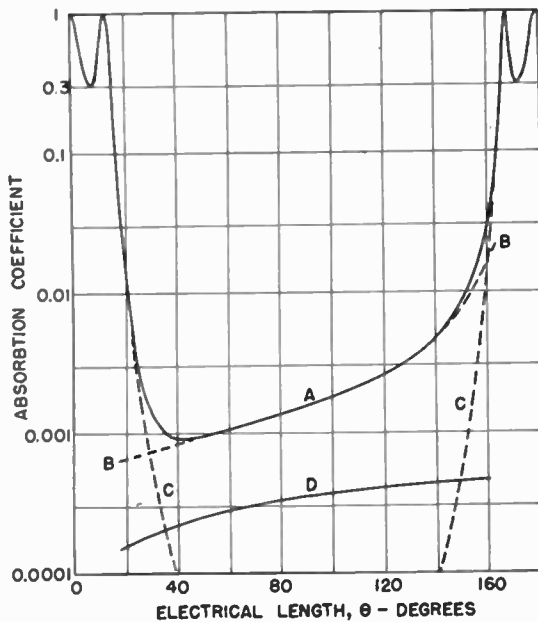

Fig. 7—Power-absorption coefficient for typical brass plunger. A, total loss; B, surface loss components; C, rear-cavity loss component; D, solid short circuit (shown for comparison).

obtain the least loss, the greater part of the working range of the plunger should correspond to electrical lengths less than $\theta=90$ degrees. To prevent excessive rear-cavity leakage at these short electrical lengths, however, requires a greater gap-impedance ratio m and the extremely small gap spacings thus needed may not be practical. Hence, the actual design must be a compromise between the maximum power absorption that may be tolerated and the minimum gap-spacing that may be maintained mechanically. The next section illustrates these design considerations.

DESIGN OF S-TYPE PLUNGER

The design of the S plunger is based upon the consideration that the electrical length should be as short as practical in order to reduce the internal power loss at the high-frequency end of the tuning range, and that throughout the tuning range the rear-cavity leakage loss must be less than the internal loss by some reasonable factor. The reason that the leakage loss as defined here must be made less than the internal loss is that resonance effects in the rear cavity may increase this loss by several times. In actual practice, where dissipative materials may be placed in the rear section of the coaxial line to reduce the Q of any resonance therein, an arbitrary safety margin of 10 to 1 has been found satisfactory. Therefore, we may empirically state that the gap-parameter m should be such as to reduce rear-cavity leakage resistance to 1/10 the value of the internal leak-

age resistance at the low-frequency end of the tuning range.

Inspection of Fig. 7 yields further design information of a rather empirical nature. A reasonable compromise between internal loss and gap spacing indicates that for a 2-to-1 tuning ratio, the design length l should be such that θ varies from 45 to 90 electrical degrees. For a 3-to-1 tuning ratio, the electrical length l should be chosen so that θ varies from 40 to 120 electrical degrees. The selection of a plunger length l still shorter than that recommended above would yield practically no decrease in internal loss and instead would increase enormously the difficulties in maintaining the mechanical tolerances required for proper operation. Hence, a 2-to-1 tuning ratio corresponding to 45 degrees $< \theta < 90$ degrees, and a 3-to-1 tuning ratio corresponding to 40 degrees $< \theta < 120$ degrees are taken arbitrarily as "optimum" design ranges.

For either a 2-to-1 or 3-to-1 tuning ratio, the internal component of the plunger resistance at the longest wavelength λ_l of the tuning range may be expressed approximately as⁵

$$r_{p,l} \approx \frac{231 \times 10^{-6}}{\sqrt{\lambda_l}} [1 + 0.72\chi]. \quad (22)$$

We shall now determine the value of m required to make the leakage resistance (as given by (8a)) equal to 1/10 or less of the internal resistance (as given by (22)). It is obvious from Fig. 7 that, if the leakage resistance is less than 1/10 of the internal resistance at the long-wavelength limit of the tuning range (i.e., at $\theta=40$ degrees or 45 degrees), the leakage resistance will be much less than that value over the remainder of the tuning range. Therefore, by substituting the appropriate value of θ in (8a) and equating to 1/10 of the value given by (22), one finds:

For a 2-to-1 tuning ratio, $l = \lambda_l/8$

$$m \approx 0.5 + 14.5 \left[\frac{1 + 0.72\chi}{\sqrt{\lambda_l}} \right]^{-1/4}. \quad (23)$$

For a 3-to-1 tuning ratio, $l = \lambda_l/9$

$$m \approx 0.71 + 17.32 \left[\frac{1 + 0.72\chi}{\sqrt{\lambda_l}} \right]^{-1/4}. \quad (24)$$

Fig. 8 shows (22), (23), and (24) in graphical form. This figure may be used to design an S-type plunger for minimum power absorption. An example of such a design will now be given.

EXAMPLE

Let us design a noncontacting plunger for use in a coaxial line having inner and outer diameters of 0.542 and 1¼ inches, respectively. The tuning range is to be from 4000 to 8000 megacycles (i.e., from 7.5 to 3.7 centimeters).

⁵ This is (21) evaluated for $\theta = 42.5$ degrees.

Since the tuning ratio is 2 to 1, we have, by (20), (22), and (23) or Fig. 8,

$$l = (7.5)/8 = 0.94 \text{ centimeter} = 0.366 \text{ inches.}$$

$$x = \left(\frac{0.366}{0.271} + \frac{0.366}{0.625} \right) / \ln \frac{0.625}{0.271} = 2.32.$$

$$\therefore m = 15.1.$$

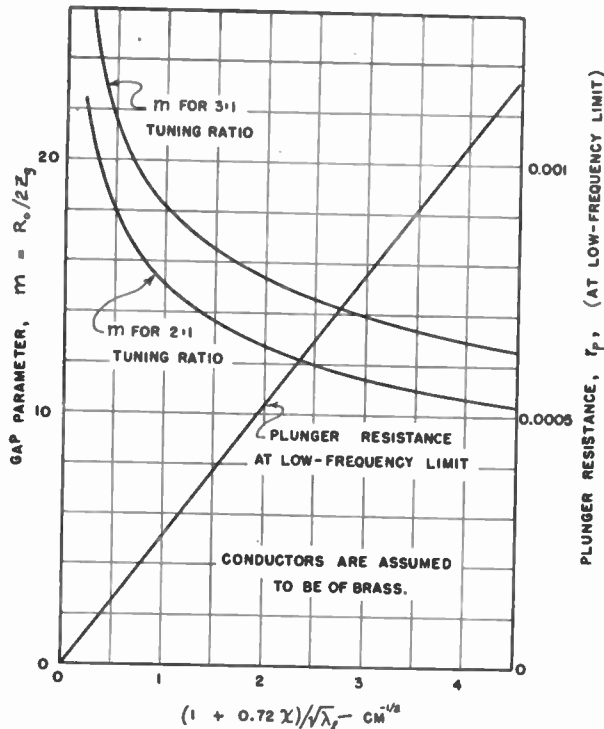

Fig. 8—"Optimum" design data.

The characteristic impedance of the coaxial line is

$$R_0 = 60 \ln \frac{b}{a} = 50 \text{ ohms.}$$

Hence, the gap characteristic impedances must not be greater than

$$Z_0 = \frac{R_0}{2m} = 1.66 \text{ ohms.}$$

For low-impedance gaps in which the gap spacing l is much smaller than the mean circumference c the characteristic impedance is approximated by $Z_0 = \eta l / c$. Hence, the gap spacings t_a and t_b between the plunger and inner and outer conductors are

$$t_a = \left(\frac{Z_0}{\eta} \right) \cdot 2\pi a = \frac{a}{2m} \ln(b/a) = 0.0075 \text{ inches.}$$

$$t_b = \frac{b}{2m} \ln(b/a) = 0.0173 \text{ inches.}$$

A scale drawing of the final plunger is shown in Fig. 9, where

$$l = 0.366 \text{ inch}$$

$$D_a = 2a + 2t_a = 0.577 \text{ inch}$$

$$D_b = 2b - 2t_b = 1.215 \text{ inches}$$

$$S = 5t_b = 0.087 \text{ inch.}$$

The dimension S is taken arbitrarily as 5 times the largest gap spacing. The plunger walls should be made as thin as mechanically practical. From either (22) or Fig. 8 the normalized minimum plunger-resistance value is found to be 0.00025.

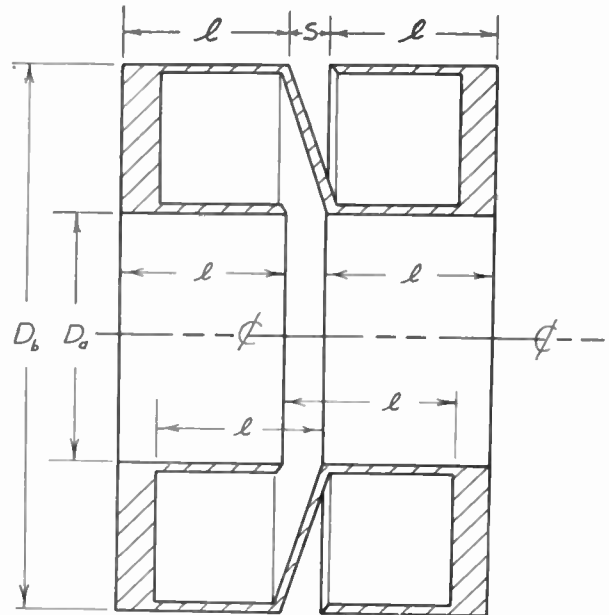

Fig. 9—Cross section of example plunger.

LARGE-GAP-SPACING DESIGN

In the event that the minimum plunger gap which may be used is restricted by other tolerances in the system, it may not be possible to obtain the value of m required for the optimum design. Since the rear-cavity leakage cannot then be reduced by using a large m value, it is necessary to achieve the necessary rear-cavity isolation by shifting the center of the operating range toward $\theta = 90$ degrees. In view of the fact that the rear-cavity leakage is ideally symmetrical about $\theta = 90$ degrees, the largest tuning range for a given rear-cavity leakage will be obtained when the center frequency corresponds to $\theta = 90$ degrees. Conversely, the greatest tuning range will be obtained with the smallest value of m under these conditions.

To illustrate, suppose in the example just considered that the smallest clearance that could safely be provided between the inner conductor and the plunger was 0.012 inch. In this event, the maximum possible value of the gap-impedance ratio m would be

$$m \approx \left(\frac{2a + t_a}{4t_a} \right) \ln(b/a) \approx 9.5. \quad (25)$$

For the optimum design previously considered, the minimum plunger resistance was found to be 0.00025.

Hence, satisfactory performance should be obtained in this present case if we can determine a minimum electrical length which will present for $m = 9.5$ a rear-cavity

$$l = \left(\frac{57}{360} \right) (7.5 \text{ centimeters}) = 1.19 \text{ centimeters} \\ = 0.467 \text{ inch.}$$

To provide an additional safety margin, the outer gap should be made as small as is mechanically convenient.

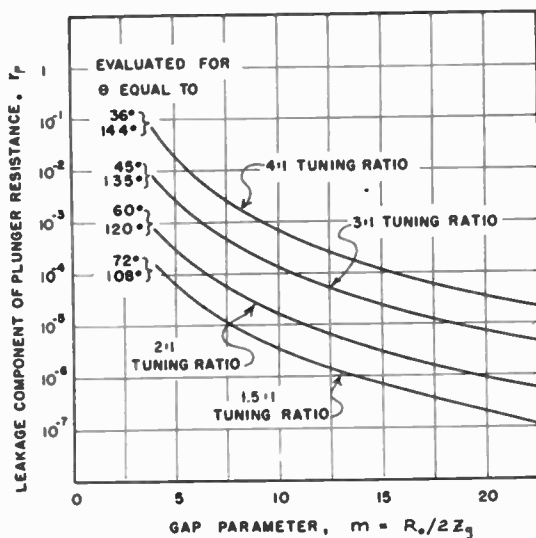

Fig. 10—Plunger leakage as a function of gap spacing.

loss of 0.000025 (i.e., $10^{-4.6}$) or less. Referring to Fig. 10, we find by interpolation that, with $m = 9.5$, the leakage loss will equal $10^{-4.6}$ when $\theta = 57$ degrees. Therefore, the 4000-to 8000-megacycle tuning range will correspond to a variation in θ from 57 to 114 degrees, and the length of the plunger sections should be

We have shown that the power loss in the plunger is of fundamental importance in determining the tuning range and have derived equations showing how this power loss is related to the physical shape of the plunger. By using these relations in an inverse manner we have derived formulas and plotted curves by means of which a plunger may be designed to operate over a given frequency range.

A word of caution must be interpolated at this point. Although the analysis as presented thus far applies quite properly to the principal wave in the coaxial line, we have said nothing about the plunger behavior to higher-order TE waves. As a matter of fact, we shall see in Part II of this paper that parasitic resonances can occur at wavelengths corresponding to submultiples of the circumferences of both the inner and outer gaps. However, as shown in Part III, these parasitic resonances may be suppressed by supplementary slots, and the design of the plunger for proper behavior to the principal mode is not changed. The design procedure described above is still that employed to obtain the major dimensions of the plunger and is in no way affected appreciably by subsequent parts of this paper.

CONCLUSION

Velocity-Modulated Reflex Oscillator*

J. M. LAFFERTY†, MEMBER, I.R.E.

Summary—A mathematical analysis of the mechanism utilized by the microwave reflex oscillator in producing high-frequency oscillations from a direct-current beam of electrons is presented. A simplified small-signal theory is postulated in which the electrodes are assumed to be ideal parallel planes and the electron motion is rectilinear, uninfluenced by space charge. The finite transit time of the electrons in traversing the modulator gap is taken into consideration.

From this theory are derived expressions for the velocity modulation and the resultant current-density modulation of the beam by action of a retarding field. An equation is derived for the fundamental-frequency component of the current induced in the tank circuit. The necessary conditions for the self-starting of oscillations are deter-

mined, and the minimum starting current is given as a function of the tank-circuit characteristics and the optimum transit-angle values. Equations are derived for the rate of change of oscillating frequency with reflector voltage and beam voltage. To determine the amount of electronic tuning possible, calculations are made of the range over which the reflector voltage can be varied for a particular mode and oscillations maintained. An efficiency curve is given for the conversion of beam-current power to high-frequency power, and optimum efficiencies are calculated for conditions in which the amplitude of oscillation is small. Efficiency curves are also presented for the case of large amplitudes when the transit angle of the modulator gap is negligibly small.

INTRODUCTION

OF ALL THE velocity-modulation oscillators, none has become more popular than the single-gap reflex type. This low-power oscillator has found wide application as a local oscillator in superheterodyne

radar receivers, and as a power source for experimental bench work. The reflex oscillator has many advantages where frequent tuning is required. Since there is only one cavity resonator the tube structure is greatly simplified, and the problem of making multiple resonators track over an appreciable frequency range is avoided. Frequency changes of as much as 15 per cent produced by changing the resonator gap length are not uncommon in present reflex-oscillator tubes. Small, rapid changes

* Decimal classification: R355.912.3. Original manuscript received by the Institute, April 24, 1946; revised manuscript received, July 29, 1946.

† General Electric Company, Schenectady, New York.

in frequency can be easily produced by varying the reflector voltage. Since the reflector is usually operated so that it draws no current, automatic-frequency-control circuits may be easily adapted to the oscillator.

Despite the importance of these tubes, the literature published on the subject has not been very abundant.¹⁻⁶ A complete analysis of the reflex oscillator would, of course, be extremely complicated and, in general, cannot be rigorously carried out. However, by postulating certain idealized conditions it is possible to determine results which are of great help in understanding the basic principles of operation. It is with this purpose in mind that the following material is presented.

Operation of reflex oscillators with the reflector at zero or positive voltages will not be discussed here. A theoretical discussion of the Hahn-Metcalf reflex oscillator⁴ with the reflector operated at zero voltage has appeared in the literature.⁵ A discussion of reflex-oscillator operation with a positive voltage on the reflector has been given in a paper by Wang.⁶

It will be assumed that the reader has an understanding of the operating principles of the reflex oscillator, and so a description of its operation will not be given here.

Certain simplifying assumptions are made in the analytical discussion which follows. The motion of the electrons is assumed to be rectilinear and expressed by means of the single space co-ordinate z which is at right angles to the electrode system. The modulating electrodes are assumed to be ideal parallel-plane grids with a uniform radio-frequency field between them. Sideway deflections or interception of the electrons by the grid wires are disregarded. Space charge is assumed to have no influence on the electron motion, and the initial velocity of the electrons at the cathode is taken equal to zero. Other assumptions are discussed in the text.

VELOCITY MODULATION OF THE ELECTRON BEAM

A simplified schematic diagram of the electrode arrangement in a reflex oscillator is shown in Fig. 1. A plane-retarding electrode reflector is placed parallel to, and at a distance S from, a parallel-plane-grid modulator. The modulator is at potential V_0 with respect to the cathode, and a negative potential V_c is applied to the reflector. These potentials are assumed to produce a retarding uniform field $E = (V_0 - V_c)/S$ in the intervening space. The modulator grids are separated by a distance d between which a high-frequency field $V/d \sin(\omega t + \alpha/2)$ is assumed to exist. An electron

current I_0 which is uniform with time enters the modulator with a velocity v_0 corresponding to the potential V_0 . The transit angle of the modulator in the absence of the radio-frequency field is then given by the following expression:

$$\alpha = \pi c \sqrt{2m/e} \left(\frac{d}{\lambda} \right) \frac{1}{\sqrt{V_0}} = 3179 \left(\frac{d}{\lambda} \right) \frac{1}{\sqrt{V_0}} \quad (1)$$

where V_0 is expressed in volts, and d and λ in the same units.

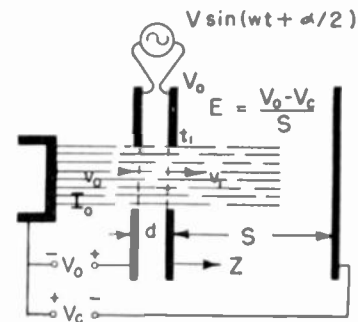

Fig. 1—Schematic diagram of modulator system with retarding field.

By applying Newton's Law and making the assumption that all the electrons cross the radio-frequency gap with the constant transit angle α , it is possible to show that the electrons will leave the modulator and enter the retarding field with a modulated velocity

$$v = v_0(1 + \delta \sin \omega t) \quad (2)$$

where

$$\delta = MK/2, \quad (3)$$

$$K = V/V_0, \quad (4)$$

and

$$M = \frac{\sin \alpha/2}{\alpha/2}. \quad (5)$$

δ is the depth of modulation, K the ratio of the peak radio-frequency voltage across the gap (i.e., the maximum instantaneous line integral of the electric field across the gap) to the direct-current beam voltage, and M the gap coefficient. It can be seen from (2) that the velocity modulation of the electrons leaving the gap lags in phase behind the modulating voltage by one-half the gap-transit angle. The assumption that all the electrons cross the gap with a constant transit angle may be realized by making α large or by making K small.

If α is practically zero, the final velocity of an electron leaving the gap at time t is, from quasi-static considerations, given by the energy relation $mv^2/2 = e(V_0 + V \sin \omega t)$, which yields

$$v = v_0 \sqrt{1 + K \sin \omega t}. \quad (6)$$

The binomial expansion of this gives

$$v = v_0 \left(1 + \frac{K}{2} \sin \omega t - \frac{K^2}{8} \sin^2 \omega t + \dots \right). \quad (6a)$$

¹ A. E. Harrison, "Kinematics of reflection oscillators," *Jour. Appl. Phys.*, vol. 15, pp. 709-711; October, 1944.

² J. R. Pierce, "Reflex oscillators," *Proc. I.R.E.*, vol. 33, pp. 112-118; February, 1945.

³ E. L. Ginzton and A. E. Harrison, "Reflex-klystron oscillators," *Proc. I.R.E.*, vol. 34, pp. 97-113; March, 1946.

⁴ W. C. Hahn and G. F. Metcalf, "Velocity modulation tubes," *Proc. I.R.E.*, vol. 27, pp. 106-116; February, 1939.

⁵ H. E. Hollman and A. Thoma, "On the theory of drift tubes," *Hochfrequenz. und Elektroakustik*, vol. 56, pp. 181-186; December, 1940.

⁶ C. C. Wang, "Reflex oscillators utilizing secondary emission current," *Phys. Rev.*, vol. 68, p. 284; December, 1945.

The first two terms of this expansion are identical with (2) for $\alpha=0$. Equation (2) may be considered to apply for all values of α when K is small and for all values of $K < 1$ when α is very large. Equation (6) is valid for all values of $K < 1$ when α is very small.

CONVERSION OF THE VELOCITY-MODULATED ELECTRON BEAM TO A CURRENT-DENSITY-MODULATED BEAM BY THE RETARDING FIELD

The electrons which leave the modulator and enter into the retarding field at time t_1 are, in accordance with (2), given a velocity $v_1 = v_0(1 + \delta \sin \omega t_1)$. Since these electrons have a uniform decelerated motion in the retarding-field space, their position at any time t is given by the familiar expression

$$z = v_1(t - t_1) - \frac{eE}{2m}(t - t_1)^2 \quad (7)$$

where $-eE/m$ is the deceleration. It is assumed that the reflector is sufficiently negative to turn back all the electrons which enter the retarding field.

The time τ for the electrons to make a complete round trip in the retarding field is obtained by letting $z=0$ in (7):

$$\tau = v_1 \frac{2m}{eE} \quad (8)$$

Writing in the value of v_1 , the results may be expressed as

$$\tau\omega = \beta(1 + \delta \sin \omega t_1) \quad (9)$$

where

$$\beta = \frac{2\omega m}{eE} v_0 = 12,716 \left(\frac{S}{\lambda} \right) \frac{\sqrt{V_0}}{V_0 - V_c} \quad (10)$$

β is the retarding-field transit angle of the electrons in the absence of the high-frequency modulating voltage. In (10) the potentials are expressed in volts, and S and λ in the same units.

It is assumed that the transit time of the electrons in crossing the modulator is short enough so that no appreciable bunching of the electrons takes place in this region. Thus the current leaving the modulator is a constant I_0 , independent of time. Electrons leaving the modulator at time t_1 will cross a plane $z=b$ in the retarding field at time t . Electrons leaving the modulator at a later time $(t_1 + dt_1)$ will cross this same plane at a later time $(t + dt)$. The quantity of charge leaving the modulator between the time t_1 and $(t_1 + dt_1)$ is $I_0 dt_1$. This same charge flowing across the plane $z=b$ in the time interval dt corresponds to a current I_b ; thus $I_0 dt_1 = I_b dt$, or

$$I_b = I_0 \left(\frac{dt_1}{dt} \right)_{z=b} \quad (11)$$

The value of this derivative is obtained by differentiation of the equation of motion (7). In general, it will be a double-valued function at any plane $z=b$; one value applying to the electrons traveling into the retarding field, and the other value to the returning electrons.

Both of these functions must be included in computing the total net-current flow across the plane. At the starting plane $z=0$, only the returning electrons contribute to the alternating component of the current density.

In the reflex oscillator the modulator plays the double role of both buncher and catcher. The current-density modulation of the returning beam has a nonsinusoidal wave form and, when it passes back through the modulator, harmonic components of current are induced to flow through the modulator tank circuit in addition to the fundamental component. However, since the impedance of the tank circuit is very low at all harmonic frequencies, the flow of harmonic currents produces very small voltage drops, and the power delivered to the load is small. At the fundamental modulating frequency the tank impedance is very high, and the fundamental-current component produces a large voltage drop across it, giving rise to appreciable power output. Thus, in determining the power output only the fundamental-frequency component of the conduction current is of importance. This is found by writing the fundamental-frequency terms of the Fourier series corresponding to the current function given by (11) in the interval 0 to 2π :

$$I_b = I_{rb} \sin \omega t + I_{zb} \cos \omega t \quad (12)$$

where

$$I_{rb} = \frac{1}{\pi} \int_0^{2\pi} I_0 \left(\frac{dt_1}{dt} \right)_{z=0} \sin \omega t d\omega t \quad (13)$$

and

$$I_{zb} = \frac{I}{\pi} \int_0^{2\pi} I_0 \left(\frac{dt_1}{dt} \right)_{z=0} \cos \omega t d\omega t. \quad (14)$$

These integrals may be simplified by the elimination of t . Electrons which return to the modulator (plane $z=0$) at time t left the modulator at an earlier time $t_1 = t - \tau$ where τ is given by (9). On substituting t_1 for t the limits remain the same, and the above integrals become

$$I_{rb} = \frac{I_0}{\pi} \int_0^{2\pi} \sin [\omega t_1 + \beta(1 + \delta \sin \omega t_1)] d\omega t_1 \quad (15)$$

and

$$I_{zb} = \frac{I_0}{\pi} \int_0^{2\pi} \cos [\omega t_1 + \beta(1 + \delta \sin \omega t_1)] d\omega t_1. \quad (16)$$

On performing these integrations the results are

$$I_{rb} = -2I_0 J_1(\beta\delta) \sin \beta \quad (17)$$

and

$$I_{zb} = -2I_0 J_1(\beta\delta) \cos \beta \quad (18)$$

where $J_1(\beta\delta)$ is a Bessel function of the first kind. The vector sum of these two currents (see Fig. 2) gives the total fundamental-frequency component of the conduction current:

$$I_b = 2I_0 J_1(\beta\delta) \sin(\omega t - \beta - \pi/2). \quad (19)$$

This current lags in phase behind the velocity modulation of the beam by $(\beta + \pi/2)$ radians. The electrons returning from the retarding field tend to bunch around

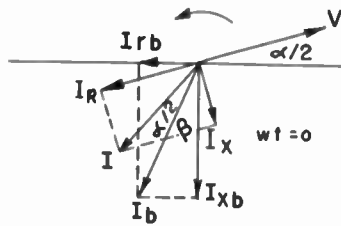

Fig. 2—Phase relations of the modulator voltage and various currents.

those electrons which emerged from the modulator when the alternating-current component of the velocity was changing from positive to negative, one quarter cycle after the velocity modulation passed through its maximum. Since the clustering of the electrons corresponds to a current maximum, the current lags 90 degrees in phase behind the velocity modulation in addition to the time β taken for the electrons to travel into the retarding space and back.

INDUCED CURRENT FLOW IN THE TANK CIRCUIT

The electron beam has been velocity modulated and directed into a retarding field from which it returns current-density modulated. The fundamental-frequency component of the current in the returning beam has been calculated (19). In traveling back across the gap again, this varying space-charge density induces a current flow in the tank circuit attached to the modulating grids. There now remains the problem of computing the magnitude and phase of the fundamental-frequency component of this induced current.

If it is assumed that a beam of electrons having a current-density modulation of the form $I_0 \sin \omega t$ passes across a radio-frequency gap with a constant velocity (as would be realized if the radio-frequency gap voltage is small compared to the beam voltage), the current induced in the circuit attached to the gap is $I_0 M \sin(\omega t - \alpha/2)$. The current is reduced in amplitude by the factor M and retarded in phase by the angle $\alpha/2$.

Applying these results to the fundamental-frequency component of the electron conduction current (19) passing back through the gap, the induced electric current becomes

$$I = 2I_0 M J_1(\beta\delta) \sin(\omega t - \beta - \alpha/2 - \pi/2). \quad (20)$$

This is shown in Fig. 2. Comparing this expression with the modulating voltage $V \sin(\omega t + \alpha/2)$, it is seen that the induced current lags in phase by the angle

$$\phi = \alpha + \beta + \pi/2. \quad (21)$$

The induced current may be resolved into an active component I_R and a reactive component I_x , as shown in Fig. 2:

$$I_R = -2I_0 M J_1(\beta\delta) \sin(\alpha + \beta), \quad (22)$$

$$I_x = -2I_0 M J_1(\beta\delta) \cos(\alpha + \beta). \quad (23)$$

The electron beam which induces the current flow I in the tank circuit may be replaced by an equivalent generator, shown in Fig. 3, with an admittance $Y_e = -I/V$. Hence,

$$Y_e = \frac{1}{R_e} + \frac{1}{jX_e} = -\frac{I_R}{V} - j\frac{I_x}{V}.$$

Substituting (22) and (23) and equating the real and imaginary parts give the electronic conductance g_e and susceptance B_e of the equivalent generator circuit:

$$g_e = \frac{1}{R_e} = \frac{I_0}{V_0} \frac{M^2}{\delta} J_1(\beta\delta) \sin(\alpha + \beta), \quad (24)$$

$$B_e = \frac{-1}{X_e} = \frac{I_0}{V_0} \frac{M^2}{\delta} J_1(\beta\delta) \cos(\alpha + \beta). \quad (25)$$

$$\frac{1}{R_e} = \frac{I_0}{V_0} \frac{M^2}{\delta} J_1(\beta\delta) \sin(\alpha + \beta)$$

$$\frac{1}{X_e} = -\frac{I_0}{V_0} \frac{M^2}{\delta} J_1(\beta\delta) \cos(\alpha + \beta)$$

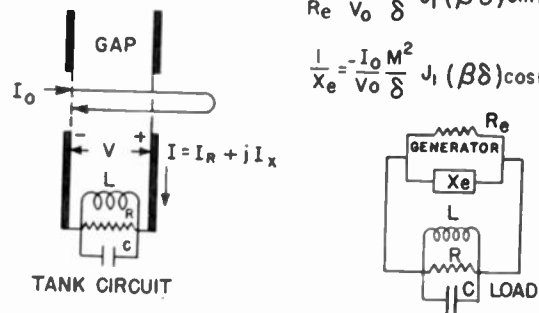

Fig. 3—Equivalent circuit for a reflex oscillator.

Under steady oscillating conditions the admittance of the equivalent circuit is zero, so that, with the equivalent load circuit⁷ shown,

$$g = \frac{1}{R} = -g_e \quad (26)$$

and

$$B = \omega C - 1/\omega L = -B_e. \quad (27)$$

CONDITION FOR SELF-STARTING OSCILLATIONS; MINIMUM STARTING CURRENT

The radio-frequency power transferred to the tank circuit and its associated load by the electron beam can be derived from (22):

$$P = V^2/2R = I_R V/2 = -2V_0 I_0 \delta J_1(\beta\delta) \sin(\alpha + \beta). \quad (28)$$

Since $V_0 I_0$ is the direct-current power input to the beam, it follows that the electronic efficiency in converting this power to radio-frequency power is

$$\eta = -2\delta J_1(\beta\delta) \sin(\alpha + \beta). \quad (29)$$

The only conditions under which the tube can oscillate are those in which η is positive. Further, if the oscillations are to be self-starting, η must remain positive as they build up from zero amplitude. Since β is always positive, $\delta J_1(\beta\delta)$ will be positive for all values of V from zero up to the point where $V = 7.66 V_0 / \beta M$, i.e., where

⁷ The load and tank-circuit losses are assumed to be lumped together in the single shunt resistance R .

$\beta\delta = 3.83$, the first root of J_1 . Hence, for the oscillator to be self-starting, $\sin(\alpha + \beta)$ must always be negative. A plot of the power $P_e = -2V_0I_0\delta J_1(\beta\delta) \sin(\alpha + \beta)$ supplied by the electron beam as a function of the modulator voltage for the case where $-\sin(\alpha + \beta) > 0$ is shown in Fig. 4. The power $P = V^2/2R$ dissipated in the load is also plotted as a function of V for three different values of R . Under steady oscillating conditions, according to (28), V will adjust itself so that the power supplied by the electron beam is just equal to the power dissipated in the load. Thus, the operating point is given by the intersection of the two curves P and P_e . It is obvious from Fig. 4 that, for a given set of beam conditions, the power output is dependent upon the value of

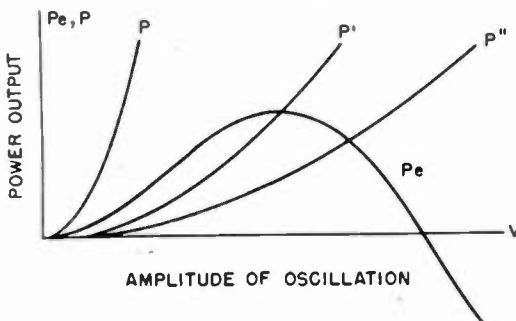

Fig. 4—Power output as a function of oscillation amplitude.

R . In fact, if R is so small that P always lies above P_e , the power output is zero and oscillations cannot start, since the curves intersect only at the origin. If R is large enough so that P lies below P_e for small values of V , as shown for example by P' and P'' , oscillations will start, because any slight current fluctuation which induces a voltage across the gap will velocity modulate the beam. This produces a current-density modulation of the returning beam which in turn induces an increased current flow in the tank circuit giving rise to a larger modulating voltage. This cycle of events repeats until the oscillations build up to the operating point. Mathematically, the condition for self-starting may be expressed as

$$V^2/2R < -2V_0I_0\delta J_1(\beta\delta) \sin(\alpha + \beta)$$

or

$$1/R < -\frac{I_0}{V_0} \frac{M^2}{\delta} J_1(\beta\delta) \sin(\alpha + \beta)$$

where δ is very small. The expansion of $J_1(\beta\delta)$ in a power series gives $\beta\delta/2$ for the first term. This substitution yields

$$1/R < -\frac{I_0}{V_0} \frac{M^2}{2} \beta \sin(\alpha + \beta). \quad (30)$$

Expressing M in terms of V_0 and α gives

$$1/R < -1.98 \times 10^{-7} \frac{I_0}{(d/\lambda)^2} \beta \sin^2(\alpha/2) \sin(\alpha + \beta) \quad (30a)$$

where I_0 is expressed in amperes, R in ohms, and d and λ in the same units. The right-hand member of these expressions gives the magnitude of the electronic start-

ing conductance. If it is greater than the conductance of the tank circuit, oscillations will start. These oscillations then build up to the point where the magnitude of the electronic conductance is reduced to a value just equal to the tank-circuit conductance. From (24) and the expression in (30) it is seen that the ratio of the beam conductance for an oscillation amplitude V to the starting conductance is $g_e/g_{e0} = 2J_1(\beta\delta)/\beta\delta$. A plot of this equation shows that beam conductance is a maximum as the oscillation amplitude approaches zero.²

From (30a) it can be seen that for a given geometry and set of operating voltages there is a minimum beam current, called the starting current I_s , below which oscillations cannot start. I_s is given by using an equality sign in (30a) and solving for I_0 :

$$I_s = \frac{5.05 \times 10^6}{-\beta \sin^2(\alpha/2) \sin(\alpha + \beta)} \left[\frac{(d/\lambda)^2}{R} \right]. \quad (31)$$

The expression in the brackets depends only on the modulator gap and connecting tank circuit. For a given tube, α and β depend upon the applied direct-current voltages.

On maximizing $-\beta \sin^2(\alpha/2) \sin(\alpha + \beta)$ with respect to α and β , the minimum starting-current conditions are found to be $\beta(3 - \beta^2)/(3\beta^2 - 1) = \tan \beta$ and $\beta = \tan \alpha/2$. The optimum values of α and β obtained from these relations are as follows:

α	β	$-\sin^2(\alpha/2) \sin(\alpha + \beta)$
2.42 + 2 πm	2.66	0.816
2.90	8.21	0.980
3.00	14.34	0.993
3.04	20.57	0.996
3.07	26.82	0.998
3.08	33.08	0.999
3.09	39.35	0.999.

For large β , α and β approach the optimum values

$$\left. \begin{aligned} \alpha + \beta &= 2\pi(n + 3/4) \\ \alpha &= 2\pi(m + 1/2) \\ \beta &= 2\pi(p + 1/4) \end{aligned} \right\} \quad (33)$$

where m , n , and p are integers. Introducing the values of α and β given by (33) in (31) gives

$$I_{ms} = 8.04 \times 10^5 \frac{(d/\lambda)^2}{R} \frac{1}{p + 1/4} \quad (34)$$

for the minimum starting current.

ELECTRONIC TUNING AND FREQUENCY STABILITY

The operating frequency of the reflex oscillator is determined by the condition expressed in (27). Multiplying this equation through by $\sin(\alpha + \beta)$ and introducing (25) and (24) gives the resonance condition:

$$\omega C - 1/\omega L = g \cot(\alpha + \beta). \quad (35)$$

Let $\omega_0 = 1/\sqrt{LC}$ be the resonant frequency of the tank circuit and $\omega_0 C/g$ the Q . Making these substitutions in (35) and solving for ω gives

$$\omega/\omega_0 = \frac{1}{2Q} [\cot(\alpha + \beta) + \sqrt{\cot^2(\alpha + \beta) + 4Q^2}]. \quad (36)$$

If Q is large compared to $\cot(\alpha + \beta)$, then

$$\omega/\omega_0 \approx \frac{\cot(\alpha + \beta)}{2Q} + 1, \quad (37)$$

or if $\Delta\omega = \omega - \omega_0$, then

$$\Delta\omega/\omega_0 \approx \frac{\cot(\alpha + \beta)}{2Q}. \quad (38)$$

For the operating conditions given by (33) in which $\alpha + \beta = 2\pi(n + 3/4)$, the power output is nearly maximum and $\Delta\omega = 0$; that is, the oscillator operates at the tank-circuit frequency ω_0 . If $(\alpha + \beta)$ is displaced from $2\pi(n + 3/4)$ by an amount $\Delta(\alpha + \beta)$, the frequency change will be

$$\Delta\omega/\omega_0 = -\frac{\tan \Delta(\alpha + \beta)}{2Q}. \quad (39)$$

For infinitesimal changes, differentiation of (35) at ω_0 where $\alpha + \beta = 2\pi(n + 3/4)$ gives

$$\frac{d\omega}{\omega_0} = \frac{-d\alpha - d\beta}{2Q}. \quad (40)$$

Since α and β are functions of the beam voltage and reflector voltage, any variation in these voltages will be accompanied by a corresponding change in the oscillating frequency. Electronic tuning by variation of the reflector voltage is particularly desirable, since the reflector draws no current.

The range over which β may be varied, by changing the reflector voltage and oscillations maintained, can be formally calculated by solving (26) for β as δ approaches zero. These calculations have been made graphically for six operating modes, and the width of the oscillating range $\Delta\beta$ for each mode is plotted as a function of $(d/\lambda)^2/R I_0$ in Fig. 5. It is seen that a large electronic tuning range is favored by a large beam current. Fig. 5 also shows that if all parameters are held constant and only the reflector voltage is varied, the tuning range is greater for the higher-order modes.

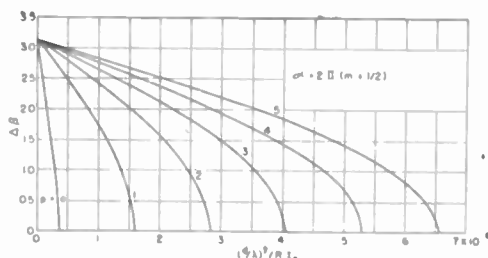

Fig. 5—Width of oscillating range for several modes of operation.

The rates of change of α and β with beam and reflector voltages are found by substitution of the partial derivatives obtained from (1) and (10) in the expressions $d\alpha = (\partial\alpha/\partial\omega)d\omega + (\partial\alpha/\partial V_0)dV_0$ and $d\beta = (\partial\beta/\partial\omega)d\omega + (\partial\beta/\partial V_0)dV_0 + (\partial\beta/\partial V_c)dV_c$, thus giving

$$d\alpha = \alpha \left[\frac{d\omega}{\omega_0} - \frac{dV_0}{2V_0} \right], \quad (41)$$

and

$$d\beta = \beta \left[\frac{d\omega}{\omega_0} + \frac{1 + V_0/V_c}{1 - V_0/V_c} \frac{dV_0}{2V_0} - \frac{1}{1 - V_0/V_c} \frac{dV_c}{V_c} \right]. \quad (42)$$

Substitution of these expressions in (40) yields:

$$\frac{d\omega}{\omega_0} = \frac{\left[\alpha - \beta \frac{1 + V_0/V_c}{1 - V_0/V_c} \right] \frac{dV_0}{2V_0} + \frac{\beta}{1 - V_0/V_c} \frac{dV_c}{V_c}}{2Q + (\alpha + \beta)}. \quad (43)$$

If Q is assumed large compared to $\alpha + \beta$, then the rate of change of frequency with beam voltage is

$$\frac{d\omega}{dV_0} \approx \frac{\omega_0}{V_0} \frac{1}{4Q} \left[\alpha - \beta \frac{1 + V_0/V_c}{1 - V_0/V_c} \right], \quad (44)$$

and with reflector voltage,

$$\frac{d\omega}{dV_c} \approx \frac{\omega_0}{V_c} \frac{1}{2Q} \frac{\beta}{1 - V_0/V_c}. \quad (45)$$

where $\alpha + \beta = 2\pi(n + 3/4)$. The rate of change of frequency with reflector voltage thus increases with loading, but from Fig. 5 it is seen that the range over which $\Delta\beta$, and hence the reflector voltages, can be varied and oscillations maintained, decreases with increased load. These two effects are opposing ones, making the total electronic tuning range less dependent on loading.

MAXIMUM POWER OUTPUT AND EFFICIENCY

It is obvious from Fig. 4 that there is an optimum value of oscillation amplitude V at which the electron beam delivers maximum power to the tank circuit. The oscillator may be made to operate at this optimum voltage if the shunt resistance of the tank circuit is chosen so that it dissipates this maximum power at the optimum voltage. This condition corresponds to curve P' in Fig. 4.

Differentiating (28) with respect to δ and setting the results equal to zero gives, as the condition for optimum V ,

$$J_0(\beta\delta) = 0, \quad (46)$$

i.e.,

$$V = 4.81V_0/\beta M. \quad (47)$$

Introducing this condition in (28) gives the maximum power output:

$$P_m = -2.50V_0I_0 \frac{\sin(\alpha + \beta)}{\beta}, \quad (48)$$

with an efficiency of

$$\eta_m = -2.50 \frac{\sin(\alpha + \beta)}{\beta}. \quad (49)$$

To obtain this optimum efficiency, the shunt conductance of the tank circuit must be

$$1/R = -0.216 \frac{I_0}{V_0} M^2 \beta \sin(\alpha + \beta). \quad (50)$$

This is obtained by substituting (47) in (24). Comparison of (50) with (31) shows that the values of α and β which make the starting current a minimum are identical with those which make the required shunt resistance a minimum under the optimum oscillating-amplitude

condition. The ratio of the electronic conductance at optimum oscillating amplitude to the starting conductance is 0.432.

An examination of (47) through (50) shows that, if the beam voltage and current are held constant and the gap spacing is increased so that α increases, for example, from π to 3π , the power output and efficiency remain constant. However, the oscillation amplitude will be increased by a factor of three, the tank-circuit current will be reduced to one-third, and the required shunt resistance of the tank circuit will be increased by a factor of nine.

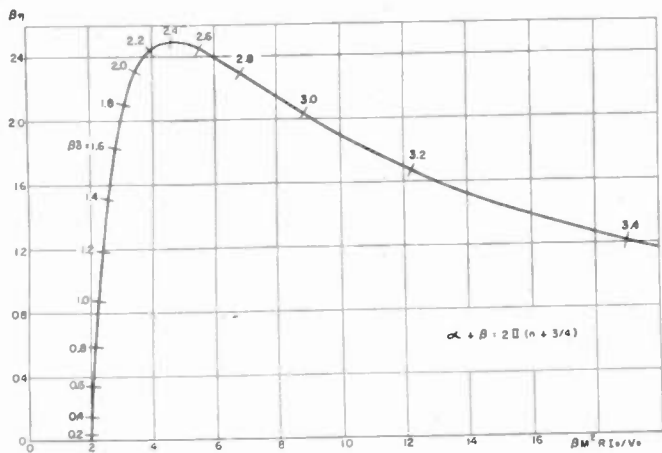

Fig. 6—Conversion-efficiency characteristic curve.

An indication of the reflex-oscillator performance under more general conditions may be obtained by eliminating the oscillation amplitude term from (28). Multiplying (28) through by $-\beta/I_0 V_0 \sin(\alpha + \beta)$ gives

$$\frac{\beta \eta}{-\sin(\alpha + \beta)} = 2\beta \delta J_1(\beta \delta). \tag{51}$$

By expressing V^2 as $4^2 V_0^2 / M^2$ in (28), the following equation may also be obtained:

$$\frac{-\beta M^2 R I_0 \sin(\alpha + \beta)}{V_0} = \frac{\beta \delta}{J_1(\beta \delta)}. \tag{52}$$

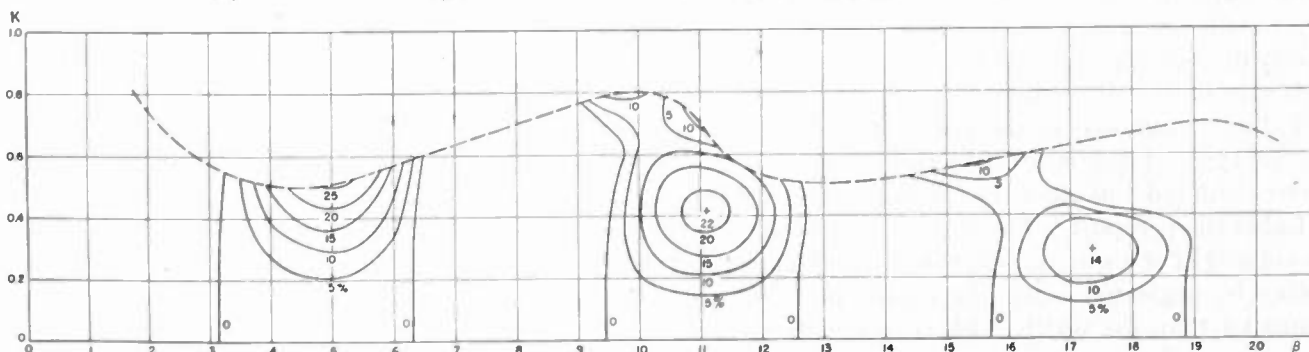

Fig. 7—Contour map of η as a function of K and β .

By plotting the left-hand members of these last two equations, one against the other, for corresponding values of $\beta \delta$, the curve shown in Fig. 6 is obtained.⁸ For simplicity in writing in the co-ordinates for this curve, $-\sin(\alpha + \beta)$ was taken equal to one; however, this restriction is not necessary, and the sine term may be included according to (51) and (52).

⁸ A similar curve is given by A. E. Harrison, "Klystron Technical Manual," Sperry Gyroscope Co., Inc., Brooklyn, N. Y., 1944, p. 39.

Equations (48), (49), and (50) may not be expected to hold accurately for small values of β , because, according to (47), under these conditions the oscillation amplitude is quite large. Similarly, Fig. 6 will not hold for large values of δ . However, the efficiency may be investigated quite easily in the region of large K values for the case in which $\alpha = 0$. Use of (6) in (8) leads to the following value of (13):

$$I_{rb} = \frac{2I_0}{\pi} \phi(\beta, K) \tag{53}$$

where

$$\phi(\beta, K) = \int_{\pi/2}^{3\pi/2} \sin \omega t_1 \cos(\beta \sqrt{1 + K \sin \omega t_1}) d\omega t_1. \tag{54}$$

Since for $\alpha = 0$ the induced current is equal to the fundamental-frequency component of the conduction current, the power output is

$$P = \frac{I_{rb} V}{2} = V_0 I_0 \frac{K}{\pi} \phi(\beta, K) \tag{55}$$

with an efficiency

$$\eta = \frac{K}{\pi} \phi(\beta, K). \tag{56}$$

In order for (56) to be valid, at no time during the radio-frequency cycle may the radio-frequency voltage be so large as to reverse the direction of the electron flow in the process of crossing the gap, i.e., there must be no piling up of electrons. There is, therefore, an upper limit for the value of K which is, in general, less than one. The final velocity v of an electron entering the gap at time t and returning through the gap is found from the following energy relation:

$$1/2 m v^2 = e[V_0 + V \sin \omega t - V \sin \omega(t + \tau)]$$

where τ is the time spent by the electron in the retarding space. From (6) and (8), $\omega \tau$ is found to be $\beta \sqrt{1 + K \sin \omega t}$. Making this substitution and letting $\omega t = \theta$, the final velocity is found to be

$$v = v_0 \{1 - K[\sin(\theta + \beta \sqrt{1 + K \sin \theta}) - \sin \theta]\}^{1/2}. \tag{57}$$

At any time θ during the cycle, K must not be so large as to permit the velocity to become imaginary. The limiting value of K is found by setting (57) equal to zero and solving for K at the most adverse time during the cycle. This has been done by a graphical method and is plotted as a dotted line on the contour map of η in Fig. 7. The efficiencies were calculated by graphical integration of (56). This work was done on the General Electric differential analyzer.

Design of Simple Broad-Band Wave-Guide-to-Coaxial-Line Junctions*

SEYMOUR B. COHN†, MEMBER, I.R.E.

Summary—A wave-guide-to-coaxial-line junction having a better than 2-to-1 bandwidth with less than 2-to-1 voltage-standing-wave ratio was required in the design of microwave filters and receiver transmission systems. Several types of junctions satisfying these requirements were designed using simple transmission-line theory. One type designed for a standard wave-guide cross section has a bandwidth ratio of 2.7 to 1. The design method is presented in this report with a detailed description of a number of particular junctions. Some of these models are for use with very thin wave guide, which is ideally suited for wave-guide filters; some for use with the more usual rectangular cross sections; and one for use with ridge ("loaded") wave guide. The latter junction is capable of at least a 6-to-1 bandwidth.

I. INTRODUCTION

MOST types of wave-guide-to-coaxial-line junctions now in use belong to one of three general classes. In the first class, the inner conductor of the coaxial line contacts the side of the wave guide opposite to the one contacted by the outer conductor. In the second class, the inner conductor projects as a probe only part way into the wave guide. In the third class, the inner conductor connects to a coupling loop inside the wave guide. The types described in this report are all of the first class. In addition, only structures in which the inner conductor of the coaxial line inside the wave guide is a small part of a quarter wavelength will be considered. With this restriction imposed, the various structures discussed in this paper can be represented quite accurately by a simple equivalent circuit.

It has been shown in the literature that a wave guide behaves like an ordinary transmission line.^{1,2} It has also been shown that reflection at an abrupt change in cross-sectional shape in a wave guide may be calculated by means of ordinary transmission-line formulas by using a properly defined wave-guide characteristic impedance on each side of the discontinuity, and by including a lumped shunt reactance at the point of discontinuity. For several types of discontinuities, this shunt reactance has been calculated and plotted in an unpublished Radiation Laboratory report.³ These data show that, for changes in height of a wave guide, this lumped reactance may often be neglected when the maximum height is much smaller than the width. This is especially true in

* Decimal classification: R118. Original manuscript received by the Institute, May 9, 1946.

The work reported in this paper was done at the Radio Research Laboratory under contract with the Office of Scientific Research and Development, National Defense Research Committee, Division 15.

† Formerly, Radio Research Laboratory, Harvard University; now, Cruft Laboratory, Harvard University, Cambridge, Massachusetts.

¹ J. C. Slater, "Microwave transmission," pp. 168-194; McGraw-Hill Book Co., New York, N. Y. 1942.

² S. A. Schelkunoff, "Electromagnetic waves," D. Van Nostrand Co., Inc., 1943.

³ To be published at an early date by McGraw-Hill Book Co., as No. 10 of the Massachusetts Institute of Technology Radiation Laboratory series, "Waveguide Handbook," by N. Marcuvitz.

the design of wide-band junctions, since neglecting small discontinuity reactances has a much smaller effect in wide-band equipment than in narrow-band equipment. In the following analysis, therefore, discontinuity reactances have been neglected, and the final experimental results have shown that this procedure is justified.

The characteristic impedance to be used for rectangular wave guide in the TE_{10} mode is

$$Z_0 = \frac{C}{\sqrt{K}} \frac{377}{a} \frac{b}{\sqrt{1 - \left(\frac{f_c}{f}\right)^2}} \quad (1)$$

where b and a are the cross-sectional dimensions (see Fig. 1), f is the frequency at which Z_0 is calculated, f_c is the cutoff frequency of the wave guide, K is the dielectric constant ($K=1$ for empty space), and C is a constant near unity which depends on the manner in which

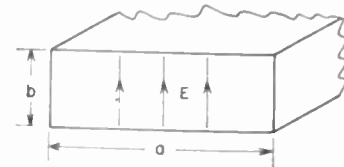

Fig. 1—Cross section of rectangular wave guide.

Z_0 is defined. It has been found experimentally that the formula for Z_0 which works best in designing wave-guide-to-coaxial-line junctions has $C=\pi/2$, and therefore⁴

$$Z_0 = \frac{377}{\sqrt{K}} \frac{\pi}{2} \frac{b}{a} \frac{1}{\sqrt{1 - \left(\frac{f_c}{f}\right)^2}} \quad (2)$$

or, very nearly,

$$Z_0 = \frac{600}{\sqrt{K}} \frac{b}{a} \frac{1}{\sqrt{1 - \left(\frac{f_c}{f}\right)^2}} \quad (3)$$

The wavelength in the wave guide differs from that in unbounded media, and is given by

$$\lambda_g = \frac{\lambda}{\sqrt{1 - \left(\frac{f_c}{f}\right)^2}} \quad (4)$$

where λ_g is the guide wavelength and λ is the wavelength in the unbounded medium K . The cutoff frequency for rectangular wave guide is given by

$$f_c = \frac{3(10)^{10}}{2a\sqrt{K}} \text{ cycles per second} \quad (5)$$

where a is in centimeters.

⁴ This corresponds to the "voltage-current" definition of Z_0 (see p. 319 of footnote reference 2).

Equations (3), (4), and (5) will be used throughout this paper, along with the usual transmission-line equations and circle-diagram charts. Only physical configurations that lead to a simple equivalent circuit will be considered.

II. THE BASIC JUNCTION

Fig. 2(a) shows the simplest junction of the type considered in this report. This particular junction has been used previously, and it has been pointed out that at the center frequency f_0 the wave-guide characteristic impedance should be equal to the coaxial-line impedance, and the wave-guide shorting block should be a quarter of a guide wavelength ($\frac{1}{4}\lambda_g$) from the point of junction.⁵ For 50-ohm coaxial line, the wave guide must also have a 50-ohm characteristic impedance at the center frequency. Equation (3) shows that the ratio of guide width to height (a/b) will be about 16 to 1.

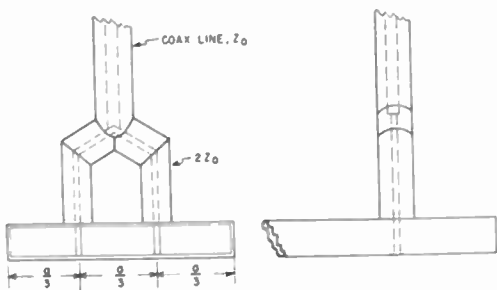
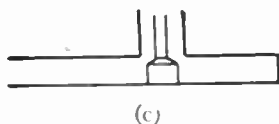
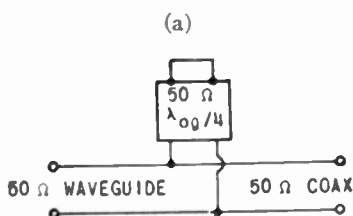
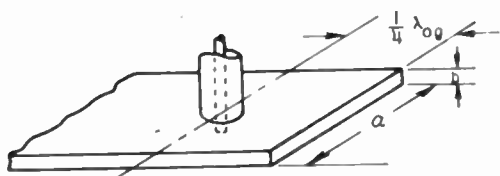
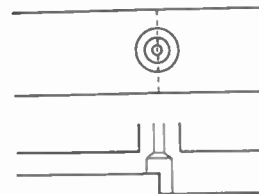

Fig. 2—Simple matched junction. (a) Basic construction. (b) Approximate equivalent circuit. (c) Center conductor widened to reduce inductance. (d) Double feed.

The approximate equivalent circuit is shown in Fig. 2(b). A more exact circuit would show an inductance in series with the coaxial line at the point of junction. This is the inductance of the short length of coaxial-line center conductor inside the guide. If its diameter is small compared to width a , its inductive reactance will cause considerable mismatch, despite the fact that it is extremely short in the 50-ohm guide. An idea of the

⁵ Reference is made to unpublished early work by Dr. J. P. Woods, J. F. Byrne, and G. A. Hulstede, formerly of the Radio Research Laboratory, Harvard University, Cambridge, Mass.

magnitude of this reactance may be obtained from an unpublished Radiation Laboratory report on a cylindrical post contacting the top and bottom of a wave guide. Our case differs mainly in that a 50-ohm load resistance must be considered in series with the post. A cylindrical



(a)

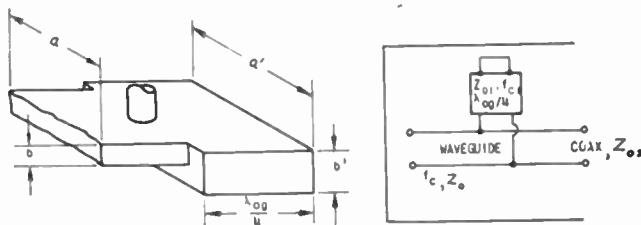

(b)

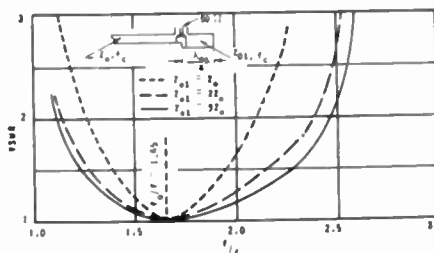

(c)

Fig. 3—Generalized matched junction. (a) Construction with high-impedance end section. (b) Most generalized design. (c) Calculated response for junction of Fig. 2(a).

post is shown to be equivalent to a tee network of a shunt inductance and series capacitances, all of whose reactances are so much less than 50 ohms that they may be neglected if the post diameter has an optimum value of about 0.15 times the width a of the wave guide.³ Therefore, in all wide-band junctions of this type, the center conductor should be about 0.15 a inside the guide. A practical compromise construction is shown in Fig. 2(c).

The equivalent circuit shows this junction to be equivalent to a continuous length of 50-ohm transmission line with a shorted length of 50-ohm line shunted across it. So long as the shunt line has a reactance large compared to 50 ohms, the voltage-standing-wave ratio of the junction will be low. The voltage-standing-wave ratio is also affected by the fact that the wave-guide characteristic impedance can be 50 ohms at only one frequency. This effect is most detrimental at the low-frequency end of the band, and complete mismatch results at the guide cutoff frequency where the characteristic impedance is infinite.

An effective method of increasing the bandwidth of the junction is now evident. By increasing the char-

characteristic impedance of the shorted shunt line, its reactance may be kept high compared to 50 ohms over a wider band (see Fig. 3(a)). Fig. 3(b) shows the most generalized design for the basic junction.

In calculating the voltage-standing-wave ratio response of these junctions, the equivalent circuits are solved by transmission-line formulas and charts. At each frequency, the proper guide wavelength and characteristic impedance given by (3) and (4) must be used. The voltage-standing-wave ratio values may be read directly from most transmission-line charts once the input impedance of the junction has been computed. In calculating the voltage-standing-wave ratio it does not matter which pair of terminals is regarded as the input, so long as the output terminals are assumed loaded by the characteristic impedance of the coaxial or waveguide line they connect to.

Fig. 3(c) shows the calculated response of the junction of Fig. 3(a), for several values of characteristic impedance of the shorted shunt wave guide. Even for Z_{01} equal to $Z_0 = 50$ ohms, the bandwidth is 1.65 to 1 for a voltage-standing-wave ratio of 2 to 1. For $Z_{01} = 3Z_0 = 150$ ohms, the bandwidth is 2.2 to 1.

These thin wave-guide junctions are particularly useful when used with a wave-guide filter requiring coaxial terminations, since such filters can, and often must, be constructed with thin wave guide. A high-pass filter can be simply a short length of wave guide with a wide-band junction at each end. The subject of wave-guide high-pass and band-pass filters have been considered in detail in a recently published book.⁶

The junctions described in this paper will not excite the TE_{20} mode, since the coaxial line connects to a point of zero electric field for that mode. Except for the junction which follows, the ones described in this section are generally not usable at frequencies above the TE_{30} cutoff frequency, which occurs at three times the TE_{10} cutoff in rectangular wave guide. Since the junctions set up the TE_{30} mode freely above its cutoff frequency, both the TE_{10} and TE_{30} modes are present at once in this region. The guide wavelength for the two modes is different, especially near the TE_{30} cutoff, and consequently the phase relation between the modes will vary with frequency, causing corresponding loss variations.

One type of junction for rectangular wave guide which theoretically will not excite the TE_{30} mode is shown in Fig. 2(d).⁷ The coaxial line (assumed 50 ohms) is split into two 100-ohm lines, each of which joins the wave guide one-third in from the sides. This is a point of zero electric field for the TE_{30} mode, and consequently this mode should not be set up. Since the two junction points are driven in phase, the TE_{20} and TE_{40} modes should likewise not be set up. A good match into the TE_{10} mode is at the same time obtainable. This design

requires very accurate locating of the junction points, and careful design of the coaxial Y connection in order to reduce discontinuity effects. Although this junction will theoretically not set up the TE_{20} , TE_{30} , and TE_{40} modes, discontinuities in a wave-guide line, such as twists and bends, can do so with consequent irregularities in the over-all transmission loss.

III. THE TRANSFORMING JUNCTION

The junctions of Part II can be used with guide having a higher impedance than the coaxial line if a sufficiently long taper, either in the guide or the coaxial line, is used to transform the coaxial-line impedance to the guide impedance. An exponential taper about one wavelength long at the lowest frequency for which good transmission is desired will suffice for many purposes. Several specific designs of this type will be described in a later section.

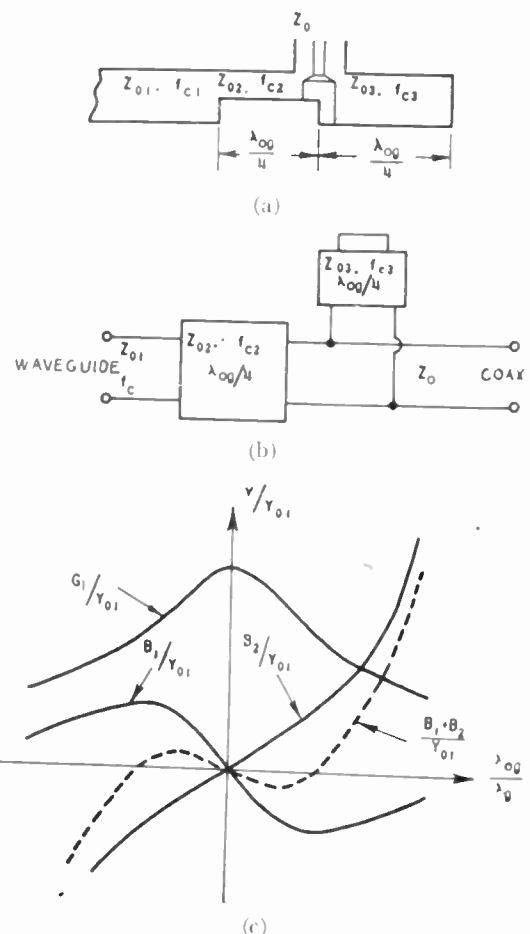

Fig. 4—Transforming-type junction. (a) Schematic. (b) Approximate equivalent circuit. (c) Admittance curves for $f_c = f_{c1} = f_{c2}$.

For guide impedance not over about three times the coaxial-line impedance, a good broad-band match may be obtained by means of a $\frac{1}{4}\lambda_{0g}$ (λ_{0g} is guide wavelength at f_0) transformer in the guide (see Fig. 4(a)). A particular case is that of "toll-ticket" tubing, which has inside dimensions of $2\frac{3}{4} \times \frac{3}{8}$ inches, a cutoff frequency of 2140 megacycles, and a characteristic impedance of 103 ohms at $1.65 f_c$. This shape of wave guide is very convenient for receivers, low- and medium-power transmitters, laboratory equipment, and filters.

⁶ Radio Research Laboratory Staff, "Very High-Frequency Technique," McGraw-Hill Book Co., New York, N. Y., 1947.

⁷ This design was proposed by J. F. Byrne of the Radio Research Laboratory, Harvard University, Cambridge, Massachusetts.

Besides providing an impedance match at the center frequency, the transforming junction has the advantage that the susceptance introduced by the $\frac{1}{4}\lambda_{00}$ transformer at frequencies other than the center frequency is of opposite sign from the susceptance of the $\frac{1}{4}\lambda_{00}$ shorted shunt line. By choosing the optimum characteristic impedance (Z_{03}) for the latter element, a cancellation of susceptance is possible over a wide band. This is illustrated by Fig. 4(c). Note that the abscissa is plotted in terms of λ_{00}/λ_0 , which in wave guide is not proportional to frequency. The ordinate is in terms of Y_{01} and Z_{02} . Note that the function plotted is not the true input impedance of the transformer, but rather is the input impedance of a hypothetical transformer that is $\frac{1}{4}\lambda_0$ long at all frequencies. The curve does, however, give an idea of the improvement in match made possible by this reduction in f_{c2} .

Fig. 5(a) shows the dimensions of a junction designed for a perfect match at a center frequency of 3200 megacycles. The measured voltage-standing-wave ratio is given in Fig. 5(b).

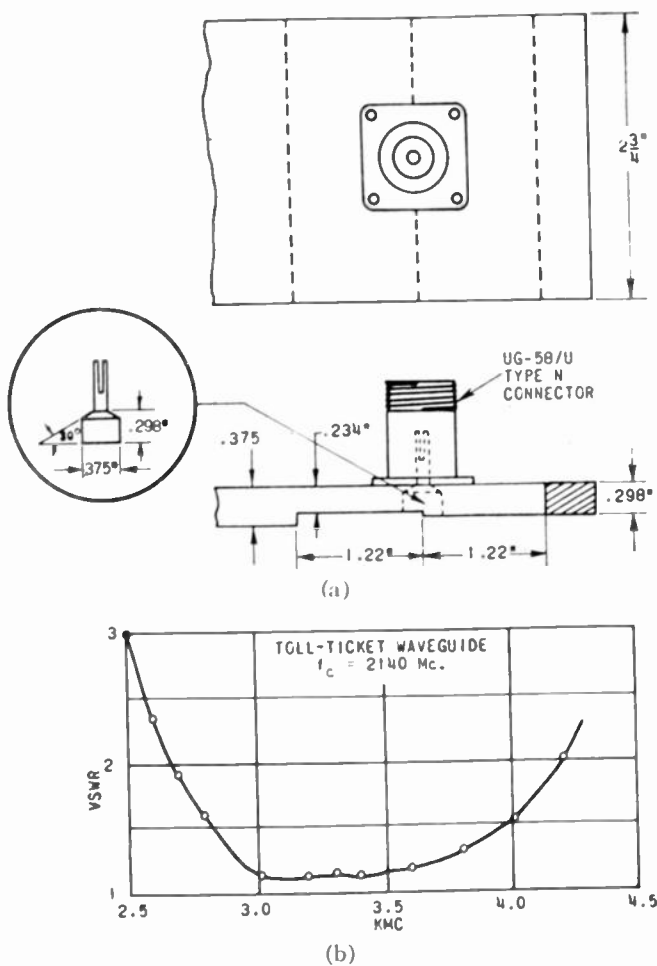

Fig. 5—Transforming junction matched at center frequency of 3200 megacycles. (a) Construction. (b) Frequency response.

By purposely transforming the guide impedance to less than 50 ohms, a wider bandwidth may be obtained. This is illustrated by the junction of Fig. 6(a) and its measured response in Fig. 6(b). This junction was designed to transform to 33 ohms at a center frequency of 3530 megacycles, giving a theoretical mid-band voltage-standing-wave ratio equal to 1.5.

Using the notation of Fig. 4(a), the junctions for Figs.

5 and 6 were designed with $f_{c1} = f_{c2} = f_{c3} = f_c$. By making f_{c2} about $0.8 f_c$ and $f_{c3} = f_c$, a large improvement near the guide cutoff is obtained. This is because the electrical length of the transformer does not become zero at f_c , and because the "transformed impedance" looking from the point of junction through the transformer towards the properly terminated wave guide is almost constant, except very near f_c . This latter point is illustrated by Fig. 7(a), where the "transformed impedance" is plotted and compared with the characteristic impedances Z_{01} and Z_{02} .

The reduction in f_{c2} may be obtained by widening this portion of the wave guide. A better method is to use a length of ridge (loaded) wave guide. The cross-sectional shape of ridge wave guide is shown in Fig. 8.

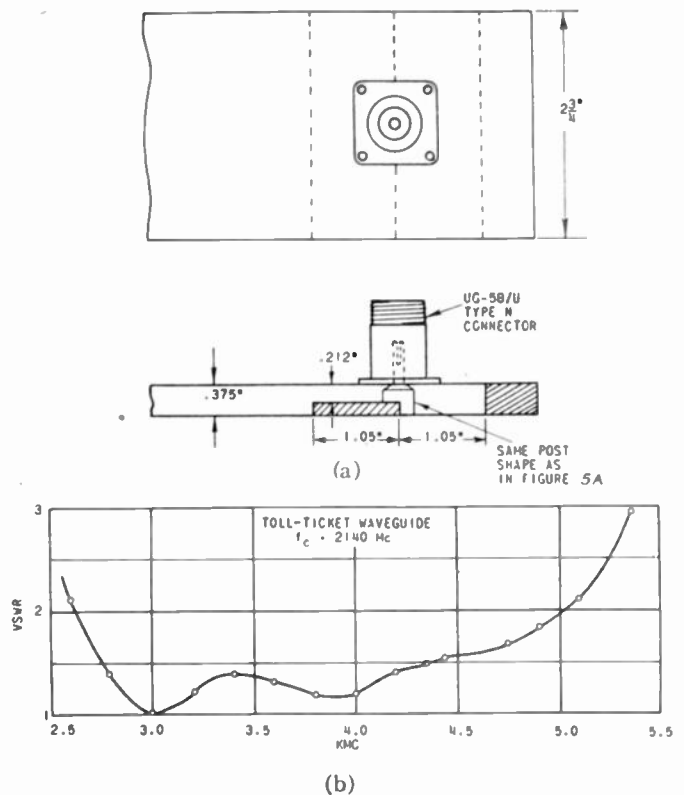

Fig. 6—Transforming junction designed to have voltage-standing-wave ratio = 1.5 at center frequency of 3550 megacycles. (a) Construction. (b) Frequency response.

This type of wave guide has a lower cutoff frequency and a lower impedance than ordinary rectangular wave guide having the same width and maximum height. The cutoff frequency of ridge wave guide may be calculated by a method given by Ramo and Whinnery.⁸ The characteristic impedance may be calculated for a cross section having a single ridge by the following formula, which is exact for infinitesimally thin wave guide, and

⁸ S. Ramo and J. R. Whinnery, "Fields and Waves in Modern Radio," John Wiley and Sons, Inc., New York, New York, 1944, p. 364.

is very close for wave guide such as "toll ticket." For double-ridge guide, the characteristic impedance is multiplied by two.

$$Z_0 = \frac{120\pi^2 b_2}{\lambda_c' \left(\sin \theta_b + \frac{b_2}{b_1} \cos \theta_b \tan \frac{1}{2} \theta_a \right)} \frac{1}{\sqrt{1 - \left(\frac{f_c'}{f} \right)^2}} \quad (6)$$

where λ_c' is the cutoff wavelength in centimeters and f_c' the cutoff frequency of the ridge guide. a_1 , a_2 , b_1 , and b_2 are the dimensions in centimeters shown in Fig. 8. θ_a and θ_b are given by

$$\theta_b = \frac{a_2}{2\lambda_c'} 360^\circ \quad \theta_a = \frac{a_1 - a_2}{2\lambda_c'} 360^\circ.$$

Derivation and discussion of this formula, together with a discussion of other useful properties of ridge

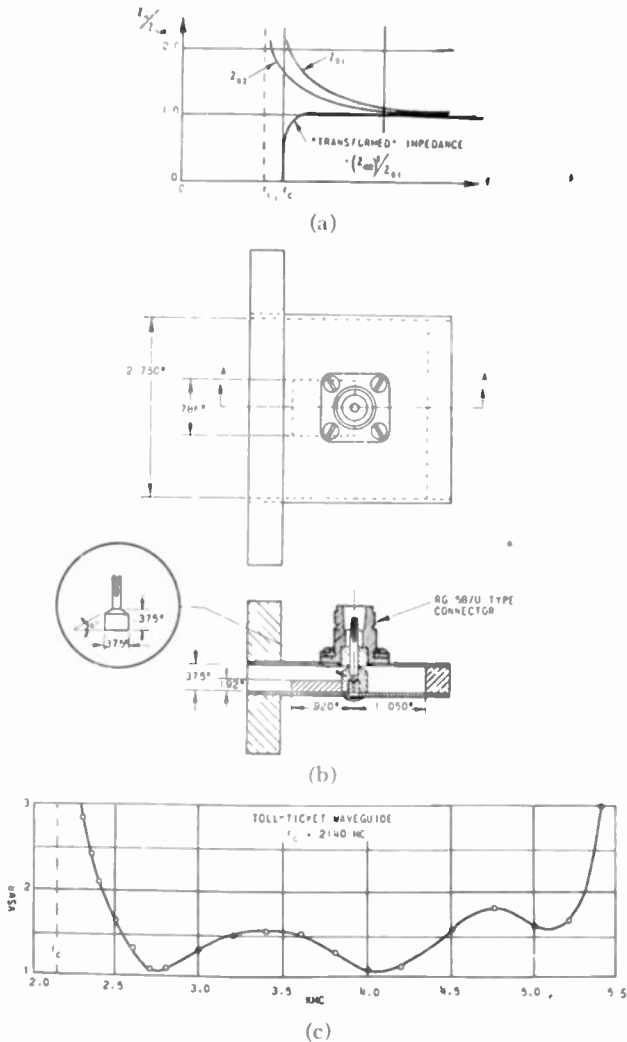

Fig. 7—Ridge-block transforming junction. (a) "Transformed" impedance. (b) Construction. (c) Frequency response.

guide,⁹ are given in another paper.⁹ Curves are included giving both Z_0 and f_c' as functions of the physical parameters, thus making a selection of dimensions to suit a particular problem very simple.

Fig. 7(b) shows the dimensions of a "toll-ticket" guide to 50-ohm cable junction using a ridge transformer. The calculated ridge-guide cutoff frequency is 1620 mega-

⁹ S. B. Cohn, "Properties of ridge wave guide," Proc. I.R.E., vol. 35, pp. 783-789; August, 1947.

cycles, and the characteristic impedance at center frequency $f_0 = 3540$ megacycles is 58 ohms. This should give a transformed impedance at f_0 of 33 ohms, corresponding to a voltage-standing-wave ratio of 1.5/1. The measured response appears in Fig. 7(c), and is seen to check closely the calculated voltage-standing-wave ratio at f_0 . Hence this checks closely (6) for these dimensions. The improvement in low-frequency response is evident, and the over-all bandwidth ratio is seen to be $5300/2400 = 2.2/1$.

IV. A JUNCTION FOR RIDGE WAVE GUIDE

As explained in Part II, the higher modes in wave guide can seriously interfere with transmission of the TE_{10} mode. This frequency range limitation can be solved by the use of ridge wave guide in place of ordinary rectangular wave guide. In the paper on ridge wave guide,⁹ it is shown that the ratio between the cutoff frequencies of the TE_{10} and TE_{20} modes can easily be made as high as about 4 or 8, or even higher, as compared to the 2-to-1 ratio for ordinary rectangular wave guide, and between the TE_{10} and TE_{30} modes about 6 to 10 as compared with 3.

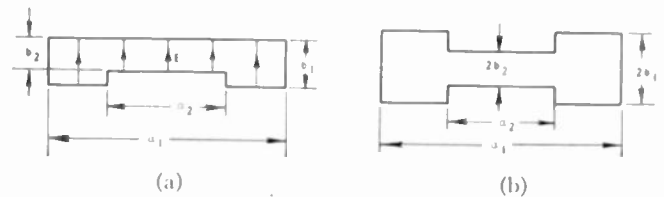

Fig. 8—Cross-section parameters of (a) single- and (b) double-ridge wave guide.

The construction of a ridge-wave-guide junction is shown in Fig. 9. Fig. 9(a) shows the generalized structure in which the shorted back cavity is of ridge guide, which may have any shape, characteristic impedance, and cutoff frequency. Figs. 9(b) and 9(c) show two easily constructed specific designs. In both cases, the cutoff frequency and characteristic impedance of the back cavity are higher than that of the ridge wave guide fed by the junction. The approximate circuit of Fig. 3(b) applies to this junction, and shows that the junction acts as though the equivalent waveguide line of characteristic impedance Z_0 were connected directly to the coaxial line of impedance Z_{02} , with a reactance X due to the shorted back cavity shunted across the point of junction. The voltage-standing-wave-ratio response may be calculated from this circuit.

The junction of Fig. 9 differs from the other junctions described in this paper principally in that the cutoff frequency of the back cavity of the former occurs within the operating range of the junction. Although the wavelength in wave guide approaches infinity as the frequency is lowered toward cutoff, the wave-guide characteristic impedance also approaches infinity, with the result that the input impedance of the back cavity in the vicinity of cutoff is greater than zero and is finite. The theoretical input impedance of a shorted length of wave guide which is a quarter of a guide wavelength long at 1.414 times the cutoff frequency is plotted in Fig. 10.

The standard equation for the input impedance of a short-circuited line was used, with Z_0 and λ_0 given by

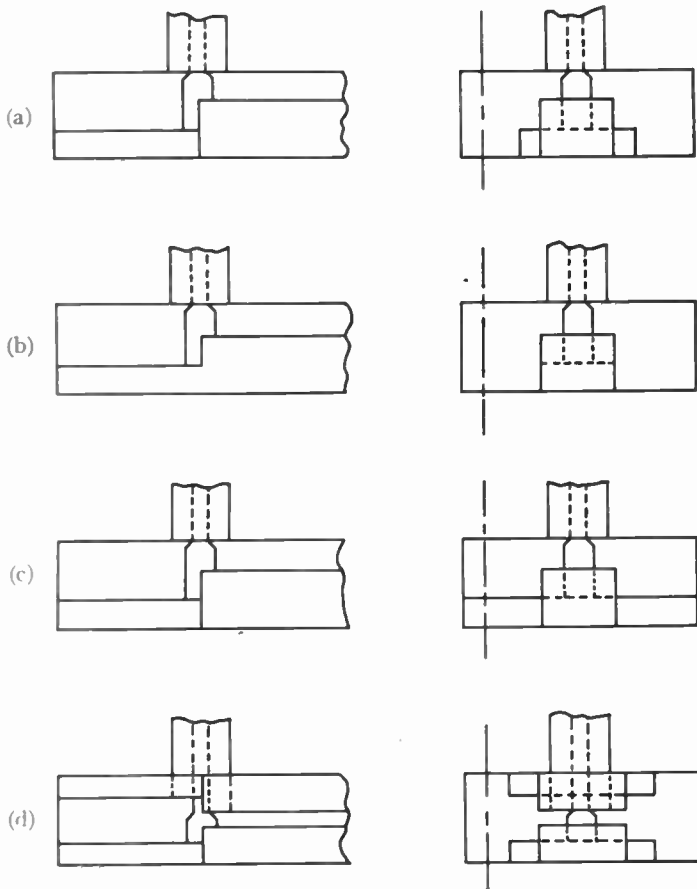

Fig. 9—Junction design for ridge wave guide. (a) Generalized type for single-ridge wave guide. (b) and (c) Two specific easily built variations of (a). (d) Generalized type for double-ridge wave guide.

(6) and (4). As indicated on this graph, if the characteristic impedance of the back-cavity section at infinite frequency $Z_{0\infty}$ is made to be three times the coaxial-line

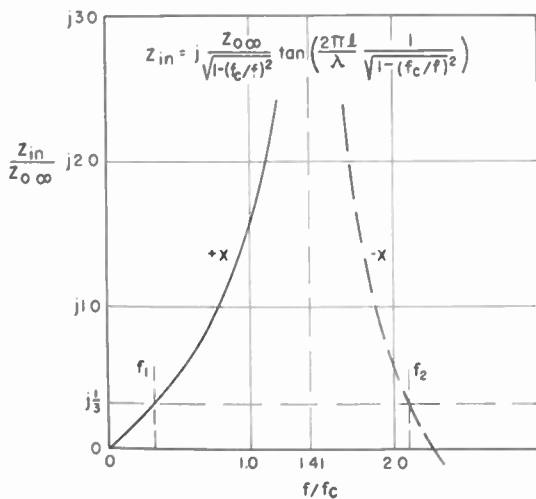

Fig. 10—Input impedance of a shorted wave-guide line. ($l = \frac{1}{2}\lambda_g$ at $f = 1.41 f_c$.)

impedance, the input reactance is greater than the coaxial-line impedance between f_1 and f_2 , about a 6-to-1 frequency range. If the cutoff frequency of the ridge wave guide fed by the junction is made to come at f_1 , the junction will work well from almost f_1 to f_2 . Other

values for the various parameters involved might give still wider bandwidth. This design may be used with any other form of "loaded" wave guide besides ridge wave guide.

V. TAPERED-RIDGE JUNCTIONS

The most common wave-guide cross-section shape for signal transmission is one with about a 2-to-1 ratio of width to height. A transforming junction like those in Part III would not give a very wide bandwidth for this shape wave guide. However, any of the junctions described above may be used with a sufficiently long tapered section of wave guide which will gradually transform the low impedance at the junction to the high impedance of the 2-to-1-ratio wave guide. "Loaded" wave guide, such as ridge wave guide, is particularly suitable for this taper, since its lowered cutoff frequency causes its impedance and wavelength to remain finite at the cutoff frequency of the main guide. The earliest junction known to the writer having this general design is shown in Fig. 11.¹⁰ The "loaded" wave guide in this case con-

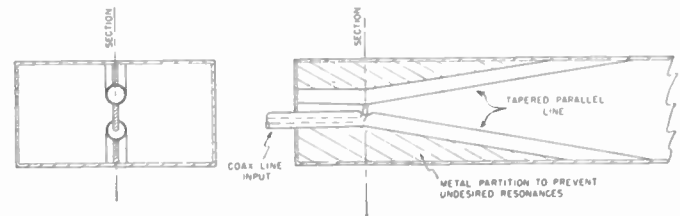

Fig. 11—A wave-guide-to-coaxial-line junction having a length of tapered loaded wave guide as matching element.

sists essentially of a parallel-conductor transmission line tapered from the 50-ohm impedance of the coaxial input line to the wave-guide impedance. The coaxial connection to this balanced line is made at a point that is a quarter wavelength from the shorted end of the balanced line at some intermediate frequency in the operating range. This junction had a measured voltage-standing-wave ratio varying between 1.3 and 2.3 over a frequency range of 2.15 to 1. Impedance measurements showed that the reactance remains close to zero, and that the resistance is high, around 100 ohms at the low-frequency end of the band, and around 60 ohms at the high-frequency end of the band. By bringing the tubes closer together, the balanced-line impedance at the junction point could be made more nearly equal to 50 ohms, and the standing-wave ratio would be improved over a large part of the frequency range.

Ridge wave guide is especially well suited for such a junction because of the simple construction it offers, and also because it can be designed so that its TE_{30} cutoff frequency is equal to or greater than that for rectangular wave guide having the same width. As shown in the paper on ridge wave guide,⁹ this is accomplished by restricting the ridge width to a value between one-third and two-thirds of the total wave-guide width.

¹⁰ This design was suggested by Andrew Alford and was developed under his direction by J. Nelson, both of whom were then at the Radio Research Laboratory, Harvard University, Cambridge, Massachusetts.

A junction using tapered ridge wave guide is shown in Fig. 12. It consists of a short length of ridge wave guide tapered from the main guide impedance to 50

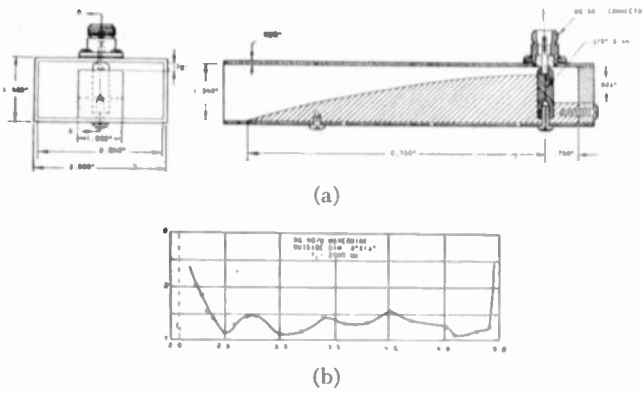

Fig. 12—Tapered-ridge junction for 3×1½-inch wave guide. (a) Construction. (b) Frequency response.

ohms at the point of junction with the 50-ohm coaxial line. Beyond this point is a quarter wavelength of 150-ohm ridge guide shorted at the end. This length is a quarter wavelength long at some point in the operating range. The operation of this junction is similar to those of Part II.

The cross-sectional shape of the ridge for a 50-ohm impedance was taken from the ridge-wave-guide curves in the paper on ridge wave guide.⁹ Experimentally it was found that these dimensions actually gave an impedance of 35 to 40 ohms, the error being due to the inaccuracy of (5) for small ratios of width to height of the wave guide. The dimensions shown in Fig. 12(a) give an impedance of about 50 ohms. They were found experimentally by a brief cut-and-try process. The frequency response appears in Fig. 12(b). The ridge was

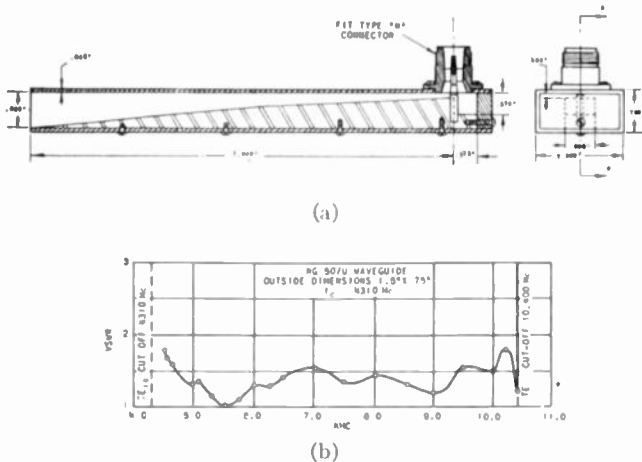

Fig. 13—Tapered-ridge junction for 1.5×0.75-inch wave guide. (a) Construction. (b) Frequency response.

given an approximately exponential taper with the change in guide wavelength along the ridge taken into account. Fig. 13 shows the dimensions and response of another junction of the same type scaled down for 1.5×0.75-inch wave guide. This second junction works much closer to cutoff than the first because its tapered-ridge section is in proportion twice as long.

The sharp increase in voltage-standing-wave ratio at the upper limit in both ridge junctions is due to the TE_{11} and/or TM_{11} modes, whose cutoff frequency is 4900 megacycles in the large guide, and 10,400 megacycles in the small guide. With a symmetrical double-ridge taper, these modes will not be excited. Also, a thin conducting sheet in the center of the guide perpendicular to the E field will suppress these modes. With such a construction, good performance up to the TE_{30} cutoff frequency (6240 megacycles in RG-48/U wave guide) is possible.

The dimensions of a double-ridge junction are given in Fig. 14, along with the measured voltage-standing-wave-ratio response. It is seen that a low voltage-standing-wave ratio is obtained from slightly above the TE_{10}

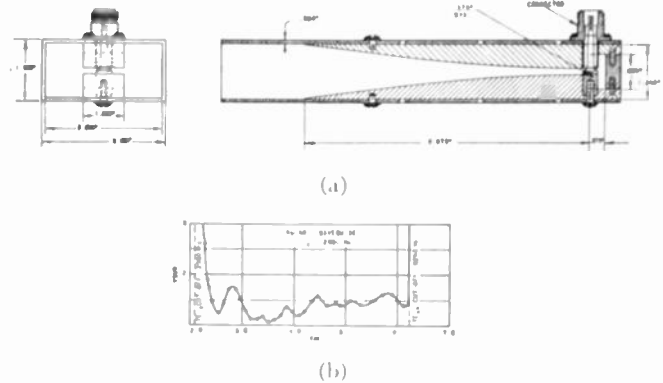

Fig. 14—Double-ridge junction for 3×1.5-inch wave guide. (a) Construction. (b) Frequency response.

cutoff up to the TE_{30} cutoff. The bandwidth ratio is 2.7 to 1 for a voltage-standing-wave ratio less than 2 to 1. If a longer ridge taper were used, a bandwidth ratio of very nearly 3 to 1 could be obtained. The 50-ohm double-ridge cross section was obtained directly from the curves in the ridge-wave-guide paper,⁹ the cut-and-try process being unnecessary in this case.

VI. METHOD OF TESTING

The test setup is shown in Fig. 15. The over-all calibration of crystal detector, amplifier, and voltmeter was carefully checked throughout the test range. Except for Fig. 13, all curves were taken using for a load over 20 decibels of RG-21A/U lossy cable with a UG-18/U type-N connector. For Fig. 13, a 100-foot length

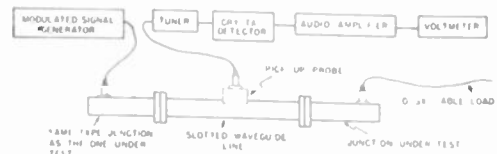

Fig. 15—Test setup.

of RG-8/U cable was used with a UG-21B/U connector. This last connector is far superior to the previously available type-N connectors, especially above 4000 megacycles. In all cases, however, it must be remembered that the connectors have a considerable effect on the over-all voltage-standing-wave-ratio response.

Discussion on

"The Maximum Range of a Radar Set"*

KENNETH A. NORTON AND ARTHUR C. OMBERG

Jerome Freedman:¹ A discussion of the factors which led Messrs. Norton and Omberg to conclude that 1000 megacycles is the optimum choice of frequency for an early-warning set is presented. It is shown that the principal factor which determined their conclusion was the choice of 5000 as a maximum permissible antenna gain. A discussion of the factors which principally control the maximum permissible antenna gain is therefore presented. The desirability of further investigation of the effect of scanning losses on permissible antenna gain is indicated. It is shown that the required amount of intelligence (plots per minute and range) will determine the maximum permissible gain and antenna-rotation speed. The antenna-rotation speed will in turn limit the maximum permissible area. This determination, plus the available transmitter energy, will principally determine the choice of operating frequency. A frequency of 1000 megacycles appears to be the optimum choice for the particular conditions of 17 plots per minute at a 300-mile range with 5 hits per target per scan. Specification of other requirements will shift this choice of frequency. Procedure and curves have been included which permit this determination for other requirements. In general, the requirement of more plots per minute shifts the choice to lower frequencies, at the expense, however, of angular resolution and increased power and attendant weight.

Discussion of Norton's Range-Index Curve

1. Several of the factors in the authors' range index (see (16)) are dependent in magnitude upon the operating frequency of the radar set. Therefore, these factors were plotted versus frequency (Fig. 1 and Fig. 2 of the paper under discussion) and the results used in calculating the range index, which is again plotted versus frequency. This equation is here restated for convenience:

$$RI = 920 (G'/f)^{1/2} (E_t L_t L_r / V \overline{NF})^{1/4} \text{ miles.}$$

2. The factors plotted by the authors versus frequency are: (a) antenna gain G' (for constant area of 1000 square feet and for constant gain equal to 5000), (b) receiver noise figure \overline{NF} , (c) transmitter pulse energy E_t (in joules), and (d) range index RI (in miles).

3. The parameters plotted by Norton and Omberg as listed do not readily illustrate the manner in which they operate on the range index. The effect each of

those factors has on the range index can be more readily perceived if they are plotted as they function in the range-index equation:

(a) antenna-gain index $(G'/f)^{1/2}$, (b) receiver noise-figure index $(1/\overline{NF})^{1/4}$, and (c) transmitter pulse-energy index $(E_t)^{1/4}$.

4. These parameters are shown in Fig. 1 versus frequency. The authors' range index is also shown in this figure. It is apparent that the receiver noise-figure index and the transmitter pulse-energy index do not have any

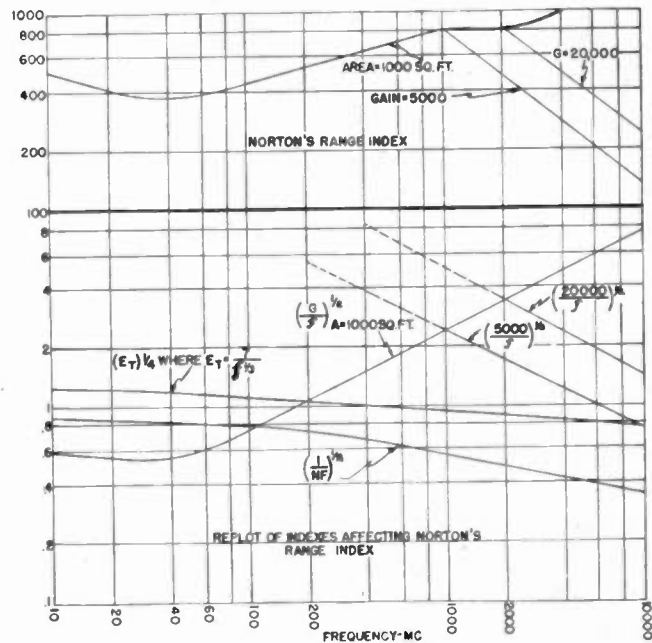

Fig. 1

significant frequency dependence compared with the antenna-gain index. The shape of the antenna-gain-index curve largely determines the shape of the range-index curve. In fact, the maximum on the range-index curve coincides with the maximum on the antenna-gain-index curve. This maximum occurs at the point of intersection of the constant-antenna-area curve with the constant-antenna-gain curve, since the first increases with frequency, while the second curve is an inverse function of the frequency. It is readily apparent, then, that the authors' determination of an optimum operating frequency at 1000 megacycles was a direct result of assuming that 5000 was the maximum utilizable antenna gain. Choice of a maximum utilizable antenna gain of 20,000 would have made 2000 megacycles equally acceptable. Their determination of 5000 as a maximum gain is based on two requirements:

* Proc. I.R.E. vol. 35, pp. 4-24; January, 1947.

¹ Watson Laboratories, Red Bank, New Jersey.

- (a) That the beam must not be so narrow in elevation that it will not illuminate all targets up to altitudes of at least 50,000 feet.
- (b) That the beam must not be so narrow in azimuth that it cannot cover its sector of search in a reasonably short period of time; experience indicates that antenna gains greater than about 5000 cannot be usefully used.

The first requirement can easily be met by using a beam as narrow as desired and obtaining the necessary vertical coverage by the use of multiple offset feeds as suggested by E. G. Schneider.² The second requirement is not clearly understood and no supporting evidence has been supplied. Therefore, the choice of 5000 as a maximum antenna gain cannot be taken as final and deserves further consideration, particularly since its choice will determine the optimum frequency.

The Effect of Scanning Losses on Maximum Antenna Gain

5. The factors which control the maximum permissible antenna gain are physical limitations, scanning losses, and vertical coverage. As stated in paragraph 4, the vertical-coverage limitation on the antenna gain can be overcome by use of multiple feeds. Scanning losses and physical limitations will then be the controlling factors, and the rotational speed will be one of the variables in each case.

6. It is important to know how scanning losses affect the range-index equation. The range index as derived by Messrs. Norton and Omberg quite properly is based on the energy contained in a single pulse. Unfortunately, at present none of our indicating devices operate properly on the basis of the return of the energy contained in one pulse, but require the integration of the energy contained in a number of pulses. If a linear integrating device were available (i.e., one whose indication would rise linearly with the number of pulses received), for the condition of searchlighting, it would merely be necessary to multiply the term E' in the authors' range index by F , the recurrence frequency of the pulses, and the basis for comparison of radar sets would then obviously be the average power. Unfortunately, the situation is complicated by the fact that the best presently available indicating device, the cathode-ray tube with A scan, is not a linear integrator. A. V. Haeff³ has experimentally shown that the results are proportional to the $F^{1/3}$ power and not F for the condition of searchlighting. Therefore, for searchlighting, the number of pulses incident on a target are of some significance but not as great as might be supposed, since the range index becomes a function *not* of average power which would be

($E \times F$) but of ($E \times F^{1/3}$). Norton and Omberg have corrected their range index from a one-pulse basis to the condition of searchlighting by incorporating Haeff's result in his visibility factor.

7. It is necessary to correct the range-index equation not for the condition of searchlighting but for the condition of scanning, since the normal early-warning set does not searchlight but scans. The scanning normally consists of rotating the antenna at a uniform rate continuously in azimuth. The rate of rotation will be determined by the permissible penetration for the attacking plane and, therefore, will be dependent on the speed of the plane. The fundamental problem is how far the plane may enter a given perimeter before the antenna again points in that direction and the plane is detected. In general, the greater the speed of the attack, the greater must be the rotation rate of our antenna. As a result of this rotation requirement, the number of pulses incident on a target at a given azimuth is limited. The effect of this limitation on the range is known as scanning loss, and we must know quantitatively how this affects the range. Norton and Omberg insert a factor k_1 in their visibility term, but give no explicit relationship.

8. The number of pulses or hits per target per scan will be determined by the rotation speed, the antenna beam angle, and the pulses per second of the transmitter. For the condition of searchlighting which Haeff's experiments assumed, F does represent the number of hits and we have

$$V \propto \frac{1}{N^{1/3}}$$

where N is the number of hits per target per second. L. V. Berkner⁴ in his range equation includes a term S which is the equivalent of the visibility factor V given by Norton and Omberg. He suggests that

$$S \propto \frac{1}{N^{1/2}}$$

where N is the number of hits per target per scan.

The normal radar search antenna, while scanning, turns at a sufficiently slow rate so that 5 to 40 hits (at a rate of about 300 per second) are placed on a target, and then the antenna moves on and does not return to the target until one revolution time (4 to 60 seconds) has elapsed. This manner of operation is sufficiently different from the experiments performed by Haeff so that there would be little justification for the application of Haeff's results to the range-index equation for the conditions of scanning except where the number of hits per target per scan is large. Unfortunately, the region of interest for early-warning systems at present lies in the range below 20 hits per target per scan. Some experimental work appears to be necessary to establish the empirical relationship between visibility and the number

² E. G. Schneider, "Radar," Proc. I.R.E., vol. 34, pp. 528-578; August, 1946.

³ A. V. Haeff, "Minimum detectable radar signal and its dependence upon parameters of radar systems," Proc. I.R.E., vol. 34, pp. 857-861; November, 1946.

⁴ L. V. Berkner, "Naval airborne radar," Proc. I.R.E., vol. 34, pp. 671-706; September, 1946.

of hits per target per scan as obtained by the normal radar set. Present experience seems to indicate that a minimum of 5 hits are required to properly illuminate the cathode-ray-tube indicators, and that there is little to be gained by increasing the number of hits above 10. This observation is probably explained by the non-linearity of the cathode-ray-tube screen, which requires a minimum energy for illumination but saturates rapidly on further increases of energy. It may, perhaps, be possible to write an expression for the visibility factor which includes Haeff's results and considers Berkner's suggestion and these observations as follows:

$$V^{1/4} \propto \frac{1}{F^{1/12}(1 - \epsilon^{-N/4})}$$

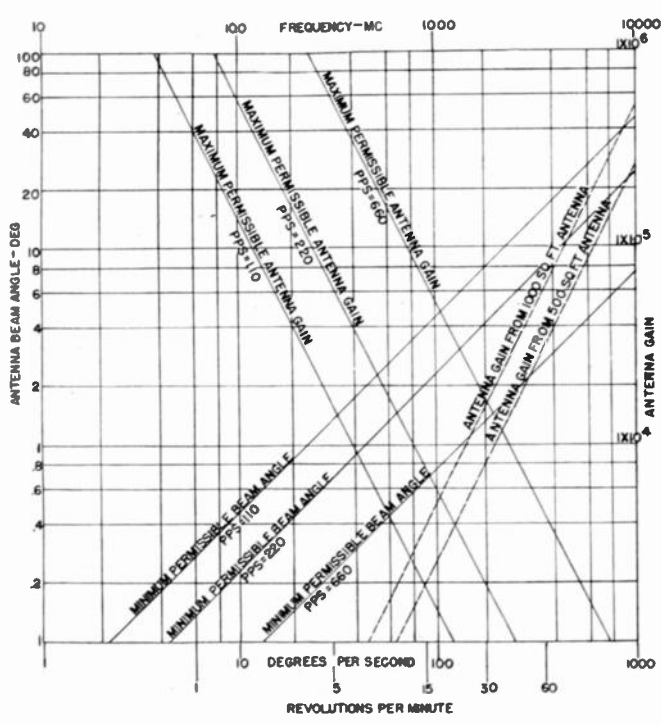

Fig. 2

9. It may be possible to incorporate such an empirical factor in the authors' range index with good results. However, there is another approach which yields results and will require no operation on the range index. The number of hits per target per scan is given by

$$N = \frac{\gamma\theta}{\omega} \tag{1}$$

where γ is the pulses per second, θ is the antenna horizontal beam angle, and ω is the scan rate in degrees per second; assuming a right conical beam the axis of which is normal to the plane of the antenna.

10. The gain of an antenna is given by

$$G' = 4\pi k_1 \frac{A}{\lambda^2} \tag{2}$$

where λ = wavelength, A = area, and k_1 = utilization factor. The utilization factor k_1 is approximately 0.65 for a

parabolic reflector.² The area A for a parabolic reflector is assumed to be the aperture area and therefore equal to

$$G' = 6.4 \frac{D^2}{\lambda^2} \tag{3}$$

where D = aperture diameter.

$$\theta = 57.3(k_2\lambda/D) \tag{4}$$

k_2 from Berkner is equal to 1.2 for a parabolic reflector. Combining 1, 3, and 4 and solving for G ,

$$G' = \frac{\gamma^2}{\omega^2} \times \frac{3.13 \times 10^4}{N^2}$$

11. An expression is now available which relates the antenna gain to the pulse-repetition frequency, scan speed, and number of hits per scan. By stipulating 5 hits for N in the expression, the maximum permissible antenna gain can be plotted versus antenna-rotation speed for various values of γ . Fig. 2 represents such a plot with pulses per second of 220 and 110 (300- and 600-mile sweeps, respectively). For convenience, the antenna gains available from 1000- and 500-square-foot antennas are also shown versus frequency. It is possible for any rotation speed at these pulses per second to determine the maximum permissible antenna gain and,

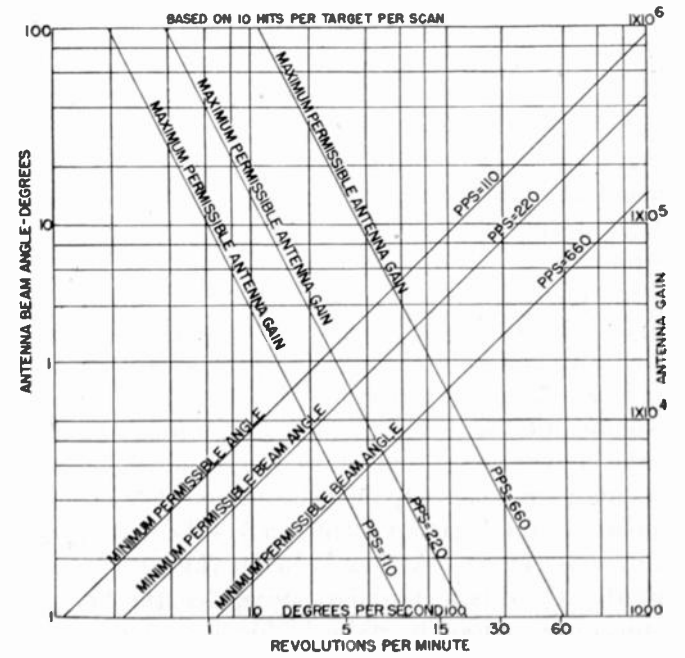

Fig. 3

by extending horizontally across the graph, to intersect the antenna-gain versus frequency curves. The maximum permissible frequency for a given antenna speed and size can then readily be determined. Fig. 3 indicates similar plots for the case where 10 hits per target has been stipulated for N .

12. A word of caution is necessary. The calculations have been based on a parabolic reflector. The tendency

has been to use truncated parabolic reflectors to increase the vertical coverage. This tends to give a smaller horizontal beam angle for an antenna of a given gain or area than would be obtained with a parabolic reflector. Therefore, the maximum permissible antenna gains obtained from the use of Fig. 2 will be somewhat larger than may actually be used in the case of truncated parabolic reflectors. The minimum permissible horizontal beam angle required to provide 5 hits per target per scan has been plotted on the same graph. While this factor does not appear directly in the range-index equation, it gives the minimum beam angle in the plane of the target permissible for any type of antenna at a given rotation speed.

13. In order to choose an optimum frequency, it appears necessary to have available a family of constant-gain and constant-area curves such as has been drawn by Norton and Omberg for an area of 1000 square feet and gain of 5000. Such curves, when drawn, should consider the latest available pulse energies as indicated in footnote 9 by Messrs. Norton and Omberg. The procedure would be first to determine the maximum permissible antenna gain based on the necessary antenna rotation speed, hits, and pulses per second. Then a decision must be made as to the maximum area which can be rotated at the stipulated rotation speed. The intersection of the constant-gain curve and the constant-area curve in the family will give the optimum frequency.

Discussion of the Factors Controlling the Range

14. The significant predictable factors affecting the range of a searchlighting radar system at any one frequency are: (a) transmitted energy, (b) antenna gains, and (c) receiver noise figure. The range index of a radar system varies with the one-fourth power of the transmitted energy, the minus one-fourth power of the receiver noise figure and the one-half power of the combined antenna gain $G_t G_r$. It is apparent then that the most significant improvement in the range index of a system can be achieved by increasing the antenna gain. In the conventional type of radar system, the increased antenna gain is accompanied by three other changes, a decrease in the horizontal and vertical beam angles and an increase in size. As has been previously stated, apparently there is a limit beyond which the horizontal beam angle cannot be reduced for any given rotation speed in the conventional system. The limit on decrease in the vertical angle is set by the vertical coverage required. For the range of frequencies over 1000 megacycles, the antenna gain and not the antenna size appears to be the limiting factor at the antenna rotation speeds presently required. It is necessary to seek methods which will reduce scanning losses and increase the vertical coverage, if further advantage of this significant factor is to be obtained. It should be borne in mind that decrease in the beam angle is by no means entirely detrimental since the amount of intelligence obtained,

a factor which is not considered in the range equation, is increased proportionately.

15. Examination of the receiver noise-figure index $(1/\overline{NF})^{1/4}$ as plotted in Fig. 1 will indicate that, if it is increased to the perfect value of one, the range improvement obtained at 100 megacycles is 1.2 times, that obtained at 1000 megacycles is 2 times, and that obtained at 10,000 megacycles is 3 times. It is important to remember that this improvement applies only in the absence of external noise. Therefore, it is apparent that no significant gain in range can be obtained at 100 megacycles by further improvement of the receiver. The range may presumably at best be doubled at 1000 megacycles. While such an improvement is attractive, since it represents the equivalent of increasing the available transmitter energy by 16 times without any accompanying increase in size and weight, it does represent the maximum increase which is available to us by receiver improvement.

16. The transmitter energy appears in the range equation to the one-fourth power. Therefore, an increase of 16 times must be obtained to double the range. Theoretically, the increase in power which can be obtained is unlimited, and therefore this represents the direction in which to proceed. Practically, however, the increase in range will be paid for in power-supply size and weight; transmitter size, weight, and cooling; pressurized transmission-line systems, etc.

17. The factors of secondary significance will be briefly stated: (a) transmission-line efficiency, and (b) visibility while searchlighting. They are considered secondary because, at present, there appears to be little possibility for improvement on the order which will have significant effect on range. The transmission-line efficiency is of the order of 0.9, and, since it operates in the range equation to the one-fourth power, there is no significant improvement available. The visibility factor while searchlighting as given by Norton and Omberg is composed of a number of terms and is restated for convenience:

$$V^{1/4} = \left[\frac{k_1 \tau B}{4} \left(1 + \frac{k_2}{\tau B} \right)^2 \right]^{1/4} \frac{1640^{1/12}}{F}$$

F while searchlighting will largely be determined by the required range. Its operation on range in the visibility factor for this condition is to the one-twelfth power and has no appreciable significance. Its relation to scanning loss has been previously discussed. k_2 is a pulse shape factor and is unity for a rectangular pulse. For detection of a rectangular pulse in noise, using A scan, k_1 is unity and τB has been rather conclusively determined to be unity. It has been suggested that, if the receiver bandwidth is made quite wide (i.e., a large departure from $\tau B = 1$), the grass (noise as seen on an A scan) becomes fine and good base-line-break detection is available. This idea was advanced by the General Electric Company engineers and incorporated in the SCR-270-DA and the

SCR-527. While the decrease in visibility predicted by Haeff has not been obtained, these sets have had exhaustive field trial without showing any particular advantage over the optimum value obtained by Haeff ($\tau B = 1$). It has been further suggested that the use of special devices not dependent on the human as an observer will permit operation at signal levels considerably below the noise power, offering an improvement in k_1 over A scan. Unfortunately, such devices are almost always based on the integration of information from many pulses, which requires extremely slow scanning.

Outline of Procedure for Choice of an Operating Frequency

18. The procedure to be followed in choosing an operating frequency, where range and number of plots per minute are the prime consideration, may be summarized as follows:

(a) Operation versus a given type of target and the intelligence required (air warning; gun control) will determine the number of plots per minute and the range required.

(b) The required number of plots per minute will determine the antenna-rotation speed.

(c) A decision as to the minimum number of hits per scan required to properly illuminate the detection device must be made.

(d) The range (pulses per second), the plots per minute (rotations per minute), and the number of hits required per scan will determine the horizontal antenna beam angle (use Fig. 2 or 3).

(e) Determination of the minimum beam angle will determine the maximum permissible antenna gain. Optimum operation at any given frequency will be obtained at this antenna gain. The range-index constant-gain curve varies inversely with frequency.

(f) The area of the antenna also increases in-

versely with frequency for constant gain. Therefore, the choice of operating frequency will be largely determined by the intersection of the maximum permissible constant-antenna-gain range-index curve with the constant-area range-index curve which represents the maximum area feasible to rotate at the chosen antenna-rotation speed.

(g) Available transmitter energy may shift the choice of frequency away from this intersection point. Any shift to lower frequency will result in sacrifice in angular resolution. Unless the increase in range index is appreciable, angular resolution must be a consideration.

Kenneth A. Norton:⁵ Mr. Freedman's discussion of the problem of the choice of an optimum frequency for an early-warning radar set provides a valuable extension to our remarks on this question. As pointed out by Mr. Freedman, the optimum frequency is largely determined by the maximum usable antenna gain and this, in turn, is dependent upon many other factors which are so closely interrelated to operational procedures and requirements as to necessitate extensive experience with a particular operational problem before a proper determination can be made. This conclusion points to the desirability of extensive operational experience with radar sets employing a variety of antenna characteristics before freezing the design of a set intended to meet a particular operational requirement. It is hoped that our paper, together with Mr. Freedman's discussion, will help to sharpen the issue and permit the operational research engineers to concentrate on the important problem of determining optimum radar early-warning antenna characteristics which, in turn, can then be used for the determination of the optimum frequency for such a service.

⁵ Central Radio Propagation Laboratory, National Bureau of Standards, Washington, D. C.

Discussion on

"The Transverse Electric Modes in Coaxial Cavities"*

ROBERT A. KIRKMAN AND MORRIS KLINE

William H. Huggins:¹ The authors of this paper are to be commended for pointing out the basic inconsistency between the accepted nomenclature for the transverse-electric fields in the circular wave guide and the nomenclature promulgated since the appearance of the paper by Barrow and Mieher for the corresponding fields in the circular coaxial transmission line.

It seems self-evident that the nomenclature for fields

in a circular coaxial line should be identical to the accepted nomenclature relating to the circular wave-guide modes obtained as the inner conductor of the coaxial line becomes vanishingly small. Unfortunately, not everyone agrees on this point. It would clarify matters considerably and aid in establishing the Standards on coaxial lines if the arguments *against* the terminology proposed by Messrs. Kirkman and Kline could be discussed openly in these columns.

Perhaps it should be mentioned here that the subject discussed in this paper is essentially one of *TE* modes

* PROC. I.R.E., vol. 34, pp. 14-17; January, 1946.

¹ Communications Laboratory, Cambridge Field Station, Air Materiel Command, Cambridge, Mass.

in a circular coaxial line and the conclusions are not restricted to *cavity resonators* as the title and 3-index notation might imply.

Also, it should be pointed out that the physical picture of the field *can* be used to determine the subscripts provided one looks for the nodal planes and nodal cylinders instead of worrying about "the number of half-periods of sinusoidal variations." Thus, if the notation proposed in this paper is accepted, it may be shown that:

1. In the designation of a $TE_{n,m}$ wave, n is the number of planes at which the circumferential component of electric field (or radial component of magnetic field) vanishes and m is one greater than the number of cylinders at which the radial component of electric field (or circumferential component of magnetic field) vanishes.

2. In the designation of a $TM_{n,m}$ wave, n is the number of planes at which the radial component of electric field (or circumferential component of magnetic field) vanishes, and m is one greater than the number of cylinders at which the circumferential component of electric field (or radial component of magnetic field) vanishes, excluding the coaxial conductors.

Application of the first rule to any of the field sketches shown in the paper under discussion will yield the proper subscripts.

Morris Kline² and Robert A. Kirkman:³ The authors of the paper feel as does Mr. Huggins that the nomenclature—specifically, the indexes used for circular coaxial guides and cavities—should be in agreement with the indexes used for the circular (pure cylindrical) guide and cavities. In particular, the designation of a coaxial mode should, if possible, be the same as the designation of the circular mode obtained as the radius of the inner conductor of the coaxial pair approaches zero. (The one exception to this practice would be the principal, or the TEM , coaxial mode, which has no circular analogue.) Mr. Huggins is rightly concerned, too, about the physical meanings that can be attached to the indexes n , m , and l for guides and cavities. The first matter, it would seem to us, does not admit of much dispute. The second is more troublesome.

On the matter of indexes for coaxial and circular modes, it should be noted first that the basis for associating coaxial and circular modes is open to choice. In the paper by Barrow and Mieher,⁴ a coaxial cavity mode is associated with the circular cavity mode which appears when the inner conductor is withdrawn. The circular mode obtained in this manner need not be the same as the one obtained by causing the radius of the inner conductor of a coaxial cavity to approach zero. For example, Barrow and Mieher associate the $TM_{0,1,0}$ coaxial cavity mode with the $TM_{0,1,2}$ circular cavity mode. One would expect that as the radius of the inner coaxial conductor approaches zero, the $TM_{0,1,0}$ coaxial

mode would approach the $TM_{0,1,0}$ circular mode. On this account, as well as on mathematical grounds, the latter association would seem preferable.

In so far as the nomenclature $TE_{n,0,l}$ used by Barrow and Mieher⁴ is concerned, there seems to us to be very little justification for the middle 0. The mathematical calculation of the resonant frequencies for those modes calls for the *first* root of the appropriate transcendental equation (5) in Barrow and Mieher's paper, not a zeroth root. Also, the field configuration approached by the coaxial $TE_{n,1,l}$ modes as the inner conductor becomes smaller is that of the $TE_{n,1,l}$ circular cavity modes. (A corresponding remark applies to guides.)

It is true that the coaxial $TE_{n,1,l}$ modes approach the rectangular $TE_{n,1,l}$ modes as the inner radius approaches the outer one. But this limiting relationship seems a far less weighty argument for the use of the middle 0 than the arguments against it.

Were the physical meanings associated with n , m and l by Barrow and Mieher correct, there might be an additional argument for the use of the zero. However, as we pointed out in our original paper, these meanings are not correct.

On the matter of physical meanings for the indexes n and m (for guides and cavities), Mr. Huggins does offer new suggestions. These seem to us somewhat unsatisfactory. In the case of $TE_{n,m}$ guide modes (circular and coaxial) Mr. Huggins suggests that m can be interpreted as "one greater than the number of cylinders at which the radial component of the electric field vanishes." However, the radial component of the electric field E_r vanishes throughout the guide for the $TE_{0,1}$ coaxial and circular mode; that is, E_r vanishes on an infinite number of cylinders.

In the case of the $TM_{n,m}$ guide modes Mr. Huggins suggests that m is one greater than the number of cylinders on which the circumferential component (E_ϕ) of the electric field vanishes. But this is not the case for the $TM_{0,1}$ mode of the circular guide. (See Fig. 2 in Barrow and Mieher's paper.) Actually, E_ϕ is zero everywhere.

For higher coaxial and circular modes the difficulties in assigning physical meanings to the indexes increase. Consider, for example, the $TE_{1,2}$ coaxial guide mode, the subscript 2 meaning that the second root of the appropriate transcendental equation is used to obtain the field expressions or cutoff frequency. When a/b , the ratio of the radius of the inner conductor to that of the outer conductor, is less than two-tenths, there is a circle concentric with the inner and outer conductors on which E_ϕ vanishes, in addition to E_ϕ vanishing on a longitudinal plane section of the guide. The circle moves toward the inner conductor as the ratio a/b approaches 0.2, and coincides with the inner conductor for $a/b \geq 0.2$. Any simple physical meaning attached to the second index will evidently not cover the cases of $(a/b) < 0.2$ and $(a/b) \geq 0.2$.

In the case of cavities, the problem of attaching physical meanings to the indexes is even more difficult. In the case of cavities, the problem of attaching physical meanings to the indexes is even more difficult. In the case of cavities, the problem of attaching physical meanings to the indexes is even more difficult. In the case of cavities, the problem of attaching physical meanings to the indexes is even more difficult.

² Department of Mathematics, New York University, New York, N. Y.

³ Evans Signal Laboratory, Belmar, N. J.

⁴ W. L. Barrow, and W. W. Mieher, "Natural oscillations of electrical cavity resonators," Proc. I.R.E., vol. 28, pp. 184-191; April, 1940.

⁵ Barrow and Mieher use l , m , n where we now, following Mr. Huggins' subsequent suggestion, use n , m , l .

cal meanings to the first two subscripts is complicated by the third one. For example, the $TM_{1,1,0}$ (circular and coaxial) field is not at all the same as the $TM_{1,1,1}$ field. Both E_r and E_ϕ are identically zero in the former case but not in the latter. Hence, any rule for physically interpreting the first two subscripts is subject to exceptions when the rule is applied to cavities.

Even in those cases where Mr. Huggins' physical interpretations of n and m do apply, the information conveyed by them is not enough. For example, in the case of a $TE_{n,m}$ mode, it is suggested that n be interpreted as "the number of planes at which the circumferential component of electric field vanishes." This is correct. But it is desirable to know more about this component. In the case of the $TE_{0,1}$ mode, coaxial (and circular), the circumferential component (E_ϕ) is zero at the inner conductor (or center), goes to a maximum, and then back to zero again as one goes radially to the outer conductor. This information is not conveyed by Mr. Huggins' interpretation.

Mr. Huggins is to be thanked for his willingness to grapple with such troublesome points. Standardization of notation and establishment of physical meanings for guide and cavity indexes are much to be desired.

W. H. Huggins:¹ I am grateful to Messrs. Kline and Kirkman for pointing out that in the event of circular symmetry the rule I proposed in my initial discussion for determining the indexes of the $TE_{n,m}$ mode is meaningless. The only apparent way out of this difficulty is to set up a special rule to be applied to circular waves, just as was done in the I.R.E. "Standard Definitions of Terms Relating to Guided Waves" (4W7 and 4W8, 1945). Since these standards use the subscripts n, m , I shall use these letters in the following discussion rather than the l, m used by Barrow, Micher, Kirkman, and Kline. It seems reasonable that the letter l could well be associated with the "length" of a cylindrical resonator and that the order n, m, l is therefore to be preferred to l, m, n because of this implication.

Following the pattern of the Standard Definitions of Waves in circular wave guides, I wish to propose the following definitions:

(a) In a circular coaxial line, the $TE_{0,m}$ wave is the circular electric wave of order m ; m is one greater than the number of cylinders, excluding the coaxial conductors, upon which the electric field vanishes.

$TE_{n,m}$ ($n \neq 0$) waves are noncircular waves; n is the number of axial planes upon which the circumferential component of the electric vector vanishes, and m is one greater than the number of cylinders upon which the radial component of the electric vector vanishes.

(b) In a circular coaxial line, the $TM_{0,m}$ wave is a circular magnetic wave of order m ; m is one greater than the number of cylinders, excluding the coaxial conductors, to which the electric field is normal.

$TM_{n,m}$ waves ($n \neq 0$) are noncircular waves; n is the number of axial planes upon which the circumferential component of the magnetic vector vanishes, and m is one greater than the number of cylinders upon which the radial component of the magnetic vector vanishes, excluding the coaxial conductors.

The definitions here proposed have two valuable properties. First, the definitions for noncircular waves are identical except for interchange of the words "electric" and "magnetic," and the definitions for the circular waves possess a certain similarity. Second, they apply equally well to the circular wave guide which generically is simply a coaxial line in which the inner conductor has become vanishingly small. Hence, they are more general than those given in the present I.R.E. Standards.

It should be recalled that the radial and circumferential components of the electric vector are proportional to the circumferential and radial components, respectively, of the magnetic vector by a factor which is simply the characteristic impedance of the wave. Hence, in the above definitions it is possible to replace the phrase "circumferential component of the magnetic vector" by "radial component of the electric vector," etc. These equivalents are useful when, for example, the magnetic field distribution of a TE wave is known and it is desired to apply rule (a) to find the proper subscripts.

Because the circumferential component of the electric field of a TE wave is apt to vanish outside of the inner conductor when $a/b < 0.2$, Messrs. Kline and Kirkman fear that "any simple physical meaning attached to the second index will evidently not cover the cases $a/b < 0.2$ and $a/b > 0.2$." This difficulty is not nearly so serious as it appears at first sight. The situation can best be explained with reference to Fig. 1, which shows the variation of the stream function F in the particular case of the $TE_{1,m}$ modes where

$$F(\chi\rho) = J_1(\chi\rho) - 0.32N_1(\chi\rho). \quad (1)$$

In this equation, J_1 is Bessel's function; N_1 , Neumann's function; ρ , the radial co-ordinate; and χ , a characteristic value related to the cutoff wavelength λ_c by $\lambda_c = 2\pi/\chi$.⁶

The circumferential component of the field will vanish when the radial derivative of the stream function vanishes. Hence, for the example here considered, conducting cylinders could be inserted at $\chi\rho = 0.76, 1.26, 5, 8.2$, etc., and the boundary conditions at these surfaces would be satisfied.

Now, it is because the derivative of the stream function may or may not vanish for two values of $\chi\rho$ less than the first positive zero of $F(\chi\rho)$ that Messrs. Kirkman and Kline feel that no definite rule can be stated. If, however, we look for the vanishing of the stream function itself rather than its derivative, this ambiguity

⁶ S. A. Schelkunoff, "Electromagnetic Waves," D. Van Nostrand Co., Inc., New York, N. Y., 1943; article 10.7, p. 390.

is eliminated. This essentially is the basis of the rule proposed above, since the radial component of the electric field will vanish whenever the stream function vanishes.

To illustrate, the $TE_{1,1}$ wave is that wave which would exist between inner and outer conductors having radii of $0.76/\chi$ and $1.26/\chi$, respectively ($a/b=0.61$). Reference to Fig. 1 will show that the stream function

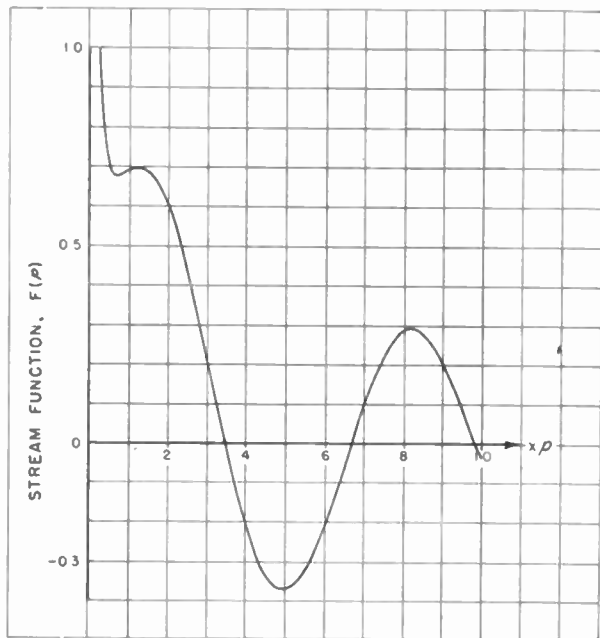

Fig. 1—Radial variations of typical stream function.

does not vanish between these limits. Therefore, if this wave is to be the first of the $TE_{1,m}$ waves, the "one greater than" phrase must be adopted. The $TE_{1,2}$ wave corresponding to the next solution of the transcendental equation would occur for a larger value of χ such that $a=5/\chi$ and $b=8.2/\chi$ (a/b still equals 0.61). In this case, the stream function passes through zero just once between the limits of the inner and outer radii, and the radial component of electric field therefore vanishes on one cylindrical surface. The "one greater than" rule gives the proper subscript 2. Similarly, the stream function for the $TE_{1,3}$ wave will vanish twice between the inner and outer conductors, etc., and the rule stated above is thus demonstrated.

For the case where $a/b < 0.2$, we refer again to Fig. 1 and place our inner conductor at a radius corresponding to $\chi\rho=0.76$ and the outer conductor at $\chi\rho=5$. This is a ratio of $a/b=0.153$, and we see that the circumferential component of the electric field does vanish at an intermediate cylinder of radius $1.26/\chi$. However, this cylindrical surface *would not even be noticed* unless one looked very carefully, for the only thing that occurs on this surface is that the electric vectors are all directed radially and there is no abrupt variation in the usual sense. It is misleading to imply that "for ratios less than 0.2

the field has more variations in it." As a matter of fact, the $TE_{1,2}$ field just considered would in no apparent way differ from the distribution shown in Fig. 6 of the paper under discussion despite the authors' implication that such would be the case.⁷

It is apparent that the rule applies in the example just stated where $a/b < 0.2$ since the radial component of the electric vector does indeed vanish once between the inner and outer conductors. Furthermore, the rule applies with this same ratio of $a/b=0.153$ for the $TE_{1,3}$ wave which corresponds to the inner and outer conductors at $\chi\rho=1.26$ and 8.2 , respectively. It is demonstratable that the rule as stated applied in general for all $TE_{n,m}$ waves, provided $n \neq 0$.

In applying the suggested nomenclature to modes in cavities, no difficulty should arise provided the cavity is truly cylindrical. The cavity fields may then be expressed in terms of forward and backward waves propagating axially along the cavity. Hence, *the same subscripts that apply to the transmission modes must also apply to the resonator modes*. The "exception" given by Messrs. Kirkman and Kline is only an apparent one. Resonance in the $TM_{1,1,0}$ mode can occur only at the

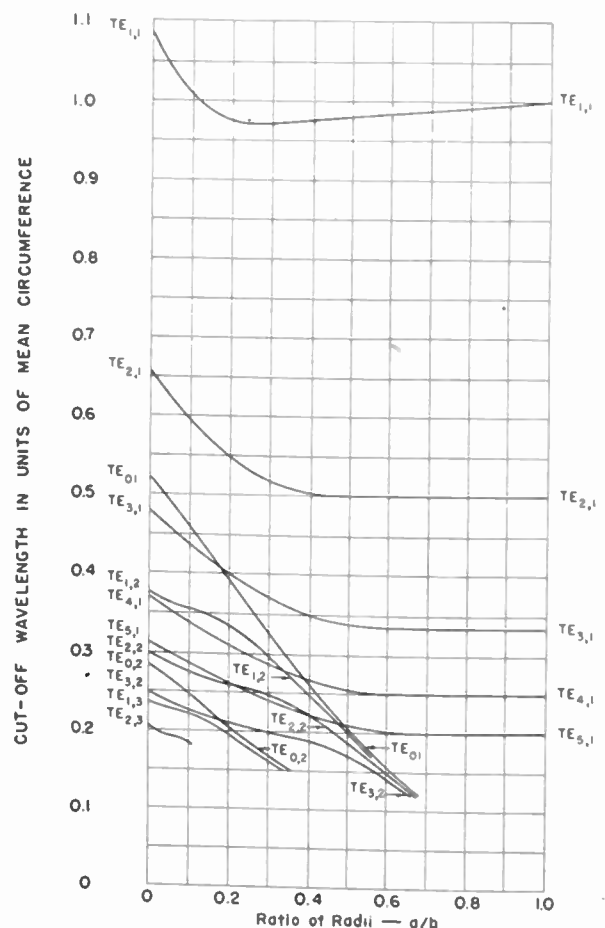

Fig. 2—Cutoff wavelengths of TE modes in a circular coaxial line.

⁷ It is informative to compare this figure with the $TE_{1,2}$ distribution in a circular guide which also possesses such a surface that is not at all obvious or easy to see.

$TM_{1,1}$ cutoff wavelength for which condition the characteristic impedance is zero; the guide wavelength is infinite; and E_r vanishes. The $TM_{1,1,1}$ resonance occurs at a somewhat shorter wavelength where the cavity is one-half guide wavelength long. The only difference between this resonance and the former one is that one can "see" more of it.

I do not understand Messrs. Kirkman and Kline's objections to n being interpreted as "the number of planes at which the circumferential component of electric field vanishes." This rule is certainly in accord with their thesis that subscripts should be based on the mathematical equations, and it may be expected to apply in all cases, even for the fractional case of $n=1/2$ (see Figs. 10.6 and 10.7 of footnote reference 6). The index n is not expected to give information as to how some quantity E_ϕ varies with ρ . Instead, n is an index of the variation of the field with ϕ , and it is precisely this that the proposed rule expresses.

In an effort to check these rules for all possible TE modes normally encountered, I solved graphically the

transcendental equations for most of the possible modes having cutoff wavelengths greater than one-fifth of the mean circumference of the coaxial line. These data are shown in Fig. 2.

It is of practical interest that adding a small inner conductor to a hollow circular guide does not appreciably change the cutoff wavelengths of the $TE_{n,1}$ modes provided $a/b < 0.1n$. Hence, for small a/b ,

$$\lambda_c \simeq \lambda_0 \quad (2)$$

where λ_0 is the cutoff wavelength in a hollow guide of radius b . For large values of a/b approaching unity,

$$\lambda_c \simeq \frac{\pi(a+b)}{n} \quad (3)$$

Equation (2) may be used to estimate the cutoff wavelengths of the $TE_{6,1}$, $TE_{7,1}$, etc., modes which for small a/b possess cutoff wavelengths lying within the range considered in Fig. 2.

Contributors to Proceedings of the I.R.E.



RANDALL C. BALLARD

Randall C. Ballard (A'41-SM'46) was born in Chicago, Illinois, in 1902. He received the B.S. degree in electrical engineering at the University of Illinois in 1928, at which time he was employed at Westinghouse in East Pittsburgh, Pennsylvania. From 1930 to 1932 he was television research engineer with RCA Victor in Camden, New Jersey. He then joined the United States Radio and Television Corporation, Marion, Indiana. From 1933 to 1935 he was chief television engineer with General Household Utilities Corporation, Chicago, Illinois. He returned to RCA Manufacturing Company, Camden, New Jersey, as television research and receiver design engineer until 1941, when he transferred to radar development work at RCA Laboratories in Princeton, New Jersey.

Since the war Mr. Ballard has returned

to television research work. He was given the "Modern Pioneer Award" in 1940 for invention of television interlacing and other developments. He is a member of Sigma Xi.



Robert W. Bauchman was born on May 14, 1920, at Idaho Falls, Idaho. He received the B.S. degree in electrical engineering in 1942 from the University of Notre Dame. He was called to active duty in the Navy in 1942 and was stationed at the Naval Research Laboratory from 1943 until 1946 where he was engaged in radar research and wave-propagation studies. At present Mr. Bauchman is in the electrical business in Idaho Falls, Idaho.

Mr. Bauchman is a member of the American Institute of Electrical Engineers and of Delta Upsilon.



ROBERT W. BAUCHMAN



LEO L. BERANEK

Leo L. Beranek (S'36-A'41-SM'45) was born in Solon, Iowa, September 15, 1914. He received the B.A. degree from Cornell College in 1936, the M.S. degree from Harvard in 1937, and the Sc.D. degree from Harvard in 1940. He served as faculty instructor at Harvard from 1940 to 1943.

In 1943 Dr. Beranek was appointed Director of Harvard's Electro-Acoustic Laboratory which operated under Office of Scientific Research and Development funds during World War II. In 1945 he was named, in addition, director of the Systems Research Laboratory. He received the Biennial Award of the Acoustical Society of America for outstanding contributions to acoustics in 1944 and was awarded an honorary Doctor of Science degree from Cornell College in June, 1946.



WILLIAM BINNIAN

Dr. Beranek is a member of the Executive Council and a Fellow of the Acoustical Society of America, a Fellow of the American Institute of Physics, a member of the American Association for the Advancement of Science, and of Sigma Xi. In 1946 he studied under a John Simon Guggenheim Fellowship jointly at the Massachusetts Institute of Technology and Harvard University. He is currently associate professor of communications engineering and technical director of the acoustics laboratory at the Massachusetts Institute of Technology.

William Binnian was born in Cohasset, Massachusetts, on April 25, 1922. He was graduated from Harvard University in 1943, with the A.B. degree in engineering sciences. During 1943 and 1944 he attended the Naval Training School of Aerology at the Massachusetts Institute of Technology. He also spent four months at the Naval Aerology School at Patuxent River, Maryland, and twenty months at the Naval Research Laboratory, engaged in wave-propagation research.

Mr. Binnian is now affiliated with Pan American World Airways, Atlantic Division, New York, as a member of the Flight Operations Planning Group whose function is to make all advance plans for the operation of the Boeing Stratocruisers and Re-



The Marshall Studio
J. D. COBINE

public Rainbows, which are expected to be in service by early 1948.

J. D. Cobine (A'34-SM'44) was born on May 10, 1905, at Oklahoma City, Oklahoma. He received the B.S. degree in electrical engineering from the University of Wisconsin in 1931, and the M.S. degree from the California Institute of Technology in 1932. In 1934 he received the Ph.D. in electrical engineering from the California Institute of Technology.

Dr. Cobine was instructor at the Graduate School of Engineering at Harvard University from 1934 to 1938, faculty instructor from 1938-1941, and assistant professor from 1941 to 1945. He also lectured in the Cruft Laboratory Officers Electronic Training Course (pre-radar) from July, 1941, to April, 1943. From 1943 to



JAMES R. CURRY

1945 he was group leader at the Radio Research Laboratory (National Defense Research Council, Division 15), Harvard University. Dr. Cobine directed the Noise Group in basic research in physics and electronics for radar countermeasure applications, and was also consultant at the Harvard Psycho-Acoustic Laboratory (National Defense Research Council, Research on Sound Control). At the present time Dr. Cobine is affiliated with the General Electric Co., Schenectady, New York, as research physicist in the Research Laboratory.

Dr. Cobine is a member of the American Institute of Electrical Engineers, the American Physical Society, the American Society for Engineering Education, the Sigma Xi, Tau Beta Pi, and Eta Kappa Nu.

James R. Curry (A'44) was born in Wooster, Ohio, in 1903. He received the B.S. degree from Dartmouth College in 1925. In 1930 he received the Ph.D. degree in physical chemistry from the Johns Hopkins University. From 1930 to 1932 he did research at the Kaiser Wilhelm Institute for Physical Chemistry in Berlin-Dahlem, and in 1933 he did research in physics at the Technical University in Darmstadt. On returning to this country he became a research associate at Columbia University.



GORDON L. FREDENDALL

In 1935 Dr. Curry joined the chemistry staff of Williams College. During the war he spent several years at the Radio Research Laboratory at Harvard University, working on radar countermeasures. He returned to Williams in the fall of 1945, where he is Ebenezer Fitch professor of chemistry and chairman of the department.

He is a member of the American Chemical Society, American Physical Society, Phi Beta Kappa, and Sigma Xi.

Gordon L. Fredendall (A'41-SM'46) was born at Kettle Falls, Washington, on December 20, 1909. He received the Ph.D. degree from the University of Wisconsin. From 1931 to 1936 he taught electrical engineering and mathematics, and engaged in research work in mercury-arc phenomena at the University of Wisconsin. Since 1936 he has been with the Radio Corporation of America, working on television research. He is at present located in Princeton, New Jersey, at the RCA Laboratories.

William H. Huggins (S'39-A'44) was born at Rupert, Idaho, on January 11, 1919. He received the B.S. and M.S. degrees in electrical engineering from Oregon State College in 1941 and 1942, respectively, at which institution he subsequently served as



WILLIAM H. HUGGINS



MARTIN KATZIN

research associate in an investigation of precipitation-static radio interference, and as an instructor in electrical engineering. In 1944 Mr. Huggins joined the staff of the Radio Research Laboratory, Harvard University, where he was engaged in the development of tunable microwave oscillators. At present he is a radio engineer with the Army Air Forces at the Cambridge Field Station of Watson Laboratories.

Mr. Huggins is a member of Sigma Xi, Tau Beta Pi, Eta Kappa Nu, the A.I.E.E., and the American Association for the Advancement of Science.

Martin Katzin (J'27-A'29-M'42-SM'43) was born in New York City on February 17, 1908. He attended the University of Michigan, from which he received the degrees of B.S.E. in electrical engineering in 1928, B.S.E. in mathematics and M.S.E. in electrical engineering in 1929. He was teaching assistant in electrical engineering during the year 1928-1929.

In July, 1929, Mr. Katzin joined the Radio Corporation of America as student engineer. He transferred first to R.C.A. Communications, Inc., in 1930 at the facsimile laboratories in New Brunswick, N. J., and then to the receiver laboratories in Riverhead, N. Y., where he remained until 1941. During this time he specialized in antenna and wave-propagation studies.



RAY D. KELL

In 1941 Mr. Katzin joined the Naval Research Laboratory, Washington, D. C., as consultant in the Radio Division. In addition to his consultant duties, he is at present acting head of the wave propagation research section of Radio Division I. He is also a lecturer in electrical engineering on the staff of the University of Maryland, where he has been teaching graduate courses in radio wave propagation.

Mr. Katzin is a member of the American Physical Society, American Meteorological Society, American Association of Physics Teachers, and an associate member of Sigma Xi.

Ray D. Kell (A'35-F'47) received the B.S. degree in electrical engineering from the University of Illinois in 1926. From 1927 to 1930 he was engaged in television research in the radio consulting laboratory of the General Electric Company. From 1930 to 1941 he was a member of the research division of RCA Manufacturing Company, and since 1941 he has been with RCA Laboratories Division. He received the "Modern Pioneer Award" from the National Association of Manufacturers in February, 1940, for inventions in television. Mr. Kell is a member of Sigma Xi.



G. C. SZIKLAI

G. C. Sziklai (A'41-M'43-SM'43) was born in Budapest, Hungary, on July 9, 1909. He received the absolutorium (equivalent to the M.S. degree) in 1930 from the Pazmany University of Budapest. He was an exchange student at the Technische Hochschule in Munich, Germany, in 1928. In 1931 he joined the Aerovox Corporation, where he became assistant chief engineer. He was the chief engineer of the Polymet Manufacturing Corporation from 1932 to 1935.

During 1934 Mr. Sziklai spent a half year in Europe providing consultation to electrical component manufacturers in London and Paris. From 1935 to 1939 he was on the research staff of the Micamold Radio Corporation. He joined the industry service division of the Radio Corporation of America in 1939, and later transferred to the Bloomington division of the same company. Since 1942, he has been in the television research section of the RCA Laboratories at Princeton, New Jersey. He is a member of the American Physical Society, Optical Society of America, and Sigma Xi.



A. C. SCHROEDER

A. C. Schroeder (A'38-SM'46) was born at West New Brighton, Staten Island, N. Y., on February 28, 1915. He received the B.S. degree in electrical engineering from the Massachusetts Institute of Technology in 1937, and the M.S. degree from the same institution in the same year. He joined the Radio Corporation of America in 1937, and is now engaged in television research at the RCA Laboratories in Princeton, New Jersey. He is a member of the American Association for the Advancement of Science, and Sigma Xi.

For biographies and photographs of SEYMOUR B. COHN and J. M. LAFFERTY, see the August, 1947, issue of the PROCEEDINGS OF THE I.R.E.

Karl R. Wendt (A'36-SM'46) was born on January 3, 1906, at Coshocton, Ohio. He attended the Municipal University of Akron, Marquette University, and the University of Wisconsin. During 1928-1929, he was a research assistant in the chemistry department of the University of Wisconsin, and in 1929-1930 he was in the research laboratory of the Sun Oil Company.

In 1930, Mr. Wendt joined the RCA Manufacturing Company and has been a member of the research department of that company since 1934. He is now located in the RCA Laboratories at Princeton, New Jersey. He is a member of Alpha Chi Sigma and Sigma Xi.



K. R. WENDT

Correspondence

Report on Professional Standing to the Canadian Council

February 21, 1947*

I have read with great interest the "Report on Professional Standing to the Canadian Council of the I.R.E." on page 61 of your January, 1947 issue, which includes a report of the Education Committee (1943-1944) of the Montreal Section of the Institute of Radio Engineers.

The problem of renovating our undergraduate university courses to provide the best possible academic preparation for the wide range of work which is now included in the professions of electrical and radio engineering is one of vital importance and considerable complexity. Whether the proper solution lies in a complete split, in the latter half of a four-year course, between "power" and "electronics" is a matter for much debate, and I personally lean to the school of thought which considers a solution to be possible in which the whole field of fundamental knowledge is properly integrated to provide a broad foundation on which to erect later postgraduate specialization in "electronics" or "power."

There is much in this report, however, with which I sympathize. Certainly those intending to enter the fields of research, development, and design need a sounder training in applied mathematics and physics, and much can be done in integrating a knowledge of basic physics with the theory of all electrical equipment. A better treatment of the physical properties of materials from the viewpoint of physics, rather than that of the structural engineer, is also necessary, and much detailed design and practical work needs revision or deletion in the light of the increasing importance of electronics. But does not this argument apply also for the student who wishes to enter the fields of research, development, and original design in the "power" field?

For those (and they are many) whose bent is towards the commercial and "application" sides of engineering, whether it be "power" or "electronics," it seems doubtful whether the high standard of mathematics and theory prescribed by the Montreal Section Committee would prove a very digestible diet.

There is one aspect of this latter report, however, on which I should like to comment. I do not know which Canadian Universities were in mind when the column under "Present Power Course" was prepared, but from my personal knowledge of the work of two Universities in Western Canada I feel that this description does not provide a representative or fair statement of electrical engineering courses in Canada in general.

For instance, the following courses are part of the electrical engineering courses at the University of Alberta:

Third Year

Fundamentals of Electronics: 2 hours lecture a week, both terms.

* Received by the Institute, February 28, 1947.

Electrical Physics: 2 hours lecture and 3 hours laboratory per week, both terms.
Higher Mathematics for Engineers (including differential equations, elliptic integrals, Fourier analysis, vector analysis, elements of complex variable): 2 hours lectures per week, both terms.

Fourth Year

Electrochemistry: 3 hours lecture per week, one term.

Electrical Communication: 2 hours lecture per week and 3 hours laboratory alternate weeks, both terms.

Fundamentals of Electrical Engineering (application of more advanced mathematics and physics to problems such as radio waves, high-frequency phenomena, etc.): 2 hours lecture per week, one term.

Option

Short- and Ultra-Short-Wave Radio: 2 hours lecture per week, 3 hours laboratory alternate weeks, both terms.

I believe that the majority of those members of the I.R.E. who are graduates of the Universities of Alberta and British Columbia (and there are many pursuing distinguished careers in the United States as radio engineers) will support my view that, whatever the many shortcomings of their undergraduate courses, the emphasis on "power" was not as one-sided as one is led to believe from the report of the Education Committee of the Montreal Section.

E. G. CULLWICK
Department of National Defence,
Ottawa, Ontario

A Source of Error in Radio Navigation Systems which Depend on the Velocity of a "Ground-Wave"

April 17, 1947*

I was much interested in the letter from K. A. Norton¹ in which he pointed out that the "ground wave" propagated from an aerial near the ground may effectively travel with a wave velocity different from that in free space, and that the magnitude of this velocity would be expected to change with the distance from the transmitter. Mr. Norton suggested that this anomalous velocity may cause errors in radio navigation devices which depend on the phase of ground waves, and that it may even be possible, "when convenient methods become available for the accurate measurement of $\Delta\phi$," to determine "the effective values of the ground constants over the propagation paths."

* Received by the Institute, April 21, 1947.
¹ K. A. Norton, "A new source of systematic error in radio navigation systems requiring the measurement of the relative phases of the propagated waves," Proc. I.R.E., vol. 35, p. 284; March, 1947.
² Y. A. Alpert, V. V. Migulin, and P. A. Ryazin, "An investigation of the phase structure of an electromagnetic field and the velocity of radio waves," Jour. Phys. (U.S.S.R.), vol. 4, p. 13; 1941.

In this connection it should be noticed that Russian authors² have shown, by a method of calculation different from Norton's, that the velocity of ground waves varies with distance, and their results for a special case are given in their Fig. 2. At the 7th General Assembly of the U.R.S.I., held in Paris in September, 1946, I drew attention to this result³ and showed how it could be deduced from the phase-distance curves published by Norton. I found that the use of Norton's curves led to the results shown in the Russians' figure, and thereby demonstrated that the two theories were essentially the same. It should also be noted that the Russians have verified their theoretical results by measurements carried out over land, and have obtained qualitative agreement with the theory.

At the U.R.S.I. meeting I also used Norton's curves to consider the case of the Decca system of radio navigation, which makes use of "ground waves" of frequency about 100 kilocycles per second. At the same meeting Mr. Mendoza⁴ reported some accurate experimental determinations of the effective velocity of the ground wave over wet grounds in Holland, which he had made by means of the Decca system, and I was able to deduce from Norton's curves that Mendoza's results would lead to a ground conductivity of 10^{-13} electromagnetic units. This measurement therefore fulfills Norton's expectation that it would be possible to determine the ground constants when a reliable phase-measuring device was available.

It is of interest to note that the measurements, and the theory, show a velocity of the ground wave less than the velocity in free space, provided we are not too far from the transmitter, and equal to that in free space at greater distances. A Zenneck ground wave would have a velocity greater than that in free space. It is possible that a proper consideration of the anomalous velocity near the source may explain the phenomena of "coastal refraction." An attempt to relate the two phenomena has already been made by the Russian workers.⁵

In considering the possible error introduced into radio navigation devices by the phenomena here mentioned, it is important to remember that we usually have to do with the difference of phase of waves traveling by two paths, and in most navigation systems the resulting error to be expected is quite small except near the transmitters. It is fortunate that, in general, navigation devices are not required to be particularly accurate near the base line.

J. A. RATCLIFFE
Cavendish Laboratory
Cambridge, England

³ J. A. Ratcliffe, "The velocity of radio waves," to be published in Proc. 7th Assembly U.R.S.I., Paris, 1946.

⁴ E. B. Mendoza, "The velocity of radio waves over the surface of the ground," to be published in Proc. 7th Assembly U.R.S.I., Paris, 1946.

⁵ Y. A. Alpert and Gorozhankin, "Experimental investigation of the structure of an electromagnetic field over the inhomogeneous earth's surface," Jour. Phys. (U.S.S.R.), vol. 9, p. 114; 1945.

Institute News and Radio Notes

A Statement to the Membership Concerning Publication Plans and Problems

The attention of the membership is directed to the fact that this issue of the PROCEEDINGS OF THE I.R.E. contains some 40 more pages of editorial content than the average issue for this year. This is the first issue to be published under an expanded publication program planned for the coming autumn and winter. Under this program it is anticipated that the present large backlog of papers awaiting publication can be greatly reduced during the remainder of 1947, and that during 1948 the publication schedule of the PROCEEDINGS can be placed on a substantially current basis, assuming no unforeseen change in the rate of receipt of technical papers or other special contingencies.

The publication problems of the I.R.E., along with those of other professional societies, have been exceedingly severe during the past two years, and these problems have continually engaged the earnest thought and planning of the Board of Directors, the Executive Committee, and the Editorial Department of the Institute. Following the cessation of hostilities two years ago, there began a literal flood of technical papers, disclosing the results of hitherto-classified wartime research. To some extent this flow of material had been anticipated, in that the Board of Directors recognized that the radio-and-electronic field had undergone an extraordinary and unprecedented expansion during the war years, and in consequence appropriated \$20,000 for a special publication fund for 1946. However, as previously reported in these pages,¹ when confronted by rising printing and paper costs this fund proved quite insufficient to meet the requirements. Meanwhile, the backlog rose steadily as disclosures of early postwar research and development began to appear in significant quantity.

In 1947 the combined problems of paper supply, printing facilities, and fiscal shortages continued. Through the generosity of various organizations who contributed to a new special publication fund for the year, and the co-operation of printers and paper suppliers, the basic 72-page editorial-section budget was augmented to an average of 107 pages for the first eight issues of the year. By this means, and through increased stringency in the papers-acceptance procedure, the backlog of accepted papers on hand, which totalled some 1400 pages at the end of 1946, has been reduced to approximately 900 pages.

Although problems still remain in connection with printing labor and paper supply, sufficient improvement has now occurred to enable envisioning the program announced above. The fiscal outlook also has improved, as a result of current planning implemented by the recent adoption of certain I.R.E. constitutional amendments, to a

point where it is now expected that 480 additional editorial pages above the basic budget can be published during the remainder of 1947.

As a closely related matter, the Board of Directors and the Executive Committee currently are devoting careful thought to a plan which will enable the provision of adequate service to the membership, in 1948 and thereafter, both as concerns publication and other functions, through an appropriate modification of the dues structure. It has been recognized for some time that increased dues will be inevitable in any case, simply to compensate for the diminished value of the dollar; but it is also imperative that funds be provided for a future publication program adequate to serve the vastly enlarged field of radio-and-electronic engineering.

It should be emphasized that the I.R.E. is not unique in having problems of this character. All engineering and professional societies have been faced with the same difficulties—inflated costs and greater demands for publication and other services. This situation is quite generally reflected either in increased dues, special assessments, or reduced surpluses. The problems of the Institute, however, are greater because of the fact that the radio-and-electronics field has expanded more in recent years than any other, except possibly aviation.

Under the plans now being evolved through the concerted efforts of the Directors, officers, and Headquarters staff of the Institute, these problems now appear to be within reach of solution.

1948 NATIONAL CONVENTION COMMITTEE

At its July 1, 1947, meeting, the Executive Committee appointed Mr. George W. Bailey as Chairman of the 1948 Convention Committee, and authorized him to proceed with the formation of the committee.

TECHNICAL COMMITTEE APPOINTMENTS

The following appointments for the Technical Committees were approved at the July 1, 1947, meeting of the Executive Committee: Mr. H. T. Lyman as Chairman of the Subcommittee on Color Television, and Mr. Duane Roller as member of the Committee on Symbols.

PRINCETON SECTION

The petition of the Princeton Subsection members for the formation of a Princeton Section was approved by the Executive Committee at its July 1, 1947, meeting, acting on behalf of the Board of Directors.

STUDENT BRANCH

The Executive Committee, at its July 1, 1947, meeting, approved, as representative of the Board of Directors, the petition for the formation of a Student Branch at the University of Utah.

NUCLEAR STUDIES COMMITTEE

At its July 1, 1947, meeting, the Executive Committee approved the formation of a Nuclear Studies Committee which will communicate with other technical societies and the Atomic Energy Commission for the purposes of establishing correlation of engineering work and elimination of duplication in the field of nuclear energy work by engineering societies and standardizing groups.

NAB ENGINEERING CLINIC

Frequency modulation, television, and facsimile will be among the wide variety of broadcast-engineering subjects discussed at an all-day engineering clinic, Monday, September 15, 1947, as part of the National Association of Broadcasters Convention in Atlantic City.

Topics already scheduled include: The Care and Maintenance of Directional Antenna Systems, Technical Training of Broadcast Personnel, Studio Control Design, Technical Regulation of Broadcasting, Recording Systems, and an F.C.C.-Industry question-and-answer panel.

Dr. John A. Willoughby, chief engineer of the F.C.C. Broadcast Division; George P. Adair, former chief engineer of the Commission; Dixie McKey, engineering consultant; and other prominent scientists and authorities in their respective fields will speak and take part in the discussions.

In addition, a display of new equipment will be presented on the main floor of Convention Hall.

Minutes of Institute Committee Meeting

PUBLIC RELATIONS COMMITTEE

Date..... April 23, 1947
Place... IRE Headquarters, New York, N. Y.
Chairman..... V. M. Graham

Present

V. M. Graham, *Chairman*

G. W. Bailey	R. A. Hackbusch
C. B. DeSoto	Keith Henney
E. K. Gannett	George Lewis
S. M. Robards (representing O. E. Dunlap)	

At the suggestion of President Baker, a Publicity Subcommittee, composed of professional publicity men, was formed to act as a working group of the Public Relations Committee. Following a discussion on publicity themes, sources, and outlets, it was voted that the Headquarters staff handle the preparation and distribution of publicity material. The Chairman announced that, in addition to seeing that letters were written to various company publicity men, he would arrange for the circularization of all section chairmen regarding their co-operation, supplying them with suggestions concerning the procurement and handling of publicity.

¹ "Publication Delays," *Proc. I.R.E.*, vol. 35, p. 396; April, 1947.

THE INSTITUTE OF RADIO ENGINEERS

(Incorporated, August 23, 1913)

Constitution

Adopted at the First Meeting of The Institute of Radio Engineers, May 13, 1912. Amended, November 2, 1914; December 5, 1915; October 7, 1931; May 1, 1939; November 5, 1941; September 8, 1943; November 29, 1944; May 5, 1945; December 15, 1945; June 27, 1946; July 30, 1946; and August 15, 1947.

ARTICLE I

Name and Object

Sec. 1—The name of this organization shall be The Institute of Radio Engineers, Incorporated.

Sec. 2—Its objects shall be scientific, literary, and educational. Its aims shall include the advancement of the theory and practice of radio, and allied branches of engineering and of the related arts and sciences, their application to human needs, and the maintenance of a high professional standing among its members. Among the means to this end shall be the holding of meetings for the reading and discussion of professional papers, and the publication of papers, discussions, communications, and such other matters as may be appropriate for the fulfillment of its objects.

ARTICLE II

Membership

Sec. 1—The membership of the Institute shall consist of:

- a. Fellows, who shall be entitled to all rights and privileges of the Institute.
- b. Senior Members, who shall be entitled to all rights and privileges of the Institute.
- c. Special Members, who shall be entitled to all rights and privileges of the Institute except the right to hold the offices of President and Vice-President.
- d. Members, who shall be entitled to all rights and privileges of the Institute except the right to hold the offices of President, Vice-President, and Director.
- e. Associates, who shall have such rights and privileges as are provided by the Bylaws. However, Associates who have maintained a continuous membership in this grade since March 1, 1939, shall have the right to vote and shall be entitled to all rights and privileges of the Institute except the right to hold any corporate office, the office of Director, and the chairmanships of standing Committees and of Sections.
- f. Students, who shall have such rights and privileges as are provided by the Bylaws.

Sec. 2—The qualifications for the various grades of membership shall be specified in the Bylaws in accordance with the following principles:

a. Fellow is a grade of unusual professional distinction and shall be conferred only by invitation of the Board of Directors.

b. Senior Member is the highest professional grade for which application may be made and shall require experience or attainment reflecting professional maturity.

c. Special Member is a grade limited to those who have shown an interest in furthering the radio or allied arts and sciences and who have attained such position or prestige that by membership they shall advance the objectives of the Institute. This grade shall be conferred only by invitation of the Board of Directors.

d. Member is a professional grade limited to those who have demonstrated professional competence in radio or allied fields.

e. Associate grade shall be open to those interested in the theory or practice of radio engineering or the allied arts and sciences.

f. Student grade shall be open to those devoting a major part of their time as registered students in a regular course of study in engineering or science in a school of appropriate standing. Membership in this grade may extend a limited time after termination of student status.

Sec. 3—The requirements for admissions, transfers, and severances of members shall be specified in the Bylaws.

Sec. 4—The term "allied" as used in this Constitution and Bylaws refers to electrical communication, electronics, and such other technical fields as are directly contributory to, or derived from radio.

Sec. 5—The terms "member" and "membership" when printed without an initial capital where used in this Constitution and Bylaws include all grades.

Sec. 6—The term "voting member" where used in this Constitution and Bylaws means a member entitled to vote on Institute matters.

ARTICLE III

Dues and Fees

Sec. 1—Dues and fees shall be specified in the Bylaws.

Sec. 2—Under exceptional circumstances, the payment of fees and dues may be deferred or waived in whole or in part by the Board of Directors.

ARTICLE IV

Officers and Directors

Sec. 1—The governing body of the Institute shall be the Board of Directors and shall consist of the President, Vice-President, Secretary, Treasurer, Editor, six Directors elected-at-large, three appointed Directors, one Regional Director elected by each Region, and the two most recent past Presidents.

Sec. 2—The Corporate Officers of the Institute shall be the President, Vice-President, Secretary, Treasurer, and Editor.

Sec. 3—The terms of office for Directors elected-at-large shall be for three years; for

appointed Directors, one year; for Regional Directors, two years; and for all Corporate Officers, one year, except as provided in Article VI, Section 1.

Sec. 4—Each year of a term of office established in Article IV shall begin with the assembly of the Board of Directors at its annual meeting and terminate with the assembly of the Board of Directors at its following annual meeting.

Sec. 5—No Corporate Officer or Director shall receive, directly or indirectly, any salary, traveling expenses, compensation, or emolument from the Institute, unless authorized by the Board of Directors or by the Bylaws.

Sec. 6—The United States and Canada, and other areas at the discretion of the Board of Directors, shall be divided into Regions, which shall be specified in the Bylaws. The Board of Directors shall delineate the Regions, make changes in the number of Regions, as it deems desirable, and number the Regions with consecutive numbers. The voting members of each Region shall elect one representative who shall thereby become a member of the Board of Directors and be designated a Regional Director.

ARTICLE V

Management

Sec. 1—The President shall be the regular presiding officer at meetings of the Board of Directors and at meetings of the Institute. He shall be an ex officio member of each committee.

The Vice-President shall assume the duties of the President in the absence or incapacity of the President.

In the event that neither the President nor the Vice-President can personally act, the Board of Directors may elect a chairman from its membership who is authorized to perform the presidential duties during the period of the incapacity of the President and Vice-President. The tenure of such temporary chairman shall be at the discretion of the Board of Directors.

Sec. 2—The Board of Directors shall manage the affairs of the Institute. An annual report on the activities and finances of the Institute shall be made to the members.

Eight members of the Board of Directors shall constitute a quorum.

Sec. 3—The Board of Directors may make, amend, or revoke Bylaws to this Constitution. The proposed changes and reasons therefor shall be mailed to all members of the Board at least twenty days before the stipulated meeting at which the vote shall be taken. Two thirds of all votes cast at the stipulated meeting shall be required to approve any new Bylaw, amendment, or revocation.

Sec. 4—The Secretary shall be responsible for the preparation for all meetings of the Board of Directors and all principal meetings of the Institute and the recording of the minutes of such meetings. He shall be responsible for the

correspondence of the Institute and the keeping of full records thereof, and shall be responsible for the provision of such information from them as is requested by the Board of Directors.

Sec. 5 — The Treasurer, under the control of the Board of Directors, shall have general supervision of the fiscal affairs of the Institute and shall be responsible for the keeping of the books of account. An annual audit of the affairs of the Institute shall be made by certified public accountants and submitted to the Board.

Sec. 6 — All funds received by the Institute shall be deposited in an account requiring the signatures of at least two of the following for withdrawal: President, Vice-President, Secretary, Treasurer, and Editor. Funds from this account may be deposited in other accounts authorized and limited in size by the Board of Directors. Funds from these accounts shall be withdrawable on the signatures of authorized bonded individuals for current disbursements. Before additional funds are transferred from the first-mentioned account to another account, the individuals responsible for such other accounts shall submit a statement of the disposition of the previously expended funds to the Treasurer.

Sec. 7 — All committees shall be appointed by the Board of Directors or in such manner as the Board may designate.

Sec. 8 — The fiscal year of the Institute shall end with the thirty-first day of December.

ARTICLE VI

Nomination, Election, and Appointment of Officers and Directors

Sec. 1 — On or before July first of each year, the Board of Directors shall submit to qualified voters a list of nominations containing at least one name each for the offices of President and Vice-President, at least four names for the office of Director elected-at-large, the names of all nominees for the office of Regional Director, and shall entertain nominations by petition for all of the offices specified.

Nominations by petition may be made by letter to the Board of Directors setting forth the name of the proposed candidate and the office for which it is desired he be nominated. For acceptance a letter of petition must reach the Institute office before twelve o'clock noon on the last weekday prior to August fifteenth of any year and shall be signed by at least one hundred voting members qualified to vote for the office of the candidate nominated.

Each proposed nominee shall be consulted and if he so requests his name shall be withdrawn. The names of proposed nominees who are not eligible under the Constitution shall be withdrawn by the Board.

On or before September first, the Board of Directors shall submit to all voting members as of August fifteenth, a list of nominees for the offices of President, Vice President, and Director elected-at-large, and shall submit to all such voting members of each Region a list of their nominees for the office of Regional Director, the names of the nominees for each office being arranged in alphabetical order. The ballots shall carry a statement to the effect that the

order of the names is alphabetical for convenience only and indicates no preference.

Voting members shall vote for the candidates whose names appear on the list of nominees, by written ballots in plain sealed envelopes, enclosed within mailing envelopes marked "Ballot" and bearing the member's written signature. No ballots within unsigned outer envelopes shall be counted. No votes by proxy shall be counted. Only ballots arriving at the Institute office before twelve o'clock noon on the last weekday prior to October twenty-fifth shall be counted. Ballots shall be checked, opened, and counted under the supervision of the Tellers Committee between October twenty-fifth and the first Wednesday in November. The result of the count shall be reported to the Board of Directors at its next succeeding meeting and the nominees for President and Vice-President, the two nominees for Director elected-at-large, and the nominees for each office of Regional Director receiving the greatest number of qualified votes shall be declared elected. In the event of a tie vote the Board shall choose between the nominees involved.

Nominees for the office of Regional Director shall be members of and live in the Regions which nominate them. They shall be elected by the voting members of the Institute in the Region. The Regional Directors from even- and odd-numbered Regions shall be chosen by the Regions in even- and odd-numbered years, respectively. In placing the Regional Representation Plan into operation, or when new Regions are established, or when changes are made in Regions, candidates for the office of Regional Director may be nominated and elected for one-year terms as required to ensure representation during the period preceding their normal election years. No Regional Director shall have his term shortened by changes in Regions. Each Region shall have a Regional Committee whose duties shall include making at least one nomination for Regional Director from its Region during election years. In the event a Regional Director dies, is unable to serve, or is disqualified by removal from the Region, the Regional Committee shall appoint a Regional Director for the unexpired portion of the term. The organization and procedure of the Regional Committees for nominating candidates for Regional Director shall be specified in the Bylaws.

Sec. 2 — The Secretary, Treasurer, Editor and three appointed Directors shall be appointed by the Board of Directors at its annual meeting to serve until the next annual meeting or until their successors are appointed and accepted.

Sec. 3 — The Board of Directors is authorized to fill a vacancy other than Regional Director occurring in the governing body.

ARTICLE VII

Meetings

Sec. 1 — There shall be an annual meeting of the Board of Directors during January of each year at which newly-elected officers shall begin their terms of service, and the Board shall make necessary appointments.

Sec. 2 — There shall be an annual meeting of the Institute as soon as practicable after the

annual meeting of the Board of Directors at which reports of the Secretary and Treasurer shall be presented.

Sec. 3 — Meetings of the Board may be held at such times as are necessary to carry out the provisions of this Constitution and shall be held at such other times as any five members of the Board may determine, but only on notice to all members of the Board. The method of calling such special meeting shall be specified in the Bylaws.

ARTICLE VIII

Sections and Other Groups

Sec. 1 — The Board of Directors may authorize the establishment of sections and other groups of members for the purpose of promoting the interests of the Institute. The Board of Directors may, at its discretion, terminate the existence of any such group.

ARTICLE IX

Amendments

Sec. 1 — Amendments to this Constitution may be proposed by means of a resolution adopted by the Board of Directors or by means of a petition signed by at least one hundred voting members. Such proposed amendment or amendments shall be submitted to legal counsel by the Board of Directors, and if, in the opinion of such counsel, they are in accordance with the laws under which the Institute is organized, a copy shall be mailed with a ballot to each voting member.

Sec. 2 — Constitutional amendment ballots shall be mailed to the voting members at least sixty days before the date appointed for counting the ballots and the ballots shall carry a statement of the time limit for their return to the Institute office. The ballots after marking shall be placed in plain sealed envelopes, enclosed within mailing envelopes marked "Ballot" and bearing the member's written signature. Only ballots within signed outer envelopes shall be counted. No votes by proxy shall be counted. Only ballots arriving at the Institute office prior to the stated time limit shall be counted. The Tellers Committee shall count such votes and report to the Board of Directors at its next meeting. If the total vote be at least twenty per cent of the total voting membership and if at least sixty-seven per cent of all votes cast shall be favorable, the proposed amendment or amendments shall be immediately declared by the Tellers Committee to be adopted.

Sec. 3 — Amendments shall take effect thirty days after their adoption, but officers and officers-elect of the Institute at the time any amendment becomes effective shall continue in office until the end of the terms for which they were elected.

Sec. 4 — Copies of the amendments shall be distributed to the members as soon as practicable after adoption.

Sec. 5 — A complete history of amendments shall be kept in the files of the Institute.

West Coast I.R.E. Convention

SAN FRANCISCO—SEPTEMBER 24 THROUGH 26, 1947

Plans for the first postwar West Coast I.R.E. Convention, which will be held at the Palace Hotel, San Francisco, California, September 24 through 26, 1947, have been completed under the leadership of Dr. Karl Spangenberg, chairman, and his convention committee.

All of the sessions will take place at the Palace Hotel convention headquarters, as will the cocktail party, luncheon, and banquet.

A total of twenty-six papers will be presented by prominent authorities on general electronic subjects of interest to all members. The titles and authors of these papers were listed on pages 796 and 797 of the August issue of the PROCEEDINGS OF THE I.R.E. Summaries may be obtained through Herman E. Held, Announcements and Publicity Chairman, 420 Market Street, San Francisco, California, or through the authors themselves. It is not planned to issue preprints or reprints of the papers. Future publication plans have not been made definite, although it is hoped that many of the papers to be presented will appear in the PROCEEDINGS.

Dr. F. E. Terman of Stanford University, Past President of the I.R.E., will be the guest speaker of the banquet Friday evening, September 26.

Another social feature of the Convention will be the cocktail party on the first day, Wednesday, September 24, where Institute members may meet with old friends and associates of the profession.

An interesting group of inspection trips has been planned which will include the more important places of interest in the San Francisco Bay region, such as the National Advisory Committee for Aeronautics wind tunnels at Moffett Field, the new 184-inch

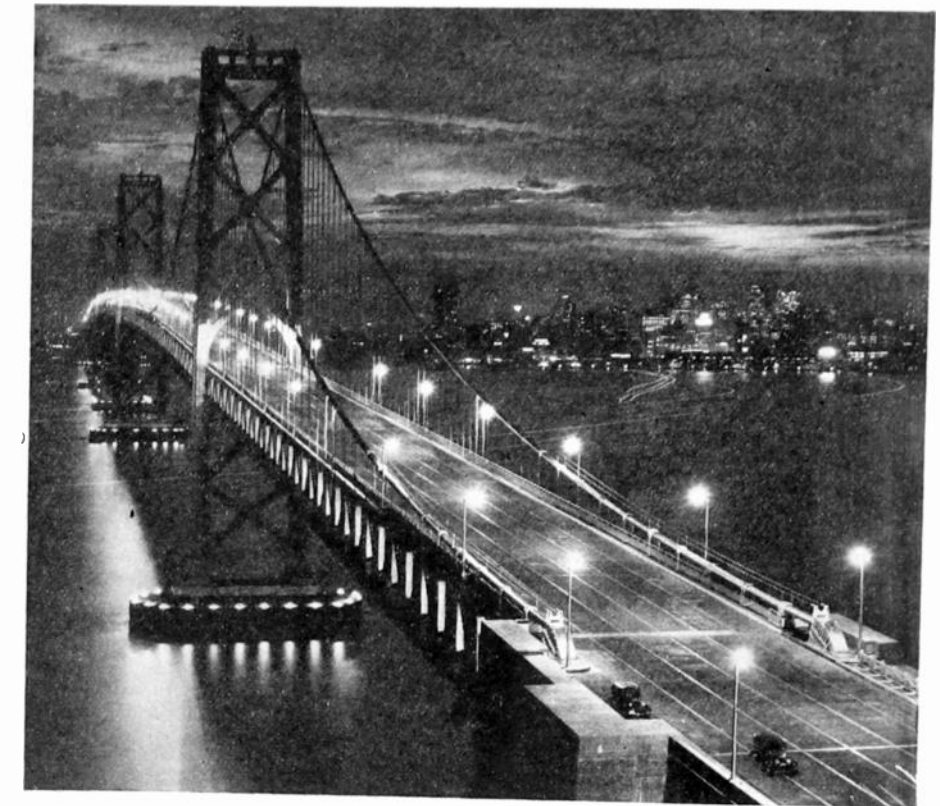

San Francisco Convention and Tourist Bureau

NIGHT VIEW OF SAN FRANCISCO BAY BRIDGE

cyclotron at the University of California at Berkeley, the Electronics Laboratory at Stanford University, as well as some of the electronic manufacturing plants in the Bay Area.

While no exhibits are being planned for

the Convention, all I.R.E. members have been invited to attend the West Coast Electronic Manufacturers Association's third annual show at the Hotel Whitcomb in San Francisco, which is being held the same week.

Industrial Engineering Notes

The following material is abstracted and published, by permission of the Radio Manufacturers Association, from the "Industry Report" of the Association of June 20, June 27, and July 3, 1947. It is regarded as of interest to a considerable group of active professional members of The Institute of Radio Engineers. The courteous cooperation of RMA in permitting this publication is appreciated.

TRANSMITTING EQUIPMENT

From January through March, 1947, a.m. transmitters were ordered totaling \$1,191,360. During the same period orders for f.m. transmitters totaled \$1,832,822. Broadcasters in the United States ordered a total of transmitting and studio equipment during that period of \$5,506,173. Deliveries

were made by manufacturers who are members of the Association totaling \$3,257,394.

During April, 1947, manufacturers who are members of the Association produced 1,759,723 radio receivers. During May, 1,316,373 receivers were produced. Accordingly there have been manufactured during 1947, through May, 7,397,502 receivers.

Television receiver production continued, with 7886 produced during April, 1947, and 8690 such receivers produced during May, 1947. The May production included 1706 console television receivers, 5646 table models, and 1338 radiophonograph combination consoles. Total television receiver production from January through May, 1947, was 34,895. Of these, 223 were of the projection type.

F.m. receivers produced in April, 1947, were 112,256, and in May, 84,507. From January through May, 1947, there have been manufactured 368,939 receivers providing f.m. reception, either alone or with a.m. reception included.

SCHOOL EQUIPMENT

The President of the Radio Manufacturers Association, Max F. Balcom, has appointed Lee McCanne of the Stromberg-Carlson Company, Rochester, N. Y., to the Chairmanship of the RMA School Equipment Committee. A. K. Ward, of the RCA Victor Division of Camden, N. J., has been appointed to the Vice-Chairmanship of that Committee. The publication of a report on recommended basic standards for school equipment for sound recording and playback, prepared by this Committee, has been authorized. This report, together with an earlier report on "School Sound Systems," is for distribution to schools and colleges by the United States Office of Education.

ENGINEERING AND ALLIED COMMITTEES

Dr. W. R. G. Baker, President of The Institute of Radio Engineers, has been re-

appointed Director of the RMA Engineering Department, and remains a member of the RMA Board of Directors. Virgil M. Graham, a Director of the I.R.E., has been reappointed by Dr. Baker to the post of Associate Director of the RMA Engineering Department. L. C. F. Horle, Past President of the I.R.E., was also reappointed by Dr. Baker as RMA Chief Engineer, and Manager of the RMA Data Bureau.

The plans of the Association in the amateur radio field are under consideration by the RMA Amateur Radio Committee, of which the Chairman is Lloyd A. Hammarlund of the Hammarlund Manufacturing Company, Inc., of New York City.

The RMA Engineering Committee on Power Transformers, under the Chairmanship of Arni Helgason, has continued its activities.

The Service Committee of the Association, under the Chairmanship of W. L. Parkinson of the General Electric Company, Bridgeport, Connecticut, has arranged for a thorough poll of individuals and organizations engaged in radio servicing with the aim of clarification of symbols appearing in the manufacturers' service data and textbooks in schematic representation of the circuits. The poll will be conducted by the John F. Rider Publishing Company of New York.

WEST COAST CONVENTION

The West Coast Manufacturers Association is planning to co-operate fully in a convention under the auspices of the Pacific Coast and Rocky Mountain Sections of The Institute of Radio Engineers in San Francisco, September 24-26, 1947. Leading national officers of the I.R.E. are scheduled to attend this convention.

TEST EQUIPMENT PRODUCTION

The RMA Parts Division, through its Instrument and Test Equipment Section, is conducting a survey to ascertain total production of various types of test equipment and appropriate methods of clarifying individual items of equipment by using standard terminology. The poll data are under analysis at RMA headquarters and will become available to those participating in the study.

AVIATION TECHNICAL STUDIES

The Technical Development Service, formerly under the Federal Airways office, has been reorganized as an independent service within the Civil Aeronautics Administration. Its Chairman is Charles I. Stanton, C.A.A. Deputy Administrator. The Service will "study and appraise all new schemes of air navigation, landing and traffic-control aids, and systems which may be under development, with a view to determining both their excellence, their timing, and the effect they may have on C.A.A. programs."

RADIO TUBES

Production of radio receiving tubes totaled 16,181,672 in April and 14,575,237 in

May. Output for May included 7,969,315 for new set equipment; 3,279,920 for replacement in individual cartons; 3,291,922 for export; and 34,080 for government agencies. The number of tubes produced from January through May totaled 88,305,323.

NEW RADAR EQUIPMENT FOR TRANSPORT PLANES

The Navy Department has contracted for the purchase of 100 sets of a new type airborne radar (designated APS-42) for installation on naval transport planes. Specifications were determined by the Army, Navy, and American Airlines after more than a year of collaboration. Reliability and ease of maintenance were prime factors of consideration. A pilot will be able to "see" land masses up to 100 miles ahead of him and, when using radar beacons, may determine bearing and distances up to 225 miles.

RADIO FOR LOCATING OIL

The F.C.C. has licensed more than 500 "geological radio stations" to probe the earth's surface for new sources of oil. A geophysical exploration company has also been authorized to experiment with radar (in the 2900-3246 Mc. band) to search the Gulf tidelands. The possibility that geological radio stations may some day be employed to ferret out new mineral and metal deposits also, has led the Commission to increase from nine to forty-nine the number of radio channels allocated to this service.

RADIO EQUIPMENT IN NAVAL CONSTRUCTION PROGRAM

Authorization of \$7,000,000 for a radio transmitting station, at a location to be determined, and construction of a bomb-proof radio communications center in Guam, was on the list of projects included in the \$255,000,000 naval construction program for which the House Armed Services Committee recently approved legislation.

UTILIZATION OF GOVERNMENT RESEARCH BY-PRODUCT VALUE

The proposed Technical Information and Services Act makes plans for a broadened use of the industrial by-product value of expenditures by the Government on military and other basic research. Through the Department of Commerce it will provide a needed central reference source for technical information of benefit to all American business but particularly valuable to smaller businesses which do not have research facilities or technical staffs.

RMA ACTIVITIES

The following RMA Engineering meetings were held:

July 8—Committee on Type Designations.

July 21—Subcommittee on Antennas and Radio-Frequency Lines.

July 23—Committee on Thermoplastic Hookup Wire.

CITIZENS RADIO SERVICE EQUIPMENT STANDARDS ISSUED

The F.C.C. has announced technical standards for equipment to be employed in the Citizens Radio Service, which have been worked out by the Commission's engineering staff in co-operation with radio manufacturers. The technical requirements and minimum equipment specifications, together with the procedure for securing type approval of equipment to be used in the new service, were outlined in F.C.C. Public Notice 8387, copies of which may be obtained from the Secretary of the Federal Communications Commission, Washington 25, D. C.

Requirements differ only slightly from the notice to manufacturers on the subject which was issued by the F.C.C. on April 3, 1947. The one major change is the power limitation of 10 watts for equipment using the frequencies 462-468 Mc., which was made to prevent the blanketing of Class B Stations by the higher-powered Class A Stations.

In its frequency allocations report of May 25, 1945, the Commission set apart the band of 460-470 Mc. for the purposes of the proposed Service, which will provide an opportunity for adapting short-range radio-communication equipment, including some of the pocket-size sets now under development, to varied personal needs. It is felt that such facilities will provide, among other advantages, contact in isolated places, and augment the established services in time of accident or disaster.

No licences are being issued to the general public, as yet, except on an experimental basis. When the Citizens Radio Service has been established and proper arrangements made, authorizations for the use of the equipment will be necessary as with all types of radio communication. In this case the Commission contemplates a simple procedure requiring no technical knowledge by the prospective user.

INDUSTRIAL HEATING EQUIPMENT REGULATIONS REVISED BY F.C.C.

The F.C.C. has amended the above regulations to permit tentative certification by manufacturers on equipment manufactured and assembled during the period July 1 to December 31, 1947.

RADAR REFLECTOR

The United States Coast Guard has announced the development of an experimental "radar reflector" which can enable ships with radar to spot buoys at up to twice the present distance and in heavy fog. The device, designed to fit on ordinary buoys, will give a much stronger echo to radar beams and make a buoy visible to radar-equipped ships up to ten miles away.

F.M. STATIONS

Conditional grants for 14 new f.m. broadcast stations have been issued by the F.C.C. The Commission's records showed a total of 238 f.m. stations on the air as of Thursday, July 2, 1947.

Sections

Chairman		Secretary	Chairman		Secretary
P. H. Herndon c/o Dept. in charge of Federal Communication 411 Federal Annex Atlanta, Ga.	ATLANTA September 19	M. S. Alexander 2289 Memorial Dr., S.E. Atlanta, Ga.	E. T. Sherwood Globe-Union Inc. Milwaukee, Wis.	MILWAUKEE	J. J. Kircher 2450 S. 35th St. Milwaukee 7, Wis.
H. L. Spencer Associated Consultants 18 E. Lexington Baltimore 2, Md.	BALTIMORE	G. P. Houston, 3rd 3000 Manhattan Ave. Baltimore 15, Md.	R. R. Desaulniers Canadian Marconi Co. 211 St. Sacrament St. Montreal, P.Q., Canada	MONTREAL, QUEBEC October 8	R. Matthews Federal Mfg. Co. 9600 St. Lawrence Blvd. Montreal 14, P.Q., Can- ada
W. H. Radford Massachusetts Institute of Technology Cambridge, Mass.	BOSTON	A. G. Bousquet General Radio Co. 275 Massachusetts Ave. Cambridge 39, Mass.	J. E. Shepherd 111 Courtenay Rd. Hempstead, L. I., N. Y.	NEW YORK October 1	I. G. Easton General Radio Co. 90 West Street New York 6, N. Y.
A. T. Consentino San Martin 379 Buenos Aires, Argentina	BUENOS AIRES	N. C. Cutler San Martin 379 Buenos Aires, Argentina	L. R. Quarles University of Virginia Charlottesville, Va.	NORTH CAROLINA- VIRGINIA	J. T. Orth 4101 Fort Ave. Lynchburg, Va.
R. G. Rowe 8237 Witkop Avenue Niagara Falls, N. Y.	BUFFALO-NIAGARA September 17	R. F. Blinzler 558 Crescent Ave. Buffalo 14, N. Y.	K. A. Mackinnon Box 542 Ottawa, Ont. Canada	OTTAWA, ONTARIO September 18	D. A. G. Waldock National Defense Headquarters New Army Building Ottawa, Ont., Canada
J. A. Green Collins Radio Co. Cedar Rapids, Iowa	CEDAR RAPIDS	Arthur Wulfsburg Collins Radio Co. Cedar Rapids, Iowa	P. M. Craig 342 Hewitt Rd. Wyncote, Pa.	PHILADELPHIA	J. T. Brothers Philco Radio and Tele- vision Tioga and C Sts. Philadelphia 34, Pa.
Karl Kramer Jensen Radio Mfg. Co. 6601 S. Laramie St. Chicago 38, Ill.	CHICAGO September 19	D. G. Haines Hytron Radio and Elec- tronics Corp. 4000 W. North Ave. Chicago 39, Ill.	E. M. Williams Electrical Engineering Dept. Carnegie Institute of Tech. Pittsburgh 13, Pa.	PITTSBURGH OCTOBER 13	E. W. Marlow 560 S. Trenton Ave. Wilkinburgh PO Pittsburgh 21, Pa.
J. F. Jordan Baldwin Piano Co. 1801 Gilbert Ave. Cincinnati, Ohio	CINCINNATI September 16	F. Wissel Crosey Corporation 1329 Arlington St. Cincinnati, Ohio	Francis McCann 4415 N.E. 81 St. Portland 13, Ore.	PORTLAND	A. E. Richmond Box 441 Portland 7, Ore.
W. G. Hutton R.R. 3 Breckville, Ohio	CLEVELAND September 25	H. D. Seielstad 1678 Chesterland Ave. Lakewood 7, Ohio	N. W. Mather Dept. of Elec. Engineering Princeton University Princeton, N. J.	PRINCETON	A. E. Harrison Dept. of Elec. Engineering Princeton University Princeton, N. J.
C. J. Emmons 158 E. Como Ave. Columbus 2, Ohio	COLUMBUS October 10	L. B. Lamp 846 Berkeley Rd. Columbus 5, Ohio	A. E. Newlon Stronberg-Carlson Co. Rochester 3, N. Y.	ROCHESTER	J. A. Rodgers Huntington Hills Rochester, N. Y.
L. A. Reilly 989 Roosevelt Ave. Springfield, Mass.	CONNECTICUT VALLEY	H. L. Krauss Dunham Laboratory Yale University New Haven, Conn.	E. S. Naschke 1073-57 St. Sacramento 16, Calif.	SACRAMENTO	G. W. Barnes 1333 Weller Way Sacramento, Calif.
Robert Broding 2921 Kingston Dallas, Texas	DALLAS-Ft. WORTH	A. S. LeVelle 308 S. Akard St. Dallas 2, Texas	R. L. Coe Radio Station KSD Post Dispatch Bldg. St. Louis 1, Mo.	St. LOUIS	N. J. Zehr Radio Station KWK Hotel Chase St. Louis 8, Mo.
E. L. Adams Miami Valley Broadcast- ing Corp. Dayton 1, Ohio	DAYTON	George Rappaport 132 E. Court Harshman Homes Dayton 3, Ohio	Rawson Bennett U. S. Navy Electronics Laboratory San Diego 52, Calif.	SAN DIEGO October 7	C. N. Tirrell U. S. Navy Electronics Laboratory San Diego 52, Calif.
P. O. Frincke 219 S. Kenwood St. Royal Oak, Mich.	DETROIT September 19	Charles Kocher 17186 Sioux Rd. Detroit 24, Mich.	W. J. Barclay 955 N. California Ave. Palo Alto, Calif.	SAN FRANCISCO	F. R. Brace 955 Jones San Francisco 9, Calif.
N. J. Reitz Sylvania Electric Prod- ucts, Inc. Emporium, Pa.	EMPORIUM	A. W. Peterson Sylvania Electric Prod- ucts, Inc. Emporium, Pa.	J. F. Johnson 2626 Second Ave. Seattle 1, Wash.	SEATTLE October 9	J. M. Patterson 7200-28 N. W. Seattle 7, Wash.
F. M. Austin 3103 Amherst St. Houston, Texas	HOUSTON	C. V. Clarke, Jr. Box 907 Paradise, Texas	C. A. Priest 314 Hurlburt Rd. Syracuse, N. Y.	SYRACUSE	R. E. Moe General Electric Co. Syracuse, N. Y.
H. I. Metz Civil Aeronautics Admin- istration 84 Marietta St., NW Atlanta, Ga.	INDIANAPOLIS	M. G. Beier 3930 Guilford Ave. Indianapolis 5, Ind.	C. A. Norris J. R. Longstagg Ltd. 11 King St., W. Toronto, Ont. Canada	TORONTO, ONTARIO	C. G. Lloyd 212 King St. W. Toronto, Ont., Canada
C. L. Omer Midwest Eng. Devel. Co. Inc. 3543 Broadway Kansas City 2, Mo.	KANSAS CITY	Mrs. G. L. Curtis 6003 El Monte Mission, Kansas	O. H. Schuck 4711 Dupont Ave. S. Minneapolis 9, Minn.	TWIN CITIES	B. E. Montgomery Engineering Department Northwest Airlines Saint Paul, Minn.
R. C. Dearle Dept. of Physics University of Western Ontario London, Ont., Canada	LONDON, ONTARIO	E. H. Tull 14 Erie Ave. London, Ont., Canada	L. C. Smeby 820-13 St. N. W. Washington 5, D. C.	WASHINGTON	T. J. Carroll National Bureau of Standards Washington, D. C.
C. W. Mason 141 N. Vermont Ave. Los Angeles 4, Calif.	LOS ANGELES September 16	Bernard Walley RCA Victor Division 420 S. San Pedro St. Los Angeles 13, Calif.	L. N. Persio Radio Station WRAC Williamsport 1, Pa.	WILLIAMSPORT	R. G. Petts Sylvania Electric Prod- ucts, Inc. 1004 Cherry St. Mortonsville, Pa.

Sections

SUBSECTIONS

Chairman		Secretary	Chairman		Secretary
J. D. Schantz Farnsworth Television and Radio Company 3700 E. Pontiac St. Fort Wayne, Ind.	FORT WAYNE (Chicago Subsection)	S. J. Harris Farnsworth Television and Radio Co. 3702 E. Pontiac Fort Wayne 1, Ind.	A. R. Kahn Electro-Voice, Inc. Buchanan, Mich.	SOUTH BEND (Chicago Subsection)	A. M. Wiggins Electro-Voice, Inc. Buchanan, Mich.
F. A. O. Banks 81 Troy St. Kitchener, Ont., Canada	HAMILTON (Toronto Subsection)	E. Ruse 195 Ferguson Ave., S. Hamilton, Ont., Canada	W. M. Stringfellow Radio Station WSPD 136 Huron Street Toledo 4, Ohio	TOLEDO Detroit Subsection	M. W. Keck 2231 Oak Grove Place Toledo 12, Ohio
K. G. Jansky Bell Telephone Labor- atories Box 107 Red Bank, N. J.	MONMOUTH (New York Subsection)	L. E. Hunt Bell Telephone Labora- tories Deal, N. J.	W. A. Cole 323 Broadway Ave. Winnipeg, Manit., Can- ada	WINNIPEG (Toronto Subsection)	C. E. Trembley Canadian Marconi Co. Main Street Winnipeg, Manit., Can- ada

SMPE SEMIANNUAL
CONVENTION

The Society of Motion Picture Engineers will hold its Sixty-second Semiannual Convention, which will feature a Theater Engineering Conference, October 20 through 24, 1947, at the Hotel Pennsylvania, New York City.

The Theater Engineering Conference will, according to present plans, include nine sessions on various aspects of the subject. These sessions will be clinics at which experts, consisting principally of engineering representatives of various manufacturers and architects, will present short formal papers on various aspects of the particular subject, to be followed by a discussion from the floor permitting an exchange of information regarding new ideas and products.

The tentative program includes sessions on physical construction, seating and viewing arrangements, floor coverings, theater television, lighting, acoustics, safety and maintenance, ventilating and air conditioning, and display.

It is hoped that the two sessions on theater television tentatively scheduled for Tuesday and Thursday evenings will include at least one actual demonstration in a theater. It is also hoped that there will be a discussion of new methods of rapid processing of 35-mm. motion picture films, as well as a discussion on the relation of equipment to theater construction and the practical use of television in a theater.

Widespread interest is already evident throughout the country and a large number of theater owners and their representatives, theater architects, and engineers representing various manufacturers in the field will attend.

The SMPE cordially invites I.R.E. members to attend this Convention.

NATIONAL ELECTRONICS
CONFERENCE

Many universities, research organizations, and industries will participate in the presentation of such subjects as infrared developments, advancements in color television, antennas, guidance devices for the blind, instruments for industry, and guided missiles, at the 1947 National Electronics Conference, to be held in Chicago November 3 through 5, 1947. Noted engineers, research workers, and educators will deliver these papers. The majority of the exhibits, sponsored by a wide variety of organizations, will be of an educational nature.

INSTITUTE REPRESENTATIVES

At its July 1, 1947, meeting, the Executive Committee approved, on behalf of the Board of Directors, the appointment of Mr. George H. Scott as Institute Representative at the University of Arkansas; and of Professor H. M. Hess as Institute Representative at Wayne University, to replace Professor G. W. Carter.

RMA-I.R.E. CORRELATING
COMMITTEE

Technical Secretary Laurence G. Cumming has been appointed a member of the Executive Committee of the RMA.

N.D.R.C. PROPAGATION SUMMARY
REPORT AVAILABLE

The Columbia University Press is printing the three volumes of the Summary Technical Report of the Committee on Propagation of N.D.R.C. to meet the government requirements. While no copies will be printed for public sale, the Columbia University Press has expressed a willingness to make an over-run of any or all of these volumes sufficient to fill orders, at cost, that are received before the volumes go to press. Orders should be sent to the Columbia University Press, c/o Mr. Wallace Waterfall, Columbia University, 64th Floor, Empire State

Building, New York, New York. An abstract of the Table of Contents is given below:

*Committee on Propagation Summary
Technical Report**Volume 1.—Historical and Technical Survey**Part 1. History*

Origin and Organization
Objectives and Research Agencies
Chronological Record
Results and Recommendations

Part 2. Summary

Standard Propagation
Elementary Theory of Non-Standard Propagation
Meteorological Measurements
Transmission Experiments
General Meteorology and Forecasting
Scattering and Absorption of Microwaves

Part 3. Conference Reports

Five Reports on Standard Propagation
Twelve Reports on Non-Standard Propagation

Part 4. Bibliography of Reports on Tropospheric Propagation

Glossary
Bibliography
Index

*Volume 2.—Radio Wave Propagation Experiments**Part 1. Transmission Experiments**Part 2. Meteorology*

Part 3. Five Chapters covering Reflection Coefficients, Dielectric Constant Absorption and Scattering, Storm Detections, Echoes and Targets, and Angle-of-Arrival Experiments.

Bibliography
Glossary
Index

Volume 3.—The Propagation of Radio Waves through the Standard Atmosphere

Introduction and Objectives
Fundamental Relations
Antennas
Factors Influencing Transmission
Calculation of Radio Gain
Coverage Diagrams
Propagation Aspects of Equipment Operation
Diffraction by Terrain
Targets
Siting

Books

Radar Engineering, by Donald G. Fink

Published (1947) by McGraw-Hill Book Company, 330 W. 42 Street, New York 18, N. Y. 626 pages+18-page index+xii pages. 471 figures. 6×9½ inches. Price, \$7.00.

This book contains a collection of the new electronic techniques developed during the war and applied to the field of radio methods for the detection and tracking of moving or stationary targets. Obviously, in view of the very great progress made in this field during the war, it would be impossible to cover all developments in great detail and the author has done a remarkably good job in selecting the more important new techniques and writing a technical account of these in sufficient detail to give the reader an over-all understanding of the problems of radar design. The general kinds of problems considered in this book are as follows: an introduction to the radar concept; the methods of presentation of radar information; the principles of pulse generation and transmission; the factors influencing the maximum range of detection, including the receiver-noise-figure concept; the reflecting characteristics of radar targets; the theory and design of transmitting and receiving circuits for radar pulses; the propagation of radio waves on frequencies used for radar, i.e., above the h.f. band; and the principal technical details of several American radar sets designed for various specific purposes.

The book appears to be remarkably free of technical errors. The only things noticed, outside of minor typographical errors, were as follows:

(1) On page 98 the author gives an incorrect explanation for the decreasing value of the relative amplitude of a repetitive pulse spectrum; his statement that the sine of an angle decreases more rapidly than the angle itself is obviously incorrect.

(2) On page 133 the author states that the available noise power from an antenna matched to a receiver is $2kT\Delta f$; i.e., twice the value from the receiver input resistance alone. A factor of 2 does enter into the effective signal-to-noise ratio since only half of the signal power is available in the matched case. Thus his final result is correct but his explanation is error.

(3) The figure on page 270 illustrating a method of plotting the vertical coverage of a radar set is not sufficiently well-described to be useful, and, in addition, appears to be in error.

It is considered that this book will meet the needs of engineers who wish to be brought up to date on the developments of radar and associated electronic techniques made during the war. As has been so characteristic of previous books by the author, the treatment is authoritative and lucid.

KENNETH A. NORTON
National Bureau of Standards
Washington 25, D.C.

Theory and Application of Radio-Frequency Heating, by George H. Brown, Cyril N. Hoyler, and Rudolph A. Bierwirth

Published (1947) by D. Van Nostrand Company, Inc., 250 Fourth Avenue, New York 3, N. Y. 351 pages+6-page index+12-page appendixes+xiv pages. 264 figures. 6×9 inches. Price, \$6.50.

Radio-frequency heating has grown so rapidly that sound engineering theory of underlying principles has been greatly neglected. This book provides in a very successful manner some of that basic thinking so necessary to those engaged in the application of radio-frequency energy to industrial heating problems.

The greatest benefit from the information contained in this book will be derived by the industrial engineer with sound radio training who is now engaged in application work. The information is sufficiently advanced that only engineers with good basic training will have a full understanding of the analytical material presented. However, a less technical reader will find the conclusions drawn from the mathematical analyses easy to understand by study of the curves which, in most cases, illustrate the mathematical results. The method in which the basic theory of conduction, induction, and dielectric heating is presented should eliminate much of the confusion surrounding the phenomena of radio-frequency heating.

The book covers the field of radio-frequency heating in a thorough manner and many satisfactory illustrations or laboratory tests are described and analyzed in detail. The first section of the book deals with the induced currents in cylindrical and flat-sheet material, the efficiency of heating coils, the effective temperature on electrical properties of metals, and many typical induction-heating problems. The second portion of the book covers heat flow in metals and how induced currents and heat flow combine to allow case hardening of steels. The metallurgical aspects, so important in obtaining the desired results in steel hardening, have, however, not been included by the authors. The latter part of the book deals with the heating of poor electrical conductors, commonly known as dielectric heating. Various applications are analyzed to illustrate the effect that frequency, voltage, and electrical properties of the material have on such heating jobs.

Because of its thoroughness, its splendid organization, and because it is one of the first of its kind in this field, this book should serve a useful purpose in all phases of this new industry.

T. P. KINN
Westinghouse Electric and
Manufacturing Company
Baltimore, Maryland

Electricity—Principles, Practice, Experiments, by Charles S. Siskind

Published (1947) by McGraw-Hill Book Company, Inc., 330 W. 42 St., New York 18, N. Y. 434 pages+8-page index+5-page appendix+ix pages. 93 illustrations. 5½×8½ inches. Price, \$2.60.

Intended for use in high schools, vocational classes and technical institutes, this new book introduces the non-engineering student to the subject of electricity and electrical machinery, with a minimum of mathematics and a maximum of experiment and practice. Each chapter is concluded with sets of questions, problems, and experiments, chosen to emphasize the important points of the chapter. The experiments seem planned for a minimum of simple equipment, much of which could be built by the students, if necessary.

The book covers d.c., and single-phase a.c., circuits and machines, with a large amount of space given to the various types of single-phase a.c. motors. To the reviewer it seems unfortunate that polyphase circuits and machines were omitted, in view of their importance industrially, and the comprehensive title of the book.

When discussing design and performance of typical circuits, instruments, or machines, the author has given clear treatment, especially in stating carefully the factors influencing a given design. However, when stating a general principle the author is inclined to errors, either in oversimplifying, or in drawing general conclusions from special cases.

The book concludes with a listing of visual aids and sources from which they may be obtained, and a set of brief biographies of outstanding electrical scientists.

J. D. RYDER
Iowa State College
Ames, Iowa

Standard FM Handbook, edited by Milton B. Sleeper

Published (1947) by FM Company, Great Barrington, Massachusetts. 149 pages+1-page index. 222 figures, illustrations, and tables. 8½×11½ inches. Price: \$2.00, paper; \$4.00, cloth.

This "handbook" is a selection of articles which have previously appeared in the magazine *FM and Television*. Most of the articles are devoted to broadcast frequency modulation, but systems such as police, railroad, facsimile, and others are also described.

The treatment of the theory of frequency modulation by Rene T. Hemmes is well done. The consideration of automatic frequency-control circuits by Burt Zimet includes not only a thorough consideration of

such circuits, but additional information on reactance tubes and discriminators.

The book is most useful to those interested in broadcast frequency modulation. Chapter XV is a handy collection of the Federal Communications Commission frequency-modulation standards of good engineering practice.

Chapter I deviates from the purpose of a technical handbook by presentation of the "background of frequency modulation." This background is a portrayal of the diffi-

culties encountered in the promotion of frequency modulation. Various controversies are mentioned, but only one side is presented. Such material, together with much of the descriptive material on specific systems, becomes excess baggage in a handbook of this type.

The complete lack of references is inexcusable for a handbook, since the user will obviously require more detailed information which must be obtained elsewhere. Also lacking are more extensive tables of Bessel

function which are so often used in frequency modulation.

Although coverage of the frequency-modulation field is by no means complete, considering the early postwar publication a helpful amount of information is collected. If extensive use is contemplated the library binding is recommended, since the paper-bound issue soon becomes rather tattered.

MURRAY G. CROSBY
Paul Godley Company
Upper Montclair, N. J.

I.R.E. People

HAROLD B. RICHMOND

Harold B. Richmond (A'14-M'23-F'29), chairman of the board of General Radio Company, was given the D.Eng. degree by Norwich University, Northfield, Vermont, on June 2, 1947, for his pioneer radio service, his work on guided missiles in World War II, and his interest in engineering education.

A graduate of the Massachusetts Institute of Technology, Mr. Richmond has served for eleven years as a member of the Corporation of M.I.T. and is trustee of Northeastern and Norwich Universities. He has been president of the Radio Manufacturers' Association, and was recently elected board chairman of the Scientific Apparatus Makers of America. Joining the General Radio organization in 1919, he became secretary in 1921, assistant treasurer in 1924, treasurer in 1926, and chairman of the board in 1944. Mr. Richmond is a Fellow of the American Institute of Electrical Engineers.



HAROLD B. RICHMOND

PETER C. SANDRETTO

Peter C. Sandretto (A'30-M'40-SM'43) has been named director of aviation for the International Telecommunications Laboratories.

Born April 14, 1907, at Point Canavese, Italy, Mr. Sandretto received the B.S. degree from Purdue University in 1930 and the E.E. degree in 1938. He has been a broadcast radio operator, a member of the aircraft radio group of the Bell Telephone Laboratories, and superintendent of United Air Lines' communications laboratories.

In 1942, Mr. Sandretto entered military service as assistant chief of the radar division at Headquarters Army Air Forces. He later held other important posts, attaining the rank of colonel, and receiving the Bronze Star for his electronics work and its contribution to the efficiency of the B-29 program in the Central Pacific.

Upon leaving the Army late last year, he joined the International Telephone and Telegraph Corporation. Mr. Sandretto is the author of the text, "Principles of Aeronautical Radio Engineering."



PHILIP G. CALDWELL

PHILIP G. CALDWELL

Philip G. Caldwell (A'41) has been appointed manager of sales of General Electric Company's transmitter division at Syracuse.

A native of Oakland, California, and a graduate of Stanford University, Mr. Caldwell has been with General Electric since 1932. After spending eight years in Schenectady on various engineering and commercial assignments, he was transferred to California where he was district electronics engineer for four years with headquarters at Los Angeles. He returned to Schenectady in 1944 to become sales manager of aircraft and marine equipment in the transmitter division, and television equipment sales manager in 1946.

While in California, Mr. Caldwell was president of the Society of Television Engineers and also chairman of its committee which organized Television Broadcasters Association, Inc., at Chicago in 1944.

VICTOR M. FAREL

Victor M. Farel (A'38-SM'46) recently joined the Telonda International Corporation as assistant to the president. A graduate of the Polytechnical Institute of the University of Grenoble, France, he did his post-graduate work in radio and communications at the Ecole Supérieure d'Electricité in Paris.

From 1930 to 1937, Mr. Farel was associated with the Société Française Radio-Electrique in Paris, engaged chiefly in the design and installation of short-wave long-distance communications circuits and the television transmitter of the Eiffel Tower. In 1939 he joined the Radio Corporation of America, where he worked in high-power radio transmitter and industrial-oscillator design.

As staff engineer of the RCA International Division, Mr. Farel put the first post-war RCA broadcast transmitter in Belgium on the air in September, 1945. He then made survey trips to France, Denmark, Switzerland, the Dominican Republic, and Puerto Rico.

G. O. PETERS

G. O. Peters (M'26) was recently elected secretary of the Philadelphia Chapter of the Army Signal Association. Mr. Peters is an electrical engineer with the Army Communications Service Division, Signal Corps Plant Engineering Agency.

E. N. WENDELL

E. N. Wendell (A'26-M'33-SM'43-F'47), vice-president in charge of Federal Telephone and Radio Corporation, Clifton, N. J., has been elected a director of the Radio Manufacturers' Association for a three-year term.

Mr. Wendell joined the International Telephone and Telegraph system in 1925 and has been with Federal since the organization was formed.



E. H. RIETZKE

E. H. RIETZKE

E. H. Rietzke (A'20-M'31-SM'43) founded the Capitol Radio Engineering Institute in 1927 to fill the need he felt existed in the industry for advanced radio engineering training. At that time he was instructor in charge of the Navy's Advanced Radio Materiel School. This year, when the CREI celebrates its twentieth anniversary, finds him still actively engaged in technical education. He is president of CREI; he has just been re-elected for his fourth term as president of the National Council of Technical Schools, of which he is a founder; he represents the proprietary technical schools of the United States on the Technical Institute Committee of the Engineers' Council for Professional Development; and is a member of the Educational Committee of the Television Broadcasters Association. He is a past chairman of the Washington Section of The Institute of Radio Engineers.



FULTON CUTTING

Fulton Cutting (M'15-F'21) has been appointed assistant to the president for research and professor of physics at Stevens Institute of Technology.

Dr. Cutting was born on December 27, 1886, in New York City; he received the B.A. degree from Harvard University, and three advanced degrees: master of arts, master of electrical engineering, and doctor of science. Active in the radio field for more than thirty years, he organized the Colonial Radio Corporation of Buffalo, New York, and was president and chairman of the board of directors from 1924-1944. Previous to that he was president of Cutting and Washington, Inc., radio manufacturers.

From 1941 until the end of the war, Dr. Cutting was a member of the Operational Research Staff in the Office of the Chief Signal Officer, United States Army. He devoted his radio and electrical engineering experience to the study and advancement of radar countermeasures and counter-countermeasures (anti-jamming). He also worked in the field of guided missiles and countermeasures against guided missiles. He was a member of the ALSOS Mission, a tactical commission of Army, Navy, and civilian scientists.

Dr. Cutting was vice-president of The Institute of Radio Engineers in 1921 and president in 1922; he has also been on the Education and Investments committees. He has served on the board of directors of the Metropolitan Opera Association, Inc., the Prison Association of New York, and the New York Trade School. He is a member of the American Institute of Electrical Engineers and of the visiting committee for the Harvard Department of Physics.



ROGER J. PIERCE

Roger J. Pierce (S'40-A'40) has been made manager of radiocommunications for the Mutual Telephone Company of Hawaii.

Mr. Pierce graduated from Iowa State College with a degree in electrical engineering in 1932 and first went to work for the Collins Radio Company of Cedar Rapids, Iowa. In 1939 he traveled in Europe where he studied foreign radio installations. Following this he spent a year in graduate study at Ohio State University, after which he returned to Collins. In 1942 he became connected with the Radio Research Laboratory at Harvard University as a research associate, and a year later joined the Galvin Manufacturing Company in Chicago where he was in charge of the development of a microwave radar transponder beacon for the Army Air Forces. Later he became assistant chief engineer of Galvin, in charge of the transmitter department.

When he joined Mutual in August, 1946, Mr. Pierce was placed in charge of the company's radiotelephone operations which included interisland radiophone and wireless telegraph services and the Hawaii terminals of six transpacific telephone channels. In his new capacity he has general charge of both radio operations and radio engineering work, and will supervise activities of a radio laboratory-shop recently established to conduct development and experimental work in the field of radiocommunications.

Mr. Pierce is the author of several papers and holds a number of patents relative to frequency modulation. He is a member of Sigma Xi.



ROGER J. PIERCE



ROBERT K. DIXON

ROBERT K. DIXON

Robert K. Dixon (M'46) has been appointed the new-product manager of broadcast equipment in the commercial products division of Raytheon Manufacturing Company.

Mr. Dixon was previously connected with the Submarine Signal Company, an affiliate of Raytheon, doing development work on new types of Coast Guard radar beacons and radar-ranging accessories. A member of the company since 1942, he has behind him experience in the short-wave department of the Columbia Broadcasting System and four years with a National Broadcasting Company affiliate, Station WJAC, Johnstown, Pennsylvania.

While in the Navy, Mr. Dixon was in charge of radar installation in patrol bombers at Norfolk, Virginia. He joined the Raytheon staff as field engineer after his discharge and was given complete charge of the Seattle field engineering office as supervisor of installation and service of Raytheon-built Navy equipment. For more than two years during the war he headed the Raytheon field-engineering school at Nahant, Massachusetts, where customers were given practical instruction on radar operation.



CHARLES J. PANNILL

Charles J. Pannill (F'29) recently retired as president and director of Radiomarine Corporation of America.

A veteran in the field of wireless, Mr. Pannill served the radio industry and the Government continuously from 1902 when he became associated with Professor Reginald A. Fessenden at Old Point, Virginia, in his early wireless experiments. In November, 1914, he left the Marconi Company to join the United States Navy as Expert Radio Aide, and assisted in laying the foundation of the present Naval Communication Service. He has been with the Radio Corporation of America since January, 1928.

Mr. Pannill holds the first certificate of skill in radio, issued August 7, 1911, and Number 1 radio operator's license, issued December 13, 1912. He has also received several decorations for his work in radio.

Officers, Princeton Subsection

MAY, 1946—MAY, 1947

Charles W. Mueller was born in New Athens, Illinois, in 1912. He received the B.S. degree in electrical engineering from the University of Notre Dame and the S.M. degree from the Massachusetts Institute of Technology.



CHARLES W. MUELLER
CHAIRMAN

From 1936 to 1938 Mr. Mueller was associated with the Raytheon Manufacturing Company, supervising factory production of receiving tubes, then developing gas-tube voltage regulators and cold-cathode thyatrons. In 1938 he returned to M.I.T. where he received the degree of Sc.D. in physics in 1942. Since 1942 he has been with the RCA Laboratories Division of the Radio Corporation of America, engaged in research on high-frequency receiving tubes and secondary electron emission phenomena.

Dr. Mueller joined The Institute of Radio Engineers as a Student in 1935, transferred to Associate in 1936, and became a Senior Member in 1945. He was the 1945-46 vice-chairman of the Princeton Subsection. He is a member of the American Physical Society and Sigma Xi.

Alda V. Bedford was born in Winters, Texas, on January 6, 1904. He received the B.S. degree in electrical engineering from the University of Texas and the M.S. degree from Union College. While still at the University, he spent one summer with the Dallas Power and Light Company, and during the latter part of his school term was engaged as assistant in the physics department.

In 1925 Mr. Bedford joined the General Electric Company to work on sound recording, audio-frequency amplifiers, loudspeakers, sound printers for film, and television. Since 1929 he has been employed in the RCA Laboratories Division of the Radio Corporation of America, first on disk sound recording and then on



ALDA V. BEDFORD
SECRETARY-TREASURER

television. He received a Modern Pioneer Award from the National Association of Manufacturers in February, 1940, for inventions in the latter field.

Mr. Bedford joined The Institute of Radio Engineers in 1931 as an Associate and became a Senior Member in 1946.

tion with the modern democratic state in which St. John's College exists and, except for Rousseau's "Social Contract," not one of these five stands up squarely and fairly for the common man. The list, however, includes Plato, an apologist for the authoritarian state, Aquinas, an apologist for an authoritarian church, and Hobbes, an apologist for an authoritarian monarchy. It includes sceptics like Lucian, Montaigne, Swift, and Hume; it includes Pascal, who taught that man knows nothing and can know nothing by the unaided reason; it contains Malthus, Darwin, and Marx, who held that life is a ruthless struggle; it contains Hegel, the theoretical ancestor of Nazi Germany. You will not find in it the names of Thomas Jefferson, Ralph Waldo Emerson, Abraham Lincoln, Walt Whitman, or Mark Twain, whom I cite, not because they are Americans, but because they are believers in the common man." When professors disagree to such an extent upon the patterns of liberal education, there is obviously a need for a more specific definition of objectives and methods.

The American tradition in the liberal college has included education in both the arts and sciences. It is hardly necessary, however, in a consideration of liberal education for the engineer, to give particular attention to further study in the fields of science. It is also desirable to by-pass any discussion of the liberal values in the scientific education of the engineer. For the purpose of attempting a more specific definition it is well to utilize the dichotomy in engineering education presented in the 1940 report of the Society for the Promotion of Engineering Education, as the humanistic-social and scientific-technological stems, and to focus attention upon the humanistic-social education of the engineer. It is, however, precisely in this area where we find the wide differences among professors regarding the means for attainment of objectives. This confusion grows from the fundamental nature of the problem.

Since the Renaissance the realism and rationalism of science have had so strong an influence upon the fields of social studies that their development has been predominantly in the formulation of basic principles and methods for observing and securing facts of a quantitative nature. This is the reason we use the term "social science" instead of "social studies." We have sought so zealously for facts that we have given little attention to the appraisal of value. There are, however, three distinct points of view which must be correlated in the study of man and his institutions.

In a very elementary form they are: the determination of "what is," the appraisal of "what is good," and the conclusion as to "what ought to be." Unless the social studies are carried beyond the determination of "what is" in social-science theory into the value of judgments of "what ought to be,"

the aims and objectives of liberal education for the engineer and others are left to the chance influence of other social forces or to complete frustration in disagreement.

For the purpose of laying a foundation for value judgments, a knowledge of philosophy, ethics, and literature is basic. Such knowledge, however, has its limitations. Seeking an understanding of our political philosophy we can trace its roots from ancient Greece to Thomas Jefferson, but attempting to explain current conditions and present trends we will do better to turn to the address of Franklin D. Roosevelt at Oglethorpe University in May, 1932, in which he said: "The country needs, and, unless I mistake its temper, the country demands bold, persistent experimentation. It is common sense to take a method and try it: if it fails, admit it frankly and try another. But above all, try something. The millions who are in want will not stand by silently forever while the things to satisfy their needs are within easy reach."

Howard Mumford Jones calls attention to an observation made by Alfred North Whitehead in 1933 which is directly related to this philosophy of empiricism, as follows: "Our sociological theories, our political philosophy, our practical maxims of business, our political economy, and our doctrines of education are derived from an unbroken tradition of great thinkers and of practical examples, from the age of Plato . . . to the end of the last century. The whole of this tradition is warped by the vicious assumption that each generation will substantially live amid the conditions governing the lives of its fathers and will transmit those conditions to mould with equal force the lives of its children. *We are living in the first period of human history for which this assumption is false.*"

The complex interrelations between economic and social conditions and government have brought problems of uncertainty, confusion, and conflict into our philosophical point of view. Basically, Western man has had a longing for a free government, a free enterprise, and the free individual. Our own Constitution is a declaration of this hope and the consummation of a struggle for freedom. It is illuminating to note, however, that the freedoms of the Constitution are "freedoms to": freedom to worship, freedom to assemble, freedom to speak, and freedom to publish. These freedoms have been deeply disturbed by the introduction of "freedoms from." The reconciliation of these "freedoms from" with the "freedoms to" is the great problem of our industrial democracy. It is folly to assume that a liberal education pursued in a college program will provide this reconciliation. The struggle for freedom, justice, and democracy is a continuing struggle which encompasses all classes domestically and most countries internationally.

A study of history, philosophy, ethics, literature, economics, sociology, political

science, and government will greatly assist in the understanding of freedom in our time. The schooling of leaders to participate in the solution of the problems preserving freedom is, however, a greater task than can be accomplished in a humanistic-social program collateral to a scientific technological education. This, however, should not dismay us in the search for an adequate introduction to the problems and the means of their solution so that engineers may be better informed of the social, economic, and political climate in which they live and of the driving forces in its changes. Even though we grant that such an introduction may be secured through the co-operation of the social and philosophical scholars, there is still a great gap between an elementary critical understanding of the problems of citizenship and the practical behavior of citizens in an industrial society.

The American Society of Mechanical Engineers has a committee on the Engineer's Civic Responsibilities under the leadership of a great citizen, Roy V. Wright, who says that "engineers, individually and collectively, like all other citizens, must do their part in helping to elevate and maintain high standards of honest, efficient, and effective governmental administration." This committee is valiantly struggling to stimulate engineers in their civic responsibilities in an active and practical manner, both among the student branches and in the local sections of its society. In a search for constructive means for stimulating greater interest in citizenship it sent a questionnaire to 115 honorary chairmen of student branches and received replies from only 19. This committee also sent a letter to local sections seeking to determine the extent to which members of the society were active in governmental or civic affairs and received replies from only 27 of the 70 local sections.

While the quantitative results of their work have been disappointing, the committee works vigorously and valiantly onward. Their experience, however, suggests that students and practicing engineers are in great need of a stimulus to their interests in civic responsibilities, and, inferentially, to their need for a broader education in the humanistic-social fields. The means of stimulating this interest, of attaining that level of critical understanding, and of discipline necessary to the achievement of the broad objectives listed in the 1940 report of the Society for the Promotion of Engineering Education are not immediately clear. The critical examination of general education by the professors of the liberal-arts colleges and the stimulation and encouragement in the practice of good citizenship initiated by the committee of the American Society of Mechanical Engineers are both, however, signs that we are making progress toward an understanding of the means for conditioning men for responsibility in a free, just, and democratic industrial society.

Proposed Method of Rating Microphones and Loudspeakers for Systems Use*

FRANK F. ROMANOW†, AND MELVILLE S. HAWLEY†

Summary—Proposed, is a method of rating microphones and loudspeakers whereby the over-all performance of a sound system may be determined by adding together the microphone and loudspeaker ratings and the gain of the interconnecting network. This sum gives the performance quite accurately for most systems. However, in some combinations of elements correction terms must be added. The formulas for these correction terms are derived.

The proposed microphone and loudspeaker ratings have the additional usefulness of being in a form which permits the comparison of instruments of different impedances.

I. INTRODUCTION

SINCE SOUND-instruments designers and systems engineers use different methods for rating microphones and loudspeakers, the integration of the performance of the components into the over-all performance of a sound system is often attended by difficulties. In order to reduce these difficulties, a method of rating microphones and loudspeakers patterned after that in use by systems engineers is proposed here for standardization. These proposed ratings will be referred to as microphone-system rating and loudspeaker-system rating. They are of such nature that the over-all performance of a sound system is approximately given by the sum of the microphone rating, the loudspeaker rating, and the gain rating of the interconnecting network.

The expression for the system performance given by the sum of the ratings of the system components is, as stated above, only approximate. The exact expression includes two terms herein referred to as coupling factors, each of which is a function of the electrical impedance of the sound instrument and the impedance of the amplifier termination to which the instrument is connected. In general, except when high-impedance microphones are used, the coupling factors are small and may be neglected. Expressions for these coupling factors are derived in the Appendix.

Consideration is also given in this paper to the problem of assigning a rated source impedance for the testing of amplifiers used with high-impedance microphones so that the gain ratings of these amplifiers will be consistent with gain ratings of amplifiers used with low-impedance microphones.

II. DEFINITIONS

The definitions of sound-system rating, microphone-

system rating, loudspeaker-system rating, amplifier gain, and coupling factor are given below.

In what follows, the input to the sound system is taken as the undisturbed sound-field pressure in a plane progressive wave at the microphone position, and the microphone is considered to be oriented in its normal manner with respect to the direction of propagation of the sound wave. Depending upon the conditions of use, it is desirable to express the output of the system either in terms of the acoustic power or in terms of acoustic pressure. In general, for reproduction of sound indoors, the acoustic power output is of more interest; while for outdoor or other relatively free-field conditions of reproduction, the output in terms of the acoustic pressure is preferred.

It must be understood that the output as a function of frequency in terms of pressure at a specified position or in terms of the acoustic power is not sufficient to characterize completely the behavior of the speaker. Also of great importance in assessing the suitability of the speaker in open or closed spaces is the spatial distribution of the speaker sound field as a function of frequency. Although in this paper the definition of system performance in terms of pressure output applies to the pressure at a specified point on the speaker axis, the method of rating the system is equally applicable when the output pressure is specified for any position in the speaker sound field. Similar remarks apply to the angle of incidence of the input sound wave and the directional characteristics of the microphone.

In order to facilitate the reading of the formulas that follow, small letter subscripts are attached to the capital letters to differentiate between microphone and speaker, output power and output pressure, output circuit and input circuit, etc. Accordingly, the system rating of a speaker in terms of pressure is written as SR_{sp} , the same expression in terms of power as SR_{sw} , the input impedance of the amplifier as Z_i , the open-circuit voltage of the microphone as E_m , etc.

2.1 Sound-System Rating

2.11 Power Basis: The sound-system rating S_w in terms of power output is defined as the ratio in decibels relative to 1 watt per dyne per square centimeter of the acoustic power output to the acoustic pressure input.

$$S_w = 10 \log \frac{W_s}{p_m^2} \quad (1)$$

* Decimal classification: R254.2×R265.2. Original manuscript received by the Institute, September 3, 1946; revised manuscript received, February 10, 1947.

† Bell Telephone Laboratories, Inc., Murray Hill, New Jersey.

tion with the modern democratic state in which St. John's College exists and, except for Rousseau's "Social Contract," not one of these five stands up squarely and fairly for the common man. The list, however, includes Plato, an apologist for the authoritarian state, Aquinas, an apologist for an authoritarian church, and Hobbes, an apologist for an authoritarian monarchy. It includes sceptics like Lucian, Montaigne, Swift, and Hume; it includes Pascal, who taught that man knows nothing and can know nothing by the unaided reason; it contains Malthus, Darwin, and Marx, who held that life is a ruthless struggle; it contains Hegel, the theoretical ancestor of Nazi Germany. You will not find in it the names of Thomas Jefferson, Ralph Waldo Emerson, Abraham Lincoln, Walt Whitman, or Mark Twain, whom I cite, not because they are Americans, but because they are believers in the common man." When professors disagree to such an extent upon the patterns of liberal education, there is obviously a need for a more specific definition of objectives and methods.

The American tradition in the liberal college has included education in both the arts and sciences. It is hardly necessary, however, in a consideration of liberal education for the engineer, to give particular attention to further study in the fields of science. It is also desirable to by-pass any discussion of the liberal values in the scientific education of the engineer. For the purpose of attempting a more specific definition it is well to utilize the dichotomy in engineering education presented in the 1940 report of the Society for the Promotion of Engineering Education, as the humanistic-social and scientific-technological stems, and to focus attention upon the humanistic-social education of the engineer. It is, however, precisely in this area where we find the wide differences among professors regarding the means for attainment of objectives. This confusion grows from the fundamental nature of the problem.

Since the Renaissance the realism and rationalism of science have had so strong an influence upon the fields of social studies that their development has been predominantly in the formulation of basic principles and methods for observing and securing facts of a quantitative nature. This is the reason we use the term "social science" instead of "social studies." We have sought so zealously for facts that we have given little attention to the appraisal of value. There are, however, three distinct points of view which must be correlated in the study of man and his institutions.

In a very elementary form they are: the determination of "what is," the appraisal of "what is good," and the conclusion as to "what ought to be." Unless the social studies are carried beyond the determination of "what is" in social-science theory into the value of judgments of "what ought to be,"

the aims and objectives of liberal education for the engineer and others are left to the chance influence of other social forces or to complete frustration in disagreement.

For the purpose of laying a foundation for value judgments, a knowledge of philosophy, ethics, and literature is basic. Such knowledge, however, has its limitations. Seeking an understanding of our political philosophy we can trace its roots from ancient Greece to Thomas Jefferson, but attempting to explain current conditions and present trends we will do better to turn to the address of Franklin D. Roosevelt at Oglethorpe University in May, 1932, in which he said: "The country needs, and, unless I mistake its temper, the country demands bold, persistent experimentation. It is common sense to take a method and try it: if it fails, admit it frankly and try another. But above all, try something. The millions who are in want will not stand by silently forever while the things to satisfy their needs are within easy reach."

Howard Mumford Jones calls attention to an observation made by Alfred North Whitehead in 1933 which is directly related to this philosophy of empiricism, as follows: "Our sociological theories, our political philosophy, our practical maxims of business, our political economy, and our doctrines of education are derived from an unbroken tradition of great thinkers and of practical examples, from the age of Plato . . . to the end of the last century. The whole of this tradition is warped by the vicious assumption that each generation will substantially live amid the conditions governing the lives of its fathers and will transmit those conditions to mould with equal force the lives of its children. *We are living in the first period of human history for which this assumption is false.*"

The complex interrelations between economic and social conditions and government have brought problems of uncertainty, confusion, and conflict into our philosophical point of view. Basically, Western man has had a longing for a free government, a free enterprise, and the free individual. Our own Constitution is a declaration of this hope and the consummation of a struggle for freedom. It is illuminating to note, however, that the freedoms of the Constitution are "freedoms to": freedom to worship, freedom to assemble, freedom to speak, and freedom to publish. These freedoms have been deeply disturbed by the introduction of "freedoms from." The reconciliation of these "freedoms from" with the "freedoms to" is the great problem of our industrial democracy. It is folly to assume that a liberal education pursued in a college program will provide this reconciliation. The struggle for freedom, justice, and democracy is a continuing struggle which encompasses all classes domestically and most countries internationally.

A study of history, philosophy, ethics, literature, economics, sociology, political

science, and government will greatly assist in the understanding of freedom in our time. The schooling of leaders to participate in the solution of the problems preserving freedom is, however, a greater task than can be accomplished in a humanistic-social program collateral to a scientific technological education. This, however, should not dismay us in the search for an adequate introduction to the problems and the means of their solution so that engineers may be better informed of the social, economic, and political climate in which they live and of the driving forces in its changes. Even though we grant that such an introduction may be secured through the co-operation of the social and philosophical scholars, there is still a great gap between an elementary critical understanding of the problems of citizenship and the practical behavior of citizens in an industrial society.

The American Society of Mechanical Engineers has a committee on the Engineer's Civic Responsibilities under the leadership of a great citizen, Roy V. Wright, who says that "engineers, individually and collectively, like all other citizens, must do their part in helping to elevate and maintain high standards of honest, efficient, and effective governmental administration." This committee is valiantly struggling to stimulate engineers in their civic responsibilities in an active and practical manner, both among the student branches and in the local sections of its society. In a search for constructive means for stimulating greater interest in citizenship it sent a questionnaire to 115 honorary chairmen of student branches and received replies from only 19. This committee also sent a letter to local sections seeking to determine the extent to which members of the society were active in governmental or civic affairs and received replies from only 27 of the 70 local sections.

While the quantitative results of their work have been disappointing, the committee works vigorously and valiantly onward. Their experience, however, suggests that students and practicing engineers are in great need of a stimulus to their interests in civic responsibilities, and, inferentially, to their need for a broader education in the humanistic-social fields. The means of stimulating this interest, of attaining that level of critical understanding, and of discipline necessary to the achievement of the broad objectives listed in the 1940 report of the Society for the Promotion of Engineering Education are not immediately clear. The critical examination of general education by the professors of the liberal-arts colleges and the stimulation and encouragement in the practice of good citizenship initiated by the committee of the American Society of Mechanical Engineers are both, however, signs that we are making progress toward an understanding of the means for conditioning men for responsibility in a free, just, and democratic industrial society.

Proposed Method of Rating Microphones and Loudspeakers for Systems Use*

FRANK F. ROMANOW†, AND MELVILLE S. HAWLEY†

Summary—Proposed, is a method of rating microphones and loudspeakers whereby the over-all performance of a sound system may be determined by adding together the microphone and loudspeaker ratings and the gain of the interconnecting network. This sum gives the performance quite accurately for most systems. However, in some combinations of elements correction terms must be added. The formulas for these correction terms are derived.

The proposed microphone and loudspeaker ratings have the additional usefulness of being in a form which permits the comparison of instruments of different impedances.

I. INTRODUCTION

SINCE SOUND-instruments designers and systems engineers use different methods for rating microphones and loudspeakers, the integration of the performance of the components into the over-all performance of a sound system is often attended by difficulties. In order to reduce these difficulties, a method of rating microphones and loudspeakers patterned after that in use by systems engineers is proposed here for standardization. These proposed ratings will be referred to as microphone-system rating and loudspeaker-system rating. They are of such nature that the over-all performance of a sound system is approximately given by the sum of the microphone rating, the loudspeaker rating, and the gain rating of the interconnecting network.

The expression for the system performance given by the sum of the ratings of the system components is, as stated above, only approximate. The exact expression includes two terms herein referred to as coupling factors, each of which is a function of the electrical impedance of the sound instrument and the impedance of the amplifier termination to which the instrument is connected. In general, except when high-impedance microphones are used, the coupling factors are small and may be neglected. Expressions for these coupling factors are derived in the Appendix.

Consideration is also given in this paper to the problem of assigning a rated source impedance for the testing of amplifiers used with high-impedance microphones so that the gain ratings of these amplifiers will be consistent with gain ratings of amplifiers used with low-impedance microphones.

II. DEFINITIONS

The definitions of sound-system rating, microphone-

system rating, loudspeaker-system rating, amplifier gain, and coupling factor are given below.

In what follows, the input to the sound system is taken as the undisturbed sound-field pressure in a plane progressive wave at the microphone position, and the microphone is considered to be oriented in its normal manner with respect to the direction of propagation of the sound wave. Depending upon the conditions of use, it is desirable to express the output of the system either in terms of the acoustic power or in terms of acoustic pressure. In general, for reproduction of sound indoors, the acoustic power output is of more interest; while for outdoor or other relatively free-field conditions of reproduction, the output in terms of the acoustic pressure is preferred.

It must be understood that the output as a function of frequency in terms of pressure at a specified position or in terms of the acoustic power is not sufficient to characterize completely the behavior of the speaker. Also of great importance in assessing the suitability of the speaker in open or closed spaces is the spatial distribution of the speaker sound field as a function of frequency. Although in this paper the definition of system performance in terms of pressure output applies to the pressure at a specified point on the speaker axis, the method of rating the system is equally applicable when the output pressure is specified for any position in the speaker sound field. Similar remarks apply to the angle of incidence of the input sound wave and the directional characteristics of the microphone.

In order to facilitate the reading of the formulas that follow, small letter subscripts are attached to the capital letters to differentiate between microphone and speaker, output power and output pressure, output circuit and input circuit, etc. Accordingly, the system rating of a speaker in terms of pressure is written as SR_{sp} , the same expression in terms of power as SR_{sw} , the input impedance of the amplifier as Z_i , the open-circuit voltage of the microphone as E_m , etc.

2.1 Sound-System Rating

2.11 Power Basis: The sound-system rating S_w in terms of power output is defined as the ratio in decibels relative to 1 watt per dyne per square centimeter of the acoustic power output to the acoustic pressure input.

$$S_w = 10 \log \frac{W_s}{p_m^2} \quad (1)$$

* Decimal classification: R254.2×R265.2. Original manuscript received by the Institute, September 3, 1946; revised manuscript received, February 10, 1947.

† Bell Telephone Laboratories, Inc., Murray Hill, New Jersey.

where W_s = the total acoustic power output from the loudspeaker in watts
 p_m = the undisturbed sound field pressure in a plane progressive wave at the microphone position in dynes per square centimeter.

The sound-system rating S_w in terms of the microphone-system rating SR_m , the loudspeaker-system rating SR_{sw} , the amplifier gain G , the input-coupling factor CF_i and the output-coupling factor CF_o is given by

$$S_w = SR_m + CF_i + G + CF_o + SR_{sw} \quad (2)$$

2.12 Pressure Basis: The sound-system rating S_p in terms of output pressure is defined as the ratio in decibels of the acoustic pressure output to the acoustic pressure input. It is given by

$$S_p = 20 \log \frac{p_s}{p_m} \quad (1a)$$

where

p_s = the acoustic pressure in dynes per square centimeter delivered by the loudspeaker at a point 10 feet from the front surface and on the axis of the loudspeaker.

This sound-system rating in terms of the component ratings and the coupling factors is given by

$$S_p = SR_m + CF_i + G + CF_o + SR_{sp} \quad (2a)$$

where

SR_{sp} is the rating of the speaker in terms of pressure output.

2.13 Coupling Factors Neglected: Except for systems using high-impedance microphones, the coupling factors in general are small and may be neglected. With the coupling factors omitted, (2) and (2a) become, respectively,

$$S_w = SR_m + G + SR_{sw} \quad (3)$$

$$S_p = SR_m + G + SR_{sp} \quad (3a)$$

2.2 Microphone-System Rating

2.21 Definition: The microphone-system rating SR_m is defined as the ratio in decibels relative to 1 watt per dyne per square centimeter of the electric power available from the microphone to the square of the undisturbed sound field pressure in a plane progressive wave at the microphone position.¹ It is given by

$$SR_m = 10 \log \frac{W_m}{p_m^2} \quad (4)$$

where

W_m = the power in watts available from the microphone.

W_m in turn is defined as

$$W_m = \frac{E_m^2}{4R_{mn}} \quad (5)$$

where

R_{mn} = a resistance expressed in ohms equal in magnitude to the nominal microphone impedance. For illustration, in this paper the nominal microphone impedance is defined as the microphone impedance at a single-frequency test signal of 1000 cycles. (If a loudness rating is desired, a suitably weighted complex test signal may be chosen.)

E_m = the open-circuit volts generated by the microphone.

The microphone system rating may also be written

$$SR_m = \rho_m - 10 \log 4R_{mn} \quad (6)$$

where

ρ_m = the microphone free-field response in decibels relative to 1 volt (open circuit) per dyne per square centimeter,

i.e.,

$$\rho_m = 20 \log \frac{E_m}{p_m} \quad (7)$$

The definition of W_m is not the one for power available commonly used; however, at 1000 cycles W_m and the actual power available will differ at most by a factor of 2, and the two will be equal if the microphone impedance is a resistance.

2.22 Examples of Microphone-System Rating: A microphone-system rating may be obtained from the free-field open-circuit voltage response by substituting the values of ρ_m and R_{mn} into (6).

2.221 System Rating of Low-Impedance Microphone: A low-impedance microphone having the following values of ρ_m and R_{mn} :

$\rho_m = -88$ decibels relative to 1 volt (open circuit) per dyne per square centimeter

$R_{mn} = 25$ ohms

has a system rating equal to

$$SR_m = -88 - 10 \log 100 = -108 \text{ decibels.}$$

2.222 System Rating of Condenser Microphone: A condenser microphone having values of ρ_m and R_{mn} as follows:

$\rho_m = -50$ decibels, $C_m = 50 \times 10^{-12}$ farad, or

$R_{mn} = 3.18 \times 10^6$ for a 1000-cycle test signal

has a system rating equal to

$$SR_m = -50 - 10 \log 12.72 \times 10^6 = -121 \text{ decibels.}$$

2.3 Input-Coupling Factor

2.31 Definition: The input-coupling factor CF_i is defined as the ratio in decibels of the available power in-

¹ For a somewhat similar definition of microphone rating, see page 17, "Western Electric Manual of Sound Systems," 1941.

put to the amplifier from the microphone to the power available from the microphone. It is given by

$$CF_i = 10 \log \frac{W_a}{W_m} \tag{8}$$

where

W_a = the available power input to the amplifier from the microphone in watts.²

Z_m = microphone impedance

R_g = the rated source impedance of the amplifier in ohms. For amplifiers used with condenser and crystal microphones, R_g is assigned the value of 100,000 ohms. (See Section 3.)

2.312 Systems with High-Impedance Microphones:

For systems using high-impedance microphones, the shunt impedance of the microphone cable must be taken

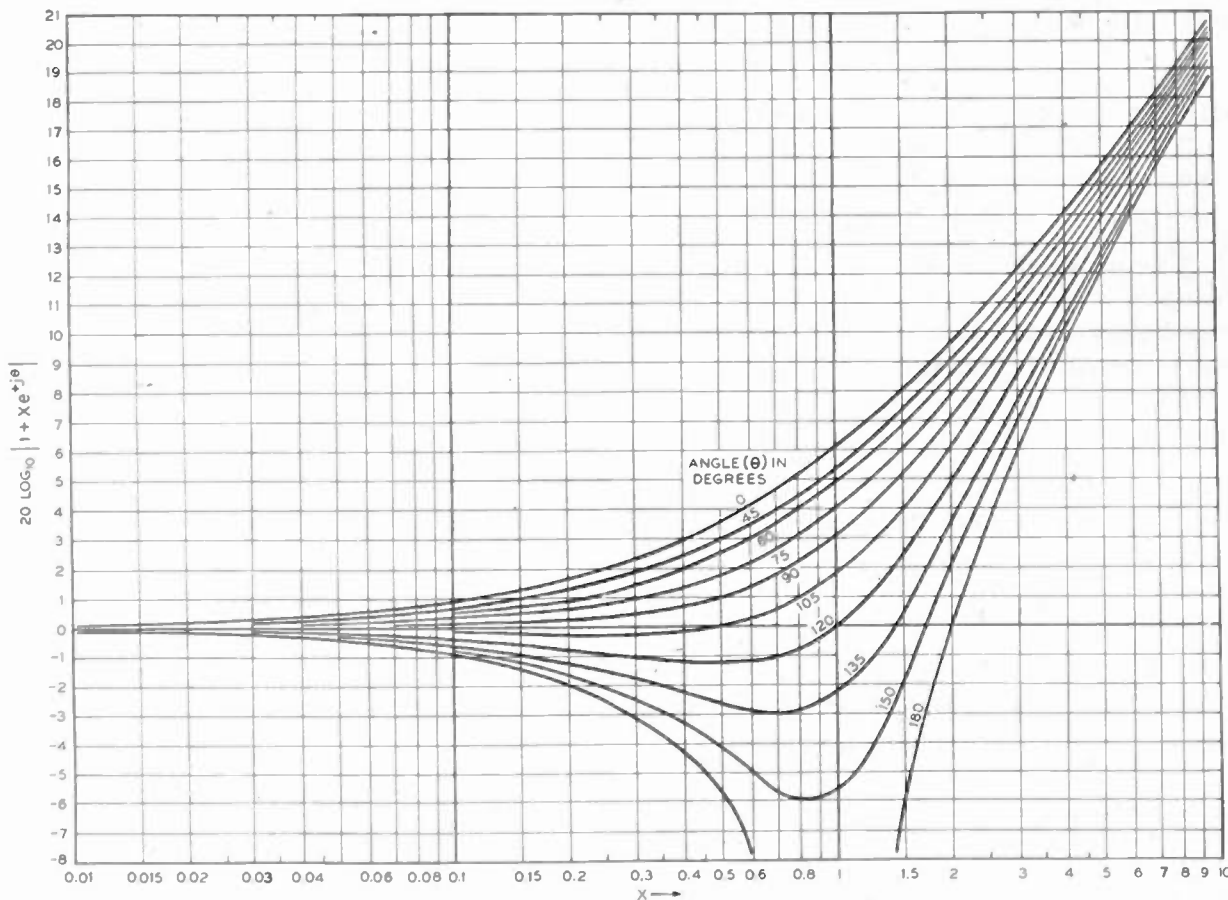

Fig. 1—Plot of function $20 \log |1 + xe^{\pm j\theta}|$ used to calculate coupling factors.

2.311 System with Low-Impedance Microphones: In a system using low-impedance microphones the effect of the microphone cable on the input-coupling factor is very small. With the cable impedance neglected, it is shown in the appendix that the expression for the input coupling becomes:

$$CF_i = 10 \log \frac{\left| 1 + \frac{R_g}{Z_i} \right|^2}{\left| 1 + \frac{Z_m}{Z_i} \right|^2} \frac{R_{mn}}{R_g} \tag{9}$$

where

Z_i = amplifier input impedance

² For clarification of the meaning of W_a , see the Appendix, Section 6.11.

into account. It can be shown that for such systems the input-coupling factor is given by

$$CF_i = 10 \log \frac{\left| 1 + \frac{R_g}{Z_i} \right|^2}{\left| 1 + \frac{Z_m}{Z_i} + \frac{Z_m}{Z_2} \right|^2} \frac{R_{mn}}{R_g} \tag{9a}$$

where

Z_2 = the shunt impedance due to the capacitance of the cable.

2.32 Examples of Input-Coupling Factor: Most of the terms in the expressions for the coupling factors are of the form $20 \log |1 + xe^{j\theta}|$. Graphs of this function are given on Fig. 1 and are useful in calculating the coupling factors.

2.321 Input-Coupling Factor for a System with a Low-Impedance Microphone: The microphone and amplifier impedances used in the examples below are typical.

	$R_o = 25$ ohms	$R_{mn} = 23.1$ ohms	$10 \log R_{mn}/R_o = -.35$
f cycles per second:	100	1000	10,000
Z_m ohms:	<u>23/0 degrees</u>	<u>23.1/3 degrees</u>	<u>26.2/22 degrees</u>
Z_i ohms:	<u>250/69 degrees</u>	<u>2600/-21 degrees</u>	<u>180/-84 degrees</u>
$20 \log \left 1 + \frac{R_o}{Z_i} \right $:	+0.4	+0.1	+0.3
$-20 \log \left 1 + \frac{Z_m}{Z_i} \right $:	-0.35	-0.1	+0.2
CF_i decibels:	-0.3	-0.35	+0.15

2.322 Input-Coupling Factor for a System with a Condenser Microphone: In this example it is assumed that the microphone is coupled directly to the amplifier, so that no lead impedance is involved. For illustration, the amplifier input impedance is assumed to consist of a capacitance C_i and resistance R_i in parallel.

$$C_m = C_i = 50 \times 10^{-12} \text{ farad}$$

$$R_{mn} = 3.18 \times 10^6 \text{ ohms}$$

$$R_i = 10^6 \text{ ohms}$$

	100	1000	10,000
f cycles per second:	100	1000	10,000
Z_m ohms:	<u>$31.8 \times 10^6/-90$ degrees</u>	<u>$3.18 \times 10^6/-90$ degrees</u>	<u>$.318 \times 10^6/-90$ degrees</u>
Z_i ohms:	<u>$30.3 \times 10^6/-72$ degrees</u>	<u>$3.18 \times 10^6/-88$ degrees</u>	<u>$.318 \times 10^6/-90$ degrees</u>
$20 \log \left 1 + \frac{R_o}{Z_i} \right $:	0	0	+0.3
$-20 \log \left 1 + \frac{Z_m}{Z_i} \right $:	-6.2	-6.0	-6.0
$10 \log \frac{R_{mn}}{R_o}$:	+15.0	+15.0	+15.0
CF_i decibels:	+8.8	+9.0	+9.1

2.4 Amplifier Gain

The amplifier gain G is defined as the ratio in decibels of the power delivered by the amplifier to its rated load to the available power input. It is given by

$$G = 10 \log \frac{W_l}{W_a} \tag{10}$$

where

W_l = the power in watts delivered by the amplifier to its rated load impedance R_l
 W_a = the available power input to the amplifier in watts. For the purpose of making gain measure-

ments of amplifiers the available power input is defined as the maximum power available from a generator whose internal impedance is a resist-

ance equal to the amplifier source impedance R_o . This power is equal to $E_o^2/4R_o$ where E_o is the open-circuit voltage of the rated source.

2.5 Output-Coupling Factor

2.51 Definition: The output-coupling factor is de-

$$R_o = 100,000 \text{ ohms}$$

$$10 \log \frac{R_{mn}}{R_o} = 15$$

	100	1000	10,000
f cycles per second:	100	1000	10,000
Z_m ohms:	<u>$31.8 \times 10^6/-90$ degrees</u>	<u>$3.18 \times 10^6/-90$ degrees</u>	<u>$.318 \times 10^6/-90$ degrees</u>
Z_i ohms:	<u>$30.3 \times 10^6/-72$ degrees</u>	<u>$3.18 \times 10^6/-88$ degrees</u>	<u>$.318 \times 10^6/-90$ degrees</u>
$20 \log \left 1 + \frac{R_o}{Z_i} \right $:	0	0	+0.3
$-20 \log \left 1 + \frac{Z_m}{Z_i} \right $:	-6.2	-6.0	-6.0
$10 \log \frac{R_{mn}}{R_o}$:	+15.0	+15.0	+15.0
CF_o decibels:	+8.8	+9.0	+9.1

defined as the ratio in decibels of the available power input to the speaker from the amplifier to the power the amplifier delivers to its rated load impedance R_l . It is given by the expression

$$CF_o = 10 \log \frac{W_{aa}}{W_l} \tag{11}$$

where

W_{aa} = the available power input in watts to the speaker from the amplifier. In testing the performance of a speaker, the speaker is connected to a source whose internal impedance is a resist-

ance R_{sn} equal to the nominal speaker impedance. Under these conditions the available power input to the speaker is defined as the maximum power available from the source. It is equal to $E_o'^2/4R_{sn}$ where E_o' is the open-circuit voltage of the source.

Substitution into (11) of the expressions for W_l and W_{as} (see the Appendix, (22) and (27)) gives for the output-coupling factor:

$$CF_0 = 10 \log \frac{\left| 1 + \frac{R_{sn}}{Z_s} \right|^2 \times \left| 1 + \frac{Z_0}{R_l} \right|^2}{\left| 1 + \frac{Z_0}{Z_s} \right|^2} \frac{R_l}{4R_{sn}} \quad (12)$$

where

R_{sn} = a resistance equal in magnitude to the nominal loudspeaker impedance. For illustration, in this paper the nominal loudspeaker impedance is defined as the impedance at a single-frequency test signal of 1000 cycles. (If a loudness rating is desired, a suitably weighted complex test signal may be chosen.)

Z_s = the loudspeaker impedance

Z_0 = the amplifier output impedance

R_l = the rated load impedance of the amplifier.

2.52 Example of Output-Coupling Factor: By substituting typical impedance values into (12), the magnitude of the output-coupling factor likely to be encountered can be determined as follows:

	$R_{sn} = 14$ ohms		
	$Z_0 = 3$ ohms		
f cycles per second:	100		
Z_s ohms:	$11/-20$ degrees		
$20 \log \left 1 + \frac{R_{sn}}{Z_s} \right $:	+5.8		
$20 \log \left 1 + \frac{Z_0}{R_l} \right $:	+2.0		
$-20 \log \left 1 + \frac{Z_0}{Z_s} \right $:	-1.9		
CF_0 decibels:	+0.2		

2.6 Loudspeaker-System Ratings

2.61 Power Basis: The loudspeaker-system rating³ SR_{pw} in terms of acoustic power output is defined as the ratio in decibels of the total acoustic power output

from the speaker W_s to the available power input W_{as} . It is given by

$$SR_{pw} = 10 \log \frac{W_s}{W_{as}} \quad (13)$$

2.62 Pressure Basis: The loudspeaker-system rating SR_{sp} in terms of acoustic pressure output is defined as the ratio in decibels relative to 1 dyne per square centimeter per watt of the square of the acoustic pressure output to the available power input. It is given by

$$SR_{sp} = 10 \log \frac{p_s^2}{W_{as}} \quad (13a)$$

2.63 Examples of Loudspeaker-System Rating: If the efficiency of a particular loudspeaker is in the neighborhood of 10 per cent, its system rating on a power basis SR_{pw} is approximately equal to -10 decibels.

As an example of the system rating of a speaker on the pressure basis, we may take as representative values

$p_s = 50$ dynes per square centimeter, $W_{as} = 10$ watts, then $SR_{sp} = 24$ decibels.

III. RATED SOURCE IMPEDANCE FOR HIGH-IMPEDANCE AMPLIFIERS

Above, in the definition of R_o (Section 2.311), it was suggested that a resistance value of 100,000 ohms be used as the rated source impedance of amplifiers for crystal- and condenser-microphone use. The reasoning behind this selection is as follows: Amplifiers used with low-impedance microphones have input transformers

		$R_l = 12$ ohms	
		$10 \log R_l/R_{sn} = -6.7$	
		1000	10,000
		$14/30$ degrees	$43/48$ degrees
		+5.6	+2.0
		+2.0	+2.0
		-1.5	-0.4
		-0.6	-3.1

between the input terminals and the grid circuit of the first vacuum tube. In general, the output-impedance rating of high-quality input transformers is in the neighborhood of 100,000 ohms. Because of the high impedance of crystal and condenser microphones, amplifiers used with these instruments do not have input transformers. If a low-impedance amplifier having an input transformer with a rated output impedance of 100,000 ohms

³ For a somewhat similar definition of loudspeaker rating see "American Recommended Practice for Loudspeaker Testing," ASC C16.4-1942, Sec. 7.1.

is converted into a high-impedance amplifier by removing the transformer and assigning to the amplifier a rated source impedance of 100,000 ohms, the gain rating of the amplifier will be unchanged. It follows, therefore, that a high-impedance amplifier with a source-impedance rating of 100,000 ohms has a gain rating which is consistent with gain ratings of low-impedance amplifiers.

IV. ALTERNATIVE METHOD OF RATING HIGH-IMPEDANCE MICROPHONES

Whenever microphones and amplifiers are closely coupled electrically, which is often the case for condenser microphones and their preamplifiers, it is more convenient to rate the microphone and amplifier combination as an integral unit than to consider them individually. To do this, the combination is given a microphone-system rating SR_m defined by (4) in which the voltage E_m and impedance Z_m are the open-circuit voltage and impedance respectively at the output terminals of the associated amplifier.

V. CONCLUSION

The method of rating loudspeakers and microphones presented in this paper fulfills, in practically all cases, the requirement that the performance of the over-all system is equal to the sum of the ratings of the individual system components. Exceptions are systems that use crystal microphones with long leads or condenser microphones. In these cases the coupling factors are appreciable and must be included to obtain the rating of the system. If the condenser microphone and its amplifier are rated as a unit, as is recommended, the coupling factor is comparable in size to that of a low-impedance microphone and may be neglected. Other cases for which the coupling factors are large are for systems in which the amplifier is improperly terminated; that is, when the ratio R_{mn}/R_0 or the ratio R_l/R_{sn} is much different from unity. These cases will occur infrequently with standardized values of terminating impedances. Even when the coupling factors are large, they tend to be uniform with frequency and, therefore, do not alter the frequency characteristic of the system.

Since the microphone-system rating is expressed in terms of available output power, it is a figure of merit whereby microphones of different electrical impedances may be compared. Similarly, the loudspeaker-system rating permits the comparison of the merits of loudspeakers of different electrical impedances. The microphone-system rating has the additional advantage of maintaining the frequency characteristic of the open-circuit field response of the instrument, this being the characteristic usually measured by microphone designers. The system ratings of loudspeakers proposed in this paper have also the advantage of being the ones normally used by loudspeaker designers.

Although the coupling factors have been derived only

for a system having a single microphone and a single loudspeaker, they are equally applicable to systems with a plurality of microphones and loudspeakers by proper interpretation of the formulas. Thus, in the expression of the input-coupling factor (9a), Z_2 should include the parallel impedance of the additional microphones. Similarly, in the expression for the output-coupling factor (12), the Z_s in the denominator should include the parallel impedance of the additional loudspeakers.

VI. APPENDIX

6.1. Derivations of Expressions for the Coupling Factors

A circuit diagram of a sound system composed of a microphone, amplifier, and loudspeaker is shown in Fig.

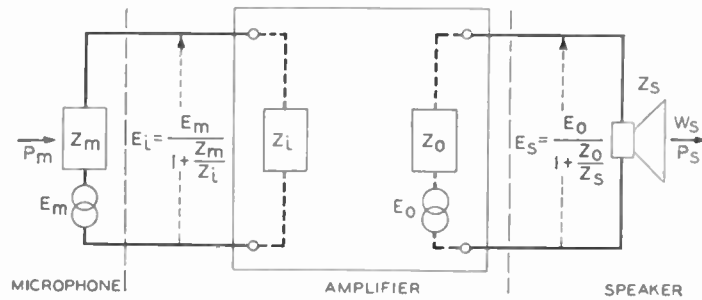

Fig. 2—Schematic of simplified sound-system circuit.

2. Simplified diagrams of circuits used in measuring the performance of the system components are shown in Figs. 3 and 4. These diagrams will be of aid in following the derivations of the coupling factors given below.

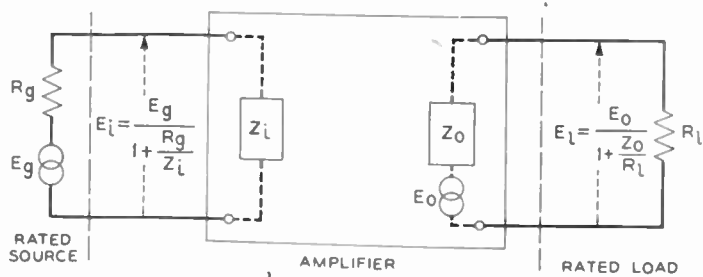

Fig. 3—Amplifier terminated in rated source and rated load for gain measurements.

Terms not already defined in the text of the paper are defined as follows:

- E_0 = the open-circuit volts generated by the amplifier rated source
- E_i = the volts applied to the input terminals of the amplifier
- E_0 = the open-circuit output volts of the amplifier
- E_l = the volts delivered by the amplifier to its rated load impedance R_l
- E_s = the volts applied to the terminals of the loudspeaker

E_g' = the open-circuit volts generated by the loudspeaker rated source.

Since the coupling factors are independent of the terms in which the output of the system is expressed, the derivations of the coupling factors are limited to one of

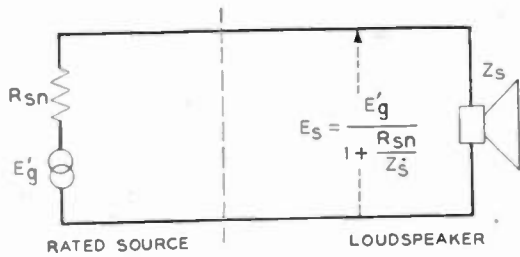

Fig. 4—Loudspeaker and associated rated source.

the two methods of rating the system performance; namely, that for which the output of the system is given in terms of acoustic power. On this basis, the over-all performance of a sound system is given by

$$S_w = 10 \log \frac{W_s}{p_m^2} \tag{1}$$

Multiplying and dividing W_s/p_m^2 by W_m , W_a , W_l , and W_{as} gives, for S_w ,

$$S_w = 10 \log \left(\frac{W_m}{p_m^2} \right) \left(\frac{W_a}{W_m} \right) \left(\frac{W_l}{W_a} \right) \left(\frac{W_{as}}{W_l} \right) \left(\frac{W_s}{W_{as}} \right) \tag{14}$$

W_a and W_{as} have been defined in the text for specific conditions. W_a was defined as the available power input to the amplifier from the amplifier rated source and W_{as} was defined as the available power input to the loudspeaker from the loudspeaker rated source. As used in (14), W_a is the available power input to the amplifier from the microphone and W_{as} is the available power input to the loudspeaker from the amplifier. Expressions for W_a and W_{as} as so used are given by (19) and (27) respectively below.

The terms in the right side of (14) are defined as follows:

$$10 \log \frac{W_m}{p_m^2} = SR_m \text{ (the microphone-system rating).} \tag{4}$$

$$10 \log \frac{W_a}{W_m} = CF_i \text{ (the input-coupling factor).} \tag{8}$$

$$10 \log \frac{W_l}{W_a} = G \text{ (the gain of the amplifier).} \tag{10}$$

$$10 \log \frac{W_{as}}{W_l} = CF_0 \text{ (the output-coupling factor).} \tag{11}$$

$$10 \log \frac{W_s}{W_{as}} = SR_{sw} \text{ (the loudspeaker-system rating).} \tag{12}$$

Substitution of these expressions into (14) gives

$$S_w = SR_m + CF_i + G + CF_0 + SR_{sw} \tag{2}$$

With the coupling factors neglected, (2) becomes

$$S_w = SR_m + G + SR_{sw} \tag{3}$$

The values of SR_m , SR_{sw} , and G are determined by measurement. The values of the remaining two terms, CF_i and CF_0 , are most easily obtained by computation. Expressions for these coupling factors are derived in Sections 6.11 and 6.12 below.

6.11 Input-Coupling Factor: To find the expression for the input-coupling factor, it is only necessary to evaluate the ratio W_a/W_m in (8).

W_m is defined as the available power from the microphone and is given by

$$W_m = \frac{E_m^2}{4R_m} \tag{5}$$

W_a , the available power input to the amplifier from the rated amplifier source, is defined by

$$W_a = \frac{E_g'^2}{4R_g} \tag{15}$$

Since the amplifier input voltage E_i from the rated source is given by

$$E_i = \frac{E_g'}{\left(1 + \frac{R_g}{Z_i}\right)} \tag{16}$$

W_a becomes, in terms of E_i ,

$$W_a = \frac{E_i^2}{4R_g} \left| 1 + \frac{R_g}{Z_i} \right|^2 \tag{17}$$

In order to find the available power from any source, it is only necessary to substitute into (17) the value of E_i delivered by this source.

The amplifier input voltage E_i delivered by a low-impedance microphone of open-circuit volts E_m and internal impedance Z_m is given by

$$E_i = \frac{E_m}{\left(1 + \frac{Z_m}{Z_i}\right)} \tag{18}$$

Substitution of (18) into (17) gives for the available power input to the amplifier from the microphone

$$W_a = \frac{E_m^2}{4R_g} \frac{\left| 1 + \frac{R_g}{Z_i} \right|^2}{\left| 1 + \frac{Z_m}{Z_i} \right|^2} \tag{19}$$

Substituting the values of W_m and W_a given by (5) and

(19) respectively into (8) gives for the input coupling factor with microphone cable impedances neglected

$$CF_i = 10 \log \frac{\left| 1 + \frac{R_g}{Z_i} \right|^2}{\left| 1 + \frac{Z_m}{Z_i} \right|^2} \frac{R_{mn}}{R_g} \quad (9)$$

6.12 Output-Coupling Factor: The expression for the output-coupling factor may be obtained by substituting the proper expressions for W_{as} and W_i into (11). Figs. 3 and 4 will aid in following the derivations of these expressions.

W_i is defined as the power that the amplifier delivers to its rated load R_i , and is given by

$$W_i = \frac{E_i^2}{R_i} \quad (20)$$

Since

$$E_i = \frac{E_0}{\left(1 + \frac{Z_0}{R_i} \right)} \quad (21)$$

W_i may be written

$$W_i = \frac{E_0^2}{\left| 1 + \frac{Z_0}{R_i} \right|^2 R_i} \quad (22)$$

W_{as} , the available power input to the speaker, is defined as the maximum power available from a generator whose internal impedance is a resistance equal in magnitude to the loudspeaker nominal impedance R_{sn} . W_{as} therefore is given by

$$W_{as} = \frac{E_g'^2}{4R_{sn}} \quad (23)$$

Since the voltage delivered by this source to the speaker terminals is

$$E_s = \frac{E_g'}{\left(1 + \frac{R_{sn}}{Z_s} \right)} \quad (24)$$

(23) becomes

$$W_{as} = \frac{E_s^2}{4R_{sn}} \left| 1 + \frac{R_{sn}}{Z_s} \right|^2 \quad (25)$$

In order to find the available power input to the speaker from any source, it is only necessary to substitute the value of E_s delivered by this source into (25).

The voltage delivered by the amplifier to the loudspeaker is

$$E_s = \frac{E_0}{\left(1 + \frac{Z_0}{Z_s} \right)} \quad (26)$$

Substituting (26) into (25) gives for the available power input to the speaker from the amplifier

$$W_{as} = \frac{E_0^2}{4R_{sn}} \frac{\left| 1 + \frac{R_{sn}}{Z_s} \right|^2}{\left| 1 + \frac{Z_0}{Z_s} \right|^2} \quad (27)$$

Using the expression for W_{as} given by (27) and the expression for W_i given by (22) in (11) gives for the output coupling factor

$$CF_0 = 10 \log \frac{\left| 1 + \frac{R_{sn}}{Z_s} \right|^2 \times \left| 1 + \frac{Z_0}{R_i} \right|^2}{\left| 1 + \frac{Z_0}{Z_s} \right|^2} \frac{R_i}{4R_{sn}} \quad (12)$$

Intermediate-Frequency Amplifiers for Frequency-Modulation Receivers*

J. J. ADAMS†, SENIOR MEMBER, I.R.E.

Summary—In order to obtain the maximum benefits from the frequency-modulation system of broadcasting, it is necessary to give special attention to the selectivity and symmetry of the receiver intermediate-frequency-amplifier channel. Voltage feedbacks must be reduced to a minimum in order to obtain good results in mass production without resorting to some sort of stagger tuning. Selectivity and stability formulas, stabilizing methods, and methods of aligning double-tuned transformers are discussed.

* Decimal classification: R363.13×R361.111. Original manuscript received by the Institute, June 20, 1946; revised manuscript received, February 20, 1947.

† Zenith Radio Corporation, Chicago 39, Illinois.

THE ADVANTAGES of fidelity and noise rejection of the frequency-modulation receiver can be lost by poor design in the intermediate-frequency amplifier. It is desirable to have a channel with a broad nose and sharp skirts that is symmetrical and will remain so, retaining its bandwidth with time and changes in temperature, and with different components and sets of tubes. It is desirable to do this at low cost. Reducing voltage feedbacks to a practical minimum is a necessary feature in obtaining the best results.

In a high-frequency-amplifier design, it is desired to obtain the wanted results with "run-of-the-mill" tubes and components with tolerances that are not too tight. To do this, variable factors should be reduced to a minimum. Excessive grid and plate loadings and voltage feedbacks should be eliminated to as large an extent as is commensurate with cost. Usually, getting these factors down to a certain stage effectively eliminates trouble due to them.

The most important factor to be considered in voltage stability is the grid-to-plate capacitance of the amplifier tube. The voltage feedback from this source usually cannot be effectively eliminated or bucked out. Also, it is not necessary to do so with present-day pentode tubes. However, this factor defines a maximum stage gain for a certain tube. In the extreme case, the tube will oscillate as a tuned-grid, tuned-plate oscillator, the grid-to-plate capacitance being the coupling means. At slightly lower gain the stage will be regenerative because the tube and its load reflects a negative impedance or negative loading into the grid circuit. Regeneration will give better gain and selectivity, but will give varying results between different tubes and components. Regeneration and degeneration (positive loading) should be avoided unless the feedback path is known and can be controlled. However, many receivers have been made with a large amount of regeneration in them and given satisfactory results. In frequency-modulation receivers, however, it is doubtful if satisfactory operations would be obtained with a highly regenerative receiver. Moreover, the good noise and fidelity characteristics, which are salient points in frequency modulation, will be much better with a symmetrical intermediate-frequency amplifier. Any regeneration will give an unsymmetrical curve. Symmetry can be obtained with a channel having some regeneration, but it is doubtful if it will remain symmetrical with time and temperature. All these factors make it necessary to design the channel to minimize the effect of the grid-to-plate capacitance.

To insure against instability due to this factor, it is necessary to choose amplifier tubes that have sufficient mutual conductance and small enough grid-to-plate capacitance to give the desired gains with stability. The maximum allowable inductance in double-tuned transformers is given by the following formula (derived using the circuit of Fig. 2(a)), assuming only inductive coupling:

$$L = \frac{A}{\omega Q} \sqrt{\frac{2}{g_m \omega C_{gp}}}$$

where L is the inductance at which oscillation will just occur; Q is the $\omega L/r$ of the tuned circuits; g_m is the mutual conductance of the tube used; C_{gp} is the grid-to-plate capacitance of the tube; and $f = \omega/2\pi$ is the operating frequency. A is a factor depending on the coupling factor K (K is unity at critical coupling). A is obtained

from the circuit equations after a number of assumptions that are accurate in most cases.

When

$$\begin{aligned} K = 1, & \quad A = 1.26 \\ K = 0.9, & \quad A = 1.22 \\ K = 0.8, & \quad A = 1.2 \\ K = 0, & \quad A = 1.0. \end{aligned}$$

From this equation the maximum gains can be derived for a number of desired conditions.

1. When $K=0$ (single-tuned transformer),

$$\text{maximum gain} = \sqrt{\frac{g_m}{\pi f C_{gp}}}$$

2. When $K=1$,

$$\text{maximum gain} = 0.63 \sqrt{\frac{g_m}{\pi f C_{gp}}}$$

3. When $K=1$ and it is desired to have no oscillation with the circuits in the plate and grid of the tube tuned but the circuits coupled to them detuned,

$$\text{maximum gain} = 0.5 \sqrt{\frac{g_m}{\pi f C_{gp}}}$$

Experience has shown that, if the gain is held within this latter figure, regeneration can be made negligible. It is probably desirable to allow something for variations in Q and inductance.

The next step is to get the above gain with stability, and with an arrangement that will give the least variation between tubes. One of the possible feedback paths in a single stage is coupling between plate and grid circuits in a cathode impedance. The mutual cathode impedance is not always negligible, even with the cathode pin grounded. At high frequencies the impedance of the cathode lead may be important. The effect of this can be minimized if the tube has two cathode connections and the grid circuit is returned to the ungrounded cathode pin. Also, in alternating-current-direct-current receivers with the cathode above ground, the cathode impedance becomes important. Calculation will show that, in a circuit represented by Fig. 1(a), Z will reflect a positive load if it is an inductance, and a negative load if it is a capacitance. The negative loading of the grid-to-plate capacitance can be bucked out by a cathode inductance of proper size at one frequency. This is difficult to hold, and also over-all stability is not helped by a cathode above ground.

In Fig. 1(b) the tuned circuits are returned to cathode. C_1 and C_2 are capacitances from grid and plate to ground. By a $Y-\Delta$ transformation, these capacitances, together with Z , form an impedance in one of the legs across the grid-to-plate capacitance. If Z is a capaci-

tance, this will be a capacitance which will increase the regeneration. This circuit appears often in alternating-current-direct-current receivers and can cause trouble, even though Z is a large bypass. The capacitances C_1 and C_2 can become large, due to the fact that the cans shielding the transformers are grounded. This type of regeneration can operate over more than one stage. The circuit of Fig. 1(c) is a combination of Figs. 1(a) and (b), but is usually better than Fig. 1(b) since C_2 is within the tube and is small.

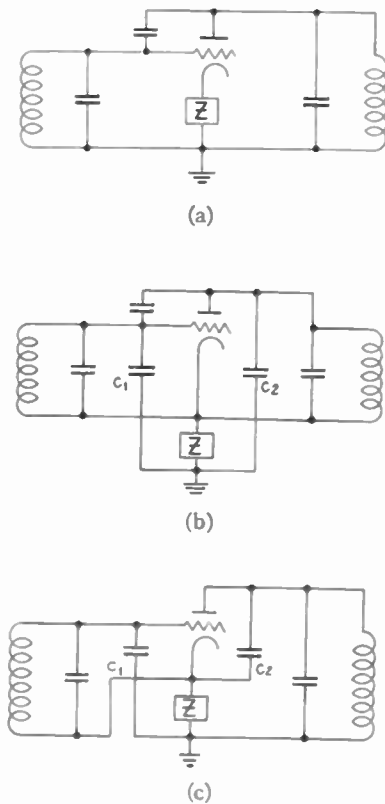

Fig. 1—Feedback paths in a single stage with the cathode ungrounded.

Over-all regeneration in alternating-current-direct-current receivers is often largely due to the common cathodes by-passed to ground by one capacitor. An inductance in series with the by-pass to tune it to the channel frequency has been used with success. At the higher frequencies it is better to isolate the cathodes and have separate by-passes. More by-passes can be used without exceeding the maximum safe value, since they can be small.

At the higher frequencies it has been found by experiment that better results can be obtained if the capacitive coupling in the transformers is kept to a minimum. Grounding the tuned circuit also helps stability. This can be done by putting the by-pass in the tuned circuit, as shown in Fig. 2(b). It is best to keep the path into which the tuned circuit current flows small. The effectiveness of these methods is probably mainly due to the

fact that they largely eliminate spurious circuits tuned at or near the channel center frequency.

It was found that a circuit like that of Fig. 2(b) gave better results than that of Fig. 2(a). Capacitive coupling is indicated in Fig. 2(a) to show that it has not been effectively eliminated. Fig. 2(c) shows a method of grounding the tuned circuit and also eliminating cathode-lead inductance, if the frequency or component spacing or both make this feedback path effective. This has been tried at 100 megacycles with excellent results.

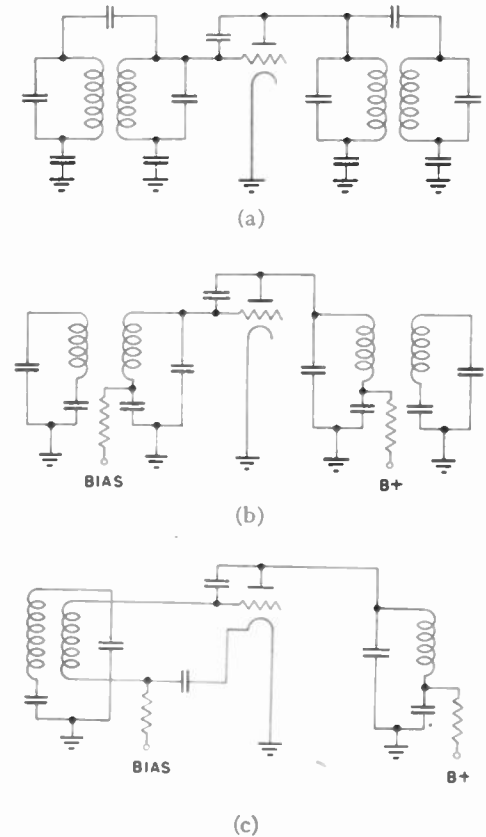

Fig. 2—Methods of improving stability at higher frequencies.

Fig. 3 shows schematically the connections for a dual channel for broadcast (455 kilocycles) and frequency modulation (8.3 megacycles).

There are other precautions necessary for stability. It may be necessary to isolate high-voltage and bias leads at the transformers. It is necessary to be sure that supposedly cold leads (high-voltage, automatic-volume-control, heaters, etc.) do not pass near hot points at the front and rear end of the channel. Isolation resistors and capacitors should be right at the point to be isolated in order to be most effective. Automatic-volume-control leads should be isolated at the detector end of the channel. It is best not to lay these supposedly cold leads together in a cable. Cathode bias should be used as little as possible, since it increases the common cathode-lead inductance.

In frequency-modulation channels it is very desirable

to have as flat a nose as possible, and also good skirt selectivity. Any regeneration will hurt the ratio of nose to skirt. This makes nearly perfect voltage stability more necessary than in the broadcast band. The ratio of bandwidth at 1000 times down to that at 2 times down depends only on the number of double-tuned transformers for a given coupling factor, and not on the channel center frequency, except to a minute degree.

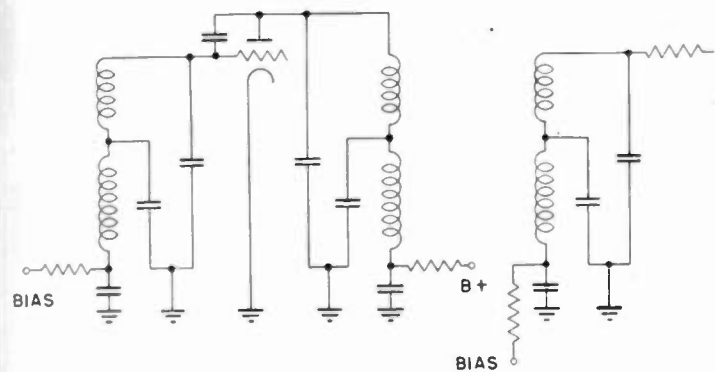

Fig. 3—Basic circuit of dual intermediate-frequency transformer.

Circuit Q 's and channel center frequency will determine the actual values of bandwidth at 2 and 1000 times down. The relation between bandwidth and times down is¹

$$Y = \left[\frac{(4x^2 + 1 - K^2)^2 + 4K^2}{(1 + K^2)^2} \right]^{n/2}$$

where

- Y = number of times down
- $X = Q(f_d/f_0)$
- $f_d = \frac{1}{2}$ bandwidth
- f_0 = center frequency
- K = the coupling factor
- n = the number of double-tuned circuits.

From this equation, by solving for $X = Q(f_d/f_0)$ we can find the ratio between two values of $f_d(f_a$ and $f_b)$:

$$\frac{f_a}{f_b} = \sqrt{\frac{\sqrt{a^{2/n}(1 + K^2)^2 - 4K^2} - (1 - K^2)}{\sqrt{b^{2/n}(1 + K^2)^2 - 4K^2} - (1 - K^2)}}$$

where f_a and f_b are half-bandwidths at "a" and "b" times down. For three transformers, if $K=1$ (critical coupling),

$$\frac{f_{1000}}{f_2} = 3.6.$$

¹J. J. Adams, "Undercoupling in tuned coupled circuits to realize optimum gain and selectivity," Proc. I.R.E., vol. 29, pp. 277-279; May, 1941.

For $K=0.8$ with three transformers,

$$\frac{f_{1000}}{f_2} = 4.1.$$

A feature that would be desirable is the ability to trim the circuits with an unmodulated signal and always obtain the same results, a flat, symmetrical curve. Unfortunately, this cannot be done with double-tuned circuits. The curve will be lopsided on one side or the other, depending on whether the circuits are originally below resonance or above. In a circuit like that of Fig. 2(b), with critical coupling, a random tuning will give the required flat nose but the curve will be unsymmetrical. A complicated procedure of starting some trimmers in and some out will give a practically symmetrical curve, but this method is not foolproof. This necessitates alignment with a sweep oscillator and an oscilloscope. Best results will be obtained if each stage is successively tuned on the oscilloscope for symmetry.

The use of single-tuned transformers would do away with this difficulty, but the ratio of f_{1000}/f_2 for three single-tuned transformers is 13, which is not very good. Another way to achieve practically symmetrical trimming with an unmodulated signal is to undercouple the double-tuned transformers somewhat and begin alignment of each stage with one coil detuned as far as possible. The curves of Fig. 4 show why this is so. These curves are based on the following factor, which is the denominator of the equation for the ratio of output voltage to input voltage of one stage:

$$Z = K^4 + 2K^2(1 - 4x_1x_2) + (1 + 4x_1^2)(1 + 4x_2^2).$$

This can be used in finding maxima and minima, since the numerator of the equation is constant.

K = coupling factor

$$x_1 = \frac{Qf_1}{f_0}, \quad x_2 = \frac{Qf_2}{f_0}$$

where f_1 and f_2 are off-resonance frequencies of primary and secondary circuits.

This factor is symmetrical in x_1 and x_2 , so that any analysis starting with the primary would apply to a series of operations starting with the secondary. It is desired to find the minimum of this factor (or the maximum transfer) as the primary and secondary are successively peaked. To do this, first assign a value of X to x_2 (this is the amount the secondary is off resonance before the primary is peaked). Then evaluate the derivative of Z with respect to x_1 .

$$\frac{dz}{dx_1} = -8K^2X + 8x_1(1 + 4X^2).$$

Set this equal to zero and solve for x_1 :

$$x_1 = \frac{K^2X}{1 + 4X^2}.$$

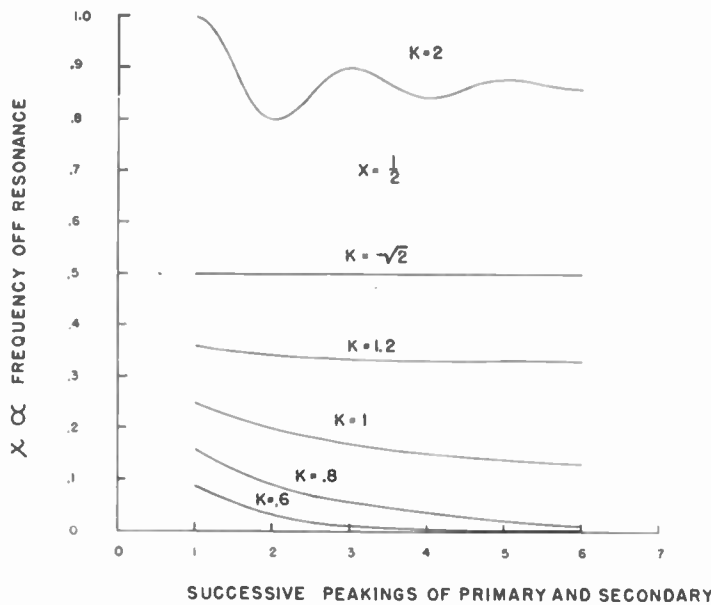

(a)

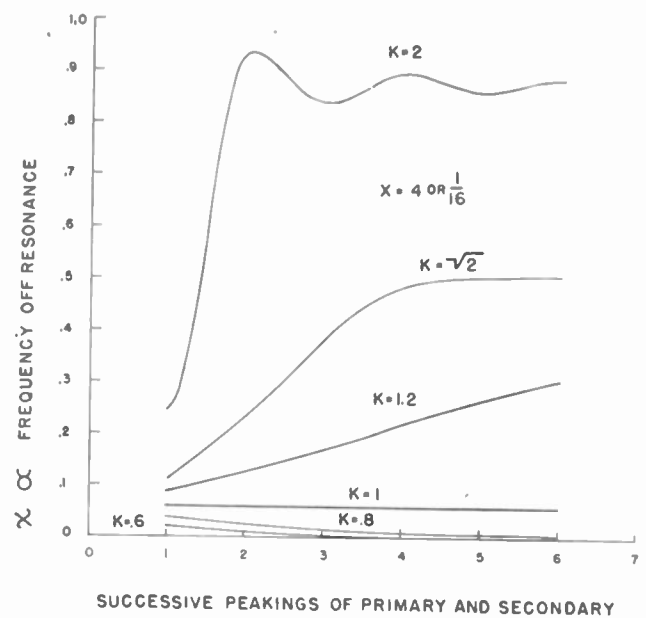

(b)

This is the amount off resonance the primary will be after it is peaked once. From the equation it can be seen that, if the secondary was on resonance ($X=0$), the primary will trim to resonance ($x_1=0$). The primary will be farthest off resonance when trimmed once, if the secondary is originally at $X = \pm \frac{1}{2}$. If X is larger than one-half, the primary will trim closer to resonance. The larger X is, the closer the primary will tune to resonance. If now the primary is left at the value x_1 and the secondary is tuned, x_2 becomes the variable with x_1 having the value from the above equation. The minimum is found at a new value for x_2 . This is then repeated for successive tunings of the primary and secondary. The curves of Fig. 4 show the results. Notice that the convergence for $K=1$ is very slow; so slow, in fact, that resonance would never be reached in practice. For overcoupled transformers, successive trimmings usually give a divergence from resonance. However, if the secondary is set far off resonance (X large), the first peaking of the primary will bring it near resonance. The indicated procedure, which is well known, is to set the secondary far off resonance, then peak the primary and then the secondary. Neither trimmer should be touched after this.

These methods of obtaining the desired selectivity and gain characteristics are not the only ones available

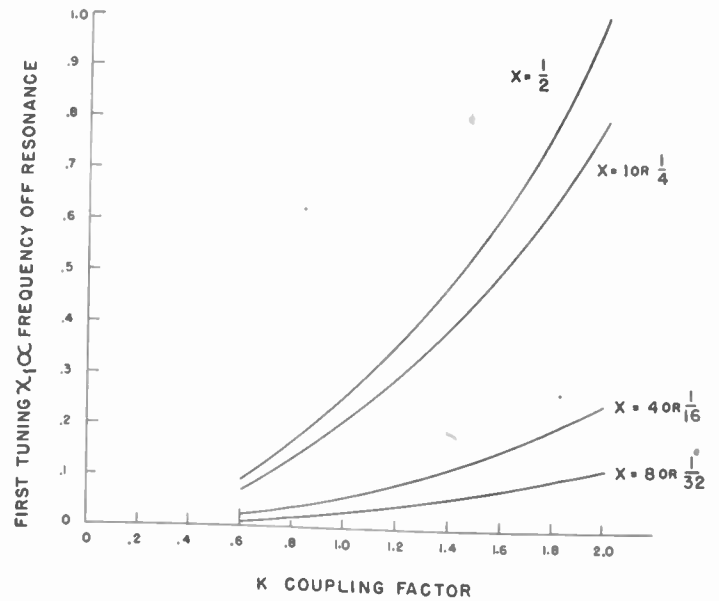

(c)

Fig. 4—Curves showing the amount the coils are off resonance after successive peakings for difference values of K and X .

but appear to be the most straightforward. Stability, of course, can be obtained by the simple expedient of having lower sensitivity. However, sensitivity, up to a certain point, is worth the effort to obtain it.



A Microwave Frequency Standard*

RICHARD G. TALPEY†, MEMBER, I.R.E., AND HAROLD GOLDBERG‡, SENIOR MEMBER, I.R.E.

Summary—The limitations of the usual types of standard-signal generators are discussed and alternative generating schemes applicable to frequency measurements in the microwave region are analyzed. A secondary frequency standard is described which makes use of a multiplier chain based on a stabilized quartz-crystal oscillator. The voltages at different frequencies are summed and applied to a silicon-crystal harmonic generator. It is pointed out that the silicon crystal is an excellent nonlinear element for the generation of harmonics in the microwave range. The result is an extremely wide output-frequency spectrum. In the particular frequency standard described, frequencies are generated to at least 10,000 megacycles. Identification of the harmonic frequencies is by means of a coaxial-line-type wavemeter, and detection is by means of a superheterodyne detector. The standard has been successfully employed in the microwave range, being no more difficult to use than the conventional secondary standards used for frequencies below 50 megacycles.

THE MICROWAVE PROBLEM

THE USE of secondary frequency standards^{1,2} for calibration purposes is well known to the radio profession. Many makes, simple in design, small, and light in weight, are available for the communications frequencies highly utilized in the past. Since these standards generally contain crystal-controlled oscillators which may be calibrated against primary standards, they afford convenient sources of voltage at accurately known frequencies for the frequency calibration of other equipment.

While the usual type of secondary standard works well up to 50 megacycles, difficulties are encountered at higher frequencies. First, as the fundamental frequency is increased, the generation of high-order harmonics becomes increasingly difficult. Second, it is not desirable to operate the crystal oscillator at frequencies above 10 megacycles.

In consequence of the foregoing difficulties, in going to the higher frequencies the simple harmonic generator based on a fundamental equal to the frequency separation fails to yield the desired results. Instead, a frequency-multiplier chain must be used. This may start with a crystal oscillator and, by steps involving frequency doubling and tripling, proceed to the frequency range required. This gives a separation equivalent to the fundamental frequency applied to the last multiplier in the chain. The desired coverage is obtained by the proper combination of several crystal frequencies and multiplication ratios. This is a cumbersome system, and

its extension into the microwave range creates serious difficulties with regard to tubes and tuned circuits.

One method of generation of harmonics in the microwave region involves the use of the klystron. As has been pointed out in the literature, the bunching of the electron stream produces currents extremely rich in harmonics. By the incorporation of suitable cavity resonators, it is easily possible to obtain harmonic orders as high as 10 to 20. The tuning range of such a device is limited, however, and the high voltages required for acceleration of the electron stream complicate the power-supply problem.

If frequencies in excess of 1000 megacycles are involved, it is possible to set up a crystal oscillator and frequency-multiplier chain using ordinary tubes which will produce output in the 300-megacycle region. If this power is applied to a nonlinear element such as the 1N21 or 1N22 silicon crystal, usable harmonics are produced to frequencies at least as high as 10,000 megacycles. The techniques involving tuned lines and cavities may now be employed for the generation and detection of the harmonics produced.

The volt-ampere characteristic of the silicon crystal is approximately square-law in the forward direction. Crystals may be driven at 30 to 40 milliamperes average current to produce harmonics in the frequency region mentioned above. When used with typical cavities for which the size of the crystal is suited, they provide a simple means for the generation of waves rich in harmonics which fall in the microwave region. The objection to such a system is that a 300-megacycle separation of reference frequencies is too large. However, in the region of 9000 megacycles, 300 megacycles represents approximately 3 per cent of the frequency. If the tuned circuits in the multiplier chain pass a band equal to 3 per cent of their midband frequency, coverage may be obtained by varying the base frequency 3 per cent without recourse to tuning of the frequency-multiplier chain. Since this scheme is feasible only when the base-frequency variation is small, it may be seen that the high-order harmonics of the crystal harmonic generator must be used.

If a somewhat lower order of stability than that obtainable from a crystal oscillator is satisfactory, continuous coverage may be obtained by using a base-frequency oscillator which is continuously variable in frequency instead of several fixed-frequency crystal-controlled oscillators. With suitable precautions, such an oscillator may be made very stable, and its calibration may be checked by comparison with a crystal-controlled oscillator at one or more points in its range.

EXPERIMENTAL INVESTIGATIONS

A secondary standard of this latter type was built for

* Decimal classification: R214.1. Original manuscript received by the Institute, May 5, 1946; revised manuscript received, July 26, 1946.

† Stromberg-Carlson Company, Rochester, New York.

‡ Formerly, Stromberg-Carlson Company, Rochester, New York; now, Bendix Radio Division of Bendix Aviation Corporation, Baltimore, Maryland.

¹ F. R. Stansel, "A secondary frequency standard using regenerative frequency-dividing circuits," *Proc. I.R.E.*, vol. 30, pp. 157-162; April, 1942.

² G. P. Harnwell and J. B. H. Kuper, "A laboratory frequency standard," *Rev. Sci. Inst.*, vol. 8, pp. 83-86; March, 1937.

use in the 3000-megacycle region. The base frequency was 7 megacycles and could be varied 5 per cent. The silicon crystal was excited at 126 megacycles. The base oscillator was checked by heterodyning the output of the first doubler with the fourteenth harmonic of a 1-megacycle crystal oscillator which was zero beat with WWV.

An investigation of this unit brought out several objectionable features of operation that had not been anticipated. For a given setting of the base frequency, say 7 megacycles, microwave frequencies separated by 7 megacycles instead of the 126 megacycles were obtained. These were not all of equal amplitude and there were gaps in the spectrum resulting in separations of as much as 42 megacycles. It was then realized that the difficulties of the original system could be utilized to form a new and superior system. Such a system would comprise a crystal-controlled oscillator, whose frequency was equal to the minimum frequency separation desired, and suitable broad-band multiplier chains driving a silicon crystal. This would afford operating characteristics equivalent to the secondary standards presently used at low frequencies.

Accordingly, a multiplier chain based on a 10-megacycle crystal oscillator and driving a silicon-crystal multiplier at 240 megacycles was constructed. It was reasoned that a partial explanation of the behavior of the system was to be found in the band-pass characteristics of the multipliers. In the new system the frequencies at each step in the chain would contain components of the submultiple frequencies and the final behavior would be the result of the interaction of all the cross-modulations. The minimum frequency separation resulting from this process is the base frequency. Accordingly, each tuned circuit was loaded so as to broaden the pass band. Tests of this circuit exhibited the expected 10-megacycle separation. The amplitude distribution of the harmonics, however, was neither satisfactory nor in accord with previous expectations. Very large amplitudes in the region of the harmonics of the 240-megacycle final driver frequency had been expected. This was not the case, however, and it was discovered that the intermodulation products did not decrease with increasing frequency as fast as the harmonics of the 240 megacycles and that, in the region investigated, the two were of comparable magnitude.

The possibility of obtaining separations in excess of the base frequency was also investigated, and a suitable method was evolved by inserting a buffer amplifier with a narrow pass band in the frequency-multiplier chain at the point where the frequency is equal to the desired separation frequency. This attenuates the frequencies below that at which the buffer operates, and results in this frequency acting effectively as the base frequency.

At this point the suggestion was made that the intermodulation effect might be increased by plate-modulating the 240-megacycle final driver with the base frequency of 10 megacycles (or the effective base frequency produced by the use of a narrow-band buffer). This was

tried, and considerable improvement resulted. It also appeared that still better results might be obtained if, instead of modulating the final silicon-crystal driver, the silicon crystal itself be driven by a mixture of the base frequency and the final driver frequency. This hypothesis was tested and proved to be correct.

Before constructing a unit based on these later findings, a consideration of the entire problem indicated that it might be profitable to check all of the hypotheses at audio frequencies. Accordingly, an audio system, duplicating in scale the proposed secondary standard, was then constructed. Four synchronized frequencies starting at 43.3 cycles were made available in the ratio 1:2:6:18, and these were mixed in any desired amplitude in the output. The mixture was fed into a series combination of a silicon crystal (or diode) and a 10-ohm resistor, the output of which was fed into a wave analyzer. A resistor was used in series with the crystal, since the current wave rather than the voltage wave is of interest. In all measurements the total average crystal current was made equal to that proposed in the actual standard.

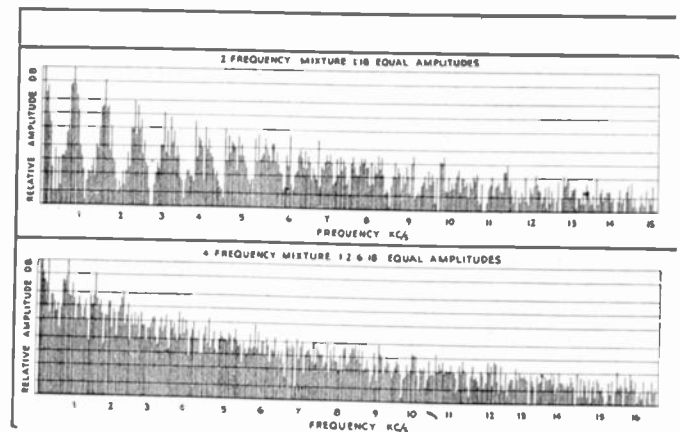

Fig. 1—Crystal multiplier.

The results of this investigation are shown by the accompanying graphs, shown in Fig. 1. For the case of two frequencies, ratio 1:18, each contributing an equal amount of average crystal current and giving a total current of 28 milliamperes, it may be seen that a quasi-continuous spectrum is obtained. As anticipated, there are peaks in the neighborhood of each harmonic of the final driver frequency, but these disappear as the harmonic order increases. The amplitude behavior in a region corresponding to the region investigated in the experimental microwave standard is nearly random. For a four-frequency combination, the spectrum analysis (Fig. 1) shows considerable improvement. More experiments were made to determine the effect of varying the relative amplitudes of the four frequencies, but little effect was noticed other than that some improvement might occur if the contribution of the final driver, or highest frequency, were made larger than the rest. Tests with a diode showed results similar to those with a crystal.

On the strength of these results, a standard involving a four-frequency combination in the silicon crystal was proposed. It was to utilize a 10-megacycle crystal-controlled oscillator with oven temperature control. This frequency would be doubled to 20 megacycles and buffered to suppress the 10-megacycle fundamental. The 20-megacycle frequency would be multiplied to 360 megacycles. The silicon crystal would be fed with a mixture of 20-, 40-, 120-, and 360-megacycle signals in such proportions that their contributions to the crystal current would be 1:1:1:2, respectively. For easy detection, audio modulation was to be applied to the final driver.

adjusted to give approximately equal average crystal-current contribution from the first three stages and about twice as much from the 360-megacycle stage. The loops are connected together and to the output jack by 50-ohm coaxial cable. The end loop is returned to ground through a capacitance and a meter is inserted to read the rectified current produced by the silicon crystal. The output may be fed to any desired crystal cavity. About 30 to 40 milliamperes of crystal current is adequate, although good signals have been recorded using only 10 milliamperes. More current may result in damage to the crystal. A good crystal having a back-to-front resistance ratio of at least 100:1 should be used.

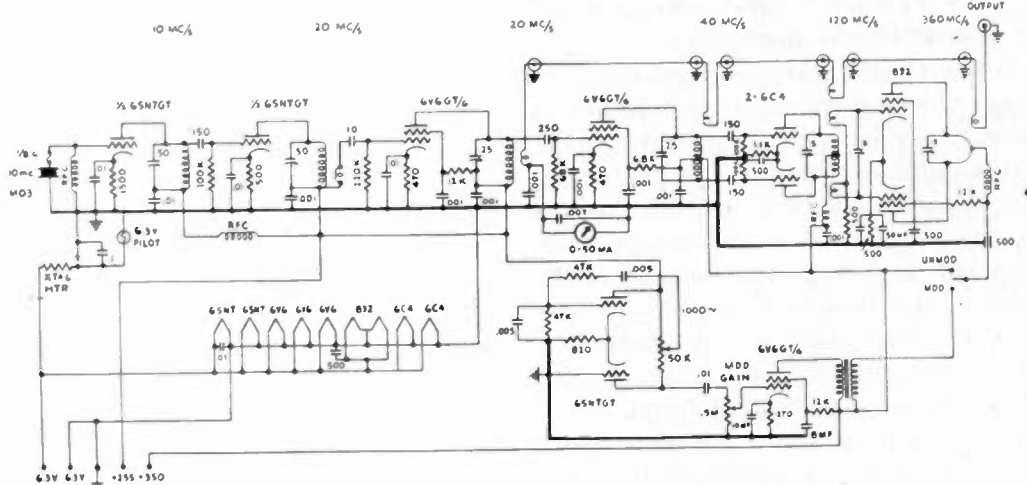

Fig. 2—Silicon crystal multiplier, secondary frequency standard.

It should be remembered that the results of the audio tests showed that, if f is the base frequency and f_0 is the final driver frequency, best results are usually obtained when the crystal is driven by the set of frequencies $f, 2f, 3f, \dots, f_0$, where $f_0 = nf$. A departure of the form $f, 2f, 4f, 8f, \dots$ or one involving tripling still gives good results and allows the use of doublers and triplers exclusively. The two-frequency case shows that large separations between the components gives rise to peaked behavior in the regions of the harmonics of f_0 . The greater the separation, the higher the order of harmonics of f_0 for which the peaks are obtained. This was tested by investigating a mixture of 1 and 150 megacycles. This showed peaking of the distribution in the region of 3000 megacycles.

DESCRIPTION OF STANDARD-FREQUENCY GENERATOR

The circuit of the standard-frequency generator is conventional and is shown in Fig. 2. A Bliley MO3 oven with a 10-megacycle crystal provides the base frequency. The crystal has a drift of -2 cycles per megacycle per degree and the temperature is maintained to ± 1 degree centigrade. A buffer amplifier is used to provide an effective base frequency of 20 megacycles. About 4 watts of 360-megacycle power modulated with 1000 cycles is available.

Output is taken from four stages at frequencies of 20, 40, 120, and 360 megacycles. A series loop circuit was found suitable, the coupling to individual stages being

The frequency spectra obtained from the generator for the region from 990 to 1100 megacycles, and for the region from 2000 to 3600 megacycles, are shown in Fig. 3. A random distribution of amplitudes similar to that found in the audio tests was obtained. No examination of the spectrum was made from 20 to 990 megacycles, but it should be realized that this standard provides usable amplitudes of frequencies at $n \times 20$ megacycles for values of n from 1 to at least 500.

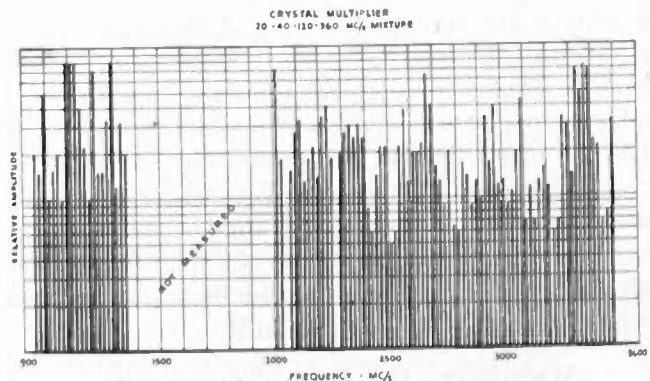

Fig. 3—Radio-frequency spectrum.

The frequencies are identified by means of a wavemeter which has been previously calibrated. Wavemeters suitable for the microwave range are now generally available or easily constructed. The limitation on the frequency difference due to characteristics of the wavemeter is the tolerance within which this meter can de-

termine the frequency. The frequency separation must exceed this tolerance by a comfortable margin or the identification of frequencies is not positive. Once the frequency is identified, its value is, of course, known to an accuracy equivalent to that of the master crystal oscillator; in this case, to approximately four parts in one million. It was found that the measurements with the wavemeter were within $\pm 1\frac{1}{2}$ megacycles of the actual frequency in the region of 3000 megacycles. On the basis of such performance, a 10-megacycle separation could be used in the region of 3000 megacycles. Since, however, the generator was intended for use up to 10,000 megacycles, a 20-megacycle separation was used, since the available wavemeters are not accurate enough to use the smaller separation at 10,000 megacycles.

The detection device chosen was of the selective superheterodyne type which, because of the recent acceleration of microwave development, has become almost universal. While it is quite possible to build microwave preselectors of given characteristics, it was not thought necessary to go to the extra work in this instance, since the image problem can be adequately solved 'by the proper choice of the intermediate frequency.

The image problem is most easily solved by choosing an intermediate frequency such that the image separation is small in comparison with the base frequency of the standard. This insures that no confusion will result in the identification and detection of signals from the standard. Any local oscillator used will have a short-time drift or instability, and the bandwidth of the intermediate-frequency amplifier must be great enough to cover the maximum drift if trouble-free operation is to be realized. The lower cutoff must be well above the audio modulation frequency. The intermediate-frequency amplifier used was a three-stage amplifier with single-tuned, antiresonant coupling between stages. Using 6AC7 tubes, a gain of about 90 decibels is obtained with a one-half-power bandwidth of about 600 kilocycles. The midband frequency is 500 kilocycles. The images are, therefore, 1 megacycle apart and are easily identified.

In some cases it may be convenient to use the newly developed spectrum analyzers which have found considerable use in microwave technique. Numerous advantages are apparent to those familiar with these instruments. The extensive frequency range of present microwave activity necessitates the use of a specially designed mixer and local-oscillator system for each particular application.

MICROWAVE HARMONIC GENERATORS

While the use of cavities for the final harmonic generator has been mentioned, these have not heretofore been discussed. Fig. 4 shows two simple types of crystal cavities which may be used. The first consists of a resonant section of coaxial line, the crystal being placed approximately $\frac{1}{4}$ wavelength (at the output frequency) from the end. It is convenient to make this resonant section tunable by means of a plunger. The harmonic

currents produced by the crystal flow in the center conductor of the section and result in wave propagation down the line. The section may be tuned to select the desired signal frequency. The tuning of the section is not critical due to the loading imposed by the crystal in shunt.

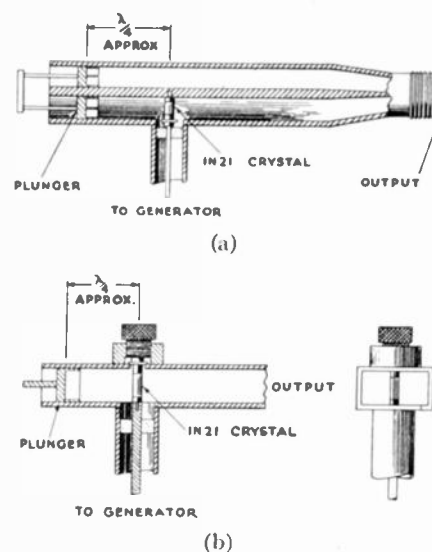

Fig. 4—(a) Coaxial crystal cavity. (b) Wave-guide crystal cavity.

Another type of microwave feed is illustrated in Fig. 4(b). This is designed for use with rectangular wave guide rather than coaxial line. Here the crystal is placed across a resonant guide section in an orientation parallel to the lines of electric intensity in the guide corresponding to the desired mode. Harmonic currents flowing in the crystal excite the wave guide in the $TE_{0,1}$ mode in the section illustrated. Other orientations of the crystal can, of course, be used to excite other modes in either rectangular or cylindrical guides. An adjustable shorting plunger is provided in the guide section for tuning purposes. These are only two illustrations of possible cavity arrangements. Many more should be apparent to those familiar with microwave techniques. Many types of re-entrant and cylindrical cavities are suitable, the only requirement being the proper arrangement of the crystal to excite the desired oscillation in the cavity.

UTILIZATION PROCEDURES

The block diagram, Fig. 5, shows a method for use of the standard. Tests were made with an unknown cavity resonator to be calibrated at 3000 megacycles. In general, the use of a wavemeter as an absorption device is indicated, although a transmission-type wavemeter might be used. The local oscillator is first tuned until a signal is obtained in the receiver. The wavemeters can then be tuned for dips in the output-meter reading. Successive frequencies may then be obtained by retuning the local oscillator.

While the entire discussion on frequency separation has been predicated on the order of precision of the wavemeter used for identification, there are methods whereby the separation may be made smaller than that dictated by this precision. In one method, markers are

generated which may be identified according to the criteria set forth. When one of these markers has been identified, a lower base frequency may be added to the mixture impressed on the crystal harmonic generator. By counting from the identified marker, other frequencies are then identified. In this fashion it is possible to obtain separations that are smaller than those which may be safely resolved with the wavemeter.

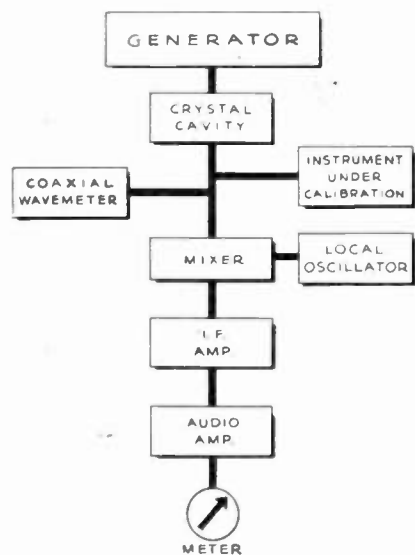

Fig. 5—Typical measuring setup.

While the matter has been touched upon, it may not be clear as to the procedure to follow in the determination of a design for a given application. Suppose that standard frequencies are required in the range of f_s . If the base or separation frequency desired is f , then a final driver frequency $f_0 = nf$ must be chosen such that appreciable harmonics of f_0 are present in the region f_s . The mixture applied to the final harmonic generator which includes f and f_0 must contain a fairly good sam-

pling of the range f to f_0 of the form mf where m takes on a series of integral values from 1 to n . Experience shows that series of the type 1, 2, 4, etc., or 1, 3, 6, 18, etc., are perfectly satisfactory. In other words, the chain starting with f and proceeding to nf may use doublers and triplers in any combination. Thus, if frequencies in the region of 100 megacycles are desired, a chain consisting of a 1-megacycle crystal oscillator, a doubler, and two triplers may be used. In this case, frequencies of 1, 2, 6, and 18 megacycles would be mixed in the final harmonic generator and a spectrum starting in at 1 megacycle and continuing in 1-megacycle steps is available to 100 megacycles and beyond.

CONCLUSIONS

The secondary standard described represents only one of possibly many systems that might be proposed. It has the disadvantage that a sensitive detector must be employed and that the frequency identification involves the use of a tertiary frequency standard. It is simple to use, however, and its drawbacks are the same as those of the present very popular secondary frequency standards in use in the low-frequency range. Numerous possibilities for the extension of the elements of the microwave standard discussed above are apparent. Certain features of the system may be elaborated to suit individual needs, or simplified for more restricted applications. Since free interchange of information on the state of the microwave art has not been possible in wartime, the authors do not claim this development to be original, or the result of a thorough survey of all possibilities. The pressure of wartime work necessitated the development of a usable instrument in a minimum of time and prevented the academic investigation of basic concepts or more elaborate systems. It is to be hoped that, despite these limitations, this information will be of assistance and use to others in the field.

A Note on Coupling Transformers for Loop Antennas*

M. J. KOBILSKY†, MEMBER, I.R.E.

Summary—The function that determines signal-to-noise ratio is calculated for loop-coupling transformers. It is shown that the optimum signal-to-noise ratio obtains when the loop inductance equals the primary inductance. General expressions are derived for calculating the sensitivity for a 6-decibel signal-to-noise ratio, gain, and selectivity in loop-coupling transformers, when the condition of optimum signal-to-noise obtains. This expression for the sensitivity for a 6-decibel signal-to-noise ratio is also shown in a graph to facilitate the computations. The discussion is limited to the case in which circuit noise is the limiting factor for the sensitivity.

* Decimal classification: R320.51. Original manuscript received by the Institute, December 17, 1945; revised manuscript received, December 3, 1946.

† Fabrica Argentina de Productos Electricos S. A., Buenos Aires, Argentina.

LIST OF THE MOST IMPORTANT TERMS

- C_0 = capacitance of the loop plus transmission line
- e_0 = voltage induced in the loop by the acting field
- f_0 = resonant frequency of loop and cable
- e_2 = output voltage across tuning capacitor
- G = gain of the system at any frequency defined as the ratio e_2/e_0
- G_r = gain at resonance of the system
- G_r' = gain at resonance at optimum signal-to-noise ratio
- L_1 = primary inductance of transformer
- L_2 = secondary inductance of transformer
- L_s = inductance of the single-tuned equivalent circuit
- L_0 = loop inductance

- L_t = total equivalent inductance of loop and primary circuit
 Q_0 = loop quality factor
 Q_1 = primary quality factor
 Q_2 = secondary quality factor
 Q_e = quality factor of the single-tuned equivalent circuit
 Q_e' = quality factor of the single-tuned equivalent circuit when the optimum condition for signal-to-noise ratio obtains
 Q_t = total equivalent quality factor of the loop and primary circuit
 r_e = resistance of the single-tuned equivalent circuit
 r_t = total equivalent resistance of the loop and primary circuit
 u = auxiliary variable defined as the ratio M/L_e
 v = auxiliary variable defined as the ratio L_0/L_e
 w = auxiliary variable defined as the ratio L_1/L_e
 $\alpha = 1/(1 - f^2/f_0^2)$
 Z = impedance of the loop plus coupling transformer viewed from the output
 $\beta = \sqrt{Z}/G_r$
 β_m = minimum value of β
 $\gamma = L_0/L_1$
 ϵ = field acting on the loop
 e_n = equivalent noise sideband input (ENSI) per unit bandwidth
 ψ = auxiliary function defined as $(\alpha\beta)^2 Q_2/\omega L_e$.

I. INTRODUCTION

ALTHOUGH the subject of loop-coupling transformers has been well covered in the technical literature,¹⁻³ it is the author's feeling that the practical means for achieving the optimum design has not yet been fully justified from a theoretical standpoint. Accordingly, the purpose of this paper will be the theoretical discussion of the conditions necessary to contrive the optimum design of such transformers. Furthermore, as the input noise establishes the ultimate limit for the sensitivity, the discussion will be limited to the analysis of the signal-to-noise ratio of loop plus coupling transformer. As a result of this analysis, graphs are plotted which permit the design of the coupling transformer.

If we neglect the tube noise, there will remain only the thermal-agitation noise of the input circuit. This is only permissible in the frequencies up to 1500 kilocycles, where circuit noise predominates. It also presumes that a low-noise converter tube or a normal radio-frequency stage is used, as is nearly always the case in radio-direction-finder practice. With the limitations just described, the total noise at the first grid per 1-kilocycle bandwidth will be

$$e_n = 4 \times 10^{-3} \sqrt{Z} \quad (Z \text{ in ohms and } e_n \text{ in microvolts}). \quad (1)$$

¹ G. F. Levy, "Loop antennas for aircraft," Proc. I.R.E., vol. 31, pp. 56-66; February, 1943.

² D. S. Bond, "Radio Direction Finders," page 163, McGraw-Hill Book Company, New York, N. Y., 1944.

³ E. E. Zepher, "The Technique of Radio Design," page 44, John Wiley and Sons, New York, N. Y., 1943.

Introducing the gain of the coupling transformer G_r , and the effective height of the loop h , the noise field will be

$$\epsilon_n = 4 \times 10^{-3} \sqrt{Z}/(hG_r) \quad (2)$$

where Z is in ohms and ϵ_n in microvolts per meter when h is in meters.

The optimum design will obviously obtain when the ratio $\beta = \sqrt{Z}/G_r$ is minimum and the effective height as great as possible. Accordingly, our object will be, first, to find a manageable expression of β , and then to discuss the conditions for the minima thereof.

It is useful to remember that the sensitivity for a 6-decibel signal-to-noise ratio is a function of the total input noise (2), so that it will be also a function of β and, from the relations given by Bond^{4,5} it will be expressed

$$e_{6db} = 23.2\beta\sqrt{\Delta f} \times 10^{-3} (\Delta f \text{ in kilocycles, } e_{6db} \text{ in microvolts}). \quad (3)$$

II. EXPRESSION FOR β

The equivalent circuit for loop and coupling means is given in Fig. 1(a). Applying Thevenin's theorem as indicated in this figure, we pass to Fig. 1(b). Assuming that the resonance of the loop and total capacitance in parallel with it is above the working range of frequencies, Fig. 1(b) is transformed into Fig. 1(c). Finally, again applying Thevenin's theorem, the circuit of Fig. 1(c) is reduced to the single-tuned circuit of Fig. 1(d). In this circuit the total resistance and inductance will be

$$r_e = r_t + (M^2/L_t^2)r_t. \quad (4)$$

$$L_e = L_2 - M^2/L_t. \quad (5)$$

Equation (5) is easily put into a more convenient form by introducing the definition of coupling coefficient and substituting L_t in accordance with its expression quoted in Fig. 1(c). By so doing, we will have

$$L_e = L_2 [1 - k^2/(1 + \gamma\alpha)] \quad (6)$$

where $\gamma = L_0/L_1$.

With the help of (4) and (5), it is possible to define the equivalent quality factor Q_e :

$$Q_e = \omega L_e / r_e. \quad (7)$$

The resonance condition will be defined as

$$1/\omega C_2 = \omega(L_2 - M^2/L_t) \quad (8)$$

or, according to (6),

$$1/\omega C_2 = \omega L_2 [1 - k^2/(1 + \gamma\alpha)]. \quad (9)$$

It can be shown that for values of $Q_e > 10$ this condition coincides, with good accuracy, with the condition of maximum e_2 with varying C_2 . Let e_{2r} be the voltage across the tuning capacitor when condition (8) is met; then the resonance gain could be written

$$G_r = \alpha Q_e M / L_t. \quad (10)$$

⁴ See page 156 of footnote reference 2.

⁵ See page 10 of footnote reference 2.

The output impedance at resonance will be

$$Z = \omega L_c Q_e \tag{11}$$

and the function

$$\beta = (L_i/\alpha M) [r_2 + (M^2/L_i)r_i]^{1/2} \tag{12}$$

$$\beta = (\alpha u)^{-1}(\omega L_c/Q_2)^{1/2} [(\alpha v + w)^2 + u^2(\alpha v + w)(1 + Q_2/Q_i)]^{1/2} \tag{17}$$

in which

$$u = M/L_e, \quad v = L_0/L_e, \quad \text{and} \quad w = L_1/L_e$$

are auxiliary variables.

Considering the value of Q_2 as another datum of the problem, we will be able to define the pure numerical function ψ as

$$\psi = (\alpha\beta)^2 Q_2/\omega L_e \tag{18}$$

which according to (17) will be written as

$$\psi = u^{-2}(\alpha v + w)^2 + (\alpha v + w)(1 + Q_2/Q_i) \tag{19}$$

Now it is clear that the problem is to discuss the conditions of minima for the purely numerical function ψ . In this function, the value of Q_i is the quality factor of the whole primary circuit including the losses of both loop and primary coupling coil. It will vary with the ratio of loop to primary inductance, even in the event that the loop quality Q_0 and primary quality Q_1 remain constant. Then, before attempting the discussion of (19), it is necessary to find Q_i as a function of the auxiliary numerical variables.

Q_i will obviously be expressed as

$$Q_i = \omega(\alpha L_0 + L_1)/(\alpha^2 r_0 + r_1) \tag{20}$$

By simple algebraic manipulation this formula leads to

$$Q_i = Q_1(\alpha v + w) [\alpha^2 v(Q_1/Q_0) + w]^{-1}, \tag{21}$$

and finally,

$$Q_2/Q_i = (Q_2/Q_1) [\alpha^2 v(Q_1/Q_0) + w](\alpha v + w)^{-1} \tag{22}$$

By inserting (22) in (19) there will be obtained an expression of ψ as a function of u , v , and w considering α , Q_1 , Q_2 , Q_0 , as parameters or data. It is not necessary for the moment to transform (19) as just outlined, since this will give us a rather long equation. It will be sufficient to consider that Q_2/Q_i is given by (22) in (19).

III. CONDITIONS FOR MINIMUM OF ψ

The function ψ is dependent on the three variables u , v , and w , but in practice these are not all independent from each other. In fact, the coupling coefficient of the transformer can be considered as another constant or datum of the problem. The coupling coefficient will be

$$k^2 = M^2/L_1 L_2 \tag{23}$$

Multiplying both members by L_e^2 ,

$$k^2 = (u^2/w)(L_e/L_2), \tag{24}$$

but

$$L_e = L_2 - M^2/(\alpha L_0 + L_1) \tag{25}$$

Multiplying and dividing the second term of the right-hand member of (25) by L_e^2 , it will become

$$L_e = L_2 - L_e u^2(\alpha v + w)^{-1} \tag{26}$$

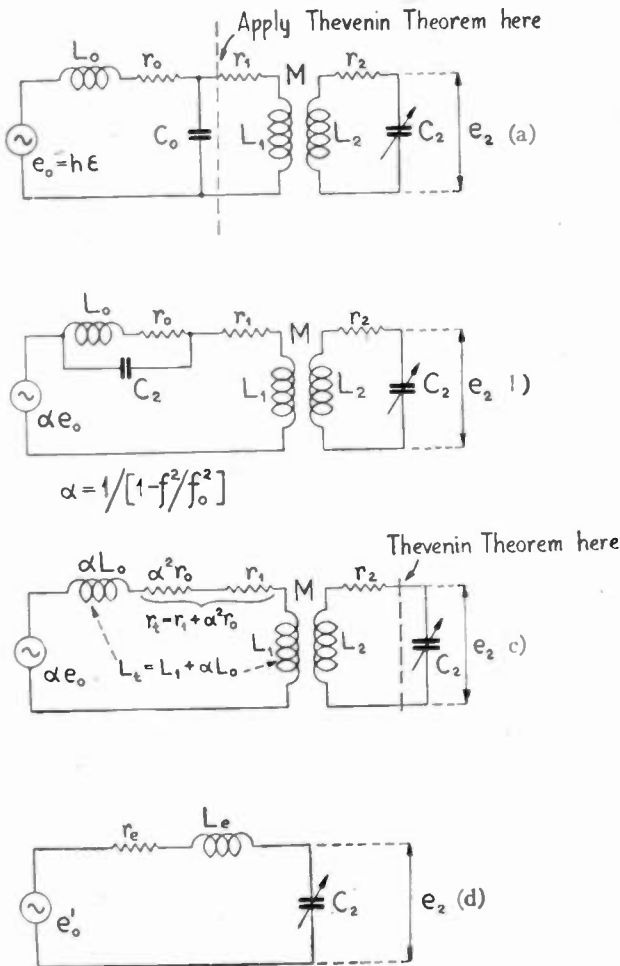

Fig. 1—In (a) the equivalent circuit for the loop and coupling transformer is given. Applying Thevenin's theorem as indicated, the circuit of (b) is obtained. By transforming the loop circuit, circuit (c) is obtained; and applying the Thevenin theorem again, the single-tuned equivalent circuit (d) is obtained.

In practice, the value of the tuning capacitance C_2 for a given frequency is generally imposed, because of tracking considerations, and according to (6) and (9) it will mean that L_e is a datum of the problem. If the following substitutions are made in (12),

$$r_2 = \omega L_2/Q_2 \text{ (secondary resistance)} \tag{13}$$

$$r_i = \omega L_i/Q_i \text{ (total primary resistance)} \tag{14}$$

$$L_2 = L_c + M^2/L_i \text{ (secondary inductance),} \tag{15}$$

by simple algebraic manipulation it could be transformed into the following:

$$\beta = \omega^{1/2} [L_e L_i^2 + M^2 L_i (1 + Q_2/Q_i)]^{1/2} / \alpha M Q_2^{1/2} \tag{16}$$

To obtain an expression with pure numerical variables, let us divide by L_e (a constant of our problem); then

From (26) we easily obtain the ratio L_0/L_2 , and by introducing this into (24) it becomes

$$k^2 = u^2 w^{-1} [1 + u^2 / (\alpha v + w)]^{-1}. \quad (27)$$

This can be easily written

$$u^2 / (\alpha v + w) = k^2 w [\alpha v + w(1 - k^2)]^{-1}. \quad (28)$$

Eliminating $u^2 / (\alpha v + w)$ between (19) and (28), we get

$$\psi = k^{-2} (\alpha v + w) [1 + k^2 (Q_2 / Q_1) + \alpha v / w]. \quad (29)$$

Now, inserting Q_2 / Q_1 as in (22), (29) will become

$$\psi = k^{-2} \{ 2\alpha v + k^2 \alpha^2 v (Q_2 / Q_0) + w [1 + k^2 (Q_2 / Q_1)] + (\alpha v)^2 / w \}. \quad (30)$$

Considering v and w (that is, L_0 and L_1) as independent variables, it can be seen that ψ is always decreasing as v decreases; and with respect to w the minimum will be found by making $\partial\psi/\partial w = 0$. Performing the derivation and solving the resulting equation, we obtain

$$w = \alpha v [1 + k^2 (Q_2 / Q_1)]^{-1/2}. \quad (31)$$

This is the value for w which makes the function minimum, as is easily shown by the positive sign of $\partial^2\psi/\partial w^2$. The negative sign of the square root of (31) has no physical meaning in our problem.

Introducing the parameter $\gamma = v/w = L_0/L_1$, (31) may be written as

$$\gamma \alpha = [1 + (Q_2 / Q_1) k^2]^{1/2}. \quad (32)$$

It is seen that, for the values most commonly found in practice (let us say Q_2/Q_1 between 0.5 and 1, k between 0.7 and 0.8, and α between 1 and 1.4), the value of γ lies between 0.8 and 1.2. This justifies the normal rule followed in practice of making γ equal to 1, and especially considering that the minimum is sufficiently broad to make the value of γ noncritical, as it is known from practice. By substitution of w according to (31) in (30), the minimum value of ψ will be obtained.

$$\psi_m = \alpha v k^{-2} \{ 2 + 2 [1 + k^2 (Q_2 / Q_1)]^{1/2} + k^2 (Q_2 / Q_0) \alpha \}. \quad (33)$$

Generally it will be permissible to neglect $k^2(Q_2/Q_0)\alpha$. This might not be obvious at first sight. Of course, in those cases in which the losses of the loop itself are very small, i.e., $Q_0 \rightarrow \infty$, the statement is true; but if we are not so drastic and assume that $Q_2/Q_0 = 1$, for $k^2 = 0.5$, $\alpha = 1.4$, and $Q_2/Q_1 = 1.5$, which may be considered as a representative case, then the omission of the term $k^2(Q_2/Q_0)\alpha$ in (33) will imply an error of 14 per cent in the value of ψ and only 7 per cent in β_m , due to the fact that β_m varies as the square root of ψ . Naturally, this will mean that the value of sensitivity for a 6-decibel signal-to-noise ratio as in (36) and (3) would be 7 per cent better than that calculated with (33). In any case, when $k^2(Q_2/Q_0)\alpha$ is greater than, let us say, 1, (33) should be used for accurate values of ψ_m . When $k^2(Q_2/Q_0)\alpha$ is neglected, (33) will become

$$\psi_m = 2\alpha v k^{-2} \{ 1 + [1 + k^2 (Q_2 / Q_1)]^{1/2} \}. \quad (34)$$

By substituting L_0/L_1 for v in (34) and taking into

account (18), the minimum value of β , which will be called β_m , is easily obtained:

$$\beta_m = \sqrt{2} k^{-1} (\omega L_0 / \alpha Q_2)^{1/2} [1 + \sqrt{1 + k^2 (Q_2 / Q_1)}]^{1/2}. \quad (34a)$$

Calling the function P

$$P = \sqrt{2} [1 + \sqrt{1 + k^2 (Q_2 / Q_1)}]^{1/2} k^{-1}, \quad (35)$$

it will give

$$\beta_m = P \sqrt{\omega L_0 / \alpha Q_2}. \quad (36)$$

A plot of the function P is shown in Fig. 2.

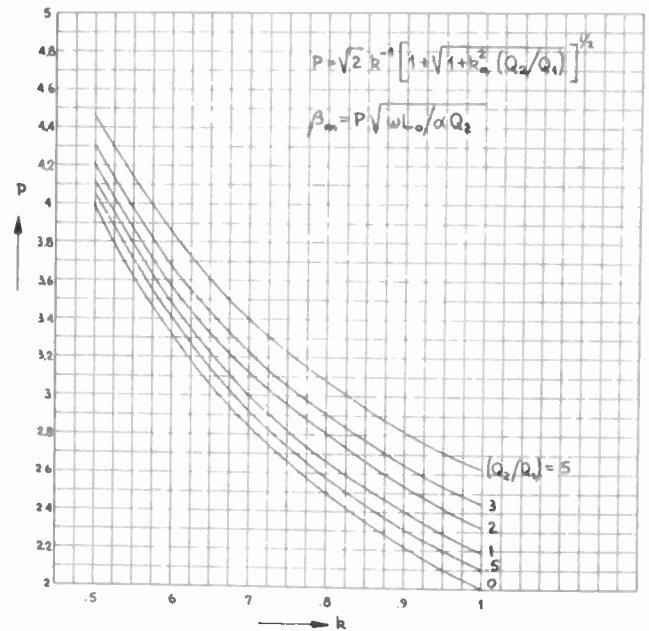

Fig. 2—Chart which permits the calculation of the function β_m and from this the optimum LNSI and sensitivity, according to equations (3) and (4).

For the sake of completeness it is useful to derive the corresponding expressions Q_s and G_r for the condition β_m , which will be called respectively Q_s' and G_r' .

For Q_s' we start from the definition of Q_s according to (7), substituting in it for r_s and L_s their values according to (4) and (5), making $L_2 = M^2/k^2 L_1$, and expressing r_1 and r_2 in terms of Q_1 , Q_2 , and L_2 . Then we get

$$Q_s = Q_2 (L_1 - k^2 L_1) / [L_1 + (Q_2 / Q_1) k^2 L_1]. \quad (37)$$

Remembering that $L_1 = L_1 + \alpha L_0$, and dividing by L_1 , and making $\gamma = L_0/L_1$, (37) will be transformed as follows:

$$Q_s = Q_2 (1 - k^2 + \gamma \alpha) / [1 + \gamma \alpha + (Q_2 / Q_1) k^2]. \quad (38)$$

Q_2/Q_1 will be given by (22) in which (31) is replaced for w . In practice, neglecting loop losses and taking into account that $\gamma \cong 1$, it will be sufficiently accurate to write $Q_2/Q_1 = \frac{1}{2} (Q_2/Q_1)$.

When the condition for β_m obtains, (32) will hold, and inserting it into (38) will give

$$Q_s' / Q_2 = [1 - k^2 + \sqrt{1 + (Q_2 / Q_1) k^2}] / [1 + 1/2 (Q_2 / Q_1) k^2 + \sqrt{1 + (Q_2 / Q_1) k^2}]. \quad (39)$$

Fig. 3 is a plot of the function Q_e'/Q_2 .

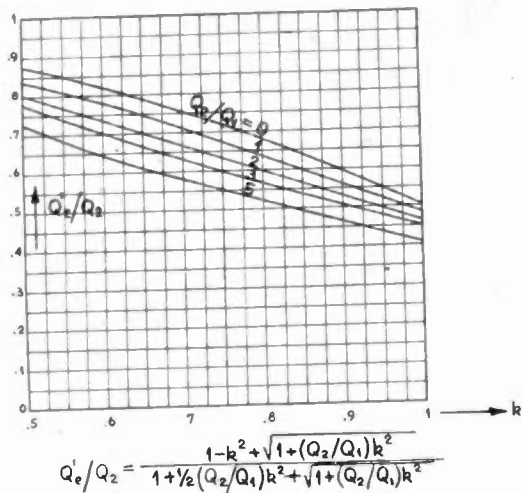

Fig. 3—Chart which permits the calculation of the quality factor of the single-tuned equivalent circuit of Fig. 1(d) for the optimum signal-to-noise ratio.

For G_r' we start from (10) and write

$$G_r' = \alpha Q_e'(M/L_1) \tag{40}$$

and $M/L_1 = u/(\alpha v + w)$. (41)

Eliminating u between (28) and (41), we will have

$$M/L_1 = k[w(1 + \gamma\alpha)(1 + \gamma\alpha - k^2)]^{-1/2}. \tag{42}$$

Introducing (38) and (42) into (40), after a few substitutions it becomes

$$G_r' = \sqrt{\alpha/v} Q_2 k \sqrt{\gamma\alpha} (\sqrt{1 - k^2 + \gamma\alpha})(1 + \gamma\alpha)^{-1/2} [1 + \gamma\alpha + 1/2(Q_2/Q_1)k^2]^{-1}, \tag{43}$$

$\gamma\alpha$ being defined as in (32). It is easy to see that G_r' is a function of k and Q_2/Q_1 , taking γ and v as parameters.

IV. DESIGN OF COUPLING TRANSFORMERS— NUMERICAL EXAMPLES

It is evident that Figs. 2 and 3 enable us quickly to design the coupling transformer for the optimum signal-to-noise ratio.

The following numerical examples are illustrative of the use of the graphs. One example will be taken from Bond's "Radio Direction Finders."⁶ Its data, in the notation used in this paper, is

$L_0 = 60$ microhenries, $L_2 = 240$ microhenries, $Q_1 = 100$, $Q_2 = 100$, $k = 707$, $f_0 = 2$ megacycles, $f = 1$ megacycle $\Delta f = 6$ kilocycles

The value of α will be:

$$\alpha = 1/[1 - (f^2/f_0^2)] = 1.33$$

For $Q_2/Q_1 = 1$, (32) gives us $\gamma = 0.92$; that of Fig. 2, $P = 2.98$; Fig. 3, $Q_e'/Q_2 = 0.71$; and from (43), $(G_r'\sqrt{v/\alpha})/Q_2 = 0.28$.

With these data we have

$$L_1 = L_0/\gamma \cong 65 \text{ microhenries}$$

$$\beta_m = 2.98\sqrt{6.28 \times 10^6 \times 60 \times 10^{-6}/1.33} = 5.02 \text{ ohms}^{1/2}$$

$$ENSI = 4 \times 10^{-3} \times 5.02\sqrt{6} = 0.495 \text{ microvolt}$$

$$Q_e' = 71.$$

Computing the value of the mutual inductance between L_1 and L_2 , and applying (25), we will obtain $L_e = 186$ microhenries; then $v = 0.322$, with this value and the value of $(G_r'\sqrt{v/\alpha})Q_2$ from (43), will give us $G_r' = 57$.

The equivalent noise-sideband input figure is practically the same as that given by Bond; the Q_e' and G_r' are slightly different, perhaps because Bond's calculation ($Q_e' = 71.8$ and $G_r' = 58.2$) are for $\gamma = 1$, while ours are for $\gamma = 0.92$.

Another example will be worked out from the following data:

$C_2 = 355$ micromicrofarads, $k = 0.84$, $Q_1 = 55$ at 120 kilocycles and $Q_1 = 110$ at 240 kilocycles, $Q_2 = 96$ at 120 kilocycles and $Q_2 = 60$ at 240 kilocycles

The loop was made with two turns of copper tube of 12-millimeter outer diameter and 10-millimeter inner diameter. The diameter of the turns was 80 centimeters and the spacing of the turns about 5 centimeters. The inductance of the loop was 8 microhenries, and the losses may be neglected in comparison with those of the primary coil. The effective height of the loop, calculated with the standard formula, is $h = 2.55 \times 10^{-3}$ meters at 120 kilocycles and $h = 5.10 \times 10^{-3}$ meters at 240 kilocycles. The band passed by the receiver $\Delta f \cong 2.7$ kilocycles.

We will design the transformer and will calculate the sensitivity for a 6-decibel signal-to-noise ratio. Accordingly, $Q_2/Q_1 = 1.74$ at 120 kilocycles and $Q_2/Q_1 = 0.54$ at 240 kilocycles. From (32) the values for γ will be: 1.48 at 120 kilocycles and 1.18 at 240 kilocycles; from Fig. 2 we obtain $P = 2.65$ at 120 kilocycles and $P = 2.48$ at 240 kilocycles. The values of β_m calculated with (36) will be $\beta_m = 0.655$ at 120 kilocycles and $\beta_m = 1.10$ at 240 kilocycles.

Finally, the sensitivity in terms of field intensity will be calculated by dividing the result of (4) by the effective height. The values will be 9.8 microvolts per meter at 120 kilocycles and 8.2 microvolts per meter at 240 kilocycles. In an actual transformer constructed with $\gamma = 1$, the other data begin as indicated above, the following values were measured: 9.5 microvolts per meter at 120 kilocycles and 7 microvolts per meter at 240 kilocycles.

ACKNOWLEDGMENTS

The author wishes to acknowledge the helpful comments on the manuscript made by Edouard Labin and A. Di Marco, of F.A.P.E.S.A.-Philips, Buenos Aires, and also the assistance of C. Denis Duffill with the English translation.

⁶ See page 169 of footnote reference 2.

A Resistance-Tuned Frequency-Modulated Oscillator for Audio-Frequency Applications*

HENRY S. McGAUGHAN†, MEMBER, I.R.E., AND CHARLES B. LESLIE†, ASSOCIATE, I.R.E.

Summary—A new-type oscillator is described which utilizes a simple resistance-capacitance feedback network with a single variable element controlling the frequency of oscillation. The design considerations outlined permit wide variations in frequency without excessive amplitude modulation or harmonic distortion. In principle, these common difficulties may be reduced to any desired minimum. This operation is achieved without the use of filters or limiter stages.

I. INTRODUCTION

A RECENT application in naval ordnance work required the use of a frequency-modulated oscillator in the audio range capable of linear frequency variation, from $\frac{1}{2}$ to $1\frac{1}{2}$ times the carrier frequency. Furthermore, this operation had to be obtained with a minimum of both amplitude modulation and harmonic distortion. Due to the wide percentage of frequency variation, it was not possible to use limiters and filters to obtain satisfactory operation. These same requirements must also be met in the design of frequency-modulated oscillators for subcarrier facsimile transmission in communication systems.¹

Direct reactance-tube modulation of an inductance-capacitance-tuned oscillator was ruled out by the wide percentage variation and the low midband frequency required. A beat-frequency system would require rather complicated circuits to minimize the instability sufficiently. Satisfactory results have been obtained in some applications by direct frequency modulation of resistance-capacitance-tuned oscillators.^{2,3} In particular, the phase-shift oscillator described by Artz appeared to have good possibilities, but it was found to have two main disadvantages. First, it was not possible to obtain wide frequency variation without excessive amplitude modulation when only one element of the phase-shift network was used as a control element. Second, there was appreciable harmonic distortion present even when no modulating signal was applied. This distortion was found to arise from the fact that a large portion of the oscillator signal appeared across the terminals of the nonlinear control element, causing a change in resistance during each cycle of oscillator operation. The first defect may be improved by simultaneous variation of two or more elements of the phase-shift network. This solu-

tion, however, will produce more harmonic distortion and introduces further complications in the circuit design.

To overcome these difficulties, a new resistance-tuned oscillator employing a different type control element was designed. The oscillator proper consists of a resistance-coupled amplifier with two feedback circuits. This general type of oscillator has been discussed by Scott⁴ with special reference to the Wien-bridge-type selective-feedback network. In the oscillator to be described, the negative loop contains a bridged-tee network of resistance and capacitance designed to attenuate a narrow range of frequencies. The effect of such feedback is to produce maximum amplifier gain at the frequency for which the negative-feedback network has minimum response. Application of the proper amount of positive feedback to such a selective amplifier produces sustained oscillation at the frequency of maximum gain. The wave form in such an oscillator is remarkably free from distortion due to the highly degenerative path the selective amplifier provides for harmonics. The desired frequency modulation of this oscillator is obtained by varying the center resistance element of the negative-feedback network which changes the frequency of maximum attenuation.

II. ANALYSIS OF THE NEGATIVE-FEEDBACK CIRCUIT

A short study of the oscillator shown in Fig. 1 will indicate those requirements which must be met to insure linear frequency modulation, freedom from amplitude modulation, and freedom from distortion.

If the negative feedback network, shown separately in Fig. 2, is assumed to operate with the output terminals open-circuited, the voltage transmission ratio becomes

$$\frac{\epsilon_o}{\epsilon_i} = \frac{q + j2n}{q + j(1 + 2n)} \quad (1)$$

where

$$q = \frac{1}{\omega RC} - n\omega RC.$$

It may be shown that a minimum in the absolute value of this ratio occurs when $q=0$. If ω_0 is defined as the frequency at which $q=0$, then

$$\omega_0 = \frac{1}{\sqrt{n} RC} \quad (2)$$

* Decimal classification: R355.912. Original manuscript received by the Institute, May 28, 1946; revised manuscript received, January 21, 1947.

† Naval Ordnance Laboratory, Washington D. C.

¹ Warren H. Bliss, "Use of subcarrier frequency modulation in communication systems," *Proc. I.R.E.*, vol. 31, pp. 419-432; August, 1943.

² Maurice Artz, "Frequency modulation of resistance-capacitance oscillators," *Proc. I.R.E.*, vol. 32, pp. 409-414; July, 1944.

³ C. K. Chang, "A frequency-modulated resistance-capacitance oscillator," *Proc. I.R.E.*, vol. 31, pp. 22-25; January, 1943.

⁴ H. H. Scott, "A new type selective circuit and some applications," *Proc. I.R.E.*, vol. 26, pp. 226-237; February, 1938.

If we make the substitution $x = \omega/\omega_0 = \omega\sqrt{nRC}$ in (1), then ϵ_0/ϵ_i will be expressed in terms of a generalized fre-

superimposed on the family of circles to illustrate the dependence of ϵ_0/ϵ_i upon frequency.

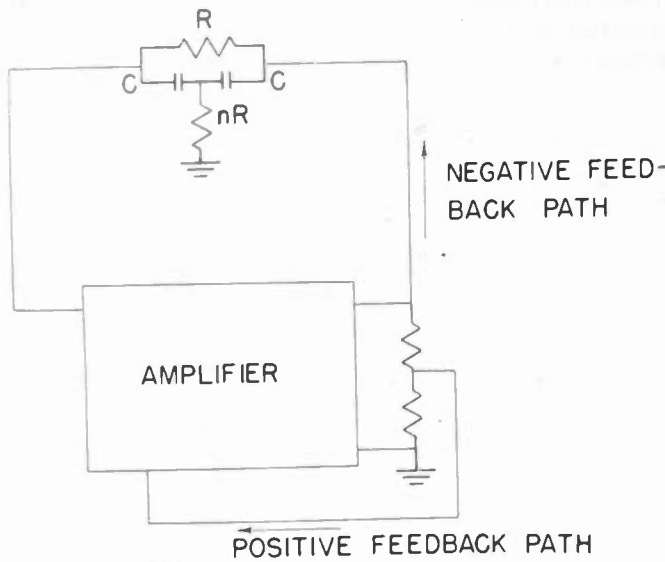

Fig. 1—Basic oscillator circuit.

quency co-ordinate x , with n as a possible variable parameter. Equation (1) now takes the form

$$\frac{\epsilon_0}{\epsilon_i} = \frac{(1/x - x) + j2\sqrt{n}}{(1/x - x) + j\left(\frac{1}{\sqrt{n}} + 2\sqrt{n}\right)} \quad (3)$$

A more graphic picture of the operation of this network, which illustrates clearly the dependence on the parameter n , is obtained by expressing (3) in terms of a real part X and an imaginary part Y , where X and Y are functions of the frequency variable x . Elimination of x between X and Y yields the equation

$$\left[X - \frac{(4n + 1)}{2(1 + 2n)} \right]^2 + Y^2 = \left[\frac{1}{2(1 + 2n)} \right]^2 \quad (4)$$

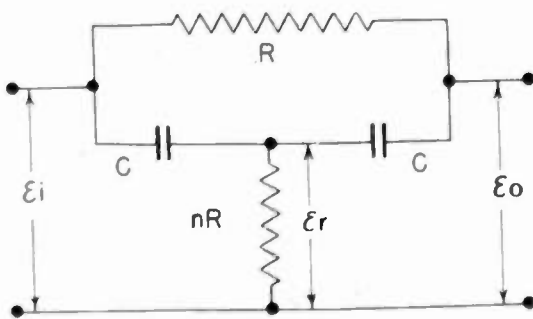

Fig. 2—Negative-feedback network.

Representative curves of (4) are plotted in Fig. 3, each circle being the locus of points representing values of the transmission ratio ϵ_0/ϵ_i for a given value of n . Curves for constant x , obtained by direct substitution in (3), are

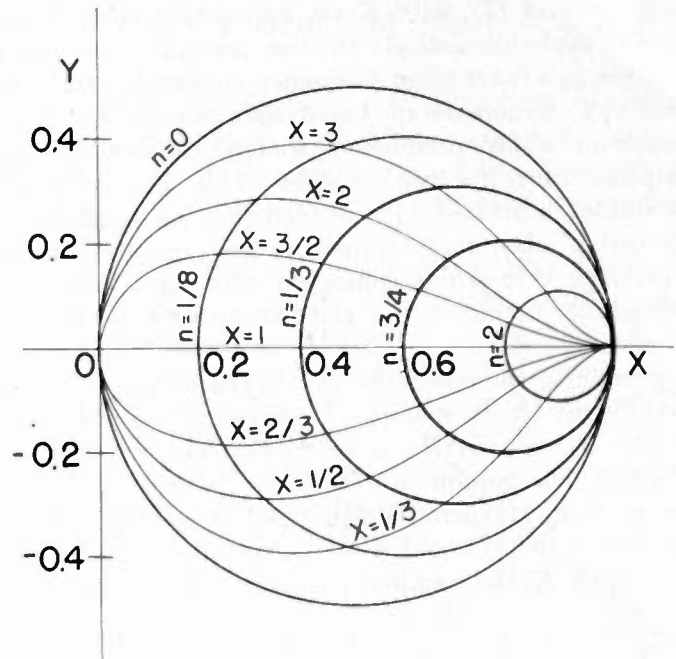

Fig. 3—Polar plot of ϵ_0/ϵ_i for bridged-tee network.

III. OSCILLATOR ANALYSIS

The bridged-tee feedback network alone is not sufficient to produce sustained oscillation since the locus of ϵ_0/ϵ_i never crosses the real axis in the negative half of the plane. It is necessary, therefore, to provide a path for positive feedback. This loop need not contain any reactance, but will be used to feed a constant fraction of the output back to the input in the positive sense. The amplification of this amplifier with two feedback paths is

$$A_f = \frac{A}{1 - A(K - \epsilon_0/\epsilon_i)} \quad (5)$$

where A = amplification without feedback
 K = positive-feedback factor referred to the input
 ϵ_0/ϵ_i = negative-feedback factor obtained from (3).

If, for the present, K is assumed to be zero in (5), the amplifier merely becomes a selective amplifier similar to the type described by Scott.⁴ Minimum amplification will correspond to maximum negative feedback. From Fig. 3 this maximum may be seen to equal unity and to occur at $x=0$ or $x=\infty$, regardless of the value of n chosen. The value of amplification under these conditions is

$$A_f = \frac{A}{1 + A} \approx 1. \quad (6)$$

Similarly, maximum amplification corresponds to minimum feedback. Fig. 3 indicates that a minimum in

ϵ_0/ϵ_i occurs for $x=1$ and equals the value of the left-hand crossing of the circle with the real axis. As n tends toward zero, this value approaches zero and the denominator of (5), with $K=0$, approaches unity. Thus, as n is made successively smaller, the maximum amplification as a function of frequency approaches the ratio of A to 1. A more detailed analysis would show that decrease in n also produces a sharper or more narrow response curve for the amplifier. This selectivity is a desirable feature, since it will tend to suppress harmonic distortion when the amplifier is used as an oscillator. Therefore, if it proves consistent with other considerations, it is desirable that the parameter n be kept as small as possible.

Removing the restriction $K=0$, the necessary condition for sustained oscillation requires that the polar plot of the quantity $A(K-\epsilon_0/\epsilon_i)$ in (5) enclose the point $(1+j0)$. The minimum condition for oscillation requires that this quantity equal $(1+j0)$, or that the denominator of (5) equal zero. Using this condition and solving for K , the required positive feedback, yields

$$K = \frac{1}{A} + \frac{\epsilon_0}{\epsilon_i} \tag{7}$$

The minimum value of K occurs when ϵ_0/ϵ_i is a minimum. This condition is obtained when $x=0$ in (3). Substituting this value of (3) in (7) therefore yields

$$K_{min} = \frac{1}{A} + \frac{2n}{1+2n} \tag{8}$$

This relation may be made more useful if n' is defined as the design-center value of n , and K'_{min} will then be the corresponding design-center value of K_{min} . Equation (8) then becomes

$$K'_{min} = \frac{1}{A} + \frac{2n'}{1+2n'} \tag{9}$$

If ω_0' is further defined as the design-center value of ω_0 corresponding to $n=n'$, then we may make the substitution $n=n'/p^2$, where $p^2 = [\omega_0/\omega_0']^2$, in (8) to give

$$K_{min} = \frac{1}{A} + \frac{2n'}{p^2 + 2n'} \tag{10}$$

Dividing both sides of (10) by K'_{min} from (9) gives

$$\frac{K_{min}}{K'_{min}} = \left[\frac{1}{A} + \frac{2n'}{p^2 + 2n'} \right] \left[\frac{1}{K'_{min}} \right] \tag{11}$$

Since the frequency is to be varied over wide limits, it is desirable that K_{min}/K'_{min} be independent of the frequency variable p . Otherwise, in order to insure oscillation over the entire range, the value of K will have to be much higher than necessary for some frequencies. This will result in overdriving and consequent excessive harmonic distortion. Study of (11) will show that

K_{min}/K'_{min} becomes independent of p as n' , the design-center value of n , approaches zero. Curves of K_{min}/K'_{min} versus p are shown in Fig. 4 for A equals 100 and n' equals 0.01, 0.001, and 0.0001. For the conditions illustrated in Fig. 4, a practical value of n' might be chosen between 0.001 and 0.0001.

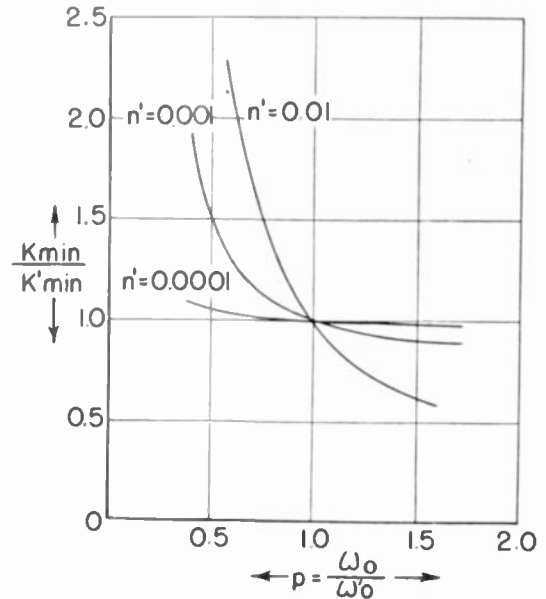

Fig. 4—Positive-feedback ratio versus ω_0/ω_0' .

IV. DESIGN OF A PRACTICAL OSCILLATOR CIRCUIT

The conclusions reached thus far have been based on the assumption that the bridged-tee network was driven from a low-impedance source and terminated in an open circuit. To preserve the symmetry of the curves of

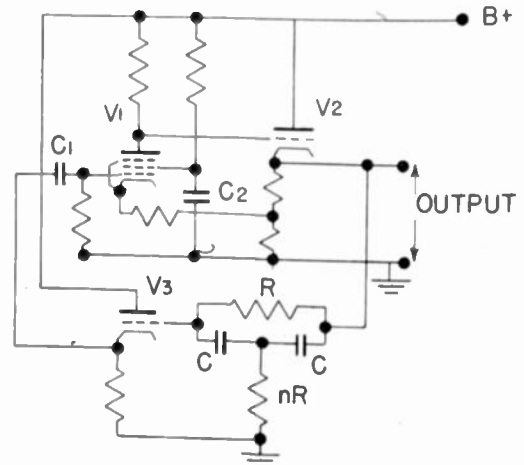

Fig. 5—Practical oscillator circuit.

ϵ_0/ϵ_i and the attendant simplification of this condition, it is desirable to operate the network as nearly as possible in this manner. A practical oscillator circuit meeting these requirements is illustrated in Fig. 5. The cathode-follower V_2 in Fig. 5 provides a low-impedance source for driving the feedback network and the direct-

coupled cathode follower V_3 presents a very high impedance to the output of the network. The only blocking capacitor in the entire oscillator is C_1 , and this must be large enough to produce negligible phase shift at the lowest oscillation frequency desired. The positive feedback is obtained by direct-coupling the cathode of the amplifier tube V_1 to a portion of the load resistor in the cathode circuit of V_2 . The positive-feedback loop, being direct-coupled, is effective down to zero frequency, while the blocking capacitor C_1 reduces the effectiveness of the negative feedback at low frequencies. To prevent instability at zero frequency, the by-pass capacitor C_2 on the screen grid of V_1 causes screen degeneration at low frequencies and thus reduces the gain below the minimum required for instability. The by-pass capacitor must be made large enough to prevent degeneration and phase shift at the lowest oscillation frequency desired. Therefore, the blocking capacitor C_1 must be large enough to maintain a large percentage of negative feedback at a frequency well below that at which screen degeneration becomes effective. The possibility of instability at zero frequency brings up another restriction on the value of the parameter n' . If we assume that the amplification A is reduced to A/r by screen degeneration at zero frequency, and further that the negative feedback is zero, we obtain

$$A_f = \frac{A/r}{1 - (A/r)(K'_{\min})} = \frac{A/r}{1 - (A/r)[1/A + 2n'/(1 + 2n')]} \quad (12)$$

To prevent instability, the denominator of (12) must be greater than zero, or

$$n' < \frac{r - 1}{2(1 - r + A)} \quad (13)$$

As an example, let $A = 100$ and $r = 2$; then

$$n' < \frac{1}{2A - 2} = \frac{1}{198}$$

This relation presents a further reason for keeping n' small.

V. REQUIREMENTS OF THE CONTROL nR

Before discussing the manner in which the control nR in Fig. 5 is to be varied, some requirements should be set up on the character of this variation. It is desirable that this resistance nR be controlled by a voltage obtained from some other source. The variation must be such that the frequency of oscillation ω_0 be linearly dependent upon this control voltage. From (2) the frequency of oscillation is

$$\omega_0 = \frac{1}{\sqrt{n}RC} = \frac{1}{\sqrt{nR}\sqrt{RC}}$$

If n is the only variable, then $\omega_0 \propto (1/\sqrt{nR})$. Thus, for linear dependence of ω_0 upon a control voltage E ,

$$\omega_0 = B + DE = F\left(\frac{1}{\sqrt{nR}}\right) \quad (14)$$

where B , D , and F are constants. Equation (14) indicates that, for satisfactory operation, a graph of the control voltage versus the reciprocal square root of the resistance should be a straight line over the usable range.

Since the resistance nR is to be a nonlinear element, it is possible that the oscillator voltage applied across this element will also vary the resistance. This would produce distortion due to resistance variation over one cycle of oscillator operation. A measure of this effect may be found by determining the fraction of the input voltage to the bridged-tee network which appears across the variable element nR . Referring to Fig. 2, if ϵ_i represents the input voltage and ϵ_r represents the voltage across nR , then

$$\frac{\epsilon_r}{\epsilon_i} = \frac{-x + j2\sqrt{n}}{(1/x - x) + j(1/\sqrt{n} + 2\sqrt{n})} \quad (15)$$

At the frequency of oscillation, $x = 1$, and

$$\left|\frac{\epsilon_r}{\epsilon_i}\right| = \frac{\sqrt{4n + 1}}{1/\sqrt{n} + 2\sqrt{n}} \approx \sqrt{n} \quad (\text{for } n \text{ very small}). \quad (16)$$

Examination of (16) shows that, for n small, $|\epsilon_r/\epsilon_i|$ is also small. For n of the order 0.0001, $|\epsilon_r/\epsilon_i|$ is approximately 0.01. Thus only one one-hundredth of the oscillator voltage will appear across the nonlinear element. This is again consistent with other factors governing the choice of n .

If the modulating voltage which governs the variation of nR appears across this element, it will appear as a signal superimposed on the frequency-modulated output. If the frequency of the modulating signal is somewhat removed from the oscillator frequency, the amplifier will be highly degenerative for such a signal and this effect will be minimized. It is desirable, however, to eliminate this possibility if practical methods may be found to do so.

VI. A PRACTICAL VARIABLE-RESISTANCE CIRCUIT

The frequency-control circuit which was found to meet all of the aforementioned requirements is illustrated in Fig. 6. The tube V_4 in Fig. 6 serves only as a phase inverter to supply a balanced signal to the control tubes V_5 and V_6 . If the modulating signal is fed from a balanced source, this tube may be eliminated. A copper-oxide double varistor unit is connected between the cathodes of V_5 and V_6 with the two elements facing the same direction. The top terminal of the desired variable-resistance combination terminates at the center of this varistor unit. If the two halves of the varistor unit are identical and the signal on V_5 and V_6 is balanced, no

change in the potential will occur at the resistor terminals. This feature prevents the modulating signal applied to V_5 and V_6 from feeding into the oscillator circuit.

ance-variation curve. Fig. 7 shows that this can be done by applying a 2.7-volt direct-current bias between the two grids. This bias may be obtained conveniently by reducing the cathode resistor R_{c6} by about 10 per cent.

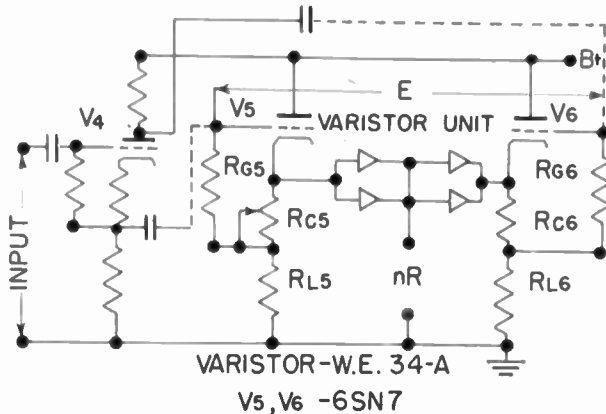

Fig. 6—Frequency-control circuit.
 $R_{g5} = R_{g6} = 1.0$ megohm
 $R_{c5} = R_{c6} = 2000$ ohms
 $R_{L5} = R_{L6} = 20,000$ ohms
 $B+ = 250$ volts

Fig. 7 shows a typical resistance-variation curve, taken with the circuit of Fig. 6, which meets all the requirements given in Section V. It was found that signals as large as 0.4 volt root-mean-square could be applied

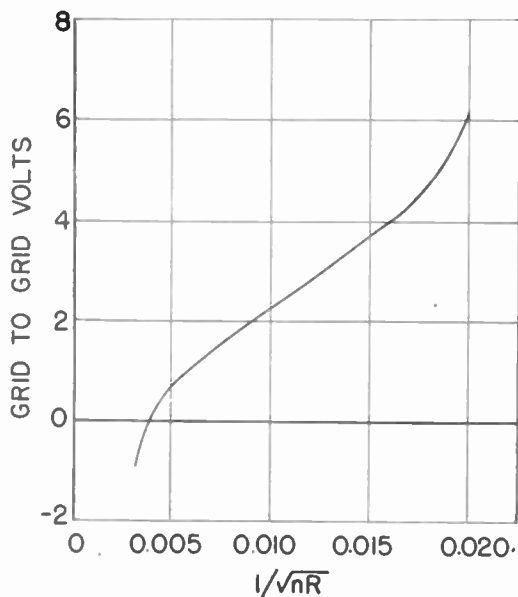

Fig. 7—Control voltage versus $1/\sqrt{nR}$.

across nR without appreciably affecting the resistance over one cycle. Thus, for a value of n of 0.0001, oscillator output voltages up to 56 volts peak may be used safely without distortion. To obtain the maximum range of linear frequency variation it is essential to operate about the midpoint of the linear section of the resist-

VII. THE COMPLETED OSCILLATOR

We now have all the components for a frequency-modulated oscillator. It is only necessary to replace the resistance element nR of Fig. 5 by the resistance terminals of the circuit of Fig. 6.

From the curve of Fig. 7 it is found that the value of nR which falls in the center of the linear portion of this graph is 7500 ohms. Using $nR = 7500$ ohms, and $R = 15 \times 10^6$ ohms, then $n = 0.0005$. With these values of n and R , the carrier frequency of the oscillator becomes

$$f_0 = \frac{1}{2\pi(0.336)C}$$

where C is in microfarads. To vary the carrier frequency of the oscillator, it is necessary only to change simultaneously the two capacitors in the bridged-tee negative-feedback network.

VIII. CONCLUSION

Oscillators of this type designed for operation in the audio range have produced reasonably linear frequency variation over a range from $\frac{1}{2}$ to $1\frac{1}{2}$ times the carrier frequency with less than 5 per cent amplitude modulation and negligible harmonic distortion. Best operation was obtained by keeping the plate voltage on the oscillator section reasonably low to keep the oscillator output low. This minimizes the effect of the carrier signal on the variable element. It was further found that relatively higher plate voltages on the resistance-control tubes produced a wider linear range on curves of the type shown in Fig. 7. Previous resistance-tuned frequency-modulated oscillators³ have inherent limitations governing the degree to which amplitude modulation and harmonic distortion may be eliminated. These limitations are not inherently present in the oscillator described, since a choice of n' sufficiently small results in the reduction of amplitude modulation and distortion to any desired degree. The only limits on the choice of n' are governed by practical circuit considerations. The major limitation present in all oscillators of this type lies in making the frequency modulation linear over a wide range of frequencies. This limit is inherent in the type of nonlinear control element used. To extend the variational range, it will be necessary to find some new control element which will present the required characteristic over a wider range of control signals. At present, if a wider range of frequencies is desired, the beat-frequency-type oscillator mentioned earlier appears to offer the most practical solution, providing the more complicated circuits required are justified by the requirements of the problem.

A Method for Calibrating Microwave Wavemeter*

LOYD E. HUNT†, SENIOR MEMBER, I.R.E.

Summary—A method of calibrating wavemeters in the microwave range is described in which the frequency of a calibrating oscillator having sufficient power to drive a wavemeter is continually checked against the harmonics of a crystal-controlled reference oscillator by visual means.

The two frequencies being compared are separately heterodyned with that of a third oscillator, which is frequency-modulated. The modulation products then pass through a narrow-band receiver to an oscilloscope whose sweep is synchronized with the saw-tooth modulation voltage. Whenever the difference between the instantaneous frequency of the modulated signal and the output of one of the generators equals the frequency to which the receiver is tuned, a pulse of energy is transmitted through the receiver and appears as a pip on the oscilloscope. Pips will appear corresponding to the moments when the instantaneous frequency is greater or less than that of each of the fixed frequencies. The oscillographic pattern then comprises two fixed pulses due to the reference oscillator, and another pair which can be shifted by changing the frequency of the calibrating oscillator. When the two pairs are superimposed, the frequency of the power oscillator matches that of the crystal harmonic.

By superimposing the higher-frequency pulse of one pair on the lower-frequency pulse of the other pair, and vice versa, additional adjustments of the power oscillator can be made to differ from the standard by \pm twice the frequency of the receiver.

INTRODUCTION

THE EXPANDING use of the microwavelengths during the war brought an increasing demand for standard-frequency sources from which wavemeters might be calibrated. A method which was successfully used for this purpose will be described.

A quartz-controlled oscillator and harmonic-generator system¹ is used as a frequency reference. Since the power output of this system is not sufficient to operate the indicators generally used on wavemeters, a more powerful calibrating oscillator is employed in such a way that its frequency can be continuously checked against the reference. This is accomplished by separately heterodyning the outputs of the two oscillators with that of a third oscillator which is frequency-modulated by a saw-tooth voltage. The resulting products are compared on an oscilloscope screen.

APPARATUS

The apparatus for the reference frequency is shown in Fig. 1. It employs a quartz oscillator whose fundamental frequency is around 6.5 megacycles, and a series of harmonic generators which delivers the 24th har-

monic (nominally 150 megacycles) to the input of a final harmonic generator. The final output, therefore, contains a large number of harmonics spaced about 150 megacycles apart. It is desirable that more closely spaced points should be available for calibration purposes, and these are conveniently obtained by using three quartz crystals differing in frequency by a small amount. One of the ranges of interest was 4000 to 4400

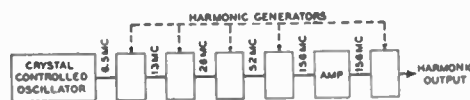

Fig. 1—The crystal-controlled reference oscillator for producing harmonics in the microwave range.

megacycles, and in that range the three crystals supply the harmonic spectrum shown in Fig. 2.

The figure illustrates how the harmonics of the three crystals overlap to form a system of calibrating frequencies whose average spacing is about 60 megacycles. The crystal frequencies were chosen so that some of the harmonics coincided with particular values that were of special interest.

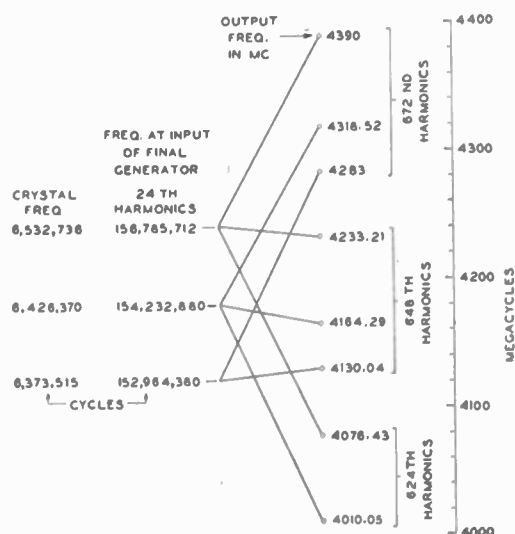

Fig. 2—The frequency spectrum in the range under consideration produced by the reference oscillator. The three crystals can be selected by a switch, and only a slight retuning of the preliminary circuits is required.

* Decimal classification: R211.11×R213.1. Original manuscript received by the Institute, March 13, 1946; revised manuscript received, January 28, 1947. Presented, Joint Meeting of International Scientific Radio Union and The Institute of Radio Engineers, Washington, D. C., May, 1946.

† Bell Telephone Laboratories, New York, N. Y.

¹ This unit was constructed originally by A. Decino, at that time a member of the Bell Telephone Laboratories, for calibrating purposes at 3000 megacycles.

The more powerful calibrating oscillator consists of a microwave generator variable over the frequency range under consideration with sufficient padding to reduce interaction between the two cavities to a negligible amount. The receiver is of a typical communications type. The frequency converters are silicon crystals.

OPERATION

The method of checking the frequency of the calibrating oscillator may be explained with reference to Fig. 3, directing attention to the equipment on the left-hand side of the diagram. The low-frequency saw-tooth voltage applied to the frequency-modulated oscillator causes

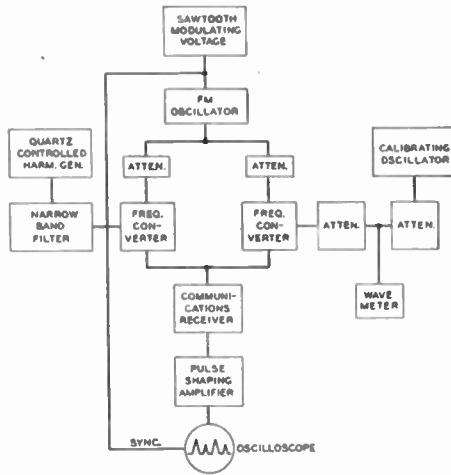

Fig. 3—General assembly of equipment to illustrate the method of matching the frequency of the calibrating oscillator to that of the reference oscillator.

the output frequency to vary above and below its mean frequency. Whenever the difference between the instantaneous frequency of the sweeping signal and the harmonic output of the crystal generator equals the frequency at which the receiver is tuned, a pulse of energy is transmitted through the receiver and appears as a pip on the oscilloscope. Two such pips will appear corresponding to the moments when the instantaneous frequency is greater and less than that of the fixed crystal

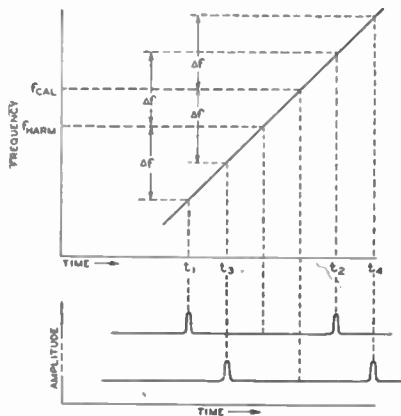

Fig. 4—This diagram shows how the pips are presented on the oscilloscope screen at the same times that the frequency of the frequency-modulated oscillator differs from that of the two fixed frequencies by Δf , the frequency of the receiver.

harmonic. Since the horizontal sweep of the oscilloscope is synchronized with the modulating voltage applied to the frequency-modulated oscillator, the two pips will always appear in the same relative positions. The narrow-band filter is adjustable and is for the purpose of

allowing only one harmonic to be transmitted to the frequency converter.

The equipment to the right of the diagram has a similar function, the main difference being that the frequency of the voltage that is applied to the right-hand converter is adjustable. The purpose of this adjustment is illustrated with the aid of Fig. 4. The upper graph represents the variation of frequency with time of the

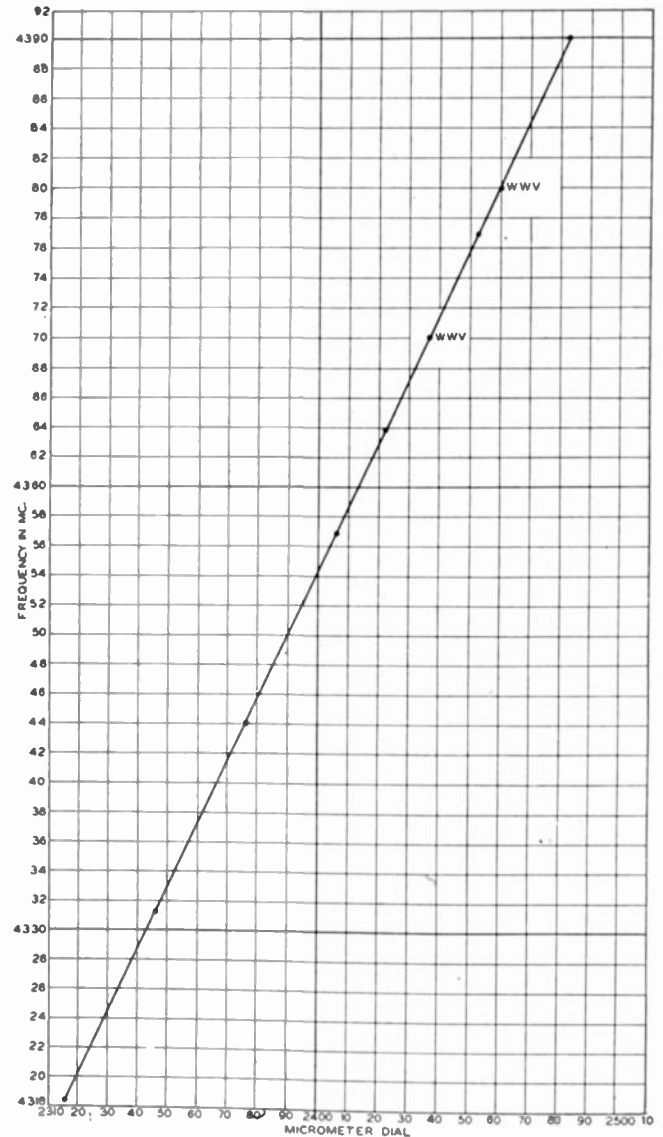

Fig. 5—A calibration curve for a particular wavemeter obtained by the method described wherein the receiver is calibrated by the lower harmonics of the quartz oscillator. The two additional points were obtained by checking the receiver against the standard-frequency broadcasts of WWV.

frequency-modulated oscillator, Δf represents the frequency to which the receiver is tuned; t_1 and t_2 then define the moments when the sweeping frequency is below and above the standard frequency by Δf , and correspondingly define the positions at which the pips appear on the oscilloscope. In like manner t_3 and t_4 give corresponding information with respect to the calibrating oscillator. As the frequency of the latter is varied, the positions of the two pips due to it are displaced accord-

ingly, while those due to the standard remain fixed in position. Consequently, when the two pairs of pips are superimposed, the frequency of the calibrating oscillator is equal to that of the standard. The sweep scale of the oscilloscope could be calibrated in terms of frequency differences. A pair of pips is separated by twice Δf , and the scale between them may be divided into fractions of that amount. In this way the wavemeter is tuned to the frequency of the calibrating oscillator that is continually checked against the standard.

It is possible to obtain additional calibrating frequencies, as close together as desired, by taking advantage of a simple expedient inherent in this method of calibration. Two other distinct frequencies are available on the horizontal scale, regardless of the linearity of the sweep with reference to Fig. 4. When the higher-frequency pulse of the calibrating oscillator is superimposed on the lower pulse of the crystal generator, the frequency of the former is lower than the latter by twice the receiver frequency. Conversely, when the lower pulse of the calibrating oscillator corresponds to the upper pulse of the standard, the frequency difference is the same amount in the opposite direction. Thus a cluster of calibrating points about each crystal frequency is obtainable by choosing various values of the receiver tuning. This method requires that the receiver be calibrated. There are a number of calibrating harmonics available from the crystal oscillator that may be used for that purpose. Fig. 5 is an example of such a calibration. The two additional calibration points shown in the figure were obtained by checking the receiver against WWV (standard-frequency broadcasts from Washington, D. C.) at 5 and 10 megacycles.

ACCURACY

The accuracy of this method depends principally upon the accuracy with which the pulses can be matched. The

frequency interval, in cycles per second, corresponding to the length of the pulse, defines a limit to the degree of accuracy to which the pips can be superposed, and this may be determined in terms of the spacing of a pair which is always $2\Delta f$. With the present equipment, as used, a pip occupies about $1/32$ inch on the screen and the separation of about three inches represents a frequency difference of 1 megacycle. The pulse width then corresponds to a frequency space of about 12 kilocycles and the pips can readily be matched with an inaccuracy of less than 12 kilocycles. This amounts to about three parts in a million. The ability to capitalize on even this degree of precision depends upon the general stability of the equipment. The uncertainty of the crystals which were reused was considerably greater than 3 parts per million. Obviously, much better crystals could have been obtained, had occasion demanded a better precision.

DISCUSSION

With the method described, the pulses are combined before final detection so that the outputs of the two frequency converters add in random phase. This causes a slight spread among the pips on successive sweeps which blurs the line as proper adjustment is approached. The maximum deflection, however, remains a sensitive indication of matching, particularly when the final detector has a square-law characteristic. The blurring could be prevented by employing an electronic switch which, on successive sweeps, permits the outputs of the frequency converters to be rectified separately. This would still permit the pulses from the two sources to be superposed on the scope and, although the blurring would be absent, the sharp change in amplitude would also be absent. It is questionable whether the advantage gained by the elimination of the blur would compensate for the loss of the sensitive indication due to changing amplitude.

A Method of Graphically Analyzing Cathode-Degenerated Amplifier Stages*

E. M. LONSDALE†, ASSOCIATE, I.R.E., AND W. F. MAIN‡, ASSOCIATE, I.R.E.

Summary—A graphical method of analyzing the performance of cathode-degenerated amplifiers and cathode-follower stages (triode, tetrode, or pentode) is outlined and illustrated. It is based on use of a curve relating grid-to-ground potential to the resulting plate current, taking into account the effects of the voltage drops across cathode and plate resistors. This method yields complete performance data for the stage, unless reactive effects are encountered, and involves a minimum amount of plotting and computation.

* Decimal classification: R363.23×R139.21. Original manuscript received by the Institute, May 28, 1946; revised manuscript received, September 27, 1946.

† The State University of Iowa, Iowa City, Iowa.

‡ Naval Research Laboratory, Washington, D. C.

INTRODUCTION

IN DESIGNING cathode-degenerated stages, it is necessary to predetermine such performance factors as maximum input level for class-A operation, stage gain at specified input levels, and the linearity of amplification. Such information can be obtained only from some method of graphical analysis based on the use of the family of plate-characteristic curves. This paper sets forth one such method in which use is made of a curve relating grid-to-ground potential to plate current.

Having plotted this curve, the designer can readily determine the performance characteristics of the stage and can easily predict the effects of circuit-parameter changes. Throughout this paper no allowance has been made for reactive effects; all loads are assumed to be purely resistive and the effects of tube capacitances to be negligible.

ANALYSIS OF A CATHODE-DEGENERATED TRIODE AMPLIFIER STAGE

The circuit diagram for a typical cathode-degenerated amplifier stage is shown in Fig. 1. A step-by-step analysis of such a stage will be made in order to illustrate the method employed.

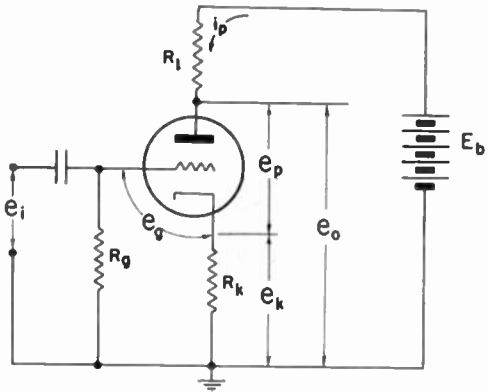

Fig. 1—Circuit diagram for a typical cathode-degenerated triode stage.

The following design data for the triode-connected 6L6 stage is assumed known: $R_l = 1000$ ohms, $R_k = 200$ ohms, and $E_b = 325$ volts. Let it be required to determine the complete operating characteristics of the stage.

As mentioned previously, the standard family of tube plate-characteristic curves will be used. However, the horizontal axis, in addition to representing "Plate Volts," also will be used to represent cathode voltage e_k , input voltage e_i , plate voltage e_p , and output voltage e_o . On the same sheet with the plate-characteristic curves will be plotted three straight lines: $e_k = f_1(i_p)$, $e_p = f_2(i_p)$, and $e_o = f_3(i_p)$; and a curve: $e_i = f_4(i_p)$. Fig. 2 shows the appearance of the curve sheet with these functions plotted.

First, e_k is plotted as a function of i_p . This relation is obviously linear and is represented by a straight line through the origin with a slope of $i_p/e_k = 1/R_k$. By assuming a convenient value of i_p , say 100 milliamperes, and applying Ohm's law (R_k is given as 200 ohms), a second point needed to plot the e_k line is found having co-ordinates ($e_k = 20$, $i_p = 100$).

The e_o line is the familiar load line showing the relationship between plate-to-ground voltage and plate current. It passes through the point ($e_o = E_b$, $i_p = 0$) with a slope of $-(1/R_l)$ and intersects the i_p axis at $i_p = E_b/R_l$. Using the values given for E_b and R_l ($E_b = 325$ volts, $R_l = 1000$ ohms), the co-ordinates of two points

needed to plot the load line are determined as ($e_o = 325$, $i_p = 0$) and ($e_o = 0$, $i_p = 325$).

Next, the e_p line is drawn. This is a plot of plate-to-cathode voltage as a function of plate current. It is also a straight line passing through the point ($e_p = E_b$, $i_p = 0$), but has a slope of $-(1/R_k + R_l)$ and intersects the i_p axis at $i_p = (E_b/R_k + R_l)$. Substituting known values gives $e_p = 325$ volts as the intersection point on the e_o axis and $i_p = 271$ milliamperes as the intersection point on the i_p axis.

Finally, the e_i curve, showing the variation of plate current with actual grid-to-ground potential, is plotted. The co-ordinates of a particular point on this curve are found in the following manner: first, a convenient e_o line is chosen, say $e_o = -22.5$, and followed to its intersection with the e_p line at point p ; next, a horizontal projection is drawn from p leftward to intersect the e_k line at $e_k = +9$ volts and the i_p axis at $i_p = 45.0$ milliamperes. Then, since e_k is in series with e_o , e_i is found by combining -22.5 with $+9.0$ to give $e_i = -13.5$. This is the value which e_i must take in order that e_o assume the value of -22.5 volts. We have thus secured a point on the e_i curve having co-ordinates ($e_i = -13.5$, $i_p = 45.0$). By choosing other values of e_o corresponding to other e_o lines on the curve sheet and by following a

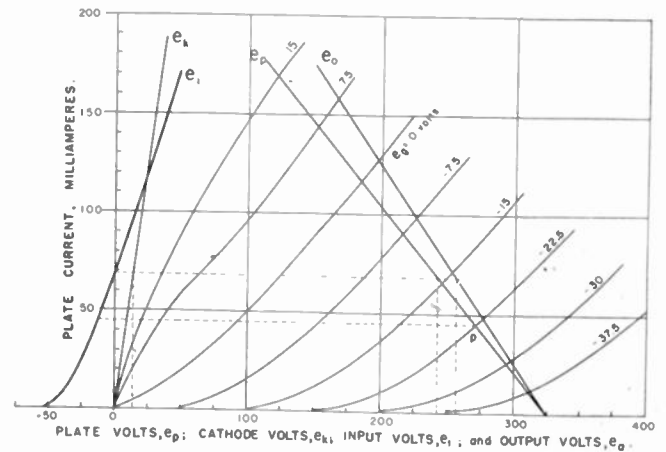

Fig. 2—Plate-characteristic curves for a triode-connected type-6L6 with the addition of the lines needed for analysis of the circuit of Fig. 1.

similar procedure, a series of points is found which, when connected, gives the e_i curve. It should be noted that when positive values of e_o are chosen, polarities are such that e_o adds directly to e_k , resulting in points on the e_i curve lying to the right of the e_k line.

Generally, the four lines needed to carry out the stage analysis can be drawn directly on the standard plate-characteristic curve sheets found in vacuum-tube handbooks. Moreover, if the stage employs a high-transconductance, low-grid-swing tube, the e_i curve is found to lie quite close to the e_k line and both lines are found to be nearly vertical. With such a plot the accurate readings needed for stage analysis are quite difficult to secure. A re-plotting of the e_i curve and the e_k line on a separate

ruled sheet with an expanded voltage scale then becomes necessary.

DETERMINATION OF STAGE PERFORMANCE

Having plotted the e_i curve, an analysis of the stage performance can be conducted. First the zero-signal (steady-state) operating conditions will be determined. Reading the ordinate at the $e_i=0$ point gives a plate-current value of 68.5 milliamperes, and following along the 68.5-milliamperer line to intersections with the e_k , e_p , and e_o lines gives values for these voltages of 14.0, 241, and 255, respectively. Knowledge of these steady-state values is of particular importance to the designer in order that he be able to determine resistor and tube power dissipations.

Proceeding with the analysis, we next locate two significant intersections on the e_i curve; one with the e_k line at $e_i=23.0$, the other with the $i_p=0$ axis at $e_i=-52.0$. Positive values of e_i greater than 23.0 result in positive-grid operation, while negative values in excess of -52.0 result in plate-current cut off. These two points, therefore, are the limits of grid excursion for class-A operation. Clearly, if the stage is to amplify a symmetrical waveform, the maximum peak-to-peak input level can be no more than twice the least of these two limits. In the present example, this would be $2(23.0)=46.0$ volts.

To determine the stage gain at a specified input level, say 40 volts peak-to-peak, the two points on the e_i curve corresponding to the limits of grid excursion for the given signal are located, $e_i=+20$ and $e_i=-20$. Then, by projecting horizontally to the e_o line from each of these points, the resulting plate-voltage swing is determined. Proceeding in this manner with the present example gives $e_o=297-217=80$ volts. Hence, the gain $\Delta e_o/\Delta e_i$, so determined, is 2.00.

ANALYSIS OF TETRODE AND PENTODE TUBES IN CATHODE-DEGENERATED STAGES

The operation of either tetrode- or pentode-type tubes in cathode-degenerated stages can also be analyzed by the method set forth above, with a slight modification in the procedures for determining the e_k and e_p lines. For purposes of illustration, a stage employing a type-6L6 tetrode in the cathode-degenerated circuit of Fig. 3 will be analyzed.

Circuit constants are chosen to be the same as those which were used in the 6L6 triode-connected stage. These are: $R_l=1000$ ohms, $R_k=200$ ohms, and $E_b=325$ volts. E_{sq} , the direct-current screen potential, is the rated value for a 6L6 tetrode, 250 volts.

As mentioned earlier, the procedures used in plotting the e_k and e_p lines must be altered slightly when a tetrode- or pentode-type tube is used. These changes are necessary in order to take into account the voltage drop R_k resulting from the flow of the direct-current component of screen current. Only the direct-current

component need be considered, since the alternating-current component is shunted directly from screen to cathode by C_{sq} . When plotting the e_k line, therefore, it becomes necessary to add the direct-current value of screen current to all values of i_p . The effect of this change is to shift this line horizontally to the right by an amount $i_{sq}R_k$. Similarly, the e_p line must be shifted to the left by an equal amount.

In the present example, in which a type-6L6 tetrode is used, the average screen current is 5 milliamperes. This current, flowing through the 200-ohm cathode resistor, results in a 1-volt displacement horizontally to the right of all points on the e_k line, and an equal displacement to the left of all points on the e_p line. Neglecting these small effects produces a negligible error in the results. However, when certain pentode tubes such as the 6AC7 are used, screen current may amount to as much as 30 per cent of plate current and its effects become quite important. Also, in other circuits where R_k may be relatively large, such as in the single-tube "phase splitter," even a small screen current results in a cathode drop of several volts. Here also the effects of screen current flowing through R_k must be taken into account when plotting the e_k and e_p lines.

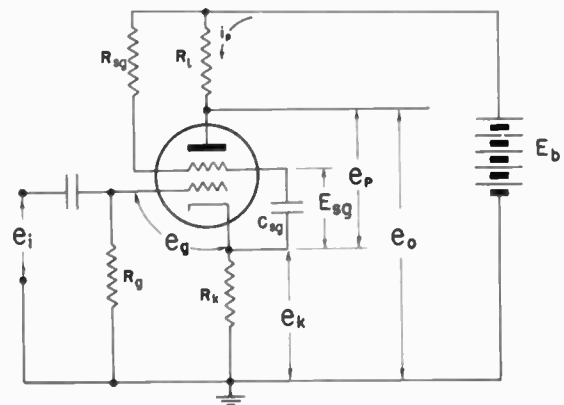

Fig. 3—Circuit diagram of a tetrode tube used in a cathode-degenerated stage.

The following performance data on the 6L6 tetrode stage was determined from the curves of Fig. 4:

- (1) Steady-state plate current = 65 milliamperes
- (2) Steady-state plate voltage = 241 volts
- (3) Steady-state cathode voltage = 14 volts
- (4) Stage gain with 40-volt peak-to-peak input signal = 2.38
- (5) Limits of grid excursion for class-A operation = $+34.5$ and -40 volts.

CATHODE-FOLLOWER ANALYSIS

A cathode follower can be treated as a special case of the cathode-degenerated amplifier with $R_l=0$ and with the output voltage taken across R_k . As such, it is easily analyzed by use of the graphical method set forth above. As an illustration, the performance characteristics of the 6L6 stage shown in Fig. 5 will be determined.

The supply voltage E_b will be taken as 350 volts, the screen voltage E_{s0} as 250 volts, and R_k as 1000 ohms. Let it be required to find: (1) steady-state current and voltages, (2) limits of grid excursion for class-A operation, (3) gain with an input signal of 40 volts peak-to-peak, and (4) a value of fixed bias which, when added in series with e_i , will allow full utilization of the stage capabilities.

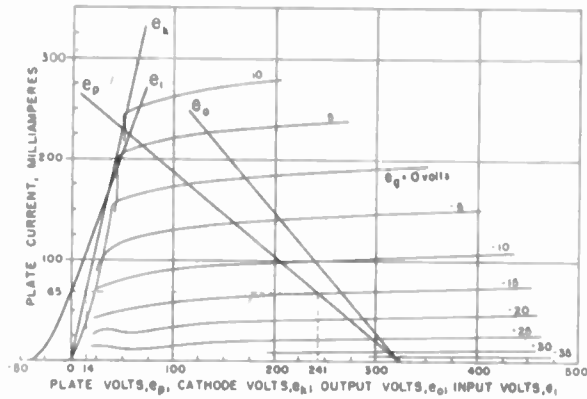

Fig. 4—Plate characteristics for a type-6L6 tetrode stage with the addition of the lines needed for analysis of the circuit of Fig. 3.

First, the e_k line is drawn. Using $I_{s0} = 5$ milliamperes as a normal value of screen current for a 6L6 tetrode, we obtain an e_k intersecting the voltage axis at $e_k = i_{s0}R_k = 5$ volts. Also, this line will obviously pass through the point $(e_k = 305, i_p = 300)$. Next, the e_p line and the e_i curve are plotted following the same procedures as were

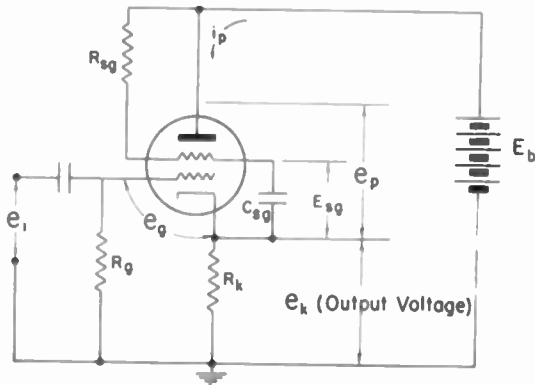

Fig. 5—Circuit diagram for a tetrode-connected cathode-follower stage.

used with the earlier example of the 6L6 tetrode. Taking into account the 5-volt drop across R_k resulting from the flow of screen current gives an e_p line passing through $(e_p = 345, i_p = 0)$ and $(e_p = 0, i_p = 345)$. An e_o line would be meaningless, since the output voltage is derived from the cathode resistor rather than a plate load resistor.

DETERMINATION OF STAGE PERFORMANCE

Steady-state operating conditions, as read from the

curves of Fig. 6, are found to be: $e_k = 26$ volts, $e_p = 324$ volts, and $i_p = 21$ milliamperes. The limits of grid swing for class-A operation occur at $e_i = +180$ and $e_i = -37$ volts. To determine the output voltage resulting from a 40-volt peak-to-peak grid swing, horizontal projections are drawn from each of the two points, $e_i = +20$ and $e_i = -20$, to intersections with the e_k line at $e_k = 40$ and $e_k = 12$ volts. This shows the stage gain $\Delta e_k / \Delta e_i$ to be 0.70.

It is interesting to note that the e_i curve closely approximates a straight line even though the e_o curves for the tube are quite bunched in the low-plate-current region. This improvement in linearity is due, of course, to the negative feedback resulting from the use of a large un-bypassed cathode resistor.

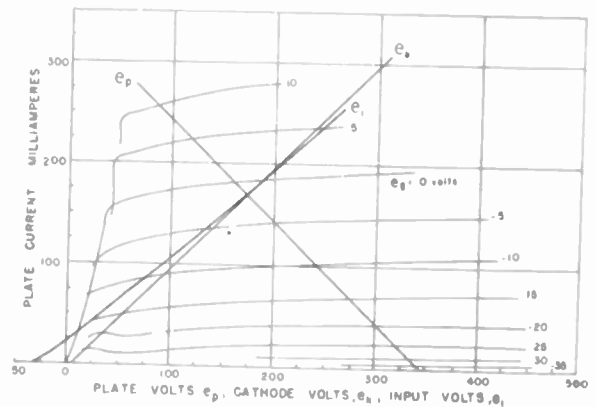

Fig. 6—Plate-characteristic curves for a 6L6 tetrode with the addition of the lines needed for analysis of the circuit of Fig. 5.

CHOICE OF OPERATING POINT

With the specified design parameters, a total input swing of $180 - (-37) = 217$ volts is available between the limits set by grid-current flow and plate-current cutoff. However, since plate-current cutoff occurs for negative input signals greater than 37 volts, the maximum symmetrical input signal which can be handled is 74 volts peak-to-peak. Moving the operating point nearer the center of the 217-volt e_i operating range would obviously result in greater signal-handling capabilities for the stage.

By use of a "cut-and-try" process, an operating point at $e_i = 50$ volts is found at which the plate dissipation of the tube is fully utilized and with which symmetrical input signals as large as 174 volts peak-to-peak may be amplified before plate-current cutoff occurs. To set the operating point at +50 volts, the "cold" end of the grid resistor is returned to a tap point on R_k at which this positive potential exists. For analysis of the stage performance under the new design conditions, the $e_i = 0$ line is shifted from coincidence with the i_p axis, 50 volts to the right, where it corresponds with what was previously the $e_i = 50$ -volt line. All performance data is then determined by using grid swings referred to this new $e_i = 0$ axis.

Contributors to Waves and Electrons Section



J. J. ADAMS

James J. Adams (A'36-M'44-SM'45) was born on July 7, 1912, in Sioux Falls, South Dakota. He received the B.S. and the M.S. in electrical engineering from the University of Colorado in 1934 and 1935. From 1936 to 1938 he was employed as a radio engineer with the Philco Radio and Television Corporation. Since 1939 he has been with the Zenith Radio Corporation.



Harold Goldberg (A'38-M'44-SM'44) was born in Milwaukee, Wisconsin, on January 31, 1914. He received the B.S. degree in electrical engineering in 1935, the M.S. degree in 1936, and the Ph.D. degree in 1937 from the University of Wisconsin. He served as Research Fellow in electrical engineering from 1935 to 1937. After teaching engineering mathematics at the University of Wisconsin, he was appointed Postdoctorate Research Fellow in Physiology and received the degree of Ph.D. in physiology in 1941.

Dr. Goldberg served as senior engineer with the Stromberg-Carlson Company research department from 1941 to 1945, and has since been with the research department of the Bendix Radio Division Bendix Aviation Corporation, in the capacity of principal research engineer. He is a member of the



HAROLD GOLDBERG

A.I.E.E., the American Physical Society, the American Association for the Advancement of Science, Sigma Xi, Tau Beta Pi, Eta Kappa Nu, and the subcommittee on Television Relays of the R.M.A.



MELVILLE S. HAWLEY

Melville S. Hawley was born on November 14, 1906, at Los Angeles, California. In 1929 he received the B.S. degree in electrical engineering at Union College, Schenectady, New York. Since 1929 Mr. Hawley has been principally engaged in the development and design of electroacoustic instruments at the Bell Telephone Laboratories. He is a member of the Acoustical Society of America.



LOYD E. HUNT

Loyd E. Hunt (M'33-SM'43) was born on November 7, 1901, at Boise, Idaho. He received the A.B. degree in physics from Reed College, Portland, Oregon, in 1927. He was a commercial wireless operator and ship wireless inspector from 1918-1926; radio instructor at the Oregon Institute of Technology from 1926 to 1927; and director of the radio-electric division of the United YMCA schools, Seattle, Washington, from 1927 to 1929. Mr. Hunt has been engaged principally in the ultra-short-wave and mi-



M. J. KOBILSKY



crowave fields at the Bell Laboratories, since 1929. He is secretary of the Monmouth County subsection of the New York Section of The Institute of Radio Engineers.



M. J. Kobilsky (A'39-M'45) received the C.E. degree from the University of Buenos Aires, in 1936. From 1936 to 1937 he was the assistant editor of the *Review of the Argentine Association of Electrical Engineers*.

Mr. Kobilsky served as radio engineer for the B. Y. E. Coil Manufacturing Company from 1937 to 1939, and was chief radio engineer at the Douglas Laboratory from 1939 to 1941. From 1941 to the present time he has been associated with the Fabrica Argentina de Productos Electricos S. A. Philips Company as chief engineer of the radio-receiver development group.



Charles B. Leslie (S'42-A'45) was born at Minneapolis, Minnesota, on June 16, 1922. He received the degree of B.E.E. in 1943 from the University of Minnesota. Since then he has been employed by the Naval Ordnance Laboratory in Washington, D. C. During 1945 he held a commission as ensign in the Naval Reserve. Mr. Leslie has been engaged in the develop-



CHARLES B. LESLIE



EDWARD M. LONSDALE

ment and design of electronic circuits and laboratory measuring equipment for several underwater ordnance programs of the Laboratory. He is a member of Eta Kappa Nu, Tau Beta Pi, and the A.I.E.E.

Edward M. Lonsdale (A'41) was born in Kansas City, Missouri, on July 21, 1915. He received the B.S. degree from the University of Kansas in 1936 and the M.S. degree from Iowa University in 1941. Mr. Lonsdale was employed by the Southwestern Bell Telephone Company in 1936. After receiving the M.S. degree in 1941, he joined the electrical engineering staff at Iowa State College. In 1942 he accepted a position in the Radio Division of Naval Research Laboratory. Since 1946 he has been an assistant professor of electrical engineering at Iowa University.

Henry S. McGaughan (M'46) was born on November 5, 1917, at Philadelphia, Pennsylvania. He received the B.S.E. degree from the University of Michigan in 1941.

From 1941 to 1946 he was employed as a physicist with the Naval Ordnance Laboratory, where he was engaged in research and development work in connection with underwater ordnance. His work was primarily concerned with problems in electronics and electrical circuit analysis. In 1947 he became an instructor at Cornell University.



HENRY S. MCGAUGHAN

W. F. Main (A'44) was born at Fresno, California in 1921. He received the A.B. degree in physics from Fresno State College in 1943. Since 1943, he has been associated



W. F. MAIN

with Naval Research Laboratory. From 1943 to 1946, he was engaged in the analysis of the operational performance of naval radar countermeasures equipment and in the evaluation of captured enemy radar equipment; at present he is employed in the development of radio-frequency components for radar receivers. He is a member of the American Physical Society and the A.A.A.S.

Harry S. Rogers received the B.S. and C.E. degrees from the University of Wyoming and the Sc.D. from Northeastern University. From 1914 to 1916 he was an in-



HARRY S. ROGERS

structor of civil engineering at the Universities of Iowa and Wyoming. In 1916 he accepted the post of assistant professor at the University of Washington, and in 1918, at Lafayette College. He then joined the Truscon Steel Company as a designing engineer. From 1920 to 1933 he became a consulting engineer at Corvallis, Oregon; and during the latter part of this period also served as dean of engineering and director of the engineering experimental station at Oregon State College. In 1933 Dr. Rogers became president of the Polytechnic Institute of Brook-



FRANK F. ROMANOW

lyn. In addition Dr. Rogers has served on numerous Government committees. As a member of the National Engineers' Committee he recently was awarded the President's Certificate of Merit. He is a member of Phi Kappa Phi, Tau Beta Pi Sigma Tau, and Sigma Xi.

Frank F. Romanow was born on March 21, 1908, at Paris, France. He received the M.E. degree in 1930 and the M.M.E. degree in 1933 from the Polytechnic Institute of Brooklyn. Since 1930 he has been a member of the Bell Telephone Laboratories and has been engaged in the design of acoustical instruments and the development of acoustical measurement techniques. He is a fellow of the Acoustical Society of America, Tau Beta Pi and Sigma Xi.

Richard G. Talpey (S'40-A'42-M'44) was born in Auburn, New York, on February 17, 1918. He attended M.I.T. taking the co-operative course in electrical engineering. Three terms of co-operative work were spent with the General Electric Company. He received the B.S. and M.S. degrees in 1941. Since then he has been associated with the Research Department of the Stromberg-Carlson Company doing development work in ultra-high frequencies and microwaves. During 1945 he was at Hazeltine Corporation on a co-operative engineering program. He has been a licensed amateur since 1933.



RICHARD G. TALPEY

Abstracts and References

Prepared by the National Physical Laboratory, Teddington, England, Published by Arrangement with the Department of Scientific and Industrial Research, England, and *Wireless Engineer*, London, England

NOTE: The Institute of Radio Engineers does not have available copies of the publications mentioned in these pages, nor does it have reprints of the articles abstracted. Correspondence regarding these articles and requests for their procurement should be addressed to the individual publications and not to the I.R.E.

Acoustics and Audio Frequencies.....	987
Materials and Transmission Lines.....	987
Circuits and Circuit Elements.....	988
General Physics.....	990
Geophysical and Extraterrestrial Phenomena.....	991
Location and Aids to Navigation.....	992
Materials and Subsidiary Techniques.....	992
Mathematics.....	994
Measurements and Test Gear.....	994
Other Applications of Radio and Electronics.....	995
Propagation of Waves.....	996
Reception.....	997
Stations and Communication Systems.....	998
Subsidiary Apparatus.....	998
Television and Phototelegraphy.....	998
Transmission.....	998
Vacuum Tubes and Thermionics.....	999
Miscellaneous.....	1000

The number in heavy type at the upper left of each Abstract is its Universal Decimal Classification number and is not to be confused with the Decimal Classification used by the United States National Bureau of Standards. The number in heavy type at the top right is the serial number of the Abstract.

ACOUSTICS AND AUDIO FREQUENCIES

116:534	2306
References to Contemporary Papers on Acoustics—A. Taber Jones. (<i>Jour. Acous. Soc. Amer.</i> , vol. 19, pp. 263-277; January, 1947.)	
534	2307
Program of the Thirty-Second Meeting of the Acoustical Society of America—(<i>Jour. Acous. Soc. Amer.</i> , vol. 19, pp. 283-293; January, 1947.) Brief summaries are given of papers read. These include: "The Propagation of Underwater Sound at Low Frequencies as a Function of the Acoustic Properties of the Bottom," by J. M. Ide, R. F. Post, and W. J. Fry; "Measurement Conditions Influencing the Front-to-Back Discrimination of an Underwater Hydrophone," by L. N. Miller; "An Acoustic Lens for Underwater Sound," by R. Herr; "Ultrasonic Lenses and Transmission Plates," by P. J. Ernst; "Surface Reflection of Short Ultrasonic Pulses in the Ocean," by R. J. Urick and H. L. Saxton; "Reflection of Sound from the Sea Surface," by L. N. Liebermann; "Reflection of Sound from Rough Surfaces," by P. G. Bergmann; "Supersonic Radar Trainers," by C. E. Teeter, Jr.; "Attenuation of Sound in Water," by D. A. Wilson and L. N. Liebermann; "Convex Wood Splays for Broadcast and Motion Picture Studios," by M. Rettinger; "Disk Recording Studio Acoustics," by J. Y. Dunbar and L. Green, Jr.; "Review of Criteria for Studio Design," by G. M. Nixon and H. M. Gurin; "A System for Reducing Scratch in Record Reproduction," by R. W. Carlisle; "A Method of Reducing Amplitude Distortion in Engraving Lateral Electrical Transcriptions," by C. E. Harrison; "On the Absolute Calibration of Phonograph Test Records by Means of Light Patterns," by W. Wathen-Dunn; "Some Factors Influencing the Choice of a Medium for Magnetic Recording," by L. C. Holmes; "Design Problems on Magnetic Recording Equipment," by S. J. Begun; "Some Physical Aspects of Magnetic	

The Annual Index to these Abstracts and References, covering those published from January, 1946, through December, 1946, may be obtained for 2s. 8d., postage included from the *Wireless Engineer*, Dorset House, Stamford St., London S. E., England

Recording," by O. Kornei; "Wow Meter," by W. W. Hansen; "Master Wire Recorder," by J. S. Boyers and R. E. Zenner; and "Mechano-Electronic Transducer," by H. F. Olson.

534.133+621.396.611.21.016.2 2308
High Intensity Ultrasonics: The Power Output of a Piezoelectric Quartz Crystal—Epstein, Andersen, and Harden. (See 2442.)

534.22 2309
Wavelengths of Sound—B. W. Hennis. (*Electronics*, vol. 20, pp. 134, 136; March, 1947.) A table of the velocity of sound in various solids, liquids, and gases, with an abac from which the wavelength can be found for any frequency from 10 c.p.s. to 100 Mc.

534.24:551.510.52 2310
[Sound] Echoes from the Atmosphere—(*Bell. Lab. Rec.*, vol. 25, pp. 75-77; February, 1947.) For a more detailed account of sodar see 330 of March.

534.321.9.001.8 2311
Ultrasonics, a New Tool—(*Electronics*, vol. 20, pp. 190, 194; March, 1947.) A short account of the application of supersonic methods to problems of emulsification, catalysis, chemical reactions, gels, degassing of liquids, physiology, and homogenizing processes.

534.321.9.001.8 2312
Ultrasonic Garage-Door Opener—B. A. Andrews. (*Electronics*, vol. 20, pp. 116-118; March, 1947.) Uses a 25-kc. vacuum-type whistle on the car and a 5-tube amplifier, with limiter and discriminator, to operate a relay in the circuit of the motor operating the door.

534.846 2313
Room Acoustics—A. Moles. (*Radio Franc.*, no. 4, pp. 13-22; 1947.) A compromise is usually necessary between reverberation time, power, and speech intelligibility. The elimination of interferences can often be achieved by tests carried out on scale models, and by the judicious use of absorbing or scattering materials.

534.862.1 2314
Design of Recording Studios for Speech and Music—G. M. Nixon and J. Volkmann. (*Tele-Tech.*, vol. 6, pp. 37-39; February, 1947.) Description of a National Broadcasting Company studio designed to obtain a diffuse sound field, thus reducing the importance of reverberation time.

534.862.4 2315
Perfect v. Pleasing Reproduction—Discussion—G. F. Redgrave; F. Slater; B. C. Sewell; F. Duerden; J. Moir. (*Electronic Eng.*, vol. 19, pp. 115-116; April, 1947.) Comments on 1185 of May and a reply by the author.

534.88 2316
Submarine Detection by Sonar—A. C. Keller. (*Bell Lab. Rec.*, vol. 25, pp. 55-60; February, 1947.)

621.395.623.7 2317

The Distribution of Acoustic Power—L. Chrétien. (*TSF Pour Tous*, vol. 23, pp. 55-59, 70-74, and 97-99; March-May, 1947.) A discussion of (a) voltage and power amplification using triodes, tetrodes, or pentodes; (b) output transformer characteristics, and matching of loudspeaker impedance for optimum performance, and (c) simple measurements on transformers and loudspeakers. To be continued.

621.395.623.73 2318

High Efficiency Loud Speaker—(*Tele-Tech.*, vol. 6, pp. 63, 131; February, 1947.) A 15-watt unit for naval use, shock and blast proof, and undamaged by deep submersion.

621.395.625.3 2319

Wire Recording. A Review of Recent Developments and Applications—(*Electrician*, vol. 138, pp. 935-936; April 11, 1947.) Summary of a lecture on "Developments in Magnetic Recording" given by P. T. Hobson to the British Sound Recording Association.

621.395.625.3 2320

Magnetophon Recorders—(*Wireless World*, vol. 53, p. 128; April, 1947.) A description of processes involved in manufacturing the tape. Extracted from a British Intelligence Objectives Subcommittee report. For other abstracts on the magnetophon see 2463 of 1946 and back references.

621.395.625.3 2321

New Magnetic Recorder—(*Wireless World*, vol. 53, p. 88; March, 1947.) Another account of the instrument described in *Tele-Tech.*, vol. 6, pp. 88-89; January, 1947; and 1832 of July.

621.395.625.6 2322

Magnetic Sound for Amateur Movies—(*Electronics*, vol. 20, pp. 140, 158; March, 1947.) A fine-grain magnetic coating along one or both edges of the film is unaffected by photographic solutions. The same head is used for recording and reproducing; it is pressed by a spring against the film while the film rides on a flywheel stabilizer.

AERIALS AND TRANSMISSION LINES

621.315[.211.2+].22 2323

Mineral-Insulated Metal-Sheathed Conductors—F. W. Tomlinson and H. M. Wright. (*Jour. I.E.E.* (London), Part II, vol. 94, pp. 84-91; February, 1947.) Discussion on 12 of February.

621.315.687 2324

Cable Terminations—D. B. Irving. (*Jour. I.E.E.* (London), Part II, vol. 94, p. 91; February, 1947.) Discussion on 3360 of 1945.

621.392.029.64+537.291 2325

Generalization of Certain Results Relative to the Interaction of Progressive Guided Waves

and an Electronic Beam—P. Lapostolle. (*Compt. Rend. Acad. Sci. (Paris)*, vol. 224, pp. 814–816; March 17, 1947.) Results have previously been given for waves having symmetry of order 0 in a guide without loss (1999 and 2003 of August). These are extended to symmetry of order n and to guides with loss.

621.392.029.64 2326
On the Theory of Excitation of Waveguides—G. V. Kusun'ko. (*Bull. Acad. Sci. (U.R.S.S.)*, ser. phys., vol. 10, no. 2, pp. 217–224; 1946. In Russian.) Calculations of the electromagnetic field in a wave guide are usually based on various simplifying assumptions with regard to the form and distribution of the exciting conductors, distribution of currents in such conductors, shape of the cross section of the wave guide, etc. The problem is here considered more generally, and the field is determined in an ideally conducting cylindrical wave guide of any arbitrary cross section when the currents in the exciting conductors can be represented by any arbitrary function of co-ordinates and time. The cases of (a) an infinitely long wave guide and (b) a wave guide closed at one end by a conducting wall, are considered separately.

621.392.029.64:534.1 2327
The Interaction of Oscillating Systems with Distributed Parameters—Krasnooshkin. (See 2386.)

621.392.029.64.018.14+621.392.029.64.091 2328
Attenuation and Q Factors in Wave Guides—A. G. Clavier. (*Elec. Comm.*, vol. 23, pp. 436–444; December, 1946.) A theoretical paper which introduces the concepts of attenuation per unit length and Q factor as applied to a coaxial line. The argument is generalized to cover the relation between the "attenuation per unit length for each wave structure propagated at a definite velocity in a wave guide, . . . [the] Q factor for a section of guide used as a resonant cavity." For easier work see 1177 of 1943.

621.392.3:621.317.382.08 2329
R.F. Generator Load—Leslie. (See 2493.)

621.392.43:621.396/397.62 2330
Transmission Line Systems for F.M. and Television Home Receivers—C. Spear. (*Radio News*, vol. 37, pp. 44–46, 140; February, 1947.) Matching methods for various aeriels.

621.396.67 2331
Recent Developments of the Theory of the Aerial: Part 1—E. Roubine. (*Rev. Tech. Comp. Franç. Thomson-Houston*, no. 6, pp. 5–25; December, 1946.) A presentation, in as elementary a manner as possible, of recent attempts to solve the aerial problem. See also 2012 of August and 2332 below.

621.396.67 2332
Recent Theories of the Aerial: Part 3—É. Roubine. (*Onde Élec.*, vol. 27, pp. 104–118; March, 1947.) An outline of the theory of Schelkunoff, discussing the "interior" and "exterior" solutions, their combination on the Σ sphere, formulas for the current distribution and input impedance, and also aeriels of arbitrary section. The elements of Hallén's theory are presented. For parts 1 and 2 see 2012 of August. To be continued.

621.396.67 2333
Concerning Hallén's Integral Equation for Cylindrical Antennas—S. A. Schelkunoff. (*Proc. I.R.E.*, vol. 35, pp. 282–283; March, 1947.) Discussion of 851 of 1946. S. Hershfield compares the experimental results of D. D. King (3684 of January) and of Brown and Woodward (2207 of 1945) with results calculated from the formulas of R. King and D. Middleton (2141 of 1946) and those of Schelkunoff. R. King, in reply, points out the difficulties of

making any such comparison without more precise knowledge of the apparatus and methods used in obtaining the experimental results.

621.396.67 2334
Square Loops for Frequency-Modulated Broadcasting at 88–108 Megacycles—R. F. Lewis. (*Elec. Commun.*, vol. 23, pp. 415–425; December, 1946.) A practical version of one of the aerial systems described in 1180 of 1946 (Kandoian). The installation of the system is discussed. Its advantages include (a) horizontal polar diagram circular to 1 decibel, (b) low over-all impedance, (c) gain increase by "stacking," and (d) ease of construction.

621.396.671:538.3 2335
Physical Interpretation of Electromagnetic Radiation from an Antenna—R. W. P. King. (*Phys. Rev.*, vol. 71, p. 134; January 15, 1947.) Summary of American Physical Society paper. A discussion of the conclusions which follow from the erroneous assumptions that the axial distribution of current in a cylindrical antenna is sinusoidal and that the Poynting vector is a true measure of the direction and magnitude of "energy flow" at every point in space.

621.396.677 2336
An Inexpensive 4-Element Array—V. C. Hale. (*Radio News*, vol. 37, pp. 47, 82; February, 1947.) Constructional details of high-gain beam.

621.396.677 2337
On the Theory of Directional Radiation with Parabolic Reflectors—F. Lüdi. (*Helv. Phys. Acta*, vol. 17, pp. 374–388; September 6, 1944. In German.) Using Kirchhoff's diffraction formula the radiation patterns in the vertical and horizontal planes are derived when the focus is in the plane of the aperture. The field intensity gain is found to be $8R/3\lambda$, R being the aperture radius, compared with $2.85 R/\lambda$ given by Darbord's theory (1932 Abstracts, p. 346). Comparison is made with the horn and the saw-tooth aerial; the latter simple system of wires gives the same performance as a mirror.

621.396.67 2338
Antennae—An Introduction to Their Theory [Book Review]—J. Aharoni. Oxford University Press, London, 265 pp., 25s. (*Wireless Eng.*, vol. 24, p. 122; April, 1947.) The treatment throughout is based on the work of Hallén, Ryder, King, Harrison, Gray, and Schelkunoff. A considerable knowledge of mathematics is assumed, especially of vector algebra.

CIRCUITS AND CIRCUIT ELEMENTS

538.3:621.396.694 2339
On the Helix Circuit Used in the Progressive Wave Valve—É. Roubine. (*Compt. Rend. Acad. Sci. (Paris)*, vol. 224, pp. 1101–1102; April 14, 1947.) An explicit formula, involving the modified Bessel function of the second kind of zero order, is given for the axial component E_z of the electric field. The formula shows that the field is propagated axially with the reduced velocity $v \sin \alpha$, where v is the velocity of electromagnetic waves in free space and α is the angle of the helix. The amplitude of E_z has a maximum value for a certain frequency and a particular value of α . See also 2340 below.

538.3:621.396.694 2340
On the Helix Circuit Used in the Progressive Wave Valve—É. Roubine. (*Compt. Rend. Acad. Sci. (Paris)*, vol. 224, pp. 1149–1151; April 21, 1947.) Replacing the helix by a uniform current distribution on the surface of the cylinder on which the helix is traced, a solution is obtained for the equivalent transmission line, with simple formulas for the power transported, the characteristic impedance and the distributed inductance and capacitance. See also 2339 above.

549.514.51:534.133]+621.396.611.21.012.8 2341
Calculation of the Equivalent Constants of a Quartz Plate in Plane Shear Vibration (Type CT, DT)—G. Dumesnil. (*Onde Élec.*, vol. 27, pp. 42–44; February, 1947.) The equivalent circuits for bars in longitudinal vibration and plates in thickness shear are well known. For a plate in plane shear an expression is found for the equivalent impedance similar to that for thickness vibrations, so that whatever the frequency the plate can be treated as a line with distributed constants. Near the resonance frequency the impedance can be considered as a self-inductance L in series with a capacitance. L depends only on the thickness and is proportional to it. Calculated values of L for CT and DT cuts are in good agreement with experimental values.

621.314.2:621.392.52 2342
The Design of Tuned Transformers—F. G. Clifford. (*Electronic Eng.*, vol. 19, pp. 83–90 and 117–123; March and April, 1947.) Three methods are discussed which have proved particularly useful. These are (a) to transform the circuit until it has the same configuration as a ladder filter of which the design data are known; (b) to evolve design data from a consideration of the impedances presented by one pair of terminals when the other pair is (i) open circuited and (ii) short circuited; (c) to apply Bartlett's bisection theorem and thereby determine the equivalent symmetrical lattice network for which the design data may be found simply. The last method is a simplification of method (b) but is applicable only to tuned transformers which are equivalent to a symmetrical T or π section. Examples of the applications of these three methods are given. Design data and characteristics of a number of useful types of low-pass, high-pass and band-pass transformers are tabulated.

621.314.23.042.14.017.31 2343
An Approximate Theory of Eddy-Current Loss in Transformer Cores Excited by Sine Wave or by Random Noise—D. Middleton. (*Proc. I.R.E.*, vol. 35, pp. 270–281; March, 1947.) The field equations governing the distribution of electric and magnetic fields in thin rectangular laminas are solved with certain approximations. Curves and formulas are thereby obtained showing the variation in the skin depth and mean eddy-current loss with variation in frequency and lamination thickness for both current and voltage-fed transformers.

621.316.86 2344
On the Mechanism of Voltage-Dependent Resistors—A. Braun and G. Busch. (*Helv. Phys. Acta*, vol. 15, pp. 571–612; October 24, 1942. In German.) Two effects are important in explaining the nonlinear current-voltage characteristic and the hysteresis loop of granular carborundum: (a) passage of electrons through impurity layers to positions of higher electric field strength and (b) temperature dependence of the conductivity of the impurity layers. These effects are confirmed by experiment and serve as a basis for a theory of the characteristic.

621.317.755.087.35:578.088.7 2345
A New 4-Way or 6-Way Electronic Commutator—M. Bladier. (*Radio en France*, no. 3, pp. 8–14; 1947.) Describes, with circuit diagram, a device enabling four (or six) electrical effects to be observed simultaneously on a single c.r.o. The device has proved useful in electro-encephalography.

621.318.572:621.317.761 2346
A Pulse Counter Circuit and Its Adaptation as a Frequency Meter—R. Lemas. (*Télev. Franç.*, no. 23, Supplement *Électronique*, pp. 4–5, 17; March, 1947.) The pulses of any shape or amplitude are used to derive a series of

pulses of the same recurrence frequency and of uniform shape and amplitude. This is done by means of a capacitor connected to the anode of a thyatron and charged from a constant voltage d.c. source through a suitable resistance. Each pulse triggers the thyatron and thus causes partial discharge of the capacitor through a milliammeter in the thyatron cathode lead. The milliammeter has a highly damped movement, and integrates these partial discharges; its deflection is directly proportional to the pulse-recurrence frequency. Methods are given for calculating the capacitance for various frequency ranges and also an appropriate value for the resistor. A complete circuit diagram is given for a 3-range instrument for pulse recurrence frequencies up to 100, 1000 and 10,000, respectively, the ranges being determined by the capacitor in use. With a relatively high value of the time constant of the charging circuit, the linear relation between milliammeter deflection and pulse-recurrence frequency no longer holds. Such an arrangement has certain advantages since it tends to keep the percentage error of frequency measurement constant.

For frequency measurement of sine waves, rectangular waves are derived and used to produce a series of positive and negative pulses, which are applied to the counter circuit. This only responds to the positive pulses and hence registers the correct sine-wave frequency. Practical circuit details are given.

621.319.4:621.315.59:621.315.616.92 2347
The Effect of Semiconducting Liquids on the Dielectric Properties of Cellulose Insulation—Clark. (See 2458.)

621.392.52.015.33 2348
Transient Response of Filters—E. T. Emms. (*Wireless Eng.*, vol. 24, pp. 126-127; April, 1947.) Reply to the letters of Belevitch and Thomson (2035 of August) agreeing with their conclusions. See also 662 of April and back references.

621.394/397.645 2349
Cathode-Follower Circuit Using Screen-Grid Valves—E. M. I. Laboratories. (*Electronic Eng.*, vol. 19, p. 97; March, 1947.) A description of a circuit arrangement using a screen grid tube as a cathode follower repeater, with reduced loss of signal transfer.

621.395.623:578.088.7 2350
A Simplified Encephalophone—M. Conrad and B. L. Pacella. (*Science*, vol. 105, p. 216; February 21, 1947.) A simplified adaptor which converts the varying l.f. voltages observed with an electroencephalograph into variations in the pitch of an audible tone.

621.396.61:517.512.2 2351
Fourier Transform Analysis—M. M. Levy. (*Jour. Brit. I.R.E.*, vol. 6, pp. 228-246; December, 1946.) A study of the properties of Fourier transforms with examples of applications to a wide variety of radio problems. A new notation is used. See also 3651 of 1946.

621.396.611.21 2352
On the Resonant Frequencies of n -Meshed Tuned Circuits—P. Parzen. (*Proc. I.R.E.*, vol. 35, pp. 284-285; March, 1947.) The fact that multiplication of all the inductances (self and mutual) and capacitances by factors of A^2 and B^2 , respectively, divides the resonant frequency by AB is proved for n -meshed coupled-tuned circuits and applied to the pre-dimensioning of quartz oscillating crystals.

621.396.611.3 2353
RC Coupling—(*Wireless World*, vol. 53, p. 131; April, 1947.) Data for the design of couplings for pulse and saw-tooth waves.

621.396.611.4 2354
Natural Frequencies of E-Type of a Ca-

pacitance-Loaded Cylindrical Resonator—F. Lüdi. (*Helv. Phys. Acta*, vol. 17, pp. 429-436; November 2, 1944. In German.)

621.396.615 2355
Phase-Shift Oscillators—P. G. M. Dawe and A. S. Gladwin. (*Wireless Eng.*, vol. 24, pp. 125-126; April, 1947.) The resistance-reactance network associated with a phase-shift oscillator is usually considered to form an aperiodically damped system, so that no oscillatory current can occur. It is pointed out that the response of such a circuit to a transient input involves voltage reversals, having the character of a heavily damped oscillation.

621.396.615 2356
Three-Phase RC Oscillator for Radio and Audio Frequencies—H. Rakshit and K. K. Bhattacharyya. (*Indian Jour. Phys.*, vol. 20, pp. 171-186; October, 1946.) Regenerative feedback from the output to the input of a 3-stage amplifier enables either audio or radio frequencies to be generated, depending on circuit arrangements. Theory is confirmed by experiment. See also 1796 of 1946.

621.396.615:621.396.619.16 2357
Pulse Modulated Oscillator—A. Easton. (*Electronics*, vol. 20, pp. 124-129; March, 1947.) A pulsed resonant circuit giving a damped wave train is combined with a keyed oscillator that builds up oscillations, thus obtaining a pulsed oscillator generating a wave train of constant amplitude.

621.396.615.029.5 2358
H.F. Beat-Frequency Oscillator—R. Aschen and M. Lafargue. (*TSF our Tous*, vol. 23, pp. 52-54; March, 1947.) Part I of another account of 1709 of July.

621.396.615.029.6:621.397.62 2359
The 6C5 and 54 Mc/s—H. Pinot. (*Télev. Franç.*, no. 22, p. 19; February, 1947.) Details of an oscillator suitable for testing the sound channel in television receivers.

621.396.615.14.012.2 2360
Q Circles—A Means of Analysis of Resonant Microwave Systems: Part 1—W. Altar. (*Proc. I.R.E.*, vol. 35, pp. 355-361; April, 1947.) A new circle diagram is given for magnetrons and similar resonant systems with an isolated single resonant mode. The diagram is drawn in terms of complex reflection coefficients, the values of which are obtained by standing-wave measurements in the outgoing line. A theoretical discussion will be given later.

621.396.615.17:621.316.729 2361
On the Synchronization of Valve Generators—H. Samulon. (*Helv. Phys. Acta*, vol. 14, pp. 281-306; August 5, 1941. In German.) A discussion of synchronization by an external a.c. potential, particularly for the case where the applied potential has a frequency close to a harmonic of the fundamental frequency of the generator. A solution is given of the phase-balance equation for the back-coupled generator with tuned anode circuit. A reference was given in 3322 of 1943.

621.396.615.17:621.317.733 2362
On a Bridge Circuit for Relaxation Oscillations—H. Zickendraht. (*Helv. Phys. Acta*, vol. 17, pp. 234-235; July 12, 1944. In German.) A bridge using two resistances and two thyatrons gives powerful oscillations whose waveform may be adjusted to provide a "saw-tooth" timebase.

621.396.616:621.396.662.2.076.2 2363
Precision Master Oscillators—T. A. Hunter. (*Tele-Tech*, vol. 6, pp. 71-73, 126; February, 1947.) Permeability-tuned and sealed units of stability equivalent to that of a crystal-controlled oscillator.

621.396.621:621.396.619.11 2364
The "Synchrodyne": A New Type of Radio Receiver for A.M. Signals—D. G. Tucker. (*Electronic Eng.*, vol. 19, pp. 75-76; March, 1947.) A description of a process of demodulation whereby the incoming signal is modulated with a frequency equal to its own carrier frequency. The modulation-frequency output of the wanted signal is then obtained correctly and all other signals become high frequencies relative to the modulation frequency and can be separated by means of a low-pass filter in the output circuit.

621.396.621:621.396.619.13 2365
Designing an F.M. Receiver: Part 1—T. Roddam. (*Wireless World*, vol. 53, pp. 143-145; April, 1947.) Discusses principles of design of the mixer and i.f. stages.

621.396.622.71:621.396.813 2366
Distortion in Diode Detectors—R. A. Lampitt. (*Electronic Eng.*, vol. 19, pp. 94-96; March, 1947.) The cause of the distortion introduced by the use of an a.f. amplifier immediately following a diode detector is discussed and two remedies are outlined.

621.396.645:518.4 2367
Graphical Analysis of Cathode-Biased Degenerative Amplifiers—W. A. Huber. (*Proc. I.R.E.*, vol. 35, pp. 265-269; March, 1947.) A method by which it is possible to predict the performance of cathode-follower and anode-resistance-loaded, cathode-degenerative triode amplifiers.

621.396.645:621.396.621.029.6 2368
I.F. Amplifier for High Gain F.M. Receiver—D. W. Martin. (*Tele-Tech*, vol. 6, pp. 60-62; February, 1947.) High sensitivity and selectivity in a v.h.f. communications receiver is obtained with a new circuit.

621.396.645.029.3 2369
A.C.-D.C. Audio Amplifier—G. Eannarino. (*Radio News*, vol. 37, pp. 40-41; February, 1947.) Full circuit details of a four-tube audio amplifier giving 8 watts output with 10 per cent distortion over the range 40-15,000 c.p.s. No transformers are used in an a.c./d.c. selenium-rectifier power supply.

621.396.645.3 2370
Balanced Amplifiers—F. F. Offner. (*Proc. I.R.E.*, vol. 35, pp. 306-310; March, 1947.) The addition of in-phase feedback to push-pull impedance-coupled amplifiers gives definite advantages. Circuits are given for various applications of such amplifiers.

621.396.645.36.078 2371
Automatic Gain Adjusting Amplifier—D. E. Maxwell. (*Tele-Tech*, vol. 6, pp. 34-36, 128; February, 1947.) A push-pull amplifier. The controlled variable negative feedback is preceded by a signal-frequency delay network, so that the controlling bias, derived from the input to the network, is applied before transient peaks can overload the amplifier.

621.396.662.21.042.1 2372
Those Iron-Cored Coils Again—P. K. McElroy. (*Gen. Rad. Exper.*, vol. 21, pp. 2-8 and 2-8; December, 1946 and January, 1947.) The application of the theory developed previously (*ibid.*, March, 1942, P. K. McElroy and R. F. Field) is simplified. Part 1 gives an empirical method for determining the maximum storage factor Q of a coil wound on a particular lamination structure, the frequency at which it occurs and the law of variation of inductance with the width of the center-leg air gap. Part 2 gives a method for obtaining the effective permeability of a core of ferromagnetic material with center-leg air gap, taking account of the fringing that occurs at the air gap. Examples of the use of the methods are given.

- 621.396.662.3:537.228.1 2373
Piezoelectric Quartz—A. V. J. Martin. (*Toute la Radio*, vol. 14, pp. 107-111; March-April, 1947.) Various types of crystal filters, using one, two, or four crystals are described and their properties compared. Recent developments briefly mentioned include a quartz transformer, using two crystal slices of identical frequency and giving a variable selectivity, with a very high Q . The pass band of such an arrangement can readily be varied from 10 c.p.s. up to 1000 c.p.s.
- 621.396.667 2374
Towards High Fidelity. Expansion Circuits—Tabard. (See 2566.)
- 621.396.69+621.317.7+621.38 2375
Physical Society Exhibition—(See 2494.)
- 621.396.69+621.317.7 2376
The R.C.M.F. [Radio Component Manufacturers' Federation] Exhibition—(*Electronic Eng.*, vol. 19, pp. 131-132; April, 1947.) A review of some of the test instruments and radio components shown at the 1947 Exhibition. See also 2055 of August.
- 621.396.69 2377
The 1947 National Salon of Radio Components and Accessories—G. Ginioux. (*TSF Pour Tous*, vol. 23, pp. 49-51, 83-90 and 111-112; March-May, 1947.) A review of some of the novelties exhibited, including coils, fixed and variable capacitors, tuning units, switches, microphones, loudspeakers, meters, etc.
- 621.396.69 2378
After the [Paris] Components Exhibition—"A Visitor." (*Radio en France*, no. 3, pp. 4-7; 1947.) A review of some of the novelties at the exhibition.
- 621.396.692.011.2.012.3 2379
Resistances in Parallel—G. S. Lowey. (*Elec. Times*, vol. 111, p. 165; February 6, 1947.) A simple graphical method of determining the resultant of any number of resistances in parallel.
- 621.396.694.012.8 2380
Circuit Conventions. The Valve "Equivalent Generator."—"Cathode Ray." (*Wireless World*, vol. 53, pp. 129-130; April, 1947.) An attempt to remove the confusion apparent in the tube "equivalent generator" principle regarding directions of the voltages and currents.
- 621.397.62.018.078.3 2381
Automatic Frequency-Phase Control in TV Receivers—Wright. (See 2599.)
- 621.392.52¹ 2382
Electric Filters [Book Review]—T. H. Turney. Pitman and Sons, London, 170 pp., 25s. (*Elec. Rev.* (London), vol. 140, p. 480; March 28, 1947.)
- GENERAL PHYSICS**
- 53.081 2383
On Unities [Units] and Dimensions: Part 3—H. B. Dorgelo and J. A. Schouten. (*Proc. Acad. Sci.* (Amsterdam), vol. 49, pp. 393-403; April, 1946. In English.) Conclusion of 1392 of June. Preference is expressed for the rationalized system of Giorgi with m , l , t , and q .
- 530.145 2384
Quantum Theory of Electromagnetic Fields Part 1.—P. Suquet. (*Télev. Franç.*, Supplement *Électronique*, pp. 1-3; February, 1947.) Preliminary mathematics and general principles.
- 530.145.6 2385
On the Polarization of Electron Waves—A. Sokolow. (*Jour. Phys.* (U.S.S.R.), vol. 9, no. 5, pp. 363-372; 1945.) The polarization is investigated for reflection from a potential barrier and for scattering by a force center possessing electrical charge and magnetic moment.
- The scattering is treated by means of Dirac's perturbation theory.
- 534.1:621.392.029.64 2386
The Interaction of Oscillating Systems with Distributed Parameters—P. Krasnooskhin. (*Jour. Phys.* (U.S.S.R.), vol. 9, no. 5, pp. 439-446; 1945.) A theoretical treatment of the waves traveling in a set of one-dimensional systems such as parallel strings with force and inertia couplings. Application is made to wave guides and to parallel Lecher systems coupled by inductance coils distributed along their length.
- 535.13+538.3 2387
An Extension of Fresnel's Formulae—R. Mercier. (*Helv. Phys. Acta*, vol. 15, pp. 515-518; October 24, 1942. In French.) The electric intensities of the waves reflected and transmitted by a plane boundary between two media are related to the ratios of the refractive indexes and of the wave resistances. The effect of difference of permeability is discussed.
- 535.13 2388
Quasi-Optical Links: Models of Ellipsoids [of Diffraction] and Spatial Aerials with Experimental Results—Dreyfus-Graf. (See 2545.)
- 535.312.2 2389
Optical Theory of the Corner Reflector—R. C. Spencer. (*Phys. Rev.*, vol. 71, p. 134; January 15, 1947.) Summary of American Physical Society paper. Experimental results with a corner made from three glass mirrors are presented graphically and discussed. The analysis of the effect of errors of perpendicularity of adjacent sides, as treated by G. A. Van Lear, Jr. is extended and applied to both triangular and square corners.
- 535.343+621.396.11.029.64]:[546.212+546.-212.02 2390
Interpretation of the Microwave Absorption of HDO at 1.3 Centimeters—G. W. King and R. M. Hainer. (*Phys. Rev.*, vol. 71, p. 135; January 15, 1947.) Summary of American Physical Society paper.
- 537.291 2391
Energy Distribution and Stability of Electrons in Electric Fields—H. Fröhlich. (*Proc. Roy. Soc. A*, vol. 188, pp. 532-541; February 25, 1947.) On the usual assumption that electrons are scattered by the lattice vibrations only, a stationary state cannot be reached. Stationary conditions can probably be obtained by considering also collisions between electrons. For very small electron density, electron collisions are negligible. In this case the possibility of reaching stationary conditions depends on the behavior of electrons whose energy is large enough to ionize, or excite ions of, the lattice.
- 537.291:621.396.615.141.2 2392
Electron Trajectories in a Plane Single-Anode Magnetron—A General Result—Brillouin. (See 2636.)
- 537.311.2 2393
What is Ohm's Law?—"First-Year Lecturer"—C. Turnbull. (*Elec. Rev.* (London), vol. 140, pp. 349-350; March 7, 1947.) Comment on 1063 of May.
- 537.5 2394
A Proposed Detector for High Energy Electrons and Mesons—I. A. Getting. (*Phys. Rev.*, vol. 71, pp. 123-124; January 15, 1947.) Depends on the emission of visual radiation by a charged particle moving at constant speed in a medium where the phase velocity of the light is smaller than the velocity of the particle. The visual radiation produced in a cone of Lucite or Plexiglass, along the axis of which the electrons or mesons are incident, is detected by focusing on to a photomultiplier to which is connected a video amplifier.
- 537.523.5 2395
On the Current Density in the Initial Stages of an Arc—R. Holm. (*Ark. Mat. Astr. Fys.*, vol. 34, part 1, section B, 7 pp.; March 7, 1947. In German.) Current densities of the order of 10^4 A/cm² may occur within times of the order of 10^{-7} second, with much greater densities immediately after striking.
- 537.523.5 2396
On the Mechanism of Arc Discharge—O. P. Semenova. (*Compt. Rend. Acad. Sci.* (U.R.S.S.), vol. 51, pp. 683-686; March 30, 1946. In English.) The effective ionization potential is determined not by the principal component of the arc gas, as is usually assumed, but by the component having the lowest ionization potential, even though present in a comparatively small quantity. Experimental confirmation of this is described.
- 537.525:621.385.18 2397
Effect of Direct-Current Potential on Initiation of Radiofrequency Discharge—A. A. Varela. (*Phys. Rev.*, vol. 71, pp. 124-125; January 15, 1947.) An explanation of the failure to improve the speed of initiation of the discharge in a gaseous discharge switch for radar duplexing by the application of a d.c. potential less than that required to initiate the discharge.
- 537.525.3 2398
The Development of Discharge Paths of an Impulse Corona—V. Hey and S. Zayentz. (*Jour. Phys.* (U.S.S.R.), vol. 9, no. 5, pp. 413-418; 1945.)
- 537.525.3 2399
The Investigation of the Impulse Corona in a Cloud Chamber—V. Hey and S. Zayentz. (*Jour. Phys.* (U.S.S.R.), vol. 9, no. 5, pp. 405-412; 1945.)
- 537.525.5+621.396.822]:621.385 2400
Effects of Magnetic Field on Oscillations and Noise in Hot-Cathode Arcs—J. D. Cobine and C. J. Gallagher. (*Jour. Appl. Phys.*, vol. 18, pp. 110-116; January, 1947.) Application of a transverse magnetic field is shown to produce two new effects, suppression of the oscillations and radical alteration of the noise spectrum. See also 3266 and 3267 of 1946.
- 537.525.5+621.396.822]:621.385 2401
Noise in Gas Tubes—J. D. Cobine and C. J. Gallagher. (*Electronics*, vol. 20, pp. 144, 198; March, 1947.) Noise characteristics are tabulated for a number of hot-cathode discharge tubes and are compared with the shot noise of a diode for two different currents and a 3000- Ω load resistance. The shape of the noise spectrum is determined by the tube geometry. See also 3266 and 3267 of 1946, 1406 of June and 2400 above.
- 537.531 2402
Radiation of a Uniformly Moving Electron Due to Its Transition From One Medium into Another—I. Frank and V. Ginsburg. (*Jour. Phys.* (U.S.S.R.), vol. 9, no. 5, pp. 353-362; 1945.) "The intensity, polarization, and angular distribution of the radiation are calculated as functions of the dielectric constants and conductivities of the two media."
- 537.533.8 2403
The Velocity Distribution of Secondary Electrons for Various Emitters—A. Kadyshевич. (*Jour. Phys.* (U.S.S.R.), vol. 9, no. 5, pp. 431-435; 1945.) Investigates the dependence on the velocity of the primary electrons and on the energy parameters of the emitter.
- 537.533.8 2404
On the Measurement of the Depth of Generation of the Secondary Electrons in Metals—A. Kadyshевич. (*Jour. Phys.* (U.S.S.R.), vol. 9, no. 5, pp. 436-438; 1945.)

537.539+621.315.61.015.5 2405

On the Theory of Dielectric Breakdown in Solids—H. Fröhlich. (*Proc. Roy. Soc. A*, vol. 188, pp. 521–532; February 25, 1947.) The theory previously developed is found to be correct only below a critical temperature T_c , above which the density of electrons (in strong fields) is so high that mutual collisions between electrons are more frequent than collisions between electrons and the lattice vibrations. In strong external fields this leads to an equilibrium distribution of the electrons at an electronic temperature T which is higher than the lattice temperature. Equilibrium can only be obtained if the field is below a critical value F^* . For stronger fields the electronic temperature T rises steadily until the crystal breaks down. F^* decreases exponentially with increasing lattice temperature. The theory now accounts for the rise of dielectric strength with temperature at low temperatures and for its decrease at high temperatures. It also shows why influences which tend to increase the dielectric strength at low temperatures (e.g., admixture of foreign atoms) tend to decrease it in the high-temperature region. The increase of electronic temperature with the field strength F leads, for $F < F^*$, to an increase of electronic conductivity with F which is calculated quantitatively. See also 1787 of 1943 and 2979 of 1944.

537.56:538.6 2406

Production of H.F. Energy by an Ionized Gas in the Presence of a Magnetic Field—J. Denisse and J. L. Steinberg. (*Compt. Rend. Acad. Sci.* (Paris), vol. 224, pp. 646–648; March 3, 1947.) The tubes used contained pure nitrogen at various pressures; in some cases they had tungsten filament cathodes and in others aluminum electrodes. A detailed account is given of the effects of magnetic fields of various strengths applied at different points along the tubes.

GEOPHYSICAL AND EXTRATERRESTRIAL PHENOMENA

523.53:621.396.82 2407

Whistling Meteors. Audible Radio Reflections from Shooting Stars—G. R. M. Garratt. (*Wireless World*, vol. 53, pp. 141–142; April, 1947.) Chamanlal and Venkataraman have found, at Delhi (1607 of 1942) that under favorable conditions meteors give faint heterodyne whistles in a communication receiver. These are attributed to a Doppler effect due to interference of the direct ground waves from the transmitter with the waves reflected from the local area of ionization caused by the passage of the meteor through the atmosphere. The effect is discussed and optimum conditions for its observation are given. See also 916 of 1946.

523.53+1946.10.09:551.510.535 2408

Ionization by Meteoric Bombardment—J. A. Pierce. (*Phys. Rev.*, vol. 71, pp. 88–92; January 15, 1947.) The meteor shower of October 9–10, 1946, produced intense ionization in the upper atmosphere, from which the energy required to produce an ionospheric layer can be calculated. The necessary power is found to be a few watts per square kilometer, a value comfortably exceeded by the black body radiation of the sun in the region of 1000 Angstroms.

523.75 2409

The Structure of the Solar Atmosphere—M. Waldmeier. (*Helv. Phys. Acta*, vol. 15, pp. 405–422; July 8, 1942. In German.) A theoretical discussion of the stratification of an atmosphere in radiation equilibrium, with application to the photosphere, sun spots, the Evershed effect, and the diminution of brightness near the edge of the disk.

523.752:[551.510.535+621.396.812] 2410

Eruptions of the Solar Chromosphere and

Their Influence on the Ionosphere and on Wave Propagation. Their Effects in Different Regions of the Radio Spectrum—Bureau. (See 2550.)

523.78+1945.07.09:621.396.812:551.510.535 2411

Results Obtained in Observing the Propagation of Radio Waves During the Solar Eclipse of 9th July 1945—A. A. Grigor'eva. (*Bull. Acad. Sci.* (U.R.S.S.), sér. phys., vol. 10, no. 3, pp. 253–260; 1946. In Russian.) Observations were made at the ionosphere stations near Moscow and Leningrad and short-wave transmissions from Leningrad, Moscow, and Kuibisheff (at frequencies of the order of 7 Mc.) were observed at 22 points in the eclipse zone.

The following main results were obtained: (a) during the optical eclipse the critical frequency of the F_1 layer decreased by 14 per cent at Moscow and by 20 per cent at Leningrad; (b) the variation of the height of the maximum ionization level remained within the accuracy limits of height measurements; (c) at certain periods during the optical eclipse increases of 100 per cent in the field intensity were observed; (d) increases in the audibility, mainly coinciding with field intensity increases, were observed during the optical eclipse; (e) in one case a considerable increase in the ionization was observed in Leningrad associated with decreases of the field intensity and audibility at a number of control points; and (f) variations of the audibility were observed in the zone of possible influence of the corpuscular eclipse. No corresponding variations were observed outside this zone.

523.78+1945.07.09:621.396.812:551.510.535 2412

On the Results of the Ionosphere Measurements Made During the Solar Eclipse of 9th July 1945—N. D. Bulatoff. (*Bull. Acad. Sci.* (U.R.S.S.), sér. phys., vol. 10, no. 3, pp. 269–274; 1946. In Russian.) Observations of the ionosphere were made at stations near Leningrad and Moscow and the field intensities of radio transmitters operating at Leningrad and Moscow (at frequencies from 1.75 to 5.0 Mc.) were measured at various points. The following conclusions were reached: (a) the decrease in the ionization of the E , F_1 , and lower absorbing layers during the passing of the optical shadow of the sun confirms that the main factor in the ionization of all layers is the ultraviolet radiation from the sun; (b) the absence of the expected effects of the corpuscular eclipse indicates that although the existence of the corpuscular stream under normal conditions is possible, the intensity of the stream is too low to produce observable changes in the ionization; (it should be noted that corpuscular eclipses are calculated neglecting the effects of the magnetic field of the earth) and (c) the sharp increase in the field intensity of radio stations during totality and a similar decrease towards the end of the eclipse indicate that the main factor in the ionization of the lower absorbing layers is the ultraviolet radiation from the sun.

537.591 2413

Absorption of Cosmic Radiation at 2100 m—G. Salvini. (*Nuovo Cim.*, vol. 3, no. 4, pp. 283–284; August 1, 1946.)

537.591 2414

The Intensity Fluctuations in the Hard Component of Cosmic Radiation on the Jungfrauoch (3500 m. Above Sea Level)—H. Wäffler. (*Helv. Phys. Acta*, vol. 14, pp. 215–256; August 5, 1941. In German.)

537.591 2415

An Example of Meson Production in Lead—G. D. Rochester, C. C. Butler, and S. K. Runcorn. (*Nature* (London), vol. 159, pp. 227–228; February 15, 1947.) The two cloud-

chamber photographs reproduced suggest that one of the particles emerging from the lead plate is a slow meson.

537.591.15 2416

The Extension of the Shower Theory to Low Energy [Levels]—N. Dallaporta and E. Clementel. (*Nuovo Cim.*, vol. 3, pp. 235–251; August 1, 1946. In Italian, with English summary.) Results obtained by an approximation method confirm the great penetration of photons into lead for energies of about 3×10^6 e.v.

537.591.15 2417

Auger Showers—M. M. Mills and R. F. Christy. (*Phys. Rev.*, vol. 71, p. 275; February 15, 1947.) Summary of American Physical Society paper. Examination of Lewis's data on coincident bursts (2889 of 1945; see also 2890 of 1945) shows that if ionization due to electrons is to afford an explanation, "it will probably require initiating electrons of energy $> 10^{14}$ e.v. produced predominantly near the top of the atmosphere and with several electrons having considerable angular spread associated in one event." An alternative possibility that the bursts are due to nuclear disintegrations is being examined.

537.591.5 2418

Production of Mesotrons up to 30,000 Feet at a Magnetic Latitude of 22° North—P. S. Gill. (*Phys. Rev.*, vol. 71, pp. 82–84; January 15, 1947.) Discovery of a marked hump in the intensity versus altitude curve at a pressure of 530 millibars.

551.510.535 2419

On the Work of the Ionosphere Bureau of the Institute of Terrestrial Magnetism—J. V. Leshchinsky and N. V. Pushkov. (*Bull. Acad. Sci.* (U.R.S.S.), sér. phys., vol. 10, no. 3, pp. 279–280; 1946. In Russian.)

551.510.535 2420

Electronic Collisional Frequency in the Upper Atmosphere—E. F. George. (*Proc. I.R.E.*, vol. 35, pp. 249–252; March, 1947.) Tables are given showing the collisional frequency as a function of height for night and day conditions, which are thought to represent maximum and minimum values.

551.510.535:525.6 2421

Atmospheric Tides in the Ionosphere: Part I—Solar Tides in the F₂ Region—D. F. Martyn. (*Proc. Roy. Soc. A*, vol. 189, pp. 241–260; April 17, 1947.) Horizontal winds due to solar tides and the earth's magnetic field cause a vertical component in the velocities of free ions. It is assumed that the velocities decrease with increase of height in the F_2 region. The theory shows that for downward velocities a Chapman region is modified so that the maximum ionization density is reduced, but its height may be above or below the Chapman height, depending on the velocity gradient. Upward velocities lead to increased ionization densities at heights generally above the Chapman height. These results are applied to account for the observed anomalous behavior of the F_2 region, including the semidiurnal period, for the existence of which observational evidence is given.

551.510.535:535.211 2422

Radiative Equilibrium in the Ionosphere—R. v. d. R. Woolley. (*Proc. Roy. Soc. A*, vol. 189, pp. 218–240; April 17, 1947.) Molecular and atomic oxygen are the principal ultraviolet absorption agents at heights below and above 250 km. respectively. Water vapor is the principal infrared radiator at 100 km., but at 250 km. the temperature is controlled by negative ions. At much greater heights the temperature is perhaps controlled by dust particles.

551.510.535:621.396.11.029.45 2423

The Oblique Reflexion of Very Long Wireless Waves from the Ionosphere—Wilkes. (See 2548.)

551.593.9:535.243 2424

Spectrophotometer Measurements of the Spectrum of the Night Sky (λλ4600-3100)—D. Barbier. (*Compt. Rend. Acad. Sci. (Paris)*, vol. 224, pp. 635-636; March 3, 1947.) Spectra for wavelengths 3100-4600 Angstroms have been obtained at the Haute-Provence observatory at zenith distances of 10 and 80 degrees. Comparison of the spectra taken at the two distances enables the altitude of emission of the bands to be determined. Discussion of the results shows that an appreciable part of the continuous background light comes from the atmosphere. The whole of the measured brightness of the night sky can now be apporportioned approximately between spectral rays, bands, zodiacal light extension, and the light of faint stars.

551.594.25 2425

The Electrical Charge on Precipitation at Various Altitudes and Its Relation to Thunderstorms—R. Gunn. (*Phys. Rev.*, vol. 71, pp. 181-186; February 1, 1947.) The free electrical charges on individual precipitation particles at various altitudes up to 2600 feet were measured by an induction method. The results are shown graphically and discussed. Electric field measurements showed that the particle charges are largely neutralized by nearby charges. Removal of the neutralizing charge will immediately produce thunderstorm electric fields and potentials.

538.691:551.594.5 2426

Experiments on the Auroras—K. G. Malmfors. (*Ark. Mat. Astr. Fys.*, vol. 34, part 1, section B, 8 pp., March 7, 1947. In English.) An account of experiments to study the motion of charged particles in a magnetic dipole field under the influence of a homogeneous electric field. The results are discussed in relation to Alfvén's theory of magnetic storms and the aurora.

LOCATION AND AIDS TO NAVIGATION

534.88 2427

Submarine Detection by Sonar—A. C. Keller. (*Bell Lab. Rec.*, vol. 25, pp. 55-60; February, 1947.)

621.396.11 2428

On the Coastal Effect in Radio Direction Finding—E. L. Feinberg. (*Bull. Acad. Sci. (U.R.S.S.)*, sér. phys., vol. 10, no. 2, pp. 196-216; 1946. In Russian.) Previous investigations of the phenomenon are briefly reviewed; it is usual to ascribe the effect to the difference in the electrical properties of land and sea and to call it "coastal refraction." The author suggests that the actual vertical configuration of the coast also affects the propagation of electromagnetic waves since it is known, for example, that the difference in the electrical constants of land and sea is greater in the case of a high coast. Accordingly a more general theory is developed in which the effect of the boundary line is taken into account and formulas are derived for different relative positions of the observer and transmitter. The considerable effect of the transitional zone is also demonstrated.

The theory is derived from a general theory of the propagation of radio waves along a non-uniform and uneven surface developed by the author elsewhere (1962 of 1946 and back references). That theory was based on an integral equation first solved by Grünberg (3386 of 1944) and more fully investigated by Fock in *Matematicheski Sbornik*, 1-2 (1944). In the present paper a method is proposed which makes the solution of the integral equation unnecessary and the problem is reduced to the evaluation of integrals of known functions. This results in a considerable simplification of the necessary calculations. In conclusion a

brief analysis is made of available experimental data, which are in conformity with the theory.

621.396.11:621.396.93 2429

A New Source of Systematic Error in Radio Navigation Systems Requiring the Measurement of the Relative Phases of the Propagated Waves—K. A. Norton. (*Proc. I.R.E.*, vol. 35, p. 284; March, 1947.) Accurate navigational fixes can be obtained only when the effective values of ground constants along the propagation path are known accurately. Methods are outlined for correcting range errors due to phase variation.

621.396.7:621.396.96 2430

The Decca Navigator—P. Giroud. (*Ann. Radioléec.*, vol. 1, pp. 409-433; October, 1946.) For other accounts see 1242 and 3606 of 1946.

621.396.93:621.396.677.1 2431

The Compensated-Loop Direction Finder—F. E. Terman and J. M. Pettit. (*Proc. I.R.E.*, vol. 35, p. 269; March, 1947.) Corrections to 2659 of 1945.

621.396.932+621.396.96 2432

Radar on the Great Lakes—N. A. Schorr. (*Radio News*, vol. 37, pp. 35-38, 147; February, 1947.) A general account of navigational difficulties and recently developed navigation aids. The p.p.i. system is outlined, and essential features are given of six different types of radar installations now operating as test units aboard lake carriers. Research to determine the most efficient system is proceeding.

621.396.933 2433

Teleran—P. Hemardinquer. (*Télev. Franc.*, no. 23, pp. 18-19; March, 1947.) A short account of the principles of operation. For a more detailed account see 1546 of 1946.

621.396.933 2434

Safety in the Air—J. A. McGillivray. (*Wireless World*, vol. 53, pp. 146-149; April, 1947.) The adoption of a universal standard air navigation system is urged. The advantages and disadvantages of nine existing types of radio aids to navigation are discussed.

621.396.933.1 2435

LANAC Two-Signal Navigation System—(*Tele-Tech*, vol. 6, pp. 49-53, 129; February, 1947.) Basic principles of a laminar navigation and anticollision system. Incorporates challenge and replier units; a different altitude code is used for each 1000-foot height layer. Position can be obtained with only one beacon. Operation is automatic.

621.396.933.23:389.6 2436

P.I.C.A.O. Recommends C.A.A. Instrument Landing—H. G. Shea. (*Tele-Tech*, vol. 6, pp. 40-43, 124; February, 1947.) Condensed specifications for aircraft loran, radar, beacons, and landing aids by the Provisional International Civil Aviation Organization. For another account, by D. H. Pain, see *Electronics*, vol. 20, pp. 80-83; February, 1947.)

621.396.96:531.55 2437

Navy Fire-Control Radars—W. M. Kellogg. (*Bell Lab. Rec.*, vol. 25, pp. 64-69; February, 1947.) A description of the Mark 3 and Mark 4 radar system employed largely in the U. S. Navy during the earlier stages of the war. Operation was in the 680-720 Mc. frequency range, with a pulse power of about 40 kilowatts. Aerials were horizontal cylindrical parabolas fed by a row of dipoles; a gas-switch enabled the same aerial and feeder to be used for transmission and reception. See also 1798-1804 of July.

621.396.96:551.594.6 2438

Storm Indication by Radio Locators—V. A. Vvedenski. (*Radio (Moscow)*, no. 1, pp. 4-8; April, 1946. In Russian.)

621.396.96:621.396.621 2439

Considerations in the Design of Centimeter-Wave Radar Receivers—Miller. (See 2563.)

MATERIALS AND SUBSIDIARY TECHNIQUES

533.5 2440

New Developments in Vacuum Engineering—R. B. Jacobs and H. F. Zuhr. (*Jour. Appl. Phys.*, vol. 18, pp. 34-48; January, 1947.) Methods are described for obtaining vacuum tightness in the K-25 gaseous diffusion plant for the separation of U²³⁵. New techniques include the helium hood method for leak detection with the mass spectrometer (2441 below) and the use of calibrated leaks.

533.5:539.163.2.08 2441

Mass Spectrometer for Leak Detection—A. O. Nier, C. M. Stevens, A. Hustrulid, and T. A. Abbott. (*Jour. Appl. Phys.*, vol. 18, pp. 30-33; January, 1947.) A simple low-resolution instrument using helium for leak detection in high vacuum equipment. One part of helium in 200,000 parts of air gives a definite indication on the output meter.

534.133+621.396.611.21.016.2 2442

High Intensity Ultrasonics: The Power Output of a Piezoelectric Quartz Crystal—L. F. Epstein, W. M. A. Andersen, and L. R. Harden. (*Jour. Acous. Soc. Amer.*, vol. 19, pp. 248-253; January, 1947.) The maximum ultrasonic power density experimentally attained up to the present with a quartz crystal is considerably less than that predicted from the characteristics of quartz. Failure is attributed to dielectric breakdown in the surrounding fluid; if the breakdown voltage gradient of the medium is independent of thickness the maximum power density is independent of frequency, but if the gradient decreases with thickness, the maximum power density increases with frequency. An output of 43 w. per cm² has been achieved at 1000 kc.

535.37 2443

Decay of Phosphorescence in Cu-Activated ZnS—H. M. James. (*Phys. Rev.*, vol. 71, p.137; January 15, 1947.) Summary of American Physical Society paper.

535.376:537.226.2 2444

Electron Traps and Dielectric Changes in Phosphorescent Solids—G. F. J. Garlick and A. F. Gibson. (*Proc. Roy. Soc. A*, vol. 188, pp. 485-509; February 25, 1947.)

537.228.1 2445

Piezoelectric Substances—M. Bruzau. (*Elec. Commun.*, vol. 23, pp. 445-459; December, 1946.) A comprehensive review, originally published in French with the title "Les Substances Piézoélectriques Synthétiques," in 1940 and including a large bibliography. Static and dynamic tests for the detection of piezoelectricity are described and all the known substances are classified in 8 tables according to their crystalline structure. Artificial crystals are discussed, with particular reference to the properties of Rochelle salt. The various measurements that have been made on the abnormal variations of its dielectric constant and piezoelectric moduli with temperature are reviewed and the different crystal cuts are described. Other artificial crystals, and the possibility of orienting small crystals to give large piezoelectric slabs are discussed.

537.228.1 2446

The Elastic Behavior of Rochelle-Type Substances—W. Bentle and W. Lüdy. (*Helv. Phys. Acta*, vol. 15, pp. 325-327; July 8, 1942. In German.)

537.228.1 2447

The Influence of Temperature on the Dynamic-Elastic Behaviour of Rochelle-Type

- Substances—W. Lüdy. (*Helv. Phys. Acta*, vol. 15, pp. 527–552; October 24, 1942. In German.)
- 537.228.1 2448
The Specific Heat of Rochelle-Type Substances. Dielectric Measurements in KD_2PO_4 Crystals—W. Bantle. (*Helv. Phys. Acta*, vol. 15, pp. 373–404; July 8, 1942. In German.)
- 537.228.1 2449
The Inverse Piezoelectric Effect of Rochelle-Type KH_2PO_4 Crystals—A. von Arx and W. Bantle. (*Helv. Phys. Acta*, vol. 17, pp. 298–318; July 12, 1944. In German.) Full paper; summary abstracted in 3643 of 1945.
- 537.228.1 2450
Electro-Optical Properties of the Rochelle-Type Crystals KH_2PO_4 and KD_2PO_4 —B. Zwicker and P. Scherrer. (*Helv. Phys. Acta*, vol. 17, pp. 346–373; September 6, 1944. In German.) Experimental investigation with theoretical discussion of double refraction, the spontaneous Kerr effect, the linear electro-optical effect at $T > \theta$ where θ is the Curie temperature, electro-optical hysteresis at $T < \theta$, dielectric constant, anomaly of the specific heat and "freezing" of polarization.
- 537.228.1 2451
Dielectric Measurements on KH_2PO_4 and KH_2AsO_4 at Low Temperatures—B. Busch and E. Ganz. (*Helv. Phys. Acta*, vol. 15, pp. 501–508; August 15, 1942. In German.) The Curie temperature is 123.5 degrees Kelvin for KH_2PO_4 and 96.5 degrees Kelvin for KH_2AsO_4 . Between about 75 degrees and 50 degrees Kelvin the dielectric constants fall to very low values and the dielectric loss reaches a maximum of 3 joules per cm.]
- 537.311.33+621.315.59]:[546.28+546.289 2452
Measurements of Hall Effect and Resistivity of Germanium and Silicon from 10^2 to $600^\circ K$ —G. L. Pearson and W. Shockley. (*Phys. Rev.*, vol. 71, p. 142; January 15, 1947.) Summary of American Physical Society paper. For *p*-type germanium the logarithm of the Hall coefficient is linear in $1/T$ below 90 degrees Kelvin, giving an activation energy of 0.007 e.v. For the *n*-type a similar linear relation is found between 17 degrees and 90 degrees Kelvin, the activation energy being about the same. "Silicon containing 0.03 atomic per cent boron, has essentially constant resistivity and Hall coefficient below 100 degrees Kelvin." These results are discussed. See also 2216 of 1946.
- 537.311.33:537.58 2453
Thermal Ionization of Impurity Levels in Semi-Conductors—B. Goodman, A. W. Lawson, and L. I. Schiff. (*Phys. Rev.*, vol. 71, pp. 191–194; February 1, 1947.) The ionization probabilities calculated by the use of a simple Debye model and an Einstein model may play an important part in determining the frequency dependence of the rectification efficiency of crystal rectifiers.
- 538.221 2454
Magnetic Spectra of Diverse Materials at Various Frequencies—V. Arkadiev. (*Jour. Phys.* (U.S.S.R.), vol. 9, no. 5, pp. 373–378; 1945.)
- 549.514.51:534.133]+621.396.611.21.012.8 2455
Calculation of the Equivalent Constants of a Quartz Plate in Plane Shear Vibration (Type CT, DT)—Dumesnil. (See 2341.)
- 621.314.632+537.311.33 2456
Photo- and Thermo-Effects in *p*-Type Germanium Rectifiers—R. Bray and K. Lark-Horovitz. (*Phys. Rev.*, vol. 71, pp. 141–142; January 15, 1947.) Summary of American Physical Society paper. Photoconductive effects, depending on the particular germanium sample and the metal, leave the forward resistance relatively unchanged, but may so greatly reduce the back resistance as apparently to reverse the rectification. Photovoltaic effects are observed usually in the back direction. Photoeffects approach maximum sensitivity in the near infra-red (about 1.3μ).
- 621.314.632:546.289 2457
Ge-Ge Contacts—S. Benzer. (*Phys. Rev.*, vol. 71, p. 141; January 15, 1947.) Summary of American Physical Society paper. Germanium crystals of various impurity content in contact with each other produce a rectification series (3628 of 1946—Brattain). Instead of the expected linear current-voltage characteristic, the characteristic observed for both polarities is of the order of the back resistance when either piece of the crystal is used with a metal. In both directions the negative resistance at high voltages appears. These effects are discussed.
- 621.315.59:621.315.616.92:621.319.4 2458
The Effect of Semiconducting Liquids on the Dielectric Properties of Cellulose Insulation—F. M. Clark. (*Gen. Elec. Rev.*, vol. 50, pp. 9–17; February, 1947.) The abnormalities met with when cellulose insulation is impregnated with high-loss liquids have been used in the development of a new type of capacitor having a high ratio of capacitance to volume. Such capacitors may be used at voltages above those at which electrolytic capacitors can be used continuously with safety, and below those at which the usual paper-spaced oil- or askarel-treated capacitors can be used with economy.
- 621.315.61:546.431.823:537.228.1 2459
Effect of Temperature on the Permittivity of Barium Titanate—J. H. van Santen and G. H. Jonker. (*Nature* (London), vol. 159, pp. 333–334; March 8, 1947.) Investigation shows that for TiO_2 (rutile), $BaTiO_3$ and titanates with various proportions of Ba and Sr, the permittivity ϵ in the cubic region is accurately represented by the formula $1\epsilon = \beta(T - C)$, where β is a constant for each material and C is a temperature only slightly different from that corresponding to the maximum value of ϵ . It is concluded that in the temperature region of cubic structures there is no permanent dipole moment.
- 621.315.612 2460
Low Loss Ceramic Dielectric—H. Thurnauer. (*Tele-Tech.*, vol. 6, pp. 86–87, 130; February, 1947.) A new material, which has been named AlSiMag 243, can be processed by standard steatite methods. The permittivity is 6.1 and the power factor 3×10^{-4} at 100 Mc.
- 621.318.23 2461
Permanent Magnet Design—D. Hadfield. (*Elec. Times*, vol. 111, pp. 290–294, 323–325, and 357–359; March 20 and 27, and April 3, 1947.) No rigid formulas for the design of permanent magnets for electrical instruments can be given, since operating conditions, leakage flux, etc., differ very much from one instrument to another. The properties of the various magnetic materials now available are shown graphically and tabulated. The relationship between magnet shape and operating point on the magnetization curve is considered for ring-shaped magnets. Maximum gap flux density for a given volume of magnet material is obtained when the magnet is operating at the $(B/H)_{max}$ point of the material of which it is made. General principles are applied to the case of a ring-shaped magnet with soft pole pieces fitted between the ground faces of the gap. Composite magnets, with a block of one of the newer permanent magnet alloys and mild steel side limbs are briefly discussed, and also the question of increasing the sensitivity of an instrument by a new magnet without modification of the movement and other parts. Stabilization is also considered. See also 3371 of 1945.
- 621.357.6 2462
Electroforming. Piece Part Production by Electrodeposition—E. A. Ollard. (*Metal Ind.* (London), vol. 70, pp. 126–128; February 14, 1947.) Conclusion of 1478 of June.
- 621.395.625.3 2463
New Magnetic Recorder—(See 2321.)
- 621.775.7 2464
Powder Metallurgy—J. W. Lennox. (*Machinery* (London), vol. 70, pp. 337–344; April 3, 1947.) An account of production methods for a wide variety of metal parts, including porous bronze bearings, iron dust cores, electrical contacts, hard-metal tools, etc. The advantages and limitations of the process are discussed.
- 621.785.5:[669.71+669.715 2465
Surface Hardening of Aluminium and Its Alloys—K. G. Robinson and B. W. Mott. (*Metallurgia*, (Manchr.), vol. 35, pp. 201–204; February, 1947.) By careful control of conditions throughout the process, it is possible to obtain a hard copper-rich surface layer of reasonably good uniformity.
- 621.791.3:621.197 2466
Soldering Litz Ends—E. Toth. (*Electronics*, vol. 20, pp. 158–166; March, 1947.) An effective method consists of (a) burning the silk insulation and wiping off, (b) applying a paste of zinc chloride and water and heating with a soldering iron, (c) tinning immediately with resin-cored solder. With this method no trace of corrosion was found after equipment had been in service for 18 months in Panama.
- 621.791.353:669.018.21 2467
Metallic Joining of Light Alloys: Parts 3 and 4—(*Light Metals*, vol. 10, pp. 111–120 and 203–209; March and April, 1947.) Discussion of fluxes for soldering aluminum, theory, and practice of hard solders and soldering for light alloys, the mechanical and corrosion properties of soldered joints, American investigations on soft-soldering practices for aluminum, and the possibilities of supersonic vibration as an aid to the tinning of aluminum. Though no adequate theory of this last process is yet available, it is thought that the mechanical vibration removes the oxide film from the surface of the metal, so that true metal-to-metal contact is achieved. Practical details are discussed briefly. For a complete account by A. E. Thiemann of this process see *Automobiltechnische Zeitschrift*, vol. 45, p. 688; December 25, 1942, of which an English summary was given in *Light Metals*, vol. 7, no. 77, pp. 263–264; 1944. For parts 1 and 2 see 2152 of August. To be continued.
- 666.1:621.385.832 2468
Gas Heat Speeds Production of Electron Tubes—(*Glass Ind.*, vol. 28, pp. 75–77; February, 1947.) Details of RCA production technique for cathode-ray tubes.
- 669.28—154.4 2469
Ductile Melted Molybdenum—(*Metal Ind.* (London), vol. 70, pp. 106, 113; February 7, 1947.) Molybdenum is melted by an electric arc in vacuo and the resulting casting, after deoxidation with carbon, is sufficiently ductile for hot working.
- 669.71+669.715 2470
Aluminium Developments—S. A. J. Sage. (*Metallurgia* (Manchr.), vol. 35, pp. 193–196; February, 1947.) A survey of improvements in production methods and of new alloy developments.
- 669.71:6 2471
Aluminium 1946—W. C. Devereux. (*Metallurgia* (Manchr.), vol. 35, pp. 191–192; February, 1947.) A general review. The Government policy of holding large quantities of secondary stock idle is considered. The need for

research and development in the industry is stressed.

669.718.4/7 2472
Metallization with Aluminium—C. R., Draper. (*Light Metals*, vol. 10, pp. 124–160; March, 1947.) "An exhaustive study of all current techniques and equipment for the coating of metallic and nonmetallic bases with aluminum. Theory and practice are considered in detail, with particular respect to the scope and economics of various fields of application."

669.718.6:621.385 2473
A Substitute for Nickel in Radio Valves—(*Electronic Eng.*, vol. 19, p. 123; April, 1947.) The Telefunken Co. have produced a specially coated aluminum-iron sheet free from zinc, whose outstanding characteristic is that the surface changes from normal aluminum brightness to a dull dark grey on heating to 600 degrees C in vacuo. This surface is an excellent radiator, comparable with the blackened surfaces at present used. The metal cannot be used with evaporated cathodes. Abstract of "Report on New Vacuum Tube Techniques" (Fiat No. 500), published by H. M. Stationery Office.

679.5 2474
Materials—F. A. Freeth. (*Jour. Roy. Soc. A.*, vol. 95, pp. 333–339; April 11, 1947. Discussion, pp. 339–341.) A general account of the properties of polythene, methoxone, plastics, and other new materials.

MATHEMATICS

512.831:535.13 2475
Matrix Representation of Maxwell's Equations—J. Baudot. (*Compt. Rend. Acad. Sci.* (Paris), vol. 224, pp. 735–737; March 10, 1947.)

512.972:537 2476
Tensors and Electricity—L. Bouthillon. (*Ann. Radio Élec.*, vol. 1, pp. 345–358; October, 1946.) Scalar, polar, axial, and pseudoscalar quantities are defined and the different varieties of tensors to represent them described. The essential elements of the tensor calculus are presented, together with an original notation based on vector notation. Application of the results to electrostatics and magnetostatics shows that the two Coulomb theories of magnetism, as well as the classic Coulomb theory of electrostatics and Ampère's electrostatic theory can be developed in parallel, with interesting points of similarity and differences. Maxwell's equations are given in tensor notation and put into the most symmetrical form possible.

517.512.2:621.396.61 2477
Fourier Transform Analysis—Lévy. (*See* 2351.)

517.63 2478
A Generalization of Laplace's Transform—R. S. Varma. (*Current Sci.*, vol. 16, pp. 17–18; January, 1947.) A generalization is given on which a new calculus is based. Five theorems of this calculus are stated, without proof.

517.941.9:53 2479
A New Method for Solving Certain Boundary Problems for Equations of Mathematical Physics Permitting of a Separation of Variables—G. A. Grünberg. (*Bull. Acad. Sci.* (U.R.S.S.), sér phys., vol. 10, no. 2, pp. 141–168; 1946. In Russian.) For problems of mathematical physics reducible to the integration of linear differential equations with separable variables and linear boundary conditions, the well known Fourier-Lamé method of partial solutions is normally used. This method is only a particular case of a more general and adequate method. As an example, the Laplace equations (1,1) for a rectangle are considered and the method of partial solutions is applied to Dirichlet's problem with boundary conditions (2, 1) and (2, 2). A complete solution is obtained but com-

plifications arise when the method is applied to Neumann's problem with boundary conditions (2, 14), consequently a solution in the form (2, 27) is derived and it is emphasized that this is radically different from that obtained by the Fourier-Lamé method. The proposed method is then generalized and applied to the following problems: (a) the distribution of current in a uniform conducting cylinder when the current is admitted through a circular electrode *AB* on one of the ends of the cylinder and taken off from a ring electrode *CD* on its curve surface (Fig. 3), (b) the propagation of electromagnetic and acoustic waves in an infinite straight wave guide with a sectorial cross section (Fig. 5), and (c), as (a) but where the cylinder consists of a number of coaxial cylindrical surfaces of different conductivities. An English version was noted in 1838 of July.

518.5 2480
Recent Developments in Calculating Machines—(*Engineer* (London), vol. 183, p. 292; April 4, 1947.) Summary of I.E.E. Measurements Section discussion opened by D. R. Hartree, "Analogue" and "digital" types of machine were distinguished. The importance of a storage or "memory" device was stressed. In particular, the I.B.M. automatic sequence-controlled calculator (787) of April and back references, and the ENIAC (462 of March) were briefly mentioned, together with a new American digital machine called EDVAC, which uses mercury vapor delay lines. Automatic indication of error from tube failure cannot yet be fully provided. A central Mathematical Institute will be needed to provide staff to advise on the capabilities of new machines.

518.5 2481
The ENIAC—High-Speed Electronic Calculating Machine—M. V. Wilkes. (*Electronic Eng.*, vol. 19, pp. 105–108; April, 1947.) A general description, with photographs and some details of the principles of operation. The apparatus contains about 1500 relays and 18,000 tubes, the power consumption being 150 kilowatts. The basic circuit is the flip-flop; these are arranged in groups of 10 connected in rings so as to give a scale-of-ten counting system. All switching for the operational sequences involved in addition, multiplication, division, etc., is performed by means of pentode gate circuits. All the 2 μ s pulses used in the ENIAC have their origin in the cycling unit and their progress through the machine is controlled by gate tubes. The numbers for the calculations are fed into the machine by means of punched cards of the kind used in the Hollerith accounting equipment. Memory, in the form of a storage device, and an adding machine are provided by units known as accumulators. A special unit carries out multiplication, making use of the method of partial products, the total time required for multiplication being about 14 addition times. Division is effected by repeated subtraction, the operating taking about 140 addition times, addition being performed in about 200 μ s. Numbers from tables of functions may be set up in advance by the operator and can be transmitted in pulse form to any part of the machine when required. Pulse control is also used for selecting the operational sequences and making the necessary inter-unit connections, a "master programmer" determining the successive routines and the number of times each process is repeated. The importance of such machines is stressed because of their ability to perform long and tedious calculations at high speed. See also 1928 and 2995 of 1946 and 462 of March.

518.5:621.3 2482
A Relay Computer for General Application—S. B. Williams. (*Bell Lab. Rec.*, vol. 25, pp. 49–54; February, 1947.)

531.31:521.4 2483
On Nearly Periodic Motions—F. Loonstra. (*Proc. Acad. Sci.* (Amsterdam), vol. 49, pp. 744–751; September, 1946. In French.) A general discussion, with consideration of nearly periodic motions that can be physically realized.

MEASUREMENTS AND TEST GEAR

389.6:621.317.36.621.396.97(73) 2484
Standard Frequency Broadcasts—(*Wireless World*, vol. 53, p. 132; April, 1947.) National Bureau of Standards transmissions are now radiated by WWV on four additional frequencies (20, 25, 30, and 35Mc.) and include regular warnings of radio propagation disturbances.

620.193.91:621.385 2485
Tubes Life Tested Under Pulsed Operating Conditions—(*Elec. World*, vol. 127, pp. 33–34; February 8, 1947.) Equipment for life-testing receiving tubes gives positive grid pulses, adjustable from 50 to 350 volts. Pulse width is 1–25 μ s and recurrence frequency 500–2500 pulses per second.

621.317.3.011.5:621.392.029.64 2486
On the Measurement of Dielectric Constant with the Aid of a Waveguide—G. Fejér and P. Scherrer. (*Helv. Phys. Acta*, vol. 15, pp. 645–684; January 20, 1943. In German.) A magnetron oscillator and a rectangular waveguide are used in the band λ 1–3 cm. for determining dielectric constant and absorption. A metal disk short-circuits one end of the wave guide and a plate of the material investigated is placed in front of it. The total phase change of the reflected wave is measured and its dependence on the thickness of the plate gives the dielectric characteristics of the material. The theory of the method is given and the advantages of using the H_{01} wave with crystals are explained.

621.317.32:578.088.7 2487
Method for Measuring High-Frequency Electric Fields and Its Use for Local Short-Wave Dosimetry—K. S. Lion. (*Helv. Phys. Acta*, vol. 14, pp. 21–50; February 20, 1941. In German.) The brightness of the electrodeless discharge in a small gas-filled sphere is proportional to the field strength. The dependence of the brightness on all the factors involved is investigated. A reference was given in 2770 of 1941.

621.317.335:621.396.694.032.2 2488
Measuring Inter-Electrode Capacitances—C. H. Young. (*Tele-Tech*, vol. 6, pp. 66–70, 109; February, 1947.) New bridge, developed for measurement in h.f. values of capacitances down to 2×10^{-8} pF.

621.317.34 2489
A Transmission Measuring Set for 0.1 to 11 c/s—Bryden. (*See* 2511.)

621.317.341.029.6 2490
Attenuation Test Equipment for V.H.F. Transmission Lines—F. A. Muller and K. Zimmerman. (*Télev. Franç.*, Supplement *Électronique*, pp. 8–10; February, 1947.) Summary of 982 of 1946.

621.317.361 2491
The Identification of Harmonically Related Frequencies—L. H. Moore. (*Electronic Eng.*, vol. 19, pp. 134–135; April, 1947.) A method for positive identification of the harmonic frequency with the minimum of apparatus. See also 3010 of 1945 (Anderson).

621.317.372 2492
Measurement of Q—U. Zelbstein. (*Toute la Radio*, vol. 14, pp. 121–123; March and April, 1947.) A simple description of indirect and of direct methods of measurement, with circuit diagrams of two Q-meters.

- 621.317.382.08:621.392.3 2493
R. F. Generator Load—F. M. Leslie. (*Wireless Eng.*, vol. 24, pp. 105-108; April, 1947.) Describes the use of a short-circuited concentric transmission line with tap water as dielectric. The input impedance is calculated, and the input power may be found by measuring the temperature rise of the water flowing through the line.
- 621.317.7+621.38+621.396.69 2494
Physical Society Exhibition—(*Electrician*, vol. 138, pp. 847-849, 937-939, and 1014-1016; April 4 and 18, 1947. *Elec. Times*, vol. 111, pp. 390-395; April 10, 1947. *Metal Ind.* (London), vol. 70, pp. 269-271; April 18, 1947. *Elec. Rev.* (London), vol. 140, pp. 559-565; April 11, 1947. *Wireless Eng.*, vol. 24, pp. 150-154; May, 1947.) Various accounts of the apparatus and equipment exhibited.
- 621.317.7+621.396.69 2495
The R.C.M.F. [Radio Component Manufacturers' Federation] Exhibition—(See 2376.)
- 621.317.7 2496
Measurement Apparatus at the [Paris] Components Exhibition—(*Toute la Radio*, vol. 14, pp. 115-116; March and April, 1947.) A short account, including descriptions of an oscilloscope, tube tester, impedance bridge, resistance and capacitance box, etc.
- 621.317.7 2497
Output Analyser—P. Bernard. (*Toute la Radio*, vol. 14, pp. 124-125; March and April, 1947.) An instrument exhibited at the Paris components exhibition. It can be used as a wattmeter, a tube voltmeter, a distortion meter or a decibel meter and also permits simple measurement of the useful sensitivity of receivers.
- 621.317.7:621.396 2498
Test Equipment and Techniques for Airborne-Radar Field Maintenance—E. A. Blasi and G. C. Schutz. (*Proc. I.R.E.*, vol. 35, pp. 310-320; March, 1947.) Techniques for measuring frequency, power, receiver sensitivity, and performance characteristics of airborne radar equipment are outlined. Test apparatus designed to carry out these measurements in the field is described with particular mention of "passive type" instruments not requiring any operating power, such as echo boxes and directional couplers.
- 621.317.72:621.396.813 2499
Distortion Analyzer—J. T. Goode. (*Radio News*, vol. 37, pp. 60-61, 144; February, 1947.) Constructional and circuit details.
- 621.317.725 2500
Stable Voltmeter—R. W. Gilbert. (*Electronics*, vol. 20, pp. 130-133; March, 1947.) By using a plate follower circuit with compound feedback, a conductively coupled instrument of high stability is obtained. Zero drift is discussed and drift factors are given for the four basic degenerating networks.
- 621.317.733:621.316.89 2501
A Bridge Method for the Investigation of Non-Linear Resistors—G. T. Baker. (*Phil. Mag.*, vol. 37, pp. 498-502; July, 1946.) $R_S (= V/I)$ is termed the steady resistance and $R_F (= \Delta V/\Delta I)$ the fluctuation resistance. When $\Delta V/V$ is small, it is shown that for resistors satisfying the relation $V = CI^\beta$, $R_F = \beta R_S$, while for the more general equation $V = RI + CI^\beta$, $R_F = R + \beta R_S$. R_F and R_S are measured directly on a simple resistance bridge fed by an adjustable d.c. voltage with a small superimposed a.c. voltage which constitutes ΔV . The d.c. balance gives R_S on a suitably calibrated scale and the a.c. balance, with galvanometer cut out and a c.r.o. used as indicator, gives β directly. The method of calibration is fully described, practical bridge details are given, and the accuracy of the method is discussed.
- 621.317.761:621.318.572 2502
A Pulse Counter Circuit and Its Adaptation as a Frequency Meter—Lemas. (See 2346.)
- 621.317.761.078 2503
Description of a New Type of Frequency Meter and Its Application to Power Frequency Control—F. Esclangon. (*Bull. Soc. Franç. Élec.*, vol. 7, pp. 11-20; January, 1947.) Three arms of a Wheatstone bridge are pure resistances and the fourth a series resonant circuit. At the resonant frequency balance is obtained with suitable values of the resistances. For any other frequency an a.c. voltage is developed across one diagonal and is in quadrature with the supply voltage; it can be observed either by a moving-coil electro-dynamometer or a rotating field instrument. The sensitivity is high and accuracy is little affected by harmonics. Simple additions to the instrument adapt it for frequency control.
- 621.317.761.087 2504
Direct Reading Frequency Meter of High Accuracy Up to 100 Mc/s, with Recorder—L. M. Berman. (*Onde Élec.*, vol. 27, pp. 87-93; March, 1947.) A rack-mounted equipment comprising a decade series of relaxation oscillators controlled by a 100 kc. quartz crystal and ranging from 10 Mc. to 10 c.p.s. a corresponding set of selectors and mixers with low-pass filters and tube voltmeters. An incoming frequency gives a series of beat frequencies with successively selected harmonics, the last digit being given by a direct-reading meter. Accuracy is to 1 part in 10^6 .
- 621.317.79:621.385 2505
A Method of Measuring Grid Primary Emission in Thermionic Valves—A. H. Hooke. (*Elec. Commun.*, vol. 23, pp. 471-478; December, 1946.) Reprint of 1598 of 1946.
- 621.317.79:621.396.62:621.396.622.63 2506
Crystal Diode Reduces Probe Size—A. Bein. (*Radio News*, vol. 37, pp. 52, 147; February, 1947.) Application to signal tracing of a germanium crystal diode test probe, which indicates difference in modulation or changes in the audio component of the signal. Operates in the frequency band 90 kc.-33 Mc.
- 621.317.79:621.397.62 2507
Television Synchronizing Signal Generating Units: Part 2—R. R. Batcher. (*Tele-Tech*, vol. 6, pp. 44-48; February, 1947. Correction, p. 127.) Method and equipment for combining picture and synchronizing signals, using the monoscope or image cameras. For part 1 see 1517 of June.
- 621.39.081 2508
Measurements in Communications—N. B. Fowler. (*Elec. Eng.*, vol. 66, pp. 135-140; February, 1947.) Includes a table, arranged for convenient reference, of some of the more common measurement units and scales used in communication engineering.
- 621.396.822.08:621.396.62 2509
Visual Measurement of Receiver Noise—Williams. (See 2570.)

OTHER APPLICATIONS OF RADIO AND ELECTRONICS

- 621.317.32:578.088.7 2510
Method for Measuring High-Frequency Electric Fields and Its Use for Local Short-Wave Dosimetry—Lion. (See 2487.)
- 621.317.34 2511
A Transmission Measuring Set for 0.1 to 11 c/s—J. E. Bryden. (*Electronic Eng.*, vol. 19, pp. 77-81 and 125-130; March and April, 1947.) A general description of the instrument and its principles of operation, with comprehensive technical details of the circuits. Developed for use with biological and servo apparatus.
- 621.317.361:531.767 2512
Measuring Velocity of V-2 Rockets by Doppler Effect—J. F. McAllister. (*Tele-Tech*, vol. 6, pp. 56-59, 129; February, 1947.) Details of German high-velocity measurement technique using a rocket-borne c.w. receiver-transmitter and a heterodyne method for measurement of the change of frequency
- 621.317.761.078 2513
Description of a New Type of Frequency Meter and Its Application to Power Frequency Control—Esclangon. (See 2503.)
- 621.365.5+621.365.92 2514
Induction and Dielectric Heating—K. Pinder. (*Elec. Eng.*, vol. 66, pp. 149-160; February, 1947.) The fundamental principles are outlined and various general types of operations are described where time, cost, equipment, or material can be saved. The types and sizes of units required in various cases are indicated.
- 621.365.5 2515
Heat Treatment of Highly Conducting Bodies by High-Frequency Eddy Currents—M. Jouguet. (*Rev. Tech. Comp. Franç.* (Thomson-Houston), no. 6, pp. 27-36; December, 1946.) Methods are given for calculating the distribution and power dissipation of eddy currents in a highly conducting solid bounded by any surface of the second degree, when placed in a uniform h.f. field of any orientation. Simplified practical calculations for h.f. furnaces are based on the determination of (a) the increase of the effective resistance of the heater winding due to the crucible and (b) the decrease of its reactance. The circular section normally used in h.f. furnaces can with advantage be replaced by an oval section. The use of suitably fixed partitions inside the furnace results in lower net and operational costs.
- 621.365.5+621.365.92:654 2516
Electronic Heating Units Show Economy, Speed—(*Elec. Ind.*, vol. 1, pp. 2-3; March, 1947.) Discusses the economics of dielectric and induction heating and gives tables of (a) dielectric heating formulas and (b) processes in which h.f. heating can be used to reduce cost or increase speed.
- 621.365.92:621.396.662.21.042.15 2517
Baking Cores Dielectrically—J. McElgin. (*Metallurgia* (Manchr.), vol. 35, pp. 223-224; February, 1947.) With h.f. heating there is perfect control of time and temperature with no under- or over-heating. Mass production methods become possible.
- 621.365.92.029.64 2518
Heating with Microwaves—J. Marcum and T. P. Kinn. (*Electronics*, vol. 20, pp. 82-85; March, 1947.) "Suggested methods of utilizing wave guides for applying microwave energy to moving or stationary wires and threads, sheets or irregularly-shaped objects to achieve uniform dielectric heating, and survey of tubes offering possibilities for continuous operation."
- 621.369.2 2519
The Infra-Red Gas Burner—L. Sanderson. (*Metallurgia* (Manchr.), vol. 35, pp. 187-189, and 239-240; February and March, 1947.) High rate of heat transmission and low heat loss are claimed. Applications to many branches of industry are described.
- 621.38:6(048) 2520
Industrial Electronic Equipment Uses—W. C. White. (*Elec. Ind.*, vol. 1, pp. 6-7; March, 1947.) A list of 154 papers, all in English, on industrial applications of electronics and on

closely related subjects. For earlier lists see 2655 of 1946 and back references.

- 621.38.078 2521
The Electron Tube As an Element in Industrial Control—R. R. Batcher. (*Elec. Ind.*, vol. 1, pp. 16-17; March, 1947.) A chart giving typical tube circuits for a wide range of control purposes.
- 621.38.078 2522
Process Control by Electronic Instrumentation—R. R. Batcher. (*Elec. Ind.*, vol. 1, pp. 12-13; February, 1947.) A chart illustrating various devices which sense the changes in a variable process and deliver a controlling signal to an electronic system.
- 621.38.001.8:621.317.39 2523
Industrial Applications of Electronic Techniques—H. A. Thomas. (*Engineer* (London), vol. 183, pp. 247-248, 271-272, and 295-297; March 21 and 28, and April 4, 1947.) Summary of I.E.E. paper. A detailed description, with numerous diagrams, of a wide variety of electronic devices for measurement, industrial instrumentation and control, production, inspection, and protection. A bibliography of some 60 papers is included.
- 621.384.6 2524
Measurement of Out-of-Phase Magnetic Fields in Betatrons—W. Bosley, J. D. Craggs, and D. H. McEwan. (*Nature* (London), vol. 159, pp. 229-230; February 15, 1947.) A method for detection and approximate measurement similar to that outlined in 1543 of June.
- 621.384.6 2525
Biased Betatron in Operation—W. F. Westendorp. (*Phys. Rev.*, vol. 71, pp. 271-272; February 15, 1947.) A schematic cross section of the machine is given, with a diagram of the principal electrical components of the energizing circuit. No compensating or phase correcting circuits of any kind were used. With oil-cooled coils, the machine will produce 50-mv X rays.
- 621.384.6 2526
F. M. Cyclotron—F. R. (*Electronics*, vol. 20, p. 119; March, 1947.) The cyclotron at the University of California has pole faces about 15 feet in diameter, with a 20-inch gap and a peak potential of 50 kv across the gap between the dees. The oscillator used to charge the dees is frequency modulated at 120 c.p.s. between 12.5 and 8.17 Mc. by a rotary vacuum capacitor.
- 621.384.6(43) 2527
European Electron Induction Accelerators—H. F. Kaiser. (*Jour. Appl. Phys.*, vol. 18, pp. 1-18; January, 1947.) The development of betatrons in Germany during and since the war is reviewed. Details are given of the constructional features of 6- to 15-M.e.v. betatrons and of the theory and design of 15- and 200-M.e.v. betatrons. The smaller units, especially the Siemens 6 M.e.v., are more advanced than comparable American units. No large machines were actually built, but the projected 200 M.e.v. design presents novel features; it would only weigh about 40 tons.
- 621.385.1.001.8:531.768.087 2528
Vacuum-Tube Acceleration Pickup—W. Ramberg. (*Bur. Stand. Jour. Res.*, vol. 37, pp. 391-398; December, 1946.) A fixed indirectly heated cathode has an elastically mounted plate on each side which is deflected when accelerations normal to the plates occur. Enough output is obtained at accelerations of the order of 10 g to drive a recording galvanometer directly.
- 621.385.833 2529
New Electron Microscope—(*Electrician*, vol. 138, pp. 789-790; March 28, 1947.) Sum-

mary and discussion of an I.E.E. Measurements Section paper entitled "The Design and Construction of a New Electron Microscope" by M. E. Ilaine.

- 621.385.833 2530
The Magnetic Electron Microscope Objective: Contour Phenomena and the Attainment of High Resolving Power—J. Hillier and E. G. Ramberg. (*Jour. Appl. Phys.*, vol. 18, pp. 48-71; January, 1947.) The Fresnel diffraction fringes present in extra-focal images obtained with small angular aperture of illumination provide a sensitive criterion of the degree of symmetry of the objective. They also provide a relatively simple method for correcting asymmetry. Image quality with corrected lenses is much improved.
- 621.385.833 2531
On the Aberration of Electrostatic Lenses Due to Ellipticity—F. F. Berstein and E. Regenstreif. (*Compt. Rend. Acad. Sci. (Paris)*, vol. 224, pp. 737-739; March 10, 1947.) Formulas are derived for the limit of resolution imposed by the ellipticity and experiments are described which confirm the existence of the aberration.
- 621.386.1 2532
A High-Intensity Source of Long-Wavelength X Rays—T. H. Rogers. (*Proc. I.R.E.*, vol. 35, pp. 236-241; March, 1947.) Description of an X-ray tube, giving radiation in intensities of several million röntgens per minute over a 180-degree solid angle. Application to bactericidal and X-ray photo-chemical research is suggested.
- 621.386.84 2533
Application of Electronic Radiography to the Detection of Thin Organic or Mineral Layers—J. J. Trillat and C. Legrand. (*Compt. Rend. Acad. Sci. (Paris)*, vol. 224, pp. 645-646; March 3, 1947.) A plate of polished steel provides secondary electrons and its surface is covered with a very thin layer of cellulose paint, grease, oil, etc. Fine-grained photographic paper is applied and, after exposure and development, provides a measure of the layer thickness. The method is applicable to thicknesses from 0.001 mm. to several hundredths of a millimeter. See also 1549 of June.
- 621.395.623:578.088.7 2534
A Simplified Encephalophone—Conrad and Pacella. (*See* 2350.)
- 621.396.9:621.397.5 2535
Television Takes to the Air—McQuay. (*See* 2587.)
- 621.396.9.083.7:551.5 2536
Telemetering from V-2 Rockets: Part 1—V. L. Heeren, C. H. Hoepfner, J. R. Kauke, S. W. Lichtman, and P. R. Shifflett. (*Electronics*, vol. 20, pp. 100-105; March, 1947.) An account, with circuit diagrams, of the time-modulated pulse equipment carried in the nose of the rocket. The readings of 23 instruments are sampled successively and transmitted to the mobile ground station on a frequency of 1000 Mc.
- 621.396.96:551.41 2537
New Radar Device—(*Engineering* (London), vol. 183, p. 181; February 14, 1947.) National Research Council of Canada attempts to speed up map making by flying aircraft fitted with a radar altimeter over uncharted territory; a contour map of 200 square miles can be made in three hours.
- 621.398:621.43 2538
A Telecontrolled Motor Car—S. Coudrier. (*TSF Pour Tous*, vol. 23, pp. 63-65; March, 1947.) Details of the control equipment of a model car, 50 cm. long. With a 15-to-30-watt transmitter working on a wavelength of 4 to 6 m. the control radius is 2 to 3 km.

621.398:629.13 2539
Teleguided Missiles—J. A. Niland. (*Radio Craft*, vol. 18, pp. 24, 57; February, 1947.) A review of the use of radio-controlled planes, bombs, and rockets with brief descriptions of methods of control.

623.454.25:621.396.9 2540
The Optical Proximity Fuze—F. A. Zupa. (*Bell Lab. Rec.*, vol. 25, pp. 70-74; February, 1947.)

623.454.25:621.396.96 2541
Guidance of Shells by Radio Brain [Proximity Fuse]—(*Télév. Franç.*, no. 22, Supplement *Électronique*, p. 3; February, 1947.) The fuse VT, known as "Madame X," is a 4-tube receiver-transmitter of small dimensions, operating on radar principles and designed by RCA. It was fitted in the nose of shells used very successfully against V1 projectiles.

623.454.25:621.396.96:621.385.3 2542
The Vibrotron—J. V. (*See* 2624.)

621.3.078 2543
Electronic Control Handbook [Book Review]—R. R. Batcher and W. Moulic. Caldwell-Clements, New York, 1946, 334 pp. \$1.00 plus two years' subscription (\$8.00) to *Elec. Ind. (Electronic Eng.*, vol. 19, pp. 100-101; March, 1947.) Believed to be the first book to present a general treatment of transducers from the viewpoint of the electronic engineer. Indispensable to those dealing with a wide range of electronic problems. A very favorable review.

621.38 2544
Electronic Engineering Handbook [Book Review]—R. R. Batcher, W. Moulic, and others. Caldwell-Clements, New York, 1944, 456 pp., 22s.-6d. (*Elec. Eng.*, vol. 19, pp. 100-101; March, 1947.) Deals mainly with fundamental tube types, circuits, and applications. Valuable to those concerned with a wide range of electronic problems. A very favorable review.

PROPAGATION OF WAVES

535.13 2545
Quasi-Optical Links: Models of Ellipsoids [of Diffraction] and Spatial Aerials with Experimental Results—J. Dreyfus-Graf. (*Helv. Phys. Acta*, vol. 17, pp. 245-250; July 12, 1944. In French.) See also 2058 of August.

538.566.2 2546
The Method of 'Phase Integral' as Applied to the Solution of the Problem of Propagation of Radio Waves Around the Earth—M. I. Ponomarev. (*Bull. Acad. Sci. (U.R.S.S.)*, sér. phys., vol. 10, no. 2, pp. 189-195; 1946. In Russian.) The problem presents great difficulties to overcome which Eckersley proposed the "phase integral" method (1932 Abstracts, p. 514). An attempt to justify the method mathematically was made by him with Millington (3835 of 1938), and later by Millington alone (2640 of 1939).

The method is examined in the present paper and the following conclusions are reached: (a) it cannot be regarded as a new method for solving the diffraction problem since it is only a modification of Watson's method; (b) it has limited possibilities and the field intensity cannot be determined without resorting to the classical solution of the problem; (c) the introduction of Fresnel's reflection coefficient is not fully justified; and (d) the existence of the modified Watson's series requires proof; the simplification of the differential equation is not justified.

621.396.11:621.396.93 2547
A New Source of Systematic Error in Radio Navigation Systems Requiring the Measurement of the Relative Phases of the Propagated Waves—Norton. (*See* 2429.)

621.396.11.029.45:551.510.535 2548

The Oblique Reflexion of Very Long Wireless Waves from the Ionosphere—M. V. Wilkes. (*Proc. Roy. Soc. A*, vol. 189, pp. 130-147; March 27, 1947.) "An attempt is made to provide a satisfactory theoretical basis for a future discussion of the experimental data on the propagation of very long radio waves (18,800 meter) given by Best, Ratcliffe, and Wilkes, and Budden, Ratcliffe and Wilkes [3441 of 1939 and back references]. The reflection of very long plane waves incident obliquely on a horizontally stratified ionized medium with a vertical magnetic field is first considered in general terms, and it is shown that the medium can be divided into a transition region and a reflecting region. If the ionization in the reflecting region increases linearly with height it is shown that propagation is governed by the equations:

$$\frac{\partial^2 L}{\partial \zeta^2} + (\alpha + \zeta)L + \beta M = 0,$$

$$\frac{\partial^2 M}{\partial \zeta^2} + (\alpha - \zeta)M + \beta L = 0,$$

where α and β are constants depending on the angle of incidence. Under the conditions of the experiments β is small, and a solution, in terms of contour integrals valid in this case is obtained."

621.396.11.029.62.64 2549

On the Propagation of Ultra-Short Electromagnetic Waves in the Zone of Direct Visibility—S. Ya. Braude and I. E. Ostrovski. (*Bull. Acad. Sci. (U.R.S.S.)*, sér. phys., vol. 10, no. 2, pp. 225-234; 1946. In Russian.) The propagation of electromagnetic waves of wavelength 1 cm. to 9 meters over sea and land is discussed theoretically. The intensity of the field due to a vertical dipole is calculated for the case of a small elevation above the surface of the earth (which is assumed to be flat) of the transmitting and/or receiving dipoles. Certain conclusions are reached with regard to the depth and extension of the field when the dipoles are raised and also with regard to the effect of the operating frequency on the intensity of the field. The variation of the dielectric and conductivity properties of the medium with frequency and the effect of this on the field intensity of the dipole are examined. In studying the propagation of the waves along the surface of the earth, data are obtained on reflection coefficients different from those derived by Fresnel.

621.396.812+551.510.535]:523.752 2550

Eruptions of the Solar Chromosphere and Their Influence on the Ionosphere and on Wave Propagation. Their Effects in Different Regions of the Radio Spectrum—R. Bureau. (*Onde Élec.*, vol. 27, pp. 45-56; February, 1947.) The main sources of information discussed are continuous records of the level of atmospheric on wavelengths in the neighborhood of 10,000 meters, together with records on various wavelengths between 20 and 24,000 meters. Comparison with results obtained in Great Britain for very long waves reveals a spectral effect which is interpreted as due to altitude. The sudden fade-outs on decimeter waves and strengthening of long-wave signals are discussed. Some records on 2000 meters show, during the same eruption, successive fade outs and strengthenings. This also is attributed to an altitude effect. February, 1946, was marked by the passage across the solar disk of groups of spots and of eruptions larger than any previously observed. Examples are given of the radio effects then noted. The majority show simultaneous strengthening of long-wave signals and fade outs on short waves. Two exceptional cases are discussed and also two cases of fade out on 24,000 meters. An explanation of the latter may be found in a

particular structure of the abnormal D region.

621.396.812:523.78"1945.07.09":551.510.535 2551

On the Results of the Ionosphere Measurements Made During the Solar Eclipse of July 9, 1945—Bulatoff. (*See 2412.*)

621.396.812:523.78"1945.07.09":551.510.535 2552

Results Obtained in Observing the Propagation of Radio Waves During the Solar Eclipse of July 9, 1945—Grigor'eva. (*See 2411.*)

621.396.812.029.64 2553

Attenuation of 1.25-Centimeter Radiation Through Rain—L. J. Anderson, J. P. Day, C. H. Freres, and A. P. D. Stokes. (*Proc. I.R.E.*, vol. 35, pp. 351-354; April, 1947.) An account of an experimental investigation over a 6400 foot optical path with 9 equally spaced rain gauges. Readings were taken over 30-second intervals. Drop sizes were measured by the blotter method but no definite conclusions were obtained. The average measured attenuation was 0.37 db per mile per mm per hr., which is somewhat higher than Ryde's calculated value (515 of March).

RECEPTION

534.862.4 2554

Perfect v. Pleasing Reproduction—Discussion—G. F. Redgrave: F. Slater, B. C. Sewell, F. Duerden, J. Moir. (*Electronic Eng.*, vol. 19, pp. 115-116; April, 1947.) Comments on 1185 of May and a reply by the author.

621.396.621+621.396.69 2555

Automatic Circuit Making. New Automatic Machine for Radio [Receiver] Production—(*Elec. Times*, vol. 111, p. 237; March 6, 1947.) Summary of 1913 of July (Sargrove).

621.396.621+621.396.69 2556

Automatic Receiver Production—(*Wireless World*, vol. 53, pp. 122-123; April, 1947.) For a full account see 1913 of July (Sargrove).

621.396.621 2557

Measurements of Temperature of the Different Parts of a Radio Receiver and of the Oscillator Drift During Warming-Up Period—I. L. Chakravarty. (*Indian Jour. Phys.*, vol. 20, pp. 193-195; October, 1946.) Tests on a Philips 595HN receiver. Temperature rise was highest (about 84 degrees centigrade) above the ballast tube. Near the i.f. transformer the temperature rose to 42 degrees centigrade. Stable conditions were reached in 2 and one-half hours. The oscillator frequency decreased from 2515 to 2492 Kc., corresponding to a temperature rise from 31 to 35 degrees centigrade near the oscillator coil.

621.396.621:621.396.619.11 2558

The "Synchrodyne": A New Type of Radio Receiver for A.M. Signals—Tucker. (*See 2364.*)

621.396.621:621.396.619.13 2559

Designing an F.M. Receiver: Part 1—Roddam. (*See 2365.*)

621.396.621:621.396.681 2560

Rodina [Receiver]—E. N. Genishta. (*Radio (Moscow)* no. 1, pp. 32-38; April, 1946. In Russian.) Description of a battery-operated receiver, with details of construction and loud-speaker characteristics.

621.396.621.029.6:621.396.645 2561

I.F. Amplifier for High Gain F.M. Receiver—Martin. (*See 2368.*)

621.396.621.029.64:621.396.96 2562

Considerations in the Design of Centimeter-Wave Radar Receivers—S. E. Miller. (*Proc. I.R.E.*, vol. 35, pp. 340-351; April, 1947.) General principles of design and operation for duplex working. Typical circuit ar-

rangements for various elements of the receiver, including the TR switches and automatic tuning unit, are described with particular reference to the 10,000-30,000 Mc. frequency band. Average values for noise figures of the elements are given.

621.396.621.54 2563

Superregenerative Frequency Converter—P. V. Trice and M. Barat, Jr. (*Radio News*, vol. 37, pp. 39, 134; February, 1947.) Construction and operation details of an inexpensive converter for extending the range of existing types of communications receivers into the v.h.f. and u.h.f. regions. The circuit diagram of a 144-Mc. unit is given.

621.396.621.54.029.56/.58 2564

A 5-Tube Ham Super—C. V. Hays. (*Radio News*, vol. 37, pp. 62-63, 120; February, 1947.) Constructional and circuit details of a receiver for the 10, 20, 40, and 80 meter bands.

621.396.667 2565

Towards High Fidelity. Expansion Circuits—R. Tabard. (*Télev. Franç.*, no. 23, Supplement *Électronique*, pp. 10-13; March, 1947.) A general discussion of frequency expansion and compression, with circuit diagrams of various practical devices.

621.396.813:621.317.72 2566

Distortion Analyzer—Goode. (*See 2499.*)

621.396.822:621.314.631 2567

Noise Spectrum of Crystal Rectifiers—P. H. Miller, Jr. (*Proc. I.R.E.*, vol. 35, pp. 252-256; March, 1947.) A study in the frequency range from 50 c.p.s. to 1 Mc. The measurement circuits are described. Noise temperature was found to vary inversely as the frequency.

621.396.822:621.396.621 2568

Specification and Measurement of Receiver Sensitivity at the Higher Frequencies—J. M. Pettit. (*Proc. I.R.E.*, vol. 35, pp. 302-306; March, 1947.) An outline of the factors involved in measuring sensitivity and an attempt to evaluate their relative importance. The influence of receiver noise at higher frequencies has led to the specification of sensitivity in terms of noise figure and a method of measuring this quantity with a diode noise generator is introduced. To include both over-all gain and noise threshold a combined sensitivity figure proposed.

621.396.822:621.396.621.53 2569

Some Considerations Governing Noise Measurements on Crystal Mixers—S. Roberts. (*Proc. I.R.E.*, vol. 35, pp. 257-265; March, 1947.) A discussion of the principles of the analysis and measurement of noise in radio receivers. Noise generated in a crystal rectifier is analysed in terms of "noise temperature." The design of a noise-measuring set is discussed. It is found practicable to measure the noise temperature of a crystal rectifier independently of its impedance.

621.396.822.08:621.396.62 2570

Visual Measurement of Receiver Noise—D. Williams. (*Wireless Eng.*, vol. 24, pp. 100-104; April, 1947.) A pulse-modulated carrier is injected into the receiver and the output observed on a c.r.o., the input being adjusted until an assigned relation between the magnitudes of the output pulse and the noise is observed. Results obtained with three variations of the method are discussed.

621.396.828:621.327.43 2571

Preliminary Study of Radio Interference as Caused by Fluorescent Lamps in the Home—L. F. Shorey and S. M. Gray. (*Illum. Eng.*, vol. 42, pp. 365-376; March, 1947.) Tests carried out on a number of fixed and portable lamps, mainly of the 32-watt circular type,

showed that by the use of metal wire screens and noninductive capacitors, interference could be reduced to a tolerable level and in some cases eliminated altogether.

- 621.396.621.004.67 2572
Wireless Servicing Manual [Book Review]
 —W. T. Cocking. Iliffe and Sons, London, 328 pp., 10s. 6d. (*Elec. Rev.* (London), vol. 140, p. 480; March 28, 1947.) Revised edition. A book essentially for the repairer.

STATIONS AND COMMUNICATION SYSTEMS

- 003.62(100.1):621.396 2573
Call Signs of the Countries—(*Radio* (Moscow), no. 1, pp. 54–55; April, 1946. In Russian.) Includes details of the Russian zones.

- 621.395.44:621.315.052.63 2574
Transmissions in Power Distribution Networks—A. Chevallier. (*Onde Élec.*, vol. 27, pp. 79–86; March, 1947.) A description of methods used in the French grid system for carrier-current telephony, the transmission of power measurements, including power exchanges with neighboring grid systems, transmission to works of control orders after measurement of power and/or frequency, and transmission of information on synchronism and of signals necessary for the selective protection of the lines.

- 621.396.029.56/.58 2575
Amateur Frequency Bands—V. S. Saltikoff. (*Radio* (Moscow), no. 2, pp. 50–52; May, 1946. In Russian.)

- 621.396.65.029.64 2576
Microwave Communications System—(*Electronics*, vol. 20, pp. 138–140; March, 1947.) Point-to-point relay equipment operating in the 2450–2700 Mc. or 3700–4200 Mc. bands. See also 265 of February.

- 621.396.65 Vanguard 2577
H.M.S. Vanguard. Radio Communication Arrangements for the Royal Cruise—G. M. Bennett. (*Wireless World*, vol. 53, pp. 80–83; March, 1947.)

- 621.396.931 2578
Radio Communication in a French Marshalling Yard—(*Engineer*, (London), vol. 183, p. 157; February 7, 1947.) For one-way working at Trappes a 25-watt 166-Mc. transmitter is used, with damp- and dust-proof receivers and loudspeakers in the shunting locomotives' cabs. Later equipment, comprising light-weight transmitter-receivers, gives a two-way communication range of 3 to 4 km.

- 621.396.931.029.62 2579
Radio Dispatching for Taxicabs—A. A. McK. (*Electronics*, vol. 20, pp. 97–99; March, 1947.) Some details of a two-way radio system now in operation in New Jersey, using f.m. on frequencies of 152.27 and 157.53 Mc., respectively.

- 621.396.97(213) 2580
Tropical Broadcasting—“Radiator.” (*Wireless World*, vol. 53, pp. 139–140; April, 1947.) Summary of and comment on 1942 of July.

SUBSIDIARY APPARATUS

- 621.314.632/.634 2581
Rectifiers: Selenium and Copper-Oxide—W. H. Falls. (*Gen. Elec. Rev.*, vol. 50, pp. 34–38; February, 1947.) A general account of their characteristics, including forward and leakage resistance, voltage rating, regulation, operating temperature, intermittent overload operation, and aging.

- 621.314.634:621.396.621 2582
Selenium Rectifiers for Broadcast Radio Receivers—E. W. Chadwick. (*Elec. Commun.*, vol. 23, pp. 464–467; December, 1946.) The high forward peak-current rating of selenium

rectifiers permits a larger input capacitance in power supply filters than is possible with diodes. The construction is described and practical circuits given.

- 621.318.5.077.8 2583
Capacity Operated Relays—R. G. Rowe. (*Radio News*, vol. 37, pp. 50–51, 137; February, 1947.) Brief notes on four general types, and a detailed account of a method depending on changes of reflected resistance in the tuned circuit of a capacitance-controlled sensing element.

- 621.398+621.314.12 2584
Selsyns and Amplidyne—F. Penin. (*Tech. Mod.*, vol. 39, pp. 126–129; April 1–15, 1947.) Describes the basic principles and applications of selsyns for telecontrol of angular position and of amplidyne in power amplification where electronic amplifiers are not practicable.

- 621.398 2585
Remote Control and Indication—(*Elec. Rev.* (London), vol. 140, p. 389; March 14, 1947.) Fundamental principles and brief constructional details of the “Mag Slip” transmission system. A basic element comprises two rotors with common a.c. feed, the stator windings being interconnected phase-for-phase so that no current flows between them when the rotors are in coincident angular positions. Displacement of one rotor upsets this balance and causes a corresponding displacement of the other rotor. Accuracy greater than 1 degree is possible.

TELEVISION AND PHOTOTELEGRAPHY

- 621.397.26.029.64 2586
U.H.F. Television Relay System—W. Boothroyd. (*Electronics*, vol. 20, pp. 86–91; March, 1947.) Wide-band f.m. equipment, operating on 1350 Mc., for black-and-white video signals. Suitable either for inter-city multiple links or studio-to-transmitter work.

- 621.397.5:621.396.9 2587
Television Takes to the Air—J. McQuay. (*Radio News*, vol. 37, pp. 57–59, 102; February, 1947.) A review of the “Block” and “Ring” systems developed during the war and of proposed applications for a video news service.

- 621.397.5(44) 2588
Television Throughout France. Coaxial [Cable], Hertzian [Radio] Relays or Stratovision—Y. Angel. (*Télév. Franç.*, no. 23, pp. 7–11; March, 1947.) A discussion of some of the problems connected with the construction of a national television network. Stratovision could serve 80 per cent of France, containing 85 per cent of the population, by means of three receiver-transmitter aircraft suitably located.

- 621.397.5(44) 2589
Incoherence—M. Chauvierre. (*Radio Franç.*, no. 4, p. 35; 1947.) Criticizes the lack of a decision as to the future line standard for television in France, but gives cogent reasons for the opinion that all the data necessary for making such a decision are not yet available.

- 621.397.5(73) 2590
Television in the U.S.A.—M. Chauvierre. (*Radio Franç.*, no. 4, pp. 36–47; 1947.) A review of the television systems and services at present available, including the N.B.C., C.B.S. and Allen B. Dumont systems, with a detailed discussion of the rival color television systems proposed by C.B.S. and by R.C.A. receiver production is also considered. The author concludes that Europe need not envy America regarding receivers, which in the United States must provide for 13 frequency bands. As regards quality of service, however, he considers much can be learned from the efficiency of private enterprise in the United States.

- 621.397.6:621.385.832 2591
Experimental C.R. Tubes for Television—F.R. (See 2629.)

- 621.397.61.029.63 2592
Color-Television Transmitter for 490 Mc/s—N. H. Young. (*Elec. Commun.*, vol. 23, pp. 406–414; December, 1946.) Specifications and description of a C.B.S. equipment with output 1 kilowatt installed in the Chrysler Building, New York. The final amplifier stages all use 6C22 tubes.

- 621.397.611:621.383 2593
Theory and Improvement of the Iconoscope—R. Barthélemy. (*Télév. Franç.*, no. 23, p. 17; March, 1947.) Short summary of paper presented at a meeting of the Television Section of the Société des Radioélectriciens, October 15, 1946. For another account of the iconoscope see 917 of April.

- 621.397.62 2594
Postwar Television Receivers—D. W. Pugsley. (*Elec. Eng.*, vol. 66, pp. 249–253; March, 1947.) Summary of A.I.E.E. paper. A general description of the design features and construction of the latest American receivers, including both direct-view and projection types.

- 621.397.62 2595
Television Receiver Construction: Parts 3 and 4—(*Wireless World*, vol. 53, pp. 103–107 and 164–169; March and May, 1947.) Frame coils are wound as plain slab coils and then bent to shape. Full details are given of winding formers, mounting board, final frame-coil assembly, frame-time base, and synchronizing separator. For parts 1 and 2 see 1245 of April and 1953 of June.

- 621.397.62 2596
The Coudert Simplified Television Receiver—A. Coudert. (*Radio en France*, no. 3, pp. 18–22; 1947.) An account of the principles, lay-out, and circuits of an economical and simple receiver with only 22 tubes.

- 621.397.62:621.317.79 2597
Television Synchronizing Signal Generating Units: Part 2—Batcher. (See 2507.)

- 621.397.62:621.396.615.029.6 2598
 The 6C5 and 54 Mc/s—Pinot. (See 2359.)

- 621.397.62.018.078.3 2599
Automatic Frequency-Phase Control in TV Receivers—A. Wright. (*Tele-Tech*, vol. 6, pp. 74–76, 127; February, 1947.) Interference which causes line instability is overcome by using a stable sine-wave oscillator for line synchronization. Variations in phase between the generated sine wave and the incoming synchronizing pulses produce a d.c. voltage which is used for automatic frequency correction of the oscillator.

- 621.397.621 2600
Interlacing—W. T. Cocking. (*Wireless World*, vol. 53, pp. 124–128; April, 1947.) Diagrams are given showing that regular timing and also similarity of waveform of successive timebase cycles are of great importance for good interlacing. To achieve this, careful design of the synchronizing pulse separator circuits and the saw-tooth generator is necessary.

- 621.397.645:621.396.615.17 2601
Electromagnetic Deflexion in Television—(*Télév. Franç.*, no. 22, pp. 2–4; February, 1947.) Summary of 3086 of 1946 (Cocking).

TRANSMISSION

- 621.396.61 2602
Station in Lipstick Tube—(*Sci. News Let.* (Washington), vol. 51, p. 117; February 22, 1947.) A development from methods used in the proximity fuse. The circuits are painted on the envelope of a miniature tube and small batteries and a microphone complete the trans-

mitter. Similar methods may give vest-pocket radio receivers and hearing aids.

621.395.61.029.56/.58 2603
10-kW Short-Wave Telegraph Transmitter, Type T.-H. 1343—J. J. Brieu. (*Rev. Tech. Comp. Franc.* (Thomson-Houston), no. 6, pp. 37-43; December, 1946.) A monobloc transmitter for transcontinental links. Six quartz-controlled frequencies are available and a high-stability auto-oscillator can be used on any frequency between 5 and 20 Mc.

621.396.61/.62].029.62(52) 2604
250-300 Mc/s Radiophone—R. F. Scott. (*Radio Craft*, vol. 18, pp. 20-21; February, 1947.) Description of a Japanese portable transceiver having a horizontally polarized directional aerial and designed for speech or interrupted continuous-wave modulation. Photographs and circuit diagrams are given.

621.396.61.029.62 2605
A Three-Phase Rotating-Field Transmitter for Ultra-Short Waves—W. Dieterle. (*Helv. Phys. Acta*, vol. 15, pp. 127-161 and 199-220; March 31 and May 8, 1942. In German.) Three horizontal rods (tripole) excited with currents of equal amplitude but 120 degrees difference provide a uniform radiation pattern. The theory of the three-wire feeder with star or delta terminations and the method of feeding it from the transmitter are described. The adjustments and monitoring of the transmitter, feeder and aerials are considered in detail with numerous diagrams. A radiated power of 300 watts on wavelengths of 6.2 meters is obtained on the system described.

621.396.65.029.63 2606
48-Channel F.M. Phone Transmitter—A. van Weel. (*FM and Telev.*, vol. 7, pp. 28-30, 61; March, 1947.) A transmitter for an u.h.f. link between the Philips factories at Eindhoven and Tilburg. Wavelengths used are 90.5 and 99 cm. in the two directions. Modulation with frequencies from 12 to 204 kc., for 48 simultaneous calls, takes place on a carrier wave with a frequency $\frac{1}{2}$ of the transmitter frequency, the maximum frequency swing being 67 kc. A new method of interstage coupling simplifies the wiring. The transmitting tubes used are QQE06/40 double tetrodes, which have a common screen grid for the two balanced systems and will give 40 watts on wavelengths of 3 meters or 30 watts on wavelengths of 1 meter.

VACUUM TUBES AND THERMIONICS

621.317.7.085 2607
"Magic Eye" as Null Indicator—D. A. Ward. (*Wireless World*, vol. 53, p. 150; April, 1947.) Comment on 1255 of May. Circuit modifications are given for the EM34 which result in a sensitivity approximately the same as that of the prewar EM1. Note: In 1255 of May EM2 should read EM1.

621.38+621.317.7+621.396.69 2608
Physical Society Exhibition—(See 2494.)

621.385:620.193.91 2609
Tubes Life Tested Under Pulsed Operating Conditions—(See 2485.)

621.385:621.317.79 2610
A Method of Measuring Grid Primary Emission in Thermionic Valves—A. H. Hooke. (*Elec. Commun.*, vol. 23, pp. 471-478; December, 1946.) Reprint of 1598 of 1946.

621.385:[621.396.822+537.525.5] 2611
Effects of Magnetic Field on Oscillations and Noise in Hot-Cathode Arcs—Cobine and Gallagher. (See 2400.)

621.385:[621.396.822+537.525.5] 2612
Noise in Gas Tubes—Cobine and Gallagher. (See 2401.)

621.385:669.718.6 2613
A Substitute for Nickel in Radio Valves—(See 2473.)

621.385.032.3 2614
Carbide Structures in Carburized Thoriated-Tungsten Filaments—C. W. Horsting. (*Jour. Appl. Phys.*, vol. 18, pp. 95-102; January, 1947.) The wide variety of carbide structures in the surface layers of such filaments is traced to carburizing conditions and subsequent processing during tube manufacture. A laminated structure frequently found contains less carbon than W_2C . Thyratron control of carburization is shown to be excellent, provided the filaments have uniform surface conditions and the hydrocarbon content in the hydrogen atmosphere is maintained. Abnormal filament current in tubes is due to changes in thermal emissivity caused by surface conditions.

621.385"1920/46" 2615
A Quarter Century of Electronics—I. E. Mouromtseff. (*Elec. Eng.*, vol. 66, pp. 171-177; February, 1947.) An outline of the main stages in the development of high-vacuum tubes from the manufacturing standpoint.

621.385.1 2616
Recent Developments in Transmitting Valve Technique. A Series of Modern Valves—R. Suart. (*Ann. Radioelec.*, vol. 1, pp. 391-408; October, 1946.) A concise review of new materials and methods of construction which have resulted in a great increase of maximum power, reduced interelectrode capacitance and transit time and increased maximum operating frequency. Details are also given, with operational characteristics, of a series of tubes made by the Société Française Radioélectrique, ranging from P2, a 2-watt pentode of very small dimensions, to water-cooled 450-kilowatt triodes.

621.385.1:621.386.16:548.0 2617
Usefulness of X-Ray Crystallography Examination in the Valve Industry—Nguyen Thien-Chi. (*Ann. Radioelec.*, vol. 1, pp. 383-390; October, 1946.) Examples are given of a wide variety of tests, mainly employing X-ray diffraction, carried out on tube parts and materials from many stages of tube production.

621.385.1.012(47) 2618
Radio Valves: Soviet Valves—K. I. Drozdoff. (*Radio* (Moscow), pp. 39-44 and 37-41; April and May, 1946. In Russian.) Tube base data and tables of characteristics.

621.385.1.001.8:531.768.087 2619
Vacuum-Tube Acceleration Pickup—Ramberg. (See 2528.)

621.385.1"1939/1945" 2620
Electron Tubes in World War II—J. E. Gorham. (*Proc. I.R.E.*, vol. 35, pp. 295-301; March, 1947.) Summary of advances made in design and performance of both transmitting and receiving tubes used by the U. S. Army. Discussion of: improvements in cathodes, filaments, and the alloys used to reduce grid emission; mode separation leading to anode strapping in magnetrons, for which methods of tuning and maximum power outputs are given; characteristics of gas-filled TR tubes and the use of crystal rectifiers as mixers, detectors, and d.c. restorers; development of both klystrons and planar triodes for low power output requirements; improvements in electron guns for c.r. tubes; various types of screen; the use of low supply voltages for receiving tubes, improved protection against vibration; and the trend towards miniature types.

621.385.3 2621
Triode Amplification Factors—J. II. Fremelin, R. N. Hall, and P. A. Shatford. (*Elec. Commun.*, vol. 23, pp. 426-435; December, 1946.) The validity of certain formulas for the amplification factor as a function of the ratio

of wire diameter to grid pitch is discussed. Experiments with a triode of high-shadow ratio, in which the anode/grid and grid/cathode spacings could be varied, indicate that Ollendorff's formula is the most accurate. The determination of amplification factor, for small anode/grid spacing, from a mechanical model, agrees closely with a formula derived by one of the authors.

621.385.3:621.396.694.012.8 2622
Valve Equivalent Circuit—B. Salzberg. (*Wireless Eng.*, vol. 24, pp. 124-125; April, 1947.) The constant voltage generator and constant current generator forms of equivalent circuit for a triode tube are compared. It is shown that they are equivalent as regards the external impedance, but not as regards the internal impedance unless the two impedances are equal. The constant-voltage representation is considered to be the more fundamental. See also Howe's editorial, 2623 below, and back references.

621.385.3:621.396.694.012.8 2623
On the Use of Equivalent Circuits to Represent the Valve—G.W.O.H. (*Wireless Eng.*, vol. 24, pp. 97-99; April, 1947.) Editorial discussion of the tube equivalent circuit, confirming Salzberg's conclusions (2622 above). For earlier discussion see 949 of April, and 1966 of July.

621.385.3:623.454.25:621.396.96 2624
The Vibrotron—J.V. (*TSF Phono-Ciné Élec.*, vol. 23, p. 17; March 10, 1947.) An RCA miniature triode weighing only 2 gm., of the type used during the war for proximity fuses. The anode passes out through a metal diaphragm forming the end of the envelope and is terminated in a stylus. Mechanical vibrations applied to the stylus produce variations of interelectrode capacitance. The triode may be used in a very light or sensitive pickup, or as a microphone if the stylus is replaced by a membrane of suitable surface area.

621.385.4 2625
Space-Current Division in the Power Tetrode—C. M. Wallis. (*Proc. I.R.E.*, vol. 35, pp. 369-377; April, 1947.) The methods already used for the determination of the current division in a triode (435 of 1942) may be applied, in a modified form, to the power tetrode.

621.385.4 2626
Subminiature Electrometer Tube—C. D. Gould. (*Electronics*, vol. 20, pp. 106-109; March, 1947.) A tetrode which requires only 13 milliwatts for filament heating and has a very high-input resistance. Applications to radiation meters are described.

621.385.82.032.29.027.3 2627
Ion Beams in High Voltage Tubes Using Differential Pumping—E. S. Lamar and W. W. Buechner. (*Jour. Appl. Phys.*, vol. 18, pp. 22-27; January, 1947.) Focused hydrogen ion beam currents of 215 microamperes were obtained at the target end of a 6-foot tube operated at 300-400 kilovolts. See also 2218 of 1941.

621.385.83 2628
The Multireflection Tube, A New Oscillator for Very Short Waves—F. Coeterler. (*Philips Tech. Rev.*, vol. 8, pp. 257-266; September, 1946.) The general principles of reflex oscillators are discussed. The new tube has a glass envelope 55 mm. in diameter. An oxide cathode behind the aperture in a control electrode sends an electron beam through holes in the sides of a box-shaped anode. A $\lambda/4$ Lecher modulator system is located inside the anode, the repeller electrodes being outside. The anode is between the repeller electrodes and the cathode. Capacitive coupling to the Lecher system is used, with strip leads sealed through the envelope. With a magnetic field directed along the beam and an

anode voltage of 3000 volts, an effective power of 15 to 20 watts is obtained on a wavelength of 12 centimeters.

621.385.832:621.397.6 2629
Experimental C.R. Tubes for Television—F.R. (*Electronics*, vol. 20, pp. 112–115; March, 1947.) New tubes include one with a screen brightness of 300-foot lamberts for monochrome receivers, a projection tube, and a direct-viewing tube for polychrome receivers, and a tube with a very fast-response phosphor for use in photovision relaying.

621.385.832:666.1 2630
Gas Heat Speeds Production of Electron Tubes—(See 2468.)

621.396.615.141.2 2631
A Magnetron Oscillator with a Series Field Winding—L. H. Ford. (*Jour. I.E.E.* (London), Part III, vol. 94, pp. 60–64; January, 1947.) A continuous-wave magnetron oscillator whose magnetic field is provided by an electromagnet energized by the anode current of the tube. Experiments were conducted over a frequency range of 40 to 750 megacycles with two-segment-anode and four-segment-anode magnetrons, and oscillations were obtained over a large range of anode voltages. With the two-segment-anode magnetron, oscillations occurred at the fundamental frequency of the circuit connected to the tube; with the four-segment-anode magnetron, oscillations at 3, 5, 7, . . . times the fundamental appeared as the anode voltage was increased. During oscillation the anode current assumes the optimum field value. Danger from excessive anode current is largely removed and stability is good.

621.396.615.141.2:537.291 2632
Electron Trajectories in a Plane Single-Anode Magnetron—A General Result—L. Brillouin. (*Elec. Commun.*, vol. 23, pp. 460–463; December, 1946.) A theorem previously developed for a plane diode (3883 of 1945) is extended as follows: if an arbitrary voltage variation is applied to the anode of a plane magnetron, electron trajectories will never cross each other provided (a) the current never becomes negative and (b) the current remains space-charge limited and saturation current is never obtained.

A method of computing the electron trajectories is discussed assuming "single stream motion" where the electrons are unidirectional. The theorem is shown to hold for space charge limited current but when saturation is reached "intercrossing of trajectories will occur near the end of the first 'double Larmor' period and the motion will become double stream." Electron trajectories are plotted using the method described. See also 75 of February.

621.396.622.63:621.317.79:621.396.62 2633
Crystal Diode Reduces Probe Size—Bein. (See 2506.)

621.396.694:538.3 2634
On the Helix Circuit Used in the Progressive Wave Valve—Roubine. (See 2339 and 2340.)

621.396.694.032.2:621.317.335 2635
Measuring Inter-Electrode Capacitances—Young. (See 2488.)

MISCELLANEOUS

001.89:061.31 2636
British Commonwealth Scientific Co-operation—(*Nature* (London), vol. 159, pp. 257–259; February 22, 1947.) Comment on 2295 of

August. See also 3828 of 1946 and 961 of April.

016:621.396"1945/1946" 2637
Radio Progress During 1946—(*Proc. I.R.E.*, vol. 35, pp. 399–425; April, 1947.) A review of the literature published during 1945 and 1946 containing some 750 references.

061.6(54) 2638
The National Physical Laboratory of India—K. N. Mathur. (*Nature* (London), vol. 159, pp. 184–186; February 8, 1947.) A comprehensive scheme detailing the functions, organization, staff, etc., for the laboratory to be erected at New Delhi, drawn up after consultation with the National Physical Laboratory, Teddington, and the National Bureau of Standards, Washington. The work to be carried out in the various sections is briefly described. An important division will be that of Electronics and Sound, which will include all aspects of electronic work and of acoustical measurements.

061.6(54) 2639
National Research Laboratories of India—S. Bhatnagar. (*Nature* (London), vol. 159, pp. 183–184; February 8, 1947.) These will include a physical, a chemical, and a metallurgical laboratory, a Glass and Ceramic Research Institute, and a Fuel Research Institute. Their functions and the scope of the work to be carried out are outlined.

535.65-16 2640
On the Stability of Spectral Characteristics of Selenium Filters for Infra-Red Radiation—A. V. Kurtener (Courtener) and E. K. Malyhev. (*Bull. Acad. Sci. (U.R.S.S.)*, sér. phys., vol. 5, nos. 4–5, pp. 475–477, 1941. In Russian with English summary.) The stability of filtration capacity was investigated for filters prepared by the deposition of selenium evaporated *in vacuo* upon rock salt. For at least three months after preparation, the characteristics of these filters remained unchanged in the range of wavelengths from 1 to 15 microns.

621.3+669(73)"1946" 2641
Research and Laboratory Investigations—(*Gen. Elec. Rev.*, vol. 50, pp. 12–15; January, 1947.) A review of developments in a wide field ranging from atomic energy to chemical and metallurgical research. Reference is made to (a) betatrons and synchrotrons giving very high accelerating voltages, (b) an X-ray photometer using a split beam from a single source, (c) Permafil-treated transformers and coils, (d) new alloys, (e) stainless wire for recorders, (f) a clear casting resin for obtaining surface replicas, and (g) new magnet alloys and materials, including Alnico 6 and Vectolite, a hardened, sintered combination of iron oxide and cobalt oxide which is nonconducting and light in weight.

621.3.016.25 2642
Sign of Reactive Power—(*Elec. Eng.*, vol. 66, pp. 206–208, 321–323; February and March, 1947.) Comment on the recent recommendation of the A.I.E.E. Standards Committee noted in 971 of April. See also 1970 of July and back references.

621.362 2643
Sensitive High-Speed Radiation Thermocouple—H. Cary and K. P. George. (*Phys. Rev.*, vol. 71, pp. 276–277; February 15, 1947.) Summary of Amer. Phys. Soc. paper. The conditions are analyzed for obtaining the maximum signal-to-noise ratio. A vacuum thermocouple designed for optimum performance at 10 c.p.s. is described.

621.39"1939/45" 2644
Telecommunications in War—(*Electrician*, vol. 138, pp. 777–778; March 28, 1947.) Summary of the speeches made by Sir Stafford Cripps and Col. Sir Stanley Angwin at the opening session of the I.E.E. Radio-communication Convention.

621.395 Bell 2645
Alexander Graham Bell, born 3rd March, 1847—died 2nd August, 1922—G.W.O.H. (*Wireless Eng.*, vol. 24, pp. 65–67; March, 1947.) A short review of his life and work.

621.395 Bell 2646
Alexander Graham Bell—Scientist—F. J. Mann. (*Elec. Eng.*, vol. 66, pp. 215–236; March, 1947.) A detailed account of his life and work.

621.396 2647
Radio Convention—R. L. Smith-Rose. (*Elec. Times*, vol. 111, pp. 351–353; April 3, 1947.) A review of about 100 papers presented at the I.E.E. convention, March 25–April 2, 1947, dealing with radio communication, broadcasting, and certain types of navigational aid excluded from the 1946 Radiolocation Convention. The subjects covered by the principal papers included the wartime developments in radio, radio components, and tube manufacture, long-distance transmission, special problems of naval, military, and aircraft communications, radar pulse technique, propagation, broadcasting, and direction finding for military and naval purposes. In many cases peace-time developments and applications were also indicated. See also 2648 and 2649.

621.396 2648
Radiocommunication Convention. I.E.E. Record of Seven Years' Progress—(*Electrician*, vol. 138, pp. 850–852, 854; April 4, 1947.) A list of the 16 main papers presented at the convention, with short summaries of four of them.

621.396 2649
Review of Radio Progress—(*Electrician*, vol. 138, pp. 853–854; April 4, 1947.) Summary of the concluding address by Sir Clifford Pater-son at the I.E.E. Radio-communication Convention. For another account see *Engineer* (London), vol. 183, pp. 293–294; April 4, 1947.

621.396.029.4/.6 2650
Classifying Frequencies and Wavelengths—(*Wireless World*, vol. 53, p. 117; April, 1947.) A plea for a generally acceptable classification, with criticism of existing systems. The classification proposed by the Inter-Services Radio Circuit Symbols Committee is favored.

621.396 Bethenod 2651
The Radio Work of Joseph Bethenod—L. Bouthillon. (*Onde Elec.*, vol. 27, pp. 65–74; February, 1947.) Reprint of 974 of April.

621.396(083.72) 2652
Glossary of Radio and Radar Terms—(*Elec. Times*, vol. 111, p. 183; February 6, 1947.) I.R.C.S.C. Paper No. 38, "Interservice Radio Glossary," published by the Central Radio Bureau, should be used by industry as well as the Services as a standard reference book.

621.3 2653
Electrical Engineering. [Book Review]—F. H. Pumphrey. Prentice-Hall, New York, 1944, 359 pp. \$5.35. (*Proc. I.R.E.*, vol. 35, p. 190; February, 1947.) A textbook for students specializing in other fields.

HOW TO PULL SIGNALS OUT OF A SAVAGE ETHER



Roaring into action on fighting PT boats, Premax Monel antennas defied salt spray, weather, and whipping wind.

Are antennas one of your headaches? Maybe the story of how the antenna problem was solved aboard PT boats will be of some help to you.

PT antennas had to fight corrosive salt air and water. They needed strength and stiffness to withstand whipping winds and plunging boats. They had to function in arctic cold and tropic heat.

An answer was worked out for the Navy by Premax Products Division of Chisholm Ryder Co., Inc., Niagara Falls, N. Y. It consisted of telescoping tubular antennas, made of sections of seamless tubing furnished by the Superior Tube Co., Norristown, Pa.

The metal that met the combination of conditions?—Monel.* To quote Premax engineers:

"Monel has been found to be the most practical material for radio antennas. Sudden shocks do not affect its toughness . . . its fatigue strength exceeds the limits of mild steel or all brasses and bronzes.

"Rigid tests by both Government and private agencies have shown Monel antennas to be dependable and satisfactory under all conditions."

Do you have an electrical problem that can be solved by the combination of properties obtainable in Monel . . . or the other INCO Nickel Alloys?

All are strong, tough, and corrosion resistant. In addition, each has special properties needed for special jobs. Write us describing your problem. Our technical assistance is yours whenever you ask for it.

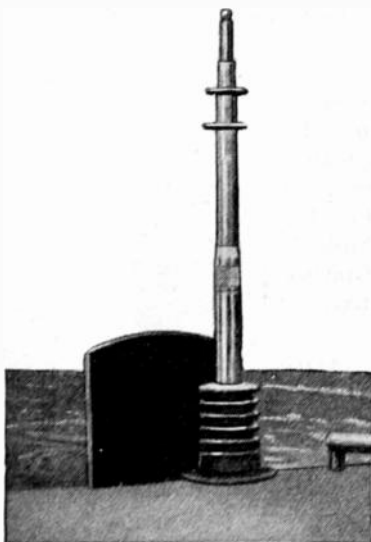

Premax Monel Antennas are built in multiple sections of tough, cold-drawn Monel tubing, telescoped one inside the other. Above illustration shows antenna in fully telescoped position.

THE INTERNATIONAL NICKEL COMPANY, INC.
67 Wall Street, New York 5, N.Y.

Monel*

EMBLEM OF SERVICE
NICKEL  **ALLOYS**

MONEL* • "K" MONEL • "S" MONEL • "R" MONEL • "KR" MONEL
INCONEL* • NICKEL • "L" NICKEL • "Z" NICKEL • Reg. U.S. Pat. Off.

The Power and Impedance Monitor

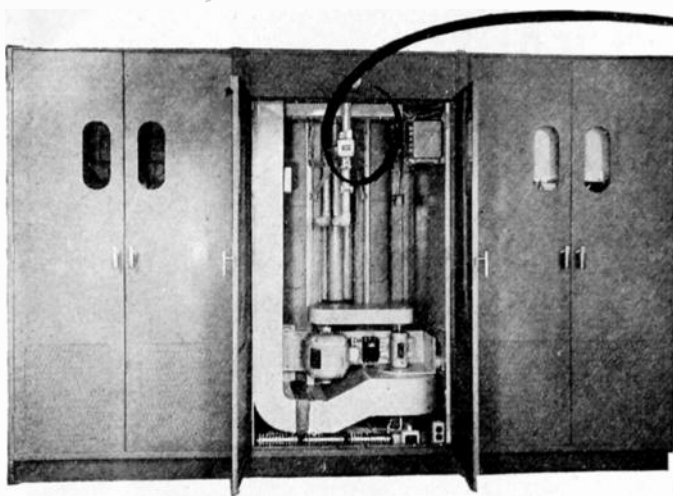

IT'S NEW...

IT'S EXCLUSIVE!

IT'S ONLY IN

Western Electric
FM TRANSMITTERS

It gives you for the first time...

- ✓ Accurate, direct measurement of the actual RF power fed into antenna system
- ✓ A simple method of measuring standing wave ratio under full power output

The new Power and Impedance Monitor designed by Bell Telephone Laboratories is another exclusive "plus" for users of Western Electric FM transmitters. It tells at a glance transmitter output power or reflected power in kilowatts ... gives a constant check on standing wave ratio while on the air ... automatically protects your equipment from excessive standing wave ratio. Here are the vital functions performed by this new device:

The MONITOR (B), located within the transmitter, registers on front panel meter the power in kilowatts actually going into the transmission line at any time, no matter what the standing wave ratio on the line.

The FRONT PANEL METER (A), connected to the Monitor, provides direct readings of output power and reflected power in kilowatts. Also gives a simple means for determining standing wave ratio at any time, while the transmitter is in operation.

The new Monitor is supplied as standard equipment with Western Electric FM transmitters of 3 kw and higher powers.

Write for literature describing in detail the operation of the new Power and Impedance Monitor. Address your request to Graybar Electric Co., 420 Lexington Ave., New York 17, N.Y., or see your local Graybar Broadcast Representative.



— QUALITY COUNTS —

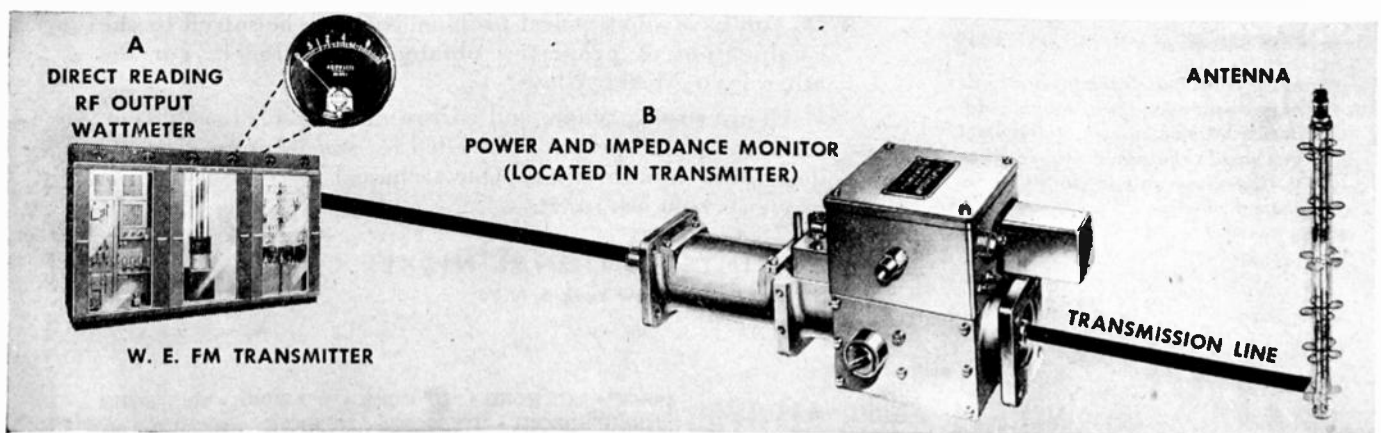



BUENOS AIRES

"The Section's Activity for 1946," by R. Hastings, Secretary-Treasurer of Outgoing Committee; April 11, 1947.

Election of Officers; April 11, 1947.

"Microwaves in Telecommunications," by E. Labin, International Telecommunications Laboratories; April 18, 1947.

"Assignment of Receiver's Intermediate Frequencies," by M. J. Kobilsky; May 9, 1947.

"Historical Subjects Related to Radio," by P. Noizeux; May 23, 1947.

"Standardization in Argentina," by B. Portnoy; May 30, 1947.

CEDAR RAPIDS

"Fundamental Considerations in Antenna Design," by J. D. Ryder, Iowa State College; June 11, 1947.

CINCINNATI

Election of Officers, June 17, 1947.

COLUMBUS

"My Cruise to Panama," by R. Higgy, Ohio State University; June 18, 1947.

Election of Officers; June 18, 1947.

CONNECTICUT VALLEY

"Magnetrans," by H. J. Reich, Yale University; April 17, 1947.

"Function of Air Traffic Control," by W. White, Airborne Instruments Laboratory; May 8, 1947.

"New Trends in Air Navigation and Traffic Control," by J. Dyer, Airborne Instruments Laboratory; May 8, 1947.

DALLAS-FORT WORTH

"Underwater Sound Instrumentation at Bikini," by G. White, Geophysical Service; June 26, 1947.

DETROIT

"A Nautical Trip by Radar," by G. B. Saviers, Westinghouse Electric Corporation; May 16, 1947.

HOUSTON

"Carrier Telephone Systems," by R. S. Caplan, Gulf Refining Company; June 17, 1947.

LOS ANGELES

"Western Electric F.M. Broadcasting Transmitters," by J. B. Bishop, Bell Telephone Laboratories; June 17, 1947.

"Current Techniques in F.M. Broadcast Receiver Design," by D. E. Foster, Hazeltine Research, Inc.; June 17, 1947.

NEW YORK

"A Few Special Electronic Developments," by E. D. Cook, General Electric Company; June 4, 1947.

Election of Officers; June 4, 1947.

PORTLAND

"Western Electric F.M. Broadcast Transmitters," by J. B. Bishop, Bell Telephone Laboratories; June 26, 1947.

SACRAMENTO

"C.A.A. Navigational Facilities," by W. C. Hill, C.A.A. Navigational Facilities; June 17, 1947.

SAN DIEGO

"The Traveling-Wave Tube," by J. Jacoby and R. Lien, United States Navy Electronics Laboratory; June 20, 1947.

(Continued on page 36A)

A Quiet Fellow NOW GOING PLACES

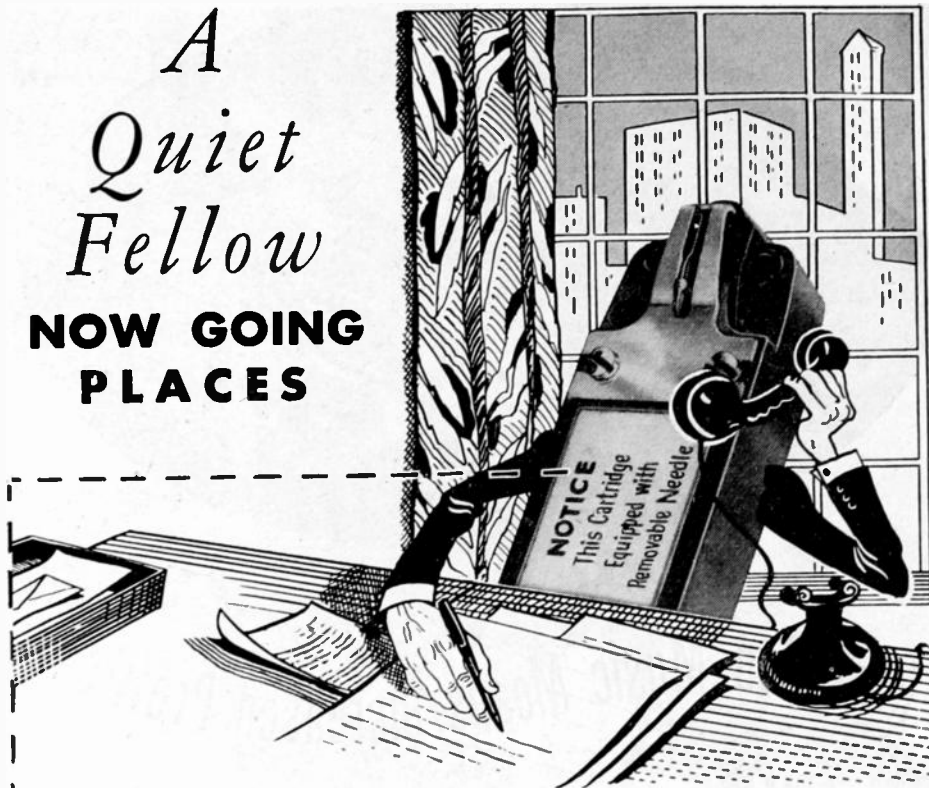

BECAUSE OF his build, character and performance, Astatic's Mr. "Q.T." Pickup Cartridge has earned the confidence of many leading radio-phonograph engineers and manufacturers, and is now "going places" as a vital unit in the newest, high quality-type record players.

If asked why the new Model "QT" Cartridge has been so generally approved, these designers and producers of phonograph equipment would undoubtedly state that the "QT" Cartridge supplies a clear, clean type of reproduction essentially free from annoying needle scratch, and that such reproduction remains constant during the life of the instrument.

This is true because the "QT" Cartridge is equipped with a **MATCHED** Needle, possessing all the qualities of a permanent needle yet having the advantage of being **REPLACEABLE**. This provides assurance that the original quality of reproduction shall be maintained throughout the life of the cartridge regardless of the number of times the needle is replaced. "QT"

Needles are available with precious metal or jewel tip, and may be easily inserted or removed when replacement is necessary. Special literature is available.

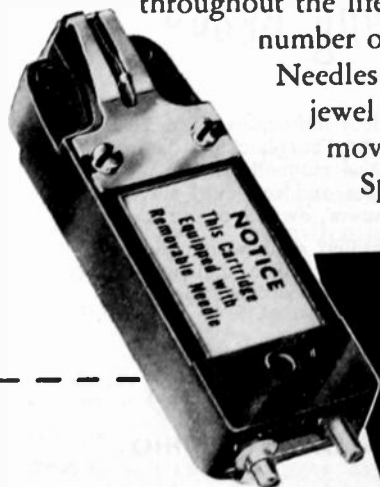

THE
Astatic
CORPORATION
CORNEAULT, OHIO

IN CANADA: CANADIAN ASTATIC LTD. TORONTO, ONTARIO

Astatic Crystal Devices Manufactured
under Brush Development Co. patents.

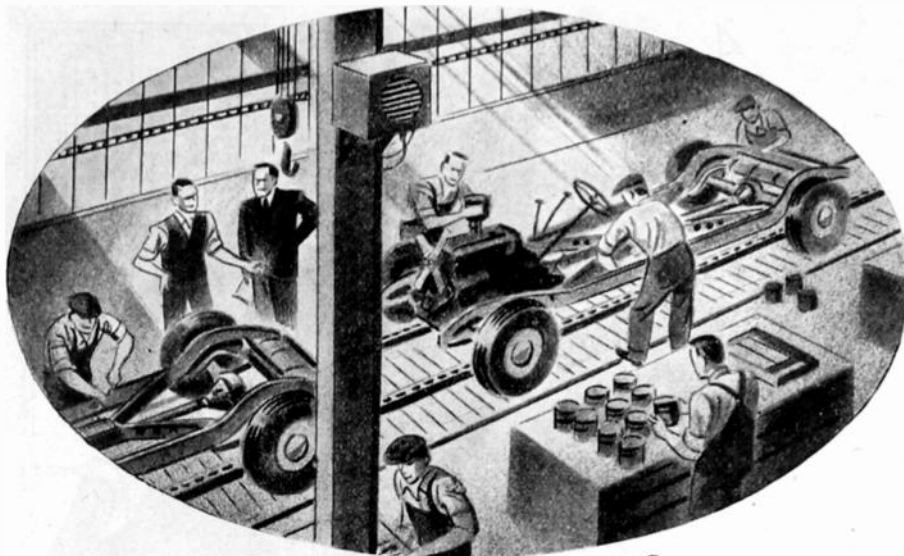

Recorded Music Means Increased Profits!

Remember how manufacturers learned that in the war? Music was "piped" into almost every production line in America! Today when keeping employees happy and production high is so important, manufacturers want continuous music. Magnetic wire recording is the answer. And smart wire recorder designers look first to Brush for the best in magnetic recording equipment. Here's why—

Brush Plated Wire

- ✓ Constant plating thickness assures uniform signal
- ✓ Correct balance of magnetic properties assures good frequency response and high level
- ✓ Excellent surface finish assures low noise and minimum wear
- ✓ Corrosion resistant
- ✓ Easy to handle—ductile—can be knotted

Brush Wire Recording Heads

Of principal interest are their excellent electrical characteristics, extreme simplicity of design to avoid trouble, and the "hum-bucking" characteristics, which reduce the effect of extraneous magnetic fields. When required, the head cartridge alone (pole piece and coil unit) may be supplied for incorporation into manufacturers' own head structure. These latest developments in magnetic recording equipment can now be obtained for radio combinations and other uses. Brush engineers are ready to assist you in your particular use of magnetic recording components.

THE BRUSH DEVELOPMENT CO.
 3405 PERKINS AVENUE  CLEVELAND 14, OHIO

SECTION MEETINGS

(Continued from page 35A)

"Practical Aspects of V.H.F. F.M. Mobile Communication," by J. F. Clark, Motorola; July 1, 1947.

"Thermistors and Their Applications," by R. McBride, McBride Engineering Company; July 18, 1947.

SAN FRANCISCO

"Modern X-Ray Equipment and Techniques," by E. Philleo, General Electric Company; May 28, 1947.

"Western Electric F.M. Broadcast Transmitters," by J. B. Bishop, Bell Telephone Laboratories; June 19, 1947.

SEATTLE

"LANAC Laminar Aerial Navigation and Anti-Collision," by E. Harper, Hazeltine Service Corporation; June 13, 1947.

"Western Electric F.M. Transmitters," by J. B. Bishop, Bell Telephone Laboratories; June 27, 1947.

TWIN CITIES

"A Few Special Electronic Developments," by E. D. Cook, General Electric Company; May 20, 1947.

SUBSECTIONS

TOLEDO SUBSECTION

"Communications Equipment for the Transportation Industry," by G. B. Saviers, Westinghouse Electric Corporation; May 26, 1947.



The following transfers and admissions were approved on August 5, 1947, to be effective September 1, 1947:

Transfer to Senior Member

- Adler, R., Zenith Radio Corp., 6001 W. Dickens, Chicago, Ill.
- Bell, A. L., 1933 Broadway, Springfield, Ohio
- Bergren, A. L., 300 W. 67 Ter., Kansas City, Mo.
- Bowie, W. S., 186 Madison Ave., Baldwin, N. Y.
- Cahoon, R. D., Box 189, Station H, Montreal, Que., Canada
- Calvelo, J. P., Cassilla de Correo 688, Buenos Aires, Argentina
- Clark, W. R., Cheltona Ave., Jenkintown, Pa.
- Cullwick, E. G., Defense Research, Department of National Defense, Ottawa, Ont., Canada
- DeArmond, J. K., 604 E St., Wright Field, Dayton, Ohio
- Drake, R. L., RFD 1, Byers Rd., Miamisburg, Ohio
- Engstrom, O. D., 180 Varick St., New York, N. Y.
- Engwicht, H., 870 Schele Ave., San Jose 11, Calif.
- Graham, R. B., Special Products Development Department, Bendix Aviation Corp., Teterboro, N. J.
- Hatfield, L. N., 75-18—189 St., Flushing, N. Y.
- Hickley, T. J., U. S. Coast and Geodetic Survey, Washington 25, D. C.
- Hilgedick, W. C., 5522 Northfield Rd., Bethesda 14, Md.
- Kunze, A. A., 313½ Jersey Ave., Spring Lake, N. J.
- Landman, A., 2 Monkwood Gardens, Ilford, Essex, England
- Martin, L., 3989—46 St., Long Island City, N. Y.
- McLean, F. C., 52 Lancaster Ave., Hadley Wood, Middx., England

(Continued on page 38A)



HORIZONS UNLIMITED

■ Today there's no mystery about the Klystron tube. It's being used in a lot of things you see and read about every day . . . radar, television, communications and even medicine.

■ Radar with Klystrons guides merchant ships and sky giants through fog, smoke, clouds. You'll find it in television relays . . . in medical diathermy . . . in dielectric heating . . . in telephone, telegraph, aircraft radio and broadcast radio relays.

■ We're anxious to put the Klystron to work even harder.

We know there must be many undeveloped applications that will make your products better or help you make new products. The Klystron is adaptable in both local oscillator and high power applications.

■ Sperry engineers will gladly cooperate with manufacturers in adapting Klystron to new fields.



Sperry Gyroscope Company, Inc.

EXECUTIVE OFFICES: GREAT NECK, NEW YORK • DIVISION OF THE SPERRY CORPORATION

NEW YORK • CLEVELAND • NEW ORLEANS • LOS ANGELES • SAN FRANCISCO • SEATTLE

CURRENTLY

SORENSEN & COMPANY, INC.
Manufacturers of

VOLTAGE REGULATORS, NOBATRONS & ELECTRONIC APPARATUS

FROM
SORENSEN
AT
STAMFORD



RUNAWAY VOLTAGES STOPPED AT 1/10 OF 1%

Rated performance of Model 1750-S guarantees delivery of output line voltages at a regulation accuracy of 0.2% under varying load. However, in actual tests of this unit voltage stabilization was held to within 0.1% under full operating conditions. This conservative safety rating of 0.2% is typical of all Sorensen performance factors.

- Input voltage range.....95-125
- Adjustable output between...110-120
- Load range.....200-2000 VA
- Regulation accuracy.....0.2%
- Harmonic distortion.....2% max.
- Recovery time.....6 cycles
- Input frequency range...55-65 cycles

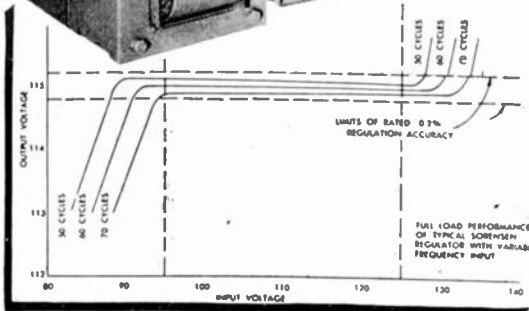
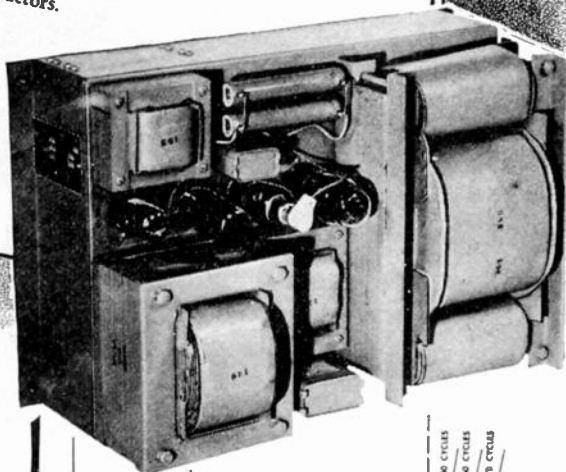

IT IS "A NATURAL" FOR CONTROLLING VOLTAGES IN LABORATORIES, ASSEMBLY LINE TESTING AND AS A COMPONENT OF YOUR ELECTRICAL UNIT.

Write
for the latest in electronic developments

Send me the Electronics Journal "Currently" regularly in addition to the resume on "Electronic Batteries."

NAME _____ TITLE _____

COMPANY _____

ADDRESS _____

SORENSEN & COMPANY, INC.
375 FAIRFIELD AVE. STAMFORD, CONN.



(Continued from page 36A)

- Moseley, F. L., Collins Radio Co., 855-35 St., N.E., Cedar Rapids, Iowa
- Packard, D., Box 931, RFD 2, Los Altos, Calif.
- Pinkerton, D. C., 312 Cherry, Syracuse 9, N. Y.
- Purinton, E. S., 244 Western Ave., Gloucester, Mass.
- Sanders, R. W., 4029 Smith St., Fort Wayne 5, Ind.
- Smith, J. E., 14 Rendall Rd., West Roxbury, Mass.
- Thomas, D. E., Bell Telephone Laboratories, Inc., 180 Varick St., New York, N. Y.
- Walter, C. W. P., 427 Lincoln Ave., Rutherford, N. J.

Admission to Senior Member

- Boothroyd, W. P., 4139 Devereaux St., Philadelphia 24, Pa.
- Code, J. A., Jr., Rm. 1800, 332 S. Michigan Ave., Chicago 4, Ill.
- Focke, A. B., 5110 Alta Vista St., San Diego 9, Calif.
- Janis, P., 40-12-221 St., Bayside, N. Y.
- Koenig, P. E., 4302 N. Main St., Dayton 5, Ohio
- Lundy, C., 428 Boulevard, Bayonne, N. J.
- Mueller, G. J., "Spruce Cottage," Sylvan Dr., Morris Plains, N. J.
- Palmer, C. W., 118 Vreeland Ave., Bergenfield, N. J.
- Pressey, B. G., 34 Osterley Ave., Osterley, Middx., England
- Rust, W. M., Jr., Box 2180, Houston 1, Texas

Transfer to Member

- Albano, J. A., 1423 Second Ave., Dayton 5, Ohio
- Altman, F. J., Federal Telecommunication Laboratories, 67 Broad St., New York 4, N. Y.
- Armstrong, H. W., 4320 Berteau Ave., Chicago 41, Ill.
- Barton, L. M., 947 James St., Syracuse 3, N. Y.
- Clarkson, L., 257 Isle Bigras, Que., Canada
- Collins, D. L., 3800 Perkins, Cleveland, Ohio
- Desaulniers, R. R., Box 1690, Place D'Armes, Montreal, Que., Canada
- Faithorn, N. R., 2602 Sacramento, San Francisco 15, Calif.
- Fernandez, O. C., 379 San Martin, Buenos Aires, Argentina
- Fortman, K. R., 219 S. Rogers St., Mason, Mich.
- Fraser, R. M., 72 N. William St., Baldwin, L. I., N. Y.
- Gates, H. P., Jr., U. S. Navy Electronics Laboratory, Point Loma, San Diego 52, Calif.
- Gardner, D. R., 21811 California Ave., Saint Clair Shores, Mich.
- George, P. H. F., Glyn Mills and Co., 3 Whitehall, London S.W.1, England
- Goldstein, M., 1111 Ainslie St., Chicago 40, Ill.
- Gollhofer, P. J., 9 Haab Ave., Babylon, N. Y.
- Green, M., 130-73-228 St., Laurelton, L. I., N. Y.
- Hougen, H. C., 6009 Blossom St., Houston 7, Texas
- Howard, W. A., 227 Arlington, Mineola, L. I., N. Y.
- Kechker, A. I., Bme. Mitre 1961, Buenos Aires, Argentina
- Kile, R. L., Fleet Post Office, New York, N. Y.
- Kramer, R. F., 505 Plainfield Ave., Joliet, Ill.
- Krause, V. R., Box 9110, Johannesburg, South Africa
- Krauth, E. A., Bell Telephone Laboratories, 180 Varick St., New York 14, N. Y.
- Levine, D., 3205 S. Dixie Ave., Dayton 9, Ohio
- Martin, R. D., 331 N. Lincoln, Burbank, Calif.
- Mather, N. W., Engineering Bldg., Princeton University, Princeton, N. J.
- Nye, W. H., General Electric Co., 1405 Locust St., Philadelphia 2, Pa.
- O'Connor, R. A., 3210 Perry Ave., New York 67, N. Y.
- Olson, O. F., 46 Rockwood Ave., Dayton 5, Ohio

(Continued on page 40A)



miniature D.C. RELAYS with Steatite Insulation

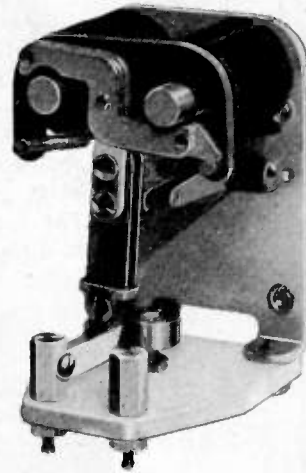
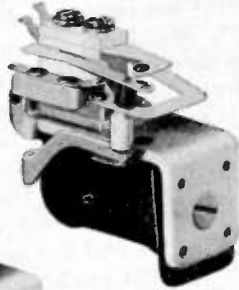
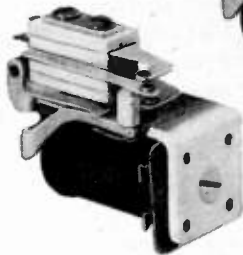
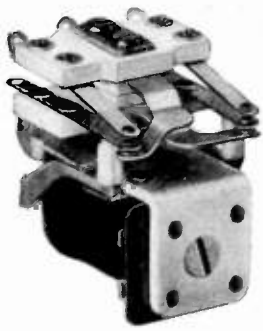

ACTUAL SIZE

ANTENNA THROW-OVER

Originally designed for use in aircraft equipment, these MINIATURE relays give completely dependable operation under extreme conditions of vibration, humidity and temperature.

The Steatite insulation and general construction of these relays makes them inherently suitable for switching circuits requiring permanently low leakage, for switching certain high frequency circuits, and for any application where a compact, light weight, yet sturdy relay is required. Particular attention has been paid to design of relays that will not "chatter" under vibration even in the un-energized position.

The antenna throw-over relay shown is of unique design and provides the wide contact spacing and positive action necessary for this special purpose, for a weight of only 0.2 lb.

The other small relays are provided in the contact combinations illustrated at right, with maximum overall dimensions of $1\frac{1}{4}$ " x $\frac{7}{8}$ " x $1\frac{3}{8}$ " and a maximum weight of 0.09 lb.

FOR EITHER 14 VOLT OR 28 VOLT D.C. OPERATION	
SINGLE ARM	DOUBLE ARM

Write on your letterhead for our Catalog describing these and our other Component Parts.

AIRCRAFT RADIO CORPORATION

DEPENDABLE ELECTRONIC EQUIPMENT SINCE 1928

Boonton, N. J.



Andrew "KNOW-HOW" in FM makes W-E-L-D technically outstanding

• Andrew Co. congratulates **LESTER H. NAFZGER**, chief engineer of Ohio's first FM station, **WELD** in Columbus, on a technically outstanding installation.

The entire transmission line system was supplied by Andrew Co. and installed by **WELD** with the assistance of skilled Andrew Engineers.

The Andrew reputation for supplying quality components, and for engineering skill, already is well established in the FM field. Call on Andrew for assistance in solving *your* FM problems!



ANDREW FM-AM isolation section with cover removed, revealing two 3/8" FM transmission lines and expansion joints.

ANDREW CO. EQUIPMENT AT WELD

- Duplicate 3/8" FM transmission lines, expansion joints, elbows, tower brackets, and all fittings.
- Horizontal "bazooka" sections for isolating WELD (FM) from WBNS (AM).
- Auxiliary antenna for standby service.
- Assistance to WELD personnel in installation of transmission line and "bazooka."

ANDREW CO.

363 EAST 75th STREET • CHICAGO 19

Pioneer Specialists in the Manufacture of a Complete Line of Antenna Equipment



WRITE FOR
COMPLETE CATALOG

BURTON BROWNE ADVERTISING



(Continued from page 38A)

- Paradise, L. P., 2280 Andrews Ave., Bronx 53, N. Y.
Peay, L. W., Jr., 1818 Ashland St., Houston 8, Texas
Pine, C. C. 86-19-260 St., Floral Park, N. Y.
Podell, S., 220 Westchester Ave., Mount Vernon, N. Y.
Prickett, T., Jr., Box 1441, College Station, Texas
Reilly, L. A., 989 Roosevelt Ave., Springfield 9, Mass.
Rleams, C. J. B., 246 E. Johnson St., Philadelphia 44, Pa.
Roberts, E. G., Jr., 111 E. Castle St., Syracuse 5, N. Y.
Rockwell, P. D., 308 Westfield Ave., Bridgeport 6, Conn.
Roemer, A. K., 2 Lawrence St., East Rockaway, N. Y.
Ryland, A., Engineering Section, New Zealand Broadcasting Service, Wellington, New Zealand
Sanderson, J. K., RFD 3, Roseville, Ill.
Schweizer, E. G., Naval Electronics Laboratory, San Diego 52, Calif.
Sharkl, P., 169 1/2 First Ave., Manasquan, Box 88, N. J.
Sidor, E. N., 1605 Connecticut Ave., N. W., Washington, D. C.
Silva, A. A., 71 N. 5 Ave., Long Branch, N. J.
Smith, H. J., 2917 Stanford St., Dallas 5, Texas
Staton, M. G., 135 Maple Ter., Merchantville, N. J.
Strom, C. A., Jr., 1910 Oak Dr., West Belmar, N. J.
Stubbs, W., Lloyds Bank, Ltd., 72 Lombard St., London E.C. 2, England
Surber, W. H., Jr., School of Engineering, Princeton University, Princeton, N. J.
Svala, G., Mariestadsavagen 28, Hammarbyhojden, Sweden
Thiel, W. H., 102 E. Bellevue Pl., Chicago 11, Ill.
Thompson, J. M., 24 South St., Eatontown, N. J.
Thompson, K. J., 711 Edgewater Ave., Fort Wayne, Ind.
Tipton, W. F., Burnside Laboratory, E. I. du Pont de Nemours and Company, Pennsgrove, N. J.
Trantham, H., Jr., Franklin Institute, Philadelphia, Pa.
Tucker, W. J., Jr., 18 Pearl St., Mystic, Conn.
Turner, W. R., 2217 Naylor Rd., S.E., Washington 20, D. C.
Van Horn, J. H., Box 4354, Station B, Kansas City, Mo.
Wade, E., 5069-45 St., Woodside, L. I., N. Y.
Wagner, R. W., 816 Englewood Ave., Buffalo 17, N. Y.
Waller, W. E., 141 Joralemon St., Brooklyn 2, N. Y.
Wardale, A. H., 25 Waratah St., Bexley, N.S.W., Australia
Welz, W. C., 422 M and M Bldg., Houston, Texas
Wentzel, A. G., Jr., 318 Gardner Ave., Trenton 8, N. J.
Williams, A. B., 327 E. 47 St., New York 17, N. Y.
Winter, N. L., 3831 Macomb St., N.W., Washington 16, D. C.
Wojcik, B. M., 63 West View Ave., San Francisco 12, Calif.
Wood, W. H., Box 5229, Radio WMBG, Richmond 20, Va.

Admission to Member

- Aldrich, C. E., 2200 Harrison, Fort Worth, Texas
Allen, W. G., 30 Wycherley Crescent, Barnett, Herts., England
Ballou, E. T. M., Box 24, Post Rd. W., Wayland, Mass.
Billhelmer, C. R., 203 S. West St., Falls Church, Va.
Browder, J. W., U. S. Navy Electronics Laboratory (Code 442), San Diego 52, Calif.
Browne, G. W., 980 James St., Syracuse 3, N. Y.
Collings, F. C., Jr., 5 Woodside Lane, Riverton, N. J.

(Continued on page 42A)

New OHMITE

**2-Watt
Molded
Composition
Potentiometer**

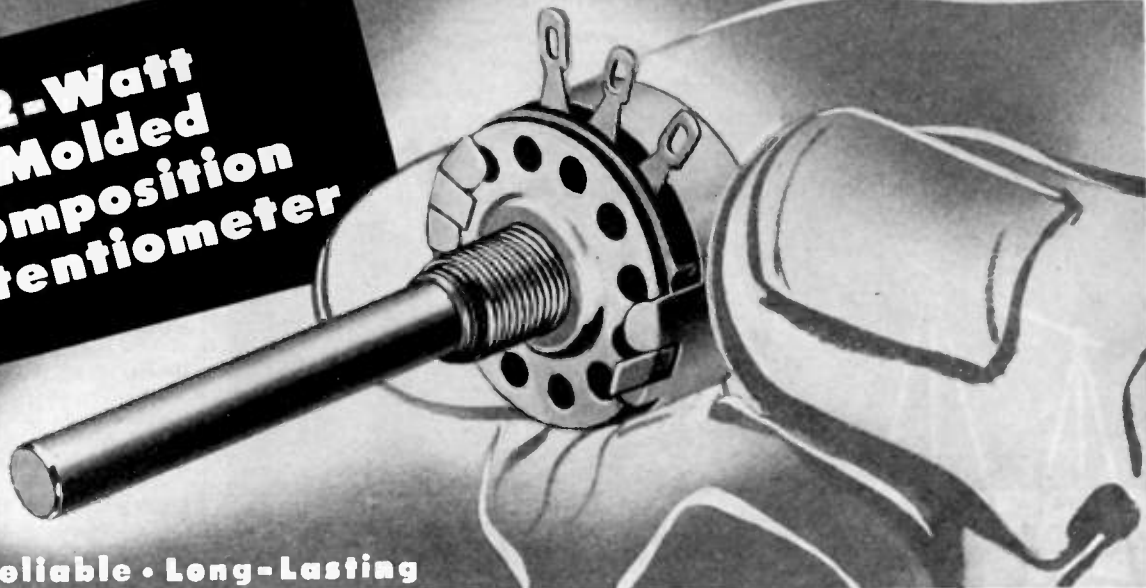

Rugged • Reliable • Long-Lasting

A high quality unit... **withstands heat, cold, moisture and severe service**

• Nothing like this potentiometer has ever been offered to the industrial market through the radio parts distributor. It is primarily a high quality unit—built to last. The resistor material is not of the paint or film type, but is solid molded. Heat, cold, or moisture cannot affect it. Wear does not change its contact resistance, hence the control retains its very low noise characteristic. Furthermore, it has a 2-watt rating with a good safety factor.

Sold only through Ohmite distributors

Specifications



Terminals are imbedded in solid molded resistor element.

RESISTANCE: Max resistance values, 50 ohms to 5 megohms in linear taper. Also logarithmic tapers in limited ranges.

POWER: Max continuous rating at 100% rotation —2.25; 50%—2.0; 25%—1.3.

VOLTAGE: Max cont. across entire resistor, 500 volts provided wattage rating is met.

AMBIENT TEMP: From —60 C to + 100 C.

OHMITE MANUFACTURING CO.

4861 Flournoy Street, Chicago 44, Illinois



Be Right with

OHMITE

RHEOSTATS • RESISTORS • TAP SWITCHES • CHOKES • ATTENUATORS

*...another NEW
Ohmite item*

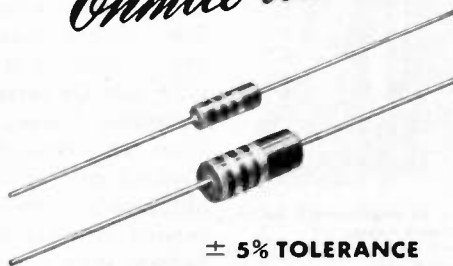

**± 5% TOLERANCE
LITTLE DEVIL
COMPOSITION RESISTORS**

• These popular resistors are now available in ½- and 1-watt sizes in tolerances of ±5%—in addition to the standard ±10% units. The resistance and wattage are clearly marked on every unit. *Sold only through Ohmite Jobbers.*



35
34
33
32
31
30
29
28
27
26
25
24
23
22



PARA-FLUX REPRODUCER

gives less wear on record . . . lighter impact of stylus . . . and improves a well-known tone quality

It's the low mechanical impedance designed into the improved PARA-FLUX . . . the special refined metals and other components now obtainable . . . that enable reducing the record pressure of all R-MC Reproducer Heads from 35 grams to 22 grams. And all three types: Vertical only, Lateral only, and Universal maintain the correct weight for permitting the pressure of 22 grams on the record. From our knowledge, we believe that PARA-FLUX Vertical only and Universal are the only heads obtainable today, which operate on commercial service at a pressure of 22 grams. This improved feature means less wear on records, and lighter impact of stylus when inadvertently dropped.

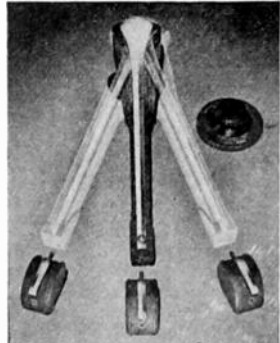

Para-Flux Reproducer with interchangeable Heads:
Universal . . .
Lateral only . . .
Vertical only

R-MC engineering skill applied to reproducer design gives all the advantages that discriminating users demand: More realistic reproduction of transcriptions . . . a reproducer of precision-build, sturdy construction, with finest materials obtainable . . . embodying up-to-the-minute features, including convenient finger lift for preventing slipping of Reproducer when lifted off record. A highly polished aluminum alloy center-piece of tone arm and head enhances the attractive design of Reproducer.

This new lightweight Head, either Vertical only, Lateral only, or Universal, functions correctly with all R-MC Tone Arms now in service. Therefore it is not necessary to change arm in service when ordering the new Head.

Whenever you may need a new PARA-FLUX Head, your R-MC Jobber will supply you with the new lightweight head . . . immediately . . . in exchange for your old one, in accordance with our standard replacement policy and exchange price.

Available through authorized jobbers. Descriptive, illustrated Bulletin upon request.

RADIO-MUSIC CORPORATION
EAST PORT CHESTER • CONN.



(Continued from page 40A)

- Crossland, W., Headquarters Anti-Aircraft, Glenthorn, Stanmore, Middx., England
- Crosson, J. W., 1707 Homan Ave., Fort Worth 6, Texas
- Cummings, J. C., Sylvania Electric Products, Inc., Brookville, Pa.
- Davis, J. H., Electronic Control Co., 1215 Walnut St., Philadelphia 7, Pa.
- Embrey, D. M., 54 Gatis St., Wolverhampton, Staffs., England
- Farrelle, P. S., 15840 Via Rivera, San Lorenzo, Calif.
- Geyer, R. A., 255 Humble Bldg., Houston, Texas
- Gray, J. B., Box 622, South Norwalk, Conn.
- Gumpertz, D. G., 4628 Beck Ave., North Hollywood, Calif.
- Harmsworth, A., 39 Mayor St., Bolton, Lancs., England
- Hebert, M. R., 3310 Decatur Ave., Fort Worth 6, Texas
- Heppner, S. A., 33 Concord Ave., Cambridge 38, Mass.
- Jacobson, R. I., 120 Bennett Ave., New York 33, N. Y.
- Keplinger, M., 1821 Harrington St., Fort Worth 6, Texas
- Kirby, M. J., 125 N. Linden Ave., Pittsburgh 8, Pa.
- Kostriza, J. A., 216 Clawson St., Staten Island 6, N. Y.
- Lamontagne, R. S., 142 Farnham St., Lawrence, Mass.
- Lehr, C. G., 35 Gilbert Rd., Belmont 78, Mass.
- Lynch, B., 3107 Bristol Rd., Fort Worth 7, Texas
- Major, R. P., 1963-71 Ave., Philadelphia 38, Pa.
- Marshall, R. V., Birchover 36, W. Bank Rd., Allestree, nr. Derby, England
- Mayer, E. G., Box 1126, Corpus Christi, Texas
- McGee, F. M., 612 E. 11 St., New York, N. Y.
- McHoney, L. M., Westinghouse Electric and Manufacturing Corp., 10 High St., Boston, Mass.
- McNees, S. G., 915-12 St. N. E., Cedar Rapids, Iowa
- Meadow, S., Reeves Ely Laboratories, Inc., 215 E. 91 St., New York, N. Y.
- Minor, W. C., 314 Hamilton Rd., Columbus 9, Ohio
- Oberbillig, D. D., Box 827, Boise, Idaho
- Patterson, R. E., 720 Chestnut Ave., Falls Church, Va.
- Pugarelli, S. T., 239 Brown St., Hartford, Conn.
- Reegan, J. E., 11 Taft Ave., Lexington 73, Mass.
- Reilly, V. E., 28 South St., Red Bank, N. J.
- Rowe, D. E., Electronics Section, Naval Aviation Ordnance Test Station, Chincoteague, Va.
- Shawver, E. F., 2528 Dryden Rd., Houston 5, Texas
- Simmons, M. R., 2120 Yucca St., Fort Worth, Texas
- Starr, B. A. L., WRGA, Rome, Ga.
- Sterns, W. G., 861 Oakland Ave., N.E., Cedar Rapids, Iowa
- Strup, C. F., Jr., 160 Fairfield Ave., Stamford, Conn.
- Swift, H. G., 24 Revere Ave., Lenola, Moorestown Turnspike, N. J.
- Thomas, A., 241 George St., Sarnia, Ont., Canada
- Tischler, M., 4019 Norfolk Ave., Baltimore 16, Md.
- Trainor, W. J., 1862 Dorchester St. W., Montreal 25, Que., Canada
- Waller, K. L., 173 Quentin St., Brooklyn 29, N. Y.
- Webster, J. A., 17 Fifth St., S.E., Washington 3, D. C.
- Williamson, G. F., 2357 Iroll Ave., Cincinnati 11, Ohio

Admission to Associate

- Arasi, D., 3835 Bronxwood Ave., Bronx 67, N. Y.
- Anderton, H. L., Naval Air Missile Test Center, Point Mugu, Calif.
- Anglin, D., 4010 Corinth Blvd., Dayton 10, Ohio
- Balakrishnan, C., Rivilin, 39 Earlsmead, South Harrow, England

(Continued on page 44A)



**RIGHT ON
"MAIN STREET"**

WHEN the most desirable FM location happens to lie in a congested area, tower design is of prime importance.

It is therefore necessary that such a structure be designed to have an adequate margin of safety, and be of pleasing appearance.

This installation has back of it the experience and engineering ability acquired in building thousands of Towers and Vertical Radiators, both here and abroad . . . This obvious advantage adds nothing to the cost of a Blaw-Knox job.

BLAW-KNOX DIVISION

OF BLAW-KNOX COMPANY

2037 Farmers Bank Building, Pittsburgh 22, Pa.

**BLAW-KNOX ANTENNA
TOWERS**

AMPHENOL

RF CABLES AND CONNECTORS

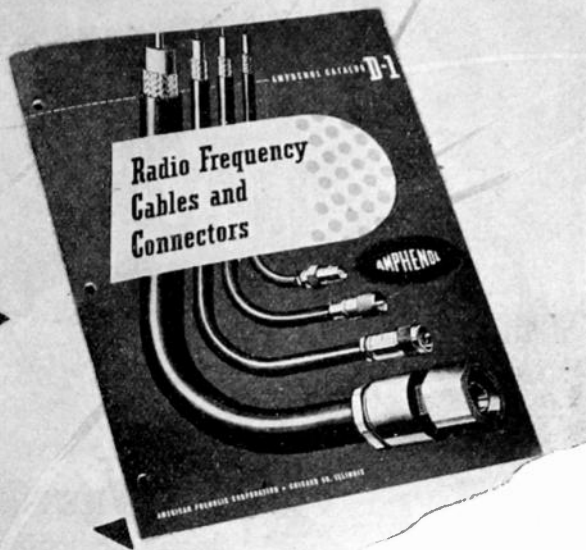

Efficient Connecting Links for Electrons at Work...

Amphenol radio frequency cables, connectors and cable assemblies assure lasting, low-loss continuity on highly critical circuits.

Available—from stock—to makers of electronic equipment and to amateurs, they are produced in several types. Each is designed to meet the requirements in a specific field of application.

To simplify your selection, the new Amphenol D-1 Catalog of radio frequency cables, connectors and cable assemblies includes decibel loss and power rating data of all cables. Functional illustrations and tabular matter quickly show which connector is needed for each cable. Installation dimensions are shown, as are instructions for the proper assembly of cables to connectors. Included is a cross-index of army-navy and Amphenol type designation numbers.

Write today on your business letterhead for your free copy of the new D-1 catalog. Amphenol will serve you well as a dependable source of supply. Catalog D-1 is today's guide for the engineer and purchasing agent in the selection of highest quality cables and connectors.

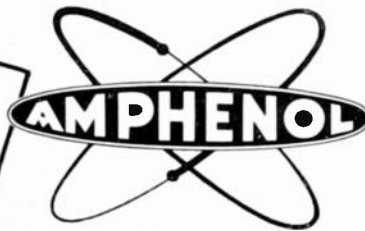

AMERICAN PHENOLIC CORPORATION

1830 South 54th Avenue, Chicago 50, Illinois

COAXIAL CABLES AND CONNECTORS • INDUSTRIAL CONNECTORS, FITTINGS AND CONDUIT • ANTENNAS • RADIO COMPONENTS • PLASTICS FOR ELECTRONICS



(Continued from page 42A)

- Bean, R. N., Brush Development Co., 3405 Perkins Ave., Cleveland 14, Ohio
- Bell, A. N., 46 Ontario St., Corning, N. Y.
- Blankmeyer, W. A., 32-51—85 St., Jackson Heights, L. I., N. Y.
- Booker, T. F., 1138 Jerome St., Houston 9, Texas
- Brown, W. R., Box 145, Cypress, Ill.
- Buchanan, H., Box 116, Angola, Ind.
- Calcagni, H. P., Casilla 127-D, Santiago, Chile
- Carstens, L., 3136 W. North Ave., Chicago 47, Ill.
- Christensen, N. T., 4956 Cape May Ave., San Diego 7, Calif.
- Christensen, N. P., 1158 Filbert St., San Francisco 9, Calif.
- Chute, R. M., 43 Hooker St., Allston 34, Mass.
- Coburn, G. S., RCAF Station, Centralia, Ont., Canada
- Cohen, A., 1329 E. 98 St., Brooklyn, N. Y.
- Coleman, S. A., 3570 Schaefer St., Culver City, Calif.
- Cooper, R. B., 508 S. Mason St., Chenoa, Ill.
- Cunningham, B. F., 926 N. LaSalle, Chicago 10, Ill.
- Currey, C. H., 7759 N. Sheridan Rd., Chicago 26, Ill.
- Dean, N. W., 249 C Claremont Ave., Long Beach 3, Calif.
- Dewey, C. H., Jr., WGFG, Kalamazoo, Mich.
- Ducati, M., Largo Augusto 7, Milano, Italy
- Egidi, C., 42 Corso Massimo d'Azeglio, Torino, Italy
- Enns, E. G., RFD 3, Kitchener, Ont., Canada
- Epstein, R. R., Praesens Film A. G., Weinbergstrasse 15, Zürich, Switzerland
- Everson, E. W., 4621 Jackson Ave., RFD 6, Evansville, Ind.
- Fenstermacher, A. L., 3750 Norwich Lane, Cincinnati 20, Ohio
- Gangopadhya, I., Area Installation Engineer Eastern Court, New Delhi 1, India
- Garcelon, J., 325 W. 4 St., New York, N. Y.
- Gay, L. O., Radio and Refrigeration Co., Selangor Rd., Georgetown, Penang, Malaya
- Greenfield, R. A., Trent View, The Ridgeway, Enfield, Middx., England
- Gundy, G. L., 3719 Southport Ave., Chicago 13, Ill.
- Hack N. R., 4541 N. Magnolia Ave., Chicago 40, Ill.
- Hall, W. F., RFD 5, Peoria 8, Ill.
- Haller, E. J., 712 N. Clark St., Chicago 10, Ill.
- Hebert, H. J., Jr., RFD 3, Box 126, Beaumont, Texas
- Hines, R. J., Pond St., Rowayton, Conn.
- Hummer, J. L., Box 125, Humarock, Mass.
- Humphrey, J. E., 1656 E. 33 St., Los Angeles 11, Calif.
- Hutcheon, R. S., 2305 S. 50 Ave., Cicero 50, Ill.
- Johnson, C. E., 506 Boyd St., Des Moines 13, Iowa
- Johnson, G. N., KRUX, Radio Arizona, Glendale, Ariz.
- Joshi, M. V., Marconi College, Arbour Lane, Chelmsford, Essex, England
- Kannan, S., c/o K. Varadaraj, 69 Kingsway S., Secunderabad, Deccan, India
- Klutz, J. F., 6815 Kenwell St., Dallas 9, Texas
- Koenig, H. G., 4512 Sheridan Rd., Chicago 40, Ill.
- Krieger, H. C., 4247 W. Roscoe St., Chicago 41, Ill.
- Kohn, E. B., 4756 S. Drexel Blvd., Chicago 15, Ill.
- Lawrence, B. F., 1327 Essex St., Bluefield, W. Va.
- Len, R. G., 39 Temple St., Boston 14, Mass.
- Long, M. C., 1825 N. Quesada St., Arlington, Va.
- Mabry, V., 2310 Angelina St., Beaumont, Texas
- Malaszewski, J. C., 2826 Washington Blvd., Chicago 12, Ill.
- McKennon, L. W., 8028 Jeffrey Ave., Chicago 17, Ill.
- Miller, K. S., 184 Truman Ave., Yonkers 2, N. Y.
- Mills, R. W., 1517 Sale Ave., Louisville, Ky.
- Moore, R. T., 10965½ S. Figueroa St., Los Angeles 3, Calif.
- Morton, J. A., 174 Indian Grove, Toronto 9, Ont., Canada

(Continued on page 46A)



THE CLINIC *that Cures Radio Noise*

For every evil
under the sun,
There is a remedy
or there is none.
Old Eng. Prov.

For radio noise, the remedy is Filterizing by Tobe . . . a complete service that enables you to guarantee that your electrical products will not interfere with radio reception. Filterizing by Tobe covers these three important aspects of every radio noise problem:

R.F. Circuit Design — Engineers with many years experience, thoroly versed in measurement techniques, and using the latest instruments, determine the radio noise output and r-f characteristics of your product and specify the correct circuit elements to stop radio interference over the desired frequency range.

Electrical Design — The filterizing circuit is checked for effect upon performance of the apparatus being Filterized and all components are selected so that normal performance is obtained after Filterizing; voltage drop, temperature rise, phase relationships — all are held within required limits.

Mechanical Design — The arrangement of circuit elements is co-ordinated with existing space limitations so that radio noise is quelled without need for extensive re-design of the apparatus.

These three design factors, embodied in every Tobe Filterette, are based on exact, scientific knowledge and, when applied by Tobe engineers, enable you to guarantee radio silence for your electrical apparatus. This guarantee, shown by the FILTERIZED label, helps build sales for your product. Ask us for details.

TOBE DEUTSCHMANN CORPORATION • CANTON, MASSACHUSETTS

ORIGINATORS OF FILTERETTES • • • THE ACCEPTED CURE FOR RADIO NOISE



4 REASONS why you should specify "KIC" GETTERS



(Continued from page 44A)

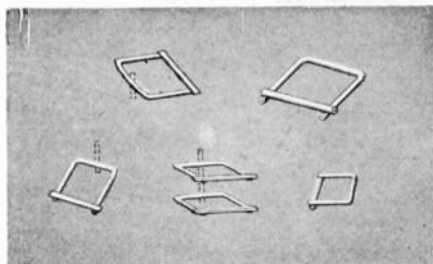

1. SO ASSEMBLY TYPES. Kemet makes getter assemblies of barium, and of barium alloyed with magnesium, or with aluminum, or with both. These getter assemblies are produced in a variety of sizes and shapes designed to meet your specific requirements.

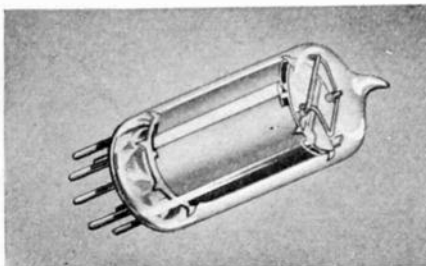

2. BETTER GAS CLEANUP. To adsorb residual gases most effectively, Kemet has designed the KIC getter assembly. This consists of a barium core protected by an iron sheath which promotes efficient dispersion of vaporized barium upon flashing.



3. AT YOUR BECK AND CALL. Kemet is always prepared to render an-the-job assistance to the user of KEMET products. Our engineers are available at all times to help you in the solution of your problems.



4. LOWERED TUBE COSTS THROUGH RESEARCH. In the search for superior gettering methods Kemet draws upon the experience and metallurgical research facilities of Units of Union Carbide and Carbon Corporation.

Write for Free Booklet

The 28-page booklet Z-1, "Getters and Gettering Methods for Electronic Tubes," tells how to overcome difficulties in gettering. It is recommended for designers of electronic tubes.

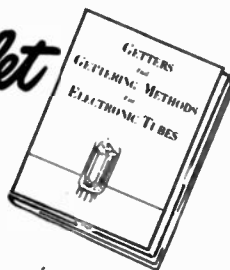

KEMET LABORATORIES COMPANY, INC.

Unit of Union Carbide and Carbon Corporation



Madison Avenue and West 117th Street, Cleveland 1, Ohio
Foreign Department—30 East 42nd Street, New York 17, N. Y.
Cable Address: Kemetlab, New York

KEMET and KIC are trade-marks of Kemet Laboratories Company, Inc.

KIC BARIUM GETTERS KEMET

Motchan, H. L., 5820 Roosevelt, St. Louis 20, Mo.
Newsteder, L., 166 Myrtle Ave., Millburn, N. J.
North, R. S. F., Communications Section, Civil Aeronautics Administration, Young Hotel Bldg., Honolulu, T. H.

Ollenburg, M. A., 1308 N. 39 St., Milwaukee 8, Wis.
Otis, J. L., 2203 Budlong Ave., Los Angeles 7, Calif.
Paige, S., 245 Sullivan Pl., Brooklyn 25, N. Y.
Pendleton, J. R., 8045 Eilerton Ave., St. Louis 14, Mo.

Phillips, J. W., 7113 Emlen St., Philadelphia 19, Pa.
Phinney, T. W., 6321 N. Greenview, Chicago 26, Ill.
Powell, H. G., 7524 Harvard Ave., Chicago 20, Ill.
Rector, R. G., 222 Robie St., Truro, N. S., Canada
Reilly, J. J., RCAF, Clinton, Ont., Canada
Rider, P. Z., 77 Hartford Ter., New Hartford, N. Y.
Rissmiller, A. D., Jr., 575 Willow Ave., Fairlawn, N. J.

Rose, I. W., 7752 S. Kingston Ave., Chicago 49, Ill.
Rose, T. T., 451 West End Ave., New York, N. Y.
Rosenbaum, E., 100 Riverside Dr., New York, N. Y.
Rothbart, A., 1570 E. 4 St., Brooklyn, N. Y.
Rouse, F. W. D., Brookleigh, Brookside Dr., Godley, Hyde, Cheshire, England

Salmond, D. S., Box 482, Cocoa, Fla.
Sandquist, J. W., 4653 Hazel, Chicago 40, Ill.
Scully, D. W., 59 Chestnut St., Cambridge 39, Mass.

Seabaugh, D. A., 418 Birdwood Ave., Haddonfield, N. J.

Shipp, G. E., 15 The Ridgeway, Sanderstead, Surrey, England

Silva, J. D., 3715 W. 1 St., Los Angeles 4, Calif.
Smith, H. A. P., 20 Oak Ter., Neptune City, N. J.
Snyder, S., 8807 First Ave., Silver Spring, Md.
Spinnenweber, J. F., 4501 Washington Blvd., Chicago 24, Ill.

Stecker, E. J., 2574 Ulric St., San Diego 11, Calif.
Tavaniotis, C., Devon Hotel, 70 W. 55 St., New York 19, N. Y.

Tetreault, G. T., RFD 1, Binghamton, N. Y.
Thomas, A. A., 538 Deming Pl., Chicago, Ill.
Valasek, H. H., 2423 S. Kedzie Ave., Chicago 23, Ill.

Van Vechten, R. K., 101 N. Clinton St., Baltimore 24, Md.

Vincent, E. P., 450 E. 78 St., New York 21, N. Y.
Wachsman, L. B., 1220 Shakespeare Ave., New York 53, N. Y.

Wilkins, W. H., Jr., 543 S. Alexandria Ave., Los Angeles 5, Calif.

Williamson, R. G., 63 N. Maple St., West Hempstead, N. Y.

Verly, J., 8014 S. Indiana Ave., Chicago 19, Ill.

ERRATA

The following memberships, which were effective as of August 1947, were erroneously listed, and should read as follows:

Transfer to Senior Member

Coxhead, H. B., Bell Telephone Laboratories, 463 West St., New York 14, N. Y.

Admission to Senior Member

Morf, F. P., RFD 1, Box 36, Little Silver, N. Y.

Transfer to Member

Blumberg, M., 45 William St., Rochelle Park, N. J.
Cohen, J., 1616 Fitzgerald Lane, Alexandria, Va.
Corbell, P. I., Jr., 551 Eaton Ave., Redwood City, Calif.

Admission to Member

Minton, M., 54 Moreland Court, Finchley Rd, London N.W. 2, England

PROFESSIONAL PERFORMANCE—that keeps the original sound alive!

**Stop
'Wow'!**



—with a positive drive at 33.3 and 78 rpm

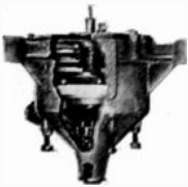

Remember this: When a listener becomes dissatisfied with the quality of your programs, he simply twists a dial. And in doing so, he also tunes out his pocketbook. So why jeopardize what is probably your best source of revenue—*your recorded programs!*

Professional recording and playback should be, and can be, 'WOW'-free. How? With the time-tested Fairchild direct-from-the-center turntable drive, shown above. It eliminates all variations in turntable speed. Evenness of speed is obtained by a carefully calculated loading of the drive mechanism to keep the motor pulling constantly; by careful precision control of all drive alignments that might cause intermittent grab and release; by carefully maintained .0002" tolerances in all critical moving parts.

Further aid to 'WOW'-free performance is provided by a perfectly balanced turntable with extra weight in the rim and a turntable clutch that permits smooth starting, stopping and shifting from 33.3 to 78 rpm in operation.

Fairchild's 'WOW'-free performance is available on professional Transcription Turntables, Studio Recorders and Portable Recorders. For complete information—and prompt delivery—address: 88-06 Van Wyck Blvd., Jamaica 1, New York.



Transcription Turntables
Studio Recorders
Magnetic Cutterheads
Portable Recorders
Lateral Dynamic Pickups
Unitized Amplifier Systems



Fairchild

CAMERA

AND INSTRUMENT CORPORATION



Electronic Regulated POWER SUPPLIES

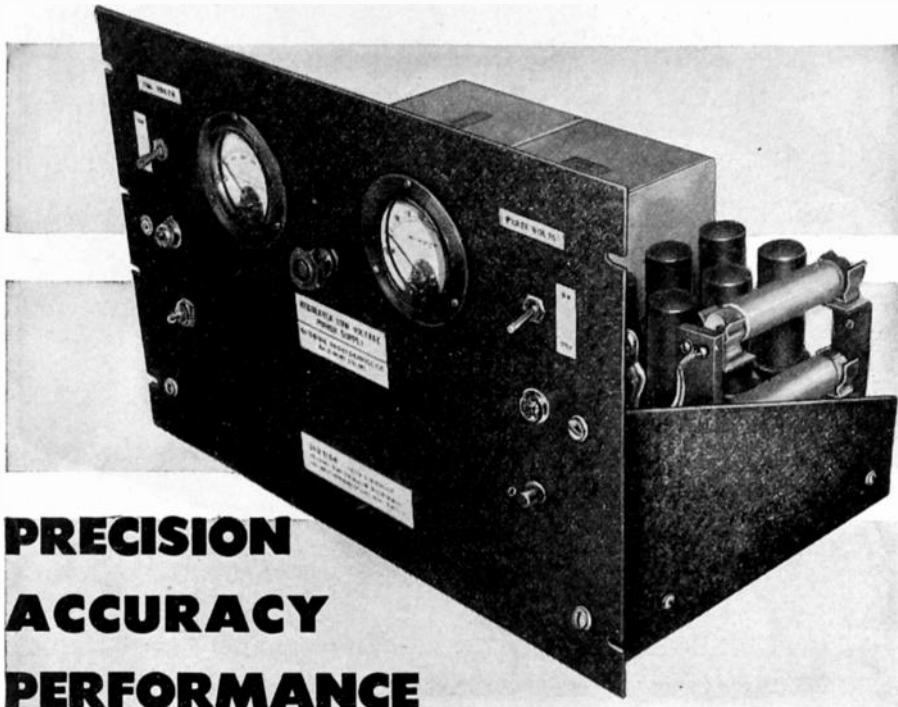

**PRECISION
ACCURACY
PERFORMANCE**

Built to rigid U. S. Government Specifications

SPECIFICATIONS

INPUT—115v. 50-60 cycle

REGULATIONS—Less than 1/20 volt change in output voltage with change of from 100-140 V.A.C. input voltage & from NO-LOAD to FULL-LOAD (over very wide latitude at center of variable range)

RIPPLE—less than 5 millivolts at all loads and voltages

DIMENSIONS—Fits any standard rack or cabinet (overall: 19 in. wide; 12 $\frac{1}{4}$ in. high; 11 in. deep; shipping wt.—100 pounds)

TYPE A—VARIABLE FROM 210 TO 335 V. D. C. @ 400 M. A.

TYPE B1—VARIABLE IN TWO RANGES: 450-600 and 600-890
V. D. C. @ 125 M. A.

CONSTRUCTION FEATURES

Weston model 301 (or equal) milliammeter and voltmeter • Separate switches, pilot lights, and fuses for FIL and PLATE VOLTS • All tubes located on shockmount assemblies • Fuses mounted on front panel and easily accessible • Can vary voltage by turning small knob on front of panel. Can easily modify Type B1 from POSITIVE to NEGATIVE output voltage • Individual components numbered to correspond with wiring diagram.

Rigid construction: components designed to withstand most severe military conditions, both physical and electrical; and were greatly under-rated.

All units checked and inspected at 150% rated load before shipment.

Tube complement: { Type A: 2-836; 6-6L6; 2-6SF5; 1-VR150; 1-VR105
Type B1: 2-836; 2-6L6; 2-6SF5; 1-VR150; 1-VR105

IMMEDIATE DELIVERY

NET PRICES—F. O. B. BALTIMORE, MD.

TYPE A—\$189.00

TYPE B1—\$185.00

Complete with tubes and ready to plug in—Prices subject to change without notice

NATIONAL RADIO SERVICE CO.

Reisterstown Rd. & Cold Spring Lane

Baltimore 15, Md.

News—New Products

These manufacturers have invited PROCEEDINGS readers to write for literature and further technical information. Please mention your I.R.E. affiliation.

(Continued from page 26A)

New Beckman UltraOHMeter

The National Technical Laboratories, Mission St., So. Pasadena, Calif., has announced production of the newly developed Beckman UltraOHMeter.



The manufacturer states that this instrument will allow precision measurements of very small currents and high resistances with the ease and convenience of ordinary test equipment.

A built-in standard voltage source provides voltages for resistance measurements in convenient steps from 0.5 to 20 volts, and the instrument is so designed that resistor linearity tests and polarization checks can be made conveniently. The UltraOHMeter can be used as a high-impedance d.c. voltmeter. Other features include: internal resistor calibration means, generous range overlap (23 ranges), minimum current sensitivity of 5 microamperes, minimum resistance of 100,000 ohms, and the ability to handle both positive and negative signals.

Beacon Antenna— Type EY3A

The Transmitter Division, Electronics Department of General Electric Co., Syracuse, N. Y., has announced a high-gain beacon antenna for two-way radio communication in the 152-162 megacycle band.

A multielement antenna, the EY3A's power gain is about two and one-half times that of the ordinary coaxial dipole, according to the manufacturer. Contained in a nonmetallic weatherized housing, the antenna is symmetrical and offers a circular azimuth pattern.

Terminal impedance is 50 ohms. It weighs approximately 37 pounds and may be mounted to a mast or tower with a two-point support.

(Continued on page 60A)

New Bulletin 547

Features **VOLTAGE CONTROL**
by **SUPERIOR ELECTRIC**

All the information required for selection
of the correct voltage control apparatus
is included—

FOR EXAMPLE . . .

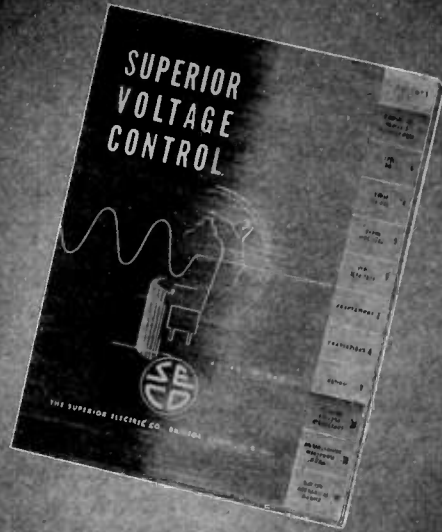

TYPE 20-2

POWERSTAT TYPE 20

Although the smallest in physical and electrical size of all POWERSTAT variable transformers, type 20 possesses all the essentials of superior voltage control equipment. It has excellent regulation . . . high efficiency . . . smooth control . . . and unusually rugged mechanical construction. Its current rating of 3.0 amperes exceeds all other units of comparable mounting dimensions. For three phase operation, type 20 can be ganged for wye or open-delta operation.

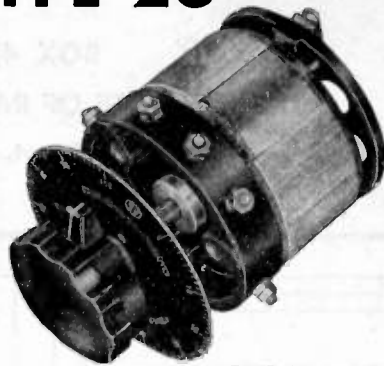

TYPE 20

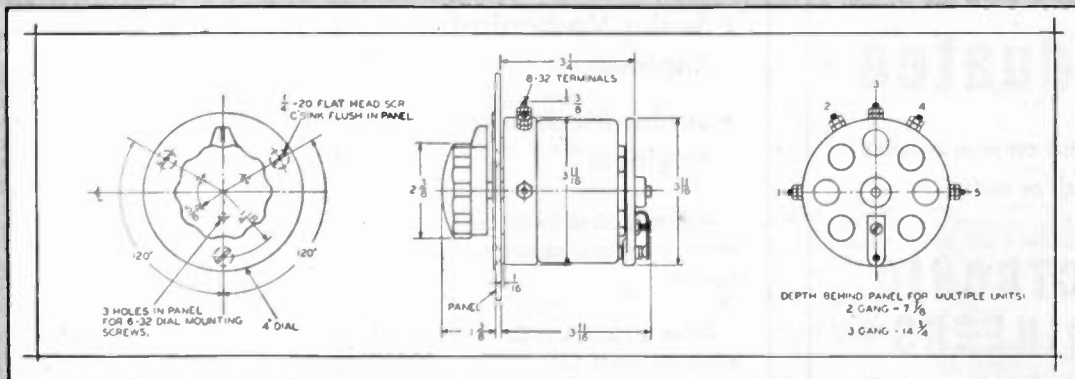

To get your copy of Bulletin 547 . . . for more information on
POWERSTAT type 20 and other voltage control equipment write

SUPERIOR ELECTRIC, 1095 Laurel Street, BRISTOL, CONNECTICUT.

THE SUPERIOR ELECTRIC CO.
BRISTOL, CONNECTICUT



POWERSTAT VARIABLE TRANSFORMERS • VOLTBOX A-C POWER SUPPLY • STABLINE VOLTAGE REGULATORS

ENGINEERS NEEDED

Large Eastern manufacturer of communication and broadcast radio equipment has positions available for the following personnel:

Broadcast Receiver Project Engineers
and Assistant Project Engineers

Television Receiver Project Engineers
and Assistant Project Engineers

Mechanical Engineers—Senior Draftsmen,
Detail Draftsmen

Personnel experienced in design methods on broadcast, television and automobile radio receivers preferred. Pleasant working conditions. Unlimited advancement opportunities. Reply in detail, giving complete résumé of business experience.

BOX 485

THE INSTITUTE OF RADIO ENGINEERS

1 East 79th Street, New York 21

PHYSICISTS Graduates

Experienced on micro-waves
and/or radar.

ELECTRONIC ENGINEERS

Radar and pulse circuits.

For established research and
development laboratory.

Excellent opportunities.

Write Box IRE 954

113 W 42 St., N.Y. 18, N.Y.

- Electronic Engineers
- Physicists
- Senior Mechanical Engineer
- Junior Mechanical Engineer

—experienced in radar development, servomechanisms and computers.

—for airborne radar and guided missiles projects.

—excellent opportunities—salaries commensurate with experience and ability.

Write to:

**FARNSWORTH TELEVISION & RADIO
CORPORATION**

Fort Wayne 1, Indiana

Attention of:

J. D. Schantz

Research Department



The following positions of interest to I.R.E. members have been reported as open. Apply in writing, addressing reply to company mentioned or to Box No. ...

The Institute reserves the right to refuse any announcement without giving a reason for the refusal.

PROCEEDINGS of the I.R.E.

1 East 79th St., New York 21, N.Y.

ENGINEERS—PHYSICISTS

Graduate engineer or physicist for design and development of electronic instruments is required by a large research laboratory. At least three years' experience in the field, familiarity with pulse technique and broad band amplifier design is essential. Living accommodation arranged. Address: National Research Council, Chalk River, Ontario.

ELECTRONICS ENGINEER

Electronics engineer capable of designing and supervising construction of oscillator circuits from 15 kilocycles to 500 megacycles for use in quartz crystal networks and testing equipment. College graduate preferred. Mid-western university town. Salary open. Send full details of education and experience. Write Box 473.

ENGINEERS—PHYSICISTS

Highly qualified engineers and physicists needed in development of electronic circuits, microwave components, UHF and VHF antenna, and servomechanisms. Highly qualified talent is also needed for analytical study of dynamical systems, complex electric circuits, and complex electronic systems. Opportunities are unlimited for the right men who are capable of assuming responsibilities. Write to Personnel Manager, Boeing Aircraft Company, Seattle 14, Washington.

ENGINEERS—PHYSICISTS

Eastern tube manufacturer has openings for experienced men for electronic tube and circuit research and development. Box 474.

COMMUNICATIONS ENGINEER OR PHYSICIST

The National Geophysical Company, Inc. has an opening on its engineering staff for a communications engineer or physicist, with electronic training, who is interested in research and development work. Projects cover all phases of geophysical work. This position is permanent. Salary open. Write National Geophysical Company, Inc. Research Laboratory, 8806 Lemon Avenue, Dallas, Texas.

RADIO ENGINEER

Radio engineer development of military receivers for low frequency and microwave regions. Must have three to four years' experience in receiver design. Location New York City. Salary up to \$4500. Box 476.

(Continued on page 52A)

Presenting the **NEW MODEL SX-43**

... to give amateurs:

**MORE
VALUE**

Never before all these features at this price

**GREATER
PERFORMANCE**

AM-FM-CW ... all essential amateur frequencies from 540 kc. to 108 Mc.

LOWER PRICE

\$169⁵⁰

Sets available after August 1947

**Built in the
Hallicrafters
Classic
Tradition**

The new SX-43 is built in the Hallicrafters classic tradition: providing custom quality, precision engineering, excellent performance and wide frequency range at a medium price. The SX-43 offers continuous coverage from 540 kc. to 55 Mc. and has an additional band from 88 to 108 Mc. AM reception all bands. CW on four lower bands and FM on frequencies above 44 Mc.

New LOW PRICE Transmitter



\$69⁵⁰

**MODEL
HT-17**

- Ham bonds from 3.5 to 30 Mc.
- 15 watts power output on low frequency bands.

Here's real Hallicrafters transmitter performance with maximum convenience and economy. A pi-section matching network, as well as a link, provides coupling to any type of antenna or permits the HT-17 to be used as an exciter for a high power final amplifier. Coil sets extra.

Added technical details on all these models in Hallicrafters New Catalog, No. 38. Ask your local distributor for a copy.

NEW BETTER QUALITY AM WITH NARROW BAND FM

Exclusively designed—**VARIABLE
MASTER OSCILLATOR \$110.00**
(amateur net)

Here is the hottest transmitter item available today. Packed with outstanding features never before available in one low-priced unit. Add to the HT-18 one or two amplifier stages and you have a complete, high quality transmitter permitting operation on phone or CW up to 1 KW.

MODEL HT-18



Narrow band FM ... direct frequency calibration ... finger-tip control of entire station ... full frequency deviation on all ham bands to 29.7 Mc. ... only 1/10 the distortion of comparable units ... excellent stability ... clean keying ...

BUILDERS OF *Skyfone* AVIATION RADIOTELEPHONE

hallicrafters RADIO

THE HALLICTRAFTERS CO., MANUFACTURERS OF RADIO AND ELECTRONIC EQUIPMENT, CHICAGO 16, U. S. A.
Sole Hallicrafters Representatives in Canada: Rogers Majestic Limited, Toronto-Montreal

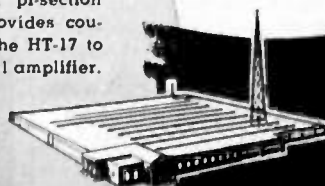

WANTED PHYSICISTS ENGINEERS

Engineering laboratory of precision instrument manufacturer has interesting opportunities for graduate engineers with research, design and/or development experience on radio communications systems, electronic & mechanical aeronautical navigation instruments and ultra-high frequency & microwave technique.

WRITE FULL DETAILS
TO
EMPLOYMENT SECTION

SPERRY GYROSCOPE COMPANY, INC.

Marcus Ave. & Lakeville Rd.
Lake Success, L.I.

BELMONT RADIO CORPORATION of Chicago

NEEDS SEVERAL ELECTRONIC ENGINEERS

Development and Research Engineers, Seniors and Juniors, well versed in all phases of RF circuits wanted. VHF or Microwave experience desirable. Top-notch applicants with Engineering degree or equivalent background for this type of work only will be considered. Chicago Area residents preferred, top salary, steady position, 40-hour week, occasional field trips. Appointment by letter only. Give background experience, educational and employment history. Address letter to Research Division, Belmont Radio Corporation, 5921 W. Dickens Ave., Chicago 39, Illinois.



(Continued from page 50A)

INSTRUCTOR OR ASSISTANT PROFESSOR

Instructor or assistant professor to teach courses in wire and radio communication and ultra-high frequency techniques at a small New England University. Prefer man 25-35 with advanced degree and industrial experience. Work Begins Oct. 1, 1947. Salary dependent upon qualifications. Box 477.

ENGINEERING ASSOCIATE

Will offer partnership in prospective professional consulting service to engineer with B.S. degree or better who is desirous of striking out for himself but who has been financially restricted. Must have experience in all phases of broadcast engineering including directional antenna array design and preparation of F.C.C. broadcast station applications both AM and FM. No investment required. West coast. Please give full particulars. Replies will be treated confidentially. Write to Box 478.

TEACHERS OF ELECTRICAL ENGINEERING

State land grant college in Northwest has openings for power and electronics men. Salaries \$3000 to \$4200 for nine months. Write giving references and complete personal data to Box 479.

SALES ENGINEERS

Old established manufacturer of broadcasting equipment has openings for several qualified sales engineers. An opportunity to have a good income selling equipment to broadcasting stations. These positions require men having a thorough knowledge of the field of broadcasting both from a technical and business standpoint. Give full details in reply concerning past employment, age, education, marital status, remuneration expected, and location preferred. Write Box 480.

PHYSICIST OR ELECTRONIC ENGINEER

Wanted: Top flight physicist or electronic engineer. Should have Ph.D. or equivalent experience. Must be capable of heading up large development projects as well as performing original theoretical and experimental research. Congenial working atmosphere amongst many former M.I.T. Radiation Laboratory personnel. Will pay salary commensurate with experience and ability. Write: Laboratory for Electronics, Inc., Att: Sims McGrath, 610 Newbury Street, Boston 15, Mass.

ENGINEERS

HEAD OF CATHODE RAY TUBE RESEARCH. Under direction of Supervisor of Electronics and in cooperation with the Electron Optics Group, he will direct applied research on and development of improved cathode ray tubes for commercial television. Responsibilities include: setting up of processes, scheduling and direction of design, testing and screen application.

CATHODE RAY TUBE DESIGN ENGINEER. Carry out experimental research on and design of electron guns for improved television cathode ray tubes used

(Continued on page 54A)

Microwave Design Engineers • Microwave Equipment Engineers

Engineers to develop microwave tubes for specific applications. To design electron guns, tube assemblies and parts; special jigs and fixtures.

Men to develop test methods and design microwave equipment for test of traveling wave tubes.

2 or more years experience in microwave plumbing, measurement techniques, measurement of noise at microwave frequencies.

SYLVANIA ELECTRIC PRODUCTS, INC.

Employment Section
Industrial Relations Department
40-22 Lawrence Street
Flushing, New York



finch

first in facsimile
for broadcasting and point-
to-point communication!

FINCH TELECOMMUNICATIONS
INCORPORATED
SALES OFFICE:
10 EAST 40th STREET, NEW YORK
FACTORIES: PASSAIC, N. J.

For Antenna Current Measurements
at Television and FM frequencies!

WESTON

*High Frequency
Thermo Ammeters*

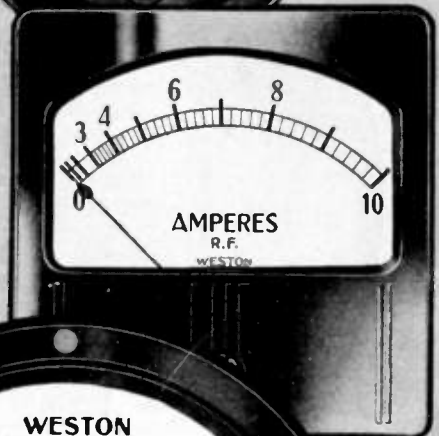

WESTON thermo ammeters are particularly designed for more accurate measurements of *very high frequency* antenna current in present FM and Television installations.

The thin-walled tubular heater*, an exclusive WESTON development, substantially reduces skin effect, thus providing vastly improved accuracy at the higher frequencies. Meeting FCC requirements, these instruments are available in sizes and ranges for all needs. Also vacuum-type thermocouple instruments for milliamperere ranges. Ask your local WESTON representative, or write Weston Electrical Instrument Corporation, 618 Frelinghuysen Avenue, Newark 5, New Jersey.

*Patent #2,100,260

WESTON
Instruments

ALBANY · ATLANTA · BOSTON · BUFFALO · CHARLOTTE · CHICAGO · CINCINNATI · CLEVELAND · DALLAS · DENVER · DETROIT · JACKSONVILLE · KNOXVILLE · LITTLE ROCK · LOS ANGELES · MERIDEN · MINNEAPOLIS · NEWARK
NEW ORLEANS · NEW YORK · PHILADELPHIA · PHOENIX · PITTSBURGH · ROCHESTER · SAN FRANCISCO · SEATTLE · ST. LOUIS · SYRACUSE · IN CANADA, NORTHERN ELECTRIC CO., LTD., POWERLITE DEVICES, LTD.

It's Better Because It's Bendix!

Now Available!

**Aviation Standard
Bendix DYNAMOTORS**

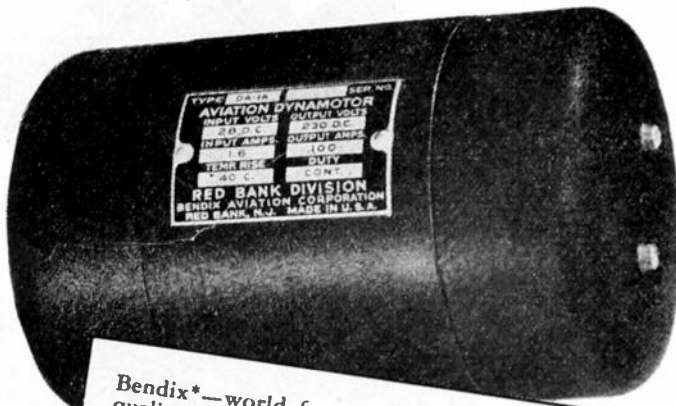

Bendix*—world famous for top-flight aviation quality—now makes available to the radio industry these low-cost D. C. Transformers.

- Specially designed for long life, light weight, and low ripple.
- Standard diameters run 2¾, 3⅞, 4, 4½, 5 and 5¼ inches.
- From 12 to 1100 volts and from 15 to 500 watts output.
- Continuous duty—enclosed.
- Intermittent duty—ventilated.
- Single, dual, and triple output.
- Regulated and unregulated.

Write to the address below for detailed information on these and other Bendix Dynamotors to meet your power requirements.

*REG. U.S. PAT. OFF.

STANDARD RATINGS					
Model	Frame Size	Input Volts	Output Volts	Output Watts	Approx. Weight
DA58A	2¾"	14	250	15	2 lb. 12 oz.
DA1A	3⅞"	14	230	23	5 lb.
DA77A	4"	5.5	600	104	9 lb. 12 oz.
DA1F	4½"	25	540	243	11 lb. 8 oz.
DA7A	5¼"	26.5	1050	420	26 lb. 10 oz.

RED BANK DIVISION of
Red Bank, New Jersey



(Continued from page 52A)

ing the theoretical information available from the Electron Optics Research Department and the customary cathode ray tube model shop facilities.

CATHODE RAY TUBE TEST ENGINEER. Test experimental models of television cathode ray tubes in cooperation with the Design Engineers and carry out the modifications of the test equipment for the testing of such special tubes. Experience in the design of television video and scanning circuits desirable. Position includes responsibilities with maintenance of cathode ray test tubes equipment but not for initial design or construction.

Apply to Supervisor of Employment, Industrial Relations Department, Sylvania Electric Products, Inc., 40-22 Lawrence Street, Flushing, New York.

**RADAR AND ELECTRONIC ENGINEERS
GUIDED MISSILE DEVELOPMENT**

Engineers needed for new missile guidance and control project. Bachelor's degree in Electrical Engineering or Physics; Master's degree very desirable, or equivalent advanced study of mathematics, electronics, applied physics. Analysis and/or development experience in one or more: radar equipment; electronic timing and control circuits; electro-mechanical servomechanisms; guided missile control and testing. Salary to \$7500 depending upon qualifications. Write or phone Mr. F. Melograno, Fairchild Engine & Airplane Corp., Pilotless Plane Division, Farmingdale, Long Island, N.Y.

DESIGN ENGINEER

Excellent opportunity for experienced electrical and mechanical engineer, with old established central Connecticut plant, who can translate intricate, precision electro-mechanical parts and assemblies into designs for mass production. Ability to develop model-shop components into production line designs of paramount importance. Write or wire Box 481.

TELEVISION INSTRUCTOR

Television instructor with degree in physics or electrical engineering. Some practical experience in the field necessary. Salary commensurate with ability. Permanent position. Progressive school. Write Louisville Radio School, 413 W. Jefferson, Louisville, Kentucky.

PHYSICISTS—GRADUATES

Experienced on microwaves and/or radar, for established research and development laboratory. Excellent opportunity. Write Box IRE 954, 113 West 42nd Street, New York 18, N.Y.

SONAR ENGINEER

Wanted by leading west coast manufacturer experienced sonar design engineer for important military and commercial work. Should be capable of handling complete design from development to production. Please include full particulars and salary requirements in first letter. Box 482.

(Continued on page 56A)

You're Looking at the Finest—



—a complete Hammarlund station

An HQ-129-X receiver, the choice of thousands of well-satisfied owners. And a Four-20 Transmitter with its companion Four-11 Modulator, a combination that is getting out all over the world. R9+ reports from China, Argen-

tina, Hawaii, Australia . . . coming in to the many amateurs now using the Four-20 on the air.

You, too, can be in this picture . . . Equip yourself with a complete Hammarlund station.

There will be no new Hammarlund receiver in the price range of the HQ-129-X until the spring of 1948 at the earliest.



HAMMARLUND

THE HAMMARLUND MFG. CO., INC., 460 W. 34TH ST., NEW YORK 1, N. Y.
MANUFACTURERS OF PRECISION COMMUNICATIONS EQUIPMENT



Write for Descriptive Booklet

Simpler FM Analysis

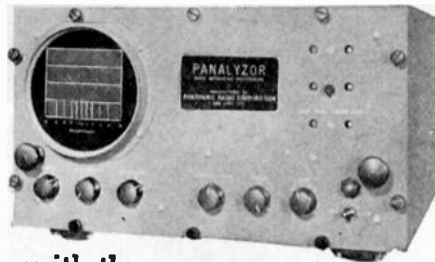

with the

PANALYZOR

Eliminates tedious, time consuming point by point frequency checks. It shows simultaneously, in one complete picture, an FM'd carrier and resultant sidebands . . . in terms of relative frequency, amplitude and stability.

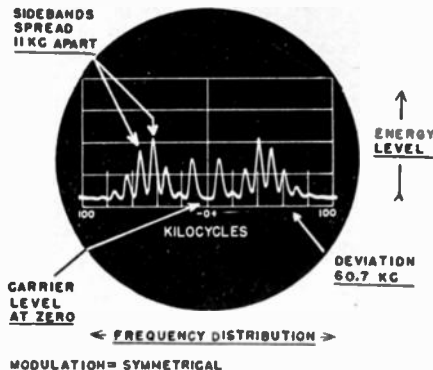

A single observation enables determination of such performance details as frequency deviation, energy distribution, sideband content, carrier shift and modulation symmetry . . . Operating procedures are simple . . . interpretations clear cut.

Actually, the PANALYZOR is a panoramic spectrum analyzer which shows, distributed in frequency, discrete quantities of r-f energy as vertical deflections on a cathode-ray tube.

Standard models now available with maximum scanning widths of 50 KC to 20 MC and corresponding resolutions of 2.5 KC to 100 KC.

Write, wire or phone now for recommendations, specifications, prices and delivery time.



(Continued from page 54A)

RADIO ENGINEER

Radio receiver engineer, Junior or Senior, experience with component parts including permeability tuners desirable. Location Chicago. Excellent opportunity and security. Reply in confidence giving training, experience, age and salaries. Box 483.

MANUFACTURING ENGINEER

Manufacturing engineer, Junior or Senior. Experience in making transformers, loud speakers, permeability tuners, and metal parts desirable. Location: Chicago. Reply in confidence giving training, experience, age and salaries. Box 484.

ENGINEER

Research and development project engineers with experience in Klystron or Storage Tube development wanted by medium size nationally known manufacturing concern in New England. Salary open. Write giving details and experience. Box 486.

ELECTRONIC ENGINEER

Graduate engineer with major in electronics is required for development of industrial and medical electronic equipment. Must have good scholastic record and have ability to do original work. Salary open. Send full details of education and experience. Write Perkin-Elmer Corporation, Glenbrook, Conn.



★ ★ ★ ★

Positions Wanted By Armed Forces Veterans

In order to give a reasonably equal opportunity to all applicants, and to avoid overcrowding of the corresponding column, the following rules have been adopted:

The Institute publishes free of charge notices of positions wanted by I.R.E. members who are now in the Service or have received an honorable discharge within a period of one year. Such notices should not have more than five lines. They may be inserted only after a lapse of one month or more following a previous insertion and the maximum number of insertions is three per year. The Institute necessarily reserves the right to decline any announcement without assignment of reason.

TELEVISION ENGINEER

B.E.E.E. (commun.) RPI 1½ years test engineer G.E.; 1½ years development engineer Naval Research Laboratory; 2½ years naval radar officer M.I.T. radar laboratory project; 1 year development engineer television. Minimum salary \$5,000. West Coast preferred. Box 91W.

PRODUCT DESIGN ENGINEER

Creative executive engineer seeks permanent affiliation with firm or financial facilities backer to bring out many obviously useful and popularly priced new radio-electronic products for wide civilian use. Box 92W.

RADIO OR SALES ENGINEER

Harvard, M.I.T., radio material Navy electronics training; 6 years radio material officer in charge at advanced base laboratory R.C.A.; Institutes, some college; 1st radio telephone, 2nd radio telegraph Class A amateur licenses, laboratory and maintenance experience. Box 94W.

JUNIOR ELECTRICAL ENGINEER

B.E.E. 1946. Cooper Union. Age 22. Single. Majored in electronics—communications. Excellent college record. Desires position in New York or within commuting distance in communications or VHF field. Box 96W.

ELECTRONIC ENGINEER

B.E.E. 1943, College of the City of New York, graduate work. Age 25. Married. 2 years Army Signal Corps radar technician on pulse position modulated radar link communications equipment. 1 year microwave research experience. Desires electronics development work vicinity New York City. Box 98W.

ELECTRICAL ENGINEER

B.S. from M.I.T. in 1942. M.A. Stanford University 1946. Two years television experience with General Electric Co. Four years Navy radar officer. Age 29. Interested in research and design of radio and television equipment. Box 102W.

ENGINEER

B.S. in E.E.; N.C.E. Age 27. Married. Graduate work, Ohio State University. Three years design and development engineer on V.H.F., A.M. and F.M. receivers for Signal Corps. One and one half years with A.A.F. Aircraft Radiation Lab., Radio Remote Control and R.C.M. receiver development. Complete resume on request. Desires equivalent position in Metropolitan area. Box 104W.

ENGINEER

B.S. Chemistry, Rutgers 1941. Age 28. Married. Naval radar and year graduate work physical chemistry M.I.T. Experience includes photochemical research, instruction in electronics, electronic maintenance officer and vacuum tube manufacturing. Special training and experience in microwave spectroscopy. Seek research and/or teaching position. Box 111W.

JUNIOR ENGINEER

B.E.E. New York University. 1947. Age 23. Single. Desires work in radio electronics, or industrial electronics in Metropolitan area. Details on request. Box 112W.

(Continued on page 58A)

Dependable VHF Radio Reception



The Collins 51M-2 VHF Receiver



for Municipal Towers

Remote Operation

The many inherent advantages of very high frequency radio communication between control towers and aircraft can be realized with Collins equipment. The Collins 51M-2 VHF radio receiver for ground stations provides continuous, reliable reception on any one frequency between 118 megacycles and 136 megacycles. It can be installed in a remote location and left unattended, with all necessary control circuits and audio output connected by telephone line to the operator's position.

Million-to-One AVC Range

A carrier operated audio muting circuit is provided; thus background noises can be greatly

reduced during the absence of radio signals. The muting threshold is adjustable. Automatic volume control maintains an essentially constant audio output even though the strength of the r-f input signal varies over a million-to-one ratio.

No Spurious Responses

High sensitivity, signal to noise ratio, and rejection of spurious signals contribute to the superior performance. Use a 51M-2 for each frequency you wish to monitor. You can mount them all in a single cabinet and utilize a single antenna without interaction.

Let us send you an illustrated bulletin giving detailed specifications of this new receiver.

IN RADIO COMMUNICATIONS, IT'S . . .

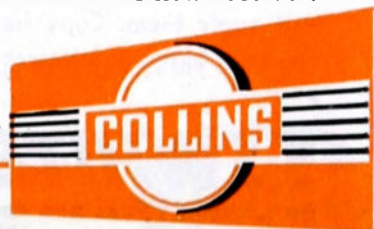

COLLINS RADIO COMPANY, Cedar Rapids, Iowa

11 W. 42nd Street, New York 18, N. Y.

458 South Spring Street, Los Angeles 13, Calif.

WHEN YOU SEE THESE SYMBOLS..

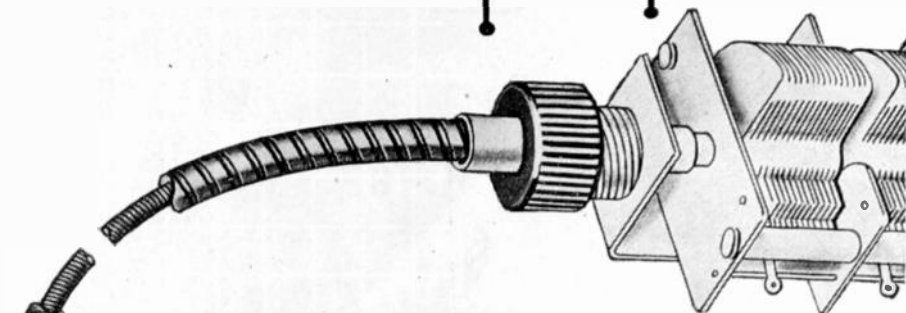
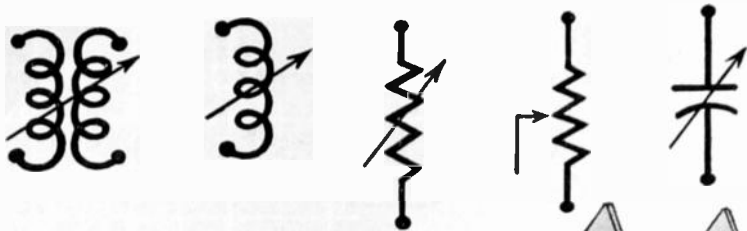

THINK OF S.S.WHITE FLEXIBLE SHAFTS

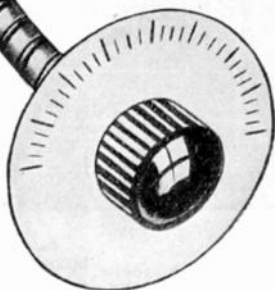

The arrow identifies these symbols as variable elements. And where there are variable elements, it pays to think of S. S. White flexible shafts. As one well-known engineer puts it—

"In electronic equipment variable elements must be strategically located for premium electrical performance. In most cases the resultant mechanical placements of these elements do not readily adapt themselves to a symmetrical front panel placement of control knobs. S.S.White flexible control shafts, as coupling between the elements and their control dials, allow us complete freedom in our mechanical and electrical design."

260-PAGE FLEXIBLE SHAFT HANDBOOK FREE TO ENGINEERS

It gives complete information and engineering data about flexible shafts and how to select and apply them. Copy free, if you write for it on your business letterhead and mention your position.



S.S.WHITE INDUSTRIAL DIVISION

THE S. S. WHITE DENTAL MFG. CO. DEPT. G 10 EAST 40th ST., NEW YORK 16, N. Y.



FLEXIBLE SHAFTS • FLEXIBLE SHAFT TOOLS • AIRCRAFT ACCESSORIES
SMALL CUTTING AND GRINDING TOOLS • SPECIAL FORMULA RUBBERS
MOLDED RESISTORS • PLASTIC SPECIALTIES • CONTRACT PLASTICS MOLDING

One of America's AAAA Industrial Enterprises

Positions Wanted

(Continued from page 56A)

ELECTRICAL ENGINEER

B.S.E.E. 1947. University of Michigan. Tau Beta Pi, Eta Kappa Nu. Navy experience in servicing test equipment, receivers and transmitters. Would like radio, television production or development. Box 122W.

ELECTRONICS AND RADIO ENGINEER

B.E.E. Drexel Institute 1936. Four years design development of radio and UHF equipment. One year bridge, oscillator, amplifier and Null detector design. Three years investigation of German electronics equipment circuit design and production methods in Germany. Box 123W.

ELECTRICAL ENGINEER

Graduate electrical engineer experienced in development and manufacture of FM and television antennas wishes to associate on an incentive basis with firm interested in manufacture of antenna line. Located in Chicago area. Box 124W.

ENGINEER

B.S.E.E. University of Pennsylvania; Graduate of training course of leading radio manufacturer; 1st class radio telegraph and radio telephone licenses. Box 125W.

ELECTRONICS ENGINEER

B.S.E.E. now completing M.S. Electronic engineer at Naval Research Laboratory, 1 year. 3 years Naval electronic officer with training at Bowdoin and M.I.T. Age 28. Married. Available October 1947. Box 126W.

ENGINEER

B.E.E. June 1948, Ohio State. Experience: 2½ years radio officer U. S. Merchant Marine; 9 months broadcast station; 7 months FM transmitter; 7 months television research. 1st class radio telephone, 2nd class radio telegraph, ham licenses. Desires electronic research or development work. Vicinity Cleveland or New York City. Box 127W.

ELECTRICAL ENGINEER

An asset to any manufacturing organization. Electrical engineer, 24, aggressive, personable, recent graduate with two years naval experience in radio, sonar, and teletype. Seeks interesting affiliation. Box 128W.

ELECTRONIC ENGINEER

Available—Registered electrical engineer, age 41. 13 years experience in estimating, supervising and procurement for electrical power construction, designing, developing and specifications for power and electronic equipment. Desire permanent position in design and development for electronic equipment with opportunity for advancement. Box 129W.

News—New Products

These manufacturers have invited PROCEEDINGS readers to write for literature and further technical information. Please mention your I.R.E. affiliation.

(Continued from page 48A)

New Improved Power Tubes

Thoriated-tungsten filaments which provide new standards of economy and performance for vacuum-tube operation have been applied to heavy-duty a.m. broadcast tubes by Federal Telephone & Radio Corp., Clifton, N. J.

Developed for use in 50-kw. broadcast transmitters, the new tubes prove that thoriated tungsten filaments can be built into tubes operating at high power levels.

Applied in pairs, the tubes are designated 9C28 and 9C30 (pictured here) in the water-cooled types, and 9C29 and 9C31 in the air-cooled types. The 9C30, designed for r.f. amplifier application at frequencies up to 20 megacycles, operates at a filament voltage of 15 volts and filament current of 135 amperes and has maximum ratings of 15,000 volts, plate voltage; 8 amperes, plate current; 120 kw. plate input; and 40 kw. plate dissipation.



Television Camera Tube

The use of television to observe dangerous operation in industry and elsewhere has been made more economically feasible with the introduction of a new small television camera tube by the Tube Department of Radio Corporation of America, Harrison, N. J.



Two inches in diameter, the new tube is claimed to have greater sensitivity and signal output than previous iconoscopes of this size. It provides a satisfactory picture when the light on the subject to be televised is 500 to 1000 foot candles, which is roughly equivalent to the light now used in present studio telecasting and which can be obtained with three 200-watt lamps placed four feet from the subject.

(Continued on page 60A)

SHURE Proudly Presents

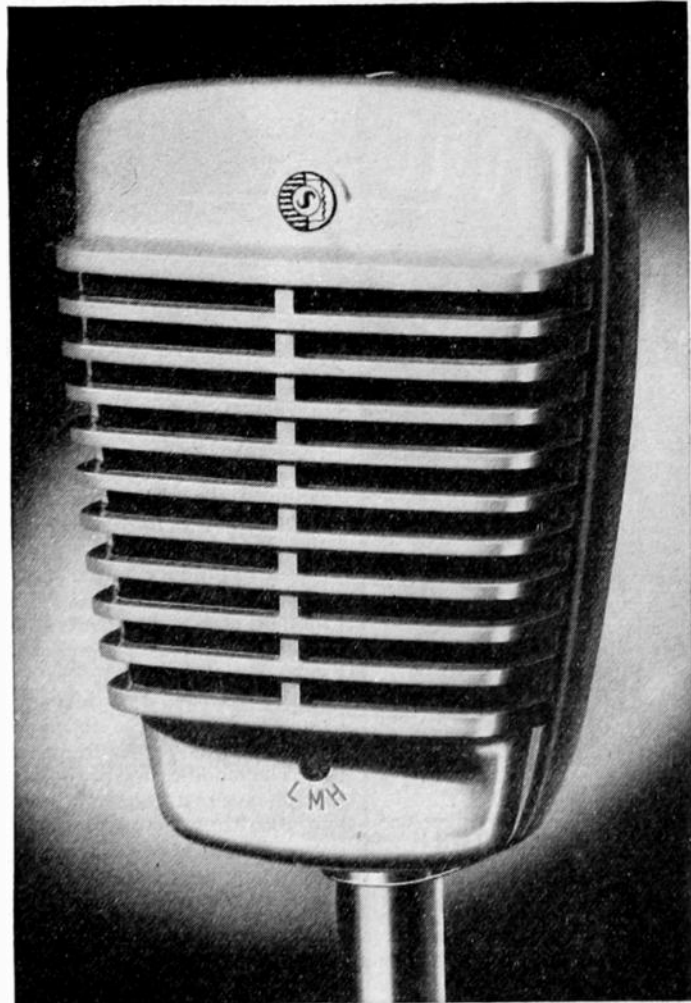

SONODYNE

A MULTI-IMPEDANCE DYNAMIC MICROPHONE

Here is *the* microphone in its class—a high output dynamic that was designed to out-sell . . . out-perform . . . out-smart even higher-priced microphones. The Model 51 Sonodyne features a multi-impedance switch for low, medium, or high impedance—plus a high output of 52 db below 1 volt per dyne per sq. cm. It has a wide-range frequency response (up to 9000 c. p. s.) and semi-directional pickup.

SONODYNE—Model 51—List Price \$31.00—Code: RUSON

Shure Patents Pending

SHURE BROTHERS, Inc.

Microphones and Acoustic Devices

225 West Huron Street Chicago 10, Illinois

Cable Address: SHUREMICRO



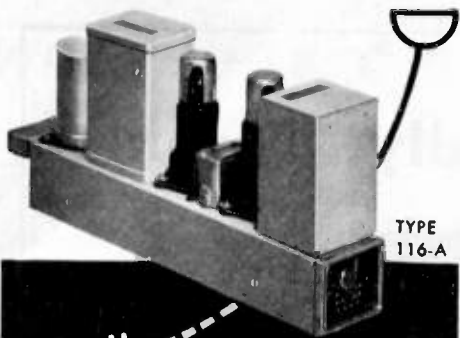

TYPE 116-A

FROM
MICROPHONE
TO LINE

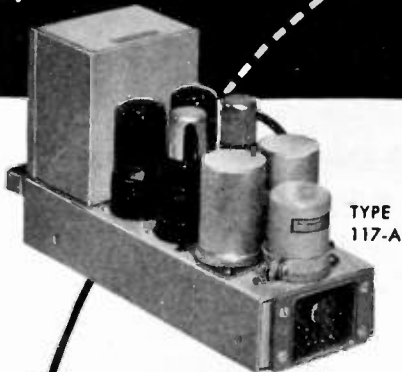

TYPE 117-A

● YOU NEED

Only two types of PLUG-IN amplifiers... Type 116-A as a pre-amplifier or booster... Type 117-A as a program amplifier, monitor, or booster.

Only two types of tubes, 1620's and 6V6GT's.

● YOU SAVE

By conserving rack space.
By simplified maintenance... Just PLUG-IN a spare amplifier should trouble occur.

● YOU HAVE QUALITY

These amplifiers are built to the Langevin standard of high quality performance... They exceed the FCC specifications for FM.

The complete story of "PLUG-IN Amplifiers by Langevin" is ready for you now in booklet form... write for it today.



The Langevin Company
INCORPORATED

SOUND REINFORCEMENT AND REPRODUCTION ENGINEERING
NEW YORK: 39 W. 65 ST. 23 • SAN FRANCISCO: 1050 HOWARD ST. 3
LOS ANGELES: 1000 N. SEWARD ST. 38

News—New Products

These manufacturers have invited PROCEEDINGS readers to write for literature and further technical information. Please mention your I.R.E. affiliation.

(Continued from page 59A)

Model M-275 Converter



This new i. f. converter has been announced by Measurements Corp. of Boonton, N. J., for use in conjunction with the Model 78-FM standard-signal generator to produce output in the i. f. range. The converter uses the beat-frequency method of signal generation and provides output voltages of 10 microvolts to 1.0 volts, variable with the 78-FM attenuator, in the 4.5 Mc., 10.7 Mc., and 21.7 Mc. ranges. Provision has been made for the addition of one extra frequency.

The modification of the Model 78-FM, which covers a frequency range of 86 Mc to 108 Mc., for use with the M-275 is very simple as all necessary connections are made externally. When companion units are ordered, the Model 78-FM is modified at the factory; otherwise complete instructions and materials are provided for this operation.

Plant Expansions

- At 170-53rd St., Brooklyn, N. Y., by Air King Products Co., Inc., for production of radios and to provide additional offices and showrooms.
- At Anaheim, Calif., by General Electric Co., for the manufacture of glyptal alkyd resins, basic ingredients for paints, enamels, and other surface finishings.
- At Schenectady, N. Y., by the Mica Insulator Co., for the fabrication of mica insulation used in electronic equipment.
- At 2160 East Imperial Highway, El Segundo, Calif., by Selenium Corp. of America, an affiliate of Vickers, Inc., for the manufacture of selenium power and instrument rectifiers and self-generating photoelectric cells.
- At 4633 West 16th St., Chicago 50, Ill., by Sola Electric Company, to consolidate all its plants. This company produces transformers and automatic voltage regulators.
- At Stirling, N. J., by the Sound Apparatus Co., for the manufacture of graphic level recorders for acoustical and electrical measurements.

(Continued on page 61A)

MICRODIMENSIONAL
WIRE & RIBBON
FOR VACUUM TUBES



Wires drawn to .0004" diameter.

Ribbon rolled to .0001" thickness.

Special Alloys for individual requirements.

WRITE for list of stock alloys.

SIGMUND COHN & CO.

44 GOLD ST. NEW YORK

SINCE 1907



News—New Products

These manufacturers have invited PROCEEDINGS readers to write for literature and further technical information. Please mention your I.R.E. affiliation.

(Continued from page 60A)

New Panel Meter

With more usable scale space and a good-looking plastic case, a new panel meter is offered by Assembly Products, Inc., Chagrin Falls, Ohio, for use on 3 1/2" panel instruments.

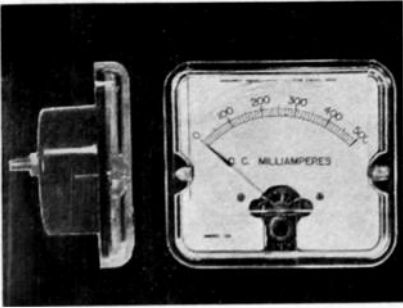

The meter is readily illuminated from the front or rear. Light played on the back of the case will pipe through the plastic to cast soft illumination on the dial, which can be finished in colors to harmonize with the equipment on which it is used.

The unbreakable front case houses a shock-resistant movement with polished pivot bearings and vee jewels. Both moving-coil and repulsion-iron-vane elements can be supplied. These meters are also built in rectifier-type and thermocouple high-frequency and pyrometer instruments. All popular ranges of volts and millivolts, as well as milliamperes and amperes, both a.c. and d.c., are furnished.

Improved Attenuators

The Daven Company of 191 Central Ave., Newark 4, N. J., announced recently another new feature in its line of attenuators.

Oilite bearings are now being supplied on standard units. Two such bearings are

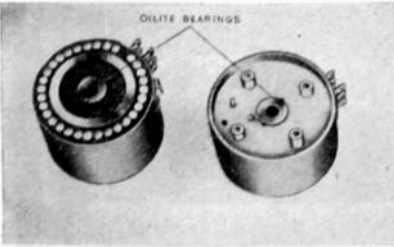

provided on each unit, one at the switch and the other at the shaft. Because of the inherent characteristics of oilite the bearings are permanently lubricated, and during the life of an attenuator in normal service no oiling or greasing will be required.

(Continued on page 62A)

GANGING SIMPLICITY

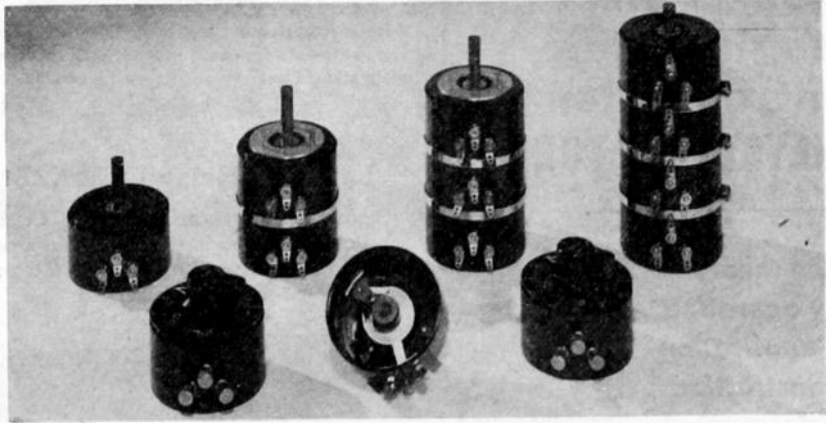

TOP: Type RVS Resistor . . . note clean design, simplicity of ganged assemblies. No need for mounting plates or spacers. Easily adjusted. BOTTOM CENTER: View of interior of resistor. BOTTOM LEFT AND RIGHT: Type RVL3 for experimental laboratories . . . direct reading.

TIC PRECISION VARIABLE RESISTORS

- Dust Proof . . . for improved performance
- Precious Metal Contacts . . . for reliability, long life
- Reliable Rotor Take-off Assembly . . . for ease of maintenance
- Adjustable Stop—360-Degree Rotation . . . for operating ease
- Adjustable Contact Pressure . . . insures correct contact

Write TODAY for full particulars and specifications.

Engineering Representatives:
 Chicago: 1024 Superior Street, Oak Park, Illinois
 Phone: VILlAge 9245
 Hollywood: 623 Guaranty Building, Hollywood 28, California
 Phone: HOLLYwood 5111

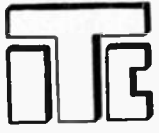

TECHNOLOGY INSTRUMENT CORP.
 1058 MAIN ST., WALTHAM 54, MASSACHUSETTS

NEY

Precious Metal Alloys

for
 ELECTRICAL CONTACTS ON POTENTIOMETERS
 SLIP RINGS, RELAYS AND SWITCHES

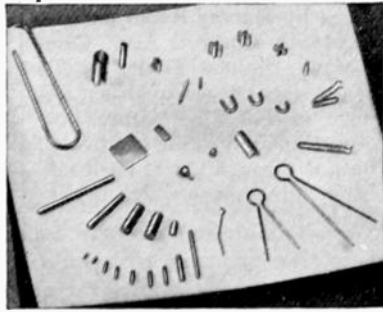

Standard Ney precious metal alloys with accurately defined properties are now available for prompt delivery in commercial quantities, and our Research Laboratory is ideally equipped to develop and test other special alloys to meet your rigid specifications.

PALINEY #7

SLIDING CONTACTS FOR POTENTIOMETERS

PALINEY #7 is being used for a contact material on potentiometers wound with a nickel-chrome alloy resistance wire. This combination is consistently producing units with life of better than one million cycles and maintained accuracy of 0.1% or better throughout the life of the unit.

NEY-ORO #28

SLIP RING BRUSHES

NEY-ORO #28 is a special alloy developed as a contact brush material for uses against coin silver slip rings. Laboratory tests and reports from users indicate life of better than 10 million revolutions with no electrical noise.



Write or telephone (Hartford 2-4271) our Research Department.

THE J. M. NEY COMPANY 171 ELM STREET • HARTFORD 1, CONN.
 SPECIALISTS IN PRECIOUS METAL METALLURGY SINCE 1812

Now—a clear engineering introduction to KLYSTRON TUBES

- theory
- operation
- application
- construction
- performance



This authoritative book provides electronic engineers, radio technicians, and others, with a sound working knowledge of both the operating principles and practical applications of klystron tubes. It supplies the bulk of the answers to your questions concerning methods of construction—performance characteristics—testing techniques, etc.—and shows how these tubes may be used as oscillators, amplifiers, frequency multipliers, and detectors or mixers.

Just Published

KLYSTRON TUBES

by A. E. Harrison

Former Klystron Applications Engineer,
Sperry Gyroscope Co.

271 pages, 6x9, 139 illustrations, \$3.50

Here is a clear explanation of how the process of velocity modulation enables the electronics engineer to transform electrical energy into radio frequency energy—and how this principle is applied to klystrons. Among the helpful features of the book are useful design charts, and much valuable new data on multiple resonator tubes and modulations.

14 helpful chapters including:

Klystron Construction	ment Techniques
Klystron Amplifiers	Klystron Frequency Multipliers
Modulation of Klystrons	Cavity Resonators
Electron-Bunching Theory	Reflex Oscillators
Klystron Operation	Klystron Power Supplies
Microwave Measure-	

SEE IT 10 DAYS—MAIL COUPON

McGraw-Hill Book Co., 330 W. 42nd St.,
New York 18

Send me Harrison's Klystron Tubes for 10 days' examination on approval. In 10 days I will send \$3.50, plus a few cents postage, or return book postpaid. (Postage paid on cash orders—same return privilege.)

Name

Address

City and State

Company

Position IRE-9-47

For Canadian price, write: McGraw-Hill Co. of Canada Ltd., 12 Richmond St. E., Toronto 1

News—New Products

These manufacturers have invited PROCEEDINGS readers to write for literature and further technical information. Please mention your I.R.E. affiliation.

(Continued from page 61A)

Latching Relay 6FZ2A2B

Sigma Instruments, Inc., of 70 Ceylon St., Boston, Mass., have announced a new multicircuit switching relay of the latching type, known as the 6FZ series.

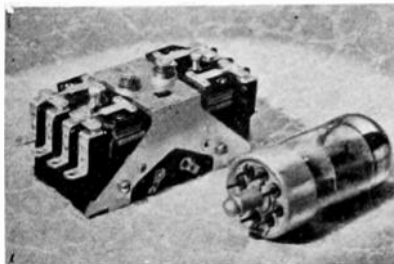

As the entire moving system is dynamically balanced, while operating with detent forces of over 200 inch-grams, an exceptional freedom from effects of vibration and shock is attained. Mechanical life well up into the millions of operations is claimed for these relays.

Individual switch positions carry a nominal rating of 5 amperes at 110 volts a.c. or 24 volts d.c., although actual ratings vary with life requirements and character of load. Contacts may be ganged or arranged in pairs for a maximum of four double-break circuits.

H.F. Signal Generator

Announced by Harvey Radio Laboratories, Inc., 456-A Concord Ave., Cambridge 38, Mass., the new Model 196 TS high-frequency signal generator has a frequency range of 140 Mc. features low leakage (approximately 0.2 microvolt), constant output through use of feedback, and an output adjustment which is calibrated directly in db.

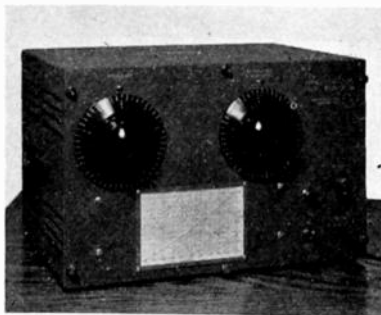

Since the output is constant over the frequency range of the instrument and independent of line-voltage variations of $\pm 10\%$, the signal generator simplifies the process of taking response curves as it is not necessary to reset the carrier level when the frequency or attenuator settings are changed.

(Continued on page 64A)



A Few of the Products
Supplied to the
Electronic Industry . . .

- ★ PRESSURIZED CONNECTORS
- ★ WATERPROOF CONNECTORS
- ★ COAXIAL AND MINIATURE CONNECTORS
- ★ PULSE CONNECTORS
- ★ WIRING HARNESSES
- ★ VHF MOBILE ANTENNAS
- ★ CABLE ASSEMBLIES
- ★ WATERPROOF CABLE CLAMPS

H. H. BUGGIE & CO.
TOLEDO 1, OHIO

LORAN BY RCA

Available Now for Commercial Aircraft

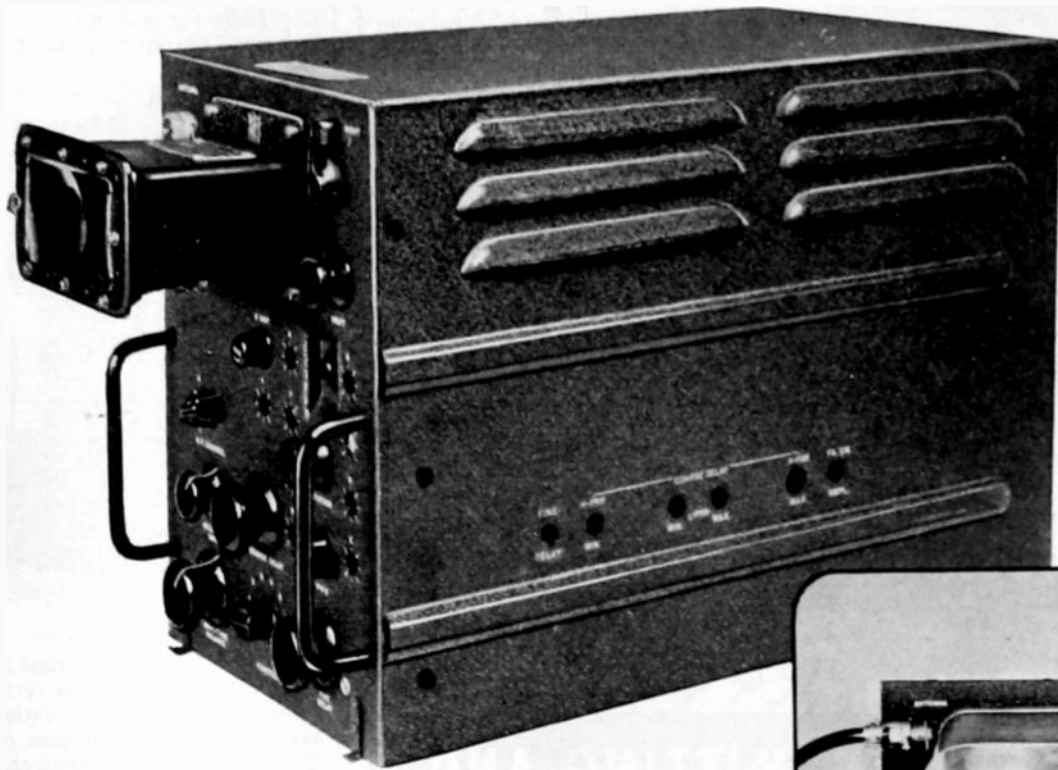

RCA, basic designer of all air-borne LORAN equipment used in this country and largest producer of LORAN for military installation, now makes this modern aid to navigation available for commercial aircraft.

Well proved under the severest conditions of wartime usage the RCA AVR-26 LORAN embodies even further refinements for peacetime application. Weighing only 35 pounds this compact unit provides the ultimate in accurate long-range navigation—precision fixes when clouds make celestial shots impossible and severe static prevents the taking of aural bearings.

LORAN is fast, too—a fix can be taken in less than a minute. Power consumption is low, and mounting space is comparatively small—the AVR-26 measures only 10½" high, 8" wide, and 15½" deep.

If you have a problem in long-range navigation it's very likely you'll find the answer in LORAN. For further details write today to Aviation Section, Dept. 67-1, Radio Corporation of America, Camden, New Jersey.

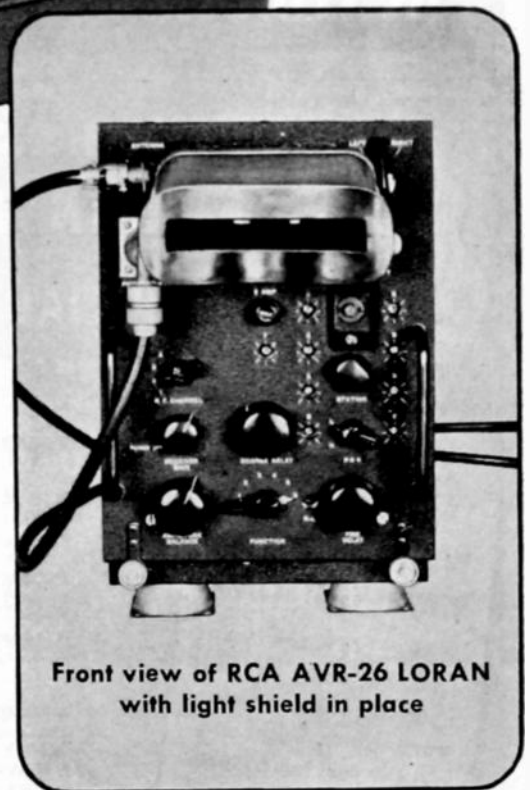

Front view of RCA AVR-26 LORAN with light shield in place



AVIATION SECTION
RADIO CORPORATION of AMERICA
ENGINEERING PRODUCTS DEPARTMENT, CAMDEN, N.J.

In Canada: RCA VICTOR Company Limited, Montreal

FOR LOW HUM... HIGH FIDELITY

SPECIFY KENYON TELESCOPIC SHIELDED HUMBUCKING TRANSFORMERS

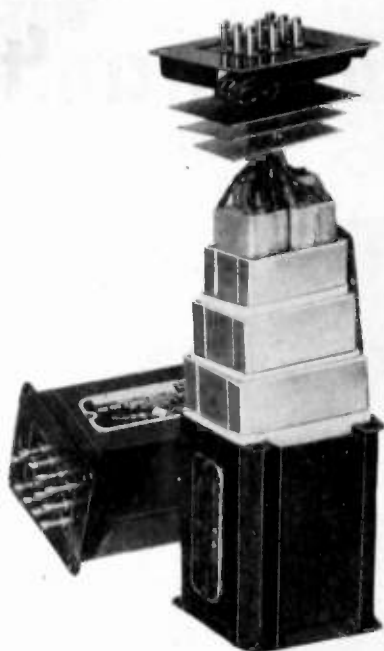

For low hum and high fidelity Kenyon telescoping shield transformers practically eliminate hum pick-up wherever high quality sound applications are required.

✓ CHECK THESE ADVANTAGES

- ✓ **LOW HUM PICK-UP** . . . Assures high gain with minimum hum in high fidelity systems.
- ✓ **HIGH FIDELITY** . . . Frequency response flat within ± 1 db from 30 to 20,000 cycles.
- ✓ **DIFFERENT HUM RATIOS** . . . Degrees of hum reduction with P-200 series ranges from 50 db to 90 db below input level . . . made possible by unique humbuckling coil construction plus multiple high efficiency electromagnetic shields.
- ✓ **QUALITY DESIGN** . . . Electrostatic shielding between windings.
- ✓ **WIDE INPUT IMPEDENCE MATCHING RANGE.**
- ✓ **EXCELLENT OVERALL PERFORMANCE** . . . Rugged construction, lightweight—mounts on either end.
- ✓ **SAVES TIME** . . . In design . . . in trouble shooting . . . in production.

Our standard line will save you time and money. Send for our catalog for complete technical data on specific types.

For any iron cored component problems that are off the beaten track, consult with our engineering department. No obligation, of course.

KENYON TRANSFORMER CO., Inc.

840 BARRY STREET NEW YORK, U. S. A.

News—New Products

These manufacturers have invited PROCEEDINGS readers to write for literature and further technical information. Please mention your I.R.E. affiliation.

(Continued from page 62A)

Polar Co-ordinate Cathode-Ray Indicator

Designed for studying all types of rotating machinery and for plotting phenomena on a circular time base, the new Type 275-A Polar Co-ordinate Cathode-Ray Indicator is announced by Allen B. DuMont Laboratories, Inc., Clifton, N. J.



The use of a circular time base for the presentation of data has certain advantages, such as: (1) the continuous time-base results in no lost time on retraces; (2) a given spot position on the time base corresponds to the same space phase, or rotation angle, regardless of speed; (3) presentation corresponds to methods customarily used in study of rotating machinery.

This instrument is designed for use in laboratory or field and is readily transportable by car. Its weight is approximately 65 pounds. Dimensions are 17" high, 19½" deep, and 10½" wide.

Recent Catalogs

• • • On mica capacitors, by Aerovox Corp., New Bedford, Mass. Write for pages 30A and 30B for insertion in Transmitting Capacitor Catalog.

• • • On facsimile, by Alden Products Co., Brockton 64, Mass. "The Brown Book" is a file to which may be added catalog sheets and facsimile data.

• • • On "Bridge-Meg" insulation and resistance testers, by James G. Biddle Co., 1316 Arch St., Philadelphia 7, Pa. Bulletin 21-60.

• • • On relays, by C. P. Clare & Co., 4719 West Sunnyside Ave., Chicago 30, Ill. An illustrated 48-page Engineering Data Book

• • • On an f.m. modulator-exciter, by Columbus Electronics, Inc., 229 So. Waverly St., Yonkers, N. Y. Bulletin P-1 on Model FMO-428.

(Continued on page 66A)

TRANSMITTING AND SPECIAL PURPOSE TUBES

HUGE
STOCKS!

WRITE FOR
NEWARK'S LIST OF TUBES

Make Newark your source, too, for all needed radio and electronic parts. Brisk, competent service assures quick delivery.

"IT'S A PLEASURE

... to do business with NEWARK!" So say hundreds of outstanding men in the Radio and Electronic Field. And here's why:

- **COMPLETE STOCKS OF ALL STANDARD MAKES**, on hand at all times.
- **CONVENIENTLY LOCATED** — Three great stores and warehouses centrally located in N. Y. C.
- **INDUSTRIAL DEPT**—staffed by technical men who specialize in Industrial requirements.
- **NEWARK IS WAA AGENT**—Acting under contract WAS(p)7-167, for distribution of TRANSMITTING & SPECIAL PURPOSE TUBES—largest stocks at lowest prices—for immediate delivery!

• MAIL AND PHONE ORDERS FILLED PROMPTLY

• WRITE: 242-N WEST 55th STREET, NEW YORK CITY

NEW YORK
Offices & Warehouse
242 W. 55th St., N.Y. 19

NEWARK TELEPHONE
Circle 6-4060
ELECTRIC COMPANY, INC.

New York City Stores: 115-17 W. 45th St. & 212 Fulton St.

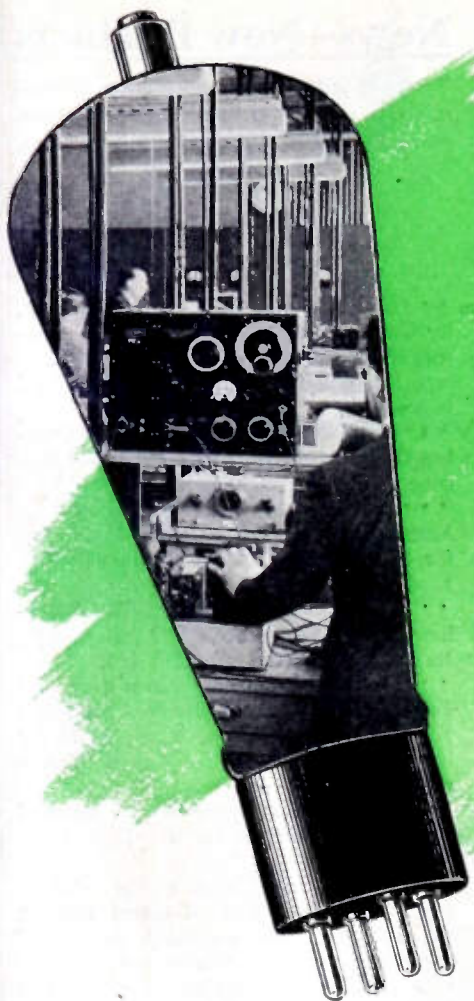

Foreseeing

Unforeseen Events via Electronics Research

No guess-monger and no axe-grinder is the Sherron laboratory scientist. He is concerned solely with the logical tasks of research. There are those who postulate the imminence or remoteness of threats to our national security. But the Sherron scientist digs in, striving to develop electronic techniques and applications in anticipation of tomorrow's surprises. He is strictly a scientist, doing a strictly scientific job. At his command in the Sherron laboratory is the finest and most advanced electronics equipment. At his side are Sherron mathematicians, physicists and engineers of the first rank.

SHERRON LABORATORY PROJECTS COVER . . .

1. Ultra and Hyper High Frequency Techniques
2. Electron Ballistics
3. Thermionic Emission
4. High Vacuum Electronic Tubes Techniques
5. Radar: (Detection — Navigation)
6. Electronic Control for Drone and Guided Missiles

SHERRON MEANS RESEARCH IN ELECTRONICS

SHERRON ELECTRONICS CO.

Division of Sherron Metallic Corporation

1201 FLUSHING AVENUE • BROOKLYN 6, NEW YORK



These manufacturers have invited PROCEEDINGS readers to write for literature and further technical information. Please mention your I.R.E. affiliation.

Recent Catalogs

(Continued from page 64A)

••• On radios and electronic equipment, by **Concord Radio Corp.**, 901 West Jackson Blvd., Chicago 7, Ill., or 265 Peachtree St., Atlanta 3, Ga. Catalog 447, 72 pages.

••• On Silicone insulation, by **Dow Corning Corp.**, Midland, Mich. Write for Silicone Notes No. B-30-1.

••• On a button-control floor stand, by **Electro-Voice, Inc.**, Buchanan, Mich. Ask for Bulletin No. 134 on the new Utility Model 430.

••• On graphic meters, by **The Esterline-Angus Co., Inc.**, P.O. Box 596, Indianapolis 6, Ind. Catalog 446.

••• On multichannel transmitters, by **Federal Telephone & Radio Corp.**, 100 Kingsland Rd., Clifton, N. J. Write for booklet, "Three Multi-Channel Transmitters."

••• On permanent magnets, by **General Electric Company**, Metallurgy Div., Pittsfield, Mass.

••• On laminated plastics, by **Plastics Div., Chemical Dept., General Electric Co.**, 1 Plastics Ave., Pittsfield, Mass.

••• On transmitting and special purpose tubes, by **Hytron Radio & Electronics Corp.**, 76 Lafayette St., Salem, Mass. Also ask for Hytron Reference Guide for Miniature Electron Tubes.

••• On circuit protection items, by **Littelfuse, Inc.**, 4757 Ravenswood Ave., Chicago 40, Ill. Catalog No. 9 includes a brief historical survey of fusing.

••• On microphones and phonograph pickups, by **Shure Bros.**, 225 West Huron St., Chicago 10, Ill. Ask for Catalog 157 illustrating microphones and Catalog 158 on pickups and replacement cartridges.

Cable Type Transformers

The **Amperite Company**, 561 Broadway, New York 12, N. Y., has announced a new cable-type input transformer, pictured below, which can be used for coupling low-impedance microphone to the standard high-impedance amplifier input. The manufacturer claims that special shielding eliminates hum pickup from stray fields.

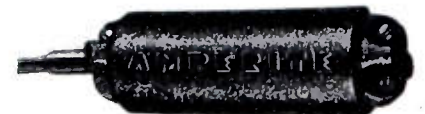

Frequency response is 50 to 12,000 c.p.s. plus or minus 2 db. Its use permits running microphone lines up to 5,000 feet with practically no loss in output or frequency response.

(Continued on page 68A)

Step by Step

Engineering

Tooling

Machining

Painting

Electroplating

Assembling

PAUL and BEEKMAN, Inc. performs a complete service in producing metal stampings

You need a lot of things to produce metal stampings efficiently at low cost. Skilled personnel . . . the right presses . . . organized planning . . . you need them all.

And Paul and Beekman, Inc., has them—plus plenty of experience. We make all types of stampings . . . large or small, simple or complex. We make them from mild or stainless steel, aluminum, copper and brass, painted or electroplated if required. We make them fast, at a cost that can help you remain competitive.

Many manufacturers have found it profitable to use our step by step service. Let us tell you how it might be applied in your case. Write for descriptive literature.

PAUL and BEEKMAN, Inc.
Eighteenth & Courtland Sts. Philadelphia, Pa.
Subsidiary of PORTABLE PRODUCTS CORPORATION

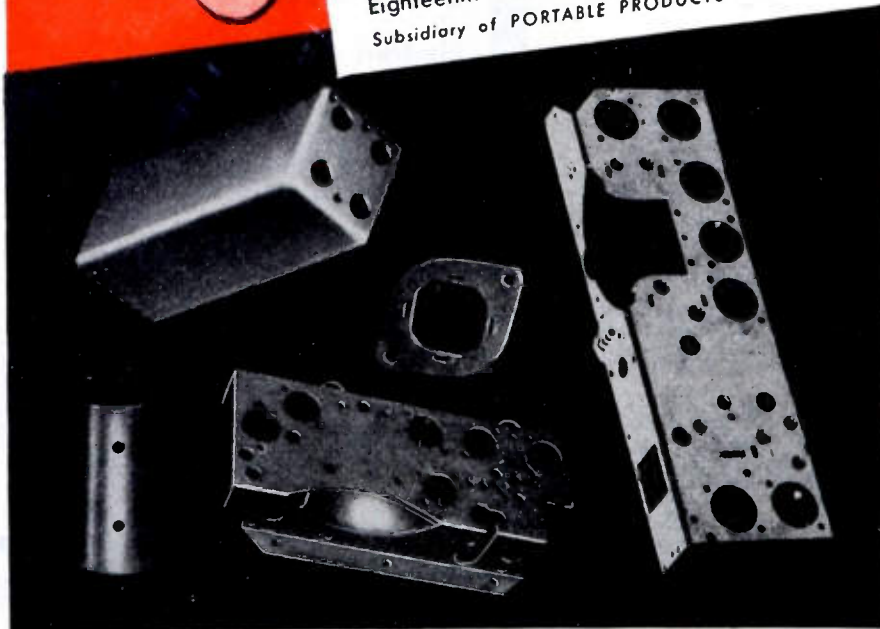

Just roll it open!

SIMPSON Model 260 Volt-Ohm Milliammeter ... with Roll Top Safety Case*

• The world's finest high sensitivity set tester certainly deserves the best in carrying cases. So we decided to give it just that by *building* the tester into the case to make an integral unit of case and instrument. Here's how we do it: we take the standard Model 260, place it inside a housing of heavily molded bakelite, and permanently fasten it there. Instrument and case become one unit. Beneath the instrument is a compartment for test leads. Over the face of the instrument a roll top (of molded bakelite, too) slides up to open, down to close, the case. With a flick of the

finger you roll it up and out of sight and the instrument is ready to carry, and fully protected. With the Roll Top Safety Case you cannot leave your carrying case behind. It is never in the way. And you have *constant, important protection to your 260 from damage, whether in use or not.*

Just remember this fact, always: You cannot touch the precision, the useful range, or the sensitivity of Simpson Model 260 in any other instrument of equal price or in some selling for substantially more.

*The regular Model 260, without Roll Top Safety Case, is always available, of course.



Simpson 260, High Sensitivity Set Tester for Television and Radio Servicing

At 20,000 Ohms per volt, this instrument is far more sensitive than any other instrument even approaching its price and quality. The practically negligible current consumption assures remarkably accurate full scale voltage readings. D.C. current readings as low as 1 microampere and up to 10 amperes are available.

Resistance readings are equally dependable. Tests up to 20 megohms and as low as 1/2 ohm can be made. With this super sensitive instrument you can measure a wide range of unusual conditions which cannot be checked by ordinary servicing instruments.

Model 260—Size 5 1/4" x 7" x 3 1/8" \$38.95

Model 260, in Roll Top Safety Case—Size 5 3/8" x 9" x 4 3/4" \$43.75

Both complete with test leads

Volts D.C. (at 20,000 ohms per volt)	Volts A.C. (at 1,000 ohms per volt)	Output	Milliamperes D.C.	Microamperes D.C.	Ohms
2.5	2.5	2.5 V.	10	100	0-2000 (12 ohms center)
10	10	10 V.	100		0-200,000 (1200 ohms center)
50	50	50 V.	500		0-20 megohms (120,000 center)
250	250	250 V.		Amperes	
1000	1000	1000 V.		D.C. (5 Decibel ranges: -10 to +52DB)	
5000	5000	5000 V.		10	





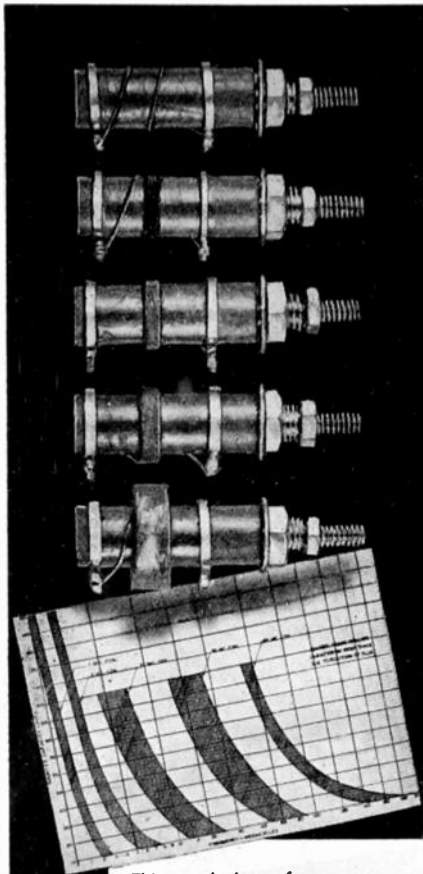

SIMPSON ELECTRIC COMPANY
5200-5218 West Kinzie Street, Chicago 44, Illinois
In Canada, Bach-Simpson Ltd., London, Ont.

Simpson
INSTRUMENTS THAT STAY ACCURATE

ASK
YOUR
JOBBER



This graph shows frequency ranges covered by each unit. Write us for your full-size copy.

-  Turret Lug
-  Split Lug
-  Double-end Lug
-  Swager
-  Terminal Board
-  HPB Crystal

Five Standard Slug-Tuned LS3 Coils Cover 1/2 to 184 mc

For strip amplifier work, the compact (1 1/8" high when mounted) LS3 Coil is ideal. Also for Filters, Oscillators, Wave-Traps or any purpose where an adjustable inductance is desired.

Five Standard Windings—1, 5, 10, 30 and 60 megacycle coils cover inductance ranges between 750 and 0.065 microhenries.

CTC LS3 Coils are easy to assemble, one 1/4" hole is all you need. Each unit is durably varnished and supplied with required mounting hardware.

SPECIAL COILS

CTC will custom-engineer and produce coils of almost any size and style of winding... to the most particular manufacturer's specifications.

Consult CTC for Three-Way Component Service

Custom Engineering... Standardized Designs...
Guaranteed Materials and Workmanship
CAMBRIDGE THERMIONIC CORPORATION
456 Concord Avenue, Cambridge 38, Mass.

News—New Products

These manufacturers have invited PROCEEDINGS readers to write for literature and further technical information. Please mention your I.R.E. affiliation.
(Continued from page 66A)

New Test Jig for Variable Capacitors



This test jig, developed by Airadio, Inc., of Stamford, Conn., consists of a dual modified Schering bridge with built-in minimum compensators. The dual bridge arrangement permits, simultaneously, the electrical indexing of the oscillator section and the tracking of the antenna section. Since this is done without switching or clip-lead changes, the gain in accuracy is obvious. The bridge is sensitive to capacitance changes of 0.1 MMfd. The manufacturer claims it can be calibrated to plus or minus 0.1 MMfd. and will retain its calibration to plus or minus 0.3 MMfd. for four hours despite large changes in temperature and humidity.

Crystal cartridge



A new PN high-temperature crystal phonograph pickup cartridge has been proven by demonstration to withstand great heat, as shown in the boiling process illustrated above. After boiling 10 minutes, being removed, and slipped into the arm of the new Brush pickup, it was demonstrated to be unharmed.

This new crystal cartridge, known as BR-903, is manufactured by The Brush Development Company, 3405 Perkins Ave., Cleveland 14, Ohio.

(Continued on page 70A)

"TAB"

That's A Buy



TESTSET 268U CRYSTAL RECTIFIER CHECKER

TESTS CRYSTALS IN21, 21A, 21B, 23, 23A, 23B, 25 & OTHERS—WESTON Multifloored English reading scale on 3/4" Sq. Bakelite MTR Tester checks forward & back resistance in Kilohms & back current. Checks British crystals. Tester comes complete in crackle finish. Navy case Alum-case 3H6W7" L. Wt. 3 Lbs. Spare parts, gasket, etc. Waterproof. INSTRUCTIONS, manual Battery included. Packed for overseas shipment. Navy Insp (G'cost \$125) Gtd NEW.

SPECIAL \$15.95

CRYSTAL DIODES IN21 ea 45¢ THREE for \$1.00
SYLVANIA IN34 ea \$1.39TWO for 2.40
WE IN23 & IN28 ea \$1TWO for 1.50
VACUUM 200KC STD 0.1% accy 5.95

TRANSF 115V/60cprl, See 15000V/35ma doubler, non grided sec. \$15.95
TRANSF 115V/400&60cy, Sec 8800V/15ma 9.95
TRANS 115V/60cprl, See 2500V/12ma (CSD) 5.95

FOXBORO STRIP RECORDER with 110V/60cy motor Mech & Elec recording \$39.95
LABORATORY RF SIG-GENERATOR I-126 2 ranges 15 to 25 & 180 to 230 Mc's accurately calibrated attnor precision control. Complete 115V/60cy—OAK CASE ... \$89.95

MICROSWITCHES TWO for 39¢ ...TEN for \$1.49
Storage battery Willard/2V non-spill \$1.98
..... TWO for 2.98
GYRO SERVO UNIT BENDIX NEW 4.95
C US for Radar Plumbing at plumbing prices

WE ARE SPECIALISTS IN SUPPLYING MATERIAL FOR GOVERNMENT CONTRACTS. WE STOCK ALL PARTS. MANY ARE S.C. AN & NAVY INSPECTED. IT WILL PAY YOU TO C "TAB" FOR YOUR REQUIREMENTS.

RAYTHEON VOLTAGE REGULATOR 115V/.58 Amp one half 1% Regulation 95-115V/60cympt \$10.95

RAYTHEON VOLTAGE REGULATOR 220V/500Watts 0.5 of 1% Regulation 198 to 140V/50-60 cycles input, case tropicalized \$39.95

PRECISION RESISTORS 1% W.E., IRC, SHALL-CROSS ETC.
95000 100000 120000 130000 147000
150000 166750 201000 229000 250000
500000 570000 600000 @ 60¢TEN for \$5.00
ONE MEG WW 1% accy each 90¢ THREE for \$2.00
C "TAB" FOR PRECISION RESISTORS OVER TWO MILLION IN STOCK

Vacuum Condors 50MMF/7500V @ \$2.95;
100MMF \$4.95
50MMF/2000V @ \$6.95;
Mica 25MMF/10000V75
WSTGHSE 3 1/2" Sq DB Mtr minus 10 plus
6 DB 4.95



Autosyns Bendix

DIEHL, ELECTROLUX, HOBART MFGRS: TO RIGID ORDNANCE & NAVY SPECIFICATIONS Brand new gov't sealed and inspected packed in overseas cans. Synchro-transmitters AC 115V.6 cy operation. Continuous heavy duty. Precision accuracy made for gun-fire control. Cost gov't \$90 each. Wgt 5 lbs. Dimensions 4 1/2" L. 3 1/4" Dia Shaft 5/16 dia 7/8" L. SPECIALTWO FOR \$18.00

SYNCHRO-DIFFERENTIAL 115V/60cy for Precision accy when used with above units \$6.95

BENOIX AC SYNCHRONOUS REPEATER TYPE II 115V/60cy bronze. TWO FOR \$18.00

AUTOSYN TYPE 5/50V can be used 110/60cy Same specs as TOPTWO FOR \$8.95

SYNCHRO DIFFERENTIAL 50V \$3.95

AIRCRAFT AUTOSYNS AY1 & 3/28V/400cy can be used 24V/60cy used gtdTWO FOR \$3.95

\$2 Min. order FOB N.Y.C. Add Postage all orders and 25% deposit. Worth 2-7230. Send for catalog 99 Specialists in International Export. School, College & Industrial trade. Moneyback "TAB" Guarantee.

"TAB", Dept. K-9 Room 200
Six Church Street, New York 6, N.Y.
Corner Church & Liberty Sts.

Airtron

FLEXAGUIDE



IMPROVED FLEXIBLE WAVEGUIDE

Army-Navy approved, electrical properties equivalent to rigid brass waveguide with constant PSWR's throughout the flexing cycle. In a position to supply all sizes and invite your inquiries.

Airtron

DESIGNS and PRODUCES

Electronic and Aircraft Components

650 Bloomingdale Road, Pleasant Plains
Staten Island 9 New York

AS GOOD AS IT LOOKS



MODEL S20X

WITH SLIDE-LOCK SWITCH AS ILLUSTRATED AT SLIGHT EXTRA COST

ALL THESE FEATURES AT LOW COST

- ★ Metolseol crystal
- ★ High level: 54db below 1 volt/dyne/sq. c.m.
- ★ Smooth response: \pm 5db from 50-7000 c.p.s.
- ★ Corrosive resistant aluminum diaphragm
- ★ Convenient, light weight
- ★ Modern styling
- ★ Turner quality

Microphones BY TURNER

It's the new Turner Model S20X Hand Microphone for home recording, public address and amateur work. Beautifully finished in rich baked brown enamel. Light in weight and convenient to use. Fits the hand perfectly, hangs on a hook when not in use.

Its performance is the kind you expect in a microphone costing three times as much. Response to voice and music pickups is smooth and flat over the most desired frequency range. Level is exceptionally high. The entire circuit is shock mounted to withstand rough treatment and is equipped with barometric compensator.

SEND NOW FOR BULLETIN

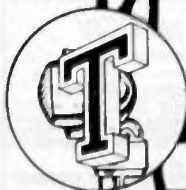

THE TURNER COMPANY

909 17th Street N.E. • Cedar Rapids, Iowa

TURN TO TURNER FOR SOUND PERFORMANCE

CRYSTALS LICENSED UNDER PATENTS OF THE BRUSH DEVELOPMENT CO

"A Well Known Name in Radio for Over 25 Years"

NO. 4
OF A SERIES

Carter
...instant power for
GENERAL ELECTRIC
30 w Transmitter

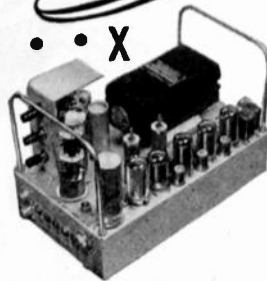

• X marks the spot where INSTANT power starts (in 3/10 second) from the CARTER GENERATOR employed in GENERAL ELECTRIC'S 30 watt, 30-40 mc transmitter. Another example where leading communication manufacturers specify CARTER for reliable power. Only CARTER GENERATOR is guaranteed to deliver over 100,000 service-free transmissions. Write for catalog.

Carter Motor Co.
Chicago, Illinois

2645 N. MAPLEWOOD AVENUE • CABLE: GENEMOTOR

News—New Products

These manufacturers have invited PROCEEDINGS readers to write for literature and further technical information. Please mention your I.R.E. affiliation.
(Continued from page 68A)

Portable Vacuum-Leak Detector

Illustrated below is a new portable, high-sensitivity leak locator manufactured by the Tube Division of Radio Corporation of America, Harrison, N. J.



This detector is designed to locate quickly and simply tiny leaks in vacuum systems or enclosures which were formerly difficult to locate except with elaborate detection equipment. Model 722-SS weighs only 25 pounds and is simple enough to be operated by nontechnical personnel.

(Continued on page 72A)

PROFESSIONAL CARDS

JOHN F. BRINSTER

Applied Physics, Mathematics and Electronics
Design Industrial Applications Engineering
Research Development Consultation
Specialist in Radio Telemetering

THE APPLIED SCIENCE
CORPORATION OF PRINCETON
P.O. Box #44, Princeton, N.J.
Phone: Lawrenceville, N.J. 430
Office & Laboratory: U. S. Highway # 1,
RD. #4, Trenton, New Jersey

HERBERT A. ERF

Architectural Acoustics
Consultant

STUDIO DESIGN

Standard Broadcast—FM—Television
Cleveland 15, Ohio

3868 Carnegie Avenue EXpress 1616

W. J. BROWN

Electronic & Radio Engineering Consultant
Electronic Industrial Applications, Commercial and Broadcasting Transmitter and Receiver Design, Test Equipment, etc.
23 years experience in electronic development
P.O. Box 5106, Cleveland, Ohio
Telephone, Yellowstone 7771

DAVID C. KALBFELL, Ph.D.

Engineer — Physicist

Complete laboratory facilities

Industrial instrumentation and control
Broadcast engineering and measurements
1076 Morena Boulevard Jackson 1939
San Diego 10, California

EDWARD J. CONTENT

Acoustical Consultant

Functional Studio Design

FM - Television - AM
Audio Systems Engineering
Roxbury Road Stamford 3-7459
Stamford, Conn.

FAirmount 5105

EXpress 7766

FRANK MASSA

Electro-Acoustic Consultant

3393 Dellwood Road 3868 Carnegie Avenue
CLEVELAND, OHIO

STANLEY D. EILENBERGER

Consulting Engineer

INDUSTRIAL ELECTRONICS

Design—Development—Models
Complete Laboratory and Shop Facilities
6309-13—27th Ave.
Kenosha, Wis. Telephone 2-4213

ROBERT E. McCOY

Consulting Engineer

Antennas, Antenna-Coupling Systems,
Direction Finders and Beacons.
Electronic Circuits for Special Purposes:
Measurement, Computation and Control.
301-302 Concord Bldg., Portland 4, Oregon

EUGENE MITTELMANN, E.E., Ph.D.

Consulting Engineer & Physicist
HIGH FREQUENCY HEATING
INDUSTRIAL ELECTRONICS
APPLIED PHYSICS &
MATHEMATICS

549 W. Washington Blvd. Chicago 6, Ill.
Phone: State 8021

IRVING RUBIN

Physicist

Radio interference and noise meters, Interference suppression methods for ignition systems and electrical devices. Laboratory facilities.

P.O. Box 153, Shrewsbury, New Jersey
Telephone: REDBANK 6-4247

ARTHUR J. SANIAL

Consulting Engineer

Loudspeaker Design; Development; Mfg. Processes. High Quality Audio Systems. Announcing Systems. Test and Measuring Equipment Design.

168-14 32 Ave. Flushing, N.Y.
FLushing 9-3574

Paul D. Zottu
Consulting Engineer
Industrial Electronics

High Frequency Dielectric and Induction Heating Applications, Equipment Selection, Equipment and Component Design, Development, Models.

272 Centre St., Newton, Mass. BIG-9240

Announcing SCOTCH *Sound Recording* TAPE BRAND

OFFERING HOME AND PROFESSIONAL RECORDERS A NEW
STANDARD OF TONE FIDELITY AND EASE OF HANDLING



Developed in the research laboratories of the 3M Company . . . the world's largest manufacturers of pressure-sensitive adhesive tapes . . . "SCOTCH" Sound Recording TAPE is now available in quantity for immediate delivery. No other magnetic recording medium can offer all these advantages:

1. Better frequency response at slow recording speeds—due to "SCOTCH" Sound Recording Tape's extremely thin, uniform magnetic coating.
2. Low noise level because of uniform dispersion of particles and mirror-like surface.
3. Higher Coercive Force—350 oersteds—insures higher frequency response and greater signal strength.
4. Flat surface and large area provide positive contact with the pick-up and give greater dynamic range.
5. Uniform width control in manufacture insures even, constant tracking.
6. Adequate space on $\frac{1}{4}$ inch width for multiple sound tracks.
7. The non-magnetic tape backing between the layers of magnetic coatings in the roll prevents "cross-talk."
8. Easy to handle. No snarls, backlashes, or kinks.
9. Freedom from breakage. Resin treated backing provides a tensile strength of 8 to 10 pounds.
10. Can be marked on back to indicate start and stop of different sound sequences in the same roll.
11. Easily edited by snipping out unwanted portions and then taping together with "SCOTCH" transparent Tape.
12. Perfect reproduction for several thousand playbacks. Erases clean with low power—no special erase head required.

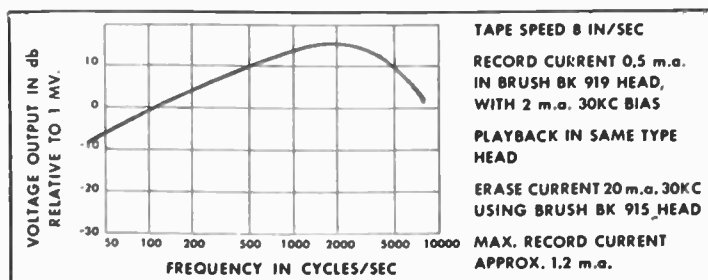

*Licensee of Armour
Research Foundation*

Made in U. S. A. by **MINNESOTA MINING & MFG. CO.** Saint Paul 6, Minn.
THE 3M COMPANY



PILOT LIGHT ASSEMBLIES

PLN SERIES—Designed for NE-51 Neon Lamp



Features

- THE MULTI-VUE CAP
- BUILT-IN RESISTOR
- 110 or 220 VOLTS
- EXTREME RUGGEDNESS
- VERY LOW CURRENT

Write for descriptive booklet

The DIAL LIGHT CO. of AMERICA

FOREMOST MANUFACTURER OF PILOT LIGHTS
900 BROADWAY, NEW YORK 3, N. Y.
Telephone—Algonquin 4-5180

TWIN Power Supply

**Electronically
Regulated for
Precise
Measurements**

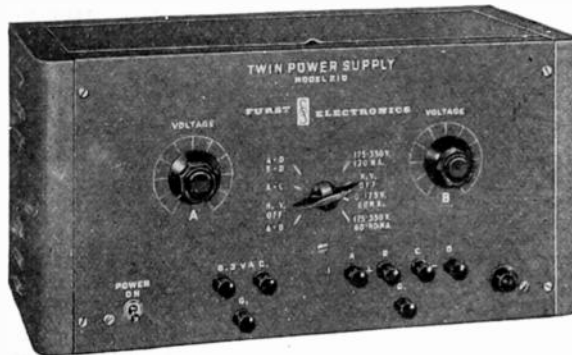

Two independent sources of continuously variable D.C. are combined in this one convenient unit. Its double utility makes it a most useful instrument for laboratory and test station work. Three power ranges are instantly selected with a rotary switch:

- 175-350 V. at 0-60 Ma., terminated and controlled independently, may be used to supply 2 separate requirements.
- 0-175 V. at 0-60 Ma. for single supply.
- 175-350 V. at 0-120 Ma. for single supply.

In addition, a convenient 6.3 V.A.C. filament source is provided. The normally floating system is properly terminated for external grounding when desired. Adequately protected against overloads.

Twin Power Supply Model 210
Complete \$115.00 F.O.B. Chicago
Dimensions: 16" X 8" X 8" Shipping Wt. 35 lbs.
(Other types for your special requirements)



FURST ELECTRONICS

North Avenue at Halsted St., Chicago 22, Illinois

- Output voltage variation less than 1% with change from 0 to full load.
- Output voltage variation less than 1 V. with change from 105 to 125 A.C. Line Voltage.
- Output ripple and noise less than .025 V.

News—New Products

These manufacturers have invited PROCEEDINGS readers to write for literature and further technical information. Please mention your I.R.E. affiliation.

(Continued from page 70A)

Variable-Frequency Oscillator

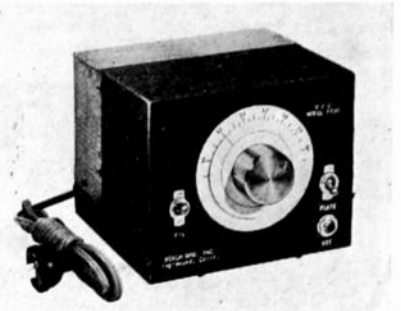

High stability, new logging accuracy and rugged mechanical qualities are claimed for the new variable-frequency oscillator, Model 1700, shown here, by Beach Manufacturing, Inc., Inglewood 3, Calif.

This model uses an improved type of electron-coupled circuit which maintains the cathode at ground potential and greatly eliminates frequency shift due to voltage variations. Temperature compensation is provided to reduce drift to a negligible form and maintain a high degree of stability.

A vernier dial movement for extremely accurate logging of spot frequencies is introduced with this v.f.o. The vernier ratio is approximately 7.5 to 1 and furnishes more than 30 inches of dial area. The frequency range of this model is from 3350 to 4000 kc and allows multiplication into any of the amateur bands below 30 Mc.

Simplicity and safety are stressed through the use of a transformer to isolate the power supply from the d.c. and r.f. circuits. Thus direct grounding is possible and fully recommended. High-voltage heater tubes are used for operating economy, but the plate supply is conventional.

Power supply requirements are standard, 115 volts, 50-60 cycles a.c., and output is approximately 1 watt over the entire range. The unit measures 6" X 5" X 5 1/2" exclusive of dial.

Improved HY75A V.H.F. Triode

The Hytron Radio & Electronics Corp., of Salem, Mass., has released a data sheet on its new improved very-high-frequency power-oscillator/amplifier HY75A which indicates notable gains over HY75, including 25% increase in power output.

The HY75A is a medium-power v.h.f. triode, designed specifically for efficient operation as an oscillator and amplifier at frequencies from 50 to 430 megacycles. It is ruggedly built to withstand operation in portable and portable-mobile equipment. Its thoriated-tungsten filament is instant-heating. Filament and plate potentials can be applied simultaneously.

(Continued on page 73A)

News—New Products

These manufacturers have invited PROCEEDINGS readers to write for literature and further technical information. Please mention your I.R.E. affiliation.

(Continued from page 72A)

Automatic Tuning Mechanism

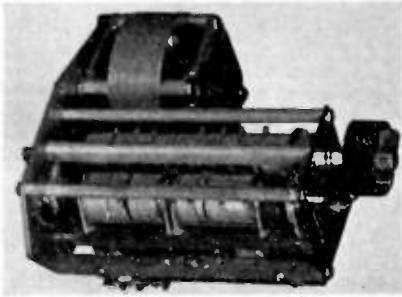

A precision automatic tuning device for industrial-control applications and for home radio receivers, the new 496-E Autotune Unit, has recently been announced by the Collins Radio Company Cedar Rapids, Iowa.

This new control unit provides 10 automatically reset positions and one manually adjustable position of a shaft. The control switch or push buttons can be located at a remote position. An accuracy of 1 part in 36,000 is provided. This accuracy is independent of line-voltage variations, normal wear, and atmospheric conditions. The operating time is less than 6 seconds. Output torque is 1 inch-pound maximum. The unit includes motor drive and control elements, and it can be built for operation for any a.c. or d.c. voltage.

(Continued on page 76A)

Specify

MYCALEX

LOW LOSS INSULATION

Where high mechanical and electrical specifications must be met.

MYCALEX 410

(MOLDED MYCALEX)

makes a positive seal with metals . . . resists arcing, moisture and high temperatures.

27 years of leadership in solving the most exacting high frequency insulating problems.

MYCALEX CORPORATION OF AMERICA

"Owners of 'MYCALEX' Patents"
Plant and General Offices: Clifton, N.J.
Executive Offices: 30 Rockefeller Plaza
New York 20, N.Y.



THE HANDY WAY TO MAKE CO-AX CABLE CONNECTIONS-RIGHT!

A light-weight water-tight assembly

Here's the quick, easy and FULLY DEPENDABLE way of terminating a coaxial line where it joins the center of a half-wave doublet antenna—the B & W CC-50 Connector. Made of cast aluminum and weighs only 12 ounces. Steatite insulation. Forged zinc dipped steel eye bolts provide handy soldering connections. Designed for all coaxial cables such as RG11/U, RG34/U or similar types with either single or twin leads. Makes an absolutely watertight seal. Ideal for use as center insulator for a half-wave doublet.

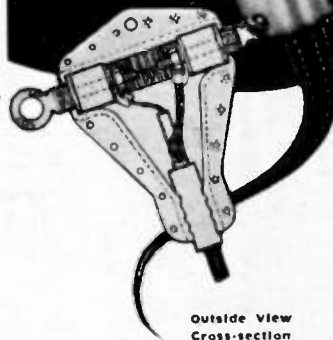

Outside View
Cross-section
View



AIR INDUCTOR HEADQUARTERS

B & W "Air-Wound" Inductors come in types, shapes and sizes for almost every coil application.

B&W

BARKER & WILLIAMSON
237 Fairfield Avenue, Upper Darby, Pa.

Export—Royal National Co.



...reliability
...quality
...satisfaction

...MERELY WORDS

Yes, they are merely words, as they stand, but when applied to GOULD-MOODY Black Seal recording blanks they take on new meanings. Highest fidelity reproduction, through wide frequency ranges, with freedom from warpage, a very minimum of surface noise mean SATISFACTION. An unconditional 10-year guarantee not to deteriorate or powder means RELIABILITY. The finest ingredients, processed with engineering precision to exacting specifications results in QUALITY.

Do as studios all over the country are doing: make your next order GOULD-MOODY. If for any reason you are not completely satisfied, return the blanks, used or unused, —there will be no charge. (That's CONFIDENCE.)



THE GOULD-MOODY CO.

Recording Blank Division

395 BROADWAY • NEW YORK 13, N. Y.

Building the Transmitter

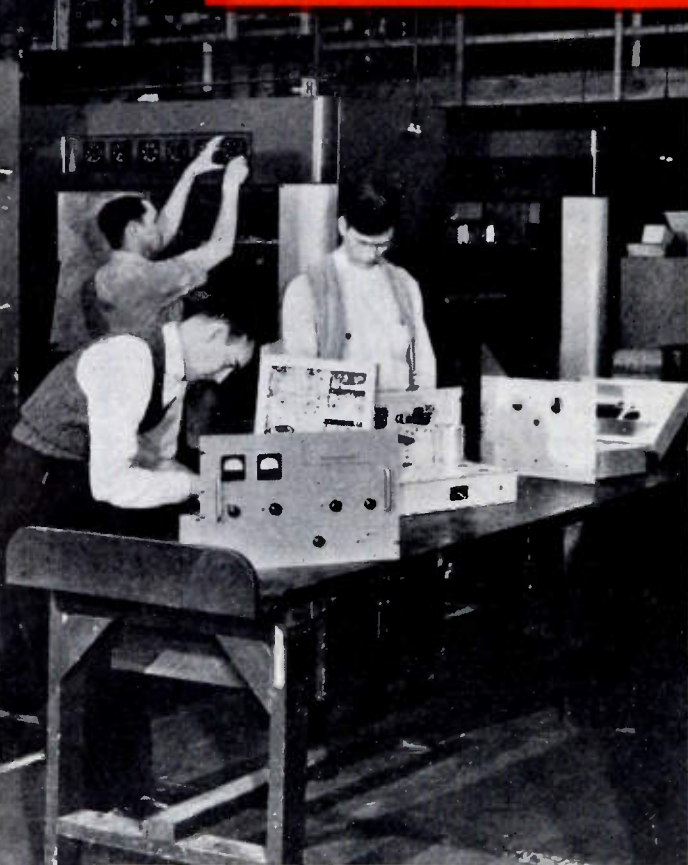

Here's where your ideal transmitter takes shape . . . in final assembly operation at the modern Westinghouse plant in Baltimore. Here, the improvements specified by you become reality as skilled workmen assemble finished parts into complete, dependable transmitters. All units are thoroughly tested before delivery.



SERVICE EVERYWHERE

Westinghouse has 17 parts warehouses, a staff of service engineers on 24-hour call and 35 maintenance and repair shops conveniently located . . . as close as your telephone. Factory trained communications sales engineers in your area are also ready to serve you.



More Information?

These new books will give you a complete picture of the operating advantages built into Westinghouse transmitters. Ask for B-3829 (1 and 3 kw, FM) or B-3850 (10 kw, FM).



Westinghouse
PLANTS IN 25 CITIES . . . OFFICES EVERYWHERE

Electronics at Work

1, 3 and 10 kw FM Transmitters

...of your ideas!

... a truly modern design based on the recommendations of your industry and the years of experience of our own engineers in operating five FM stations.

Now you can throw away the "can opener". You won't need one to get at the tubes—they're all within reach of your finger tips, from the front of the transmitter. This is what you asked for ... and get ... in all Westinghouse FM transmitters. And here are a few more of those "examples" which help to make your operating and maintenance job easier.

- New 270° meters at eye level.
(You can see the grid and plate currents in all stages simultaneously.)



CENTRALIZED CONTROLS... all major controls are located on the front panel to make simultaneous adjustments easy. All tubes are replaceable from the front of the cubicle.

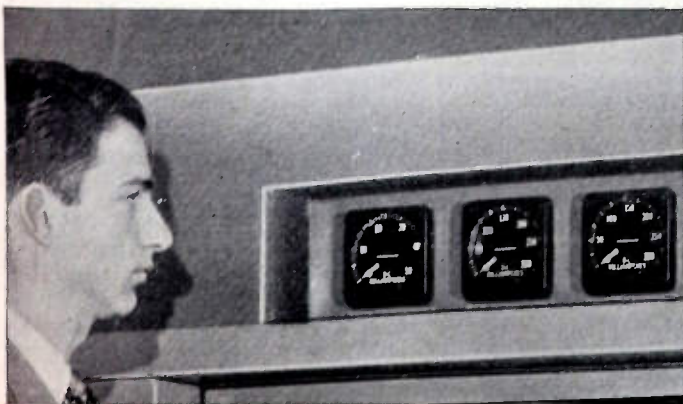

ONE-JOB, EYE-LEVEL METERS... new 270° circular scale meters are at eye level for easy reading. Each instrument operates in but one circuit, eliminating instrument switching.

- Visible, conventional-type tubes—nothing tricky.
- Fuseless overload protection and excellent shielding, lead covered wire.
(“De-ion” circuit breakers used throughout.)
- No 1/4-watt receiver resistors.
(Only heavy-duty resistors are used throughout.)
- Individual voltage regulators for bus voltage and high-voltage rectifier.

This “duo of experience” ... yours and ours ... assures these features, and more, in all Westinghouse FM transmitters—1, 3, 10, and 50 kw.

Your Westinghouse office will give you more details or you can write to us at P.O. Box 868, Pittsburgh 30, Pa.

J-02105-A

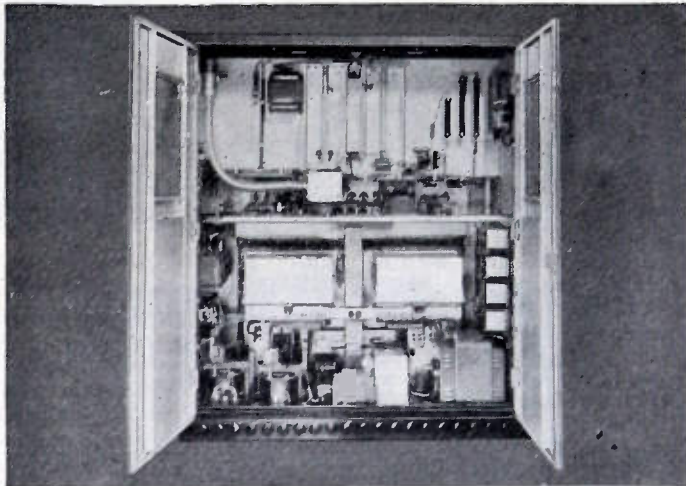

EASY TO MAINTAIN... full-opening doors, open vertical arrangement of components and power outlets, facilitate inspection and maintenance. All access doors are electrically and mechanically interlocked for safety of service personnel.

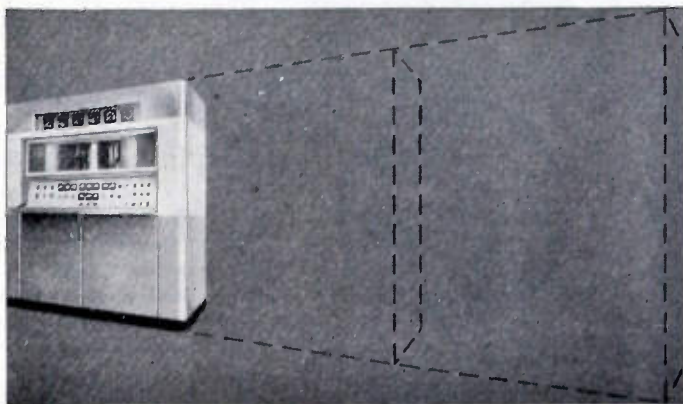

BUILDING BLOCK DESIGN... your Westinghouse 3 kw, FM transmitter, a complete unit in a single cubicle, can be stepped up to 10 or 50 kw simply by adding cubicles. Each added cubicle is a complete rectifier or amplifier within itself. Thus, a minimum of inter-cubicle wiring ... your assurance of a quick, easy change-over.

See our display at I.R.E. Conference, San Francisco, September 24 to 26.

Visit us at booth 147 NAB Convention, Atlantic City, September 15 to 19.

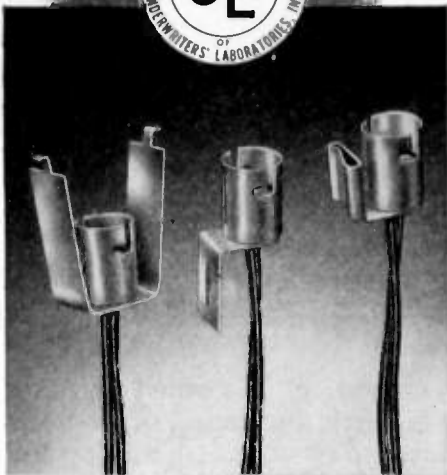

**NEW UNDERWRITER'S APPROVED
125 VOLT—CANDELABRA
BAYONET SOCKET ASSEMBLIES**

Now you can get fine Underwriter's Approved candelabra Dial Light Socket Assemblies by DRAKE! The No. 900 series is designed for radio use, and the No. A900 series for general use. Both are double contact, candelabra, bayonet Assemblies housing 115V household type lamps, available from 5 to 25 watts. They are U.L. approved for 75W-125V service. Can also be used with 6V automotive lamps.

The bayonet type eliminates vibration-loosened lamps and requires less space than screw type. Can be supplied with any type mounting bracket. Lead-in wires from 2½" to 60". Made to traditional DRAKE standards of precision and rugged dependability. Check with our engineers on your requirements, today!

ASK FOR OUR NEW CATALOG • NO OBLIGATION!



**Socket and Jewel
LIGHT ASSEMBLIES**

**DRAKE
MANUFACTURING CO.
1713 W. HUBBARD ST., CHICAGO 22**

News—New Products

These manufacturers have invited PROCEEDINGS readers to write for literature and further technical information. Please mention your I.R.E. affiliation.
(Continued from page 73A)

High-Speed Micro-oscilloscope

The Central Research Laboratories, Inc., of Red Wing, Minn., are now manufacturing a commercial version of the three-beam high-speed oscilloscope previously described in PROCEEDINGS of the I.R.E. (vol. 34, pp. 121W-127W; March, 1946).



Model 1, illustrated, extends the range of application of single-sweep oscillographic recording by a factor of approximately 10 in frequency over previous limits imposed by transit-time distortion and makes possible the single-sweep recording of three simultaneous phenomena at frequencies up to 10,000 megacycles.

Removal of an exposed plate, insertion of an unexposed plate, and establishing an operating vacuum requires about 5 minutes. Plate dimensions of 1¼" by 1½" allow 9 sets of 3, or 27, oscillograms to be recorded on a single plate with no overlapping. Enlargements up to 100 diameters may be profitably used. Chassis is 26" wide, 35" deep, and 76" high. Total-weight, 700 pounds. Ionization gauge and thermocouple gauge are provided for pressure measurement. Power consumption is 1 k.v.a. at 115 volts, 60 cycles.

Interesting Abstracts

••• An announcement in the current issue of *The Experimenter*, published by General Radio Co., 275 Massachusetts Ave., Cambridge 39, Mass., offers to place the names of engineers, scientists, technicians, and others interested in communication frequency-measurement and control problems on a mailing list to receive gratis copies of this monthly bulletin. ••• The "Speed X" line has been purchased by the E. F. Johnson Company, of Waseca, Minn., from the Les Logan Co., San Francisco. The line includes transmitting and high-speed keys which will be manufactured at Waseca.

(Continued on page 77A)

Surplus Equipment

Signal Generator, 300 to 1000 megacycles, Measurements model 84, 1 to 100,000 microvolts metered output, pulse and cw modulation, meter for percent modulation, 115 volts 60 cps, in good working order.

Signal Generator, 7.5 to 330 megacycles, General Radio model 804 B, 1 to 20,000 microvolts metered output, metered modulation, in good working order \$275.00

Signal Generator, 15 to 25 and 150 to 230 megacycles, Measurements model 78B, 1 to 100,000 microvolts metered output, 400 and 8200 cps modulation, new \$90.00

Microwave Generator TS 155 B/UP, 2700 to 2900 megacycles, pulse modulated 120 to 2000 pps, variable pulse width and delay, thermistor bridge, r.f. power meter for internal and external metering, and direct reading calibrated attenuator. 9 tubes, complete with antenna, adapters, cables, and spare tubes, new \$300.00

Microwave communication transceiver, line of sight transmission at 2200 to 2400 megacycles, Navy type MAF, 115 volts 60 cps, complete with antenna, reflector, power supply, microphones and phones, entire equipment housed in a searchlight shell, new \$200.00

Synchroscope, Browning model P-4, in good working order \$200.00

General Radio Precision Wavemeter, type 724-A, 16 kc to 50 megacycles, 0.25% accuracy, V.T.V.M. resonance indicator, complete with accessories and carrying case, new \$200.00

Panoramic Adapter, BC-1032, input frequency 5.25 mc, sweepwidth 1000 kc, 115 volts 60 cps, new \$85.00

RCA Beat Frequency Audio Signal Generator, 30 to 15000 cps, portable, output impedance 250, 500, and 5000 ohms, 115 volts 60 cps operation, new \$60.00

RCA Voltohmst model 165, V.T.V.M. and electronic Ohmmeter, input resistance 11 megohms on ranges 0.3, 10, 30, 100, 300, and 1000 volts d.c. AC voltmeter, 5 ranges 0-10, 30, 100, 300, 1000 volts at 1000 ohms per volt. Ohmmeter covers 0.1 ohm to 1000 megohms in 6 ranges. 115 volts 60 cps operation, new \$50.00

BC 947 Radar Transmitter with 10 cm Magnetron, used \$40.00

Transformers, 115 volts to 60 cps primaries:

- 1. 7500 volts 35 ma ungrounded, Thordarsen \$15.00
- 2. 6250 volts 80 ma ungrounded, G.E. 12.00
- 3. 5500 volts 2 ma. 6.3 volts 0.6 amps, 2.5 volts 2 amps potted 10.00
- 4. 500 volts 5 amps, 500 volts 5 amps, weight 210 pounds 50.00

Late Arrivals:

- TS 14 AP, Microwave Generator for Sa band, power output meter, calibrated attenuator, variable pulse width and delay.
- TS 13 AP, Microwave Generator for Xa band, power output meter, calibrated attenuator etc.
- TS 125/AP, Thermistor Bridge Wattmeter, 0-2 milliwatts.

**ELECTRO IMPULSE
LABORATORIES**

P.O. Box 250 Red Bank, N.J.
Red Bank 6-4247

News—New Products

These manufacturers have invited PROCEEDINGS readers to write for literature and further technical information. Please mention your I.R.E. affiliation.

(Continued from page 76A)

Interesting Abstracts

• • • The integration of Kimble Glass as a division of the Owens-Illinois Glass Co., Toledo 1, Ohio, has occasioned the appointment of R. W. Rogers as Sales Manager of the Industrial and Electronics Division of Kimble Glass.

• • • Announcement has recently been made of the incorporation of The St. Louis Microphone Co., with headquarters at 2726 Brentwood Blvd., St. Louis 17 Mo., where a complete line of the new St. Louis dynamic microphones are being manufactured.

• • • An interesting publication has recently been inaugurated with the release of Number 1, Volume 1 of "Microtecnic," printed in English and French, and introduced as an international review for measuring and gauging technique, optics, and precision mechanics. Illustrations are particularly clean-cut. Address subscription inquiries to the Editor, 24 Avenue de la Gare, Luzanne, Switzerland.

New Oscilloscope Permits "Plug-in" Interchange of Cathode-Ray Tubes

This portable and versatile cathode-ray oscilloscope, known as Type WO-60C, manufactured by Radio Corporation of America, Camden, N. J., features quick interchange of three different types of cathode-ray tubes through the front panel.

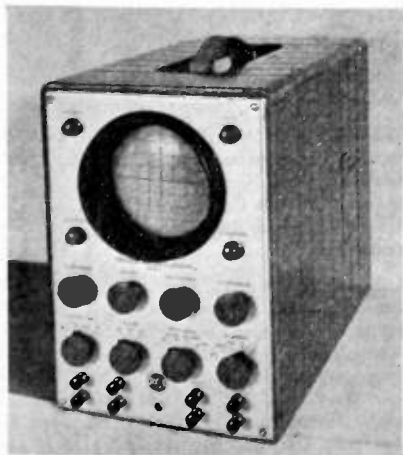

A plug-in connection permits interchange of tubes with specialized phosphor-persistence characteristics in as little as 10 seconds, according to the manufacturer, by merely lifting the light shield on the front panel. The unit is a general-purpose scope, constructed of heavy-duty components to withstand shock and vibration in industrial applications. It will handle input voltages as high as 850 volts peak to peak, and its low-frequency response permits the observation of wave forms from 0.5 to 300,000 cycles.

RH-7B

RH-7B can be supplied with 3-15 mc fundamental output frequencies, or 15.75 mc harmonic mode output frequencies.

By doubling or tripling in the plate circuit of the crystal stage, sufficient output can be obtained to excite the following stage in a transmitter to frequencies as high as 200 mc.

This versatile crystal unit can also be used as a local oscillator in a receiver at frequencies up to 200 mc.

Capacity between pins in the harmonic mode unit is less than 4 mmfd. As low as $\pm 0.05\%$ maximum frequency drift over a temperature range of -55°C to $+90^{\circ}\text{C}$.

Write for Bulletin RHC-3

REEVES-HOFFMAN CORPORATION

SALES OFFICE: 215 EAST 91 STREET, NEW YORK 28, N. Y.
PLANT: 321 CHERRY STREET, CARLISLE, PA.

Laboratory Standards

FM MODEL 78 SIGNAL GENERATOR

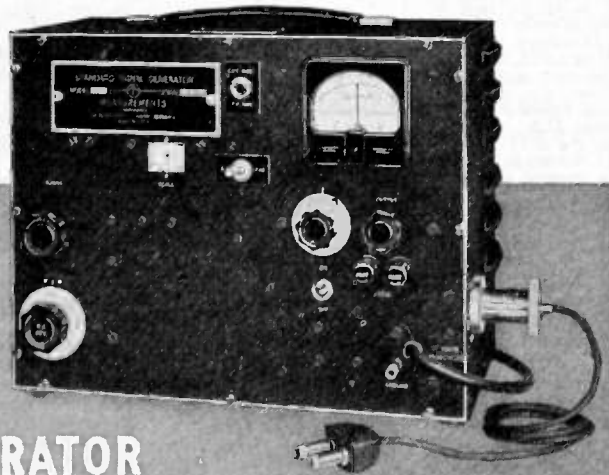

SPECIFICATIONS:

- CARRIER FREQUENCY RANGE:** 86 to 108 megacycles. Individually calibrated dial.
- OUTPUT SYSTEM:** 1 to 100,000 microvolts with negligible carrier leakage.
- OUTPUT IMPEDANCE:** Constant at 17 ohms.
- MODULATION:** 400 cycle internal audio oscillator. Deviation directly calibrated in two ranges: 0 to 30 kc. and 0 to 300 kc. Can be modulated from external audio source. Audio fidelity is flat within two db from d.c. to 15,000 cycles. Distortion is less than 1% at 75 kc. deviation.

PROMPT DELIVERY

MANUFACTURERS OF
Standard Signal Generators
Pulse Generators
FM Signal Generators
Square Wave Generators
Vacuum Tube Voltmeters
UHF Radio Noise & Field Strength Meters
Capacity Bridges
Megohm Meters
Phase Sequence Indicators
Television and FM Test Equipment

MEASUREMENTS CORPORATION

BOONTON  NEW JERSEY

Announcing

The 1st volume in the long-awaited
Massachusetts Institute of Technology
RADIATION LABORATORY SERIES

Bringing you

the engineering data you need to design RADAR SYSTEMS

Here is an important book which presents the general principles of the design of various radar systems. From the standpoint of the designer the book discusses the basic considerations which underlie and are particular to systems design. After a general approach to problems encountered, it takes up the leading design considerations for the important components that make up a radar set. Two new and important auxiliary techniques—moving target indication and the transmission of radar displays to a remote indicator by radio means—are fully treated. Detailed examples of actual systems are included. Anyone interested in the varied applications of radar will find this new volume of immense value as a basic, useful reference.

Just Published

RADAR SYSTEMS ENGINEERING

Edited by Louis N. Ridenour, Editor-in-Chief, Radiation Laboratory Series; Associate Professor of Physics, University of Pennsylvania. 748 pages, 6 x 9, illustrated, \$7.50.

This is the first of twenty-eight volumes prepared principally by members of the Radiation Laboratory maintained during the war at the Massachusetts Institute of Technology under contract with the National Defense Research Committee of the Office of Scientific Research and Development. The Laboratory was the foremost U.S. research and development institution in the field of microwave radar. The accuracy of the material made available in these volumes is attested by their authoritative background.

Contents

- | | |
|---|--|
| 1. Introduction | 9. Antennas, Scanners, and Stabilization |
| 2. The Radar Equation | 10. The Magnetron and the Pulsar |
| 3. Properties of Radar Targets | 11. R-F Components |
| 4. Limitations of Pulse Radar | 12. The Receiving System—Radar Receivers |
| 5. C-W Radar Systems | 13. The Receiving System—Indicators |
| 6. The Gathering and Presentation of Radar Data | 14. Prime Power Supplies for Radar |
| 7. The Employment of Radar Data | 15. Examples of Radar System Design |
| 8. Radar Beacons | 16. Moving-target Indication |
| | 17. Radar Relay |

See it
10 days
FREE



McGraw-Hill Book Co., 330 W. 42nd St., N.Y. 18
Send me M.I.T. Radiation Lab., No. 1: Ridenour—Radar System Engineering for 10 days' examination on approval. In 10 days I will send \$7.50 plus few cents postage or return book postpaid. (Postage paid on cash orders.)

Name
Address
City and State
Company
Position IRE-9-47

For Canadian price, write: McGraw-Hill Co. of Canada Ltd., 12 Richmond St. E., Toronto 1

INDEX AND DISPLAY ADVERTISERS

Section Meetings	35A
Membership	36A
Positions Open	50A
Positions Wanted	56A
News—New Products	26A

Tobe Deutschmann Corp.	45A
Dial Light Co. of America	72A
Drake Manufacturing Co.	76A
Allen B. DuMont Labs., Inc.	14A

Stanley D. Eilenberger	70A
Eitel-McCullough, Inc.	16A
Electro Impulse Laboratories	76A
Electro Motive Mfg. Co., Inc.	23A
Herbert A. Erf	70A
Erie Resistor Corp.	25A

DISPLAY ADVERTISERS

Aerovox Corporation	31A
Aircraft Radio Corp.	39A
Airtron, Inc.	69A
Alliance Mfg. Co.	29A
American Lava Corp.	17A
American Phenolic Corp.	44A
Amperex Electronic Corp.	Cover II
Andrew Company	40A
Arnold Engineering Co.	18A
Astatic Corporation	35A

Barker & Williamson	73A
Bell Telephone Labs.	2A & 3A, 34A
Belmont Radio Corp.	52A
Bendix Aviation Corp.	54A
Blaw-Knox Company	43A
John F. Brinster	70A
W. J. Brown	70A
Browning Labs., Inc.	78A
Brush Development Co.	36A
H. H. Buggie & Co.	62A

Cambridge Thermionic Corp.	68A
Carter Motor Company	70A
Centrelab	8A
Cleveland Container Co.	28A
Sigmund Cohn & Company	60A
Collins Radio Company	57A
Edward J. Content	70A
Cornell-Dubilier Electric Corp.	Cover III

Fairchild Camera & Instrument Corp.	47A
Farnsworth Television & Radio Corp.	50A
Finch Telecommunications, Inc.	52A
Furst Electronics	72A

General Electric Company	1A
General Radio Company	Cover IV
Gould-Moody Company	73A

Hallicrafters Company	51A
Hammarlund Mfg. Co., Inc.	55A
Hewlett-Packard Company	10A & 11A
Hytron Radio & Electronics Corp.	15A

Insulation Manufacturers Corp.	79A
International Nickel Co., Inc.	33A
International Resistance Co.	5A

David C. Kalbfell	70A
Karp Metal Products Co., Inc.	19A
Kemet Laboratories Co., Inc.	46A
Kenyon Transformer Co., Inc.	64A

Langevin Manufacturing Corp.	60A
Lavoie Laboratories	27A

Maguire Industries, Inc.	21A
P. R. Mallory & Co., Inc.	6A
Frank Massa	70A
Robert E. McCoy	70A
McGraw-Hill Book Co.	62A, 78A
Measurements Corp.	77A
Minnesota Mining & Mfg. Co.	71A
Eugene Mittelmann	70A
Mycalex Corp. of America	73A

National Company, Inc.	20A
National Radio Service Co.	48A
Newark Electric Co., Inc.	64A
J. M. Ney Company	61A

Ohmite Mfg. Co.	41A
-----------------	-----

Panoramic Radio Corp.	56A
Paul & Beckman, Inc.	66A

Radio Corp. of America	32A, 63A, 80A
Radio-Music Corporation	42A
Raytheon Mfg. Co.	24A
Reeves-Hoffman Corp.	77A
Revere Copper & Brass, Inc.	4A
Irving Rubin	70A

Arthur J. Sanial	70A
Selenium Corp. of America	9A
Sherron Electronics Co.	65A
Shure Brothers, Inc.	59A
Simpson Electric Co.	67A
Sorenson & Co., Inc.	38A
Sperry Gyroscope Co., Inc.	37A, 52A
Stackpole Carbon Co.	12A
Superior Electric Co.	49A
Sylvania Electric Prods., Inc.	7A, 52A

Tab	68A
Technology Instrument Corp.	61A
Triplett Electrical Instrument Co.	30A
Turner Company	69A

Union Carbide & Carbon Corp.	46A
United Transformer Corp.	13A

War Assets Administration	22A
Western Electric Company	2A & 3A, 34A
Westinghouse Electric Corp.	74A & 75A
Weston Electrical Instrument Corp.	53A
S. S. White Dental Mfg. Co.	58A

Paul D. Zottu	70A
---------------	-----

S-4
FREQUENCY METER

Designed especially for mobile transmitters. Reading accuracy to one part in one thousand. Tests frequencies from 1.5 to 100 mc. Telescoping antenna farms convenient handle.

RJ-12 FM - AM TUNER

Hi-sensitivity tuner for FM-AM reception. Separate RF and IF systems on both bands. Armstrong FM circuit. One antenna serves both FM and AM. Tuning eye shows correct tuning.

OTHER BROWNING INSTRUMENTS

MJ-9 Frequency Meter and ECO for Hams. RH-10 Frequency Calibrator for full, accurate use of WWV signals. Model OL-15 Oscilloscope for laboratory work, production testing or research.

WRITE FOR DESCRIPTIVE LITERATURE

BROWNING LABORATORIES, INC.
WINCHESTER, MASS.

The IMC ENGINEER



on your Staff—
but not on your

payroll

INSULATION PRODUCTS with these well-known names

- ✓ Dieflex
- ✓ Fiberglas
- ✓ Inmanco
- ✓ Macallen
- ✓ Manning
- ✓ National Fibre
- ✓ Pedigree
- ✓ Permacel
- ✓ Silicones
- ✓ Vartex

HAS THE RIGHT INSULATION TO SOLVE YOUR PROBLEM

The imposing list of electrical insulation products which the IMC Engineer represents can be a valuable help to you in solving your electrical assembly problems. Ask him to help you. His knowledge and experience qualify him to be the electrical insulation consultant on your staff. Because of his wide experience, he can help you save money. Just ask him to:

1. Assist in selection of the best insulating materials for the specific job.
2. Familiarize you with the proper application of these materials.
3. Suggest ways to use these materials to eliminate waste.
4. Help you increase the production of your electrical products.

IMC PRODUCTS: Macallen Mico Products—Vartex Varnished Cloth and Tapes—Varslot Combination Slot Insulation—Varnished Silk and Paper—Fiberglas Electrical Insulation—Manning Insulating Papers and Pressboards—Dow Corning Silicones—Dieflex Varnished Tubings and Saturated Sleeveings of Cotton and Fiberglas—Notional Hard Fibre and Fishpaper—Phenolite Bakelite—Permacel Adhesive Tapes—Asbestos Woven Tapes and Sleeveings—Cotton Tapes, Webbing and Sleeveings—Pedigree Insulating Varnishes—Wedgie Brand Wood Wedges.

INSULATION

MANUFACTURERS CORPORATION

*CHICAGO 6
565 W. Washington
Boulevard

MILWAUKEE 2
312 East Wisconsin
Avenue



*Local Stocks Available

*CLEVELAND 14
1231 Superior
Ave., N. E.

DAYTON 2
1315 Mutual Home
Building

Representatives in: DETROIT 2: 11341 Woodward Avenue
MINNEAPOLIS 3: 1208 Harmon Place PEORIA 5: 101 Heinz Court



The RCA Metal Detector "blows the whistle" on any particle of metal that may have crept into the package.

**RCA Electronic Metal Detector—
arrests "stowaways" in packaged products!**

It stands guard over everything from breakfast cereals to after-dinner mints, from cigarettes to cough drops . . . eliminating the chance that a bit of foreign metal might slip by. It helps American industry—that employs every precaution to assure product purity—to protect automatically the foods you buy.

High-frequency radio waves form an invisible wall—sound the alarm, if any metal is accidentally present. Even metallic flakes with a diameter of 70-thousandths of an inch cause rejection by this amazing RCA achievement.

The RCA Metal Detector was developed by RCA product engineers in co-

operation with RCA Laboratories—world center of radio and electronic research. The same pioneering and research that produced this Metal Detector keep *all* RCA products at the top in their fields.

So when you buy anything made by RCA—an RCA Victor radio, television receiver, Victrola radio-phonograph, phonograph record or radio tube, you get one of the finest instruments of its kind science has achieved.

When you're in New York, don't miss seeing the radio and electronic wonders at RCA Exhibition Hall, 36 West 49th Street, across from Radio City. Free admission. Radio Corporation of America, RCA Building, Radio City, New York 20.

"Victrola" T. M. Reg. U. S. Pat. Off.



The RCA Metal Detector operates through a rejection device, or by stopping the conveyor belt or by giving an alarm. The RCA Metal Detector also saves machinery from damage by "tramp" metal. For details, write to RCA, RCA Bldg., Radio City, New York 20.



RADIO CORPORATION of AMERICA

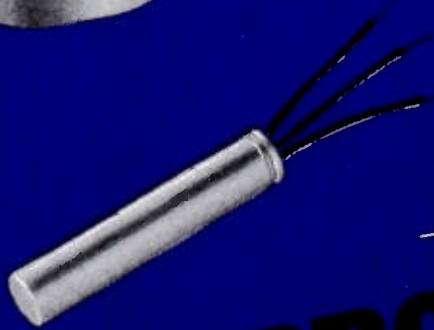
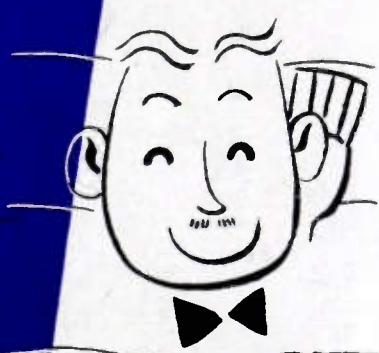
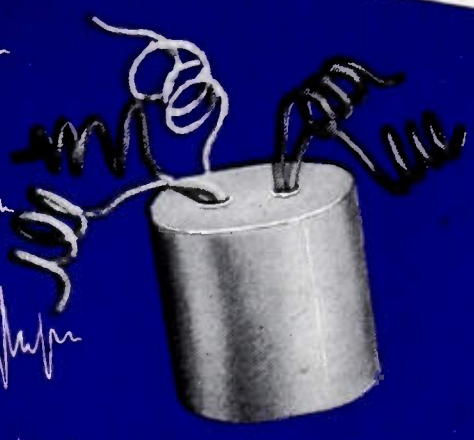
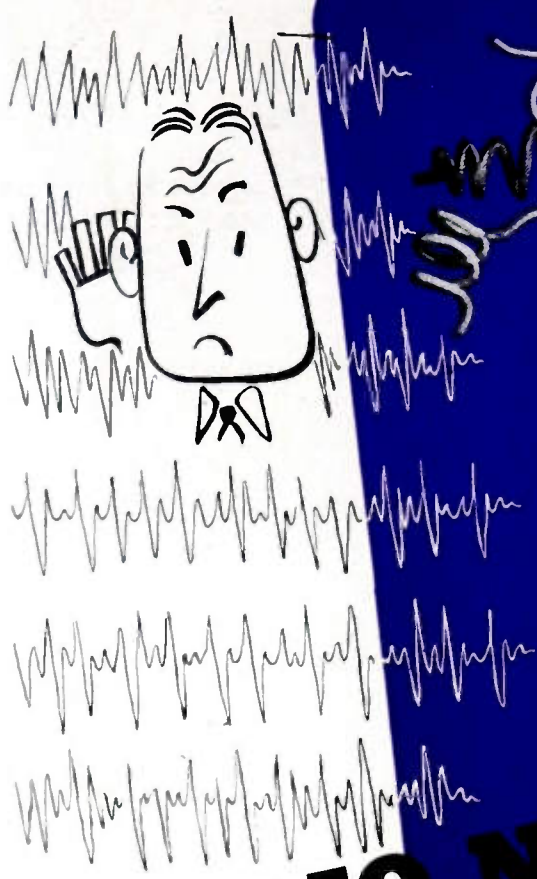

RADIO NOISE-PROOFED WITH C-D QUIETONES

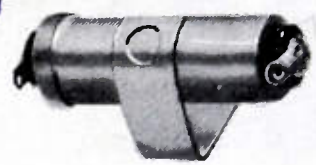
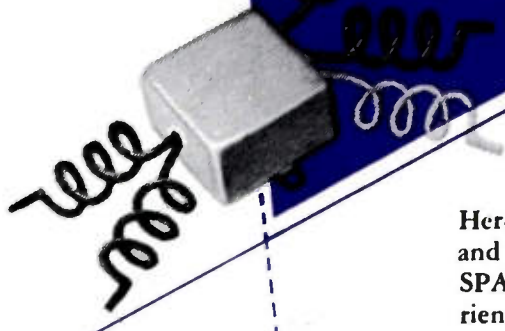

More and more, electrical appliance customers are asking – "Will it cause radio interference?" And in the answer to that question lies the secret for many more sales of your products.

Here at Cornell-Dubilier you'll find *your* answer – in a modern and complete laboratory, devoted to RADIO NOISE AND SPARK SUPPRESSION DEVICES – the industry's most experienced engineers – the thirty-seven-year C-D background, unequalled in the capacitor field. They're all at your disposal – NOW. Whether you want to Radio Noise-Proof equipment already in production – or if you're engineering a new product from the ground up – C-D Quietones will do the job efficiently and permanently. **YOUR INQUIRIES ARE INVITED.** Cornell-Dubilier Electric Corporation, Dept. M9, South Plainfield, New Jersey. Other large plants in New Bedford, Worcester and Brookline, Mass., and Providence, R. I.

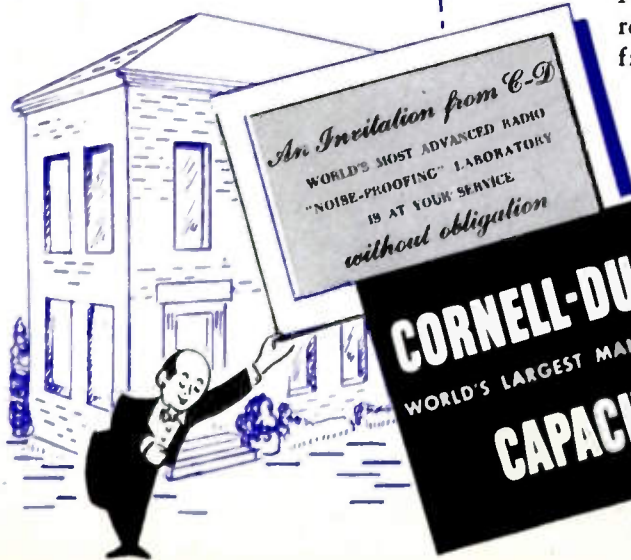

CORNELL-DUBILIER
WORLD'S LARGEST MANUFACTURER OF
CAPACITORS

Make Your Products More Saleable with C-D Quietone Radio Noise Filters and Spark Suppressors

MICA • DYKANOL • PAPER • ELECTROLYTIC



TO MEASURE

- RESISTANCE
- INDUCTANCE
- CAPACITANCE
- STORAGE FACTOR
- DISSIPATION FACTOR

IN

ANY LABORATORY



IN ANY laboratory where electrical equipment is used this self-contained, portable, direct-reading bridge is indispensable. It is always set up and ready for immediate use. Its accuracy is sufficient for the majority of routine measurements over these very wide ranges:

RESISTANCE: 1 milliohm to 1 megohm

INDUCTANCE: 1 microhenry to 100 henrys

CAPACITANCE: 1 micromicrofarad to 100 microfarads

STORAGE FACTOR (X/R): .02 to 1000

DISSIPATION FACTOR (R/X): .002 to 1

The bridge includes built-in standards, batteries, a 1000-cycle tone source for a-c measurements, a zero-center galvanometer d-c null detector and terminals for a headset for 1000-cycle null detection. Provision is made for use of an external generator for measurements over a wide range from a few cycles to 10 kilocycles. Direct-reading dials add greatly to the ease and rapidity with which measurements can be made.

**TYPE 650-A IMPEDANCE
BRIDGE.....\$240.00**

Write for complete information



This useful accessory converts the Type 650-A bridge to a-c operation. It includes a vacuum-tube oscillator, amplifier, and rectifier for providing dc for the bridge. All are mounted in a metal cabinet with top control panel which replaces the wooden cover used on the battery compartment. The sensitivity of the bridge is increased greatly with this oscillator-amplifier for both a-c and d-c measurements. TYPE 650-P1 OSCILLATOR-AMPLIFIER — \$150.00.



GENERAL RADIO COMPANY Cambridge 39,
Massachusetts

90 West St., New York 6

920 S. Michigan Ave., Chicago 5

950 N. Highland Ave., Los Angeles 38